

# **BRIGADE AND BATTALION INTELLIGENCE AND ELECTRONIC WARFARE OPERATIONS**

## **Table of Contents**

	PAGE
PREFACE .....	III
<b>CHAPTER 1. The Mission .....</b>	<b>1-0</b>
Intelligence .....	1-0
Electronic Warfare .....	1-7
<b>2. Intelligence and Electronic Warfare Resources .....</b>	<b>2-0</b>
Battalion IEW Resources .....	2-0
Brigade IEW Resources .....	2-15
<b>3. Command and Control .....</b>	<b>3-1</b>
Command and Control Process .....	3-2
Command and Control Organization and Facilities .....	3-8
Command, Control, and Communications .....	3-17
<b>4. Preparation For Combat .....</b>	<b>4-1</b>
Decision-Making Process .....	4-1
Collection Management .....	4-4
IEW Tasks .....	4-9
Reconnaissance and Surveillance .....	4-41
<b>5. Combat Operations .....</b>	<b>5-0</b>
Prehostility Phase .....	5-0

\*This publication supersedes TC 30-28, 30 June 1977.

Combat Phase .....	5-19
Special Operations and Environments .....	5-60
<b>6. Combat Service Support .....</b>	<b>6-1</b>
Responsibilities .....	6-2
Coordination .....	6-3
Services .....	6-3
Other Combat Service Support .....	6-10
<b>7. Training .....</b>	<b>7-0</b>
Combat Training .....	7-0
Integrated Training .....	7-1
<b>APPENDIX A. Request and Report Formats .....</b>	<b>A-0</b>
B. Briefing Techniques .....	B-0
C. The Surveillance Card .....	C-1
D. Army of Excellence .....	D-1
E. Reconnaissance and Surveillance Planning .....	E-1
<b>GLOSSARY .....</b>	<b>Glossary-0</b>
<b>REFERENCES .....</b>	<b>References-0</b>
<b>INDEX .....</b>	<b>Index-0</b>

## PREFACE

Intelligence and electronic warfare (IEW) support is critical to the success of the divisional brigades and battalions conduct of close operations. Commanders at these tactical echelons require accurate intelligence to plan the battle and timely combat information to win it. Counterintelligence (CI) support to battlefield deception and operations security (OPSEC) ensures the critical element of surprise and helps sustain the effective combat power of tactical forces. Electronic warfare (EW) provides combat information and targeting data for both maneuver and fire support units, protects friendly command, control, and communications (C<sup>3</sup>) systems, and augments maneuver and fires to suppress, neutralize, and destroy enemy C facilities.

FM 34-80 is intended primarily for use by the intelligence staff officer (S2) and his section at the maneuver battalion and brigade levels. It describes the IEW tasks for which the S2 has responsibility and how the S2 operations are integrated into the command and staff process at the battalion and brigade levels. This manual may also be used by commanders, other staff officers, and military intelligence personnel within the division to gain a better understanding of the IEW system and IEW tasks applicable to brigade and battalion operations. For a more thorough understanding of tactical IEW doctrine, the reader should review FMs 34-1 and 34-10. FMs 71-3 and 71-2J should be reviewed for general doctrinal guidance for maneuver operations at the brigade and task force levels.

Information contained within FM 34-80 is applicable to division- and corps-based units organized according to (Army 86) tables of organization and equipment (TOE). Appendix D, Army of Excellence (AOE) points out those organizational and operational areas that have been changed in one way or another by the current restructuring of IEW resources under the AOE force design. FM 34-80 describes how various elements of the IEW system extending from battalion to corps are best used in support of brigade and battalion combat operations. Essential IEW functions, performed in peacetime, are also described in sufficient detail to ensure the combat readiness of IEW resources and the maneuver units they support.

Users of this publication are encouraged to recommend changes or submit comments for its improvement. Comments should be keyed to the specific page, paragraph, and line of text in which the change is recommended. Reasons should be provided for each comment to assure understanding and complete evaluation. Comments should be prepared using DA Form 2028 (Recommended Changes to Publications and Blank Forms) and forwarded to Commander, US Army Intelligence Center and School, ATTN: ATSI-TD-PAL, Fort Huachuca, Arizona 85613-7000.

Provisions of this manual are subject to international standardization agreements (STANAGs) 1059,2003,2008,2014, 2033,2044,2082,2084, 2097,2113,2844,2868, 2936,3277, and 6004. Provisions of this manual are in compliance with quadripartite agreements 101-3, 170, 295, 311, 321, 492, 502, 506, 511, 523, 528, and 593. When amendment, revision, or cancellation of this publication is proposed that will affect or violate the agreement concerned, the preparing activity will take proper action through international standardization channels.

When used in this publication, “he”, “him”, “his”, and “men” represent both masculine and feminine genders unless otherwise stated.

## CHAPTER 1

### THE MISSION

Brigade and battalion commanders plan and direct the close operations on the air-land battlefield against enemy battalions and companies of first-echelon regiments. They must also be prepared to engage follow-on forces and first-echelon sustainers located within or entering their assigned areas of operations (AO).

Successful close operations depend on the ability of the combined arms team to find, fix, fight, and finish enemy forces through a combination of offensive and defensive operations. IEW resources, to include the S2, the S3, and all reconnaissance, surveillance, and target acquisition (RSTA) assets are members of the combined arms team. Their mission is to provide brigade and battalion commanders the accurate, timely, and effective intelligence, counterintelligence, and electronic warfare support necessary to plan, direct, and conduct successful combat operations.

#### INTELLIGENCE

Intelligence impacts directly on the effects of maneuver, firepower, protection, and leadership—the components of combat power. Accurate intelligence is critical to the brigade and battalion commander's decisions regarding when, where, and how to employ maneuver and firepower. It provides the information necessary to select appropriate protective measures essential to the security of the command. It also provides the knowledge which enables leaders to lead and win. Historically, commanders who have possessed superior knowledge of the enemy, weather, and terrain—intelligence—have proven victorious in bat-

tle. Their success, the result of avoiding enemy strengths while exploiting weaknesses and the element of surprise, depended on their knowledge of the area in which they fought.

Today, brigade and battalion commanders consider the battlefield in terms of the time and space necessary to defeat or bypass an enemy force before it can reactor be reinforced. They are concerned about an area of operations in which they need to see and fight by means of maneuver and fire support; and an area of interest about which they seek and receive information regarding the enemy, weather, and terrain.

#### AREA OF OPERATIONS

An area of operations is defined as that portion of an area of conflict necessary for military operations (JCS Pub 1). Areas of operations are geographical areas assigned to commanders for which they have responsibility and in which they have authority to conduct military operations. The assigned area of operations is based on the factors of METT-T and must be of sufficient size to allow completion of the assigned mission. Commanders at each level are normally assigned areas of operations which extend beyond the FLOT or attack objectives a distance commensurate with the planning horizons shown on page 1-1. They rely on the next higher echelon and adjacent units for information pertaining to enemy forces located beyond the limits of their respective AO and within their areas of interest.

#### AREA OF INTEREST

An area of interest is not assigned by a higher headquarters and is not delineated

by any boundaries. It is determined by brigade and battalion commanders and usually includes their assigned area of operations and adjacent areas in which enemy forces are or maybe located. The area of interest extends into enemy-held territory to the objectives of current and planned operations. Such areas frequently contain named areas of interest (NAI), routes or avenues of approach, and specific enemy units which may jeopardize the accomplishment of the unit's mission. A phase line is normally used to distinguish the forward limits of the assigned AO. Phase lines support "hand-

off" operations as enemy forces enter or exit the division, brigade, and battalions' assigned AO and specified areas of interest, respectively, as shown below.

Rear, close, and deep operational responsibilities for the division are summarized below. Brigade and battalion responsibilities for rear and close operations are also shown. Divisional brigades and smaller tactical units do not normally conduct separate deep operations but their planning and operations must anticipate actions of enemy uncommitted units.

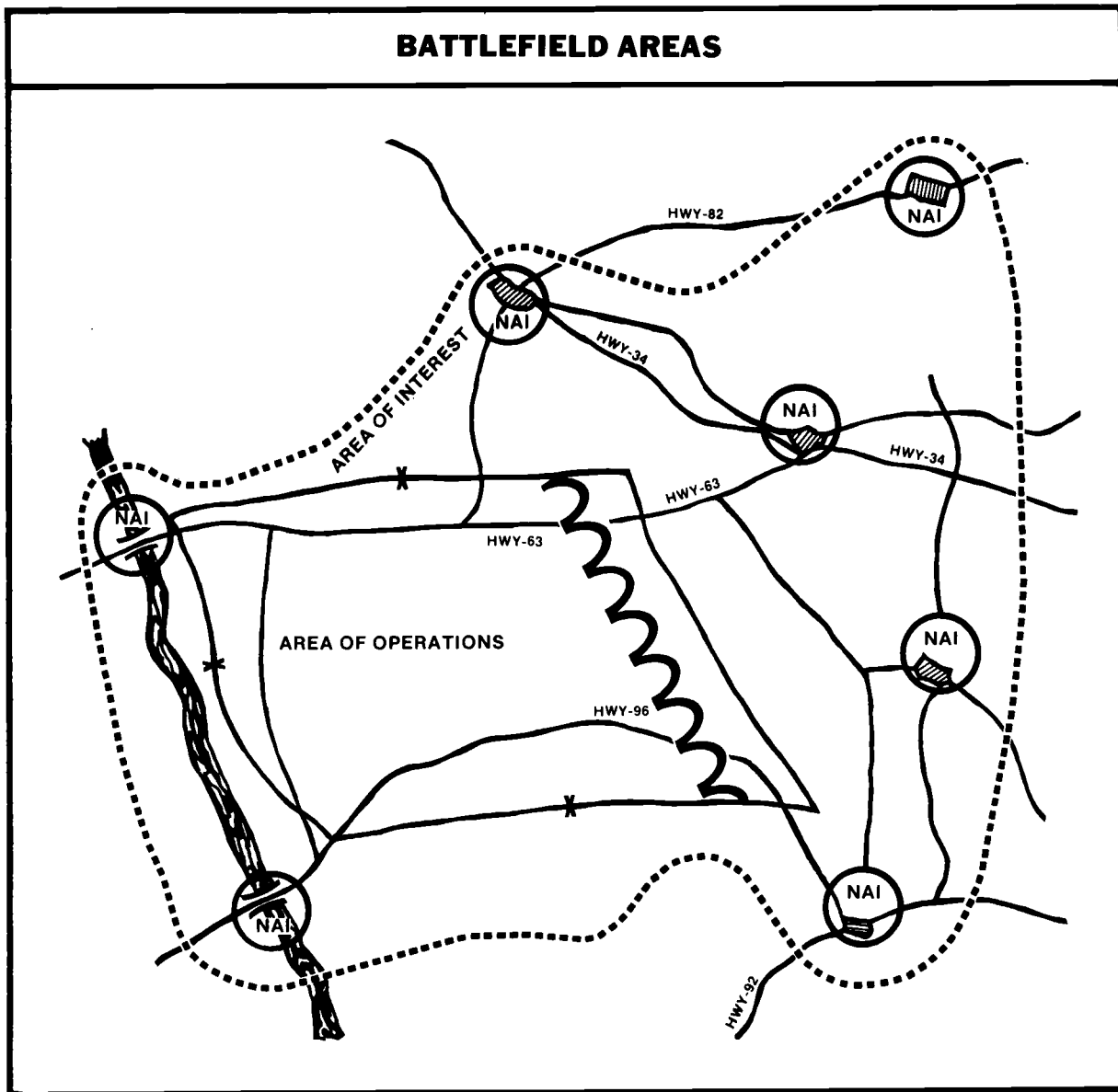

## RESPONSIBILITIES—AREAS OF OPERATIONS/INTEREST

<p style="text-align: center;"><u>REAR</u></p> <p>Provide security of rear areas and facilities</p> <p>D I V I S I O N</p> <p>Prevent or minimize interference with C<sup>3</sup></p> <p>Provide continuous CS and CSS forward</p> <p>Destroy enemy incursions in rear area</p> <p>Provide area damage control</p>	<p style="text-align: center;"><u>CLOSE</u></p> <p>Fights brigades against first echelon regiments</p>	<p style="text-align: center;"><u>DEEP</u></p> <p>Attacks follow-on regiments</p> <p>Attacks first echelon sustainers</p> <p>Provides information to brigades</p>	<p style="text-align: center;"><u>AREA OF INTEREST</u></p> <p>Receives information from corps</p>
AREA OF OPERATIONS			
<p style="text-align: center;"><u>REAR</u></p> <p>Provide security of rear areas and facilities</p> <p>B R I G A D E</p> <p>Prevent or minimize interference with C<sup>3</sup></p> <p>Provide continuous CS and CSS forward</p> <p>Destroy enemy incursions</p> <p>Provide area damage control</p>	<p style="text-align: center;"><u>CLOSE</u></p> <p>Fights battalions against first echelon battalions</p> <p>Plans for and conducts operations against follow-on enemy battalions</p>	<p style="text-align: center;"><u>AREA OF INTEREST</u></p> <p>Receives information from division and adjacent brigades</p>	
AREA OF OPERATIONS			
<p style="text-align: center;"><u>REAR</u></p> <p>Provide security of rear areas and facilities</p> <p>B A T T A L I O N</p> <p>Prevent or minimize enemy interference with C<sup>3</sup></p> <p>Destroy enemy incursions</p>	<p style="text-align: center;"><u>CLOSE</u></p> <p>Fights companies against first-echelon companies</p> <p>Conducts operations against follow-on enemy companies</p>	<p style="text-align: center;"><u>AREA OF INTEREST</u></p> <p>Receives information from brigade and adjacent battalions</p>	
AREA OF OPERATIONS			

### Commanders' Information Needs

Areas of operations and interest are significant because they generate, in general terms, the commanders' information needs.

There are two categories of information which are critical to brigade and battalion commanders. They are intelligence and combat information.

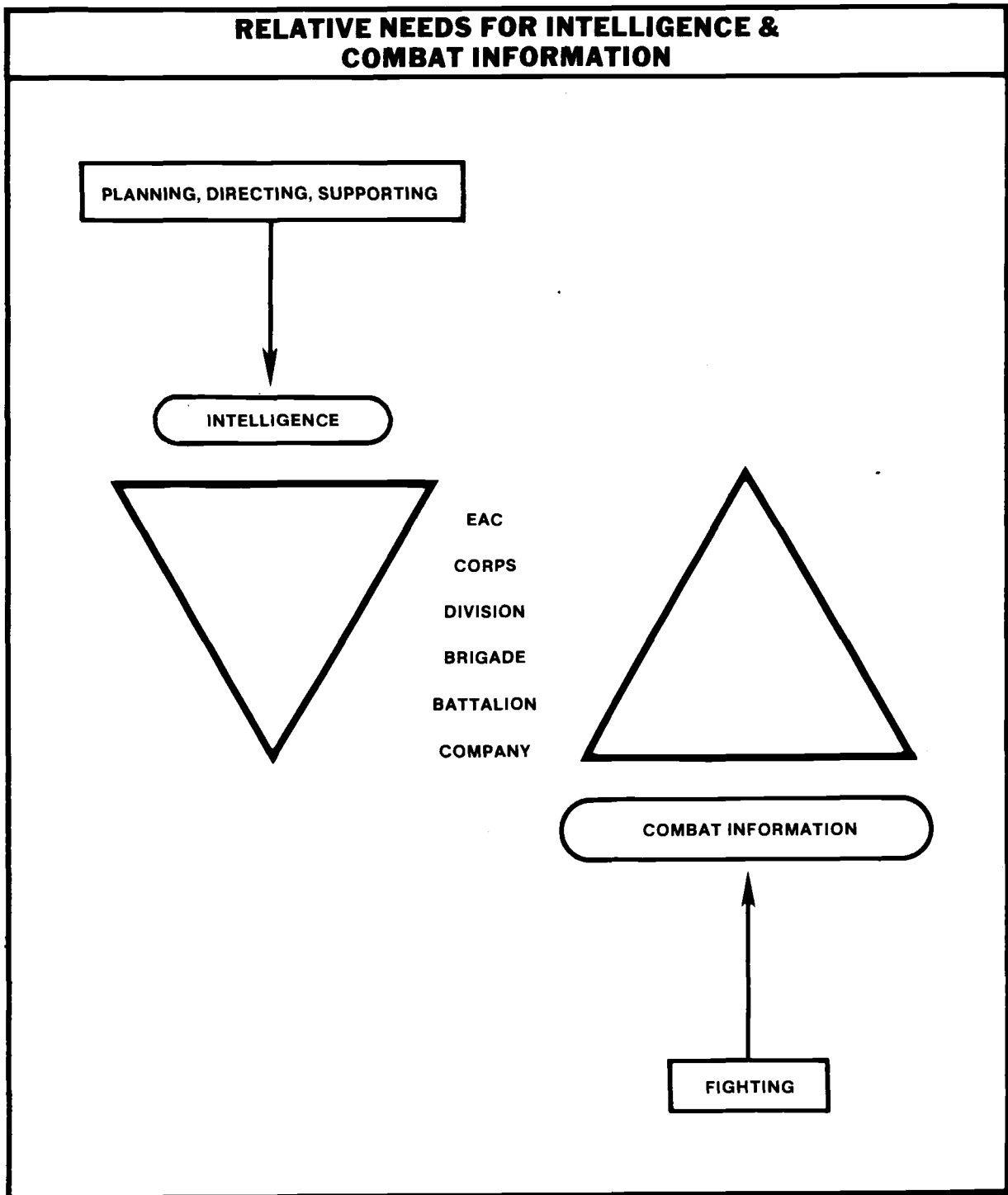

Intelligence is the result of processing all available information known about enemy forces—their composition, disposition, and intentions, as well as their locations, their direction and speed, and their combat readiness. Expedient processing, timely production, and rapid dissemination of intelligence is necessary to plan, direct and support the brigade and battalions' close operations.

Combat information, on the other hand, is unevaluated data gathered by, or provided directly to, the tactical commander. Due to its highly perishable nature or the criticality of the situation, it cannot be processed into tactical intelligence in time to satisfy the user's tactical intelligence requirements.

Intelligence and combat information are equally important. Both provide targeting data for IEW, maneuver, and fire support systems at each echelon. The inverse relationship regarding their relative worth at higher and lower echelons is directly keyed to the time available for respective commanders to make decisions and take the action necessary to accomplish their mission.

Company and battalion commanders fight what they can see and shoot. They need information about enemy activity within their AO as it becomes available. Brigade commanders need such information within 15-30 minutes. Information about enemy activity within brigade and battalion areas of interest must be provided in time to plan future operations. The specific time required to plan future operations at brigade and battalion is METT-T dependent.

### **Specific Information Requirements**

Tactical intelligence operations at the brigade and battalion begin with the commander. He conveys his information needs to the S2 who converts them into priority intelligence requirements (PIR) and other information requirements (IR) for the commander's approval or modification. The intelligence officer translates PIR and IR into specific intelligence, reconnaissance, and surveillance missions for subordinate,

attached, and supporting units and requests information from the next higher echelon. He receives and evaluates information from all sources, develops and nominates high payoff targets (HPT), and reports intelligence results to higher, lower, and adjacent units.

Battalion commanders plan, direct, coordinate, and support the brigade's close operations against enemy first-echelon battalions. Their mission is to locate, close with and destroy enemy forces using firepower, maneuver, shock effect and surprise in coordination with other combat arms. They must also be prepared to attack enemy second-echelon battalion maneuver forces and first-echelon sustainers, as well. Detailed preplanning and rigorous RSTA activities prior to the initiation of hostilities or before actual contact with enemy forces is made are absolutely critical to the battalions' success.

Battalion commanders need specific information and accurate intelligence from the brigade and higher headquarters to plan their operations. They need timely combat information and targeting data from subordinate, adjacent, and supporting units to refine their plan and to win their offensive and defensive battles. Their specific information requirements for attacking and defending are consolidated, due to the speed with which they must react on the extremely dynamic and volatile air-land battlefield. They must know—

- Location, direction, and speed of platoon and company-size elements within the enemy's first-echelon battalions.
- Location, direction, and speed of enemy second-echelon battalions which indicate the first-echelon regiment's main effort.
- Locations and activities of follow-on battalions in enemy second-echelon regiments.
- Disposition and strength of enemy defensive positions and fortifications.
- Location of antitank positions, crew-served weapons, individual vehicle positions, and dismounted infantry.



- Locations of barriers, obstacles, minefield, and bypass routes.
- Effects of terrain and prevailing weather conditions throughout the course of combat operations.
- Capability of enemy force to employ air assets.
- Availability and probability of use of enemy radioelectronic combat (REC) assets to disrupt friendly C<sup>3</sup>.
- Possibility of special weapons.
- Probability of enemy use of nuclear, biological, and chemical (NBC) weapons.

Brigade commanders need and use specific information to plan, direct, coordinate, and support the close operations of the division against enemy first-echelon regiments, their battalions, companies, and combat support units—the sustainers. They also need accurate intelligence about enemy second-echelon regiments within first-echelon divisions and any follow-on forces which can close on their AO before the current engagement can be decisively concluded.

Brigades strive to attack enemy first-echelon forces while they are on the move and before they can deploy into combat formations. The brigade commander needs specific information about—

- Composition, equipment, strengths, and weaknesses of advancing enemy forces.
- Location, direction, and speed of enemy first-echelon battalions and their subordinate companies.
- Locations and activities of enemy second- and follow-on echelons capable of reinforcing their first-echelon forces in the close operations area.
- Location of enemy indirect fire weapon systems and units.
- Location of gaps, assailable flanks, and other tactical weaknesses in the enemy's order of battle (OB) and OPSEC posture.
- Air threat.

- Enemy use of NBC.
- Effects of weather and terrain on current and projected operations.
- Anticipated timetable or event schedule associated with the enemy's most likely course(s) of action.

Should the enemy succeed in establishing his defensive positions, then brigade commanders' specific information requirements increase. They must then know the specific types, locations, and organization of enemy first- and second-echelon defensive positions and fortifications. These include—

- Barriers, obstacles, fire sacks, and antitank (AT) strong points.
- Locations of anti-aircraft and missile artillery (AAMA) units.
- Locations of surface-to-air missile (SAM) units.
- Location of REC units.
- Location of reserve maneuver forces.
- Enemy ability to conduct deep attack into friendly rear area.

Brigade commanders given defensive missions, or forced to defend in given sectors, require specific information about assaulting enemy companies, battalions, regiments, and divisions—generally, their strength, composition, and direction of attack. The same information is required about enemy follow-on units that can affect brigade combat operations. Of specific concern are the locations, size, activities, direction, and speed of enemy air-assault, heli-borne, and tactical air (TACAIR) units capable of dealing lethal and decisive blows to brigade units and which could potentially be used to thwart any counterattack.

Specific information about enemy first- and second-echelon regimental C<sup>3</sup> facilities is of paramount concern to the brigade commander, whether on the offense or defense. He must know the specific locations of enemy—

- Division forward, and main command posts (CPs).
- Regimental and battalion CPs.
- Fire direction control (FDC) centers.

- Command observation posts (COPS).
- Radio and radar reconnaissance sites.
- Radioelectronic combat sites.
- Target acquisition sites.

The suppression, neutralization, and destruction of enemy C<sup>3</sup> systems and facilities are critical to the success of the close operations. Brigade commanders, in concert with supporting division and corps IEW, maneuver, and fire support (FS) units, use all available means to identify, locate, disrupt, and destroy these extremely high payoff targets. Their objective is to neutralize the enemy commanders' capability to command troops and control weapon and combat support systems. Degrading or denying the ability of the enemy commander to conduct his attack as planned is done by systematically attacking key "nodes" and "information links" in the enemy commander's command and control (C<sup>2</sup>) system, which supports their decision making process. This form of command and control warfare is founded upon the basic tenets of command, control, and communications countermeasures (C<sup>3</sup>CM) strategy, defined below.

*The integrated use of operations security (OPSEC), military deception, jamming, and physical destruction, supported by INTELLIGENCE, to deny information, to influence, degrade, or destroy enemy command, control, and communications (C<sup>3</sup>) capabilities; and to protect friendly C<sup>3</sup>.*

The protection of friendly command, control, and communications—protect C<sup>3</sup>—is the number one priority under C<sup>3</sup>CM strategy. Intelligence supports the protection of friendly C<sup>3</sup> primarily through counterintelligence support to OPSEC and deception.

## COUNTERINTELLIGENCE

The mission of CI is to detect, evaluate, counteract, or prevent hostile intelligence collection, subversion, sabotage, and international terrorism conducted by or on behalf of any foreign power, organization, or person operating to the detriment of the US Army. CI personnel are responsible for

identifying the hostile intelligence collection threat. They, together with operations personnel, develop friendly force profiles, identify vulnerabilities, and make recommendations to reduce those vulnerabilities.

Counterintelligence operations support the division's overall OPSEC program. They are designed to protect the brigade and battalion by countering enemy attempts to identify and locate friendly combat and combat support forces. Division CI operations are conducted to support OPSEC, deception, and rear operations.

### COUNTERINTELLIGENCE SUPPORT TO OPSEC

CI support to OPSEC is the principal role of CI at echelons below division. It includes—

- The identification and analysis of enemy reconnaissance, surveillance, and target acquisition (RSTA) capabilities, personnel, units, and activities.
- The identification and analysis of enemy REC units, locations, and activities.
- Assisting in the development of friendly force profiles.
- Determining friendly vulnerabilities to enemy RSTA and REC activities.
- Recommending and evaluating appropriate OPSEC and deception measures.

### COUNTERINTELLIGENCE SUPPORT TO DECEPTION

Military deception operations are planned, controlled, directed, and conducted by commanders at echelons above division (EAD). They are designed to mislead enemy senior military and political leaders regarding our true military objectives, our combat capabilities and limitations, and the composition and disposition of our combat forces.

Battlefield deception operations are controlled, directed, coordinated, and executed by corps and division commanders in

accordance with the overall military deception plan. Battlefield deception is deliberate action to achieve surprise on the air-land battlefield. Its purpose, ultimately, is to mislead enemy ground force commanders as to our true combat objectives, our tactical order of battle, our major axis of advance, and the disposition of our reserve and combat support units, defensive positions, fortifications, and C facilities.

Corps, division, brigade, and battalion commanders also plan, direct, coordinate, support, and conduct battlefield deception operations to achieve surprise and create opportunities for decisive tactical maneuver in order to break contact with and bypass enemy forces, seize their true objectives, and accomplish their missions. Such battlefield deception operations support the attack and defense; however, they are offensive rather than defensive in nature. They are directly keyed to deceptive forms of maneuver, such as demonstrations and feints. Such deceptive maneuvers may be used to seize secondary tactical objectives. They may also represent or turn out to be the preparatory phase of a combat operation designed to achieve surprise in seizing primary tactical objectives.

Brigades and battalions participate in the deception effort regardless of its nature, military or tactical, and whether they know it or not. Their participation may be limited to practicing sound OPSEC measures on a regular and standard basis in accordance with established unit standing operating procedures (SOP). They may also participate in or employ active deceptive measures such as outlined above. In either case, counterintelligence does support their deception operations. The principal CI functions conducted in support of brigade and battalion deception operations are similar to those performed in support of OPSEC.

### **COUNTERINTELLIGENCE SUPPORT TO REAR OPERATIONS**

Counterintelligence support to rear operations includes identifying and analyzing the enemy threat to brigade trains and both division support command (DISCOM) and corps support command (COSCOM) operations. CI personnel recommend steps to

neutralize enemy agents, saboteurs, terrorists, sympathizers, and special purpose forces. Brigade and battalion commanders, their staffs, and all subordinate personnel must be trained and prepared to identify and report enemy units or activities which may pose a threat to brigade trains, DISCOM, and COSCOM operations. The potential impact on close operations from the rear cannot be overlooked.

### **ELECTRONIC WARFARE**

EW is an essential element of combat power. It can provide brigade and battalion commanders both a passive and an active means to protect their C<sup>3</sup> systems and a passive and an active means to attack the enemy commanders' C system as well. Protecting C<sup>3</sup> is the number one priority for EW in accordance with C<sup>3</sup>CM strategy. Action taken to deny, influence, and degrade or destroy enemy C capabilities, counter-C<sup>3</sup>, is equally important. Electronic warfare, like other elements of combat power on the air-land battlefield, is waged by employing a combination of both offensive and defensive operations, tactics, and procedures. Air-land battle doctrine and the spirit of the offense are the overriding considerations in planning and conducting EW operations. (See Chapter 5, FM 34-1.)

### **PROTECT COMMAND, CONTROL, AND COMMUNICATIONS**

Electronic counter-countermeasures (ECCM), or defensive EW, are the responsibility of all soldiers who use or who supervise the use of communications-electronics (C-E) equipment. ECCM are passive in nature and are used to protect friendly C<sup>3</sup> systems against enemy REC activities. Passive ECCM include both anti-intercept and locate (for example, emission control, terrain masking, and avoidance) procedures and antijam or kill (for example, C-E equipment design) features. ECCM also includes the immediate identification and reporting of meaconing, intrusion, jamming, and interference (MIJI) on a friendly C facility.

Electronic warfare support measures (ESM) can provide commanders the capability to intercept, identify, and locate enemy emitters. It represents a source of

information required for jamming, deception, ECCM, targeting, and other tactical employment of combat forces. ESM supports the destruction and jamming of enemy C<sup>3</sup> systems through acquisition and reporting of targeting data. ESM also supports the commander's efforts to counter enemy OPSEC and deception.

Electronic countermeasures (ECM), in general, and communications jamming (COMJAM) systems, in particular, can provide brigade and battalion commanders two active capabilities to protect their C<sup>3</sup> systems. The first is screen jamming, or COMJAM screening. COMJAM screening is the jamming of enemy communications intercept and direction finding (DF) receivers to preclude this information gathering or locating efforts against friendly high-value communications.

Communications jamming systems can provide brigade and battalion commanders with a means to communicate with one another, as well as with senior and adjacent unit commanders in worst-case situations when enemy jamming is experienced and no other means of C<sup>3</sup> is possible. The high-power amplifier provided with COMJAM systems is used to "burn through" enemy jamming. Calls for fire, situation reporting, and orders to subordinate units can still be communicated.

### **COUNTER COMMAND, CONTROL, AND COMMUNICATIONS**

The offensive components of EW, passive ESM and active ECM, provide to brigade and battalion commanders—

- Intelligence to plan, direct, coordinate, support, and conduct combat operations.
- Combat information and targeting data to maneuver their forces and target their weapon systems.
- ECM nonlethal attack capability to systematically disrupt the C<sup>3</sup> systems of enemy first- and second-echelon units located within the brigade's and the division's assigned AO.

### **CRITICAL TASKS**

Command and control warfare in air-land combat operations is complex when viewed as a maze of intangible electronic signals criss-crossing above and over the battlefield. Command and control warfare, however, can be reduced to the most simple terms of reference and understanding. It is composed of both tangibles and intangibles. The tangibles are the C<sup>3</sup> "nodes" which present visual signatures for commanders to see and shoot. The intangibles are the "information links" between the nodes which can be intercepted, identified, and jammed. There are also the nodes themselves which can be intercepted, identified, and jammed. Depending on the tactical situation and the desired effects of friendly operations, there may also be nodes and links which must be seen and monitored, but neither shot nor jammed. As a general rule, we normally jam and kill the fighters and sustainers, and collect information from the planners and coordinators. When attacking the planners and coordinators will result in the desired alteration of the enemy commander's battle plans, this general rule would obviously be reversed.

Electronic warfare resources available to, or in support of, the brigade and battalions, close operations, though limited, are specifically trained to cope with the intangibles of command and control warfare. However, the critical tasks they must perform in support of the battalion and brigade to win, begin and end with the commander. His operational needs for EW support are just as important as his information needs discussed earlier in this chapter. The following list summarizes the brigade commander's critical tasks for EW.

Each of the IEW tasks derived from the IEW mission (situation development, target development, EW, and CI) is essential to the success of the brigade's and battalion's operations. The composition of the IEW system and how it fulfills the commander's requirements of each IEW task, the employment for specific operations, and the critical functions of sustaining combat operations are explained in specific terms in the chapters which follow. The doctrine is based on,

and requires an understanding of, the air-land battle doctrine of FM 100-5 and IEW doctrine espoused in FM 34-1.

<b>CRITICAL TASKS FOR ELECTRONIC WARFARE</b>	
<b><u>PROTECT C<sup>3</sup></u></b>	<b><u>COUNTER C<sup>3</sup></u></b>
— ECCM	— ESM
— ESM- (MIJI TIP-OFF) <sup>1</sup>	* Intelligence
— ECM	* Combat Information
* Screen Jamming	* Targeting Data
* High-power Communications <sup>1</sup>	— ECM (COMJAM) <sup>2</sup>
<sup>1</sup> Preplanned and on-call	<sup>2</sup> Preplanned or SOP

## CHAPTER 2

### Intelligence And Electronic Warfare Resources

The ability of the brigade and battalion to successfully accomplish their combat missions with minimum casualties is dependent upon the knowledge and tactical skill of the brigade and battalion commanders and their staffs. Commanders and staff officers who understand the capability of organic, attached, and supporting IEW resources can integrate these capabilities with their combat maneuver forces. They get the full potential from their IEW, maneuver, and fire support systems.

Battalion and brigade IEW resources are components of a large IEW system that begins at the national level and extends down to the individual soldier. The IEW system includes virtually every individual soldier and operational element at every level of command capable of collecting and processing information, disseminating intelligence, providing CI support, and managing or executing EW operations. The IEW resources at each level are interlocked with other resources at higher, lower, and adjacent commands to provide a single, integrated, and interdependent IEW structure. The Army's IEW system is shown on the next page. It is fully described in FM 34-1. While the total IEW system is interlocked and interdependent, the focus of intelligence operations varies at each echelon. Brigade and battalion intelligence operations focus on the development of a responsive combat information system and the infusion of intelligence provided by division. Therefore, brigades and battalions base their intelligence operations on the reconnaissance, counterreconnaissance, and surveillance capabilities of organic, attached, and supporting combat units. Intelligence requirements that can not be satisfied by these elements are passed to the division G2 for satisfaction. Although, brigades and battalions do analyze informa-

tion and produce intelligence, the focus is on the timely collection and use of combat information in the conduct of close operations. Division normally provides intelligence needed to execute deep operational missions assigned to brigades and battalions. The following discussion of RSTA systems is intended to familiarize brigade and battalion commanders and their S2s with the numerous collection systems that support the development of combat information and intelligence through reconnaissance and surveillance (R&S) and formal collection management efforts. The allocation and apportionment of these systems to the brigade and battalion levels is dependent upon METT-T planning and doctrinal norms. Detailed information about IEW operations at echelons above brigade is provided in FM 34-10, FM 34-25, and FM 34-37.

The IEW systems at battalion and brigade consist of the commanders, their staffs, supporting IEW resources from MI units at division and corps, and other organic, attached, and supporting combat and fire support units. The IEW mission is accomplished through the integrated efforts of all of its components.

This chapter describes the basic organization and composition of the brigade and battalion IEW systems. It provides information about the functions, capabilities, and limitations of IEW resources which are organic or attached to the brigade and battalion or which support their combat operations. The IEW responsibilities of the brigade and battalion staff are also discussed, where pertinent; they are detailed in Chapter 3.

#### BATTALION IEW RESOURCES

The maneuver battalion is the basic combat unit in the US Army. It is the lowest echelon where combat, combat support, and combat service support capabilities are brought together, integrated, and directed

against enemy forces. Accurate intelligence and effective CI support provided by the brigade and higher echelons is critical for planning and directing the battalion's employment. The battalion, however, relies primarily on the combat information provided by its organic, attached, and supporting IEW resources to execute all missions

assigned. The availability and capability of the battalion's IEW resources to provide timely and accurate combat information may well determine the success of the battle.

The principal IEW resources available to the battalion include its organic scout platoon and subordinate maneuver companies.

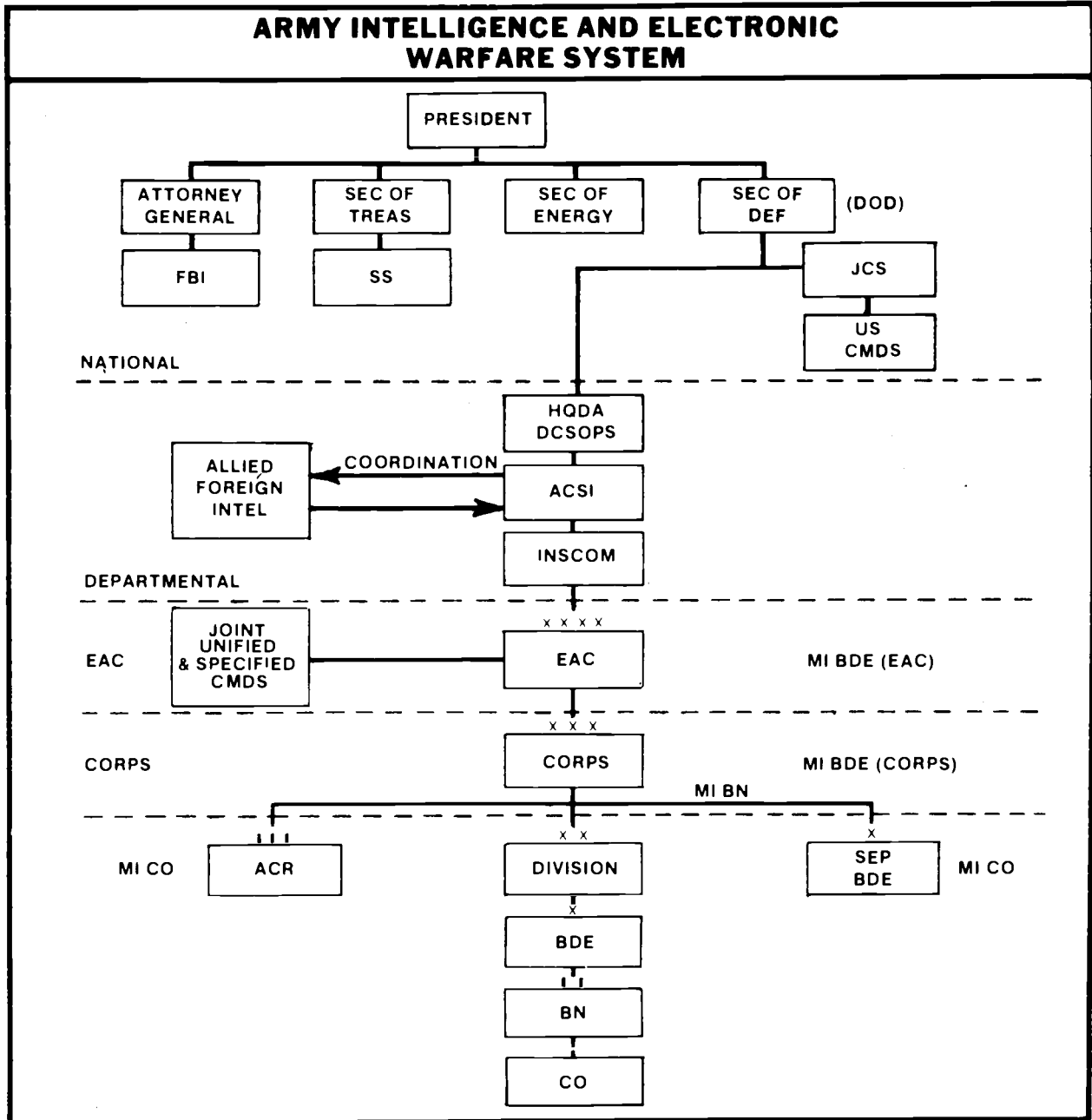

Patrols, observation posts, and individual soldiers are used and relied upon to collect and report information about the enemy, terrain, and weather.

### **INDIVIDUAL SOLDIERS**

Individual soldiers provide company and battalion commanders with a large quantity of timely combat information. They perform patrols, man observation posts, and observe enemy forces with which they are in contact. They observe and report first-hand information concerning enemy troops and equipment, patrols, reconnaissance units, and the activities of each. The size, activity, location, unit, time, and equipment (SALUTE) formula is the basis for both the training of individual soldiers and the reporting of combat information.

### **OBSERVATION POSTS**

Observation posts (OPs) are established to observe and listen to enemy activity within particular sectors and from which warning of the enemy approach is provided. They are placed where they can be supported by fire and where withdrawal routes are covered and concealed.

Communications between the parent unit and each observation post are essential.

Observation posts may be augmented by ground surveillance radars, remote sensors, or night observation devices. Night observation devices are either active or passive equipment designed to permit observation during the hours of darkness. Active equipment transmits infrared or white light to illuminate an object or an area. Passive devices use either ambient light—resulting from the stars, moon, or other low-intensity illumination in the battle area—or operate by detecting the differences in heat (infrared energy) radiated by different objects. These devices may be adversely affected by heavy rain, snow, fog, and smoke.

Night observation devices, organic to maneuver companies and the scout platoon, are used extensively for night patrols, observation posts, and night defensive positions. They may also be used to augment radar surveillance. This equipment includes night vision sights for crew-served weapons such as the tube launched, optically tracked, wire guided (TOW) missile system. The thermal sights on the improved TOW vehicle penetrate fog, smoke, dust, light foliage, as well as darkness. This improved capability enhances the TOW gunner's ability to observe the battlefield under adverse conditions.

### **NIGHT OBSERVATION DEVICES**

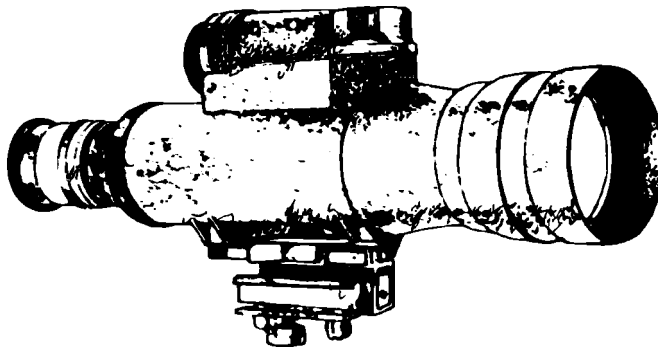



## PATROLS

Patrols are conducted both prior to and during combat operations for reconnaissance, counterreconnaissance, and security purposes. They are also used to conduct small-scale combat operations. There are two categories of patrols, reconnaissance and combat.

Reconnaissance patrols are used to collect information and confirm or disprove the accuracy of other information gained previously. The three main types of reconnaissance patrols are—

- Route reconnaissance to obtain information about the enemy and any dominating terrain features along the route.
- Zone reconnaissance to collect the information about enemy forces and the terrain between specific boundaries.
- Area reconnaissance to gather information about the enemy or the terrain within a defined area, such as a town, ridgeline, woods, or other features critical to current or planned operations.

Combat patrols are used to provide security and to harass, destroy, or capture enemy personnel, equipment, and installations. There are three types of combat patrols—raid, ambush, and security. The collection and reporting of combat information is usually a secondary mission for combat patrols. Captured enemy soldiers, equipment, and documents are evacuated to the rear for exploitation at higher echelons. The results of such actions may prove to be of significant value as either tactical or strategic intelligence.

## MANEUVER COMPANIES

Individual soldiers (or troops), observation posts, listening posts (LPs), and patrols are the principal means available to maneuver company commanders to gather information about the enemy, terrain, and weather in their immediate areas and to acquire targets for immediate attack. A fire support team (FIST) from divisional artillery and ground surveillance radar teams and remote sensor teams (if available) from the division's MI battalion are also available to help satisfy the maneuver

company and battalion commanders' IEW requirements. The functions, capabilities, and limitations of these supporting resources are discussed later in this chapter. Their general capabilities, however, together with those of the company's organic resources described above, are shown on the following page.

Company commanders direct the placement of organic and attached RSTA assets in accordance with the guidance provided by the battalion commander or his S2. The battalion S2 plans for and recommends the deployment of all organic, attached, and supporting RSTA assets, to include the battalion's reconnaissance or scout platoon. Subordinate company commanders deploy patrols, establish OPs, and task subordinate platoons to collect the information needed or to provide security for their combat operations. CI and EW support is limited and that which may be required is satisfied by higher echelons.

## SCOUT PLATOON

As the primary intelligence-gathering asset, the mission of the scout platoon is to provide reconnaissance and security for its parent battalion and to assist in the control and movement of the battalion and its subordinate elements. The scout platoon is used—

- To conduct route, zone, and area reconnaissance missions.
- To establish observation posts.
- To conduct chemical detection and radiological survey and monitoring operations.
- To screen one flank, the front, or rear of the battalion.
- To act as part of an advance, flank, or rear guard.
- To establish a roadblock.
- To provide traffic control and road guides.
- To participate in area damage control operations.
- To provide contact teams, conduct liaison missions, and perform quartering functions. It also conducts limited pioneer and demolition work.

## COMPANY RESOURCES

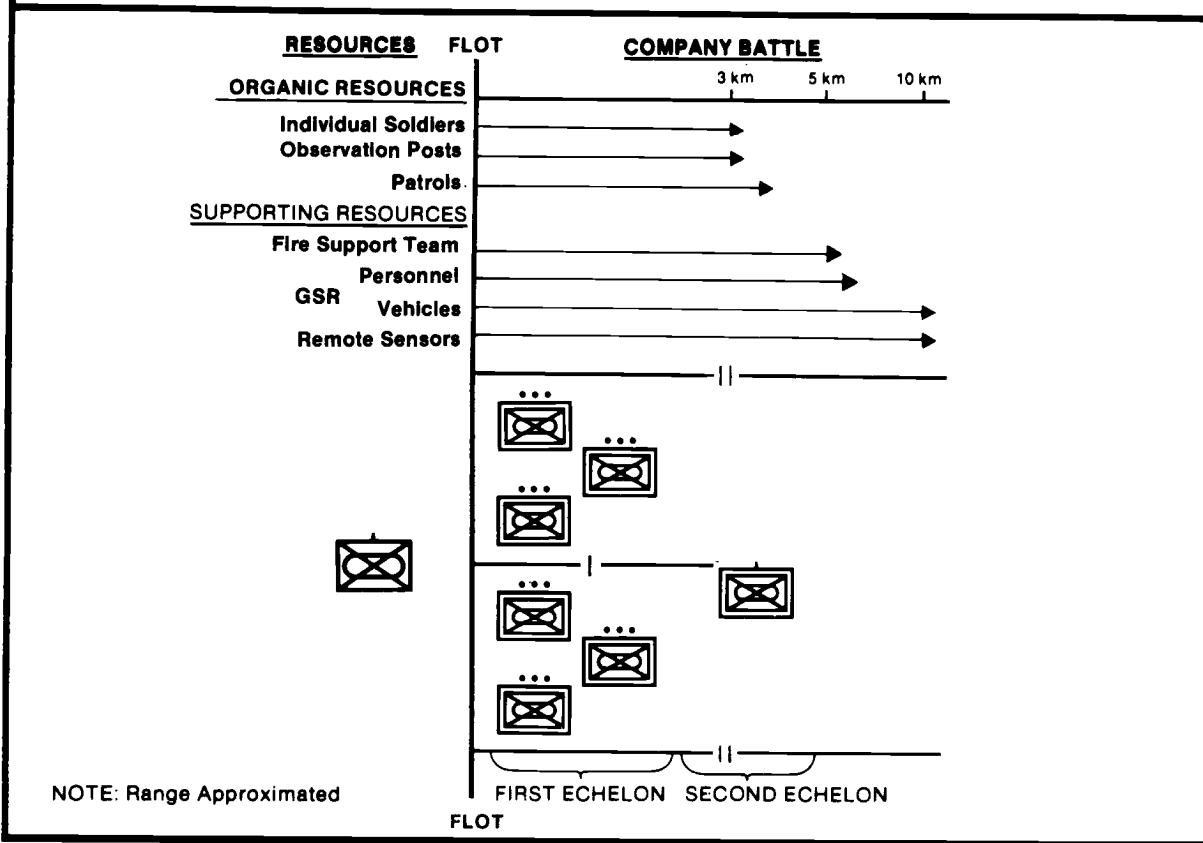

The scout platoon, or elements thereof, may be attached to a maneuver company for a specific operation. Reconnaissance operations are conducted under the staff supervision of the battalion S2, who coordinates these requirements with the battalion S3. Security operations are conducted to provide early warning of enemy maneuvers and to deny information to the enemy concerning the battalion's disposition or movements. Security operations are planned and conducted under the supervision of the battalion S3, who coordinates with the S2 for information on enemy activity. The organization and operations of the scout platoon are detailed in FMs 71-2J and 7-20.

### SUPPORTING RESOURCES

Field artillery, military intelligence, Army aviation, tactical air forces, air defense artillery, combat engineers, and

various combat service support units all provide the maneuver battalion commander additional means and resources to satisfy his IEW requirements.

### Field Artillery

Field artillery battalions, in direct support of the brigade, provide each maneuver battalion headquarters with a fire support section (FSS) to help plan, direct, and coordinate fire support operations. The FSS establishes and maintains the fire support element (FSE) at the maneuver battalion's command post. The FSS also provides the FIST, mentioned earlier, to each of the battalion's maneuver companies. The fire support officer (FSO), who is in charge of the maneuver battalion's FSE, also supervises the operations of the company FIST.

Forward observers (FOs) from each FIST are deployed at both company and platoon

levels and may accompany reconnaissance patrols or help to man observation posts. They are the "grass roots" of the field artillery's target acquisition effort. They observe the battlefield to detect, identify, locate, and laser-designate targets for suppression, neutralization, or destruction. They also monitor friendly fires on specific targets to assess damage effectiveness, adjust fires, and ensure that the desired effects are achieved. They report both targeting data and combat information to the maneuver battalion FSO and S2, respectively, using either organic or supporting communications means.

Fire support teams and forward observers are specially equipped to accomplish their

tasks. Digital message devices (DMDs) are used to send and receive messages digitally using existing FM radios. It is a hand-held, battery-powered unit used to call for fire, to pass targeting data, and provide the location of the FO, or to send plain text messages with combat information.

The battery-powered AN/GVS-5 laser range finder is held and sighted like a large pair of binoculars. The FO looks through a single 7 x 50mm eyepiece to locate and range targets. Distance is displayed in meters. By ranging the initial adjusting round, an FO gives instant feedback to fire direction control centers through the DMD, "closing the loop" and facilitating rapid massed fire for effect.

### DIGITAL MESSAGE DEVICE

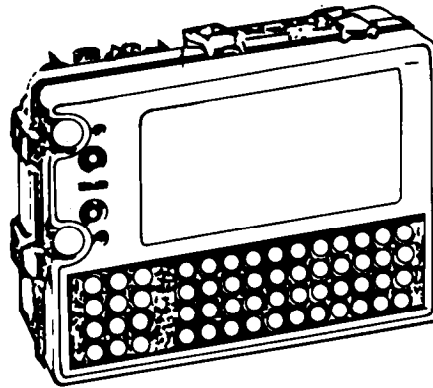

### AN/GVS-5

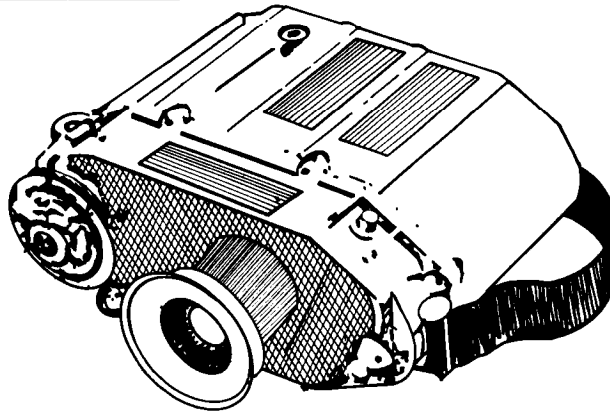

The ground or vehicular laser locator designator and its ancillary equipment are configured to provide distance, direction, and vertical angle as well as laser illumination termed "designation" for Army, Navy, and Air Force laser guided munitions. While the designator can be transported by members of a FIST, it is normally mounted in a vehicle. It is battery powered and operates with an AN/TAS-4 night sight. It inputs target location direction into the DMD, which sends the data to the tactical fire direction system (TACFIRE).

The FIST vehicle (FISTV) integrator, ground laser designator-range finder, the DMD, and night observation devices with the improved TOW vehicle enhances the FIST chiefs role as an FO and fire support coordinator (FSCoord) at the company

level. The improved accuracy of this system and the speed of its operations greatly enhance the fire support provided the company and battalion.

The capability of the FIST to provide real-time combat information and intelligence to the battalion cannot be overlooked. The battalion FSO receives information from, and passes information to, the FIST. He also exchanges targeting data and combat information with the brigade FSO and elements from the direct support field artillery battalion. He coordinates with the battalion S2 and S3 to identify and verify targeting data and combat information derived from the battalion's overall collection effort. Thus, the FSO is both a producer and consumer of combat information and intelligence at the maneuver battalion. He is also the battalion's FSCoord.

### **GROUND/VEHICULAR LASER LOCATOR DESIGNATOR**

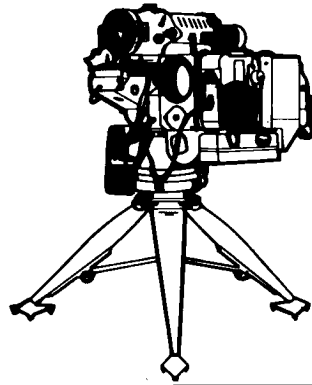

### **FIST VEHICLE**

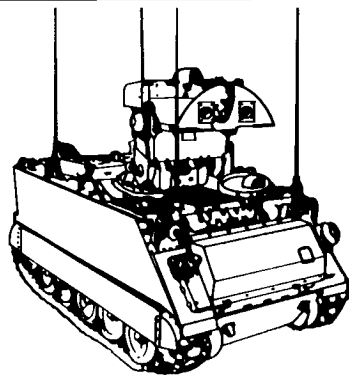

## Military Intelligence

Leaders from other combat support elements such as MI, air defense, and engineer, perform functions similar to those of the FSO. This is especially true for supporting MI resources, in general, and the ground surveillance radar (GSR) squad or team leader, in particular, when attached to or placed in direct support of battalion, company, or scout platoon operations. Extensive coordination and effective C<sup>3</sup> are required.

**GSR Resources.** GSRs provide the maneuver battalion a highly mobile, near

all-weather, 24-hour capability for battle-field surveillance. They may be employed on patrols and at observation posts and are used with remote sensors and night observation devices. They may be employed near the FLOT, forward of the FLOT, on the flanks, or in the rear area. The supported battalion S2, company commander, or scout platoon leader selects general locations from which the radar may operate. The GSR team leaders select the actual site within these general locations. GSR site requirements and selection criteria are shown in the following illustration.

### GSR SITE SELECTION



**PRIMARY SITE:** Best possible position from which to accomplish the primary radar mission.

**ALTERNATE SITE:** A second position from which the primary mission may be accomplished should the primary site prove untenable.

**SUPPLEMENTARY SITE:** A position from which a secondary mission may be accomplished should the primary mission be discontinued.

#### Site selection criteria

- Line-of-sight between radar set and target area.
- Radio or wire communications capability.
- Near routes for rapid displacement.
- Protection by combat elements.
- Cover and concealment.
- Protection against electronic countermeasures (ECM).

Surveillance platoons organic to the division's MI battalion are currently equipped with two types of radar—the AN/PPS-5 and the AN/PPS-15. These systems provide the supported commander with timely and accurate combat information and target acquisition data. They are designed to detect and locate moving objects under conditions unfavorable to other RSTA assets. They are best used to search small areas on a continuing basis for random or specific targets. Their capabilities are best exploited when used to cover specific areas on a scheduled basis. The AN/PPS-5 radar is

used to detect and provide early warning of enemy movements at ranges greater than the AN/PPS-15 radar. The AN/PPS-5 is also used to search beyond engaged forces for indications of reinforcement or withdrawal activities and enemy movements to out-flank or bypass friendly forces in the engagement area. The AN/PPS-15 radars provide the commander with highly mobile GSR support in operations where the heavier, less portable AN/PPS-5 radar is impractical. The range and accuracy of both these radars are shown below.

### RADAR CHARACTERISTICS

	AN/PPS-4	AN/PPS-5	AN/PPS-15
<b>RANGE:</b> Personnel Vehicles	1,500m 6,000m	6,000m 10,000m	3,000m
<b>ACCURACY:</b> Range Azimuth	±25 m ±10 mils	±20 m ±10 mils	±20 m ±10 mils
<b>SECTOR SCAN:</b>	Manual	Automatic—553, 1,067; 1,600; and 1,955 mils (selectable)	Automatic 800 or 1,600 mils
<b>INDICATORS:</b>	Audio	Audio and visual (A- and B-scope)	Audio and visual (Digital Readout)
<b>REMOTE CAPABILITY:</b>	None	50 ft	30 ft

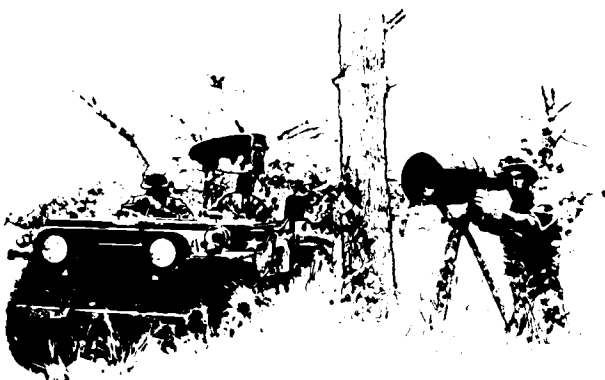

**NOTES:** The GSR may be employed with night observation devices (NOD) to provide positive identification of detected targets. The range for identification is dependent upon the range of the NOD.

The AN/PPS-15 is currently being programmed for use in the Ground Surveillance Company, CEWI Battalion (Div). When the equipment is issued, the company will be equipped with a mixture of AN/PPS-5 and AN/PPS-15 radar sets.

The AN/PPS-5 and AN/PPS-15 radars can detect targets and provide more accurate distance and directional data than is possible by visual estimate. However, they add to, rather than replace, other surveillance means. They can detect and locate targets over a considerable distance under conditions of darkness and poor visibility. However, they can be used just as effectively during periods of good visibility. Their use should not be limited to a certain type of terrain, a rigid set of conditions, or to a few particular operations. Their common capabilities and limitations, other than those unique to each system and reflected in the preceding illustration, are the determining factors in how they are best employed. The capabilities of the AN/PPS-5 and AN/PPS-15 include—

- They can penetrate smoke, haze, fog, light rain and snow, and light foliage.
- They are equally effective day or night.
- They can detect moving personnel and equipment.
- They can distinguish between wheeled vehicles, tracked vehicles, and personnel.
- They are transportable and man-portable.
- They have quick set-up and tear-down times.
- They are capable of real-time reporting.

The limitations of the AN/PPS-5 and AN/PPS-15 are—

- They require line of sight (LOS) to the targeted area.
- Their performance is degraded by heavy rain and snow, dense foliage, and high winds.
- They are active emitters and are subject to enemy REC activities and subsequent enemy fires.
- They cannot distinguish between enemy and friendly movers.
- One unique limitation—the AN/PPS-5 is a heavy system and its effectiveness is reduced in fast-mewing operations.

The AN/PPS-5 and AN/PPS-15 GSR are capable of performing a variety of surveillance missions to support the battalion's combat operations. They can be used—

- To search for enemy activity on avenues of approach, possible enemy attack positions, and assembly areas.
- To observe point targets, such as bridges, road junctions, or defiles, to detect movement.
- To scan final protective fire areas for enemy movement to ensure timely firing.
- To confirm targets developed by other collectors, such as remotely employed sensors (REMS), OP, and other surveillance means.
- To extend surveillance capabilities of patrols by surveying surrounding areas and distant points for enemy movement.
- To help in the control of units, especially during night operations, by locating friendly units, vectoring patrols, and warning them of enemy activity near their positions or along their routes.
- To assist the visual observation of units during daylight by detecting targets partially hidden by haze, smoke, or bright sun.
- To increase the effectiveness of fire support by accurately locating targets.
- To cue the FIST by reporting enemy activity.
- To determine the rate of movement of a target by plotting its location and measuring the time it takes to move from one point to another.
- To survey target areas immediately after friendly-fires are lifted to detect enemy activity and determine effectiveness of fire.

**Remote Sensors.** REMS, like GSRs, are a near all-weather, day/night surveillance system. They provide an additional source of information for the battalion commander. These sensors can be used either alone or to complement or supplement other

RSTA assets, such as ground surveillance radars. They provide information for the production of intelligence and timely, accurate target acquisition data. They are emplaced in areas of expected enemy activity and monitored by teams located in friendly forward areas. Movement of enemy forces within the sensor radius is detected and indications are transmitted to the monitoring team. These indications are then analyzed by the team and the resulting information is reported to the battalion S2.

The major advantages of remote sensors are—

- Timeliness. Information is near-real time and can effect an immediate response or target acquisition role by the supported command.
- All-weather. Adverse weather conditions will not affect the operational cycle of remote sensors.
- Full-time or constant operation without regard to visibility or fatigue.
- Suitable for employment in high-risk environments due to expendability and a high probability of recovery in certain situations.

Sensors may be hand-emplaced by maneuver unit patrols, long-range reconnaissance patrols, long-range surveillance operations, or by sensor teams. The major advantages of hand emplacement include accurate determination of sensor location, better camouflage, and confirmed detection radius of each sensor. Disadvantages include threat to the implant team, the time factor required to install several strings, and the limited number of sensors that can be carried by the implanting team. Aerial emplacement is primarily by helicopter. This method provides an accurate and quick response to the ground commander's request for support. Air delivery provides access to areas inaccessible to ground elements, speeds emplacement, and increases the number of sensors that can be emplaced during a single mission. Army air asset capabilities are limited by enemy air defense measures, the inability to accurately determine the detection radius, and adverse weather conditions. Although not currently used in this role, high performance aircraft and Army fixed-wing aircraft may also perform sensor implant missions.

### HAND EMBLACEMENT





## AERIAL EMPLACEMENT



Remote sensor personnel from the division's MI battalion may be attached to, or placed in direct support of the maneuver battalion as members of the surveillance platoon or squad mentioned earlier. They may be further attached to the maneuver battalion's subordinate companies or the scout platoon. These sensors are used—

- To monitor roads, trails, and avenues of approach.
- To monitor road junctions and bridges.
- To monitor possible assembly areas.
- To monitor drop and landing zones.
- To provide target data for immediate use.
- To extend OP capabilities.
- To monitor obstacles and barriers.
- To perform similar tasks designed to detect the movement of personnel or vehicles.

**Other MI Support.** Counterintelligence, signals security (SIGSEC), enemy prisoner of war (EPW) interrogators, and EW resources from brigade and higher echelons are capable of providing IEW support to the maneuver battalion. However, this support is limited and is normally indirect in nature. The maneuver battalion's requirements for such support are usually submitted to, and satisfied by, echelons above battalion level.

OPSEC evaluations conducted by CI, SIGSEC, and other specially trained IEW personnel is one form of support which would require direct contact with the maneuver battalion commander and his staff.

These forms of IEW support provided by MI organizations are described in greater detail later in this chapter and in follow-on chapters, as well.

### Army Aviation

Division- and corm-based Army aviation units provide the maneuver brigade and battalion commanders a responsive, mobile, and extremely flexible means to find, fix, disrupt, and destroy enemy forces and their supporting C<sup>3</sup> facilities. These combat aviation assets include—

- **Cavalry or reconnaissance squadrons** to perform reconnaissance, surveillance, and security or screening missions.
- **Attack helicopter battalions** to provide aerial escort and suppressive fires to support air assault operations, to destroy enemy C<sup>3</sup> and logistics assets, to attack enemy formations penetrating the close operations area, and to conduct deep attack and joint air attack team (JAAT) operations.

- **Combat aviation companies and battalions** to provide airlift support for combat troops and assault forces; to evacuate damaged equipment, casualties, and EPW; and to implant aerial-delivered scatterable mines and REMS.
- **Aerial Scouts**
- **MI combat electronic warfare and intelligence (CEWI) aviation assets at division and corps** perform offensive EW and aerial reconnaissance and surveillance missions.

The majority of combat aviation assets discussed above normally remain under the operational control of their parent organization or respective branch command and control authorities. They usually provide general support (GS) to echelons above brigade. This is especially true for the MI CEWI assets. For example, the aerial EW and surveillance companies subordinate to the MI brigade (CEWI) (corps) always remain as integral elements of all MI brigades and usually are GS to the corps, as a whole. The QUICKFIX flight platoon subordinate to each division's combat aviation brigade (CAB) also remains OPCON to the MI battalion (CEWI); it is usually held in GS to the division.

The combat missions capable of being performed by Army aviation assets are of extreme importance to maneuver brigade and battalion commanders, regardless of the command and support relationships involved.

EPW evacuation plans should address aviation asset availability to expedite captured personnel, documents, and equipment to the rear as fast as possible.

Remote sensor operations must be coordinated, especially if MI supporting REMS monitoring teams are required in the forward maneuver battalions' AO.

Combat information, target acquisition data, and intelligence must also be exchanged.

Both lethal attack and nonlethal ECM attack efforts against close or penetrating enemy forces must be integrated and syn-

chronized with the brigade and battalions' ground maneuver schemes and supporting fire plans.

The suppression of enemy air defense (SEAD) weapons systems and their supporting C<sup>3</sup> system as well, is an integral part of any combat aviation operation. It is only through the fully synchronized and coordinated effort of the entire air-ground combat team that the success of close maneuver forces can be achieved. Air-ground combat and combat support operations require the full participation and both intra- and interaction of all staff sections at echelons of command. The maneuver battalion's participation is limited, however, to operations conducted within its immediate or adjacent AO after proper coordination has been conducted. The maneuver battalion commander plans for and requests Army combat aviation and tactical Air Force support, as well. Their plans and requests for Army or joint air support include all of the forms of IEW support described above.

### **Tactical Air Force**

JAAT, a combination of Army attack and scout helicopter and Air Force close air support (CAS) aircraft, normally operate with ground maneuver forces of brigade or battalion size. They combine with field artillery, mortars, and air defense weapon systems to attack high payoff targets. Both Air Force electronic combat and Army aerial and ground-based jammers support their attack to suppress enemy air defenses. Army ECM systems may also support or participate in the attack of primary and secondary C<sup>3</sup> targets.

Preplanned JAAT missions, even those planned on a contingency basis, are absolutely essential if the full potential of the entire air-ground combat team is to be realized. The forecasting of operational requirements and generation of operational concepts stimulates the detailed planning necessary at higher echelons and supporting headquarters. Again, all staff officers participate, especially the S2, the S3, S3-air, fire support officer, and Air Force liaison officer (ALO) from the tactical air control party (TACP).

The TACP at the maneuver battalion is the bottom link in the tactical air control system (TACS). The TACS, together with the Army air-ground system (AAGS), comprise the air-ground operations system (AGOS). The AGOS provides an interface for the joint air-ground fire support system. It links Army fire support coordination agencies—the fire support elements—with TACP from battalion through corps level and on up to the tactical Air Force headquarters or tactical air control center (TACC).

The AGOS also provides the means for the maneuver battalion S2 to forward immediate tactical air reconnaissance requests up the chain in the most expeditious manner. Air reconnaissance (air recce) reports, in-flight combat information reports, and air situation reports are all available via the AGOS and TACP.

Joint protect and counter C<sup>3</sup> actions—all actions, to include coordination of Air Force electronic combat (EC) and Army offensive EW—are communicated via the AGOS. It provides the most expeditious means for forwarding EC\EW support requests. Immediate recognition of probable EC interference on friendly C<sup>3</sup> systems is communicated via the AGOS. An immediate means to recognize such interference is available and will be discussed later within this manual.

### Air Defense Artillery

Short-range air defense (SHORAD) elements normally support the maneuver battalion. These may include both Stinger/Redeye teams or sections and Chaparral/Vulcan squads. The air defense artillery (ADA) platoon or section leader functions as the battalion air defense officer. He works closely with the battalion S3-air, the fire support officer, and the ALO. He helps plan, direct, and coordinate both offensive and defensive counter-air and air defense operations. He also interfaces and exchanges information with the battalion S2 regarding enemy ground and air activities. The battalion air defense officer's resources are specially equipped to support this function.

Forward area alerting radar and target alert data display set (FAAR/TADDS) systems provide air alert warning information to Chaparral and Vulcan squads and Stinger/Redeye teams. Alert warning information includes the tentative identification and approximate range and azimuth of approaching low-altitude aircraft out to a range of 20 kilometers. Other characteristics and capabilities are shown on the following page.

The FAAR/TADDS systems provide low-altitude air defense weapons early warning to assist the engagement process. Final identification, however, for all low-altitude ADA weapons is always visual. Nonetheless the information provided by the FAAR/TADDS systems, together with information available from the area-wide ADA command and control system, provides the battalion commander important combat information regarding the enemy air situation. The possibility of enemy air assault and air-ground attack operations to exploit close-in tactical objectives or to thwart counterattacks carried out by the battalions should never be forgotten. The dissemination of early warning information to forward-deployed subunits allows for earlier final identification. Small arms air defense systems such as 25mm cannons and 7.62mm or .50 caliber machine guns can then be used to engage the aircraft in accordance with active air defense procedures and objectives.

### Combat Engineers

The maneuver battalion receives engineer support from the engineer company normally placed in direct support of the brigade—a combat engineer platoon. Its mission is to provide mobility, countermobility, survivability, and general engineering support to the battalion and its organic, attached, or supporting units.

- **The mobility mission** is to negate the effects of natural or man-made obstacles and to enhance the mobility of maneuver and combat support forces.
- **The countermobility mission** is to construct obstacles, barriers, and denial positions. The purpose is to

impede the mobility of enemy forces, to increase the time for target acquisition, and to maximize the effects of friendly maneuver of firepower in designated engagement areas.

- **The survivability mission** is to develop protective positions in order to

counter enemy surveillance capabilities and to reduce the effectiveness of enemy weapon systems.

- **General engineering missions** are performed to support any other requirements deemed essential for maneuver and combat support units.

## FAAR AND TADDS CHARACTERISTICS

**TADDS**

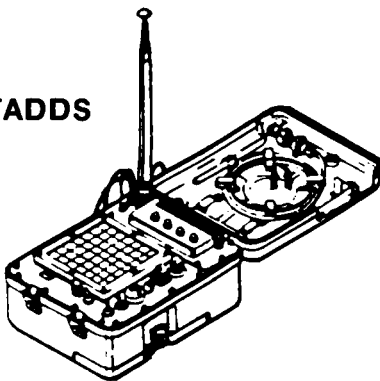

The battery-operated TADDS is a lightweight receiver used by weapon crews to receive target alert information transmitted from a FAAR. It receives and displays, on a matrix, location, and tentative identification of aerial targets detected by its associated FAAR.

The FAAR system (radar system AN/MPQ-49) is a complete self-contained acquisition radar system consisting of radar set AN/TPQ-43—AN/TPX-50 (IFF), the M561 Gama Goat, and a 5-kw generator set mounted in a cargo trailer.

**TADDS**

LOS required to FAAR

**FARR (Radar)**

Range	
Target Detection	20 km
FM Data Link	15 km and LOS
Communications	VRC-46
Emplacement Time	20-45 min
March Order Time	20-30 min
IFF System	AN/TPX Mark XII

**Prime Mover**

Weight (Combat Loaded)	12,000 lbs
Fording Depth	24 in
Slope Limitations	
Emplacement	10°
Max Traverse (Curbside)	
Downhill	17°
Uphill	21°

**MAJOR COMPONENTS**

- PRIME MOVER
- SHELTER
- AN/TPQ-32
- AN/TPX-50 (IFF)
- COMMUNICATIONS
- EQUIPMENT
- CARGO TRAILER
- GENERATOR

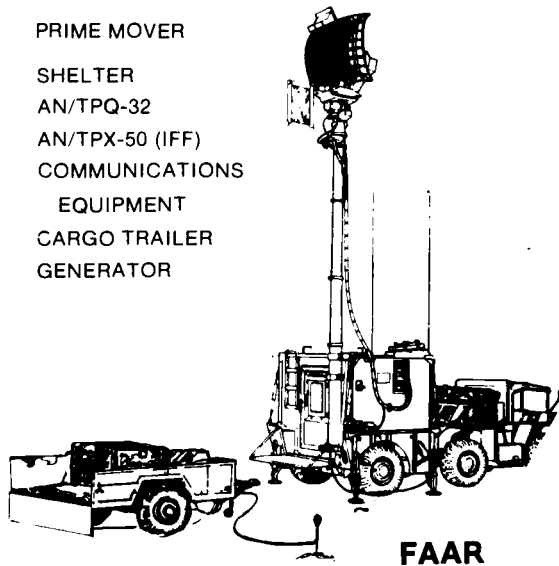

Intelligence and electronic warfare support, per se, is not endemic to the mission of combat engineers. It is limited to the combat information provided by individual soldiers and engineer reconnaissance or terrain data obtained to support their assigned missions. The support which combat engineers provide to other IEW resources however, is absolutely essential.

Electronic warfare resources from the division and corps require line-of-sight to their target areas and, for the most part, operate within the maneuver battalion's AO. Many of these systems have limited mobility. Others require flat terrain for the employment of given antenna systems. The degree of slope in given geographical areas may render these vital collection and jamming systems virtually inoperative. Accessibility to key terrain is imperative. Combat engineer support is critical and must be provided prior to combat, when required.

This is another situation in which direct contact and extensive coordination among the S2, S3, and engineer support officer, and the EW platoon or team leader is required. Such coordination at brigade and division level early in the planning process sets the stage for effective follow-through actions at the maneuver battalion itself.

### **Combat Service Support**

Combat service support (CSS) resources organic or available to the maneuver battalion, like combat engineers, do not have an IEW mission beyond that of the individual soldier. Their support to other IEW resources, however, is just as essential as that of the combat engineers, when required.

One requirement which must be considered and planned for is the evacuation of captured enemy documents (CEDs), equipment, and EPW from the forward combat areas. The maneuver battalion S2 must anticipate the accrual rate. The availability of transportation and security assets required to ensure the most rapid evacuation of captured EPW and material must then be determined. Requirements that exceed the battalion's capability are forwarded to the brigade and higher headquarters for incorporation into the area-wide evacuation plan. Contingency plans

must also be considered, developed, and maintained. This is the job of the battalion staff, the support platoon leader, and subordinate company commanders. Battalion resources are illustrated on the next page.

The maneuver battalion's organic, attached, and supporting IEW resources are capable of providing the commander with a vast amount of information about close-in enemy forces. The ADA FAAR/TADDS systems and MI GSR resources provide the commander early warning and indications of enemy air and ground activity out to and beyond the limits of the battalion's AO. They can acquire, track, and monitor HPT as they enter the battalion's close operations area. Field artillery FIST at the maneuver companies acquire, track, and report close HPT for immediate destruction by indirect fire means. Patrols, night observation devices, and observation posts conducted, used, and established by the maneuver company commanders and the scout platoon leader also acquire, confirm, report, track, and monitor HPT in the close operations area. Ultimately, it is the individual soldier, who is in the right place at the right time, who knows, sees, and kills his enemy and wins the fight.

### **BRIGADE IEW RESOURCES**

Brigade, division, and corps commanders ensure the success of the maneuver battalions' close and rear operations. They plan, direct, and coordinate attacks against enemy follow-on echelons. They attack enemy first-echelon sustainers and follow-on echelons, as well. Their purpose is to attrite the fighting capacity of advancing enemy forces before they close on the maneuver battalions' AO. Intelligence and electronic warfare resources support their synchronized battle plans.

The maneuver brigade commander's IEW resources include his coordinating and special staff, cross-reinforced maneuver battalions—battalion task forces—and attached or supporting combat and combat service support units. The manner in which the brigade is organized for combat is derived from the division commander's concept of operations and his evaluation of the

# BATTALION RESOURCES

## RESOURCES

## BATTALION BATTLE

### ORGANIC RESOURCES

Scout Platoon

Maneuver Companies

### SUPPORTING RESOURCES

Field Artillery (FIST)

Military Intelligence (GSR)

Army Aviation

Tactical Air Force

Air Defense Artillery

3 km 5 km 10 km 20 km

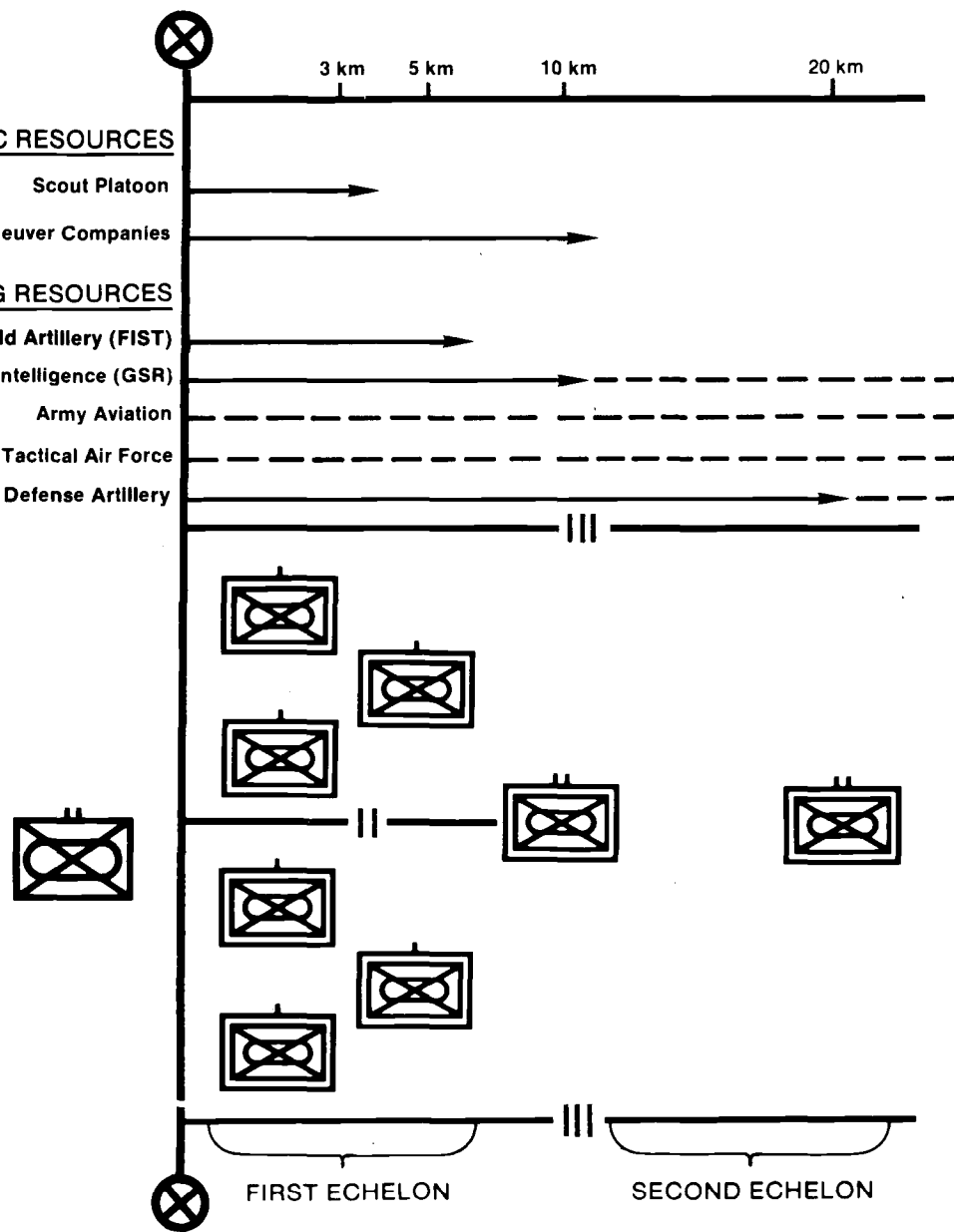

NOTE: Range Approximated

brigade commander's information and operational needs—the METT-T planning factors.

The maneuver brigade commander has direct influence on how his brigade is organized for combat. He and his staff continuously plan and forecast their requirements to higher headquarters. They consider the functions, capabilities, and limitations of all IEW resources available within division- and corps-based units. They integrate IEW into their operations plan. They realize the maximum potential from their IEW, maneuver, and fire support systems. They succeed in combat.

However, requirements not considered are requirements not specified. Requirements not specified are, potentially, requirements not fulfilled. And requirements not fulfilled in combat lead to defeat. All requirements must be considered, specified, and fulfilled if the division's close operations are to be successful.

### **FIELD ARTILLERY**

Field artillery target acquisition resources detect, identify, and locate HPT for immediate attack. They also provide accurate and timely combat information to orient and cue other RSTA assets. Sound-ranging and weapons-locating radars are the principal means within division artillery for locating active enemy indirect-fire weapon systems. Moving-target-locating radars and sound observation posts normally positioned along the forward edge of the battle area (FEBA) are also capable of acquiring targets and collecting combat information. Division artillery also provides survey support to divisional and non-divisional RSTA assets using conventional survey techniques or the position and azimuth determination system (PADS).

#### **Weapons-Locating Radars**

The target acquisition battery (TAB) of division artillery (DIVARTY) is equipped with three AN/TPQ-36 mortar-locating radars and two AN/TPQ-37 artillery-locating radars.

**AN/TPQ-36.** The AN/TPQ-36 radar detects and locates enemy mortars and artillery for immediate engagement by indirect fire means. It uses a combination of

radar techniques and computer-controlled signal processing methods to detect, verify, and track projectiles in flight. The tracking data are used to determine the projectile's trajectory. These data are used to determine the location of enemy weapon systems and firing batteries via the back azimuth of the projectiles. The data are transmitted digitally to a fire direction center (FDC) or the DIVARTY tactical operations center (TOC). This system can detect and locate weapons firing simultaneously from multiple positions. It can also be used to register and adjust friendly indirect fire. The maximum range of the AN/TPQ-36 is 15 kilometers for mortars and artillery and 24 kilometers for rockets.

**AN/TPQ-37.** The AN/TPQ-37 detects and locates enemy artillery and rocket weapons for immediate counterfire. It uses techniques similar to those of the AN/TPQ-36 radar system and has similar capabilities. Its automatic search and simultaneous tracking capabilities allow it to detect and locate enemy weapon systems firing simultaneously from multiple positions. Its maximum range is 30 kilometers for artillery and 50 kilometers for rockets.

**AN/MPQ-4A.** The AN/MPQ-4A radar can detect and locate enemy mortars, cannons, and rockets using techniques similar to those of the AN/TPQ-36 and AN/TPQ-37 radars. However, it has only a one-round detection capability. It is vulnerable to saturation from multiple rounds being fired. Its range is limited to 15 kilometers. The AN/MPQ-4A is currently being replaced by the new AN/TPQ-36 and AN/TPQ-37 radars. It may still be used in some DIVARTY TABs.

All of the weapons-locating radars discussed above are active emitters and are, therefore, subject to enemy radio direction finding activities and subsequent jamming or destruction.

### Sound Ranging Equipment

The DIVARTY TAB is currently equipped with four sound ranging sets—the AN/TNS-10. Two AN/TNS-10 are used with an OL-274 computer, two radio data links, AN/GRA-114, and two sound plotting sets, M-53. Two AN/TNS-10 systems can cover an area 10 kilometers in width and approximately 20 kilometers in depth.

Under favorable conditions, accuracies of 0-150 meters can be obtained. Sound ranging does not require line-of-sight and can be used, therefore, to locate enemy artillery in defilade. It is particularly effective in fog. It is a passive collection system. It is not vulnerable to enemy detection and subsequent jamming or destruction. Gusty winds, mountainous terrain, and heavy bombardment are factors which limit its performance.

### Moving-Target-Locating Radars

The DIVARTY TAB is equipped with either one AN/TPS-25A or one AN/TPS-58B moving-target-locating radar (MTLR). These battlefield surveillance radars are similar to the GSR described earlier, in that they can detect, locate, and distinguish wheeled vehicles, tracked vehicles, and dismounted personnel. They are used as the GSR to augment other radar surveillance systems to cover critical areas, such as major avenues of approach.

The AN/TPS-25A radar can locate moving targets to within 100 meters. Its maximum range is 18.28 kilometers for vehicles and 12 kilometers for personnel.

The AN/TPS-58B radar's maximum range is 10 kilometers for personnel and 20 kilometers for vehicles. It can locate targets to within 50 meters.

More detailed information about the capabilities and employment of MTLR, weapons locating radars, and sound ranging systems is shown below.

FIELD ARTILLERY TARGET ACQUISITION ASSET CAPABILITIES							
ASSET	MAXIMUM RANGE (KM)	SECTOR WIDTH COVERAGE	ACCURACY OF LOCATION	REQUIRED SURVEY	EMPLOYED DISTANCE FROM FLOT (KM)		TECHNICAL DATA
					OFFENSE	DEFENSE	
<b>WEAPONS-LOCATING RADARS</b>							
AN/MPQ-4	15	445 mils	50 meters high-angle radial error RE 200 meters low-angle (RE)	5th order	1-4	3-7	FM6-161
AN/TPQ-36	15 (mortar/ artillery) 24 (rockets)	1,600 mils	± 50 meters	5th order	1-6	3-8	FM6-161
AN/GLQ-37	30 (artillery) 50 (rockets)	1,600 mils	± 50 meters	4th order	1-12	8-12	FM6-161
<b>MOVING-TARGET-LOCATING RADARS</b>							
AN/TPS-25	18 (vehicles)	360 or 540 mils	100 meter	5th order	1-2	1-2	FM 6-161
AN/TPS-58	20 (vehicles)	500- 2,500 mils	50 meters	5th order	1-2	1-2	FM6-161
<b>SOUND RANGING</b>							
AN/TNS-10	20 nominal, based on terrain and weather	270 mils right and left of flank microphones	150 meters RE	4th order	1-4	3-5	FM6-122



## Air Observers

The DIVARTY support platoon of the heavy division's CAB provides rotary wing aircraft for DIVARTY air observers. Field artillery air observers (FAAOs) are allocated by the DIVARTY S3 to augment other target acquisition assets in the forward areas, as required. Their mission is to call for and adjust fires from any fire support means available. FAAO are used to cover areas masked from ground observers, to cover thinly resourced areas, to provide coverage while ground-based RSTA assets displace, and to reinforce surveillance of vulnerable areas. They accompany highly mobile forces and normally operate as close to the line of contact as possible. Targeting data and combat information are reported to the FSO at the maneuver brigade or battalion, the DIVARTY TOC, or the FDC of the direct support (DS) field artillery battalion responsible for that brigade zone or sector.

## Direct Support Field Artillery Battalion

A field artillery battalion from DIVARTY is usually placed in direct support of the maneuver brigade. One mortar-locating radar, the AN/TPQ-36, is normally attached to the DS field artillery battalion. Other target acquisition assets which may be employed are battalion observation posts and MTLR.

**Weapons-Locating Radar Section.** An AN/TPQ-36 radar section, when attached to the DS field artillery battalion, maybe further attached to a subordinate firing battery. However, it remains under the operational control of the DS battalion. The radar section also remains responsive to DIVARTY guidance on positioning, coverage zones, cuing, frequencies, and transmission duration.

The DS field artillery battalion S2 has staff supervision responsibility for the radar. He coordinates with the DIVARTY counterfire office, the DS field artillery battalion S3, and the FSO at the maneuver brigade to integrate his target acquisition effort and to ensure that both fire support and maneuver coverage requirements are met. Cuing instruction and target criteria

are required to maximize the effectiveness of the radar. Such information is routed through the DS field artillery battalion's TOC to the radar. Again, EW resources operating in the brigade or battalion's AO can provide information to cue the AN/TPQ-36 before the enemy fires. They strive to locate mortar and artillery firing batteries, FDC, and COP. They can also disrupt enemy mortar and artillery C<sup>3</sup>. These capabilities and the staff interaction necessary to see that it gets done are discussed later in this chapter.

**Battalion Observation Posts.** Field artillery battalion observation posts (BOPs) are established to increase area coverage. These BOPs are manned by personnel from the field artillery battalion's survey parties or other available trained personnel. These personnel survey designated target areas. They perform field artillery observation duties to include high burst (HB) and mean point of impact (MPI) registrations. Targeting data and combat information collected by personnel are transmitted to the field artillery battalion FDC or the FSO at the maneuver battalion or brigade.

The employment of BOPs is dependent upon the availability of survey personnel who provide survey support to all field artillery and other combat support units operating within the brigade's AO. Survey requirements have priority over BOP prior to combat. Most EW intercept and direction-finding systems require survey support, especially at night. Other IEW resources may require similar support. The IEW support element (IEWSE) should coordinate all survey requirements with the DS battalion S3.

**Moving-Target-Locating Radar Section.** The DS field artillery battalion may have one MTLR section equipped with either the AN/TPS-25A or the AN/TPS-58B. The MTLR section is normally kept under DIVARTY control. However, it may be attached to the DS field artillery battalion to provide DS to the maneuver brigade in certain situations. The MTLR is a source of both targeting data and combat information for the maneuver brigade commander, regardless of the command and support relationship which may exist. The FSO at

the maneuver brigade TOC receives information collected by the MTLR from the DS field artillery battalion or the DIVARTY TOC itself. He exchanges this information with the maneuver brigade S2 and S3. The opposite is also true. The maneuver brigade S2 and S3 provide the FSO targeting data, combat information, and intelligence collected or produced by all other resources available to them to help cue the MTLR.

### Fire Support Coordination

The DS field artillery battalion commander is the FSCoord for the maneuver

brigade. He provides the brigade headquarters with the FSS which was described earlier in this chapter. The FSS establishes and maintains an FSE at the brigade TOC. The brigade FSE is similar to the maneuver battalion FSE described earlier. It is run by an FSO. The FSO is the brigade's assistant FSCoord. He is the DS field artillery battalion commander's senior representative at the brigade TOC. The FSO interfaces with members of the brigade's coordinating and special staff to help integrate, plan, direct, and coordinate IEW, maneuver, and fire support operations. The FSE is responsible for coordinating both lethal and nonlethal attack means for the brigade S3.

### VARIABLE FORMAT MESSAGE ENTRY DEVICE

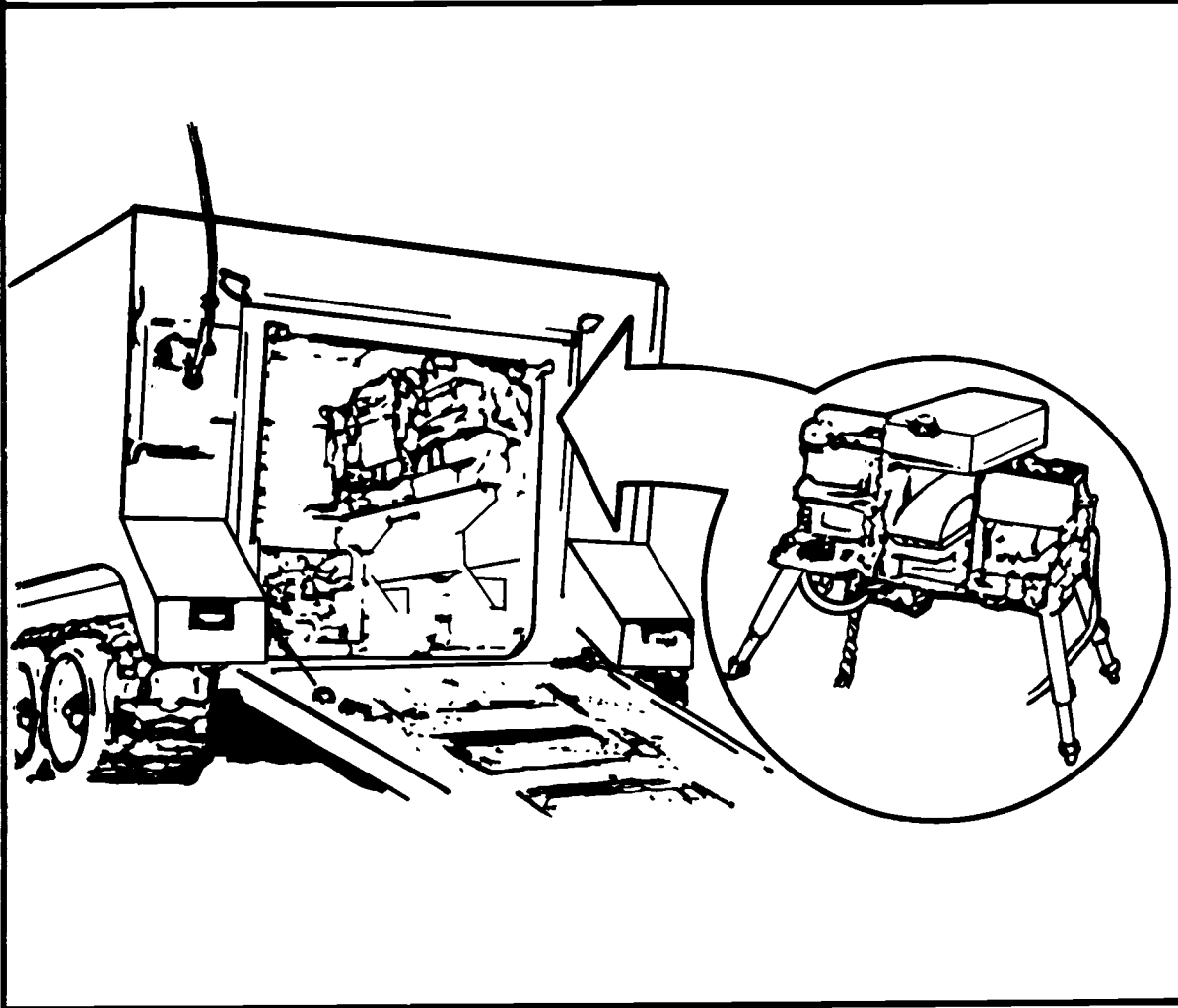

The FSEs at brigade and maneuver battalions are equipped with a variable format message entry device (VFMED) to send and receive information to and from TACFIRE computers at the DS field artillery battalion TOC and DIVARTY TOG. An FSE at the division TOC is also equipped with a VFMED. Thus, the fire support command and control system in TACFIRE-equipped organizations is extremely responsive to tactical commanders at all echelons from company through division-level. The company FIST DMD, discussed earlier in this chapter, interfaces with the VFMED-equipped FSE at the maneuver battalion and also the TACFIRE computer at the DS field artillery battalion. Each firing battery subordinate to the DS field artillery battal-

ion is equipped with a TACFIRE receive-only battery computer system (BCS). The BCS can receive TACFIRE information from either the company FIST using the DMD or the DS field artillery battalion's TACFIRE computer. Command and fire nets using secure FM voice communications provide a secondary means to interface components of the fire support C<sup>2</sup> system. Secure FM voice communications are the primary means of C<sup>2</sup> in non-TACFIRE units. Intelligence and operations nets also extend from company- through division-level to provide maneuver and field artillery commanders a continuous flow of targeting data, combat information, and intelligence. The fire support C<sup>2</sup> system is illustrated below.

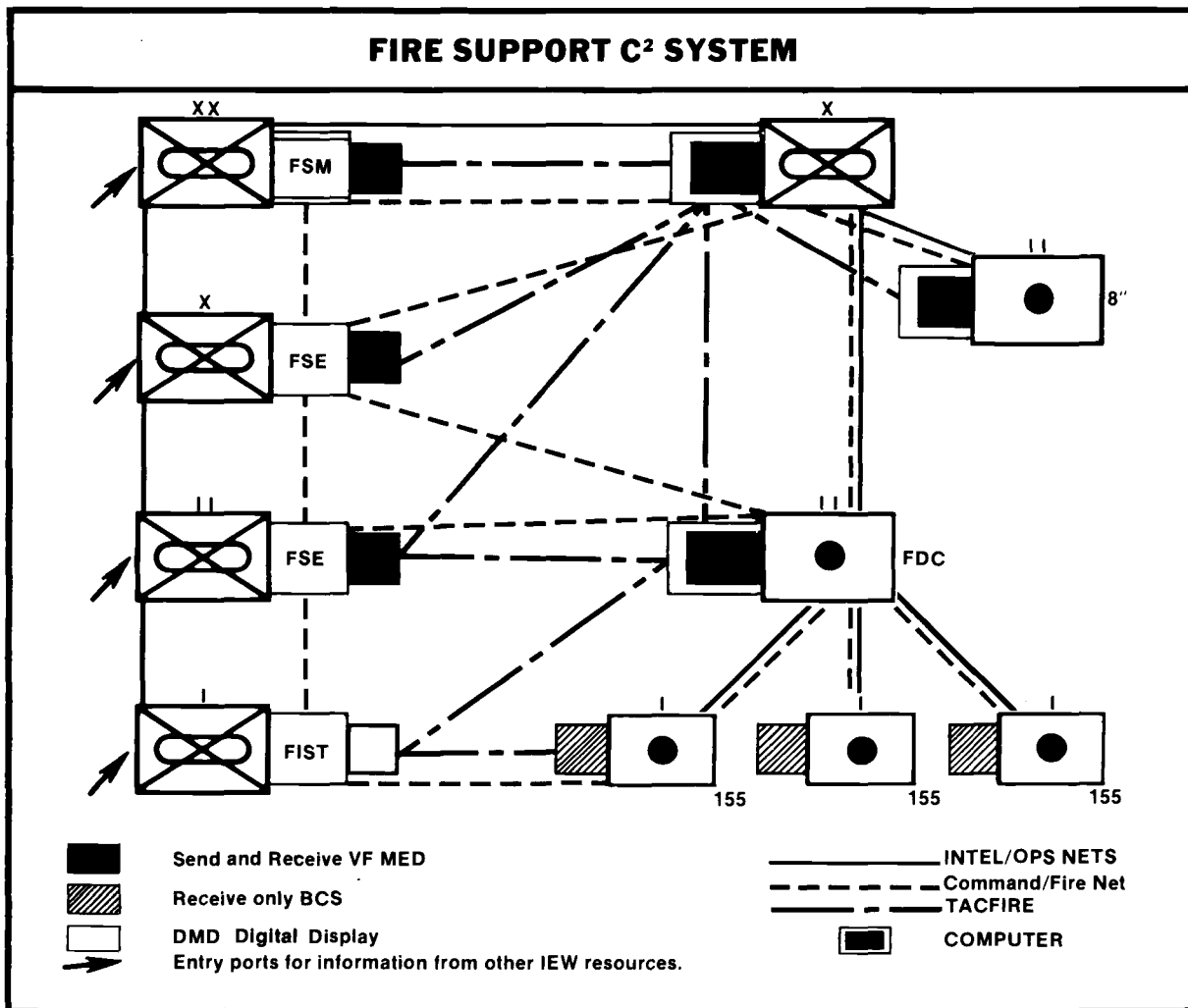

The maneuver brigade and battalion S2 have direct access to the fire support C<sup>2</sup> system via the FSO. Targeting data, combat information, and intelligence collected by other IEW resources such as GSR and EW are passed to the FSO. Such information flows both ways. Thus, the maneuver brigade and battalion S2, S3 and FSO provide the conduit for exchanging all forms of information. Well planned and effectively executed RSTA activities and lethal and nonlethal attack missions depend on their knowledge and ability to skillfully maximize the combat potential of all fire support, maneuver, and IEW resources.

### MILITARY INTELLIGENCE

Military intelligence resources are dedicated to the IEW missions. Multidisciplined intelligence, CI, and EW resources are available at both division and corps levels to support the maneuver brigade and battalion. The MI battalion (CEWI) (division)

provides GS and DS IEW capabilities to the division and elements of the division based on METT-T planning. The MI brigade (CEWI) (corps) may provide the division MI battalion additional IEW resources depending on the factors of METT-T, aggregate requirements, and mission priorities. The IEW resources organic or OPCON to the MI brigade and MI battalion include:

- EPW interrogator—both.
- CI support personnel—both.
- Aerial surveillance assets—side-looking airborne radar (SLAR), infrared, and photography—corps only.
- Aerial EW assets—ESM only at corps, ESM and ECM at division.
- Ground-based EW assets—both.
- GSR and REMS assets—division only.

The distribution of these IEW resources and their normal allocation of support to the division and its subordinate maneuver brigades and battalions are shown below.

MI RESOURCES						
ECHELON	ORGANIC RESOURCES			ALLOCATED SUPPORT		ALLOCATED SUPPORT
CORPS	<b>MI BRIGADE (EAC):</b> EPW Interrogators    Aerial Surveillance CI Support            SLAR Ground-based EW    Infrared Aerial ESM            Photography					
DIV	<b>MI BATTALION</b> EPW Interrogators    Ground-based EW CI Support            GSR Aerial EW <sup>1</sup> REMS			Interrogators CI Support Ground EW		
BDE	NONE			Interrogators <sup>2</sup> CI Support <sup>2</sup> Ground EW <sup>2</sup> GSR REMS		
BN	NONE					Interrogators <sup>3</sup> CI Support <sup>3</sup> GSR REMS

NOTES: <sup>1</sup>Organic to the division's combat aviation brigade,<sup>1</sup>but under the operational control of the MI battalion.  
<sup>2</sup>Normally hid in general support (GS) of the division and provide direct support (DS) to divisional brigades on a priority basis.  
<sup>3</sup>Direct support (DS) on a contingency basis, only. Operational control remains with brigade or the MI battalion.

The corps MI brigade commander normally retains his organic aerial surveillance and aerial ESM resources in GS of the corps and under his operational control. He retains and allocates EPW interrogator and CI resources, as required, to satisfy corps, division, and brigade requirement. Most of his ground-based EW resources, however, require LOS to their target areas and must operate within the forward areas close to the FLOT. They are normally allocated, therefore, to divisional and nondivisional MI units to support their respective IEW operations.

The division commander, like the corps commander, normally retains his aerial EW resources in GS of the division and under his operational control. His organic and supporting EPW interrogator and CI resources are task organized to provide GS to the division and DS to the maneuver brigades when required. His organic and supporting ground-based EW resources, however, normally remain under the operational control of the MI battalion commander. The ground-based EW resources respond to brigade requirements in accordance with the priorities and coordinating instructions established by the division commander and the G2 and G3, respectively. The MI battalion commander task organizes his GSR and REMS assets to provide support to divisional brigades. These resources are normally attached to the brigade. They can be further attached to the brigades' maneuver battalions, scout platoon, and company teams.

Brigade and battalion commanders' information and operational needs—their

IEW requirements—and the division commander's concept of operation are the major considerations which ultimately determine how MI resources are task organized. The capabilities, limitations, and availability of MI resources to satisfy aggregate maneuver and fire support requirements are the prime factors considered by all commanders and staff personnel, battalion through corps. The process begins at the maneuver battalion.

### Ground Surveillance Radars and Remote Sensors

The capabilities and limitations of GSR and REMS were discussed earlier in this chapter. Most of these resources operate in DS of the maneuver battalions. However, some of them may be held in DS of or attached to the brigade or placed in DS of other division elements. For example, the brigade elements and DISCOM'S forward support battalion (FSB) in the brigade support area (BSA) may require GSR support for security purposes. Rear operations cannot be forgotten. Aggregate requirements are considered by the brigade S2, the division tactical surveillance officer (TSO), the division G2, and the MI battalion commander and his staff. Reconnaissance and security requirements, mission priorities, and the availability of GSR and REMS resources are the determining factors.

The number of GSRs authorized the MI battalions organic to armored and mechanized divisions (heavy), infantry divisions (light), and air assault and airborne divisions, respectively, are shown in the illustration below.

<b>GSR AUTHORIZATIONS</b>				
<b>GSR</b>	<b>ARM/MECH DIVISION</b>	<b>INFANTRY DIVISION</b>	<b>AIR ASSAULT DIVISION</b>	<b>AIRBORNE DIVISION</b>
<b>AN/PPS-5</b>	<b>6</b>	<b>9</b>	<b>9</b>	<b>9</b>
<b>AN/PPS-15</b>	<b>18</b>	<b>21</b>	<b>24</b>	<b>27</b>
<b>TOTAL</b>	<b>24</b>	<b>30</b>	<b>33</b>	<b>36</b>

The number of GSR systems equates to the number of GSR teams available. There are three personnel per AN/PPS-5 team and two people per AN/PPS-15 team. Team mobility is tailored by TOE to match that of supported units. The types of vehicles used range from armored personnel carriers, M1 T3, to the new highly mobile and multi-wheeled vehicle (HMMWV) 5/4-ton 4x4 truck, M1028. Each team is equipped with a standard VHF FM radio—an AN/VRC-46, an AN/PRC-77, or an AN/GRC-160.

There are three surveillance platoons organic to each MI battalion. The surveillance platoons in the heavy division MI battalions have two GSR squads. Each squad has one AN/PPS-5 team and three AN/PPS-15 teams. The three surveillance platoons subordinate to the MI battalions organic to other types of divisions have three GSR squads. Each of these squads

has one AN/PPS-5 team and one AN/PPS-15 team. An additional 12, 15, and 18 AN/PPS-15 teams are also authorized the MI battalion organic to infantry, air assault, and airborne divisions, respectively. These additional AN/PPS-15 teams are task organized to round up the number of GSR teams available to each GSR squad and surveillance platoon placed in DS of or attached to maneuver brigades and their subordinate battalions. They may also be held in DS of the brigade or placed in DS of other brigade and division elements. Thus, a maneuver brigade subordinate to the heavy, light, air assault, or airborne division may expect at least one surveillance platoon with from 8 to 12 or more GSR teams in support of their combat operations. A nominal brigade slice of GSR assets for each type of brigade is shown in the following illustration.

<b>GSR ASSETS — NOMINAL BRIGADE SLICE</b>				
<b>GSR</b>	<b>ARM/MECH BRIGADE</b>	<b>INFANTRY BRIGADE</b>	<b>AIR ASSAULT BRIGADE</b>	<b>AIRBORNE BRIGADE</b>
<b>PLATOON</b>	1	1	1	1
<b>SQUADS</b>	2	3	3	3
<b>AN/PPS-5 TEAMS</b>	2	3	3	3
<b>AN/PPS-15 TEAMS</b>	6	7	8	9
<b>TOTAL<sup>1</sup></b>	8	10	11	12

**NOTE: <sup>1</sup>Total GSR dependent on METT-T and cross-attachments.**

The MI battalions organic to heavy, light, and air assault divisions are authorized five REMS teams each. The MI battalion organic to the airborne division is authorized three REMS teams. Each REMS team consists of three personnel, one vehicle, and one radio, together with REMS monitoring equipment. Their employment is dependent on mission requirements and the actual availability of sensors themselves. The REMS teams are task organized to augment the surveillance platoons in DS of the maneuver brigade and its subordinate battalions. Additional REMS teams are authorized on augmentation TOE for employment of the Remotely Monitored Battlefield Sensor System (REMBASS), when fielded.

The GSR squads and their subordinate teams are usually attached to the maneuver brigade's subordinate battalions. They may operate with the maneuver battalion's scout platoon, its subordinate company teams, rifle platoons; FIST or other supporting combat units. Staff responsibilities are discussed later in this chapter. Command, control, and communications are discussed in Chapter 3.

### EPW Interrogations

Interrogators are specially trained linguists and intelligence analysts. Their job is to screen and interrogate EPW, detainees, and refugees and to translate CED. Their mission is to collect and report all information possible to satisfy the supported commander's priority intelligence and information requirements. Interrogators are capable of providing information about—

- The past, present, and future missions of given enemy units.
- The composition of given enemy units to include their type (for example, artillery, tank, motorized rifle), organizational structure, and chain of command.
- The disposition of enemy units at given locations, security measures employed, and anticipated times of departure.
- The strength of given enemy units, to include personnel, weapons, ammunition, equipment, and fortifications.
- The tactics, procedures, and techniques used by enemy units to satisfy their mission requirements.
- The logistical support provided enemy units to include the location of rearming and refueling points, supply points, and maintenance repair facilities.
- The combat effectiveness of enemy units, to include their training status, combat readiness, morale, losses, and replacements.
- Electronic technical data with major emphasis on the enemy's C-E operating instructions—frequency usage, call signs, and operating schedules.
- Other miscellaneous information such as the names, background, experience, and competence of enemy unit commanders and staff officers.

The capability of interrogators to provide such information is limited by—

- The time provided at different locations to screen and interrogate EPW, detainees, and refugees.
- The willingness of EPW, detainees, and refugees to cooperate with the interrogator.
- The content and subject matter of CED.
- The number of EPW, detainees, refugees, and CED to screen, interrogate, and translate, respectively.
- The availability of interrogators to do the job.

The number of interrogators authorized within the MI battalions organic to armored, mechanized, infantry, air assault, and airborne divisions follows.

Interrogation resources are task organized to satisfy aggregate mission requirements. The interrogation section is normally deployed at the division collecting point in GS of the division. Interrogation teams are normally placed in DS of forward-deployed brigades. Interrogation

<b>INTERROGATOR AUTHORIZATIONS</b>				
<b>UNIT/PERSONNEL</b>	<b>ARM/MECH DIVISION</b>	<b>INFANTRY DIVISION</b>	<b>AIR ASSAULT DIVISION</b>	<b>AIRBORNE DIVISION</b>
<b>Interrogator Section</b>	<b>1</b>	<b>1</b>	<b>1</b>	<b>1</b>
<b>Interrogators</b>	<b>6</b>	<b>5</b>	<b>5</b>	<b>8</b>
<b>Interrogation Teams</b>	<b>3</b>	<b>3</b>	<b>3</b>	<b>3</b>
<b>Interrogators</b>	<b>6</b>	<b>6</b>	<b>6</b>	<b>6</b>
<b>Total Number of Interrogators</b>	<b>12</b>	<b>11</b>	<b>11</b>	<b>14</b>

teams extend the division's human intelligence (HUMINT) collection effort into the forward areas, when required. Forward-deployed teams usually operate from the maneuver brigade's EPW collection point in the BSA. Each team includes two interrogators, one vehicle, and one VHF FM radio. The interrogation section has two vehicles and two or three VHF FM radios. Additional resources from the corps MI brigade may augment the interrogation section or interrogation teams. The teams may also be cross-attached, based on mission priorities and the workload itself, in one or another brigade AO.

Interrogation operations conducted below division level emphasize rapid screening and brief tactical interrogations of EPW, detainees, and refugees. Enemy documents found on EPW are used to support the screening and interrogation efforts and may themselves provide substantive combat information or intelligence for the commander. All other CED are evacuated to the rear areas as swiftly as possible for exploitation purposes.

Forward-deployed interrogation teams may be placed in DS of the maneuver brigade. The brigade may further allocate these DS interrogation teams to its subordinate maneuver battalions to accomplish specific missions for a specific period of time. Direct support interrogation teams are tasked by, and respond to the brigade or battalion S2. On occasion, DS interrogators

may be attached to a company team or combat patrol. Such missions are unique and usually require detailed planning and approval by higher headquarters, brigade and above. Command and control in such situations is normally retained by the brigade or battalion commander.

### **Counterintelligence Support**

Counterintelligence activities are conducted on a continuous basis throughout all phases of military operations at all levels of command from battalion through EAC. The commander, his staff, and all assigned, attached, and supporting personnel take the actions necessary at each echelon to defeat or degrade the enemy's multidiscipline RSTA effort. Counterintelligence operations include all staff functions regarding the identification of enemy RSTA capabilities and activities; they support the development, execution, and maintenance of OPSEC, deception, and rear operations plans. Counterintelligence operations also include specific operational activities such as—

- Liaison.
- Security investigations.
- Defensive source operations.
- Technical OPSEC and deception evaluations and assistance.
- Security training.
- CI screening and line-crosser operations.



The specific operational activities outlined above are conducted primarily by specially trained CI personnel assigned to MI organizations at echelons above brigade. Such operations are oriented to identifying and defeating or degrading sabotage and espionage activities, such as those conducted by terrorist groups, enemy sympathizers, and enemy-controlled agents—the Level I threat to rear operations areas.

The staff and operational CI functions described above are also designed to identify and counter Level II and Level III threats to rear operations areas. Level II threats include sabotage, reconnaissance, and diversionary operations conducted by special purpose forces (that is, sabotage and reconnaissance groups) and raids, ambushes, and reconnaissance missions conducted by regular combat reconnaissance units of smaller than battalion size. Level III threats include heliborne, air assault, airborne, and amphibious operations conducted by regular and special purpose forces, and deliberate ground force combat operations conducted by an operational maneuver group (OMG) or conventional ground forces to exploit a specific breakthrough in the close operations area. Tactical Air Force, attack helicopter, long-range artillery, rocket, missile, and REC units will also conduct and support deep attack missions against key elements in friendly rear operation areas. These threats may be present at all rear area threat levels, such as I, II, or III. Enemy collection means are illustrated on the following page.

Enemy commanders, as friendly commanders, need accurate and timely intelligence, combat information, and targeting data in order to conduct deep attack missions, while conducting their close and rear operations at the same time. Accurate and timely intelligence, combat information, and targeting data are dependent on the availability and capabilities of multidiscipline collection means and a responsive C<sup>3</sup> system. The enemy has a vast array of multidiscipline collection means to satisfy his intelligence, combat information, and targeting requirements. These collection means include HUMINT, imagery intelligence (IMINT), signals intelligence (SIGINT), and surveillance and target

acquisition resources shown in the foregoing illustration.

The majority of enemy HUMINT collection resources were discussed above in regard to Level I, II, and III threats to friendly rear operations areas. Enemy IMINT, SIGINT, and to a lesser degree, enemy surveillance and target acquisition resources also pose a significant threat to brigade, division, corps, and EAC rear operations. The RSTA threat to the maneuver brigade and battalions' close operations is also readily apparent—it is intense.

The maneuver brigade and its subordinate, attached, and supporting units require extensive CI support during peacetime and prior to actual combat. The division and corps provide the brigade and battalion with intelligence pertaining to enemy RSTA capabilities and existing or anticipated threats to the brigade rear area. The division G2, G3, and MI battalion commander may allocate organic or attached resources to maneuver brigade commanders to satisfy their aggregate CI requirements for OPSEC, deception, and rear operations. These resources come from OPSEC support teams, which include CI and other specially trained personnel from the division staff and the MI battalion.

CI members of the support teams are capable of identifying and countering the specific enemy HUMINT, IMINT, SIGINT, and surveillance and target acquisition means which pose a significant threat to brigade operations. They help develop or refine friendly forces profiles and monitor and evaluate the most sensitive aspects of the division and brigades' OPSEC program and deception operations. More specifically, they assist the brigade's coordinating and special staff in—

- Identifying the hostile collection and rear operations threat to the brigade and its subordinate maneuver battalions.
- Determining the essential elements of friendly information (EEFI) that require protection.
- Identifying brigade and battalion vulnerabilities to enemy RSTA, REC, and

## ENEMY COLLECTION MEANS

ENEMY	TO:				
	EAC	CORPS	DIV	BDE	BN
<b>HUMAN INTELLIGENCE (HUMINT)</b>					
Terrorists	X	X	X		
Enemy Sympathizers	X	X	X	O	O
Enemy Agents	X	X	X		
Line Crossers	O	O	O	X	X
Sabotage and Reconnaissance Groups	X	X	X	O	
Reconnaissance Units		O	O	X	X
Combat Units			X	X	X
Enemy Prisoner of War Interrogators			O	X	X
Individual Soldiers				O	X
<b>IMAGERY INTELLIGENCE (IMINT)</b>					
Photographic Reconnaissance	X	X	X	O	O
Infrared Reconnaissance (Near/Far)	X	X	X	O	O
Side-Looking Airborne Radar (SLAR)		X	X	O	O
<b>SIGNALS INTELLIGENCE (SIGINT)</b>					
Radio Intercept	O	O	X	X	X
Radar Intercept		O	O	X	X
Direction Finding (DF)	O	O	X	X	X
<b>SURVEILLANCE and TARGET ACQUISITION</b>					
Air Defense Radars		O	O	X	X
Counter-mortar/battery Radars		O	X	X	X
Sound Ranging			O	X	X
Flash Ranging			O	X	X
Sonic Listening Devices			O	X	X
Battlefield Surveillance Radars				X	X
Remote Sensors (REMS)				O	X
Range Finders and Laser Designators					X
Night Observation Devices (NOD)					X
	<b>REAR OPERATIONS</b>			<b>CLOSE OPERATIONS</b>	

LEGEND: X Intense    O Moderate

destruction activities—vulnerability assessments.

- Performing risk analyses and selecting EEFI that must be protected.
- Maintaining intelligence, OPSEC, and deception data bases.
- Nominating enemy RSTA and REC assets or units for suppression, neutralization, destruction, or exploitation.
- Recommending OPSEC and deception measures to be employed.
- Monitoring the effectiveness of OPSEC and deception measures employed or counteractions taken—OPSEC evaluations.
- Recommending adjustments to the brigade's OPSEC program, deception operations, or battle plans.
- Training brigade and battalion personnel in counterintelligence and security matters.

Most of the CI functions listed above support the development and refinement of battalion, brigade, and division operation plans and orders (OPLANs and OPORDs) and the training necessary to ensure combat readiness at each respective echelon.

**Counter-HUMINT.** The maneuver brigade, its subordinate battalions, and attached or supporting combat and combat service support units face a HUMINT threat posed principally by close enemy maneuver forces. The HUMINT threat also includes enemy sympathizers, agents, saboteurs, and interrogators. The enemy's HUMINT collection effort is focused on determining the types of units in given areas, their disposition, strengths, weaknesses, capabilities, and current or projected activities. Signatures and patterns developed by the enemy maybe used for immediate targeting and maneuver or for the development of friendly unit profiles. The brigade and its subordinate, attached, or supporting units uses basic countersurveillance techniques such as light, litter, and noise discipline, camouflage, and other selected OPSEC and deception measures to counter enemy HUMINT activities. All efforts are made to conceal the brigade's

true signature and patterns. False signatures and patterns which the enemy is most likely to believe and verify are also implemented for deception purposes.

Counterintelligence personnel perform a number of functions to counter enemy HUMINT capabilities. These include—

- Personnel, physical, and document security investigations, to include incidents of sabotage and espionage directed against the US Army (SAEDA).
- Counterinterrogation training, to include threat awareness briefings regarding enemy collection capabilities and information pertaining to hostile interrogator techniques and procedures.
- Liaison activities with local military, paramilitary, and civilian authorities and indigenous CI elements to identify CI targets and to impair the effectiveness of enemy HUMINT operations.
- Screening and line-crosser operations to identify enemy sympathizers, agents, or saboteurs; the knowledge they or the enemy commander may have of friendly units and their activities; and collaborators for potential return as low-level US agents to the enemy-held area from which they came.
- CI screening and interrogation of refugees, detainees, and EPW to determine the effectiveness of friendly OPSEC and deception measures and the enemy RSTA collection effort itself. CI personnel and EPW interrogators provide one another mutual support to accomplish common intelligence and CI objectives, missions, and tasks.

**Counter-IMINT.** Counterintelligence personnel may assist the brigade and battalion S2 in determining enemy imagery collection capabilities and activities to include side-looking airborne radars and photographic, thermal, and infrared systems. They may also perform friendly pattern and movement analyses to assist the S2 in determining the enemy's knowledge of friendly

activities based on exposed signatures, patterns, and recognized vulnerabilities.

Army aviation and Air Force reconnaissance assets may provide SLAR, infrared and photographic reconnaissance support to CI OPSEC, and deception operations directed and coordinated at division and higher echelons. The brigade and battalion S<sup>2</sup> requests such support through operations and intelligence channels or the AGOS C<sup>2</sup> systems as described earlier in this chapter. Results of such missions provide the S<sup>2</sup> and supporting CI analysts additional information to confirm or negate their previous conclusions. Enemy actions are determined and friendly counteractions are recommended, selected, and implemented.

**Counter-SIGINT.** Both enemy and friendly commanders use camouflage, cover and concealment, radio silence, emission control, and disinformation to protect their respective C<sup>3</sup> activities and combat operations. However, C-E emitters are employed by each force to command and control their forces and gather and transmit combat information and intelligence both prior to and during combat operations. SIGINT resources, therefore, are a lucrative source of information to both enemy and friendly commanders prior to the initiation of hostilities. Such information is used for planning purposes. It is also used to cue close RSTA assets to look for, find, and report the locations of HPT to maneuver and fire support systems—direct targeting data.

Enemy SIGINT or radio and radio-radar reconnaissance assets are a significant threat to both brigade and battalion C<sup>2</sup> systems. These assets are distributed among—

- Enemy regimental, division, and army reconnaissance units.
- Enemy division, army, and FRONT-level artillery target acquisition units.
- Both army and FRONT-level intelligence and REC units.

Enemy SIGINT resources at division and lower echelons are RSTA assets. They have one prime objective—to detect, identify, and locate battalion, brigade, and division C<sup>3</sup> emitters and facilities. Their targets

include: radiotelephone, radioteletype, multichannel communications emitters, and noncommunications or radar emitters such as GSR, weapons-locating radars, MTLR, and air defense radars. These enemy RSTA assets are organic to close-in maneuver and fire support units. They provide direct targeting data to lethal attack systems. Close-in army and FRONT-level REC assets are similarly equipped with organic radio direction finding (RDF) systems which provide direct targeting data to nonlethal ECM attack systems.

Army and FRONT-level SIGINT assets are also targeted against battalion, brigade, and division C<sup>3</sup> emitters and facilities. Their purpose is to monitor current close operations to support on-going operations and near-term maneuver, logistics, and fire support planning functions. These SIGINT resources are also targeted against corps and EAC C<sup>3</sup> systems to support long-term planning efforts for future battles. REC assets are also targeted against higher level C<sup>3</sup> systems, extending from brigade through corps, to disrupt our senior tactical commanders' decision making process. Lethal attack against deep targets such as division and corps main CPs, brigade trains, and DISCOM or COSCOM support facilities is anticipated.

Brigade commanders, their staffs, and all assigned, attached, or supporting personnel take the steps necessary to counter enemy SIGINT/REC capabilities and to protect their own C<sup>3</sup> systems. These measures include—

- Data bases maintained on enemy SIGINT/REC capabilities.
- The predicted location and disposition of enemy SIGINT/REC assets, units, and support facilities.
- Friendly electronic signatures, C-E profiles, operating patterns, and vulnerability assessments developed and maintained on a continuous basis.
- Development of OPSEC and deception measures, appropriate lethal and nonlethal counteractions, coordinating instructions, and attack schedules.
- Employment of deception, SIGSEC, and defensive EW measures.

- The conducting of OPSEC evaluations.
- Confirmation of the location and disposition of close-in enemy SIGINT/REC assets, using specific operational techniques and procedures and by capitalizing on the aggregate capabilities of all IEW resources.
- Suppression, neutralization, and destruction of critical HPT in the enemy's SIGINT/REC forces on a systematic basis in the earliest stages of combat

CI personnel may assist the brigade staff in performing many of the counter-SIGINT functions described above. The primary emphasis of CI services are communications security (COMSEC) and electronic security (ELSEC) vulnerability assessments which are usually conducted as integral tasks of an OPSEC evaluation in general, and a SIGSEC survey in particular.

The need for a SIGSEC survey is directly related to the hostile SIGINT/REC threat. Intelligence about enemy SIGINT/REC capabilities and their potential threat to brigade and battalion operations, as previously mentioned, is usually provided by division and higher echelons. Preliminary SIGSEC vulnerability assessments are conducted by division, brigade, and battalion staff personnel. They are used to determine the need for the SIGSEC survey itself, and aid in the selection and prioritization of subjects to be examined and tasks to be performed.

Signal security specialists conduct the SIGSEC survey as a C-E review and not as a security investigation or inquiry with disciplinary overtones. The objective of the SIGSEC survey is to conduct on-the-spot examinations of all C-E required for planning and executing brigade and battalion combat operations. It assists commanders in eliminating SIGSEC weaknesses that serve as sources for enemy intelligence. The survey begins with the planning stage of an operation and continues through the execution, evaluation, and adjustment phases.

The purpose of a SIGSEC survey is to identify areas for improvement in the overall operating effectiveness of the brigade and its subordinate battalions through

improved SIGSEC practices and procedures. Particular attention is focused on the means of communications and the operational use of noncommunications or radar systems. The SIGSEC survey emphasizes—

- Personal interviews.
- On-site observations.
- COMSEC monitoring and analysis of unencrypted communications.
- ELSEC assistance.
- Cryptofacility inspections.
- Cryptonet evaluations.
- Identification of C-E profiles associated with the combat operations and staff functions.

Personal interviews are critical to the success of the SIGSEC survey. When coupled with on-site observations, they provide valuable insight into how the unit actually performs. Participation in the actual operation of the unit is an invaluable part of the survey as it allows "the teams to observe and listen to what actually occurs rather than to rely solely on information obtained through personal interviews and the review of documents. C-E operations are observed as they are normally conducted to make realistic judgements and recommend practical solutions for enhancing SIGSEC practices. Participation in the actual operations also permits brigade and battalion personnel to do their job without interference, but with positive assistance.

COMSEC monitoring is an extremely important SIGSEC function. COMSEC monitoring operations are well planned. They focus on specific C facilities which are critical to the success of division, brigade, and battalion combat operations. They are conducted to enhance the brigade and battalions' OPSEC posture. They are designed to augment rather than replace the application of effective ECCM and SIGSEC practices. They also ensure the continued use of the commanders' C system.

SIGSEC personnel are capable of conducting both passive and active COMSEC

operations. Passive operations include COMSEC monitoring and analysis functions. Operations listen to, copy, and record the content of friendly radiotelephone communications. Analysts evaluate such material to determine the degree of security provided to these communications. COMSEC monitoring is one of the best methods for gathering the data necessary for traffic studies and vulnerability assessments. It also provides the commander with a means to evaluate the adequacy of his SIGSEC training program and the effectiveness of applied ECCM. COMSEC monitoring also plays an important role in developing the data base needed to plan and successfully execute an electronic cover and deception operation.

The COMSEC monitoring functions described above support the planning and preparatory phase of combat operations, to include peacetime garrison activities. They also support active COMSEC operations in combat. SIGSEC personnel are capable of performing the following active COMSEC support functions—

- Operators transmit MIJI tip-off reports to friendly ESM resources to identify and locate enemy jammers, as required.
- Operators relay messages to appropriate recipients when enemy jamming of critical transmissions is experienced and primary routing is impossible.
- Operators coordinate, evaluate, and support COMJAM screening operations to ensure their effectiveness and to preclude their inadvertent disruption of critical friendly C<sup>3</sup>.

Counterintelligence personnel may provide ELSEC assistance to the brigade and its subordinate, attached, or supporting units regarding the operational employment of given noncommunications emitters or radars. ELSEC assistance includes the usual CI support activities, such as the identification of enemy collection capabilities, friendly profiles, pattern analyses, risk assessments, and training. Personal interviews and on-site observations may also be used for conducting ELSEC vulnerability assessments. However, the best means of

evaluating the ELSEC posture of any unit supporting the brigade is by targeting friendly noncommunications or ELINT intercept and DF equipment against friendly radar emitters during field training exercises (FTX). ELSEC targeting, like COMSEC monitoring, in peacetime is an extremely effective means for evaluating the adequacy of applied ECCM and ELSEC measures. ELSEC targeting also plays an important role in developing the data base needed for OPSEC and deception plans and operations. Personal observations conducted at RSTA radar sites while ELSEC targeting is under way, with the necessary C<sup>3</sup> between ELSEC observers and ELINT operators, is an extremely effective method for training radar operators and developing sound operational techniques and procedures. The dialogue and interaction between ELINT personnel from the division's MI battalion and RSTA radar operators from other division-based units (such as field artillery and ADA) greatly enhances the interoperability among mutually supporting IEW, fire support, and ADA systems on the battlefield. A greater appreciation for each other's missions and operational environments is obtained. Cuing procedures, coordinating instructions, and mutually supporting techniques and procedures are developed, tested, evaluated, and refined. The commander realizes the full potential from all of his noncommunications collection means. His troops survive. They win the battle.

Cryptofacility inspection, cryptonet evaluations, and the identification of friendly C-E profiles are also important SIGSEC support functions. They, like passive COMSEC monitoring and ELSEC assistance, are performed in garrison. They have little or no value later in actual combat. However, actions taken as a result of such efforts may well determine the success or failure of brigade and battalion combat operations. These SIGSEC support functions are fully explained in FM 34-60. The latter—C-E profiles—are also discussed in greater detail within this manual.

The enemy's surveillance and target acquisition effort against the brigade

and its subordinate, attached, and supporting units is extremely intense. The means for surveillance and target acquisition available to the enemy include—

- Air defense radars.
- Counter-mortar and counter-battery radars.
- Sound and flash ranging systems.

- Sonic listening devices.
- Battlefield surveillance radars.
- Remote sensors.
- Range finders and laser designators.
- Night observation devices.

Enemy collection capabilities are illustrated below.

<b>ENEMY COLLECTION</b>			
THREAT	TO: BRIGADE OPERATIONS		
HUMAN INTELLIGENCE (HUMINT)	REAR OPERATIONS	OPSEC <sup>1</sup>	DECEPTION <sup>1</sup>
<b>Terrorist</b>			
<b>Enemy Sympathizers</b>	○	x	x
<b>Enemy Agents</b>	x	○	○
<b>Line Crossers</b>	○	x	x
<b>Sabotage and Reconnaissance Groups</b>	x	○	○
<b>Reconnaissance Units</b>	x	x	x
<b>Combat Units</b>		○	○
<b>Enemy Prisoner Of War Interrogators</b>	○	x	x
<b>Individual Soldiers</b>		○	○
<b>IMAGERY INTELLIGENCE (IMINT)</b>			
<b>Photographic Reconnaissance</b>	x	x	x
<b>Infrared Reconnaissance (Near/Far)</b>	x	x	x
<b>Side-Looking Airborne Radar (SLAR)</b>	x	x	x
<b>SIGNALS INTELLIGENCE (SIGINT)</b>			
<b>Radio Intercept</b>	x	x	x
<b>Radar Intercept</b>	x	x	x
<b>Direction Finding (DF)</b>	x	x	x
<b>SURVEILLANCE and TARGET ACQUISITION</b>			
<b>Air Defense Radars</b>	x	x	x
<b>Counter-mortar/battery Radars</b>		x	x
<b>Flash Ranging</b>		x	x
<b>Sonic Listening Devices</b>		x	x
<b>Battlefield Surveillance Radars</b>		x	x
<b>Sound Ranging</b>		x	x
<b>Remotely Employed Sensors (REMS)</b>		x	x
<b>Range Finders and Laser Designators</b>		x	x
<b>Night Observation Devices</b>		x	x
<b>LEGEND:</b> x = Intense       ○ = Moderate			
<sup>1</sup> OPSEC and deception support brigade close and rear operations.			

These resources are organic to enemy ADA, rocket, missile, artillery, reconnaissance, and maneuver units. All of these resources, less air defense radars, are integrated organizationally with HUMINT and SIGINT resources in given combat, reconnaissance, and target acquisition units. All of these resources, to include air defense radars, are fully integrated with the maneuver forces or weapon systems they support.

The enemy also has an extremely robust C<sup>3</sup> system to support the interaction among all the RSTA, maneuver, and fire support systems or units previously mentioned. Long range RSTA assets provide the intelligence needed to focus short range systems. Lower echelon close-in RSTA assets detect, identify, tip off, locate, and confirm or negate HPT in the close operations area. They provide direct targeting data to maneuver and fire support systems.

Counterintelligence operations, deception operations, and corps, division, and brigade OPSEC programs are conducted and implemented to counter both long-range and short-range enemy RSTA capabilities and C<sup>3</sup> activities. Their emphasis at echelons above brigade is weighted on the former—countering the enemy's long-range HUMINT, IMINT, and SIGINT collection capabilities, since poor intelligence results in an ill-informed, misguided, and ineffective RSTA effort close-in.

The enemy's close-in RSTA effort is further complicated by RTO and radar operators who use sound operating procedures and proven ECCM and SIGSEC techniques. Enemy attempts to detect, identify, and locate friendly C<sup>3</sup> facilities and key maneuver units and weapon systems early on are thwarted. The enemy's short-range RSTA effort directed against the maneuver brigade is also countered by—

- The effective application of engineer survivability and counter-surveillance support measures.
- The effective planning and timely execution of field artillery countertop and counter-CP programs.
- Well-planned, fully coordinated, effectively executed EW operations to

include both protect and counter C<sup>3</sup> programs.

- The effective use of smoke-generating systems.
- Soldiers who are well trained in the use of camouflage, cover, and concealment, as well as light, litter, and noise discipline.

Ultimately, it is the well-trained individual soldier who ensures the elements of surprise up to the moment of actual contact with enemy force.

CI personnel may assist brigade and battalion staffs in performing all CI functions previously described. In regard to other CI activities—

- They help to identify the close-in enemy surveillance and target acquisition capabilities.
- They help to identify friendly force vulnerabilities, perform risk analyses, and recommend appropriate OPSEC, deception, and countersurveillance measures.
- They recommend HPT for destruction and disruption.
- They conduct OPSEC evaluations in peacetime and countersurveillance investigations in combat, as required.
- They help train brigade and battalion personnel in the proper use of the basic countersurveillance techniques previously described.

### CI Resources

Resource availability and mission priorities are the prime factors which determine the degree of CI support to brigade and battalion operations. Sufficient resources should be available from division, corps, and EAC to satisfy peacetime requirements—planning, training, and evaluation. However, in combat, mission priorities change. Mission requirements for CI resources, per se, increase, especially with regard to Level I, II, and III threats to friendly rear operations areas. Level I threat activity will most likely have been accelerated during the 24- 48-hour period prior to actual combat. Level II threats, such as small sabotage-reconnaissance



groups, may also become active within rear operations areas during the last few hours before combat. Naturally, units stationed within contingency areas will have deployed to their general deployment plan (GDP) area many hours and, hopefully, several days before the initiation of actual hostilities. Counterintelligence resources, just like all other IEW assets, will also have deployed with their parent or supported units. They will have been performing their primary combat support functions for some time.

The primary combat support functions of CI resources organic or attached to the division MI battalion include a number of staff and operational support activities previously described. Among the many staff support functions necessary to be performed in combat, emphasis is placed on the function of monitoring the effectiveness of applied OPSEC and deception measures. Many other staff functions stem from, or depend on, the results of this task.

Operational support functions also emphasize the monitoring of the effectiveness of applied OPSEC and deception measures. They include those specific field activities designed to counter enemy HUMINT and SIGINT capabilities, namely liaison activities, CI screening, line-crosser or interrogation operations, and COMSEC monitoring. Countersurveillance investigations, as previously mentioned, are also performed in combat, as required.

The CI resources authorized in the MI battalions, organic to armored and mechanized divisions (heavy), infantry divisions (light), and air assault and airborne divisions respectively, are shown on the following page. These resources are distributed among five CI teams and five COMSEC teams on the TOE of each MI battalion. An ELSEC assistance team of three specially trained ELINT personnel is also authorized in the MI battalion (CEWI), infantry division (light). Each of the CI teams has two or three CI agents per team, depending on the type of division to which the MI battalion itself is subordinate. The five COMSEC teams authorized in the MI battalions organic to heavy, light, and air assault divisions have three SIGSEC specialists each; they employ either a telephone or radio

monitoring sets—the AN/TTR-1A or AN/TRR-33, respectively. Two of the five COMSEC teams authorized in the MI battalion (CEWI), airborne division, have five SIGSEC specialists each and employ either the AN/TTR-1A or AN/TRR-33. The other three COMSEC teams have three SIGSEC specialists each and employ a standard VCR-12 series radio for COMSEC monitoring purposes. These CI resource authorizations are shown on the following page.

The CI resources, assigned or attached to the MI battalion, are task organized to provide CI support on an area-wide basis throughout the division AO. The actual number and makeup of CI support teams and their individual zones of responsibility are based on aggregate mission requirements and other METT-T planning factors. The availability of CI resources from corps and EAC, cross-attachments between organic CI and COMSEC teams, and the mission requirements of all of the division's major subordinate commands (MSCs) are considered. An example of CI support teams employed on an area-wide basis is shown on the following page.

The majority of CI resources, like other HUMINT assets in the MI battalion (that is, EPW interrogators), are usually held in GS of the division. Teams deployed within the division's rear area are normally collocated with the rear area operations center (RAOC) in the division support area (DSA). Personnel from these CI support teams assist the rear operations officer (ROO) and staff in identifying the threat to rear operations areas and in monitoring the effectiveness of applied OPSEC measures and deception operations. Individuals from one or more of these teams may operate with EPW interrogators at the division EPW collection point to perform CI screening and line-crosser operations. Other individuals may be dispatched to locations within their CI support team's assigned zone of responsibility to perform liaison activities and countersurveillance investigations.

Forward-deployed CI support teams are usually collocated with the brigade rear CP of committed divisional brigades. They perform CI functions similar to those just described for CI support teams deployed in the

## CI RESOURCE AUTHORIZATIONS

PERSONNEL & EQUIPMENT	ARM/MECH DIVISION	INFANTRY DIVISION	AIR ASSAULT DIVISION	AIRBORNE DIVISION
CI Agents	10	10	10	10
SIGSEC Specialists	15	18 <sup>1</sup>	15	19 <sup>2</sup>
AN/TTR-1A (# of sys)	1	1	1	1
AN/TRR-33 (# of sys)	4	4	4	1 <sup>3</sup>
Total Number of CI personnel <sup>4</sup>	25	28	25	34

**NOTES:** <sup>1</sup> Includes three ELINT specialists on the ELSEC assistance team; they usually are not available for CI duties in combat.

<sup>2</sup> Includes two additional SIGSEC specialists on each of the two COMSEC teams in GS of the division.

<sup>3</sup> The three DS COMSEC teams use AN/VRC-47 vice AN/TRR-33.

<sup>4</sup> Does not include supervisory and administrative support personnel in the Operations Platoon or OPSEC Support Section.

**LEGEND:** AN/TRR-33 - - Radio Monitoring Set  
AN/TTR-1A - - Telephone Monitoring Set

## COUNTERINTELLIGENCE RESOURCES IN AN AREA-WIDE SUPPORT ROLE

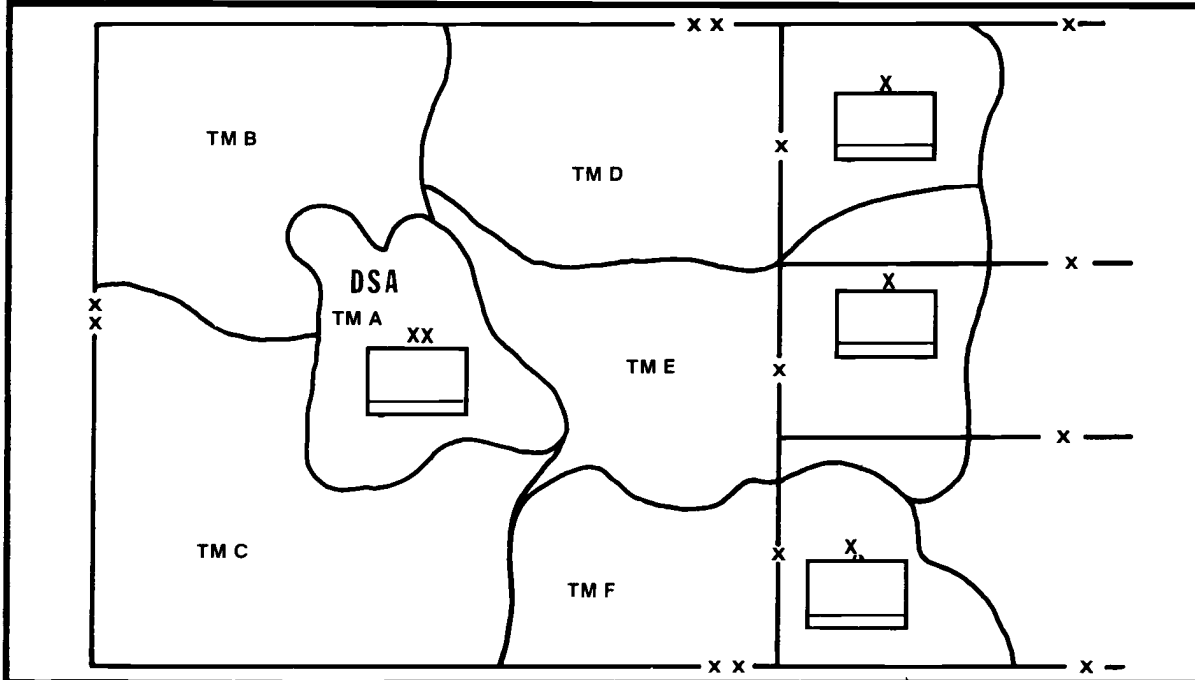

division's rear area. Their assigned zones of responsibility may transcend division and brigade AO boundaries. It is for this reason that the forward-deployed CI support teams are normally held in GS of division combat operations and deployed under an area support concept. However, personnel and resources from these forward-deployed teams may be placed in DS of the maneuver brigade or its subordinate, attached, or supporting units on a temporary basis to perform specific CI missions. For example, COMSEC resources may be assigned tasks to monitor and actively support brigade and battalion C<sup>3</sup> facilities. Counterintelligence resources may also be assigned tasks to perform countersurveillance investigations or missions in the brigade's close operations area.

Contingency missions for light, air assault, and airborne divisions, and the manner in which their subordinate maneuver brigades are deployed may also dictate one or more CI support teams (reinforced) to be placed in DS of brigade combat operations. CI teams may be placed in DS to the brigade when such requirements exist. The CI support teams revert to MI battalion control for GS to the entire division once the division is deployed and operational.

### **Electronic Warfare Support**

The EW resources organic to, or attached to, the division's MI battalion are capable of performing a number of tasks in support of brigade combat operations.

- They can identify, locate, track, and monitor the activities of enemy RSTA, REC, and fire support units which pose a threat to brigade C<sup>3</sup> facilities—combat information and targeting data.
- They can disrupt enemy SIGINT and REC collection activities by screening friendly communications deemed critical to the success of brigade combat operations—COMJAM screening.
- They can communicate essential orders and requests of brigade and battalion commanders when enemy jamming is experienced or long-range skip-echelon communications are required—high power communications support.

- They can deceive enemy commanders by jamming specific enemy C<sup>3</sup> facilities in support of friendly battlefield deception operations, such as demonstrations and feints—demonstrative COMJAM operations.
- They can create a series of time delays in the enemy commanders' decision cycle by disrupting specific enemy command, control, communications, and intelligence (C<sup>3</sup>I) facilities in concert with maneuver and fires—offensive COMJAM operations.
- They can identify, locate, track, and monitor the activities of enemy first- and second-echelon battalions and regiments and supporting fire, combat engineer, and combat service support units—combat information and direct targeting data.

The capability of EW resources to perform any one of the tasks described above is dependent upon a number of METT-T factors. The primary factor is intelligence and the availability of specific electronic order of battle (EOB) information about the enemy's disposition, frequency utilization, and C-E operating instructions (CEOI). National agencies and SIGINT resources at EAC may provide corps and division MI units with this essential EOB information. However, this information may not be available in given contingency areas. It may also prove to be of little or no value in the initial hours and days of actual combat in given theaters of operations. These statements are predicated upon the following assumptions:

- The enemy will conduct extensive OPSEC and deceptions to cover the movement of combat forces to wartime assembly areas and firing positions.
- Wartime frequency utilization may differ significantly from the established norm in peacetime.
- The enemy may introduce and use more highly sophisticated C-E equipment than originally anticipated.
- The CEOI used by the enemy, once the attack begins, will be drastically different than the CEOI used prior to combat.

The conclusion drawn from the above discussion is that “cold start” EOB or SIGINT data bases may have to be developed by corps and division EW resources, once deployed. Thus, the EW resources available to support brigade combat operations have another mission to perform, a mission which is actually endemic to all of the EW tasks previously described. This mission is SIGINT.

The SIGINT mission is an operational imperative for all division EW resources, especially in the prehostility and post-deployment phases of combat operations.

The primary objective is to provide the division, brigade, and battalion commanders with the intelligence they need to plan, direct, coordinate, support, and conduct their combat operations. All of the EW resources available to the division are “netted” via the IEWC<sup>2</sup> system. The combat information, targeting data, and SIGINT technical data collected by each EW collection or jamming team is reported to intermediate processing, analysis, and control elements located within the forward brigade AO.

An intermediate processing, analysis, and control element may be an EW platoon operations center, a SIGINT processing platoon operations center, or an IEWC company team TOC. Either one of the former may be collocated with the latter.

EW and SIGINT analysts at these locations relay all information received to the technical control and analysis element (TCAE) located at the MI battalion tactical operations center. Combat information and targeting data essential to brigade planning and targeting efforts are provided immediately to the brigade S2 by the IEWCSE, which gleans the information by monitoring the MI battalion TCAE to the EW platoon tasking and reporting net (FM). EW and SIGINT analysts at the MI battalion tactical operations center process and analyze all information received. Combat information and targeting data essential to the division's overall planning and targeting effort is reported immediately to the division G2, upon recognition.

Intelligence resulting from the comparison and analysis of combat information

and the correlation of targeting and technical data is reported to the division G2 for further analysis or immediate dissemination to the appropriate MSC.

The SIGINT process and reporting flow described above provides essential information needed by each division MSC to further refine and adjust their respective collection plans, battle plans, attack schedules, and HPT lists—both prior to and during combat operations. The entire process begins and ends with SIGINT technical data. SIGINT technical data, such as frequencies, call signs, and C-E operating schedules, when combined with SIGINT RDF results and combat information, is the basic means used by SIGINT/EW analysts to “sort” and isolate HPT emitters and to “template” the electronic battlefield.



The SIGINT/EW analysts at the TCAE and intermediate processing, analysis, and control elements use intelligence preparation of the battlefield (IPB) procedures to template the electronic battlefield and to develop and maintain EOB maps. They use target value analysis (TVA) procedures to identify high value target (HVT) emitters. In addition, they use SIGINT technical data, SIGINT RDF results, combat information, and special SIGINT analytical methodologies to identify, locate, track, and monitor HPT emitters, enemy C<sup>3</sup>I facilities, and the units or weapon systems they support.

Electronic templating and EW targeting are endemic to specific IEWC responsibilities of the brigade S2 and S3. The S2 is responsible for collection management, situation development, and target development. Electronic templating—general in nature and done without SIGINT technical data—supports both situation and target development functions and helps determine the brigade's EW collection requirements. The S2's ability to identify high value C<sup>3</sup>I targets, to include the predicted locations of enemy SIGINT, REC, and other electronic surveillance and target acquisition systems, is critical to the S3. The S3 is responsible for EW, overall, and ECM in particular. He ensures that ECM is integrated with brigade maneuver schemes and supporting fire plans. High value C<sup>3</sup>I targets, developed by

the S2, are considered by the S3, FSO, and EW officer from the IEWSE in their overall targeting effort. High payoff target emitters, C<sup>3</sup>I facilities, and both active and passive SIGINT, surveillance, and target acquisitions systems are identified and scheduled for attack. The availability of munitions and delivery means and the desired effects on the commander ultimately determine the brigade's ECM requirements. Aggregate EW requirements are forwarded to the division for considera-

tion and incorporation into the division and MI battalion's OPLAN/OPORD.

The mission, functions, and tasks capable of being performed by EW resources in support of brigade combat operations are summarized in the following illustration. They relate directly to the brigade commander's critical EW tasks discussed in Chapter 1.

<b>ELECTRONIC WARFARE SUPPORT</b>		
<b>MISSION<sup>1</sup></b>	<b>FUNCTIONS</b>	<b>TASKS</b>
<b>PROTECT C<sup>3</sup></b> 	<b>ESM</b>	<b>COMBAT INFORMATION TARGETING DATA</b>
	<b>ECM</b>	<b>COMJAM SCREENING</b>
	<b>ECM</b>	<b>HIGH POWER COMMS</b>
<b>COUNTER C<sup>3</sup></b> 	<b>ECM</b>	<b>OFFENSIVE COMJAM OPERATIONS</b>
	<b>ESM</b>	<b>COMBAT INFORMATION TARGETING DATA</b>
<b>SIGNALS INTELLIGENCE</b>	<b>COMINT</b>  <b>ELINT</b>	<b>EOB TECHNICAL DATA</b>
<p><b>NOTE: <sup>1</sup>Missions are derived from and support C<sup>3</sup>CM strategy in accordance with US Army EW Policy. AR 525-22.</b></p>		

Electronic templating, IPB, TVA, collection management, situation development, target development, EW targeting, and all other IEW functions performed to prepare the brigade for combat operations are discussed in Chapter 4. Similar functions performed in combat are discussed in Chapter 5. Division tactical SIGINT operations and detailed information about EW and SIGINT processing, analysis, and reporting functions performed in the TCAE are further described in FMs 34-10 and 34-40(S). Detailed information about the specific capabilities and limitations of all division EW systems is also contained in FM 34-10. Information deemed essential to brigade commanders and staff officers is provided in the following discussion of this chapter.

### EW Collection Resources

All ground-based EW collection systems available within the corps MI brigade and the division MI battalion may operate within the AO of forward maneuver brigades. The division's airborne EW system, QUICKFIX, also having a significant collection capability, operates within the forward area. All these systems are capable of supporting brigade combat operations. They include—

- A ground-based HF and VHF communications intercept and VHF DF system—TRAILBLAZER—heavy divisions only.
- Ground-based noncommunications intercept and line of bearing (LOB) systems—TEAMPACK—all divisions (less the light divisions) and corps.
- Ground-based HF, VHF, and UHF communications intercept and LOB systems—such as TEAMMATE—all divisions and corps.
- Airborne VHF communications intercept and LOB systems—QUICKFIX—all divisions.

**TRAILBLAZER.** The special purpose detecting set, AN/TSQ-114A, or TRAILBLAZER, is a ground-based HF and VHF communications intercept system with a VHF DF capability. The A-model TRAILBLAZER system consists of two

master control stations (MCSs) and three remote slave stations (RSSs). Each MCS and RSS is configured in a protective shelter, mounted on a modified M548 ammunition carrier, the M-1015 tracked vehicle. The MCS is capable of intercepting and providing LOB data on enemy AM, FM, continuous wave (CW), single side band (SSB), single channel voice (SCV) and manual Morse communications. The RSS can operate in a remote or local mode. In the remote mode, the RSS is remotely turned by, and tasked to provide LOB data to, the MCS. No operator control is required in this mode, once deployed and initialized. In the local mode, the RSS functions as an independent platform providing intercept and LOB data. Intercept and LOB data, generated by either the MCS or RSS, is correlated at the MCS to provide DF locations on enemy communications emitters. Each station has identical 30 kw power units transported by a 6-ton flatbed trailer. Backup power is provided by an on-board 60 kw generator. A self-supporting telescopic DF antenna is mounted on top of each MCS and RSS shelter. (Note: All future doctrinal publications will refer to a remote slave station (RSS) as an out station (OS) instead.)

The MCS equipment is contained in a ballistically protected S-280 shelter. The S-280 shelter can be mounted on a tracked cargo carrier or a 5/4 ton truck. Each MCS and RSS is equipped with a quick-erecting antenna. The antenna system is mounted on the S-280 shelter. The quick-erecting antenna assembly consists of a self-supporting telescoping mast and a folding antenna array. The mast is erected to the vertical position by a hydraulic ram system and raised to the desired height by a pneumatic system. The antenna can be operational within 6 minutes. One station of the TRAILBLAZER system is shown in the following illustration.

Each MCS has two identical intercept positions. These two intercept positions, shown in the illustration on page 2-42, are also used for DF target acquisition. Each position enables the operator—

- To tune on-board receivers.
- To remotely tune RSS DF receivers.
- To initiate DF commands to the computer.
- To intercept HPT communications emitters.
- To record and gist HPT communications traffic.
- To edit DF results.
- To initiate or generate reports.

### TRAILBLAZER — AN/TSQ-114A

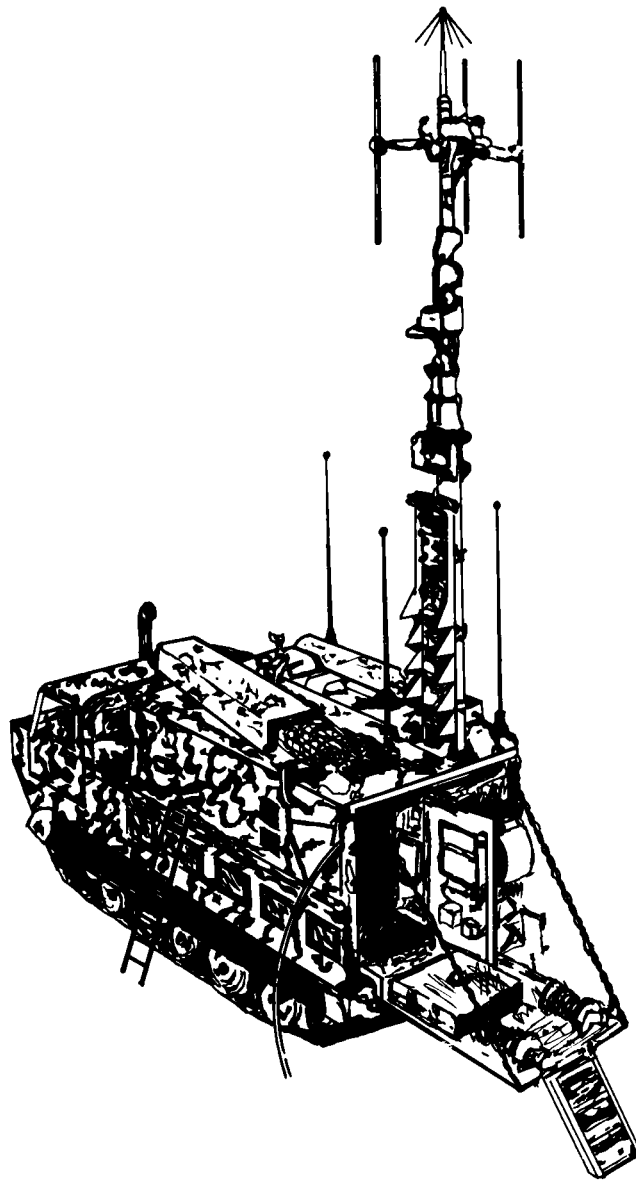

## MCS INTERIOR—TWO OPERATOR POSITIONS

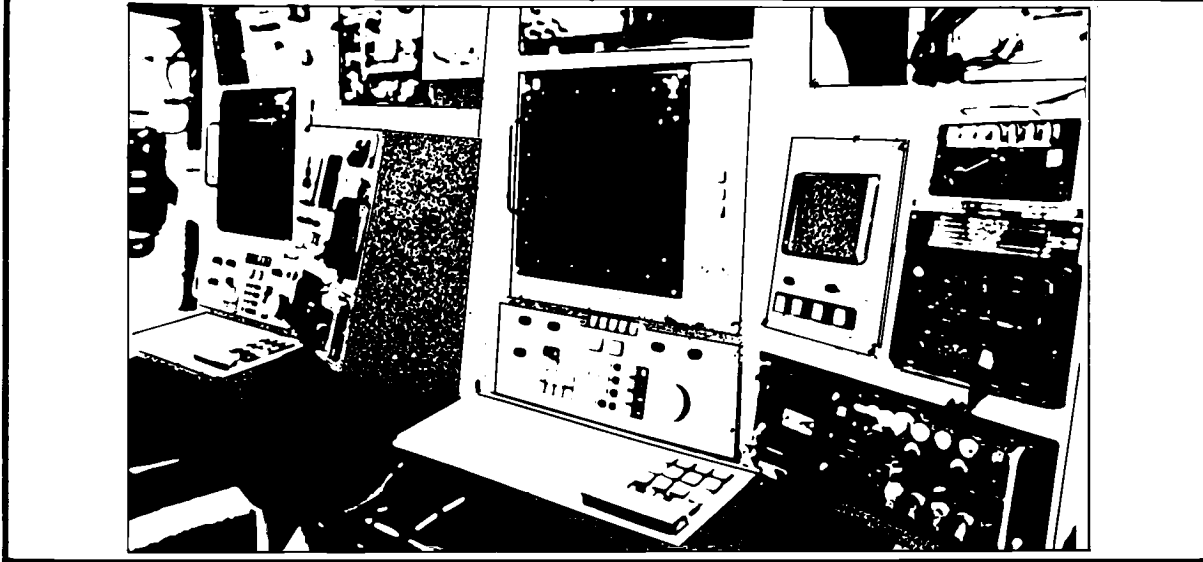

Each MCS intercept and DF team consists of five voice intercept operators and one manual Morse operator—six operators total. The MCS team leader and a senior voice operator are usually designated as work shift supervisors. They man one position within the MCS and continually search the band for HPT emitters. They tip off the second operator regarding HPT emitters. The second operator initiates DF requests into the system. The DF requests are automatically processed within the on-board computer and transmitter via UHF data link to the other MCSs and RSSs for LOB data. The LOB data, received from the other MCSs and RSSs, are automatically processed; the DF results are displayed to the DF operator in the MCS.

One MCS is always designated as the net control station (NCS) for automatic DF operations. A second MCS functions essentially as an RSS when the system is in automatic mode. The two operators in the second MCS receive HPT emitter tip-offs from the NCS primary officer/team chief. They record and gist HPT communications traffic. All DF results and SIGINT technical data are transmitted via HF radioteletype (RATT) communications to the TCAE for further analysis and reporting. Combat information, targeting data, and DF results

are also reported to the TCAE via VHF FM communications. Such information is also transmitted to other intermediate processing, analysis, and control elements, such as the EW platoon, which may be operating in the same brigade AO. SIGINT technical data may also be included. Information pertinent to brigade combat operations is passed to the brigade S2 via the IEWSE.

Each of the three RSSs has one DF position. Each RSS team consists of one vehicle and generator mechanic and two DF operators. No recording or gisting of enemy HPT communications traffic can be performed at the RSS. The DF operators merely set up the RSS for remote or automatic DF operations. As mentioned previously, they can provide basic intercept and LOB data in local mode operations. Local mode operations are conducted by netting all MCS and RSS via VHF FM secure voice communications. The VHF FM secure voice communications provide a backup to automatic UHF data link operations. Thus, local mode operations equate to degraded mode operations. No one station, by itself, can produce DF fix results. Three of the stations, the RSSs, cannot provide combat information, targeting data, or anything more than basic technical data. The RSS DF operators are not language qualified.



The M-1015 is a 6-ton tracked vehicle designed to provide improved mobility and a higher degree of survivability for TRAILBLAZER and other EW systems, as well. Its physical characteristics are the same as the M-548 with the following modifications:

- A trailer-towing capability.
- An intercommunication system which allows operators in the S-280 shelter to speak with personnel in the cab of the vehicle.
- An electronically-operated ground rod driver which reduces system set-up and tear-down times.
- A 60 kw generator backup power sub-system, previously mentioned.

The tactical mobility of the M-1015, the quick-erect pneumatic mast antenna, and the electronically-operated automatic ground rod driver significantly enhance the ability of TRAILBLAZER stations to operate well forward in the brigade AO.

All five stations of the TRAILBLAZER system require radio LOS to their predicted or assigned HPT communications emitters. They also require radio LOS for UHF data link communications between stations for effective  $C^3$  and automatic DF operations. The stations must also be protected from enemy detection and possible direct fire attacks. Thus, the TRAILBLAZER system normally occupies an area 40 kilometers wide and 10 kilometers deep with forward RSS kept at least 3-5 kilometers behind the FLOT.

Optimum DF accuracy and target area coverage with the five stations of the TRAILBLAZER system is relatively simple if the target area is small and the stations can be positioned anywhere desired to establish the required baseline. However, in many combat situations the target area is very large; it may be much wider than TRAILBLAZER is capable of covering. Terrain may also preclude the intercept and DF of critical HPT emitters in given sectors. Target priorities and the division and brigade commanders' information needs are the primary factors which determine how and where the TRAILBLAZER system will

be used. At any rate, all of the stations must be positioned to provide as much coverage of the enemy's AO as possible. They must be deployed to concentrate their "fix" area where it is most probable the HPT emitters will be located. Plans are made to combine the LOB and "cuts" obtained from other LOB systems in the area in order to obtain a fix and to provide the necessary combat information and targeting data. A defilade area may require redeployment of the system itself.

Examples of various deployment configurations of the TRAILBLAZER stations and their respective areas of coverage are shown in the illustration on the following page. These examples are based on LOS ranges for flat terrain and assume the FLOT will be a relatively straight line. Local terrain conditions and radio wave propagation conditions are taken into consideration when planning TRAILBLAZER operations.

Deployment 1, as shown in the following illustration, indicates that if the stations operate at the maximum radio line-of-sight range for effective  $C^3$ , the system will not produce any DF fixes-only LOB and "cuts". The other two deployments illustrate how the fix, cut, and LOB areas are modified by the relative positioning of the stations. Deployment 2 permits a relatively large fix area and provides for deployment of the MCS at a closer distance to the FLOT. The distance to the TCAE for radio communications, however, is increased. Deployment 3 represents the optimum baseline for effective TRAILBLAZER operations; the target area of DF coverage is maximized and deeper targets can be located. All METT-T factors and especially  $C^3$  must be considered.

TRAILBLAZER stations must also be redeployed frequently even when required to maintain coverage of one target area for an extended period. Failure to do so is a sure way to have all of the stations in the TRAILBLAZER system located by the enemy. Caution must be exercised to avoid detection during the redeployment by selecting march routes that cannot be observed and by eradicating any telltale signs, such as vehicle tracks leading into the new site.

## EFFECTS OF TRAILBLAZER DEPLOYMENT ON DF COVERAGE

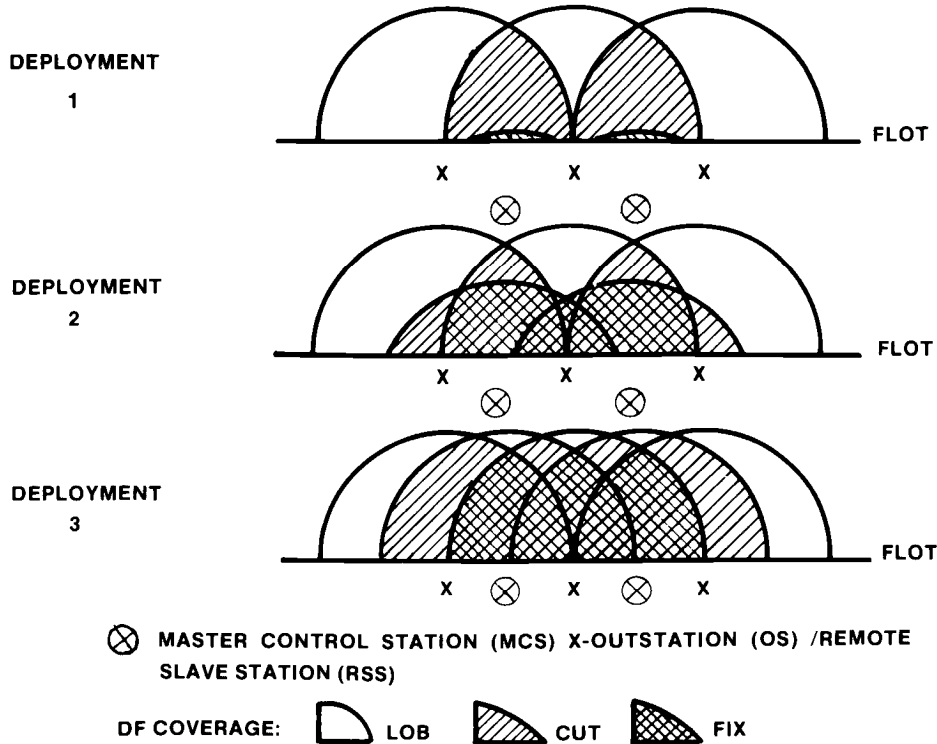

The TRAILBLAZER system is the heavy division G2's primary organic means for identifying, locating, tracking, and monitoring the movement of enemy first- and second-echelon regiments, division and Army C<sup>2</sup> facilities: fire support units, and CSS facilities. The DF accuracy of the TRAILBLAZER system is not sufficient, itself, for targeting most lethal attack fire support systems. However, the DF results obtained and produced by TRAILBLAZER are more than adequate for the cuing of other available RSTA systems as the enemy forces move closer to or into the forward brigade AO. The DF results are also adequate for division and brigade commanders to make decisions regarding the employment of maneuver forces. High payoff targets may also be developed for deep attack as a result of performing terrain analysis and by comparing the DF results with information provided by other RSTA assets.

The greatest limitation of the

TRAILBLAZER system is the fact that it can only cover a one- or two-brigade front. This limitation is directly related to, and actually is the reason for, the system's greatest vulnerability. The UHF data link communications system, which is the primary means for C<sup>2</sup> and automatic DF operations, presents a unique signature on the battlefield. Data link signals are emitted 360 degrees from omni-directional whip antennas. Thus, the system itself is not only vulnerable to enemy SIGINT, DF, and indirect fire systems, its employment against high priority target areas or on major avenues of approach used by friendly forces may provide the enemy commander a significant indicator of brigade and division main objectives. The TRAILBLAZER MCS and RSS teams use special operating procedures and techniques and battlefield facts to reduce their vulnerability, to preclude compromise of the division and brigades' objectives, and to enhance their target coverage area capability at the same

time. These special operating procedures, techniques, and tactics are discussed in Chapter 5. They are detailed in FM 34-10. Degraded mode operations, using backup VHF FM voice communications means, may be favorable in high density SIGINT threat environments. The UHF data communications signature could also be used to friendly advantage for deception purposes.

Other factors which limit TRAILBLAZER's effectiveness are—

- MCS and RSS cannot fully deploy their antennas in high winds (50 mph or more).
- MCS and RSS cannot fully deploy their antenna in high winds (50 mph or more).
- Heavy rains and snow, dense foliage, metallic objects, tall buildings, close proximity to railroad tracks, power lines, buried cables and pipelines, wire fences, and bodies of water all degrade system performance.

The principal means used to counter the threat and to maximize the effectiveness of TRAILBLAZER operations is effective C<sup>3</sup> and system flexibility.

The TRAILBLAZER MCS and RSS teams are assigned to the SIGINT processing platoon (SPP) subordinate to the EW company in the heavy division's MI battalion. The SPP is normally held in GS of the division. However, the platoon normally deploys its MCS and RSS teams within the AO of forward brigades. An EW and SIGINT analysis team, also assigned to the SPP, is usually deployed with the MCS designated as the TRAILBLAZER NCS. An AN/GRC-122 RATT system from the MI battalion's service support company also deploys with the SPP to provide HF communication record traffic between the SPP and TCAE. The MI battalion S3, TCAE operations officer, IEW company team commanders, and EW support officers effect the necessary coordination with the brigade S2 and S3. The MCS and RSS team leaders interface with battalion S2 and S3 for coordination purposes, when required.

The platoon leader and platoon sergeant form the SPP headquarters. They are equipped with one VCR-12 series VHF FM radio and one 5/4-ton cargo truck. The platoon headquarters is usually collocated with the TRAILBLAZER MCS designated NCS.

The EW and SIGINT analysis team is normally deployed as part of the SPP headquarters. The team consists of three DF analysts and three ELINT analysts. This team is equipped with one S250 and one S280 shelter-mounted M1028 5/4-ton truck and one AN/VRC-47 radio. The DF analysts maintain an EOB map and perform preliminary analysis of the DF results produced by the TRAILBLAZER system. The ELINT analysts compute the LOB data reported by the MI battalion's three TEAMPACK systems, which will be discussed shortly. The ELINT and DF analysts work together to correlate RDF fixes on HPT communications and noncommunications or radar emitters. They report both initial and follow-on SIGINT technical data and RDF results to the TCAE over the HF RATT net.

The SPP analysis team's COMINT and ELINT RDF correlation effort is the initial step in templating the electronic battlefield, which was previously explained. Their major effort, however, is to ensure that TRAILBLAZER stations and TEAMPACK systems are targeted on the HPT emitters in a synchronized manner and to ensure that the desired RDF results are passed to the TCAE on a timely basis. The analysis team may also pass or relay combat information and HPT location data to the brigade S2 via the IEWSE. Reporting criteria are determined by the division G2 and G3 and the MI battalion S3. When the NCS-designated MCS reaches its storage capacity, it transfers TRAILBLAZER NCS responsibility to the other MCS. This permits continuous operations. The second MCS is usually collocated with an EW platoon operations center or the IEW company team TOC in an adjacent brigade's AO for C purposes and analysis support.

In actuality, NCS responsibility may change dynamically between the two MCS on a time-shared basis in order to satisfy

aggregate mission requirements and HPT priorities for the division and its subordinate maneuver brigades. Time-shared NCS responsibility lends greater flexibility to the TRAILBLAZER system. It is a basic technique employed for maintaining continuity of operations as given RSS and other MCS displace to new positions.

Time-shared requirements are determined as HPT emitters located in each brigade AO. Deeper targets are developed by the TCAE and become the responsibility of the MCS in the AO of the brigade most likely to be affected by the HPT emitter and the enemy unit or weapon system it supports. HPT revisit requirements to provide target location update information (tracking data) ultimately determine the HPT sets for which each MCS is responsible. Combat information and HPT location data pertaining to target units within or approaching the brigade AO are passed via the IEWC<sup>2</sup> system to the brigade S2 in accordance with established unit SOP, coordinating instructions, and the reporting criteria mentioned earlier. The brigade S2 uses all other RSTA assets organic, attached, or supporting brigade and battalion combat operations to acquire, track, and monitor HPT units associated with the target emitters. These RSTA assets may include other EW resources from the division's MI battalion.

TEAMPACK. There are three noncommunications collection teams assigned to each MI battalion. Each team is equipped with a TEAMPACK system, the AN/MSQ-103A. The teams consist of four electronic intelligence (ELINT) operators each. These teams are targeted against HPT radars and other noncommunications emitters, the majority of which may be found within the brigade's close-in and deep operations areas of responsibility. Priority targets usually include—

- Meteorological radars supporting enemy fire support units, to include surface-to-surface missile (SSM) units.
- Countermortar and counterbattery radars associated with enemy rocket and artillery units.
- Battlefield surveillance radars supporting enemy reconnaissance and fire support units.

- Target surveillance, target tracking, and fire control radars associated with enemy anti-aircraft artillery (AAA) and SAM units.

The AN/MSQ-103A, shown in the following illustration, is configured in an S-623 shelter mounted on the M-1015 EW system carrier, previously described. Like the TRAILBLAZER stations, it utilizes a quick-erect antenna and has an on-board power generator to facilitate rapid set-up and relocation operations in heavy divisions. A lightweight version of TEAMPACK is currently being developed for use by airborne and air assault divisions. The lightweight version will be a similarly shelter-mounted system on the 5/4-ton M-1028 commercial utility cargo vehicle (CUCV) or M990 HMMWV.

Each TEAMPACK system is capable of detecting, intercepting, and providing LOB information on HPT noncommunications emitters, such as those described above. The on-board computer can be programmed to rapidly search specified frequency bands. SIGINT technical data and LOB information is stored in the computer's memory and can be displayed to the operator or printed out on hard copy upon command. The approximate location of an HPT radar emitter can be determined by triangulation of several TEAMPACK intercepts. The approximate locations of HPT radars, like the communications intelligence (COMINT) DF results produced by TRAILBLAZER, are adequate for cueing other RSTA assets in the close operations area. In fact, it is standard practice to cue COMINT systems with ELINT tip-offs, and vice versa, within EW units. Information provided by aggregate TEAMPACK systems, once processed at the SPP or TCAE, is also sufficient to provide front-line traces and AO parameter information about close-in enemy forces. Terrain analysis, target correlation with COMINT DF results, and comparison with enemy communications operating schedules generate, in many cases, HPT nominations suitable for targeting lethal fire support systems. TEAMPACK DF accuracy is also greatly enhanced when intercept sites are surveyed by field artillery survey teams using the PADS system mentioned earlier.

## TEAMPACK AN/MSQ-103A

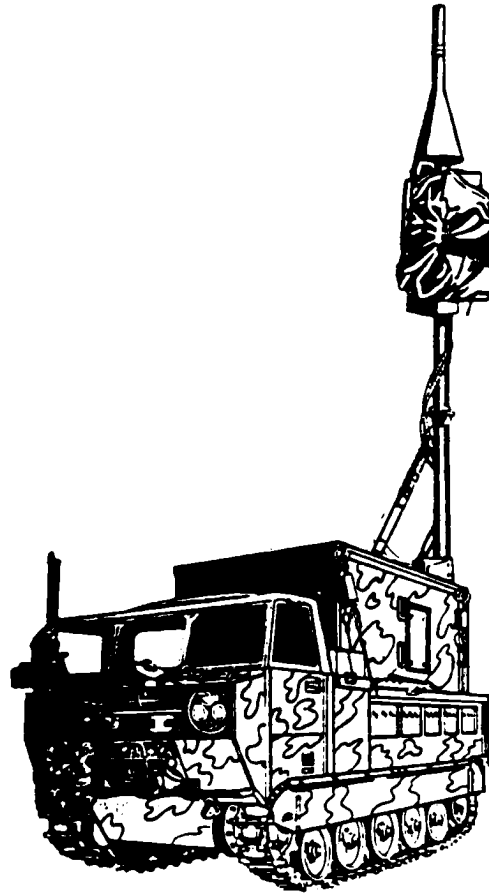

The circular error probable (CEP) is reduced and greater RDF accuracy is achieved.

There are two major factors which limit the effectiveness of TEAMPACK operations. The first limitation factor is that the VHF FM voice communications means used for DF flash tip-offs, technical data, and LOB information reports are slow. The second limitation factor is the fact that three TEAMPACK systems, like the five stations of the TRAILBLAZER system, cannot cover the entire division front. The fields of view and forward deployment of each TEAMPACK to achieve triangulation, maximum range, and LOS to the HPT emitters, restricts the target coverage area, front-wise, to that of one and possibly two brigades in best case situations, flat and

level terrain notwithstanding. Dense foliage, ground clutter, the enemy's use of terrain masking, electromagnetic propagation losses, and the multipath effects of given radar systems can also have adverse impact on TEAMPACK's RDF capability and detection range. The intercept and DF capability of each TEAMPACK, however, is not hampered by smoke, haze, fog, light rain or snow, or light foliage.

The two major limitation factors mentioned above are well recognized. Major efforts are under way to provide TEAMPACK a UHF data link communications capability similar to that which is employed on the TRAILBLAZER system. Corps augmentation (three TEAMPACK

systems authorized) and the cross-attachment of other TEAMPACK systems in adjacent divisions and the corps separate brigade or armored cavalry regiment (ACR) may also be used to increase TEAMPACK's target coverage area. Corps, division, separate brigade, and ACR intelligence officers and TSOs work together to ensure adequate ELINT DF coverage of critical areas. National, EAC, and corps-based airborne ELINT systems such as QUICKLOOK are also considered. The intelligence, combat information, and targeting data capable of being collected and produced by ELINT systems at echelons above division is of paramount concern to both division and brigade commanders. The challenge is getting it down to the division and brigade commanders who can put it to best use. Such information may not only provide direct targeting data for lethal deep attack systems, but cueing data for TEAMPACK and other close-in RSTA assets, as well.

The manner in which the three TEAMPACK systems are deployed and employed ultimately determines their individual and collective contributions to battalion, brigade, and division combat operations.

One of the three TEAMPACK systems and noncommunications collection teams assigned to each MI battalion is subordinate to one of three EW platoons (heavy division), collection and jamming (C&J) platoons (light and air assault divisions), or C&J companies (airborne division), depending upon the type of division to which the MI battalion itself is organic. It has been common practice, doctrinally and historically speaking, to place each of the three platoons or companies mentioned above in DS of the division's three maneuver brigades. The field of view, maximum range, LOS, and RDF tip-off and reporting requirements, however, dictate a more flexible operational concept for TEAMPACK systems.

Centralized control at the TCAE and intermediate control at the SPP or MCS is required. Trade-offs between maximum range (depth) and frontal coverage (width) capabilities are determined by the division G2 and TSO in coordination with the MI

battalion S3 and TCAE operations officer. The three TEAMPACK systems, and any additional systems from corps, are task organized in accordance with the division commander's operational guidance, information requirements, and concept of operations. They may be placed in DS of one brigade or held in GS of the division to provide priority of support to two forward-committed brigades. In either case, the TCAE and SPP exercise technical control of TEAMPACK operations; OPCON is retained by the IEW company team commander or the MI battalion commander and S3, depending upon the situation.

The three or more TEAMPACK systems are targeted against HPT noncommunications emitters supporting enemy first-echelon reconnaissance and fire support units found beyond the limits of friendly observation and within the brigade and divisions' indirect fire range. The LOB information, emitter identification, and combat information regarding the specific activities indicated are reported to the TCAE via the TEAMPACK-designated NCS and intermediate processing, analysis, and reporting elements, previously specified. The TEAMPACK systems may be collocated with TRAILBLAZER MCS or RSS or with other EW communications intercept and LOB systems operating in the forward areas. Their collocation enhances the cueing effort between communications and noncommunications collection systems and provides an enhanced communications and reporting capability. CSS and security requirements are also reduced. Additional information about the deployment and employment of TEAMPACK systems and the support they are capable of providing the maneuver brigade is contained in Chapter 5. More detailed information is provided in FM 34-10.

The MI battalions subordinate to heavy, light, air assault, and airborne divisions are authorized an equivalent number of voice collection teams to satisfy division and brigade requirements. They have three teams each, with six operators per team to man three intercept positions. The air assault and airborne division MI battalions are authorized an additional six and nine

low-level voice intercept (LLVI) teams, respectively. These LLVI teams employ the AN/TRQ-30 manpack radio intercept receiving set. The AN/TRQ-30 is actually a component of the AN/TRQ-32 voice collection and LOB system used by the voice collection teams mentioned above. The LLVI teams augment the voice collection teams—two and three LLVI teams per voice collection team in air assault and airborne divisions, respectively. The LLVI teams in the air assault division are authorized two operators per team. The airborne division LLVI teams, however, have three operators per team—a greater capability to satisfy aggregate combat requirements.

The voice collection teams in each MI battalion consist of six operators each. They are equipped with one AN/TRQ-32 per team. Each AN/TRQ-32 has two intercept positions. The AN/TRQ-30, as a component of the AN/TRQ-32 system, provides the team one additional position and a capability to reach intercept sites otherwise inaccessible to the voice collection team. The AN/TRQ-30 provides a backup and surge augmentation capability to the team's primary system. It also provides the team a means to maintain continuity of operations in fast-paced combat situations. The above information is summarized in the following illustration.

<b>VOICE COLLECTION TEAM AUTHORIZATIONS</b>				
<b>TEAM COMPOSITION</b>	<b>ARM/MECH DIVISION</b>	<b>INFANTRY DIVISION</b>	<b>AIR ASSAULT DIVISION</b>	<b>AIRBORNE DIVISION</b>
<b><u>VOICE COLL TM</u></b>	<b>3</b>	<b>3</b>	<b>3</b>	<b>3</b>
<b>OPERATORS</b>	<b>18</b>	<b>18</b>	<b>18</b>	<b>18</b>
<b>AN/TRQ-32<sup>1</sup></b>	<b>3</b>	<b>3</b>	<b>3</b>	<b>3</b>
<b>AN/TRQ-30<sup>2</sup></b>	<b>3</b>	<b>3</b>	<b>3</b>	<b>3</b>
<b><u>LLVI TM</u></b>			<b>6</b>	<b>9</b>
<b>OPERATORS</b>			<b>12</b>	<b>27</b>
<b>AN/TRQ-30<sup>2</sup></b>			<b>6</b>	<b>9</b>
<b>TOTAL SYSTEMS</b>	<b>6</b>	<b>6</b>	<b>12</b>	<b>15</b>
<b>TOTAL POSITIONS</b>	<b>9</b>	<b>9</b>	<b>15</b>	<b>18</b>
<b>TOTAL OPERATORS</b>	<b>18</b>	<b>18</b>	<b>30</b>	<b>45</b>
<p><b>NOTES: 1. Currently being replaced by the TEAMMATE, AN/TRQ-32(V) System.</b></p> <p><b>2. Will eventually be replaced by the AN/PRD-10, Manpack Radio Direction Finding System (MRDFS).</b></p>				

The AN/TRQ-32 system is configured within an S-250 shelter. The shelter is usually mounted on a 5/4-ton M-880 cargo truck. It can also be mounted on the M-561 Gamma Goat. The replacement for the AN/TRQ-32, the TEAMMATE system,

which will be discussed shortly, is mounted on an M-1028 5/4-ton truck. The AN/TRQ-30 is usually carried and maybe mounted in an M151A 1/4-ton jeep or the new M1009 3/4-ton 4x4 truck. These systems are illustrated below.

### AN/TRQ-30 and AN/TRQ-32 VOICE COLLECTION SYSTEMS

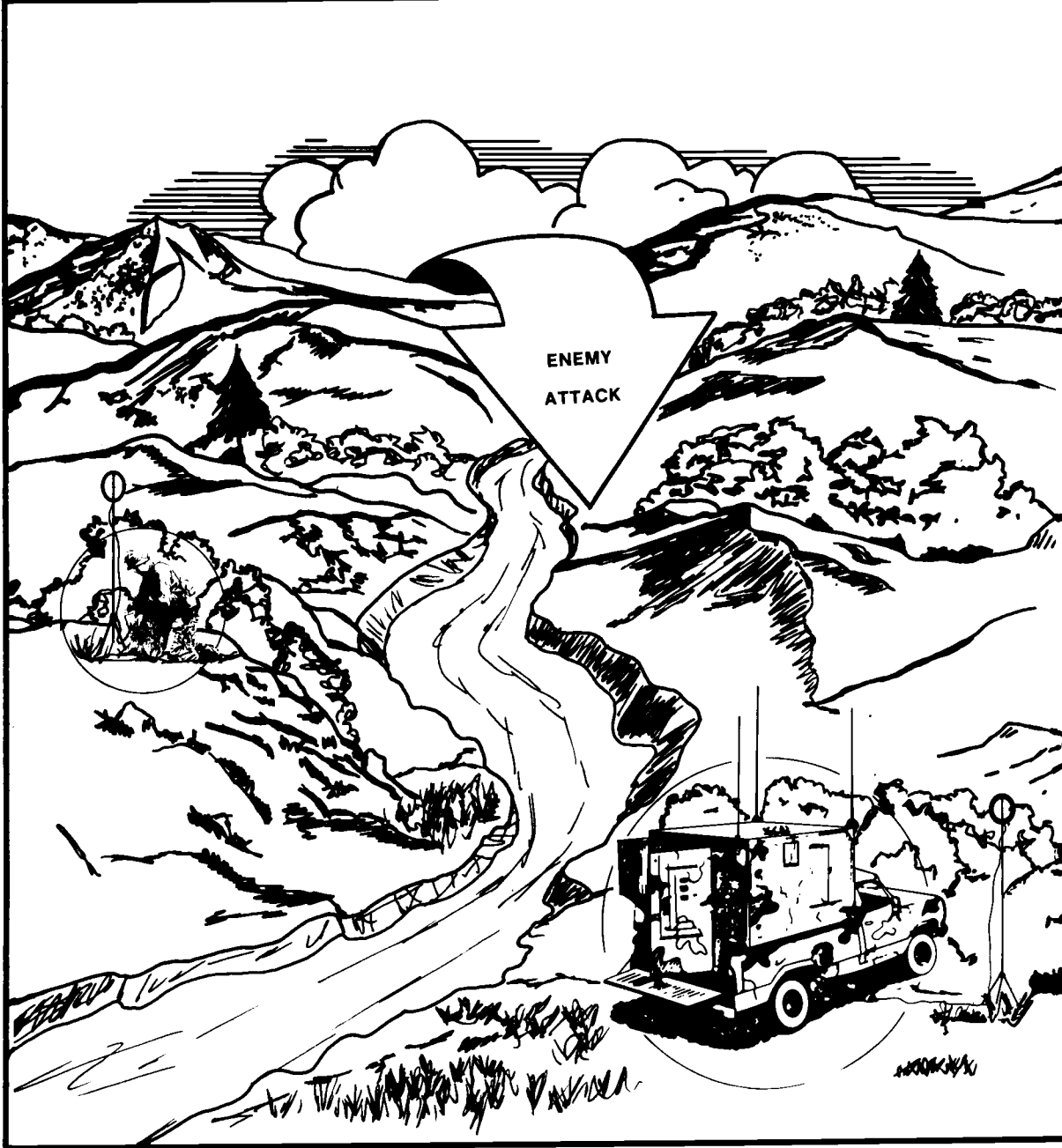



These systems have similar capabilities and limitations. They are capable of intercepting both HF and VHF single channel voice and manual Morse communications facilities supporting enemy first-echelon units.

Both of these systems also have a VHF line of bearing capability. Their primary HPTs usually include the C<sup>3</sup> facilities supporting—

- Enemy first- and second-echelon battalion CP.
- Enemy first- and second-echelon regimental CP.
- Enemy first-echelon division forward and main CP.
- Fire direction control centers and command observation posts associated with rocket and artillery units supporting enemy first-echelon divisions.
- Meteorological stations supporting enemy first-echelon fire support units.
- Rocket, artillery, AA, and SAM firing batteries.

The AN/TRQ-32 and AN/TRQ-30 systems are the primary means available to the heavy division G2 for extending the RDF baseline of the TRAILBLAZER system described earlier. Secure VHF FM voice communications provide the basic means for netting TRAILBLAZER MCS with the AN/TRQ-32 and AN/TRQ-30 via the IEW C<sup>2</sup> system. RDF flash tip-offs are communicated both ways over these VHF FM circuits. Rapid identification and location of HPT emitters is given primary emphasis in the TRAILBLAZER system, especially in the pre-hostility phase of combat operations. However, combat information and targeting data, and the tracking and monitoring of HPT, is the primary effort for AN/TRQ-32 and AN/TRQ-30 operators. They track and monitor the communications activity on the HPT C<sup>3</sup> facilities mentioned above. They provide indications and warning data to the brigade S2 via the IEW C<sup>2</sup> system as targets approach the brigade AO or as enemy fire support units target friendly close-in forces. They flash RDF tip-offs and help provide target location update

information on HPT as they enter and proceed to close on brigade battle positions. They also monitor the lethal and nonlethal attack against critical HPT located beyond the limits of observed fire. They provide battle damage assessment reports to the brigade S2 and division G2 via the IEW C<sup>2</sup> system. They also evaluate the effectiveness of COMJAM operations against enemy HPT emitters; they coordinate directly with ECM operators located nearby to ensure proper COMJAM adjustments to counter enemy ECCM activities.

#### **TEAMMATE-AN/TRQ-32(V1).**

TEAMMATE, the AN/TRQ-32(V1), is a product improvement of the AN/TRQ-32 system described above. It provides HF, VHF and UHF communications intercept, and VHF LOB data. The system is mounted on the M-1028 5/4-ton 4x4 CUCV. The quick-erect antenna, antenna mast, and hydraulic 5 kw generator and air conditioner are attached to the exterior of the S-457 shelter, making the system self-contained.

The TEAMMATE system, shown in the following illustration, will eventually replace all AN/TRQ-32 systems on a one-for-one basis; some are available in given MI battalions today.

**The AN/PRD-10, MRDFS.** The AN/PRD-10 Man-transportable Radio Direction Finding System (MRDFS)—vehicle or pack-frame mounted—is a lightweight modular radio intercept and direction finding system. It is capable of operating in two modes—autonomous or netted. In the autonomous mode, an individual station can provide intercept and LOB data. In the netted mode, up to four stations can be interfaced to provide intercept and RDF fix location data on HPT. The MRDFS will eventually replace all AN/TRQ-30 systems on a one-for-one basis, Armywide. Some are in the hands of troops today.

**Voice Collection and LLVI.** The voice collection and LLVI teams previously described are distributed evenly among the three EW platoons, C&J platoons, and C&J companies in the MI battalions subordinate to heavy, light, air assault, and airborne

## TEAMMATE-AN/TRQ-32(V)1

- A. Commercial utility cargo vehicle.
- B. Hydraulic generator and air conditioner.
- C. Pneumatic mast.
- D. All weather shelter.

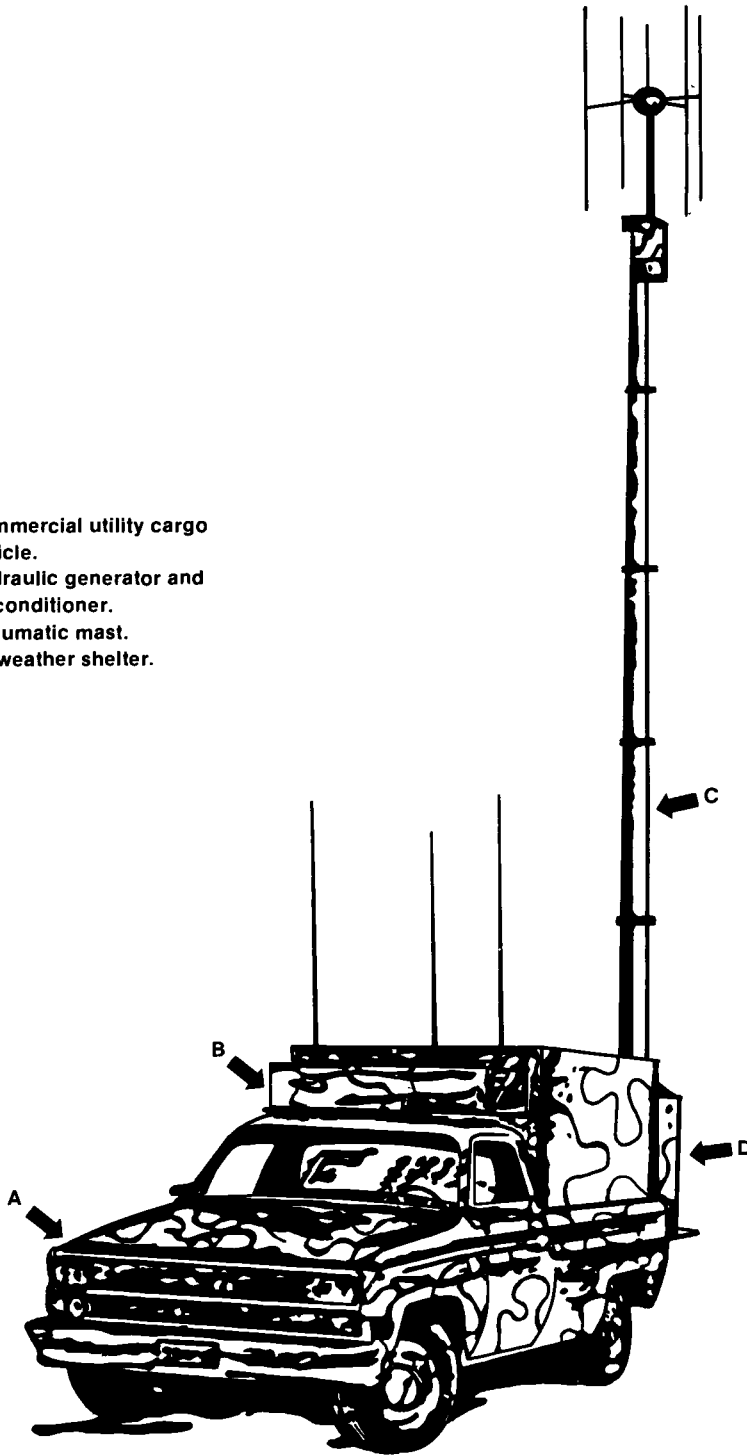

divisions, respectively. These E W platoons, C&J platoons, and C&J companies, as mentioned in the discussion about TEAMPACK, have been traditionally placed in DS of the respective division's subordinate maneuver brigades.

The number of SCV collection and LOB systems authorized in air assault and airborne divisions, and their equal distribution among three C&J platoons or companies, permits effective DS to each maneuver brigade. These DS assets can still operate under the technical control of the TCAE to satisfy SIGINT and the division G2's intelligence requirements. The individual voice collection and LLVI teams are netted under the control authority of the C&J platoon or company in each brigade's area; the voice collection teams, using the AN/TRQ-32, serve as the RDF NCS. The C&J platoon and company processing, analysis, and control elements are similarly netted under the centralized control authority of the division MI battalion's S3 and TCAE. A continuous flow of combat information, LOB and RDF fix location targeting data, and SIGINT technical data provides all elements—to include the division G2 and brigade S2—the information needed to successfully conduct the division's close, deep, and rear operations. The brigade S2 has direct access to the communications intercept and LOB systems via the IEWSE and C&J platoon leader or company commander. A C&J platoon or company may be reinforced with other voice collection and LLVI teams, cross-attached from other C&J platoons or companies. A prime example is when a divisional brigade is deployed forward by itself, as the initial division maneuver MCS, into a given contingency area. In such situations, the TCAE, or personnel therefrom, may augment the IEWSE at the brigade TOC. A tighter interface and more responsive support is then provided the brigade commander. The MI battalion commander and S3 may accompany the forward MI elements with the brigade making the initial assault or deployment.

The number of voice collection teams in the divisional MI battalions does not normally permit DS to maneuver brigades of DF assets. Each team has only one

AN/TRQ-32; the AN/TRQ-30, even when used, is collocated with the AN/TRQ-32 most of the time. These two systems cannot be deployed to provide a sufficient baseline for DF purposes. In any case, only a "cut"-two LOBs—would be produced. Thus, the single voice collection team within any one brigade AO cannot produce anything other than a general direction to HPT emitters. A general direction to an HPT emitter is adequate for nonlethal COMJAM attacks. However, a general direction to an HPT is inadequate for targeting by lethal attack systems. All three of the voice collection teams, therefore, must be netted under one centralized control authority.

The TCAE is the centralized control authority in most situations when the entire division is deployed and operational. Tasking and reporting, however, between the voice collection teams and TCAE, are still performed using intermediate control elements—the C&J platoon operations centers, TRAILBLAZER MCS/SSP, or EW platoon headquarters. In heavy divisions equipped with TRAILBLAZER, the voice collection teams may be cross-attached to provide an extended RDF baseline against key target coverage areas. Thus, one brigade may have up to two or three voice collection teams and one RSS from TRAILBLAZER operating within its AO. The actual mix of communications intercept and LOB or RDF stations within any brigade's AO is METT-T and situation dependent.

The infantry division (light) is authorized three voice collection teams. These teams are sufficient for providing DS to only one maneuver brigade at a time in most situations. These three voice collection teams, however, cannot possibly cover a division front in excess of 40 kilometers unless special preparations and modifications are made in regard to personnel availability, enhanced CSS, and high-powered communications. These changes could include—

- Moving a number of personnel forward to augment the C&J platoon's analysis effort and reinforcing the voice collection team with two voice intercept operators from the C&J platoon's transcription and analysis element.

- Identifying personnel from the IEW company team or a local CSS unit to transport fuel and rations to forward-displaced AN/TRQ-32 and AN/TRQ-30 teams on a scheduled basis.
- Using the high-powered communications capability of COMJAM systems operating on the flanks of the division or designated brigade AO to support the extended baseline requirement. A third COMJAM system would be needed at the centrally-located AN/TRQ-32 which, in most cases, may be designated the RDF NCS.

The type of DF and COMJAM support operations described above may be well suited to light division operations conducted against an adversary which lacks sophisticated DF capabilities. The use of COMJAM systems to support DF operations in high density enemy SIGINT environments, however, is not recommended.

The infantry division (light), because of its limited number of authorized voice collection teams and LOB systems, will have to optimize the communications intercept and LOB capabilities of other EW systems it has available to satisfy aggregate mission requirements. QUICKFIX is one of these systems.

**QUICKFIX.** Each MI battalion exercises operational control over the three QUICKFIX aircraft which are organic to the division CAB. Two versions of QUICKFIX are currently fielded. The first version is the QUICKFIX IB, AN/ARQ-33-A, which is mounted on the EH-1H modified helicopter. This version is capable of intercepting and jamming HPT communications emitters in the VHF band. It also has an HF intercept capability. It does not have an LOB or RDF capability.

The second version is the QUICKFIX IIA, AN/ALQ-151, which is mounted on the EH-1X modified Huey helicopter. It has all of the capabilities of the AN/ARQ-33, plus an LOB or RDF capability. It has only one operator position, however, whereas its predecessor has two. A new model of QUICKFIX, the QUICKFIX IIB, mounted in an EH-60A Blackhawk helicopter, has all of the capabilities of the QUICKFIX IIA,

plus two operator positions. QUICKFIX IIB in the Blackhawk is not yet fielded.

The LOB and RDF capability of QUICKFIX IIB was originally designed to provide general direction LOB information in support of QUICKFIX COMJAM operations. However, QUICKFIX, as with all other COMJAM systems, has an inherent mission to collect combat information and both targeting and SIGINT technical data to satisfy the aggregate information requirements of the division. Its collection mission during the prehostility phase of combat operations is extremely important to both division and brigade commanders.

QUICKFIX is usually considered a deep attack jamming system. Its enhanced radio LOS provides the division G2 and G3 with and extended VHF intercept and jamming capability which reaches beyond brigade AO into the division's deep attack zone. Its HF intercept range is unlimited. The division G2 and MI battalion S3 use the QUICKFIX aircraft to extend the DF baseline of ground-based communications, intercept, LOB, and RDF systems. They, in coordination with the division G3 and brigade S2 and S3, also use QUICKFIX to target key NAI and target areas of interest (TAI) in defilade to ground-based collection and jamming assets. The QUICKFIX aircraft are used extensively to support the division's overall SIGINT collection and electronic battlefield templating effort prior to combat.

The QUICKFIX aircraft operate well forward in brigade AO prior to combat operations. QUICKFIX missions are preplanned and on call. One aircraft is on station at all times during the specified mission time frame, while another aircraft is enroute to or from a forward arming and refueling point (FARP). A series of flight tracks may be established across brigade fronts to support area-wide communications DF operations for key time periods against key target areas.

QUICKFIX operations are controlled by the MI battalion S3 and TCAE. The IEW company team TOC, E W platoon operations centers, SSP, C&J platoon operations centers, or C&J company TOC serve as intermediate control authorities when required.

They also provide a communications relay, alternate communications routing, or back-up communications capability to support QUICKFIX operations. Combat information and LOB or DF fix location targeting data pertinent to specific maneuver brigades is transmitted by TCAE analysts to the brigade S2 via the IEW C<sup>2</sup> system in accordance with the reporting criteria and coordination instructions previously described. At times, such information may be routed directly from the QUICKFIX aircraft to the brigade S2 via one of the intermediate control authorities previously mentioned and the IEWSE at the brigade TOC. The latter communications routing is most prevalent in those unique situations when QUICKFIX aircraft are placed in DS of a specific maneuver brigade. Independent brigade operations, such as described for air assault and airborne operations previously, are good examples of when such procedures are used.

**The Ultimate Challenge.** The EW and SIGINT collection, DF, and electronic battlefield templating efforts are predominant in the prehostility, postdeployment phase of combat operations. Virtually all EW collection and jamming resources remain in GS of the division during this time period. Their aggregate collection capabilities are exploited to support the templating done at the MI battalion TCAE. The results, refined EW target lists and jamming schedules (EWTL/JS), are used to program forward-deployed E W collection and jamming systems. HPT sets are keyed to specific forms of maneuver schemes. They are time- and location-phased in accordance with supporting fire plans. Direct support to maneuver brigades is now feasible. Individual voice collection and COMJAM teams are focused on specific HPT emitters, units, and weapon systems. They are prepared to collect and report pertinent combat information and targeting data critical to the brigade and division commanders. COMJAM operators are prepared to attack HPT communications links critical to brigade and division combat operations. E W operators are ready when the attack begins.

In connection with the scenario described above, when expanded to the all-source

intelligence and overall targeting effort of the division, readiness is the ultimate goal of EW operations in the prehostility phase of combat. However, this goal is extremely difficult to achieve. The enemy's use of radio silence, OPSEC, deception, and new CEOI in combat are elementary factors to deal with when compared to another factor not yet mentioned. That factor is the enemy's extensive use of secure communications means to command and control troops and weapon systems. This last factor reinforces the need for an aggressive SIGINT collection, processing, and analysis effort within the division as a whole. "Aggressive" does not mean "extensive". EW operators and analysts concentrate on five information elements deemed essential to all tactical commanders. These essential elements of information are—

- Branch.
- Echelon.
- Activity.
- Location.
- Time of intercept.

EW operators and analysts are specially trained to provide such information. ELINT operators and analysts are not constrained in their efforts to identify and locate HPT noncommunications emitters. The foundation they provide to the electronic battlefield templating effort is tremendous. COMINT technical data and signal parametric data, together with LOB and RDF information and IPB products from the division G2 staff, when compared with ELINT EOB information, provide an overview of the enemy situation and order of battle on the battlefield. HPT communications and noncommunications emitters can be determined, and both lethal and nonlethal attack schedules can be refined. The electronic battlefield templating can only be done by EW and SIGINT analysts at the TCAE.

The information derived from the electronic templating process, described above, provides the voice intercept and COMJAM operators the initial identification and general location data of HPT emitters within their respective zones of responsibility.

COMJAM operations in the initial hours of combat are conducted to drive HPT communications facilities into the clear. Once the enemy is forced into clear-text voice communications—

- HPT identifications can be confirmed.
- Enemy event schedules and intentions can be determined or confirmed.
- Indications and warning data can be provided.
- HPT can be provided to target lethal attack fire-support systems.
- The enemy's event schedule will have been significantly altered to provide the necessary time windows for decisive tactical maneuver by friendly forces on and over the air-land battlefield.

This scenario and its ultimate goal, a series of battlefield successes which will win the air-land battle, is the ultimate challenge facing all EW personnel.

The above scenario is focused on COMJAM operations and the necessity of driving critical enemy C<sup>3</sup> facilities into the clear. The disruption of HPT enemy C<sup>3</sup> facilities must begin at the exact moment of the attack. It must be a concerted effort of all available maneuver and fire support assets. The combined effects of maneuver, fires, and communications jamming against critical enemy C<sup>3</sup>I facilities will result in a geometrical degradation of the enemy commanders' ability to effectively command and control their maneuver forces and fire support units. The elimination or degradation of key C<sup>3</sup> facilities such as regimental and division CP, force ill-informed decisions to be made at ever higher and lower echelons in a disjointed manner. The skip-echelon communications required to command and control far distant forces lend themselves, at the same time, to ever more effective COMJAM operations. The COMJAM resources, their capabilities and limitations, and their availability to support division and brigade combat operations in a unified and single coherent manner may determine who succeeds and who does not succeed on the electronic battlefield of today.

## COMJAM Resources

All of the ground-based and airborne COMJAM resources available to the division can be used to augment the division's overall EW and SIGINT collection effort prior to combat, when deemed necessary. QUICKFIX IIA, however, is the only COMJAM system in the inventory that has an on-board LOB or RDF capability. All of the ground-based COMJAM systems, therefore, cannot be used to extend the division's RDF baseline. They can and are used, however, as search and monitoring positions.

Ground-based COMJAM operators are capable of identifying and tipping off HPT emitters to other EW collection, LOB, and RDF resources in their immediate areas of employment. Such interaction is normally coordinated by the intermediate processing, analysis, and control authority in the assigned AO. Ground-based COMJAM operators are also tasked to monitor HPT communications and to report all essential combat information, targeting data, and SIGINT technical data heard.

The TCAE ensures adequate EW and SIGINT collection coverage throughout the division AO. All efforts are made to ensure that forward EW collection and jamming resources are focused on HPT emitters critical to the brigade in whose AO the resources are operating. Such focusing greatly enhances the ability of the entire EW system to respond to specific brigade requirements. The development of SIGINT/EW technical data is a major effort with both the TCAE and intermediate processing, analysis, and control elements having ECM control authority over COMJAM operations. This information, such as primary, alternate, reserve, and skip-echelon frequencies; call signs; powerout; LOB; and vertical or horizontal antenna polarization, is absolutely essential to optimize the COMJAM capabilities of given systems.

The Huey-mounted (EH-IX) QUICKFIX IIA, AN\ALQ-151, EW system was described earlier. This airborne EW system employs the VHF AN/TLQ-17A jammer. This jamming system can be programmed for up to 256 frequencies for enhanced search and monitoring functions. Sixteen

frequencies can be prioritized for automatic time-shared sequential spot jamming operations. A number of the sixteen frequencies can also be used to "lock out" and protect friendly frequencies from being inadvertently jammed. The QUICKFIX system uses an omni-directional whip antenna and radiates jamming signals 360 degrees. The brigade S3, S3 air, and C-E officer must all consider the QUICKFIX when developing their respective portions of the brigade OPLAN. COMJAM targets, such as regiment-to-battalion C links, airspace management and fire support coordination means, CEOI, and protected frequencies must all be considered. The brigade S2 should also consider QUICKFIX collection capabilities in his collection, reconnaissance, and surveillance plans.

**TRAFFIC JAM.** TRAFFIC JAM also employs the AN/TLQ-17A jammings sys-

tem. This ground-based version is capable of jamming both HF and VHF HPT communications emitters. It has the same programming and automatic jamming capabilities as mentioned above for QUICKFIX. It also employs omni-directional whip antennas for communications intercept and jamming operations. An illustration of this system follows.

The TRAFFIC JAM system, is usually mounted on the M-151A 1/4-ton jeep. It may also be mounted in the M-113 armored personnel carrier or on the M-1028 5/4-ton 4x4 CUCV. The HF band-1 antenna has seven mast elements which, when fully erected, reach a height of 28 feet. Five and seven elements are used for COMJAM operations against HPT emitters in the higher and lower bands of the HF spectrum, respectively.

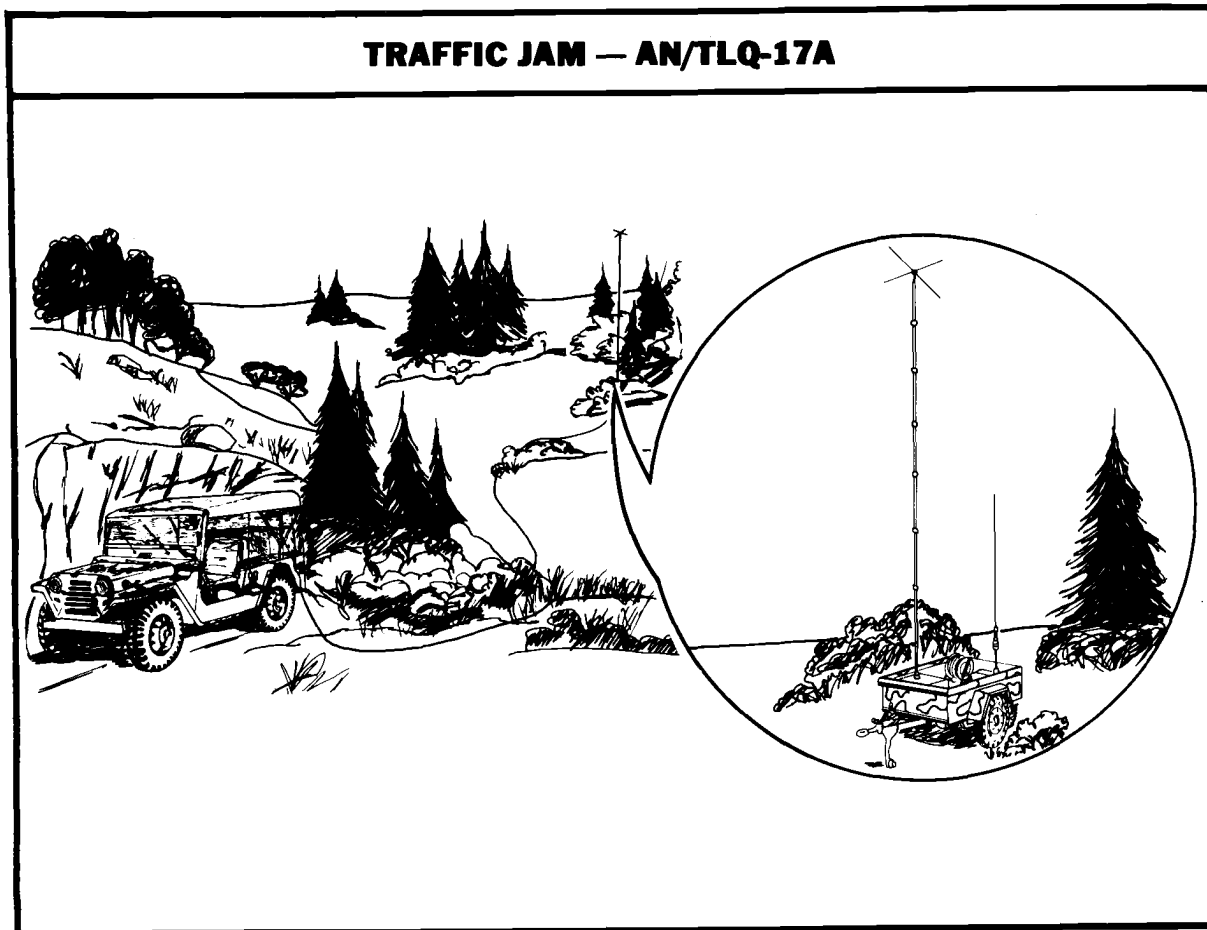

The HF band-1 antenna can be mounted in the M-416 trailer, as shown above, or dismounted and set upon more favorable terrain. The VHF band-2 whip antenna can also be trailer-mounted, as shown above. However, it is usually mounted on the rear of the M-151A to facilitate rapid set-up and tear-down time.

The TRAFFIC JAM HF and VHF COMJAM teams also have an additional vehicle for support purposes. It is an additional M-151A 1/4-ton jeep which pulls a second M-416 trailer. The support vehicle, an M-1028 CUCV, in the future will be used to carry the TRAFFIC JAM teams' VHF FM radios used for C<sup>3</sup> purposes.

The brigade and battalion S2, S3, and C-E officers consider the use of TRAFFIC JAM systems when planning combat operations. They take special care to ensure that these systems are not employed closer than one kilometer to friendly battle positions. Friendly CEOI and COMJAM schedules are also coordinated to ensure minimum interference with friendly C<sup>3</sup>. Rules of engagement, ECM control mechanisms, and coordinating instruction are developed and employed. Major coordination is required among the brigade S3, C-E officer, and the EW support officer from the IEWSE.

Some MI battalions may still be equipped with the older AN/TLQ-17 HF and VHF jamming system, rather than TRAFFIC JAM. The AN/TLQ-17 does not have a 256 frequency programmable capability. It does have a 15-frequency COMJAM prioritization or friendly lockout capability, however. The normal ratio of enemy HPT emitter frequencies to be jammed and friendly frequencies to be protected is 10:5. The AN/TLQ-17, unlike TRAFFIC JAM, has a directional VHF log periodic antenna (LPA). This VHF LPA allows for greater effective radiated power (ERP) and also reduces the likelihood of COMJAM interference with friendly communications in the area. This LPA, however, takes considerable time to setup and tear down. It is a manual operation. Thus, the AN/TLQ-17 may not be employed as closely to the FLOT as the TRAFFIC JAM system.

There are three HF and VHF COMJAM teams which employ either TRAFFIC JAM or the older AN/TLQ-17 in the MI battalion subordinate to heavy and light divisions. The air assault and airborne division MI battalions are authorized six such teams. These HF and VHF COMJAM teams normally operate within the main battle area (MBA). They are usually located on the flanks of their supported unit relatively close to the FEBA when conducting VHF COMJAM operations. They deploy further to the rear and are more centrally located when conducting HF COMJAM operations.

The TRAFFIC JAM and AN/TLQ-17 systems, the latter also M-151A-mounted, are effective against VHF HPT communication facilities within the brigade's close operations area beyond the limits of observed fire. They are not effective against short communications link-distanced targets within the close operations area 1-5 kilometers beyond the FLOT. TRAFFIC JAM, due to its omni-directional whip antennas, is not suitable for performing COMJAM screening operations or providing high power communications support. The potential interference to critical friendly C<sup>3</sup> and the broadcasting of critical information in 360 degrees must be precluded in most combat situations. Calls for fire using the TRAFFIC JAM system, however, may override all other considerations at given times in battle. The enemy commander knows where a maneuver battalion is when he has it cut off, pinned down, and encircled. Direct accessibility to TRAFFIC JAM's high power communications capability and its use by the maneuver battalion or brigade commander is recommended in such situations.

**TACJAM-AN/MLQ-34.** The TACJAM, AN/MLQ-34, is the most powerful and mobile ground-based COMJAM system in the inventory today. It is a semi-automatic, computer-assisted VHF COMJAM system, capable of jamming up to three enemy HPT communications facilities at one time. TACJAM, shown in the following illustration, is enclosed in an S-595 shelter, mounted on the M-1015 EW System Cargo Carrier. It utilizes a quick-erect pneumatic antenna mast, folding LPA, and on-board



**TACJAM — AN/MLQ-34**

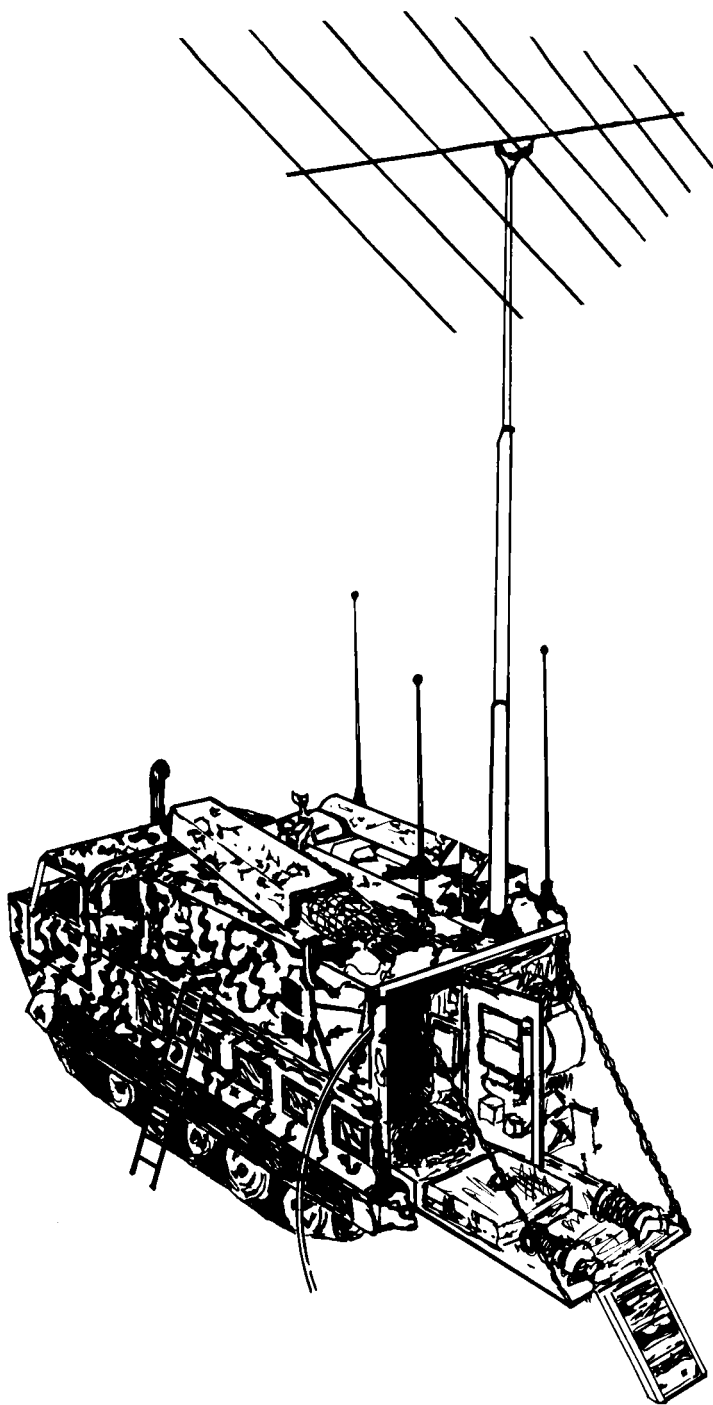

power generator. It is a completely self-contained system.

TACJAM has the most rapid set-up and tear-down times of any ground-based COMJAM system. The power take-off (PTO) unit allows the system to become operational by simply putting the transmission into neutral. The automatic ground-rod driver and pneumatic mast antenna allow the system to become operational within approximately two minutes. Pre-loaded "mission data" are stored in the on-board computer. The 40-foot pneumatic mast, VHF directional LPA, and the system's high ERP make TACJAM extremely effective against HPT communications facilities supporting enemy first-echelon units in both the brigade and division's deep operations areas. TACJAM is also effective against close-in HPT. However, these HPT are numerous. TACJAM, therefore, is normally targeted against HPT C<sup>3</sup> facilities beyond the limit of observed fire—both HPT within and beyond the range of TRAFFIC JAM systems.

There are three VHF COMJAM teams which employ the TACJAM system in the MI battalions of armored and mechanized divisions. There are also three TACJAM teams in the corps MI brigade. These TACJAM teams are usually employed well forward in the division AO. They can operate in the MBA or in the covering force area (CFA). They are usually deployed with TRAFFIC JAM systems when operating in the MBA and conducting VHF COMJAM operations.

TACJAM, due to its high ERP and directional LPA, is an extremely valuable COMJAM asset. It can be used to screen friendly C<sup>3</sup> without unintentionally jamming friendly communications. This capability, however, is limited to just one frequency at a time, due to the manual nature of the jamming operation and the rather sophisticated techniques and procedures used. These techniques and procedures, explained in FM 34-10, are designed to

deceive the enemy SIGINT or REC intercept and DF operators, to ensure that the brigade and division's OPLAN and intentions are not inadvertently compromised, and to ensure the survivability of the TACJAM team itself. COMJAM screening operations require detailed planning and extensive interaction among many members of the IEW team. Two COMJAM systems are required for each frequency to be screened. COMSEC operators may assist the up and down cuing effort. Such operations are executed on a preplanned basis. They are conducted for cover and deception purposes. They should not be attempted unless all personnel involved are adequately trained.

COMJAM screening operations are also conducted for pure OPSEC purposes in the heat of battle. The full capability of TACJAM—three-frequency automatic jamming, simultaneously performed—can be used when such operations are required. This type of COMJAM screening operation does not require the use of sophisticated procedures and techniques. They are conducted on an on-call basis and do not require extensive preplanning and coordination. They do require, however, a more precise knowledge of where the enemy SIGINT and REC assets are located. This requirement is reduced though, when two TACJAM systems are used in tandem; their overlapping field of cover toward suspect target areas is adequate to do the job for a short period of time. Their field of cover can also be increased when augmented by the PIRANHA systems, soon to be discussed. More information pertaining to COMJAM screening operations, procedures, and techniques is provided in FM 34-10.

TACJAM systems are also extremely valuable as skip-echelon high power communications systems. Directional COMJAM systems, using emission control (EMCON) procedures and being strategically placed on the battlefield from battalion through corps rear areas, allow for the continued use of friendly C<sup>3</sup> in all situations. This C<sup>3</sup> capability provides commanders at all echelons with an important means to synchronize close, deep, and rear operations throughout the corps AO in worst-case situations when no other means of C<sup>3</sup> are available.

**AN/GLQ-3B.** The AN/GLQ-3B is the fore-runner to the TACJAM system. It is employed in both the heavy division's MI battalion and corps MI brigade. The AN/GLQ-3B is mounted on the 5/4-ton M-880 series wheeled vehicle. It is a manual system capable of jamming just one HPT frequency at a time. It has no programmable capability. It is an extremely effective COMJAM system even in light of its stated limitations. It has the highest VHF frequency range of any COMJAM system. It employs a directional LPA and has the equivalent ERP of TACJAM, when TACJAM is used in the three-channel mode of operation. The AN/GLQ-3B is more effective against longer range HPT than the TRAFFIC JAM system. It is also capable of providing both high power communications and COMJAM screening support to the brigade and division or corps.

There are three AN/GLQ-3B assigned to the MI battalion in each heavy division. These COMJAM systems normally operate in the MBA. They are not usually located as close to the FEBA as the lighter and more mobile TRAFFIC JAM or AN/TLQ-17 systems. They may be employed with the TRAFFIC JAM or AN/TLQ-17 systems when the latter two systems are held back to conduct HF COMJAM operations. The AN/GLQ-3B systems may also operate in conduction with other forward-deployed HF COMJAM systems, such as the AN/TLQ-15, from the corps MI brigade. The AN/TLQ-15 HF jammer will be discussed shortly.

All of the VHF COMJAM systems described above are authorized a backup VHF COMJAM system for surge augmentation purposes and to provide an enhanced capability to maintain continuity of operations in a swift-paced combat situation. This back-up system is the PIRANHA.

**PIRANHA OG-181.** Each divisional MI battalion is authorized three PIRANHA OG-181 amplifier groups. The PIRANHA system is composed of an SG-886 signal generator, a power amplifier, spectrum analyzer, frequency scanner, and directional LPA. It can be used to augment COMJAM

operations. The system is illustrated on the following page.

The directional LPA, mounted on the front bumper of the M-151A 1/4-ton jeep, is a significant improvement over the LPA used on the AN/TLQ-17. It is a telescopic hand-cranked antenna which allows the system to be set up in just a few minutes. It can be taken down in seconds. It folds back over the vehicle when the team moves. The omni-directional whip antenna on the rear bumper can also be used for VHF COMJAM operations. This dual antenna feature allows for greater flexibility and continuity of operations. The whip antenna can be used when HPT emitters dip down out of radio LOS of the primary LPA—an important feature in hilly or mountainous terrain. The whip antenna also permits jamming operations while on the move—a design feature and capability which is of extreme importance in fast-paced retrograde and pursuit operations. The ERP is limited, however, when jam-on-move COMJAM operations are performed.

The team can now also provide high-power communications support using the PIRANHA system. COMJAM screening operations are possible. The potential interference to friendly C<sup>3</sup> is reduced. In addition, the C<sup>3</sup> capability of all VHF COMJAM teams is greatly increased. The PIRANHA's high-powered communications capability, directional in nature, can be used for long-range C<sup>3</sup> and coordination purposes even while the primary COMJAM systems are operational.

**AN/TLQ-15.** The AN/TLQ-15, mentioned previously, is an HF COMJAM system. There are three AN/TLQ-15 HF COMJAM teams assigned to each MI brigade at corps. These HF COMJAM systems usually operate well forward in the division and brigade AO for radio LOS requirements to HF ground-wave HPT and communications facilities. They are usually attached to the division's MI battalion and are normally held in GS of the division. They must collocate with other E W resources for C<sup>3</sup> purposes; the HF COMJAM teams have no organic C<sup>3</sup> means. The normal deployment for AN/TLQ-15 teams is to collocate with AN/GLQ-3B VHF COMJAM teams in the MBA. Collocation with TRAFFIC JAM

## PIRANHA — OG-181

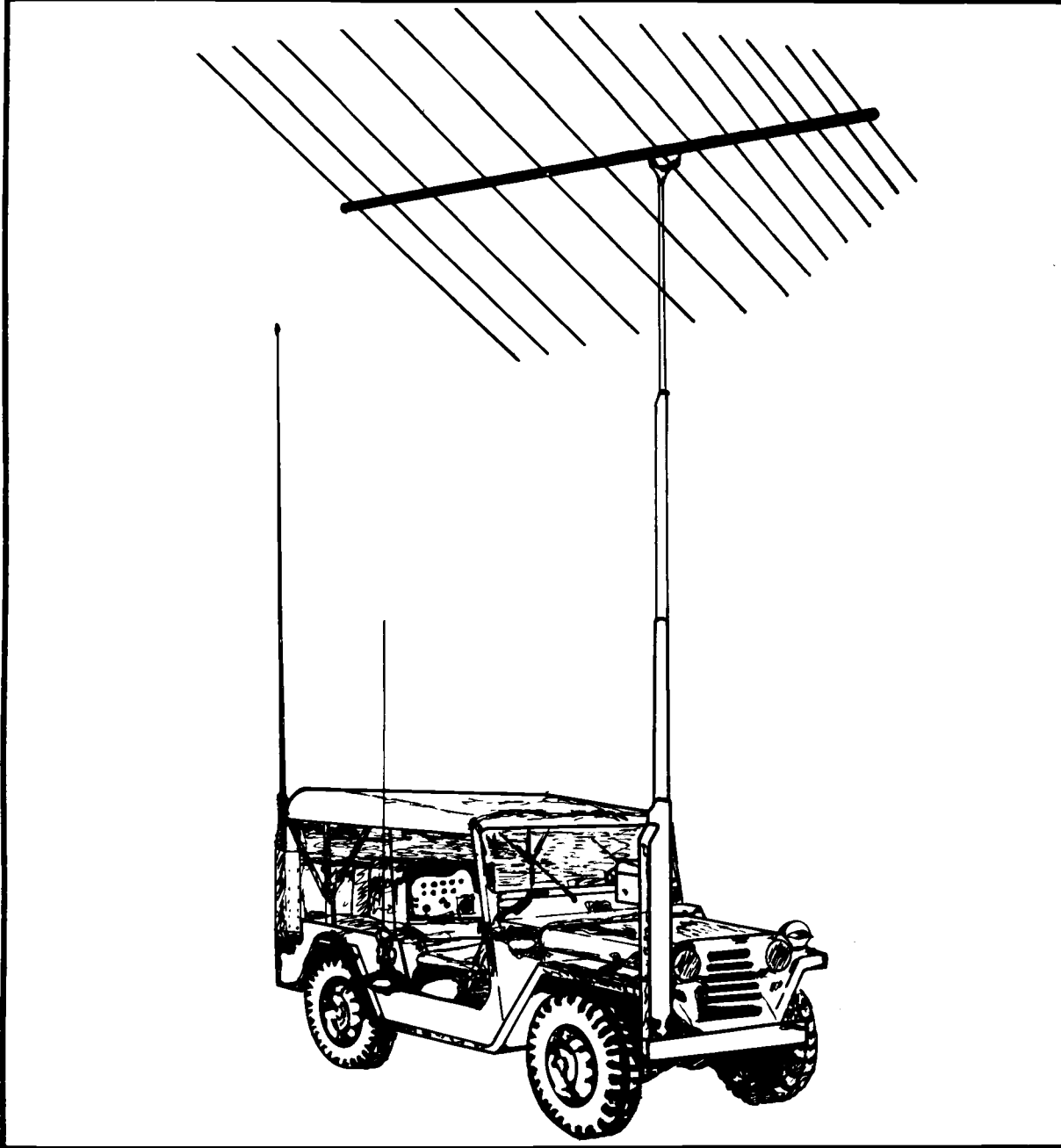

teams conducting HF COMJAM operations is also very practical in given situations.

The AN/TLQ-15, like the AN/GLQ-3B and PIRANHA, is a manual COMJAM system. However, it provides the corps and division commander an extended

HF COMJAM range capability. The AN/TLQ-15, however, uses an omnidirectional whip antenna; HF COMJAM schedules and friendly CEOI must be fully coordinated at all echelons of command from brigade through corps.

**COMJAM Resource Availability.** The number of given COMJAM resources authorized in division and corps MI battalions and brigades are summarized in the illustration below.

The number of jamming systems shown below equates to the number of COMJAM teams authorized in each type of division and corps MI unit. Each ground-based COMJAM team has three operators—two voice operators and one manual Morse operator. A fourth operator has been authorized each COMJAM team under new TOE force structures.

The three QUICKFIX aircraft assigned to each combat aviation brigade are subordinate to the GS aviation company, as previously mentioned. One HF and VHF TRAFFIC JAM team and one VHF TACJAM or AN/GLQ-3B team are assigned to each of the three EW platoons, C&J platoons, and C&J companies in the MI battalions subordinate to heavy, light, air assault, and airborne divisions, respectively. The ground-based COMJAM teams at corps are assigned to the EW company in the tactical exploitation battalion (TEB) of the corp's MI brigade.

<b>COMJAM RESOURCE AVAILABILITY</b>					
<b>SYSTEM</b>	<b>CORPS</b>	<b>ARM/MECH DIVISION</b>	<b>INFANTRY DIVISION</b>	<b>AIR ASSAULT DIVISION</b>	<b>AIRBORNE DIVISION</b>
<b>QUICKFIX</b>	<b>0</b>	<b>3</b>	<b>3</b>	<b>3</b>	<b>3</b>
<b>TRAFFIC JAM</b>	<b>3</b>	<b>3</b>	<b>3</b>	<b>6</b>	<b>6</b>
<b>TACJAM</b>	<b>3</b>	<b>3</b>	<b>0</b>	<b>0</b>	<b>0</b>
<b>AN/GLQ-3B</b>	<b>3 (1)</b>	<b>0</b>	<b>3</b>	<b>3</b>	<b>0</b>
<b>AN/TLQ-15</b>	<b>3</b>	<b>0</b>	<b>0</b>	<b>0</b>	<b>0</b>
<b>TOTAL</b>	<b>9</b>	<b>9</b>	<b>9</b>	<b>12</b>	<b>9</b>
<b>NOTE: 1 The new light corps has three AN/GLQ-3B vice TACJAM.</b>					



## Electronic Attack Options and Task Organization

The EW collection and jamming teams, described on the preceding pages, are task organized to satisfy aggregate mission requirements. The corps and division G2, G3, and electronic warfare officers (EWOs) work closely with the MI brigade and battalion commanders and S3 to determine task organization requirements for each operation. They consider both the informational and operational EW requirements of all subcommanders.

“Identify, locate, and jam” are the major electronic attack options available to the

corps and division G2, G3, and EWO. The capability of individual and collective EW resources to identify and locate HPT emitters and the enemy units and weapon systems they support is a major consideration; it provides a fourth attack option—destruction. The destruction of enemy CSI facilities at critical times in battle is the preferred attack option.

The electronic attack options are considered for each high payoff C<sup>3</sup> target set associated with given enemy combat, combat support, and CSS units found in specific attack zones beyond the FLOT. Nominal attack zones and HPT sets are shown in the following illustration.

ELECTRONIC ATTACK OPTIONS									
ENEMY C3 TGT BY ECHELON	FIRST ECHELON						SECOND ECHELON		FRONT
Distance from FLOT (km)	0-3	3-6	6-9	9-15	15-20	20-30	30-50	50-100	100-150
RSTA	LOC JAM	LOC JAM	LOC JAM	LOC JAM	LOC JAM	LOC	ID	ID	ID
REC	LOC	LOC	LOC	LOC	LOC				
MANEUVER		LOC	LOC JAM	LOC JAM	LOC JAM	LOC	LOC	ID	ID
ROCKET and ARTILLERY		LOC JAM	LOC JAM	LOC JAM	LOC JAM	LOC	LOC	LOC	LOC
SSM				LOC JAM	LOC JAM	LOC JAM	LOC	LOC	LOC
SAM/AAA	LOC	LOC JAM	LOC JAM	LOC JAM	LOC JAM	LOC JAM	LOC	LOC	LOC
ENGINEERS		LOC JAM	LOC JAM	LOC	LOC	LOC	ID	ID	ID
CSS		LOC JAM	LOC JAM	LOC JAM	LOC	LOC	LOC	LOC	LOC
FRIENDLY ECHELON	BATTLE RESPONSIBILITIES								
BATTALION	[REDACTED]								
BRIGADE	[REDACTED]								
DIVISION	[REDACTED]								
CORPS	[REDACTED]								
<b>LEGEND:</b>  - Close Operations  - Deep Operations  - Area of Interest <b>NOTES:</b> <sup>1</sup> JAM pertains to communications jamming only. <sup>2</sup> LOC pertains to both communications and noncommunications emitters in given units.									

Corps and division ground-based EW resources and the division QUICKFIX aircraft are focused primarily on the HPT C<sup>3</sup>I facilities within the division AO. The division AO, as shown in the illustration, may represent the corps' close operations area. The enemy's C<sup>3</sup>I system within this AO, as mentioned earlier in the discussion about CI support, is extremely robust. Alternate means of communication are available at almost every echelon of command in the enemy's force structure, from battalion through Front levels. The compatibility among given HF, VHF, and UHF C<sup>3</sup> facilities, and the skip-echelon capability of the enemy, offer a significant challenge to friendly EW systems. The flexibility and capability of friendly EW systems to work in such a dynamic signal environment can only be ensured by applying a centralized control and decentralized execution concept of operations on the battlefield. EW communications-intercept, DF, and jamming targets—the NCS or specific subscribers or outstations on critical C<sup>3</sup> facilities—may be located in different battalion, brigade, and division AOs. In other words, the communications links of given enemy C<sup>2</sup> nets may cross friendly battalion, brigade, and division commanders' AO boundaries and their respective battle areas of responsibility. In fact, a major goal of combined maneuver, fires, and jamming is to force this to happen—force the enemy to use skip-echelon communications to slow down his C<sup>3</sup> process and to make his critical communications facilities more susceptible to COMJAM attack at the same time. This is the geometrical degradation of the enemy's C<sup>3</sup>I system mentioned earlier.

The centralized control and decentralized concept of operations for division EW and SIGINT operations dictates the need for all EW resources to be held in GS of the division as a whole. It is only through GS that effective EW support can be provided any brigade commander. The IEW C<sup>2</sup> system, reinforced by IEW company teams in each brigade AO, is the means by which aggregate EW requirements are satisfied on a division-wide basis through all phases of combat.

## INTELLIGENCE AND ELECTRONIC WARFARE COMPANY TEAM

The MI battalion's IEW resources which support the brigade or operate in the brigade AO are normally organized into an IEW company team. The IEW company team provides for centralized control and coordination of MI resources. It provides the brigade commander and staff with a single point of contact for tasking supporting MI units and for requesting additional MI support which maybe necessary to satisfy the brigade commander's aggregate IEW mission requirements. A nominal IEW company team is illustrated on the following page.

The composition of each IEW company team is based on the division and brigade commanders' overall IEW requirements and the METT-T planning factors. An IEW company team, as portrayed in the following illustration, may include—

- The IEWSE which is normally located at the brigade TOC.
- An EW platoon with one transcription and analysis (T&A) team and a number of voice collection, noncommunications intercept (ELINT), and COMJAM teams.
- An intelligence/surveillance platoon with a number of GSR and REMS teams, as well as one or more EPW interrogator, CI, and COMSEC teams which normally deploy in the area of the brigade rear CP.
- A service support section to provide logistical and maintenance support to the company team.

In heavy division operations, an SSP element with at least one RSS and possibly an MCS as well, may be attached to the company team for service support purposes only.

The IEW company team maybe "heavy", such as shown in the preceding illustration, or "light", with few resources other than the GSR assets portrayed.

The majority of MI resources in each IEW company team are usually held in GS of the division, as previously stipulated. They can, however, be placed in DS of the maneuver

# THE IEW COMPANY TEAM

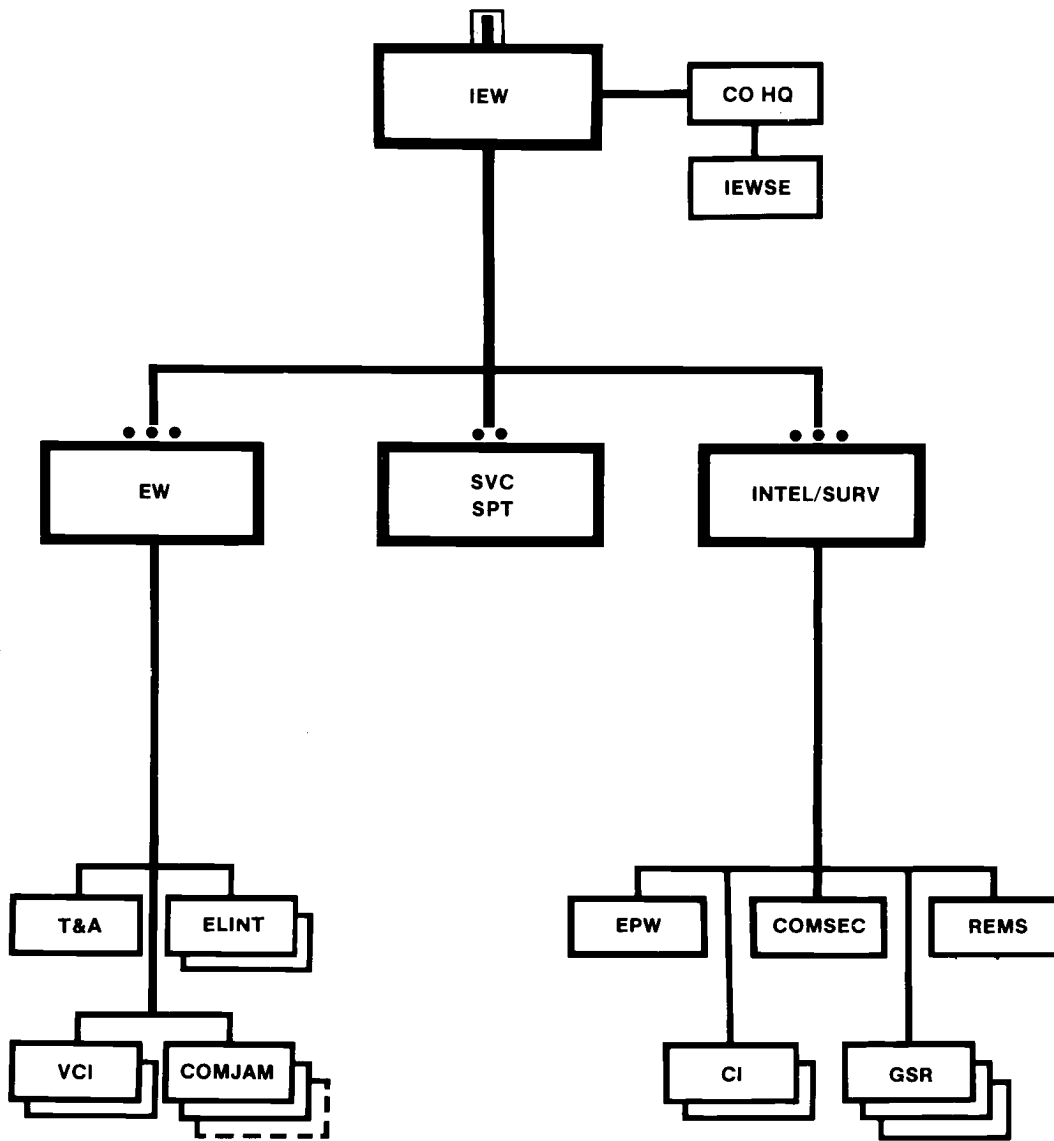



brigade when METT-T factors and existing battlefield situations so dictate. The GSR and REMS assets are normally attached to the maneuver brigade and further allocated to the brigade's subordinate battalions.

The division OPLAN/OPORD prescribes the designation of the IEW company team supporting each brigade and the control and support relationships, as well. The MI battalion OPLAN/OPORD prescribes the composition and task organization of each of these company teams.

### **IEW Support Coordination**

The IEW company team commander is the MI battalion's IEW support coordinator for the brigade. He is responsible for—

- Exercising control over MI assets placed under his command.
- Coordinating with the brigade S2 and S3 concerning the deployment, movement, and security of MI units operating in the brigade AO.
- Coordinating combat service support for MI assets in the brigade AO.

The IEW company team commander also provides the IEWSE at the brigade TOC. The IEWSE is supervised by a trained electronic warfare officer in charge (OIC) assigned by the MI battalion. The OIC, IEWSE serves as the IEW company team commander's senior representative at the brigade TOC. He functions as a special staff officer. He interfaces with other members of the brigade's coordinating and special staff to help integrate, plan, direct, and coordinate MI operations conducted within the brigade AO.

The brigade commander and his staff have direct access to the MI battalion's IEW C<sup>2</sup> system via the IEWSE. The MI battalion's IEW C<sup>2</sup> system is further described in Chapter 3; and is described in detail in FM 34-10.

### **OTHER COMBAT SUPPORT UNITS**

The Army aviation, tactical Air Force, ADA, and combat engineer units, described earlier in this chapter, all support brigade combat operations.

### **Army Aviation**

All combat aviation resources have an implied mission to observe the battlefield and report enemy activity to include enemy locations, equipment, and movement. They also report weather observation and terrain information. Aviation units support OPSEC by observing and reporting poor camouflage and light discipline. Aviation units normally report through aviation channels to the division unless OPCON to the brigade. When OPCON to the brigade, they report highly perishable information directly to brigade, S2, S3, and FSO in accordance with defined brigade procedures.

### **Air Defense**

Division air defense units are deployed throughout the division area to protect critical facilities and other potential targets of enemy aircraft. The ADA units supporting the brigade or operating in the brigade AO employ the FAAR/TADDS system described earlier in this chapter. They report combat information directly to the brigade via the ADA support officer. They can provide information about enemy air activity, aircraft losses, and air avenues of approach into and within the brigade area of influence. A type of deployment of division ADA units and the FAAR/TADDS systems is provided in the following illustration.

### **Armored Cavalry**

The armored cavalry squadron is the primary reconnaissance and security force for the heavy division. As such, it may operate on the flanks, forward, or to the rear of the maneuver brigades. It collects and reports combat information about enemy identification, disposition, and movement. It also provides information about the terrain and the effects of weather on the terrain.

### **Combat Engineers**

A combat engineer company is routinely placed in DS of the brigade. This company is critical to the brigade IEW effort in several respects. First, through engineer reconnaissance, it provides critical information concerning where brigade and enemy

forces can and cannot move. Second, terrain data is vital to the intelligence process—engineer reconnaissance data, along with terrain data, helps the brigade S2 determine the limitations and tactical

opportunities that the terrain presents. The DS engineer company also helps the brigade reinforce the terrain; it conducts both mobility and countermobility operations as described earlier in this chapter.

### TYPE FAAR EMPLOYMENT

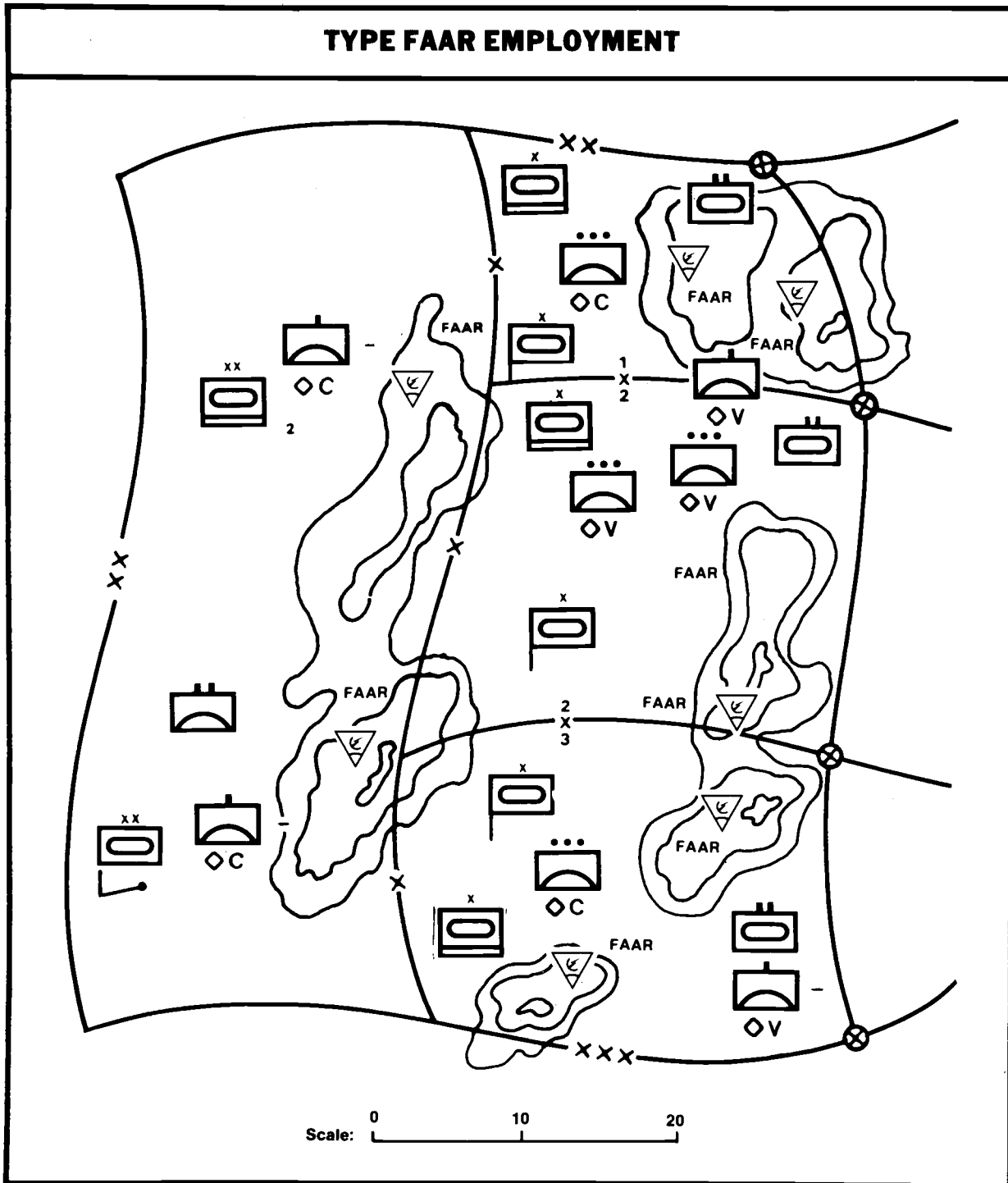

## **Military Police**

A military police (MP) platoon is usually provided DS to each maneuver brigade. It performs both battlefield circulation control and area security operations within the brigade AO. It secures the division's forward EPW collection point in the BSA. In this capacity it plays a vital role in supporting interrogation operations. The MP platoon supports OPSEC by observing and reporting activity in the vicinity of facilities with which it is charged, and by securing LOCs during battlefield circulation control operations. MP personnel can also provide vital information to CI teams supporting the brigade and division.

## **Supply and Transportation**

The supply and transportation (S&T) battalion from DISCOM provides essential support to the brigade. It provides basic transportation means for evacuating EPW, detainees, and refugees, as well as CED and material from the forward BSA. Thus, S&T resources, as well as Army aviation assets, must be considered by the brigade staff when developing its evacuation plans. Brigade requirements feed the division and corps area-wide EPW evacuation plans.

## **Command and Control**

The maneuver companies, maneuver battalion, and attached or supporting IEW resources from field artillery, MI, combat aviation, tactical Air Force, ADA, combat engineer, and CSS units in the division and corps provide the brigade commander a significant wartime IEW capability. The capability, shown in the following illustration, permits the brigade commander to secure his force and provide intelligence support, allowing the commander to synchronize his total combat operations.

The capabilities and limitations of each IEW resource available to support brigade combat operations were described in considerable detail within this chapter. The ability of the brigade commander and his staff to realize the full potential of each IEW resource is dependent on how well they plan, support, and coordinate individual and collective IEW missions. Synchroniza-

tion of combat power on the battlefield is a basic tenet of air-land battle doctrine. Synchronization begins with the integration of combat power in the OPLAN/OPORD itself. Synchronization, however, is ultimately dependent on an effective C<sup>2</sup> system. Command and control of brigade IEW operations is discussed in Chapter 3. It provides the foundation for follow-on subject matter regarding IEW preparation for combat and actual combat operations as well. These subjects are covered in Chapters 4 and 5, respectively.

# BRIGADE RESOURCES

## BRIGADE BATTLE

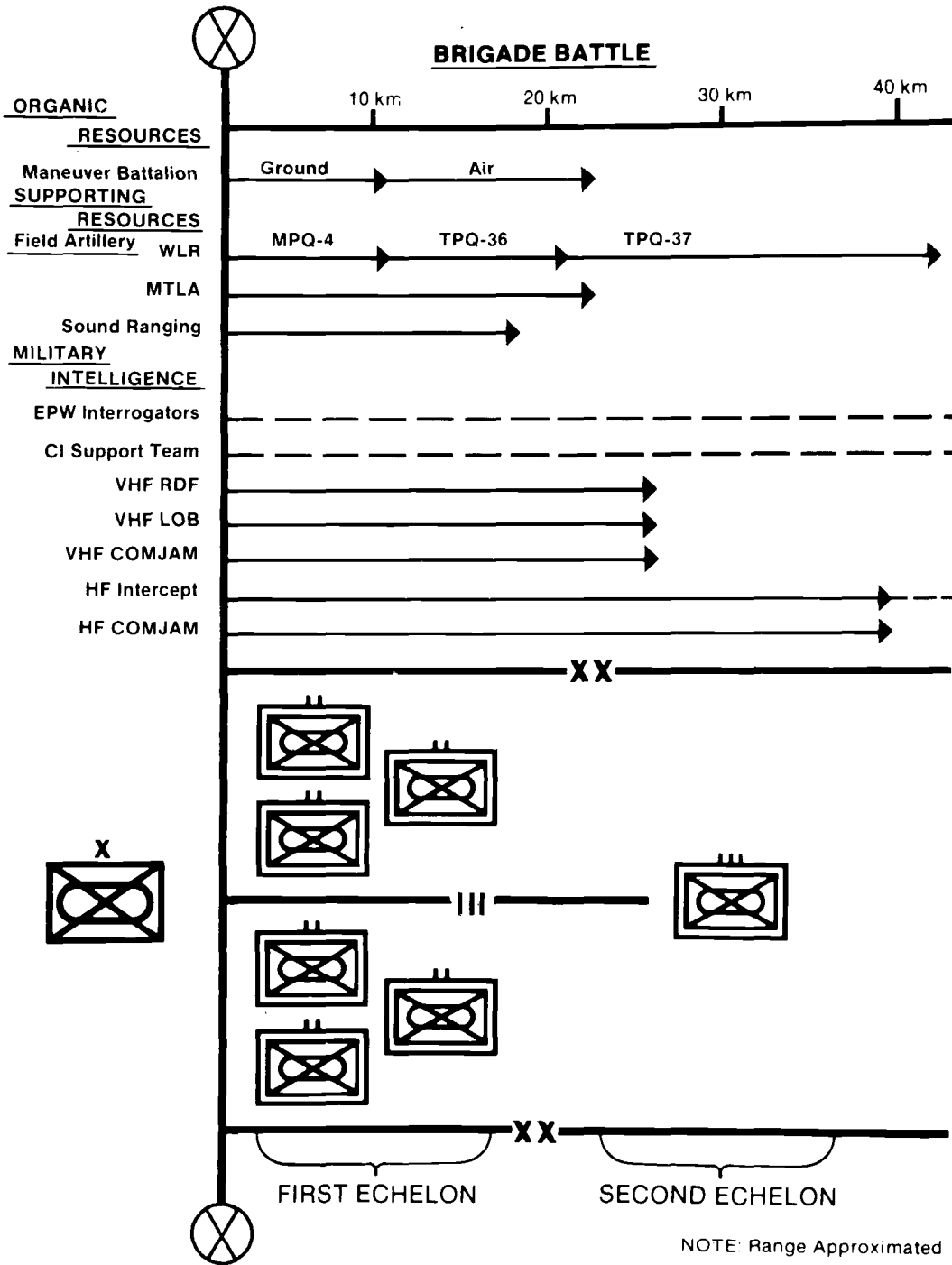

## CHAPTER 3

### Command and Control

Tactical skill and effective leadership are the foremost elements of combat power on the air-land battlefields of today. Modern technology has compressed both the time and space required for effective combat operations. The high mobility of air-land combat forces, and the speed, range, precise accuracy, and lethality of modern weapon systems place stringent demands on all commanders and staff officers. Highly sophisticated, multidiscipline RSTA systems are all-seeing, and computers react faster and more accurately than man. These capabilities further compound the factors that contribute to victory or defeat. They render every area of the battlefield virtually insecure.

C<sup>2</sup> facilities are HPT for both friendly and enemy commanders. Both friendly and enemy commanders use a vast array of RSTA assets to rapidly identify and locate their adversary's critical C<sub>2</sub> facilities.

Enemy commanders conduct extensive RSTA operations and detailed planning prior to beginning an offensive operation. Targeting priorities are directly aligned to support preparatory air and artillery fires against the defender's main defensive forces, reserves, and key CPs. The enemy commanders continue their efforts to locate and destroy C<sup>2</sup> facilities once the attack begins. Their intent is to systematically disrupt their opponent's ability to command and control his available troops and supporting weapon systems. Their ultimate goal is to maximize the degradation of friendly C<sup>3</sup>I systems.

Enemy doctrine is founded on the Soviet military strategy known as Command and Control Disruption (C<sup>2</sup>D)-NARUSHENIE UPRAVLENIYA. This strategy, unlike the joint US strategy of C<sup>3</sup>CM, is purely offensive in nature. However, C<sup>2</sup>D is executed in conjunction with extensive cover and deception (MASKIROVKA) plans and operations. Thus, C<sup>2</sup>D, when combined with cover and deception, is the equivalent of C<sup>3</sup>CM strategy, which was defined in Chapter 1.

The application of C<sup>2</sup>D and C<sup>3</sup>CM strategies on the air-land battlefield results essentially in command and control warfare. C<sup>2</sup> warfare is an integral component of all combat operations today. It is a battle for time, speed, and efficiency-time to plan and make decisions; speed to communicate combat orders; and the efficiency of combat power applied at the critical time and place in battle.

The implications for C<sup>2</sup> of brigade and battalion combat operations are clear. The nature of the battlefield requires a responsive and efficient C<sup>2</sup> system. A fundamental element of this C<sup>2</sup> system is streamlined command posts to plan, conduct, and sustain the battle. In turn, command and staff relationships and staff procedures must reflect the efficiency and proficiency required to operate the various elements of each CP. Moreover, the C<sup>2</sup> system must be reliable, secure, fast, and durable. It must be capable of communicating intelligence and combat orders, coordinating support, and providing direction to the entire force under all battlefield conditions. Above all, the C<sup>2</sup> system must function faster and more effectively than that of the enemy. It must allow brigade and battalion commanders to receive information, process that information, and consistently make and execute decisions faster than the enemy.

Brigade and battalion commanders need IEW support. They must be able to see, hear, and assimilate the multitude of data essential to effective C<sup>2</sup>. IEW support must be timely, accurate, and totally dedicated to extending the commander's perception of the battle.

This chapter provides the principles, procedures, and techniques of IEW doctrine as it applies to C<sup>2</sup> at the brigade and battalion level. It outlines an IEW C<sup>2</sup> system which allows brigade and battalion commanders to practice the basic tenets and operational concepts of air-land battle doctrine-initiative, agility, depth, and synchronization.

## **COMMAND AND CONTROL PROCESS**

The success of brigade and battalion combat operations depends on accurate intelligence, sound tactical plans, “focused” elements of combat power, and quick exploitation of tactical advantages and opportunities. The C<sup>2</sup> process supports these requirements. It consists of the procedures and techniques used to make and execute tactical decisions.

### **PLANNING REQUIREMENTS**

Brigade and battalion commanders, their staffs, and all attached or supporting unit commanders use the basic military decision-making process to develop their battle plans. This process permits the full coordination among all commanders and staff officers, the development of staff estimates, and the preparation of detailed plans and orders. Planning, however, can only be as thorough as time will permit. Plans and SOPS must include criteria for actions to be taken when mission-type orders are used on the fluid battlefield. The military decision-making process and the specific procedures and techniques used by given staff personnel to plan IEW operations in support of the brigade and battalion are fully described in Chapter 4 of this manual. The entire IEW system, illustrated at the beginning of Chapter 2, provides the intelligence necessary to support the detailed planning effort. The brigade and battalion staffs must use all of the time available prior to combat to plan the operation. Their commanders’ information and operational requirements for IEW support, as mentioned previously, must be forecast to the next higher headquarters early in the planning process.

The thorough planning of IEW operations allows command and staff functions to be performed on a proactive rather than a reactive basis. IEW resources are “focused” on HPT associated with each enemy course of action perceived. They provide the information essential for rapid processing at the brigade and battalion TOC in support of the decision-making process. The disposition and intentions of the enemy are determined by the HPT array depicted on the S2’s situation map as information flows into the TOC. Friendly courses of action and the information thresholds for their execution, determined in the detailed planning phase, allow rapid decisions to be made and executed before the enemy commander can initiate or complete any given action. Effective OPSEC, deception, and countersurveillance measures impede the ability of the enemy commander to see the battlefield clearly enough to adjust his plan to friendly initiatives. The combined effects of maneuver, fire support, and COMJAM operations conducted at critical times in battle against the enemy commander’s key C<sup>2</sup>I facilities further compound his seemingly proactive decision-making process. Tactical advantages and opportunities for decisive maneuver, anticipated in the detailed planning phase, are developed and exploited in combat to achieve success.

The division’s close operations cannot be won by the brigade without C<sup>2</sup>. And the battle for C<sup>2</sup> cannot be won without coherent plans. These plans must develop and ensure a firm understanding of the next higher commander’s intent and concept of operations, encourage and develop the confidence in subordinate commanders and small unit leaders to seize the initiative and exploit the tactical opportunities which arise in war, and provide an indestructible C<sup>2</sup> system in combat. In short, critical actions in response to mission-type orders are the prerequisite for successful operation on the air-land battlefield.

### **Combat Requirements**

Brigade and battalion commanders, their staffs, and all attached and supporting unit commanders or leaders use the related processes of troop-leading procedures and

command and staff actions common to the military decision-making process. Tactical field SOPS, which detail the responsibilities of personnel and staff sections and routine operations, facilitate the rapid planning and execution processes in combat.

The C<sup>2</sup> process used in combat consists of the eight troop-leading procedures. These procedures are particularly applicable to fast-paced combat situations in which limited staff input is possible. Brigade and battalion commanders use these procedures with some elements of the command and

staff actions included as time and the situation permit. This combined set of procedures is the most frequently used C<sup>2</sup> process at the brigade and battalion levels. It permits staff participation when possible, and allows for rapid decision making and execution. This combined set of procedures is shown in the illustration which follows. Command and staff actions, which may be accomplished as time permits, are shown in parentheses under each troop-leading procedure or step.

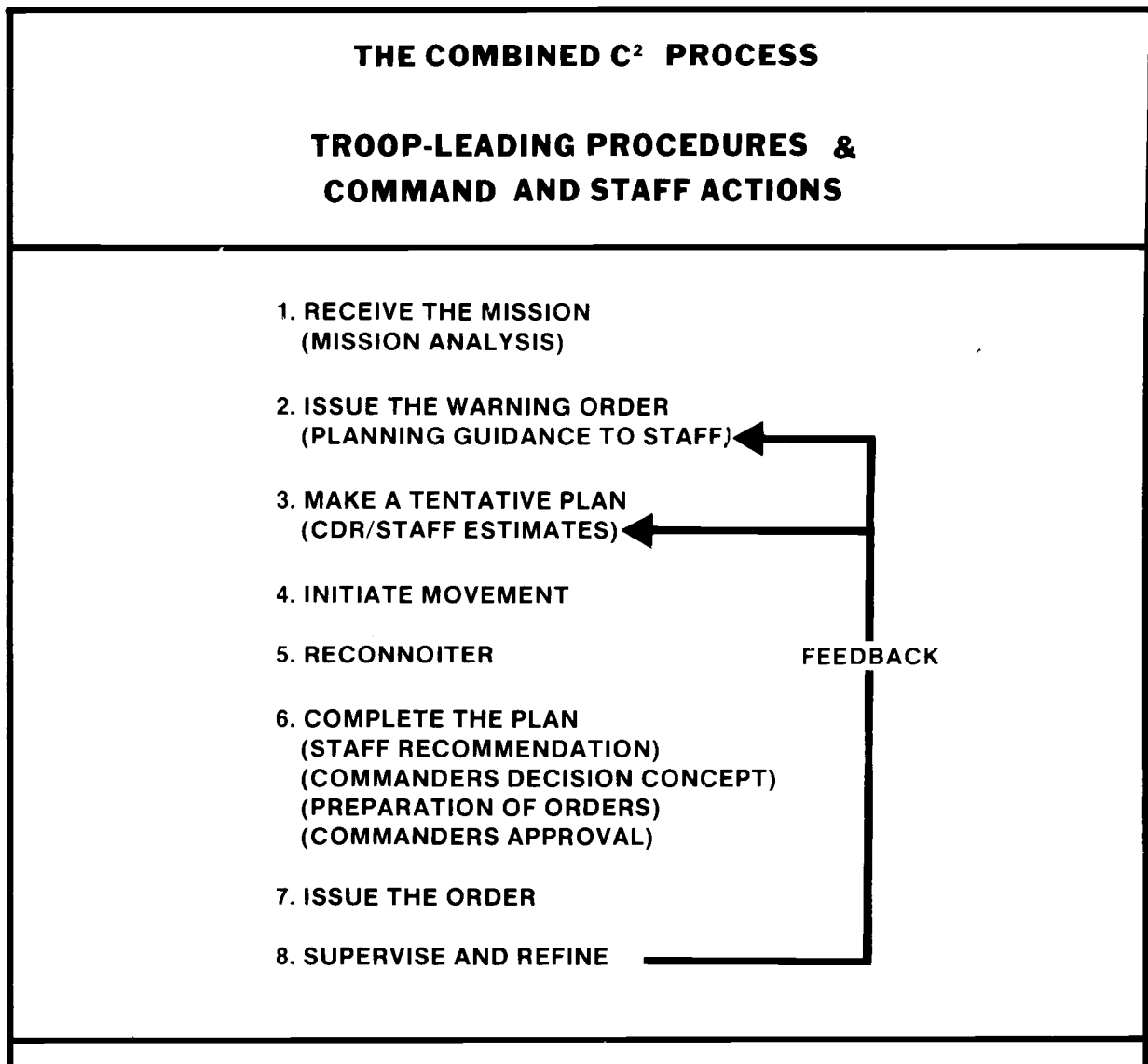

The troop-leading procedures used at the battalion and brigade levels are fully described in FMs 71-2J, 71-3, and FM 7-30, respectively. The commanders and staff officers within the MI battalion and all of its subordinate units which support the brigade also use these same troop-leading procedures. Information pertaining to special troop-leading considerations unique to the internal operations of the MI battalion are provided in FM 34-10.

The combined set of procedures, shown in the preceding illustration, provides the framework for planning, preparing for, and executing assigned and implied missions. The C<sup>2</sup> process is initiated, formally or informally, each time information requiring some action is received. The commander collects and analyzes information, decides what to do, orders someone to do it, and supervises the execution of this decision. The types of information which initiate the C<sup>2</sup> process may be as complicated as an OPORD or as simple as something which causes the decision and action to be accomplished as a matter of SOP. The cycle begins each time a decision has to be made and continues until the mission is complete, a new mission is received, or the combat situation indicates the need for a new or alternate course of action.

The commander's decision cycle, as shown in the following illustration is designed to turn inside the decision cycle of the enemy commander. The commander must make better and quicker decisions than his adversary if he is to succeed in combat. The goal, proactive in nature, is to never give the enemy commander time to complete one tactical response before another is required. This forces the enemy commander to deal with more than one tactical decision at a time and to react to friendly plans rather than carry out his own.

Each phase of the decision cycle requires certain activities to take place and a certain amount of time for completion. If there is enough time, the commander completes each step of the troop-leading procedures in detail. The commander covers each step, however, even when time is limited. The time spent on each step may be only a few seconds. This does not mean that shortcuts

are taken, because the resulting decision might be faulty or erroneous.

The illustration shows the relationship of the troop-leading procedure and each phase of the decision cycle. Time, speed, and efficiency are of paramount concern to brigade and battalion commanders. They reduce the decision-making time by establishing an organized, systematic C<sup>2</sup> process, making the process a matter of SOP, and by practicing command and staff drills at every opportunity.

Time, as shown in the following illustration, is the critical ingredient. Brigade and battalion commanders establish a "time-critical" factor for the completion of each step and phase in the decision cycle. The "time-critical" factor is keyed to the specific time in which the commander must make his decision in order to effect the action necessary to accomplish the task or mission at hand. Adherence to "time-critical" factors ensures greater speed and efficiency in the application of combat power.

These "time-critical" factors are developed as a result of war-gaming and FTX experiences. They are specifically designed to ensure the brigade and battalion commanders' ability to function inside the enemy commander's decision cycle. IEW resources, deployed well forward in the brigade AO prior to and during hostilities, provide the basic information from which the enemy's course of action and associated event schedule is derived or confirmed. Knowing the enemy's event schedule is the key to effective C<sup>2</sup>.

The enemy's event schedule is initially predicted as a result of the detailed situation and target development activities conducted at division, brigade, and battalion levels prior to combat or prior to the next anticipated engagement. Time measurements are estimated between each event anticipated. The aggregate result is a time-sequenced series of events clearly depicting the "time-critical" factors of the enemy commander. Friendly courses of action and corresponding time-sequenced event schedules are juxtaposed against each enemy event schedule. Friendly and enemy "time-critical" factors are compared and measured. The result is a series of friendly battle options designed to get ahead and stay



ahead of the enemy commander. Information provided by IEW resources in combat reflect exactly where the enemy commander is in his event schedule. Appropriate battle

options, or alternative courses of action, predetermined, can then be selected and executed by the commander in a very short of time.

### THE FOUR-PHASE DECISION CYCLE— TROOP- LEADING PROCEDURES

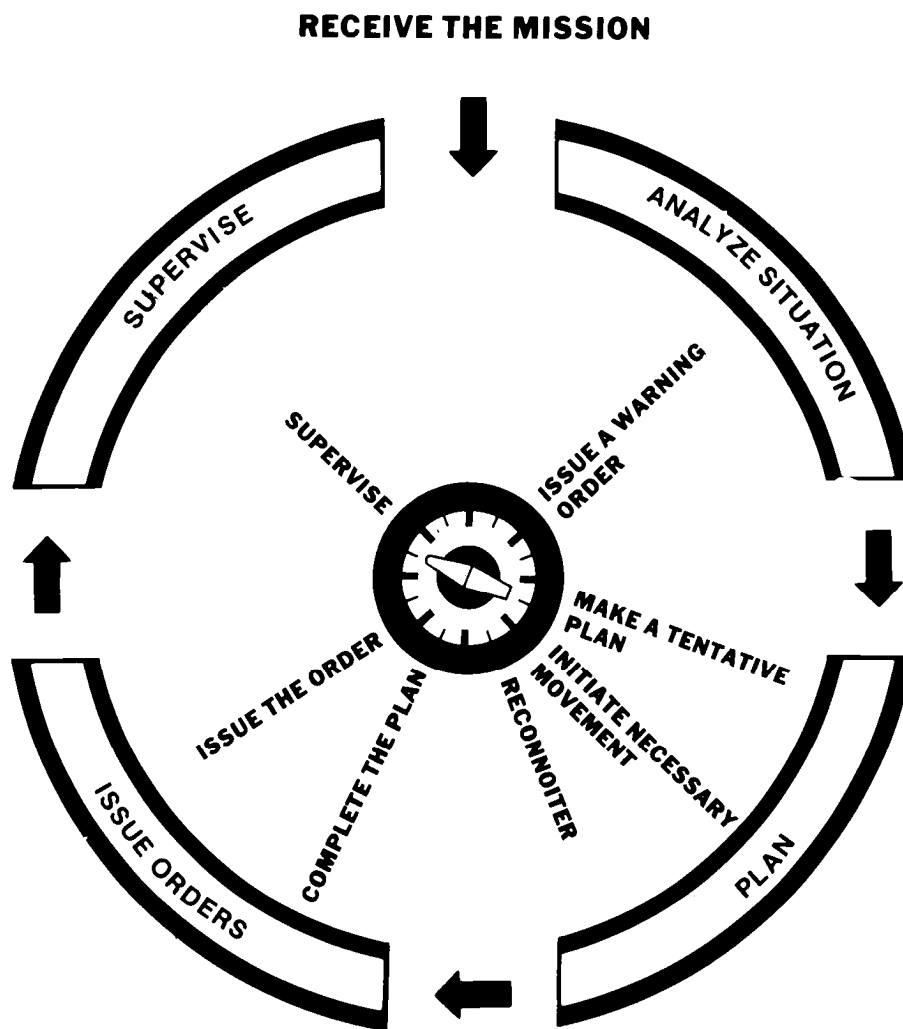

## Principles of IEW Support

The IEW missions described in Chapter 1, and the IEW functions, capabilities, and limitations described in Chapter 2, provide the basis for the principles of IEW support to both offensive and defensive combat operations. These IEW principles are directly keyed to the brigade and battalion C<sup>2</sup> requirements described above. The principles of IEW support are—

- Knowing the battlefield-multi-discipline RSTA assets to provide essential information about the enemy, terrain, and weather.
- Denying the enemy intelligence—EW and COMSEC resources to protect C<sup>3</sup> and CI support to OPSEC deception, and rear operations
- Disrupting and destroying enemy C<sup>3</sup>I facilities—COMJAM resources to disrupt HPT C<sup>3</sup>I facilities and ESM resources to target fire-support systems.
- Maintaining the integrity of IEW operations—task organization to satisfy aggregate mission requirements and the full integration of IEW to maintain the integrity of the force as a whole.

## IEW COMBAT POWER

The principles of IEW support provide commanders and staff officers a significant insight regarding the application of IEW combat power. The application of IEW combat power begins in the planning phase of combat operations and continues throughout the course of battle. IEW combat power, applied today in peacetime, adds a new dimension to brigade and battalion combat operations and the commanders' C<sup>2</sup> process, as well. This new dimension is portrayed in the following illustration.

The combat power IEW brings to the commanders' C<sup>2</sup> process is intelligence. In peacetime, intelligence supports contingency and battle plan development activities at all levels of command from the battalion through EAC and the national command authority. The intelligence available in peacetime provides the information

essential to formal planning initiated from the top down. The top-down planning effort is supported by the lower-echelon commands that generate their information and operational requirements from the bottom up.

Three of the four decision-cycle functions portrayed in the preceding illustration—collect, process, and assess battle damage—are IEW functions. They are three major components of the intelligence cycle which is described in FM 34-1. The intelligence cycle is driven by the commander, his mission, and his concept of operations. Constant supervision and direction by the G2/S2 ensures a continuous flow of information to the commander and other staff members in both peace and war; that is, the dissemination of intelligence.

Attack, the fourth function depicted in the preceding illustration, is also supported by, and endemic, to IEW. The intelligence provided by the IEW system supports the commander, G3/S3, and FSCoord' efforts to select HPT, based on decisions on what, when, where, and how to attack. The attack plan may include IEW missions for COMJAM systems.

The combined intelligence and attack cycle, superimposed upon, and intertwined with, the decision cycle reflects the commander's targeting process, described in Chapter 4. The targeting and decision processes are inseparable in both peace and war. Substitute "plan" or "train" for "attack" and the cycle and processes continue to turn. Planning, training, and refining SOPS, followed by continued planning, training, and evaluation, ensures the combat readiness of the force. It also ensures that the commander's C<sup>2</sup> system and process can do the job in war. The commander's C<sup>2</sup> system must be well-exercised and stressed during peacetime.

The combat power of IEW is maximized when it is applied in accordance with C<sup>3</sup>CM strategy in war. C<sup>3</sup>CM strategy supports the top-down formal planning process mentioned above. It provides the corps, division, and brigade commanders with four options to protect and counter friendly and enemy C<sup>3</sup>I systems, respectively. The four C<sup>3</sup>CM

options are defend (OPSEC), deceive (tactical deception), disrupt (jamming), and destroy (physical destruction). Intelligence supports all four C<sup>3</sup>CM options. Protect C<sup>3</sup> is a "constant" on the battlefield; it is assured through the application of effective OPSEC and deception measures. Active

support measures, such as demonstrations, feints, COMJAM screening, high-power communications support, and COMSEC monitoring also help to protect friendly C<sup>3</sup> systems. OPSEC and deception measures to protect brigade and battalion C<sup>2</sup> systems are described in FMs 71-3 and 71-2J.

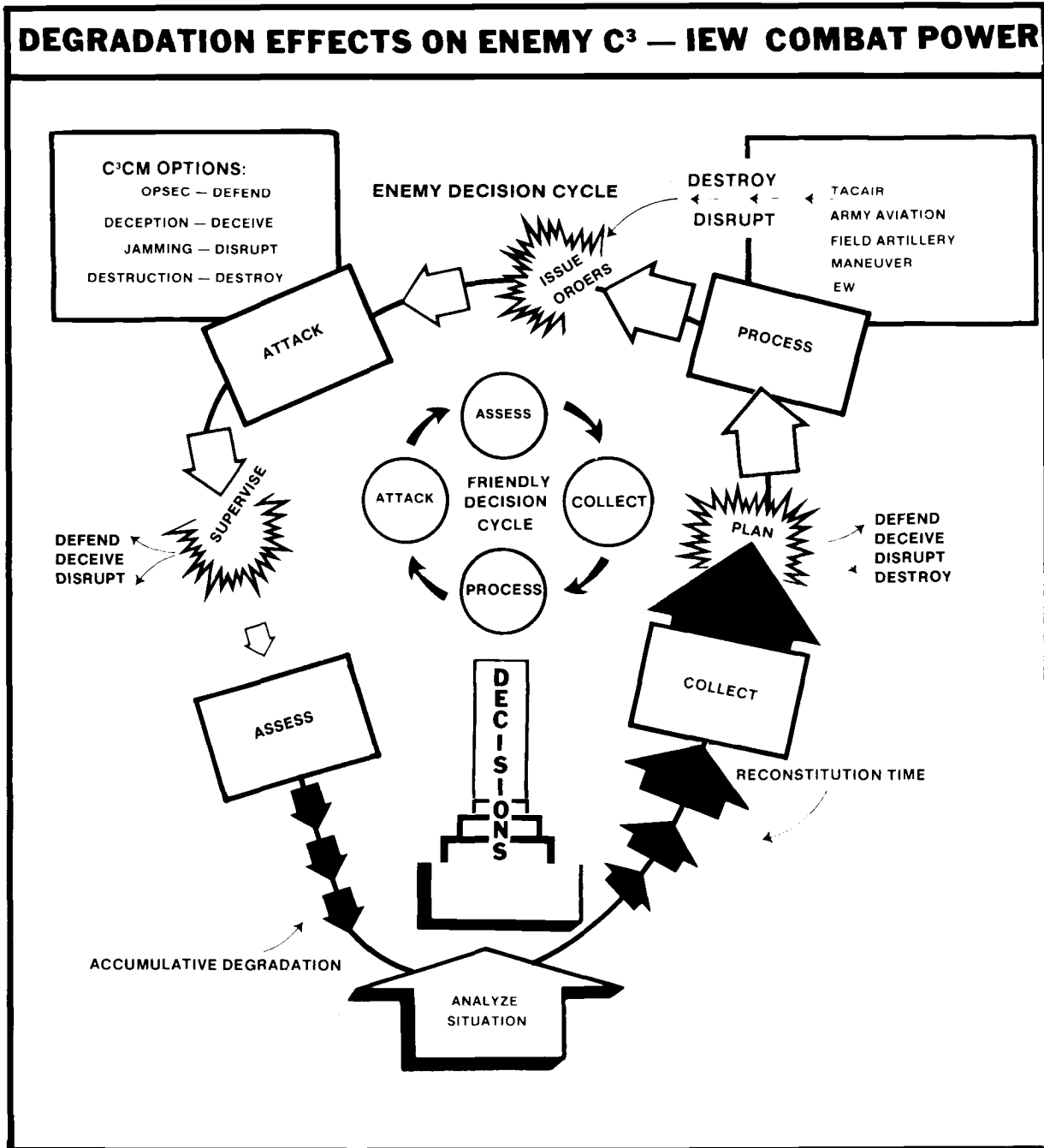

The offense is at the very heart of air-land battle doctrine. Thus, the disruption and destruction of enemy C<sup>3</sup>I facilities is the first and foremost consideration to protect friendly C<sup>3</sup>I facilities. Depth is extended, tactical opportunities arise, agility is exercised, initiatives are taken, and battles are won.

The combined effects of maneuver, fire support, and EW attacks against key C<sup>3</sup>I facilities in battle interdict and impede the enemy commanders' C<sup>2</sup> process and decision cycle. The cumulative degradation, shown in the last illustration, creates indecisiveness on the part of enemy commanders. The time needed to make decisions is lengthened, for key CPs and alternate C<sup>2</sup> facilities need to be reconstituted. The incessant attack against key C<sup>3</sup>I facilities renders the enemy commanders' C<sup>2</sup> system virtually ineffective. It can never be reconstituted long enough to regain effective C<sup>2</sup>.

As mentioned previously, C<sup>3</sup>CM strategy is applied in a top-down planning process starting at EAC. Brigade and battalion commanders fully realize the intent of senior commanders who apply C<sup>3</sup>CM strategy to their battle plans. They must do so, since their C<sup>2</sup> systems extend to, and are a part of, the next higher commander's C<sup>2</sup> system. The entire system needs to be protected in a coherent, well-orchestrated manner. The maneuver brigades, their subordinate maneuver battalions, and supporting fire support and MI units are also the major action arms for attacking key C<sup>3</sup>I facilities supporting enemy close-in forces. Friendly C<sup>3</sup> in combat, cannot totally rely on the availability of all communications facilities at all times. Protecting and countering C<sup>3</sup> actions must be considered on a regular basis in performing all C<sup>2</sup> functions. They must be executed using the same degree of initiative applied to other battle tasks. In fact, the application of C<sup>3</sup>CM strategy and commensurate IEW combat power is much more imperative when friendly forces are outnumbered and outgunned on the air-land battlefields. A deaf, dumb, and blind enemy force is not too worthy an opponent. Available maneuver, fire support, and IEW systems must be employed against the highest payoff

targets. Some of these HPT are key C<sup>3</sup>I facilities of the enemy force commander.

## **COMMAND AND CONTROL ORGANIZATION AND FACILITIES**

The brigade and battalion CP consists of the facilities and locations from which the respective commanders, assisted by their staffs, plan and direct the battle and sustain the force. Exercise of C<sup>2</sup> is focused in three major facilities at both commands—the tactical CP, the main CP, the rear CP at brigade, and the command group, TOC, and administration and logistics center (ALC) at battalion. This section outlines the IEW responsibilities of the staff personnel and describes the facilities through which the commander accomplishes his C<sup>2</sup> functions.

## **COMMANDERS AND STAFF**

Brigade and battalion commanders define the IEW mission and explain how it supports their concept of operations. They coordinate with supporting IEW unit commanders, such as the MI IEW company team commander, to organize IEW resources for combat. They state their informational and operational needs, specify their desired effects, and assign missions to subordinate unit commanders. They ensure that all organic, attached, or supporting unit commanders understand their intentions for IEW support to combat operations. They provide subordinate commanders the necessary latitude to make decisions that can allow rapid reaction to fleeting tactical opportunities.

The commanders position themselves to effectively control their combat forces. They accurately determine where the IEW effort must provide support priorities to ensure success. The relative need for information from the depth and width of the AO and the synchronization of various IEW resources, arms, and services are the two tactical considerations which determine where to place CPs, and the commanders themselves.

Brigade and battalion commanders leave their CPs and position themselves at vantage points well forward in the AO, when circumstances so dictate. Regardless of

location, the commanders monitor and follow enemy actions based on real-time combat information obtained by IEW resources positioned throughout their respective AOs. They track the actions of subordinate battalions and companies respectively, through close coordination with their subordinate unit commanders. They also remain cognizant of how units are being supported throughout their AO.

Succession of command and delegation of authority are established within all unit SOPS. At the brigade and battalion levels, the executive officers (XOs) know the commander's location and communicate with him by several alternate means—face to face, AM or FM radio, or messengers. Special staff officers at both brigade and battalion main CPs, such as the IEW support officers from the MI battalion, maintain similar contact with their unit commanders who are in support of brigade and battalion combat operations. Unit SOPS establish who is in charge. Succession of command in all units is planned to permit continued combat operations in the event of the commanders' incapacitation.

Brigade and battalion staffs are composed of people specifically ordered or detailed to assist the commander in the exercise of command. The staff reduces the demands on the commander's time and assists the commander and subordinate units by issuing warning orders, providing information, making estimates and recommendations, preparing plans and orders, and supervising the execution of established orders. The staff permits the commander to accomplish his duties without becoming continually involved in many of the specific details incident to command, thus allowing him to obtain first-hand knowledge by visiting subordinate units. The relationship between the commander and staff must be close and effective. The commander clearly articulates his concept and intent for all operations. The staff then takes appropriate actions before and during the battle to attain the commander's objectives. This must be done without constant communication with the commander. The staff, understanding the commander's intent, and fully aware of time and distance

factors, takes appropriate actions as the conditions of battle change.

The above is also applicable to all attached or supporting IEW units in the brigade and battalion AO—especially the MI battalion's IEW company team and its subordinate or attached platoons, squads, and teams.

### **The Brigade Staff**

The brigade staff consists of the officers and enlisted personnel required to plan and supervise brigade operations. The brigade staff monitors combat service support operations to ensure that adequate support is provided to all attached or supporting maneuver, fire support, and MI resources within its AO. The overall duties and responsibilities of the members of the brigade staff are detailed in FMs 71-3 and 7-30. Many of the specific IEW responsibilities of members of the brigade's coordinating and special staff were described in Chapter 2, where it was deemed essential to understanding mission requirements based on the capabilities and limitations of given IEW systems and organizations.

**The Intelligence Officer—S2.** The S2 is the principal advisor to the brigade commander concerning the enemy, terrain, and weather. He manages intelligence operations to satisfy the commander's requirements. He assists the commander in identifying the specific information requirements such as are described in Chapter 1. He plans, supervises, and coordinates the collection and analysis efforts to ensure that combat information and intelligence are disseminated promptly to staff elements or subordinate units.

An S2's first and most important responsibility is to provide the intelligence his commander needs to make sound tactical decisions. He uses every means available to develop timely, complete, and accurate intelligence to satisfy these needs.

The S2 recommends IR to the commander. First, he identifies requirements to support planning. Planning requirements are based on the assigned and implied missions given the battalion or brigade, and the

commander's planning guidance. They become the basis for the intelligence estimate, which supports other command and staff estimates. After the commander decides on the friendly course of action, the S2 develops intelligence requirements to support his concept of the operation.

Based on the concept of the operation, the S2 develops intelligence requirements to support every battlefield function that contributes to the accomplishment of the mission.

Requirements to support maneuver and fire support are always high priority. Other important functions that require intelligence support include—

- OPSEC
- Deception
- EW
- ADA support
- Combat aviation/tactical Air Force support
- Engineer support
- CSS

The S2 coordinates closely with the brigade commander, the brigade XO, the S3, and other staff officers. He also coordinates with subordinate and supporting commanders and staffs to determine what intelligence they need in order to plan and conduct operations within their functional areas of responsibility.

The S2 expresses intelligence requirements as PIR. The commander approves the PIR. The S2, with the assistance of the battlefield information control center (BICC), identifies other IR to satisfy the commander's information needs. The PIR, with associated IR, are the basis for the R&S plan.

The S2 develops and implements the R&S plan as the formal collection management tool. An informal collection plan may also be developed, but is not required at the brigade and battalion levels. He provides staff supervision over organic and allocated R&S assets. He coordinates with the S3 to ensure that the intelligence and resulting R&S plan supports the commander's concept of the operation.

The brigade S2 also manages the personnel and information security programs. He assists the S3 in planning and evaluating the effectiveness of the unit's OPSEC program by providing information on enemy intelligence collection capabilities, and assisting in evaluating friendly vulnerabilities.

The brigade BICC provides the brigade S2 with an organic collection management, analysis, production, and reporting capability that enables him to supply the commander with the intelligence required for making decisions. Acting under the supervision of the brigade S2, the brigade BICC controls and coordinates the combat intelligence collection effort for the brigade. It expedites the dissemination of information and intelligence among the BICC, the brigade's subordinate maneuver battalions, the DS field artillery battalion, the air defense artillery battery, elements of the IEW company team from the division's MI battalion, adjacent brigades, and higher headquarters.

The brigade BICC assists the S2 in developing intelligence requirements. After the brigade commander approves the requirements, the BICC develops the R&S plan. It forwards collection requirements to the division G2 section that cannot be satisfied by resources assigned to, or supporting, the brigade.

The brigade R&S plan integrates intelligence requirements of units assigned to, or supporting, the brigade, adjacent brigades, and the division. The BICC receives division requirements in the intelligence annex of the division OPORD. Requirements may be stated as PIR, IR, or as assigned collection missions.

The BICC develops and manages the execution of the brigade R&S plan. It reviews the maneuver battalions' R&S plans and incorporates them into the brigade plan. It consolidates requests for aerial R&S support from the maneuver battalions with brigade requirements and submits the consolidated requirements to the division collection management and dissemination (CM&D) section.

The BICC maintains the current status of organic, attached, or supporting RSTA assets. The S2 coordinates tasking with the

S3 to ensure compatibility with the brigade commander's scheme of maneuver and the tasked unit's primary mission. It tasks the DS IEW company team operating within the brigade AO through the IEWSE. It normally transmits tasking as fragmentary orders.

The brigade BICC processes incoming intelligence reports to develop the situation and targets in response to brigade requirements. It screens reports to isolate significant information, evaluates them for accuracy and reliability, correlates them with currently held information, and analyzes them to determine enemy intentions and to develop targets. It also develops intelligence to support brigade EW, OPSEC, and deception operations. It identifies gaps in the data base, which become new collection requirements. The BICC maintains the enemy part of the brigade situation map (SITMAP).

The BICC disseminates information and intelligence to all subordinate units of the brigade and to units supporting the brigade, to the division, and to adjacent brigades. It disseminates combat information immediately to those elements that need it.

***The Operations and Training Officer—S3.*** The S3 is responsible to the brigade commander for plans, operations, and training. He plans and directs OPSEC, deception, and EW operations.

The S3 has a vital interest in the production of intelligence. He uses intelligence as the basis for all operations planning. He ensures that friendly courses of action are evaluated in light of the enemy situation, the battlefield terrain, and the weather conditions under which the battle will be fought. Through the application of intelligence to planning, the S3 ensures the most effective use of the combat resources at the right time and place to achieve the results the commander desires.

EW operations are planned in detail at the division; they usually support the brigade battles. The division G3 allocates EW support to the brigades based on the aggregate requirements of the brigades and the division commander's overall concept of operations. The brigade staff plans and coordinates EW operations conducted

within the assigned AO. The staff relies on the IEWSE from the divisional MI battalion to assist in planning and executing EW operations and to request additional EW support, when required.

The S3 has primary staff responsibility for planning and coordinating EW operations conducted in the brigade AO. He integrates EW with maneuver and fires to ensure that supporting EW resources are used effectively to support brigade and battalion combat operations. He establishes priorities and recommends deployment and missions for EW systems. The S3 forwards EW requirements to the division G3 for consideration and incorporation into the division and MI battalion's OPLAN/OPORD.

The MI battalion's IEW support element assists the brigade S3 in planning EW operations. The assistant brigade S3 is a specially trained EW staff officer and should have the additional 5M skill identifier. He assists the S3 in planning brigade EW operations and in integrating EW with the scheme of maneuver and supporting fire plan.

The S3, S2, and C-E officer coordinate closely in planning and executing EW operations.

The C-E officer ensures that friendly electronic systems are protected from enemy REC operations. Coordination between the S3 and the C-E officer ensures that ECM will not significantly degrade brigade communications.

The S3 manages the OPSEC program. He analyzes the commander's concept of the operation to determine sensitive aspects that must be protected from enemy intelligence. He recommends EEFI to the commander. He relies on the S2 to assess enemy intelligence collection capabilities and friendly indicators that might compromise the EEFI.

The S3, in coordination with the S2, performs a risk analysis and develops appropriate OPSEC and deception measures, as well as other lethal and nonlethal counteractions. He monitors the effectiveness of the brigade's OPSEC program and deception operations, making adjustments as required.

**The IEW Support Element.** The MI battalion provides an IEWSE to support each maneuver brigade staff and coordinates all MI operations in support of the brigade. The IEWSE is the essential link between the brigade TOC, the IEW company team commander, and the MI battalion tactical operations center. It provides assistance in planning the use of MI assets and in identifying and requesting additional support from the MI battalion.

The IEWSE normally is collocated at the brigade TOC. Personnel assigned or attached to the IEWSE perform the following functions:

- Advise the brigade S2 and S3 on the capabilities, limitations, and employment of supporting MI assets.
- Assist the brigade S1 and S3 in planning the use of supporting MI assets and in preparing taskings for EPW interrogators, CI, GSR, and E W resources.
- Coordinate with supporting MI elements or the IEW company team commander to ensure a rapid response to all requirements.
- Ensure rapid dissemination of combat information from EW elements directly to the brigade S2, S3, and FSO.
- Ensure that deployed EW elements are advised of friendly force maneuvers that directly affect their security.
- Coordinate with the MI battalion tactical operations center on all matters concerning MI support within the brigade.
- Coordinate with the brigade staff to ensure the availability of necessary support for MI elements.
- Advise the brigade S2 and S3 of the organic capabilities of the MI assets at corps, and assist in the preparation of requests for that support via the division staff.

**Brigade Command Posts.** The single purpose of CPs at any echelon is to support the commander by providing the framework and system necessary to facilitate his rapid decision-making process. No CP can achieve its purpose if it does not survive. A

single CP, degraded, suppressed, or destroyed, can greatly impede the commander's decision cycle—as shown in the last illustration. Thus, there are numerous imperatives each CP must meet if success is to be achieved. These CP imperatives are as shown on the following page.

A simple comparison of the considerations and functions listed under the three CP imperatives, shown above, and the decision-cycle functions and troop-leading steps shown earlier, reflects the importance of CP survival on the air-land battlefield. Failure to survive is failure to operate, and failure to operate is defeat.

The brigade commander knows the importance of survival. He takes all the steps necessary to ensure maximum redundancy, austerity, dispersion, and mobility when organizing his C<sup>2</sup> system for combat. Minimum signatures for each CP and strict adherence to established OPSEC, SIGSEC, and ECCM procedures are demanded.

The brigade commander organizes his headquarters for combat by grouping staff sections or elements of sections within the headquarters by function for efficient staff coordination. Under ideal conditions, the organization of the brigade C<sup>2</sup> elements includes a main CP, a tactical CP, and a BSA.

**The Main Command Post.** Brigade C<sup>2</sup> is accomplished primarily through a main CP. For security, only essential elements are located in this CP. It consists of those coordinating and special staff personnel, and representatives from the division or other units necessary to carry out combat operations. It is concerned with the activities required to sustain current operations and plan for the future. This includes intelligence production and receiving and processing combat information, as well as submitting required reports to higher headquarters.

The main CP of the brigade is usually located to the rear of battalion task forces, out of range of enemy direct fire and mortar fire where possible. It is close enough to maintain FM communications with the CPs of subordinate elements. Since its location is often within range of enemy artillery, its



electronic and visual signature, too, must be no larger than that of a battalion CP.

Most of the brigade staff operates from the brigade main CP. The S3; S2; fire support; chemical, biological, and radiological sections; TACP; IEWSE; FSE; engineer elements, and ADA elements are all present. Communications with division are estab-

lished by elements from the division signal battalion.

The armored vehicles shown in the following illustration are located in the main CP complex and are an example of how a heavy division brigade CP (armor or mechanized) may be composed.

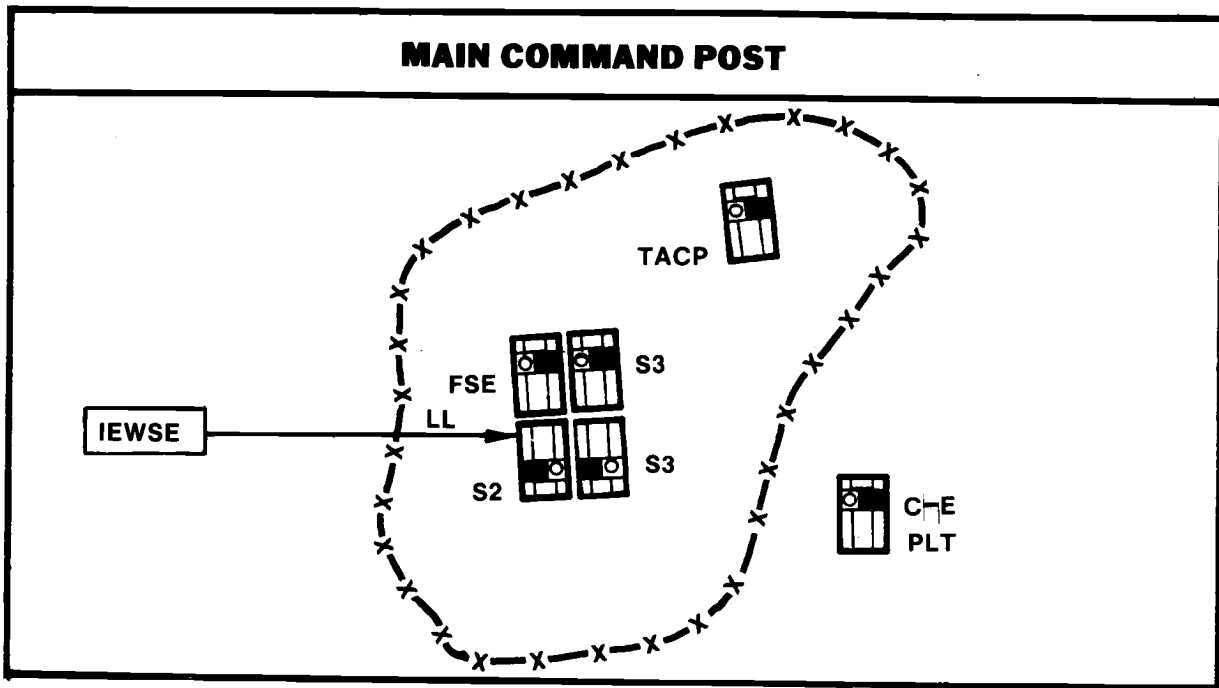
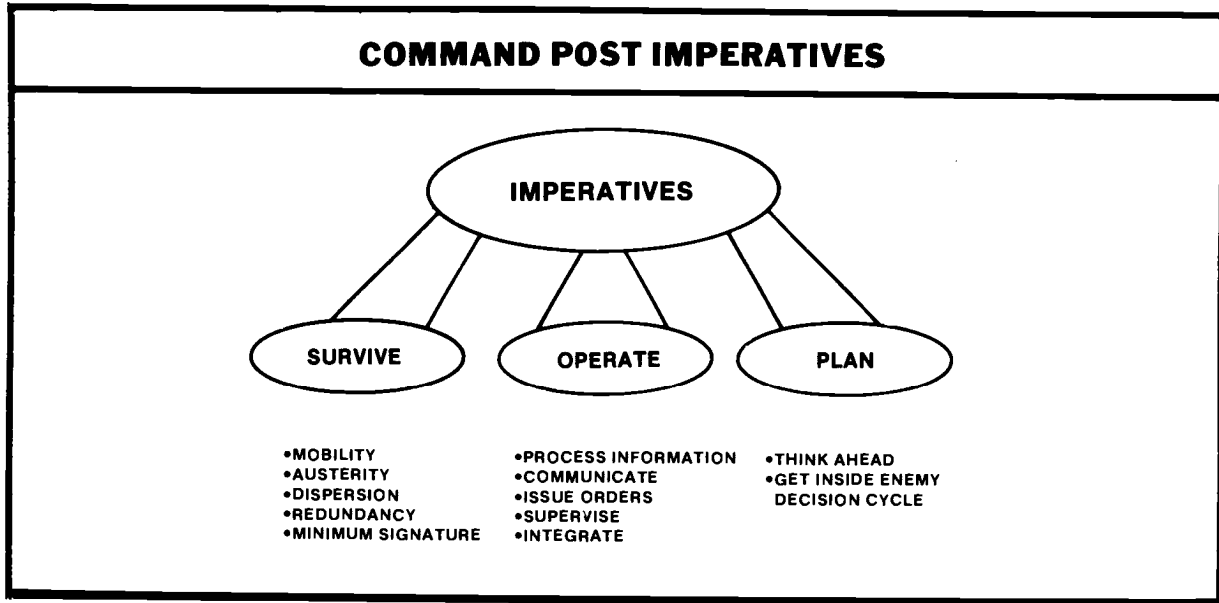

These include one each from the S2 and FSE sections and two from the S3 (one S3 vehicle used to establish the TAC CP when necessary). These four vehicles make up the tactical operations center. The remaining two armored vehicles are the communications platoon's vehicle that carries the RATT, normally remoted from the CP and a vehicle (normally M113) for the TACP. Elements from supporting air defense artillery elements and engineer elements are also found in the CP. The TACCP vehicle is only located here when it is not employed elsewhere on the battlefield. These six armored vehicles and accompanying vehicles required to support the main CP are dispersed over an area of approximately 500 square meters.

The brigade main CP is primarily a coordination, information, communications, and planning center. It includes a TOC for operations and intelligence functions. The main CP is arranged to facilitate work and security, take advantage of cover, and permit quick displacement. Its physical arrangement is prescribed by unit SOP. The brigade main CP communicates with the brigade commander and subordinate battalion task forces over the brigade command net (FM). The brigade MAIN also communicates with subordinate elements over the brigade operations and intelligence net (FM) and the administrative logistics net (FM). Land line communications are used whenever possible as an alternate means of communication. The IEWSE, as mentioned previously, maintains communications with the IEW company team commander and MI battalion tactical operations center via

VHF FM communications. The FSO and DS field artillery battalion communications interface was described in Chapter 2 in discussion of the overall fire support C<sup>2</sup> system.

Communications are maintained with the division using multichannel, radioteletype, division command net (FM), and division operations and intelligence net (FM). Single side-band (AM) communications are also used in communicating with the division TOC. Multichannel communications are provided to the brigade MAIN by the division signal battalion. Multichannel and voice communications are augmented by RATT nets which include the division operations/intelligence net and the division command net.

**The Tactical Command Post.** When required, a brigade commander may employ a TAC CP. This provides command and control of the immediate battle and contains only those personnel required for immediate control of the battle. The presence of a C<sup>2</sup> element well forward places the brigade commander near his subordinate commanders.

The TAC CP is used when a key phase of an operation is taking place that requires additional control: when the main CP is displacing, during river crossings, passage of lines, or when the disposition of brigade units requires that communications be relayed. A TAC CP is ideal for fast-moving mounted operations since it allows the commander to directly influence that battle while the remainder of his staff, supervised by the executive officer, operates from the main CP.

**Brigade Support Area.** The BSA of the brigade is located well to the rear and provides the CSS function required to support the brigade. The brigade S4 is responsible for the operation and displacement of this element. The S1 and the S4 maintain continuous contact with the brigade executive officer located at the main CP to ensure the adequacy of CSS operations. The forward area support team, or the forward support battalion CP from the division support command, is also located in this support area and provides support to the brigade

units. This support team or battalion CP locates and displaces according to the directions of the brigade S4. Another unit located in this area is the brigade headquarters company minus those company elements located at the main. EPW collecting point, military police, and civil affairs personnel may be located with or in proximity to the BSA.

**The Alternate Command and Control Facility.** The brigade commander establishes an alternate C<sup>2</sup> facility in case his primary C<sup>2</sup> elements are destroyed. It may be the CP of a subordinate unit or supporting unit. Succession of brigade command is usually to the senior task force or battalion commander. These subordinate units are designated to implement this procedure when required.

### **The Battalion Staff**

**The Intelligence Officer—S2.** The S2 has the staff responsibility for intelligence and security training. The S2 organizes for continuous operations during combat in coordination with the S3. The S2 and S3, through close coordination and cooperation, are prepared to perform each other's duties. The S2 is responsible for preparing and executing R&S plans. The S2 is normally located in the TOC during operations, although he may also be placed in the command group displaced forward. The battalion S2 is responsible for—

- Recommending PIR and IR.
- Directing and managing the command's reconnaissance, surveillance, and target acquisition assets.
- Processing information into intelligence.
- Performing rapid target and situation development activities before and during combat and providing pertinent information to subordinate, higher, and adjacent units.
- Coordinating and consolidating command requirements for weather and terrain analysis support.
- Planning and supervising the implementation of countersurveillance measures to support all operations.

- Supervising the command's personnel security and information security programs.
- Disseminating combat information.
- Assisting the S3 in targeting battalion weapon systems, and planning, executing, and assessing battle damage results.

The battalion S2 is primarily concerned with directing and coordinating the collection, reporting, and dissemination of combat information and targeting data. He plans and supervises R&S operations, using organic, attached, and supporting resources. He amplifies IPB products received from the brigade S2 based on the battalion commander's PIR. Requirements exceeding the capability of battalion resources are forwarded to the brigade.

The tactical intelligence officer works under the supervision of the S2 and is part of the two-man BICC. The BICC's primary responsibility is to effectively manage the unit intelligence collection, processing, and disseminating effort for the S2. The BICC normally operates in the TOC.

The battalion BICC is a vital link in the IEW system. It is the first element to begin the analysis and processing of front-line combat information. The BICC provides combat information, performs limited analysis of information, and acts as the intelligence resource management element for the battalion. It forwards requests for information outside the capability of the battalion's IEW resources to higher headquarters. The BICC also provides the S3 with intelligence support to OPSEC. Additionally, the BICC—

- Develops and maintains an intelligence data base.
- Plans and manages the battalion collection effort and prepares the battalion's R&S plan.
- Integrates information and intelligence from all sources.
- Processes and disseminates intelligence and information.

- Prepares intelligence summaries and reports.
- Assists the S3 in evaluating the command's OPSEC posture.
- Assists the S3 in identifying friendly vulnerabilities to enemy intelligence collection systems.
- Assists the S3 in identifying the type and amount of OPSEC support required.

**The Operations and Training Officer—S3.** The S3 has staff responsibility for matters pertaining to the organization, training, and operations of the battalion and attached units. He maintains necessary liaison with the brigade S3 and adjacent units' S3. The S3 supervises TOC operations. He is responsible for coordinating the actions of the FSO, engineer support officer, and other planners in preparing the battalion's OPLAN\OPORD. The S3 is normally in the TAC CP during operations. The S3 is also responsible for—

- Identifying EW support requirements.
- Coordinating with C-E officer to establish ECCM to protect battalion C<sup>3</sup>1 facilities.
- Identifying and recommending EEFI.

**Battalion Command Posts.** The battalion TOC is the C<sup>3</sup> center for combat and IEW operations. The TOC is composed of the S2 and S3 sections, elements of the communications platoon, the FSE, and representatives from other attached elements, such as the GSR squad leader and ADA support officer. The organization of the TOC in terms of vehicles and personnel must be as small as possible to allow for rapid displacement but sufficiently manned to accomplish its C<sup>3</sup> functions in support of the commander. The personnel in the TOC monitor operations on a 24-hour-a-day basis.

The functions of the TOC when the command group is deployed forward in a TAC CP are to monitor and assist in the C<sup>2</sup> of current operations by integrating CS and CSS into ongoing operations, maintaining coordination with higher and adjacent units, continuously updating the enemy

situation, reporting to higher headquarters, and planning future operations. Factors which have immediate operational impact and must be monitored by the TOC and communicated to the commander are specified in priority (friendly or enemy) as follows:

#### **FRIENDLY**

- Changes in mission or status of the task force or higher adjacent units.
- Changes in status of supporting fires or CAS priority.
- Loss of unit combat effectiveness of a platoon-size or larger equivalent force (including loss of DS or attached units both maneuver and support).
- Strength, location, and activity of operational forces down to platoon level (including DS and attached units, both maneuver and IEW support).
- Changes in status of major organic systems having a significant impact on combat power.
- Class III and V status.
- Priority of fires and CAS.
- Status of friendly or enemy obstacles and contaminated areas.

#### **ENEMY**

- Major contact with, or withdrawal of, platoon-size or large enemy units.
- Changes in location or sighting of enemy platoon-size or larger units.
- Employment of NBC weapons.
- Appearance of nuclear fire support weapons.
- Location, strength, identification and activity of units in contact and capability of enemy units to reinforce and support.
- Significant changes in enemy logistics capabilities.

The TOC must be capable of continuous operations for extended periods of time. Because of the limited number of personnel available, continuous operations are usually conducted in two duty shifts. Although

all personnel must be available during critical periods, off-duty personnel are usually performing maintenance on vehicles and equipment, providing security for the CP, and resting.

The battalion SOP describes specific responsibilities for each individual in the TOC. The responsibility for maintenance of friendly and enemy situation maps, entering and monitoring radio nets, maintaining daily journals, controlling access to the TOC, obtaining and maintaining current logistics status (ammunition, fuel, equipment availability rate, unit strengths, and so forth), and rendering required reports should be included.

The headquarters and headquarters company (HHC) XO is normally responsible for CP security. He coordinates with the S2 and S3 to determine—

- Sector designations.
- Mine and anti-intrusion device emplacement locations.
- Chemical alarms.
- Dismount points.
- Parking areas.

Security arrangements are specified in the individual battalion SOP.

### **COMMAND GROUP**

The command group is that element which the commander takes forward with him to help C<sup>2</sup> the battle. The composition of this command group depends on the situation and the desires of the commander. The command group will generally consist of the commander, S3, FSO, ALO, and the crews from the assigned tracked vehicles.

The command group is not a permanent organization and is normally prescribed by SOP and modified as necessary. The command group is highly mobile, enabling the commander to move about the battlefield as necessary. It is normally activated and employed for the actual conduct of the battle only, with the battalion TOC controlling subordinate battalion or battalion task forces during other periods.

The command group fights the battle. The commander will position himself so that he can “see the battle” and issue appropriate orders at the critical times. “Seeing the battle” consists of more than positioning this command group in a location to observe decision points and critical actions. It also implies that the command group is in a position to receive reports on those key indicators that he has discussed with his subordinates and, upon receipt of these reports, that he is in a position to order decisive action. The FSO must be in a position to coordinate indirect fires and respond to changes in the situation or mission with recommended changes to the fire support plan. The ALO must also be in a position to see the battlefield in order to coordinate CAS, shift preplanned CAS targets, and advise the commander on CAS issues.

The command group normally operates in two or three armored vehicles modified for C<sup>2</sup>. The crews of the tracked vehicles in the command group assist in operating radios, posting maps, moving the vehicles, and providing security, thus freeing the commander and S3 to concentrate on the battle.

### **ADMINISTRATION AND LOGISTICS CENTER**

The ALC is the coordination center for CSS for the battalion. The battalion S4 is responsible for operations, movement, and security of the ALC. He is assisted by the S1. The ALC locates within, and is the control element of, the combat trains. It is located in a position on the battlefield to provide forward CSS to all elements of the battalion task force. The position also must allow the ALC to function as the alternate TOC if necessary, normally within 2 to 4 kilometers of the TOC. Although the ALC is normally designated as the alternate TOC, it must be understood that, if required to function as the TOC, its logistical functions will be degraded.

### **COMMAND, CONTROL, AND COMMUNICATIONS**

The air-land battlefield is dynamic and lethal, and places demands on tactical

communications systems not experienced in the past. Communications systems must be capable of delivering to the commander the information he requires for decision making quickly and in a form that facilitates the decision-making process. It is imperative that brigade and battalion commanders be able to turn their decision cycle inside that of the enemy. Rapid, reliable, and secure communications are the means by which this can be accomplished.

Rapid, reliable, and secure C<sup>3</sup> provide a means for tasking and coordinating IEW resources and for receiving intelligence, combat information, and targeting data from these assets. They also provide a means for brigades and battalions to report information to the division, to disseminate intelligence, combat information, and targeting data to their subordinate maneuver units, and to support fire support systems.

This section describes the communications systems that support brigade and battalion IEW operations. It describes brigade and battalion IEW communications requirements, and the complementary intelligence and EW nets of the battalion and brigade.

The communications system supporting brigade and battalion IEW operations is primarily composed of the VHF FM and HF RATT intelligence nets, described earlier in Chapter 3. Intelligence nets are established at each level of command throughout the division.

## COMMUNICATIONS MEANS

Brigades and battalions rely on multiple means of communications, Radio, wire, and other systems are integrated to complement each other. This provides maximum flexibility, reliability, and responsiveness to brigade and battalion commanders' IEW needs.

### Radio Teletypewriter

HF RATT facilities are the primary backup means of communications in the division. They provide a rapid method of transmitting lengthy or technical information. HF RATT requires greater power, more maintenance, and higher quality circuits than simpler means of communications, such as wire or FM radio. Some EW

elements located in the brigade or battalion AO may have RATT capability. However, this capability is used for communications with the MI battalion tactical operations center and TCAE. There are no direct RATT links to either the brigade or maneuver battalion from IEW elements operating within the brigade or battalion AO.

### Radio (FM)

Secure VHF, FM, and HF AM communications means are used to interface most of the IEW elements located in brigade and battalion AO. These communications—especially the data systems—are fast, and can handle large amounts of traffic. They need a minimum number of personnel and space for equipment and can be remoted or operated while on the move. They can also be integrated into compatible wire systems. Retransmission of these secure communications increases their range for enhanced C<sup>2</sup>. Limitations include a high susceptibility to jamming or interception and interference from atmosphere, terrain, or man-made sources. If security equipment is not used, FM radio is the least secure means of communications. Critical C<sup>3</sup>I facilities can be immediately identified by enemy SIGINT/REC units and targeted by both lethal and nonlethal attack systems.

### Wire

Wire communications (telephone) is a backup system for FM radio. It is one of the most dependable means of communications and is more secure than radio. It is not vulnerable to enemy disruption or DF, although wire can be tapped (with or without a physical connection) if the wire is not covered or guarded. Wire is generally used to interconnect closely located activities, to integrate radio with wire, or to tap into existing commercial lines.

One of the major disadvantages of wire is that it cannot be used under mobile conditions. It also requires more time, men, and equipment to install and maintain than radio. Even when it is laid properly, signal integrity diminishes over long distances. When it is not laid properly, it may be damaged by tracked and wheeled vehicles or be susceptible to wiretaps.

Brigades and battalions normally use wire for internal communications within their CP area and assembly areas. MI and other units located in the brigade or battalion AO use wire to remote active COMJAM systems and other C<sup>3</sup> emitters from their actual locations for survival purposes, when the situation permits.

### **Messengers**

Messengers provide a secure means of delivery for bulky items or large quantities of message traffic. The use of messengers is limited only by the availability of trained personnel and transportation, and by the tactical situation. Using messengers reduces the electromagnetic signature and provides a means of communicating if electrical means are destroyed or their use is inadvisable. Although messenger service is very flexible, it is slower than electrical transmission. Weather, terrain, and operational considerations also impact on the type and frequency of messenger service.

At the brigade and battalions, messengers are used regularly between CPs, trains, higher headquarters, and subordinate elements. MI and other units do not have the assets to establish a regular messenger service. However, depending upon the nature of the material and the combat situation, special messenger service may be performed by IEW company team personnel or established by the supported battalion or bri-

gade. Specific instances when this may be required is the evacuation of captured enemy documents for immediate exploitation at higher headquarters. Messenger operations are described in FM 21-1.

## **TACTICAL COMMUNICATIONS SYSTEM**

There are two major means of radio communications available to support IEW operations within the brigade AO—HF RATT and VHF FM. When these individual systems are supplemented with wire and net radio interface (NRI), they become part of the division's comprehensive tactical communications system. This system provides the brigade with the ability to coordinate, task, report, and disseminate intelligence and combat information with higher, lower, and adjacent units within the division.

### **The Multichannel System**

The maneuver battalions, field artillery, MI, and other supporting units in the brigade or battalion AO do not have a multichannel capability. They rely on the forward area signal center (FASC) in the BSA for multichannel communications when required. CI and EPW interrogators from the MI battalion may require access to these multichannel facilities for intelligence reporting purposes. The normal deployment of FASC is shown in the following illustration.

# DEPLOYMENT OF FOWARD AREA SIGNAL CENTERS

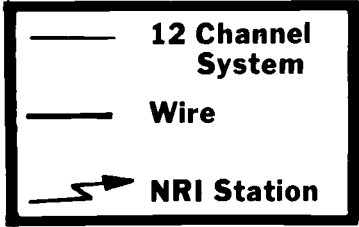
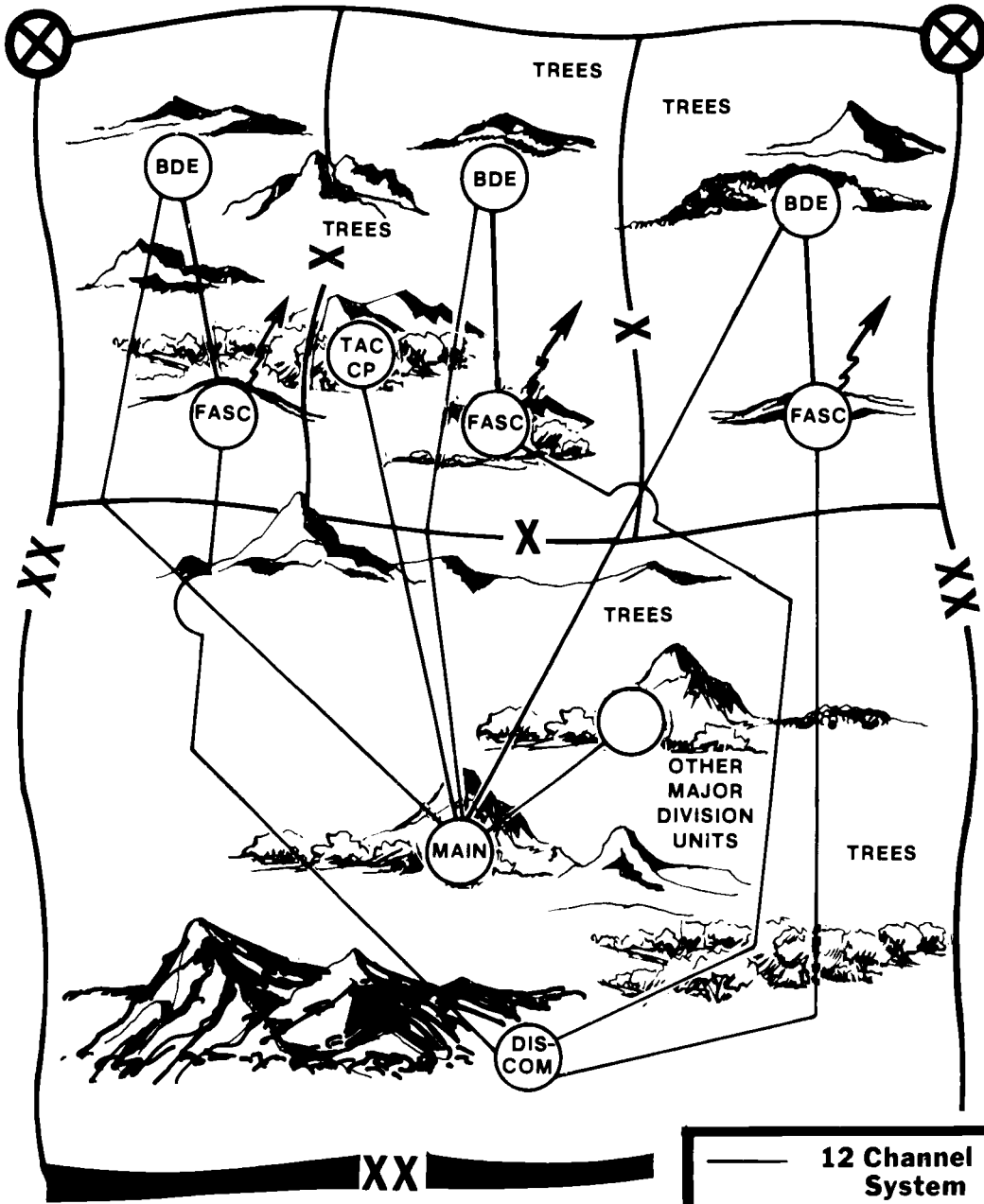



## HF RATT Communications System

The brigade communications platoon establishes an HF RATT net between the brigade and its subordinate battalion headquarters. This net provides a means to disseminate and report intelligence and combat information between the brigade and its subordinate battalions.

The MI battalion's service support company installs, operates, and maintains

RATT nets that link the EW platoons and the SIGINT processing platoon with the TCAE and S3 at the MI battalion tactical operations center. This provides a means to send and receive record copy traffic and large volumes of technical data to and from the platoons and the TCAE. The EW platoon has no direct RATT or FM link with the brigade or the brigade's subordinate battalions. The illustration below depicts the RATT communications system in the brigade AO.

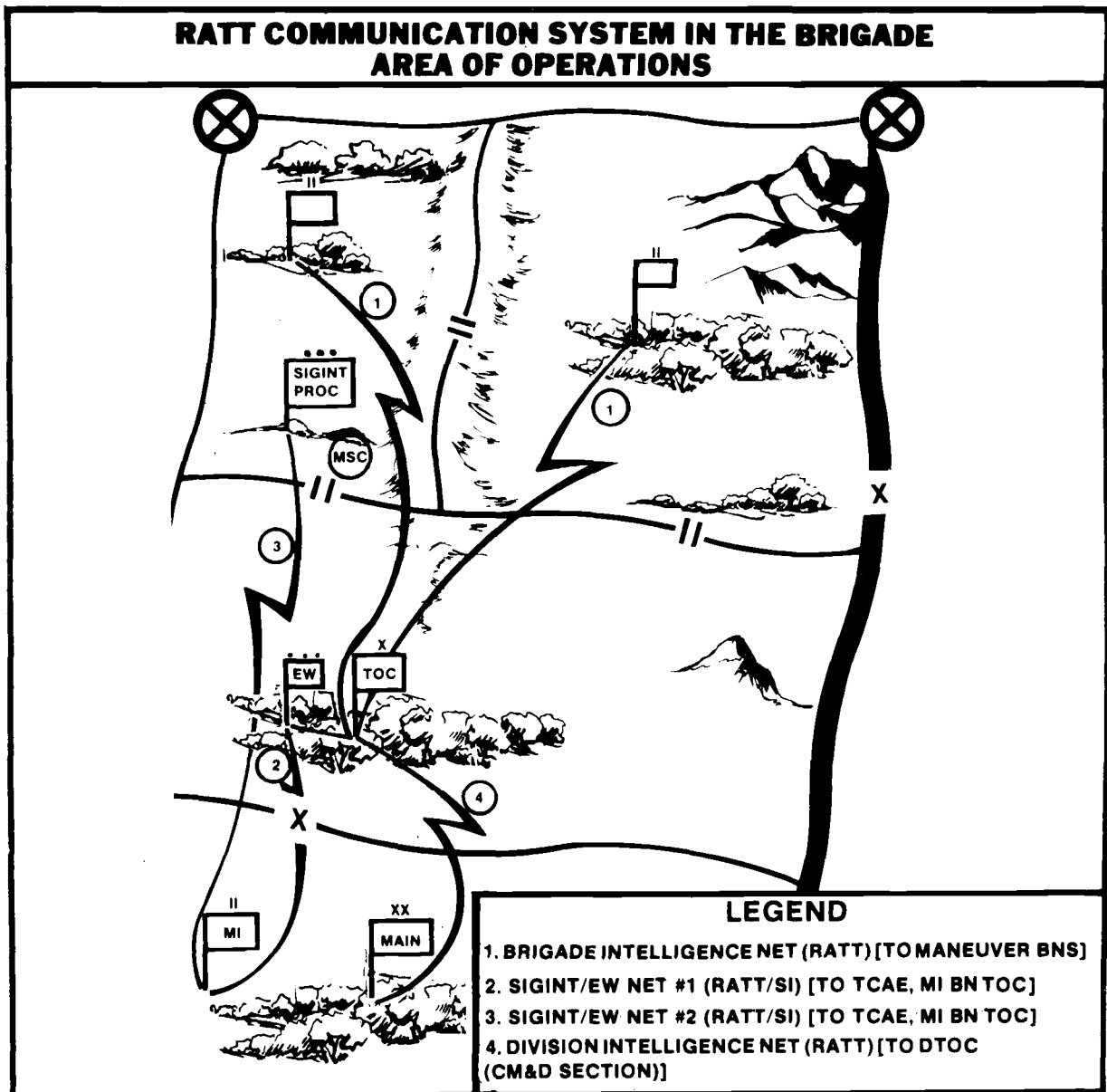

## VHF FM Communications System

**Division Nets.** Brigade VHF FM communications links to the division are established through two division FM nets: the command net and the operations/intelligence (0/1) net. The brigade receives C<sup>2</sup> information and operational tasking from the division G3 via the FM command net.

The FM division 0/1 net provides the brigade with a means for receiving intelligence and information from the division G2 and other commands within the division. The brigade S2 uses this net to report information and intelligence developed by the brigade and to pass requirements and requests for additional IEW support to the division G2. The MI battalion S2 and S3 are subscribers on the division 0/1 net; they report information to, and receive intelligence products and IEW mission tasks from, the division G2 and G3 sections.

**Brigade Nets.** The brigade 0/1 net links the battalion S2 and other units, as required, to the brigade S2 section (BICC). This net provides a means for coordinating, tasking, and disseminating combat information and intelligence.

Supporting GSR/REMS teams, CI support teams, and EPW interrogator teams located in the brigade or battalion AO, may also be assigned to this net for tasking and reporting purposes when operating in direct support of the brigade. This net gives the brigade S2 the capability to task and receive reports and information from these MI resources. Such tasking is coordinated with the IEWSE at the brigade TOC. The IEW company team commander is always informed of any major requirements.

**Military Intelligence Nets.** The IEW support officer who heads the IEWSE is a subscriber on the MI battalion operations center\TCAE SIGINT/EW tasking and reporting net (FM) to the EW platoon operating in the respective brigade's AO. The EW platoon headquarters located in each brigade AO is also a subscriber on its respective EW tasking and reporting net.

**Maneuver Battalion Nets.** Maneuver battalions rely primarily on FM radio communications to transmit highly perishable information. Intelligence and combat information is passed to the battalion TOC from the brigade through the brigade intelligence net (FM). A secure command net is used for C<sup>2</sup> of the battalion, itself. All organic and attached units normally operate in this net to include the FSO, ALO, and leaders of supporting elements, such as GSR squads or team leaders. The command net is controlled by the S3 or S2 in the battalion TOC.

Maneuver battalions may use a surveillance net or establish a separate 0/1 net, if required. The battalion may establish an 0/1 net by unit SOP if required. The purpose of the 0/1 net is to transmit routine, lengthy reports, thus freeing the command net of this type of traffic. Reports such as routine unit situation reports, bridge/route reports, obstacle reports, NBC reports, and so forth, would be transmitted on this net. This net may also be used by the S3 or commander to relay instructions to the TOC regarding upcoming operations. One radio at the TOC will monitor the 0/1 frequency.

The scout platoon net may function as a surveillance net when required. The S2 and elements assigned surveillance missions operate on these nets.

## OTHER COMMUNICATIONS SYSTEMS AND NETS

Information about the specific network structures and other communications systems, some of which were mentioned in Chapter 2, is beyond the scope of this manual. Such information is provided in FMs 71-3, 71-2J, 34-10, 7-20, and 7-30.

## CHAPTER 4

### Preparation For Combat

Combat support operations are organized as integral parts of combined arms operations. Maneuver, fire and IEW makeup the significant components of combat power.

This chapter describes how combat operations are preplanned to support brigade and battalion combined arms operations. It describes IEW system interface to accomplish the IEW mission and how IEW is integrated with other combat functions in combined arms operations. This chapter focuses on those activities conducted prior to combat with support from division IEW assets.

In preparation for combat, each staff section reviews the commander's mission and determines the specific task to be performed. The commander's guidance and concepts of the operation, along with individual staff estimates, provide the basis for determining brigade and battalion IEW requirements to organize the unit's contingency mission.

The brigade or battalion S2 focuses on critical intelligence and information needs dealing with enemy, weather, and terrain. He supplies the information on potential enemy forces, thereby assisting other staff elements and subordinate elements in satisfying their requirements.

The brigade or battalion S3 depends on the S2 for information needed to support EW and OPSEC. This data assists in the deployment of EW systems, the selection of OPSEC measures and the selection of possible jamming targets to support brigade and battalion OPLANs.

#### DECISION-MAKING PROCESS

When this mission is received, the S2 begins a preliminary analysis of the AO and enemy situation. Obtaining a copy of higher headquarters analysis is vital to support this function (see OPLAN/OPORD on specific requirements). Data is derived from a variety of sources available to division and higher echelons.

Examples are—

- Intelligence estimates of higher headquarters.
- OB books.
- Register of Intelligence Publications (RIP).
- Defense Intelligence Agency (DIA) handbook on (specific country) armed forces.
- Scientific Technological Intelligence Reports (STIR).
- DIA and Central Intelligence Agency (CIA) periodical technical intelligence reports.
- Area studies handbook (specific country).
- Foreign materiel catalog (FOMCAT).
- Division, corps, and theater intelligence products, which include intelligence estimates and OB listings.
- Theater topographic products.
- Engineer soils analysis.
- Climatic weather studies.

These data are consulted for additional information or to answer questions when developing initial estimates. The results of the initial work are provided to the commander.

The planning guidance phase consists of mission analysis, restated mission, and commanders' planning guidance.

#### MISSION ANALYSIS

Mission analysis ensures that the commander identifies all of the tasks required to accomplish the mission. Some tasks are specified in the OPLAN/OPORD as received from higher headquarters. Other tasks may be implied by the situation, mission, and purpose of the operation, and must be deduced by the commander during the analysis. The commander relates tasks, if possible, to the terrain or enemy.

## RESTATED MISSION

The restated mission results from the commander's mission analysis. It is a clear, concise statement of the task (or tasks) to be accomplished by the command and the purpose to be achieved. Multiple tasks are normally described in the sequence to be accomplished. Many tasks may be identified during the mission analysis; however, the commander's restated mission includes only those tasks which are essential to the overall success of the operation. Tasks which are routine or inherent responsibilities of a commander are not included in the restated mission. For example, routine tasks, such as establishing liaison, or refueling of vehicles are a matter of SOP and, while important, should not be included in the restated mission. The restated mission becomes the basis of all command and staff estimates and is paragraph 1 of those estimates, whether oral or written. The restated mission is also paragraph 2 (Mission) of the command's OPLAN/OPORD.

## COMMANDER'S PLANNING GUIDANCE

Commander's planning guidance is provided by the commander to the staff as required. The frequency, amount, and content of planning guidance will vary with the mission, time available, situation, information available, and experience of the commander and staff. The commander may choose to issue initial planning guidance to the staff when the restated mission is announced. This guidance is used to direct or guide the attention of the staff in the preparation or revision of staff estimates and serves to expedite the decision-making process. Initial planning guidance might include:

- Courses of action that should be addressed or disregarded.
- Unusual restrictions placed on the command.
- Considerations for the employment of nuclear or chemical weapons.
- Directions regarding deception.
- Other factors considered important.

If planning guidance is necessary, the commander must take care not to unduly bias staff estimates.

## Estimate

The staff assists the commander in reaching a decision by making estimates in their assigned areas of responsibility. These estimates analyze the influence of factors within the staff officer's particular field of interest on the accomplishment of the command's mission. It also identifies factors that affect formulation, analysis, and comparison of feasible courses of action. The staff estimate concludes and recommends feasible courses of action. In making an estimate, the staff officer consults with other staff officers and agencies. The S2 is key to the estimative process at all echelons. IPB formulations concluding with a decision support template (DST), the intelligence estimate in graphic form, serve as the basis for other staff planning.

**Staff.** The staff estimates may be prepared mentally, orally, or in writing. Often, only the staff officer's conclusions or recommendations are presented to the commander. The intelligence estimate format is found in Appendix A. At battalion and brigade, enemy capabilities are normally drawn from the higher headquarters' estimates and restated in terms specific to the brigade's and battalion's assigned area of operations.

**Commander.** The commander's estimate is based on personal knowledge of the situation and estimates provided by the staff. It also contains modifications to compared courses of action and judgment on facts not known, recognized, or available. The estimate should ensure a course of action that is feasible when supported with available resources. The commander's estimate is constantly reviewed as new information is obtained.

## Concept

The commander announces his decision and concept to key members of the staff. Subordinate commanders may also be present. The concept is the commander's description of the present operation. The commander normally announces his decision and concept orally to staff officers and

subordinate commanders so they can execute the operation in the absence of further instructions.

### Plans and Orders

Plans and orders are procedures for the commander's decision and concept. This procedure requires some compromise between speed and responsiveness and orderly procedure and detailed planning. At this point, the S2 prepares the intelligence plans and intelligence portions of OPLAN/OPORD.

Specific documents include but are not limited to—

- Intelligence Estimate.
- Intelligence Annex.
- R&S plan to the OPORD.

Detailed discussions of these documents are found in FM 101-5, Appendix G. Once approved by the commander, the OPORD/OPLAN is published and issued to the command. The next step is to supervise the operation.

The military decision-making process is illustrated below.

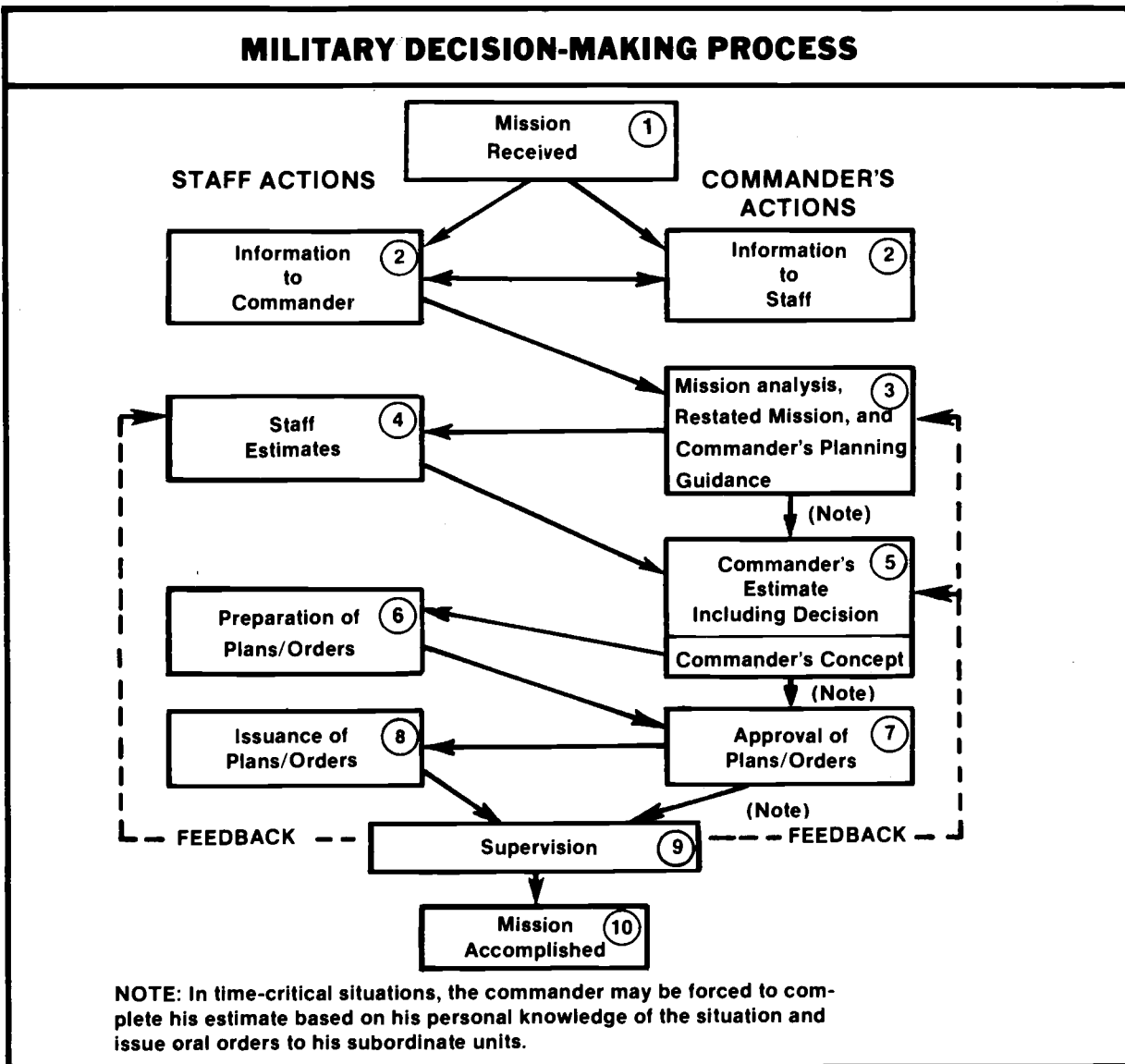

## COLLECTION MANAGEMENT

Collection management is defined as the timely, efficient process of assigning approved intelligence requirements (including the commander's PIR and IR) to collectors in support of military operations. Principles governing collection management include—

- There is only one top priority—the commanders. All other IR are prioritized by the collection manager.
- The OB data base must be checked to ascertain if requirements can be answered immediately.
- Specific questions must be asked of collectors—they must know where to look, when to look, and what to look for.
- A higher headquarters should not be told what collector to use; the collection manager at that level is better able to determine that.

In the battalion task force and brigade, collection management is defined as limited by the principles above, and is the job of the S2 and BICC. The BICC, under the direction of the S2, prepares a complete R&S plan which is most often accompanied by an overlay. The R&S plan is disseminated as an appendix to the Intelligence Annex of the unit OPOD and updated via fragmentary orders (FRAGO).

The collection plan (Appendix A) assists the S2 in managing requirements, collection agencies, and time constraints. As such, the collection plan is dynamic and is updated continually. The collection plan format should include the following entry headings, as a minimum:

- PIR/IR.
- Indicators.
- Specific information requirements (SIR).
- A list of collection agencies.
- A place and time to report.

The plan identifies the basic information required to answer the commander's PIR/IR, indicates the collection agencies available to best satisfy the collection

requirement, and identifies the timeliness and reporting procedures to be followed. Any collection requirement(s) that cannot be accomplished by organic, subordinate, or adjacent units' collection agencies are passed to higher headquarters for consideration.

The collection effort involves continuous planning, updating, and revising to satisfy the commander's PIR/IR. As PIR/IR and available collection agencies change, so does the collection plan. The collection management cycle is depicted in the following illustration.

## RECEIVE AND ANALYZE REQUIREMENTS

Collection requirements and priorities are expressed in terms of PIR/IR. The most important collection requirements given to the BICC are the commander's PIR. To accomplish this support it is necessary to—

- Receive requirements.
- Determine indicators.
- Determine SIR.
- Determine reporting requirements.

Received requirements are processed by the brigade or battalion BICC in the following manner:

- They are logged into the journal. The system used is flexible or dependent upon SOP; a control numbering system, however, will ensure uniformity and an audit trail.
- The new requirements are compared to active collection requirements to ascertain if current collection missions can answer those new requirements, thereby reducing the number of collection missions assigned to already limited numbers of collectors.
- The validity of the requirement must be determined. (The commander's PIR are always valid.) Requirements generated outside the headquarters are usually accepted as valid. However, requirements levied by organizations which have the organic means of collecting that requirement will be considered invalid.

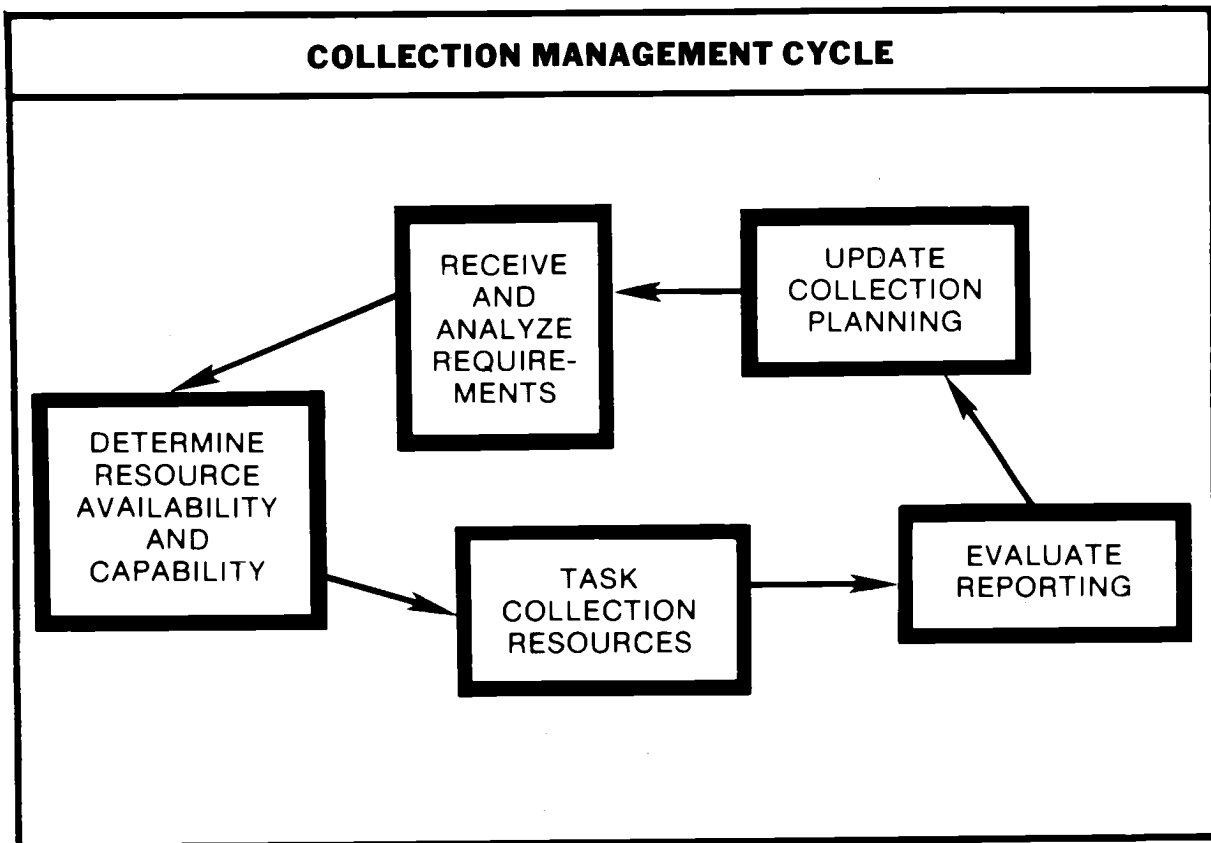

- The new requirements are then compared to the OB data base to ascertain if the required information is already available. If so, collection agencies will not be tasked, leaving them free to execute other collection missions. New collection missions should *never* be tasked without researching the data base.
- The requirement must then be evaluated to determine its priority of collection. For example, a battalion task force in a movement to contact has varying levels of requirements. The GSR platoon leader requires the friendly avenue of approach (or mobility corridor) more than the air defense officer needs an obstacle overlay. The most critical requirements should be satisfied first.

An indicator is any positive or negative evidence of enemy activity or any characteristic of the area of operations that points toward enemy capability, vulnerabilities, or

intentions. Indicators provide the "what to look for" information required by collectors. A list of enemy indicators is found in Appendix F of FM 34-3.

Indicators can be specified by location through the use of NAI. An NAI is any point or area on the ground, usually along an avenue of approach or mobility corridor, where activity (or lack of activity) will confirm or deny a particular enemy course of action. The S2 depicts NAI on the event template, thus using it as a collection tool. In fact, the event template is the vital link between the collection effort and IPB, because NAI specify the "whereto look" information required by collectors. NAI can be numbered, named, or lettered.

Determining SIR is a function of the BICC. SIR are the basic questions that need to be answered to confirm or deny the existence of an indicator. Essentially, SIRs are indicators in question form in sufficient detail to be the basis for tasking collection agencies. For example, as an indicator of

possible enemy intentions, the locations of air defense units are needed. An SIR would be a question, asking whether or not there are any ZSU-23-4s at location X. Medium air defense guns are displaced forward prior to the attack to protect assault forces and to facilitate forward displacement during the attack. ZSU-23-4s protecting the regimental artillery group (RAG) are approximately 1.25 KM to the rear of the FLOT. After SIR have been prepared, the S2 incorporates them into the collection effort.

Like PIR, SIR should be assigned priorities. Remember that the commander's PIR are always the highest priority collection requirements. The primary basis for determining the priority of any requirement is its criticality to the friendly mission accomplishment and the time and information is needed (or will no longer be of value).

Reporting requirements specify when, where, and in what detail information is reported. Reporting requirements are developed in terms that are understandable by collection units or agencies. The collection manager must speak the language of the HUMINT, IMINT, or SIGINT collector. The purpose is to provide the collection agency with specific collection and reporting requirements which ensure that the right data is collected and reported promptly to the appropriate user. (Where to look, when to look, and what to look for.)

Unit SOP should outline the reporting requirements, to include report format, frequency of reports, and methods of transmission. Requirements are based on the needs of the requester.

### **DETERMINE RESOURCE AVAILABILITY AND CAPABILITY**

The selection and tasking of organic and supporting collection units and the formulation of requirements for higher echelon support require a basic knowledge of the units, agencies, and sources that can provide information by the S2/BICC. The following chart defines sources and agencies and lists what units and activities fit into each category. Usually, only capable agencies will be tasked; rarely will a collection manager task a source directly. Sources and agencies are explained on the following page.

The capability and requirement correlation matches the collector to an SIR. For example, to locate a ZSU-23-4 air defense-related radar, the tasking would be submitted to a unit capable of collecting radar signals (ELINT) or a unit or agency capable of seeing or imaging a ZSU-23-4 (aerial scouts or IMINT). This understanding of capability eliminates tasking an incapable collector. For example, a SLAR mission would be inappropriate to locate the whereabouts of the enemy commander. The collection manager specifies the most capable collector. There may be several collectors capable of answering an SIR; the collection manager must choose those collectors most capable of collecting the SIR. The specific elements of the capability and requirement correlation are—

- Range-to-target location. (Consider the tactical employment of collectors and the range of the collectors, usually from the FLOT.)
- Time available should be compared to the historical or estimated response time of the collector. The period begins when an information request (PIR or IR) is received and concludes when the information is received by the requester. Times required to complete each event should be calculated or estimated from each available collector based on the tactical situation and local SOPs. The S2/BICC must ensure that communication media times and priorities are considered. Often, timeliness can only be derived from experience.
- The technical characteristics of each collector must be examined in detail to ensure that the collector has the technical capability to perform the mission. The S2 should not hesitate to refer to the DOD Sensor Capabilities Handbook which provides information on the technical characteristics of collectors. Location by IMINT/HUMINT sensors is very accurate; however, the ESM/SIGINT sensors may not be as accurate as IMINT/HUMINT. The local weather conditions can affect collection capability and exploitation of data collected. Weather support can be obtained from the USAF staff weather



## SOURCES AND AGENCIES

<b>SOURCES</b>	<b>AGENCIES</b>
<p style="text-align: center; margin: 0;"><b>A source is a person, system, or activity from which information is originally obtained. Source may or may not be under friendly control.</b></p>	<p style="text-align: center; margin: 0;"><b>An agency is any individual or organization which exploits a source to collect and/or process information.</b></p>
<b>COMMON SOURCES</b>	<b>COMMON AGENCIES</b>
<p>EPW <span style="float: right;">Maps</span></p>	<p>HUMINT</p>
<p>Enemy activities <span style="float: right;">Patrols</span></p>	<p>Front Line Troops Maneuver Battalion FA Units Engineers Weather Teams</p>
<p>Local residents <span style="float: right;">Front Line Troops (e.g.)</span></p>	<p>Maneuver Brigades</p>
<p>Recoverd US Military <span style="float: right;">Cav Troops ADA Teams FIST Engineers</span></p>	<p>MI Battalions and Brigades HUMINT IMINT SIGINT</p>
<p>Refugees</p>	<p></p>
<p>Enemy documents</p>	<p></p>
<p>Shells/Duds</p>	<p></p>
<p>Informants</p>	<p></p>

officer (SWO) at division or from the artillery meteorological sections. Another source at brigade and battalion level is the forward area limited observing program (FALOP) or "belt weather kit".

- Collector vulnerability to the anticipated threat depends on the collector. Penetrating collectors, such as patrols, are the most vulnerable.
- The local terrain with its potential LOS limitations will affect the LOS capabilities of given types of collection systems (such as SIGINT and GSR).

The above factors must be matched or correlated to determine the proper or capable collector. Although a collector may be evaluated as capable, the collector may not be physically available for the mission. For example, if it's determined that an aircraft photo mission is the most capable collector, the collection agency to which the collector is organic could respond that no aircraft are available because of maintenance, adverse weather, or existing requirements of a

higher priority. The next most capable collection agency would then be tasked to execute the collection mission.

The brigade or battalion S2, in conjunction with the S3, determines selection of collection resources based on their unit's primary mission, outstanding collection requirements, and that collection resource's ability to collect SIR. Combat and combat support units constitute the primary collection capability of the maneuver brigade and battalion task force (BTF). The brigade may have multidisciplined MI collection support available; however, the BTF relies primarily on maneuver and fire support elements, which are controlled by the S3.

The collection manager should use one collection agency to cue another when possible. For example, a communications intercept may detect and determine the approximate location of an enemy battalion's CP. The collection manager can then effectively use other collection systems to pinpoint the location. He must plan and coordinate the use of cuing and confirming systems against priority targets. The unit SOP,

however, should specify standard cuing and confirming relationships and procedures for coordination of these collection agencies.

The collection manager also uses a selected redundancy and resource mix against high-priority targets. Redundancy is the use of multiple agencies with known capabilities to provide information concerning a single target or SIR. Similarly, the collection manager may employ a mix of collection agencies with different capabilities to exploit the different signatures of a target.

Various procedures may be used to select the collection agencies capable of SIR. One format is the asset evaluation worksheet (AEW). The purpose of the AEW is to determine the capability of a collector to satisfy SIR. When the AEW is completed and the collectors identified as fully or marginally capable, those assets are applied to the collection plan beside the SIR they could possibly supply.

Devising a collection strategy includes resource integration, cuing, collector mix, and redundancy. Resource integration enhances the efficiency of the overall collection effort. The collection manager must attempt to integrate new collection requirements into current missions, which offers three benefits:

- Employs the fewest number of collectors.
- Decreases cost and risk.
- Increases the utilization of overall collection capacity available.

The result is increased productivity. Before requesting additional missions, however, the collection manager must consider three factors: present operating missions, scheduled future missions, and new tasking requests. The S2/BICC should, as a rule, task those agencies under his control first before requesting collection missions from higher or adjacent units.

Cuing is the use of one collector to provide necessary targeting information to direct collection by a more accurate point-target system.

Collection against a target requires using a combination of collectors. This may be

justified against high priority targets when the probability of intercept by any one system is less than 100 percent. Examples are air defense (AD) units and CPs.

## TASK COLLECTION RESOURCES

Following selection of collection agencies, intelligence requirements tasking is prepared. The tasking of organic agencies is accomplished according to command SOPS but is normally accomplished through the use of the R&S plan at the brigade and battalion levels. Tasking of agencies controlled by higher headquarters must be submitted through proper channels and requires justification. Issuing specific orders and requests (SOR) depends entirely upon command relationships. For example, a battalion S2 can initiate patrolling missions by the authority of the battalion S3. The line companies must provide the patrols to execute the orders from battalion. On the other hand collection missions stated to higher headquarters are requested, not tasked.

The key to successful tasking of collection missions is in remembering which echelon is involved. Lower echelons "ask" or request from higher, and higher echelons "tell" or task the lower ones. The standard collection asset request format (SCARF) is used for intelligence requirements tasking and for requesting information from higher or adjacent headquarters. The SCARF can be used for all intelligence disciplines. It specifies the following: the information needed (what to look for); where and when to look for the movers, shooters, sitters, and emitters; and when the information is needed. In some cases, a collection means may be recommended. For additional information on the SCARF, refer to Appendix A and Chapter 3 of FM 34-1.

The S2 coordinates all taskings with the S3 for those collection agencies organic to the battalion or brigade. This coordination ensures that the collection taskings are compatible with, and support, the current scheme of maneuver and future operations. Units assigned, attached, or supporting the brigade or battalion, except for MI units, are tasked through the operations (S3) channels. Intelligence tasking channels for potential IEW resources supporting brigade

and battalion collection missions were outlined in Chapter 2.

Another method of tasking is through the use of the brigade and battalion OPLAN or OPORD. If an intelligence annex is not published with the OPLAN or OPORD, tasking instructions may be included in paragraph 3 of the OPLAN or OPORD. Tasking instructions are as follows:

A further explanation of OPLAN and OPORD is given later in this chapter.

Once engaged in combat, this collection plan is updated as required.

## IEW TASKS

IEW operations, in both peace and war, support the winning of campaigns and battles. The mission of IEW operations is to provide the combined arms commander with three forms of support: intelligence, counterintelligence, and EW.

<b>TASKING INSTRUCTIONS</b>	
TYPE OF TASKING	OPLAN/OPORD Paragraph
For SIR tasking individual units	Paragraph 3, subparagraphs that task individual units.
For PIR/IR tasking multiple units	Paragraph 3, Coordinating Instructions
<p>(SIR pertain to specific instructions provided to individual units regarding their use of intelligence assets appropriate coordinating instructions.)</p> <p style="text-align: center;">A further explanation of OPLAN/OPORD is given later in this chapter.</p>	

## EVALUATE REPORTING

Collection management is a dynamic process that does not end with tasking. The BICC must monitor collection and reporting to ensure that collection agencies respond to assigned collection missions and report their results to designated users in a timely manner.

## UPDATE COLLECTION PLAN

The BICC continuously updates the collection or R&S plan in response to changing requirements. It purges the plan to eliminate requirements that have been satisfied or are no longer needed, due to changes in the situation.

The S2 integrates new requirements according to priorities, changing the priority, or eliminating old requirements when necessary.

A formal R&S plan is normally prepared as part of the S2's intelligence planning process at battalion and brigade levels prior to combat. A collection plan may also be prepared informally at the brigade level to help define the numerous tasks and collection agencies applicable to brigade collection operations. This collection plan serves as the basis for the development of the R&S plan which is an appendix to the Intelligence Annex to the OPLAN or OPORD.

The combined application of these forms of support, the IEW mission, translates into four major tasks: situation development, target development, CI support, and EW.

## SITUATION DEVELOPMENT

The situation development process provides to commanders the intelligence data they need to plan and conduct combat operations. This process incorporates the intelligence cycle and IPB functions.

Situation development enables commanders to see and understand the battlefield in sufficient time and detail to employ their forces and weapons systems effectively. In situation development, the S2 uses IPB to produce a description of enemy force dispositions on the battlefield in terms of location, size, type, direction, rate of movement, and activity. This portrayal is based on an analysis of intelligence data which is continuously updated through the collection and processing of information.

## Intelligence Cycle

The intelligence cycle consists of four phases: directing, collecting, processing, and disseminating. It is a continuous process, and each phase is conducted in sequence. However, all phases are being conducted concurrently. While new information is being collected, the intelligence

staff plans and redirects efforts to meet new demands, while previously collected information is processed and disseminated. All phases of the cycle focus on the commander's mission. The intelligence cycle is illustrated below.

**Dissemination.** The dissemination and use of intelligence is the last and most vital step of the intelligence cycle. Usable information and intelligence is distributed to those who need it.

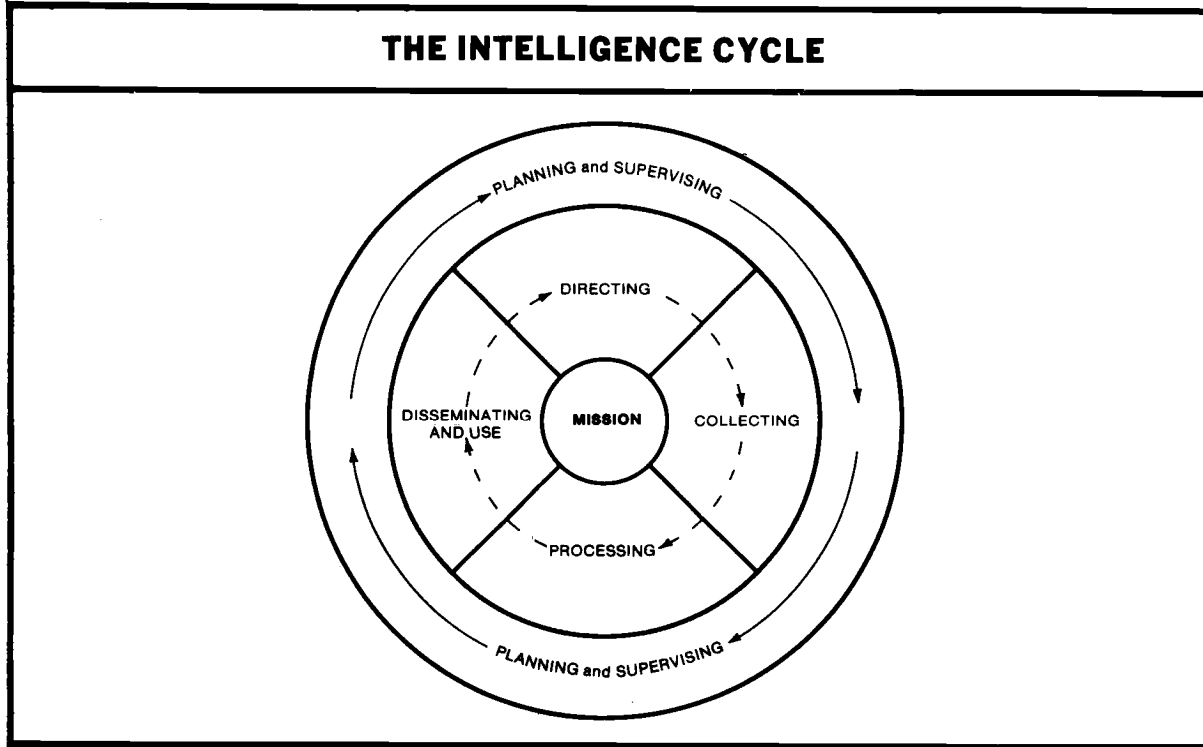

**Directing.** The commander, through the S2, directs the intelligence effort. The S2 translates the commander's guidance and concept of the operation into intelligence requirements and established priorities. Intelligence requirements and priorities are expressed in terms of PIR and IR. These terms are defined as shown on the following page.

**Collecting.** This is the process of gathering information from all available sources. Collection operations are guided by the commander's requirements and are facilitated by use of the collection plan and IPB.

**Processing.** This is the phase of the intelligence cycle whereby information becomes intelligence. Information from all sources is evaluated, correlated, and analyzed to produce a current all-source assessment stating the enemy's current dispositions, capabilities, and most probable course of action.

Most information is used in the development of intelligence, and can often be used immediately for fire, maneuver, or ECM. When raw data can be used as received for fire, maneuver, or ECM, with no interpretation or integration with other data, it is combat information.

Combat information is further defined as unevaluated data gathered by, or provided directly to, the tactical commander. Due to its highly perishable nature or the criticality of the situation, combat information cannot be processed into tactical intelligence in time to satisfy the user's tactical intelligence requirements.

Once raw data (including combat information and ESM) is validated, integrated, compared, and analyzed, it becomes intelligence. In other words, the difference between intelligence and combat information

<b>INTELLIGENCE AND INFORMATION REQUIREMENTS</b>	
<b>PRIORITY INTELLIGENCE REQUIREMENTS</b>	Those intelligence requirements for which a commander has an anticipated and stated priority in his task of planning and decision making.
<b>INFORMATION REQUIREMENTS</b>	Those items of information regarding the enemy and his environment which need to be collected and processed in order to meet the intelligence requirements of a commander.

is in the method of handling the data. If the information must be processed and analyzed, it is intelligence and not combat information. Information may be both combat information and intelligence.

### **Intelligence Preparation of the Battlefield**

IPB is an important function in situation development. It is an excellent tool for preparing for combat. It provides a guide to the commander and his staff in determining where and when to use available resources to achieve decisive results based upon expected dispositions.

The brigade S2 initiates intelligence operations by developing an intelligence data base, which is applicable for each potential area in which a unit may be required to operate. The BICC acquires the required data, and using IPB methodology, converts it into graphics that can be readily used by the brigade and battalion commanders and staffs. Brigade and battalion BICCs are not sufficiently resourced to perform formal IPB without assistance from higher echelons. They request IPB products from the division all-source production section (ASPS), which they refine to satisfy their commander's needs based on their specific assigned area of operations, mission, and PIR or IR. They do, however, use IPB methods to record and analyze information about the enemy, weather, and terrain that the commander and staff needs for planning, decision making, and the conduct of combat operations.

In preparation for combat, IPB is conducted based on assigned missions. It supports the planning and execution of most other battlefield functions, as well.

IPB is a vital function of situation development. Actually, it is the key to preparing for combat. Today's intelligence must enable the commander to "see" the battlefield in all its aspects: graphically, red depicts the enemy, white shows the terrain and weather, and blue portrays friendly forces.

IPB provides a mode that ensures uniformity in how intelligence personnel within each echelon of command are to analyze weather and terrain and evaluate the effects of each on enemy and friendly courses of action. Commanders must make more complicated decisions than ever before. Therefore, each commander needs timely and accurate intelligence that will aid his decision-making process.

IPB is the continuous and systematic process of evaluating the enemy, weather, and terrain for a specific battlefield area. IPB provides the basis for a dynamic R&S plan and a guide for the effective employment of collection, reconnaissance, and surveillance assets. Through the systematic process, all the battlefield's elements can be incorporated into easily understood graphic products. IPB graphics are communicated through the use of templates and multi-layered overlays. These graphic data bases provide a basis for situation and target development.

The IPB process and the associated products have applications across a broad continuum of operations. Terrain analysis, integrated with knowledge of how a specific foe would like to fight, can provide likely areas on the battlefield where intelligence operations can be focused to determine enemy courses of action. Likewise, terrain and weather analysis can be used to support friendly OPSEC operations, allowing

for optimum siting of units to deny the enemy vital intelligence.

IPB is the link between intelligence operations and air-land battle doctrine. By integrating the air-land battle with the IPB process and carrying it over to intelligence operations, the air-land battle can be won. Intelligence is vital to the successful conduct of the air-land battle. The commander must know where the enemy is and know the best point to engage him in order to win the next battle.

IPB is “homework” that each echelon must accomplish before the battle begins. Through IPB, gaps in the intelligence data base become readily apparent. Thus, through collection management, requirements can be fulfilled before the first shot is fired.

IPB analysis provides a basis for planning and executing the battalion and brigade battles. It helps the commanders to visualize the battlefield—where friendly and enemy forces can move, shoot, and communicate; where the critical areas of the battlefield are; and where enemy systems become most vulnerable to attack. It helps the S3s to determine where the battalion and company teams can be employed to take maximum advantage of the terrain, and where and how the terrain can best be reinforced. It guides the S2 concerning when and where to employ collection systems for maximum effectiveness. It also provides a basis for analyzing collected information to determine enemy intentions.

The products developed through IPB are used to support many battlefield functions. IPB is most valuable to commanders and operations officers, allowing the commander to better track and predict enemy movement, and interdict and target enemy units. IPB, also referred to as the intelligence estimate in graphic form, enables the commander to make better decisions regarding operations and planning.

IPB, as illustrated, is a continuous and systematic process performed for a specific geographic area. It consists of five functions or steps. Step 1 is the battlefield area evaluation. Steps 2 and 3 are the analysis of the terrain and weather. Step 4 is an evaluation of the Threat forces expected to be found operating in the battlefield area. Step 5 is the nucleus of IPB where Threat forces (red) are integrated with the weather and terrain (white) and friendly operations (blue). This combination of red, white, and blue into final graphic products aids the commander’s decision-making process in the areas of—

- Battlefield area evaluation.
- Terrain analysis.
- Weather analysis.
- Threat evaluation.
- Threat integration.

NOTE: Chapter 3, FM 34-1 and Chapter 4, FM 34-3 provide additional discussion on the IPB process illustrated here.

The battlefield area evaluation function of IPB must be performed first. Terrain and weather analysis and threat evaluation may be performed concurrently or in sequence, since all three are equally important. For example, a unit assigned a mission might first need the evaluation of the areas of operation and interest. The key is to use the IPB process to satisfy the mission. But keep in mind that the first four functions or steps must be completed before Threat integration can be accomplished.

However performed, one of the significant benefits of IPB is that the framework is complete before the battle begins. Since it is paramount that the first battle be won, IPB must be conducted and constantly updated before the conflict begins.

The first function of the IPB process deals with an evaluation of the battlefield area; for example, the areas of operation and interest. It is within these areas that the battles will be fought. The AO is defined by higher headquarters. Commanders select their own areas of influence and interest. The following illustrations depicts the areas of operations and interest.

## IPB PROCESS

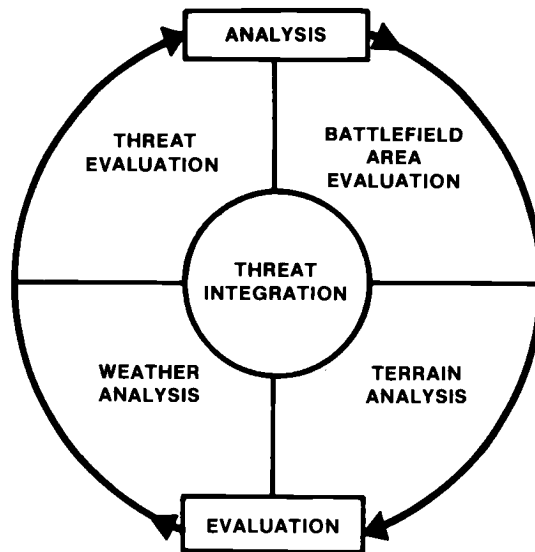

NOTE: Chapter 3, FM 34-1 and Chapter 4, FM 34-3 provide additional discussion on the IPB process illustrated here.

## AREAS OF OPERATION AND INTEREST

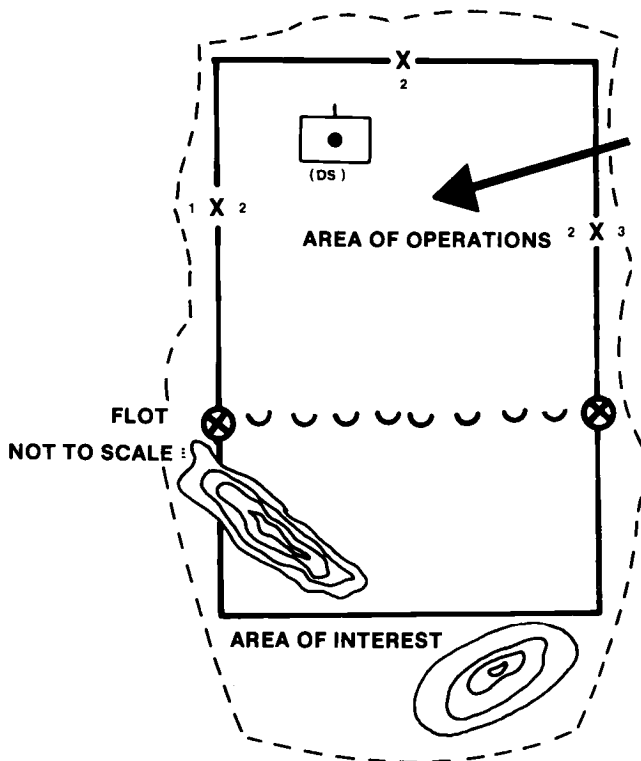

The 2d brigade boundaries depict the maneuver and operations area. The commander can maneuver his forces only within these areas—not outside.

The area of interest is that area in which the commander has an interest.

This function involves filling in the time and space framework of the Threat model and can be referred to as thinking “white”. This creates an organizational structure for the Threat model and identifies the impact of the environment on the enemy (red) and friendly (blue) units. We need to be able to think about the environment in two basic modes: time and geography.

Commanders must be able to “see” the battlefield in terms of the dimensions of depth, width, height (airspace), and time. These dimensions are examined in light of the defined areas of operations and interest. As a result, PIR are developed by the commander (that is, his highest priorities).

In terrain analysis, the military significance of terrain is analyzed in detail to determine how it affects friendly and enemy capabilities, vulnerabilities, and courses of action. To be successful, a combat force must be able to move, shoot, and communicate. Thinking “white” is used when considering environmental effects on battle outcome, regardless of whether it is the enemy or friendly force. In other words, rarely does the terrain change.

Terrain includes natural features, such as mountains, forests, rivers, and manmade features, including cities, highways, and cultivated areas. Terrain usually dictates how the battle will be fought.

Terrain analysis is one of the most critical and important steps of IPB, since commanders must use terrain to site weapon systems, minimize vulnerability to enemy fires, canalize enemy movement, and protect vital lines of communication (LOC).

Regardless of who does the work, there are certain aspects of terrain analysis that apply in all areas. Commanders and their

S2s must have information on observation and fields of fire, concealment and cover, obstacles, key terrain, and avenues of approach and mobility corridors (OCOKA), to be successful in their missions.

Basic topographic maps serve as the foundation for terrain analysis. Depending upon the map editions and the actual terrain, the information contained on each may not be totally accurate. They do, however, depict elevations, road systems, towns, waterways, depressions, and other vital terrain information. Topographic maps provide a wealth of good information. Layer tinting, or presenting elevations in different colors, is a technique that can be used for LOS.

The S2 should not rely solely on map reconnaissance. Visually observing the terrain will add another dimension to terrain analysis. If this is not possible, discussion with scouts, OP and listening post (LP) personnel, reconnaissance patrols, and GSR teams will establish more credibility with the commander and staff.

The S2 does not have the organic capability to produce the detailed products necessary to support the terrain analysis process. The S2 can request terrain support or products from the division’s terrain team. These teams have personnel trained and equipped to create the detailed terrain products called terrain subfactor overlays. These overlays—not templates—present detailed information for specific areas.

Should the terrain team (or its products) not be available, the S2 should develop a system or technique for terrain analysis. This should include—

- Establishment of a terrain data base and identification of intelligence gaps.
- Development of terrain subfactor overlays based upon different times of the year.
- Development of combined obstacles overlays.
- Identification and analysis of avenues of approach and mobility corridors.
- Consideration is to analyze the terrain from both offensive and defensive standpoints.



Although the terrain doesn't change, defending a battle position is different than a movement to make contact with an armor unit. The same terrain may be viewed differently. The numbers of overlays will depend upon factors of METT-T.

Terrain cannot be analyzed without taking the effects of weather into consideration. During Step 3, climatic data and weather for the AO are analyzed to determine their effects on friendly and enemy operations. Historic weather data and weather subfactor overlays are integral parts of the intelligence data base. The close relationship between terrain and weather in a tactical environment make Steps 3 and 4 inseparable.

The five military aspects of the weather that concern intelligence support to operation planning are: temperature and humidity, precipitation, winds, clouds, and visibility. The tactical significance of these aspects, and the risk or opportunities they present, depend upon knowledge of weather data acquired and the significance of the effects of weather elements on Army user operations.

The S2 can obtain weather support from the division's SWO, the division's artillery meteorological section, or from their own assets. The FALOP or "belt weather kits" provide the S2 with the organic capability to gather existing weather data.

There are numerous weather subfactor overlays that can be developed. For example, for the brigade commander on the demilitarized zone (DMZ) in Korea, an ice thickness overlay would be extremely important. Weather overlays are used to augment the more traditional weather products such as light data tables and climatic summaries.

Weather is critical to Army tactical operations. Reliance on mobility requirements for thoroughly integrated air and ground operations, and the need to see and attack deep into the battlefield, may be affected significantly by prevailing weather conditions. Complex weapon and support systems frequently depend on favorable weather conditions for accuracy and effectiveness. Virtually every operation, every piece of equip-

ment, and every person on the battlefield is affected by the weather. Commanders plan to take advantage of weather conditions favorable to the mission. Similarly, they plan operations to minimize the adverse effects of the weather.

Threat evaluation focuses on the specific enemy force expected to be found operating in the battlefield area. To adequately evaluate the Threat, the analyst must think like the enemy. That is, he must see the battle through the enemy's eyes. The analyst begins to create a baseline threat model by building an OB data base. Although a data base usually exists, none is totally complete. The data base should be established around the nine OB factors: composition, disposition, strength, tactics, training, logistics, combat effectiveness, electronic technical data, and miscellaneous information. Chapter 3, FM 34-3 contains a detailed discussion of OB factors.

As much of the written data as possible is then portrayed graphically in the form of doctrinal templates. Steps 1 and 5 of the IPB process are accomplished through the analytical technique known as templating, or converting written data into graphics. Templating itself can be thought of as a visual OB data base, and thus is another technique of "cataloging" information on the enemy and the environment. OB factors, to include formations, frontages, depths, equipment numbers, and HVT are types of information that can be displayed on doctrinal templates. Doctrinal templates depict enemy doctrinal deployment for various types of operations without the constraints imposed by the terrain and weather. In other words, if the world were flat, with no terrain or weather, the enemy could deploy units exactly as desired; however, such is not the case. Practically any situation, unit, formation, or rate of movement, or such features as petroleum, oils and lubricants (POL) points and ADA systems, can be doctrinally templated.

Examples are, an MRR in a hasty river crossing, ZSU-23-4 deployment, MRB in the defense, MRD in the attack of a defending enemy, an MRB in pursuit, and so on. This is only a sampling of the doctrinal templates the S2 can produce. Depicted below

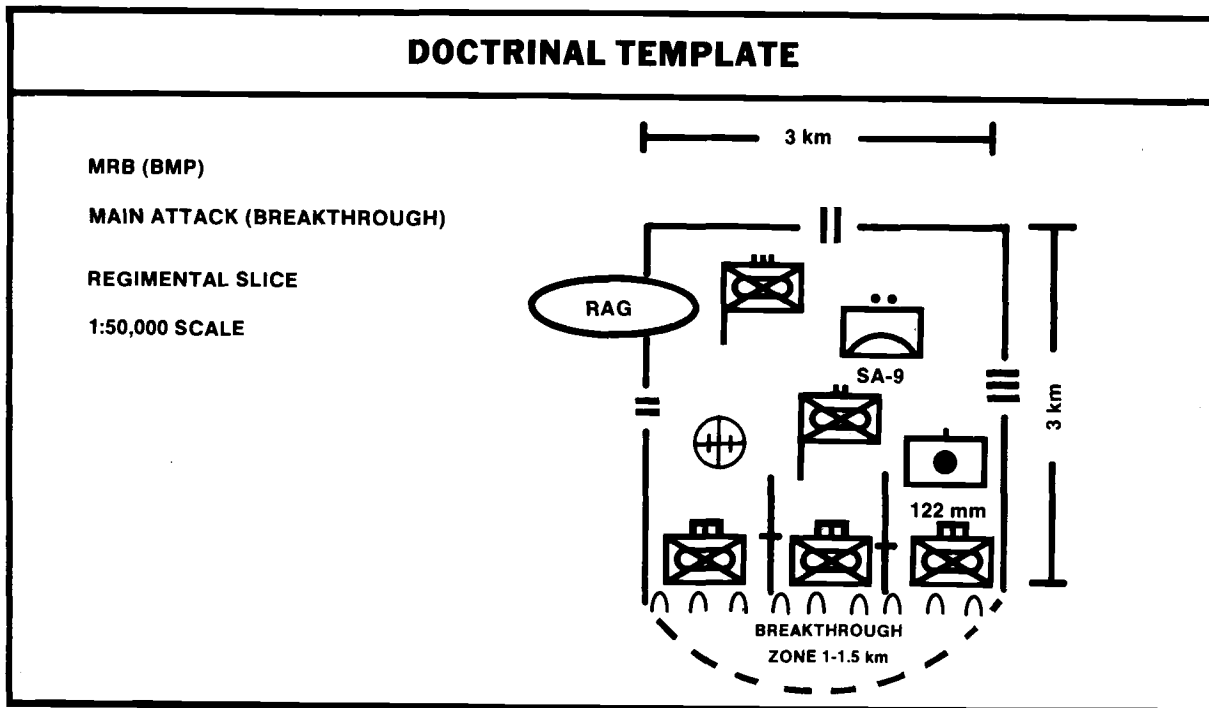

is a type of doctrinal template.

The last function of the IPB process is the integration of the Threat with the weather, terrain, and friendly operations. Threat doctrine is examined in relation to the existing situation and to the constraints imposed by the weather and terrain. By doing this, the analyst is able to determine how the Threat forces will probably fight.

Friendly courses of action are also integrated with the effects of the terrain and weather and anticipated enemy courses of action. This assists the commander in selecting a friendly course of action.

Through the use of situation templating, the enemy's doctrine is integrated into the constraints created by the weather and terrain for a specific battlefield area.

The situation template is basically a doctrinal template with terrain and weather constraints applied. It is produced by placing a doctrinal template over a selected mobility corridor or specific terrain configuration and noting how the enemy force must modify its doctrinal configuration to account for environmental constraints.

The analyst uses military logic to fit the enemy force to the terrain as closely as possible.

As an enemy force moves along a particular area of the battlefield, it will be required to do certain things at certain places which are dictated by weather, terrain, and tactical doctrine.

The situation template shows how Threat forces might deviate from doctrinal dispositions, frontages, depths, and echelon spacing to account for the effects of the terrain and weather.

The following illustrations are examples of situation templates. Note how unit dispositions have been adjusted and frontages compressed.

A doctrinal template of an MRR is overlaid on subject terrain. "Obviously, doctrinal frontages and unit configurations do not fit the confines of the subject terrain.

As enemy forces move along mobility corridors, their actions continue to be influenced by terrain and the tactical situation. Since this movement is sequential, situation templates are sequential snapshots of how the enemy might look as the force progresses.

Unit distances and frontages are adjusted, but kept as close to doctrine as possible with relation to the subject terrain.

### SITUATION TEMPLATE 1

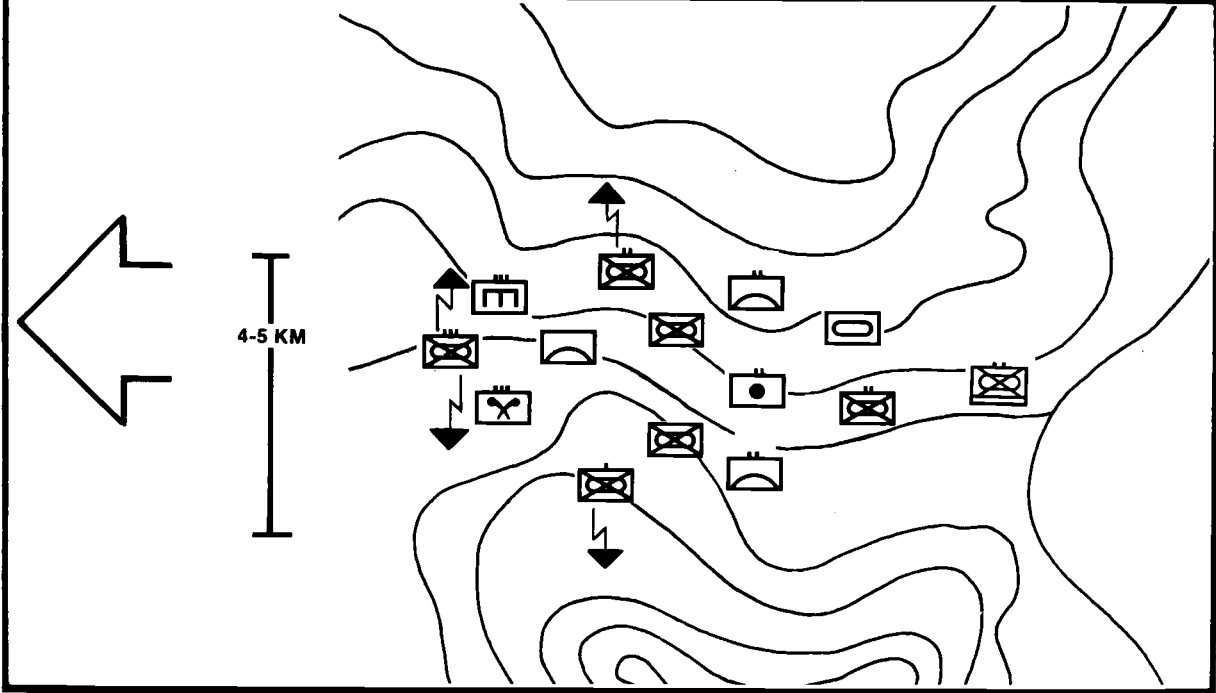

### SITUATION TEMPLATE 2

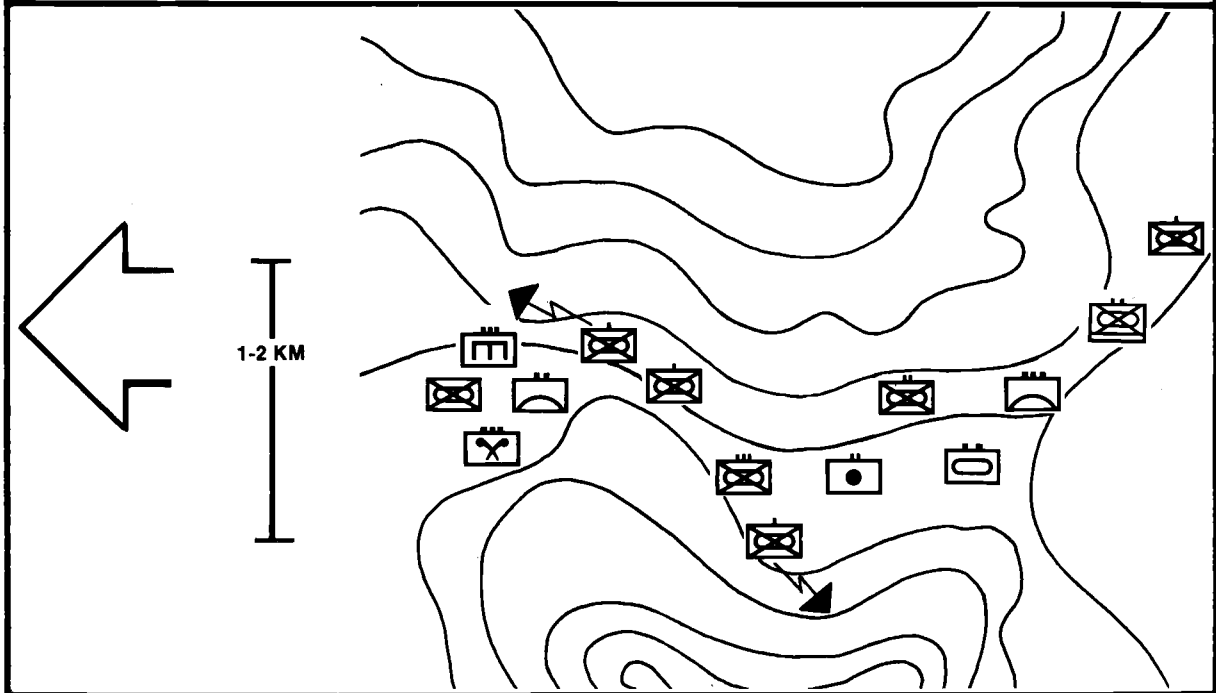

In order to generate hypotheses concerning the enemy and environmental effects on the friendly mission, it is important that the S2 know the commander's mission so that the information needs can be anticipated, identified, and understood. This involves more than "knowing" the mission. To "understand" the mission, the S2 **must** think like the commander. That is, he must know how the friendly unit is organized and equipped, as well as friendly tactics and battlefield functional systems. Once this is known, a hypothesis as to the impacts of the enemy and environment can be assessed.

Situation templating is a basis for event templating. Event templating is the identification and analysis of significant battlefield events and enemy activities which provide indicators of the enemy course of action. As the enemy force moves along a mobility corridor, critical areas become apparent. These areas are significant because, within them, significant events and activities will occur. It is within these areas that targets will appear. These areas are identified as NAI. An NAI is a point or area along a mobility corridor where enemy activity or lack of activity will confirm or deny a particular enemy course of action.

NAIs facilitate intelligence collection, reconnaissance and surveillance, and analysis because—

- Attention is focused on areas where the enemy force must appear if it has selected a particular mobility corridor.
- Significant military events can be framed by time and location within NAIs.
- Events in one NAI can be compared to events occurring in NAIs of other mobility corridors as the basis for determining enemy intentions.

- Information thresholds can be assigned to each NAI, which alert the analyst that the expected action is confirmed or not confirmed within the time limit set.
- Events within NAIs can be analyzed for indicators against which intelligence and target acquisition resources can be directed or redirected as required. NAIs are a basis for collection and R&S planning.

The third of four templates produced during the IPB process can be created at this point. The event template is nothing more than a collection of NAIs which are time-related, logically sequenced indications or events based on a series of situational templates. The NAIs will determine what you are looking for, and generally when and where to look.

Thus, event templating is the vital link between intelligence collection requirements and the commander's intelligence needs.

The following illustration is an example of an event template. NAIs numbers 1 through 9 are areas where particular types of activity would provide indications of intent.

The event analysis matrix (EAM) is another IPB tool used in conjunction with collection and R&S management. An event analysis matrix is developed for each mobility corridor. Based on terrain constraints and enemy doctrinal rates of movement, estimated times between NAIs can be computed. For example, using the previous illustration, the distance between NAI 1 and NAI 3 is 7 kilometers. Time phase lines (TPLs) graphically depict estimated enemy movement rates. Using a covering force rate of movement of 6 kilometers per hour, the estimated time between these NAIs is 70 minutes (1 hour 10 minutes).

## EVENT TEMPLATE

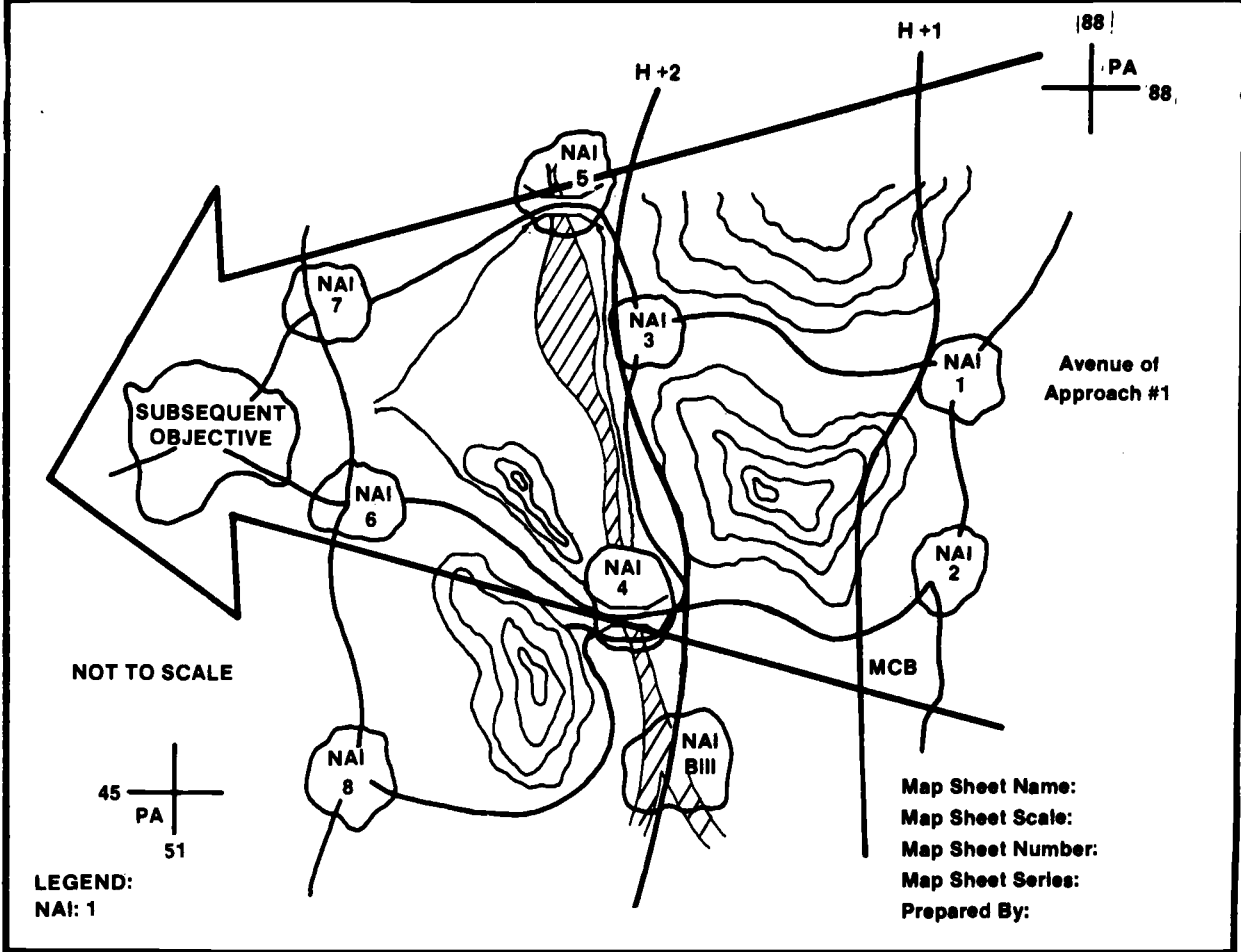

## RATE X DISTANCE FORMULA

Formula:  $T = \frac{D}{R}$  where T = time (in hours), D = distance, and R = rate of movement.

Thus, in this case,  $T = \frac{7\text{km}}{8\text{km}} / \text{hr}$ , or  $T = \frac{7}{8}$  hr, or 1 hour 10 minutes.

The EAM assists in the collection by specifying the "when to look" information required by a collector.

Through the use of both the event template and the event analysis matrix, the S2 can direct assets to the NAI at the right time to observe enemy acts and events. Both of these tools will confirm or deny enemy intentions by location and time. Depicted below is an example of an EAM. Note the NET (not earlier than) time and NLT (not later than) time. The observed time column allows for adjusting enemy rates of movement and estimated times in subsequent NAIs.

analyst has the basis for predicting what the enemy intends to do next. Such information provides the basis for constructing decision support templates.

Intelligence products are the "output" of the IPB activities. To produce usable products, it is necessary to know what the various users require, the detail required, and in what format. Up to this point in the IPB process, a number of products have been created. For instance, the doctrinal templates created during threat evaluation were essentially for intelligence use. The event template can be used by all collection managers, and by the collection agencies themselves.

<b>EVENT ANALYSIS MATRIX</b>					
<b>AVENUE OF APPROACH #1</b>		<b>COORDINATES</b>			<b>FM:</b>
					<b>TO:</b>
<b>MOBILITY CORRIDOR Alpha</b>		<b>COORDINATES</b>			<b>FM:</b>
					<b>TO:</b>
<b>ESTIMATED TIMES</b>					
<b>NAIs</b>	<b>DISTANCE</b>	<b>NET</b>	<b>NLT</b>	<b>EVENT/ACTIVITY</b>	<b>OBSERVED TIME</b>
<b>NAI 1 PA 801704 INTERSECTION</b>					
<b>NAI 3 PA 695725 INTERSECTION</b>					
<b>NAI 5 PA 666833 BRIDGE</b>					

The matrix enables the analyst to more precisely correlate what event or activity is expected within the geographical location and at what time the event is expected to take place. This capability, along with doctrinal and situation templates, provides the basis for critical node of HVT analysis. The estimated times between NAI within a mobility corridor are derived from determining the effects of terrain and normal seasonal conditions on doctrinal rates of advance. The event template and EAM allow for the initiation of precise collection requirements, maximizing the use of limited collection assets against the vast array of potential targets on the future battlefield. By knowing in advance what the enemy can do and by comparing it with what he is doing, the

The basic product used by the tactical commander is the decision support template (DST). As a matter of fact, the DST is traditionally considered the only real product of the IPB process, with all the other templates and overlays serving as the basis for its creation.

The DST is essentially the intelligence estimate in graphic form. It relates the details of event templates to decision points (DP) that are of significance to the commander. It does not dictate decisions to the commander, but rather identifies critical events and threat activities relative to time and location, which may require tactical decisions.

Central features of the DST are target areas of interest. These TAIs are areas along each avenue of approach or mobility corridor where the commander can influence the enemy through fire and maneuver. Usually identified previously as NAIs, these areas afford the commander the option of delaying, disrupting, destroying, or manipulating the enemy force. Key bridges, tunnels, major road junctions, choke points, and known drop and landing zones are examples of TAIs.

TAIs which are essential to the uninterrupted advance of the enemy (for example, a tunnel) may become HVTs. Other areas may be designated as TAIs because they are good interdiction points through which HVTs are expected to move.

Part of determining TAIs involves TVA. TVA is a joint activity among intelligence, operations, and fire support personnel. Through analysis of enemy doctrine, TVA names and provides the basis for locating enemy elements which are key to the enemy's success. These enemy elements are known as HVTs. A second category of targets is known as HPTs. Destruction of HPTs is advantageous to friendly operations. HPTs are designated by the commander. For example, suppose the enemy must cross a wide, deep river in a friendly sector as part of a probable attack. Enemy engineer assets will be very important to the enemy commander's success. The engineer units and equipment are HVTs, without which the river crossing would be impossible. The friendly commander, who is briefed on this HVT, may designate the enemy engineers as an HPT, since their destruction would be of great value to the friendly defense plan. If so, then this particular HPT is prioritized among other HPTs for location by intelligence personnel and subsequent attack by fire support or EW personnel.

An analyst who has an in-depth knowledge of doctrine can indicate potential HVTs (CPs, missile units, logistics points) on situation and event templates. This helps cue collection assets to possible HVT locations, and helps designate TAIs for the decision support template. The S2 recommends areas (usually NAIs) as potential

TAIs. The actual selection of TAIs is a command responsibility.

Following the selection of TAIs, DPs are identified.

DPs link battlefield events to friendly options for action. They represent the last point in time for a decision to be made that will allow effective action with a specific system or weapon. Decisions must be made early enough to ensure that they can be implemented in time to achieve the desired effect. However, decisions cannot be made until there are indications that particular battlefield events will occur and their locations are determined with a high degree of confidence.

DPs equate time to specific points on the battlefield. They are determined by comparing times required to implement decisions, enemy movement rates, and distances. For example, if it requires 2 hours to implement a decision, the decision must be made while the enemy is at least 2 hours from the NAI where the event will occur. Enemy doctrinal movement rates, adjusted to compensate for the effects of the terrain, weather, and friendly action on mobility, provide the basis for computation.

For example, the enemy has been templated within an avenue of approach that requires crossing a bridge. S2s should think like the commander by anticipating his needs. In other words, will the commander want to interdict the enemy in terms of EW, artillery, air interdiction, or maneuver of forces? Thus, each TAI should have a series of DPs, or a decision point cluster (DPC). For example, though not doctrinal, ***the following items could apply to a DPC:***

- EW (depends on the enemy electronic order of battle (EEOB) developed): 5 minutes to 12 hours
- Artillery: 15 minutes
- Air Force: 1 hour
- Maneuver forces: 5 to 6 hours

Based upon this information, the S2 could accurately depict areas where the commander must decide which course of action to employ. He may not take any action, but

the S2 has to anticipate the commander's needs. There should be as many DP (within each DPC) as there are tactical options.

By referring to the EAM, the S2 can depict enemy time-phase lines.

TPLs are based upon enemy doctrinal rates of advance modified by terrain constraints. They are drawn across the avenue of approach or mobility corridor and listed as H+1, H+2, and so forth.

Through the use of well-prepared DSTs, the commander can influence the battle by

concentrating critical assets at the right time and place. The DST allows the commander to act, not react.

The production of one DST does not conclude the IPB process. The threat model is never complete. IPB is a continuous process with one or all five steps occurring at the same time. New contingencies arise and missions change; IPB developed for both the offense and defense—before the battle—ensures success on the modern battlefield. A sample of a DST is shown below.

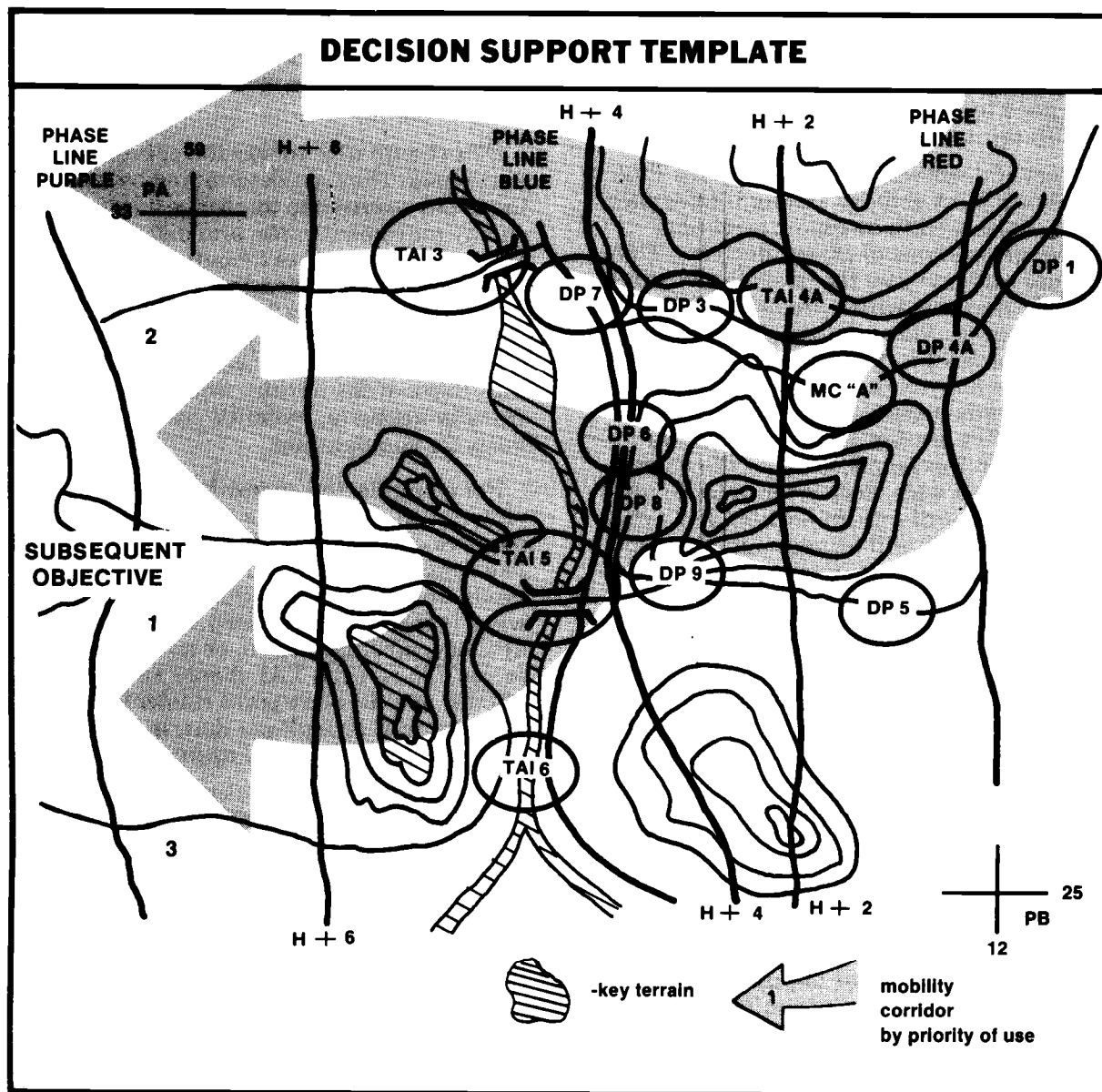



## TARGET DEVELOPMENT

The target development role of the brigade and battalion S2 in support of combat operations is very important. Principally concerned with situation development, the S2 staff and supporting IEW elements process a great deal of target information. This section discusses target development (primarily the tactical situations when targets are encountered and the method for determining the value of the targets) and the role of the S2 and his staff in formulating target data during preparation for combat. Target acquisition and the actual development of the target, once it is acquired, will be discussed in Chapter 5.

Upon receipt of a mission (whether contingency or actual), the BICC will conduct an analysis of the AO and implement the IPB process based upon this information. The intelligence staff determines enemy capabilities and determines the most probable course of action.

Contingent on enemy courses of action and the commander's tactical requirements, the TVA tools are used by the S2 (who coordinates with the S3/FSO) to determine which elements of the enemy's force are most important to his success.

Tactical requirements vary among the following areas or conditions of the battlefield:

- Close operations.
- Deep operations (as battalion\brigade operations support the division's deep operations effort).
- Rear operations.
- Protect/counter-C<sup>3</sup>.
- Battle damage assessment.

The location and composition of the enemy force compared against the mission and targeting assets of the friendly forces drives the TVA process.

TVA involves—

- Determination of HVT.
- Preparation of target spread sheets.
- Preparation of target sheets.
- Establishment of target list.

Using IPB templating, TVA is done before the battle so that, during the battle,

the commander can quickly select and attack specific targets to manipulate the enemy force. When faced with a numerically superior enemy force, commanders will not have enough resources to attack every target that can be acquired. Therefore, TVA must be keyed to determining which targets, out of the entire enemy array, should be attacked (and when) to achieve the greatest tactical benefit for the resources expended. TVA determines—

- The critical targets.
- When these targets should be attacked.
- Where these targets should be attacked.

TVA begins in IPB by a detailed analysis of enemy doctrine, tactics, equipment, organizations, and expected behavior. Information derived is then used to project how, in each tactical formation, the enemy will respond when confronted with different tactical situations. TVA identifies activities, behavior, equipment, and elements of the selected enemy force which are critical to successful operations in each situation. An example of this is the engineer company in an MRR during a march to contact. When the MRR is faced with making a river crossing, the engineer company's location within the march formation changes. Other preparatory activities must also take place in order for the river crossing to succeed. Through TVA, a listing of actions and elements is developed that would prevent the MRR from conducting a river crossing. Preventing the river crossing may accomplish the desired effect by disrupting, delaying, or blocking the MRR based on the commander's tactical plan. In-depth TVA provides a means of determining which targets should be attacked for the greatest tactical benefit in a given situation. These targets are identified as HVT.

When conducting TVA, the situational value of a target is a significant factor. As the distance from the FLOT increases, the value of combat forces decreases with respect to CSS forces and facilities. For example, at the FLOT, an attack battalion is a significant threat and is a very important target to the maneuver battalion commander. However, 100 kilometers forward of the FLOT, that tank battalion is not as

important to the success of the enemy's immediate mission as an ammunition supply point (ASP) or a fuel dump. Recognition of this situational value element is important in TVA.

Each echelon of command should have and use target spread sheets that apply to the enemy forces that commanders can be expected to face. These sheets are maintained within the brigade TOC by the S2 and S3.

During TVA and preparation of target spread sheets, potential targets are grouped into 12 sets. These sets are shown in the following illustration.

Once an analysis of enemy doctrine is

completed, a spread sheet is prepared for each specific tactical situation and level of command.

The results of TVA are used to prepare target spread sheets and target sheets.

Spread sheets are a means of describing and identifying targets in specific situations and various echelons of Soviet-type forces. The S2 and S3 use spread sheets as indicated below.

Currently, spread sheets have been prepared for use in Europe against Soviet- or Warsaw Pact-type forces in any mid-to high-intensity environment. Spread sheets normally used are shown in the following matrix.

<b>TARGET SETS</b>	
1. LOC	7. REC
2. Fire Support	8. Nuclear/Chemical
3. Maneuver	9. Class III POL
4. ADA	10. Class V (Ammunition)
5. Engineer	11. Class IX (Maintenance)
6. RSTA	12. Lift (Surface Transport/Helicopters)

<b>SPREAD SHEET USES</b>	
S2	S3
<ol style="list-style-type: none"> <li>1. FOCUS intelligence collection assets</li> <li>2. Determine target development needs</li> <li>3. Recommend target priorities to S3 and commander</li> </ol>	<ol style="list-style-type: none"> <li>1. Develop target priorities for the commander</li> <li>2. Develop methods of attack</li> <li>3. Establish priority for attack</li> <li>4. Develop fire support plans</li> <li>5. Develop fire support plans</li> </ol>

## SPREAD SHEETS

TACTICAL SITUATION	ECHELON OF COMMAND			
	REGIMENT	DIVISION	ARMY	FRONT
Movement to Contact	X	X		
Meeting Engagement	X			
Attack Against a Defending Enemy To Seize Subsequent Objective	X	X	X	X
Forced River Crossings	X	X		
Assault Crossing From the March	X	X		
Hasty Defense	X	X		
Prepared Defense		X	X	
Withdrawal	X	X	X	

A sample spread sheet is illustrated below.

SAMPLE SPREAD SHEET					
	SUPPRESS	NEUTRALIZE	DESTROY	TARGET SET	RELATIVE WORTH
Contribution in this situation to disrupt/delay unit responses	X	X	X	LOC	■
	X	X		Fire Support	■
	X	X	X	Maneuver	■
The nuclear/chemical target set is high payoff at division and higher levels regardless of the situation. Its contribution varies too greatly to be predictable thus, the different graphical treatment.	X			ADA	■
				Engineer	■
	X	X		RSTA	■
	X	X		REC	■
	X	X	X	Nuclear/Chemical	▨
				Class III POL	■
		X		Class V ammo	■
				Class IX maint	■
				LIFT	■
					■
<b>DESIRED EFFECT</b>					
<b>THREAT IS ATTACKING</b>			<b>THREAT IS DEFENDING</b>		
<b>SUPPRESS</b>	Limits enemy in target area. EW, fire, and smoke cause surprise, apprehension, and confusion. The effect usually lasts only while efforts are continued.			Same.	
<b>NEUTRALIZE</b>	Target is knocked out of battle temporarily. Ten per cent or more casualties will neutralize a unit. Unit becomes effective again when casualties are replaced and equipment is repaired.			Decreases defensive capabilities and/or causes requirement for reinforcements.	
<b>DESTROY</b>	Target out of action permanently. Thirty per cent or more casualties. Normally renders a unit permanently ineffective.			Same	
NOTE: The tactical situation and size of force are identified on actual spread sheets.					

The spread sheet is divided into five columns. The first three columns describe the effect desired from attacking the target. The Xs in the columns identify which effects can be achieved in a particular situation against the size of formation for which the sheet is being prepared.

The TARGET SET column lists the 12 target sets identified previously. The RELATIVE WORTH column depicts the worth of attacking one target set with respect to the other target sets on the sheet. The subdivisions in the column are not scaled and should not be interpreted as absolute values. This column allows a rapid identification of the priority which different target sets should have when resources for attack are scarce.

The spread sheet also contains information on enemy doctrine. This includes likely formations and distances (event template), objectives of the force, and likely enemy courses of action if the attacks on this force are successful.

The spread sheet presents the attack objective for a particular target set and refers to specific targets within that set which should be attacked. Individual spread sheets identify which specific targets within a set should be attacked. For example, in the blank left column, ZSU-23-4S within the ADA set would be indicated.

A target sheet is prepared for each potential HVT and supports the spread sheets discussed earlier. Target sheets are designed to indicate the critical elements of various target groups which, when attacked, will restrict options or capabilities of the enemy. The target sheet identifies the target and provides information target category, nomenclature and command relationship, function and capability, physical description, signature (visual and electronic), graphic representation of critical target elements, and the effects of a successful attack against the target.

The target sheets are further enhanced by electronic target sheet addenda provided by the MI battalion TCAE. These target sheet addenda are organized into two major sets of information for each target:

- Organizational, radio, radar, and operational data.
- Radio, radar, and photo profiles.

Both of these products are classified because of the nature of the information depicted. Once completed, these sheets are used by the S2 and S3 to identify and prioritize enemy potential HPTs.

A list of HPTs is provided to the commander. Upon approval, the HPTs subsequently drive the friendly collection effort and attack planning. The S2 will designate certain targets on the HPT list as protected targets (those elements that might be exploited using COMINT assets). See FMs 34-1 and 6-20 for a more detailed explanation of the above procedures.

### **COUNTER INTELLIGENCE SUPPORT TO OPSEC**

CI support to OPSEC is a critical element in preparation for combat operations and determines what actions the CI personnel will take. CI support orients on defeating or degrading an enemy's multidisciplined RSTA capabilities.

The support requires continuous planning, data collection, analysis, reporting, and execution of orders and instructions. It is a 10-step process that is cyclic in nature, which continually considers the changing nature of the enemy threat and friendly vulnerabilities. The following chart depicts the OPSEC cycle.

# THE OPSEC PROCESS

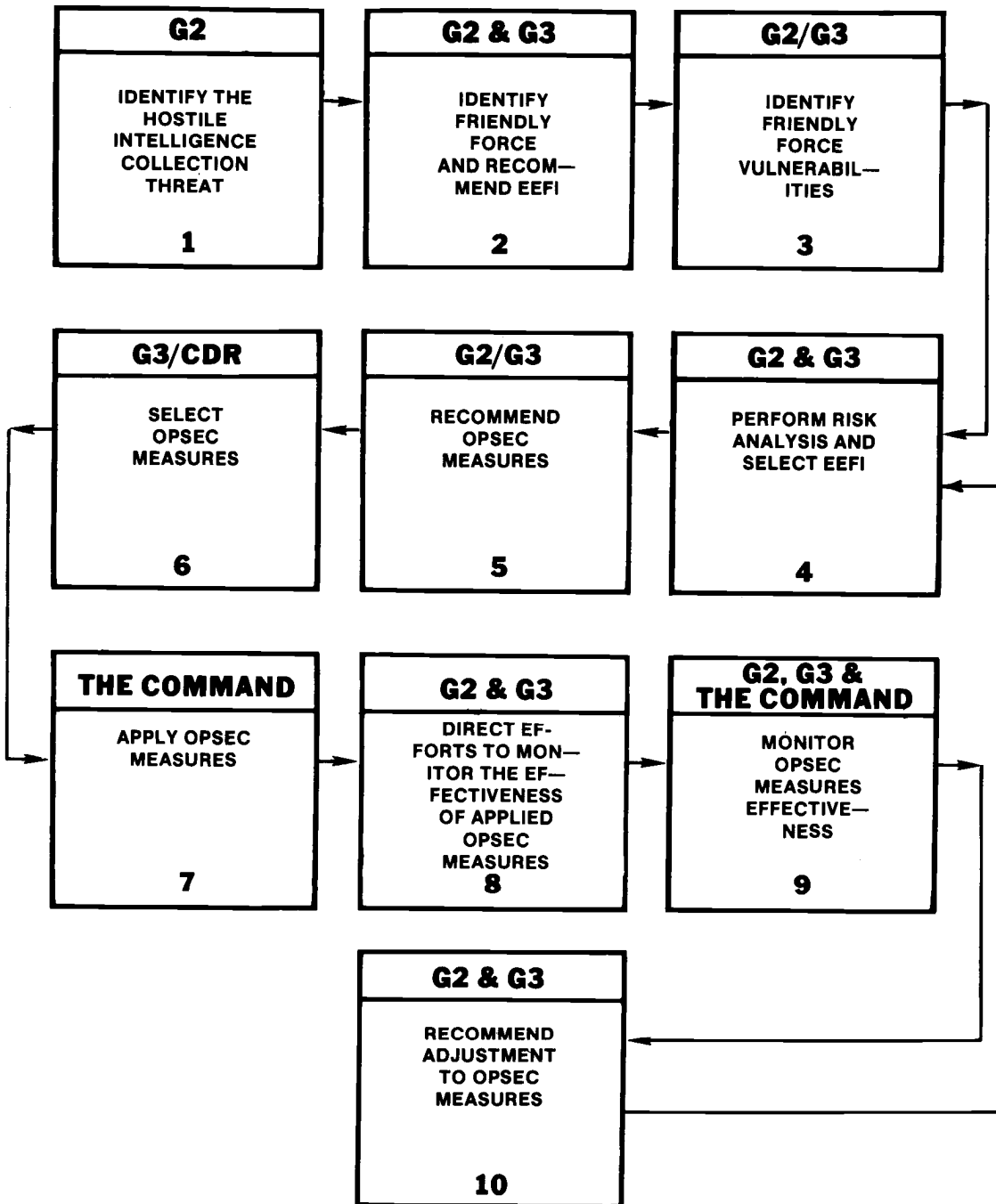

## Step 1. Identify the Hostile Intelligence Collection Threat

This step is an intelligence function performed by the CI analysts. The enemy intelligence collection threat is all-source, multi-disciplined, and extremely effective.

Information on the enemy intelligence collection systems is developed and stored in the OPSEC data base at division level.

## Step 2. Develop Friendly Force Profiles and Recommend EEFI

Friendly force profiles, signatures, patterns, and indicators show how a unit might appear through the eyes of the enemy. The friendly force data base is crucial to planning operations because it aids in developing EEFI, countermeasures, accurate appraisals, and effective deception plans.

Profiles result from actions, including the timing of those actions, taken by military units and individual soldiers. Analysis of a unit's profiles reveals signatures and patterns about unit procedures and may be used to determine intentions. Collectively, profiles can be used by the enemy to predict probable friendly courses of action. The CI analysis section develops profiles on all division units to determine weaknesses and to recommend corrections. Profiles which must be maintained include—

- Administration.
- Intelligence.
- Logistics.
- Operations.
- Communications.

The following illustration depicts a type of brigade CP showing physical and electronic signatures.

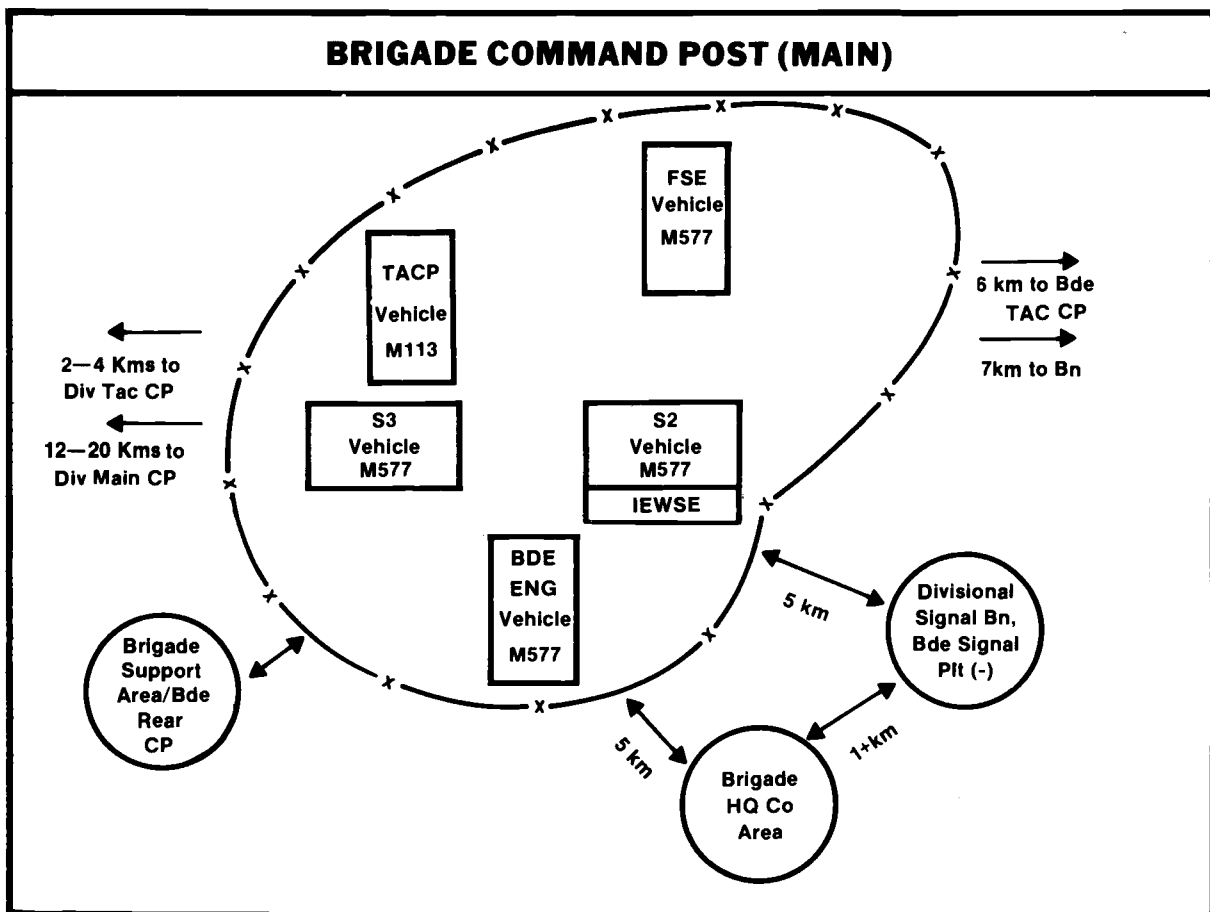

## **SIGNATURES**

**Physical signatures: 4xM577, 1xM113, additional vehicles camouflaged in woods or town.**

**Electronic signatures:**

<b>AN/VRC-46</b>	<b>Div Cmd</b>
<b>AN/VRC-46</b>	<b>Div O/I</b>
<b>AN/VRC-46</b>	<b>Bde Intel</b>
<b>AN/VRC-46</b>	<b>IEWSE/TCAE Pit Tasking Net</b>
<b>AN/VRC-46</b>	<b>Bde Cmd/Op Net</b>
<b>AN/GRC-47</b>	<b>DS FA CF Net/Div Cmd/Op Net</b>
<b>AN/GRC-106</b>	<b>Div TOC SSB Net</b>
<b>AN/BRC-142</b>	<b>Bde RATT Net</b>
<b>AN/GRC-142</b>	<b>Div Ops RATT/Div Intel</b>
<b>AN/TRQ-145</b>	<b>MC to Div, FASC</b>
<b>AN/MRQ-108B</b>	<b>USAF Air Nets</b>



Unit profiles should be developed by OPSEC support teams which will subsequently be compiled to develop major unit profiles. For example, the profile of a brigade will include all profiles of units within that brigade area plus patterns that will occur to support the operations. (See the following example.)

<b>FIRST BRIGADE PROFILE</b>	
<b>Command and Control</b>	
<b>Brigade CP (Do for brigade forward, main, and rear CPs, and battalion CPs)</b>	
<b>PHYSICAL SIGNATURE</b>	<b>ELECTRONIC SIGNATURE</b>
_____	_____
_____	_____
<b>Actions Taken:</b> <b>When and how does it move into position?</b> <b>Who assists in its position preparation?</b> <b>Who collocates with it or near it?</b> <b>How often does it redeploy?</b>	
<b>1-31 (M)</b>	<b>Operations and Maneuver</b>
<b>PHYSICAL SIGNATURE</b>	<b>ELECTRONIC SIGNATURE</b>
_____	_____
_____	_____
<b>Actions Taken:</b> <b>When and how does it conduct reconnaissance?</b> <b>When and how does it move into position?</b> <b>Who prepares its position?</b> <b>When are alternate positions reconnoitered and prepared?</b> <b>How is it supplied and by whom?</b>	

This profile will be an in-depth analysis of the signatures and patterns of the brigade and must show the interrelationships of command, support, and maneuver units.

Signatures result from the presence of a unit or activity on a battlefield. Signatures peculiar to specific units are detected and the units identified based on unique characteristics of equipment, size, electronic signal emission (communications, noncommunications, thermal, acoustic, and seismic emanations). Detection of individual signatures can be grouped by analysts to show installations, units, and activities.

Patterns are the result of the way operations are conducted. Military forces have SOPs for virtually everything they do. Predictable patterns may be developed by commanders, planners, and operators. Types of patterns are as numerous as procedures in military operations. For example, before every offensive operation the volume of communications increases dramatically and then drops off equally dramatically just before the attack. Enemy analysts would note this pattern and be able to predict our intentions for future offensives.

Indicators are activities that can contribute to the determination of a friendly course of action. In preparing for a tactical operation, it is virtually impossible for military forces to avoid or hide all indicators. In many cases, these activities can be detected by the enemy and used to predict probable courses of action. Indicators that cannot be eliminated or hidden may be considered as a basis for a deception plan.

Identification and interpretation of specific indicators are critical tasks in intelligence operations whether the indicator is friendly or enemy. CI analysts look for indicators, analyze them, and make estimates of capabilities, vulnerabilities, and intentions. These analyses lead to requests for information and planning and eventually provide the basis for decisions and orders.

Data bases on friendly forces are continually updated as the situation changes. Changes in operations, tactics, equipment, or personnel that may alter any signatures

and patterns are immediately entered into the data base. Reports from the OPSEC survey teams may disclose indicators not previously considered in assessing a command's subordinate unit's profile.

Determining EEFI is based solely on the analysis done in Step 2 of developing friendly force profiles. Once identified, this EEFI will be recommended to the commander to protect the combat force.

### **Step 3. Identify Friendly Force Vulnerabilities**

Vulnerabilities are specific weaknesses in a command's OPSEC posture that are susceptible to the enemy's intelligence collection threat. Vulnerabilities may include poor COMSEC, inadequate use of camouflage, poor physical or document security, or any predictable patterns or activities offering indications of specific intentions. This step is primarily an intelligence function. Vulnerabilities are determined through comparison of friendly profiles (or indicators) to hostile collection capabilities. A vulnerability exists whenever the enemy has the capability to collect information on our forces which would cue him as to our intentions (or courses of action). Time, date, locations, and type of collector are the first important considerations during this step.

Threat evaluation is accomplished through comparison of friendly indicators and hostile collection capabilities to identify friendly force vulnerabilities. As an aid to analysis, IPB techniques are applied to friendly force patterns and signatures so we can see ourselves as viewed by enemy collection systems. For example, the range and focus of hostile collection means can be plotted on a map and, with intervisibility overlays, a determination made regarding what friendly activities are vulnerable to enemy observation. Further, IPB can be applied to develop countermeasures recommendations. For example, a map overlay could be constructed to indicate which routes minimize detection during movement, or which areas would afford concealment and cover for signature-unique equipment.

#### **Step 4. Perform Risk Analysis and Select EEFI**

Risk analysis is the process by which projected friendly vulnerabilities are compared to the enemy's capabilities to defeat the friendly force. Nonelection of a countermeasure may incur certain risks to the force or its operations and activities. This cost of countermeasure versus benefit expected to be derived requires the coordinated efforts of the S2 and S3 staff elements. The coordinated risk analysis is presented by the S3 to the commander for decision. The results of risk analysis include the selection by the S3 of the EEFI which are critical enough to warrant the application of countermeasures to conceal them from the enemy.

EEFI provide the basis for applying appropriate OPSEC countermeasures. The EEFI are derived from the commander's guidance and from after-action reports, staff evaluations, and vulnerability analysis.

Once the threat has been identified, to include methods of operation, timeliness of reaction, and known capabilities, it is compared with the OPSEC profiles and the friendly mission. The S3 outlines the plan for the aspects of the assigned mission. These aspects include many terms of information that could, if compromised, lead to failure, or could limit the success of a given operation.

#### **Step 5. Recommend OPSEC Measures**

Based on the risk analysis process of Step 4, countermeasures are selected to minimize vulnerabilities. Because this selection is a resource management and risk decision function, it falls to the operations staff element to make the decisions. Resolving the competition-for-resources problem is an S3 function. Generally, there are five options for the decision maker:

- Apply countermeasures.
- Accept risk of detection.
- Use deception.
- Combine any of the above.
- Prohibit the activity (cancel the mission).

Selected countermeasures are directed by the OPSEC annex to the OPORD.

The OPSEC annex to the OPORD is, in reality, the OPSEC plan. There are five paragraphs: Situation, Mission, Execution (Countermeasures), Service Support, and Command and Signal. (See FM 34-60, Appendix B.) The EEFI (which should be listed in paragraph 3 of the OPSEC annex) are set up in priority order. Generally, these priorities will coincide with enemy doctrinal priorities for reconnaissance and the employment of their fire support and jamming resources.

The plan may be disseminated by any of the following means:

- Annex to the OPORD.
- Fragmentary order (FRAGO).
- Verbal or written instructions.

In selecting and planning countermeasures, the OPSEC countermeasures worksheet is completed. The worksheet describes countermeasures for the force as a whole and specific countermeasures to be employed by the subordinate maneuver and support units. The worksheet becomes part of the OPSEC annex to the OPORD (see FM 34-60, Appendix C).

#### **Steps 6, 7, 8, and 9**

Step 6, Select OPSEC Measures; Step 7, Apply OPSEC Measures; Step 8, Direct Efforts to Monitor the Effectiveness of Applied OPSEC Measures; and Step 9, Monitor OPSEC Measures Effectiveness, are closely related to the previous step. It is in these steps that an OPSEC survey is done and countermeasures are evaluated. Teams are formed with personnel from the operations staff (the team leader), and representatives from the functional areas of intelligence, communications, logistics, and administration. Other specialists may be required. For example, if engineer operations are to be evaluated, then an engineer expert should be designated as a team member.

CI personnel assigned to the teams assist in evaluating units for identifiable patterns and signatures exploitable by the enemy.

Their knowledge of enemy intelligence collection capabilities and effective countermeasures is critical to the effectiveness of the team. Additionally, the CI personnel interrogate EPW and refugees to determine enemy intelligence requirements and to gauge the effectiveness of OPSEC measures.

During the course of OPSEC surveys, the OPSEC teams advise their commanders and staffs about security practices that may compromise EEFI or provide indicators of any planned or ongoing operations. If any actions indicate possible compromise of essential information, the data is reported to the CI element for analysis of the probable information disclosed and the risks to which the command may be subjected. Examples of data to be reported are—

- Suspected disclosure of designated EEFI.
- Serious violations of established security procedures.
- Friendly losses attributable to probable compromise.
- Indications that the enemy had prior knowledge of a friendly operation.
- Enemy activity directed against otherwise well-concealed friendly vulnerabilities.

### **Step 10. Recommend Adjustments to OPSEC Measures**

Intelligence and operations staffs jointly make adjustments to the OPSEC program. When necessary, new EEFI are recommended and changes to countermeasures are devised and recommended.

After-action reports about OPSEC conditions and the effectiveness of countermeasures previously implemented are presented to commanders and operations officers. The detail of these reports will vary with the extent of an operation, size of a unit, time available, and current situation.

### **Additional Functions**

CI personnel perform various additional functions. These functions include—

- CI screening or line-crosser operations. During initial screening, individuals are approached for possible return as

low-level US agents to the enemy-held territory from which they came. Individuals are also screened for their identification on the black, gray, and white lists (see below).

- Investigations. CI personnel investigate incidents to try to detect and nullify espionage, sabotage and subversion activities. In overseas areas, they also investigate personnel to ensure they are suitable for a position of trust and responsibility with the US Government.
- CI defensive operations. CI personnel develop defensive source operations to obtain information on potential threats to the rear area.
- Liaison. Liaison is conducted at all levels of the Army. It is essential to the success of the CI exploitation of information in overseas areas of operation. Liaison is conducted with both military and civilian agencies in the area.
- Black, gray, and white lists. These lists identify persons selected as US targets. Black lists contain those hostile to the US, gray lists identify those whose inclinations and attitudes toward the US are obscure, and white lists contain those friendly to the US. They are used during screening operations to locate personnel of CI interest.
- Training. CI personnel conduct security training in various areas, such as SAEDA and counterinterrogation. This includes classes, briefings, and other training to meet the requirements of the command's mission.

### **ELECTRONIC WARFARE**

The ground-based EW resources available to the MI battalion and MI brigade at division and corps, respectively, and the three QUICKFIX aircraft of the division CAB, are all capable of providing EW support to divisional brigades and their subordinate maneuver battalions. These resources, however, as discussed in Chapter 2, are extremely limited, and the missions they may be called upon to perform are extremely diversified. Their individual and collective capability to effectively support any battalion or brigade, or the division as a whole,

for that matter, ultimately depends upon how well EW operations are planned, prior to combat. The following describes the formal top-down, bottom-up EW planning process in which the battalions and brigades participate.

The brigade S3 has the primary responsibility for the planning, targeting, execution, and evaluation of EW operations in support of the brigade. Maneuver battalion EW needs are identified to the brigade for incorporation in brigade priorities. The brigade S3 is specifically concerned with ECM and ensuring that EW operations support the commander's overall concept of the

operations by integrating ECM with the targeting of lethal fires and the scheme of maneuver. ESM, although a critical element of EW, are the responsibility of the S2. ESM operations are conducted the same as other collection operations and require the same type of S2/S3 coordination. The S3 identified his combat information requirements to the S2, who incorporates them with other ESM/SIGINT needs. The six principles of EW support, shown in the following illustration, provide corps, division, and brigade staff officers alike with a common point of reference to ensure maximum effectiveness of EW operations to support all operations.

## **PRINCIPLES OF ELECTRONIC WARFARE SUPPORT**

- 1. INTEGRATION WITH MANEUVER AND FIRES IS ESSENTIAL.**
  - a. OPLANs, ORDERS, and SOPs.
  - b. COMBINED ARMS, JOINT, and ALLIED OPERATIONS.
- 2. SYNCHRONIZATION ON THE BATTLEFIELD IS CRITICAL.**
  - a. EW TEAMS—ESM and ECM REINFORCED.
  - b. EW TEAMS—MEMBER OF COMBINED ARMS TEAM.
- 3. MOBILITY MUST BE SUFFICIENT TO KEEP UP WITH THE FORCE.**
  - a. LEAPFROG OPERATIONS—PHASED WITH FIRES.
  - b. BOUNDING OVERWATCH—PHASED WITH MANEUVER.
- 4. ALL BATTLES MUST BE SUPPORTED SIMULTANEOUSLY.**
  - a. NEVER HELD IN RESERVE—EMPLOYED LIKE ARTILLERY.
  - b. MUST HAVE FLEXIBILITY—DEEP, COVERING FORCE AREA (CFA), MAIN BATTLE AREA (MBA), REAR OPERATIONS AREA.
- 5. CONTINUITY OF OPERATIONS MUST BE MAINTAINED.**
  - a. CENTRALIZED CONTROL and DECENTRALIZED EXECUTION.
  - b. COORDINATION BETWEEN GS and DS EW ASSETS.
  - c. DECENTRALIZED EXECUTION BY SOP WHEN REQUIRED.
- 6. MUTUAL INTELLIGENCE AND EW SUPPORT IS MANDATORY.**
  - a. CENTRALIZED CONTROL AND DECENTRALIZED EXECUTION.
  - b. COORDINATION BETWEEN EW ASSETS AND SUPPORTED COMMAND.

## Types of Targets

The types of targets for EW missions are the same as for other fire missions. They are: preplanned targets, on-call targets, and targets of opportunity.

Preplanned EW targets are communication or noncommunication entities which are identified during the planning of an operation. These targets can be identified before the operation as key elements to be jammed or collected on during the operation. Through IPB and existing data bases, target locations are predicted. Through analysis of the concept of the operation, their importance and priority for EW action is determined.

On-call EW targets are elements identified during the conduct of an operation for immediate jamming or collection. These are targets which could not be predicted before the start of the operation, and whose importance is identified as the operation progresses.

EW targets of opportunity are communication or noncommunication entities which were not identified as specific preplanned targets and which the EW operator acquires and recognizes during the conduct of ESM or ECM operations. Once these targets are recognized, they become candidates for jamming or intercept operations. Normally, categories of targets of opportunity are preplanned to allow action by operators upon recognition. They are usually given a lower priority than specific preplanned targets or on-call missions.

All three types of targets will be identified in an operations. Preplanned ESM targets are selected so as to detect the movement of enemy second-echelon forces at key times. Preplanned ECM targets are identified to degrade critical communications. Additionally, categories for targets of opportunity

are generally identified to degrade enemy operations if and when these targets are located. Finally, as the operation progresses, on-call targets are identified and missions attacking or exploiting them are requested.

The development of targets of all types is through the standard target development process described in FM 34-1 and FC 34-118. Initial analysis of the enemy's deployment and intentions leads to the development of HVTs. Comparison of these HVTs to the friendly commander's intent and concept of the operation leads to the selection of HPTs. Identification of the priority for each target relative to other targets of all types is critical to ensure effective control. For example, if an on-call mission is requested, the requester must identify the priority of that mission as compared to existing priorities for preplanned and other targets. If he does not, that on-call mission may preempt a more important preplanned mission or other on-call missions.

## Planning Process

The planning process for EW operations closely parallels the targeting process. The S3, S2, and IEWSE cooperate closely to plan EW missions. The initial planning process is performed prior to an operation for development of preplanned targets and identification of categories of targets of opportunity. The process continues during the actual conduct of an operation to identify on-call targets. As well as the identification of targets, the EW planning process drives the task organization of EW assets and initiates requests for EW missions to be performed by higher echelons.

The EW planning process begins with the analysis of the battlefield situation based on IPB and current intelligence data. EW system capabilities and limitations are then compared to the emitters associated with the targets identified through IPB. The result of this first step is the identification of significant targets which we can affect with available EW assets. This is the selection of HVTs in the targeting process. This step is performed by G2 or S2 staffs in close coordination with the electronic warfare section (EWS) or IEWSE.

The second step in the EW planning process entails development of a strategy for use of EW in the operation. The corps G3, assisted by his EWS, will identify the general focus of EW operations. This includes establishing priorities for EW operations throughout the area of influence. Priorities are identified for each phase of an operation. For example, a strategy in a particular operation might be to prioritize SEAD operations, and to counter the enemy's intelligence and reconnaissance systems during movement-to-contact. As the main attack begins, this priority might shift to countering enemy artillery. Finally, in the exploitation of success, priority would be to disrupt the enemy command and control to prevent his regaining control of the situation. In turn, the division G3 and brigade S3 will apply this strategy to their operation, assisted by their EWS or IEWSE. They compare the focus and phases of higher echelon EW strategy to their operations plan, and identify a focus or priority for EW missions that will support their operation and comply with the overall strategy. This ensures that EW operations at all echelons complement each other and apply limited EW assets with maximum effectiveness.

After targets which we can jam or collect against have been identified and the general strategy has been established the next step is to decide which specific targets to preplan. At brigade the S3 makes this determination based on recommendations from the IEWSE. Key enemy elements whose movement or action is considered important are prioritized for ESM missions. If appropriate, their control links are prioritized for jamming to delay receipt of orders to move. Other key communications links are also prioritized for jamming and emitters associated with unique missions or enemy actions are prioritized for intercept.

After the G3 or S3 has selected the preplanned targets which he desires to influence or exploit, the IEWSE at the brigade documents these missions on worksheets called EW target lists. These worksheets serve as planning documents for coordination between elements in the EW system. The worksheets at brigade are provided to the division's EWS to coordinate missions and to request support for missions which

are beyond the capability of the assets available at a given echelon. Giving these worksheets to the next higher level allows for review to avoid conflicts, such as simultaneously tasking for both jamming and collecting on the same target. These worksheets also are exchanged with adjacent units to avoid similar conflicts.

To complete the planning process, the EWS at division uses the completed EW target list to examine the distribution of missions and recommend allocation of EW assets. At division, this involves recommendations for placing assets in DS of brigades or in GS of the division.

### **EW Target Lists**

The worksheets described above list desired preplanned EW targets with details on unit identifications and locations. Technical data is added only when the tasked mission reaches the appropriate TCAE.

A proposed format for a brigade-level EW target list is provided on the following page.

The EW target lists developed at the brigade level are consolidated at the division EWS on a similar worksheet. Missions planned at the division level are added to this worksheet. A proposed format for a division composite EW target list is also provided on the following page:

**SAMPLE BRIGADE EW TARGET LIST/JAMMING  
SCHEDULE WORKSHEET**

**BRIGADE EW TARGET LIST/JAMMING SCHEDULE WORKSHEET**

TIME WINDOW	TARGET UNIT	TARGET LOCATION*	TARGET ACTIVITY	PRIORITY		FEEDBACK REQUIRED
				ESM	ECM	
310100Z-310400Z	ITB, 39 GMRD	NB448292	Move from Bn assembly area	1	NA	TACREP w/in 5 min
310100Z-310200Z	RAG, 141 MRR	NB325310	Call for fire	NA	1	ECMMEER

\*Can only be used when detailed enemy information is available.

**SAMPLE DIVISION COMPOSITE EW TARGET LIST**

**DIVISION COMPOSITE EW TARGET LIST**

TIME WINDOW	TARGET UNIT	TARGET LOCATION	PRIORITY		EW UNIT	CONTROL MECHANISM	COORDINATION
			ESM	ECM			
310300-310400	HQ, 131 MRR	UNKNOWN	1	NA	CORPS MI (AE)	NA	
310001-310100	RECON 39 GMRD	NB227314	NA	1	DIV MI BN	Negative	
310100-310200	RAG, 141 MRR	NB448292	NA	2	DIV MI BN	ON-OFF	



### **Planning On-call EW Targets**

Unlike preplanned EW targets, information regarding on-call EW targets cannot be predicted in detail. Their locations and the key times to interdictor collect on these targets are not clear until the operation is underway. Therefore, these missions could not be included on the EW target lists which were prepared before the operation, and will need to be forwarded separately for execution.

While the specific data to jam or collect on these targets cannot be predicted, potential targets can be identified and tracked until they are selected for EW action. To do this, the IEWSE monitors the situation map in order to identify enemy units of potential significance. He maintains his own overlay depicting the location of EW assets in his area with their range based on LOS. Comparison of this overlay to the situation map then determines which of the potential targets may be engaged.

Based on his overlay and the current situation map, the IEWSE will recommend on-call EW targets to the S3 as the operation progresses. The S3 will also select on-call targets based on his analysis of the ongoing friendly operation.

The IEWSE will normally maintain a separate list of potential targets. Using the same format as the EW target list, this list will be a working document which is not provided to higher and adjacent units. As the detailed data on these potential targets is not all available, there will be many blanks or incomplete entries on the worksheet. The IEWSE will fill in this worksheet as the situation map provides answers. By maintaining and constantly updating this worksheet, on-call EW targeting data is ready for rapid identification and for request of EW missions. When these targets are to be jammed or exploited, the IEWSE at brigade calls these missions directly to their servicing TCAE for execution. FM 34-40(S) provides more detail on planning and tasking of both on-call and preplanned EW missions.

### **Electronic Warfare Operations**

COMJAM attack and ECM control procedures are initially determined during

the EW planning process with specific attention to the C3 means available for implementation. They are specified in the "control mechanism" and "coordinating instructions" columns of the refined EWTL, previously described. Each type of COMJAM attack and ECM control procedure requires extensive preplanning in critical situations.

Negative ECM control procedures against categories of targets of opportunity are used by COMJAM operators extensively during the initial hours of combat when little or no technical data base is available to support their operations. Such procedures are used predominantly against enemy secure communications facilities to support the division and corps' overall SIGINT collection, processing, analysis, and reporting effort. They provide COMJAM operators a positive means to "get into" the enemy's decision-cycle or "event schedule." HPTs for jamming are developed by the EWS at division and corps. Extensive coordination with the G2, MI unit S3, and each TCAE, is required. Target of opportunity jamming missions are reflected on the EWTL, previously described. They are based on the commander's specified rules of attack priorities, and critical task lists.

Targets of opportunity jamming missions are usually conducted on an area-wide basis against generic sets of HPTs such as all enemy secure communications facilities operating in a specified frequency band; all fire support facilities operating within a specified attack zone; or all SAM/AAA C<sup>3</sup> facilities passing operational information within a given time period. Generic HPT sets are prioritized by the G3/S3 based on recommendations from the G2/S2, EWS, FSE, and the MI unit S3 and TCAE. SIGINT analysts and ECM managers within the TCAE determine the specific elements of information or types of transmissions to be jammed, the respective employment area for each EW team or platoon, and the frequency bands for which each EW team or platoon is responsible. COMJAM operators execute missions against high pay-off targets of opportunity "upon recognition" only when the specific attack criteria, specified on the EWTL have been met. Voice collection and DF operators monitor the mission. All combat information, technical EOB data, frequencies, and COMJAM results are transmitted to the TCAE via the IEW C<sup>2</sup> system.

Positive ECM control procedures for offensive COMJAM attack against preplanned EW targets begin at the earliest possible point in battle. They commence as specific HPTs are identified and located. Again, the reporting of combat information regarding enemy activities or "events" provides the key for synchronizing the overall fire support effort. Knowing where the enemy is and what the enemy is doing, and slowing the enemy down by disrupting his critical communications means, provide the time necessary to "adjust" all lethal and non-lethal attack schedules.

Preplanned jamming requires the greatest amount of detail, identifying the unit, location, and time. It must be totally synchronized with fire support and maneuver to achieve maximum results. Preplanned jamming missions may engage a target simultaneously with fire, or singularly engage lower priority targets, while simultaneous fire is brought to bear on higher priority targets. Preplanned targets, like targets of opportunity, are reflected on the EWTL for each EW team or platoon. Technical data (such as frequencies and call signs, or indications that technical data is available to support attacks against specific HPT facilities) are the primary means for differentiating preplanned HPTs from target of opportunity sets on the EWTL. Preplanned COMJAM operations are conducted on a scheduled or on-call basis.

Preplanned missions, depicted on the EWTL, as previously mentioned, are both time- and location-phased according to the scheme of maneuver and the supporting fire plans. The enemy unit's C<sup>3</sup> facility, its location, and the time at which the COMJAM attack is to begin are all reflected on the EWTL. This type of COMJAM attack is usually synchronized with the lethal attack fire missions to provide the greatest support to the supported maneuver unit and to ensure maximum degradation to the enemy's C<sup>3</sup> system. SOP COMJAM attack priorities allow for the immediate attack of unforeseen or nonscheduled HPTs as the battle develops. Such targets are normally attacked on an on-call basis, having been anticipated early in the planning process. Extensive coordination is required among the S3, S2, and the FSE of the supported maneuver unit, their counterparts at higher echelons, and, most importantly, the IEW resources operating within their AO. This will ensure that preplanned and on-call targets are attacked at the time and place they require COMJAM support. Such coordination in combat is virtually impossible unless detailed targeting, COMJAM attack and ECM control procedures, alternate communications means, and coordinating instructions are determined prior to combat. On-call COMJAM attack and ECM support missions are the most difficult tasks to perform.

On-call jamming missions, like other pre-planned missions, are reflected on the EWTL for given EW teams or platoons operating in each AO, as HPT C<sup>3</sup> facilities are identified, located, and scheduled for attack. Positive control procedures and specific coordinating instructions are always stipulated. However, the basic technical data and the exact time of the COMJAM attack may not be available or immediately known. There are three types of on-call missions:

- COMJAM attacks against immediate HPTs as they become active or cross into pre-established attack zones.
- High-power communications support to specific commanders in critical situations.
- COMJAM screening missions. discussed in Chapter 2.

COMJAM attacks, performed on an on-call basis against immediate HPTs are very similar to preplanned jamming, previously described. On-call jamming missions, however, differ from preplanned missions, in that they are developed as the battle progresses to attack specific HPT C<sup>3</sup> facilities supporting specific enemy units in specific attack zones during specific time periods. On-call COMJAM attacks are conducted primarily in support of "hand-off" operations as enemy units transcend attack zone boundaries or when the COMJAM effectiveness of one ECM system is degraded and another ECM system can acquire the HPT and conduct operations more effectively. On-call targets are anticipated in the planning process prior to deployment. The IEWSE and TCAE personnel develop and refine on-call attack missions as the battle unfolds. ECM managers in the TCAE schedule on-call targets for given EW teams or platoons as HPTs are identified and located. COMJAM operators report the time of acquisition and their readiness condition to the TCAE and supported command following SOP and predetermined coordinating instructions. On-call COMJAM control authority in such situations may reside with the supported commander or his S3 to ensure that the COMJAM attack is synchronized with his specific maneuver and

fire support operations. Proper authentication procedures must be used and CEOI must be known by all members of the combined arms team involved in these types of operations.

On-call high-power communications support should be considered when determining the manner in which ECM resources are task organized to support the synchronization of all operations. These operations are performed only in extreme circumstances, COMJAM screening operations are also used only in extreme situations. FM 34-40(S) will provide more detail on these operations.

Effective on-call COMJAM support may ultimately determine the outcome of close operations. The MI battalion and its TCAE and EW resources must render that support to the brigades and battalions conducting close operations. This includes COMJAM attacks against immediate HPTs, high-power communications to call in air or artillery strikes, or screen jamming protection for friendly C<sup>3</sup> activities. These subjects are discussed in greater detail in Chapter 5. Additional information regarding the procedures, tactics, and techniques used to plan, conduct, coordinate, and evaluate such operations are provided in FMs 34-10, 34-25(S), and 34-40(S).

## **RECONNAISSANCE AND SURVEILLANCE**

R&S provides a systematic watch over the battlefield. It provides early warning of

enemy activity, targets for fire and maneuver, and, most important, information to help satisfy the commander's PIR in preparing for combat operations. R&S therefore provides the commander with information-collection capabilities throughout the battle area. In addition, other services' capabilities may augment those of the Army. For example, Army capabilities are extended well forward by Air Force tactical air reconnaissance. This extension provides critical intelligence of enemy second-echelon forces before they are within the range of Army collection capabilities. R&S yields much of the information necessary for decisions and targeting.

Most information needed in combat comes from assets within the combat force. These assets perform R&S operations in the area of immediate interest.

### INTERRELATIONSHIPS

Reconnaissance is undertaken to collect information by visual or other detection means. It is characterized by its direction toward coverage of one or more specific target areas. The reconnaissance mission may be developed from cues indicating that an area possesses intelligence value or because current or planned operations require detailed coverage of a specific area.

Surveillance is the systematic observation of aerospace, surface or subsurface areas, places, persons, or things by visual, aural, electronic, photographic, or other means. Surveillance is characterized by wide coverage of a target area and by repetition. It is normally used to gain information in those aforementioned areas over a long period of time to note any changes that may take place.

Because of the interrelationship of reconnaissance and surveillance, the same assets used to execute reconnaissance missions may also be used for surveillance tasks.

As noted above, surveillance missions are characterized by a systematic, constant watch of persons, places, or things by HUMINT, IMINT, or SIGINT resources. Surveillance missions are usually pre-planned. Surveillance missions are particularly suited to—

- Cover large areas rapidly and repetitively.
- Minimize risk to the collector.
- Observe or detect changes on the enemy side of the FLOT.
- Cue other collectors for more detailed coverage.

### ROLES OF RECONNAISSANCE AND SURVEILLANCE

R&S is a vital part of the battalion and brigade intelligence collection effort. The BICC does the detailed R&S planning and integrates it into the overall collection effort. For a more detailed discussion of the S2/BICC responsibility and procedures in R&S planning see Appendix E.

The main reconnaissance effort supports the main maneuver effort: main attack along with main defensive effort. The primary reconnaissance effort is designated by redundancy; for example, using two patrols along the main axis of advance or attack. Detailed instructions given to R&S assets include: mission, start-completion time, objective-passage points, action on enemy contact at barriers, control measures (that is, phase lines and checkpoints), PIR, SOR, and actions on completion of mission. The higher headquarters' (brigade and division) intelligence and combat information on the TF area of operations must be confirmed. The commander should receive timely information in order to adjust his scheme of maneuver as new combat information is acquired.

In preparing for R&S in the offensive, the TF commander must focus the collection effort, based on SOR derived from a situation or event template on platoon locations, vehicle locations, crew-served weapon locations, individual fighting positions, barriers and obstacles, and locations of the reserve and counterattack elements. For planning purposes, the collection effort focuses on the threat echelon two levels below the R&S planning level. Reconnaissance patrols will watch the objective during changes to the threat posture.

For R&S in the defensive, the commander must focus collection effort on the following

- Identifying the enemy reconnaissance effort for counter-reconnaissance purposes.
- Identifying the enemy main effort as indicated by enemy unit locations, particularly the second echelon.

For counter-reconnaissance purposes the collection effort must—

- Define EEFI: barriers or obstacles, platoon locations, reserve and counterattack elements.
- Assess enemy collection capabilities and methods.
- Assess friendly vulnerabilities.
- Coordinate countermeasures with the S3.

Countermeasures accomplish two things:

- Orientation of TF collection capabilities (scouts, patrols, GSRs, and OPs) on protecting EEFI to identify enemy reconnaissance.
- Orientation of combat elements on the identified reconnaissance to neutralize or destroy them by combat.

## PLANNING PRIORITIES

In planning R&S, it should be understood that long-range planning of R&S operations and events is conducted by division echelon and higher, using the formal collection management process, whereas brigade and battalion planning usually involves events that will occur within a few days. The results of planning at the brigade and battalion levels includes a written or graphic R&S plan. The R&S plan prepared at brigade and battalion levels may include all R&S data.

The BICC will assign priorities to all R&S requirements based on the urgency and importance of the information needed.

- Priority 1: Takes precedence over all other requirements except previously assigned Priority 1 missions. The results of these missions are of para-

mount importance to the immediate battle situation or objective.

- Priority 2: The results of these requirements are in support of the general battle situation and will be accomplished as soon as possible after Priority 1 requirements. These missions are to gain current battle information.
- Priority 3: The results of these missions update the intelligence data base, but do not affect the immediate battle situation.
- Priority 4: The results of these missions are of a routine nature. These requirements will be fulfilled when the reconnaissance effort permits.
- Priority 3 and 4 taskings are not assigned to subordinate units. Information required which falls in these categories is included in PIR and IR transmitted to subordinate units.

The BICC will also use planning factors to develop R&S information. Planning factors are those elements or conditions which may have a serious impact on the command's R&S effort.

The friendly and enemy situation includes the composition and disposition of friendly and enemy forces, enemy tactical doctrine, and the type and extent of planned operations.

Resources include brigade and battalion collection assets (discussed previously) and supporting assets. Capabilities, limitations, and availability of collection assets are considered when allocating resources for reconnaissance and surveillance requirements. The objective is to assign each requirement to the best available collection asset or assets to most economically support the requirement.

Terrain and weather are studied to determine their effects on available resources and are also considered during the determination of R&S requirements. That is, likely avenues of approach would normally be allocated greater resources.

EW is considered in all R&S plans. Planning should include consideration of friendly and enemy SIGINT, DF, and jamming capabilities.

SIGINT, DF, and jamming capabilities.

OPSEC includes all measures that can be taken to deny intelligence of friendly force composition, disposition, and activities to the enemy.

R&S plans must be scrutinized to ensure that they do not inadvertently disclose such information to the enemy.

See FMs 30-20 and 100-5 for further explanation of R&S planning.

### **REQUESTS FOR INFORMATION**

Generally, requests for information can be identified as either reconnaissance or surveillance. Classifying requests by this method assists the brigade or battalion S2 in determining the basic elements of the request.

Planning for surveillance operations is conducted after determining the general mission of the tactical force. Surveillance missions are often developed as a joint effort involving all of the intelligence organizations having an interest in the same AO. This is due to the limited availability of surveillance systems and the large number of overlapping requests that could be generated in a joint or combined operation.

A reconnaissance mission seeks to obtain information by visual or other detection means and is characterized by limitations of coverage to one or more specific target areas at a particular time without the requirement for systematic coverage.

Reconnaissance missions are conducted by HUMINT, IMINT, and SIGINT resources and are designed to—

- Collect specific, detailed information at a particular location and time.
- Support current or planned operations.

Most reconnaissance requests are pre-planned before the operation; however, once operations begin, many reconnaissance requests will be immediate. The time constraints of the typical reconnaissance request will not allow for elaborate planning or coordination. A request that would be classified as a requirement for a reconnaissance mission might be for urgent photographic coverage of a proposed helicopter

landing zone (LZ) some distance beyond the FLOT.

Valid justification is particularly important for immediate surveillance or reconnaissance requests. This is critical if corps and EAC systems may be required to collect the information.

The BICC manages all R&S assets available which provide a complete picture of the area of operations to the commander, staff, subordinate commanders, and higher headquarters. Effective management requires the determination of R&S requirements, tasking, controlling and coordinating assigned assets, and requesting R&S support from higher headquarters to satisfy those requirements beyond the capabilities of assigned assets.

To effectively manage the R&S effort, the BICC must consider the following:

- Unit mission and the commander's concept of the operation.
- R&S assets available from assigned units.
- Resources available from higher headquarters and other services.
- Capabilities situation, including location, composition, and disposition of both friendly and enemy forces.
- The S2's estimate of the situation and possible enemy course of action.
- Weather, vegetation, and terrain as they may affect employment of R&S resources.

The BICC analyzes all available R&S data and uses organic R&S resources to best cover the battlefield and satisfy PIR and targeting requirements. It requests additional resources or support needed to accomplish R&S requirements from higher headquarters. See Chapter 2 and Appendix E for the R&S resources assigned to and supporting the brigade and battalion.

The BICC examines the capabilities and limitations of each R&S resource and matches resources to specific information and R&S requirements. Careful planning ensures the most effective use of R&S resources.

The BICC uses various aids to help manage R&S operations, including the unit intelligence SOP. The SOP specifies standard R&S procedures. It standardizes procedures that are done repeatedly in order to reduce the number of orders that must be transmitted during combat. The R&S SOP should include the following:

- Procedures and formats for requesting R&S support.
- Reporting procedures, channels, and formats.
- Standard R&S activities, such as conducting patrols and operating OPs.

Another aid used by the BICC is the SITMAP. The SITMAP portrays the friendly and enemy situation and conveys plans and orders in a condensed form. The BICC posts pertinent parts of the R&S plan to the SITMAP to ensure that R&S operations are integrated with maneuver, fire, and other intelligence operations. (See Appendix E.)

The R&S plan includes the R&S requirements of subordinate units. Each echelon requests R&S support from higher headquarters to satisfy those requirements that are beyond its own capabilities. The BICC evaluates these requirements, assigns priorities, and satisfies them in one or more of the following ways:

- Includes them in the R&S plan.
- Allocates R&S resources to the requesting unit.
- Forwards the request to higher headquarters, indicating approval.

The BICC coordinates the R&S plan within the brigade or battalion staff with subordinate and supporting units, and higher headquarters. Coordination objectives are as follows:

- Ensure that the plan identifies and meets all R&S requirements.
- Avoid duplication of effort and to consolidate missions, when practical.
- Avoid conflicts with other combat activities.

- Identify and task R&S resources and ensure that R&S missions are compatible with other assigned missions.

When time permits, the BICC coordinates the R&S plan through informal and formal means, including briefings, personal contacts, and liaison visits. The BICC uses several methods to disseminate orders and requests for R&S support. These include, but are not limited to—

- OPOORDs.
- R&S plans as part of or separate from the OPOORD.
- SCARFs.

Battalion plans are generally informal, while the brigade plan is more formalized. As the plans move vertically, the BICC reviews them to ensure there is no gap in the R&S scheme. It satisfies any gaps with assigned resources. If this is not possible, it requests assistance from higher headquarters. A formal R&S plan follows the format of a five-paragraph OPLAN/OPOORD with appropriate overlays. (See Appendix E.)

Aerial surveillance is vital to the R&S program, particularly at brigade level and above. The OV1-D Mohawk, with SLAR, infrared, and aerial photography capabilities, represents the primary Army surveillance system available to the tactical commander. The supporting Air Force tactical air reconnaissance squadron satisfies aerial R&S requirements that exceed the capabilities of Army aircraft. There are two types of aerial surveillance and reconnaissance requests: Preplanned and immediate.

The brigade or battalion S2 submits preplanned requests for aerial surveillance through intelligence channels to division. They are submitted for anticipated requirements for reconnaissance support. The approval or disapproval of each request is contingent upon the following questions:

- Is the request valid?
- Can the requesting unit satisfy the requirement with organic or supporting resources?
- Can the request be satisfied in time?
- Is the requested information or intelligence already available?

- Can it be included in missions which are in progress?
- Can it be satisfied by missions previously requested and planned at the reviewer's level?
- Are air assets available at the reviewer's echelon which can accomplish the mission?

Actions taken upon completion of this review include—

- Disapprove the request and return it to the requestor with the reason for disapproval.
- Approve the request and task assets at the local echelon.
- Approve the request and pass it on to the next higher headquarters.

Immediate requests, by virtue of their urgency, are sent by a different communications channel. The USAF maintains a system from battalion to corps to provide liaison, rapid communications, and control for both close air support and air reconnaissance. A TACP, equipped and staffed by the Air Force, is assigned to each Army echelon from battalion to corps and has direct radio contact with all echelons. (It should be noted here that TACP radios are not usually compatible with those of the supported unit.) The immediate request is delivered to the TACP, which transmits it directly to the air support operations center (ASOC) at corps. The TACPs at intermediate command echelons monitor immediate requests,

and notify their Army counterparts. Approval at each echelon is signified by remaining silent on the air request net. If a higher echelon decides to disapprove the request or to accomplish the mission with organic assets, then that echelon enters the air request net and notifies the originating TACP of its decision. If all echelons approve the request by maintaining silence, the corps ASOC forwards it to the TACC.

Each echelon of command has a time limit (established by SOP) within which to disapprove a request.

In addition to the preplanned and immediate requests, the brigade or battalion S2 may request intelligence imagery reports (IIRs) on missions already flown that may have information they can use.

The following illustration shows the procedures for requesting tactical air reconnaissance support. As shown, the S2 and tactical surveillance officer at each level are responsible for the request, and must assume responsibility for satisfying valid requests they disapprove. See TC 34-50 for further explanation of R&S.

#### **OPERATION ORDER/OPERATION PLAN**

The preparation of an OPORD/OPLAN is an essential element in preparing for IEW operations. Upon determination of intelligence tasking requirements, the brigade or battalion staff will prepare an intelligence estimate and annex to support the OPORD or OPLAN which is used for initial tasking.

An operation order gives subordinate commanders the essential information needed to carry out an operation. This includes the situation, mission, assignment of tasks, and support and assistance to be provided. When an operation is to be conducted immediately, the complete order is prepared, based on the commander's announced decision and concept. When an operation is to be conducted at some future time, the OPORD may be an OPLAN that will be implemented by appropriate instructions. A new order is prepared whenever a significant change in the mission occurs or a new mission is received.



An OPORD should include only the details that are necessary to enable commanders of subordinate units to issue their own orders, and to ensure coordination.

The brigade or battalion S3 has the primary responsibility of preparing the OPORD in accordance with the commander's guidance.

When preparing the OPORD/OPLAN, the S2 must read and review the higher

headquarters intelligence estimate and annex before writing his own. Essentially, the battalion or brigade S2 is scaling down the higher headquarters annex or estimate to fit the needs of his echelon. The generated annexes and estimates should provide more specific information about the enemy and AO as it affects the battalion or brigade. Formats for the intelligence annex and estimate, and the analysis of the AO can be found in Appendix A.

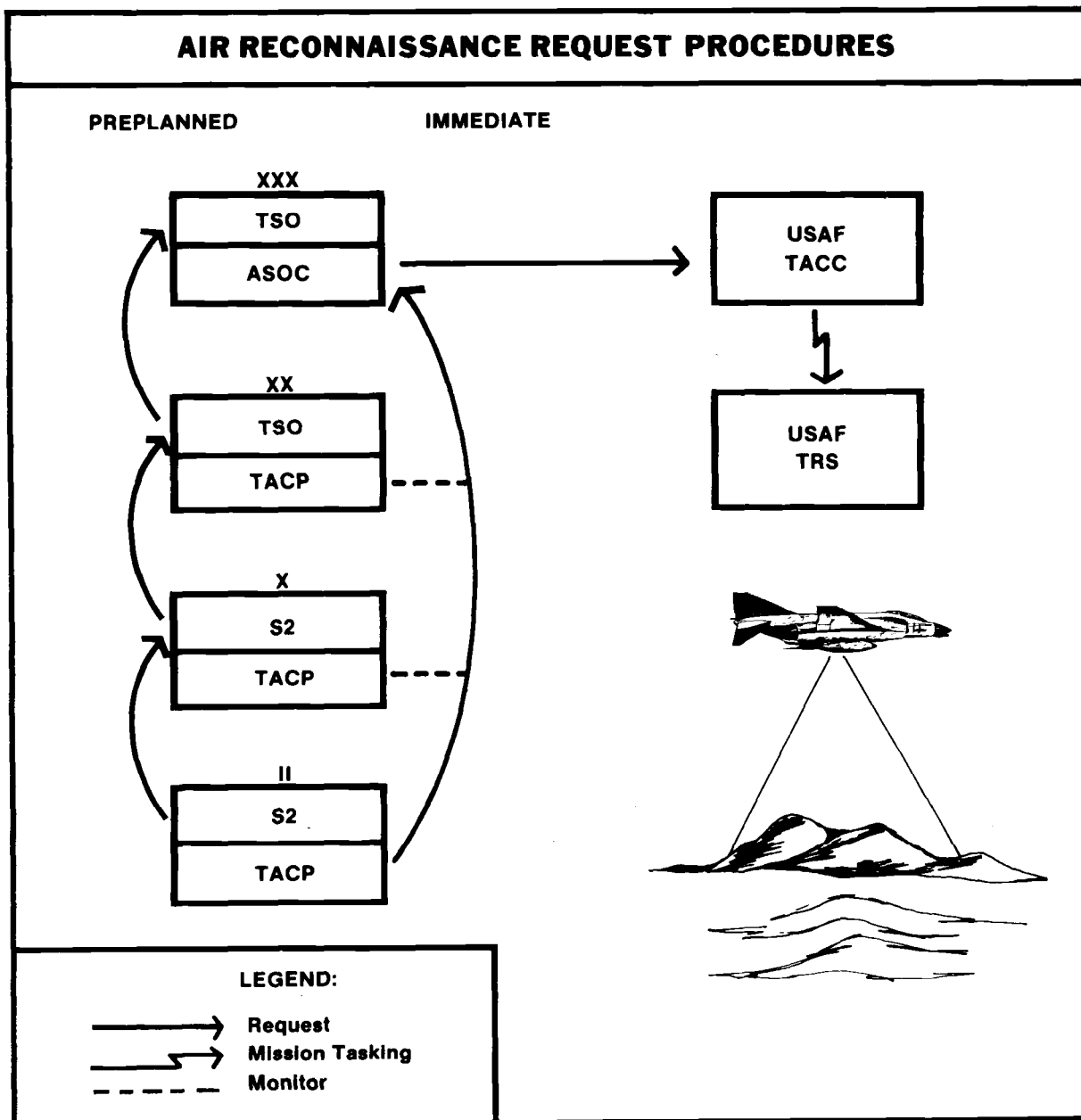

## CHAPTER 5

### Combat Operations

IEW resources contribute to, and are essential to, the combat power of the brigade and battalion in offensive and defensive operations, and during retrograde and other tactical situations. Leaders at all levels of command must know how to increase the effectiveness of IEW systems and resources in support of the maneuver commander's combat operations and, at the same time, reduce the vulnerability of their units to enemy intelligence and combat activities.

The low density of IEW resources and the independent and decentralized nature of MI operations require that leaders exercise a high degree of competence, initiative, and innovative thought to accomplish the commander's mission requirements in the brigade and battalion areas of operations and interest.

Divisional MI assets should be task organized according to the situation, type of combat operation, and METT-T factors. This will result in the formation of IEW company teams which may be in GS to divisions or placed in DS to brigades depending on METT-T criteria. All IEW elements, including corps augmentation assets supporting the brigade and battalion operations, are normally attached to the company team when such teams are formed. (See Chapter 4).

This chapter will discuss how to employ IEW resources during combat operations to best achieve the commander's requirements and intent.

Although there is a difference between the light and heavy division's IEW resources, they respond to the commander's requirements similarly. Where there is a significant difference, it will be noted.

#### PREHOSTILITY PHASE

IEW support to the combat force in the field during the prehostility phase begins with the OPORD tasking division RSTA assets and the MI battalion (CEWI) with the mission of collecting information on enemy force profiles. This action will prove

or disprove estimates and enemy intentions hypothesized during predeployment analysis and planning phases. The majority of MI battalion IEW assets will deploy into the various brigade and battalion AOs, but remain tasked in GS of the division. This GS role is necessary for centralized C<sup>2</sup> needed to accomplish the mission. (See, Chapter 3.) GSR and REMS teams, however, may at this time be attached to the forward brigades or the covering force, if the latter is organized. GSRs and REMS may be further attached to battalions for individual surveillance missions or for attachment to scout platoons. The missions of the MI battalion's IEW assets are continuously changed and updated by various tasking messages and fragmentary orders. It is during these times, and especially upon the outbreak of hostilities, that certain IEW assets may become DS to the brigade in whose area they are operating.

#### DEPLOYMENT OF ASSETS

Once the mission has been received, the next task is to deploy the assets in areas where they can accomplish the mission. The deployment of, and site selection for, IEW assets demands close and continuous coordination between MI units and the brigade or battalion in whose AO they may be located. The deployment of IEW assets and site selection are critical tasks for leaders of MI units operating in the brigade and battalion AOs. Normally, the staff of the headquarters that exercises operational control of an MI element selects the general deployment areas for SIGINT and EW systems based on the recommendations of the supporting EW unit commander. For example, if the covering force commander exercises OPCON of an EW platoon that is employed in the covering force area, it will designate general deployment areas for SIGINT and EW systems based on the recommendations of the platoon leader. The brigade or battalion commander or S2 selects general employment areas for GSR elements that are attached. The controlling

commander may, however, delegate employment area selection to a subordinate commander. For example, the battalion may delegate this authority to a maneuver company commander, particularly if the GSR team(s) will support the company.

Normally, MI platoon leaders select the general operational site locations for their systems after coordination with the supported maneuver unit.

The MI squad or team leader normally selects the specific operational site.

Operational site selection requires coordination with the supported unit commander or staff and with the commander and staff of the maneuver unit in whose AO the system is to be deployed.

MI unit leaders and maneuver unit commanders and staff must establish and maintain close and continuous coordination to ensure effective MI support. Direct coordination begins between the MI battalion and brigade, and is continued at every echelon where MI units support or operate in the AO of maneuver units. It may go as low as MI teams and maneuver platoons. Although MI unit commanders and leaders coordinate with maneuver unit commanders, staffs, and leaders on a variety of mutual concerns, the following are common items for coordination:

- MI support missions and how they are to be integrated with and support the maneuver commanders' schemes of fire and maneuver.
- Times and routes for deploying MI units within the brigade AO.
- Operational areas and sites.
- Security.
- Coordinating and communicating procedures.
- Final coordination of prearranged CSS requirements.

The MI battalion tactical operations center initiates coordination with the brigade prior to the deployment of MI assets in the brigade AO. If an IEW company team is operating in the brigade AO, it coordinates through the team commander and his attached brigade IEW support element. Dur-

ing the initial coordination, the following factors are coordinated:

- Designation, type, and mission of the deploying MI unit.
- Time of deployment and route the unit will use to deploy.
- General operational area and operational site requirements.
- CSS requirements.
- Arrangements for direct coordination between the MI unit and the appropriate subordinate MI unit.
- Exchange of radio frequencies and call signs.

The MI battalion C-E officer coordinates with the division signal officer for call signs and frequencies that MI units need to coordinate with the brigade and its subordinate units.

Upon initial deployment of the IEW company team to the brigade AO, the company team facilitates the coordination. If time permits, the company team commander and the MI platoon leaders conduct a ground reconnaissance and personal coordination with the brigade staff and subordinate unit commanders and staff prior to deploying the company team.

After the IEW company team deploys, the team commander facilitates coordination between MI and brigade units. The MI battalion notifies the team commander when it plans to deploy an MI unit in the brigade AO. The commander ensures that the brigade IEW support element coordinates this deployment with the brigade staff. The brigade S3 notifies the battalion in whose area the MI unit will deploy over the brigade operations net. The battalion, in turn, notifies the maneuver company through the battalion command operations net.

The commander or leader of the deploying MI unit contacts the IEW company team commander when he gets within communications range. The team commander gives the MI leader instructions for establishing radio and physical contact with the maneuver commander or staff.

MI elements such as GSR and CI teams who are attached or DS to the brigade,

operate in the brigade intelligence net. If they are further attached or placed in DS of a battalion or maneuver company team, the MI element operates the battalion surveillance or company operations net of the unit it supports.

Detailed and continuous coordination with maneuver units is especially critical for GS MI units. Maneuver units tend to forget GS units that are operating in the AO—often forgetting to notify them when they displace to new locations. The IEW team commander makes arrangements for the MI unit and the appropriate maneuver commander to initiate coordination. The MI unit leader and maneuver unit commander or staff officer coordinate the following issues:

- Security.
- Operational sites.
- Deployment and displacement routes.
- CSS.
- Coordination and communications procedures.

While the maneuver unit may or may not be assigned a mission to specifically secure an MI operational site, the MI unit does enjoy some degree of security by locating near a maneuver unit. The MI unit leader and maneuver unit commander should establish definitive procedures that ensure the security of the MI unit.

Reliable communications should be established between the two units. Most MI platoons and teams do not have sufficient radios to remain in the maneuver unit's communications net; however, both units should exchange radio frequencies, call signs, and other appropriate CEOI to ensure immediate access to each other's communications net. The MI unit should hook into the maneuver unit's wire system if they are within a reasonable distance of their CP.

Both parties to this coordination must carry out the procedures that they agree on. For example, if the maneuver unit commander agrees to notify the MI unit when it displaces, he must do it in sufficient time for the MI unit to displace—especially if the maneuver unit withdraws because of enemy

pressure. On the other hand, the MI unit must pass directly to the unit any perishable combat information that the maneuver unit needs.

The MI unit leader must coordinate the mission with the supported unit. He coordinates with the maneuver unit commander who controls the AO to ensure that there will be no undue interference between MI and other units that may need the site or are operating nearby.

Most MI systems need LOS to operate effectively. The need for high ground for operational sites usually exceeds its availability. The maneuver unit commander or leader operating in the AO resolves conflicting requirements for the high ground. The MI unit commander must coordinate with the maneuver unit commander for his operational sites. He must inform the maneuver unit commander of how MI elements can support him from various sites and the relative impact of the terrain on the effectiveness of MI systems in various potential sites.

There are three basic types of operational sites. The primary site is the principal position from which the MI team will accomplish the assigned mission. An alternate position is another position where the same target area can be covered. The supplementary position is used to cover a different target area. The following schematic below illustrates these positions.

All operational sites should—

- Permit coverage of the assigned area.
- Provide cover and concealment for the team, vehicles, and operational equipment.
- Facilitate communications and permit coordination with other MI and supported elements.
- Provide good ingress and egress.
- Take advantage of security provided by maneuver elements.
- Provide LOS to the target area. Be relatively free of ground clutter.

MI leaders should perform ground reconnaissance to select operational sites when

time permits. During the reconnaissance operation they—

- Select routes to the AO.
- Identify and coordinate with friendly units in the area.
- Determine status of security.

MI squad and team leaders plan the organization and occupation of an operational site in detail. They should make detailed sketches to include—

- Primary, alternate, and supplementary positions.
- Exact positions of equipment and antennas at each site.
- Entry and withdrawal routes, and routes between positions.
- Directions and distances to threat forces.
- Location of friendly forces.
- Friendly minefield and planned barriers.

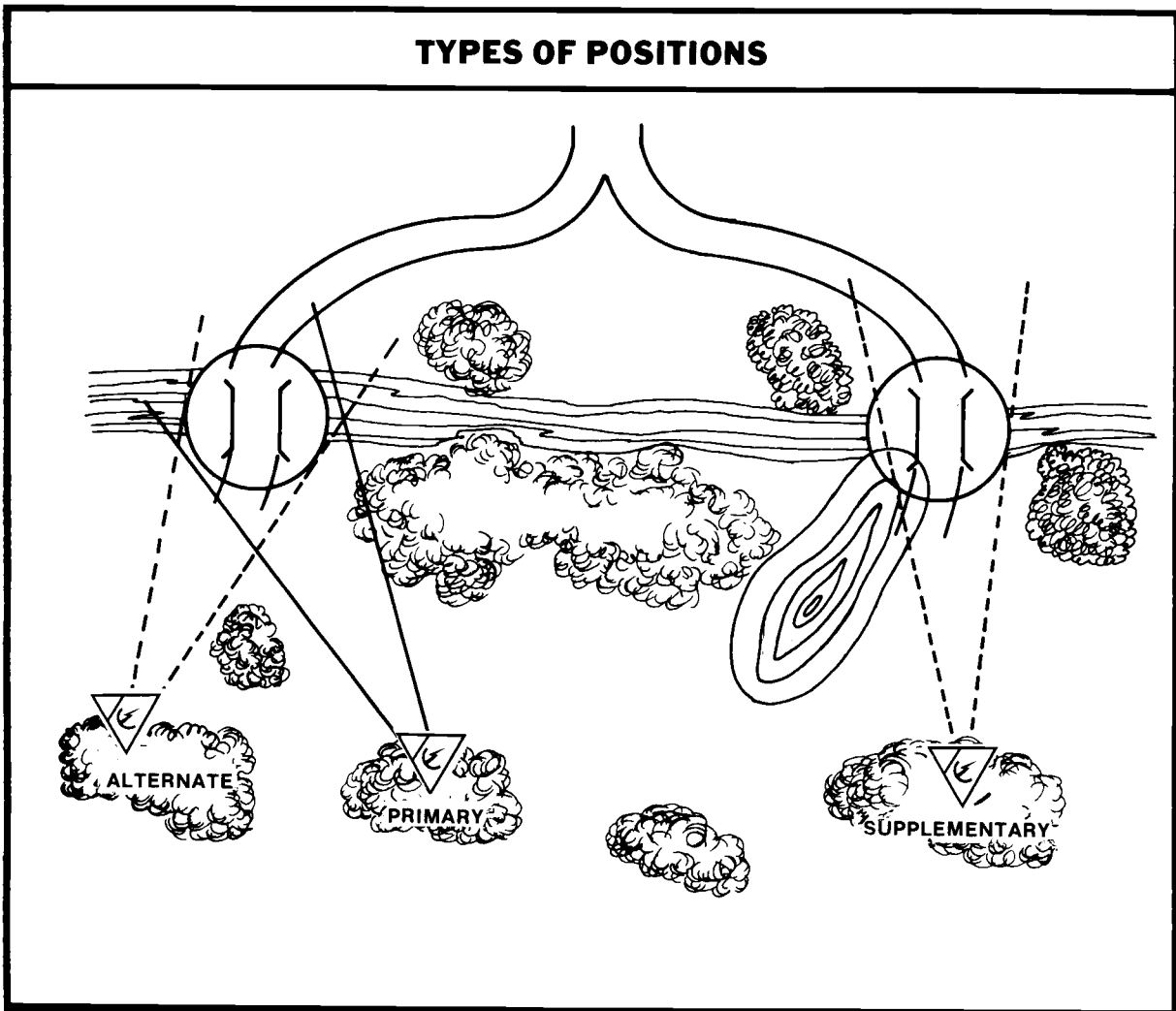

A typical organization of an operational site is illustrated below.

The EW platoon establishes a platoon headquarters in the brigade area from which the platoon leader directs and controls operations of subordinate elements. The T&A team is also located here. This enables the T&A team to disseminate combat information rapidly to the brigade S2.

The MI battalion provides an IEWSE to each brigade. The IEWSE operates from within the brigade TOC. It is the link

between the MI battalion TOC and the brigade TOC. The primary purpose of the IEWSE is to coordinate operations in support of the brigade. Working with the brigade S2 and S3, the IEWSE helps plan EW operations in support of the brigade. It also coordinates MI unit and team occupation and movement with the brigade AO on behalf of the company team commander, reviews possible combat information from MI units in the sector, and rapidly introduces it into the brigade intelligence system.

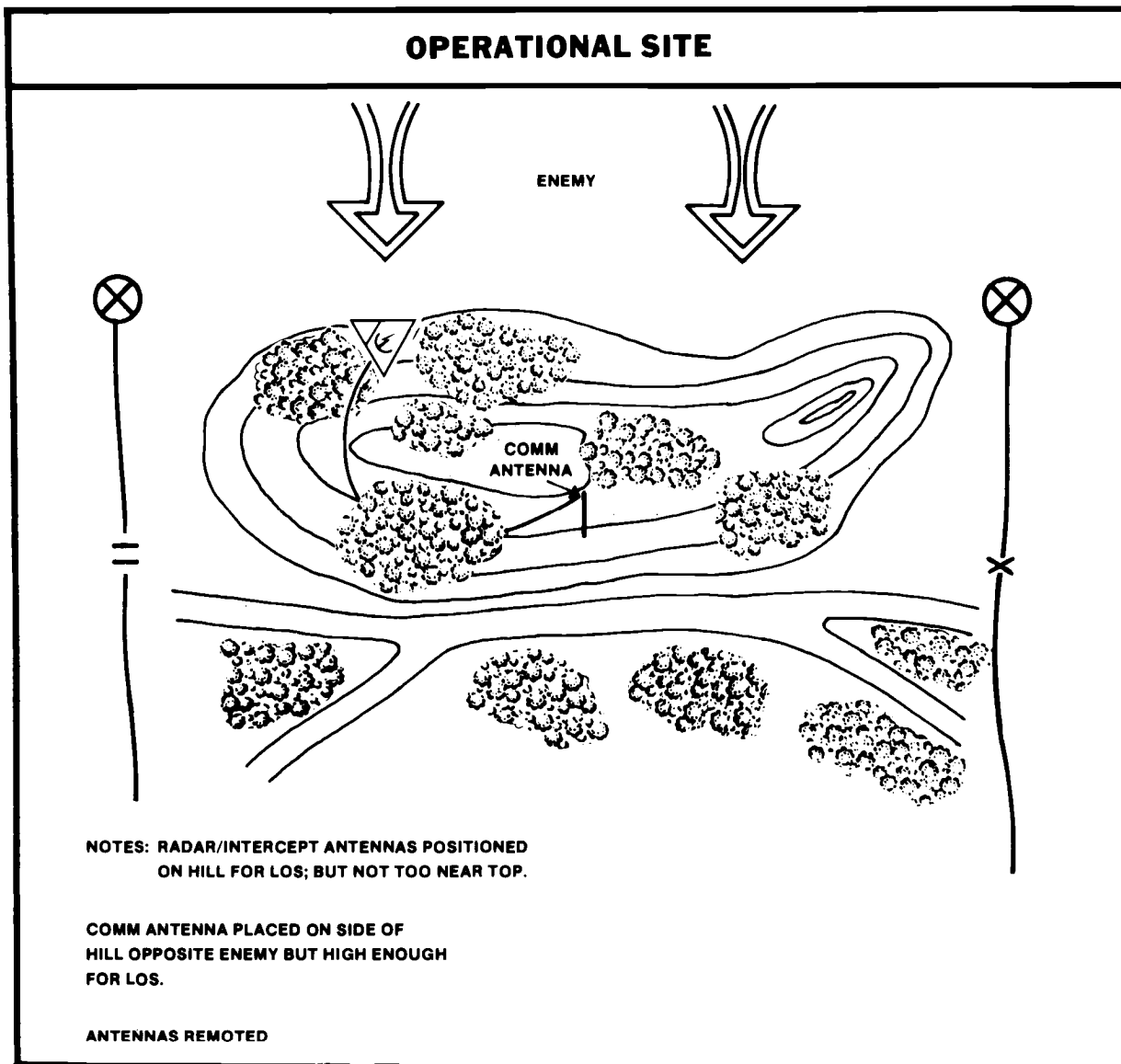

## Interrogation Assets

When EPW interrogation assets are desired, the brigade's S2 identifies brigade requirements during collection planning. He requests interrogation assets through intelligence channels. He coordinates the deployment of the team through the IEWSE.

The team deploys to, and operates at, the EPW collection point, which is normally located near the brigade trains. The actual point on the ground where the interrogation team deploys is determined by the brigade S2 in coordination with the brigade S4 and brigade trains commander. The interrogation team, upon deployment to the brigade, coordinates with the brigade S2, through the IEW support element. The S2 briefs the team concerning—

- Brigade mission and the commander's concept of the operation.
- PIR/IR.
- Communications and reporting procedures.
- Contacts with the S4 to coordinate logistic support.
- Coordination with the S1 and MP platoon leader regarding procedures for securing and moving EPW.

Although many of the IEW assets have common requirements for coordination and site selection, the EW, GSR, REMS, and other elements have peculiar needs that must be met.

## Electronic Warfare Assets

As noted in Chapter 2, most ground-based EW assets at ECB must be deployed in the brigade and battalion AO to be most effective. ESM equipment must be deployed in a manner to allow overlapping areas of intercept coverage. This not only ensures coverage of the area forward of the FLOT but also allows targets in the overlapping areas to be handed from one asset to the other. ECM sites selected along the FLOT should be located in such a way as to facilitate electronic massing of several jammers against single targets. ESM and ECM sites have common requirements that must be

met if the equipment is to do its job. These requirements include—

- Must be located within range of targeted receivers and transmitters.
- Must ensure that the receiving antenna is positioned to intercept the arriving signal.
- Must be located near its supporting elements.

Positioning the intercept antenna is the most important factor to take into consideration when selecting EW sites. Without acquiring the target signal, intercept and jamming missions cannot be accomplished. Wide variations in the signal strength may exist within relatively small areas. When hearability problems occur, try the antenna at several heights, orientations, and locations in the vicinity of the site. Trial and error is the accepted technique to obtain maximum reception. A detailed study of the surrounding terrain should be used to check a site location with respect to the location of the target area. Hills and mountains between the intercept antenna and the enemy emitter will limit the quality of intercept. An illustration of an EW site is on the following page.

In mountainous terrain, selected antenna positions should be relatively high on the slopes or, when possible, removed to the forward slopes. Locations at the base of a cliff or in a deep ravine or valley must be avoided. For operations above the HF range, a location that will give LOS reception should be selected. In mountainous terrain, the objective is to get the antenna as high as possible.

Trees near the antenna system offer advantages and disadvantages. Foliage can be used to camouflage the antenna system. It also can be used to mask the antenna system from unwanted signals. However, trees with heavy foliage absorb radio waves. Leafy trees have more of an adverse effect than evergreens. Foliage should not be positioned between the antenna elements and the target signals, and it should never touch the elements of the antenna. Intercept antennas should extend above the surface of the vegetation level when "looking" at the target transmitter. The antenna can be

## ELECTRONIC WARFARE SITE



“masked” from unwanted signals if the foliage behind and to each side of it extends higher than the antenna. This is illustrated on the following page.

Man-made objects near an intercept site can reduce the quality of the target signal. Buildings located between radio intercept stations and their targets, especially if they are of steel or reinforced concrete, will hinder reception. Every attempt should be made to position the intercept antenna as far from man-made objects as possible. But, in a tactical situation, it is not always possible to follow the recommended standards. The rule to follow in this case is “as far as possible.”

Wire lines, such as telephone, telegraph, and high-tension power lines should be avoided when selecting a site for intercept. These wire lines absorb an incoming signal like a receiving antenna, and introduce distortion, hum, and noise into the receiving antenna. Some distortion of the arriving waveform may be acceptable if the site is for intercept operations only. But other systems, such as direction finding, must be free from outside influences. Positions adjacent to heavily traveled roads and highways

should be avoided. In addition to the noise and confusion caused by vehicles, their ignition systems may cause electrical interference. Copying weak signals requires a great deal of concentration by the intercept operator. His attention should not be diverted by extraneous noises. Heavy traffic areas also are prime targets for air and artillery attacks.

Friendly transmitters can also interfere with intercept. Communications nets and DF flash and report nets are examples.

Terrain-masking techniques can be used to isolate receiving antennas from transmitting antennas as shown on page 5-7.

If practical, communications antennas should be positioned so a hill mass screens them from intercept antennas and from the enemy. This will cause a minimum of interference to intercept antennas and will decrease the enemy's ability to locate the site with direction finding. Coordination between intercept and communications equipment should be accomplished by field phones or runner, not by radio. Generators should be placed away from intercept equipment to reduce noise and electronic interference.



**ANTENNA MASKING**

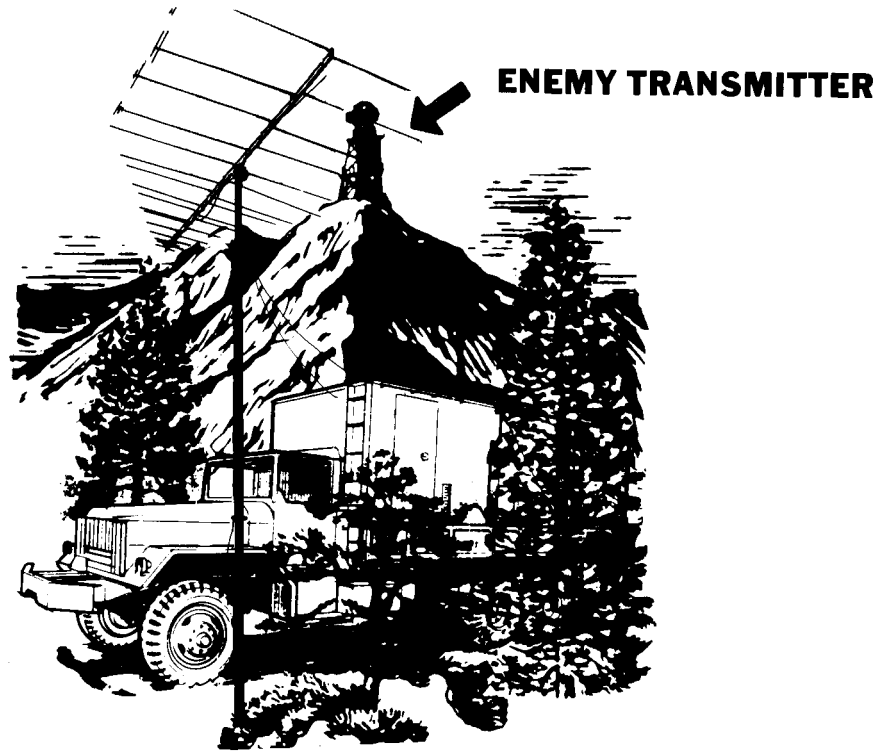

**TERRAIN MASKING**

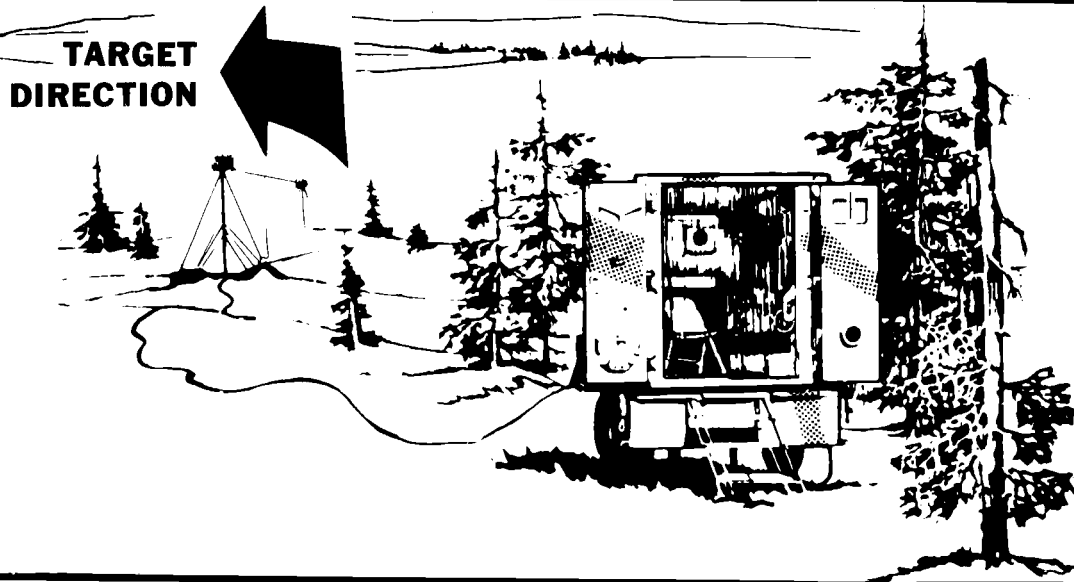

## Ground Surveillance Radar Assets

The surveillance platoon leader moves the platoon to the brigade AO, either independently or as part of the IEW company team. Upon arrival at the brigade CP, he coordinates with the brigade IEWSE or company team commander, giving him a status report on the platoon. If the platoon is attached to the brigade, control passes to the brigade commander, who normally delegates operational control to the S2.

The brigade or battalion S2, or a maneuver team commander, initially briefs the GSR teams. The briefing, as a minimum, includes—

- Surveillance mission.
  - General site location, area of surveillance, type of surveillance to be conducted, specific targets, the frequency of coverage, and how, when, and to whom information is to be reported.
  - Friendly situation, including the unit mission, the tactical plan, location of unit elements in relation to each other, the activities and operations of adjacent units and patrols, and when and where friendly units are expected to move through the surveillance area.
  - Terrain characteristics and terrain analyses, which highlight mobility corridors, intervisibility, terrain masking, and trafficability conditions. This information is used by the supported unit's S2 and the GSR teams in selecting primary, alternate, and future operating sites.
  - Enemy situation, including the types of targets expected, and the location and direction of expected enemy movement.
  - Prevailing or forecast weather that might affect the interpretation of signals.
  - Procedures for coordinating with the friendly units, to include radio frequencies, call signs, and other CEOI.
  - Covered and concealed routes into the site, and routes between sites.
- OPSEC procedures, to include the sign and countersign, noise and light discipline, and other OPSEC procedures.

Following the S2's briefing, the team leaders move their teams to the general site location. They perform the following tasks to prepare to accomplish the surveillance mission:

- Reconnoiter the general site.
- Select specific sites, to include primary, alternate, and supplementary positions.
- Coordinate position selection with adjacent companies and platoons.
- Prepare positions, to include fortification, cover, and concealment for primary and alternate sites.
- Enter designated radio nets and the wire communications system, when so directed.
- Forward specific locations of radar and area of radar coverage (left and right) limits to the supported element by the fastest, most secure means.
- Prepare radar surveillance overlays and submit copies for each position to the supported commander or S2. A supported company commander forwards one copy to the battalion S2.

The surveillance platoon leader, even though losing some degree of OPCON of platoon assets through attachment, supervises the initial deployment of platoon assets to the operational area. He monitors the operations of his units to ensure that they effectively accomplish their assigned mission. He coordinates with the brigade and battalion commanders and their staffs, and with company team commanders and platoon leaders to advise them on how GSRs can be effectively used to support their operation and to ensure that his units are provided the support and security they need in order to operate. He also takes care of administrative and leadership problems and keeps the IEW team commander apprised of the status of platoon assets.

When the GSR teams are attached to a maneuver company team or platoon, the company commander or platoon leader

deploys and tasks the team. Even if the GSR team is only operating within a maneuver unit's AO, it coordinates with the unit commander or leader. The GSR team leader and maneuver unit commander should coordinate—

- Local friendly and enemy situations.
- Procedures for reporting combat information. Even if the GSR team is instructed to report information it collects to someone other than the local combat maneuver unit, it should report combat information, particularly early warning of enemy movement and targets to the local unit commander.
- Communications frequencies, call signs, and procedures. The GSR team should tie into the company or platoon wire line, if there is one in the area. Arrangements should be made for mutual support in relaying messages under poor communications conditions.
- Security. The GSR team should select a site near a maneuver unit for greater security. The team that must be overly concerned about its own security will be less effective. Procedures for notifying the team, in case the maneuver unit displaces, must also be coordinated.
- CSS requirements. The team leader and unit commander coordinate these requirements, particularly how the maneuver unit will provide food service, fuel, and ammunition.

The GSR team should be totally integrated with the supported unit. Integration means that the team responds to the requirements and orders of the supported unit commander. In turn, the supported unit provides security and other support that the team needs. A habitual relationship between a GSR team and a supported unit enhances the effectiveness of this integration.

The general GSR site is normally selected through the use of map reconnaissance; however, the GSR team leader conducts a detailed ground reconnaissance to select the specific operational site. The sup-

ported unit commander or S2 will decide the general site location for the attached AN/PPS-5 and AN/PPS-15 radars. This general site location depends on the mission. The GSR squad or team leader selects the specific site location.

To take advantage of the maximum range of the GSR, it should be sited as far forward as necessary to support the mission. It is normally positioned on the forward slopes of dominating terrain. Frequently, GSRs are located with or near OPs. However, personnel of the GSR team should not be used to man the OP. The GSR and OP observers must mutually support each other. Since the enemy can detect radar signals, GSRs should not be located near troops or key installations.

Once the radar squad or team leader has selected a site and the GSR is emplaced, the supported commander should check the site. The site should provide the same common features as described earlier.

The most important feature of an operational site is the capability to support the accomplishment of the surveillance mission.

The site selected should use the terrain to increase ELSEC and ECCM protection. Hills, embankments, trees, and other terrain features are used to absorb side lobes. The following illustration shows the advantageous use of terrain for a GSR site.

Terrain, such as hilltops, is used to avoid transmitting to enemy intercept sites. Although LOS to the target is required, terrain features, such as hilltops, are not used as GSR sites.

If the terrain cannot be used effectively to block the radar signal, a low power signal can be used to limit its range.

A soft target background, such as heavily wooded terrain, will help absorb the radar signal. A hard background, such as rock terrain or buildings, scatters and reduces the signal, thus limiting the enemy's capability to detect the signal and locate the radar.

In addition to the primary site, the team leader selects alternate and supplementary

# ADVANTAGEOUS USE OF TERRAIN FOR A GSR SITE

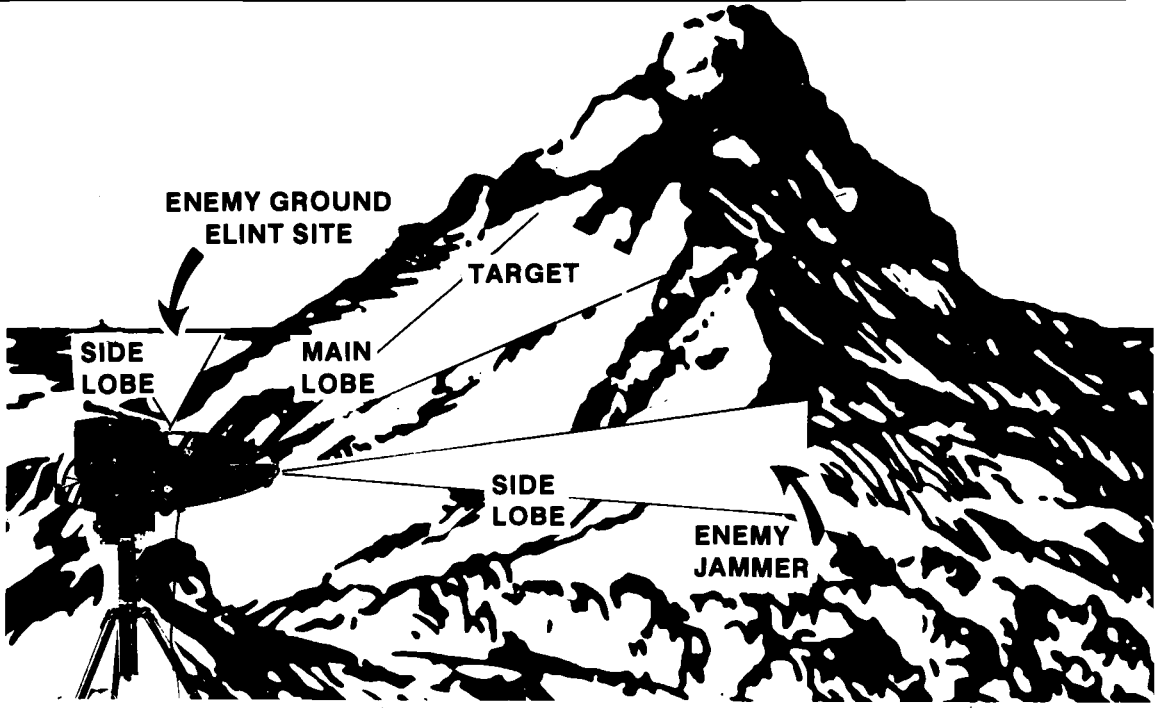

# RADAR SITE SELECTION

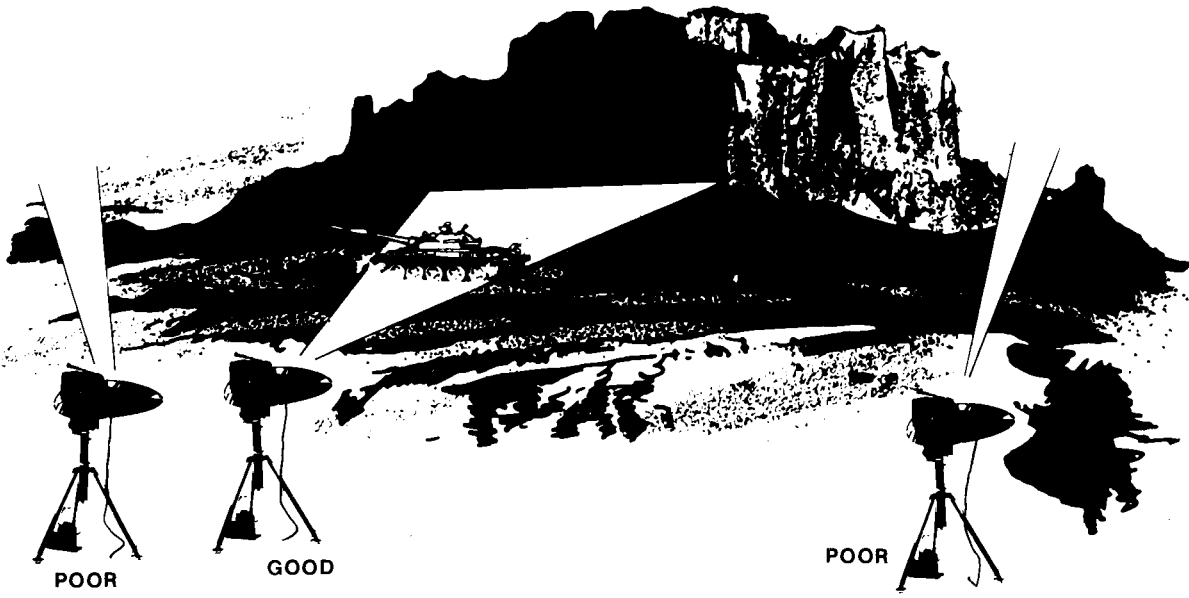

positions. He must use the same care in selecting these positions as he did in selecting the primary position. The illustration on the following page shows primary and alternate positions which cover a road junction and a supplementary position which covers a bridge.

The operational site must provide cover and concealment for the GSR team and LOS to the target. Therefore, the team must effectively use the available terrain and improve the site.

Cover and concealment are best obtained through the construction of field fortifications. The type and extent of fortifications depend on the mission and the time available. A hasty position is prepared when time is limited. It uses the natural terrain more for protection of the team. A deliberate position is well fortified and camouflaged. It may be completed in 3 to 4 hours. Most deliberate positions begin as hasty positions which have been improved in time.

The team prepares its position in the following stages:

- Site radar and clear surveillance area.
- Initiate camouflage and concealment.
- Prepare operator protective and fighting positions.
- Improve position.

Initially, the team emplaces the radar and clears the surveillance area. It emplaces the radar where it can best cover the target area, yet provides an acceptable degree of concealment and cover from enemy fire. It clears a surveillance area in front of each GSR. Clearing operations follow these principles:

- Clearing should not be excessive or it will disclose the radar position.
- Clearing should start at the GSR position and work forward as far as required.
- A thin natural screen of vegetation should be left to hide the GSR position.

Clearing a surveillance area is very similar to clearing a field of fire in front of weapons systems. FM 5-15 describes the procedure for clearing fields of fire.

In a hasty position, the initial emphasis is on concealment from enemy observation. The radar must be sited in a camouflaged position which will allow you to cover your assigned area.

A position with the GSR remoted is shown in the illustration on the following page.

Soon after occupying a new operational site, the GSR team develops a surveillance card. The team chief or senior operator prepares a card for the primary, alternate, and supplementary radar positions. The card is maintained at the GSR site and transferred to a new GSR unit when the team is relieved in place. Copies of the card are forwarded to the commander of the supported unit and to the BTF or brigade S2. Appendix C describes how to prepare a surveillance card.

### **Remotely Employed Sensor Assets**

REMS provide an additional source of information for the ground commander. Sensors can be used either alone or to complement or supplement other information gathering sources, such as ground surveillance radars. REMS provide information for the production of intelligence and timely, accurate target-acquisition data.

Deployment of remote sensors is similar to that of the GSR, with one major exception: Remote sensors are not as flexible as GSRs. Once employed, they may not be accessible for recovery. Because of recovery problems, additional sensors must be issued before new missions can be assigned. Sensors may be recovered during offensive operations as friendly forces advance. However, additional sensors usually are required for employment ahead of attacking forces.

Remote sensors may be effectively employed for many operational tasks—alone or with other surveillance assets. For optimum potential to be achieved, sensors must be fully integrated into the overall surveillance plan in the early planning stages. Sensor employment is planned by the type, number, location, and layout of sensors on the ground. Sensors are emplaced by hand, aircraft, or artillery, depending on the tactical situation.

## TYPES OF POSITION

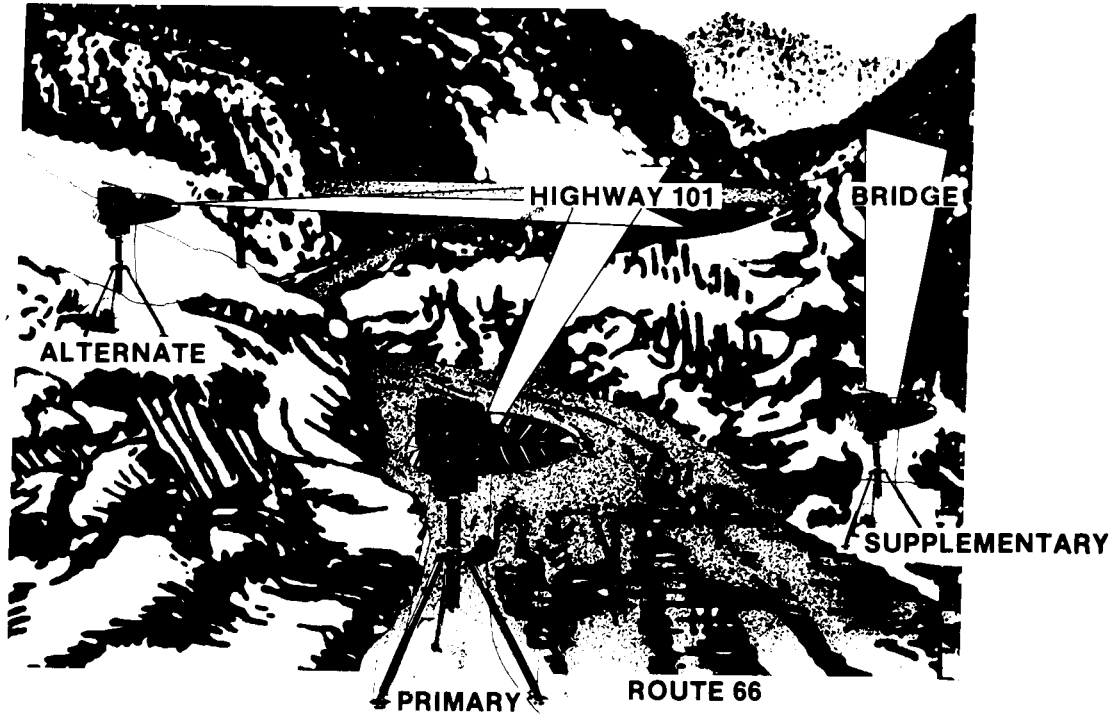

## REMOTE OPERATIONS

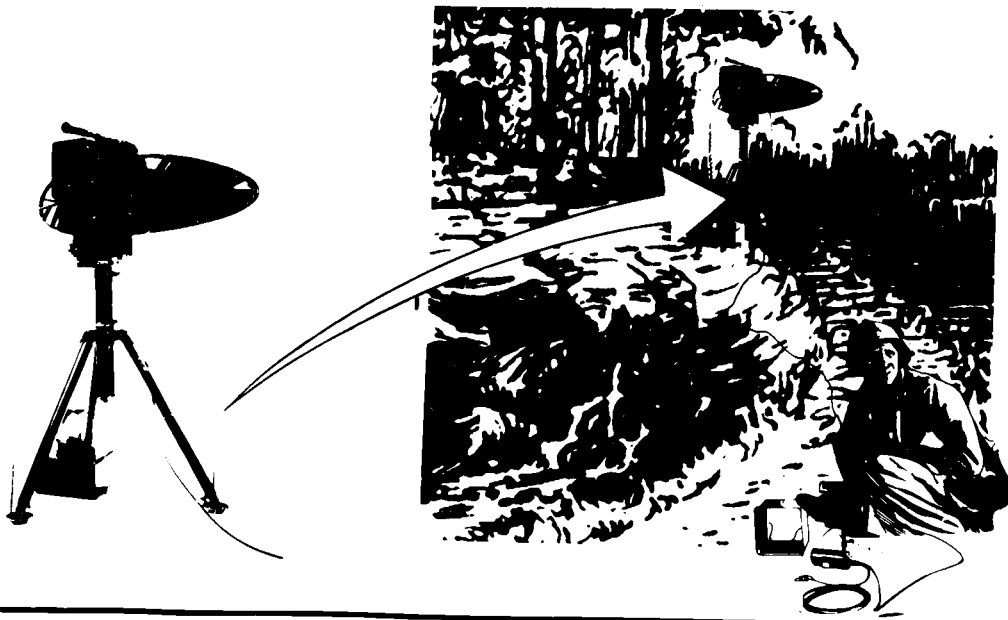

The major advantages of remote sensors are—

- Timeliness. The information is near real time and therefore may provide enough to effect an immediate response or target acquisition capability by the supported command.
- All-weather use. This is possible, provided that the sensor data is interpreted so as to account for changes in the environment.
- Full-time operation without regard to visibility or fatigue.

Battlefield expendability will result in sensors being able to be employed in high-risk environments. Implant areas may be attacked by supporting arms with a high probability of the sensors being undamaged.

Sensors may be hand-emplaced by maneuver unit patrols, long-range reconnaissance patrols, long-range surveillance operations, or by sensor teams. The major advantages of hand-emplacement include accurate determination of sensor location, better camouflage, and confirmed detection radius of each sensor. Disadvantages include threat to the implant team, the time factor required to install several strings, and the limited number of sensors that can be carried by the implant team.

Air delivery provides an accurate and quick response to the ground commander's request for support. Air delivery provides access to areas inaccessible to ground elements, speeds emplacement, and increases the number of sensors that can be emplaced during a single mission. Army air assets are limited by enemy air defense measures, the inability to accurately determine sensor detection radius, and adverse weather conditions.

### **TEMPLATING THE BATTLEFIELD**

Successful accomplishment of the mission during the prehostility phase of operations requires that all deployed IEW assets be used to template the battlefield. This is done to produce a description of enemy force disposition on the battlefield in terms of location, size, types, direction, rate of movement, and activity. It helps commanders to

visualize the battlefield—where friendly and enemy forces can move, shoot, and communicate, given the terrain available; the location of critical areas of the battlefield; and the enemy systems that would be most vulnerable to attack. This information, along with weather and terrain data, aids commanders and their staffs in the planning and decision-making process. Data is obtained through tasking, reporting, processing, and dissemination of information obtained from all IEW assets deployed in support of the mission.

### **Tasking**

Following deployment of the MI battalion element, the asset tasking function is altered to facilitate effective control. This modification is required because of communications constraints and support relationships dictated by the tactical situation.

The EW assets of the MI battalion are tasked by the MI battalion S3 or his staff on behalf of the MI battalion commander. The S3 receives mission tasking from the G2, CM&D section. Primary considerations of asset tasking are:

- Mission requirements.
- Tactical situation.
- Asset capabilities.
- Status of available assets.
- Current and planned missions.
- Current deployment of assets under control.
- Flexibility.
- Economy of effort.
- Terrain.
- Weather.

The S3 selects a specified element capable of accomplishing the mission. Mission tasks and pertinent supporting data are then forwarded to the selected element.

The surveillance platoon consists of GSRs and, when augmented, REMS. A surveillance platoon is habitually task organized to support a brigade. The brigade and battalion S2 normally tasks and coordinates the operations of GSR and REMS teams

that are attached to the brigade and BTF. They prescribe the general employment of platoon assets based on the brigade or battalion R&S plan. Teams attached to lower echelons are controlled by maneuver commanders and leaders.

Interrogation assets are assigned to either a GS or DS role. Operating in a GS role, they will receive tasking from the S3 of the MI battalion in response to requirements mission tasking from the CM&D section. The CM&D section consolidates requirements from subordinate brigades and ensures that they are tasked. DS interrogation assets at the brigade EPW collection point receive tasking directly from the brigade S2.

CI and OPSEC support teams remain in GS to the division. They are tasked by the G2 or G3 through the MI battalion tactical operations center to aid maneuver brigades, to help develop or refine friendly forces profiles, and to monitor and evaluate division and brigades' OPSEC program and deception operations.

### **Reporting**

Combat information, to include targeting data resulting from collection resources, is reported immediately to the organization requesting the information or as directed in SOP. Normally the SOP will specify the way targeting data will be passed to the FSE at the supported headquarters. In some cases, targeting data may be transmitted directly to a field artillery battalion or battery fire direction center. The types of information to be reported directly to such units should be specified by the commander or S3 of the supported unit. Other combat information will be reported to a battalion or brigade S2 through the EW platoon headquarters and the IEWSE. All combat information and data requiring analysis is transmitted by the EW platoon headquarters to the MI battalion's TCAE, and is simultaneously monitored by the IEWSE at the brigade TOC for use as combat information supporting combat operations.

### **Processing**

The S2, with the help of the brigade BICC, processes combat information received from the deployed IEW assets to develop intelligence to satisfy brigade and

battalion commanders' PIR and targeting needs. Processing is the systematic analysis used to produce intelligence from information. Combat information is recorded, evaluated (together with data from other sources), and interpreted during processing. These three steps are continuous, but are not necessarily accomplished in any particular order. Recording is necessary for future reference. Depending on the combat situation and the complexity of the information, evaluation and interpretation by BICC personnel may consist of only a rapid mental process. Information received from IEW sources during the prehostility phase is posted on the SITMAP and evaluated and interpreted against doctrinal templates produced before deployment. However, during combat, time and the requirement for the collection and rapid dissemination of combat information limit the amount of processing possible during combat at the brigade and battalion levels.

At the brigade and battalion levels, much of the incoming information is combat information which fire and maneuver elements need immediately. Successful targeting relies on the ability to process information and pass it to a maneuver unit or FSE. The interface between intelligence and FS must be a viable and functioning system.

### **Target Acquisition**

Target acquisition, or obtaining targets for attack by FS weapons, has traditionally been the responsibility of combat units. However, with the introduction of new technology, such as sophisticated detection equipment, it has become necessary to centralize the target acquisition effort at the major unit level, such as with the G2 and S2 at the division and brigade TOC, respectively. Because of the lethality and large number of weapons on the modern battlefield, intelligence from all sources must be used to obtain targets for attack by FS weapons. Intelligence collection assets must look deeper, and "over the hill" for a concealed enemy well before he detects and attacks us.

The success of division and brigade combat operations on the air-land battlefield will greatly depend on this timely detection, classification, and location of ground



targets in sufficient detail to permit the most effective employment of maneuver forces, fire support, and EW weaponry to attack these targets.

The future battlefields foreseen by today's combat commanders entail extreme violence and lethality, combined with rapid, continuous combat maneuvers. For the brigade to win such battles, the commander must be extremely flexible and have foreknowledge of enemy intent. The brigade commander must be able to concentrate combat power at critical times and places, and his ability to do so depends on how well he "sees" these enemy targets on the battlefield. His ability to "see" these targets will depend greatly on the effective employment of available target acquisition assets.

The S2 has staff responsibility for the target acquisition program. He will receive continuous reports from his IEW collection assets on which targets, or potential targets, are located on the battlefield. The S2 is required to identify HPT from these reports and pass them to the S3 and FSO for engagement.

Target acquisition is that part of combat intelligence which pertains to detection, identification, classification, and location of a target (any enemy activity) in sufficient detail to permit the effective employment of weapons. Target acquisition elements of the field artillery are specifically organized, trained, and equipped to accomplish the target acquisition mission. Target acquisition elements of the field artillery, as discussed in Chapter 2, have specialized equipment and trained aerial and ground observers to target enemy units—especially enemy artillery units and front line formations. As targets are acquired, they are reported either to the FS coordinator at the maneuver unit TOC or to the artillery FDC for immediate use. The two methods of target acquisition are **direct** and **indirect**.

Direct target acquisition is accomplished by **one** intelligence collection means. For example, an artillery FO observes enemy activity (a target) and calls for a fire mission. The fire direction center immediately brings artillery fire onto that target and neutralizes it.

Traditionally, direct target acquisition has been thought to be accomplished by only those collectors designed specifically for the purpose of **direct**—only target acquisition. Some of these collectors include—

- Forward observers.
- Observation posts.
- Aerial observers.
- Radars (weapons-locating radar (WLR) and MTLR).

However, direct target acquisition can be accomplished by other means. These other means may include combat units, GSR, night vision devices, searchlights, aerial surveillance assets, SIGINT elements, and remote sensors. Their primary mission is **not** direct target acquisition, but they play an extremely important part in direct target acquisition in support of current tactical operations.

Direct target acquisition may also be used to assess target damage after engagement by FS weapons.

This assessment, furnished to intelligence channels, updates the intelligence data base, influences collection and operational planning activities, and appropriately modifies the target acquisition process.

Indirect target acquisition is that target data which is developed from the evaluation of intelligence information supplied by two or more means.

Indirect target acquisition can best be defined by the term **target development**. Target development is the detection, location, and identification of suspect, probable, or confirmed targets as a result of the process of analyzing and correlating information from more than one information collection means. It is the development of targets obtained through use of the intelligence cycle. Seemingly unrelated items of information (which by themselves are not substantial enough to be defined as a target or potential target) are collected, processed, and developed into substantial targets, and then disseminated to the proper FS agencies.

The success of target development depends on the active management of all available information-gathering resources

in order to refine intelligence about the enemy which will continuously portray the enemy situation. This will give the commander a basis for rendering timely decisions.

### Target Development

The most common source of target information is target development. Target development involves the use of—

- Map tracking.
- SITMAP.
- Pattern analysis.

**Map Tracking.** Map tracking is the ability to “track” enemy activity on a map from first detection to its present position. By determining where the enemy has been, how long he spent in each location, and what he did there, it may be possible to determine enemy unit size, capabilities, and limitations. Most important of all, we may learn enemy intentions.

Map tracking should be accomplished for each separate and distinct enemy activity. Map tracking can be effective only as long as locations are plotted accurately and reports on enemy activity are conscientiously received, logged, and filed in the proper manner.

**Situation Map.** The brigade’s SITMAP represents the most accurate portrayal of the enemy situation. Enemy capabilities and intentions which may result in targeting data can be revealed through a careful study of who the enemy is, how and where he is deployed, what he is doing, and what he intends to do.

**Pattern Analysis.** The culmination of the use of the SITMAP, map tracking, and other techniques, such as receiving intelligence reports and comparing data with each other, is called pattern analysis. It is the detection of definite and predictable patterns of enemy activity through the use of careful mapping and the chronological recording of minute details of enemy activity. By analyzing this data, information on enemy targets may evolve.

**Threat Development.** Target development is conducted by the S2, who tasks collection agencies with specific orders and requests to collect target information. As

these collection agencies obtain information, they send preliminary reports back to the S2, who determines whether potential or suspected targets may be derived from this information. When analyzing data to determine whether there is sufficient targeting information, four areas of concern must be studied:

- The brigade’s mission.
- AO characteristics.
- Enemy tactics.
- Enemy patterns of activity.

As the S2 and BICC personnel review the incoming information and perform their analysis, a list of suspected and potential targets will be developed. Since this list is based on early information, it will often be necessary to go back to the collection agencies and request additional information on these possible targets. This subsequent information could—

- Verify that the target actually exists.
- Accurately identify the target by description, category, and posture sequence.
- Accurately locate the target.
- Disprove the presence of the target.

Once a potential target has been developed to the point where it is suitable for employment of a weapons delivery system, it must be included among those targets selected for attack. However, before a target can be selected for attack, the type of target must be determined, to allow for the selection of an appropriate weapon system to be employed. The following must be determined:

- What is the target composed of? (For example, troops, tanks, trucks, emitters, and so forth.)
- What is the target’s strength? (For example, number of personnel, equipment, and so forth.)
- What are the vulnerabilities of the target? (For example, overhead cover available, lack of adequate terrain concealment, and so forth.)

- How permanent is the target? (For example, truck park, permanent-type structures, tents, convoy, and so forth.)

After processing has been completed and the target has been forwarded to the S3 or FSO for target attack, the intelligence and targeting data is used to update the IPB and targeting data base. It is also used to guide the issuance of future brigade collection plans.

### Dissemination

It is vital that combat information and intelligence be disseminated to brigade and battalion elements in time for effective tactical decisions and actions. The BICCs ensure the timely distribution of information and intelligence to those who need it. It ensures that dissemination is limited to those elements with an operational need.

Most reports generated by the brigade and battalion are driven by events. Periodic reports should be limited to those that are essential to pass intelligence to those units or elements that need it. The intelligence SOP and the intelligence annex of a higher unit headquarters should prescribe the types, formats, means, frequencies, times, addresses, and information required for each report.

For event-generated reports, such as spot reports, the standard addressees are normally the next higher, lower, supporting, and adjacent headquarters. However, the BICC should evaluate each report individually to determine who needs it. Vertical dissemination and reporting is normally limited to the next higher or lower echelons. For example, the maneuver battalion normally does not disseminate data directly to the division. An exception may be dictated by a battlefield situation. In the event that communications are lost with brigade headquarters, the battalion S2 may disseminate directly to the division G2, and indicate that communications with the brigade are out.

Dissemination means are selected based on timeliness and security requirements. High-priority communication channels are only used to transmit highly perishable, critical information. Every effort is taken to

safeguard information on the battlefield. The only time security measures are not followed is when they severely impede the rapid flow of critical, perishable data. The S2 must carefully weigh the possible adverse consequences if the recipient fails to get the report in time to act against an OPSEC risk.

The brigade and battalion normally use the reports listed below to report and disseminate information and intelligence. Appendix A describes the format for the following reports:

- MIJFEEDER—meaconing, intrusion, jamming, and interference feeder.
- INTREP—intelligence report.
- INTSUM—intelligence summary.
- NBC-1—nuclear, biological, and chemical-1 report.
- RII—request for intelligence information.
- RRII—response to request for intelligence information.
- NBC-6—nuclear, biological, and chemical-6 report.
- TACELINT—tactical ELINT report.
- TACREP—tactical report.
- SIR—serious incident report.
- MAER—multiple assets effectiveness report.
- MASTR—multiple assets status report.
- MATM—multiple assets tasking message.
- SALUTE—size, activity, location, unit, time, and equipment message.
- FREETEXT—free text message.
- Order report.
- Patrol report
- SITREP—situation report.
- Interrogation report.
- Intelligence estimate.
- Intelligence annex.
- R&S plan.

The S2 and BICC disseminate information and intelligence to the commander, staff, and other personnel within the headquarters through briefings and personal contact.

Briefings are designed to present information and intelligence to the commander, staff, and other designated personnel. Briefings are given to obtain a decision, influence a mission, or inform the commander and remaining members of the staff. S2 briefings are normally informal. The formal briefing guide found in Appendix B is modified to fit the S2's briefing situation and requirements.

The information briefing enables the audience to gain an understanding of a problem, a situation, or a military operation.

The decision briefing is presented to obtain a decision. Usually based on staff study results, the briefing identifies a problem, discusses the available options, and recommends the adoption of a particular solution.

The mission briefing imparts mission-related information and intelligence, gives specific instructions, and instills an understanding of the mission during operational situations. At the battalion and brigade levels, the mission briefing is used by the commander to state the mission and provide guidance and direction.

The staff briefing is used to secure a coordinated or unified staff effort. This briefing is usually presided over by either the commander or the executive officer. Staff briefings may combine portions of the information, decision, or mission briefing. This briefing provides principal staff members an opportunity to update the commander and other staff members about the operations and activities of the various staff sections.

One of the best ways to disseminate information is through personal contact. Through frequent staff contact, the S2 can fully appreciate the purpose and intent of the commander's guidance and directions, how he operates, and what is expected of the staff. The importance of this personal contact is surpassed only by the coordinat-

ing relationship between the S2 and S3 sections. When information, combat information, and intelligence become available, they are passed to the appropriate staff section. In turn, they keep the S2 section informed of their intelligence requirements and of any situations which impact on S2 operations.

Frequent liaison with other unit personnel and agencies to exchange information and intelligence is mutually beneficial and contributes to the achievement of intelligence objectives.

In combat, the S2 ensures that information is not disseminated to addressees who do not have an operational need for that information. The single exception is to addressees listed in the SOP for required reports. Limiting dissemination reduces the communications system workload by eliminating unnecessary reports. It also enhances the security of the data by limiting access on a need-to-know basis.

Divisions and corps need information to support the development of the intelligence picture along the front line. Battalions and brigades are primary sources for this information. Lower echelons do not have the time, manpower, or storage capability to conduct an extensive analysis of disseminated data. Subordinate commands depend on the next higher command for intelligence to plan and conduct combat operations. They use extensive amounts of combat information, especially targeting information, upon which they act promptly. Adjacent units extract, correlate, and integrate data into their respective intelligence assessments. They also need combat information that may affect their operations. Effective dissemination of intelligence is important to the successful accomplishment of the intelligence mission at all echelons. Communication of significant amounts of data can place a severe workload on communication systems. Overloading communications systems must be avoided. Use of correct message priorities and limiting the number of addressees contributes to rapid and effective communications.

## COMBAT PHASE

### OFFENSIVE OPERATIONS

Brigades conduct offensive operations as part of division and corps offensives, during division and corps defensive operations, as contingency forces, or internally within the context of their own defensive operations. Offensive operations are characterized by aggressive initiative on the part of the subordinate (brigade and battalion) commanders, the ability to make rapid shifts in the main effort to take advantage of opportunities, and momentum to effect deep, rapid destruction of enemy forces. These operations are conducted throughout the brigade and battalion areas of operations and interest.

Brigades and battalions conduct offensive operations to carry the fight to the enemy and to destroy his capability to resist. Depending upon the commander's intent for a particular operation, one or more of the following may be the specified purpose for attacking:

- Destroy an enemy force.
- Secure or seize key terrain.
- Destroy a key element of enemy combat power.
- Fix or contain enemy forces to deprive them of resources or to prevent them from reinforcing elsewhere.
- Deceive the enemy.
- Conduct reconnaissance to gain information about the enemy and terrain.

The destruction of the enemy fighting force and its will to resist is the only way of winning in combat. This purpose is well served by effective and efficient IEW support.

In the offense, certain IEW principles are essential to battlefield success:

- Knowing the battlefield.
- Denying intelligence to the enemy.
- Disrupting and destroying enemy CI and reconnaissance capabilities.
- Maintaining the integrity of IEW operations.

Knowing the battlefield requires detailed intelligence on the enemy, weather, and terrain. Detailed, accurate, and comprehensive IPB begins before initial deployment, is refined during the prehostility phase, and continues, once the battle is joined.

MI battalion assets serve to support economy of force operations by providing early warning and support to deception operations within risk levels acceptable to the commander. MI battalion assets supporting the main attack and economy of force operations must be task-organized according to the tactical situation and METT-T requirements.

Survivability of IEW assets is essential for successful battle outcome. Consistent with security and communications requirements and mission responsiveness, MI battalion assets should disperse to the maximum extent possible. They also apply the full range of OPSEC measures.

C<sup>2</sup> of IEW resources and their effectiveness are directly related. If IEW is to be continuous and responsive, the level, type, and means of C<sup>2</sup> of these assets must be determined early, as defined in Chapter 3.

The primary types of offensive operations include—

- Movement to contact.
- Hasty attack.
- Deliberate attack.
- Exploitation.
- Pursuit.

These operations are described in detail in FM 100-5 and FC 71-100.

#### Movement to Contact

A movement to contact is conducted to gain or regain contact with the enemy and to develop the situation so that either a hasty or deliberate attack can be made. It is characterized by a lack of information about the enemy; therefore, it is necessary for the brigade or battalion to move using techniques that provide maximum security and afford flexibility. It moves aggressively toward the enemy. Maximum use of intelligence resources is made to find the enemy before the enemy can detect the brigade or

battalion presence. OPSEC measures deny intelligence to the enemy about the friendly forces during movement to contact. When contact is made, combat information and intelligence are used by the commander to determine where to attack, bypass, or defend, and with what force to overcome enemy resistance.

During the movement to contact, IEW resources are employed primarily to provide early detection and location of enemy forces. This effort begins in the planning stage. The BICC, with supporting data from division intelligence sources, expands the division IPB data, relative to the brigade battlefield area, to address the commander's PIR concerning the brigade areas of operations and interest. Through this process, information about the enemy, terrain, and weather are tied together to give the brigade or battalion commander a clear picture of expected battlefield conditions in the areas of interest and operations.

The BICC, with guidance from the S2, defines collection tasks based on the PIR/IR. The BICC prepares mission tasking and transmits it to organic and supporting IEW assets according to C<sup>2</sup> procedures outlined in Chapter 3. Collection missions are also levied through the S3 on combat, combat support, and CSS units within the brigade or battalion. These functions are an inherent part of each operation and are performed prior to, and during, all brigade and battalion operations. IEW resources supporting the movement to contact will normally include interrogators, EW assets, and GSR teams from the surveillance platoon of the MI battalion.

Interrogators move with and support the advance elements. Until contact is made with the enemy and EPW are available, primary sources of information are limited to refugees, line crossers, and other non-combatants. Interrogators determine—

- Locations, size, composition, and direction of movement of enemy forces.
- Enemy unit objectives.
- Location of minefield, obstacles, and antitank weapons.
- Terrain conditions along the route of advance.

EW support to the movement to contact is aggressive, both in planning and execution. Every effort is made to provide continuous coverage of the battlefield. Alternate positions, with LOS along the axis of advance, are selected to enable the EW assets to “leapfrog” forward to support the operation. High terrain to the rear and along the flanks of the maneuver force is identified. Assets requiring long set-up and tear-down times may be best employed in these areas.

EW support is initially provided from positions as close as is tactically possible to the line of departure. As the maneuver elements move forward, their rate of march is computed. This information, along with the estimated set-up, tear-down, and displacement times of supporting EW equipment, allows the ESM and ECM assets to “leapfrog” forward and maintain continuous support for the operations.

ESM collection assets, primarily voice collection teams, intercept and record enemy HF and VHF voice transmissions. Emphasis is placed on detecting forward enemy elements as early as possible. During the movement to contact, intercept priorities include—

- Reconnaissance C<sup>2</sup> nets.
- Tank communications.
- C<sup>2</sup> nets of maneuver units.
- Artillery FS nets.
- Engineer nets.
- REC nets.

HF/VHF and VHF ECM teams deploy and move with the ESM assets during this phase of combat. Although they have no active ECM missions during this time frame, jammers may be used as passive voice intercept positions to augment existing ESM collection assets.

Surveillance squads and teams move forward with the units to which attached. They support troops or companies or operate with platoons or teams. GSR teams move with the supported unit using “leapfrog” movement, monitoring the terrain

forward and to the flanks of the force to detect enemy activity. They—

- Acquire targets for immediate engagement.
- Provide early warning.
- Search and monitor ambush areas.
- Search areas of conventional fires for signs of enemy activity immediately after firing.
- Cue direct-fire weapon systems.

A type of organization for brigade movement to contact with supporting MI battalion resources deployed is illustrated below.

The movement to contact terminates when enemy resistance requires deployment and a coordinated effort by the main body. All available collection resources are employed to determine the size, capabilities, intentions, and deployment of the enemy force. Tasking of EW assets is redirected to support whatever action the brigade or battalion undertakes.

### Hasty Attack

The hasty attack is an offensive operation conducted to defeat the enemy. It also may be conducted to seize key terrain, gain information, or support a deception plan. It is usually conducted following a movement to contact, for which a unit has not made extensive preparations. A hasty attack uses the resources immediately available in order to maintain momentum. From the early moments, every available element of combat and combat support is committed to the attack.

### Deliberate Attack

The deliberate attack is also an offensive operation conducted to defeat the enemy. This type of attack, as with the hasty attack, may be used to seize key terrain, gain information, or support a deception plan.

A deliberate attack is planned in detail and is often expensive in terms of manpower, equipment, and supplies. A deliberate attack involves overcoming strong

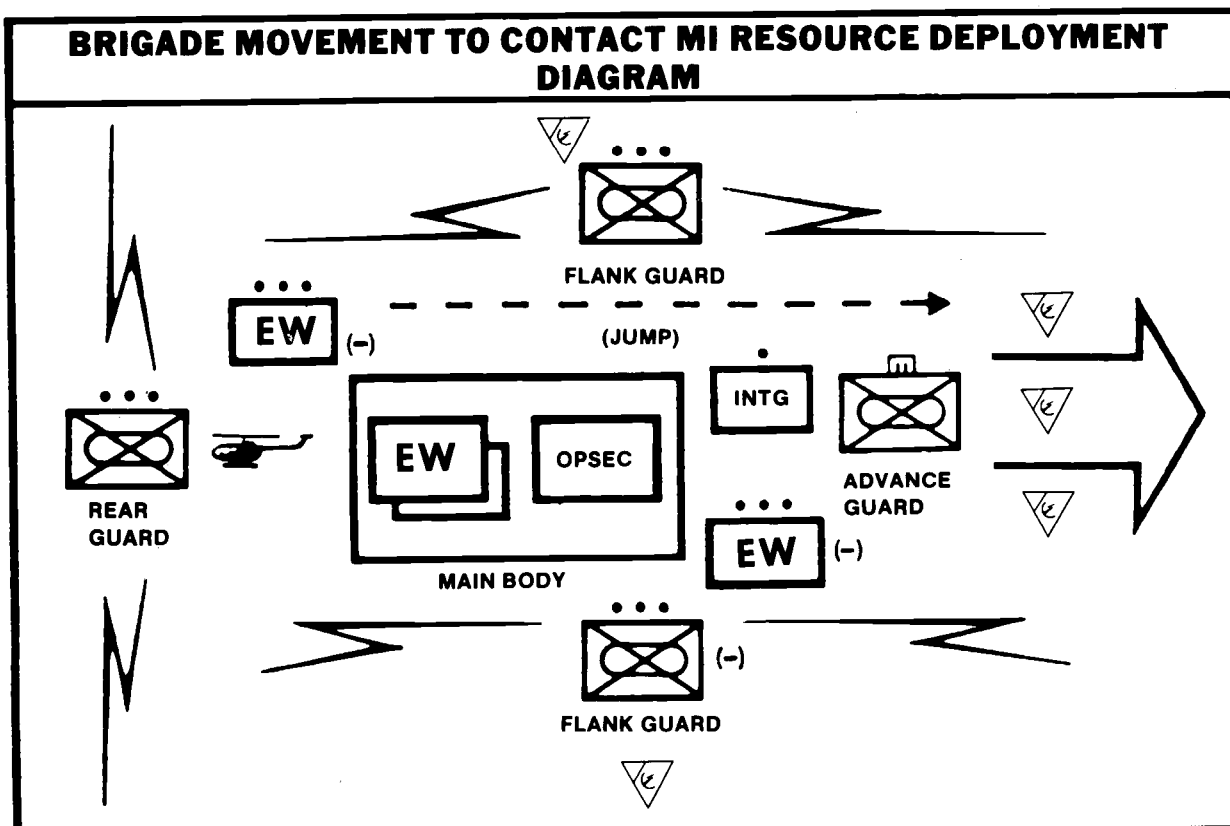

enemy forces in established positions and is undertaken after thorough reconnaissance, acquisition, and development of targets. It follows an analysis of all other factors af-

fecting the situation. The following illustrates an enemy MRR defense configuration.

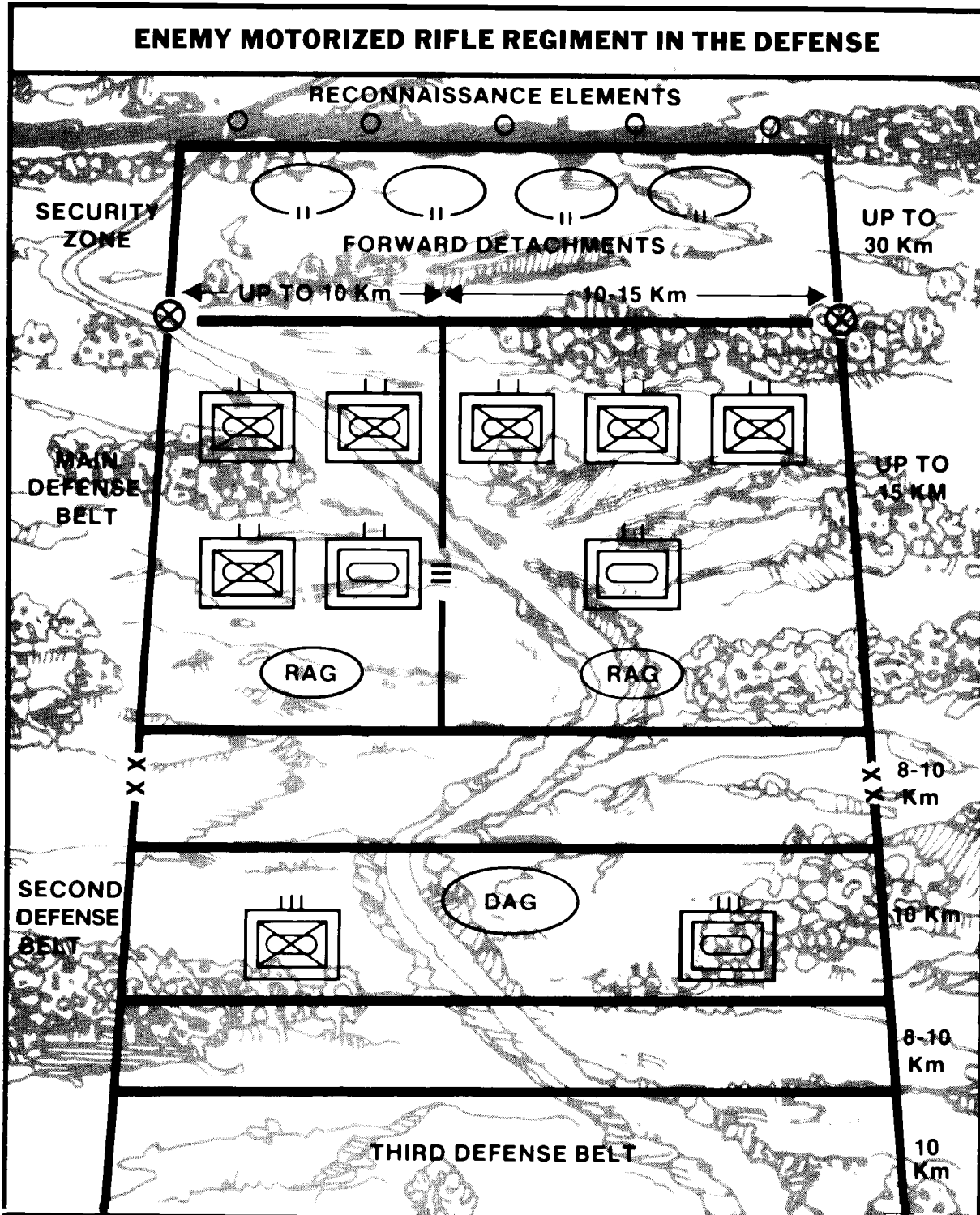



It is critical for the S2 to collect detailed combat information and intelligence about the enemy from higher, lower, and adjacent units. Sources of information include patrols, reconnaissance by fire, aerial photography, prisoners, deserters, electronic warfare assets, radar, and remote sensors. Information about terrain can be collected from many of the same resources.

When attacking, the brigade or battalion commander is particularly concerned about the location and commitment of enemy reserves; timing, strength, and location of counterattacks; and time, location, and strength of forces attempting to envelop the attacking forces.

MI resources are initially employed well forward, as far as terrain and the tactical situation permit. As the tempo of the attack increases, certain collection assets become less effective. GSR assets maybe limited to flank screening and rear area security. Ground-based EW assets maybe outrun quickly. When possible, MI commanders "leapfrog" their resources in order to provide continuous coverage. Maximum use of assets must be made to support the attack.

Interrogators locate forward in DS of the BTF. They briefly interrogate EPW, line crossers, and refugees to determine—

- Location and disposition of enemy forces.
- Location of forward line of main defense belt, including location, type, and strength of defensive positions.
- Extent of obstacles and mines.
- Planned operations such as counterattacks, envelopments, and NBC operations.
- Enemy unit objectives.
- Weaknesses in the enemy defense which can be exploited through maneuver, fire, or deception.

OPSEC support teams may support the effort and monitor the posture of the command to detect compromises or conditions that may affect the commander's EEFL. OPSEC is most important before the attack begins. The brigade or battalion must retain the advantage of surprise until it is

too late for the enemy to react effectively. Therefore, OPSEC support teams—

- Monitor and observe unit activity to ensure proper employment and coordination of OPSEC and deception plans.
- Monitor deception and countermeasures to detect deficiencies or compromises.
- Perform COMSEC monitoring.

Voice collection teams intercept, record, and provide LOB on enemy voice communications. Combat information is reported immediately for use by FS and ECM elements in accordance with existing SOP. It is also sent via the T&A team to the MI battalion TCAE for processing into intelligence. During the attack phase, high-priority targets include—

- Reconnaissance nets in the security zone.
- C<sup>2</sup> nets between reconnaissance units in the security zone and regiments in the main defensive belt.
- Rocket and artillery FS nets.
- Air defense nets.
- Enemy reserve forces.

Locations of enemy communications emitters in the VHF range are obtained by the TRAILBLAZER DF system. They are then reported immediately to the MI battalion TCAE and the IEWSE of the affected brigade in accordance with procedures outlined in Chapters 2 and 3. TRAILBLAZER is targeted against the same type of targets as the voice collection teams.

Noncommunications collection teams are important to the offense because they detect, identify, and give LOB on enemy radars, noncommunications jammers, and telemetry systems which indicate enemy force disposition and weapon systems to be encountered. Examples of priority noncommunications include—

- Surveillance, countermortar, counterbattery, and air defense radars in the security zone and main defensive belt.
- Nuclear and chemical meteorological radars and telemetry.
- Noncommunications jammers.

ECM teams concentrate their efforts on disrupting or degrading enemy C<sup>2</sup> and FS communications. The teams are tasked to jam—

- C<sup>2</sup> nets linking battalions, regiments, and divisions in the main defensive belt with reconnaissance units in the security zone.
- Critical C<sup>2</sup> links associated with FS and air defense units in the security zone and main defensive belt.
- C<sup>2</sup> nets of reserve forces.

GSRs move with attacking elements, focusing initially on enemy security and forward defenses. They may vector friendly maneuver elements through these gaps. They also monitor the flanks and the gaps between attacking elements.

GSRs support the consolidation of objectives by monitoring possible enemy withdrawals and counterattack routes.

In an envelopment, GSRs detect gaps or exposed flanks in the enemy defenses. A

lack of activity is not a sure sign of a gap in the enemy defenses. It is an indicator, however, and can cue other collection systems to locate enemy weak spots. GSRs may be employed with the enveloping force to provide early warning of enemy activity.

Upon contact with the enemy, GSRs cover areas that the enemy might use for maneuvering forces. They can also vector friendly units that are maneuvering against the enemy. They are especially valuable in providing early warning of enemy maneuver against friendly flanks and attempts at envelopment. They also detect movement of enemy reinforcing or counterattack forces.

By detecting enemy activity, both before and during the attack, GSRs locate targets to determine whether there is any reinforcement, shifting, or withdrawal of enemy units.

MI resources supporting the attack may be deployed as illustrated below.

### MI RESOURCE DEPLOYMENT DIAGRAM

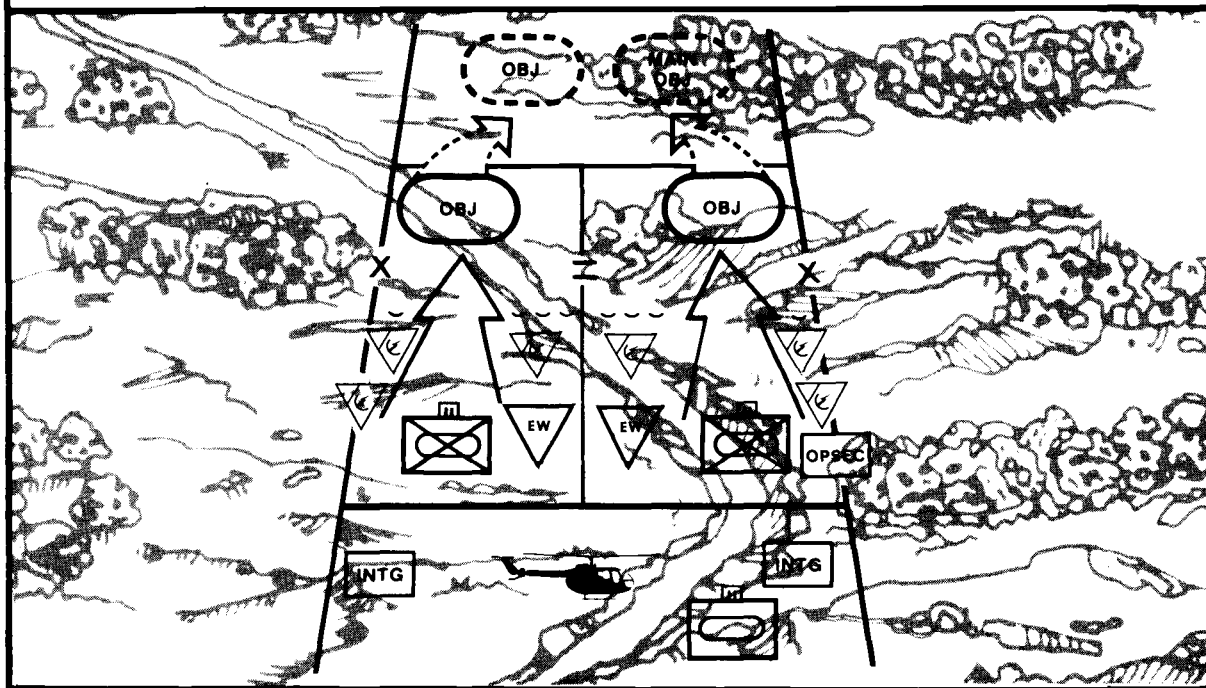

## Exploitation

Exploitation is the following up of gains to take full advantage of success in battle. It is a phase of the offensive that destroys the enemy's ability to reconstitute an organized defense or to conduct an orderly withdrawal in the face of threatened destruction or capture. It may follow either a hasty or deliberate attack. The brigade can exploit its own success, act as the exploiting force for a higher echelon, or follow and support another exploiting force.

The exploitation is initiated when an enemy force is having recognizable difficulty in maintaining its position. Although local exploitations may appear insignificant, their cumulative effects can be decisive. Exploiting forces can have the mission of securing objectives deep in the enemy rear, cutting lines of communication, surrounding and destroying enemy forces, denying escape routes to an encircled force, and destroying enemy reserves. They require mobility and balanced firepower. Tanks, mechanized infantry, and cavalry, supported by engineers, artillery, and attack helicopters make up the forward elements.

Once the exploitation has begun, it is carried out without interruption to the final objective. The enemy is given no relief from offensive pressure. The exploiting force secures terrain only as necessary to accomplish its mission. Deep attack is used to cut off enemy forces from escape or reinforcement and to inhibit the enemy's re-establishment.

MI resources support exploitation operations by identifying and locating enemy C<sup>2</sup>, FS, air defense, and logistical communications and activities. Information gathered from voice collection teams, DF, and EPW interrogators, helps the S2 determine—

- Identification and location of defensive positions.
- Identification and disposition of enemy reserves.
- Enemy unit morale, strength, and logistical status.
- Enemy plans and intentions.

ECM teams are employed to degrade the enemy C<sup>2</sup>, and FS communications, adding to the confusion and disorientation caused by the successful attack by friendly fires and maneuver forces. ECM are also employed against the C<sup>2</sup> communication of reserve or reinforcing units to disrupt the enemy reinforcement attempts. This inhibits successful enemy reaction at critical phases during the exploitation.

GSRs continue to support the attack, extending the observation capabilities of forward attacking elements by enabling them to survey distant points or areas of special interest. GSRs also assist the visual observation of attacking units during daylight by making initial detection of partially obscured targets at long ranges.

## Pursuit

As enemy forces begin to disintegrate under pressure, exploitation may develop into pursuit. The primary function of pursuit is to complete the destruction of the enemy force which is in the process of disengagement. While a terrain objective may be designated, the enemy force itself is the primary objective.

The brigade conducts local pursuit or is used as the direct pressure or enveloping force of a higher echelon in the pursuit. Exploiting forces must be alert for indications of enemy collapse which enables pursuit. Commanders prepare for pursuit by issuing warning orders, regrouping forces, and providing logistic support. Ground-based IEW elements must be aware of the supported commander's intentions in order to ensure that they are prepared to operate as self-sustaining entities during this period of fast-paced operation.

The speed of advance, the enemy's inability to react effectively, and the dispersion of forces contribute to the security of the pursuing forces. The pursuit is conducted on as broad a front as possible. Forces engaged in direct pressure and enveloping maneuvers are given deep objectives, mission-type orders, and minimum controls. If the attempt to cut the enemy's escape routes fails, a new enveloping force is immediately dispatched. Subordinate and CSS means are decentralized.

The pursuing force employs all available means of ECM to confuse the enemy, to deny him use of his C<sup>2</sup> communications, and to hinder his attempts to consolidate and reorganize.

During the exploitation and pursuit, IEW assets supporting the attacking force continue their missions as originally tasked or as modified by the S2 in accordance with updated PIR/IR to support the commander and the decision-making process. Both operations require that enemy communications, FS, and surveillance systems be located and suppressed or destroyed. This is accomplished with effective coordination and integration of EW and fire and maneuver.

### **Night and Limited Visibility Combat**

All the previously mentioned offensive operations are affected by night and limited visibility operations.

Units attack at night and during periods of limited visibility to continue an attack started in daylight, to achieve surprise and psychological superiority, to gain important terrain for further operations, to use concealment afforded by darkness or limited visibility to avoid heavy losses, or to compensate for friendly air and armor inferiority.

Terrain and weather information must be available to the S2 to aid in planning for night and limited visibility combat. Analysis of the terrain and weather factors affecting trafficability is vitally important to the selection of routes of march for the attack. Terrain features that offer concealment and can be used for heading reference are also important.

IEW collection assets (communications or noncommunications intercept teams, DF, and EPW interrogators) will be tasked to supply information pertaining to enemy defenses such as—

- Location of enemy positions (personnel, weapon systems, routes, and fields of fire).
- Presence and number of searchlights and night vision devices.

- Nature of obstacles, barriers, and bypasses.
- Unoccupied sectors, gaps between sectors, or sectors held by weak forces.
- Overwatch positions for TOWs and tanks.

GSRs maybe oriented along the direction of attack to report and correct deviations for the attacking force. GSRs are more effective when employed with thermal sights to overwatch movement of the attacking forces. The illustration on the following page depicts night attack orientation.

ECM operations employed against C<sup>2</sup> communications of enemy forces in the security zone and the main defense zone are intensified.

ECM, with supporting fires and illumination of the objectives during the critical moment of attack, contribute to enemy confusion and lack of control, and to their eventual defeat.

### **DEFENSIVE OPERATIONS**

The purpose of the defense is to defeat the enemy and regain the initiative. Defense is a temporary measure conducted to identify or create enemy weakness which can be exploited at the earliest opportunity by offensive action. The defender uses fire and maneuver to seek an advantageous position from which to blunt the attack, and concentrates combat power to counterattack. Defending forces are required to hold their positions and terrain and destroy the enemy or cause him to stop or retreat. Defending forces may move to subsequent positions on order or as planned, but their intent—**TO DESTROY THE ENEMY AND SEIZE THE INITIATIVE**—does not change.

The brigade or battalion will normally defend as part of a larger force. Depending on the commander's intent for a particular operation, one or more of the following may be the specific purpose for defending:

- Concentrate forces elsewhere on the battlefield.
- Gain time without sacrificing the defended area.

- Preserve forces, facilities, or installations.
- Control key terrain.

Brigades conduct close and rear operations. They conduct deep operations-only in

terms of participating in the division's deep operational effort. The organization of the defensive battlefield is depicted on the following page.

### ORIENTATION IN THE NIGHT ATTACK



## ORGANIZATION OF THE DEFENSE

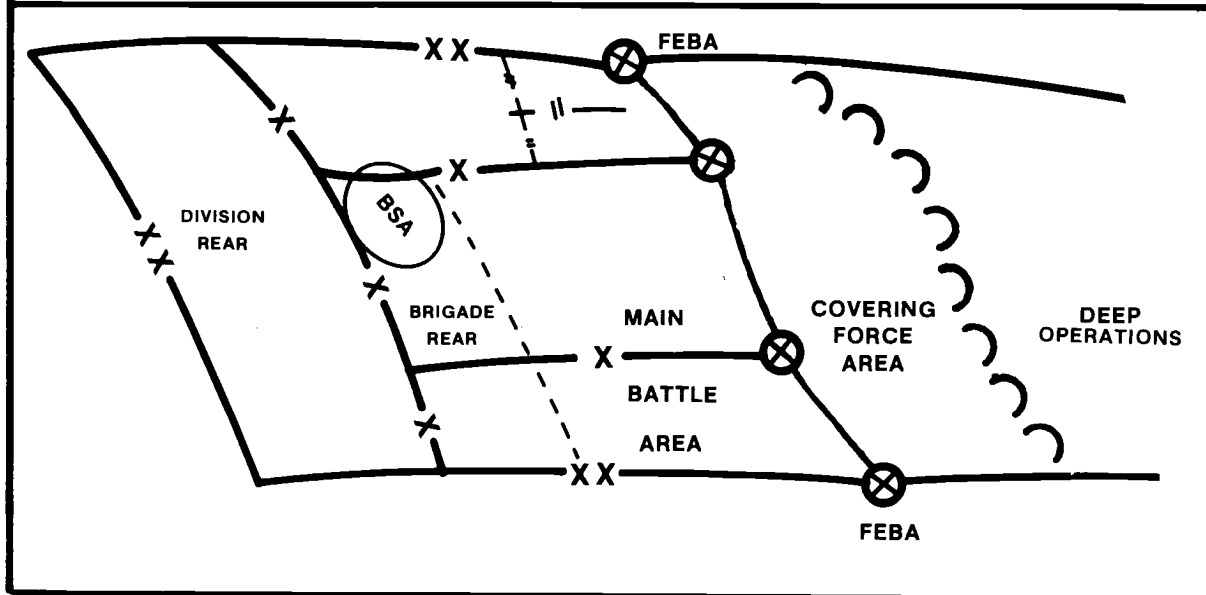

The battalion can be employed in each of the operational areas listed below:

- Deep operations.
- Covering force operations.
- Main effort in the MBA.
- Rear area.

The tactical situation and METT-T determine how the commander plans his defensive efforts. The MI resources to support the overall operation are task organized and allocated based on the need. These resources may either be GS to the division or DS to the brigade in whose area they are operating.

The IEW principles discussed in offensive operations apply to the defense as well.

- Knowing the battlefield.
- Denying intelligence to the enemy.
- Destroying and disrupting enemy C<sup>3</sup>I.
- Maintaining integrity of operations.

IEW support enables the commander to see the battlefield clearly. Collected information from IEW assets is analyzed at the BICC to provide the commander with early

warning of enemy intentions and targets for fire and maneuver forces. IEW assets must also be alert to enemy deception attempts and report them in sufficient time for the commander to act effectively. It is essential, therefore, that the IEW assets be task organized and deployed early to provide intelligence, combat information, and targeting data to support the division's deep operation, the covering force, the MBA, and the rear area.

The first task, once the battle begins, is for IEW assets to identify and collect against the enemy's main effort as early as possible. Enemy methods of movement and attack must be understood to identify the enemy's main effort.

The following figure depicts a motorized rifle division (MRD) in its movement to contact. The tank division (TD) is similar.

Once contact is made, the enemy commander will deploy his maneuver elements for a deliberate attack.

In the offense, enemy forces concentrate numerically superior forces for a combination of frontal attacks, envelopments, holding attacks, and deep thrusts. Normally, a

# TACTICAL MARCH OF AN ENEMY MOTORIZED RIFLE DIVISION

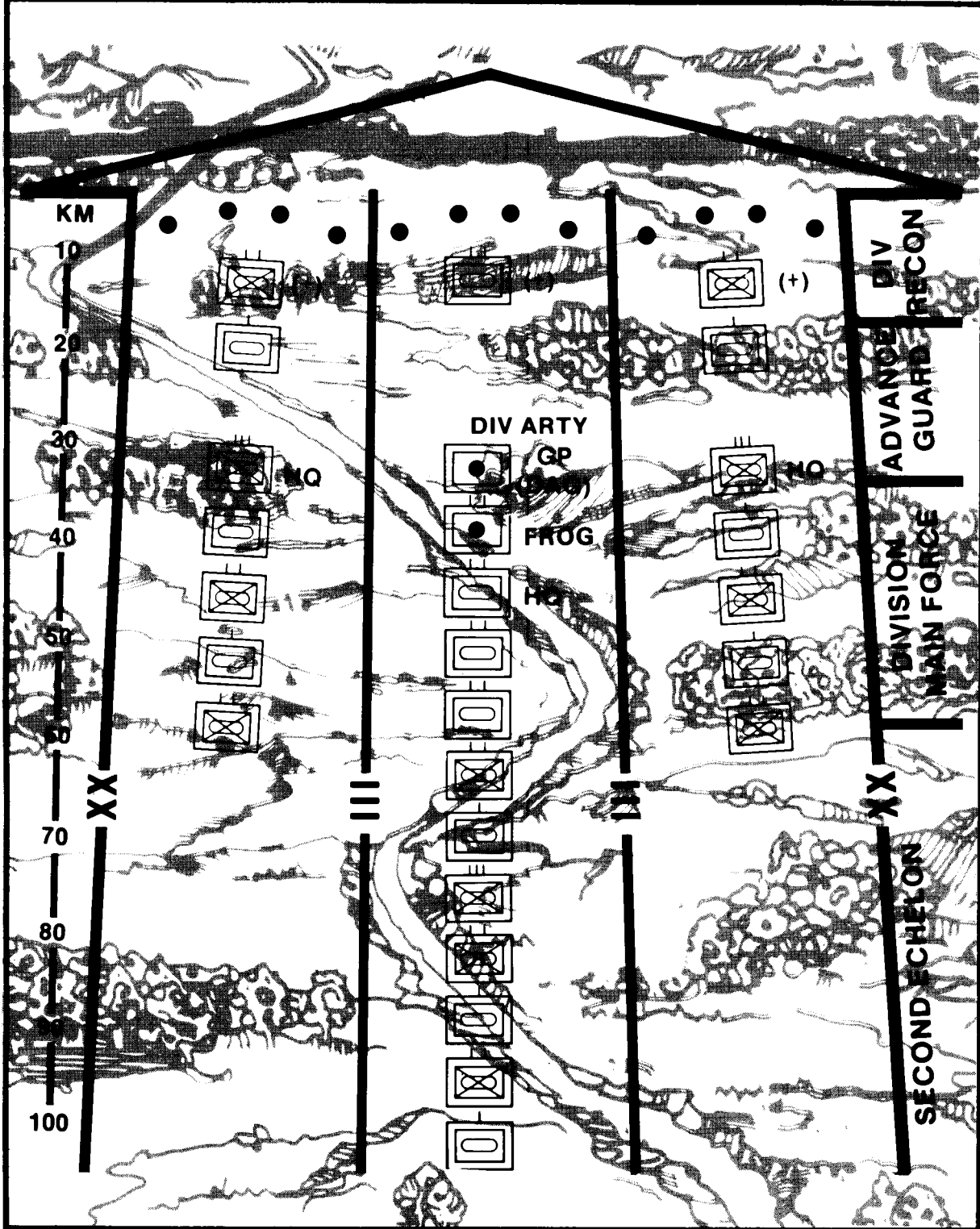

division will select one main and one secondary axis of attack. The entire division may move along a single axis if that is necessary to achieve force superiority. Rather than attempting to seize key terrain, it concentrates on breaking through weakly

defended or unoccupied areas to carry the battle to the rear. Momentum of the attack is sustained through echelonment of forces and extensive artillery fires. The following figure depicts an enemy's configuration for deliberate attack.

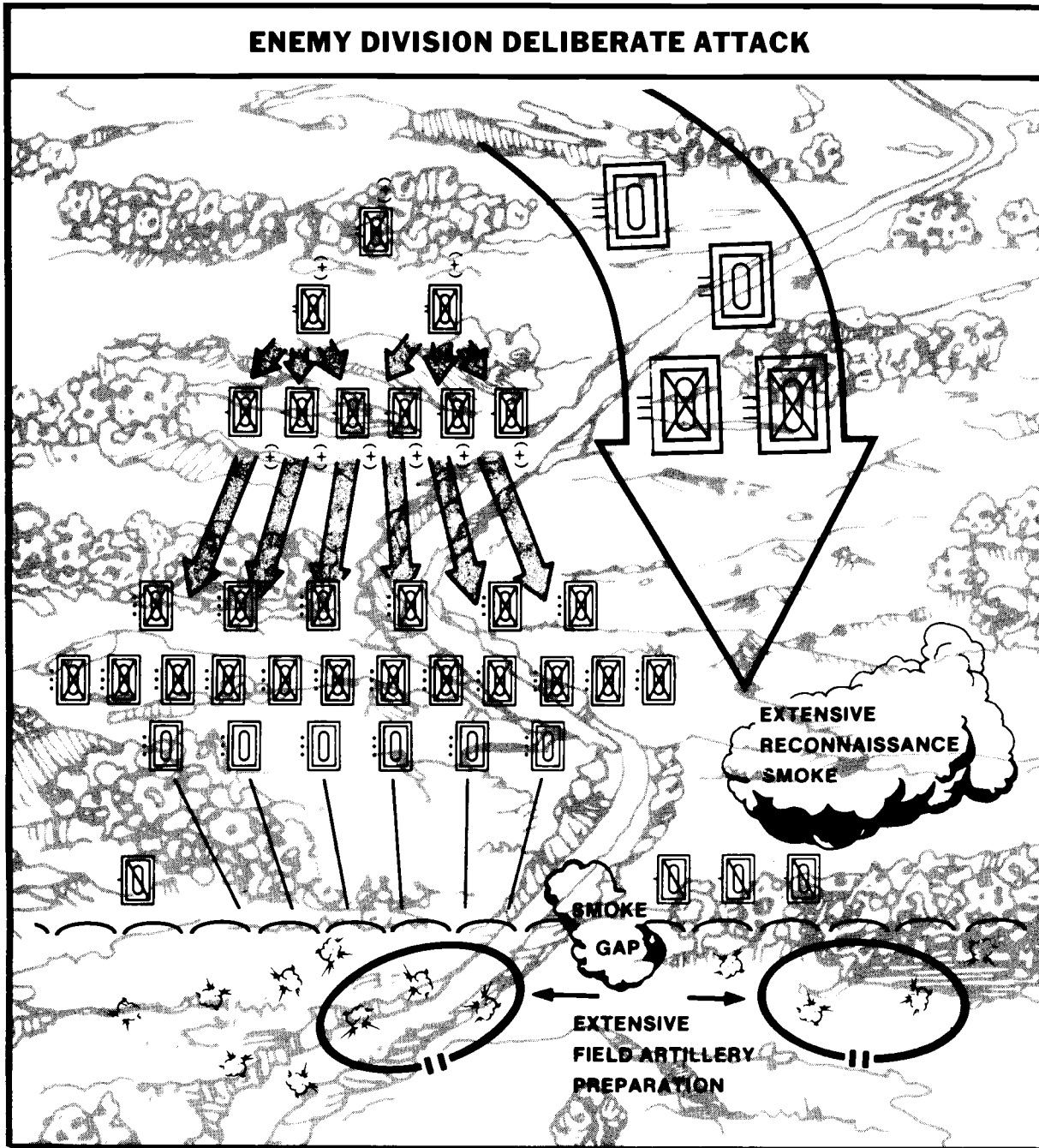



## Deep Operations

The deep operation is used by the division and higher echelons to affect the closure times of follow-on elements and create windows of opportunity for decisive action against leading enemy echelons. Brigades and battalions participate in deep operations as part of the overall division force. Areas of interest and operations extend forward of the FLOT far enough to give the commander time to identify approaching enemy forces, assess his options, and execute operations accordingly. The deep component of the operation begins before the enemy closes with the close-in maneuver forces, goes on throughout the covering force and MBA battles, and usually continues after direct contact between forces has ended.

In conducting the deep operation, the commander's intelligence collection effort is focused by making specific demands on the intelligence system. As enemy formations approach the FLOT, the commander monitors their movement, seeks high-value targets, disrupts and delays them, and modifies his defensive plan as necessary.

The means available for deep attack may be limited in number and effect. Special care is taken to use deep fires and maneuver efficiently to obtain effects which contribute directly to the success of the overall defense. Air-delivered weapons, tactical nuclear weapons, air maneuver units, and special operation warfare forces are the chief weapons of the deep operation, though other maneuver forces may be used. Generally, more sensors and weapons become available as the enemy nears the FLOT.

Effective employment of these means depends on careful planning and IPB at the division level before the operations begin and on a responsive surveillance operation once operations are under way.

The brigade S2 receives intelligence products from higher, adjacent, and supporting IEW resources to satisfy the brigade commander's deep operation information requirements.

IPB in the brigade's area of interest for the deep operation was initiated prior to deployment. This process continued during the prehostility phase with the majority of

the situation and target development data being produced by division, corps, and EAC assets. Aerial COMINT and ELINT systems collect information on, and locate, enemy C<sup>2</sup> communications and noncommunications systems. Long-range patrols, when available, provide detailed HUMINT on activities and locations deemed critical to the deep operation. This data is passed through corps and division intelligence channels to the brigade S2 as needed.

During the defense, the brigade is concerned with the approaching enemy force composition, disposition, strength, rate of movement, and intentions in its area of interest. As enemy formations approach the brigade's AO, the commander monitors their movement through collection, analysis, and reporting from division; seeks HPT; and initiates deep attack options against follow-on battalions and first-echelon sustainers. EW and REMS resources provide the S2 with data on approaching forces which, when coordinated with the FSO and S3 and integrated into the fire and maneuver plans of the brigade, allows for destruction, disruption or delay of these forces.

ESM resources support the deep operation by-

- Locating and monitoring C<sup>2</sup> nets between first- and second-echelon battalions, regiments, and divisions.
- Locating and monitoring C<sup>2</sup> nets associated with artillery and rocket units, especially those with NBC capability.
- Locating and monitoring enemy air defense nets.
- Jamming C<sup>2</sup> communications of reserves of second-echelon battalions and regiments.
- Jamming communications nets used to coordinate passage of lines, maneuver, and traffic control.

Noncommunications collection teams detect, identify, and give LOB for enemy noncommunications emitters in the deep operations area. This emitter information assists in the situation and target development process within the BICC. Priorities include:

- Surveillance radars of second-echelon battalions.

- Air defense radars of second-echelon units.
- Meteorological radars in the deep operations area.
- Counterbattery radars.

REMS provide an additional source of information for the ground commander that can be used for the production of intelligence and timely, accurate target acquisition data. To support the deep operation, REMS may be emplaced deep in the enemy's rear area to provide indications of reinforcement. Sensors may be hand-emplaced by maneuver-unit patrols, long-range reconnaissance patrols (LRRPs), long-range surveillance operations, or by

sensor teams. For monitoring movement in the enemy's rear area, especially at specific NAIs, the REMS can be employed at specific road junctions or as sensor fields over a wider area.

The road or trail junction string includes two seismic sensors placed at each end of the three approaches of a Y-type road or trail junction. A rule of thumb is to place two seismic sensors on every approach and confirming sensors at all road junctions or intersections. This is illustrated by the following.

A sensor field is two or more sensor strings employed to monitor two or more specific locations within an area of interest, as shown here.

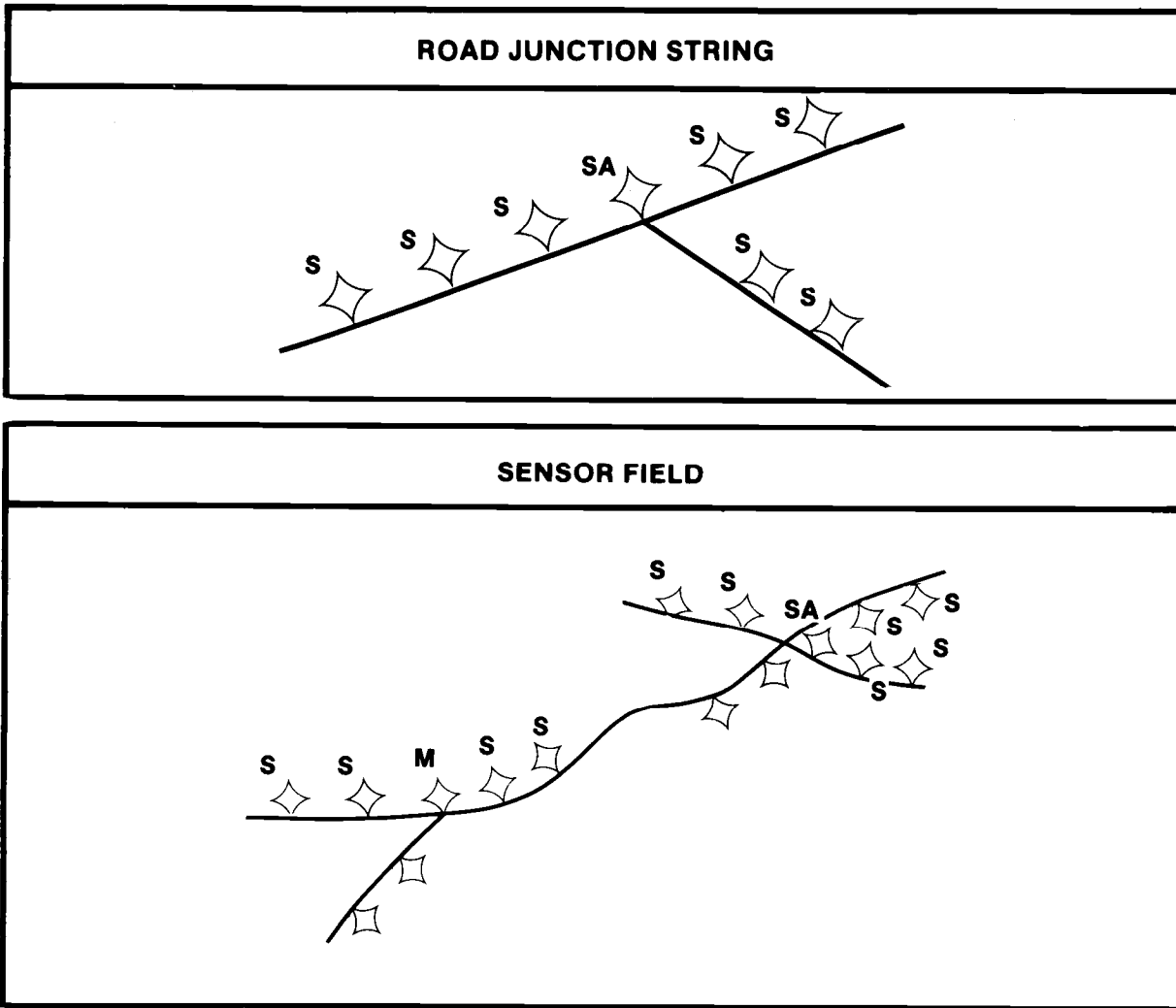

There are two situations in which sensor relays must be employed. The first is when the sensor implant location is not within radio LOS of the monitoring site. The second is when the distance between the sensor implant location and the monitoring site is greater than 50 miles or 80 kilometers. The current relay, used with remote sensors, is the expendable relay AN/GRQ-21. It will receive digital sensor signals on one channel and retransmit this signal to the monitor site on a different channel. The relay receiver channel must be the same as

the sensor's transmit channel. Because the relay transmits the sensor signal on a different channel, the RF monitor at the monitor site must be set on the same channel as the relay's transmit channel. Because the relays can only receive and retransmit one channel, each sensor string will require two relays to retransmit all sensor information. In most situations, each sensor string is employed with a two-channel mix which will require two relays, as down by the example below.

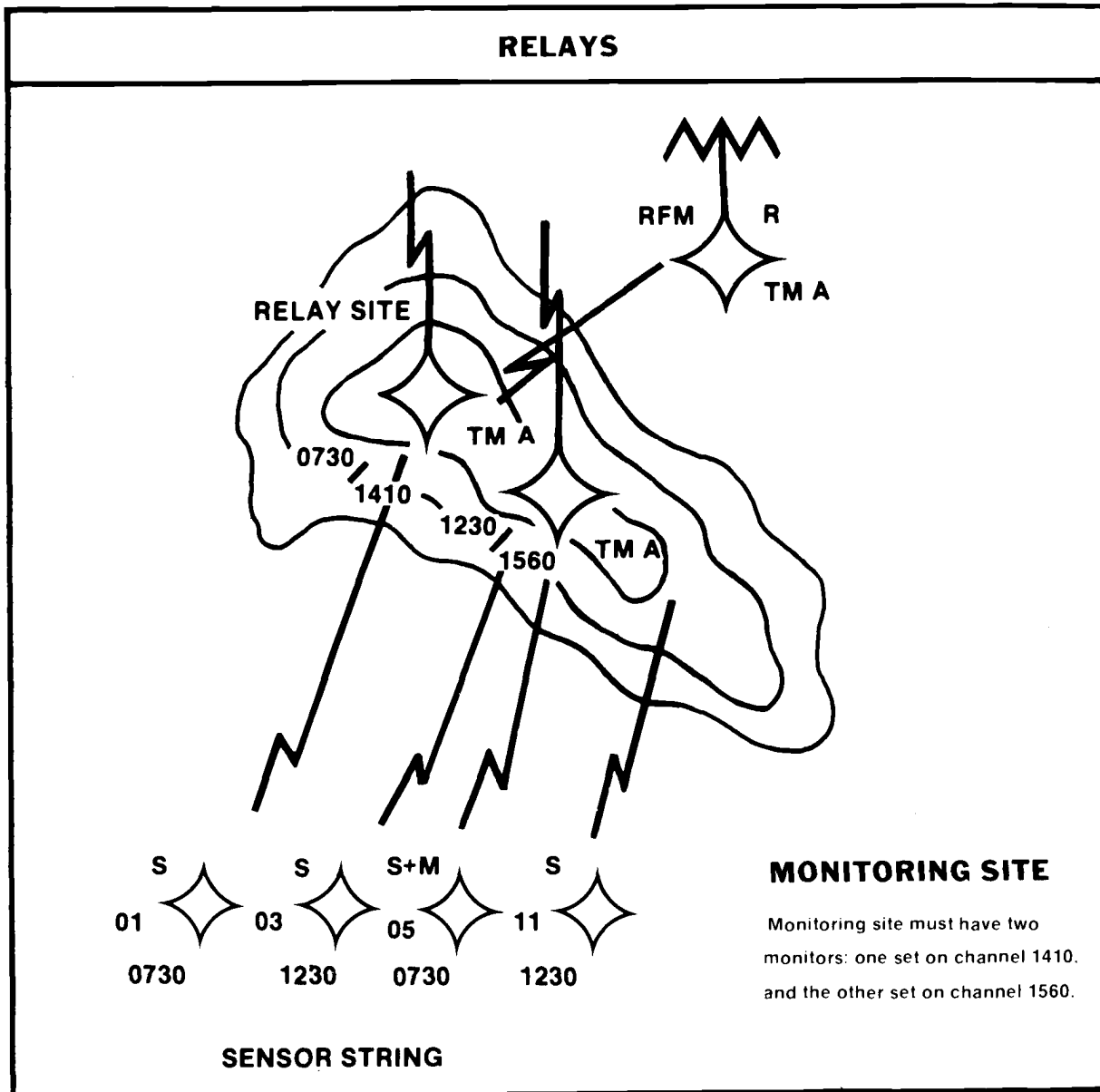

The timeliness and accuracy of sensor-derived data make REMS an excellent target acquisition resource. The REMS team emplaces sensors near predesignated target areas and reports activations to the FIST. Properly employed, REMS can indicate the type, size, number, direction of movement, and speed of the target.

A typical target acquisition sensor employment is shown below.

It is the fusion of all the IEW collected data and its integrated use in target and situation development that allows the commander to see deeply and conduct the deep operation.

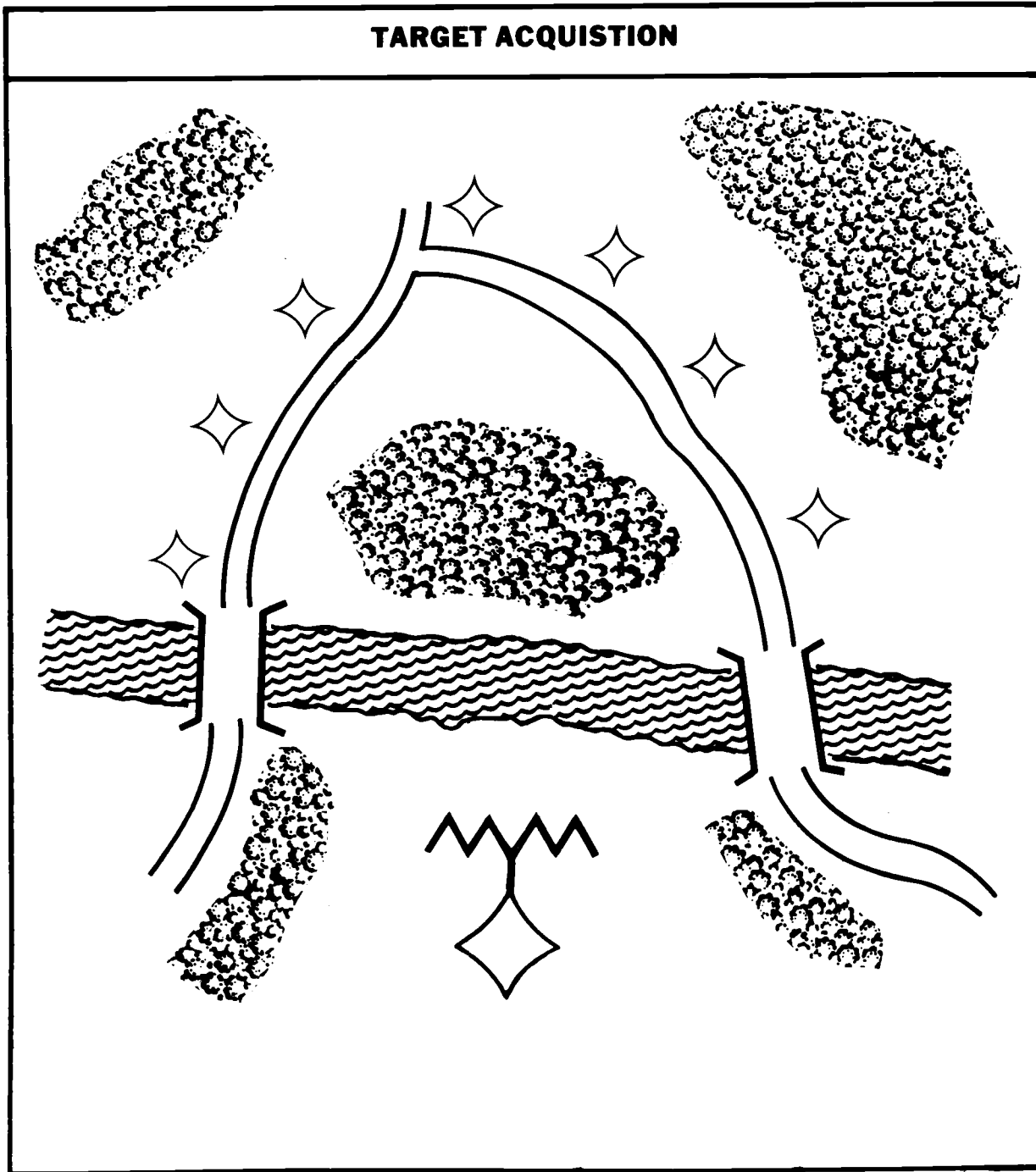

## Covering Force Operations

The covering force is formed by the forward security echelons. It defends or delays and withdraws in a “staggered” sequence, when appropriate.

The fundamental purpose of the covering force in defense is to serve as the forward security echelon. It occupies a sector far enough forward of the FEBA to protect MBA units from surprise, to allow MBA forces to move to meet the enemy attack, to prevent the delivery of enemy medium-range artillery fire against MBA units, and to deceive the enemy on the location of the main defensive positions. The mission of the covering force is to gain and maintain contact with attacking enemy forces and to develop the situation.

In many instances, corps and division commanders establish a strong covering force to form the first echelon of a defense in depth. The covering force conducts a major operation to destroy leading enemy formations, causes the commitment of follow-on battalions or regiments, causes repositioning of enemy artillery and air defenses, and thus forces the enemy to disclose his main effort. While the covering forces are fighting the enemy’s leading echelons, the next higher level of command conducts the deep operation against enemy follow-on forces and prepares for the main operation based on covering force and deep operation developments.

The size and composition of the covering force area depends on the mission, enemy, terrain, and available forces. These factors take on added significance and complexity, depending on the attack mode chosen by the enemy, the depth and width of the area available for covering force operations, and the time required for MBA defenders to get set for action. The covering force is normally tank-heavy. A defensive covering force operating in front of a division could well consist of four or five tank-heavy battalion task forces, attack helicopters, field artillery, air defense, and engineer units.

IEW resources that are used to identify the enemy’s main effort will be deployed in the covering force area as dictated by their capabilities and limitations outlined in Chapter 2, and by task organization.

Target confirmation, validation, and development is conducted in accordance with the division and brigade collection plan. The EW resources will respond to the brigade’s collection plan through the IEWSE and EW platoon headquarters, rather than directly from the S2 as GSR, REMS, CI, and interrogation assets would.

The covering force area, where IEW resources will be initially deployed, begins at the FLOT and extends rearward to the FEBA. This is where the covering force performs its four basic tasks of—

- Deceiving the enemy as to situation.
- Forcing the enemy to deploy from his march formation.
- Stripping away enemy air defenses.
- Delaying the enemy.

MI resources in the defense will be based on the MI battalion in support of the heavy division, because of the preponderance of this type of unit in the US Army. Light divisions, air assault and airborne divisional MI assets, although different in numbers, will be employed similarly to the heavy division in defensive operations. Differences will be discussed later in this chapter.

In the defense, most combat and intelligence elements are relatively static until contact is actually made with the enemy. GSR and EW elements, on the other hand, because of their unique electronic signatures, must continuously reposition themselves to avoid enemy REC activities and subsequent destructive fires.

MI assets are deployed to support the covering force operations. RSTA assets extend the capabilities of the covering force in the collection of vital combat information and intelligence, based on the commander’s PIR and IR.

Covering force area operations are enhanced when the two types of GSR teams are deployed together tactically. The AN/PPS-5 teams can be positioned to exploit their long-range capabilities, while the mobility and quickness of the AN-PPS-15 can cover areas immediately beyond the

FLOT. Both types of GSR teams are used for—

- Search missions. Search for enemy activity on likely avenues of approach or withdrawal, attack positions, and assembly areas.
- Point surveillance. Monitor point targets such as bridges, defiles, or road junctions to detect movement in and around the point. Similarly, this type of surveillance can be conducted to cover gaps between friendly units and key terrain where observation posts might be established.
- Route surveillance. Scan roadways or portions thereof to detect and obtain information on traffic density, rate, direction, and type of movement.
- Control and coordination. Assist in the control of units, especially during the night operations, by monitoring and vectoring the movement of friendly RSTA and warning them of enemy and other friendly activities along their routes.
- Fire control support. Acquire targets for fire missions and track the advancing or retreating enemy to permit the timely shifting of fire. When coordinated with final protective fires and illumination plans, GSR teams are used to locate the enemy and alert the supported unit so that fires, illuminations, and pre-positioned munitions can be employed at the appropriate time and survey target areas immediately following the lifting of fires to detect any remaining activity.
- Observation. Vector friendly maneuver while concurrently searching for enemy activity during periods when visibility is limited or obscured.
- Riverine defense. Detect and monitor the movement of both friendly and enemy watercraft.
- Perimeter security. Enhance security and provide early warning of intrusions, movements in likely routes of approach toward the perimeter, and unusual or suspicious activities near long stretches of pipeline or LOCs. The

AN/PPS-15 team is equipped ideally to accompany motorized security patrols and provide early warning of suspicious activities along the patrol's intended route of march.

GSRs with EW assets often can help locate the enemy's main effort by comparing activities noted in other parts of the CFA. They can be used to anticipate enemy maneuvers, establish the depth of the enemy offensive, or uncover an enemy feint or demonstration. They cover gaps between friendly units and monitor exposed flanks and other critical areas, such as the rear.

During the covering force operation, REMS can be used with GSRs to provide flank security. When employed on lightly defended flanks of maneuver elements, sensors provide early warning of enemy attempts to conduct envelopments. When employed in this manner, REMS will permit economy of force by reducing the number of troops needed to protect a unit's flank in the CFA.

EW support to the CFA is task organized to accomplish four primary tasks:

- Provide early warning.
- Assist in targeting.
- Augment combat power with ECM.
- Support the commander's deception plan (when such plans exist).

EW provides early warning and targeting assistance through ESM. ESM consists of communications and noncommunications intercept and direction finding and is described along with ESM systems in Chapter 2. Early warning may also be provided the brigade and battalion by corps and EAC aerial ESM assets.

These assets can provide early warning of enemy troop disposition, movements, and intentions at a much greater range than those ground assets organic to the division. Requests for tasking of these elements originate at the division G2 or G3. Brigades and battalions receive intelligence from these missions through normal intelligence channels.

As enemy units close on the CFA, the brigade and battalion resources assume the

task of early warning, identification of the enemy's main attack, and target development.

Voice collection teams are deployed 2 to 5 kilometers behind the FLOT, coordinating with maneuver elements for deployment sites. The voice collection teams require radio LOS along probable enemy avenues of approach for best utilization.

DF elements of TRAILBLAZER require the same considerations in siting as the voice collection assets. The voice collection elements are found solely in the brigade area and are tasked to support only avenues of approach within that brigade. TRAILBLAZER, on the other hand, will be located not only in a brigade area but also straddling brigade lines.

By its nature, TRAILBLAZER requires a large area for deployment and, because of its unique electronic signature, must continuously redeploy throughout the MBA to avoid enemy REC and subsequent fires. To retain continuity of intercept and direction finding, TRAILBLAZER must use the "leapfrog" method for redeployment. To accomplish this, for example, one MCS and one RSS will deploy to new positions while the remaining MCS and two RSS hold their positions and continue with tasking. The SPP headquarters element will deploy with the same MCS throughout deployment to maintain continuity. When the redeploying elements are in position and in communications on line with TCAE and SPP HQ element, the remaining MCS and RSS will redeploy. The SPP headquarters element will at that time pass control of the mission to the MCS that has communications with the TCAE. When the SPP headquarters element is in its new location, it will reassume control of the mission. This leapfrog concept is shown on the following page.

Priority of effort for the SPP is to the interdiction battle in the CFA. As the covering force operation is handed off, priority of support shifts to forces in the MBA. During operation in the MBA, targets include—

- NBC delivery systems.
- HVT and HPT as directed by the commander.
- Enemy jamming operations.

- CPs.
- Fire support C<sup>2</sup> elements.
- REC systems.

The voice collection elements determine branch, echelon, location (LOB), direction of movement, and capabilities of enemy combat, and combat support, targets.

At the direction of the TCAE, voice collection elements in GS to division can be used to augment the SPP by acting as additional RSS with separate intercept capabilities. This increases the DF baseline and offers more LOB data for a more accurate emitter location. Drawbacks to this augmentation are a conflict of tasking to the voice collection site, and communications equipment incompatibility. The voice collection team must use FM VHF transceivers and cannot talk directly to the MCS computer. LOB data must be manually collated at the SPP or TCAE to be incorporated with the TRAILBLAZER product.

This product, target emitter locations, is used by the S2 with target information from other sources; GSRs, imagery interpretation, voice intercept and noncommunications intercept, to provide a target list to the brigade and battalion FSEs for fire missions.

The light, air assault, and airborne divisions will not have an SPP and will rely on the voice collection team equipment for the DF missions.

Noncommunications intercept elements require the same siting considerations as the voice collection and SPP elements. The LOB, cut, and fix data produced by TEAMPACK are correlated with GSR, countermortar/counterbattery radar, communications intercept, and DF, compared to the brigade and battalion target list, and fed to the FSE and TACP for suppression, fire, and air strike.

The ECM elements in the CFA and MBA will be deployed in the battalion area and must coordinate closely with the battalion for sites. The C<sup>3</sup> facilities supporting enemy RSTA, REC, and both division and regimental artillery groups are HPT for all ECM resources as enemy forces enter and

## TRAILBLAZER DEPLOYMENT: LEAPFROG

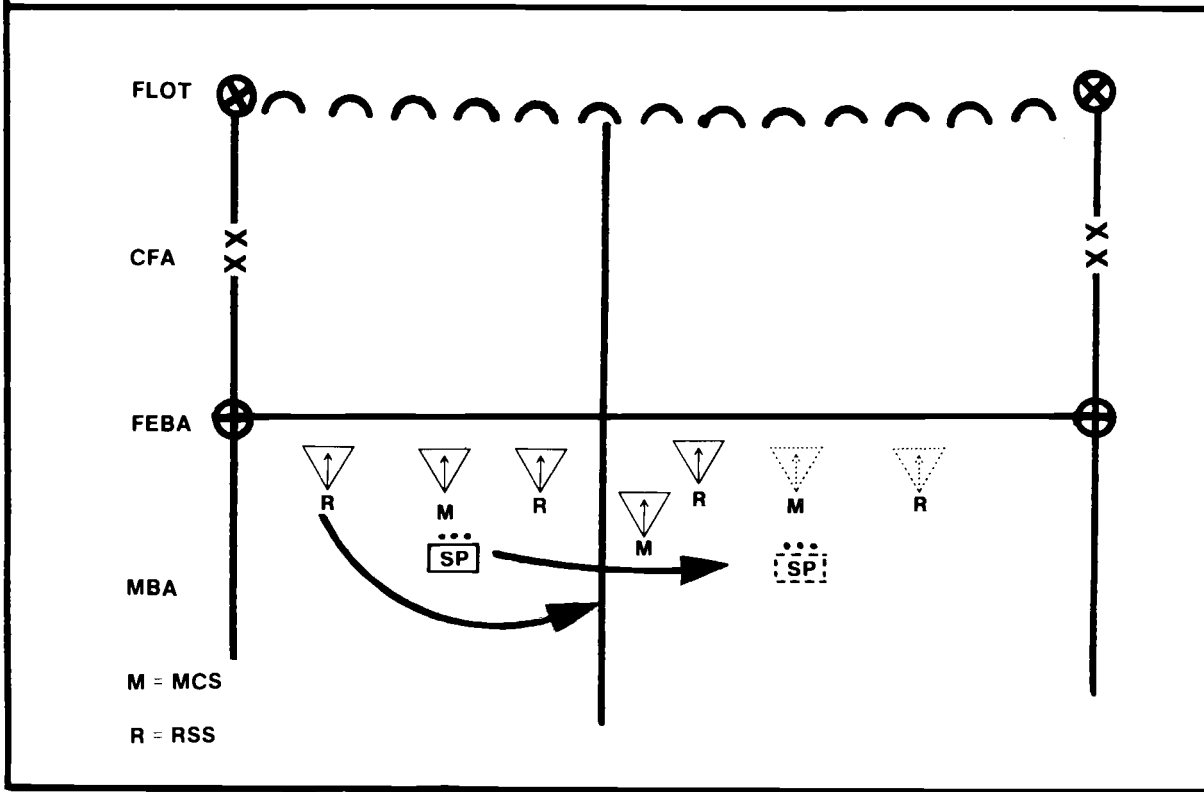

advance through the CFA. COMJAM operators selectively jam critical communications links. They use both conventional and special operating techniques and procedures which are specifically designed to delay and confuse enemy commanders and fire control operators. Enemy maneuver C facilities are also attacked on a selective jamming basis. Frequently, two or more jammers alternately engage the same target. This not only increases the effectiveness of the ECM attack but decreases the danger from enemy REC and subsequent fire. Frequent redeployment is also required to reduce the danger of enemy fire.

During the defense, the ECM assets are most effective because of the enemy's heavy reliance on C<sup>3</sup> for control of the attacking forces.

ECM has many methods at its disposal for the disruption and denial of enemy communications. The ECM equipment available to the friendly commander can, after detection and identification of enemy

HPT, block transmission at regiment to battalion levels. Nuisance intrusion by ECM operators may be conducted to confuse the enemy and disrupt his advance, provide false data to be acted upon by enemy ADA and FSE, and require the enemy to waste valuable time confirming radio communications.

Enemy barrage jamming of friendly communications will be present and heavy during their offense. ECM assets can and should be used to provide high-power "burn-through" VHF communications for the brigade and battalion upon tasking from the TCAE and the brigade and battalion commanders.

Deployment of ECM assets is designed to provide not only ECM capability but ESM augmentation.

The high-powered and more mobile TAC-JAM resources may be developed forward in the CFA to attack close-in and distant



HPT in the enemy's force and to augment the division's or brigades' overall collection effort. The lower-powered and less mobile TRAFFIC JAM resources may be deployed near the FEBA and will be used for close-in jamming missions. Also, because of its frequency spectrum scanning capability, TRAFFIC JAM is used to assist voice collection tasking efforts.

A typical deployment plan in a brigade area of the CFA is shown below.

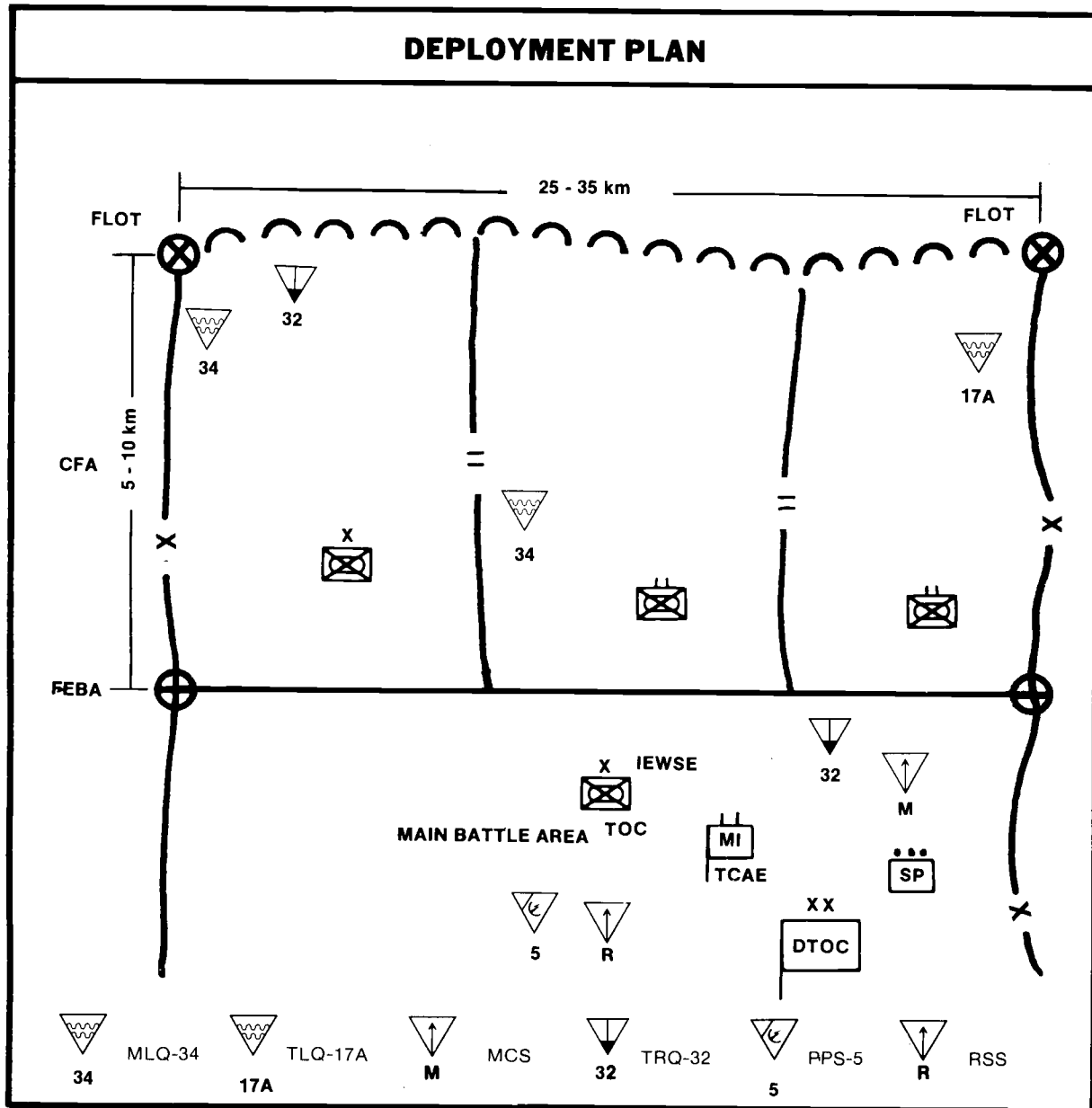

The light, airborne, and air assault divisions will not see the concentration of equipment seen by the heavy division, and may not be able to saturate their AO. The types and numbers of equipment will be used in the same way and will provide the same intelligence and information as the heavy division's assets.

When dictated by the tactical situation, the voice collection, ECM, and noncommunications intercept teams will deploy to the MBA and take up sites along the FEBA to provide the same EW support as is done in the CFA.

ECM, voice collection, DF, and noncommunications coverage of the battlefield must remain constant. To remain constant, the leapfrog method of redeployment used by TRAILBLAZER will be used by the other elements to reach the MBA.

To preclude being left behind during withdrawals, the EW platoon leaders ensure that coordination is maintained with the maneuver element in whose area the EW assets are deployed.

The decentralized, fluid nature of the covering force operation requires interrogation support at the lowest echelons, often at troop and company level. This requires DS interrogation teams from supporting MI companies, battalions, and the corps MI brigade. Questioning of civilians and EPW is brief and conducted to gain information of immediate tactical value. Interrogators gather information about the identification, composition, location, direction of movement, strength, and capabilities of enemy forces involved in the immediate covering force operation.

### Close Operations

In his close operations, the brigade commander concentrates on the interrelationships of the terrain, the estimated enemy, the capability of the battalion's direct fire weapons, and supporting fires. The brigade commander's organization for combat considers the capabilities of his unit and their employment to stop, delay, or attack the enemy.

The analysis of the terrain influences the concept of the brigade commander's plan

for battle. From the defensive perspective, the terrain offers open maneuver spaces and chokepoints or restrictive maneuver areas. The S2, assisted by the BICC, continually updates the SITMAP. Using weather and terrain data and the IPB process, BICC personnel analyze the battlefield to estimate the course of action the enemy force will take during the attack in the MBA. This analysis is aided by IEW input from MI battalion resources deployed in the brigade AO.

Generally, MI support to the brigade battle requires a high degree of centralized control and decentralized execution. Use of the IEW company team concept is especially appropriate in the close operation since it maximizes both control and execution of IEW support. Corps assets may augment the assets in the company team:

Interrogation teams are deployed at the brigade collection point. When necessary, they may be deployed at battalion level. Screening operations and interrogations are conducted at the brigade collection point to gain information of immediate tactical value about—

- Locations, types, and disposition of enemy forces, including reserves.
- Enemy unit objectives.
- Location of the enemy's main attack.
- Enemy weaknesses.
- Enemy tactics and intentions, to include use of NBC weapons.

When requirements exceed the capabilities of organic interrogator assets, augmenting interrogation teams may be provided by the MI brigade (corps).

OPSEC in the close operation is essential to maximize the natural advantages of the defense. OPSEC support teams may operate throughout the brigade or battalion area. When so deployed they advise and assist the brigade S3 on matters concerning OPSEC and deception. OPSEC teams—

- Monitor the execution of OPSEC and deception measures approved by the commander or S3.
- Recommend countermeasures to reduce the potential of compromise of EEFI.

- Perform COMSEC monitoring.
- Recommend and assist in planning deception operations.

GSRs continue to be used as they had been during covering force operations. Targeting enemy assault forces, overcoming obscurations caused by weather or battlefield smoke, and covering gaps and exposed flanks are a few of the tasks performed by GSR teams. When deployed in gaps or on flanks, the GSR teams increase the combat power of the defending elements by providing early warning of enemy activity and by targeting the enemy force at maximum range. GSRs can often help locate the enemy's main attack by comparing activities in various parts of the sector. They can anticipate enemy maneuvers, establish the depth of an enemy offensive, or uncover an enemy feint or demonstration.

REMS may be effectively used in defensive operations as an early warning system to provide indications of enemy movement and location. The amount of activity detected by the sensors may provide indications of main or supporting attacks, feints, or diversions. Since activity will be at its peak on the battlefield, sensors may be saturated with activation and may not be able to provide anything other than warnings of imminent attack. Other than this disadvantage, defensive uses may include any or all of the following:

- Targeting.
- Detection of enemy patrol activity.
- Detection of enemy infiltration.

Communications and noncommunications intercept collection, and direction finding resources concentrate their efforts against enemy first-echelon forces and the potential introduction of the second-echelon ESM resources (both communications and noncommunications), target maneuver, FS, air defense, and other critical elements of the enemy force. Intercept and DF resources in the conduct of close operations concentrate on—

- Enemy maneuver nets.
- Enemy REC elements, especially communications jammers.
- Regimental and division FS systems.

- Surveillance radars with first-echelon battalions.
- Air defense radars with first-echelon regiments.
- Countermortar and counterbattery radars.
- Meteorological radars.

### Rear Operations

A major tenet of Soviet military doctrine is to disrupt an adversary's rear area through the use of agents, saboteurs, terrorists, special action, and diversionary forces; attacks by maneuver units; and aerial and artillery fires. Soviet heliborne or air assault operations are the primary means of attacking or infiltrating the rear area. Enemy doctrine stresses the use of battalion-size units conducting heliborne operations to depths of 50 kilometers. Airborne assault operations, up to division size, may be introduced up to depths of 300 kilometers in support of strategic objectives. Attacks against rear area targets are carefully coordinated as an extension of combat in either the CFA or MBA. The goal of heliborne operations in the brigade area is to degrade friendly support and sustainment of CFA and MBA battle and to divert forces from these areas. These attacks also contribute to the demoralization of friendly forces.

The brigade S3 will ensure that all units operating in and around the brigade support area have taken adequate security measures. These include—

- Ensuring that all units supporting the brigade establish a base defense (villages and towns will assist their defense capability).
- Positioning bases near reserve locations.
- Coordinating with military police to ensure aggressive patrolling and early warning.
- Positioning base clusters to permit observation near critical points, such as bridges or points along main supply routes (MSRs) to observe critical areas.

- Establishing an alert system and communications net for defense of the brigade support area.

The enemy's reliance on communications is extensive for the command and control of attacking maneuver forces and fire support assets, once they are committed to the major battle in the MBA. HPT for ECM resources during this phase in battle include both division-to-regiment and regiment-to-battalion command nets, command observation post (COP)-to-fire direction center (FDC) C<sup>3</sup> facilities, and FDC-to-firing battery communications links.

COMJAM efforts are concentrated against enemy forces conducting or supporting the main attack. ECM operators, targeted against close-in and supporting HPT, maximize the semiautomated capabilities of their COMJAM systems. Other ECM operators are targeted against deeper- and higher-echelon HPTs, such as army-to-division command nets, division-to-battalion skip-echelon nets, and the C<sup>3</sup> facilities supporting the commanders of missile troops and artillery (CMTAs) or army- and front-subordinate artillery and SSM units. They use the full range of capabilities, procedures, and techniques to accomplish their assigned tasks. They selectively jam some HPT using both conventional and special operating techniques. At other times, they may automatically jam these same or other HPT, depending on the HPTs' operational status and the criticality of the information being passed over the given communications links. Unit field SOP and EWTL/JS developed and refined prior to combat and maintained on a dynamic basis as the battle is under way, and special operating instructions and technical data from the TCAE on EW platoons, provide the COMJAM operators the information they need to effectively execute their assigned missions. Direct coordination between the EW team or platoon and the supported maneuver battalion or brigade ensures the synchronization of COMJAM, maneuver, and fire support operations.

Though the maneuver units alternate from offensive to defensive actions, the support units of the brigade must also maintain a constant awareness because

they will remain under combat conditions at all times. The illustration on the following page is an example of a BSA.

The battalion combat trains are positioned so close to combat forces that their defense mutually aligns with the security of the battalion they support. Their defense will be addressed in this manual.

Rear operations will be characterized by intense enemy activity whose intent is to create panic and disruption.

Enemy forces have several objectives in the rear area. These include—

- Destroy nuclear delivery systems, headquarters, logistics, and nuclear storage sites.
- Disrupt C<sup>3</sup>, airfield operations, and air defense systems.
- Assassinate high-ranking political and military figures.
- Destroy or seize important LOCs such as highways, bridges, tunnels, and so forth.
- Harass supply lines and troop movements.

The intelligence preparation of the rear operations area is absolutely critical to the success of the air-land battlefield. Besides looking deep and close-in, the intelligence system must also look at the rear operation. To conduct the rear operation successfully, echelon commanders must know enemy capabilities and intentions. They must anticipate enemy actions and receive early warning of incoming incursions in the rear area. This knowledge is obtained through coordination and staff planning by all elements of the brigade staff, especially the S2 and S3.

The BICC, in accordance with S2 guidance, performs the IPB process on the brigade rear operations area in its IPB of the brigade total area of operations. This continuous process develops a comprehensive and accurate data base of weather, enemy, and terrain information from all available sources during hostilities. This information, when integrated and analyzed with other intelligence during hostilities, is the key to determining Level III threat targets, land-

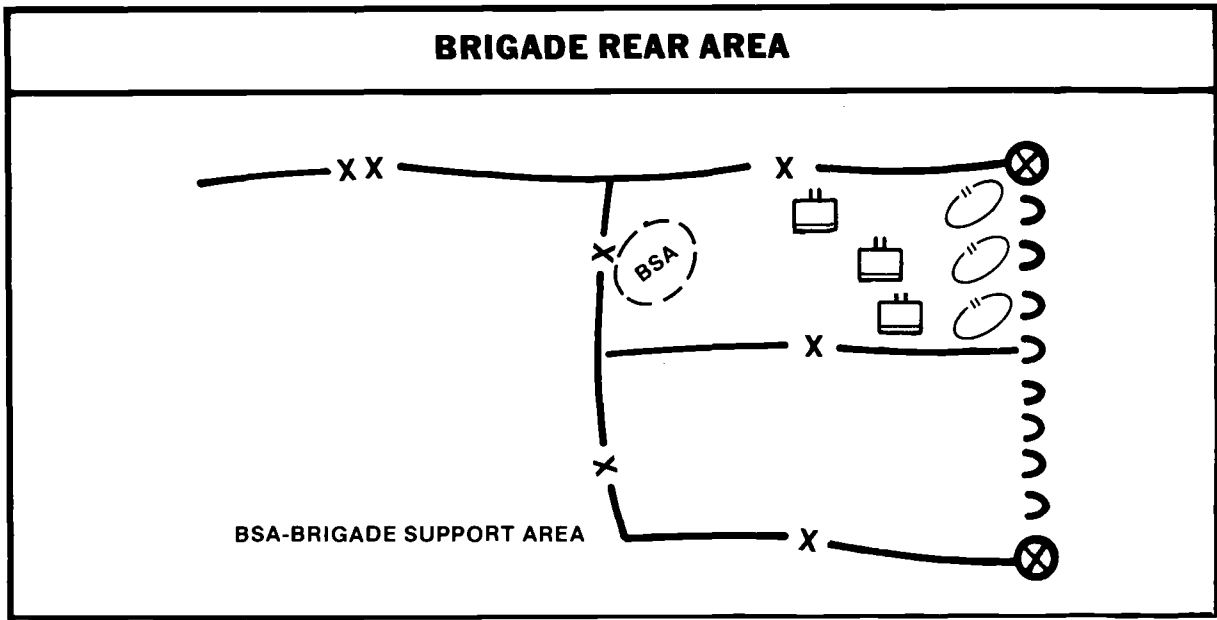

ing sites, and air avenues of approach affecting rear operations. This effort is aided by the various intelligence assets available to respond to brigade tasking.

Besides being familiar with the hostile threat capabilities in the rear area, CI personnel are aware of the scheme of maneuver for friendly deployed units. They know and understand the commander's rear operation plan.

Upgrading intelligence holdings from reports submitted by all sources plays an important part in providing an accurate picture of enemy intentions for the rear operation. Because the rear operation threat is dynamic, CI personnel must continually assess the level of threat and develop and recommend appropriate countermeasures to frustrate or eliminate the Threat.

Incidents of suspected espionage or subversion are investigated by CI personnel as directed. These investigations can lead to identification and elimination of perpetrators of hostile actions in the rear area. Pattern analysis of multiple incidents can reveal enemy plans and intentions.

Identification and neutralization of hostile teams and cells are important priorities in rear operations. Information provided by CI personnel is passed to local police, MP, or allied forces. In a similar manner, these

local agencies serve as sources of information in support of CI operations.

Tactical HUMINT operations are employed to exploit those captured personnel who can quickly identify other hostile agents and saboteurs and pinpoint unit and team locations, future plans, or weaknesses. Time constraints generally prevent extensive tactical HUMINT operations against level III threats, but enemy agents, sympathizers, and terrorists can often be neutralized at levels I and II.

CI teams located near, or collocated with, the brigade EPW cage will have EPW, refugees, defectors, and line crossers identified by interrogators as being of CI interest. CI personnel conduct interviews or interrogations of these individuals, and are primarily concerned with CI information of current tactical value. Frequently, these interviews or interrogations require a joint effort by CI and interrogation personnel.

OPSEC support provides the commander with the ability to see his rear operations area through the eyes of the enemy commander. The OPSEC data base is used to evaluate enemy intelligence capabilities and friendly unit high-value targets, patterns, and profiles. OPSEC surveys conducted by OPSEC support teams identify

the vulnerabilities of friendly forces and recommend countermeasures.

COMSEC support teams deploy into the brigade rear area and monitor friendly communications, reporting security violations and unsafe practices to the S2. Enforcement of proper COMSEC procedures denies the enemy critical information through inter-

cept efforts targeted against rear area communications.

When emplaced in likely landing and drop zones, REMS permit rapid identification of enemy heliborne or airborne assault locations as shown below. This applies to small and large insertions of troops behind friendly lines.

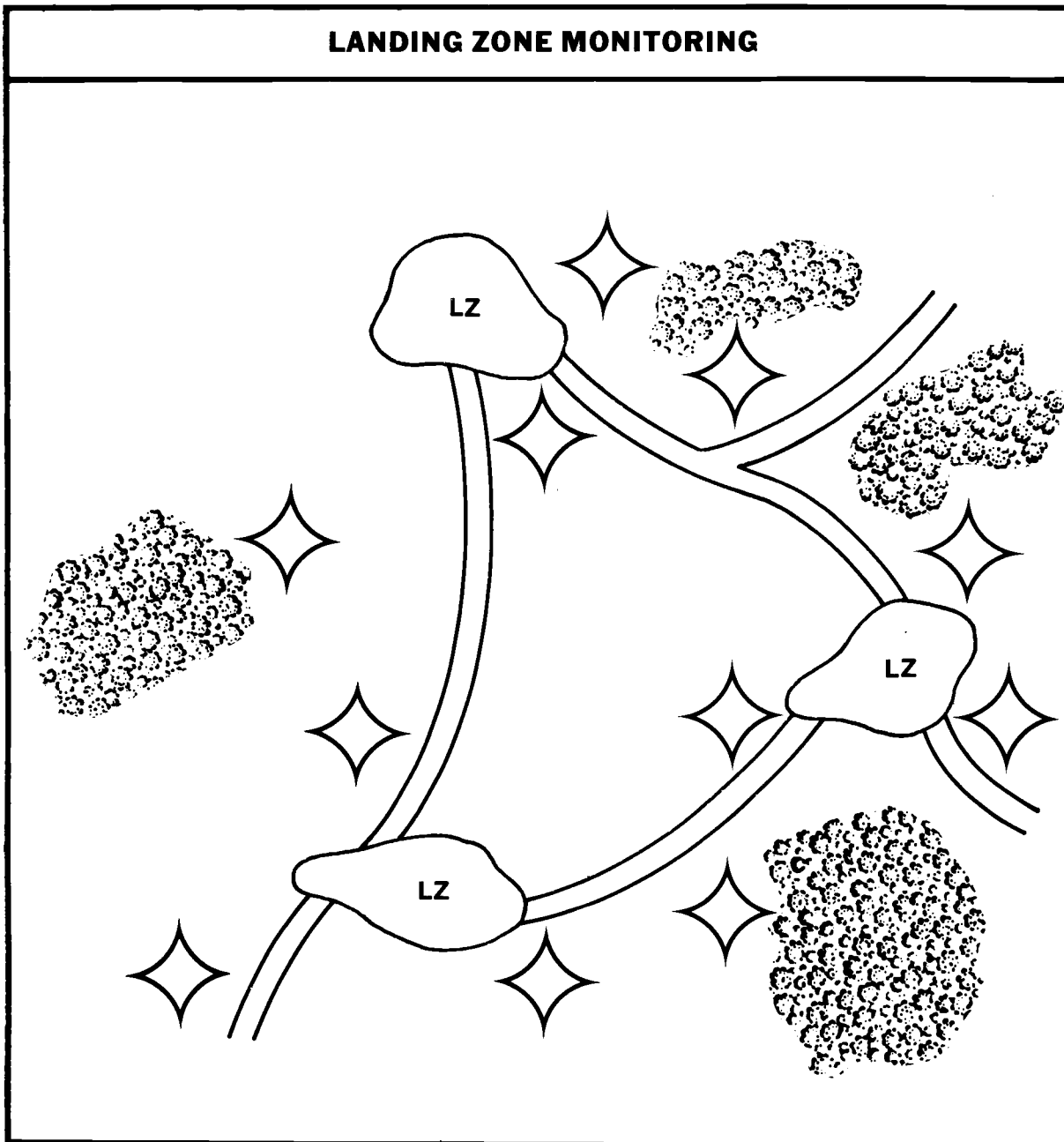

Sensors may also be extensively used to provide early warning to CSS elements.

The S2, through the IEWSE, may also request ESM support for the rear operation. ESM resources are not generally located in the rear area but may, because of METT-T requirements and the situation, be placed in support of the rear operation. Depending on their availability, resources such as TRAILBLAZER, AN/TRQ-32, or the AN/PRD-10, maybe tasked to intercept and locate enemy radio transmitters in the rear operations area. When there is no SOP for deployment of ESM assets within the rear area, the S3 of the MI battalion will advise the supported element as to the positioning of that resource.

The brigade S3 may request countermeasures to block espionage and saboteur control nets and to jam psychological warfare transmissions and other enemy radio broadcasts. ECM resources in the rear area are also used to isolate enemy special units from their control element's communications. The MI battalion normally retains operational control over all EW assets used in support of rear operations and is responsible for furnishing them with technical data to accomplish their assigned missions.

### **Retrograde Operations**

Retrograde operations are organized movements away from the enemy with the intent of avoiding enemy contact. They are conducted to gain time for the commander to prepare for offensive operations. The primary purpose of retrograde operations is to preserve the force so that, under more favorable conditions, the offense may be resumed. Retrograde operations are also conducted to—

- Harass, exhaust, resist, delay, and otherwise inflict damage on the enemy.
- Draw the enemy into an unfavorable position.
- Allow forces to be used elsewhere.
- Avoid combat when conditions are unfavorable.
- Gain time.
- Reposition forces.
- Shorten LOCs.

The three types of retrograde operations are—

- Delay—trading space for time.
- Withdrawal—disengaging from an enemy in contact.
- Retirement—moving to the rear without enemy contact or pressure.

Because there is no enemy pressure involved during a retirement, no extraordinary IEW operations are required. Normal OPSEC and SIGSEC precautions will be observed.

The IEW principles discussed in the offense and defense both apply to retrograde operations. Commanders require accurate, timely information on which to base their decisions and to execute, at the precise moment, those actions associated with the combat operation.

The commander requires a clear, precise picture of the enemy's disposition, and accurate indications of his intent to conduct operations over the terrain.

IEW resources focus their attention on—

- Locating and tracking enemy forces.
- Determining when and where enemy forces will mass for offensive operations.
- Identifying natural obstacles and key terrain on which the commander plans and conducts his delay in withdrawal operations.

Priority of effort is given to detecting enemy attempts to outflank and isolate friendly forces. IPB will identify routes to enhance friendly force security and mask activities from enemy observation.

IEW support to C<sup>3</sup>CM is oriented on destroying or disrupting key enemy C<sup>2</sup> and intelligence links during critical periods of the operation. Especially critical is the period when enemy forces have been stopped and forced to deploy. When this occurs, the delaying force must break contact and withdraw to avoid becoming decisively engaged. Destruction or disruption of key enemy communication links during this

period delays enemy response to the disengagement and withdrawal. This gains additional time for the friendly force to prepare and occupy the next delay position. Simulative electronic deception (SED) is also used to deceive the enemy as to when disengagement has occurred.

OPSEC and deception are essential to the successful conduct of retrograde operations. CI supports OPSEC by assisting the S3 in identifying those critical friendly activities that must be protected to keep the enemy uncertain of their time and place of actual disengagement. IEW systems are used both physically and electronically to deceive the enemy about the disposition of the friendly force. IEW support concentrates those measures that obscure the size and intent of the delaying force and preserve the element of surprise. Each time enemy commanders are engaged by the delaying force they must be convinced through the application of combat power, OPSEC, and deception that they have engaged the main force. This causes them to deploy their forces, reinforce, and prepare to sustain an attack. The delay incurred is the purpose of the delay operation. In addition, the operation creates a situation in which the enemy commanders may expose weaknesses and vulnerabilities that the friendly force can exploit to regain the initiative.

In retrograde operations, centralized control of IEW resources at division level is required. This enables the IEW coordinators to draw upon the full spectrum of the division's IEW assets to achieve the support required for operations.

GSR and ESM assets must be deployed well forward to provide maximum coverage for the flanks, any gaps, and for thinly held areas. Support to the brigades must be provided, as well as support to the entire force. To accomplish this, IEW assets must remain flexible and also capable of supporting any follow-on operations.

During retrograde operations, remote sensors may provide an element of security to units conducting the delaying action. Sensors can be emplaced and left in a stay-behind role to provide warnings of when and where enemy forces are moving. Units conducting retrograde may be able to use

sensors for flank and rear security. Once the forward echelon of attacking enemy forces has progressed beyond the stay-behind sensors, the sensors will prove valuable by providing indications of resupply or reinforcement activities of enemy rear echelon units. Retrograde operations must be carefully planned in order to locate and install sensor relay equipment. These relays will require camouflage and remote emplacement to avoid detection by enemy forces.

Sensors should also be emplaced in front of the new position to be occupied by our friendly forces. These sensors are employed for several reasons. One reason is to inform the commanders when the friendly units are approaching their new positions. Another application is to offer these units the early warning necessary to continue to avoid decisive engagement. An example of sensor emplacement in retrograde operations is shown in the illustration on the following page.

### **Delay Operations**

In delay operations, a force conducts combat operations designed to retain initiative while relinquishing as little space as possible for as much time as possible. Attack, defend, ambush, screen, raid, and feint make up the delay. There are two basic types of delay techniques under which these operations will fall. These are delay from successive positions and delay from alternate positions. There may be situations in which the commander may want or need to combine the two techniques. The factors of METT-T and the situation will determine the techniques used.



## RETROGRADE OPERATIONS

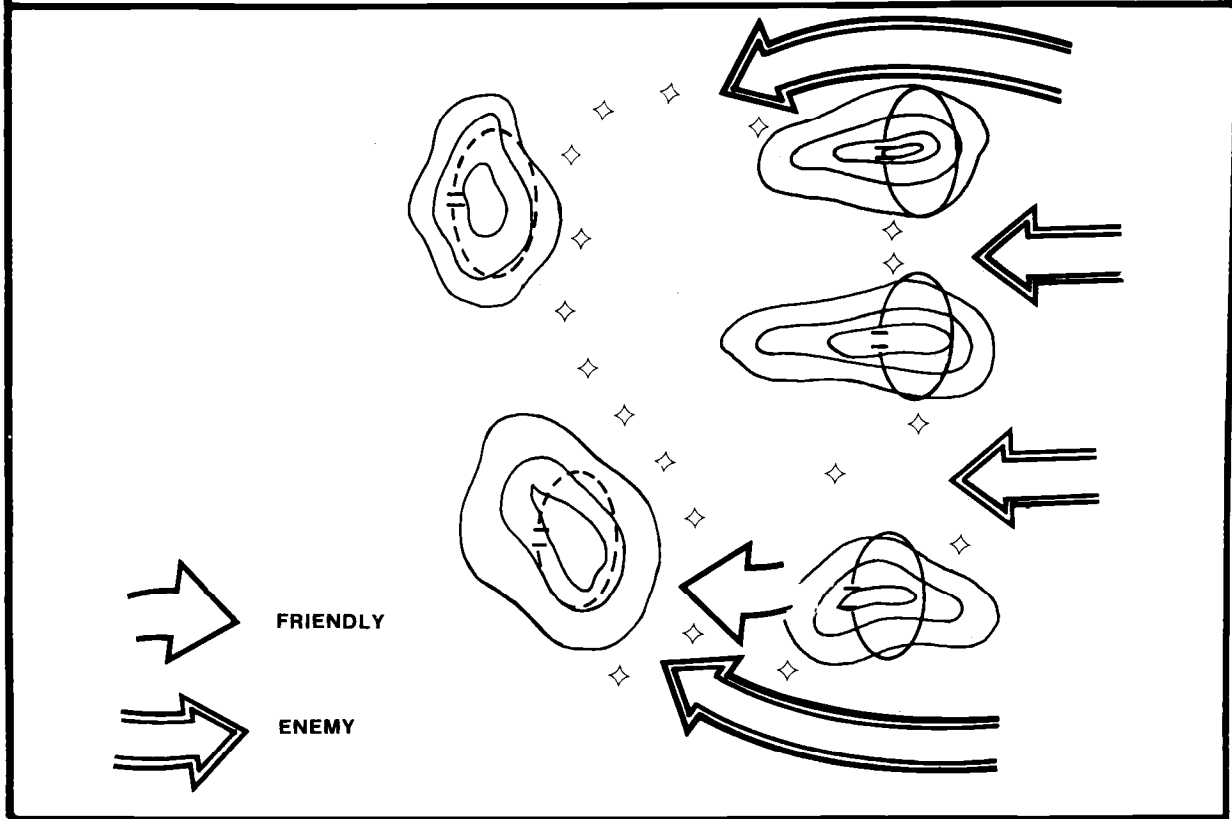

### Delay from Successive Positions

This technique is used when the sector is so wide that available forces cannot occupy more than a single tier of positions simultaneously. It requires units to continuously delay in or between positions and is characterized by simplicity of control, minimum preparation of positions, and less depth of forces. It is more easily penetrated than the delay from alternate positions technique. A graphic representation of the delay from successive positions techniques is shown in the illustration on the following page.

This tactic requires that the majority of available forces deploy forward along the most critical sector as determined by IEW resources and, due to the inherent vulnerability to flank penetration, provides major

mission support to units conducting an economy of force screen along the flanks. This frees the maximum number of maneuver units for the major avenue of approach, since selection of this tactic presumes a thinly spread force over a wide front.

As discussed in Chapter 4, IPB efforts will identify a series of delay positions that use the natural value of the terrain.

The MI battalion resources are tasked to support brigade and BTF commanders in maintaining contact with the enemy, identifying the enemy's weaknesses, disposition, and intentions. These resources will be located behind the initial delay positions (IDPs) and will focus on first- and second-echelon forces.

## DELAY FROM SUCCESSIVE POSITIONS

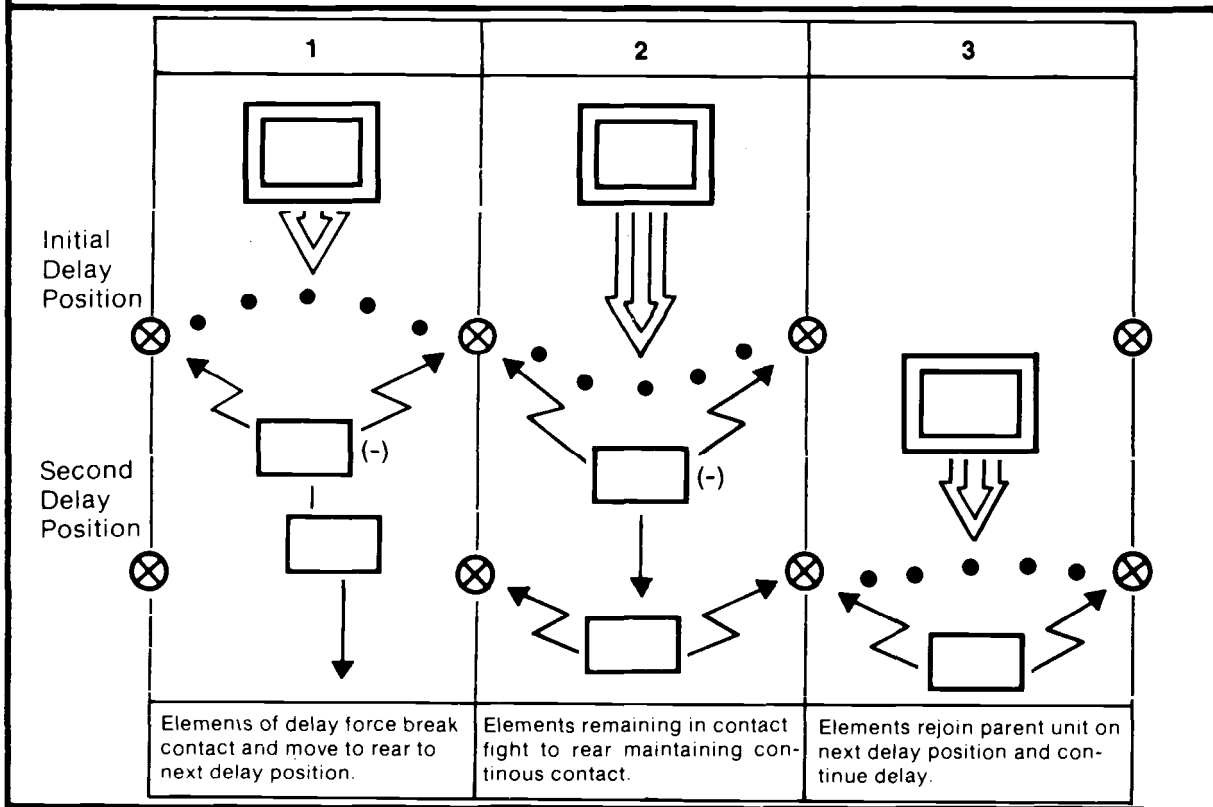

CI personnel enhance the force OPSEC posture by ensuring that the IDP, secondary delay-positions (SDPs), and time and routes of withdrawal are concealed from enemy intelligence efforts.

Interrogation assets will not find much activity during this phase of operations, and will assist other IEW functions at the direction of the MI battalion commander.

GSR will be used to survey gaps, critical areas, and avenues of approach, and to obtain target information for long-range fires. They are used primarily for early warning and can furnish significant information about the enemy. The AN/PPS-15, along with other surveillance devices, is used forward of, or on, the IDPs to detect areas of greatest enemy pressure. The information provided will help the commander decide the best time to withdraw to his SDPs. GSRs and other surveillance systems are kept in position as long as possible, both to monitor enemy avenues of

approach and to continue the radar emissions to deceive the enemy.

GSR teams in position simulate normal activity, maintain surveillance over the enemy, and move to the SDP prior to the withdrawal of the last maneuver elements left in contact.

EW resources will intercept and locate enemy first-echelon regiment and division communications and noncommunications emitters and perform ECM against enemy high-payoff communications emitters.

Voice collection teams' resources deploy with or behind the maneuver elements' IDPs. Close coordination with the maneuver elements must be established and maintained throughout the operation. Voice collection teams intercept enemy HPTs as determined and tasked by the TCAE. The brigade S2, using PIR and IR of brigade and battalion commanders, requests mission tasking through the IEWSE. The voice collection product will be reported to the

TCAE and concurrently monitored by the IEWSE for information requiring immediate action on the part of the supported commanders. In this instance, combat information will be passed by TACREP to the affected commander through the IEWSE to the S2 or BICC. The technical intelligence is forwarded to the TCAE. Redeployment of the voice collection teams is by order of the next higher commander. Those collection assets located in the SDP will assume coverage of the mission to permit the forward elements' displacement to the SDP. Elements along the flanks between the IDP and SDP will retain their positions until physically relieved and picked up by IDP forces. Upon the completion of occupation of the SDP by IDP elements, those elements originally in the SDP will withdraw to the next delay position.

Throughout the delay operation, EAC aerial assets will provide voice collection targeted against enemy emitters located within the division's deep operations area.

The SPP (TRAILBLAZER) deploys its elements as in the defense. Redeployment uses the same internal leapfrog methods used during both the offense and defense. TRAILBLAZER seeks locations of HPT as tasked by TCAE. Its DF information, together with data from GSR, TEAMPACK, voice collection teams, and other RSTA assets, enable HPTs to be engaged by friendly fire support. Because TRAILBLAZER continuously moves throughout the division area, DF support is less direct than the voice collection support. TRAILBLAZER deploys between the IDP and SDP across the division front, focusing on the expected enemy main effort as determined by METT-T and analysis of the voice collection product. SPP HQ, collocated with one of the MCSs, reports DF results and intercept data to the TCAE which provides information to the brigade S2 via the IEWSE. When the information received by TRAILBLAZER is extremely perishable, the SPP, by TACREP, reports directly to the IEWSE at the affected brigade. TRAILBLAZER redeployes on orders from the MI battalion commander through the TCAE. The leapfrog method is used to retain continuity of the mission. It will be relocated approximately

5-10km behind the SDP and be directed against the main enemy effort.

The noncommunications data produced by TEAMPACK is combined with GSRs, TRAILBLAZER voice collection, and other RSTA assets to assist in targeting for friendly fire support. TEAMPACK is valuable in suppressing and defeating enemy air defense systems, surveillance radars, and counter mortar or counterbattery radars by locating them. Identifying the system and plotting its movement provides the commander with the location of the enemy's main effort. Unnetted TEAMPACK reports its data through the EW platoon headquarters to the TCAE, where it is analyzed and reported to the brigade S2. Netted TEAMPACK reports directly to the TCAE and then follows the same route as the unnetted system.

Redeployment of TEAMPACK as the operation progresses is conducted in the same manner as with voice collection resources.

ECM systems are carefully controlled in retrograde operations. Friendly ECM assets are high-priority REC and FS targets and therefore come under the centralized control of the TCAE and division G3. Brigade and battalion commanders will see the ECM systems in their AO but may be unable to task them with the jamming of enemy communications. However, if it becomes necessary to use high-powered communications, because of enemy ECM, the brigade and battalion commanders can task the ECM elements, through the brigade IEWSE, to provide "burn-through" communications capability. Friendly SIGSEC elements can task the ECM elements to conduct COMJAM screening of friendly communications to prevent inadvertent disclosure of sensitive information to the enemy. The MI battalion commander authorizes this ability on orders from the division commander. ECM perform the same function against the same targets as in offense and defense operations. TACJAM will be located in the vicinity of the IDP and TRAFFIC JAM will be located near the SDP. Redeployment of ECM assets is accomplished as is the voice collection team, with the SDP elements assuming the mission for the IDP during relocation. The original SDP elements will

move to other deployment positions toward the rear, once the IDP elements are established in the SDP.

Typical EW element deployment is illustrated in the following figure.

### Delay from Alternate Positions

The principal difference between alternate and successive delay operations is that, in the alternate system, two units are used in a single sector. Each delays alternately. While the first is fighting, the second unit occupies the next delay position in depth and prepares to assume delay responsibility. As the first disengages and passes through or around the second unit, the second unit takes up the fight. The first unit then occupies a deeper position and prepares to subsequently resume the delay. Delay from alternate positions is characterized by continuous, more complicated coordination of fire and maneuver, requires

more forces, and provides greater security. It is also more difficult to maintain contact with the enemy. A graphic representation of this technique is shown in the illustration on the following page.

The delay from alternate positions is characterized by a higher density of forces operating on a narrow front.

GSR elements are employed in the same manner as during the delay from successive positions, with the exception that those elements organic to Task Force A will remain with Task Force A, while those elements organic to Task Force B stay with their own.

EW elements operate in the same fashion as is accomplished in operations from successive positions.

In all cases, coordination with the maneuver elements is essential.

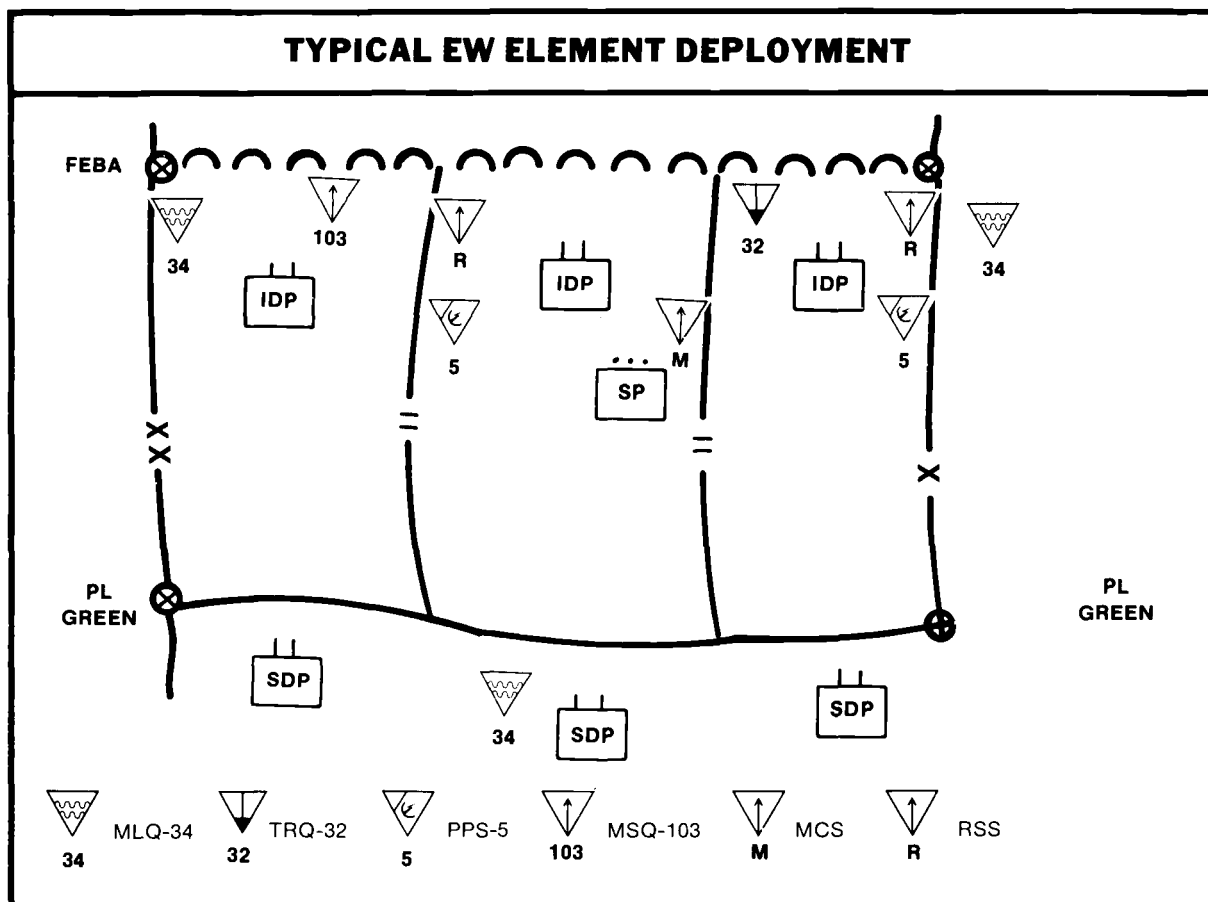

## DELAY FROM ALTERNATE POSITIONS

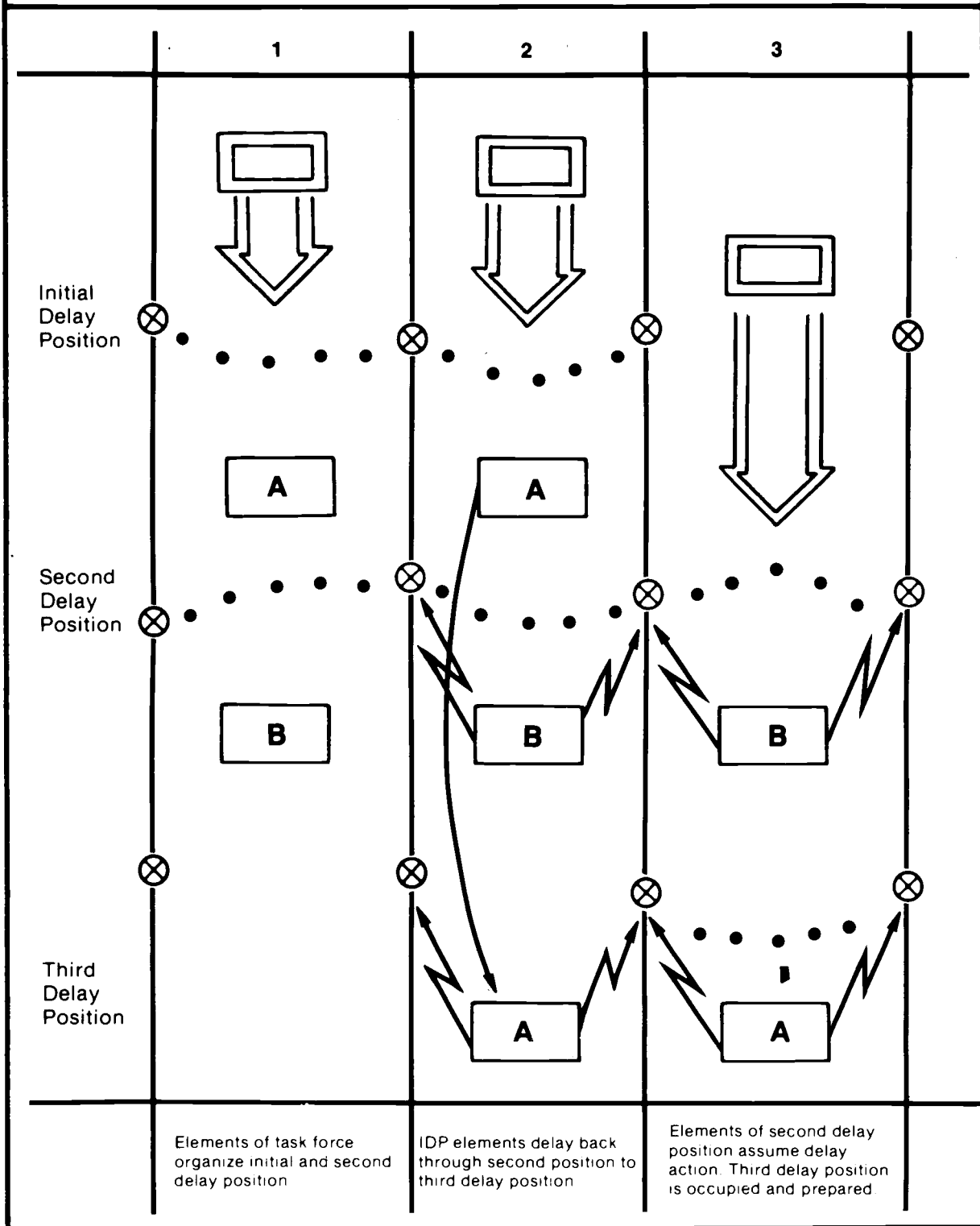

## Withdrawal

Brigades and battalions assigned a withdrawal mission maintain contact with the enemy to provide security and deception, and to prevent a rapid enemy advance. There are two basic types of withdrawals—

- Withdrawal not under enemy pressure.
- Withdrawal under enemy pressure.

Withdrawal not under enemy pressure affords the commander enhanced freedom to maneuver with minimum casualties. This type of withdrawal is characterized by centralized control and contingency planning, to include alternative routes, priorities, and effective traffic control.

The following diagrams graphically display this technique.

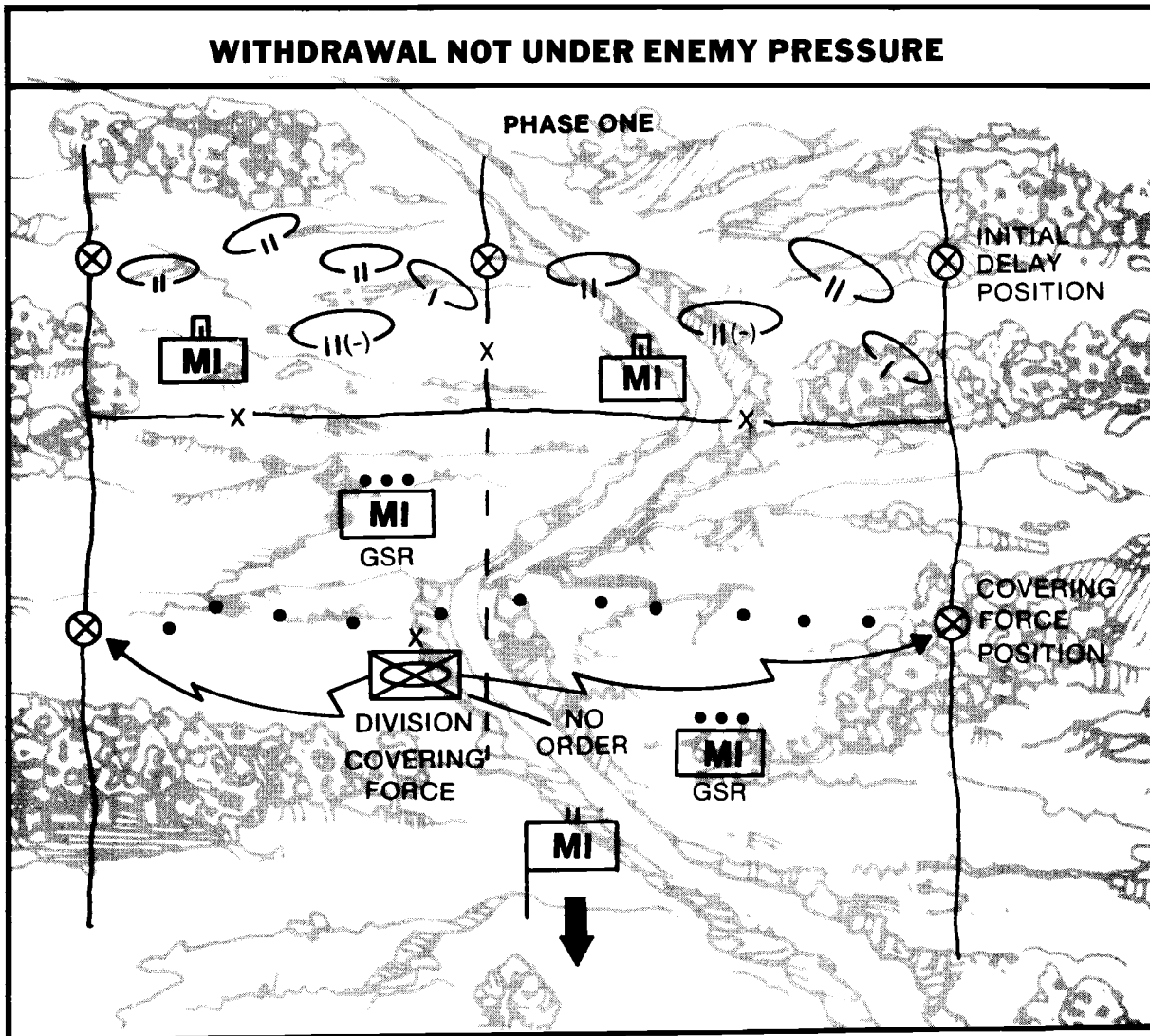

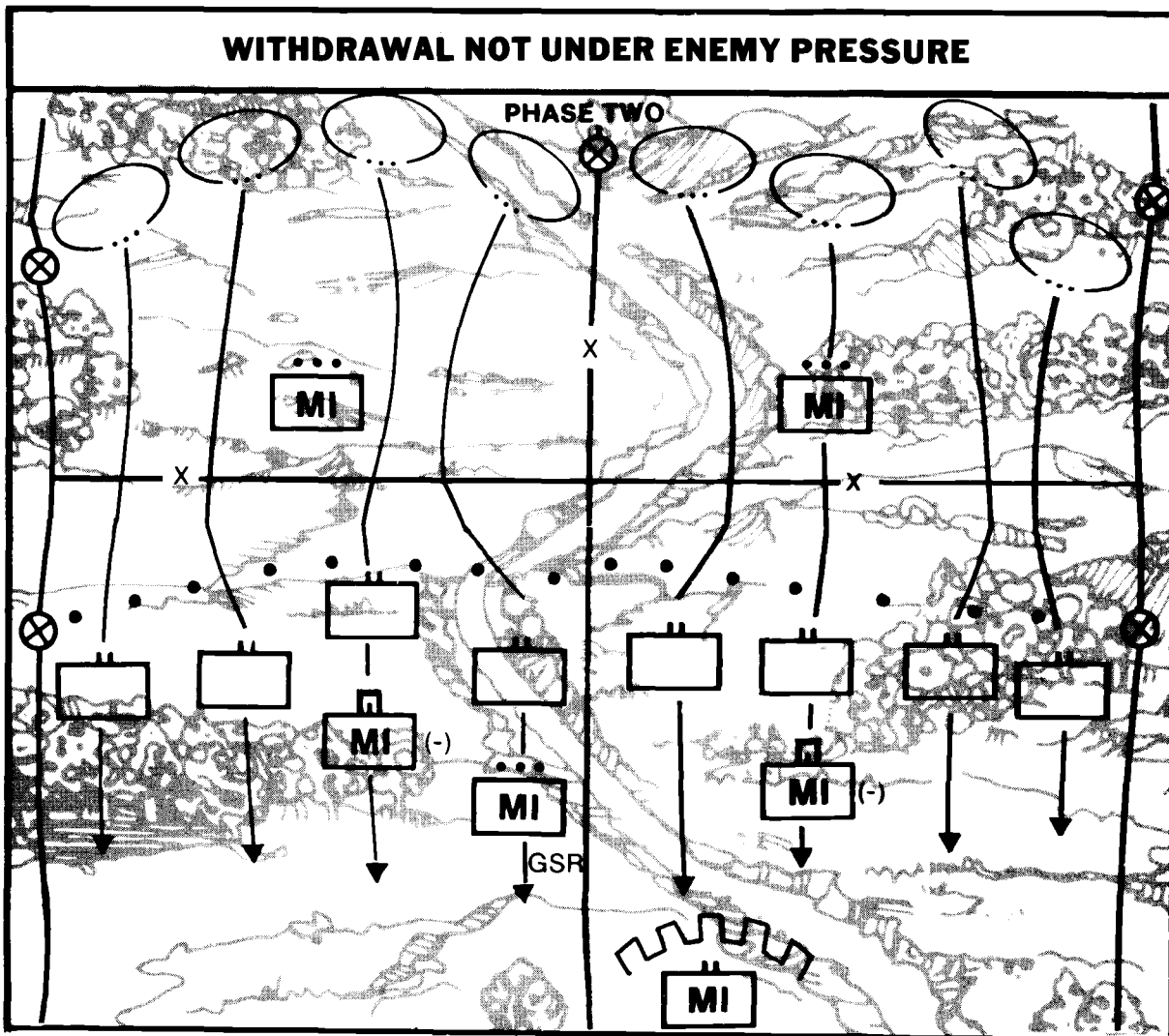

A withdrawal not under enemy pressure operation is begun by the brigade commander designating detachments to be left in contact (DLICs) to protect the initial movement of the main body of the force. DLICs also perform a vital deception role by simulating normal brigade activity, thus masking from enemy intelligence the main body's movement. IEW resources, especially CI teams, play a vital role in this operation.

The simulation of normal unit activity is closely monitored by OPSEC evaluation teams, based on the unit's signatures, patterns, and profiles. In addition to other countermeasures, fire and maneuver are employed to reduce the effectiveness of

enemy intelligence collection capabilities. CI personnel assist MP and civil affairs units in maintaining control of the civilian populace in the zone.

GSR elements are deployed as in delay operations and are tasked to observe probable avenues of approach, open areas, and key terrain features, both natural and man-made. In short, they make the enemy believe that the brigade is on line while providing vital information to the DLIC elements.

EW elements will be used in the brigade's CFA, ready to support the operation. All elements not vital to the DLIC withdraw to

final new positions. The TCAE and the MI battalion support elements are in the first withdrawal. Voice collection, SPP, noncommunications, and some ECM assets will be deployed with the DLIC. Tasking for all EW elements is from the TCAE with a jammer system used to provide high-power VHF "burn-through" communications, if needed. All combat information and perishable intelligence will be reported to the brigade S2 through the IEWSE and all technical intelligence will be routed to the TCAE through the SPP when communications allow.

All MI assets with the DLIC will deploy to new positions through the covering force when the DLIC withdraws. GSR assets assist to vector the DLIC during periods of poor visibility and darkness.

Withdrawal under pressure differs significantly from withdrawal without pressure. Units use delaying tactics to fight their way to the rear. All units initiate action simultaneously in a given sector. A covering force is highly desirable to assist the disengagement of committed units. It may also be used to initiate a counterattack. Key to the successful conduct of a withdrawal under enemy pressure is superior mobility, effective covering force employment, sound C<sub>2</sub>, and local air superiority. A graphic example of a withdrawal under pressure is shown below.

IEW support and actions are similar to a delay from alternate positions.

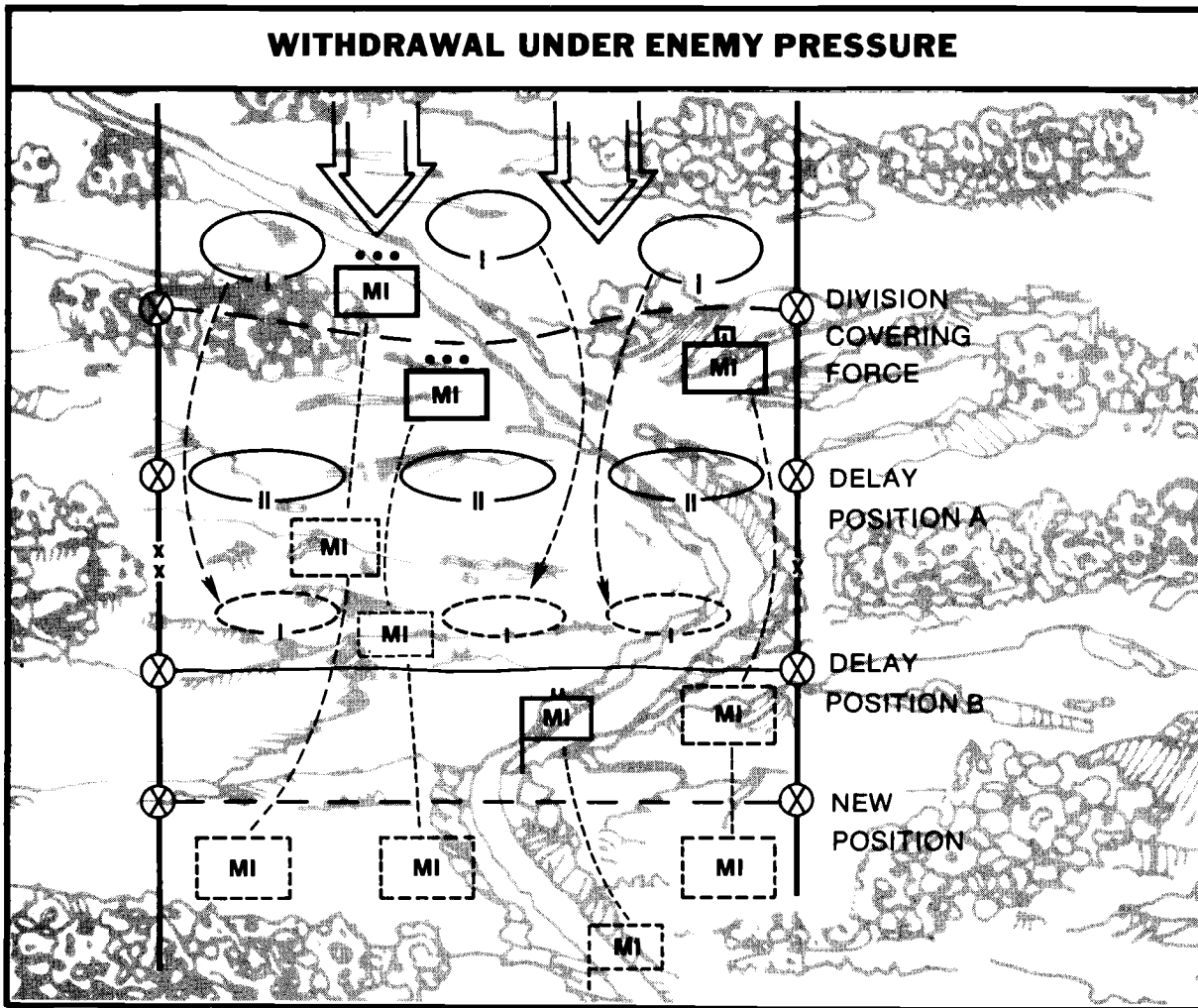



## OTHER TACTICAL SITUATIONS

### Defense and Breakout of Encircled Forces

The nonlinear nature of the modern battlefield presents units with a high probability that enemy forces will encircle them. This is especially true at the brigade and BTF and of the MI elements supporting them. Encirclement of friendly forces may happen by a rapidly changing situation or may be by design.

#### Defense

When encirclement is unforeseen, the first action to be accomplished is that the senior commander present must organize a defense and establish a unity of command. The most immediate problem facing the commander is the preservation of the force. Breakout from the encirclement is the next priority. If a breakout is to be made, the attempt must occur before the enemy can consolidate their positions. If no breakout

attempt can be made, the commander continues the defense and plans for a linkup and to assist a relieving force. The commander must reorganize and consolidate the units within the encirclement to include the IEW assets and MI units.

IEW support to the encircled forces is vital. The force commander must receive intelligence immediately concerning the following:

- Composition and disposition of encircling enemy force.
- Enemy reinforcement units.
- Exploitable weaknesses in the enemy disposition through which breakout or linkup can be effected.
- Enemy intent to use NBC weapons.

ECM support is crucial to the breakout and deception operations.

The following chart depicts the tasks that the commander must accomplish and what the S2 and senior MI commander must do to support those tasks.

<b>IEW SUPPORT TO DEFENDING ENCIRCLED FORCE</b>	
<b>ENCIRCLED FORCE COMMANDER</b>	<b>IEW SUPPORT</b>
Re-establishes chain of command	<ul style="list-style-type: none"> <li>• MI chain of command established</li> <li>• Re-establishes communications with higher (parent) MI unit</li> </ul>
Establishes a viable defense	<ul style="list-style-type: none"> <li>• Orients on the dangerous avenue of approach</li> <li>• Disperses and protects IEW systems for survivability</li> <li>• Integrates MI elements into defensive plan</li> </ul>
Establishes a reserve	<ul style="list-style-type: none"> <li>• Assigns MI elements on-order missions to support commitment of reserves to contain penetrations/maintenance of interior lines</li> </ul>
Reorganizes fire support	<ul style="list-style-type: none"> <li>• Establishes procedures for integration of EW</li> </ul>
Reorganizes force logistics	<ul style="list-style-type: none"> <li>• Centralizes common supplies</li> <li>• Enforces supply discipline</li> <li>• Acquires external SIGINT/EW/GSR unique re-supply if required, possibly by air drop or helicopter lift</li> </ul>
Establishes security	<ul style="list-style-type: none"> <li>• Integrates IEW assets</li> <li>• Provides CI support</li> </ul>

While part of an encircled force, MI elements respond directly to that force commander's requirements. The senior S2 of the force will establish the HVT and HPT for the MI units based on the previous chart and METT-T. The efforts of the MI elements of the encircled force must be coordinated with efforts of those MI elements at the main force outside the encirclement. Use of high powered jammers could be required to provide "burn-through" communications for this coordination because of heavy enemy COMJAM operations.

The senior MI commander assumes temporary C<sup>2</sup> over the MI elements within the encircled force. That officer is responsible for the quick reorganization of the MI elements available to the force commander. That reorganized MI unit will then respond to the commander as the divisional MI battalion does.

EPWs are interrogated by available EPW interrogation teams to ascertain the size of the enemy force and its strengths and weaknesses, to include personnel and equipment makeup. Information as to the size, location, and availability of enemy reserve forces is also obtained.

GSR teams are deployed around the encircled force to provide the S2 and force commander with information on locations and size of enemy front-line forces, and to provide early warning about enemy movement to attack. GSRs are also used to vector patrols through enemy front lines during probing actions.

EW elements deploy, are employed, and redeploy similarly to the delay from successive positions in retrograde operations.

All tasking for the ESM elements is from a reorganized TCAE or analysis section based on the force commander's priority and target list as outlined in Chapter 4. Primary targets will include enemy forces' disposition and any reinforcing elements. Reported combat information goes directly to the force commander through the IEWSE and S2. Any technical data will be reported to the analysis section of the reorganized TCAE as time and the situation permit. SPP (TRAILBLAZER) elements in the encircled force area will respond to tasking as

will other voice collection assets. Target locations are unlikely, so the SPP elements that are available will provide communications intelligence and LOB data. The SPP headquarters element, if in the encircled force area, becomes the primary element in technical control and analysis for the encircled EW elements if there is no other TCAE present. The MCS, if present, will be used as the primary intercept and LOB station, due to its accuracy and sensitivity above the AN/TRQ-32 and MRDFS elements. The RSS elements are used as LOB data stations. All ESM elements are employed within 2 to 5 kilometers of the FLOT as directed by the MI commander based on the force commander's priorities.

Noncommunications intercept elements (TEAMPACK) will be used primarily to locate the enemy fire support radar systems, GSR systems, and air defense radar systems. This enables the S2 to determine the enemy's main effort and troop concentration. Intelligence from TEAMPACK is reported to the S2 through the IEWSE. All technical intelligence is transmitted to the designated TCAE as time and situation permit. As with TRAILBLAZER, TEAMPACK will most likely be separated so that only one or two units will be available to the MI unit commander for tasking. Precise locations of the enemy radar systems will be impossible using the separated TEAMPACK element, but LOB data will be available. Using this, along with other ESM data, GSR results, OP observations, and friendly countermortar and counterbattery radar results, an accurate location can be determined.

ECM assets have, as stated previously, the number one priority of providing the force commander with a high-powered communication capability that allows for continuous coordination with the main force. If the commander requires a deception operation, C—E and CI assets provide a vital element for SED operations. COMJAM equipment can be used for demonstration and feints. Deployment of COMJAM systems is dependent upon specific mission requirements. Because of heavy enemy REC activity, the TACJAM and TRAFFIC JAM systems must redeploy, often away from

any friendly C<sup>2</sup> elements. All ECM assets in the encircled force are tasked by the MI unit commander to attack HPT, based on the force commander's priority. Tasking is accomplished through the EWO and the supported staff element.

All IEW elements are prepared to support breakout and linkup operations. The attack to break out of an encirclement is conducted on a narrow front, while a simultaneous defense is conducted in the remaining sectors of the perimeter. The encircled force is organized into four elements for the breakout:

- Rupture force.
- Reserve force.

- Main body.
- Rear guard.

The force commander, as with defense of the encircled force, has certain tasks he must perform to accomplish the breakout. The chart on the following page shows the commander's tasks and the applicable IEW support measures for those tasks.

The following figure portrays the breakout force and possible IEW resource disposition within that force.

The rupture force opens the gap that the rest of the breakout force will pass through. It holds the shoulders until the main body passes through and is joined by the rear

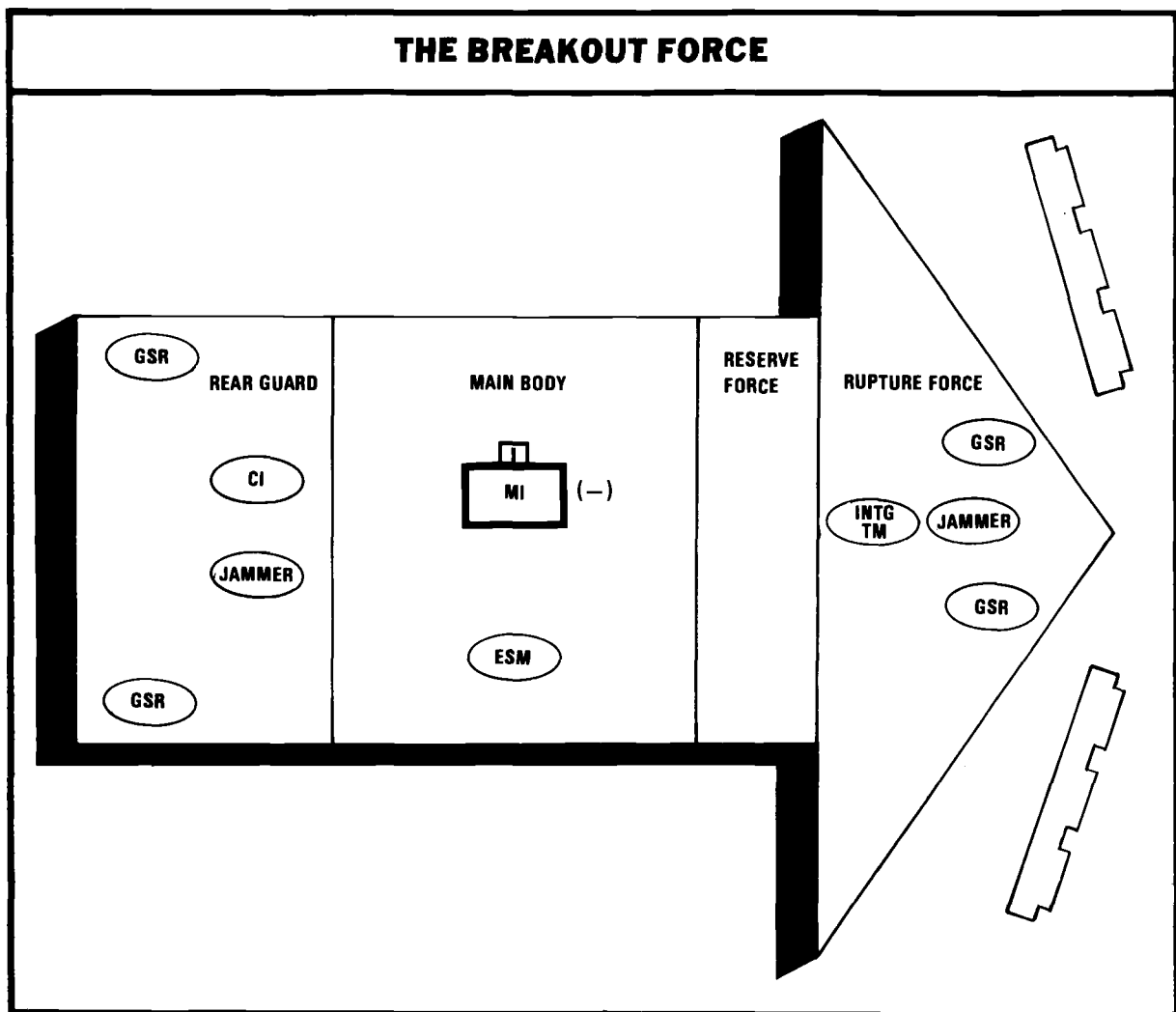

## IEW SUPPORT TO PREPARATIONS FOR BREAKOUT

ENCIRCLED FORCE COMMANDER	IEW SUPPORT	
Deceives the enemy as to the time and place of breakout	<ul style="list-style-type: none"> <li>• Advises and assists in preparation of plan to include OPSEC aspects</li> </ul>	<ul style="list-style-type: none"> <li>• Provides CI and ECM support</li> </ul>
Exploits gaps and weaknesses in enemy forces	<ul style="list-style-type: none"> <li>• Identifies enemy dispositions and possible reinforcements</li> <li>• Identifies exploitable advantages of weather and terrain; especially concealed routes</li> <li>• Directs collection to fulfill information gaps</li> </ul>	<ul style="list-style-type: none"> <li>• Identifies assailable weaknesses</li> </ul>
Exploits darkness and limited visibility	<ul style="list-style-type: none"> <li>• Uses GSR to vector forces</li> </ul>	<ul style="list-style-type: none"> <li>• Uses GSR for targeting</li> </ul>
Organizes the breakout force	<ul style="list-style-type: none"> <li>• Integrates MI support into advance force, main body, and rear guard</li> <li>• Integrates ECM into breakout to magnify surprise, enhance shock effect, and "freeze" enemy in place</li> <li>• Sees ahead of advance force to maintain momentum to breakout</li> <li>• Provides combat information to unit conducting supporting attack</li> </ul>	<ul style="list-style-type: none"> <li>• Ensures continuity of IEW communications via aerial relay during breakout</li> <li>• Uses ECM to "slow/freeze" enemy reinforcements</li> <li>• Jams fire control communications</li> <li>• Provides surveillance and reconnaissance for flanks and rear</li> <li>• Coordinates coverage with higher IEW staff/unit</li> <li>• Provides CI support</li> </ul>
Re-establishes communications	<ul style="list-style-type: none"> <li>• Reports all deep operations data to higher headquarters</li> </ul>	<ul style="list-style-type: none"> <li>• Requests aerial/ground relays</li> </ul>
Limits damage by nuclear or chemical attack	<ul style="list-style-type: none"> <li>• Increases MOPP level</li> <li>• Locates and reports enemy NBC delivery systems</li> </ul>	<ul style="list-style-type: none"> <li>• Ensures NBC readiness</li> <li>• Takes action to minimize effects of EMP</li> </ul>
Continues the defense	<ul style="list-style-type: none"> <li>• Develops contingency plans</li> </ul>	<ul style="list-style-type: none"> <li>• Provides continuous IEW support</li> </ul>
Maintains morale	<ul style="list-style-type: none"> <li>• Counters rumors, subversion, sedition, and propaganda</li> </ul>	<ul style="list-style-type: none"> <li>• Jams enemy PSYOP intrusions</li> </ul>
Considers exfiltration	<ul style="list-style-type: none"> <li>• Develops intelligence reporting channels to exploit HUMINT in the breakout corridor</li> <li>• Provides CI coverage for evacuated areas and CPs</li> </ul>	<ul style="list-style-type: none"> <li>• Provides counter-technical intelligence for destroyed equipment</li> <li>• Provides wounded with EEFI</li> <li>• Supports creation of diversions</li> </ul>

guard. As shown on page 5-57, the armor-heavy rupture force will use GSR, usually the high-powered AN/PPS-5 to vector away from enemy force concentrations or during periods of low visibility or darkness. The EPW element screens any prisoners or documents acquired during the rupture force breakout. The information gathered is sent to the encircled force commander through the S2 at the main body. EW elements consist solely of jammers. The jammers disrupt enemy C<sup>2</sup> to both maneuver and fire support elements near the breakout area. The MI command element, with the main body, will task and control the rupture force jammers based on ESM and GSR collection efforts.

The reserve force does not possess any IEW resources until it assumes the role of lead element to the breakout. The rupture force holds the flanks to allow the remaining forces to break out. When the reserve force passes through the rupture force, it assumes the rupture force IEW assets. The GSR, EPW, and ECM elements continue to perform the same functions and are tasked and respond the same way as when attached to the rupture force.

The main body consists of the encircled force commander, his headquarters, and remaining combat support and CSS elements. The MI units' headquarters analysis element and all ESM elements move with the main body. From this area, the ESM assets can cover the rupture and reserve force, flanks, and rear guard area. The MI headquarters assists the force S2 and commander in controlling all the MI assets.

The rear guard provides the deception effort to confuse the enemy as to where the main effort is to occur, and provides protection to the rear of the force as it progresses through the rupture. The rear guard is usually placed under the control of the force XO, and contains a representative force structure to simulate the main body. The rear guard acts as a covering force. CI elements provide for OPSEC and prevent disabled equipment, supplies, and CPs from falling into enemy hands. GSR elements provide flank and rear security and targeting data for FSE. The ECM assets will dis-

rupt the enemy's C<sup>2</sup> and slow down any reinforcement.

Once the breakout is accomplished, the force commander re-forms the force into movement to contact configuration, as described earlier in this chapter. Every effort is made to bypass enemy forces along the route. If bypass is not possible, the force will move to the hasty attack from the movement to contact mode.

If a breakout is not possible, relief by another friendly force is probable. The relief force attacks the encircling enemy force's rear area and defeats him. The encircled force commander and IEW assets perform the tasks outlined in the chart on the following page.

Heavy enemy REC is expected in this phase of operations. ECM assets will provide high-powered communications among the encircled force commander, relief force commander, encircled MI element commander, and MI commander attached to the relief unit. ESM elements will operate as in defense operations.

GSRs provide the relief force commander with probable avenues of approach, and assist in vectoring the relief force during periods of darkness and low visibility.

## IEW SUPPORT TO LINK-UP OPERATIONS

ENCIRCLED FORCE COMMANDER	IEW SUPPORT
Coordinates plans for linkup	<ul style="list-style-type: none"> <li>• Shifts IEW control to linkup force</li> <li>• Exchanges enemy situation data</li> <li>• Coordinates and fulfills PIR</li> <li>• Provides IEW-unique logistic requirements</li> <li>• Sees deep and develops situation for actions after linkup</li> <li>• Receives IEW liaison officer</li> <li>• Coordinates CEOI for IEW</li> </ul>
Supports the relief attack	<ul style="list-style-type: none"> <li>• Reads battle and reports to relief force</li> <li>• Supports with ECM</li> </ul>
Coordinates subsequent actions	<ul style="list-style-type: none"> <li>• Coordinates subsequent actions</li> </ul>

### SPECIAL OPERATIONS AND ENVIRONMENTS

The geographic range of US interests in the world today requires that the Army be prepared to fight and win in all types of terrain and climate.

Army tactical units may be committed to battle in those areas where severe weather, climate, and terrain impact on military operations and the intelligence mission. In addition to the physical effects on the individual soldier, environmental extremes limit intelligence collection capabilities. Regardless of environmental conditions, the commander needs information about the enemy, weather, and terrain.

Special operations are those in which the natural and man-made characteristics of the area, the nature of the operations, and the unique conditions under which the operations are conducted, may require specially trained personnel and special techniques, tactics, or equipment.

The environments that have a strong effect on special operations are—

- Mountains.
- Jungles.
- Deserts.
- Winter.
- Urbanized terrain.

While the fundamental principles discussed in previous chapters apply to special environments, brigade and battalion S2 personnel must understand the limitations imposed on collection resources by harsh environments. Specialized training and acclimatization periods are required before personnel can be effective in certain parts of the world.

The effects of extreme climatic and terrain factors generally cause military operations to proceed at a slower rate than in more favorable environments. Set-up and break-down times may be longer, and rates of march slower. Routine functions, such as communications, can become a major

undertaking. S2s ensure that intelligence planning for combat operations takes into consideration the influence of a special environment on intelligence functions, personnel, and friendly and enemy operations.

While the means to collect data in special environments are identical to those employed in a normal environment, the methods of employment and equipment used may differ.

The enemy's methods of employment and deployment will also differ, but only to the extent permitted by their doctrine, or dictated by the environment.

## MOUNTAIN OPERATIONS

Mountainous terrain exists in the jungle, temperate, and arctic regions of the world. Operations conducted in mountainous areas are characterized by heavy use of indirect fires, canalized movements along valley floors, decentralized combat, increased collection operations from aerial IEW operations, and reduced C<sup>2</sup> capabilities. Mountain operations conducted by MI units have restricted operational and sustainment capabilities.

Mountainous terrain degrades target acquisition and early warning capability of GSRs, and collection capabilities of EW systems. Such degradation places an increased importance on emplacement and utilization of GSR and EW systems. Both elements may have to use their manpack equipment to best support the commander.

Because of the low density of manpack IEW equipment in the division, brigade areas will be unsupported or severely reduced in GSR and EW support. Although operations may be severely hampered, the mission for all MI assets remains the same as in any other type of operation. The optimum operation of these IEW systems in mountainous terrain is affected by interrupted LOS, extreme temperature variations, heavy precipitation, and a lack of readily available support and supply parts.

In mountain operations, the terrain isolation of friendly units may require brigades and battalions to operate more independently than in other environments. In this case, the S2 is required to make judgments

beyond the scope of his usual role. S2s may find themselves unable to communicate with higher and adjacent units, forcing them to rely on their own resources to develop intelligence and determine an enemy's probable course of action.

Mountain weather is difficult to predict. In many areas, the weather can change dramatically in short periods of time. As storms develop, the effects of the temperature and windchill factor may become as important an item of intelligence as the location and activity of major enemy units. Exposed flesh can freeze in a matter of seconds. The higher elevations are frequently shrouded by rain, snow, sleet, and fog. Electronic surveillance and visual observation are severely limited under these conditions.

When weather permits, mountain heights offer outstanding conditions for long-range visual observation and electronic surveillance.

Weather data and forecasts are increasingly more important in selecting areas and times to conduct operations.

Cross-country movement and trafficability become more important in determining enemy capabilities and intentions. Potential enemy use of nuclear weapons in mountainous terrain is a prime intelligence consideration. In some mountainous terrain, the effects of nuclear detonation can be effectively contained within a specified area.

Wooded mountainous terrain has the same general effect on intelligence operations as does dense jungle. Enemy forces are difficult to locate and collect against. As in jungle terrain, the S2 will find his best sources of information to be EPW, defectors, and friendly reconnaissance patrols.

Mountainous terrain favors those operations which use stealth and the cover of darkness. Forces will likely be deployed to control passes, road junctions, built-up areas, and the high ground adjacent to these areas. Enemy tactics include bypassing defensive positions and attacking from the flanks and rear. Enemy forces will decentralize the employment of artillery

and use multiple rocket launchers as individual fire units.

S2s rely on front-line soldiers, aircraft crews, vehicle operators, and maps for terrain analysis.

Mountain tactics favor the use of helicopters to drop enemy forces behind friendly emplacements, and for reconnaissance, C<sup>2</sup>, resupply, and evacuation.

Enemy forces can be expected to use infantry troops in the higher elevations. Motorized rifle units and tanks may be encountered in the lower elevations, broad valleys, depressions, and on the slopes of small hills.

In defensive positions, enemy tanks will be found in tiers on both forward and reverse slopes, usually within platoon-sized strongpoints. Enemy defensive frontages can be expected to increase in mountain warfare. The enemy force will select the terrain most suitable for defense and the most inaccessible to the friendly force. Mountain operations are usually directed at the control of passes. The force that controls the mountain passes controls a significant amount of terrain.

Rugged, irregular mountain terrain degrades AM and FM communications effectiveness and associated C<sup>2</sup>. Heavy reliance on retransmission and relay is required. Heavy (TACJAM) and medium (TRAFFIC JAM) ECM equipment can be used to relay communications when necessary.

HUMINT provides the commander with his best source of combat information and intelligence. Mountain heights offer exceptional OP sites which may be supplemented by foot patrols. Population centers in valley areas provide a HUMINT collection and interrogation potential, especially for terrain intelligence information.

OPSEC, as in all operations, will be of prime importance for attacking forces. Defending forces will have a distinct advantage to deceive and contain any attack.

EW operations suffer a definite disadvantage in mountainous terrain. Enemy communication sites use terrain masking, relay,

and retransmission to thwart both RDF and ECM activities.

The irregular terrain, multitude of dead spaces, and degraded C<sup>2</sup> will render EW less effective in the mountains than in other types of terrain.

ESM systems, such as TRAILBLAZER and TEAMPACK, are best employed on high ground, concentrating on enemy approaches.

ECM systems will find the most effective use in the same area as the ESM assets. Their employment is directed against the population centers, enemy broadcast blocking, and avenues of approach. ECM equipment (TRAFFIC JAM) is also used to retransmit friendly C<sup>2</sup> messages.

Aerial systems, SLAR and QUICKFIX, are used in other operations, although the mountainous altitude may require the QUICKFIX crew to use oxygen and operate for a shorter duration.

Ground-based RDF is accomplished by the MRDFS often employed in DS to the brigades. The amount of support provided will depend on equipment density. LOB data may be questionable, due to the terrain, but will normally be used in conjunction with QUICKFIX.

Sustainment considerations in special operational environments can be numerous. Equipment used in a mountainous environment must be rugged and man-portable. Cold weather in the higher elevations, or during seasonal variations, will affect equipment in the same manner as in winter operations.

Transportation limitations will require greater use of field expedients than in other types of operations. Because of the rugged nature of the terrain, greater consumption of Class IX repair parts will occur, and will demand a 20 percent overage in PLL and ASL for such items as tires, transmissions, clutch plates, filters, brake shoes, tracks, track pads, and fuel pumps.

The key to sustaining soldiers in the mountains, as in other special environments, is training. Mountain combat can affect a soldier's mental alertness, accentuate fears of heights and closeness, and cause dehydration and sickness.



Additional information on mountain operations is contained in FM 90-6.

## JUNGLE OPERATIONS

The jungle regions of Asia, Africa, and Central and South America are potential areas of conflict where US forces could be involved. Jungles vary from tropical rain forests and secondary growth to swamps and tropical savannas. Heavy rainfall, high and constant temperature, high humidity, and thick vegetation are the dominant features of jungle areas. These factors—climate and vegetation—contribute to the restriction of operational and sustainment capabilities of MI units.

Because of the nature of the jungle, IEW operations will be decentralized. Ground mobility restrictions of the jungle require that all IEW systems be light, man-portable and rugged, and fielded in greater densities than in other, more open environments.

The climate, dense vegetation, and subsequent reduced radio LOS, significantly reduces communications in both AM and FM. Electromagnetic radiation is absorbed by a factor of 10 to 25 percent and communication ranges will decrease by a factor of 20 percent. To facilitate effective C<sup>2</sup>, hilltops or aerial relays may often be used. Although wire appears a logical method, security and maintenance considerations may preclude its use.

Jungle vegetation limits identification of sounds, smells, deployments, movements, locations, and other activities which might otherwise be detected. It severely limits the use of enemy force signatures to identify types of units and activities. Intense tropical storms can temporarily preclude the use of electronic collection equipment. Thick jungle terrain restricts mobility largely to roads and footpaths. The S2 may find that the best sources of information are EPWs, defectors, patrols, and the local populace—in other words, HUMINT.

The local populace can provide a wealth of information about enemy forces operating in the local area. In insurgency situations, efforts are made to identify individuals that support the enemy by providing supplies, food, and information about friendly forces in the area.

Heavy rain showers limit the detection of enemy electronic signatures to short ranges. GSRs in heavy jungle foliage will be of little or no value. Signal reflections from vehicles and troops passing through or behind dense foliage tend to be inaccurate and unreadable. Although GSR operations in jungle environments normally are limited, they are still a valuable asset to the supported commander when properly employed. GSR is particularly useful in preventing surprise when used with other battlefield surveillance devices. REMS located along roads and trails indicate activity on those routes, but cannot distinguish between enemy and other activity.

Lightly equipped LRRPs and long-range surveillance units (LRSUs) play a major role in jungle intelligence collection operations. The terrain improves chances for accomplishing their mission unobserved and undetected. In patrol planning, consideration is given to the possibility that an aerial resupply, often required in jungle operations, will provide the enemy with indications of patrol activity and possibly reveal the location of the patrol. Communications are also a problem. The intelligence value of the reconnaissance is reduced if intelligence and targeting data is not rapidly communicated.

The limitations discussed in Chapter 2 for the EW systems are heightened by the jungle environment. ESM ground systems are located in various base camps throughout the division's AO, concentrated in the brigade where the expected enemy main effort will occur.

ESM systems, to include TRAILBLAZER and TEAMPACK, may be used more as individual collection stations than as integrated systems, due to the environment.

The lightweight, highly mobile systems, such as the MRDFS, will find extensive use. Deployment will be with patrols—foot or mounted. The MRDFS provides intercept and LOB data to the patrol leader and TCAE.

The divisional aerial assets provide the best means of intelligence operations for IEW elements. The supporting corps SLAR aircraft, in conduction with GSR and

REMS, present the commanders with the best picture of the battlefield. The QUICKFIX provides excellent radio LOS to all targets for LOB, intercept, and COMJAM operations. The TCAE, based on IPB and the brigade's needs, tasks and controls the aerial assets. High incidence of rust, corrosion, and fungus, caused by jungle moisture and humidity, highlights the necessity for daily maintenance on equipment—especially at the operator level. This is especially true for electronic systems and COMSEC gear, which are subject to very high failure rates in jungle environments. Continuous operation of such systems generates heat, which combats moisture, corrosion, rust, and fungus, decreasing the mean time between failures, but hastening system wearout.

Mountainous regions may also be found in jungle areas. These areas are particular difficult for patrols to traverse, especially during the rainy season. In these regions the extremes of weather can run from very hot and humid at the lower elevations; to cold and wet at the highest elevations.

## DESERT OPERATIONS

The use of IEW assets in desert operations demands special preparation in order to conduct combat operations.

Deserts are semiarid regions containing a wide variety of soils in varying relief. There are three types of desert: mountain, rocky plateau, and sandy or dune. Optimum operation of EW equipment in desert terrain is affected by dust, sand, temperature variations, static electricity, and wind.

Desert operations are characterized by the use of forces that are capable of conducting highly mobile operations. These operations significantly increase the size of the area of interest at virtually all echelons. Collection assets are focused on targets at significantly greater distances than normal. Brigades and battalions may become even more dependent upon the division and corps for intelligence, because collection requirements may exceed the range of their collection capability. This requires more DS and GS reinforcing missions. The mobility factor of the desert requires more tracked and fewer wheeled vehicles for EW systems.

The desert battle is highly mobile. An attack may be carried out from the line of march. Enemy battalions deploy to company columns 12 to 15 kilometers, and platoon columns at 3 to 5 kilometers from the assault position. Enemy doctrine dictates that tank formations will generally be used in the first echelon, and that the attack may be conducted using a single echelon. The enemy may employ airborne and helicopter assaults to seize objectives in the rear.

Frequent and extreme changes in desert weather have a significant influence on intelligence collection capabilities. Long periods of unlimited visibility are abruptly interrupted by violent winds and sandstorms. These storms reduce visibility and drive sand into mechanical and electronic equipment, causing frequent breakdowns.

The wear and tear, particularly on mechanical equipment, requires frequent replacement of moving parts. Increased requirements for spare parts place an additional burden on the supply system, increasing the vulnerability of friendly logistic operations. Wide variations in day and night temperatures also have detrimental effects on people and machines. Precautions must be taken to prevent casualties resulting from direct exposure to the sun and high temperatures.

The high desert temperatures may cause equipment to overheat. Heat causes batteries to lose power more quickly. High temperatures cause overheating in communications equipment resulting in equipment failure. Lenses on DODs can become discolored when directly expose to sun. Communications equipment must be protected from heat and from the direct ray of the sun.

Degradation of AM and FM radio communications occurs due to extreme heat. Communications during hours of darkness are excellent. During daylight, a 20- to 30-percent loss of radio communications is experienced, due to heat. Frequency drift will also limit radio capabilities.

EW systems and radioteletype equipment will also suffer frequent down time from sand and dust, if not protected. IMINT systems are subject to heat wave distortion and

dust storms. HUMINT operations are reduced, due to smaller population areas. OPSEC responsibilities increase significantly due to the long range of enemy IMINT and SIGINT systems in the desert. Like OPSEC, the value of EW has increased in importance. The expansiveness of the desert precludes using terrain masking to avoid jamming. ECM can freeze the battle for destruction by fire and maneuver, and plays a significant role in air defense and CAS suppression.

Vehicle maintenance requirements increase in extreme heat. The heat dries out seals and gaskets and causes tires to crack. The effects of sand on equipment creates the need to constantly replace bearings and other moving parts. Since reconnaissance in desert operations is generally accomplished using mobile patrols, maintenance requirements will directly impact on reconnaissance capabilities.

Humidity and temperature variations cause condensation and rust. Condensation degrades the effectiveness of the optical devices by causing mold to form on lenses, requiring extra precautions to be taken. Equipment must be cleaned on a daily basis. The problems associated with desert observations and reconnaissance include—

- Long ranges and the refraction of visible light impairing visual perception.
- Heat waves, blurring detail.
- The actual location of observed objects becoming difficult to determine.
- Mirages, which can distort objects to the point of being unrecognizable.

The intensity of these effects often depends on the angle of the sun in relationship to the observer. Observation in the desert is enhanced by placing observers as high above the desert floor as possible. In rolling desert terrain, tanks and other vehicles are spread over a wide area, permitting observation in areas which cannot be seen by adjacent vehicle crews.

GSR and REMS are used to overcome visual distortion caused by the magnification by heat waves.

In a desert environment, GSRs can be used to acquire targets at extended ranges

and cover considerable distances across the front.

The optimum operation of radar in desert terrain is degraded by—

- Dust and sand.
- Temperature variations.
- Static electricity.
- Wind.

To obtain the best performance in target detection, place the radar set as high as possible above the area under surveillance, so that the radar antenna overlooks the area. On smooth, sandy surfaces, the detection range for moving targets may be reduced, because sand presents a surface that does not reflect an appreciable amount of clutter. Increasing the operating angle helps to reduce this deficiency. A second disadvantage caused by the terrain is that little natural cover and concealment are available for radar positions.

It is extremely difficult to conceal combat forces and operations in flat, open terrain. Airborne collection platforms are very effective in locating concentrated enemy forces.

Foot patrols are generally limited to static defensive operations, while mobile patrols are effective in desert operations. Air reconnaissance is used to the maximum extent possible. When a unit is on a march, ground elements will normally be located at least 2,000 to 4,000 meters to the front and flank of the lead elements, depending on the terrain. OPs in static situations are sited in pairs as far apart as possible to permit accurate intersection.

The desert terrain favors wide envelopments and turning movements. The intelligence collection effort must cover all directions and use all available collection systems, especially those with long-range capabilities. Since large unit consolidations and preparations for attack are virtually impossible to hide, commanders on both sides may decide to conceal the time and place of attack through the use of deception operations. The S2 must be prepared to provide intelligence support to the S3 for deception planning. The S2 incorporates all of the collection means available in his collection plan to achieve as much redundancy as

possible. All efforts are made to confirm or deny significant indications of enemy intentions.

## WINTER OPERATIONS

Because over 50 percent of the world can become a winter battlefield, the Army must be prepared to conduct IEW operations in a winter environment. This environment is characterized by low temperatures, fog, freezing rain, snow, ice, frozen conditions, and a series of freeze-thaw cycles. The effects of the winter environment on personnel and equipment are numerous. Because of the effort and extra equipment necessary to keep warm, common tasks take longer and are more difficult to perform. Mobility over frozen ground can be better than over unfrozen ground. Snow or spring mud, on the other hand, can hinder or halt movement on roads or cross country. Fog and blowing snow can reduce visibility to zero. Performance of most electro-optical systems is degraded or changed. Assessing enemy capability to live and fight in extreme cold is an essential intelligence requirement. Historically, Warsaw Pact forces conduct numerous exercises during the winter, giving them experience in conducting combat operations in cold climates. Snow and cold weather have detrimental effects on the operations of both mechanical and electronic equipment. The following factors can cause degradation of IEW operations:

- Reduced mobility of vehicle-mounted systems.
- Poor or inaccurate performance of radars, sensors, radios, and other electro-optical systems.
- Antenna icing, which can reduce range, increase noise, alter frequency, or simply collapse antennas.
- Thickened oil and lubricants, which can cause mechanical problems in generators and vehicles.
- Decrease in battery life and performance.

Certain environmental phenomena, such as snow and fog, can significantly degrade visibility, making the GSR a valuable asset. These same phenomena can affect the per-

formance of the GSR, and must be considered by the operators. The successful operation of the radar on the winter battlefield is affected by—

- Signal scattering by ice, fog, and airborne snow.
- Variation of radar images caused by snow cover and frozen ground.
- Reduced ability of the equipment operators to function in the cold.
- Reduced battery life and performance.
- Cold- and condensation-induced maintenance problems.

Winter battlefield operations require longer periods of time to perform even simple tasks. Experience shows that five times the normal time may be needed. Therefore, increased time must be allowed in planning for set-up and relocation of the GSR.

A major impact of winter operations on equipment is caused by cold and snow. Extremely low temperatures cause metal parts of weapons to become brittle, resulting in a high breakage factor for internal parts. Vehicle engines and generators require frequent starting, and the frequent starts cause condensation in the internal parts of the engine, which later freezes. The intake filters of carburetors and C-E equipment are particularly susceptible to icing. Condensation covers on microphones and telephone handsets ice frequently if not protected. Blowing snow will also jam air-intake valves. Pneumatic antenna masts and ADP equipment freeze because of condensation. Power supplies have greatly reduced life spans. RATT equipment is very susceptible to malfunction in these circumstances. Units preparing for winter operations require a larger than normal PLL and ASL. Each unit will need larger Class III allocations because of frequent engine starting. Higher PLL usage factors will be experienced for filters, batteries, spark plugs, hydraulic hoses, and all types of seals. Thinner lubricants are required.

In winter operations, the human element is all-important and demands concerned leadership and thorough training. Particular attention must be given to minimizing the effects of vision whiteouts, with the

attendant loss of perception, which affects driving and flying. High windchill factors and the potential problems of frostbite and immersion foot are additional considerations.

Only with the proper training, planning and preparation, can IEW operations be successfully conducted on the winter battlefield.

## URBAN AREAS

Urban centers have always been recognized as important strategic objectives. Commanders must not commit their forces to attack or defend an urban center unless a distinct advantage can be recognized.

Military operations on urbanized terrain (MOUT) are characterized by short engagement ranges, structured obstructions to observation and communications, extreme canalization, excellent cover and concealment, and a new vertical dimension added to the battlefield. Frequently, there are problems which include obstructions, such as rubble, control of civilian population, and reduced R&S effectiveness. These elements constrain IEW operational and sustainment capabilities.

Intelligence collection requires intensified management to be effective. The collection effort is severely hampered by the enemy's use of cover and concealment, which suppress enemy unit signatures. An urban environment, particularly one that is extensive, will eliminate many of the indicators used to determine enemy activities and disposition. The flash, sound, smoke, and dust signatures of weapons are suppressed or distorted.

Urban areas are characterized by abundant cover and concealment and limited visibility. Because of LOS considerations, the target acquisition capability of GSR within built-up areas is reduced. Inaccurate range and azimuth readings may result when the radar beam is ricocheted off buildings.

GSR will normally be used against enemy forces beyond the built-up area. Radar teams are positioned to monitor routes into and out of the built-up area. Inside the built-up area, radars are positioned to detect movement along streets, alleys, and open

areas, especially during periods of limited visibility. FM 90-10 describes MOUT.

HUMINT, as with jungle and mountain operations, provides the commander with the best means of gathering intelligence.

Troop observations, reported rapidly and accurately, can contribute extensively to the collection effort. Troops supply first-hand knowledge about the location and type of enemy equipment and activity, most of which is submitted to the S3 for targeting. Interrogations of EPW, civilians, line crossers, and defectors will probably be the best source of information on enemy concentrations within the city. Civilians recently routed from their homes may provide the location of enemy forces and information on structures, such as fortifications, major facilities, and vehicle or foot bridges. HUMINT collection activity prior to the battle focuses on collection and analysis of city plans for IPB.

The urban environment restricts or limits the use of AM and FM C<sup>2</sup> communications. Enemy forces will make heavy use of wire and established civilian telephone systems. There will be considerable crowding on the FM band with emitters located on tall structures to afford radio LOS.

Communications and noncommunications intercepts become less valuable as an intelligence collection source. Manpack intercept and DF equipment are well suited to operations in MOUT due to their ability to be used in high-tower buildings. Vehicle-mounted ground collection systems are best used to provide early warning and indications of enemy intentions on the approaches to the urban area.

ECM also has little use in MOUT due to the perturbation of the radio LOS required for effective operations. As with the collection assets, ECM systems are best employed to provide COMJAM support in the outlying areas along suspected avenues of approach. Additionally, ECM systems are tasked with collection and early warning missions to support other ESM assets.

Because there are fewer LOS restrictions, QUICKFIX is tasked with ESM/ECM missions against the urban area. Airborne ECM systems will be useful in disrupting

the hearability of enemy C<sup>2</sup> links from higher echelons.

Defender advantages of cover and concealment; protected, elevated platforms for IMINT and SIGINT systems covering approaches to the urban areas; and the ability to hide key installations without risk or detection, all place a premium on good OPSEC by the approaching force. The

urban environment limits the use of EW; however, airborne EW systems may be useful in disrupting the hearability of enemy C<sup>2</sup> links from higher echelons.

There are no unique sustainment considerations for MI equipment, supplies or soldiers in the urban environment.

Additional information on operations on urbanized terrain is contained in FM 90-10.

## CHAPTER 6

### Combat Service Support

CSS feeds, fuels, arms, maintains, and moves the brigade, maneuver battalions, supporting MI elements, and other combat, combat support and CSS elements. It provides this support as far forward as possible and throughout the AO.

This chapter describes the CSS necessary to maintain MI assets operating in the brigade or battalion AO. It outlines the brigade's responsibilities to these elements, identifies the key players who coordinate this support, and lists the services provided by the MI battalions' CSS elements. While the description centers heavily on the responsibilities of logistical planners and maintenance personnel within the MI organization, it is incumbent upon the brigade and battalion S2 to understand these roles and their relationship to the maneuver commanders and the logistical systems supporting these commanders.

Sustaining those elements that conduct combat operations is no less important than the operations of the fighters themselves. Understanding CSS principles common to the Army, and the sometimes unique support required of tactical MI organizations, is fundamental to understanding how the total Army fights.

IEW elements deployed and operating in the forward maneuver battalion and brigade zones will be provided CSS based upon their task organization, designated command relationship to the forward maneuver force, and, in certain areas, maintenance requirements unique to tactical MI organizations. IEW elements such as GSR, CI, and EPW teams, when attached to, or in DS of, the brigade or subordinate units of the brigade, will be supported logistically with all classes of supply by CSS elements of the brigade, less those unique areas such as GSR repair parts or maintenance which only the MI battalion can provide. Unlike many other organizations, however, tactical MI elements deployed well forward in the brigade sector and dispersed geographically across the brigade and division frontage, require CSS from forward maneuver units regardless of the command relationship

between these IEW elements and the maneuver unit(s) in their proximity. This is due to the operating characteristics of tactical SIGINT and EW systems which require their deployment to be well forward in order to be effective. For integrity of intelligence operations through the analysis of technical information, they are designated as GS resources of the division. No other Army tactical organization operates throughout the width and depth of the division sector, yet requires centralized direction and management for coherent operations, like the MI battalion's technical collection assets.

As a result, support to these elements is more often misunderstood than not. To the maximum extent possible, the MI battalion commander ensures that his organic CSS capabilities are pushed as far forward as possible to meet the sustainment requirements of forward-operating IEW teams. This effort is mandated in those MI-unique areas such as fault diagnosis and repair of SIGINT collection systems, jammers, and radars. For Army common support such as classes I, II, III, IV, V, and IX, IEW teams deployed well forward will draw their support from CSS elements of the brigade in whose sector they are deployed. To ensure that this happens, CSS planning within the MI battalion is accomplished early and in great detail to account for all classes of supply and all levels of maintenance required. Most important, this planning is done along with the expected deployment scheme for IEW assets developed by the

commander and S3, responding to stated and implied IEW missions. The concept for CSS to IEW elements, then, centers on the principles of—

- Fix forward.
- Draw CSS from forward-deployed units for Army common supply and service items.
- Sustain the IEW teams in all areas to the maximum extent possible, but coordinate CSS for those beyond the MI battalion's range of support.
- Identify CSS areas requiring division, brigade, and maneuver battalion support, and coordinate to ensure that support.

The MI battalion alone repairs, or evacuates for repair, MI-unique systems.

## **RESPONSIBILITIES**

As in other organizations, the battalion executive officer serves as the commander's principal architect of unit CSS operations. The executive officer—

- Supervises S1 (administrative) and S4 (logistic) staff activities.
- Directs administrative and CSS planning accomplished by the MI battalion's S1 and S4.
- Ensures that the administrative and CSS systems work by coordinating required activities to maintain continuous support for all MI battalion elements.

The MI battalion S1 and S4 are the principal workers who, with their respective staff sections, accomplish the individual administrative and CSS tasks under the supervision of the executive officer.

The battalion S1 sustains the force by providing support to personnel within the battalion. Personnel support operations maintain unit strength to ensure crew manning and see to the morale and welfare of the individual soldier.

The MI battalion S4 is the principal staff officer responsible for developing the battalion's logistical plans, policies, and programs. Like personnel support operations, logistical support operations are based on detailed estimates resulting from the S4's analysis of the MI battalion's concept of the operation and deployment plan and planned to include all classes of supply and services and all levels of maintenance. The S4 coordinates logistical and maintenance requirements with the division G4 and those brigade S4s who will have IEW teams operating within their area of operations. Again, the unique capabilities provided by the MI battalion require thorough coordination to ensure the evacuation, repair, or replacement of uncommon mission-essential systems such as radars, intercept systems, and jammers. These systems are not replaced by spares stored within the DISCOM, since no such spares exist at that location for most of these low density items of equipment.

The final key coordinator for CSS operations is the IEW company team commander. Once deployed to operational sites, IEW teams rely on the company team commander for responsive CSS beyond that provided by forward maneuver units. This is assured through detailed prior coordination. The company team commander accomplishes



that final required coordination with maneuver unit commanders or their S4s to guarantee the sustainment of forward-deployed teams under his command. He also receives daily strength accounting reports, reports of maintenance status, and requests for maintenance support from his IEW teams or platoons. He then coordinates the responsive support from the MI battalion's trains or supporting CSS units in the sector. The company team commander is the final key link in the uninterrupted chain of coordinated CSS to sustain the IEW force. Maintenance support teams or contact teams formed from assets of the MI battalion's service support company will normally be organized within the IEW company team to provide responsive support to the company team elements. The tailoring of this organic CSS, when done well, minimizes the problems normally encountered by IEW elements operating well forward of the limited CSS capabilities of the MI battalion.

## **COORDINATION**

Preliminary coordination for CSS is initiated by the MI battalion S4 as soon as the battalion is notified that MI assets are being deployed to the brigade AO. The MI battalion S4 coordinates with the G4 and the brigade S4. The G4 includes in the division OPORD the anticipated support requirements. The brigade S4 arranges for all classes of supply which MI elements cannot obtain through the parent MI organization, when deployed. The brigade S4 coordinates with the maneuver battalion S4 for CSS required at that level. The IEW company team commander or the brigade IEW support element, when there is no IEW company team, coordinates with the brigade S4 for additional maintenance support. Additional requirements may be satisfied by organic brigade or maneuver battalion maintenance assets.

When an IEW company team is formed, the IEW company team commander assumes the CSS coordination responsibilities for all MI elements in the brigade AO. The initial requirements of the IEW company team, previously coordinated among the MI battalion S4, division G4, and brigade S4,

are confirmed and expanded at this time. The IEW company team commander may deal directly with the brigade S4 or through the IEWSE at the brigade TOC. He coordinates the support required from the maneuver battalion with the brigade S4.

## **SERVICES**

### **CLASSES OF SUPPLY**

Supplies are grouped into 10 categories or classes, so that items may be easily identified. This establishes a common supply terminology and eases logistical planning and operations. MI elements use only 9 out of the 10 classes of supply. These nine classes are illustrated below.

### **SUPPLY SOURCES FOR MI ELEMENTS IN BRIGADE AREA OF OPERATIONS**

#### **Class I**

Class I supplies include subsistence and gratuitous issue health and welfare items. Class I requirements are determined from daily strength reports. The MI company team commander receives strength reports from each of the MI elements deployed throughout the brigade AO. He consolidates these reports and presents a copy to the brigade S1 and S4. The brigade S1 integrates MI requirements into the brigade daily strength determined from this report and delivered to the Class I supply distribution point in the BSA.

The brigade S4 and the IEW company team commander coordinate the best means of Class I distribution. Generally, an IEW company team representative collects Class I from the brigade Class I supply distribution point and distributes them to MI units located in or near the BSA. Class I is prepared at multiple food service sections within the brigade AO and is released to MI units based on a distribution scheme developed by the IEW company team commander.

The IEW company team commander coordinates Class I support for MI units located near maneuver battalions with each battalion S4. Class I for MI units is distributed from the maneuver battalion field trains. Organic MI units' vehicles are used to pickup and deliver these supplies to IEW

## SUPPLY SOURCES FOR MI ELEMENTS IN BRIGADE AREA OF OPERATIONS

SUPPLY CLASS LOCATION	IN OR NEAR BDE SPT AREA	IN OR NEAR BN AREA	OTHER
CLASS I	FOOD SVC ELM	FOOD SVC ELM	
CLASS II	FSB or FAST and IEW Co TM Area	ESTABLISHED BN/CO SUPPLY PTS OR DELIVERED DIRECTLY TO USING MI ELEMENTS BY ORGANIC MI VEHICLES	
CLASS III	CLASS III DIST PT	CLASS III DIST PT	
CLASS IV	FORWARD DIST PT	SAME AS CLASS II	
CLASS V	AMMO TRANSFER PT IN BDE SPT AREA	AMMO TRANSFER PT IN BN TRAINS AREA	
CLASS VI	SAME AS CLASS I	SAME AS CLASS I	THEATER OR ARMY PX
CLASS VII	FSB OR FAST	FSB OR FAST	
CLASS VIII	BDE AID STATION	BN AID STATION	
CLASS IX	FORWARD SPT MAINT CO (DISCOM) OR FSB BDE SPT AREA SUPPLY PTS	BN SUPPLY PTS	MI-PECULIAR REPAIR PARTS ARE DELIVERED TO MI ELM BY MI MAINT REPAIR TEAMS OF THE MI BATTALION

site locations. When hot meals are available, the IEW company team commander coordinates with the maneuver battalion S4 to ensure that MI personnel receive these rations in the battalion field trains, or that the appropriate number of meals is released to IEW team representatives for distribution at IEW site locations. When individual MI units are deployed to the brigade or battalion AO, the MI unit leader must coordinate Class I support with the nearest combat unit. Potable water, although not a Class I item, can normally be obtained from the food service element.

### **Class II and IV**

MI units in the battalion AO request Class II and IV items through the IEW company team commander. The IEW company team commander coordinates with the maneuver battalion S4. If the requisition cannot be filled, it is passed to the brigade S4.

If individual MI units are deployed in the brigade AO, they must rely on previous coordination between the MI battalion and the brigade and battalion S4s for Class II and IV supplies. After deployment, they must confirm previous coordination and establish supply request procedures to ensure that they receive adequate supply support while deployed in the brigade AO.

### **Class III**

MI elements located in the brigade AO require a full load of POL to meet mission requirements. The initial additional allocation of POL to the brigade for MI units is usually based on consumption experience records which are consolidated and maintained by the MI battalion S4. Other factors which must be considered when preparing a POL estimate are the duration of deployment and terrain trafficability.

The MI battalion S4 uses this information to prepare an estimate of POL requirements for MI elements about to be deployed to brigade AO. He coordinates with the brigade S4 and maneuver battalion S4. This ensures that adequate POL is available for MI elements once they are deployed in the maneuver brigade or subordinate battalion sectors.

Empty fuel vehicles and containers presented at the distribution point are sufficient to obtain POL; a formal request is not necessary. Bulk oil and lubricants are also distributed at Class III distribution points. Class III requirements for high POL consumption systems such as the MI battalion's M1015 and 30-kilowatt generators must be supported by the MI battalion refueling assets. POL for all other equipment can be supported by the maneuver battalion trains or BSA.

When the IEW company team is formed and deployed in the brigade AO, the team commander coordinates with brigade and battalion S4s to confirm and expand previous POL support arrangements and to ensure that MI elements receive adequate POL supply support. POL support to MI elements in the brigade AO is obtained through brigade and battalion supply channels. Daily consumption reports are submitted by MI elements to the battalion or brigade S4 (depending on the element's deployed position). Deployed MI elements provide POL consumption information to the IEW company team commander, who consolidates the reports and forwards them to the MI battalion S4. The MI battalion S4 uses these reports to plan for future operations.

### **Class V**

Deployed MI elements' personnel and vehicles carry a basic load of Class V ammunition. The MI battalion S4 coordinates Class V ammunition supply requirements with the brigade and battalion S4s before MI elements are deployed into the brigade AO. Replenishment supplies of Class V ammunition and pyrotechnics are drawn from Class V distribution points in the battalion combat trains and BSA.

Coordination is essential to provide for ammunition resupply for MI elements in the brigade AO. Coordination enables MI elements to draw Class V supplies directly from these nearby resources.

The IEW company team commander confirms ammunition resupply arrangements with the brigade and battalion S4s. He is responsible for ensuring that problems in

method, procedure, or location of ammunition resupply for MI elements are resolved as quickly and efficiently as possible.

### **Class VI**

MI elements in the brigade AO may obtain personal items from mobile PX stations, when this service is available. For convenience, these stations are usually set up near food service sites. When PX service is not available, requests for Class VI items are routed through the IEW company team commander to the S1 of the MI battalion, the maneuver battalion, or the brigade. The requisition channel depends upon prior coordination between the S4s of the MI battalion and the brigade and battalion.

Sundries packs are basic personal items allocated to personnel in the brigade AO and should not be confused with Class X items. Sundries packs are usually distributed along with Class I rations.

### **Class VII**

Class VII major components and end items are identified in daily loss reports and obtained through formal requisition channels. When an IEW company team is formed, MI elements in the brigade AO submit daily loss reports to the IEW company team commander. The IEW company commander validates and consolidates the reports and forwards his report to the MI battalion S4 for further action. When an IEW company team is not formed, MI elements in the brigade AO report losses through the IEWSE or EW platoon headquarters, depending upon the type of maintenance support required. The IEWSE relays this information to the MI battalion S4.

The MI battalion S4 is responsible for consolidating these daily loss reports and for preparing requisitions for replacements. If the item can be replaced from equipment or systems already in the MI battalion trains area, he arranges for delivery to the using element. If the item cannot be replaced from MI battalion stockage, the S4 prepares a formal requisition.

When major end items are delivered to the MI battalion trains area, the S4 ensures that it is in ready-to-fight condition and that it is delivered promptly to the using

IEW element. Through coordination with the S1, the S4 also ensures that personnel to operate the equipment are available at the receiving unit prior to delivery of the item.

### **Class VIII**

When MI units deploy, their vehicles are equipped with first aid kits. Individual first aid kits are also issued to personnel. Additional supplies or replacements for expended Class VIII items from either the personal or vehicular kits are provided by the medical unit nearest to the deployed MI element. At the BSA, the medical clearing station provides this service. In the maneuver battalion AO, MI elements receive replacement Class VIII items from either the medical aid station in the battalion trains or from a maneuver company team aid station.

### **Class IX**

Deployed MI elements receive maintenance and repair parts support from maintenance teams organic to the MI battalion. When MI units are task organized into IEW company teams, maintenance elements are included in the organization. Forward-deployed MI elements also may receive common equipment repair support from division intermediate DS maintenance units based in the BSA.

To expedite maintenance and keep critical systems operating, a direct exchange (DX) system is used. DX is accomplished between the using unit and the intermediate DS maintenance unit. It is a simple system of trading an unserviceable DX-coded component or assembly needing repair for a serviceable one from stock.

MI-peculiar repair parts are requisitioned through the MI battalion S4. These supplies may be delivered to the IEW company team area or picked up from the MI battalion by IEW team vehicles. Maintenance support teams take these parts or equipment to the using units as required.

Specialized repair parts, for such items as TEAMPACK and ECM sets, must be closely monitored by the MI battalion S4. Because of the low density of this equipment, sufficient repair parts are difficult to maintain in large quantity. The battalion S4 keeps a prescribed load of repair parts on

hand or on order to support deployed MI elements in the brigade AO. Repair parts for MI-particular equipment are requisitioned by the unit that provides intermediate DS maintenance support. In most cases involving MI-unique systems, intermediate DS and sometimes intermediate GS maintenance is performed by elements of the MI battalion's service support company.

### **MAINTENANCE, REPAIR, AND RECOVERY**

Repair is accomplished as far forward as possible. When repairs cannot be performed on site, or the equipment cannot be transported to a repair site, recovery operations are initiated. Equipment is moved, through the maintenance system, to maintenance facilities that can repair or replace unserviceable parts, components, or units. Although maintenance, repair, and recovery are separate operations, the overall system supporting these activities is generally referred to as maintenance.

The three-level maintenance system consists of—unit maintenance, intermediate DS and intermediate GS maintenance, and depot maintenance.

Unit maintenance is the care and repair done by a unit on its own equipment. It is characterized by replacement, minor repairs, adjustments, cleaning and lubricating, and repair by replacement. It includes operator maintenance.

Intermediate DS and GS maintenance are characterized by a more substantial maintenance or repair effort conducted in support of the user. Units conducting intermediate maintenance are specified. Intermediate-level maintenance is composed of intermediate DS maintenance and intermediate GS maintenance. Intermediate DS maintenance is performed in support of the user. Units performing this level of maintenance are tailored to perform repair on equipment and return it to the user. Intermediate DS maintenance units are employed at different locations, but the tasks performed are the same. The focus of intermediate DS maintenance is mobile support as far forward as possible, repair by replacement, and the ability to maintain high volume, fast moving operational readiness floats (ORF). Maintenance tasked at

this level includes diagnosis, fault isolation, repair by replacement, and repair of selected high usage components in support of the DX system. Each intermediate DS unit also establishes and operates maintenance collection points (MCP) and base maintenance areas for support of all customer units. Intermediate GS maintenance is performed in support of the theater supply system through the repair of assemblies, components, modules, DX items, printed circuit boards (PCB), and ORF. It is performed by designated TOE and TDA units. The units are normally located at EAC and operate in semifixed or fixed facilities, and are semimobile. Intermediate GS maintenance units are job- or production line-oriented for repair of Class VII and Class IX items. Maintenance tasks at this level include diagnosis and repair of assemblies, components, modules, and PCB.

Depot maintenance includes complete rebuilding of entire systems and is usually accomplished in large, fixed manufacturing plants. Army Materiel Command (AMC) depots or activities, contractors, and host-nation support (HNS) personnel perform this level of maintenance in support of the supply system. Repair parts supply support for depot maintenance is limited to items to support assigned maintenance missions.

Though each level is separate and distinct, there are times when a shop performs more than one category of maintenance. The following chart gives a brief synopsis of the unit or organization which provides levels of maintenance for different types of equipment.

### **Maintenance Operations**

Maintenance operations are conducted in support of MI elements deployed in the brigade AO. Maintenance for these elements during actual combat is guided by the mission and the situation. Maintenance contact teams are formed from the MI battalion and deployed to the brigade AO to accomplish equipment repair as far forward as possible. They repair this equipment on site, if possible. Other maintenance is situation dependent and generally conducted as time and conditions permit.

## LEVELS OF MAINTENANCE

TYPE OF EQUIPMENT	UNIT	INTERMEDIATE MAINTENANCE DS	INTERMEDIATE MAINTENANCE GS	DEPOT
COMMON EQUIPMENT	SVC SPT CO MI BN	FWD SPT BN	COSCOM	AMC CONUS HNS
C-E EQUIPMENT	SVC SPT CO MI BN	SVC SPT CO, MI FWD SPT BN	COSCOM	AMC CONUS/HNS
COMSEC EQUIPMENT	SVC SPT CO MI BN	DIV SIG BN	THEATER CLSU	AMC CONUS/HNS
RADIAC EQUIPMENT	SVC SPT CO MI BN	MAINT CO (TMDE) DIV SIG BN	MAINT CO (TMDE) COSCOM	AMC CONUS/HNS
SIGINT/EW EQUIPMENT	SVC SPT CO MI BN	SVC SPT CO, MI BN	THEATER	AMC CONUS/HNS
GSR/REMS EQUIPMENT	SVC SPT CO MI BN	SVT SPT CO, MI BN	THEATER	AMC CONUS HNS

### Maintenance and Repair Resources

MI elements deployed in the brigade AO depend upon the IEW company team commander to coordinate their maintenance and repair requirements. A variety of resources are used to meet these requirements quickly and efficiently.

Organic MI maintenance personnel and equipment deploy with the IEW company team as a maintenance contact team. They provide unit maintenance and repair support. They deploy with the capability to provide this support for common, C-E, GSR or REMS, and EW equipment. The IEW company team commander coordinates the activity of this team and ensures that deployed MI elements receive immediate unit maintenance and repair according to mission priorities. If additional or specialized support is needed, maintenance elements from the MI battalion service support company may be task organized and deployed to the AO on a case by case basis.

The IEW company team commander also may request assistance from elements of the forward support battalion located in the BSA. These maintenance elements provide mechanical and some C-E maintenance and

repair support. The team commander coordinates requests for maintenance support through the brigade S4. These elements support MI units, depending on priorities established by the brigade S3, coordinating with the brigade S4.

Brigade and battalion also have supporting maintenance resources which can provide intermediate DS maintenance support to MI elements. The IEW company team commander coordinates this support with brigade and battalion S4s. Depending upon priorities established by the combat unit S3, each S4 determines the type and frequency of support they can provide to nearby MI elements. The essential ingredient in receiving brigade maintenance support for MI operations is continuous coordination between all involved personnel: the MI battalion S4, brigade S4, and IEW company team commander.

### COMMON EQUIPMENT

Vehicles, air conditioners, and power generators make up the bulk of items known as common equipment. The MI company team's contact maintenance team performs on-site unit maintenance on MI-common equipment deployed throughout the brigade AO.

If equipment cannot be repaired on site, it is generally evacuated to the intermediate DS maintenance facility. It may be repaired there or further evacuated to intermediate maintenance or to a corps maintenance unit.

Unit maintenance for vehicles and generators belonging to GSR and REMS teams attached to the battalion task force is provided by the brigade maintenance support team (MST). When it is necessary to evacuate such equipment to an intermediate DS maintenance facility, it is generally moved by elements of the FSB. If beyond their repair capability, this equipment is evacuated to an intermediate maintenance (GS) unit.

Maintenance and repair parts support are closely related. The maintenance contact teams from the MI battalion carry repair parts as part of their mission load. These teams carry the following repair parts:

- Army-common equipment (track/wheeled vehicle parts, generator parts).
- MI-unique (SIGINT or EW, GSR or REMS) spare parts and assemblies.

If the contact team does not have the necessary repair parts, assistance can be obtained from the supported brigades only if the item is not MI-unique. Again, coordination among the MI battalion S4, brigade S4, and the company team commander, is essential.

### **COMMUNICATIONS-ELECTRONIC EQUIPMENT**

Unit maintenance for C-E equipment (except for COMSEC and RADIAC equipment) is provided by the tactical communications system repairer of the MI battalion's C-E maintenance section. This equipment is maintained and repaired on site, if possible. The forward operating elements, elements of the forward support battalion (heavy division) may provide on-site unit support—depending upon mission priorities and available resources—or equipment may be evacuated to the BSA for repair.

If additional maintenance is required, the equipment is evacuated to the MI battalion intermediate maintenance facilities located

in the MI battalion trains area. The C-E maintenance platoon maintains a shop stock of repair parts and DX items for this equipment.

Unit maintenance is performed by radar operators. Other unit maintenance is provided by C-E maintenance personnel found within the MI battalion's contact team organized with the IEW company team. This element maintains and repairs equipment on site or evacuates the equipment to the C-E platoon repair facilities located in the MI battalion trains area for intermediate maintenance of DX replacements.

### **COMMUNICATIONS SECURITY EQUIPMENT**

COMSEC equipment cannot be repaired on site. On-site unit maintenance is limited to minor adjustments and maintenance which can be performed by the operator. This equipment must be evacuated to the C-E platoon facilities in the MI battalion trains area for further evacuation to the division signal battalion for intermediate DS maintenance. If the signal battalion is able to repair the equipment, it is returned through established maintenance requisition channels. If repair is not possible, the signal battalion evacuates the equipment to the theater COMSEC logistics support unit (CLSU). In that case, the MI battalion S4 must requisition a replacement through supply channels.

### **SIGNALS INTELLIGENCE AND ELECTRONIC WARFARE EQUIPMENT**

Unit maintenance for SIGINT and EW equipment is provided to deployed MI elements by the MI battalion contact teams. Equipment which cannot be repaired on site is evacuated to the MI battalion trains. The MI battalion provides intermediate DS maintenance support for this equipment. If the MI battalion cannot repair it, it is evacuated to an intermediate GS maintenance battalion repair facility.

## RECOVERY AND EVACUATION OPERATIONS

Recovery and evacuation (R&E) operations are important elements of maintenance operations. Rapid return of equipment to users is required to sustain the battle. R&E operations consist of retrieving immobile, inoperative, or abandoned materiel, including enemy materiel from the battlefield or immediate vicinity. MI equipment is evacuated directly to the appropriate activity where repair or other disposition may be accomplished. Captured enemy equipment is recovered and immediately evacuated to the nearest unit authorized to evaluate and analyze it.

While the MI battalion service support company has primary responsibility for recovery of its organic equipment and systems, these recovery operations may also be performed by other maintenance units in the brigade AO. The IEW company team commander is responsible for coordinating recovery operations. He coordinates them with brigade and battalion S4s, as well as with the S4 of the MI battalion. In this way, support for recovery operations is provided by the nearest and most capable recovery support unit. Recovery operations may be conducted by elements of the supply and transportation battalion motor transport element, by the MI battalion service support company elements, or by organic maintenance units of nearby combat units.

Recovery operations are initiated when on-site repair of MI battalion equipment is not practical or possible. Whenever possible, organic or support resources are used to recover and evacuate these damaged or disabled items. Items of equipment are moved to nearby safe locations for immediate repair. If the MI battalion cannot recover the equipment, other maintenance resources are called to evacuate it to the nearest safe recovery point.

The MI battalion service support company evacuates recovered equipment, which cannot be repaired, to other maintenance support facilities using MI battalion resources. Prior to evacuation, the maintenance officer considers a controlled exchange of parts according to regulation and command guidance. With appropriate

authorization, systems which have suffered extensive damage may be repaired by controlled substitution.

## OTHER COMBAT SERVICE SUPPORT

Personnel and administrative support for MI elements deployed in the brigade AO is coordinated through the IEW company team commander. He coordinates and consolidates leave and pass requests, pay dispersals, requests for special legal services, and other personnel and administrative support for deployed units. He forwards these consolidated requests, requirements, and information, along with recommendations, to the S1 section of the MI battalion.

Medical support for deployed MI elements is provided by medical units supporting the brigade. MI personnel located near the battalion task force receive medical support from the battalion aid station. When evacuation is necessary, it is generally to a divisional medical company in the BSA. Here treatment is given, and the patients are returned to their units or evacuated further to the rear, if necessary. In any case, the IEWSE company team commander must arrange for medical support for forward MI elements, and inform each element where to get its support.

Chaplain support is provided to all units deployed in the brigade AO on an area basis. Personnel from MI elements may attend services nearest to their deployed site.

The IEW company team commander forwards requests for additional or special transportation support to the MI battalion S4 or brigade S4, depending upon the type and amount of support required.

When bath and clothing exchange services are available in the BSA, MI elements are authorized to use these facilities.

Laundry service, when available, is also provided by units located in the BSA to deployed MI personnel.

When the combat situation prevents evacuation or recovery of damaged or inoperative equipment, or when equipment must be abandoned, MI equipment must be destroyed to prevent eventual repair and use



by the enemy. Detailed methods of destroying MI equipment are covered in unit SOPs, user handbooks, and soldier training manuals. Each MI element is responsible for destroying its own equipment when ordered to do so or when capture is likely.

Destruction of this equipment must be thorough enough to prevent the enemy from duplicating it or from learning its method of operation. Any accompanying documents, notes, instructions, or other written material concerning the operation, maintenance, or use of the equipment, including drawings or parts lists, must be destroyed in such a manner that they will be useless to capturing forces.

## CHAPTER 7

### Training

The S2, in coordination with the S3, develops and supervises the unit's intelligence and security training program. The S2 plans and develops the intelligence and security scenario for exercises and training tests. The S2 establishes training levels based on the unit's ARTEP and the individual soldier's training manuals. The S2 ensures that intelligence training is integrated into all appropriate phases of combat training.

This chapter describes the S2's and the S3's duties and functions in unit combat training, training of the individual soldier, and the training of intelligence personnel.

#### COMBAT TRAINING

The S2 ensures that intelligence is integrated with all unit and individual training. He develops the intelligence scenarios for field and command post exercises, as well as training tests and evaluations. Normally, intelligence inputs are preplanned and designed to exercise and test intelligence procedures as well as to trigger friendly reactions to hostile indicators. S2 exercise planners portray the threat as realistically as possible, employing recognized enemy tactics and doctrine. Input into intelligence channels as the exercise progresses should present intelligence personnel with challenging situations. If indicators of enemy capabilities and intentions are too obvious, or exercise scenarios too standard and predictable, the training value of the exercise is greatly reduced.

Since intelligence inputs trigger friendly moves and reactions, the S2 scenario planners need to gain an appreciation for the manner in which the S3 desires the exercise to progress. Establishing a close liaison with S3 planners ensures that the intelligence input will present friendly staff sections with challenging exercise situations. S2 personnel note intelligence strengths and weaknesses through the duration of the exercise to evaluate both personnel and standard procedures. Should major intelligence or security problems develop, the S2 determines the underlying cause and pursues corrective action. Follow-

ing the exercise, the S2 should resurface the problem, verify its causes, and take action(s) necessary to prevent recurrence. Evaluators must be careful when determining how and why a problem developed to make sure that the real cause is identified. An individual's performance may be blamed, for example, when the real culprit could be an unrealistic or impractical requirement prescribed in the SOP. You must look beyond the symptom to determine the root cause of the problem.

Unit training also is conducted during nonexercise field training. The S2 assists subordinate units in conducting intelligence and security training. He periodically inspects intelligence and security training, points out weaknesses, and makes suggestions and recommendations for improvement.

#### INDIVIDUAL SOLDIER TRAINING

It is the commander's responsibility to train subordinates. The S2 plans and implements, through the S3, the intelligence and security training program to train the combat soldier in scouting, reconnaissance, and the intelligence aspects of patrolling and security procedures. All soldiers are trained in observation techniques to ensure accurate description and reporting of what has been perceived. The ability to recognize and report what they have observed, especially under adverse weather conditions, improves with practice. The soldier is trained to quickly identify friendly and enemy equipment. On the air-land battlefield, this is a matter of significant concern. Some types of enemy equipment are very similar in appearance to that of our European allies. FM 21-2 contains basic intelligence-related skills in which every soldier gains proficiency. Leaders down to squad level should train to perform the following tasks:

- Collect/report information—SALUTE.
- Recognize and identify friendly and threat armored vehicles.
- Visually identify threat aircraft.
- Estimate range.

- Send a radio message.
- Identify terrain features on a map.
- Determine the grid coordinates of a point on a military map using the military grid reference system.
- Determine a magnetic azimuth using a compass.
- Determine direction using field-expedient methods.
- Conduct day and night surveillance without aid of electronic devices.

Communications personnel must comply with proper COMSEC procedures. Radio communications must be limited in duration to prevent identification and location of the emitter. The C-E officer assists in integrating COMSEC training into every feasible training opportunity.

Reconnaissance by combat soldiers, properly trained by S2 personnel, can be a very reliable intelligence source and an important part of the collection effort. S2s rely heavily on reconnaissance patrols. Each time reconnaissance patrols are used in an exercise, their reports are carefully reviewed for accuracy and the patrols are debriefed.

The individual soldier is trained to appreciate the importance of security. Soldiers are taught what is authorized and prohibited regarding security rules and regulations. They are taught the procedures for handling and protecting classified information and materials. These training requirements are an integral part of the command's security education program.

The program also includes training designed to prevent SAEDA and deliberate security violations. Additional periodic security training is provided for personnel who routinely handle classified material.

## INTEGRATED TRAINING

A useful method of conducting IEW training is to integrate it into subjects which are ordinarily not considered to have IEW implications. Imagination and innovation can create many additional opportunities for intelligence training for the unit as a whole. The following examples show how this can be accomplished.

## INTELLIGENCE TRAINING

Without a realistic peacetime training program, intelligence personnel gradually lose their skills. In developing a training program for intelligence personnel, the S2 determines the degree of knowledge and the skill levels required. These are accomplished by examining the ARTEP, reviewing training reports and appropriate field manuals, and by consulting soldier manuals. Individual skill levels can be evaluated through assessment or review of—

- Daily, routine duty performances.
- Performance during exercises and unit training tests.
- Supervisor's periodic performance ratings.
- Results of skill qualification tests.

By comparing required and current performance and training levels, strengths and weaknesses can be identified. Weak areas require additional or refresher training. One of the best ways to maintain critical intelligence skills is to work with real world data by producing intelligence documents, updating data base holdings, developing PIR and IR for contingency operations, and by studying enemy organization, doctrine, tactics, and equipment capabilities.

A comprehensive unit tactical intelligence course is an excellent way to provide refresher training and correct training deficiencies. Tactical intelligence blocks of instruction are developed and presented at the brigade and battalion level to initially train or reinforce all of the components of tactical intelligence. Because this requires a considerable amount of time and effort, the S2 should obtain command concurrence prior to developing the course of instruction. The S3 may agree to incorporate a tactical intelligence course into the command's overall training program. Other staff sections provide input within their areas of expertise by identifying their standard intelligence requirements and identifying how they use intelligence. The S2 can and should assist these staff elements in the development of intelligence requirements.

The S2 may not have to develop the entire course. The division G2 and MI battalion

## TRAINING OPPORTUNITY EXAMPLES

Principal Subject	IEW Subject
Character Guidance and Code of Conduct	Security—Stress the moral obligation of all military personnel to report violations of security.
Employment of the Armed Force	The intelligence chain—Present the intelligence structure from DA to the individual soldier.
Rules of Land Warfare and Geneva Convention	Correct handling of EPW and other persons of intelligence value means more information during interrogations.
Target Acquisition	Threat doctrine and vehicle identification—Stress the identification of friend or foe equipment for the echelon at which the training is conducted.
Land Navigation	Map reading and terrain appreciation—Stress pinpointing targets on a map while traversing the terrain.
CEOI and Radio Procedures	ECCM measures, enemy ESM, and ECM capabilities; SIGSEC procedures which reinforce ECCM.

(CEWI) in support of the division can provide expertise and data which can be used in creating or modifying a course of instruction. For example, the ASPS at division has experts on the IPB process. They can assist the S2 in creating lesson plans on battalion and brigade IPB functions. The CM&D and the CI analysis sections of the division can provide expertise and data on their functional areas. Exportable training packages from service schools could also be used to aid the S2 in unit instruction.

Prior to implementing a course, the S2 ensures that all instructors are thoroughly versed in their subjects. Good instructors always rehearse. Rehearsals provide an opportunity to identify problem areas and make corrections prior to entering the class-

room. Rehearsals also provide instructors with an opportunity to perfect delivery techniques and the use of visual aids. A soldier's opinion of the S2 shop's collective opinions can affect the quality and quantity of support the S2 receives.

Evaluation and critique are two separate actions used to improve classroom training and course presentation. A course evaluation can be conducted by any knowledgeable individual invited to observe the reaction of the students, presentation of course material, use of training aids, and the comprehensiveness of the instruction. The instructor and S2 review the evaluation, and take the necessary action to correct deficiencies. FM 25-3 should be consulted regarding training evaluation.

Examinations are given to all students to assist in identifying weak areas in which additional training is required. Additional instruction is scheduled, and subsequent courses are designed to eliminate weak areas.

### **THREAT EDUCATION**

A comprehensive threat education program, developed by the S2 section, will pay large dividends in combat. A poorly trained unit is likely to fail in the first fight. A unit's readiness for combat is made apparent by its state of training. An important part of that training is a thorough knowledge of enemy capabilities and equipment, and how the enemy fights and thinks. There are distinct target audiences to which a threat education program is oriented. While the depth and detail vary with each target audience, the subject matter is essentially the same.

The RIP published semiannually, and the Defense Intelligence Production Schedule (DIPS), both classified SECRET NO FOREIGN DISSEMINATION, are published by DIA. These two documents provide the S2 the means to research sources of threat education materials. These and other source documents should be available at the ASPS, division, and corps G2 section. To be placed on automatic the distribution point of contact for either hard copy or microfiche RIP, is DIA (RTS-2C). The same office is the point of contact for DIPS procurement. DIAM 59-3 provides additional information. Once document requirements are identified, the S2 submits a statement of intelligence interest (S11) to the G2.

Intelligence personnel must understand all aspects of the threat. In addition to receiving threat education training, they are candidates to present instruction in threat recognition, doctrine, and tactics.

Leaders at all levels require knowledge of the threat to make sound decisions in tactical situations. They should be the experts in enemy equipment recognition, tactics, and how the enemy thinks. Principal staff and special staff officers have both generalized and specific threat education needs. The S2, for example, needs to know about the demography of indigenous personnel in the AO. The S3 needs specific technical and para-

metric information about enemy nuclear weapon capabilities. The S4 needs to plan routes for resupply of forward elements. The C-E officer needs to know enemy REC capabilities and doctrine.

Troop threat education is designed primarily to teach individual soldiers how to identify enemy weapons and equipment and to rapidly distinguish friend from foe. In battle, the combat soldier may have only a few seconds to make an identification. Posters showing US, allied, and enemy equipment, posted on the walls of barracks, in day rooms, dining facilities, and motor pools are effective ways of reinforcing classroom and field training in equipment identification.

All soldiers must know what to do with captured enemy equipment and personnel. Soldiers need to know how the enemy fights, the extent of their training, and how they think. Our soldiers must be told, truthfully, what our weaknesses are, and how the enemy will attempt to exploit those weaknesses.

### **EW TRAINING**

The S3 has primary staff responsibility for both training and EW. The focus for brigade and maneuver battalion EW training is defensive. That is, those actions taken to ensure the continued effective friendly use of electronic equipment despite the enemy's efforts to disrupt, degrade, deceive, or destroy that use. The preceding is the standard definition of ECCM. FM 32-30 provides the S3 and unit trainers tried and proven ECCM techniques which have been developed for use with current and projected equipment.

The S3 also has primary staff responsibility for OPSEC. Training conducted in ECCM should be integrated with that portion of OPSEC which deals with the SIGSEC problem. ECCM and SIGSEC training work together to provide an integrated understanding of preventive measures we take to assure secure and continued use of our tactical communication means.

## APPENDIX A

### REQUEST AND REPORT FORMATS

Standard formats are used to report intelligence or information, task assets, or to receive information, intelligence, and orders or instructions. These formats can be echelon-specific, like the patrol report usually prepared at battalion level; or it may be general in nature, like the spot report used at all echelons.

This appendix provides a brief description of the most common intelligence-related formats prepared or used at the brigade and battalion level. Several of the reports within this appendix have been written in the new JINTACCS format. For more information refer to the JINTACCS Users Manual.

#### **MIJFEEDER—Meaconing, Intrusion, Jamming, and Interference Feeder**

**Purpose or Use of Message:** The MIJFEEDER is used to report MIJI incidents to the appropriate C-E officer. The example shown illustrates a representation MIJFEEDER report.

#### **MIJFEEDER REPORT**

##### FORMAT

LINE 1: CLASSIFICATION  
LINE 2: SET FIELD NAME/EXERCISE NAME//  
LINE 3: SET FIELD NAME/FRIENDLY UNIT DESIGNATOR/CALL SIGN//  
LINE 4: SET FIELD NAME/ELECTRONIC COUNTERMEASURES TYPE/LOCATION/  
DATE-TIME//  
LINE 5: SET FIELD NAME/TYPE OF ELECTRONIC INTERFERENCE EXPERIENCE/  
ELECTRONIC COUNTERMEASURES EFFECT/FRIENDLY ELECTRONICS  
COUNTER-COUNTERMEASURES ACTION/ENEMY REACTION TO FRIENDLY ECCM  
ACTIONS//  
LINE 6: SET FIELD NAME/FREQUENCY OF ECM/LOWER RADIO FREQUENCY LIMIT/  
UPPER RADIO FREQUENCY LIMIT/RATED SIGNAL STRENGTH//

##### EXAMPLE

UNCLAS  
EXER/BRAVE SHIELD 8 5//  
MSGID/MIJFEEDER/CTG21.4.3/0622002//  
UNIT/USS NEW JERSEY (BB-62)/CHARLIE FOUR//  
MIJITYP/JAMMING/521825 N0251350E/221155Z/-/SURFACE SEARCH RADAR//  
MIJIEFF/NOISESTATC/DELAYS/WORKTHRU/INCREPER//  
MIJIPRM/5450.5MHZ/5600.5MHZ/RSS:2//

## INTREP-Intelligence Report

**Purpose or Use of Message:** The INTREP is the primary method of reporting HUMINT information. It is used for the joint exchange of information provided through tactical collection efforts. This report provides timely information regarding events that could have an immediate or significant effect on current planning and operations. It is also used to pass critical information to national level agencies.

### INTELLIGENCE REPORT

#### FORMAT

LINE 1: CLASSIFICATION  
LINE 2: SET FIELD NAME/EXERCISE NAME//  
LINE 3: SET FIELD NAME/MESSAGE TITLE//ORIGINATOR/DATE TIME//  
LINE 4: SET FIELD NAME/HEADING INFORMATION//  
LINE 5: SET FIELD NAME/TYPE OF SOURCE OF INTELLIGENCE INFORMATION/  
ACTIVITY DATE-TIME/EVALUATION OF INFORMATION//  
LINE 6: SET FIELD NAME  
LINE 7: /DATE ELEMENT/TARGET TYPE/EQUIPMENT NAME/EQUIPMENT  
MODEL/QUANTITY  
LINE 8: AMPLIFYING DETAILS  
LINE 9: AMPLIFYING DETAILS  
LINE 10: AMPLIFYING DETAILS//

#### EXAMPLE

EXER/BRAVE SHIELD 95//  
MSGID/INTREP/1STBN 2DMAR/0622019//  
HEADING/INFORMATION//  
SOURCE/PATROL/220735Z/A1//  
1BL  
/DE TGTYP EQPT                   EQMOD   QTY  
/01 MDMTK T-62                   -       10  
/02 LTUHL 2.5 TON TRKS           -       12//

## INTSUM—Intelligence Summary

*Purpose or Use of Message:* The INTSUM is used to provide a brief summary of information of intelligence interest covering a specific period of time. It provides a summary of the enemy situation in forward and rear areas, enemy operations and capabilities, and weather and terrain characteristics.

### INTELLIGENCE SUMMARY

#### FORMAT

LINE 1: CLASSIFICATION  
LINE 2: SET FIELD NAME/EXERCISE NAME//  
LINE 3: SET FIELD NAME/MESSAGE TITLE/MESSAGE SERIAL NUMBER//  
LINE 4: SET FIELD NAME/DATE-TIME FROM/DATE-TIME TO//  
LINE 5: SET FIELD NAME/HEADING INFORMATION//  
LINE 6: HEADING  
LINE 7: /DATA ENTRY/CONTEXT QUANTITY/TARGET TYPE/EQUIPMENT TYPE/ACTIVITY  
TYPE/LOCATION  
LINE 8: /AMPLIFYING DETAILS  
LINE 9: /AMPLIFYING DETAILS  
LINE 10: HEADING  
LINE 11: /DATA ENTRY/ENEMY UNIT DESIGNATOR  
LINE 12: /AMPLIFYING DETAILS  
LINE 13-14: SET FIELD NAME/LOCATION/RADIUS,WIDTH,ELLIPTICAL AREA/LOCATION/  
LOCATION/LOCATION/LOCATION//  
LINE 15-16: SET FIELD NAME/NARRATIVE//  
LINE 17-18: SET FIELD NAME/AMPLIFYING DETAILS//  
LINE 19: SET FIELD NAME/HEADING INFORMATION//  
LINE 20: HEADING  
LINE 21: /DATA ENTRY/CONTEXT QUANTITY/COUNTRY OF SIGHTING/AIRCRAFT NAME/  
ACTIVITY TYPE/ACTIVITY DAY-TIME/LOCATION  
LINE 22: /AMPLIFYING DETAILS  
LINE 23: /AMPLIFYING DETAILS  
LINE 24-26: SET FIELD NAME/NARRATIVE//  
LINE 27: SET FIELD NAME/COUNTRY OF SIGHTING/AIRFIELD NAME/LOCATION//



**ELECTRONICS  
INTELLIGENCE  
REQUIREMENT  
TASKING MESSAGE**

The electronic intelligence requirement tasking message (ERTM) is used for operational control of ELINT collection resources by operational commanders or requests for ELINT collection sources outside the commander's control.

**ELECTRONICS INTELLIGENCE REQUIREMENT TASKING MESSAGE**

ERTM FORMAT (JINTACCS)

LINE 1: CLASSIFICATION  
LINE 2: SET NAME/ERTM/ORIGINATOR//  
LINE 3: SET NAME/PLACE//  
LINE 4: SET NAME/DATA ENTRY/ELINT NOTATION/EMITTER DESIGNATION  
/LOWER LIMIT/HIGHER LIMIT/TARGET LOCATION//  
LINE 5: SET NAME/REF NUMBER/LOCATION/FINGERPRINT/DEVIATION  
/COMBINATIONS/ACCURACY/ACCEPTABLE ERROR/TIME INTERVAL  
/INTERVAL BETWEEN VIEWING/REPORTING TIME/REPORTING DELAY  
/DURATION//

ERTM EXAMPLE {JINTACCS}

UNCLAS  
MSGID/ERTM/533 MI BN//  
AREAREQ/CTRY:BC//  
SELTGT  
/DE/ELNOT/EMIT-DESIG /LOWRF /HIGHRF /TGTLOC  
/01/A123 /ADOBE / 190MHZ/ 210MHZ/733ZNL0249W  
/02/A321 /CHIEF / 82MHZ/ 98MHZ/3541N9620W//  
SELRQR  
/DE/DE/L/I/P/E/REQACC /ACPTACC/ERR/ERA/TR /TA /DUR  
/01/- /Y/Y/N/Y 50M/ 100M/ 2H/ 8H/10M/20M/ 2D  
/02/- /N/N/Y/Y 50M/ 100M/12H/ 1D/ 2H/ 4H/12H//

## TACTICAL REPORT

Use the tactical report (TACREP) to quickly report vital intelligence information such as fleeting target, threat or danger to friendly units, distress situation, radio DF and other EW information, newly discovered enemy intentions, battle damage assessment data, and combat information that cannot be exchanged with tactical data systems between tactical units.

This message includes enemy activity; ship, aircraft, or ground vehicle type; related unit; location; speed and direction of movement for maritime, air, and ground enemy units with amplifying information; and E W information such as emitter frequency, bandwidth, call sign, and type of EW.

### TACTICAL REPORT

#### TACREP FORMAT

LINE 1: CLASSIFICATION  
LINE 2: SET NAME/TACREP/ORIGINATOR//  
LINE 3: SET NAME/EFFECTIVE TIME/AMOUNT/SOURCE/SUBJECT TYPE/PRIMARY  
IDENTIFIER/UNIT IDENTIFICATION/LOCATION//  
LINE 4: SET NAME/AMPLIFYING DATA//  
LINE 5: SET NAME/RADIO FREQUENCY/BANDWIDTH/CALL SIGNS//

#### TACREP EXAMPLE {JINTACCS}

UNCLAS  
MSGID/TACREP/CTF134//  
GNDOP/121130Z/1/US/TTY/TGR-1/UNK/UK:123ABC234//  
OPSUP/SER:A/UNID:6TH CAA/AREANM:NORTHERN FRONT/ACTTYP:RVRCS/ETD:121530Z  
/DEPART:GEROFT//  
COMEW/12.530MHZ/2.5/ATRAS//

## RII—Request for Intelligence Information

**Purpose or Use of Message:** The RII is utilized to request intelligence information from other units. It is also used to request the status of an anticipated response of a previous request.

### REQUEST FOR INTELLIGENCE INFORMATION

#### FORMAT

LINE 1: CLASSIFICATION  
LINE 2: SET FIELD NAME/EXERCISE NAME//  
LINE 3: SET FIELD NAME/MESSAGE TITLE/MESSAGE SERIAL NUMBER/DATE-TIME//  
LINE 4: SET FIELD NAME/DATE-TIME DESIRED/LATEST TIME INFORMATION OF VALUE/MISSION PRIORITY//  
LINE 5: SET FIELD NAME/LOCATION/RADIUS, WIDTH, ELIPTICAL AREA/LOCATION/LOCATION/LOCATION/LOCATION//  
LINE 6: SET FIELD NAME/LOCATION/RADIUS//  
LINE 7: SET FIELD NAME/LOCATION/WIDTH//  
LINE 8: SET FIELD NAME/LOCATION/ELLIPTICAL AREA//  
LINE 9: SET FIELD NAME/NARRATIVE//

#### EXAMPLE

UNCLAS  
EXER/BRAVE SHIELD 95//  
MSGID/RII/9T18/0622320//  
REQDATF/DATDES:9506231320Z/LTI0V:9506231750Z/PRY:2//  
TRCPL0T/453724N1573418E/-/45050N1573816E/455019N1572618E  
/454327N1565137E/453724N1573418E//  
TRCPL0T/453724N1573418E/RAD:10NM//  
TRCPL0T/453724N1573418E/WIDTH:2000YD/454050N1573816E//  
TRCPL0T/453724N1573418E/ELP:2000YD-1000YD-135.5//  
NARR/REQUEST ALL ENEMY AIR DEFENSE INSTALLATIONS IN THIS AREA//  
RMKS/INCREMENTAL RESPONSE REQUESTED BY FASTEST MEANS POSSIBLE AS INFORMATION BECOMES AVAILABLE//

## RRII—Response to Request for Intelligence Information

**Purpose or Use of Message:** The RRII is utilized to reply to a Request for Intelligence Information. If information is contained in a previous message, the RRII should reference that message.

### RRII

#### FORMAT

LINE 1: CLASSIFICATION  
LINE 2: SET FIELD NAME/MESSAGE TITLE/ORIGINATOR/DATE-TIME//  
LINE 3: SET FIELD NAME/SERIAL LETTER/ORIGINATOR/DATE-TIME//  
LINE 4: SET FIELD NAME/NARRATIVE//

#### EXAMPLE

UNCLAS  
EXER/BRAVE SHIELD 95//  
MSGID/RRII/III MAG/062202Z//  
REF/A/RII/9TIS/062232Z//  
NARR/WE SHOW THAT TEN SAM SITES ARE ACTIVE IN REQUESTED AREA AT:

	LOCATION	TYPE SAM	NOTE
1	453721N1573420E	SA 8	LAST KNOWN LOC
2	453905N1574010E	SA 2	4 LAUNCHERS UP
3	453901N1575010E	SA 2	6 CONFIGUR
4	454010N1565130E	SA 8	
5	454015N1571020E	SA 2	HGT FINDR DAM
6	455120N1565959E	SA 2	
7	454131N1570110E	SA 4	
8	454120N1565739E	SA 4	
9	454130N1792731E	SA 3	
10	454122N1575751E	SA 6	LAST LOC//

## TACELINT-Tactical ELINT Report

**Purpose or Use of Message:** The TACELINT is utilized to report time-critical operational ELINT and parametric information. It may be used for indications and warning, data base maintenance, order of battle, and strike planning. ELINT collectors use this message as a reporting vehicle.

### TACTICAL ELINT REPORT

#### FORMAT

LINE 1: CLASSIFICATION  
LINE 2: SET FIELD NAME/EXERCISE NAME  
LINE 3: SET FIELD NAME/MESSAGE TITLE/ORIGINATOR/DATE-TIME//  
LINE 4: SET FIELD NAME/COLLECTOR DIGRAPH/COLLECTOR MISSION NUMBER//  
LINE 5: SET FIELD NAME/TARGET SIGNAL IDENTIFIER/DETECTION TIME/TIME  
LOST/ELINT NOTATION OR SORTING CODE/EMITTER DESIGNATION/COUNTRY  
OF SIGHTING//  
LINE 6: DATA ENTRY/EMITTER LOCATION DATA CATEGORY/LOCATION/RADIUS/  
ORIENTATION IN DEGREES TO THE TENTH, TRUTH, MAGNETIC, OR  
GRID/DECIMAL LENGTH OF SEMI-MAJOR AXIS//DECIMAL WIDTH OF  
SEMI-MAJOR AXIS//  
LINE 7: SET FIELD NAME/DOWNGRADING AND CLASSIFICATION MARKINGS//

#### EXAMPLE

SECRET\*  
EXER/BRAVE SHIELD 95//  
MSGID/TACELINT/TP 501 CEWI BN/0506001//  
COLLINFO/HB/-/DF266//  
SOI/-/060812Z/060821A/XXXXX/HIGHBLOW/GC/P00418001//\*\*  
EML0C/-/F/LS:512242N0115030E/-/027T/02.4NM/01.NM//  
DWNGRADE/DECLAS: 31 DEC 99//

\* NOTE: CLASSIFICATION IS FOR EXAMPLE PURPOSES ONLY.

\*\*ACTUAL ELINT NOTATION, OR SORTING CODE FOR FIELD 4 OF THE SOI SET, IS NOT SHOWN.

## ELECTRONIC WARFARE MISSION SUMMARY

The electronic warfare mission summary (EWMSNSUM) is used to summarize significant EW missions and the status of offensive EW assets. It is not to be used for reporting results of ESM operations (see the following illustrations for format and example).

### ELECTRONIC WARFARE MISSION SUMMARY

#### EWMSNSUM FORMAT (JINTACCS)

LINE 1: CLASSIFICATION

LINE 2: SET NAME/EWMSNSUM/ORIGINATOR//

LINE 3: SET NAME/TIME FROM/TO: /ASOF: //

LINE 4: SET NAME/HEADING//

LINE 5: SET NAME/DATA ENTRY/REQUEST NUMBER/COUNTRY/LOCATION/CALL SIGN  
/UNIT NAME//

LINE 6: SET NAME/DATA ENTRY/FUNCTION/EQUIPMENT NAME/NOTATION  
/FREQ BANDWIDTH/SIGNAL TYPE//

LINE 7: SET NAME/DATA ENTRY/ON TIME/OFF TIME/PRIORITY/ECM TYPE/ECM  
TECHNIQUE//

LINE 8: SET NAME/DATA ENTRY/PRIME FREQ/SECOND FREQ/LOWER RF/UPPER RF/PRFPRI//

LINE 9: SET NAME/DATA ENTRY/EW ASSET//

## ELECTRONIC WARFARE MISSION SUMMARY (Cont)

EWMNSUM EXAMPLE {JINTACCS}

UNCLAS

MSGID/EWMNSUM/1ST PLT CO A 501 MI BN//

PERID/081200Z/T0:081800Z/ASOF:081200Z//

HEADING/EW/MISSIONS//

SETGWHO

/DE/REQNO /CY/EMITLOC /TGT-CALL-SIGN /ENUNIT

/01/A123 /WA/4523N12246W /ABADABA /1ST ADA BN//

SETGWAT

/DE/FC/TGT-EQUIP-NAME /ELNOT/RF BANDWIDTH/SIG

/01/RR/SWAMPRAT /AM159/ 14.2/C//

SEECMACT

/DE/ON-TIME/OFFTIME/PRY/ECM-TYP/ECM-TECQ

/01/100001Z/Z02400Z/ 4/INTERFER/INCDSP00F//

SETGFREQ

/DE/PRYFREQ /SECFREQ /LOWRF /HIGHRF /PRFPRI

/01/ -/ -/ 58.2 MHZ/ 79.3 MHZ/PRI20//

SEWSYST

/DE/TYPES

/01/MSQ-103C//

NOTE: The TACREP is to be used to report ESM operational results.

## ELECTRONIC WARFARE REQUESTING/TASKING MESSAGE

The electronic warfare requesting/tasking message (EWRTM) is for tasking units under your control to perform EW missions or to request EW support from units not under your control. This message includes descriptions of ECM and ESM targets you need support against (see the following illustrations for format and example).

### ELECTRONIC WARFARE REQUESTING/TASKING MESSAGE

#### EWRTM FORMAT (JINTACCS)

- LINE 1: CLASSIFICATION
- LINE 2: SET NAME/EWRTM/ORIGINATOR//
- LINE 3: SET NAME/UNIT NAME//
- LINE 4: SET NAME/ECM TARGETS//
- LINE 5: SET NAME/DATA ENTRY/REQUEST NUMBER/COUNTRY CODE/EMITTER LOCATION  
/TARGET CALL SIGN/ENEMY UNIT NAME//
- LINE 6: SET NAME/DATA ENTRY/RADIO-RADAR FUNCTION/TARGET EQUIPMENT NAME  
/ELINT NOTATION OR SORTING CODE/FREQUENCY BANDWIDTH/SIGNAL TYPE//
- LINE 7: SET NAME/DATA ENTRY/ON TIME/OFF TIME/PRIORITY/ECM TYPE  
/ECM TECHNIQUE//
- LINE 8: SET NAME/DATA ENTRY/PRIMARY FREQUENCY/SECOND FREQUENCY  
/LOWER RF LIMIT/UPPER RF LIMIT/PRIPRF//
- LINE 9: SET NAME/ESM TARGETS//
- LINE 10: SET NAME/DATA ENTRY/REQUEST NUMBER/COUNTRY CODE/EMITTER LOCATION  
/TARGET CALL SIGN/ENEMY UNIT NAME//
- LINE 11: SET NAME/DATA ENTRY/RADIO RADAR FUNCTION/TARGET EQUIPMENT NAME  
/ELINT NOTATION/FREQUENCY BANDWIDTH/SIGNAL TYPE//
- LINE 12: SET NAME/DATA ENTRY/PRIMARY FREQUENCY/SECOND FREQUENCY  
/LOWER RF LIMIT/UPPER RF LIMIT/PRIPRF//
- LINE 13: SET NAME/DATA ENTRY/ESM ON TIME/ESM OFF TIME/EEI CATEGORY/PRIORITY//



## ELECTRONIC WARFARE REQUESTING/TASKING MESSAGE (Cont)

EWRTM EXAMPLE {JINTACCS}

```
UNCLAS
MSGID/EWRTM/501 MI BN/
TASKUNT/2D C&J PLT//
HEADING/ECM TARGETS//
SETGWHO
/DE/REQNO /CY/EMITLOC /TGT-CALL-SIGN /ENUNIT
/01/A543A /ZZ/4530N08045E /UNK /-//
SETGWHAT
/DE/FC/TFT-EQUIP-NAME /ELNOT/RF-BANDWIDTH/SIG
/01/RR/JUMPER /A0001/ 14.5/S//
SEGCMACT
/DE/ON-TIME/OFFTIME/PRY/ECM-TYP/ECM-TECQ
/01/051200Z/100600Z/ 2/JAMMING/BLANKET//
SETGFREQ
/DE/PRYFREQ /SECFREQ /LOWRF /HIGHRF /PRFPRI
/01/ 32.0MHZ/ 42.0MHZ/ -/ -/PRI10//
HEADING/ESM TASKING//
SETGWHO
/DE/REQNO /CY/EMITLOC /TGT-CALL-SIGN /ENUNIT
/01/26021 /ZZ/32VMN123123 /SGEZZ /34TH MRR//
SETGWHAT
/DE/FC/TGT-EQUIP-NAME /ELNOT/RF-BANDWIDTH/SIG
/01/GM/FASTDITCH /P555A/ 28.5/P//
SETGFREQ
/DE/PRYFREQ /SECFREQ /LOWRF /HIGHRF /PRFPRI
/01/ -/ -/ 67MHZ/ 83MHZ/--//
SECOLACT
/DE/ON-TIME/OFFTIME/EEICAT/PRY
/01/051200Z/072400Z/ 22/ 1//
```

NOTE: Use EWEM to answer EWRTMs that you receive. Do not use EWRTM to task/request SIGINT assets. Use the ERTM and COMINTADTSK to task/request SIGINT assets.

## ORDER MESSAGE

*Purpose or Use of Message:* The Order Message contains the standard five-paragraph combat order. Use it to send directives and instructions to subordinate commands. Send information copies to higher and adjacent headquarters as required. The message includes the type of order; task organization; and comments about situation, mission, execution, administration, log, and command signal.

### ORDER MESSAGE

#### FORMAT

LINE 1: SET FIELD NAME/EXERCISE NAME//  
LINE 2: SET FIELD NAME/OPERATION NAME/PLAN ORIGINATOR AND NUMBER//  
LINE 3: SET FIELD NAME/MESSAGE SHORT TITLE/ORIGINATOR//  
LINE 4: SET FIELD NAME/SERIAL LETTER/MESSAGE SHORT TITLE/ORIGINATOR/  
DATE-TIME-GROUP//  
LINE 5: SET FIELD NAME/TYPE OF PLAN OR ORDER/ORIGINATOR AND NUMBER//  
LINE 6: SET FIELD NAME/MAP SERIES/SHEET NAME/EDITION NUMBER/REFERENCE  
NAME//  
LINE 7: SET FIELD NAME/SET FIELD NAME/TIME ZONE//  
LINE 8: SET FIELD NAME/MESSAGE SHORT TITLE//  
LINE 9: HEADING  
LINE 10: UNIT NAME/LOCATION/COMMENTS  
LINE 11: AMPLIFYING DETAILS  
LINE 12: AMPLIFYING DETAILS  
LINE 13: AMPLIFYING DETAILS  
LINE 14: AMPLIFYING DETAILS  
LINE 15: AMPLIFYING DETAILS//  
LINE 16: SET FIELD NAME/MESSAGE SHORT TITLE/AMPLIFYING DETAILS  
LINE 17: AMPLIFYING DETAILS//  
LINE 18: SET FIELD NAME/MESSAGE SHORT TITLE/AMPLIFYING DETAILS//  
LINE 19: SET FIELD NAME/MESSAGE SHORT TITLE/AMPLIFYING DETAILS  
LINE 20: AMPLIFYING DETAILS//  
LINE 21: SET FIELD NAME/MESSAGE SHORT TITLE/AMPLIFYING DETAILS  
LINE 22: AMPLIFYING DETAILS//  
LINE 23: SET FIELD NAME/MESSAGE SHORT TITLE/AMPLIFYING DETAILS//  
LINE 24: SET FIELD NAME/MESSAGE SHORT TITLE/AMPLIFYING DETAILS//  
LINE 25: SET FIELD NAME/ACKNOWLEDGE INDICATOR//

## ORDER MESSAGE CONTINUED

### EXAMPLE

EXER/BOLD PUSH 85//  
OPER/YELLOWSTONE/IICORPS 1602//  
MSGID/ORDER/6TH INF DIV//  
REF/A/ORDER/II CORPS/251630ZSEP85//  
ORDTYP/FRAGORD/6TH INF DIV 1602-2//  
MAP V1075/CULVER CITY/AMS2/ATLAS//  
TIMEZONE/Z//  
HEADING/TASK ORGANIZATION//  
SUNIT  
/UNITDES                                    /UNITLOC                                    /CMNTS  
/1ST BDE                                    /320MNL23123                                /EFF 261800Z SEP  
/3-326 INF BN                                /-    /-  
/3-327 INF BN                                /-    /-  
/3-328 ARMOR BN                              /-    /-  
/1-319 FA BN                                /-    /DS//  
GENTEXT/SITUATION/ENEMY: ANNEX A {INTELLIGENCE}  
FRIENDLY: 23D ARMD DIV REPLACES 50TH ARMD DIV ON THE NORTH, DEFENDS IN  
SECTOR//  
GENTEXT/MISSION280600Z, 6TH INF DIV DEFENDS IN SECTOR//  
GENTEXT/EXECUTION/CONCEPT OF OPERATION: ANNEX B {OPERATIONS OVERLAY}  
1ST BDE REPLACES 3RD BDE ON THE NORTH. RETENTION OF HILL 528 IS CRITICAL//  
GENTEXT/ADMIN AND LOG/ANNEX J {SERVICE SUPPORT} ANNEX K {CIVIL-MILITARY  
OPERATIONS}//  
GENTEXT/COMMAND AND SIGNAL/DIV MAIN VIC MV 132163, DIV TAC VIC MV 132163//  
GENTEXT/AUTHENTICATION/HOPE, MG OFFICIAL: YOUNG, COL G3//  
AKNLDG/Y//

## SITUATION REPORT

Use the commander's situation report (SITREP) for changes in the situation since the last report. Areas covered are current operational plans, current status, unit readiness, situations that may affect operations, operational problems recommended course of action, and items are included in other reports.

This message is divided into areas of effective time period, map reference, enemy situation changes, friendly situation changes, administration and logistical situation, general comments and recommendations, and the commander's personal evaluation of the situation.

### SITUATION REPORT

#### SITREP FORMAT (JINTACCS)

LINE 1:           Classification

LINE 2:           SET NAME/SITREP/ORIGINATOR//

LINE 3:           SET NAME/TIME FROM/TO:/ASOF://

LINE 4:           SET NAME/HEADING//

LINE 5:           SET NAME/COUNTRY/ACTIVITY TYPE/ENEMY UNIT NAME/UNIT LOCATION  
                  /TIME OF SIGHTING//

LINE 6:           SET NAME/HEADING//

LINE 7:           SET NAME/UNIT NAME/UNIT LOCATION//

LINE 8:           SET NAME/AMPLIFICATION DATA//

LINE 9:           SET NAME/HEADING//

LINE 10:           SET NAME/AMPLIFICATION DATA//

LINE 11:           SET NAME/HEADING//

LINE 12:           SET NAME/AMPLIFICATION DATA//

## SITUATION REPORT (Cont)

SITREP EXAMPLE {JINTACCS}

UNCLAS

MSGID/SITREP/12TH INF DIV//

PERID/121315Z/T0:122330Z/ASOF:121330Z/HEADING/ENEMY//

SEUNIT

/CY/ACTTYP/ENUNCT

/UNIT LOC

/TIMPOS

/ZZ/RECON /UNK RECON CO

/SWAYBACK RIDGE

/120830Z

/ZZ/DEPLOY/4TH MRB

/32FUD875182

/120910Z//

HEADING/OWN SITUATION//

SNREADY

/UNITDES

/UNITLOC

/C-1-B MECH

/VIC HILL 428

/4-4 ARMOR

/32FUD875182//

AMPN/C-1-B MECH C4 FOR PERSONNEL, COMBAT READY 72 HOURS.

4-4 ARMOR C4 FOR EQUIPMENT, READY 24 HRS//

HEADING/GENERAL//

AMPN/WORK CONTINUING ON UPGRADE OF MRL SYSTEMS//

HEADING/COMMANDER EVALUATION//

AMPN/ATTACK WITHIN 72 HOURS UNLIKELY//

## THE INTELLIGENCE ESTIMATE

The intelligence estimate is a logical and orderly examination of the intelligence factors affecting mission accomplishment. It provides the commander with a basis for planning operations and for disseminating intelligence to his staff and to other headquarters. It consists of five paragraphs which outline an analysis of the AO, enemy strength, and enemy capabilities that can influence the mission.

It is generally written at division and higher headquarters and briefed down to battalion, although, in a contingency operation, it may be written at the brigade level. It may be presented to the commander formally or informally and may be written or

oral, detailed or summarized. However, when possible, a written estimate is preferred.

The intelligence staff officer prepares the intelligence estimate of the enemy situation. An estimate is prepared at the commander's direction or on the intelligence staff officer's initiative.

The intelligence estimate includes—

- Mission.
- Area of operations.
- Enemy situation.
- Enemy capabilities.
- Conclusions.

An annotated example of an intelligence estimate format follows.

### THE INTELLIGENCE ESTIMATE

(Classification)

Headquarters  
Place  
Date, time, and zone

INTELLIGENCE ESTIMATE NO. \_\_\_\_\_

References: Maps, charts, or other documents.

#### 1. MISSION

The restated mission determined by the commander.

#### 2. THE AREA OF OPERATIONS

This paragraph discusses influence of the AO in arriving at conclusions. It is based on the facts and conclusions of IPB and the analysis of the AO, if one has been prepared. It may be a reference to an analysis of the AO, if adequate coverage and discussion are contained therein.

##### a. Weather.

(1) Existing situation. Include light data and either a weather forecast or climatic information, as appropriate. Use appendixes for detailed information.

(2) Effect on enemy courses of action. Describe the effects of weather on each broad course of action (such as attack, defend). Each description concludes with a statement of whether the weather favors the course of action. Among the courses of action, include use of chemical agents, nuclear weapons, and special methods, techniques, equipment, procedures, or forces.

(Classification)

(Classification)

(Short title identification)

(3) Effect on own courses of action. Describe in the same manner as for (2) above, except that the estimate excludes the use of biological agents.

b. Terrain.

(1) Existing situation. Use graphic representations such as IPB templates where possible. Use annexes for detailed material. Include as much information as necessary for an understanding of observation and fire, concealment and cover, obstacles, key terrain features, and avenues of approach. Include effects of nuclear fires, enemy biological and chemical agents, and any other pertinent considerations on each of these factors as appropriate.

(2) Effect on enemy courses of action. Describe in the same manner as for the effects of weather in a. (2) above. For defensive courses of action, state the best defense area and the best avenues of approach leading to it. For attack courses of action, state the best avenues of approach.

(3) Effect on own courses of action. Describe in the same manner as for effects of weather in a. (3) above.

c. Other Characteristics. The following additional characteristics considered pertinent are included in separate subparagraphs: sociology, politics, economics, psychology, and other factors. Other factors may include such items as science and technology, materiel, transportation, manpower, and hydrography. These factors are analyzed using the same subheading as weather and terrain.

3. ENEMY SITUATION

This paragraph gives information on the enemy which will permit later development of enemy capabilities and vulnerabilities and refinement of these capabilities into a specific course of action and its relative probability of adoption.

a. Disposition. Reference may be made to overlays, enemy SITMAPs, or previously-published documents.

(Classification)

(Classification)

(Short title identification)

b. Composition. Summarize enemy OB that can influence accomplishment of the mission. Reference may be made to previously-published documents. Special mention is made of units capable of EW, low-intensity operations, and other special operations, as appropriate.

c. Strength. Enemy strength is listed as committed forces, reinforcements, air, nuclear weapons, and chemical and biological agents. The purpose of this listing is to assist in developing enemy capabilities and vulnerabilities for use by the commander and staff in selecting courses of action. The unit mission, location of the enemy, enemy doctrine, and the level of command at which the estimate is being prepared are factors to be considered.

(1) Committed Forces. List those enemy ground maneuver units currently in contact and those ground maneuver units with which imminent contact can be expected, regardless of the specific friendly course of action implemented. Designation of enemy forces as committed forces depends on disposition, location, controlling headquarters, and doctrine. The intelligence officer usually accounts for committed forces based on the size of unit doctrinally used to oppose the friendly unit. Generally, enemy units are counted in terms of units two echelons below the friendly unit's size. (For example, a brigade S2 normally considers committed forces in terms of companies; a division G2, in terms of battalions; and a corps G2, in terms of regiments). If there is doubt whether a unit is a committed force or a reinforcement, it is considered a reinforcement. This attributes to the enemy the maximum capability to reinforce forces to oppose a given friendly course of action.

(2) Reinforcements. Include designation and location. Reinforcements are those enemy maneuver units that may or may not be employed against us, depending upon our specific choice of a course of action and upon enemy plans. Reinforcements are enemy units not committed in or out of the friendly sector, but which can react to the friendly course of action, subject to time and distance considerations, in time to influence the accomplishment of the mission. Imminent contact is not expected. Disposition, location, level of control, or other factors at the time of the estimate are considered in determining which enemy forces are reinforcements.

(Classification)



(Classification)

(Short title identification)

(3) Air. List the number of enemy aircraft by type within operational radius. Include the number of possible sorties per day by type of aircraft, if known.

(4) Nuclear Weapons and Chemical and Biological Agents. Estimate, as appropriate, the number, type, yield, and delivery means of enemy nuclear weapons and chemical and biological munitions or agents available to the enemy.

d. Recent and Present Significant Activities. List selected items of information to provide bases for analysis to determine relative probability of adoption of specific courses of action and to determine enemy vulnerabilities. Enemy failure to take expected actions is listed, as well as positive information.

e. Peculiarities and Weaknesses. Based on knowledge of enemy tactical doctrine, practices, the principles of war, the AO, and the enemy situation previously described and discussed, list peculiarities and weaknesses. Briefly describe each, indicating the extent to which they may be vulnerable and how they influence possible friendly courses of action. The items listed are grouped under the headings indicated below. Only pertinent headings are used.

(1) Personnel. An estimate of strength is usually included if less than 80 percent of authorized strength. Status of morale is included, if known.

(2) Intelligence. An estimate of enemy intelligence success, ineffectiveness, or susceptibility to deception and detection is usually included.

(3) Operations. An estimate of combat effectiveness is usually included if less than excellent.

(4) Logistics. An estimate of the enemy's capability to support its forces logistically is included if there are apparent weaknesses.

(5) Civil-Military Operations. An estimate of the attitudes of the enemy and the civilian populace and the status of food supply, medical facilities, communications, and other critical resources is usually included.

(Classification)

(Classification)

(Short title identification)

(6) Personalities. An estimate of the capabilities and weaknesses of the enemy commander and principal staff officers is usually included.

4. ENEMY CAPABILITIES

Based on all the previous information and analyses, develop and list enemy capabilities. The listing provides a basis for analyzing the available information. It shows those capabilities the enemy can adopt as specific courses of action and their relative probability of adoption.

a. Enumeration. State what, when, where, and in what strength for each capability.

b. Analysis and Discussion. Discuss each capability (or appropriate combination of capabilities) in a separate subparagraph. This will provide a basis for conclusions of enemy capabilities and their relative probability of adoption. Include consideration of enemy deception measures. All the previous pertinent information and conclusions are tabulated as either supporting or rejecting the adoption of the capability. After listing all the evidence, each capability is judged from the point of view of whether the adoption of the capability is advantageous to the enemy. Such judgments need not be made if the conclusion is obvious or if there is no evidence that the enemy will adopt the capability, unless the capability is one that will make the accomplishment of the friendly mission highly doubtful or impossible. This exception is to focus attention on dangerous threats.

5. CONCLUSIONS

Based on all the previous information and analyses, state conclusions concerning the total effects of the AO on friendly courses of action. State the courses of action most likely to be adopted by the enemy, including their relative probability for adoption, and the effects of enemy vulnerabilities that can be exploited. These conditions assist in the selection of a friendly course of action.

(Classification)

(Classification)

(Short title identification)

a. Effects of Intelligence Consideration on Operations. Indicate whether the mission set forth in paragraph 1 above can be supported from the intelligence standpoint. Indicate which course(s) of action can best be supported.

b. Effects of the AO on Own Courses of Action. For attack courses of action, indicate the best avenues of approach. For defensive courses of action, indicate the best defense areas and the best avenues of approach leading to and into the defense areas. (This subparagraph is omitted if the discussion of the effects of the area on own courses of action in paragraph 2 has been omitted because of the availability of a current analysis of the AO.)

c. Probable Enemy Courses of Action. List courses of action in order of relative probability of adoption. A listed course of action may include several subordinate courses of action that can be executed concurrently. Usually, no more than two or three courses of action, in order of probability of adoption, can be justified by the available evidence.

d. Enemy Vulnerabilities. List the effects of peculiarities and weaknesses that result in vulnerabilities which are exploitable at own, higher, or lower levels of command. The order of listing these vulnerabilities has no significance.

/s/ \_\_\_\_\_  
(Designation of staff officer)

Annexes (as required)

(Classification)

## THE INTELLIGENCE ANNEX

The purpose of the intelligence annex is to disseminate information about forces essential to the conduct of the operation. It also gives any other necessary intelligence orders or guidance for the operation in question. In addition, the intelligence annex serves as a medium for instructing subordinate commanders to acquire information necessary for the conduct of the operation. Such information often can only be obtained immediately before, or during, the operation itself. The intelligence annex is not a substitute for an intelligence collection plan.

The intelligence annex is a formal intelligence tasking document that may accompany an operation plan or order. It should be as brief as possible, consistent with clarity. Its first paragraph gives a summary of the enemy situation necessary to understand the plan or order, and may refer to annotated maps, enemy situation overlays, or current intelligence reports. Subsequent paragraphs contain specific collection requirements and instructions. SOP information should not be repeated in the intelligence annex. An example of an intelligence annex is on the following pages.

### EXAMPLE OF A DIVISION INTELLIGENCE ANNEX (WHEN ISSUED SEPARATELY FROM AN OPERATION ORDER)

(Classification)

(Change from Oral Orders, if any.)

Copy No 4 of \_\_\_\_\_ copies  
20th Inf Div (Issuing headquarters)  
ZELLE (4671), BUTTANO (Place of Issue)  
101900 September 19\_\_ (DTG of Signature)  
BQ 13 (Msg reference number)

Annex A (Intelligence) to Operations Order 24

Reference: Map, BUTTANO, Edition 2, 1:50,000 sheets 204 (ZELLE-PAGT.) (Time zone used throughout the order. Maps, charts, and other relevant documents.)

#### 1. SUMMARY OF ENEMY SITUATION

See INTSUM, this HQ, 101800 September, and Appendix 1, Situation Overlay.

#### 2. PRIORITY INTELLIGENCE REQUIREMENTS

##### a. Priority Intelligence Requirements.

(1) Will enemy reinforce his forces along the FLOOD River before the time of attack? If so, when, where, and with what forces? Special attention to the mechanized regiment and the medium tank regiment in vicinity of BURG.

(2) Will enemy employ nuclear weapons against us? If so, when, where, how many, of what yield, and by what delivery means?

##### b. Information Requirements.

(1) Will enemy continue to defend in his present position? If so, how will he organize his forces on the ground, and with what troops? Special attention to locations and activities of reserves, and vulnerability to nuclear attack.

(Classification)

(Classification)

(2) Will enemy attack prior to 110500 September? If so, when, where, and in what strength? Special attention to the axis Hill 536-Hill 524-CR 981.

(3) Will enemy use CB agents? If so, what agent, when, how, and where?

3. INTELLIGENCE ACQUISITION TASKS

a. Orders to attached and subordinate units.

(1) 1st Bde.

(2) 2d Bde.

(a) Report as obtained.

1. Status of construction of defensive positions and minefields on and to the east of the FLOOD River.

2. Location size of ammunition storage sites and location, size, and content of engineer equipment parks.

3. Clearing of lanes through obstacles within aggressor position in division zone.

4. Number, size, and composition of enemy patrols, and time they were observed.

5. Activity and size of units blocking our patrolling in forward areas.

6. The interception of enemy patrols equipped for CB activity.

7. The presence of enemy troops carrying protective masks or wearing protective clothing.

(b) Report as obtained. Negative reports by 110400 September.

1. Activity in medium tank regiment (-) and tank battalion assembly area in vicinity of BURG.

2. Location and activity of mechanized regiment in vicinity of BURG.

(3) 3d Bde.

(a) Report as obtained.

1. Activity of mechanized battalion north and east of CR 987.

2. Activity of mechanized battalion on Hill 503.

3. Status of construction of defensive positions and minefields on and to the east of FLOOD River.

4. Location and size of ammunition storage sites and location, size, and content of engineer equipment parks.

5. Clearing of lanes through obstacles within aggressor position in division zone.

6. Number, size, and composition of enemy patrols and time they were observed or contacted.

7. Activity and size of units blocking our patrolling in forward areas.

8. The interception of enemy patrols equipped for CB activity.

9. The presence of enemy troops carrying protective masks or wearing protective clothing.

(b) Report as obtained. Negative report by 110400 September.

1. Activity in medium tank regiment (-) and tank battalion assembly area in vicinity of BURG.

(Classification)

(Classification)

2. Location and activity of mechanized regiment in vicinity of BURG.

(4) 1/21 Cav Report as obtained.

(a) Activity of mechanized battalion on Hill 503.

(b) Status of construction of defensive positions and minefields on and to the east of the FLOOD River.

(c) Location and size of ammunition storage sites and location, size, and content of engineer equipment parks.

(d) Clearing of lanes through obstacles within aggressor position in division zone.

(e) Number, size, and composition of enemy patrols, and time they were observed.

(f) Activity and size of units blocking our patrolling in forward areas.

(g) The interception of enemy patrols equipped for CB activity.

(h) The presence of enemy troops carrying protective masks or wearing protective clothing.

(5) Div Arty.

(a) Report as obtained.

1. Status of construction of defensive positions and minefields on and to the east of the FLOOD River.

2. Clearing of lanes through obstacles within aggressor position in division zone.

3. Number, size, and composition of enemy patrols, and time they were observed or contacted.

4. Activity and size of units blocking our patrolling in forward areas.

5. The interception of enemy patrols equipped for CB activity.

(b) Report as obtained. Negative reports by 110400 September.

Locations of artillery positions, including number of weapons, caliber, and state of preparation of position.

(6) 20 Avn.

(a) Report as obtained.

1. Activity of mechanized battalion north and east of CR 987.

2. Activity of mechanized battalion on Hill 503.

3. Location, size, and type of unit in vicinity of Hill 536

(north of BURG).

4. Status of construction of defensive positions and minefields on and to the east of the FLOOD River.

5. Location and size of ammunition sites, location, size, and content of engineer equipment parks.

6. Preparation of emplacements suitable for, and presence of equipment appropriate to, atomic demolition munitions (ADM).

7. The interception of enemy patrols equipped for CB activity.

(b) Report as obtained. Negative reports by 110400 September.

1. Movement on the following roads:

a. North on Highway 25.

b. West on Highway 2.

c. West on Highway 4.

(Classification)

(Classification)

2. Activity in medium tank regiment (-) and tank battalion assembly area in vicinity of BURG.
3. Location and activity of mechanized regiment in vicinity of BURG.
4. Location of artillery positions, including number of weapons, caliber, and state of preparation of positions.
  - (7) 20 Engr. Report as obtained.
  - (a) Status of construction of defensive positions and minefields on and to the east of the FLOOD River.
    - (b) The interception of enemy patrols equipped for CB activity.
  - b. Requests to higher, adjacent, and cooperating units.
    - (1) 1st Corps is requested to provide:
      - (a) As obtained.
        1. Location, size, and type of unit in vicinity of Hill 536 (north of BURG).
        2. Number, types, direction of movement, and time of movement of air or surface vehicular traffic within the division zone, with special attention to Highway 2.
        3. Troop concentrations, including types of vehicles, east of Highway 25 within the divisional area of interest.
        4. Evidence of field fortifications and troop concentrations along the following lines:
          - a. Hill 503-CR 987
          - b. Hill 518-Hill 536-Hill 499
        5. Location and size of ammunition storage sites and locations, size, and content of engineer equipment parks.
        6. Instances of heavily guarded vehicular movement. Special attention to Highway 2 from ZILCH to BURG.
        7. Areas under unusual security restrictions in the divisional area of interest.
        8. Presence of special security troop units in any area east of Highway 25.
        9. Any location in the divisional area of interest from which civilians have been evacuated.
        10. Launcher sites for guided missiles or rockets within divisional area of interest.
        11. Preparation of emplacements suitable for, and presence of equipment appropriate to, ADM.
        12. The interception of enemy patrols equipped for CB activity.
        13. All CB supply movement and dumping in zone.
        14. The presence of enemy troops carrying protective masks or wearing protective clothing.
      - (b) As obtained; negative reports by 110400 September.
        1. Movement on Highway 25.
          - a. North on Highway 25.
          - b. West on Highway 2.
          - c. West on Highway 4.
        2. Activity in medium tank regiment (-) and tank battalion assembly area in vicinity of BURG.

(Classification)

(Classification)

- BURG.
3. Location and activity of mechanized regiment in vicinity of
  4. Location and activity of mechanized regiment southwest of CR 994.
  5. Locations of artillery positions, including number of weapons, caliber, and state of preparation of positions.
  6. Command posts, supply points, and medical facilities east of Highway 25.
    - (2) 18 Inf Div is requested to provide:
      - (a) As obtained.
        1. Troop concentrations, including types of vehicles, east of Highway 25 within the divisional area of interest.
        2. Instances of heavily-guarded vehicular movement. Special attention to Highway 2 from ZILCH to BURG.
        3. Areas under unusual security restrictions in the divisional area of interest.
        4. Presence of special security troop units in any area east of Highway 25.
        5. Any location in the divisional area of interest from which civilians have been evacuated.
        6. Launcher sites for guided missiles or rockets within divisional area of interest.
        7. Locations of heavy artillery positions, including number of weapons, caliber, and state of preparation of positions.
        8. Preparation of emplacements suitable for, and presence of equipment appropriate to, ADM.
        9. The interception of enemy patrols equipped for CB activity.
        10. All CB supply movement and dumping in zone.
        11. The presence of enemy troops carrying protective masks or wearing protective clothing.
      - (b) As obtained; negative reports by 110400 September.
        1. Movement on Highway 25.
          - a. North on Highway 25.
          - b. West on Highway 2.
          - c. West on Highway 4.
        2. Location and activity of mechanized regiment southwest of CR 994.
    - (3) 52 Mech Div is requested to provide as obtained:
      - (a) Troop concentration, including types of vehicles, east of Highway 25 within the divisional area of interest.

(Classification)



(Classification)

(b) Instances of heavily guarded vehicular movement. Special attention to Highway 2 from ZILCH to BURG.

(c) Areas under unusual security restrictions in the divisional area of interest.

(d) Presence of special security troop units in any area east of Highway 25.

(e) Any location in the divisional area of interest from which civilians have been evacuated.

(f) Launcher sites for guided missiles or rockets within divisional area of interest.

(g) Locations of heavy artillery positions, including number of weapons, caliber, and state of preparation of positions.

(h) Preparation of emplacements suitable for, and presence of equipment appropriate to, ADM.

(i) The interception of enemy patrols equipped for bn activity.

(j) All CB supply movement and dumping in zone.

(k) The presence of enemy troops carrying protective masks or wearing protective clothing.

(4) Supporting MI elements provide information derivable from SIGINT and ESM and will respond to specific tasking as described in separate instructions.

4. MEASURES FOR HANDLING PERSONNEL, DOCUMENTS, AND MATERIEL. See Division SOP.

5. DOCUMENTS AND EQUIPMENT REQUIRED.

a. Maps. SOP distribution of map, BUTTANO, 1:50,000. SELLE-PAGT.

b. Photographic. The following aerial photographs will be furnished:

(1) Basic cover of division zone (1:20,000 approximate), six copies of each brigade and div arty; one copy each tank battalion, mechanized infantry battalion, 1/21 Cav, division engineer, aviation battalion or group, and division signal officer.

(2) Annotated airphotos distributed automatically, as available.

6. COUNTERINTELLIGENCE.

a. Appendix 2, Counterintelligence.

b. All units coordinate use of Army aircraft through DTOC to minimize number of aircraft in air over division zone prior to attack.

7. REPORTS AND DISTRIBUTION.

Effective 110800 September units will submit INTSUM at 0800, 1200, 1600, 2000, 2400, and 0400 hours daily in lieu of times prescribed in division SOP.

(Classification)

(Classification)

8. OTHER INSTRUCTIONS (as required).

None.

Acknowledge.

POWERS  
MG

Appendixes: 1 - Situation Overlay  
2 - Counterintelligence

Distribution: Same as OPORD

OFFICIAL:

/s/ AUSTIN

AUSTIN

G2

NOTE: In joint service operations where international standardization agreements do not apply, the intelligence annex in JCS Publication 12 will be used.

(Classification)

## COLLECTION PLAN

A collection plan helps the collection manager coordinate and integrate the effort of collection resources. It provides a visible aid for balancing collection requirements. It is a dynamic working tool that changes with requirements and resources. It is a slate where obsolete entries are easily removed and new entries easily recorded. A formal collection plan is used at the division and higher echelons. An informal collection plan may be used by the brigade S2 to help focus the development of the brigade's R&S plan. Battalion collection operations are directed through use of the R&S plan. A collection plan is not normally developed at the battalion level due to the limited collection assets available.



## APPENDIX B

### BRIEFING TECHNIQUES

The nature and roles of the military services require communication skills that are most exacting. Faced with the need for extreme accuracy, absolute thoroughness, and attention to detail on one hand, and brevity, speed, and almost instantaneous response on the other, a highly specialized and stylized type of speech has evolved. This type of speech has been called the "military briefing". It requires specific techniques with respect to the role of the briefer, to the purpose it serves, and to the nature of the required response. As with the intelligence estimate and the OPORD, the military briefing is an operational tool of the trade.

Brigade and battalion S2s must communicate to the commander, primarily by means of the military briefing. The military briefing is used so extensively that it has become an accepted staff procedure technique. The primary reasons for frequent use of the military briefing are to save time for the senior officer; to enable him to question the briefer and to clarify points; and to facilitate rapid, coordinated response and thereby reduce reaction time.

The principles and techniques of effective speaking apply to the briefings just as to any other type of speech. The more concise the briefing, the better. It's usually limited to bare, un glossed facts and to the minimum amount of information needed for comprehension. Intelligence analysts and officers often will be required to brief on a very broad subject in a very limited time.

The intelligence briefing usually is a "one time only" presentation of unfamiliar facts, with reference to enough familiar material to establish the scope and content for the listeners, but it is always tailored to the user. There are no "attention-getters." Only the essentials are delivered in an objective manner. This is the significant difference between the military briefing and everyday public speaking techniques.

The term "briefing" has been loosely applied to almost every form of oral communication in which a military man is involved or in which a military subject is discussed. This usage is unfortunate because it tends to detract from the importance of the military briefing. Consequently, the briefer must understand precisely what is required of him in each situation.

The intelligence briefing is a specialized type of speech. Its purpose is to present selected information. The briefings are designed to accomplish a specific purpose: to impart information, to obtain a decision, to exchange information, or to review important details. The objective common to every briefing is that of facilitating a rapid, coordinated response.

Effective briefing cannot be learned by simply reading a book. Skill in presenting briefings requires knowledge of the principles of speech and experience gained by considerable practice. Even the most accomplished briefer will learn something new and pick up pointers every time he briefs.

First, know your user. "Just who is being briefed?" What is his official position? What are his personal likes and dislikes concerning briefings? What does the user expect of the briefer?

Each audience to be briefed is different. Each has its own particular needs (personal likes and dislikes). You should attempt to determine these needs and, on that basis, be guided by them in constructing the briefing. This procedure will lead to more effective planning and a more successful presentation.

The second step in analyzing the situation is to determine the purpose of the briefing. Is it merely to present the facts, or is a recommendation required? The purpose of the briefing is extremely important. It will form the basis of the presentation.

The third step is to survey the facilities. Where will the briefing be presented? What kind of aids might be used? If it is to be held in an office, it may be impossible to use equipment. If it is to be held in the field, there may be no electricity and no means of preparing transparencies. Will charts or graphs be placed on chalkboards? Are they available? Are draftsmen available with material to produce the necessary aids? Is time available to prepare aids? These and countless other questions must be answered in the survey step. When planning for, and preparing to use, aids, prepare a detailed presentation plan. Ensure that any assistants, if used, are familiar with what is expected of them. Consider the physical facilities available.

The fourth step is to schedule preparation to ensure that necessary actions are accomplished. Every intelligence officer should formulate a briefing checklist. (See sample, below.) This checklist provides an outline of the tasks to be accomplished. Fill in the outline as the briefing takes shape; as the tasks are accomplished, check off the items. Finally, make an initial estimate of the deadlines needed to accomplish each task. Schedule facilities for practice, and request critiques. Thorough preparation is essential to a successful briefing. A sample of a briefing checklist is shown below.

### BRIEFING CHECKLIST

#### 1. ANALYSIS OF SITUATION

##### **a. Audience**

- (1) Who and how many
- (2) Official position
- (3) Knowledge of subject
- (4) Personal preferences

##### **b. Purpose and type**

##### **c. Subject**

##### **d. Physical facilities**

- (1) Location
- (2) Arrangements
- (3) Visual aids

#### 2. SCHEDULE PREPARATIONS

##### **a. Complete analysis**

##### **b. Prepare outline**

##### **c. Determine requirements**

##### **d. Schedule rehearsals**

##### **e. Arrange for final review**

#### 3. CONSTRUCT THE BRIEFING

##### **a. Collect material**

##### **b. Prepare first draft**

##### **c. Revise and edit**

##### **d. Plan use of visual aids**

##### **e. Practice**

- (1) Rehearse
- (2) Isolate key points
- (3) Memorize outline
- (4) Develop transitions
- (5) Use of definitive words

#### 4. DELIVERY

##### **a. Posture**

- (1) Military bearing
- (2) Eye contact
- (3) Gestures and mannerisms

##### **b. Voice**

- (1) Pitch and volume
- (2) Rate and variety
- (3) Enunciation

##### **c. Attitude**

- (1) Businesslike
- (2) Confident
- (3) Helpful

#### 5. FOLLOW UP

##### **a. Ensure understanding**

##### **b. Record decision**

##### **c. Inform proper authorities**

After analyzing the situation, the next task is to construct the briefing. The analysis helps to determine which type of briefing to make. An information briefing will, among other things, consist of assembling all available information, selecting key points, deciding how best to present these key points, and deciding what visual aids should be used. If it is to be a decision briefing, the problem must be stated, courses of action isolated and analyzed, conclusions reached, recommendations made, and an understandable decision received.

Constructing military briefings is a five-step process.

- First, know the subject thoroughly. Attempt to acquire as much knowledge

of the subject as time and circumstances permit. A logical and thorough briefing is the result.

- Second, isolate essential points to be presented. Be certain to present all essential facts. Even if a fact should prove detrimental to prepared conclusions, if it is a vital consideration, discuss it. If the users want to know more, they will ask questions, giving you an opportunity to provide additional background material.
- Third, arrange facts in a normal and logical order for presentation. The order of arrangement will depend on the type of briefing, the subject, and the visual aids available.
- Fourth, select only those visual aids that will illustrate the point. Aids should be simple, effective, and clear. Good titles or captions help. If the aids consist of charts, be certain the lettering is large enough to read. Ensure there are enough handouts for everyone in the room and have an assistant pass them out. Try to determine ahead of time if the users prefer to read the charts for themselves or have you read them. If the users read the charts, allow plenty of time for reading and comprehension. Watch the users; many commanders will signal when they are ready to continue. Even if the audience reads the charts, it may be helpful if you emphasize the especially significant points. Good visual aids, well handled, add to clarity; bad or poorly used aids are worse than none. If the aids are cumbersome or complicated, plan to have someone assist you.
- The fifth step is to establish key words. Good briefers ensure that the words are understood. Use familiar terms, when possible, define the unfamiliar, and give warning when familiar words will be used in uncommon ways. Rehearse, if possible. Adequate practice within whatever time limits there may be, will pay dividends in familiarity with the subject, smoothness of presentation, impact on the audience, and success of the briefing.

Briefings are characterized by conciseness, objectivity, and accuracy. With certain exceptions, the basic rules for effective speaking also apply to the delivery of a briefing. The success of the briefing is directly affected by the manner in which it is presented. A confident and relaxed, but forceful delivery, clearly enunciated and obviously based on a full knowledge of the subject, helps convince the users that the briefing has merit.

Exhibit confidence, enthusiasm, and sincerity. Maintain a relaxed but military bearing. Use appropriate gestures, move about naturally, and avoid distracting mannerisms. These fundamental delivery principles, common in effective speaking, apply.

In a decision briefing, the presentation of all feasible courses of action, their advantages and disadvantages, and a discussion are required. Use logic to arrive at conclusions and recommendations. Reveal the reasons for arriving at the stated conclusion as the most logical course of action. Understand questions before attempting to answer them. If you do not know the answer, say so and offer to provide an answer later. If the person being briefed does not indicate otherwise, be sure to provide him with an answer later. Answer questions directly, briefly, and to the point. Answer the question and only the question, then stop. The intelligence officer is responsible for presenting the material and furnishing the user with comprehensive information.

Strive for a smooth, convincing, friendly, and effective delivery, with a proper military bearing. A pleasant, well-modulated voice, suited to the size of the area or room is a requisite. Be confident. Confidence is achieved through practice and a thorough knowledge of the subject.

Following the briefing, prepare a concise memorandum for record (MFR). It should record the subject, date, time, and place of the briefing; as well as ranks, names, and job titles of those present. The substance of the briefing may be recorded in very concise form; however, depending on local custom,

this summary may be omitted. Recommendations and their approval, disapproval, or approval with modification, is recorded, as well as any instructions or directed action resulting from the briefing. If there is any doubt about the intent of the decision maker, a draft of the MFR should be submitted to him for approval or correction before it is prepared in final form and distributed.

There are four recognizable types of intelligence briefings: information briefing, decision briefing, staff briefing, and mission briefing. Although there are elements common to all, each type is distinct and is discussed separately.

### INFORMATION BRIEFING

The purpose of the information briefing is to inform the listener—to keep him abreast of the current situation or to supply specific requested information. It does not require a decision. The desired response is comprehension. Information briefings provide—

- High priority information that requires the immediate attention of the commander.
- Complex information, such as statistical charts, that requires detailed explanation.
- Controversial information which requires elaboration for thorough understanding.

The information briefing deals only with facts. It usually does not include conclusions or recommendations. It should contain a brief introduction to indicate the area to which the briefing is addressed and to orient the listener. As with all briefings, presentation of the facts must be orderly, strictly objective, honest, clear, and concise. You should avoid presenting redundant information. Information must be tailored to the user.

Mastery of the techniques of the information briefing is most important. Mental discipline is required in order to present the essential facts objectively, without drawing conclusions. Information briefing elements form an essential part of each of the other three types of briefing techniques.

### INTRODUCTION

**Greeting.** Use military courtesy, address the person(s) being briefed, and identify yourself.

**Classification.** Announce the classification of your briefing.

**Purpose.** Explain the purpose and scope.

**Procedure.** Explain any special procedures such as demonstrations, displays, or tours.

### BODY

**Arrangement.** Arrange main ideas in logical sequence.

**Aids.** Use visual aids correctly.

**Transitions.** Plan for effective transitions.

**Questions.** Be prepared to answer questions at any time.

### CLOSE

**Conclusions.** Give a concluding statement.

**Questions.** Ask for questions.

**Announcements.** Announce the next briefer, if any.

### DECISION BRIEFING

Although the decision briefing contains elements of the information briefing, it is much broader and more comprehensive in scope, and it is presented for an entirely different purpose. The specific response to the decision briefing is an answer to a question or a decision to take a course of action.

The first requirement in preparing for a decision briefing is to isolate and define the problem. Never present problem-solving situations too complex for solution by any step-by-step logical reasoning process. The assumptions may be stated or not. Examples of proper assumptions might be "Adequate resources will be provided" or "The enemy will continue to defend." Assumptions must be both reasonable and supported.

The next step is to collect and present the facts bearing on the problem. This portion of the decision briefing is essentially the same as the information briefing, and the

same rules generally apply, with the following exceptions.

- If already known facts have a direct bearing on the problem they should be repeated. Since this briefing is presented to elicit a decision, the users may need to be reminded of pertinent facts directly related to the problem so they can arrive at a sound decision.
- Facts previously unknown to the users should be limited to those that have a direct bearing on the problem and that might influence the outcome of the decision to be made or the subsequent action to be taken.

In presenting facts, you should strive for objectivity. All of the more pertinent positive and negative facts should be presented. All the important facts must be brought out accurately and fully. Facts may be substantiated by citing single authoritative sources, multiple supporting opinions or personal experiences, or by demonstrating their reasonableness. You should be familiar with the sources of your information. Wrong conclusions or recommendations can be more readily excused if they are a matter of incorrect judgement than if they are an improper or biased presentation of the facts. The facts must have a bearing on the problem.

Next, state the probable courses of action, and briefly point out the advantages and disadvantages of each. Prior to the presentation, you should analyze possible reactions to each of the courses of action and state concisely the potential dangers involved. This discussion is followed by the conclusions, which consist essentially of succinct statements of the acceptability or undesirability of each course of action and reasons why each should be so considered.

Both the discussion and conclusion portions of the briefing must be logically constructed. A logical presentation allows the commander to make correct conclusions from the facts presented. Throughout a presentation, you must be certain that conclusions flow reasonably from the facts presented. Each recommendation should be stated so that its words can be used to state the decision, whenever appropriate.

In your conclusions, list the possible courses of action in order of merit. If possible, prior to the actual briefing, solicit concurrences and nonconcurrence from interested staff sections. When presenting recommendations, you should be prepared to identify nonconcurrence and state from whom and for what reason they were made.

You must be prepared for interruptions and questions at any point during the briefing. When interruptions occur, questions should be answered completely before proceeding. At the same time, you should not be distracted from rapidly resuming the planned sequence of presentation. You must be able to support, by explanation, any part of the briefing. When preparing for the briefing, possible questions are anticipated and answers prepared.

A decision is the expected response of the decision briefing. At the outset of the briefing, you must announce clearly that you are seeking a decision. At the conclusion, if no decision is received, ask for it. You must be certain the decision given by the decision maker is understood. If you are uncertain, you should ask for clarification.

It is not always necessary to use the complete form of the decision briefing. For example, a battalion S3 might present his commander with one new facet of a current problem. He might explain the new aspect and its effect on current operation plans, recommend a course of action, and ask for a decision. At other headquarters, depending largely on the personality and desires of the commander, only portions of the briefing might be presented. However, the processes used to formulate the decision briefing remain essentially the same, regardless of the local peculiarities of presentation.

The decision briefing is designed to obtain an answer or a decision. It is comparable to an oral staff study and generally follows the same sequence.

## INTRODUCTION

**Greeting.** Use military courtesy, address persons being briefed, and identify yourself.

**Classification.** Announce the classification of your briefing.



**Purpose.** State that the purpose of the briefing is to obtain a decision. Announce the problem statement.

**Procedure.** Explain any special procedures such as additional briefers.

**Coordination.** Indicate what coordination has been accomplished.

### BODY

**Assumption.** Must be valid, relevant and necessary. Omit if there is none.

**Facts Bearing on the Problem.** Must be supportable, relevant, and necessary.

**Discussion.** Analyze courses of action. Plan for smooth transition.

**Conclusion.** Degree of acceptance or the order of merit for each course of action.

**Recommendation.** State actions recommended. Be specific. Do not solicit opinion.

### CLOSE

**Questions.** Ask for questions.

**Decisions.** Request a decision.

### FOLLOW UP

**Inform.** Following the briefing, if the chief of staff or executive officer is not present, the briefer must inform him or the staff secretary of the commander's decision.

### STAFF BRIEFING

The staff briefing is the most widely used type of military briefing. It is designed for the rapid oral dissemination of information to a group of people and is similar to the information briefing. Although it is not commonly used for planning purposes or for solving problems, it bears a similarity to the decision briefing whenever it leads to a command decision. It is used at every military echelon to keep the commander and his staff informed of the current situation. The anticipated response is a coordinated or unified effort.

In headquarters of larger units, staff briefings are normally scheduled periodically. Unscheduled staff briefings are called as the need arises. In combat, briefings are held as often as the situation requires. Such briefings are especially valuable in operational conditions when a general awareness

of the situation is difficult, if not impossible, to achieve by any other means. Therefore, the staff briefing is an effective tool employed by the commander to ensure unity of command.

In the staff briefing, each staff representative may be called on to present information pertinent to his particular activity. The staff briefing is usually presided over by the immediate superior of the general staff or coordinating staff officers. He usually calls on staff representatives to present matters that might pertain to, or require coordinated action by, other staff sections. Each headquarters usually has an established order of staff presentation. The staff presentation might be preceded or followed by remarks from the chief of staff or XO and by the commander if he is in attendance.

Staff briefings are the commander's tool for developing coordinated, unified staff action. The commander's personality and the needs of movement will lead him to use his staff as he sees fit in the exercise of command.

The nature of the information presented at the staff briefing varies at each level of command. At lower levels, the information will pertain only to the immediate unit and its activities. At higher levels, information will be of a more general nature and will deal with policies instead of particular actions. In field operations, information will emphasize tactical matters and will tend to take on fewer characteristics of the information briefing and more of the decision briefing.

The staff briefing is a valuable and flexible instrument available to the commander or chief of staff at every level of command. It is used to achieve a unified, coordinated effort in accomplishing the mission of the command.

### MISSION BRIEFING

The mission briefing is designed especially for use during combat operations. It is used to emphasize information, give specific instructions, or instill an appreciation of the mission. The desired response is a thorough understanding and appreciation of operational conditions that will lead to

the successful execution of the mission. It is closely related to the information briefing.

The intelligence portion of the mission briefing is usually conducted by the G2 or S2, depending on the nature of the mission to be performed, or the level of the headquarters involved.

The first step in accomplishing a mission—informing those involved of their tasks—is taken by issuing oral or written orders. When a situation is unique or the mission is of a critical nature, particularly as it relates to the actions of individual participants, the mission briefing will provide individuals or small units with very specific mission data. The mission briefing reinforces previously issued orders. It also provides a more detailed list of requirements and particular instructions for individuals, often explaining the overall significance of their roles. This type of briefing must be prepared and presented with great care to ensure that it neither confuses mission or objectives nor conflicts with previously issued orders.

A good example of the use of the mission briefing in larger operations comes from World War II, prior to the invasion of Normandy. The 101st Airborne Division had received its mission: Conduct an airborne

assault into Normandy on the night of 5-6 June 1944. Because each smaller unit and even each individual had a vital role to play, mission briefings were used to inform each man of his critical role in the operation. First, the men were told of the general situation and mission of the division. Then each individual was informed of the specific mission of his unit and was given detailed instructions for accomplishing it. Using photographs and terrain mock-ups, the briefers made certain that each man was intimately familiar with his job and his particular AO. Each man learned to recognize distinguishing landmarks, how to orient himself no matter how far he missed his drop zone (DZ), where he was to go once on the ground, the situation he might expect to find, and how to deal with them. Finally, he was told of the significance of his role, and how it would contribute to the successful accomplishment of the division mission and, even more, to the success of the Allied invasion.

The purpose of the mission briefing can be summarized as the final review of a forthcoming military action that is designed to ensure that those taking part are certain of their objectives and the particular problems that may confront them.

## APPENDIX C

### THE SURVEILLANCE CARD

The preprinted surveillance card is a reusable plastic device used to record temporary information about target areas for preplanning surveillance and to record data concerning targets detected during normal operations of the radar site. By using the mil scale around its outer edge and the attached pivot al range arm, you can also use the card to determine exact locations of targets quickly and accurately. The card is to a scale of 1:50,000 and can be easily fabricated at the radar section level if the preprinted card is lost or mutilated. Normally, the surveillance card is prepared by the senior operator or the team chief from information furnished by the S2, section leader, or platoon sergeant. Surveillance cards should be prepared for primary, alternate, and supplementary radar sites. They should be transferred to the new unit when you are relieved in place by another radar team. This will save them the trouble of preparing a new surveillance card for the same area.

### ORIENTING THE SURVEILLANCE CARD WITH A COMPASS

#### STEP 1

Determine the 6-digit coordinate of your radar location and mark it on your map with a dot. Select a target in the center of your surveillance area and mark it on your map. With your compass, measure the azimuth to the target (860 mils magnetic).

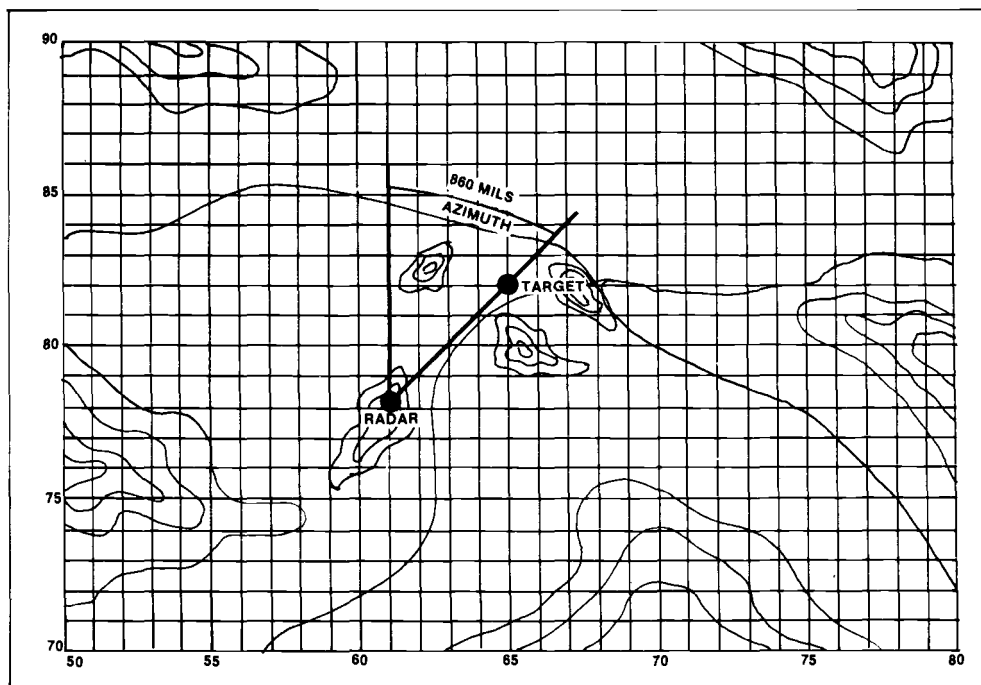

**NOTE:** All azimuths used are grid azimuths. Therefore, all compass readings must be converted from magnetic to grid azimuth.

### STEP 2

On your surveillance card, write 8 before the two zeros in the center at the top of the card.

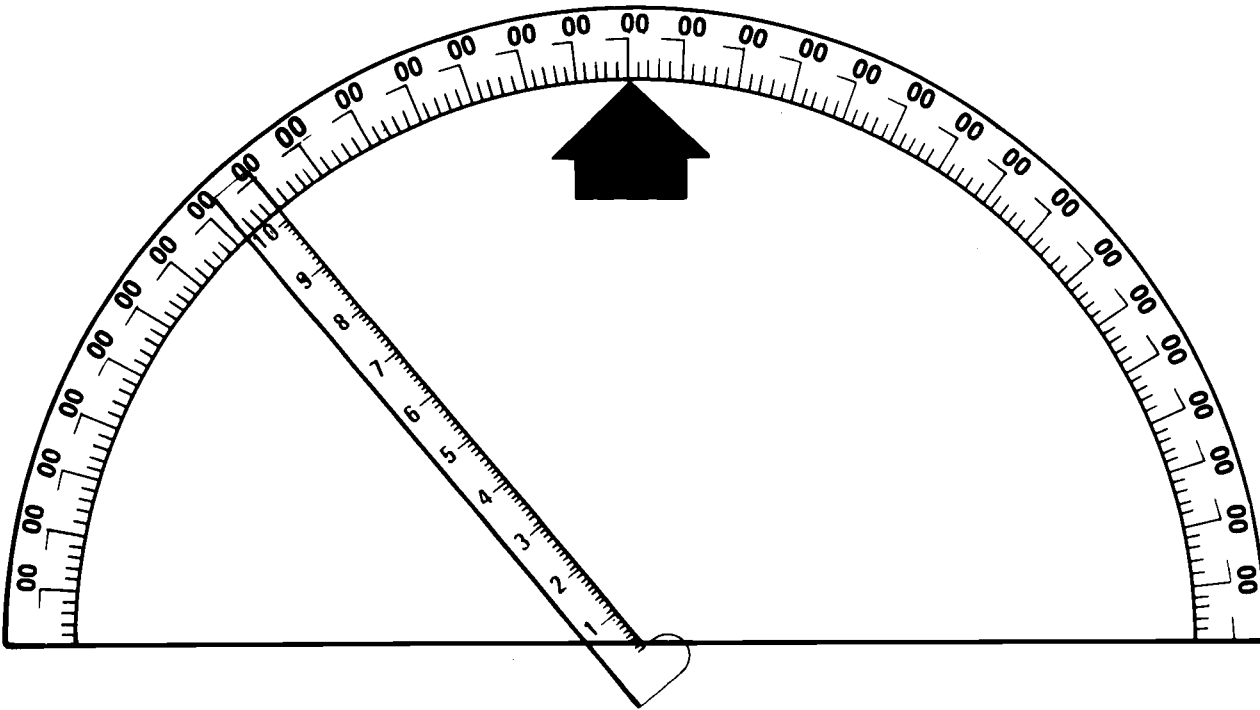

### STEP 3

Number the even hundred mil marks around the edge of the surveillance card. Begin, clockwise, with 9, which indicates the next hundred or 900 mils and continue. Counterclockwise enter 7 on the first hundred mil tick mark and compute all numbers on the card.

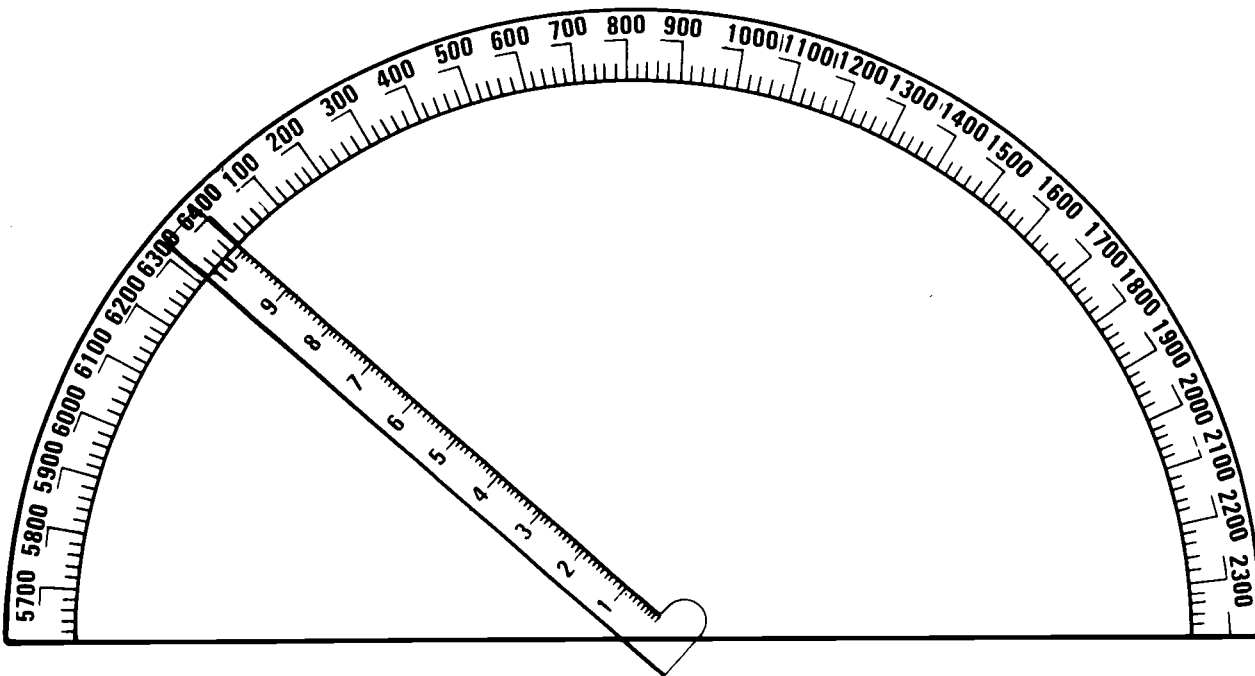

### STEP 4

Align the range arm on 860m (azimuth to the target). Since each small tick mark is 20m, the range arm should be three small tick marks past 800m.

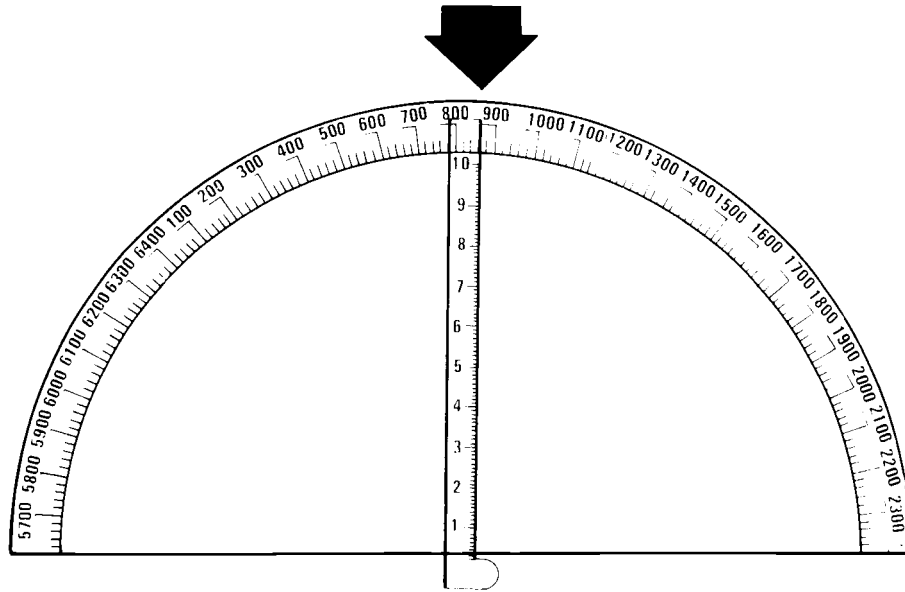

### STEP 5

Place the surveillance card over the map, aligning the hole at the base of the pivot arm over your site. Rotate the card until the range arm is aligned with the target. Be careful that the range arm stays on 860m and the hole remains over your radar position.

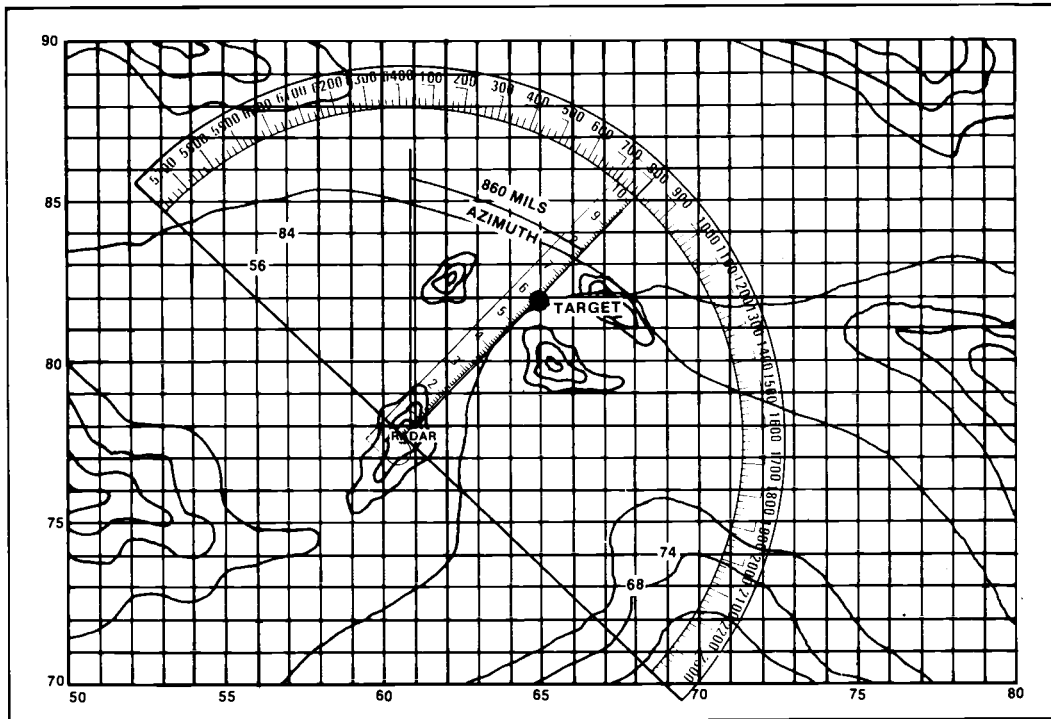

## STEP 6

Tape the overlay to the map. Draw your reference marks on the overlays so that the overlay can be removed and reoriented. On the right and left sides of the overlay outside the surveillance area, find a north/south and east/west grid line cross. Trace over these lines to form a small cross about one-inch long and one-inch wide. At the top or bottom of the north/south grid line write the 2-digit number of that grid line. At the left or right of the east/west line write the 2-digit number of that grid line.

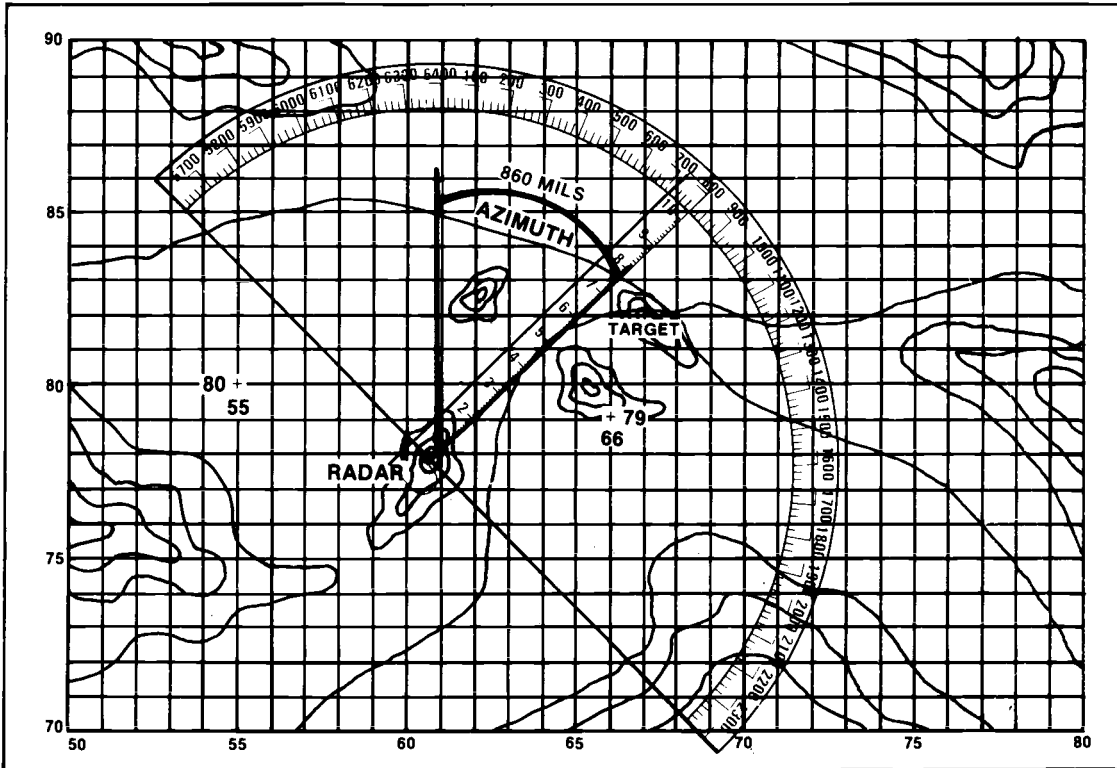

## STEP 7

Check the orientation of the overlay by shooting two or three more azimuths to objects that are shown on the map. Convert them to grid azimuths. Move the range arm until it is over the object on the map and read the azimuth that you shoot for each object. This reading should be within 10 mils of the azimuth that you shoot for each object. If not, do the orientation procedures again and recheck.

### ORIENTING THE SURVEILLANCE CARD WITHOUT A COMPASS

In most instances the general site and sector to be covered will be designated by the supported unit. In all cases, the LEFT and RIGHT limits of your sector must be determined prior to mounting the surveillance card on your map.

### MOUNTING THE SCAP

The following steps will allow you to mount your surveillance card and plotter (SCAP) quickly and accurately.

### Step 1

Perform a resection and plot this location on your map.

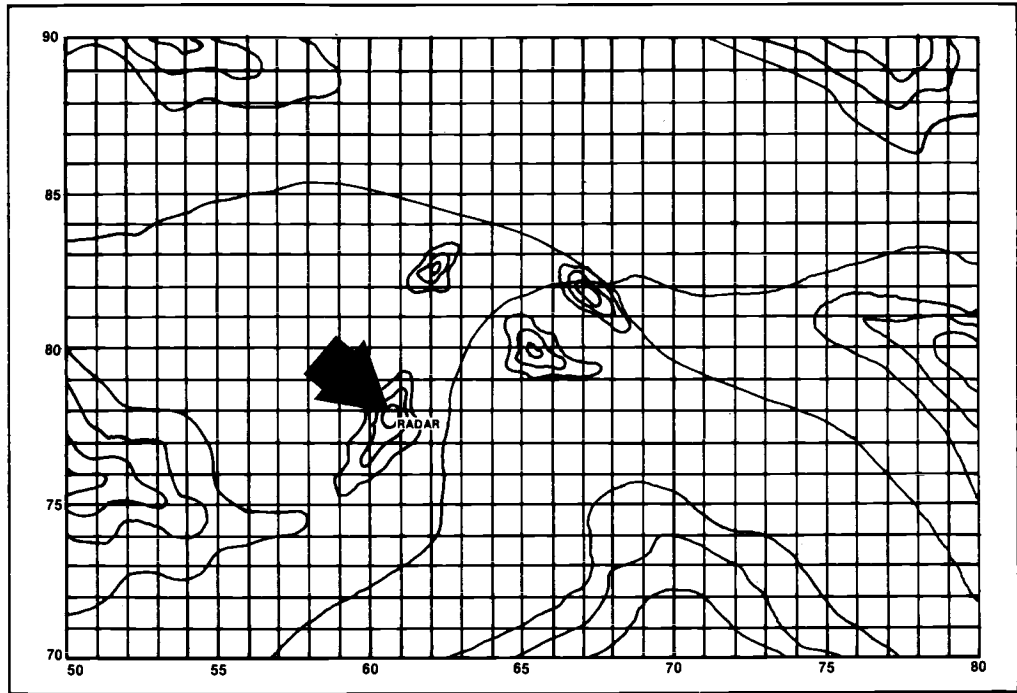

### Step 2

Plot the LEFT and RIGHT limits of your sector on your map.

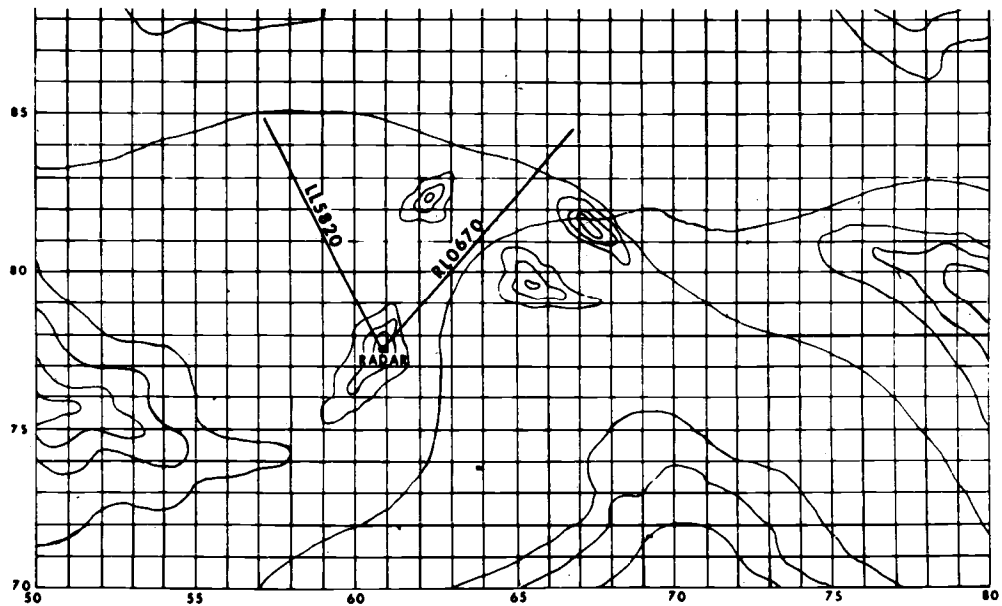

### Step 3

Place your SCAP on the map.

a. Locate the SCAP pivot point directly over the radar location.

Rotate the SCAP until your surveillance area is centered in the SCAP target area.

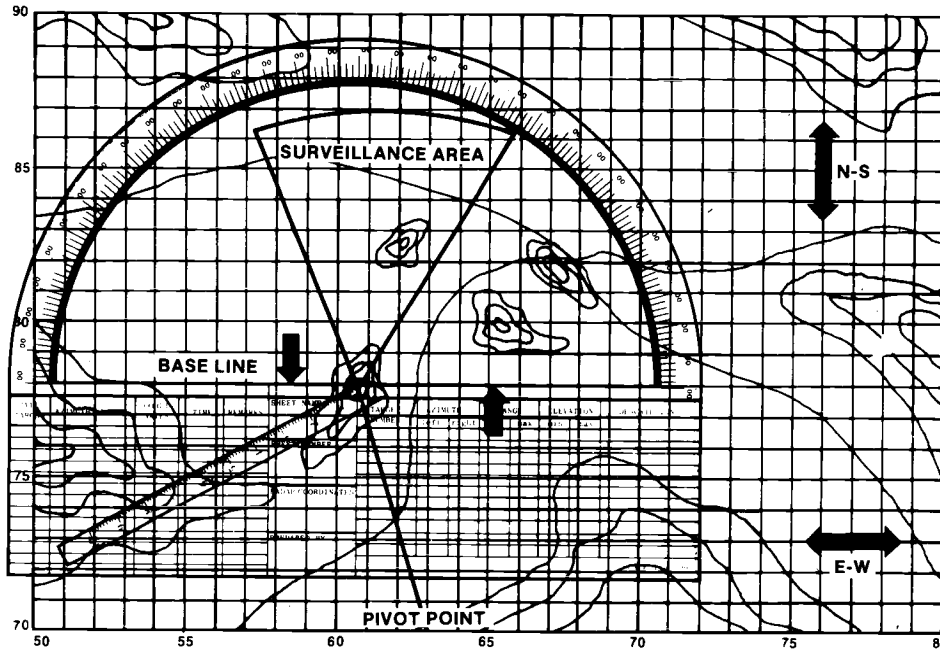

b. Now rotate the SCAP, lining the BASE LINE up parallel with either a NORTH-SOUTH or an EAST-WEST grid line.

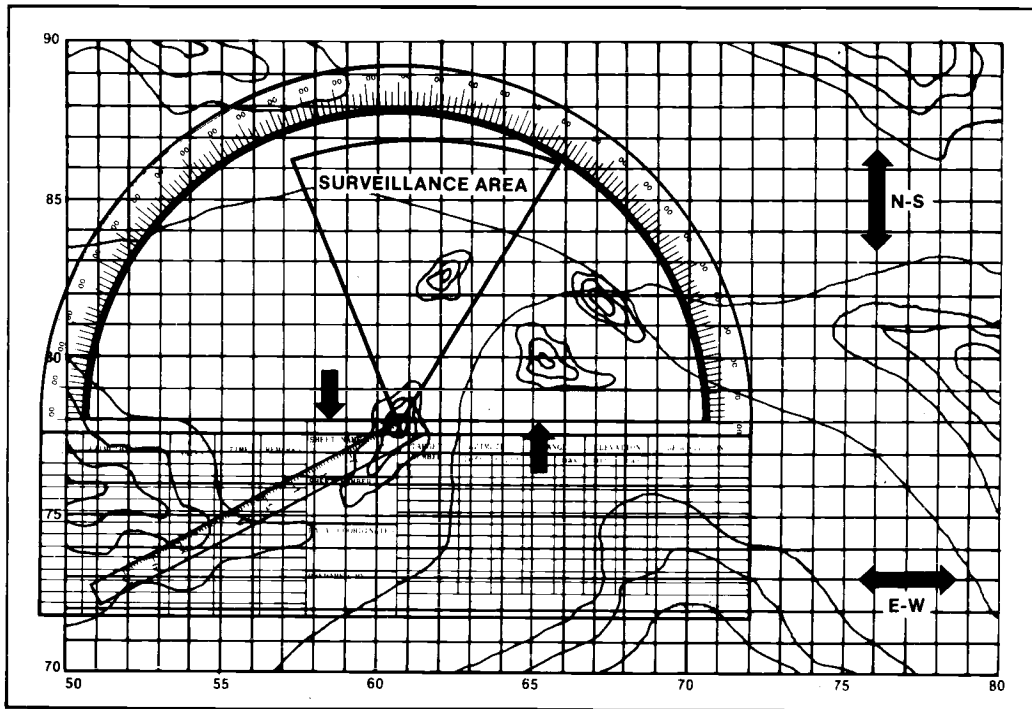



The surveillance area MUST remain inside the SCAP target area, though it does NOT have to be centered.

#### Step 4

Tape the SCAP to the map. While doing this, ensure the pivot point remains over the radar location AND the base line remains parallel to the grid line you used to orient the SCAP.

Draw reference marks on the S-CA-P-SO it can be removed and remounted. On the left and right sides of the plotter outside the surveillance area, locate a grid line intersection. Trace over this grid line to form a cross about one inch long and one inch wide. At the bottom of the north-south grid line you have drawn, write the 2-digit number of the 'grid line.

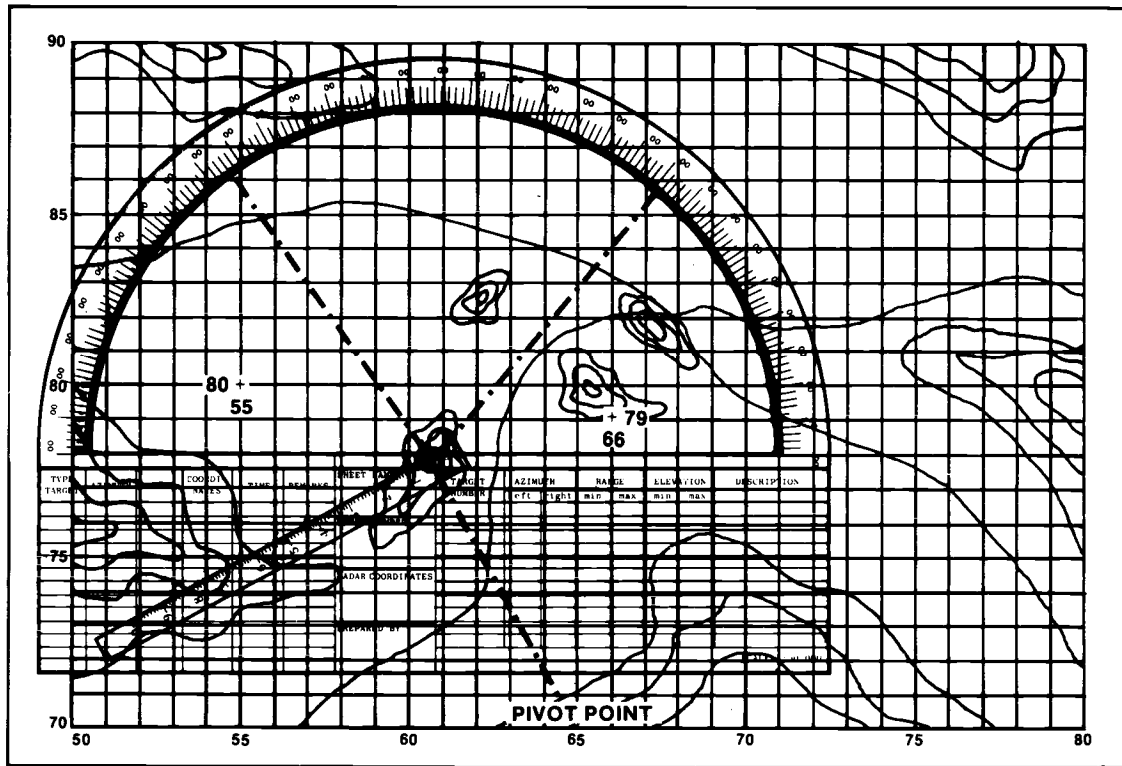

#### Step 5

Check the orientation of the plotter by shooting two or three azimuths to objects shown on the map. Convert these azimuths to grid azimuths.

Swing the range arm to a position over the object on the map, and read the azimuth. This azimuth reading should be within 10 mils of your compass reading. If not, do the orientation procedures again and recheck.

#### Step 6

Complete your SCAP by filling in the dead spaces, writing in the correct numbers in the azimuth ring, and completing the preparation data. Mark the predetermined point, area, and sector targets in the surveillance area and enter the appropriate information in the legend.

If the supported unit has given you specific targets, plot and number these targets on the SCAP. The symbols below will be used to indicate the type of target:

- POINT TARGETS—A point-type target is recorded by making a dot at the point of interest and numbering this line. Indicate this target in the legend using the same number.

EXAMPLE: ●

- AREA TARGETS—An area-type target is recorded by drawing a line over the area and numbering this line. Indicate this target in the legend using the same number.

EXAMPLE: 

- AREA TARGETS REQUIRING A CHANGE IN RANGE—Some area targets require a change in range or a change in azimuth. The area target symbol used above remains the same.

EXAMPLE: 

### RECORDING INFORMATION

Target numbers. Target numbers should coincide with the number assigned to the target by the S2.

Azimuths. Enter the azimuth or azimuths required to orient the radar toward the target or area. If it is a point-type target, one azimuth will be required. Area-type targets, such as a stretch of road, will require both the right and left azimuth covering the area.

The single azimuth of a point target is determined by aligning the range arm over the target and reading the azimuth at the top of the surveillance card. This azimuth is then recorded in the legend. The area-type target, which requires two azimuths, is determined by using the range arm to the right and left limits of the area. These azimuths are then recorded in the legend.

**REMEMBER: The long marks represent 100 mils and each short mark represents 20 mils. A high degree of accuracy (to within 10 mils) can be determined.**

Ranges. Next, enter the range or ranges required to survey the point or area. The range is obtained by aligning the range arm over the target area and reading the distance marked on the range arm. The arm is numbered from 1 to 10; each number represents 1,000 meters and each tick mark represents 100 meters.

In some instances, while monitoring a point, you may have to make range changes. This is determined by measuring the minimum and maximum ranges which can be adequately covered in the area.

Elevation Settings. The elevation setting is determined by aligning the telescope of the radar on the target or area and reading the elevation. In hilly terrain, you may require more than one elevation setting for each target or area. When these readings are determined, enter the minimum and maximum elevation in the legend.

LEGEND							
Target Number	Azimuth		Range		Elevation		Description
	Left	Right	Min	Max	Min	Max	
#1	950		6000		+20		Building (POINT TYPE)

Description. Enter the type and frequency of surveillance for the point or area or any other information that is required.

Other uses. The surveillance card overlay can also be used to record dead space that cannot be covered by your radar. If there is a hill that blocks your LOS, record this on your overlay.

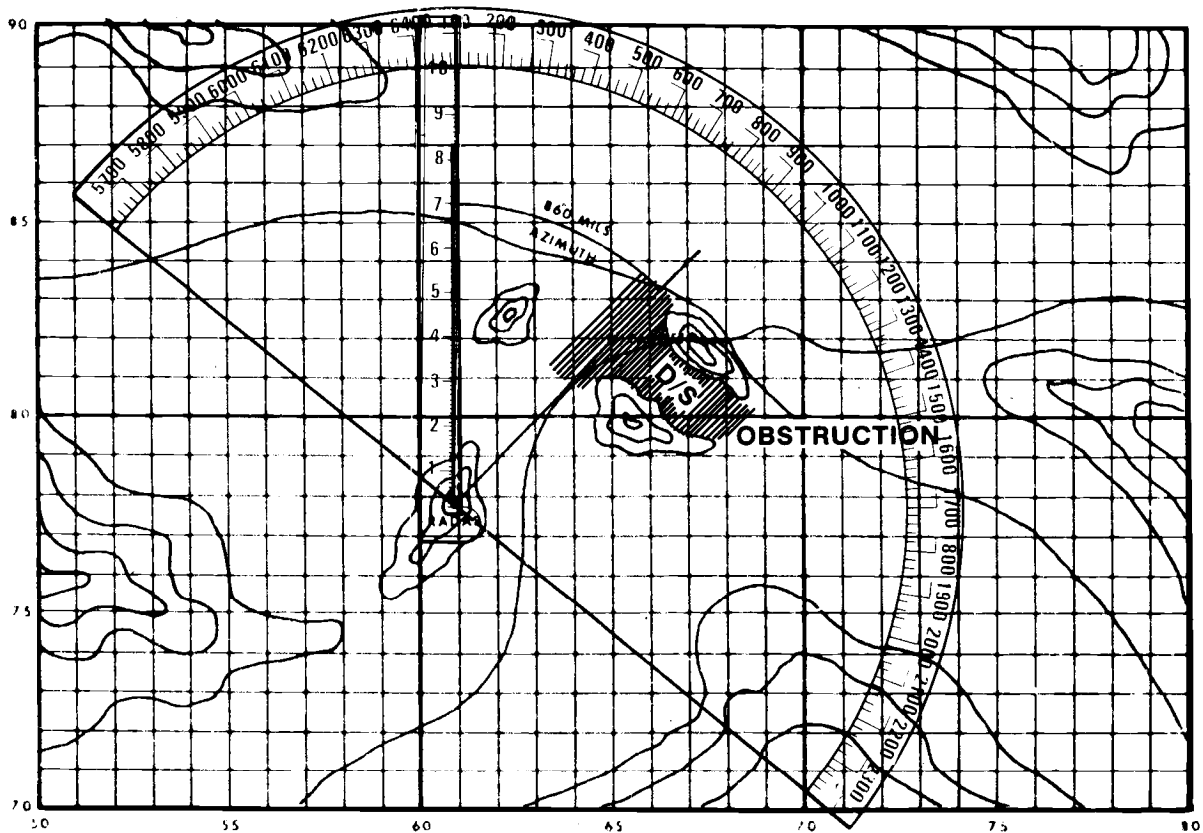

Coordinates. With the surveillance card, you can determine the 6-digit coordinate of a target in about 20 seconds. Take the target azimuth and range from the radar. Set the range arm on the correct azimuth and go out the arm to the proper range. Mark the target's position on the overlay and, using a coordinate scale, read the 6-digit coordinates from the map.

Surveillance area. Use a compass or map to determine the right and left limits of your surveillance area. Once you have determined the grid azimuths of the left and right limits, align the range arm on those azimuths and draw a line from your radar position to the azimuth marks.

Targets data log. The data log is used to record information about targets or areas of interest not listed in the legend. It is also used as a record of targets detected and reported.

## **POINTS TO REMEMBER**

Each small tick mark represents 20 mils.

Each large tick mark represents 100 mils.

Be sure to recheck your orientation by shooting two or three more azimuths to objects shown on your map.

All magnetic azimuths must be converted to grid azimuths.

Be careful that the pivot point hole and range arm do not move when working with orientation.

Be simple, accurate, and fast.

## APPENDIX D

### ARMY OF EXCELLENCE

Army of Excellence organizations were developed as a direct result of the Army's AOE study in 1983. The study recognized the necessity of implementing the revolutionary air-land battle doctrine but with organizations that could be manned and equipped at design authorized levels, particularly authorized level of organization 1. AOE design addressed the Army leadership's studied conclusion that the division was too large and cumbersome to effectively move about the battlefield. It was concluded that most of the corps was dedicated to supporting the division, and that divisions possessed combat support assets equal to or in excess of those at the corps. Under the Army's emerging air-land battle doctrine, the doctrinal requirements existed for the corps commander to orchestrate the battle through a corps operational plan. The operational level of war specifically addresses the desired plans and operations required to confront and defeat potential adversaries organized and deployed at a level commensurate with the US corps. AOE organizations represent the culmination of an effort of force design and force restructuring to facilitate the force modernization process, while reducing or eliminating the Army's "hollowness," and improving the corps commander's ability to execute air-land battle doctrine.

#### **AOE IMPACT ON BATTALION/BRIGADE IEW OPERATIONS**

The impact of AOE on IEW operations at battalion and brigade levels is considered to be a positive one. At the battalion and brigade levels, no significant changes have occurred in the AOE-designed combat organizations that would significantly change IEW operations previously described within this manual. AOE changes in supporting combat organizations such as DIVARTY, the combat aviation brigade and air defense battalion, as well as combat support and CSS organizations, have been offsetting.

For example, while redundant and often dated acquisition systems have been reduced or eliminated, new collection capabilities have been incorporated into organizations within the division in response to intelligence, EW missions, and responsibilities mandated by the proper execution of air-land battle doctrine.

#### **BATTALION IEW RESOURCES**

AOE force design changes impose no changes to those IEW capabilities described earlier. However, capabilities supporting IEW resources provided by combat and combat support organizations such as the DIVARTY, air defense artillery battalion, and MI battalion have, in select cases, been changed by the number and types of sensors or acquisition capabilities provided in what may be regarded as the nominal "brigade slice."

#### **BRIGADE IEW RESOURCES**

IEW systems and resources available to support the brigade and subordinate maneuver battalions and task forces have been changed in some instances with the emergence of AOE organizations. Described below are the specific changes resulting from AOE.

#### **FIELD ARTILLERY**

Field artillery cannon support to the brigade remains unchanged. However, AOE changes the organization of target acquisition assets available within the division artillery's TAB. The TAB retains the counter mortar, counterbattery capabilities provided by the AN/TPQ-36 and AN/TPQ-37 (FIREFINDER) systems and the moving-target-locating radar surveillance capability provided by the AN/TPS-25A or AN/TPS-58B systems. Eliminated from the TAB under AOE are the four AN/TNS-10 sound-ranging sets which provide part of the passive counter mortar, counterbattery

detection capability of the TAB. With the development and fielding of the PADS and the resulting reconfiguration of survey elements with DIVARTY, flash ranging teams organized around these survey party members and associated with field artillery battalion observation posts have been similarly reduced. The net result of reductions within the sound and flash ranging sections has been the total elimination of the DIVARTY sound and flash platoon. Reductions in the number of air observers, from ten to six; and lasing teams, from three to one per DS artillery battalion, have also reduced the division's (as well as brigade's) observation capability by reducing the number of eyes observing the battlefield.

### MILITARY INTELLIGENCE

MI resources dedicated to the IEW mission have been selectively altered in numbers and types based on AOE redesign criteria. Of significant impact is the knowledge that, while AOE has led to the formation of the new infantry division (light), it is also responsible for the creation of a specifically tailored MI battalion (CEWI) to support this type division. MI resources remain organized with multidisciplined capabilities found within the MI battalion structure of each type division. While variations are observed in the density of HUMINT vs. technical collection systems provided in the MI battalion structure for each type division, these variants have been specifically designed in concert with the scope of missions the IEW system is expected to support, the levels of conflict for which each type division is reorganized, force constraints, and the acknowledgement of acceptable risk to IEW mission performance prompted by constrained manpower ceilings. IEW resources organic or OPCON to the MI brigade and MI battalion continue to include IPW, CI, aerial surveillance and aerial EW assets, ground-based EW assets, GSR and, in the airborne, air assault, and light divisions, the REMBASS. The distribution of these IEW resources and their normal allocation of support to the division and its subordinate maneuver brigades and battalions are shown on the following page.

AOE represents a change in HUMINT collection capabilities with the addition of a long-range surveillance capability at the corps and division levels. Long-range surveillance operations are conducted in response to operational tasking from the ACofS, G2 at each respective echelon, and operations are targeted in areas across the FLOT in response to deep targeting and intelligence requirements. Interdiction of enemy forces is not an LRSU function. While this HUMINT capability is added, CI interrogation capabilities within the heavy division have been reduced due to force level constraints. Within the heavy corps, CI and interrogation teams operating within the division AO will require augmentation from the corps MI brigade if normal DS (to brigade) and GS capabilities are to be provided. When such augmentation is not available, specific plans will be required within the corps detailing IPW and CI support procedures to be followed at reduced support levels. Concepts commonly associated with light division operations, such as the area support concept, may apply to such operations as mobile CI team operations in forward brigade AOs. While these teams would be deployed as GS assets of the division, their operations under area support concepts should preclude interrupted CI support to forward deployed forces. IPW assets assigned to the MI battalion, heavy division, are found at minimum essential levels. The ACofS, G2, in coordination with the G3 and MI battalion commander and S3 will determine the desired command relationship under which these limited assets will be deployed. As IPW personnel within the heavy division are organized as an interrogation team with limited communications and mobility, they will normally be deployed in GS of the division as the nucleus of the division EPW collecting point in the division's rear area. IPW teams provided by the corps MI brigade will, when allocated, normally be deployed in DS of forward-deployed brigades within the division. CI or IPW resources allocated to the airborne and air assault divisions will normally be deployed in DS of brigades and GS of the division based on the type operations.

<b>MI RESOURCES</b>					
<b>ECHELON</b>	<b>ORGANIC RESOURCES</b>		<b>ALLOCATED SUPPORT</b>		<b>ALLOCATED SUPPORT</b>
<b>CORPS</b>	<b>MI Brigade</b> Long Range Surv Co <sup>1</sup> EPW Interrogators CI Support Aerial Surveillance SLAR Infrared Photography Aerial ESM Ground Based EW <sup>2</sup>				
<b>DIVISION</b>	<b>MI Battalion</b> LRS Det <sup>1</sup> EPW interrogators <sup>3</sup> CI Support <sup>4</sup> Aerial EW <sup>5</sup> Ground Based EW GSR REMBASS <sup>6</sup>		Interrogators CI Support Ground EW		
<b>BRIGADE</b>	<b>NONE</b>		Interrogators <sup>3</sup> CI Support <sup>4</sup> Ground EW GSR REMBASS <sup>6</sup>		
<b>BATTALION</b>	<b>NONE</b>				GSR REMBASS <sup>6</sup>

NOTES: 1. LRSD HUMINT capability added under AOE.  
 2. Corps ground EW assets limited.  
 3. EPW personnel at reduced strength in MI bn hvy div, requires corps augmentation. Allocated DS to bde and bn normally for specific missions only. GS/DS capability in all other type divs.  
 4. In hvy div, CI support normally held in general support and deployed within div AO under area support. tasking; GS/DS CI support capability in other type divisions.  
 5. Organic to CAB, OPCON to the MI bn.  
 6. REMBASS organic to airborne, air assault, and light division only.

Within the newly created light division, the HUMINT capabilities provided by organic CI and IPW teams are significantly expanded when compared with similar disciplines within the heavy division. This results from the recognized need for an expanded HUMINT operational capability in support of light division operations in lower levels of conflict for which the division is optimized. Ground-based EW assets, formerly found within the TEB of the corps' MI brigade have been reduced to minimum essential levels. The reserve component (RC) TEB is organized to increase the corps' total IEW capability in war when the full corps complement of divisions are deployed, that is, active and reserve divisions. Provided by the RC, TEB are ground-based HF collection, HF/VHF jamming, and ground-based ELINT capabilities. While pre-AOE TOES for MI organizations included provisions for remote sensor teams augmenting the MI structure, the living TOE process does not. Remote sensors monitoring teams

GSR teams assigned to these divisions and, with the exception of the heavy division, greater reliance upon the lightweight, mobile AN/PPS-15 radar system. GSR allocations for each division under AOE are as shown in the following illustration.

GSR teams will continue to be provided DS or attached, less radar maintenance, to maneuver brigades and battalions or task forces based on reconnaissance and surveillance planning conducted by the ACofS, G2.

### Enemy Prisoner of War Interrogators

Interrogators have been assigned to EPW sections in varying numbers by type division in anticipation of the expected need for this HUMINT capability. Manpower force ceilings have had impact on the total number of interrogators which could be placed in certain organizations, the heavy division, for example, where a conscious decision was made in decreasing HUMINT

<b>GSR AUTHORIZATIONS</b>				
<b>GSR</b>	<b>Arm/Mech Division</b>	<b>Lt Inf Division</b>	<b>Air Assault Division</b>	<b>Airborne Division</b>
<b>AN/PPS-5</b>	<b>12 (+2 Float)</b>	<b>0</b>	<b>3 (+1 Float)</b>	<b>3 (+1 Float)</b>
<b>AN/PPS-15</b>	<b>0</b>	<b>12 (+2 Float)</b>	<b>9 (+2 Float)</b>	<b>9 (+2 Float)</b>
<b>TOTAL (Operational Teams)</b>	<b>12</b>	<b>12</b>	<b>12</b>	<b>12</b>

are currently documented in the TOE of the MI battalion (CEWI) of the airborne division only. REMBASS and remote sensor monitoring teams will be added to other type division MI battalion TOES based on the basis of issue plan for the REMBASS, when fielded.

### Ground Surveillance Radars

GSRs remain in the MI battalion structures of all type divisions. AOE design of GSR sections in each type division has resulted in a reduction in total numbers of

spaces in favor of the return and inclusion of technical collection assets. The reverse is also true. In the light division, where ground based ECM systems are not incorporated into the MI battalion TOE, due to their low intensity conflict (LIC) orientation, space savings were used to increase the strength of the CI and interrogation sections where this added HUMINT manpower was deemed most appropriate. The number of interrogators authorized within the MI battalions for all types of divisions under AOE are as follows.



<b>INTERROGATOR AUTHORIZATIONS</b>				
<b>UNIT/PERSONNEL</b>	<b>ARM/MECH DIV</b>	<b>LT INF DIV</b>	<b>AIR ASSAULT DIV</b>	<b>AIRBORNE DIV</b>
<b>INTERROGATION PLT</b>		1 <sup>1</sup>		
<b>INTERROGATION SECTION</b>			1	1
<b>INTERROGATION TEAM</b>	2			
<b>INTERROGATORS</b>	10		7	7
<b>OB ANALYST</b>			1	1
<b>ADMIN SPECIALIST (7IL)</b>			1	1
<b>TOTAL INTERROGATORS</b>	10	25	7	
<b>TOTAL SECTION STRENGTH</b>	10	26 <sup>2</sup>	9	9
<p>NOTES: 1. Platoon Leader (SC 35A, 02) also provided.</p> <p>2. Platoon strength includes personnel assigned to platoon HQ, division cage, DOC exploitation, and interrogation teams.</p>				

Additional interrogators required for sustained EPW operations in the heavy, air assault, and airborne divisions will be obtained from interrogation assets available within the CI interrogation company, TEB of the MI brigade at corps.

### **COUNTERINTELLIGENCE**

CI resources within each type division have undergone important changes in missions and resourcing with the emergence of AOE. SIGSEC assets have been removed from the division and corps and placed at

EAC. Additionally, manpower limitations within the division base structure have caused a reduction in the number of CI authorizations within each type division, with the notable exception of the infantry division (light), where HUMINT resources have been given priority over technical collection systems and resources. While SIGSEC authorizations have been placed within the MI brigade at EAC, their employment in support of ECB remains integral to operating security doctrine.

CI resource authorizations for each type division are as follows.

## CI RESOURCE AUTHORIZATION

ORGANIZATION AND PERSONNEL	ARM/MECH DIV	LT INF DIV	AIR ASSAULT DIV	AIRBORNE DIV
CI PLT		1 <sup>1</sup>		
CI (OPS) SEC		1	1	1
CI OPS SPT ELM	1 <sup>2</sup>			
CI TM	2	4		
TOTAL CI AGENT/TECH	10	22	10	10
TOTAL ORGANIZATION STRENGTH	10	23	10	10

NOTES: 1. Includes platoon leader, SC 35A, LT  
2. Includes CPT, 36A and E7, 97B

As with interrogators, the sustainment of CI operations at ECB requires the augmentation of CI personnel from the CI interrogation company of the TEB, MI brigade at corps. This is particularly true for CI operations within the heavy division. CI team deployment using area support concepts rather than DS is expected to be prevalent when CI augmentation from corps is unavailable.

### ELECTRONIC WARFARE SUPPORT

EW support in each type division has remained largely unchanged when compared to pre-AOE levels. Exceptions, however, are found in the allocation of EW systems within the MI battalion of the infantry division (light), and the corps MI brigade's TEB. Additionally, the QUICKFIX flight platoon has been placed within the combat division brigade structure based on its demonstrated performance in the airborne division under this organizational design in the past. In the infantry division light, the need for expanded HUMINT resources and constraints on the number of vehicles due to strategic mobility requirements has taken precedence over the allocation of ground-based ECM assets in the MI battalion structure. Airborne ECM, provide by the

QUICKFIX flight platoon, constitutes the only ECM capability organic to the light division. The corps' TEB is organized with ground-based ECM and ELINT systems intended to roundout EW capabilities within the corps' sector by providing additional ECM and ELINT collection teams where most needed. Based on the retention of these few EW resources in the corps TEB, and in response to the impact of force level ceilings within the corps base structure as a whole, additional EW resources formerly found within the active component TEB of the corps' MI brigade have been removed. The EW capabilities provided by the reserve component TEB are designed to bring the corps EW arsenal up to full operating strength. With respect to maneuver battalion and brigade operations, the impact of these changes within the corps MI brigade's active component TEB are considered of less import than would have been the case if ground-based EW resources had been assigned to the corps MI brigade, rather than the division's MI battalion, and deployed forward to the FLOT or FEBA as augmentation resources to the division.

EW collection and jamming resources for the AOE divisions are summarized in the following illustrations.

## COLLECTION TEAM AUTHORIZATIONS

COLLECTION TEAMS/SYSTEMS	HVY CORPS AC	TEB RC	ARM/MECH DIV	LT INF DIV	AIR ASSAULT DIV	AIRBORNE DIV
VOICE COLL TM	0	3	3	3	3	3
OPERATORS		18	18	18	18	18
AN/TRQ-32 <sup>1</sup>		3	3	3	3	3
AN/TRQ-30 <sup>2</sup>		3	3	3	3	3
LLVI TM	0			6 <sup>3</sup>	9 <sup>3</sup>	9 <sup>3</sup>
OPERATORS				24	36	36
AN/TRQ-30/PRD-10				6	9	9
TRAILBLAZER (AN/TSQ-114A/B)	0		1			
OPERATORS			24			
MCS			2			
RSS			3			
TEAMPACK MSQ-103	3	3	3		3	3
OPERATORS	12	12	12		12	12
TOTAL SYSTEMS	3	9	10	12	18	18
TOTAL POSITIONS	3	12	16	15	21	21
TOTAL OPERATORS	12	18	54	42	66	66

NOTES: 1. Currently being replaced by the TEAMMATE, AN/TRQ-32(V) system.  
 2. AN/TRQ-30 will be replaced by the AN/PRD-10, manpack radio direction finding system (MRDF).  
 3. LLVI teams are equipped with AN/TRQ-30/PRD-10 and are manned by a four-man team to provide additional intercept capability.

## COMJAM RESOURCES AVAILABILITY

SYSTEM	HVY CORPS AC	TEB 1 RC	ARM/MECH DIV	LT INF DIV	AIR ASSAULT DIV	AIRBORNE DIV
QUICKFIX			3	3	3	3
TRAFFIC JAM			3		3	3
TACJAM	3		3			
AN/GLQ-3B		6				

NOTE: 1. Nine AN/TLQ-17A systems are allocated within the active component EW co, TEB, light corps. The reserve component TEB provides an additional six AN/TLQ-17A and six AN/GLO-3B ECM systems to the light corps structure.

AOE restructuring has permitted the refinement of organizational and other concepts key to describing how EW resources are employed. By example, noncommunications intercept teams of the heavy division were formerly placed singularly within the organization of the EW platoons with little noncommunications analysis or ELINT DF anticipated. While the product-improved TEAMPACK system will be netted electronically by a data link in a manner similar to TRAILBLAZER, the AOE MI battalion structure for the heavy division places the noncommunications intercept teams within the SIGINT processing platoon. COMINT analysts and noncommunications intercept operators or analysts, MOS 98J, assigned to the analysis section of the SIGINT processing platoon conduct initial correlation of COMINT/ELINT DF reporting and provide for the enhanced C<sup>2</sup> of these critical resources. Similarly, team restructuring under AOE and modern equipment has permitted the replacement of generator mechanics (MOS 52D) at each of the three RSSs within the SIGINT processing platoon with EW/SIGINT voice intercept operators (98G) enhancing their independent voice collection and gisting or reporting capabilities when automatic DF operations are not in effect.

AOE has not changed other key doctrinal concepts stated in FM 34-1, or in previous chapters within this manual. IEW company

teams will normally be deployed in a brigade sector when sufficient MI battalion resources are deployed forward to warrant the formation of the company team and the need for a single MI commander representing all IEW elements in the sector is deemed appropriate for the successful execution of IEW missions.

### OTHER COMBAT SUPPORT UNITS

AOE redesign of other divisional organizations has also produced changes within the overall area of IEW support provided commanders. The reduction in the number of FAARs from eight to six systems in the heavy division has reduced the overall air threat warning capability within the division, though for intelligence purposes, this reduction will be more than compensated for in the foreseeable future with innovative changes being evaluated in the integration and exchange of air threat warning information between corps and division air defense organizations. The loss of engineer battalion reconnaissance teams for terrain reconnaissance, brigade classification, and damage assessment or weather effects assessments necessitates greater reliance, as in the past, on similar assessment being provided by cavalry reconnaissance elements, scouts, air observers, and other units

throughout the division. While the loss of engineer reconnaissance teams can have an impact on intelligence support provided to commanders, training of other elements to accomplish these tasks, and concise statements of intelligence requirements related to the terrain intelligence function remedy their loss. IEW support provided by other combat support organizations described earlier in this manual remain unaffected by AOE design.

## LONG-RANGE SURVEILLANCE OPERATIONS

The formation of long range surveillance organizations within the division and corps MI organization under AOE represents the most significant change in IEW support to forward maneuver forces. The primary mission of the long-range surveillance detachment (LRSD), division, is to provide collection by HUMINT means within the division's areas of operations and interest; and to observe and report enemy dispositions, facilities, and activities, as well as terrain and weather conditions. Specifically, the LRSU-

- Conducts long-range information collection through surveillance and reconnaissance.
- Determines and reports the location, strength, equipment, disposition, organization, and movement of enemy forces and determines the location of high-value targets, to include NBC weapon delivery systems; nuclear weapon storage sites; reserves; C<sup>2</sup> elements; and key installations, including both fixed and mobile facilities.
- Conducts damage assessment and NBC monitoring.
- Emplaces and employs unattended sensors and electronic intelligence, target acquisition, and designation equipment.
- Employs photographic and night image enhancement devices.

- Obtains information on possible drop and landing zones for airborne and airmobile or air assault operations.
- Provides information on terrain and weather conditions.
- Provides an assessment of indigenous communications facilities for possible future allied use.

The LRSU (heavy division) is organized as shown in the following chart.

The C<sup>2</sup> element includes the detachment headquarters and a subelement for communications support. It directs the functions and activities of all elements of the LRSD. The base station section operates base communications stations to maintain communications with deployed reconnaissance teams and forwards combat information by secure communications and messenger immediately to the CM&D section within the G2. The reconnaissance teams obtain and report information about enemy forces, activities, terrain, and weather within their assigned areas of surveillance and are capable of operating independently. The LRSD may be augmented by an additional base station from the corps long-range surveillance company for timely receipt of combat information from corps long-range surveillance teams deployed beyond the range of surveillance provided by LRSD teams. Long-range surveillance plans of the divisions and corps are coordinated to ensure complementary surveillance coverage.

The LRSD is organic to the MI battalion of the division. The LRSD provides the division with the capability to conduct long-range surveillance missions to supplement intelligence collection and surveillance provided by other IEW sources. The results of these long-range surveillance operations will significantly enhance the IEW system in providing current intelligence to tactical commanders as to threat formations within their respective areas of operations and interest.

# LRSD (HEAVY DIVISION)

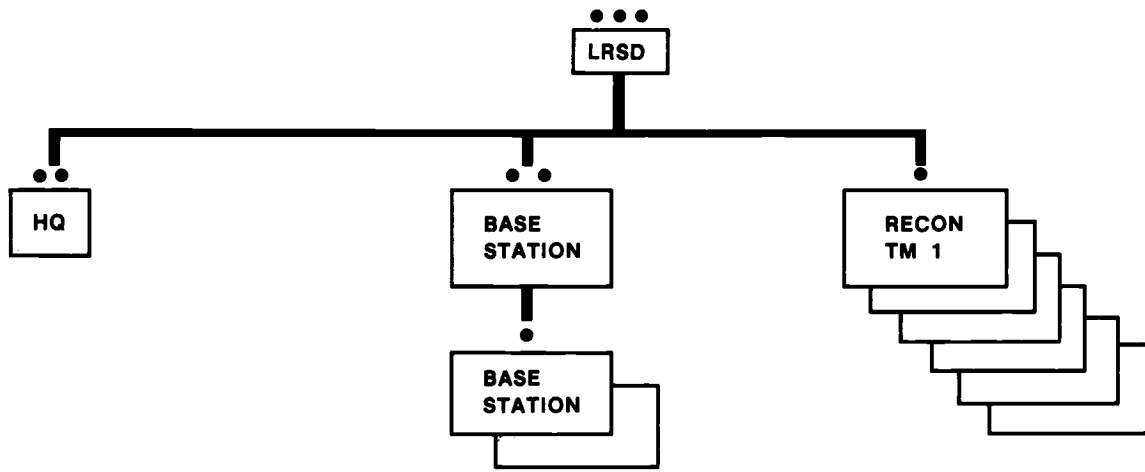

1. The LRSD (light division) is organized with four reconnaissance teams.

## APPENDIX E

### RECONNAISSANCE AND SURVEILLANCE PLANNING

The S2 is responsible for planning R&S operations within the BTF or brigade. Based upon his detailed knowledge of the enemy, weather, and terrain through IPB, his goal is to ensure the full surveillance coverage of the BTF/brigade battlefield area to the extent that resources will allow.

Special attention will be directed to the systematic surveillance of NAI and TAI developed through IPB to confirm or deny the enemy situation as analyzed from prior intelligence on hand. In R&S planning, the S2 must consider and include the capabilities of all reconnaissance, surveillance, and target acquisition means under his direct control, as well as those which may support this effort, in providing timely intelligence and targeting information to his commander. These means normally include GSR, REMS, subordinate company LP or OP, scouts and patrols, as well as supporting systems within the brigade and division such as target acquisition radars and SIGINT/EW systems.

Once the S2 has developed the unit R&S plan, subordinate units are tasked through the BTF S3 for the execution of missions, such as planning LPs or OPs and deploying patrols and scout sections into specific target areas, as outlined in the unit R&S plan and other intelligence portions of the BTF or brigade OPORD. Requirements beyond the BTF's or brigade's R&S capabilities must be satisfied by requests for information to the brigade S2 or division G2, who have access to collection assets at these echelons. To assist the S2 in planning for R&S, there are tools including overlays, scout patrols and GSR or REMS plans, and patrol orders and reports.

The BTF R&S overlay on the following page is prepared to integrate company team security or counterreconnaissance plans (LP or OP, local security patrols) with BTF assets, and those assets provided by the brigade, to eliminate gaps in coverage. The BTF R&S overlay is consolidated with other

BTFs' R&S overlays by the brigade S2 to reveal possible gaps in the brigade's total R&S coverage. Similarly, all brigade R&S overlays are consolidated by the division TSO, who identifies gaps in the division's coverage.

#### Reconnaissance and Surveillance Overlay

The R&S overlay is constructed with R&S assets graphically oriented to satisfy the commander's PIR. As a minimum, the R&S overlay will include three sections—

- A graphic display of deployed R&S assets.
- A planned R&S deployment.
- Distribution

The R&S graphic display should depict—

- Number, location, and parent unit of LP or OP.
- Patrol routes, SP, RP, and checkpoints.
- Scout screen line or locations.
- GSR primary, alternate, and subsequent locations, left and right scan limits, GSR mission, and target area (monitor or general search).
- REMS locations (strings or fields).

The R&S overlay's legend will include administrative information (map information, title, and preparer) and instructions to each R&S asset. The instructions include—

- Required operational times.
- Coordination instructions (passage points through units).
- Enemy activities likely to be detected.
- Reporting requirements.

Finally, a distribution listing will be provided. R&S overlays should be coordinated with and provided to—

- Company teams.
- Scout platoon leader.
- GSR or REMS team leaders.

- S3.
- FSO.
- Engineer platoon leader \LNO.  
Brigade S2.

the S2 in specifying mission, control measures, reporting instructions, time requirements, and coordination measures. These plans may be written or oral, but offer the S2 a means of ensuring that all information required by the R&S asset is provided.

Scout, patrol order, and GSR or REMS plans (see illustrations which follow) assist

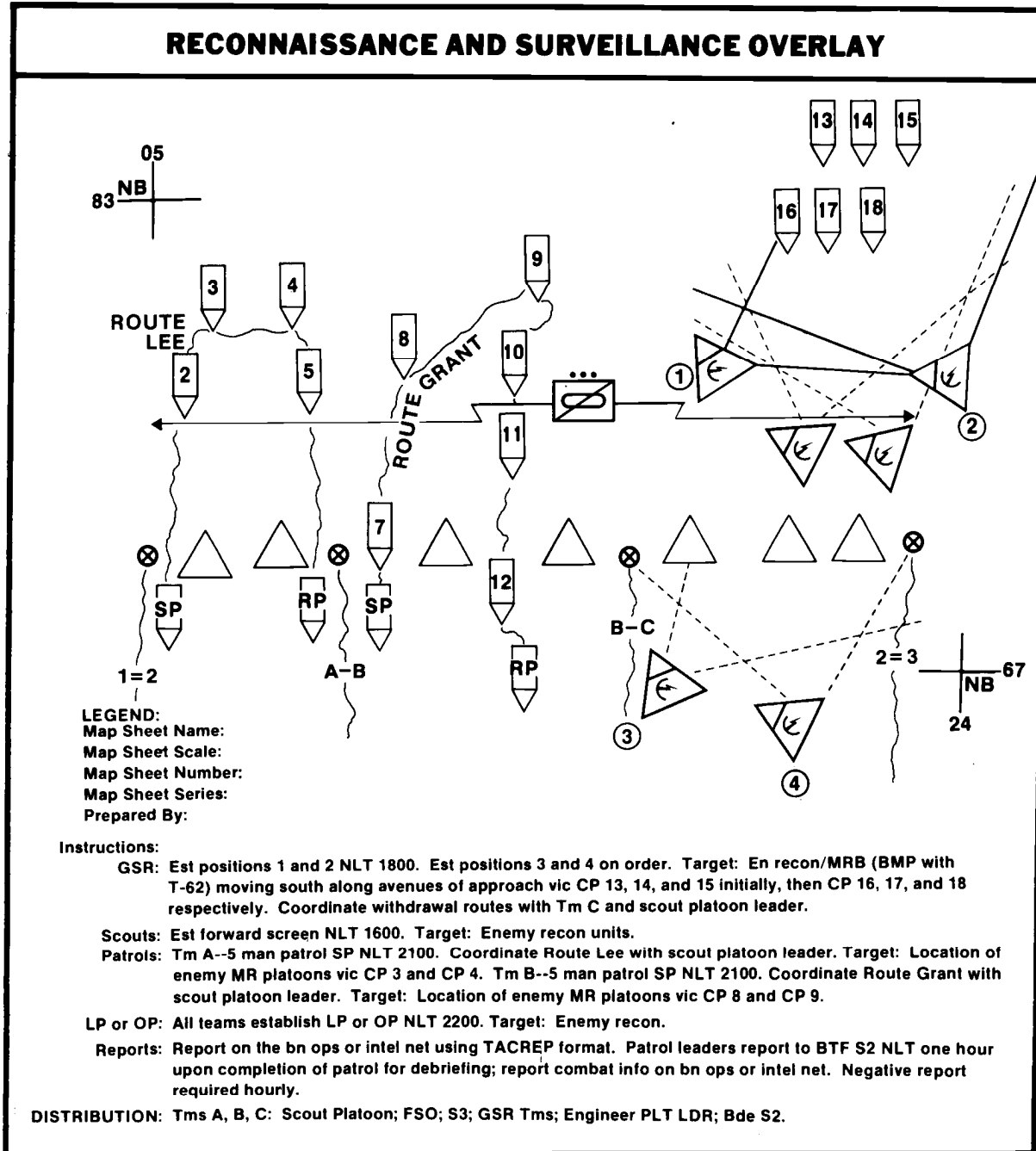



## SCOUT PLAN FORMAT

1. Mission (PIR or IR included):
2. Start time:
3. Completion time:
4. Actions upon enemy contact:
5. Actions at obstacles:
6. Location of friendly minefield and barriers:
7. Routes:
8. Boundaries:
9. Phase Lines:
10. SP, LD, RP, PP, and checkpoints:
11. Fire support planning:
12. Organization and communications frequency for reporting:
13. Platoon actions upon completion of the mission:
14. Special instructions:

## PATROL ORDER

1. Situation
  - a. Enemy Forces
    - (1) Identification
    - (2) Location
    - (3) Activity
    - (4) Strength
    - (5) Capabilities
    - (6) Probable Course of Action
  - b. Friendly Forces
    - (1) Mission of next higher unit
    - (2) Location and actions of adjacent units
    - (3) Mission and routes of adjacent patrols
    - (4) Unit providing fire support
  - c. Weather
  - d. Terrain
2. Mission
3. Execution
  - a. Concept of Operation
    - (1) Maneuver
    - (2) Fire Support

- b. Subunit Tasks
- c. Coordinating Instructions
  - (1) Actions at the objective
  - (2) Time of departure and return
  - (3) Movement technique and order of movement
  - (4) Route(s)
  - (5) Departure and reentry of friendly lines
  - (6) Rally points and actions at rally points
  - (7) Actions on enemy contact
  - (8) Actions at danger areas
  - (9) Actions at halts
  - (10) Locations of friendly minefield and other obstacles
  - (11) Rehearsals
  - (12) Inspections
  - (13) Debriefings
  - (14) PIR or IR
  - (15) Annexes
4. Service and Support
  - a. Rations and Water
  - b. Arms and Ammunition
  - c. Uniform and equipment each patrol member will carry
  - d. Methods of handling wounded, dead, and EPW and their equipment
5. Command and Signal
  - a. Signal
    - (1) Frequencies and call signs
    - (2) Pyrotechnics
    - (3) Hand and arm signals
    - (4) Challenge and password
    - (5) Codewords and reports
  - b. Command
    - (1) Chain of command
    - (2) Location of patrol leader during movement and at the objective

## ANNEXES

- A-Patrol Base
- B-Link-up
- C-Intelligence
- D-Overlay
- E-Air Movement

### **PATROL PLAN FORMAT**

1. Patrol Number:
2. Unit assigned and size of patrol:
3. Mission (PIR or IR included):
4. Start time:
5. Completion time:
6. Actions upon enemy contract:
7. Actions at obstacles:
8. Locations of friendly minefield and barriers:
9. Route:
10. SP, RP, PP, and checkpoints:
11. Fire support planning:
12. Organization and communications frequency for reporting:
13. Actions upon completion of the mission:
14. Special instructions:

### **GSR OR REMS PLAN FORMAT**

1. Mission:
2. Time GSR or REMS required to be operational:
3. Routes to GSR site or REMS emplacement areas:

4. Location of primary or alternate and subsequent GSR sites and REMS strings and fields.
5. Left and right scan limits in mils of GSRs (search missions); point target location (monitor mission):
6. Withdrawal routes to subsequent GSR sites:
7. Location of friendly minefield and barriers:
8. Actions upon enemy contact:
9. PP and checkpoints:
10. Fire support planning:
11. Organization and communications frequency for reporting:
12. Special instructions.

Patrol reports are prepared in detail, based upon the S2's debriefing of the patrol leader and other key members of the patrol. Results are relayed to potential users as combat information and are included in the S2's intelligence data base for later use. Results of patrols are normally transmitted to the brigade S2 when obtained. Patrols will also report information of immediate use via radio to the S2, based on reporting instructions stated in the patrol plan. Other R&S assets report combat information using SOP reporting formats or the SALUTE format. R&S assets may report on the battalion command net, the operations net, or the intelligence net, or some combination of the three. Reporting is detailed in the instructions found on the R&S plan and will be normally based on the unit SOP at the BTF level. An example of a patrol report format is found on the following page.

## PATROL REPORT FORMAT

### PATROL REPORT FORMAT

(DESIGNATION OF PATROL)

TO: \_\_\_\_\_

MAPS: \_\_\_\_\_

- A. Size and composition of patrol.
- B. Mission.
- C. Time of departure.
- D. Time of return.
- E. Routes out and back.
- F. Terrain. (Description of the terrain--dry, swampy, jungle, thickly wooded, high brush, rocky; depth of ravines and draws; condition of bridges as to type, size, and strength; effect on armor and wheeled vehicles.)
- G. Enemy. (Strength, disposition, condition of defense, equipment, weapons, attitude, morale, exact location, movements, and any shift in disposition; time activity was observed; coordinates where activity occurred.)
- H. Any map corrections.
- I. (Not used.)
- J. Miscellaneous information (including aspects of nuclear, biological, and chemical warfare).
- K. Results of encounters with enemy. (Enemy prisoners and disposition, identifications, enemy casualties, captured documents and equipment.)
- L. Condition of patrol, including disposition of any dead or wounded.
- M. Conclusions and recommendations (including to what extent the task was accomplished and recommendations as to patrol equipment and tactics).

\_\_\_\_\_  
Signature                                  Grade/Rank                                  Organ Unit of Patrol Leader

N. Additional remarks by interrogator.

\_\_\_\_\_  
Signature                                  Grade/Rank                                  Organ Unit of Patrol Leader Time

O. Distribution.

## GLOSSARY

AA	antiaircraft
ALA	antiaircraft artillery
BAGS	Army air-ground system
ALMA	antiaircraft and missile artillery
ACofS	Assistant Chief of Staff
ACE	armored cavalry regiment
ACSI	Assistant Chief of Staff for Intelligence
actv	activity
AD	air defense
ADA	air defense artillery
ad	adjustment
AD	atomic demolition munitions
ad	advance
ANEW	asset evaluation Worksheet
A	adjutant general
ADOS	air-ground operations system
air recce	air reconnaissance
ALA	administrative and logistics center
ALO	Air Force liaison officer
alto	alternate
AM	amplitude modulation
AM	Army Materiel Command
ammo	ammunition
A	area of operations
ACE	Army of Excellence
arid	armored
armd/mech	armored and mechanized
ARTEP	Army Training and Evaluation Program
arty	artillery
ASOC	air support operations center
ASP	ammunition supply point
ASPS	all-source production section
at	antitank
ark	attack
attn	attention
BUS	battery computer system
bd e	brigade
BE	basic encyclopedia
BICC	battlefield information control center
bn	battalion
BOMREP	bombing report
BOA	battalion observation post
BAA	brigade support area
BTF	battalion task force
BOX	ballistic weather

C<sup>2</sup>..... command and control  
C<sup>2</sup>D..... command and control disruption  
C<sup>3</sup>..... command, control, and communications  
C<sup>3</sup>CM:..... command, control, and communications countermeasures  
C<sup>3</sup>I..... command, control, communications, and intelligence  
CAB..... combat aviation brigade  
C&J..... collection and jamming  
CAS..... close air support  
cav..... cavalry  
CB..... chemical biological  
C-E..... Communications-Electronics  
CAD..... captured enemy document  
CEOI..... Communications-Electronics Operating Instructions  
CEP..... circular error probable  
CEWI..... combat electronic warfare and intelligence  
CF..... counterfire  
CFA..... coveringforcearea  
C G..... commanding general  
CI..... counterintelligence  
CIA..... Central Intelligence Agency  
CLSU..... COMSEC logistic support unit  
CM..... countermeasures  
CM&D..... collection management and dissemination  
cmm..... comma  
CMTA..... commander of missile troops and artillery  
co..... company  
coll..... collection  
cmd..... command  
COMINT..... communications intelligence  
COMJAM..... communications jamming  
comm..... communications  
COMSEC..... communications security  
con..... control  
CONUS..... continental United States  
COP..... command observation post  
COSCOM..... corps support command  
CP..... command post  
CRTA..... Chief Rocket Troop Artillery  
CSS..... combat service support  
CTL..... critical task list  
CUCV..... commercial utility cargo vehicle  
C W..... continuous wave  
DA..... Department of the Army  
DCSOPs..... Deputy Chief of Staff or Operations and Plans  
def..... defense  
DF..... direction finding  
DIA..... Defense Intelligence Agency  
DIPS..... defense intelligence production schedule  
DISCOM..... division support command  
div..... division

## Glossary-1

DIVARTY ..... division artillery  
 DLIC ..... detachment to be left in contact  
 DMD ..... digital message device  
 DMZ ..... demilitarized zone  
 doc ..... document  
 DOD ..... Department of Defense  
 DP ..... decision point  
 DPC ..... decision point cluster  
 DS ..... direct support  
 DSA ..... division support area  
 DST ..... decision support template  
 DTOC ..... division tactical operations center  
 DX ..... direct exchange  
 DZ ..... drop zone  
 EAC ..... echelons above corps  
 EAD ..... echelons above division  
 EAM ..... event analysis matrix  
 EC ..... electronic combat  
 ECB ..... echelons corps and below  
 ECCM ..... electronic counter-countermeasures  
 ECM ..... electronic countermeasures  
 ECMMEER ..... electronic countermeasures mission effectiveness evaluation report  
 EEFI ..... essential elements of friendly information  
 EEOB ..... enemy electronic order of battle  
 ELINT ..... electronic intelligence  
 elm ..... element  
 ELSEC ..... electronic security  
 EMCON ..... emission control  
 EMP ..... electromagnetic pulse  
 engr ..... engineer  
 EOB ..... electronic order of battle  
 EPW ..... enemy prisoner of war  
 ERP ..... effective radiating power  
 ESM ..... electronic warfare support measures  
 est ..... estimate  
 EW ..... electronic warfare  
 EWO ..... electronic warfare officer  
 EWS ..... electronic warfare section  
 EWTL/JS ..... electronic warfare target lists and jamming schedules  
  
 FA ..... field artillery  
 FAAO ..... field artillery air observer  
 FAAR ..... forward area alerting radar  
 FALOP ..... forward area limited observation plan ("belt weather kit")  
 FARP ..... forward arming and refueling point  
 FASC ..... forward area signal center  
 FAST ..... forward area support team  
 FBI ..... Federal Bureau of Investigation  
 FC ..... field circular  
 FDC ..... fire direction control/fire direction center  
 FEBA ..... forward edge of the battle area  
 FIST ..... fire support team  
 FISTV ..... fire support team vehicle  
 FLOT ..... forward line of own troops  
 FM ..... field manual/frequency modulation

**Glossary-2**

FO ..... forward observer  
 FOMCAT ..... foreign materiel catalog  
 FRAGO ..... fragmentary order  
 FREETEXT ..... free text message  
 FS ..... fire support  
 FSCoord ..... fire support coordinator  
 FSB ..... forward support battalion  
 FSE ..... fire support element  
 FSO ..... fire support officer  
 FSS ..... fire support section  
 FTX ..... field training exercise  
 fwd ..... forward  
  
 G1 ..... Assistant Chief of Staff, G1, Personnel  
 G2 ..... Assistant Chief of Staff, G2, Intelligence  
 G3 ..... Assistant Chief of Staff, G3, Operations  
 G4 ..... Assistant Chief of Staff, G4, Logistics  
 G5 ..... Assistant Chief of Staff, G5, Civil Affairs  
 GDP ..... general deployment plan  
 GFC ..... green flare cluster  
 GMT ..... Greenwich Mean Time  
 GS ..... general support  
 GSR ..... ground surveillance radar  
  
 HB ..... high burst  
 HF ..... high frequency  
 HHC ..... headquarters and headquarters company  
 HMMWV ..... highly mobile and multiwheeled vehicle  
 HNS ..... host-nation support  
 HPT ..... high-payoff target  
 HQ ..... headquarters  
 HQDA ..... Headquarters, Department of the Army  
 HUMINT ..... human intelligence  
 HVT ..... high-value target  
  
 IDP ..... initial delay position  
 IEW ..... intelligence and electronic warfare  
 IEWSE ..... intelligence and electronic warfare support element  
 IFF ..... identification, friend, or foe (radar)  
 IIR ..... imagery interpretation report  
 IMINT ..... imagery intelligence  
 inf ..... infantry  
 INSCOM ..... Intelligence and Security Command, USA  
 intel ..... intelligence  
 intel net ..... intelligence network  
 intg ..... interrogation  
 INTREP ..... intelligence report  
 INTSUM ..... intelligence summary  
 IPB ..... intelligence preparation of the battlefield  
 IR ..... information requirement  
  
 JAAT ..... joint air attack team  
 JCS ..... Joint Chiefs of Staff  
 JINTACCS ..... Joint Interoperability of Tactical Command and Control Systems  
 JS ..... jamming schedule  
 JTF ..... joint task force

KIA	..killed in action
km	.. kilometer(s)
KW	.. kilowatt(s)
L D	.. light discipline
LIC	.. low-intensity conflict
LLVI	.. low-level voice intercept
LNO	.. liaison officer
LOB	.. line of bearing
LOC	..line of communication
LOS	..line of sight
LP	.. listening post
LPA	.. log periodic antenna
LRRP	.. long-range reconnaissance patrols
LRSO	.. long-range surveillance detachment
LRSU	.. long-range surveillance unit
LZ	.. landing zone
MAE R	.. multiple assets effectiveness report
maint	.. maintenance
MASTR	.. multiple assets status report
MATM	.. multiple assets tasking message
MBA	.. main battle area
MC	.. mobility corridor/multichannel
MCP	.. maintenance collection point
MCS	.. master control station
mech	..mechanized/mechanical
METT-T	.. mission, enemy, terrain, troops, and time available
MFR	..memorandum for record
MG	.. major general
MI	.. military intelligence
MIJI	..meaconing, intrusion, jamming, and interference
MIJFEEDER	.. beaconing, intrusion, jamming, and interference feeder
min	..minute
mm	.. millimeter
MOPP	.. mission oriented protective posture
MORTREP	.. mortaring report
MOUT	.. military operations on urbanized terrain
MP	.. military police
MPI	..mean point of impact
MRB	.. motorized rifle battalion
MRD	..motorized rifle division
MRDFS	.. man-transportable radio direction-finding system
MRR	.. motorized rifle regiment
MSC	.. major subordinate command
MSR	.. main supply route
MST	..maintenance support team
MTLR	.. moving target-locating radar
MTM	.. mission tasking message
NAI	..named area of interest
NBC	.. nuclear, biological, and chemical
NBC-1	.. nuclear, biological, and chemical-1 report
NBC-6	..nuclear, biological, and chemical-6 report
NCO	.. noncommissioned officer
NCS	..net control station
neg	.. negative

## Glossary-4



net	network
NET	not earlier than
NLT	not later than
NOD	night observation device
NRI	net radio interface
OB	order of battle
OCOKA	observation and fields of fire concealment and cover obstacles key terrain avenues of approach and mobility corridors
O/I	operations/intelligence
OIC	officer in charge
OMG	operational maneuver group
op	operations
OP	observation post
OPCON	operational control
OPFOR	opposing forces
OPLAN	operation plan
OPORD	operation order
OPSEC	operations security
O \ O	on/off
ORF	operational readiness float
org	organization
P	positive
PADS	position and azimuth determination system
para	paragraph
paren	parentheses
PCB	printed circuit board
pd	period
PIR	priority intelligence requirement
plt	platoon
POL	petroleum, oils, and lubricants
pos	position
prep	preparation
PSYOP	psychological operations
PTO	power take-off
RADIAC	radiation, detection indication, and computation
RAG	regimental artillery group
RAOC	rear area operations center
R&E	recovery and evacuation
R&S	reconnaissance and surveillance
RATT	radio teletypewriter
RC	reserve component
rd	road
PDF	radio direction finding
RE	radial error
REC	radio-electronic combat (not a US term)
RECCEXREP	reconnaissance exploitation report
recon	reconnaissance
regt	regiment
REMBASS	Remotely Monitored Battlefield Sensor System
REMS	remotely employed sensors

req ..... request  
 RII ..... request for intelligence information  
 RIP ..... Register of Intelligence Publications  
 rqr ..... required  
 RRII ..... response to request for intelligence information  
 RSR ..... resource status report  
 RSS ..... remote slave station  
 RSTA ..... reconnaissance, surveillance, and target acquisition  
 RTO ..... radioteletype operator  
  
 S ..... secret  
 S1 ..... Adjutant (US Army)  
 S2 ..... Intelligence Officer (US Army)  
 S3 ..... Operations and Training Officer (US Army)  
 S4 ..... Supply Officer (US Army)  
 S5 ..... Civil Affairs Officer (US Army)  
 SAEDA ..... Sabotage and Espionage Directed Against the US Army and  
 Deliberate Security Violations  
 SALUTE ..... size, activity, location, unit, time, and equipment  
 SAM ..... surface-to-air missile  
 S&T ..... supply and transportation  
 SCARF ..... standard collection asset request format  
 SCV ..... single channel voice  
 SDP ..... secondary delay position  
 SEAD ..... suppression of enemy air defenses  
 sec ..... section  
 SED ..... simulative electronic deception  
 sep ..... separate  
 SEP ..... scientific and engineering personnel  
 SF ..... spotlight flash/support flash  
 SHELREP ..... shelling report  
 SHORAD ..... short-range air defense  
 SIGINT ..... signals intelligence  
 SIGSEC ..... signal security  
 SII ..... statement of intelligence interest  
 SIR ..... specific information requirement/serious incident report  
 SITMAP ..... situation map  
 SITREP ..... situation report  
 SLAR ..... side-looking airborne radar  
 SOP ..... standing operating procedure  
 SOR ..... specific orders and requests  
 SP ..... self-propelled  
 SPP ..... SIGINT processing platoon  
 spt ..... support  
 SS ..... Secret Service  
 SSB ..... single side band  
 SSM ..... surface-to-surface missile  
 STANAG ..... standardization agreement  
 STIR ..... Scientific Technological Intelligence Reports  
 survl ..... surveillance  
 svc ..... service  
 SWO ..... staff weather officer  
 sys ..... system

TA	target acquisition
T&A	transcription and analysis
TAB	target acquisition battery
tac	tactical
TACAIR	tactical air
TACC	tactical air control center
TAC CP	tactical command post
TAC-D	tactical deception
TACELINT	tactical electronics intelligence
TACFIRE	tactical fire direction computer system
TACP	tactical air control party
TACREP	tactical report
TACS	tactical air control system
TADDS	target alert data display set
TAI	target areas of interest
TASS	tactical air support system
TCAE	technical control and analysis element
TD	tank division
TDA	tables of distribution and allowances
TEB	tactical exploitation battalion
tech	technical
TECHDOC	technical document
TF	task force
TL	target list
tm	team
TM	technical manual
TMDE	test, measuring, and diagnostic equipment
TOC	tactical operations center
TOE	tables of organization and equipment
TOW	tube launched, optically tracked, wire guided (missile system)
TPL	time-phase line
treas	treasury
TRS	tactical reconnaissance squadron
TSO	tactical surveillance officer
TVA	target value analysis
UHF	ultra-high frequency
US	United States
USAF	United States Air Force
UTM	universal transverse mercator (grid)
vic	vicinity
VFMED	variable-format message entry device
VHF	very high frequency
WIA	wounded in action
WLR	weapons-locating radar
XO	executive officer

## REFERENCES

### REQUIRED PUBLICATIONS

Required publications are sources that users must read in order to understand or to comply with this publication.

#### Field Manuals (FMs)

34-1	Intelligence and Electronic Warfare Operations
34-3	Intelligence Analysis
34-10	Division Intelligence and Electronic Warfare Operations
71-2J	Task Force Operations
71-3	Armored and Mechanized Brigade Operations
100-5	Operations

### RELATED PUBLICATIONS

Related publications are sources of additional information. They are not required in order to understand this publication.

#### ARMY REGULATIONS (ARs)

310-25	Dictionary of United States Army Terms
310-50	Catalog of Abbreviations and Brevity Codes
380-series	Security
381-series	Military Intelligence
525-22	(S) Electronic Warfare (EW) Policy (U)

#### FIELD MANUALS (FMs)

5-15	Field Fortifications
5-30	Engineer Intelligence
5-140-series	Engineer
6-20	Fire Support in Combined Arms Operations
6-121	Field Artillery Target Acquisition
7-20	The Infantry Battalion (Infantry, Airborne and Air Assault)
7-30	Infantry, Airborne, and Air Assault Brigade Operations
10-14	Unit Supply Operations (Manual of Procedures)
10-23	Army Food Service Operations
10-67	Petroleum Supply in Theaters of Operations
11-50	Combat Communications Within the Division
17-95	Cavalry
19-1	Military Police Support Division and Separate Brigade
21-2	Soldier's Manual of Common Tasks (Skill Level 1)
24-1	Combat Communications
24-24	Radio and Radar Reference Data
24-25	Wire and Multichannel Reference Data
29-2	Organizational Maintenance Operations
29-52	Supply and Field Service Operations in Separate Brigades and Armored Cavalry Regiment
30-15	Intelligence Interrogation

32-16	(C) Electronic Countermeasures Handbook (U)
34-20	Military Intelligence Group (CEWI) (Corps)
34-22	Military Intelligence Battalion (CEWI) Aerial Exploitation (Corps)
34-60	Counterintelligence
34-60A	(S) Counterintelligence Operations
63-2	Combat Service Support Operations Division
71-1	Tank and Mechanized Infantry Company Team
71-2	The Tank and Mechanized Infantry Battalion Task Force
71-100	Armored and Mechanized Division Operations
90-6	Mountain Operations
90-10	Military Operations on Urbanized Terrain (MOUT)
90-13	River Crossing Operations
100-2-1	Soviet Army Operations and Tactics
100-2-2	Soviet Army Specialized Warfare and Rear Area Support
100-2-3	The Soviet Army Troops, Organization, and Equipment
100-10	Combat Service Support
100-15	Larger Unit Operations
101-5	Staff Organization and Operations

#### TRAINING CIRCULARS (TCs)

30-49	(C) QUICKFIX Operations (U)
34-10-1	Remotely Monitored Battlefield System
34-41	(C) Planning Communications Jamming(U)
34-50	Reconnaissance and Surveillance Handbook
34-60	Radio Monitoring Set, AN/TRR-33
34-83	(C) AN/TSQ-114A, TRAILBLAZER Operations (U)
34-84	AN/TLQ-17A(V) Countermeasures Set Operations
34-90	(C) AN\ MLQ-34 Tactical Communications Jammer Operations(U)
34-94	Standardized Crew Drill-Establish a Communications Security (COMSEC) Monitor Site
34-95	(C) Radio Receiving Sets AN/TRQ-30* AN/TRQ-32(U)

#### UNITED STATES SIGNAL INTELLIGENCE DIRECTIVES (USSIDs)

300	Sterilized Products
301	Critical Intelligence
302	Signals Intelligence Alert
306	Tactical Report
306(P)	Tactical Report
316	NON-CODEWORD Reporting

#### MISCELLANEOUS PUBLICATIONS

JCS Pub 1	Dictionary of Military and Associated Terms
JCS Pub 12	Tactical Command and Control Planning Guidance and Procedures for Joint Operations, Volume II, Procedures and Formats Basic Encyclopedia

#### STANDARDIZATION AGREEMENTS (STANAGS)

1059	National Distinguishing Letters of Use by NATO Forces
2003	Patrol Reports

2008	Bombing, Shelling, Mortaring, and Location Reports
2014	Operation Orders, Annexes to Operation Orders, and Administration and Logistic Orders
2033	Interrogation of Prisoners of War
2044	Procedures for Dealing with Prisoners of War (PW)
2082	Relief of Combat Troops
2084	Handling and Reporting of Captured Enemy Equipment and Documents
2097	Nomenclature for Soviet Bloc Army Weapons and Equipment
2113	Destruction of Military Technical Equipment (OP)
2844	Counterintelligence Procedures
2868	Land Force Tactical Doctrine (ATP-35)
2936	Intelligence Doctrine-AINTP-1
3277	Air Reconnaissance Request/Task Form
6004	Meaconing, Intrusion, Jamming, and Interference Report

#### QUADRIPARTITE STANDARDIZATION AGREEMENTS (QSTAGs)

502	Patrol Reports
506	Operation Orders, Annexes to Operation Orders, and Administration and Logistic Orders
511	Intelligence Reports
170	Interrogation of Prisoners of War
523	Procedures for Dealing with Prisoners of War (PW)
528	Handling and Reporting of Captured Enemy Equipment and Documents
295	Command and Control of Tactical Electronic Warfare in the 1976-85 Time Frame on a Formation of Corps Size
311	Components of Electronic Warfare Information
321	Electronic Warfare Definitions and Terms
492	Electronic Counter-Countermeasures
593	Tactical Signals Intelligence

STANAGs and QSTAGs may be obtained from the Naval Publications and Forms Center (NPFC), 5801 Tabor Avenue, Philadelphia, PA 19120.

#### FORMS

DA Form 2028 . . . . . Recommended Changes to Publications and Blank Forms

#### PROJECTED PUBLICATIONS

Projected publications are sources of additional information that are scheduled for printing but are not yet available. Upon being printed, they will be distributed. They may not be obtained from the USA AGF Publications Center until indexed in DA Pamphlet 310-1.

FM 34-40	(S) Electronic Warfare Operations
FM 34-25	Corps Intelligence and Electronic Warfare Operations
FM 34-37	(S) Echelons Above Corps Intelligence and Electronic Warfare Operations

#### COMMAND

Command publications cannot be obtained through Armywide resupply channels. Determine availability by contacting the address shown. Field circulars (FCs) expire three years from the date of publication unless sooner rescinded.

FIELD CIRCULAR

34-118 . . . The Targeting Process, May 1984, US Army Intelligence Center and School, Fort Huachuca, Arizona 85613-7000

71-100 . . . Armored and Mechanized Division and Brigade Operations, May 1984, US Army Combined Arms Center, Fort Leavenworth, Kansas 66027-6900

# INDEX

<b>A</b>	
AAGS.....	(see Army air-ground system)
AD.....	(see air defense)
ADA.....	(see air defense artillery)
administration and logistics center (ALC), .....	3-17
aerial surveillance .....	4-45
AGOS.....	(see air-ground operations system)
air defense (AD) .....	2-67
air defense artillery (ADA) .....	2-13, 5-38
Air Force liaison officer (ALO) .....	2-12
air-ground operations system (AGOS) .....	2-13, 2-30
air support operational center (ASOC).....	4-46
ALC .....	(see administration and logistics center)
all-source production section (ASPS) .....	4-11
ALO .....	(see Air Force liaison officer)
alternate position .....	5-2, 5-9, 5-11
AN/GLQ-3B .....	2-61
AN/TLQ-15 .....	2-61
AO.....	(see area of operations)
AOE .....	(see Army of Excellence)
<b>area</b>	
evaluation, battlefield .....	4-12
of interest .....	1-0, 1-1, 1-2, 4-13, 5-31
of operations (AO) .....	1-0 through 1-4, 1-8, 4-13, 4-46, 4-49, 5-1, 5-2, 5-3, 5-9, 5-40, 5-49, 5-63, 6-1, 6-3, 6-5, 6-6, 6-7, 6-8, 7-3, D-2, D-3
armored cavalry .....	2-67
army air-ground system (AAGS) .....	2-13
army aviation .....	2-4, 2-11, 2-12, 2-30, 2-67
Army of Excellence (AOE) .....	iii, D-1 through D-9
ASOC.....	(see air support operations center)
ASPS .....	(see all-source production section)
asset tasking .....	5-13
<b>B</b>	
battalion .....	3-15, 3-16
battlefield information control center (BICC) .....	3-15
combat trains .....	5-42
observation post (BOP) .....	2-19
resources .....	2-15, 2-16
staff .....	2-15, 3-15
battlefield area evaluation .....	4-12
battlefield deception .....	iii, 1-6, 1-7, 2-37
battlefield information control center (BICC) .....	3-22, 4-4, 4-6, 4-8, 4-23, 4-42, 4-43, 4-44, 4-45, 5-20, 5-28, 5-31, 5-40, 5-42, 5-49
battalion .....	3-15
brigade .....	3-10, 3-11, 4-11, 5-14
BICC .....	(see battlefield information control center)
breakout operations .....	5-57, 5-58, 5-59
briefing .....	5-18, B-0
checklist .....	B-1



decision .....	5-18, B-2, through B-5
information .....	5-18, B-3
military .....	5-18, B-1
mission .....	5-18, B-3, B-5, B-6
staff .....	5-18, B-3, B-5
techniques .....	B-0
brigade	
battlefield information control center (BICC) .....	3-10, 3-11, 4-11, 5-14
R&S plan .....	3-10
command post .....	3-12, 3-13
intelligence and electronic warfare (IEW) resources .....	2-15
resources .....	2-22, 2-23, 2-25, 2-26, 2-70
staff .....	2-27, 2-31, 3-9
support area (BSA) .....	2-23, 3-14, 3-15
BSA .....	(see brigade support area)
C	
C <sup>2</sup> .....	(see command and control)
C <sup>2</sup> D .....	(see command and control disruption)
C <sup>3</sup> .....	(see command, control, and communications)
C <sup>3</sup> CM .....	(see command, control, and communications countermeasures)
CAB .....	(see combat aviation brigade)
CAS .....	(see close air support)
CFA .....	(see covering force area)
CI .....	(see counterintelligence)
classes of supply .....	6-3 through 6-7
close air support (CAS) .....	2-12, 3-16, 3-17, 5-65
close operations .....	5-40
collection	
management .....	4-4, 4-5, 4-9
manager .....	4-7, 4-8
plan .....	4-4, A-29
requirements .....	4-4
combat	
aviation assets .....	2-12
aviation brigade (CAB) .....	2-12, 2-19
engineers .....	2-4, 2-13, 2-14, 2-15, 2-67, 2-68
information .....	1-3, 1-4, 2-0, 2-3, 2-6, 2-8, 2-26, 2-27, 2-30, 5-14
intelligence .....	2-21, 2-26, 2-30, 4-10, 4-11, 5-15
night and limited visibility .....	5-26, 5-27
requirements .....	3-2
service support (CSS) .....	2-0, 2-4, 2-15, 3-16, 6-1, 6-2, 6-3
service support (CSS) coordination .....	3-16, 6-3
training .....	2-29, 7-0
COMJAM .....	(see communications jamming)
command and control (C <sup>2</sup> ) .....	1-8, 2-46, 2-51, 2-69, 3-1, 3-2, 3-4, 3-8, 3-17, 5-57, 5-59, 5-61, 5-62, 5-67, 5-68, D-9
disruption (C <sup>2</sup> D) .....	3-1, 5-59
process .....	3-2, 3-3, 3-4
system .....	1-6, 2-13, 2-30, 2-69, 3-1, 3-2, 3-6, 3-7
command, control, and communications (C <sup>3</sup> ) .....	iii, 1-5, 1-8, 1-9, 2-34, 2-45, 2-51, 2-60, 2-61, 2-64, 3-18, 3-19
counter- .....	1-7, 1-8, 2-13, 4-23, 5-37, 5-38, 5-42
systems .....	iii, 3-6, 3-7, 3-8, 3-18, 3-19
command, control, and communications countermeasures (C <sup>3</sup> CM) .....	1-6, 1-7, 3-1, 3-7

options	3-6, 3-7
strategy	1-6, 1-7, 3-6, 3-8
command group	3-17
commander's, commanders'	
decision cycle	3-4, 3-5
information needs	1-3
planning guidance	4-2
communications jamming (COMJAM)	1-8, 2-32, 2-54, 2-55, 2-56, 2-58, 2-60, 2-61, 2-63, 3-19, 4-38, 4-39, 4-40, 4-41, 5-38, 5-42, 5-49, 5-56, 5-64, 5-67
operations	2-37, 2-54, 2-56, 2-58, 2-60, 2-61, 5-56
resource availability	2-63
resources	2-56, 2-63
screening	1-8, 2-37, 2-60, 2-61, 5-49
screening operations	1-8, 2-32, 2-37, 2-58, 2-60, 2-61
communications security (COMSEC)	2-31, 2-32, 2-35, 5-41, 5-44, 5-64, 6-9
monitoring	2-32, 2-35
support teams	2-35, 5-44
COMSEC	(see communications security)
coordination for CSS	2-0, 2-4, 2-15, 3-16, 6-1, 6-2, 6-3
counter-	
HUMINT	2-27, 2-29
IMINT	2-27, 2-29
SIGINT	2-27, 2-30
counterintelligence (CI)	iii, 1-0, 1-6, 1-7, 2-11, 2-26, 2-27, 2-29, 2-32, 2-34, 2-35, 2-36, 3-19, 5-35, 5-43, 5-53, 5-56, 5-59, 6-1, D-2, D-5, D-6
operations	2-26, 5-43, D-6
resources	2-34, 2-35, 2-36, D-6
support	2-0, 2-3, 2-34, 4-9
Support to OPSEC	4-27
covering force	5-35, 5-40
area (CFA)	5-35 through 5-40, 5-53
area operations	5-35
tasks	5-35
CSS	(see combat service support)
<b>D</b>	
decision	
briefing	5-18, B-3, B-4
point (DP)	4-20, 4-21, 4-22
support template (DST)	4-20, 4-22
decision-making process	4-1, 4-3
deep attack	5-25
deep operations	5-31, 5-35
defensive operations	5-26, 5-27, 5-28
delay from alternate positions	5-50, 5-51
delay operations	5-46, 5-47, 5-48
deliberate attack	5-21, 5-22, 5-30
deployment of assets	5-0
depot maintenance	6-7, 6-8
desert operations	5-64, 5-65,

direct support field artillery battalion	2-4, 2-6, 2-19, 2-20
dissemination	5-17
dissemination means	5-17, 5-18
division support area (DSA)	2-35
doctrinal templates	4-15
DP	(see decision point)
DSA	(see division support area)
DST	(see decision support template)
<b>E</b>	
EAM	(see event analysis matrix)
ECCM	(see electronic counter-countermeasures)
ECM	(see electronic countermeasures)
ECM teams	5-20, 5-24, 5-25
electronic	
attack options	2-64
counter-countermeasures (ECCM)	1-7, 2-31, 2-32, 2-34, 3-12, 3-16, 7-3
countermeasures (ECM)	1-8, 1-9, 2-12, 2-22, 2-30, 2-38, 2-39, 4-10, 4-35, 4-36, 4-39, 4-40, 4-41, 5-5, 5-20, 5-25, 5-26, 5-36, 5-37, 5-38, 5-40, 5-42, 5-45, 5-48, 5-49, 5-54 through 5-60, 5-62, 5-65, 5-67, 6-6, D-6
order of battle (EOB)	2-37
security (ELSEC)	2-31, 2-32, 2-35
electronic warfare (EW)	iii, 1-0, 1-7 through 1-9, 2-12, 2-13, 2-15, 2-17, 2-19, 2-22, 2-23, 2-37, 2-39, 2-48, 2-54, 2-55, 3-11, 4-9, 4-21, 4-34, 4-35, 4-41, 5-0, 5-4, 5-5, 5-26, 5-31, 5-35, 5-36, 5-50, 5-53, 5-54, 5-56, 5-59, 5-61, 5-63, 5-64, 5-65, 5-68, 6-1, 6-8, 6-9, D-6, D-8
assets	4-37, 5-5, 5-20, 5-36, 5-40, 5-45, D-2, D-3, D-4
collection resources	2-40, D-8
officer (EWO)	2-64
operations	2-34, 3-11, 4-35, 4-36, 5-4, 5-62
planning considerations	4-36, 4-37
sections (EWS)	4-36
support	1-0, 2-3, 2-37, 2-39, 4-35, 4-36, 5-20, 5-36, 5-61, D-6
support measures (ESM)	1-7, 1-8, 1-9, 4-10, 5-5, 5-20, 5-31, 5-36, 5-38, 5-45, 5-56, 5-59, 5-62, 5-63, 5-67
support principles of	4-35
support to the CFA	5-36
target list/jamming schedule (EWTL/JS)	2-55, 4-36 through 4-41, 5-42
training	7-3
ELSEC	(see electronic security)
encirclement	5-55
enemy prisoner of war (EPW)	
interrogation	2-25, 2-26, 2-29, 2-35, 5-23, 5-43, 5-59, 5-67, 6-1, A-19, D-3
interrogators	2-25, 2-26, 3-19, 5-5, 5-23, 5-25, 5-26, 5-56, D-3, D-4
enemy radioelectronic combat (REC)	1-5, 1-6, 2-27, 2-29, 2-30, 2-37, 2-38, 2-60, 5-20, 5-35, 5-37, 5-41, 5-49, 5-56, 5-59
enemy use of NBC	1-5, 5-31, 5-40, 5-55, D-9
EOB	(see electronic order of battle)
EPW	(see enemy prisoner of war)
ESM	(see electronic warfare support measures)
event	

analysis matrix (EAM) ..... 4-19, 4-20, 4-22  
templating ..... 4-18, 4-19  
event-generated reports ..... 5-17  
EW ..... (see electronic warfare)  
EWTL/JS ..... (see electronic warfare target list/jamming schedule)  
exploitation ..... 5-25

**F**  
FAAO ..... (see field artillery air observer)  
FDC ..... (see fire direction center)  
FEBA ..... (see forward edge of the battle area)  
field artillery ..... 2-4, 2-5, 2-6, 2-12, 2-17, 2-18, 2-19, 2-20, 2-21  
field artillery air observers (FAAOs) ..... 2-19  
fire direction center (FDC) ..... 2-17  
fire support (FS)  
    coordination ..... 2-12, 2-13, 2-19, 2-20, 2-21, 2-23, 2-30  
    element (FSE) ..... 2-4, 2-13, 2-15, 5-37, 5-38, 5-59  
    section (FSS) ..... 2-4  
    team (FIST) ..... 2-3, 2-4, 2-6, 2-9, 2-15, 2-21, 5-34  
FIST ..... (see fire support team)  
FO ..... (see forward observer)  
forward  
    edge of battle area (FEBA) ..... 2-17, 2-58, 5-28, 5-35, 5-39, 5-40, D-6  
    observer (FO) ..... 2-4  
    support battalion (FSB) ..... 2-23, 6-9  
FS ..... (see fire support)  
FSB ..... (see forward support battalion)  
FSE ..... (see fire support element)  
FSS ..... (see fire support section)

**G**  
general support (GS) ..... 2-12, 2-23, 2-25, 5-0, 5-2, 5-28, 5-37, 6-1, 6-9, D-2  
ground surveillance radar (GSR) ..... 2-2, 2-7, 2-8, 2-9, 2-18, 2-23, 2-24, 2-25, 2-30, 3-17, 4-5, 4-45,  
    5-8 through 5-14, 5-24, 5-25, 5-26, 5-35, 5-36, 5-37, 5-41, 5-49, 5-50, 5-53, 5-56, 5-59, 5-61 through  
    5-67, 6-1, 6-8, 6-9, D-2, D-3, D-4, E-1, E-2  
    assets ..... 2-22 through 2-25, 2-67, 5-8, 5-11, 5-48, 5-54  
    resources ..... 2-7, 2-15, 2-22, 2-23  
    teams ..... 2-3, 2-24, 4-14, 5-0, 5-1, 5-8, 5-9, 5-11, 5-20, 5-36, 5-41, 5-48, 5-56, 6-1, D-4  
GS ..... (see general support)  
GSR ..... (see ground surveillance radar)  
GSR or REMS plan format ..... E-2, E-4  
guidance, planning ..... 4-1

**H**  
hasty attack ..... 5-21  
hasty position ..... 5-11, 5-12  
high payoff target (HPT) ..... 1-4, 1-6, 2-30, 2-34, 2-41 through 2-48, 2-51, 2-55, 2-56, 2-57,  
    2-64, 2-65, 3-6, 3-8, 4-21, 4-27, 4-41, 5-31, 5-37, 5-39, 5-42, 5-48, 5-49, 5-57  
high value target (HVT) ..... 2-38, 4-15, 4-20, 4-21, 4-23, 4-27, 5-37, D-9  
highly mobile and multi-wheeled vehicle (HMMWV) ..... 2-24

**Index-4**

**HMMWV** ..... (see highly mobile and multi-wheeled vehicle)  
**HPT** ..... (see high payoff target)  
**human intelligence (HUMINT) collection**... 2-26, 2-27, 2-29, 2-34, 2-35, 4-6, 4-7, 4-42, 4-44, 5-31,  
5-43, 5-62, 5-63, 5-65, 5-67, D-2 through D-6  
**HUMINT** ..... (see human intelligence)  
**HVT** ..... (see high value target)

**I**

**IDP** ..... (see initial delay positions)  
**IEW** ..... (see intelligence and electronic warfare)  
**IEWSE**..... (see intelligence and electronic warfare support element)  
**imagery intelligence (IMINT)** ..... 2-27, 2-34, 4-6, 4-7, 4-42, 4-44, 5-64, 5-65, 5-68  
**IMINT** ..... (see imagery intelligence)  
**individual soldier training** ..... 7-0  
**information**  
    **briefing** ..... 5-18, B-3  
    **combat** ..... 1-3, 1-4, 2-0, 2-3, 2-5 through 2-8, 2-26, 2-27, 2-30, 5-14  
    **commanders' needs** ..... 1-3, 2-3  
    **requirements (IR)** ..... 1-4, 3-10, 4-4, 4-10, 4-11, 5-26, 5-35, 5-48, 7-1, E-3  
**initial delay positions (IDP)** ..... 5-47, 5-48  
**integrated training** ..... 7-1, 7-2  
**intelligence** ..... 1-0, 1-4, 1-5, 1-6, 2-0, 2-3, 2-6, 2-7, 2-10, 2-12, 2-20, 2-21, 2-22, 2-25, 2-26, 2-27,  
2-29, 2-30  
**intelligence and electronic warfare (IEW)**... iii, 1-9, 2-32, 2-45, 2-46, 2-51, 2-67, 3-5, 3-6, 3-8, 3-9,  
3-18, 4-23, 5-0, 5-19, 5-25, 5-26, 5-34, 5-40, 5-45, 5-46, 5-48, 5-55, 5-57, 5-59, 5-61, 5-63, 5-64, 5-66,  
5-67, 6-1, 6-2, 6-3, 6-6, 7-1, 7-2, D-2, D-4, D-8, D-9  
    **annex** ..... A-22 through A-28  
    **company team** ..... 2-54, 2-65 through 2-67, 3-9, 3-19, 3-22, 5-1, 5-8, 5-40, 6-2, 6-3, 6-5, 6-6, 6-8,  
6-9, 6-10, D-8  
    **company team commander** ..... 5-1, 5-2, 5-8, 6-2, 6-3, 6-5, 6-6, 6-8  
    **cycle** ..... 4-10  
    **estimate** ..... A-16 through A-21  
    **preparation of the battlefield (IPB)** ... 2-38, 2-40, 2-55, 3-15, 4-5, 4-11 through 4-19, 4-22, 4-23,  
4-32, 5-19, 5-31, 5-40, 5-42, 5-47, 5-67, 7-2, E-1  
    **principles** ..... 5-19, 5-28, 5-45  
    **report (INTREP)**, ..... 5-17, A-1  
    **resources**, ... 1-0, 2-0, 2-15 through 2-17, 2-22, 2-31, 2-69, 3-4, 3-5, 3-8, 4-42, 5-0, 5-20, 5-35, 5-45,  
5-47, 5-53, 5-57, 5-59, D-2  
    **summary (INTSUM)**, ..... 5-17  
    **support element (IEWSE)** ..... 2-19, 2-38, 2-39, 2-42, 2-45, 2-53, 2-55, 2-58,  
2-67, 3-12, 3-13, 3-14, 4-36, 4-41, 5-1, 5-4, 5-5, 5-8, 5-23, 5-35, 5-45, 5-48, 5-49, 5-54, 6-3, 6-6  
    **support, principles of** ..... 3-6, 5-28, 5-60  
    **support to C<sup>3</sup>CM** ..... 5-45  
    **systems** ..... 2-0, 2-17, 3-6, 3-9, 4-1, 5-0  
    **tasks** ..... 1-9, 4-9  
    **training** ..... 7-1  
**intermediate DS maintenance** ..... 6-7  
**intermediate GS maintenance** ..... 6-7  
**interrogation assets** ..... 5-5, 5-14, 5-35, 5-48  
**interrogation teams** ..... 2-26, 5-40, D-2

interrogator(s)	2-11, 2-22, 2-26, 5-20, 5-23, 5-40, 5-43, D-4, D-5
INTREP	(see intelligence report)
INTSUM	(see intelligence summary)
IPB	(see intelligence preparation of the battlefield)
IR	(see information requirements)
<b>J</b>	
jamming	
on-call	4-40
preplanned	4-39
schedule (JS)	2-55
JS	(see jamming schedule)
jungle operations	5-63, 5-64
<b>L</b>	
levels of maintenance	6-8
LIC	(see low intensity conflict)
logistical plans	6-2
long-range	
reconnaissance patrol (LRRP)	5-32, 5-63
surveillance detachment (LRSD)	D-9, D-10
surveillance organizations	D-9
surveillance unit (LRSU)	5-63, D-2, D-9
low-intensity conflict (LIC)	D-4
LRRP	(see long-range reconnaissance patrol)
LRSD	(see long-range surveillance detachment)
LRSU	(see long-range surveillance unit)
<b>M</b>	
maintenance	6-7
operations	6-7
support team (MST)	6-9
maneuver battalion	2-0, 2-4, 2-7, 2-11, 2-23, 2-27
maneuver company	2-0, 2-2, 2-3, 2-4
master control station (MCS)	2-40, 2-42 through 2-46, 2-48, 2-51, 5-37, 5-49, 5-56, D-7
MASTR	(see multiple assets status report)
MCS	(see master control station)
meaconing, intrusion, jamming, and interference (MIJI)	1-7, 2-32
METT-T	(see mission, enemy, terrain, troops, and time available)
MI	(see military intelligence)
MIJI	(see meaconing, intrusion, jamming, and interference)
military	
briefing	B-1
deception	1-6, 1-7
operations on urbanized terrain (MOUT)	5-67
police (MP)	2-69, 5-53
military intelligence (MI)	2-4, 2-7, 2-22, 3-19, 5-0, 5-1, 5-2, 5-35, 5-54 through 5-57, 5-59, 5-61, 6-1, 6-3, 6-5 through 6-9
battalion (CEWI) (division)	2-3, 2-8, 2-11, 2-12, 2-22, 2-35, 2-39, 2-45, 2-48, 3-22, 4-27, 5-0, 5-1, 5-2, 5-4, 5-19, 5-35, 5-45, 6-1, 6-2, 6-3, 6-6, 7-1, D-2 through D-6, D-9
brigade (CEWI) (corps)	2-12, 2-22
resources	2-17, 2-22, 2-23, 5-24, 5-35, 5-47, D-3

mission briefing .....	(see briefing)
mission, enemy, terrain, troops, and time available (METT-T) .....	1-0, 1-4, 2-37, 2-43, 2-53, 5-0, 5-19, 5-28, 5-45, 5-46, 5-49, 5-56
mission tasking .....	5-13
mountain operations .....	5-61, 5-62
MOUT .....	(see military operations on urbanized terrain)
movement to contact .....	5-19
moving-target-locating radar (MTLR) .....	2-8, 2-9, 2-18
MTLR section .....	2-19
MP .....	(see military police)
MST .....	(see maintenance support team)
MTLR .....	(see moving-target-locating radar)
multiple assets status report (MASTR) .....	5-17
<b>N</b>	
NAI .....	(see named area(s) of interest)
named area(s) of interest (NAI) .....	1-1
NBC .....	(see nuclear, biological, and chemical weapons)
night and limited visibility combat .....	5-26
noncommunications collection teams .....	5-23, 5-40
nuclear, biological, and chemical (NBC) weapons, enemy use of .....	1-5, 5-31, 5-40, 5-55, D-9
<b>O</b>	
observation post(s) (OP) .....	2-2, 2-3, 2-4, 5-62, E-1
offensive operations .....	5-19
OMG .....	(see operational maneuvers group)
on-call jamming .....	4-40
OP .....	(see observation post)
operation order (OPORD) .....	2-39, 2-67, 3-16, 4-47, 4-48, 4-49, 5-0, B-0, B-1, E-1
operational	
maneuver group .....	2-27
readiness floats (ORFs) .....	6-7
sites .....	5-2, 5-4, 5-11
operations	
deep .....	5-31, 5-34, 5-35
defensive .....	5-26, 5-27
delay .....	5-46, 5-47
offensive .....	5-19
personnel support .....	6-2
rear .....	1-6, 2-26 through 2-27, 2-35, 5-41
recovery and evacuation (R&E) .....	6-10
retrograde .....	5-45
operations security (OPSEC) .....	iii, 1-5, 1-7, 2-26, 2-27, 2-29, 2-30, 2-34, 2-35, 2-37, 2-55, 3-10, 3-11, 3-12, 4-1, 4-11, 4-28, 4-33, 4-34, 4-46, 5-8, 5-17, 5-19, 5-40, 5-43, 5-46, 5-59, 5-62, 5-65, 5-68, 7-3
annex .....	4-33
counterintelligence support to .....	4-27
cycle .....	4-27
support team .....	2-27, 4-31, 5-23, 5-43
teams .....	4-34, 5-40, 5-53
OPORD .....	(see operation order)

OPSEC .....	(see operations security)
ORF .....	(see operational readiness floats)
<b>P</b>	
PADS .....	(see position and azimuth determination system)
patrol	
order .....	E-3
plan format .....	E-4
report .....	E-4 E-5
personnel support operations .....	6-2
PIR .....	(see priority intelligence requirements)
PIRANHA .....	2-60 through 2-63
planning guidance .....	4-1
position and azimuth determination system (PADS) .....	2-17
preparation for combat .....	4-1
preplanned jamming .....	4-40, 4-41
primary site .....	5-2, 5-9, 5-11, 5-12
principles of IEW support .....	3-6
priority intelligence requirements (PIR) .....	1-4, 3-10, 4-4, 4-10 4-11, 4-14, 4-44, 4-45, 5-26, 5-35, 5-48, 5-49, 7-1, E-3
protect C <sup>3</sup> .....	1-6 through 1-9, 3-7, 4-23
pursuit .....	5-25
<b>Q</b>	
QUICKFIX .....	2-40, 2-54 through 2-57, 2-63, 2-65, 4-34, 5-62, 5-64, 5-67, D-6
QUICKFIX II A .....	2-54, 2-56
<b>R</b>	
R&E .....	(see recovery and evacuation)
R&S .....	(see reconnaissance and surveillance)
radioelectronic combat (REC), enemy .....	1-5, 1-6, 2-27, 2-29, 2-30, 2-37, 2-38, 2-60, 5-20, 5-25, 5-37, 5-41, 5-49, 5-56, 5-59
RAOC .....	(see rear area operations center)
rear area operations center (RAOC) .....	2-35
rear operations .....	1-6, 2-26, 2-27, 2-35, 5-41, 5-42, 5-43, 5-45, 5-59
REC .....	(see radioelectronic combat)
reconnaissance .....	2-3, 2-13, 2-23, 2-27, 2-30, 4-44
reconnaissance and surveillance (R&S) .....	3-10, 4-41 through 4-46, 5-67, E-1 E-2, E-4
operations .....	4-44, 4-45, E-1
overlay .....	E-1, E-2, E-4
plan .....	3-10, 4-45, 4-46, 4-47, 5-14, E-1
requirements .....	4-45, 4-46, 4-47
SOP .....	4-47
reconnaissance mission .....	4-46
reconnaissance, surveillance, and target acquisition (RSTA) ...	1-6, 2-17, 2-22, 2-26, 2-27, 2-29, 2-30, 2-32, 2-34, 2-37, 2-44, 2-46, 3-1, 3-6, 3-10, 4-27, 5-0, 5-35 through 5-38
recovery and evacuation (R&E) operations .....	6-10
REMBASS .....	(see Remotely Monitored Battlefield Surveillance System)
remote	
sensor .....	2-2, 2-7, 2-9, 2-10, 2-23, 5-11, 5-46
sensor team .....	2-3
slave station (RSS) .....	2-40, 2-42, 2-44, 2-45, 2-48, 5-37, 5-56, D-7



remotely employed sensor (REMS) .....	2-9, 2-10, 2-12, 2-22, 2-23, 2-25, 2-65, 5-0, 5-13, 5-14, 5-31, 5-32, 5-34, 5-35, 5-36, 5-41, 5-44, 5-63, 5-64, 5-65, 6-8, 6-9, E-1, E-2
remotely employed sensor (REMS) assets .....	2-23, 5-11
Remotely Monitored Battlefield Surveillance System (REMBASS) .....	2-25, D-2, D-3, D-4
REMS .....	(see remotely employed sensor)
resources	
availability, COMJAM .....	2-63
battalion .....	2-15, 2-16
CI .....	2-34, 2-35, 2-36, D-6
COMJAM .....	2-56
retrograde operations .....	5-45, 5-46, 5-47
RSS .....	(see remote slave station)
RSTA .....	(see reconnaissance, surveillance, and target acquisition)
<b>S</b>	
scout plan format .....	E-3
scout platoon .....	2-0, 2-2, 2-3, 2-4, 2-7, 2-11, 2-23, 2-25
screen jamming .....	1-8, 4-40 (see also COMJAM screening)
SDP .....	(see secondary delay position)
secondary delay positions (SDP) .....	5-48, 5-49
SIGINT .....	(see signals intelligence)
signals intelligence (SIGINT) ....	2-27, 2-30, 2-34, 2-35, 2-37, 2-38, 2-44, 2-45, 2-46, 2-53 through 2-56, 2-60, 3-21, 4-6, 4-7, 4-42 through 4-44, 5-0, 5-1, 5-65, 5-68, 6-1, 6-9, D-8
mission .....	2-38
processing platoon (SPP) .....	2-45, 2-48, 5-37, 5-49, 5-54
signals security (SIGSEC) survey .....	2-11, 2-31, 3-12, D-5
SIGSEC .....	(see signals security)
SIR .....	(see specific information requirements)
site selection .....	2-7, 5-0
SITREP .....	(see situation report)
situation	
development .....	4-9
report (SITREP) .....	A-14, A-15
template .....	4-16, 4-17
sound ranging equipment .....	2-18
special operations .....	5-60
specific information requirements (SIR) .....	1-4
spot reports .....	A-0
SPP .....	(see signals intelligence processing platoon)
spread sheet .....	4-24 through 4-27
staff	
battalion .....	2-15, 3-15
briefing .....	5-18, B-5
brigade .....	2-27, 2-31, 3-9
supplementary position .....	5-2, 5-3, 5-9, 5-11, 5-12
surveillance .....	2-9, 2-10, 2-12, 2-14, 2-27, 4-44
card .....	C-1 through C-12
card overlay .....	C-12
mission .....	2-9 2-12, 4-44
platoon .....	2-8, 2-11, 2-24, 2-25

<b>T</b>	
<b>TAB</b>	..... (see target acquisition battery)
<b>TACC</b>	..... (see tactical air control center)
<b>TACFIRE</b>	..... (see tactical fire direction computer system)
<b>TACJAM</b>	..... 2-58 through 2-61, 5-38, 5-39, 5-49, 5-56, 5-62
<b>TACP</b>	..... (see tactical air control party)
<b>TACREP</b>	..... (see tactical report)
<b>TACS</b>	..... (see tactical air control system)
<b>tactical</b>	
air control center (TACC)	..... 2-13
air control party (TACP)	..... 2-12, 2-13, 3-13, 3-14, 4-48, 5-37
air control system (TACS)	..... 2-13
air force	..... 2-12
communications system	..... 3-19
fire direction computer system (TACFIRE)	..... 2-6, 2-21
report (TACREP)	..... 5-17, 5-49, A-4
surveillance officer (TSO)	..... 2-23
<b>target</b>	
acquisition	..... 2-14, 2-19, 5-14, 5-15, 5-34
acquisition battery (TAB)	..... 2-17
acquisition program	..... 5-15
area(s) of interest (TAI)	..... 2-54, 4-21
development	..... 4-9, 4-23, 5-15
sets	..... 4-24, 4-26, 4-27
sheet	..... 4-24, 4-27
spread sheets	..... 4-24
value analysis (TVA)	..... 2-38, 4-21, 4-23, 4-24
<b>TCAE</b>	..... (see technical control and analysis element)
<b>TEAMMATE</b>	..... 2-49 through 2-52, D-7
<b>TEAMPACK</b>	..... 2-45 through 2-48, 5-37, 5-49, 5-56, 5-62, 5-63, 6-6, D-7, D-8
<b>technical control and analysis element (TCAE)</b>	..... 2-38, 2-43, 2-45, 2-46, 2-53, 2-56, 4-27, 4-41, 5-23, 5-37, 5-38, 5-42, 5-48, 5-49, 5-54, 5-56, 5-63
<b>template</b>	
decision support (DST)	..... 4-20, 4-22
doctrinal	..... 4-15
event	..... 4-18, .....
situation	..... 4-16, 4-17
<b>templating the battlefield</b>	..... 5-13
<b>terrain analysis</b>	..... 4-11, 4-12, 4-14, 5-40, 5-61, 5-62
<b>Threat education</b>	..... 7-3
<b>Threat evaluation</b>	..... 4-12, 4-13, 4-15
<b>three-level maintenance system</b>	..... 6-7, 6-8
<b>TRAFFIC JAM</b>	..... 2-57, 2-58, 2-60 through 2-63, 5-39, 5-49, 5-50, 5-56, 5-57, 5-62
<b>TRAILBLAZER</b>	..... 2-40, 2-41, 2-43 through 2-48, 2-51, 2-53, 5-23, 5-37, 5-38, 5-40, 5-45, 5-49, 5-56, 5-62, 5-63, D-7, D-8
<b>training</b>	..... 7-0
combat	..... 2-25, 2-29, 7-0
electronic warfare (EW)	..... 7-3
individual soldier	..... 7-0
integrated	..... 7-1, 7-2

intelligence .....	7-1
TSO .....	(see tactical surveillance officer)
TVA .....	(see target value analysis)
U	
unit maintenance .....	6-7
urban areas .....	5-67
V	
variable format message entry device (VFMED) .....	2-20, 2-21
VFMED .....	(see variable format message entry device)
voice collection .....	2-49, 2-51, 2-53, 5-40
team(s) .....	2-49, 5-23, 5-40, 5-48, D-7
team authorizations .....	2-49
W	
weapons-locating radar section .....	2-19
weather .....	1-0, 1-5, 2-0, 2-67, 4-11 through 4-16, 4-45, 5-13, 5-60 through 5-66
winter operations .....	5-60, 5-66, 5-67
withdrawal .....	5-52, 5-53, 5-54

**FM 34-80**  
**15 APRIL 1986**

By Order of the Secretary of the Army:

**JOHN A. WICKHAM, JR.**  
*General, United States Army*  
*Chief of Staff*

Official:

**R. L. DILWORTH**  
*Brigadier General, United States Army*  
*The Adjutant General*

DISTRIBUTION:

*Active Army, USAR, and ARNG:* To be distributed in accordance with DA Form 12-11A, Requirements for Battalion and Brigade IEW Operations (Qty rqr block no. 1141).