



IBM High Rate Wireless LAN (PCI) Card

User's Guide

OPTIONS
by IBM

Note: Before using this information and the product it supports, read the information under “Appendix B. Notices” on page B-1.

First Edition (September 2001)

© Copyright International Business Machines Corporation 2001. All rights reserved.
US Government Users Restricted Rights – Use, duplication or disclosure restricted by
GSA ADP Schedule Contract with IBM Corp.

Safety: Read first

Before installing this product, read the Safety Information.

مج، يجب قراءة دات السلامة

Antes de instalar este produto, leia as Informações de Segurança.

在安装本产品之前，请仔细阅读 **Safety Information** (安全信息)。

Prije instalacije ovog produkta obavezno pročitajte Sigurnosne Upute.

Před instalací tohoto produktu si přečtěte příručku bezpečnostních instrukcí.

Læs sikkerhedsforskrifterne, før du installerer dette produkt.

Ennen kuin asennat tämän tuotteen, lue turvaohjeet kohdasta Safety Information.

Avant d'installer ce produit, lisez les consignes de sécurité.

Vor der Installation dieses Produkts die Sicherheitshinweise lesen.

Πριν εγκαταστήσετε το προϊόν αυτό, διαβάστε τις πληροφορίες ασφάλειας (safety information).

לפני שתתקינו מוצר זה, קראו את הוראות הבטיחות.

A termék telepítése előtt olvassa el a Biztonsági előírásokat!

Prima di installare questo prodotto, leggere le Informazioni sulla Sicurezza.

製品の設置の前に、安全情報をお読みください。

본 제품을 설치하기 전에 안전 정보를 읽으십시오.

Пред да се инсталира овој продукт, прочитајте информацијата за безбедност.

Lees voordat u dit product installeert eerst de veiligheidsvoorschriften.

Les sikkerhetsinformasjonen (Safety Information) før du installerer dette produktet.

Przed zainstalowaniem tego produktu, należy zapoznać się z książką "Informacje dotyczące bezpieczeństwa" (Safety Information).

Antes de instalar este produto, leia as Informações sobre Segurança.

Перед установкой продукта прочтите инструкции по технике безопасности.

Pred inštaláciou tohto zariadenia si pečítajte Bezpečnostné predpisy.

Pred namestitvijo tega proizvoda preberite Varnostne informacije.

Antes de instalar este producto lea la información de seguridad.

Läs säkerhetsinformationen innan du installerar den här produkten.

安裝本產品之前，請先閱讀「安全資訊」。

Contents

Safety: Read first	iii
Preface	vii
About this book.	vii
Registering your option	vii
Installation and User's Guide	1-1
Product description	1-1
Installing the device drivers and software	1-2
Installing the IBM High Rate Wireless LAN (PCI) Card	1-2
Installing and removing the antenna.	1-3
Installing and removing the antenna.	1-4
Installing device drivers	1-5
Installing the device drivers for Windows 95	1-5
Installing the device drivers for Windows 98	1-6
Installing the device drivers for Windows Me	1-10
Installing the device drivers in Windows NT with networking already installed	1-13
Installing the device drivers in Windows 2000	1-18
Setting up TCP-IP for Windows 95, Windows 98, or Windows Me	1-22
Setting up TCP-IP in Windows NT	1-25
Setting TCP-IP in Windows 2000.	1-28
Installing the IBM Wireless LAN Client Manager	1-31
Using the IBM Wireless LAN Client Manager	1-33
Configuration	1-33
Mode.	1-34
SSID	1-35
Transmit Rate	1-36
Power Save Enabled.	1-37
AdHoc Channel	1-37
Encryption	1-38
Encryption (WEP)	1-38
Create Key with Passphrase	1-38
Create Key Manually	1-39
Link Status	1-41
State	1-41
Current channel	1-42
Current Tx Rate	1-42
Throughput.	1-42
Link Quality	1-42
Signal strength.	1-42
About	1-43
Adjusting the antenna orientation to get better performance	1-43

Appendix A. Product warranty and support information	A-1
Warranty information	A-1
Warranty period	A-1
Service and support	A-1
Warranty information on the World Wide Web	A-1
Online technical support	A-1
Telephone technical support	A-2
IBM Statement of Limited Warranty Z125-4753-06 8/2000	A-2
Part 1 - General Terms	A-3
Part 2 - Country-unique Terms	A-6
Appendix B. Notices	B-1
Trademarks	B-2
Electronic emission notices	B-2
Federal Communications Commission (FCC) statement	B-2
Appendix C. Wireless Regulatory Information	C-1

Preface

About this book

This User's Guide contains instructions for installing and using the IBM High Rate Wireless LAN (PCI) Card and is provided in the following languages:

- English
- German
- French
- Spanish
- Italian
- Brazilian Portuguese
- Traditional Chinese
- Japanese

Registering your option

Thank you for purchasing OPTIONS by IBM. Please take a few moments to register your product and provide us with information that will help IBM to better serve you in the future. Your feedback is valuable to us in developing products and services that are important to you, as well as in developing better ways to communicate with you. Register your option on the IBM Web site at

<http://www.ibm.com/pc/register>

IBM will send you information and updates on your registered product unless you indicate on the Web site questionnaire that you do not want to receive further information.

Installation and User's Guide

This section provides the product and software descriptions and the installation and user's guide.

Product description

The IBM High Rate Wireless LAN (PCI) Card is a standard PCI card that fits into any standard PCI slot. It has one light-emitting diode (LED) indicator and an external antenna. This PCI card is used to create a wireless network that complies with the IEEE 802.11b standard on wireless LANs. It supports data-transfer rates up to 11 Mbps. This PCI card is fully compatible with any other wireless LAN system based on direct sequence spread spectrum (DSSS) radio technology that complies with the IEEE 802.11b standard on wireless LANs. The card supports the following wireless LAN features:

- Automatic Transmit Rate select mechanism in the range of high, medium, standard, and low
- Frequency channel selection (2.4 GHz)
- Roaming over multiple channels
- Card Power Management
- Wired Equivalent Privacy (WEP) data encryption, based on the 64-bit and 128-bit WEP encryption algorithm as defined in the IEEE 802.11 standard on wireless LANs

In addition to this manual, your package contains the following:

- IBM High Rate Wireless LAN (PCI) Card
- The *IBM Driver and Utility CD*
- *IBM High Rate Wireless LAN (PCI) Card Quick Installation Guide*

If any of these items are missing or damaged, contact your reseller.

The PCI card is a standard PCI bus card that you can use to install the IBM High Rate Wireless LAN (PCI) Card into a computer.

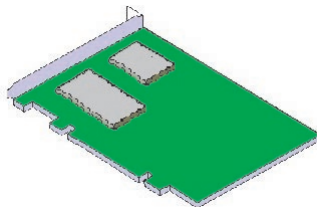

Installing the device drivers and software

Your computer must meet the following requirements to work with the IBM High Rate Wireless LAN (PCI) card:

- PCI specification compliant PCI slot
- Microsoft® Windows® 95, Windows 98, Microsoft Windows 2000 Professional, Windows Millennium Edition (Me) or Windows NT operating system (Service Pack 6 or higher)
- A minimum of 5 MB of free disk space for the driver and utility program

Installing the IBM High Rate Wireless LAN (PCI) Card

To install the PCI card into your computer, carefully follow these steps:

1. Shut down your computer.
2. Disconnect the power cords from your computer and all external devices that are connected to your computer.
3. Remove the top or side cover of your computer, according to the instructions in the user's guide that came with your computer.
4. Select an available PCI slot for the card, and remove the metal filler strip. Keep the screw for mounting the card.

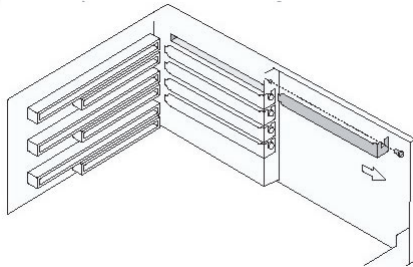

5. Make sure that you remove the antenna from the card, and gently insert the connector of the PCI card into the slot.

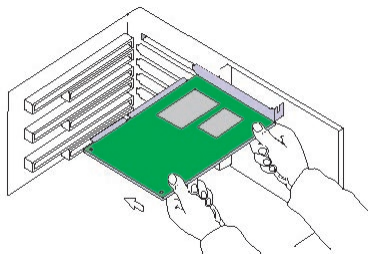

6. Secure the card into place with the screw that you removed in step 4.

7. Install the antenna, see “Installing and removing the antenna” on page 1-3 for more information.
8. Replace the computer cover according to the instructions in the user’s guide that came with your computer.
9. Reconnect all the external devices and power cords to your computer.
10. Turn on your computer to complete the hardware installation.

Installing and removing the antenna

There are two types of antennas that could be used with this Wireless LAN (PCI) Card:

- Helical antenna is for the IBM NetVista™ X41 computer

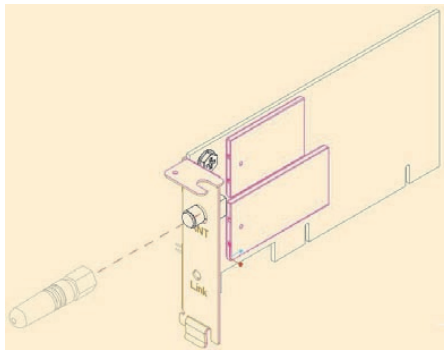

- Dipole antenna is for other IBM or non IBM computers

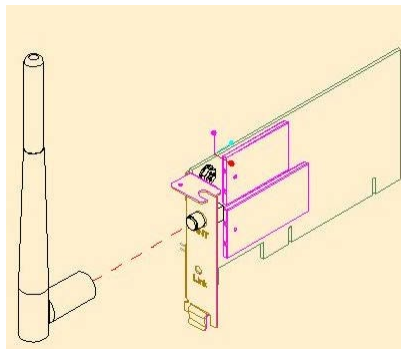

CAUTION:

Make sure the computer is off when you install or remove the antenna. Installing or removing the antenna while the computer is on might cause injury or might damage the PCI card. Never operate the High Rate Wireless LAN (PCI) Card without the antenna installed.

Installing and removing the antenna

1. Make sure that the computer is turned off.
2. Insert one end of the antenna into the antenna connector labeled ANT.

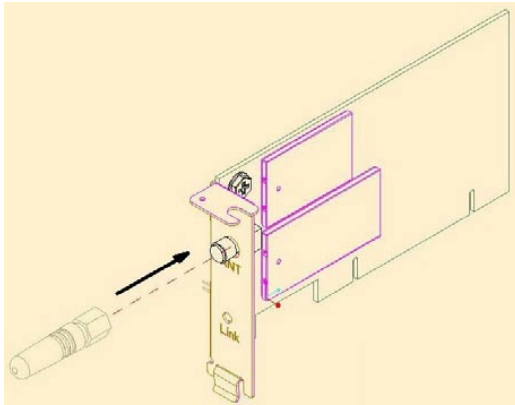

3. Install the antenna by threading it counterclockwise until it is firmly seated. Do not overtighten.

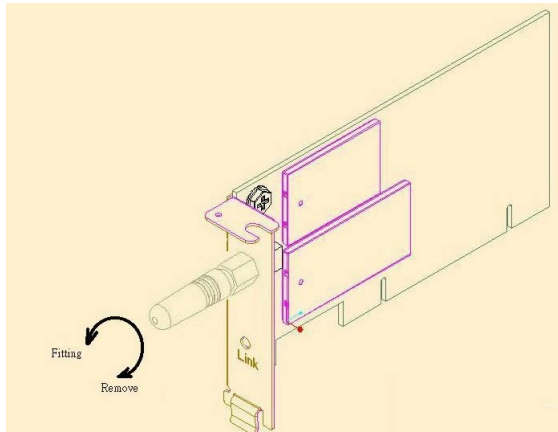

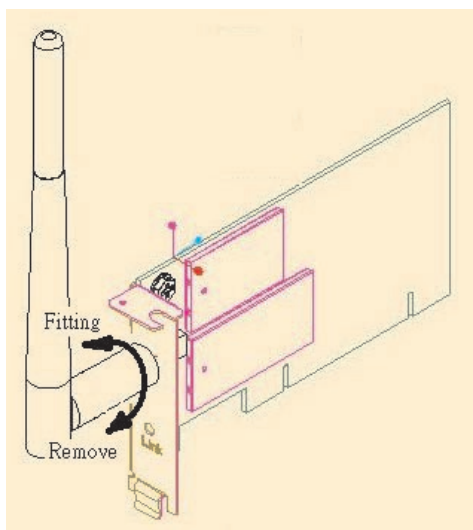

To remove the antenna, reverse the above procedure.

Installing device drivers

Make sure that you have completed hardware installation before you turn on your computer and start installing the device drivers and software.

Installing the device drivers for Windows 95

Use this procedure to install the device drivers and software:

Notes:

- Do not install hardware first.
- Windows 95 OSR2 or higher is required for the IBM High Rate Wireless LAN (PCI) Card.
- This software is intended only for Windows 95 OSR2 or higher.
- Follow instructions below.

Downloading device drivers and software.

1. Visit the IBM PC Support web page at <http://www.ibm.com/support>.
2. Download the file "LP-PCIWin95Only.exe" for IBM High Rate Wireless LAN (PCI) Card.

Extracting the device drivers and software.

3. Execute the self-extracting zip file "LP-PCIWin95Only.exe" by double-clicking on the icon.

4. Extract the files to the default folder or a folder of your choice.
5. Select **Finish** to extract and copy the files to the specified location. Select the option which allows you to create the folder if it does not already exist.
6. Click **OK** to complete extraction.

Installing the device drivers and software

Note: Do not install hardware first.

1. Execute setup.exe located in the "\setup" directory under the path where the files were extracted.
2. Refer to "Installing the IBM Wireless LAN Client Manager" on page 1-31.
3. Shutdown your computer.
4. Install the hardware. Refer to "Installing the IBM High Rate Wireless LAN (PCI) Card" on page 1-2.
5. Windows 95 will automatically install drivers for the new device.
6. Installation is complete.

Installing the device drivers for Windows 98

Use this procedure to install the device drivers:

1. Windows will automatically find the IBM High Rate Wireless LAN (PCI) after the card has been physically installed.
2. Insert the *IBM Driver & Utility CD* in the CD-ROM drive.
3. Click Next.



4. Choose "Search for the best driver for your device".

5. Click Next.



6. Select **Specify a location**.

7. Input the location of the driver. The location is the drive in which the CD was inserted with a directory path of "\Driver". See example in figure below.



8. Windows will find the following file for device driver installation.

9. Click Next.



10. Enter any specific wireless network information in the utility page to setup your wireless card.
11. Click **OK** when finished.

Note: These settings can be changed at a later time, as described on page 1-31 through 1-35.

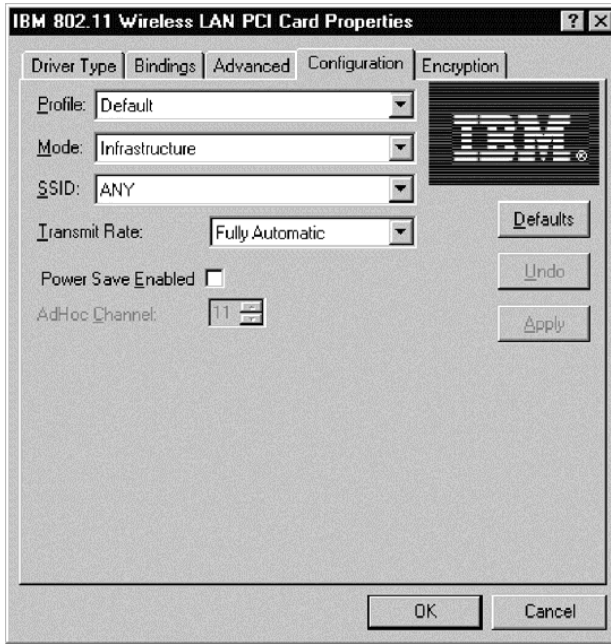

12. Windows will require the original Windows CD-ROM to complete driver installation. Please remove the *IBM Driver & Utility CD* and insert the Windows disc to complete installation.



Note:

Windows may have difficulty finding the appropriate files. If so, ensure that the path to the CD-ROM drive is correct with a path of \WIN98 or

\WIN95 dependent upon your operating system. Click **OK**.

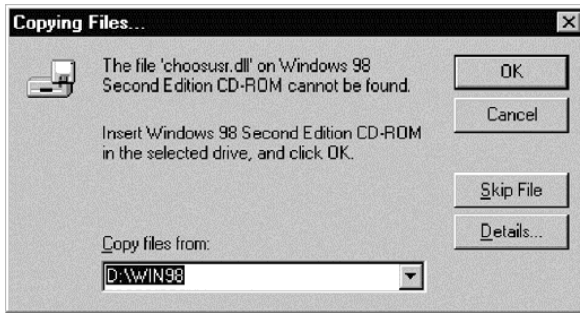

13. Click **Finish** to complete the installation procedure.



14. Select **Yes** to restart your computer.



Installing the device drivers for Windows Me

To install the device drivers for Microsoft Windows Millennium Edition (Me), do the following:

1. Windows will automatically find the IBM High Rate Wireless LAN (PCI) after the card has been physically installed.
2. Insert the *IBM Driver & Utility CD* into the CD-ROM drive.
3. Select **Automatic search for a better driver**.
4. Click **Next**.

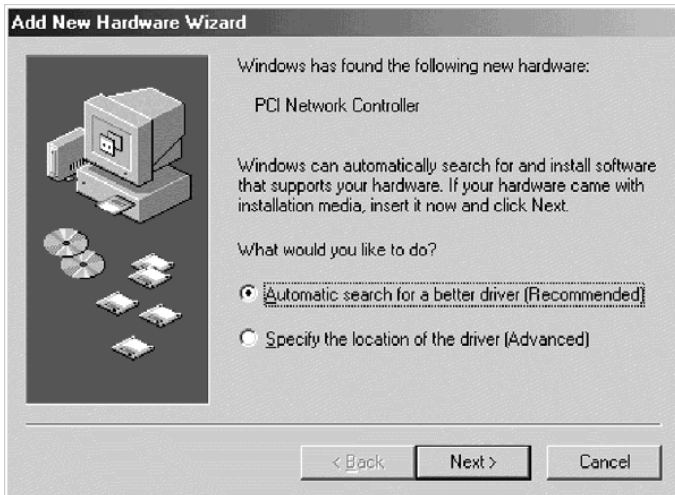

5. Enter any specific wireless network information in the utility page to set up your wireless card.
6. Click **OK**.

Note: These settings can be changed at a later time, as described on page 1-31 through 1-35.

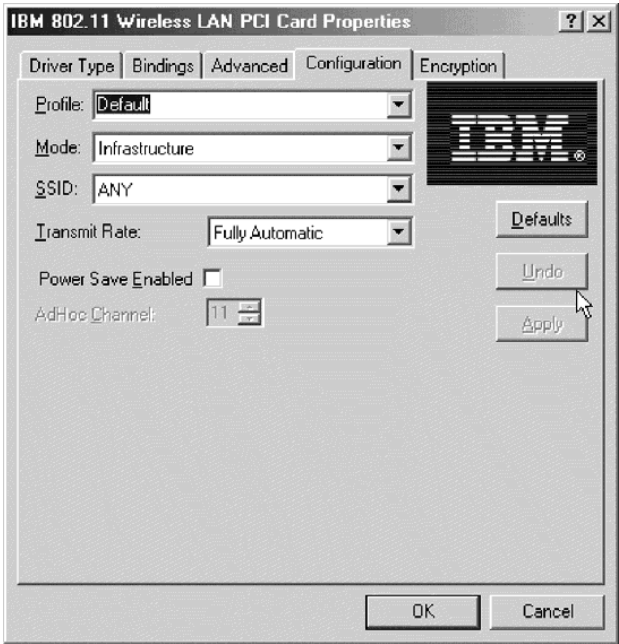

7. Click **Finish** to complete the installation procedure.



8. Click **Yes** to restart your computer.



Installing the device drivers in Windows NT with networking already installed

Use this procedure to install the device drivers in a computer running Windows NT 4.0 with networking already installed:

1. Click **Start** → **Settings** → **Control Panel**.
2. Double-click the **Network** icon.



Note: If Windows NT Networking is not installed on your computer, the following window will be shown. Please consult your network administrator for further information on installing Windows NT

Networking.

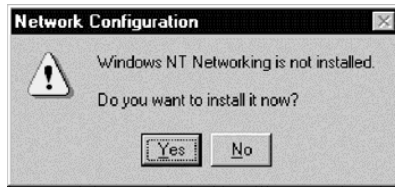

3. Click the **Adapters** tab.
4. Click **Add** to add a new adapter.

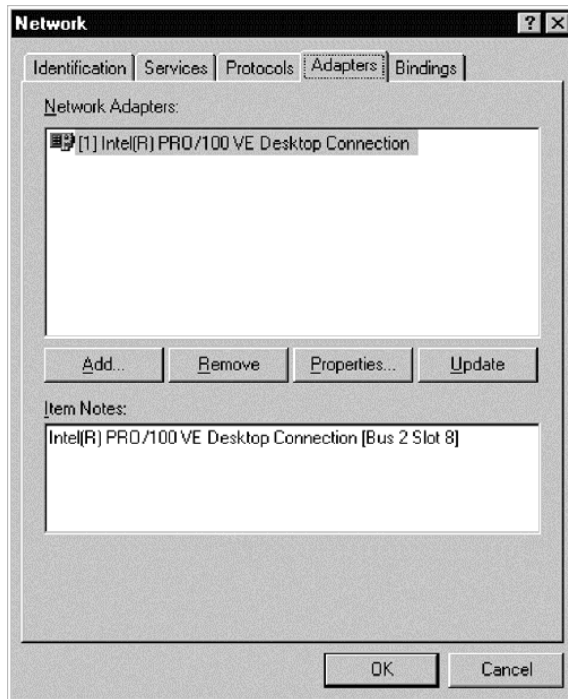

5. Click **Have Disk**.

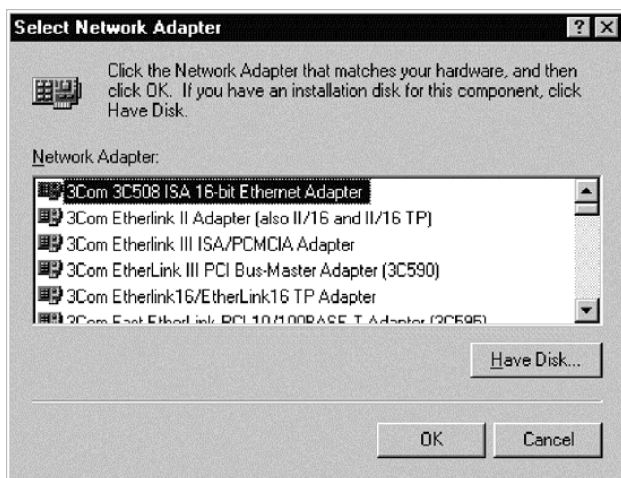

6. Input the location of the driver. The location is the drive in which the CD was inserted with a directory path of "\Driver." See example in figure below.
7. Click **OK**.

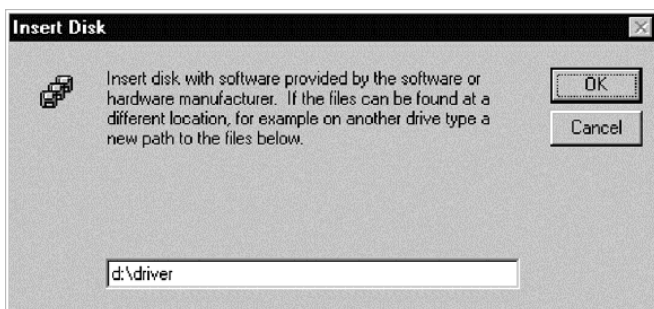

8. Select **IBM High Rate Wireless LAN (PCI) Card**.

9. Click **OK**.

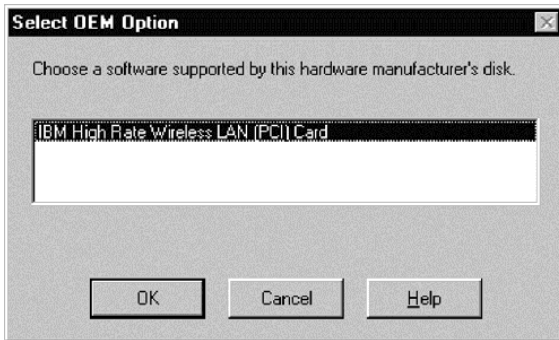

10. Enter any specific wireless network information in the utility page to set up your wireless card.

11. Click **Next**.

Note: These settings can be changed at a later time, as described on page 1-31 through 1-35.

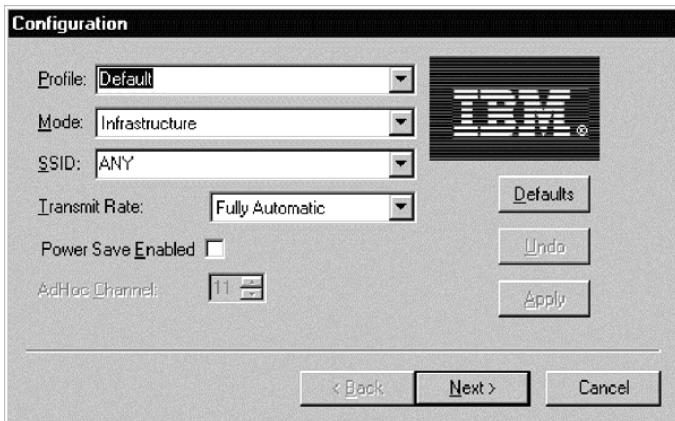

12. If your wireless network requires encryption (WEP), modify the encryption settings to meet network requirements as described on page 1-35 through 1-38.

13. Click **Finish**.

For additional information, contact your network administrator.

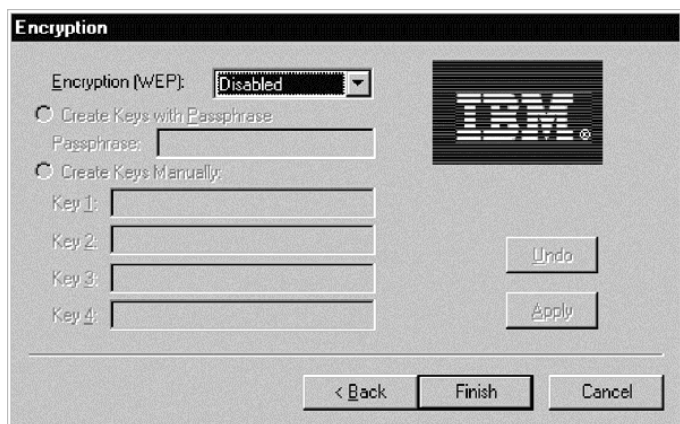

14. In the list of adapters, the IBM High Rate Wireless LAN PCI Card will be displayed.
15. Click Close to complete the installation.

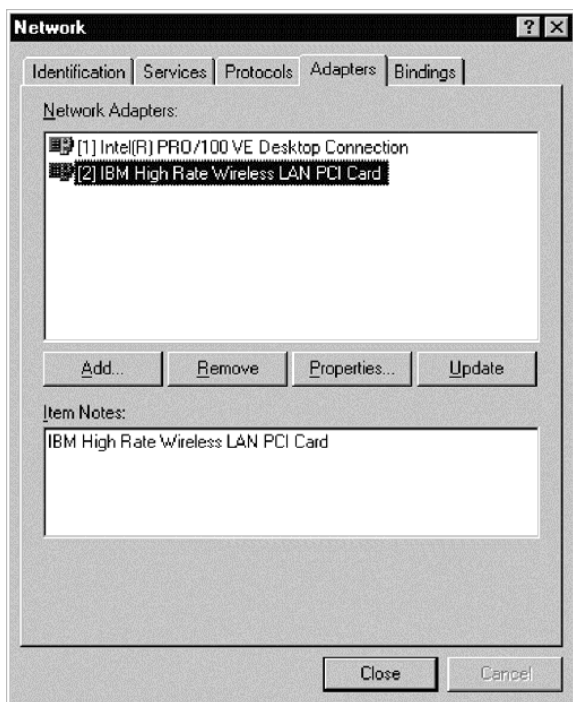

- If you have a DHCP server on your network, select "Obtain an IP address from a DHCP server". Otherwise, you may manually input IP information. For further information, contact your network administrator or Internet Service Provider (ISP).
- Click OK.

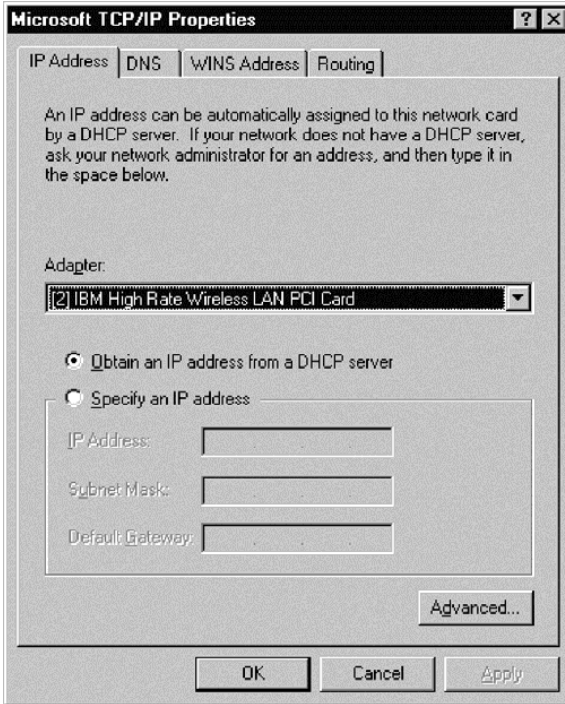

- Click Yes to restart your computer to complete the installation procedure.

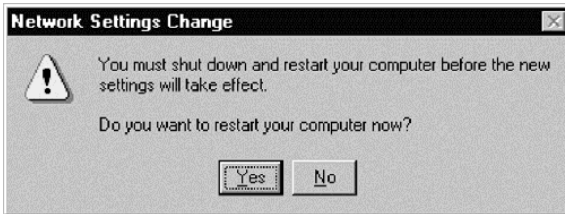

Installing the device drivers in Windows 2000

Use this procedure to install the device drivers in a computer running Windows 2000:

1. Windows will automatically find the IBM High Rate Wireless LAN (PCI) after the card has been physically installed.
2. Insert the *IBM Driver & Utility CD* into the CD-ROM drive.
3. Click Next.



4. Select "Search for a suitable driver for my device".
5. Click Next.



6. Verify that the "CD-ROM drives" check box is selected.

7. Click **Next**.



8. Windows will find the following file for the device driver installation.

9. Click **Next**.



10. Enter any specific wireless network information in the utility page to set up your wireless card and click **Next**.

Note: These settings can be changed at a later time, as described on page 1-31 through 1-35.

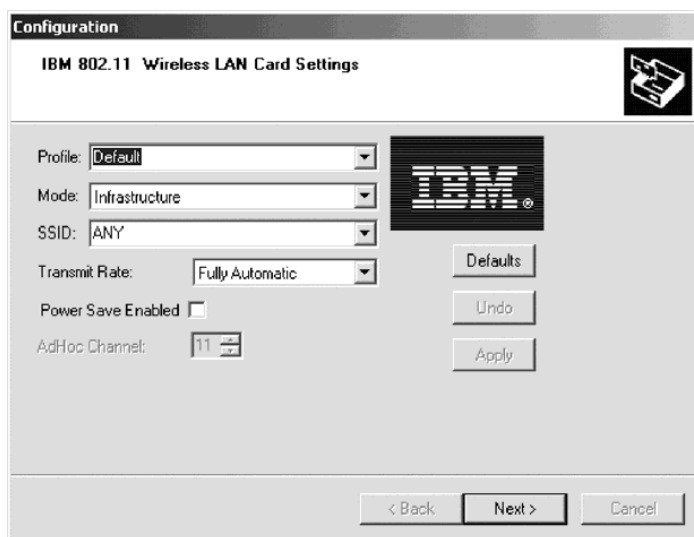

11. If your wireless network requires encryption (WEP), modify the encryption settings to meet network requirements as described on page 1-35 through 1-38.
12. Click **Next**.
13. Click **Finish** to complete the installation procedure.

For additional information, contact your network administrator.



Setting up TCP-IP for Windows 95, Windows 98, or Windows Me

To set up TCP-IP for Windows 95, Windows 98, or Windows Me, do the following:

1. From the **Start** button, go to **Start->Settings->Control Panel**.

2. Double-click the **Network** icon.



3. Select TCP/IP->IBM 802.11 Wireless LAN PCI Card.

4. Click **Properties**.

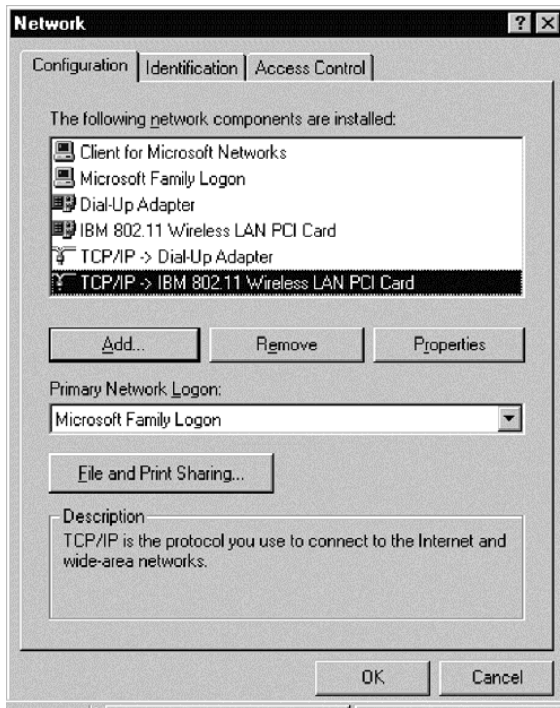

5. If you have a DHCP server on your network, select "Obtain an IP address automatically". Otherwise, you may manually input IP information. For further information, contact your network administrator or Internet Service Provider (ISP).

6. Click **OK** to finish.

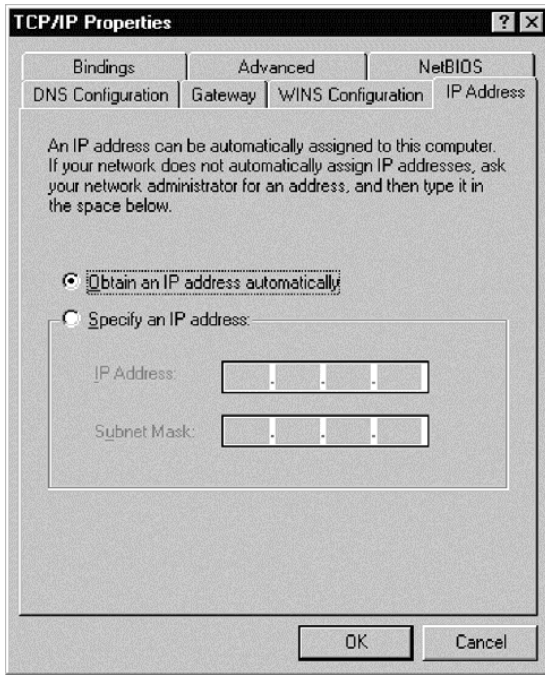

Setting up TCP-IP in Windows NT

To set up TCP-IP in Windows NT, do the following:

1. From the **Start** button, go to **Start->Settings->Control Panel**.

2. Double-click **Network**.



3. Select **Protocols**.

4. Select **TCP/IP Protocol**.

5. Click **Properties**.

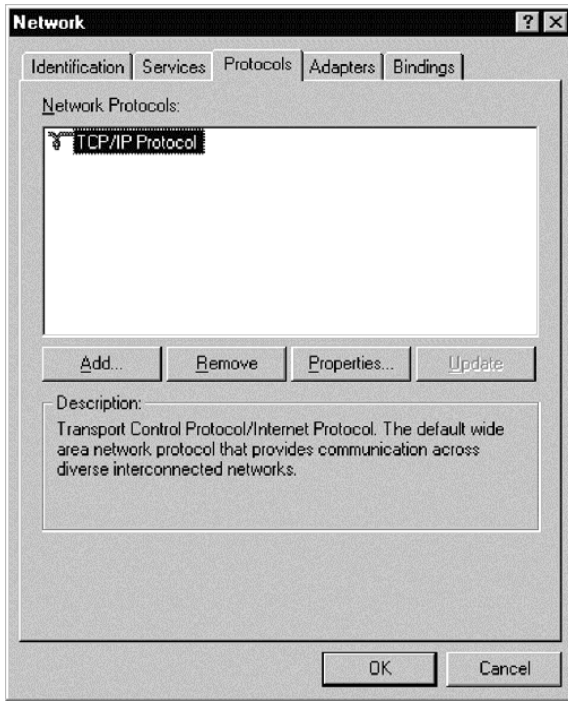

6. In the Adapter section, select the IBM High Rate Wireless LAN PCI Card.
7. If you have a DHCP server on your network, select "Obtain an IP address from a DHCP server". Otherwise, you may manually input IP information. For further information, contact your network administrator or Internet Service Provider (ISP).
8. Click **OK** to finish.

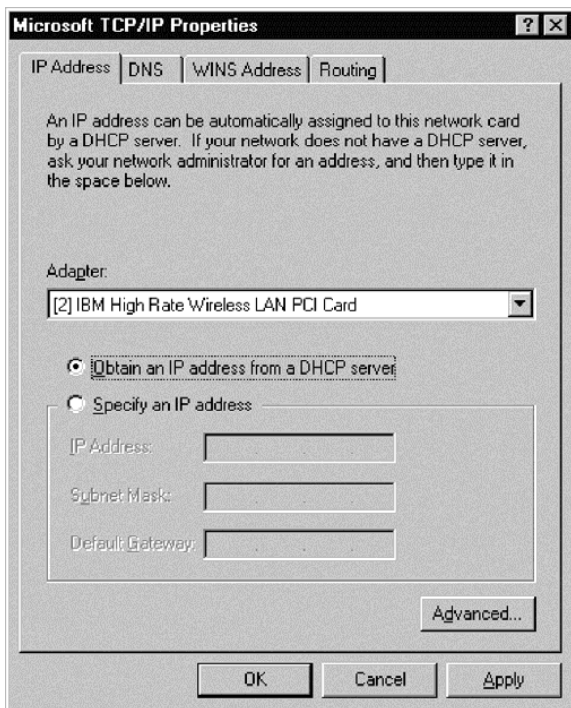

Setting TCP-IP in Windows 2000

To set up TCP-IP in Windows 2000, do the following:

1. Go to **Start->Settings->Control Panel**.

2. Double-click **Network and Dial-up Connections**.



3. Using the right mouse button, click **Local Area Connection** that refers to the wireless network.
4. Select **Properties**.

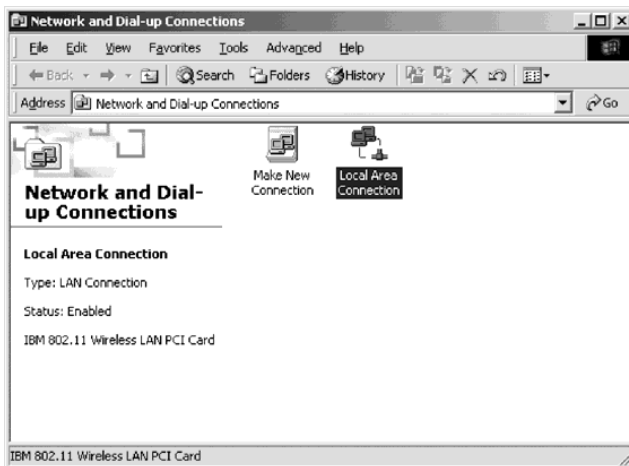

5. Select **Internet Protocol (TCP/IP)**.

6. Click **Properties**.

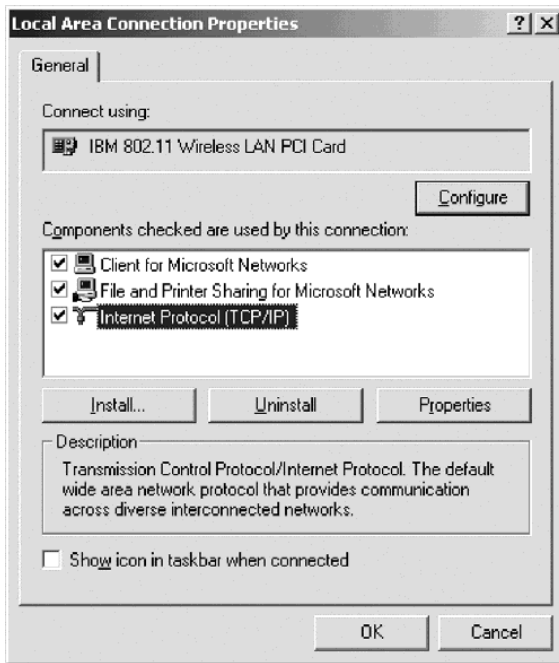

7. If you have a DHCP server on your network, select "Obtain an IP address automatically". Otherwise, you may manually input IP information. For further information, contact your network administrator or Internet Service Provider (ISP).

8. Click **OK** to finish.

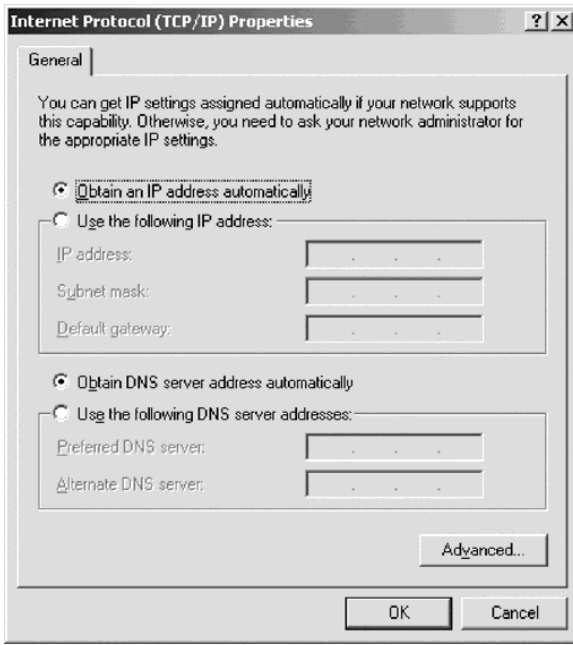

Installing the IBM Wireless LAN Client Manager

After the device drivers are installed and the computer is restarted, use this procedure to install the IBM Wireless LAN Client Manager:

1. Insert the *IBM Driver and Utility CD* into the CD-ROM drive.
2. If the CD does not start automatically, consult the CD label for instructions.
3. Select **Install IBM Wireless LAN Client Manager**.

4. Click **Next**.



5. Select the Program Folder in which the shortcut must be installed.
6. Click **Next**.

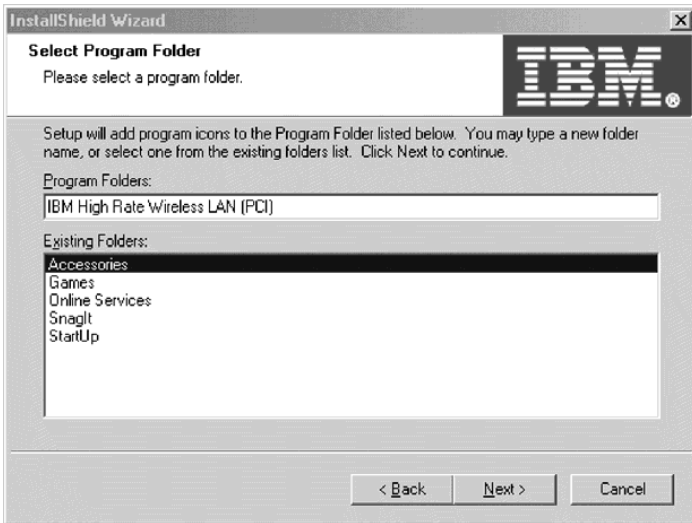

7. Select **Yes, I want to restart my computer now**.

8. Click **Finish** to complete installation procedure.

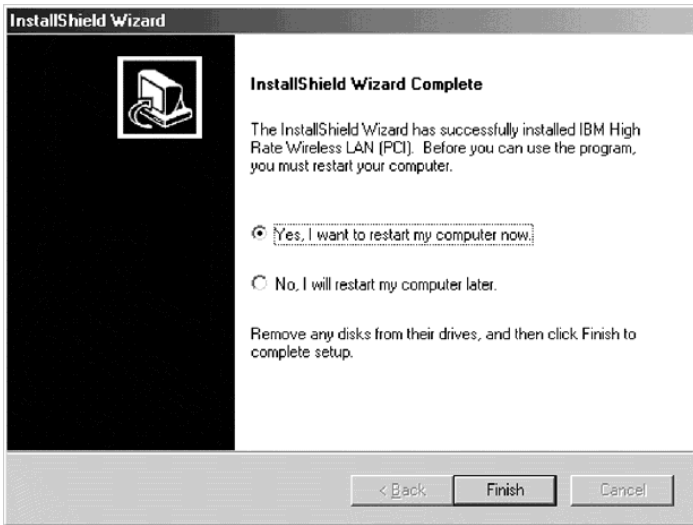

Using the IBM Wireless LAN Client Manager

The functions of the IBM Wireless LAN Client manager are on four pages:

1. Configuration
2. Encryption
3. Link
4. About

The following sections describe these functions.

Configuration

This section describes the settings on the Configuration page.

Profile

If you are going to use the Wireless LAN (PCI) Card in multiple networking environments that require different configuration settings, you can define a dedicated profile for each environment. For example, you can create one profile for your office and another for your home office.

Each profile has a profile name and contains the network name, network type, communication channel, communication data rate, power-management setting and any encryption keys for the environment. The initial configuration is stored in the default profile.

When you move your computer from one environment to another, you can quickly change the Wireless LAN (PCI) Card settings by selecting the profile for the new environment.

To create a new profile, simply type the name that you would like for the profile and make the appropriate selections in the IBM Wireless LAN Client Manager window.

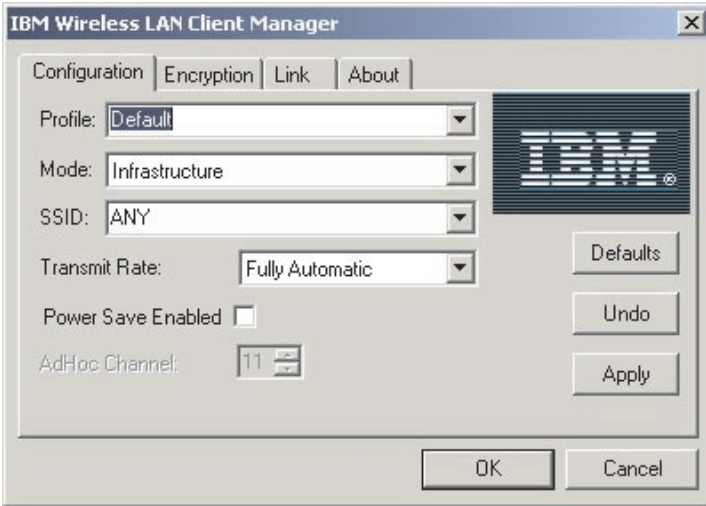

Mode

You can select between two modes:

- **Infrastructure** - An infrastructure network consists of wireless workstations that are interconnected through one access point or through multiple access

points and a wireless backbone.

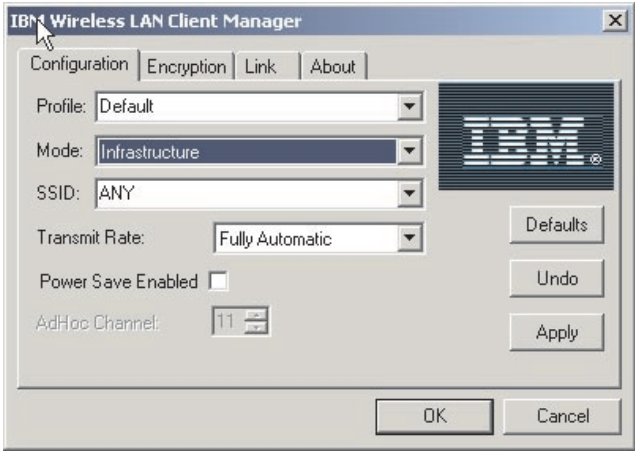

- **802.11 AdHoc** - An AdHoc network consists of workstations within mutual communication range of each other through the wireless medium.

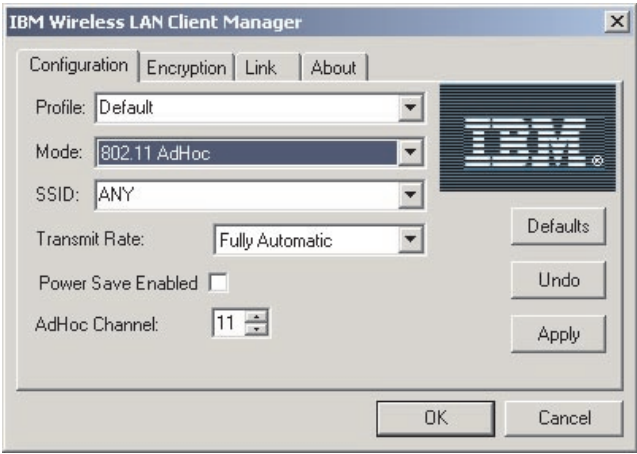

SSID

To join your computer to an existing network that includes access points or to set up an AdHoc network, select or type the network name in the SSID field. If the Wireless LAN (PCI) Card is operating in Infrastructure mode, use the infrastructure network name, or if you want the Wireless LAN (PCI) Card to connect any IEEE 802.11 infrastructure network it can find, use the name ANY

(all capital letters).

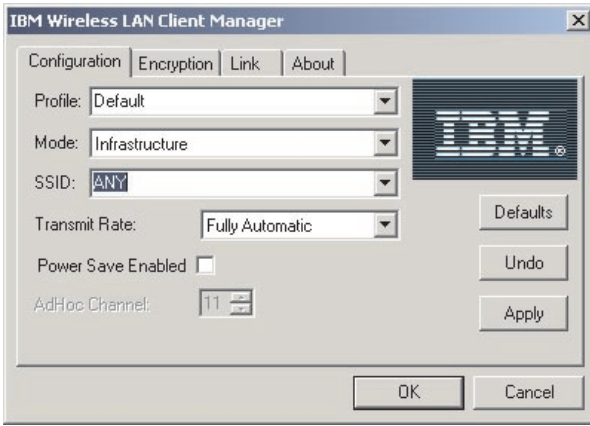

Transmit Rate

Select a transmission rate:

- Auto 1 or 2 Mb
- 5.5 Mb
- 11 Mb
- Fully Automatic

Note: Fully Automatic selects the transmission rate that is optimal for the network environment.

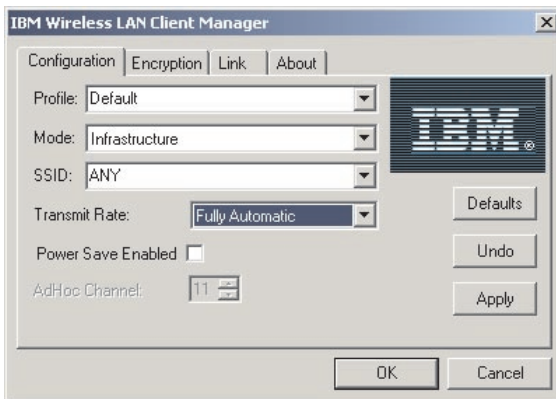

Power Save Enabled

To enable power management, select the **Power Save Enabled** check box.



AdHoc Channel

The **AdHoc Channel** field is available only if you have selected 802.11 AdHoc in the Mode field. Select a channel number from 1 to 14. In some countries, only 11 channels might be available.



Encryption

This section describes the settings on the Encryption page.

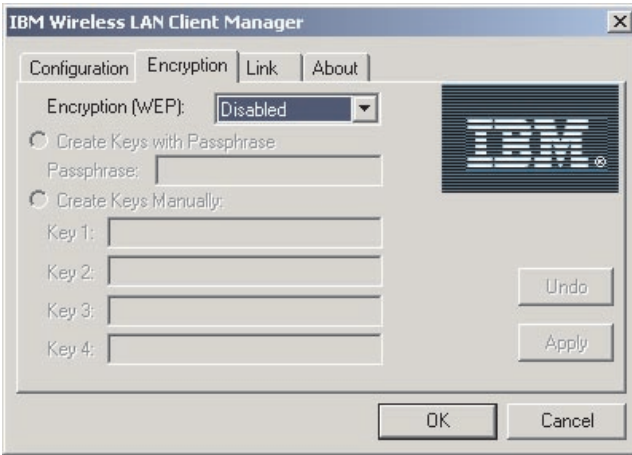

Encryption (WEP)

Select **Disabled** to disable encryption. Select **64 bit** or **128 bit** to enable encryption.

Create Key with Passphrase

This window allows you to enter a generic phrase consisting of any characters that takes the pass phrase and generate random keys automatically for you.

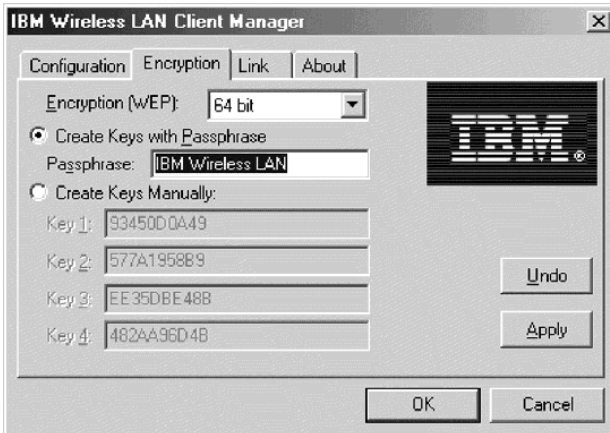

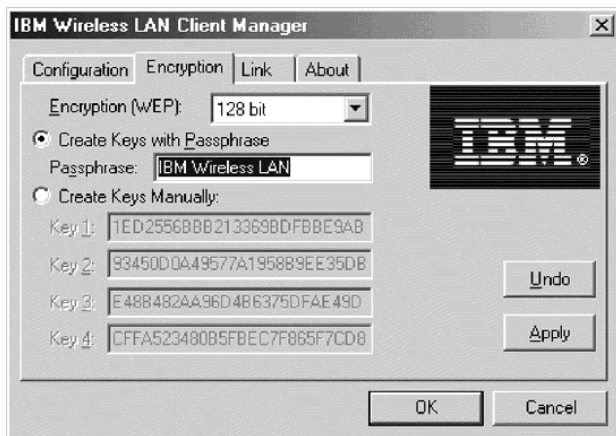

Create Key Manually

If you have enabled encryption and select this option, specify up to four different keys to decrypt data that is received by your computer through the wireless network. The keys must be hexadecimal values. If you have selected 64-bit encryption, specify 10-digit hexadecimal values (for example, ABCD123456). If you have selected 128-bit encryption, specify 26-digit hexadecimal values (for example, ABCD123456ABCD123456987654). The only valid character entries are 0-9 and A-F.

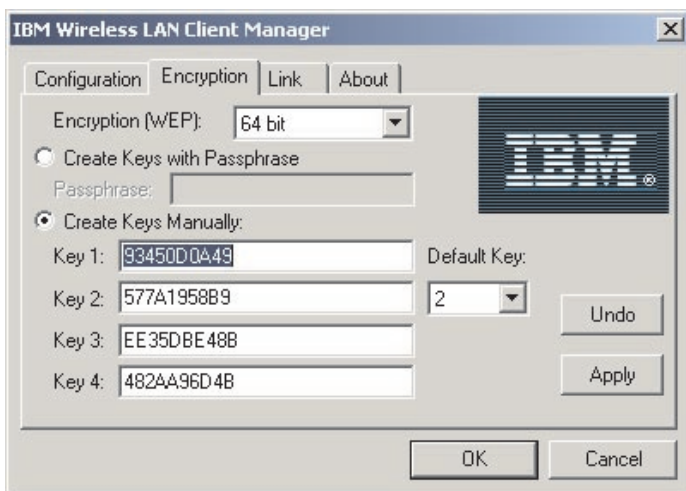

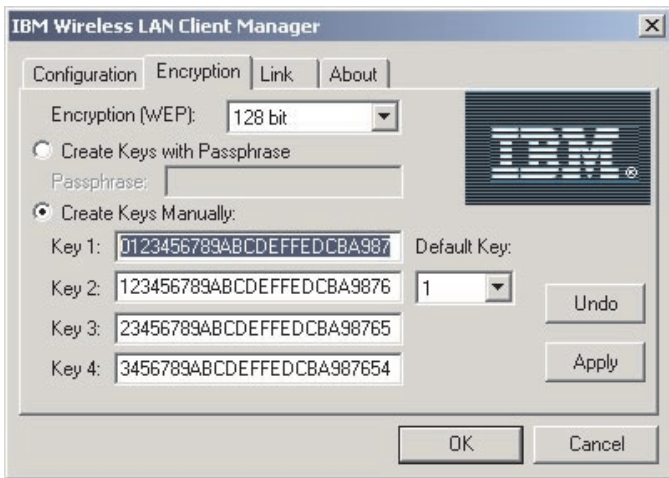

Default Key

Select the key that is to be used to encrypt packets that will be transmitted from your computer.



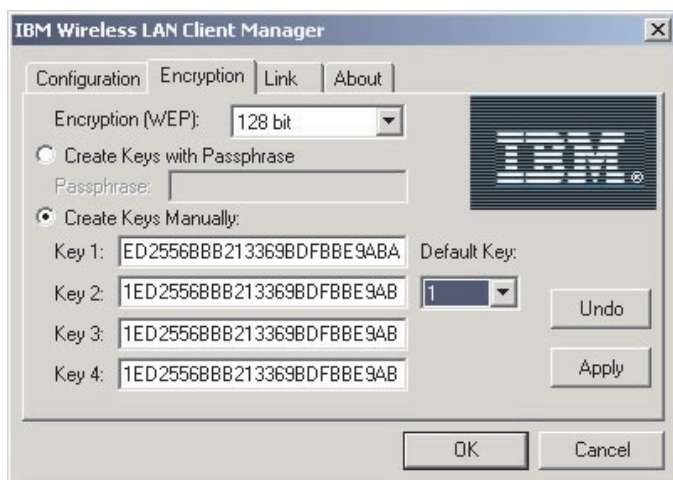

Link Status

This section describes the settings on the Link page.

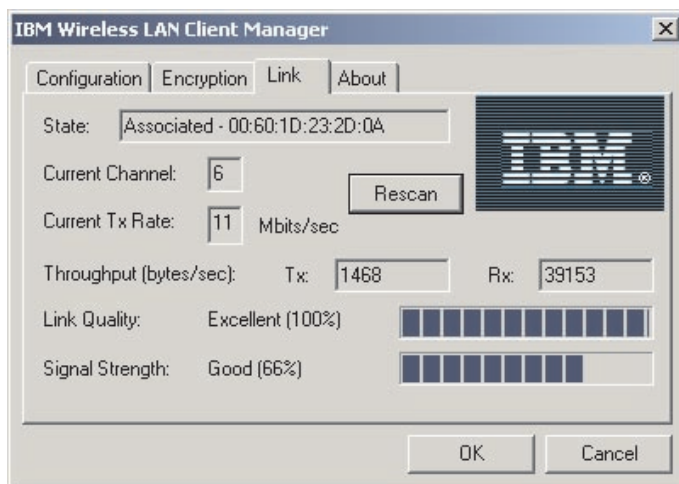

State

This field displays the current connect status of the computer. The status can be any of the following:

- The current station is disabled
- Searching for initial connection

- Associated (connected to a network)
- Reassociation (a current association is being transferred from one access point to another)

Current channel

This field displays the number of the communication channel that is being used by the network to which the computer is connected.

Current Tx Rate

This field displays the data rate (in Mbits/sec) that is being used for data transmission. If the Wireless LAN (PCI) Card is operating in AdHoc mode, this field will not show the correct value, because the field displays the data rate only for the first frame.

Throughput

This field displays the throughput rate (in bytes per second) of transmitted (Tx) and received (Rx) data.

Link Quality

This field displays the quality of communication in relation to the network to which the computer is connected.

Signal strength

This field displays the strength of the signal in relation to the network to which the computer is connected.

About

This page displays the version and built date of each component of the IBM Wireless LAN Client Manager.

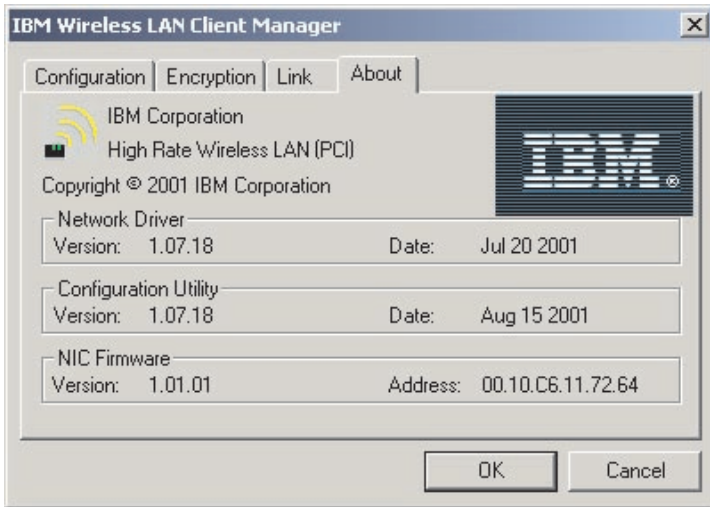



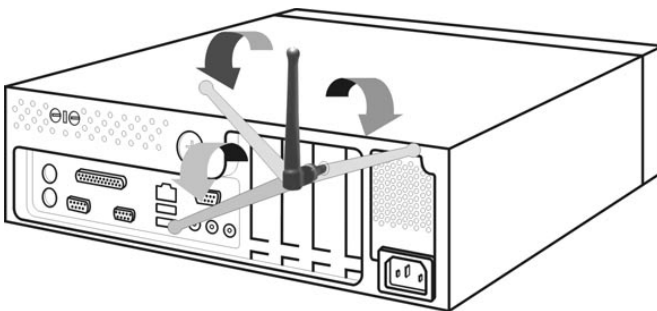

Adjusting the antenna orientation to get better performance

The default antenna orientation pointing straight up, generally provides the best signal strength and quality. Look at the icon tray and adjust the orientation of the antenna so that the optimal connection is achieved as described in “Understanding the IBM Wireless LAN Client Manager System tray icon”.



Understanding the IBM Wireless LAN Client Manager System tray icon

The following table describes the IBM Wireless LAN Client Manager System tray icon.

Icon	Description
	Good radio connection
	Fair radio connection
	Poor radio connection
	No radio connection

Note: To launch the Client Manager, double-click the icon.

Appendix A. Product warranty and support information

Warranty information

This section contains the warranty period for your product, information about obtaining warranty service and support, and the IBM Statement of Limited Warranty.

Warranty period

Contact your place of purchase for warranty service information. Some IBM Machines are eligible for on-site warranty service depending on the country or region where service is performed.

Machine - IBM High Rate Wireless LAN (PCI) User's Guide
--

Warranty period - One year

Service and support

The following information describes the technical support that is available for your product, during the warranty period or throughout the life of the product. Refer to your IBM Statement of Limited Warranty for a full explanation of IBM warranty terms.

Warranty information on the World Wide Web

The IBM Machine Warranties Web site at http://www.ibm.com/servers/support/machine_warranties/ contains a worldwide overview of the IBM Limited Warranty for IBM Machines, a glossary of terms used in the Statement of Limited Warranty, Frequently Asked Questions (FAQ), and links to Product Support Web pages. The IBM Statement of Limited Warranty is available from this Web site in 29 languages in Portable Document Format (PDF).

Online technical support

Online technical support is available during the life of your product. Online assistance can be obtained through the Personal Computing Support Web site and the IBM Automated Fax System.

Online technical support	
IBM Personal Computing Support Web site	http://www.ibm.com/pc/support/
IBM Automated Fax System	1-800-426-3395 (U.S. and Canada)

During the warranty period, assistance for replacement or exchange of defective components is available. In addition, if your IBM option is installed in an IBM computer, you might be entitled to service at your location. Your technical support representative can help you determine the best alternative.

Telephone technical support

Installation and configuration support through the IBM HelpCenter® will be withdrawn or made available for a fee, at IBM's discretion, 90 days after the option has been withdrawn from marketing. Additional support offerings, including step-by-step installation assistance, are available for a nominal fee.

To assist the technical support representative, have available as much of the following information as possible:

- Option name
- Option number
- Proof of purchase
- Computer manufacturer, model, serial number (if IBM), and manual
- Exact wording of the error message (if any)
- Description of the problem
- Hardware and software configuration information for your system

If possible, be at your computer. Your technical support representative might want to walk you through the problem during the call.

For the support telephone number and support hours by country, refer to the following table. If the number for your country or region is not listed, contact your IBM reseller or IBM marketing representative. Response time may vary depending on the number and nature of the calls received.

Support 24 hours a day, 7 days a week	
Canada (Toronto only)	416-383-3344
Canada (all other)	1-800-565-3344
U.S.A. and Puerto Rico	1-800-772-2227
All other countries and regions	Go to http://www.ibm.com/pc/support/ , and click Support Phone List .

IBM Statement of Limited Warranty Z125-4753-06 8/2000

This warranty statement consists of two parts: Part 1 and Part 2. Be sure to read Part 1 and the country-unique terms in Part 2 that apply to your country or region.

Part 1 - General Terms

This Statement of Limited Warranty includes Part 1 - General Terms and Part 2 - Country-unique Terms. The terms of Part 2 replace or modify those of Part 1. The warranties provided by IBM in this Statement of Limited Warranty apply only to Machines you purchase for your use, and not for resale, from IBM or your reseller. The term "Machine" means an IBM machine, its features, conversions, upgrades, elements, or accessories, or any combination of them. The term "Machine" does not include any software programs, whether pre-loaded with the Machine, installed subsequently or otherwise. Unless IBM specifies otherwise, the following warranties apply only in the country where you acquire the Machine. Nothing in this Statement of Limited Warranty affects any statutory rights of consumers that cannot be waived or limited by contract. If you have any questions, contact IBM or your reseller.

The IBM Warranty for Machines

IBM warrants that each Machine 1) is free from defects in materials and workmanship and 2) conforms to IBM's Official Published Specifications ("Specifications"). The warranty period for a Machine is a specified, fixed period commencing on its Date of Installation. The date on your sales receipt is the Date of Installation unless IBM or your reseller informs you otherwise.

If a Machine does not function as warranted during the warranty period, and IBM or your reseller are unable to either 1) make it do so or 2) replace it with one that is at least functionally equivalent, you may return it to your place of purchase and your money will be refunded.

Extent of Warranty

The warranty does not cover the repair or exchange of a Machine resulting from misuse, accident, modification, unsuitable physical or operating environment, improper maintenance by you, or failure caused by a product for which IBM is not responsible. The warranty is voided by removal or alteration of Machine or parts identification labels.

THESE WARRANTIES ARE YOUR EXCLUSIVE WARRANTIES AND REPLACE ALL OTHER WARRANTIES OR CONDITIONS, EXPRESS OR IMPLIED, INCLUDING, BUT NOT LIMITED TO, THE IMPLIED WARRANTIES OR CONDITIONS OF MERCHANTABILITY AND FITNESS FOR A PARTICULAR PURPOSE. THESE WARRANTIES GIVE YOU SPECIFIC LEGAL RIGHTS AND YOU MAY ALSO HAVE OTHER RIGHTS WHICH VARY FROM JURISDICTION TO JURISDICTION. SOME JURISDICTIONS DO NOT ALLOW THE EXCLUSION OR LIMITATION OF EXPRESS OR IMPLIED WARRANTIES, SO THE ABOVE EXCLUSION OR LIMITATION MAY NOT APPLY TO YOU. IN THAT EVENT, SUCH

WARRANTIES ARE LIMITED IN DURATION TO THE WARRANTY PERIOD. NO WARRANTIES APPLY AFTER THAT PERIOD.

Items Not Covered by Warranty

IBM does not warrant uninterrupted or error-free operation of a Machine.

Any technical or other support provided for a Machine under warranty, such as assistance via telephone with “how-to” questions and those regarding Machine set-up and installation, will be provided **WITHOUT WARRANTIES OF ANY KIND.**

Warranty Service

To obtain warranty service for a Machine, contact IBM or your reseller. If you do not register your Machine with IBM, you may be required to present proof of purchase.

During the warranty period, IBM or your reseller, if approved by IBM to provide warranty service, provides without charge certain types of repair and exchange service to keep Machines in, or restore them to, conformance with their Specifications. IBM or your reseller will inform you of the available types of service for a Machine based on its country of installation. At its discretion, IBM or your reseller will 1) either repair or exchange the failing Machine and 2) provide the service either at your location or a service center. IBM or your reseller will also manage and install selected engineering changes that apply to the Machine.

Some parts of IBM Machines are designated as Customer Replaceable Units (called “CRUs”), e.g., keyboards, memory, or hard disk drives. IBM ships CRUs to you for replacement by you. You must return all defective CRUs to IBM within 30 days of your receipt of the replacement CRU. You are responsible for downloading designated Machine Code and Licensed Internal Code updates from an IBM Internet Web site or from other electronic media, and following the instructions that IBM provides.

When warranty service involves the exchange of a Machine or part, the item IBM or your reseller replaces becomes its property and the replacement becomes yours. You represent that all removed items are genuine and unaltered. The replacement may not be new, but will be in good working order and at least functionally equivalent to the item replaced. The replacement assumes the warranty service status of the replaced item. Many features, conversions, or upgrades involve the removal of parts and their return to IBM. A part that replaces a removed part will assume the warranty service status of the removed part.

Before IBM or your reseller exchanges a Machine or part, you agree to remove all features, parts, options, alterations, and attachments not under warranty service.

You also agree to

1. ensure that the Machine is free of any legal obligations or restrictions that prevent its exchange;
2. obtain authorization from the owner to have IBM or your reseller service a Machine that you do not own; and
3. where applicable, before service is provided:
 - a. follow the problem determination, problem analysis, and service request procedures that IBM or your reseller provides;
 - b. secure all programs, data, and funds contained in a Machine;
 - c. provide IBM or your reseller with sufficient, free, and safe access to your facilities to permit them to fulfill their obligations; and
 - d. inform IBM or your reseller of changes in a Machine's location.

IBM is responsible for loss of, or damage to, your Machine while it is 1) in IBM's possession or 2) in transit in those cases where IBM is responsible for the transportation charges.

Neither IBM nor your reseller is responsible for any of your confidential, proprietary or personal information contained in a Machine which you return to IBM or your reseller for any reason. You should remove all such information from the Machine prior to its return.

Limitation of Liability

Circumstances may arise where, because of a default on IBM's part or other liability, you are entitled to recover damages from IBM. In each such instance, regardless of the basis on which you are entitled to claim damages from IBM (including fundamental breach, negligence, misrepresentation, or other contract or tort claim), except for any liability that cannot be waived or limited by applicable laws, IBM is liable for no more than

1. damages for bodily injury (including death) and damage to real property and tangible personal property; and
2. the amount of any other actual direct damages, up to the charges (if recurring, 12 months' charges apply) for the Machine that is subject of the claim. For purposes of this item, the term "Machine" includes Machine Code and Licensed Internal Code.

This limit also applies to IBM's suppliers and your reseller. It is the maximum for which IBM, its suppliers, and your reseller are collectively responsible.

UNDER NO CIRCUMSTANCES IS IBM LIABLE FOR ANY OF THE FOLLOWING: 1) THIRD-PARTY CLAIMS AGAINST YOU FOR DAMAGES

(OTHER THAN THOSE UNDER THE FIRST ITEM LISTED ABOVE); 2) LOSS OF, OR DAMAGE TO, YOUR RECORDS OR DATA; OR 3) SPECIAL, INCIDENTAL, OR INDIRECT DAMAGES OR FOR ANY ECONOMIC CONSEQUENTIAL DAMAGES, LOST PROFITS OR LOST SAVINGS, EVEN IF IBM, ITS SUPPLIERS OR YOUR RESELLER IS INFORMED OF THEIR POSSIBILITY. SOME JURISDICTIONS DO NOT ALLOW THE EXCLUSION OR LIMITATION OF INCIDENTAL OR CONSEQUENTIAL DAMAGES, SO THE ABOVE LIMITATION OR EXCLUSION MAY NOT APPLY TO YOU.

Governing Law

Both you and IBM consent to the application of the laws of the country in which you acquired the Machine to govern, interpret, and enforce all of your and IBM's rights, duties, and obligations arising from, or relating in any manner to, the subject matter of this Agreement, without regard to conflict of law principles.

Part 2 - Country-unique Terms

AMERICAS

BRAZIL

Governing Law: *The following is added after the first sentence:*

Any litigation arising from this Agreement will be settled exclusively by the court of Rio de Janeiro.

NORTH AMERICA

Warranty Service: *The following is added to this Section:*

To obtain warranty service from IBM in Canada or the United States, call 1-800-IBM-SERV (426-7378).

CANADA

Governing Law: *The following replaces "laws of the country in which you acquired the Machine" in the first sentence:*
laws in the Province of Ontario.

UNITED STATES

Governing Law: *The following replaces "laws of the country in which you acquired the Machine" in the first sentence:*
laws of the State of New York.

ASIA PACIFIC

AUSTRALIA

The IBM Warranty for Machines: *The following paragraph is added to this Section:*
The warranties specified in this Section are in addition to any rights you may have under the Trade Practices Act 1974 or other similar legislation and are only limited to the extent permitted by the applicable legislation.

Limitation of Liability: *The following is added to this Section:*

Where IBM is in breach of a condition or warranty implied by the Trade Practices Act 1974 or other similar legislation, IBM's liability is limited to the repair or replacement of the goods or the supply of equivalent goods. Where that condition or warranty relates to right to sell, quiet possession or clear title, or the goods are of a kind ordinarily acquired for personal, domestic or household use or consumption, then none of the limitations in this paragraph apply.

Governing Law: *The following replaces "laws of the country in which you acquired the Machine" in the first sentence:*
laws of the State or Territory.

CAMBODIA, LAOS, AND VIETNAM

Governing Law: *The following replaces "laws of the country in which you acquired the Machine" in the first sentence:*
laws of the State of New York.

The following is added to this Section:

Disputes and differences arising out of or in connection with this Agreement shall be finally settled by arbitration which shall be held in Singapore in accordance with the rules of the International Chamber of Commerce (ICC). The arbitrator or arbitrators designated in conformity with those rules shall have the power to rule on their own competence and on the validity of the Agreement to submit to arbitration. The arbitration award shall be final and binding for the parties without appeal and the arbitral award shall be in writing and set forth the findings of fact and the conclusions of law.

All proceedings shall be conducted, including all documents presented in such proceedings, in the English language. The number of arbitrators shall be three, with each side to the dispute being entitled to appoint one arbitrator.

The two arbitrators appointed by the parties shall appoint a third arbitrator before proceeding upon the reference. The third arbitrator shall act as chairman of the proceedings. Vacancies in the post of chairman shall be filled by the

president of the ICC. Other vacancies shall be filled by the respective nominating party. Proceedings shall continue from the stage they were at when the vacancy occurred.

If one of the parties refuses or otherwise fails to appoint an arbitrator within 30 days of the date the other party appoints its, the first appointed arbitrator shall be the sole arbitrator, provided that the arbitrator was validly and properly appointed.

The English language version of this Agreement prevails over any other language version.

HONG KONG AND MACAU

Governing Law: *The following replaces "laws of the country in which you acquired the Machine" in the first sentence:*

laws of Hong Kong Special Administrative Region.

INDIA

Limitation of Liability: *The following replaces items 1 and 2 of this Section:*

1. liability for bodily injury (including death) or damage to real property and tangible personal property will be limited to that caused by IBM's negligence;
2. as to any other actual damage arising in any situation involving nonperformance by IBM pursuant to, or in any way related to the subject of this Statement of Limited Warranty, IBM's liability will be limited to the charge paid by you for the individual Machine that is the subject of the claim.

JAPAN

Governing Law: *The following sentence is added to this Section:*

Any doubts concerning this Agreement will be initially resolved between us in good faith and in accordance with the principle of mutual trust.

NEW ZEALAND

The IBM Warranty for Machines: *The following paragraph is added to this Section:*

The warranties specified in this Section are in addition to any rights you may have under the Consumer Guarantees Act 1993 or other legislation which cannot be excluded or limited. The Consumer Guarantees Act 1993 will not apply in respect of any goods which IBM provides, if you require the goods for the purposes of a business as defined in that Act.

Limitation of Liability: *The following is added to this Section:*

Where Machines are not acquired for the purposes of a business as defined in the Consumer Guarantees Act 1993, the limitations in this Section are subject to the limitations in that Act.

PEOPLE'S REPUBLIC OF CHINA (PRC)

Governing Law: *The following replaces this Section:*

Both you and IBM consent to the application of the laws of the State of New York (except when local law requires otherwise) to govern, interpret, and enforce all your and IBM's rights, duties, and obligations arising from, or relating in any manner to, the subject matter of this Agreement, without regard to conflict of law principles.

Any disputes arising from or in connection with this Agreement will first be resolved by friendly negotiations, failing which either of us has the right to submit the dispute to the China International Economic and Trade Arbitration Commission in Beijing, the PRC, for arbitration in accordance with its arbitration rules in force at the time. The arbitration tribunal will consist of three arbitrators. The language to be used therein will be English and Chinese. An arbitral award will be final and binding on all the parties, and will be enforceable under the Convention on the Recognition and Enforcement of Foreign Arbitral Awards (1958).

The arbitration fee will be borne by the losing party unless otherwise determined by the arbitral award.

During the course of arbitration, this Agreement will continue to be performed except for the part which the parties are disputing and which is undergoing arbitration.

EUROPE, MIDDLE EAST, AFRICA (EMEA)

THE FOLLOWING TERMS APPLY TO ALL EMEA COUNTRIES:

The terms of this Statement of Limited Warranty apply to Machines purchased from IBM or an IBM reseller.

Warranty Service:

If you purchase an IBM Machine in Austria, Belgium, Denmark, Estonia, Finland, France, Germany, Greece, Iceland, Ireland, Italy, Latvia, Lithuania, Luxembourg, Netherlands, Norway, Portugal, Spain, Sweden, Switzerland or United Kingdom, you may obtain warranty service for that Machine in any of those countries from either (1) an IBM reseller approved to perform warranty service or (2) from IBM. If you purchase an IBM Personal Computer Machine in Albania, Armenia, Belarus, Bosnia and Herzegovina, Bulgaria, Croatia,

Czech Republic, Georgia, Hungary, Kazakhstan, Kirghizia, Federal Republic of Yugoslavia, Former Yugoslav Republic of Macedonia (FYROM), Moldova, Poland, Romania, Russia, Slovak Republic, Slovenia, or Ukraine, you may obtain warranty service for that Machine in any of those countries from either (1) an IBM reseller approved to perform warranty service or (2) from IBM.

If you purchase an IBM Machine in a Middle Eastern or African country, you may obtain warranty service for that Machine from the IBM entity within the country of purchase, if that IBM entity provides warranty service in that country, or from an IBM reseller, approved by IBM to perform warranty service on that Machine in that country. Warranty service in Africa is available within 50 kilometers of an IBM authorized service provider. You are responsible for transportation costs for Machines located outside 50 kilometers of an IBM authorized service provider.

Governing Law:

The applicable laws that govern, interpret and enforce rights, duties, and obligations of each of us arising from, or relating in any manner to, the subject matter of this Statement, without regard to conflict of laws principles, as well as Country-unique terms and competent court for this Statement are those of the country in which the warranty service is being provided, except that in 1) Albania, Bosnia-Herzegovina, Bulgaria, Croatia, Hungary, Former Yugoslav Republic of Macedonia, Romania, Slovakia, Slovenia, Armenia, Azerbaijan, Belarus, Georgia, Kazakhstan, Kyrgyzstan, Moldova, Russia, Tajikistan, Turkmenistan, Ukraine, and Uzbekistan, the laws of Austria apply; 2) Estonia, Latvia, and Lithuania, the laws of Finland apply; 3) Algeria, Benin, Burkina Faso, Cameroon, Cape Verde, Central African Republic, Chad, Congo, Djibouti, Democratic Republic of Congo, Equatorial Guinea, France, Gabon, Gambia, Guinea, Guinea-Bissau, Ivory Coast, Lebanon, Mali, Mauritania, Morocco, Niger, Senegal, Togo, and Tunisia, this Agreement will be construed and the legal relations between the parties will be determined in accordance with the French laws and all disputes arising out of this Agreement or related to its violation or execution, including summary proceedings, will be settled exclusively by the Commercial Court of Paris; 4) Angola, Bahrain, Botswana, Burundi, Egypt, Eritrea, Ethiopia, Ghana, Jordan, Kenya, Kuwait, Liberia, Malawi, Malta, Mozambique, Nigeria, Oman, Pakistan, Qatar, Rwanda, Sao Tome, Saudi Arabia, Sierra Leone, Somalia, Tanzania, Uganda, United Arab Emirates, United Kingdom, West Bank/Gaza, Yemen, Zambia, and Zimbabwe, this Agreement will be governed by English Law and disputes relating to it will be submitted to the exclusive jurisdiction of the English courts; and 5) in Greece, Israel, Italy, Portugal, and Spain any legal claim arising out of this Statement will be brought before, and finally settled by, the competent court of Athens, Tel Aviv, Milan, Lisbon, and Madrid, respectively.

THE FOLLOWING TERMS APPLY TO THE COUNTRY SPECIFIED:

AUSTRIA AND GERMANY

The IBM Warranty for Machines: *The following replaces the first sentence of the first paragraph of this Section:*

The warranty for an IBM Machine covers the functionality of the Machine for its normal use and the Machine's conformity to its Specifications.

The following paragraphs are added to this Section:

The minimum warranty period for Machines is six months. In case IBM or your reseller is unable to repair an IBM Machine, you can alternatively ask for a partial refund as far as justified by the reduced value of the unrepaired Machine or ask for a cancellation of the respective agreement for such Machine and get your money refunded.

Extent of Warranty: *The second paragraph does not apply.*

Warranty Service: *The following is added to this Section:*

During the warranty period, transportation for delivery of the failing Machine to IBM will be at IBM's expense.

Limitation of Liability: *The following paragraph is added to this Section:*

The limitations and exclusions specified in the Statement of Limited Warranty will not apply to damages caused by IBM with fraud or gross negligence and for express warranty.

The following sentence is added to the end of item 2:

IBM's liability under this item is limited to the violation of essential contractual terms in cases of ordinary negligence.

EGYPT

Limitation of Liability: *The following replaces item 2 in this Section:*

as to any other actual direct damages, IBM's liability will be limited to the total amount you paid for the Machine that is the subject of the claim. For purposes of this item, the term "Machine" includes Machine Code and Licensed Internal Code.

Applicability of suppliers and resellers (unchanged).

FRANCE

Limitation of Liability: *The following replaces the second sentence of the first paragraph of this Section:*

In such instances, regardless of the basis on which you are entitled to claim damages from IBM, IBM is liable for no more than: *(items 1 and 2 unchanged).*

IRELAND

Extent of Warranty: *The following is added to this Section:*

Except as expressly provided in these terms and conditions, all statutory conditions, including all warranties implied, but without prejudice to the generality of the foregoing all warranties implied by the Sale of Goods Act 1893 or the Sale of Goods and Supply of Services Act 1980 are hereby excluded.

Limitation of Liability: *The following replaces items one and two of the first paragraph of this Section:*

1. death or personal injury or physical damage to your real property solely caused by IBM's negligence; and
2. the amount of any other actual direct damages, up to 125 percent of the charges (if recurring, the 12 months' charges apply) for the Machine that is the subject of the claim or which otherwise gives rise to the claim.

Applicability of suppliers and resellers (unchanged).

The following paragraph is added at the end of this Section:

IBM's entire liability and your sole remedy, whether in contract or in tort, in respect of any default shall be limited to damages.

ITALY

Limitation of Liability: *The following replaces the second sentence in the first paragraph:*

In each such instance unless otherwise provided by mandatory law, IBM is liable for no more than:

1. *(unchanged)*
2. as to any other actual damage arising in all situations involving nonperformance by IBM pursuant to, or in any way related to the subject matter of this Statement of Warranty, IBM's liability, will be limited to the total amount you paid for the Machine that is the subject of the claim.

Applicability of suppliers and resellers (unchanged).

The following replaces the third paragraph of this Section:

Unless otherwise provided by mandatory law, IBM and your reseller are not liable for any of the following: *(items 1 and 2 unchanged)* 3) indirect damages, even if IBM or your reseller is informed of their possibility.

SOUTH AFRICA, NAMIBIA, BOTSWANA, LESOTHO AND SWAZILAND

Limitation of Liability: *The following is added to this Section:*

IBM's entire liability to you for actual damages arising in all situations involving nonperformance by IBM in respect of the subject matter of this

Statement of Warranty will be limited to the charge paid by you for the individual Machine that is the subject of your claim from IBM.

UNITED KINGDOM

Limitation of Liability: *The following replaces items 1 and 2 of the first paragraph of this Section:*

1. death or personal injury or physical damage to your real property solely caused by IBM's negligence;
2. the amount of any other actual direct damages or loss, up to 125 percent of the charges (if recurring, the 12 months' charges apply) for the Machine that is the subject of the claim or which otherwise gives rise to the claim;

The following item is added to this paragraph:

3. breach of IBM's obligations implied by Section 12 of the Sale of Goods Act 1979 or Section 2 of the Supply of Goods and Services Act 1982.

Applicability of suppliers and resellers (unchanged).

The following is added to the end of this Section:

IBM's entire liability and your sole remedy, whether in contract or in tort, in respect of any default shall be limited to damages.

Appendix B. Notices

This publication was developed for products and services offered in the U.S.A.

IBM may not offer the products, services, or features discussed in this document in other countries. Consult your local IBM representative for information on the products and services currently available in your area. Any reference to an IBM product, program, or service is not intended to state or imply that only that IBM product, program, or service may be used. Any functionally equivalent product, program, or service that does not infringe any IBM intellectual property right may be used instead. However, it is the user's responsibility to evaluate and verify the operation of any non-IBM product, program, or service.

IBM may have patents or pending patent applications covering subject matter described in this document. The furnishing of this document does not give you any license to these patents. You can send license inquiries, in writing, to:

*IBM Director of Licensing
IBM Corporation
North Castle Drive
Armonk, NY 10504-1785
U.S.A.*

The following paragraph does not apply to the United Kingdom or any country where such provisions are inconsistent with local law:

INTERNATIONAL BUSINESS MACHINES CORPORATION PROVIDES THIS PUBLICATION "AS IS" WITHOUT WARRANTY OF ANY KIND, EITHER EXPRESS OR IMPLIED, INCLUDING, BUT NOT LIMITED TO, THE IMPLIED WARRANTIES OF NON-INFRINGEMENT, MERCHANTABILITY OR FITNESS FOR A PARTICULAR PURPOSE. Some states do not allow disclaimer of express or implied warranties in certain transactions, therefore, this statement may not apply to you.

This information could include technical inaccuracies or typographical errors. Changes are periodically made to the information herein; these changes will be incorporated in new editions of the publication. IBM may make improvements and/or changes in the product(s) and/or the program(s) described in this publication at any time without notice.

IBM may use or distribute any of the information you supply in any way it believes appropriate without incurring any obligation to you. Any references in this publication to non-IBM Web sites are provided for convenience only and do not in any manner serve as an endorsement of those Web sites. The materials at those Web sites are not part of the materials for this IBM product,

and use of those Web sites is at your own risk. Any performance data contained herein was determined in a controlled environment. Therefore, the result obtained in other operating environments may vary significantly. Some measurements may have been made on development-level systems and there is no guarantee that these measurements will be the same on generally available systems. Furthermore, some measurements may have been estimated through extrapolation. Actual results may vary. Users of this document should verify the applicable data for their specific environment.

Trademarks

The following terms are trademarks of International Business Machines Corporation in the United States, other countries, or both:

IBM
HelpCenter
NetVista

Microsoft, Windows, and Windows NT are trademarks of Microsoft Corporation in the United States, other countries, or both.

Other company, product, or service names may be the trademarks or service marks of others.

Electronic emission notices

IBM High Rate Wireless LAN (PCI) Card

Federal Communications Commission (FCC) statement

Note: This equipment has been tested and found to comply with the limits for a Class B digital device, pursuant to Part 15 of the FCC Rules. These limits are designed to provide reasonable protection against harmful interference in a residential installation. This equipment generates, uses, and can radiate radio frequency energy and, if not installed and used in accordance with the instructions, may cause harmful interference to radio communications. However, there is no guarantee that interference will not occur in a particular installation. If this equipment does cause harmful interference to radio or television reception, which can be determined by turning the equipment off and on, the user is encouraged to try to correct the interference by one or more of the following measures:

- Reorient or relocate the receiving antenna.
- Increase the separation between the equipment and receiver.
- Connect the equipment into an outlet on a circuit different from that to which the receiver is connected.
- Consult an IBM authorized dealer or service representative for help.

Properly shielded and grounded cables and connectors must be used in order to meet FCC emission limits. Proper cables and connectors are available from IBM authorized dealers. IBM is not responsible for any radio or television interference caused by using other than recommended cables and connectors or by unauthorized changes or modifications to this equipment. Unauthorized changes or modifications could void the user's authority to operate the equipment.

This device complies with Part 15 of the FCC Rules. Operation is subject to the following two conditions: (1) this device may not cause harmful interference, and (2) this device must accept any interference received, including interference that may cause undesired operation.

Responsible party:

International Business Machines Corporation
New Orchard Road
Armonk, NY 10504
Telephone: 1-919-543-2193

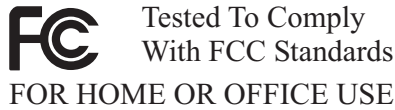

Industry Canada Class B emission compliance statement

This Class B digital apparatus complies with Canadian ICES-003.

Avis de conformité a la réglementation d'Industrie Canada

Cet appareil numérique de la classe B est conforme à la norme NMB-003 du Canada.

Deutsche EMV-Direktive (electromagnetische Verträglichkeit)

Zulassungsbeseinigunglaut dem Deutschen Gesetz über die elektromagnetische Verträglichkeit von Geräten (EMVG) vom 30. August 1995 (bzw. der EMC EG Richtlinie 89/336):

Dieses Gerät ist berechtigt in Übereinstimmungmit dem Deutschen EMVG das EG-Konformitätszeichen - CE - zu führen. Verantwortlich für die Konformitätserklärung nach Paragraph 5 des EMVG ist die:

IBM Deutschland Informationssysteme GmbH, 70548 Stuttgart.

Informationen in Hinsicht EMVG Paragraph 3 Abs. (2) 2:

Das Gerät erfüllt die Schutzanforderungen nach EN 50082-1 und EN 55022 Klasse B.
--

EN 50082-1 Hinweis:

“Wird dieses Gerät in einer industriellen Umgebung betrieben (wie in EN 50082-2 festgelegt), dann kann es dabei eventuell gestört werden. In solch einem FA11 ist der Abstand bzw. die Abschirmung zu der industriellen Stromquelle zu vergrößern.”

Anmerkung:

Um die Einhaltung des EMVG sicherzustellen sind die Geräte, wie in den IBM Handbüchern angegeben, zu installieren und zu betreiben.

European Union - emission directive

This product is in conformity with the protection requirements of EU Council Directive 89/336/ECC on the approximation of the laws of the Member States relating to electromagnetic compatibility.

IBM can not accept responsibility for any failure to satisfy the protection requirements resulting from a non-recommended modification of the product, including the fitting of non-IBM option cards.

This product has been tested and found to comply with the limits for Class B Information Technology Equipment according to European Standard EN 55022. The limits for Class B equipment were derived for typical residential environments to provide reasonable protection against interference with licensed communication devices.

Union Européenne - Directive Conformité électromagnétique

Ce produit est conforme aux exigences de protection de la Directive 89/336/EEC du Conseil de l'UE sur le rapprochement des lois des États membres en matière de compatibilité électromagnétique.

IBM ne peut accepter aucune responsabilité pour le manquement aux exigences de protection résultant d'une modification non recommandée du produit, y compris l'installation de cartes autres que les cartes IBM.

Ce produit a été testé et il satisfait les conditions de l'équipement informatique de Classe B en vertu de Standard européen EN 55022. Les conditions pour l'équipement de Classe B ont été définies en fonction d'un contexte résidentiel

ordinaire afin de fournir une protection raisonnable contre l'interférence d'appareils de communication autorisés.

Unione Europea - Directiva EMC (Conformidad electromagnética)

Este producto satisface los requisitos de protección del Consejo de la UE, Directiva 89/336/CEE en lo que a la legislación de los Estados Miembros sobre compatibilidad electromagnética se refiere.

IBM no puede aceptar responsabilidad alguna si este producto deja de satisfacer dichos requisitos de protección como resultado de una modificación no recomendada del producto, incluyendo el ajuste de tarjetas de opción que no sean IBM.

Este producto ha sido probado y satisface los límites para Equipos Informáticos Clase B de conformidad con el Estándar Europeo EN 55022. Los límites para los equipos de Clase B se han establecido para entornos residenciales típicos a fin de proporcionar una protección razonable contra las interferencias con dispositivos de comunicación licenciados.

Union Europea - Normativa EMC

Questo prodotto è conforme alle normative di protezione ai sensi della Direttiva del Consiglio dell'Unione Europea 89/336/CEE sull'armonizzazione legislativa degli stati membri in materia di compatibilità elettromagnetica.

IBM non accetta responsabilità alcuna per la mancata conformità alle normative di protezione dovuta a modifiche non consigliate al prodotto, compresa l'installazione di schede e componenti di marca diversa da IBM.

Le prove effettuate sul presente prodotto hanno accertato che esso rientra nei limiti stabiliti per le apparecchiature di informatica Classe B ai sensi della Norma Europea EN 55022. I limiti delle apparecchiature della Classe B sono stati stabiliti al fine di fornire ragionevole protezione da interferenze mediante dispositivi di comunicazione in concessione in ambienti residenziali tipici.

이 기기는 가정용으로 전자파 적합등록을 기기로서

주거지역에서는 물론 모든 지역에서 사용 할 수 있습니다.

この装置は、情報処理装置等電波障害自主規制協議会（VCCI）の基準に基づくクラスB情報技術装置です。この装置は、家庭環境で使用することを目的としていますが、この装置がラジオやテレビジョン受信機に近接して使用されると、受信障害を引き起こすことがあります。
取扱説明書に従って正しい取り扱いをして下さい。

Japanese statement of compliance for products less than or equal to 20 A per phase

高調波ガイドライン適合品

Appendix C. Wireless Regulatory Information

The device must be installed and used in strict accordance with the instructions as described hereafter. This product complies with the following radio frequency and safety standards:

USA - Federal Communications Commission (FCC)

This device complies with part 15 of the FCC rules. Operation is subject to the following two conditions:

1. This device may not cause harmful interference, and
2. This device must accept any interference received, including interference that may cause undesired operation.
3. **FCC RF Radiation Exposure Statement:** This device and its antenna(s) must operate with a separation distance of at least 20 cm from all persons and must not be co-located or operating in conjunction with any other antenna or transmitter. End-users must be provided with specific operating instructions for satisfying RF exposure compliance.

Canada - Industry Canada (IC)

"NOTICE: The Industry Canada label identifies certified equipment. This certification means that the equipment meets telecommunications network protective, operational and safety requirements as prescribed in the appropriate Terminal Equipment Technical Requirements document(s). The Department does not guarantee the equipment will operate to the user's satisfaction.

Before installing this equipment, users should ensure that it is permissible to be connected to the facilities of the local telecommunications company. The equipment must also be installed using an acceptable method of connection. The customer should be aware that compliance with the above conditions may not prevent degradation of service in some situations. Repairs to certified equipment should be coordinated by a representative designated by the supplier. Any repairs or alterations made by the user to this equipment, or equipment malfunctions, may give the telecommunications company cause to request the user to disconnect the equipment.

Users should ensure for their own protection that the electrical ground connections of the power utility, telephone lines and internal metallic water pipe system, if present, are connected together. This precaution may be particularly important in rural areas.

Caution: Users should not attempt to make such connections themselves, but should contact the appropriate electric inspection authority, or electrician, as appropriate."

"NOTICE: The **Ringer Equivalence Number (REN)** assigned to each terminal device provides an indication of the maximum number of terminals allowed to be connected to a telephone interface. The termination on an interface may consist of any combination of devices subject only to the requirement that the sum of the Ringer Equivalence Numbers of all the devices does not exceed 5."

Low Power License-Exempt Radiocommunication Devices (RSS-210)

Operation is subject to the following two conditions: (1) this device may not cause interference, and (2) this device must accept any interference, including interference that may cause undesired operation of the device.

Permis d'émission à faible puissance - Cas des appareils de communications radio (CNR-210)

Le fonctionnement de ce type d'appareil est soumis aux deux conditions suivantes : (1) Cet appareil peut perturber les communications radio, et (2) cet appareil doit supporter toute perturbation, y compris les perturbations qui pourraient provoquer un dysfonctionnement.

"To reduce potential radio interference to other users, the antenna type and its gain should be so chosen that the equivalent isotropic radiated power (EIRP) is not more than that required for successful communications."

Europe - CE Declaration of Conformity

- Hereby Universal Scientific Industrial Co. Ltd. declares that the IBM High Rate Wireless LAN PCI adapter device integrated in this product is in conformity with the essential requirements and other relevant provisions of Directive 1999/5/EC. IBM cannot accept responsibility for any failure to satisfy the protection requirements resulting from a non-recommended modification of the product.
- Universal Scientific Industrial Co. Ltd. déclare par la présente que le dispositif IBM High Rate Wireless LAN PCI adapter device intégré à ce produit sont en conformité avec les principales exigences et autres dispositions appropriées de la Directive 1999/5/EC. IBM décline toute responsabilité en cas de modification non recommandée de ces produits.
- Universal Scientific Industrial Co. Ltd. erklären hiermit, dass die in diesem Produkt integrierte drahtlose IBM High Rate Wireless LAN PCI adapter device die Voraussetzungen sowie alle wichtigen Anforderungen der

Richtlinie 1999/5/EC erfüllen. IBM übernimmt keine Verantwortung für Fehler, die sich aus einer nicht empfohlenen, unsachgemäßen Modifizierung an diesem Produkt zur Erfüllung der Sicherheitsanforderungen ergeben.



 **Universal Scientific Industrial Co., Ltd.**

CE Declaration of Conformity

For the following equipment:
IEEE 802.11b Wireless LAN PCI Adapter

(Product Name)

PCI111200

(Model Designation)

is herewith confirmed to comply with the requirements set out in the Council Directive on the Approximation of the Laws of the Member States relating to the European Council Directive 89/336/EEC, the Low Voltage Directive 73/23/EEC & The Amendment Directive 93/68/EEC, Radio & Telecommunication Terminal Equipment Directive (R&TTE) 1999/5/EC. For the evaluation regarding the Directives, the following standards were applied:

EN300 328-2 July 2000 V1.1.1

EN301 489-1 August 2000 V1.2.1

EN301 489-17 September 2000 V1.1.1

EN60950 2000

The following manufacturer is responsible for this declaration:

Universal Scientific Industrial Co., Ltd.

(COMPANY NAME)

135, Lane 351, Taiping Road, Sec. 1, Tsao Tuen, Non-Tou, Taiwan

(COMPANY ADDRESS)

TEL : 886-49-2350876

FAX : 886-943226744

Fred Chen

Director

(NAME)

(TITLE)

(SIGNATURE)

(DATE)

CE 802.11b Frequency Restrictions

802.11b (maximum power > 10 mW and <100 mW)

Belgie B: Gebruik buiten gebouw alleen op kanalen 10 (2462 MHz) en 11 (2467 MHz). Voor privé-gebruik buiten gebouw over publieke grond over afstand kleiner dan 300m geen registratie bij BIPT/IBPT nodig; voor gebruik over

afstand groter dan 300m is wel registratie bij BIPT/IBPT nodig. Voor publiek gebruik buiten gebouwen is licentie van BIPT/IBPT verplicht. Voor registratie of licentie kunt u contact opnemen met BIPT.

Belgium B: For outdoor usage only channel 10 (2462 MHz) and 11 (2467 MHz) is allowed. For private usage outside buildings across public grounds over less than 300m no special registration with IBPT/BIPT is required. Registration to IBPT/BIPT is required for private usage outside buildings across public grounds over more than 300m. An IBPT/BIPT licence is required for public usage outside building. For registration and license please contact IBPT/BIPT.

Belgique B: L'utilisation en extérieur est autorisée sur le canal 10 (2462 MHz) et 11 (2467 MHz). Dans le cas d'une utilisation privée, à l'extérieur d'un bâtiment, au-dessus d'un espace public, aucun enregistrement n'est nécessaire pour une distance de moins de 300m. Pour une distance supérieure à 300m un enregistrement auprès de l'IBPT est requise. Pour une utilisation publique à l'extérieur de bâtiments, une licence de l'IBPT est requise. Pour les enregistrements et licences, veuillez contacter l'IBPT.

France F: A l'intérieur des bâtiments, utilisation sans contrainte géographique avec puissance maximale de 100 mW dans la bande 2446,5-2483,5 MHz. A l'extérieur des bâtiments, utilisation non autorisée. Vous pouvez contacter l'Autorité de Régulation des Télécommunications (<http://www.art-telecom.fr>) pour tout autre cas particulier.

France F: Indoor, no geographical restriction with a maximum power of 100 mW within the band of 2446.5-2483.5 MHz. Outdoor, the band is not opened. Please contact ART for any other specific case.

Deutschland D: Anmeldung im Outdoor-Bereich notwendig, aber nicht genehmigungspflichtig.

Germany D: License required for outdoor installations.

Italia I: E' necessaria la concessione ministeriale anche per l'uso interno. L'uso per installazione in esterni non e' permessa.

Italy I: License required for indoor use. Use with outdoor installations not allowed.

The Netherlands: NLLicense required for outdoor installations.

Nederland: NLLicentie verplicht voor gebruik met buitenantennes.

Japan:



USI PCI111200
TD01- 0839JP
01NYDA1028

下記「電波干渉についての注意」は、重要な注意事項なので、このページを印刷して大切に保管してください。

電波干渉についての注意

この機器の使用周波数は2.4GHz帯です。この周波数帯ではレンジ等の産業・科学・医療用機器のほか、他の同種無線局、工場の製造ライン等で使用される免許を要する移動体識別用構内無線局、免許を要しない特定小電力無線局、アマチュア無線局等（以下「他の無線局」と略す）が運用されています。

- この機器を使用する前に、近くで「他の無線局」が運用されていないことを確認してください。
- 万一、この機器と「他の無線局」との間に電波干渉が発生した場合には、速やかにこの機器の使用チャンネルを変更するか、使用場所を変えるか、又は機器の運用を停止（電波の発射を停止）してください。
- 本製品に関してお困りの時は、次の連絡先までお問い合わせください。

連絡先：ダイヤルIBM

（最新の電話番号は、次のホームページでご確認ください。）

<http://www-6.ibm.com/jp/services/its/info/>)

2.4 DS 4

この無線機器は 2.4GHz 帯周波数、DS-SS 変調方式を採用しており、与干渉距離は 40m です。



Printed in the United States of America
on recycled paper containing 10%
recovered post-consumer fiber.