

IBM 9514-B03 or B13
Color LCD Monitor

GA18-7521-00

Installation and Operation Guide

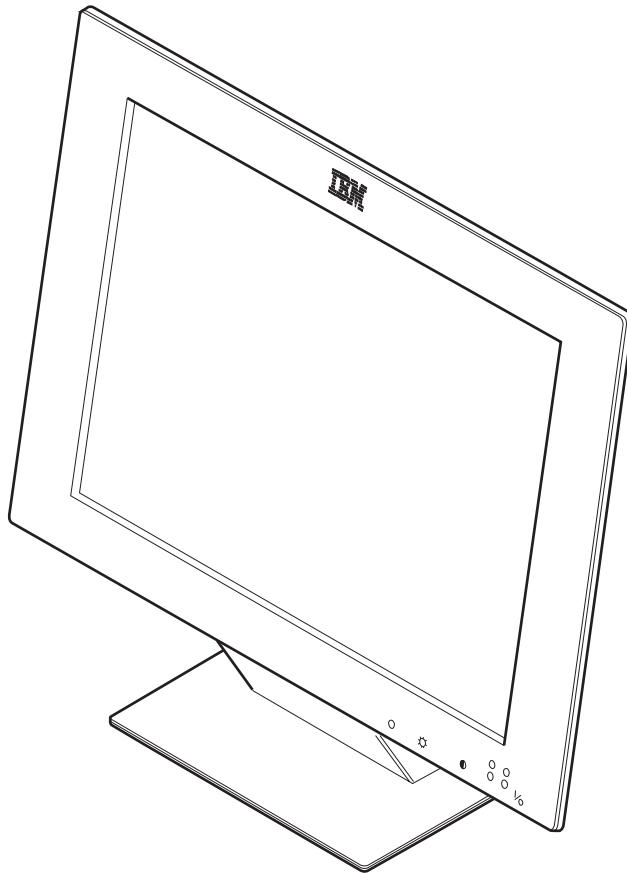

IBM 9514-B03 or B13
Color LCD Monitor

GA18-7521-00

Installation and Operation Guide

Note

Before using this information and the product it supports, be sure to read "Safety" on page v and the general information under "Notices" on page 43.

First Edition (September 1997)

The following paragraph does not apply to the United Kingdom or any country where such provisions are inconsistent with local law: INTERNATIONAL BUSINESS MACHINES CORPORATION PROVIDES THIS PUBLICATION "AS IS" WITHOUT WARRANTY OF ANY KIND, EITHER EXPRESS OR IMPLIED, INCLUDING, BUT NOT LIMITED TO, THE IMPLIED WARRANTIES OF MERCHANTABILITY OR FITNESS FOR A PARTICULAR PURPOSE. Some states do not allow disclaimers of express or implied warranties in certain transactions; therefore, this statement may not apply to you.

This publication could include technical inaccuracies or typographical errors. Changes are periodically made to the information herein; these changes will be incorporated in new editions of the publication. IBM may make improvements or changes in the products or the programs described in this publication at any time.

Comments may be addressed to IBM Japan, Ltd., Yamato Laboratory, 1623-14 Shimotsuruma, Yamato-shi, Kanagawa-ken 242, Japan. IBM may use or distribute any of the information you supply in any way it believes appropriate without incurring any obligation to you. Requests for technical information about IBM products should be made to your IBM Authorized Dealer or your IBM Marketing Representative.

Copyright International Business Machines Corporation 1997. All rights reserved.

Note to U.S. Government Users - Documentation related to restricted rights - Use, duplication, or disclosure is subject to restrictions set forth in GSA ADP Schedule Contract with IBM Corp.

Contents

Safety	v
About This Book	vii
Chapter 1. Setting Up Your Monitor	1
Precautions	1
Lifting the Monitor	1
Placing the Monitor	1
Before Setting Up	2
Locations	3
Connecting the Interface Cables	5
Setting the Viewing Angle	10
Caring for Your Monitor	10
Chapter 2. Operating Your Monitor	11
Turning On the Monitor	11
Adjusting the Brightness and Contrast	12
Setup Menus	13
Chapter 3. Configuring Your Monitor Using Automatic Setup	15
Auto Setup for PC-DOS	16
Auto Setup for Windows 3.1/Windows 95/Windows NT	19
Auto Setup for OS/2	22
Quick Setup	25
Appendix A. The Setup Menus	27
The Setup Main Menu	27
Using the Main Menu	27
Saving Power with Standby Mode	29
The Manual-Adjust Menu	30
Using the Manual-Adjust Menu	30
Information Menu	33
Appendix B. Setting Noninterlace Mode	35
Appendix C. Troubleshooting	37
Appendix D. Specifications	39
Default Preset Timing	41
Appendix E. Notices	43
Trademarks	43
Energy Saving	44
Electrical Emissions	45

Safety



DANGER:

Electrical current from power, telephone, and communication cables is hazardous. To avoid shock hazard, connect and disconnect cables as shown below when installing, moving, or opening the covers of this product or attached devices. The power cord must be used with a properly grounded outlet.

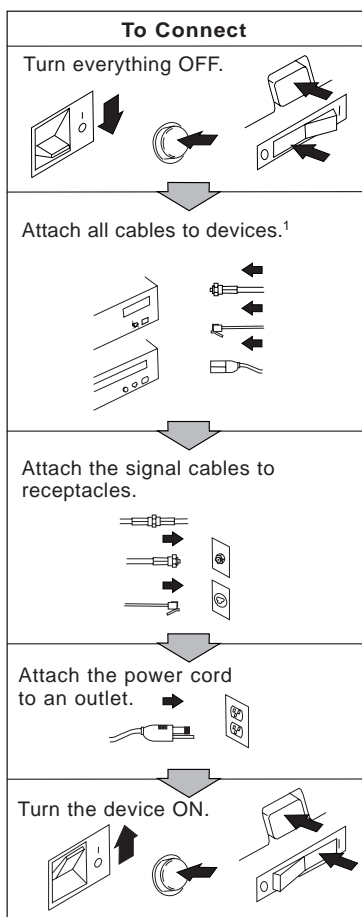

¹ In the U.K., by law, the telephone line cable must be connected after the power cord.

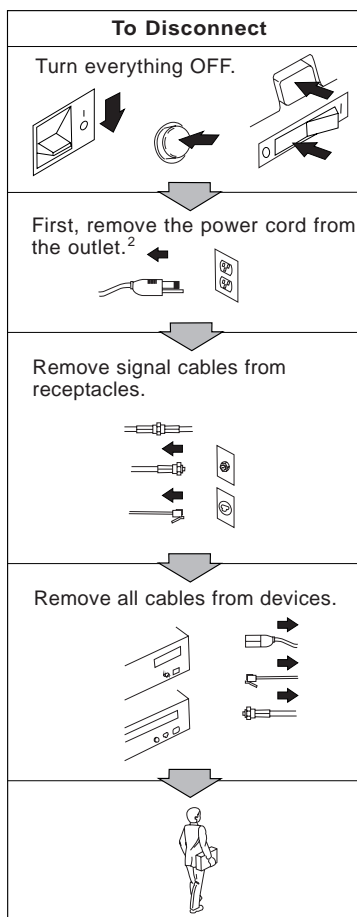

² In the U.K., by law, the power cord must be disconnected after the telephone line cable.



DANGER

Do not install or reconfigure the monitor during an electrical storm.

CAUTION:

1. This product is equipped with a grounded plug for the user's safety. It is to be used in conjunction with a properly grounded outlet to avoid electrical shock.
2. Do not open any covers on the equipment. No user-serviceable parts are inside.
3. An ac power switch is incorporated in this equipment. The equipment should be installed near an easily accessible electrical outlet.
4. In an emergency, disconnect the ac power plug or completely turn off power supplied to the equipment.
5. Always use the AC Adapter shipped with your monitor.

CAUTION:

The fluorescent lamp in the liquid crystal display (LCD) contains mercury (50 mg maximum). Do not place in trash that is disposed of in landfills. Dispose of it as required by local ordinances or regulations.

CAUTION:

1. Do not remove and use the LCD panel separately from its stand.
2. Do not lay this monitor in a horizontal position when operating.

CAUTION:

Handle this device with care when moving it. See "Precautions" on page 1.

CAUTION:

The liquid crystals in the display panel contain several irritants. If the panel is damaged or broken, do not let the liquid come in contact with your skin, eyes, or mouth. If you do come in contact with the liquid, flush the affected part with running water for at least 15 minutes, and then consult a doctor.

About This Book

This guide contains information on how to set up, operate, and configure the IBM 9514-B03 or B13 14.1-inch Color LCD Monitor (hereafter called monitor).

Chapter 1 describes how to set up the monitor and attach it to the personal computer (hereafter called PC).

Chapter 2 describes how to handle and operate the monitor.

Chapter 3 describes how to configure the monitor to attain the best condition.

There are four appendixes with additional information.

Chapter 1. Setting Up Your Monitor

This chapter describes the following:

- Precautions before setting up the monitor
- How to prepare for setup
- The location of the switches and indicators
- How to connect the cables
- How to set the viewing angle
- How to care for your monitor

Precautions

Be careful when handling the monitor. The LCD screen is fragile and should not be bumped or dropped.

Lifting the Monitor

Carefully remove the monitor from its carton.

Hold the bottom of the screen with both hands when lifting the monitor.

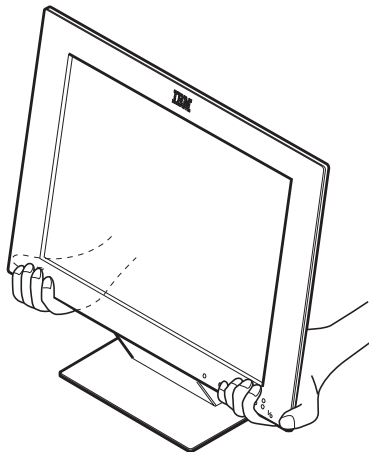

Placing the Monitor

Before setting up the monitor, make sure that there is enough work space around it and a power outlet near it.

- Place the monitor on a hard, flat surface.
Avoid the following conditions:
- Humidity
 - High temperature
 - Dust
 - Vibration
 - Static electricity caused by dryness

Before Setting Up

Check your box for the following items:

Setup option diskettes

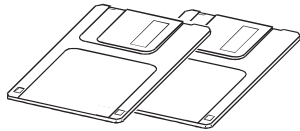

The diskettes contain information used by the Auto Setup program for tuning the monitor performance. The monitor operates under standard video software.

AC Adapter and Cable

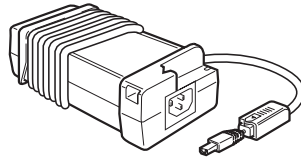

Printed matter

IBM 9514-B03 or B13 Color LCD Monitor: Installation and Operation Guide (this book)
Warranty

If any items are missing or damaged, contact the Display Business Unit (DBU) Helpline.

Locations

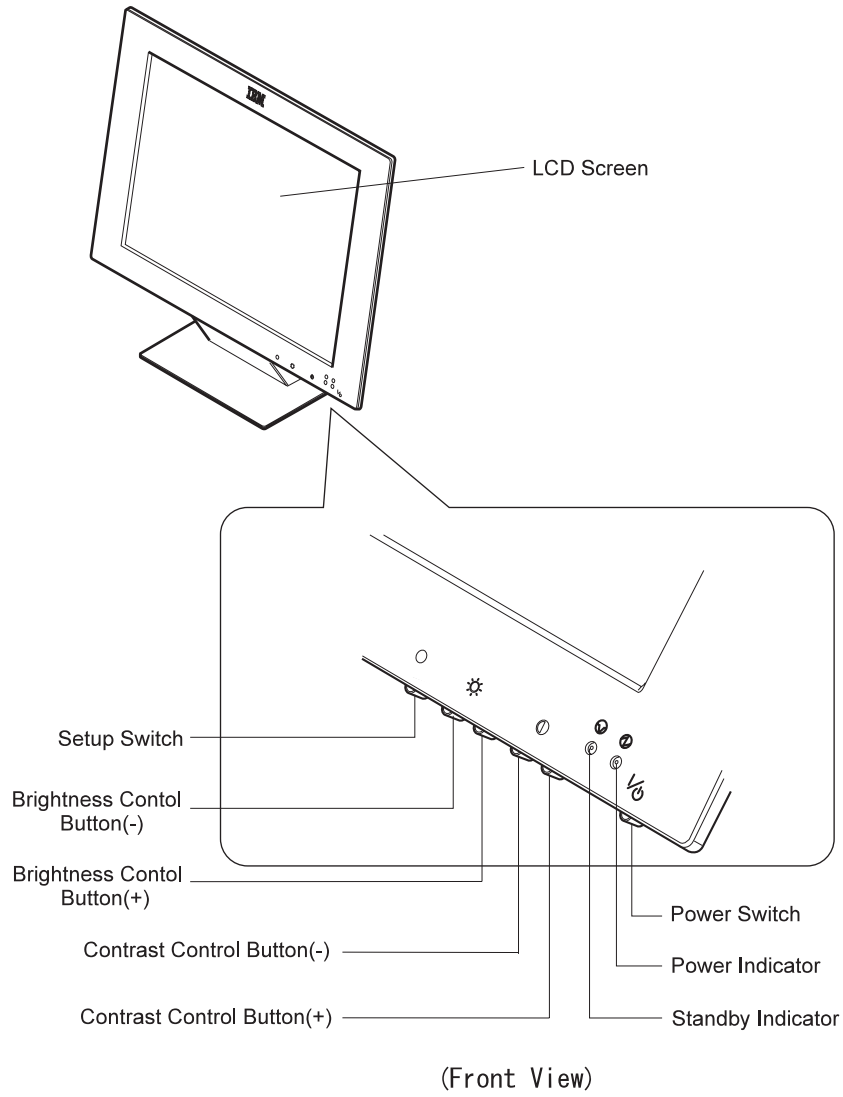

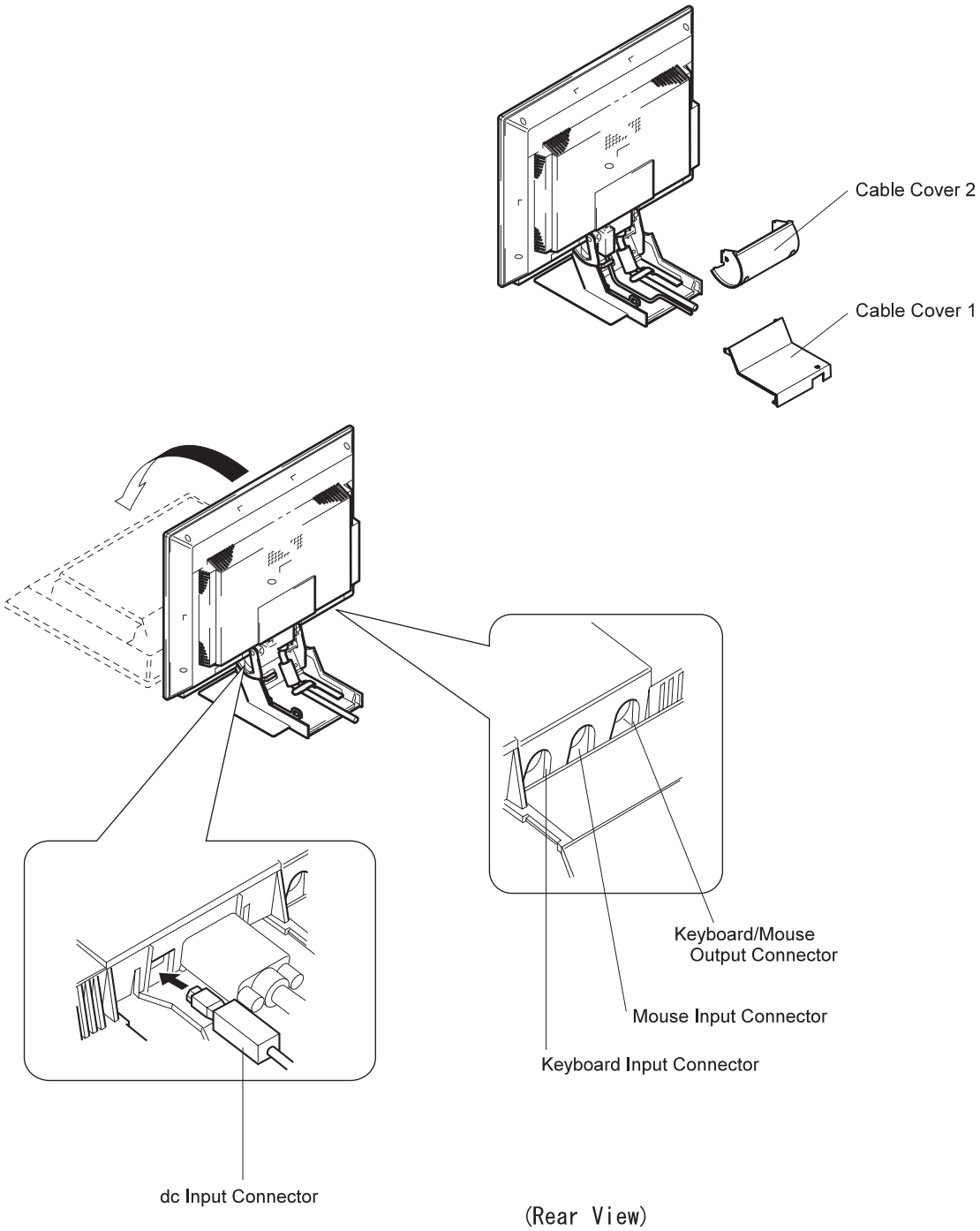

Connecting the Interface Cables

 **DANGER**

Be sure to read “Safety” on page v before connecting the power cord.

- 1** Turn off your PC and all attached devices.
- 2** Make sure that the monitor stands vertically.
- 3** Remove the cable covers at the rear of the monitor.
 - 1 Insert your finger into the cable hole and pull Cable Cover 1.
 - 2 Hold both sides of Cable Cover 2 tightly and pull.

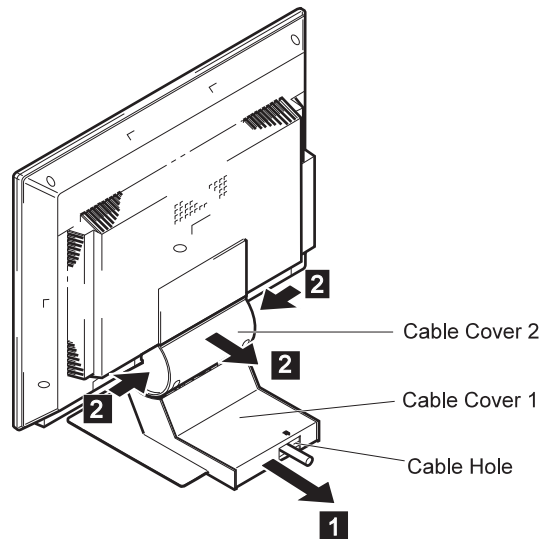

- 4** Turn the monitor screen face down on a flat surface, such as a desk, and connect the AC Adapter cable.

Note: Be careful not to damage the screen.

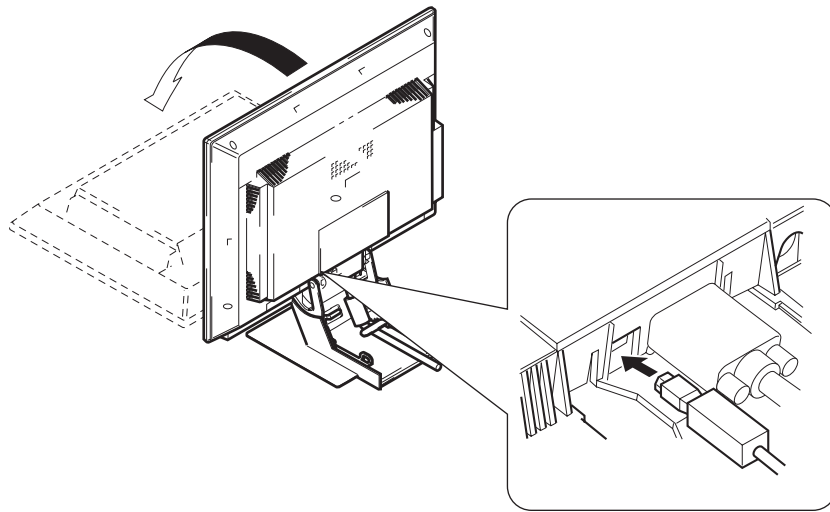

- 5** Thread the AC Adapter cable under the metal hook.

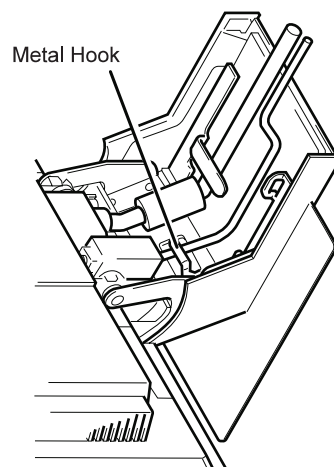

- 6** Release the cables from either side by removing the chips or from the rear.

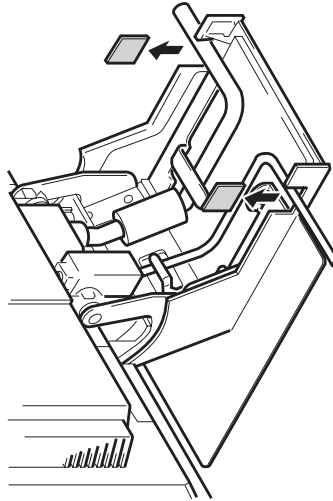

- 7** If your computer does not have a power-saving function and you want to use standby mode, or if you are using an extension cable on the keyboard and mouse; then connect the optional keyboard/mouse cable as shown:

- 1 Disconnect the keyboard cable from your PC; then connect it to the keyboard connector at the rear of the monitor.
- 2 Disconnect the mouse cable from your PC; then connect it to the mouse connector at the rear of the monitor.
- 3 Connect the keyboard/mouse cable (P/N:83H7859) to the connector at the rear of the monitor. Then connect the other end to the keyboard and mouse connectors on the PC.

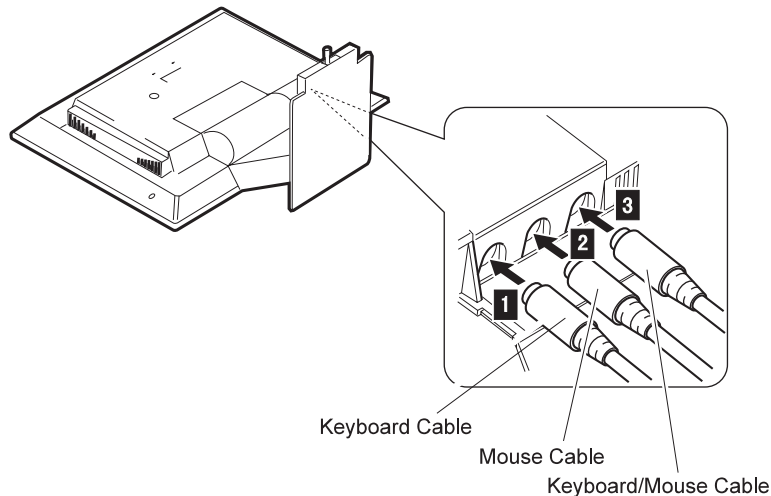

Notes:

- a. Do not connect or disconnect the keyboard cable or the mouse cable when the PC is in operation.
- b. You must use this connection method when you want to reset the display standby mode when the keyboard or the mouse is activated.
- c. You don't need to use this connection method when you don't reset the display standby mode.
- d. You cannot use the keyboard speaker if you use this connection method.
- e. You don't need to use this connection method if you are going to use the DPMS function for the standby mode.

Otherwise, go to the next step.

- 8** Turn the monitor upright.
- 9** Fit the cable covers on the monitor.
 - 1 Fit cable cover 2.
 - 2 Fit cable cover 1.

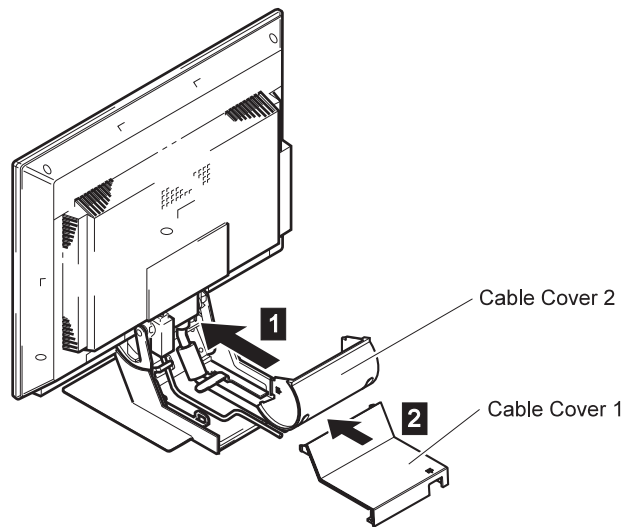

10 Connect the display connector of the monitor to your PC.

- 1 Plug in the connector.
- 2 Tighten the screws.

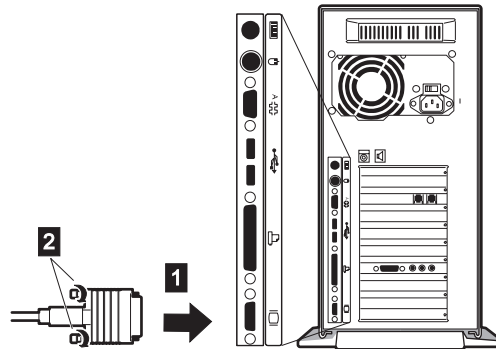

11 Connect the power cord to the AC Adapter.

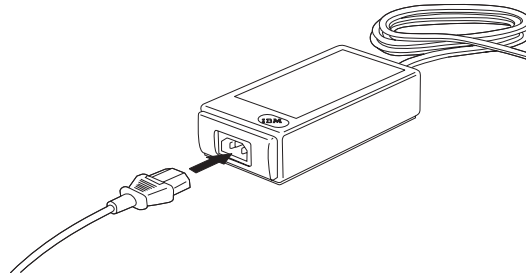

12 Connect the other end of the power cord to a correctly grounded ac power source.

You have finished setting up your monitor.

Setting the Viewing Angle

You can tilt the screen forward or backward, as shown in the figure.

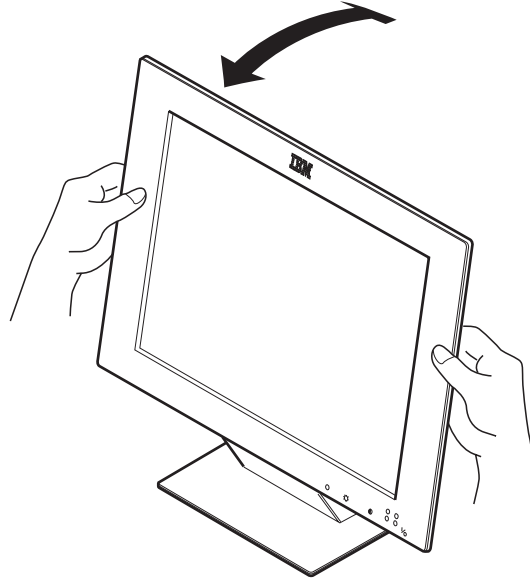

Caring for Your Monitor

Be sure to turn off the power before you clean the monitor by doing the following:

- Gently wipe the device covers and the screen with a soft cloth.

- Do not use chemicals such as thinner or benzene. They may damage the surface coating.

Chapter 2. Operating Your Monitor

This chapter describes the following:

- Turning on the monitor
- Adjusting the brightness and contrast
- The Setup Menus

Turning On the Monitor

To turn on the monitor, push and release the power switch. To turn it off, push and release the switch again.

Note: When you turn off the monitor, wait at least 5 seconds before turning it back on again.

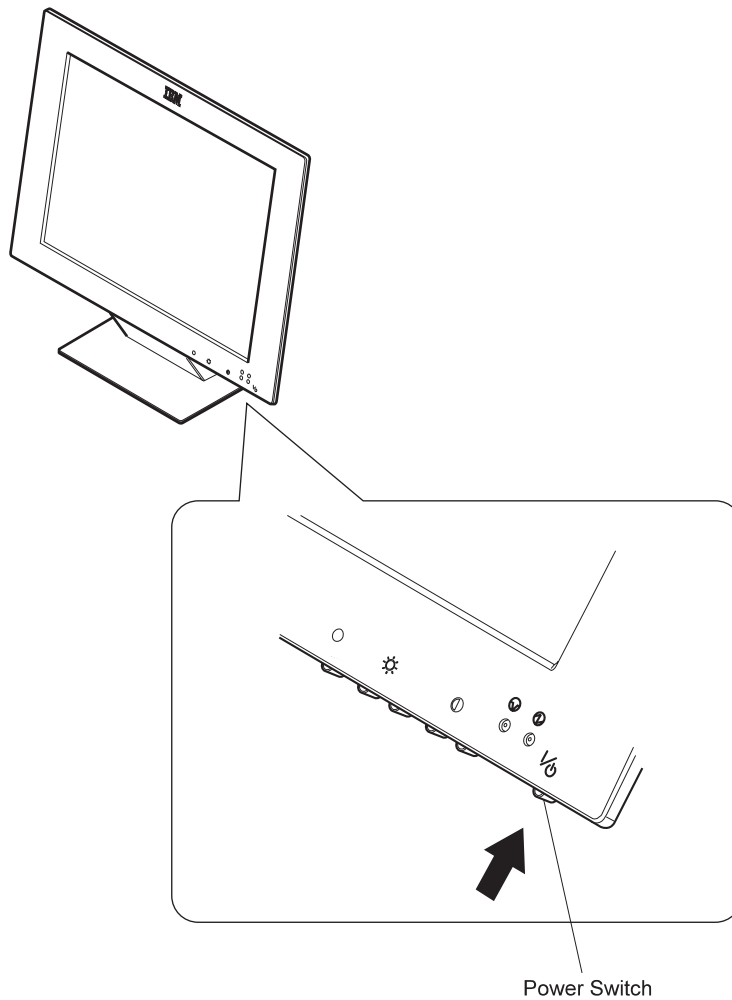

Adjusting the Brightness and Contrast

Brightness



To adjust the brightness of the screen, push the + button to make the screen brighter, or the - button to make the screen dimmer. The brightness value appears on the screen when you push either of these buttons.

Contrast



To adjust the clarity of the screen, push the + button to increase the contrast, or the - button to lower the contrast. The contrast value appears on the screen when you push either of these buttons.

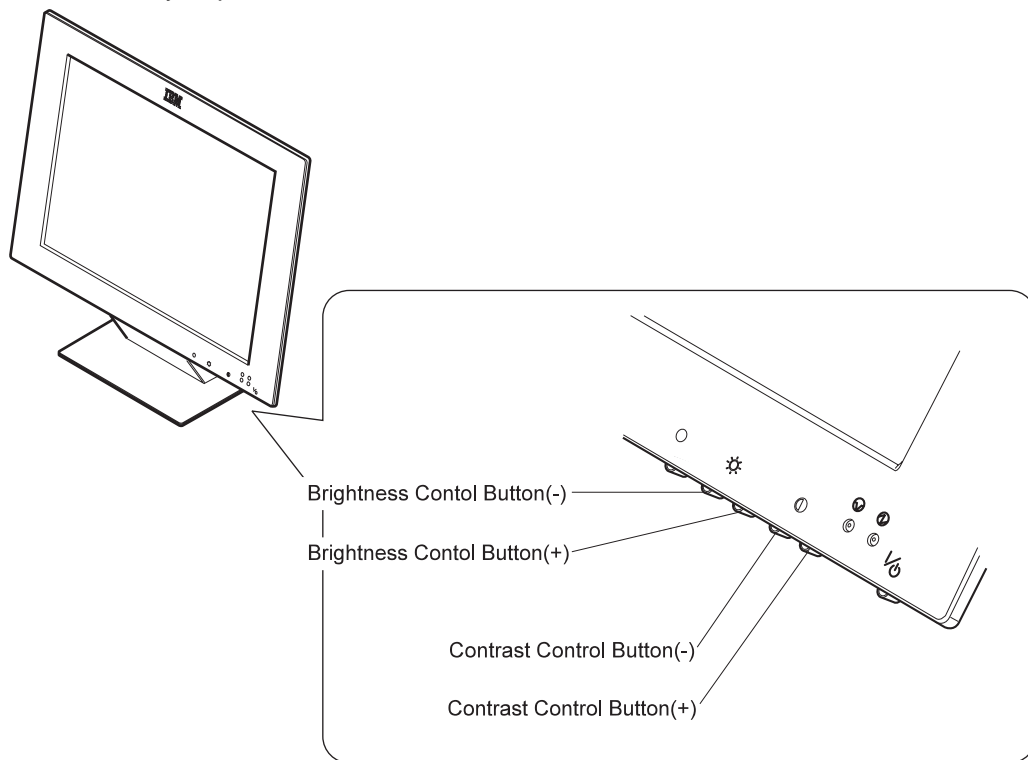

Setup Menu

The setup menu provide the functions to optimize the monitor status and to set the power-saving mode. To display the first setup menu, press the setup switch. Refer to Chapter 3 for details.

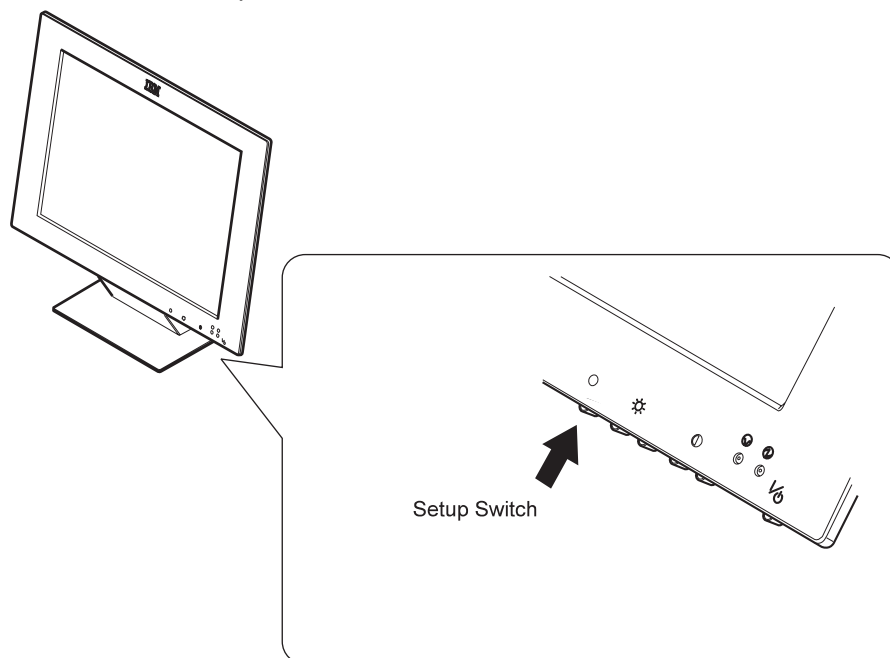

Here is an example of a setup menu:



Chapter 3. Configuring Your Monitor Using Automatic Setup

Check the operating system installed on your PC and go to the respective section.

If only **PC-DOS** is installed on your PC:

Perform the auto setup procedure for PC-DOS. (Go to page 16.)

If Microsoft **Windows 3.1** is installed on your PC as well as PC-DOS:

1. If you are going to use full-screen on your PC, perform the auto setup procedure for PC-DOS. (Go to page 16.)
2. Perform the auto setup procedure for Windows. (Go to page 19.)

If **Windows 95** or **Windows NT** is installed on your PC:

1. If you are going to use full-screen on your PC, perform the auto setup procedure for PC-DOS in full-screen mode. (Go to page 16.)
2. Perform the auto setup procedure for Windows. (Go to page 19.)

If **Operating System/2 (OS/2)** is installed on your computer:

1. If you are going to use full-screen on your PC, perform the auto setup procedure for PC-DOS. (Go to page 16.)
2. Perform the auto setup procedure for OS/2. (Go to page 22.)
(You do not need to perform the auto setup procedure for Windows.)

Note

If your PC does not run with the setup option diskettes shipped with the monitor, refer to "Quick Setup" on page 25.

Before you begin the auto setup for your PC:

- Make a backup copy of the setup option diskettes shipped with the monitor.
- Make sure the PC's video mode is set in the range of the supported screen resolution shown in the table on page 39. If your PC's screen mode is not set in the range, adjust frequencies to put it in the scan range specified in the operating manuals for your PC or the operating system.
- Perform the auto setup for each screen mode you use.

Settings for Plug & Play

If your PC supports DDC 1/2B, select the DDC monitor (Plug & Play monitor) on the operating system.

Auto Setup for PC-DOS

To perform auto setup for PC-DOS or PC-DOS/V:

1 Start with the monitor and the PC turned off.

2 Turn on the monitor first; then turn on the PC.

Note: The screen remains blue until the computer is ready. This is not a problem.

If an error message is displayed

If the message "UNSUPPORTED VIDEO" is displayed, or if nothing is displayed, check that:

The video interface cable is connected properly.

The correct video adapter card (see page 40) for your PC is installed.

The correct supported display mode is selected for your PC.

3 Insert the diskette labeled "Setup Option Diskette (for DOS/Windows)" into the diskette drive.

Note: The application programs included in the setup option diskettes are used only for displaying the color-bar patterns. They are not for changing the display driver.

4 Wait about 15 minutes until the monitor warms up.

Note: If the monitor is in standby mode, it may automatically turn off while you are waiting for it to warm up. Exit standby mode (refer to "The Setup Main Menu" on page 27).

5 Display the command prompt screen of the PC-DOS full-screen display by pressing **Enter** while pressing **Alt**.

If Windows is installed, open the PC-DOS prompt from the Program Manager to display the PC-DOS full-screen.

If OS/2 is installed, open the PC-DOS full-screen display from the command prompt of OS/2.

If only PC-DOS is installed, the command prompt is displayed when the system is started.

6 If you are using PC-DOS/V, change to U.S. mode by typing `CHEV US` and pressing **Enter** at the command prompt.

7 At the command prompt, type `A:` and press **Enter**.

- 8** Type `TESTPATD` and press **Enter**.



- 9** Push the setup switch on the bottom of the monitor.

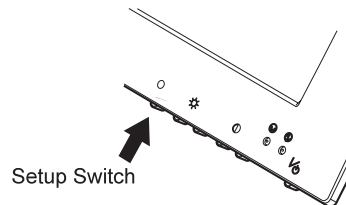

The setup main menu appears:

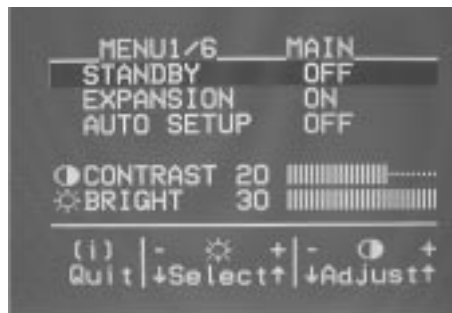

- 10** Push one of the brightness control (☀) buttons to select **AUTO SETUP**.
- 11** Push one of the contrast control (●) buttons. The **AUTO SETUP** line changes to **START**, and auto setup starts.
- 12** Wait until the “PRESS [ENTER] KEY” message is displayed (after 10 to 20 seconds).
- 13** Press **Enter** to start the auto setup procedure.

The **AUTO SETUP** line changes to “COMPLETED” when auto setup is completed.

The screen may be distorted during setup. This is not a problem.

If “AUTO SETUP COMPLETED” is not displayed

Return to step 10 and repeat the auto setup procedure. If the “AUTO SETUP FAILED” message appears, repeat the auto setup procedure several times.

If you still cannot complete the setup, adjust it manually by using the manual-adjust menu (see “The Manual-Adjust Menu” on page 30), or contact your IBM representative.

- 14** Push the setup switch on the bottom of the monitor to turn off the setup main menu.

You have completed the monitor setup.

Auto Setup for Windows 3.1/Windows 95/Windows NT

To perform auto setup for Windows:

1 Start with the monitor and the PC turned off.

2 Turn on the monitor first; then turn on the PC.

Note: The screen remains blue until the computer is ready. This is not a problem.

If an error message is displayed

If the message "UNSUPPORTED VIDEO" is displayed, or if nothing is displayed, check that:

The video interface cable is connected properly.

The correct video adapter card (see page 40) for your PC is installed.

Your PC's screen setting is in the range of the supported screen resolution shown in the table on page 39.

If Windows appears on only the upper half of the screen, change the mode from interlace to noninterlace. If your PC is an IBM PC, change the mode by referring to Appendix B. If you are using some other PC or another video adapter card, follow the instructions in the manual shipped with your PC or video adapter card.

3 Insert the diskette labeled "Setup Option Diskette (for DOS/Windows)" into the diskette drive.

Note: The application programs included in the setup option diskettes are used only for displaying the color-bar patterns. They are not for changing the display driver.

4 Wait about 15 minutes, until the monitor warms up.

Note: If the monitor is in standby mode, it may automatically turn off while you are waiting for it to warm up. Exit standby mode (refer to "The Setup Main Menu" on page 27). Standby mode is not set when the monitor is shipped.

5 For Windows 3.1 and Windows NT 3.5, open **Program Manager** and click on **File Manager**.

For Windows 95 and Windows NT 4.0, click on **Start**, click on **Programs**, and **Explorer**.

6 Click on the **drive A:** icon.

7 Double-click on the **TESTPAT.EXE** file name.

(Some settings on the PC do not show the file extension .EXE in the file name.)

After about 20 seconds, the color-bar pattern appears. The size of the color-bar pattern varies with the screen resolution.

Move the mouse pointer (and the icon bar and tool bar if they are displayed) to the bottom center of the screen. Otherwise, setup might not run properly.



- 8 Push the setup switch on the bottom of the monitor.

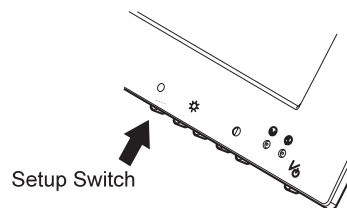

The setup main menu appears:

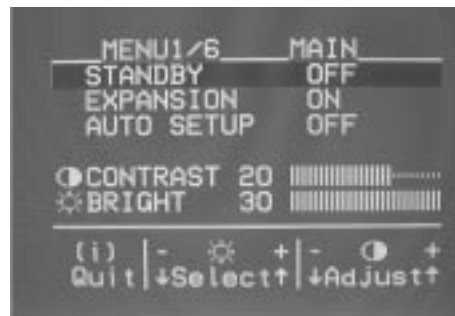

- 9 Push one of the brightness control (☀️) buttons to select AUTO SETUP.
- 10 Push one of the contrast control (●) buttons. The "AUTO SETUP" line changes to "START," and auto setup starts.

Note: For better adjustment on Windows, the color-bar pattern should be displayed before the main menu. (See “Quick Setup” on page 25.)

- 11** Wait 10 to 20 seconds. The “AUTO SETUP” line changes to “COMPLETED” when auto setup is completed.

If the screen flickers, go back to step 9 and redo setup several times until the flicker is minimized, or adjust it manually by using the manual-adjust menu.

The screen might be distorted during setup. This is not a problem.

“If AUTO SETUP COMPLETED” is not displayed

If the “COMPLETED” message is not displayed after 1 minute, make sure that the PC’s screen setting is in the supported screen resolution in the table on page 39.

Go back to step 8 and redo auto setup. If the setup procedure does not complete successfully, an “AUTO SETUP FAILED” message appears. In that case, repeat the auto setup procedure three times.

If you still cannot complete the setup, adjust manually by using the manual-adjust menu (see “The Manual-Adjust Menu” on page 30), or contact your IBM representative.

If, after you perform auto setup, the display is still distorted, perform the manual setup described in “The Manual-Adjust Menu” on page 30.

- 12** Press **Alt+F4** to exit auto setup.

Note: If you change the resolution or the number of the colors, repeat auto setup from step 5.

- 13** Push the setup switch on the bottom of the monitor to turn off the setup main menu.

You have completed the monitor setup.

Auto Setup for OS/2

To perform auto setup for OS/2:

1 Start with the monitor and the PC turned off.

2 Turn on the monitor first; then turn on the PC.

Note: The screen remains blue until the computer is ready. This is not a problem.

If an error message is displayed

If the message "UNSUPPORTED VIDEO" is displayed, or if nothing is displayed, check that:

The video interface cable is connected properly.

The correct video adapter card (see page 40) for your PC is installed.

The correct supported display mode is selected for your PC.

The PC's screen setting is in the supported screen resolution shown in the table on page 39.

If the desktop display appears on only the upper half of the screen, change the mode from interlace to noninterlace. If your PC is an IBM PC, change the mode by referring to Appendix B. If you are using some other PC or another video adapter card, follow the instructions in the manual shipped with your PC or video adapter card.

3 Insert the diskette labeled "Setup Option Diskette (for OS/2)" into the diskette drive.

Note: The application programs included in the setup option diskettes are used only for displaying the color-bar patterns. They are not for changing the display driver.

4 Wait about 15 minutes until the monitor warms up.

Note: If the monitor is in standby mode, it may automatically turn off while you are waiting for it to warm up. Exit standby mode (refer to "The Setup Main Menu" on page 27). Standby mode is not set when the monitor is shipped.

5 Open the OS/2 full-screen window or an OS/2 window.

6 At the command prompt, type `A:` and press **Enter**.

7 Type `TESTPATS` and press **Enter**.

After about 1 minute, the color-bar pattern appears. The size of the pattern varies with the resolution.

Move the mouse pointer (and the icon bar and tool bar if they are displayed) to the bottom center of the screen. Otherwise, setup might not run properly.



- 8 Push the setup switch on the bottom of the monitor.

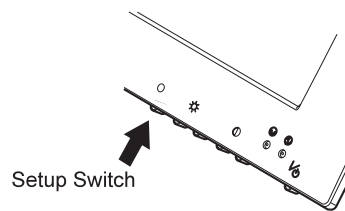

The setup main menu appears:

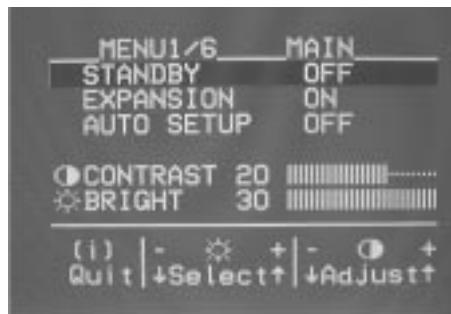

- 9 Push one of the brightness control (☀) buttons to select AUTO SETUP.
- 10 Push one of the contrast control (●) buttons. The “AUTO SETUP” line changes to “START,” and auto setup starts.

Wait 10 to 20 seconds.

Note: For better adjustment, the color-bar pattern should be displayed before the main menu, although “AUTO SETUP” changes to “START” when the color-bar pattern is not display on the screen. (See “Quick Setup” on page 25.)

The “AUTO SETUP” line changes to “COMPLETED” when auto setup is completed.

If the screen flickers, go back to step 9 and redo the setup several times until the flicker is minimized, or adjust it manually by using the manual-adjust menu.

The screen may be distorted during the setup. This is not a problem.

If “AUTO SETUP COMPLETED” is not displayed

If the “COMPLETED” message is not displayed after 1 minute, make sure that the PC’s screen setting is in the supported screen resolution in the table on page 39.

Go back to step 9 on page 23 and redo the auto setup. If the setup procedure does not complete successfully, an “AUTO SETUP FAILED” message appears. In that case, repeat the auto setup procedure three times.

If you still cannot complete the setup, adjust manually by using the manual-adjust menu (see “The Manual-Adjust Menu” on page 30), or contact your IBM representative.

If, after you perform auto setup, the display is still distorted, perform the manual setup described in “The Manual-Adjust Menu” on page 30.

11 Press **Alt+F4** to exit auto setup.

Note: If you change the resolution or the number of the colors, repeat auto setup from step 5 on page 22.

12 Push the setup switch on the bottom of the monitor to turn off the setup main menu.

You have completed the monitor setup.

Quick Setup

You can do a quick setup without running the auto-setup application.

- 1 Turn on the monitor and the PC and wait for about 15 minutes until the machines warm up.
- 2 Start the operating system on your PC.
- 3 Display a full-screen image, and adjust the screen to maximum brightness.

A full-screen image is needed

Auto setup of the monitor involves detecting the conditions at the vertical and horizontal edges of the screen. Therefore, you need a full screen image to perform proper auto setup. You also need a clear contrast between the brightest part of the screen and the darkest for correct adjustment. Otherwise, the screen may flicker. If necessary, try to display some other full-screen image.

- 4 Push the setup switch on the bottom of the monitor.

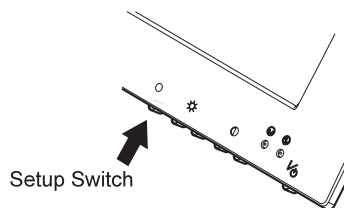

The setup main menu appears:

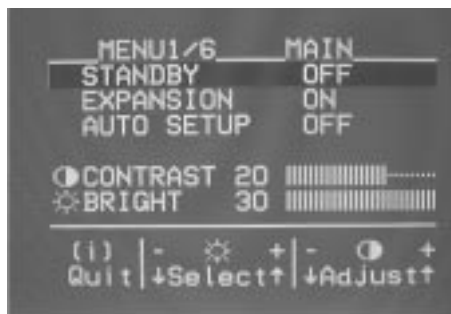

- 5 Push one of the brightness control (☀️) buttons to select AUTO SETUP.
- 6 Push one of the contrast control (🔵) buttons. After about 10 seconds, the message "Save parameters?" is displayed.
- 7 To save the settings for the monitor, push a contrast control button. To discard the settings (because some problem such as a screen flicker occurs), push a brightness control button.

If the “Save Parameters?” message is not displayed

If the “Save Parameters?” message is not displayed or the auto setup value START does not change, push the contrast control button to exit auto setup and go back to step 3. Display another full-screen image and redo auto setup. If auto setup is not completed after several tries, adjust it manually by using the manual-adjust menu (see “The Manual-Adjust Menu” on page 30).

- 8** Push the setup switch on the bottom of the monitor to turn off the setup main menu.

Appendix A. The Setup Menu

The setup menus provide the functions to optimize the monitor status and to set the standby (power-saving) mode. This appendix describes the contents of the menus and explains how to use them.

The Setup Main Menu

Use the setup main menu to set the following functions:

Auto setup Adjusts the monitor to conform with your PC characteristics and optimizes the monitor status.

Power saving Saves power by automatically turning off the screen when it is not used.

Screen size Selects the screen size.

Brightness control  Adjusts the brightness of the screen.

Contrast control  Adjusts the contrast of the screen.

Using the Main Menu

- 1 Push the setup switch on the bottom of the monitor.

The following menu is displayed:

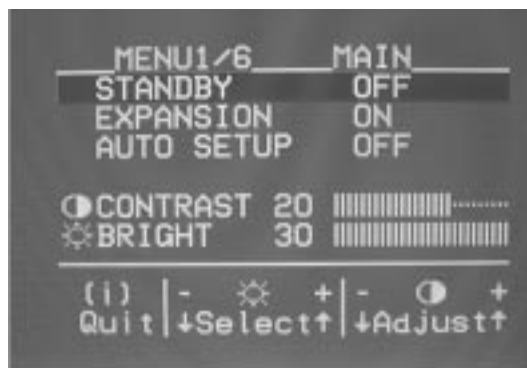

Function	Explanation
STANDBY:	<p>Set the number of minutes without any input from keyboard, mouse, brightness (☀) buttons, or contrast (●) buttons before the monitor enters power-saving mode. Specify OFF if you do not use this function. See “Saving Power with Standby Mode” on page 29 for more details.</p> <p>You can set the following values: OFF, 5, 10, ..., 60, DPMS.</p>
EXPANSION:	<p>To display a screen with resolution less than 1024 × 768 (the resolution of the monitor), select the size you want by specifying one of the following:</p> <p>ON: Displays a full screen. This is the normal selection.</p> <p>OFF: Displays the screen specified by your PC.</p> <p>USER: Enables you to set the screen size by specifying H-size and V-size in manual-adjust menu (see “The Manual-Adjust Menu” on page 30).</p>

The following settings can be set and stored for each screen resolution.

AUTO SETUP: To start auto setup, select this item and push one of the contrast (●) buttons.
 (“START”→“COMPLETED” are displayed in sequence until auto setup is complete.)

CONTRAST: Adjust contrast. This parameter works the same as the contrast adjustment described in “Adjusting the Brightness and Contrast” on page 12. You can set values from 0 to 30.

BRIGHT: Adjust brightness. This parameter works the same as the brightness adjustment described in “Adjusting the Brightness and Contrast” on page 12. You can set values from 0 to 30.

2 Push one of the brightness control (☀) buttons to select an item to set.

If you push and hold one of the brightness control buttons, the manual-adjust menu (see page 30) is displayed.

3 Push one of the contrast (●) buttons to change the function or value for that item.

- 4** Push the setup switch to exit from the main menu. The values you set are automatically stored.

Saving Power with Standby Mode

Case A

To use the power-saving function of your PC, set STANDBY in the main menu to DPMS. The monitor then enters standby mode by receiving signals from your PC.

Case B

If there is no power-saving function in your computer, you can set the time before the monitor enters standby mode with the STANDBY parameter in the setup main menu. You must connect the keyboard, mouse, and the optional keyboard/mouse cable (P/N:83H7859) to the connectors at the rear of the monitor.

The following table shows the power dissipation and the state of indicators when the monitor is in standby mode.

Mode	Power Dissipation	Case A (DPMS Mode)	Standby Indicator	Power Indicator	Case B
Normal operation	30 W (Max)		Off	On	
Standby mode	15 W	No horizontal sync signal input	On	On	Set time (5 to 60 minutes)
Power-off mode	8 W	No vertical sync signal input	On	On	10 minutes after entering standby mode
<p>Notes:</p> <ol style="list-style-type: none"> When the monitor status changes from standby mode to normal operation, the standby indicator blinks. For the time in case A, see the manuals of your computer. In case B, the monitor automatically enters power-off mode when there is no input for 10 minutes after entering standby mode. 					

The Manual-Adjust Menu

You can run the following functions from the manual-adjust menu.

- Decreasing the noise, such as the noise on the screen
- Adjusting the hue
- Adjusting the display position and size on the screen

You can reduce the noise and vertical stripes on the screen by adjusting the PHASE and CLOCK parameters, respectively. Normally, you do not need to use the manual-adjust menu, since its parameters are set to optimum default values in auto setup.

Using the Manual-Adjust Menu

- 1 Push and hold one of the brightness control (☀) buttons. The following menu is displayed:



- 2 Use one of the brightness control (☀) buttons to select an item, and use one of the contrast (●) buttons to set the values for that item.
Adjust CLOCK to reduce the vertical stripes.
- 3 Adjust PHASE to reduce the noise on the screen.
- 4 Adjust the display position with H-POSI and V-POSI, which are on a subsequent menu.
- 5 When you have specified the settings in the manual-adjust menu, select **SAVE VALUES**. Push one of the contrast (●) buttons to store the values.
- 6 Push the setup switch on the bottom of the monitor to exit the menu.

If the message “Quit without saving?” is displayed

The message “Quit without saving?” is displayed if you specify the settings in the manual-adjust menu and try to exit the menu. Select **SAVE VALUES** to store the values and exit, or select **Quit** to exit without saving them.

Function	Explanation
PHASE:	When there are visual noises on the edges of characters and graphics, adjust this parameter to suppress the noise. You can set values from 0 to 23.
CLOCK:	Adjust this parameter to suppress the display of vertical stripes. (This parameter adjusts the frequency of the sample A/D video signal from your PC.)
RED:	Adjust this parameter to change the red hue level of the screen. You can set values from 0 to 255.
GREEN:	Adjust this parameter to change the green hue level of the screen. You can set values from 0 to 255.
BLUE:	Adjust this parameter to change the blue hue level of the screen. You can set values from 0 to 255.
COLOR:	When there are visual noises on the black part of the screen, adjust this parameter to suppress it. You can set values from 0 to 255.
H-POS:	Adjust this parameter to change the horizontal position of the screen. The values you can set depend on your PC.
V-POS:	Adjust this parameter to change the vertical position of the screen. The values you can set depend on your PC.
H-SIZE:	If the screen resolution is less than 1024 × 768 (the resolution of the monitor), adjust the horizontal size. EXPANSION (in the main menu) should already have been selected. The value you can set varies with the resolution.
V-SIZE:	If the screen resolution is less than 1024 × 768 (the resolution of the monitor), adjust the vertical size. EXPANSION (in the main menu) should already have been selected. The value you can set varies with the resolution.

SAVE VALUES:

Use this parameter to store the values you set in the manual-adjust menu. Otherwise, the values you set are erased when you exit the menu.

LOAD DEFAULT VALUES:

Use this parameter to restore all the values in the manual-adjust menu to the settings of auto setup. (If auto setup was not performed, the values are restored to the original settings when the monitor was shipped.)

SYSTEM RESET:

Use this parameter to restore all the values to the original settings when the monitor was shipped.

Information Menu

You can display the following in the information menu:

- The frequency and the polarity of the video signal from your PC
- The screen resolution of the video signal from your PC
- The version number of the control program installed in the monitor

You can see this information, but you cannot change the values.

To display the information menu, push and hold one of the brightness control (☀) buttons.

The following is an example of the information displayed:

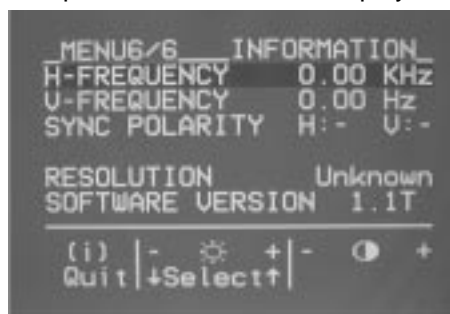

Function	Explanation
H-FREQUENCY:	The frequency of the video signal (horizontal sync signal) from your PC.
V-FREQUENCY:	The frequency of the video signal (vertical sync signal, or refresh rate) from your PC.
SYNC POLARITY:	The polarity of the video signal from your PC. H stands for the horizontal sync signal, and V stands for the vertical sync signal.
RESOLUTION:	The resolution of the video signal from your PC.
SOFTWARE VERSION:	The version number of the control program installed in the monitor.

Appendix B. Setting Noninterlace Mode

The monitor does not support interlace mode. If the video settings of your IBM PC specify interlace mode, change them with the following steps:

- 1** Turn on the monitor.
- 2** Turn on your PC.
- 3** Press **F1** while the message "Press F1 for configuration/setup" is being displayed.
- 4** Select **Device and I/O** in the **Device Configuration Utility**.
- 5** Select **Setup Video**.
- 6** Set the display type to **Customize** and the refresh rate to **60Hz** or **75Hz**.
- 7** Press **ESC** three times.
- 8** Select **Save and Exit**.

Noninterlace mode has been set.

Appendix C. Troubleshooting

Is something wrong?

If you suspect something is not working correctly, you should:

- 1** Turn on the computer and monitor.
- 2** Set the brightness (☀) control to the proper position.
- 3** Ensure that all cables are securely connected.
- 4** Disable standby mode if it is enabled. Push the setup switch on the bottom of the monitor to determine whether standby mode is enabled.
- 5** Disable the computer's screen saver program if it is enabled.
- 6** Run the auto setup procedure described in Chapter 3.
- 7** If there is screen noise, adjust the PHASE parameter in the manual-adjust menu.
- 8** Adjust the CLOCK parameter in the manual-adjust menu to suppress the display of vertical stripes.
- 9** To restore all the auto setup or manual-adjust menu settings to the original values in effect when the monitor was shipped, perform SYSTEM RESET in the manual-adjust menu, or press each minus button of the brightness and the contrast control simultaneously and turn on the monitor. Both LED indicators turn on and off, and all settings are restored.
- 10** Set the screen mode to the supported screen resolution in the table on page 39.
- 11** Disable interlace mode. (The monitor does not support interlace mode.) Refer to Appendix B.
- 12** Perform AUTO SETUP for each display mode (each screen resolution).

If you have still a problem

Contact the DBU Helpline.

About the LCD

The LCD contains over 2,300,000 thin-film transistors (TFTs). A small number of missing, discolored, or lighted dots may be present on the screen, which is an intrinsic characteristic of the TFT LCD technology and is not an LCD defect. If there is a problem with the LCD, contact the DBU Helpline.

Appendix D. Specifications

Screen size	14.1-inch (antiglare hardcoat processed)
Number of dots	1024 × 768 (XGA)
Dot pitch	0.279 mm (H) × 0.279 mm (V)
Colors	16 million
Brightness	150 cd/m ²
Contrast	100 : 1
RGB input connector	15 pin D-sub (mini)
Video input impedance (RGB)	75 ohms
Composite video amplification	0.7V _{p-p}
Sync signal	Separate sync.
Functions	Power-saving (VESA DPMS) Plug & Play (DDC ½B)
Input voltage (AC Adapter)	100 240 V ac ±10% 50/60Hz
Power dissipation (max)	30W
Power dissipation (in power-off mode)	8W
Note: This monitor does not support interlace mode or composite sync.	

The following table shows the supported screen resolutions:

Type	Screen resolution (D × L)	Hsync (KHz)	Vsync (Hz)
VGA	640 × 350 (NI)	29 – 38	69 – 88
	640 × 450 (NI)	24 – 38	55 – 88
	640 × 480 (NI)	29 – 38	59 – 75
	720 × 350 (NI)	29 – 38	69 – 88
	720 × 400 (NI)	29 – 38	55 – 88
SVGA	800 × 600 (NI)	34 – 50	55 – 76
XGA	1024 × 768 (NI)	48 – 62	59 – 76
Notes:			
1. Set the vertical scan range of your computer to the values in this table.			
2. NI: Noninterlaced			

The monitor supports the screen resolutions shown in the table on page 41.
The following are examples of some common video adapters:

IBM PCs, such as PC750, PC720, PC350, PC330, and Aptiva series,
equipped with the following video chips or Matrox Millennium video cards:

- Trident 9680XGI
- S3 Vision 864
- S3 Trio 64V+
- Cirrus GD5446
- Cirrus GD5436
- ATI 3D RAGE

MGA Millennium (Matrox Graphics Inc.)

MGA Mystique (Matrox Graphics Inc.)

ATI 3D EXPRESSION

NEC PC 9800 series computers that support resolutions more than 640 ×
400 and horizontal scan range of 31.5 or more.

Default Preset Timing

The monitor retains the following timing parameters for “Clock,” “Hsync,” “Vsync,” and “Displayable Dots” as default values. The monitor automatically selects the corresponding values to the video signal from your PC.

Screen Resolution (Horiz. × Vert.)	Timing			
	Clock (MHz)	Hsync (KHz)	Vsync (Hz)	Displayable Dots (Horiz. × Vert.)
640 × 400	25.18	31.47	70.09	800 × 449
640 × 480	25.18	31.47	59.94	800 × 525
720 × 400	28.32	31.47	70.09	900 × 449
640 × 480	31.50	37.86	72.81	832 × 520
640 × 480	31.50	37.50	75.00	840 × 500
800 × 600	36.00	35.16	56.25	1024 × 625
800 × 600	40.00	37.88	60.32	1056 × 628
800 × 600	50.00	48.08	72.19	1040 × 666
800 × 600	49.50	46.88	75.00	1056 × 625
1024 × 768	65.00	48.36	60.00	1344 × 806
1024 × 768	75.00	56.48	70.07	1328 × 806
1024 × 768	78.75	60.02	75.03	1312 × 800
1024 × 768	80.00	58.14	72.00	1376 × 808

Note: The Hsync and Vsync frequencies in this table are not the only ones to be displayed. Refer to the table on page 39 for the supported frequencies. The parameters that you set through AUTO SETUP on the main menu or the manual-adjust menu are saved in the monitor memory. Up to 25 settings can be stored.

Appendix E. Notices

References in this publication to IBM products, programs, or services do not imply that IBM intends to make these available in all countries in which IBM operates. Any reference to an IBM product, program, or service is not intended to state or imply that only that IBM product, program, or service may be used. Any functionally equivalent product, program, or service that does not infringe any of the intellectual property rights of IBM may be used instead of the IBM product, program, or service. The evaluation and verification of operation in conjunction with other products, except those expressly designated by IBM, are the responsibility of the user.

IBM may have patents or pending patent applications covering subject matter in this document. The furnishing of this document does not give you any license to these patents. You can send license inquiries, in writing, to:

IBM Director of Licensing
IBM Corporation
500 Columbus Avenue
Thornwood, NY 10594
U.S.A.

Trademarks

The following terms are trademarks of the IBM Corporation in the United States or other countries or both:

IBM
OS/2

The following terms are trademarks or service marks of other companies:

Microsoft	Microsoft Corporation
VESA	Video Electronics Standards Association

Windows, Windows NT, and the Windows 95 flag logo are trademarks of the Microsoft Corporation.

Energy Saving

IBM participates in the International Energy Star Program, a U.S. program that promotes power saving on computer monitors. IBM has determined that the IBM 9514-B03 or B13 14.1-inch Color LCD Monitor's built-in power-saving function conforms to the program standards.



Electrical Emissions

Federal Communications Commission (FCC) Statement

Note: This equipment has been tested and found to comply with the limits for a Class B digital device, pursuant to Part 15 of the FCC Rules. These limits are designed to provide reasonable protection against harmful interference in a residential installation. This equipment generates, uses, and can radiate radio frequency energy and, if not installed and used in accordance with the instructions, may cause harmful interference to radio communications. However, there is no guarantee that interference will not occur in a particular installation. If this equipment does cause harmful interference to radio or television reception, which can be determined by turning the equipment off and on, the user is encouraged to try to correct the interference by one or more of the following measures:

- Reorient or relocate the receiving antenna.
- Increase the separation between the equipment and receiver.
- Connect the equipment into an outlet on a circuit different from that to which the receiver is connected.
- Consult an IBM authorized dealer or service representative for help.

Properly shielded and grounded cables and connectors must be used in order to meet FCC emission limits. Proper cables and connectors are available from IBM authorized dealers. IBM is not responsible for any radio or television interference caused by using other than recommended cables and connectors or by unauthorized changes or modifications to this equipment. Unauthorized changes or modifications could void the user's authority to operate the equipment.

This device complies with Part 15 of the FCC Rules. Operation is subject to the following two conditions: (1) this device may not cause harmful interference, and (2) this device must accept any interference received, including interference that may cause undesired operation.

Responsible Party:

International Business Machines Corporation
Old Orchard Road
Armonk, NY 10504
Telephone: 1-919-543-2193

Canadian Department of Communications Compliance Statement

This equipment does not exceed Class B limits per radio noise emissions for digital apparatus, set out in the Radio Interference Regulation of the Canadian Department of Communications. Operation in a residential area may cause unacceptable interference to radio and TV reception requiring the owner or operator to take whatever steps are necessary to correct the interference.

Avis de conformité aux normes du ministère des Communications du Canada

Cet équipement ne dépasse pas les limites de Classe B d'émission de bruits radioélectriques pour les appareils numériques, telles que prescrites par le Règlement sur le brouillage radioélectrique établi par le ministère des Communications du Canada. L'exploitation faite en milieu résidentiel peut entraîner le brouillage des réceptions radio et télé, ce qui obligerait le propriétaire ou l'opérateur à prendre les dispositions nécessaires pour en éliminer les causes.

United Kingdom Office of Telecommunications Statement of Compliance

United Kingdom Telecommunications Act 1984. This apparatus is approved under number NS/G/1234/J/100003 for indirect connections to the public telecommunications systems in the United Kingdom.

Japan VCCI Notice

電波障害自主規制 届出装置の記述

注意

この装置は、情報処理装置等電波障害自主規制協議会（VCCI）の基準に基づき第二種情報技術装置です。この装置を家庭環境で使用すると電波妨害を引き起こすことがあります。この場合には使用者が適切な対策を講ずるよう要求されることがあります。

IBM

GA18-7521-

