



For more Hi-Fi manuals and set-up information  
please visit [www.hifiengine.com](http://www.hifiengine.com)

# A-760

## SERVICE MANUAL

### FRONT PANEL

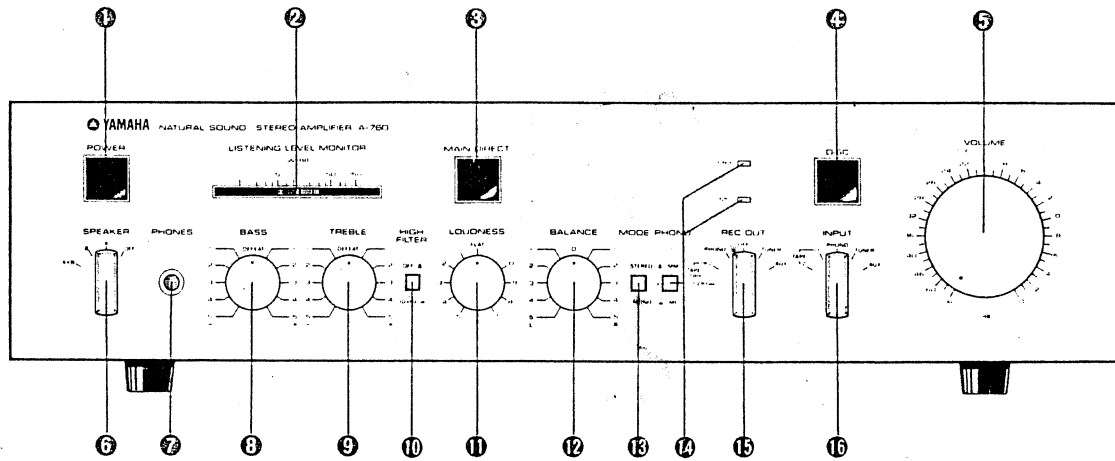

- ① POWER (power pushswitch)
- ② LISTENING LEVEL MONITOR (indicator)
- ③ MAIN DIRECT (tone amp bypass pushswitch)
- ④ DISC (phono disc selector pushswitch)
- ⑤ VOLUME (volume control)
- ⑥ SPEAKER (speaker selector switch)
- ⑦ PHONES (headphone jack)
- ⑧ BASS (bass control)
- ⑨ TREBLE (treble control)
- ⑩ HIGH FILTER (high filter in/out pushswitch)
- ⑪ LOUDNESS (loudness control)
- ⑫ BALANCE (balance control)
- ⑬ MODE (mode selector pushswitch)
- ⑭ PHONO (phono input selectors/indicators (MM/MC))
- ⑮ REC OUT (recording output selector switch)
- ⑯ INPUT (input selector)

### CONTENTS

REAR PANEL/INTERNAL VIEW .....	1
DISASSEMBLY .....	2
ADJUSTMENT/ADJUSTING POINTS .....	4
BLOCK DIAGRAM/SPECIFICATIONS .....	5
WIRING .....	6
CONTROL C. BOARD/SCHEMATIC DIAGRAM (General model) .....	7
CONTROL C. BOARD/SCHEMATIC DIAGRAM (British, Australian, North European model) .....	8
SCHEMATIC DIAGRAM .....	9

004417

SINCE 1887



**YAMAHA**

NIPPON GAKKI CO., LTD. HAMAMATSU, JAPAN

'80.11. 2.42K. KT. Printed in Japan

## REAR PANEL

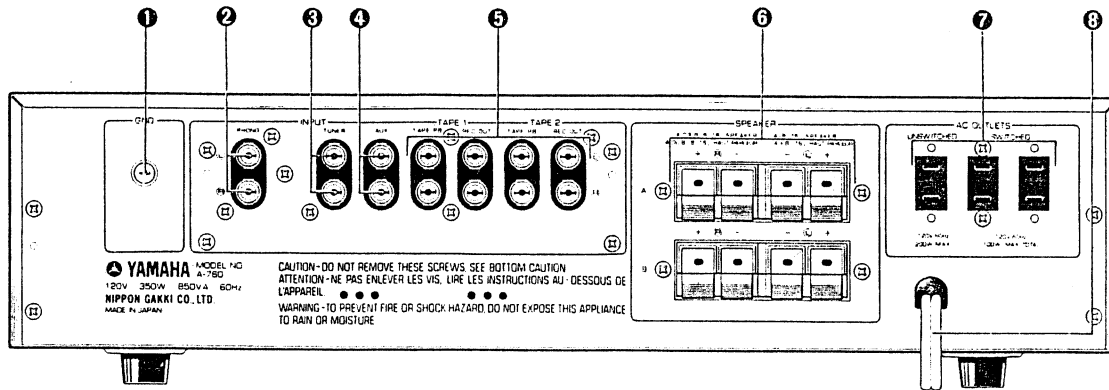

- ① GND (ground terminal)
- ② PHONO (phono input jacks)
- ③ TUNER (tuner input jacks)
- ④ AUX (auxiliary input jacks)
- ⑤ TAPE 1/2 (Tape 1/2 record/playback jacks)
- ⑥ SPEAKER (speaker terminals A/B)
- ⑦ AC OUTLETS (switched and unswitched auxiliary outlets)
- ⑧ Power cord

## INTERNAL VIEW

Top View

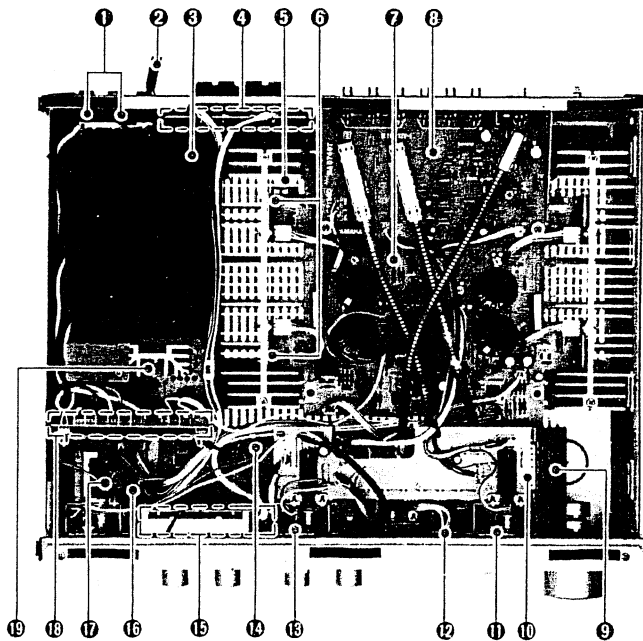

- ① AC outlet
- ② Power cord
- ③ Power transformer housing (power transformer: GA63580)
- ④ Main C. board (3) NA07490-3
- ⑤ Heat sink
- ⑥ Power transistor(s)
- ⑦ Main C. board (1) NA07490-1
- ⑧ Function C. board NA07486
- ⑨ Tone control C. board (3) NA07488-3
- ⑩ Tone control C. board (2) NA07488-2
- ⑪ DISC switch
- ⑫ Phono indicator LED
- ⑬ MAIN DIRECT switch
- ⑭ Tone control C. board (1) NA07488-1
- ⑮ Main C. board (4) NA07490-4
- ⑯ Main C. board (2) NA07490-2
- ⑰ Power pushswitch
- ⑱ Control C. board (1) NA07495-1
- ⑲ Control C. board (2) NA07495-2

## DISASSEMBLY

### 1. Top Cover Removal

Remove screws ① and ② in Photo 1 from the both sides of the unit. The top cover removed by sliding it toward of the arrow.

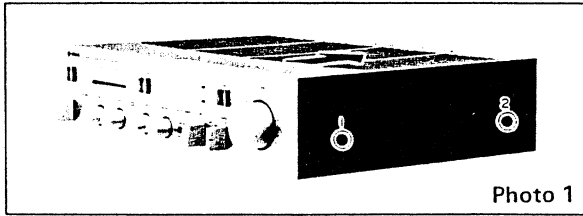

Photo 1

### 2. Bottom Cover Removal

Turn the unit to place it. Remove the nine bottom cover retaining screws (in Photo 2) and remove the bottom cover.

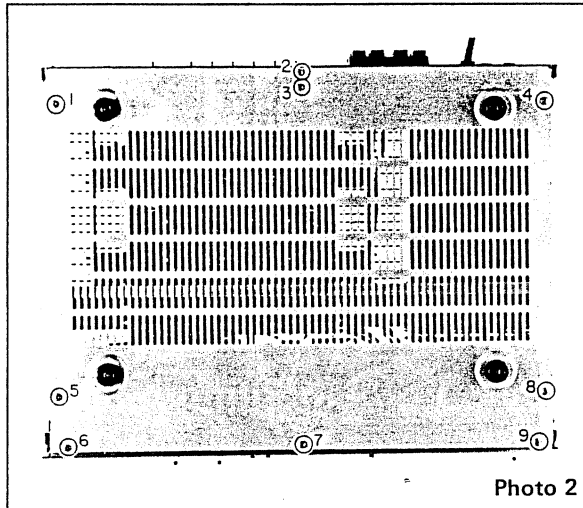

Photo 2

### 3. Front Panel Removal

- Remove the top cover (step 1).
- Remove the bottom cover (step 2).
- Use an M 1.5 hexagon wrench to loosen the retaining screws. (SPEAKER, REC OUT, and INPUT switches.) then pull out these knobs.
- Pull out the illuminating lamps from the POWER, MAIN DIRECT, and DISC pushswitches' lamp holders, carefully to avoid damaging the lamp leads.
- Disconnect the MM and MC indicator lamps lead at the connectors.
- Remove screws (1) and (2) shown in Photo 3. The front panel removed by slowly pulling it in the forward direction.

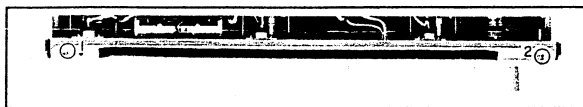

Photo 3

### 4. Rear Panel Removal

- Remove the top cover (step 1).
- Remove the bottom cover (step 2).
- Disconnect the power cord at the AC OUT-LETS. The rear panel removed by taking off screws ① ~ ⑳ shown in Photo 4.

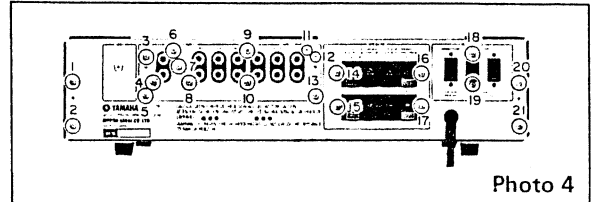

Photo 4

### 5. Function C. Board Removal

- Remove the top cover (step 1).
- Disconnect all leads and connectors from the function C. board, then remove the flexible wires from each on-board switch using a small standard screwdriver (Figure 1).
- Remove screws ③ ~ ⑬ shown in Photo 4 to remove the function C. board.

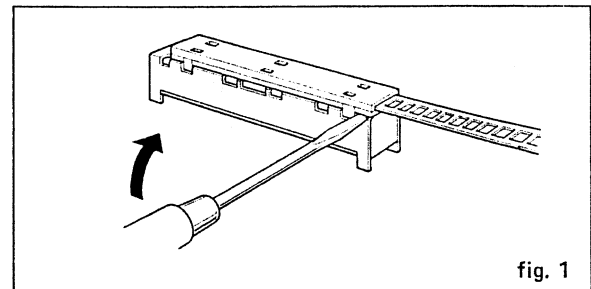

fig. 1

### 6. Tone Control C. Boards (1), (2), and (3), Main C. Boards (2) and (4), and Control C. Board (3) Removal

- Remove the top and bottom covers and front panel from the unit (see steps 1, 2, and 3.).
- Remove the BASS, TREBLE, LOUDNESS, BALANCE, and VOLUME control knobs located on the front panel.
- Remove nut (A) and screws ① ~ ④ in Photo 5 to remove tone control C. boards (2) and (3).
- Remove screws ⑤ and ⑥ and nuts (B) ~ (E) in Photo 5 to remove tone control C. board (1).

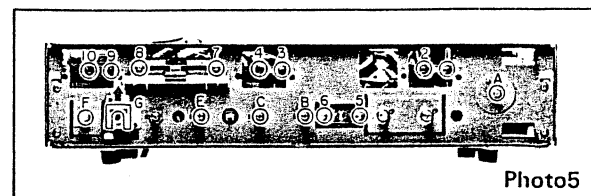

Photo 5

- e) Remove screws ⑦ and ⑧ in photo 5, then pull out the LISTENING LEVEL MONITOR knob to remove main C. board (4).
- f) Remove screws ⑨ and ⑩ in Photo 5 to remove control C. board (3).
- g) Remove nut ① in Photo 5, then take off phone jack retention metal ② in the arrow direction. Main C. board (2) can now be removed.

### 7. Main C. Board (1) and Heat Sink Removal

- a) Remove the top and bottom covers (steps 1 and 2).
  - b) Remove the function C. board (step 5).
  - c) Remove the solder from all power transistors lead. (TR331~334)
  - d) Remove screws ① ~ ④ in Photo 6 to remove main C. board (1).
  - e) Remove screws ⑤ ~ ⑧ in Photo 6 to remove the heat sink.
- \* Before reinstalling the main C. board, check that transistors TR317 and TR318 are thermally coupled.

### 8. Power Transformer and Control C. Boards (1) and (2) Removal

- a) Remove the top cover (step 1).
- b) Disconnect all leads from the control C. board.
- c) Remove screw ① in Photo 7, then remove the control C. Board from board holders ② and ③. Control boards (1) and (2) can now be removed.
- d) Remove screws ④ ~ ⑤ in Photo 7 to remove the cover transformer.
- e) Remove screws ⑥ ~ ⑧ in Photo 8 to remove the power transformer.

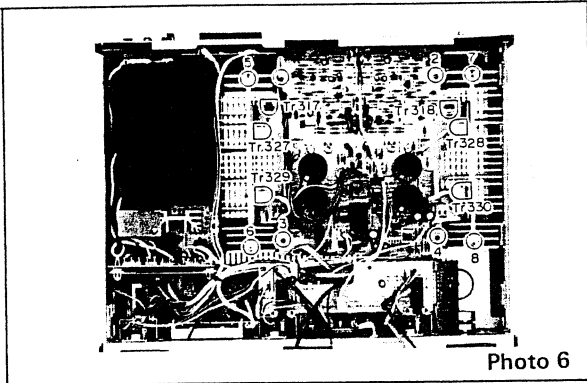

Photo 6

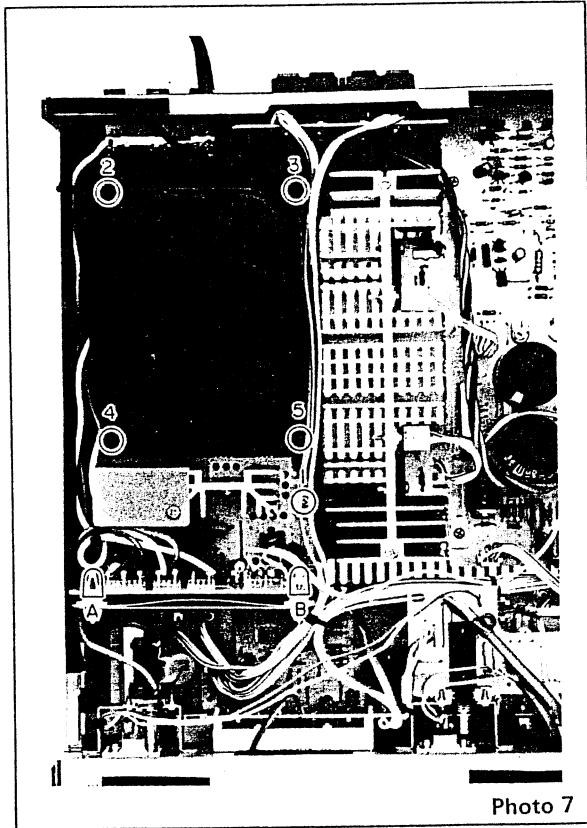

Photo 7

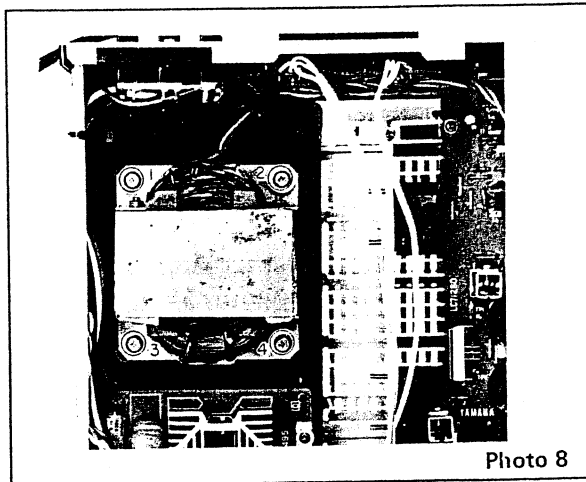

Photo 8

## ADJUSTMENT

### Prior To Adjustment

- Idle the unit for about 5 minutes before adjustment.

Power Supply voltage

- U.S.A. and Canadian : AC 120V
- General : AC 115V
- North European : AC 220V
- Australia and British : AC 240V

Step	Item	Condition	Adjustment	Test Point	Specification	Measuring Instrument
1	Idling current adjustment	VOLUME minimum position	Main board (1) VR303 (L-ch) VR304 (R-ch)	TP <sub>1</sub> -TP <sub>2</sub> (L) TP <sub>3</sub> -TP <sub>4</sub> (R)	10 ± 5mV	Digital volt-meter
2	Offset voltage adjustment	VOLUME minimum position	Main board (1) VR301 (L-ch) VR302 (R-ch)	TP <sub>5</sub> -TP <sub>6</sub> (L) TP <sub>7</sub> -TP <sub>8</sub> (R)	0 ± 10mV	Same as above
3	Main ± B voltage adjustment	Non-load	Main board (1) VR305	Control board P1 terminal - Chassis earth	***	Digital volt-meter
4	Photo-coupler current check	VOLUME minimum position; non-load	Across P <sub>1</sub> and TP <sub>3</sub> on the control board (If the voltage is outside the specification, adjust VR501 on the control board and VR305 on the main board alternately until the ± B voltage and the voltage across P <sub>1</sub> and TP <sub>3</sub> are within the specification.)		1.2V ± 0.2V	Same as above

\*\*\* U.S.A. and Canadian, General 47.5V ± 0.3V  
N. European, Australia, British 47.0V ± 0.3V

## ADJUSTING POINTS

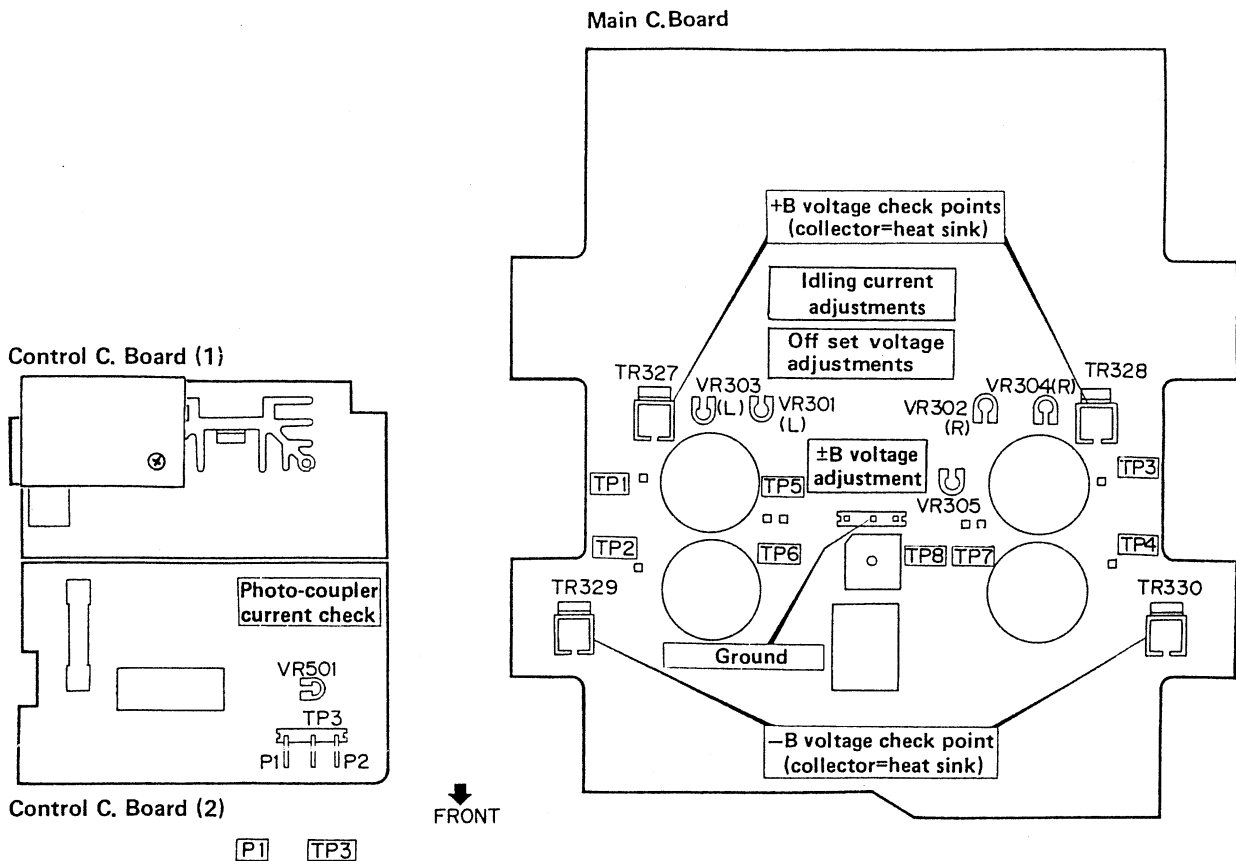

**■ BLOCK DIAGRAM**

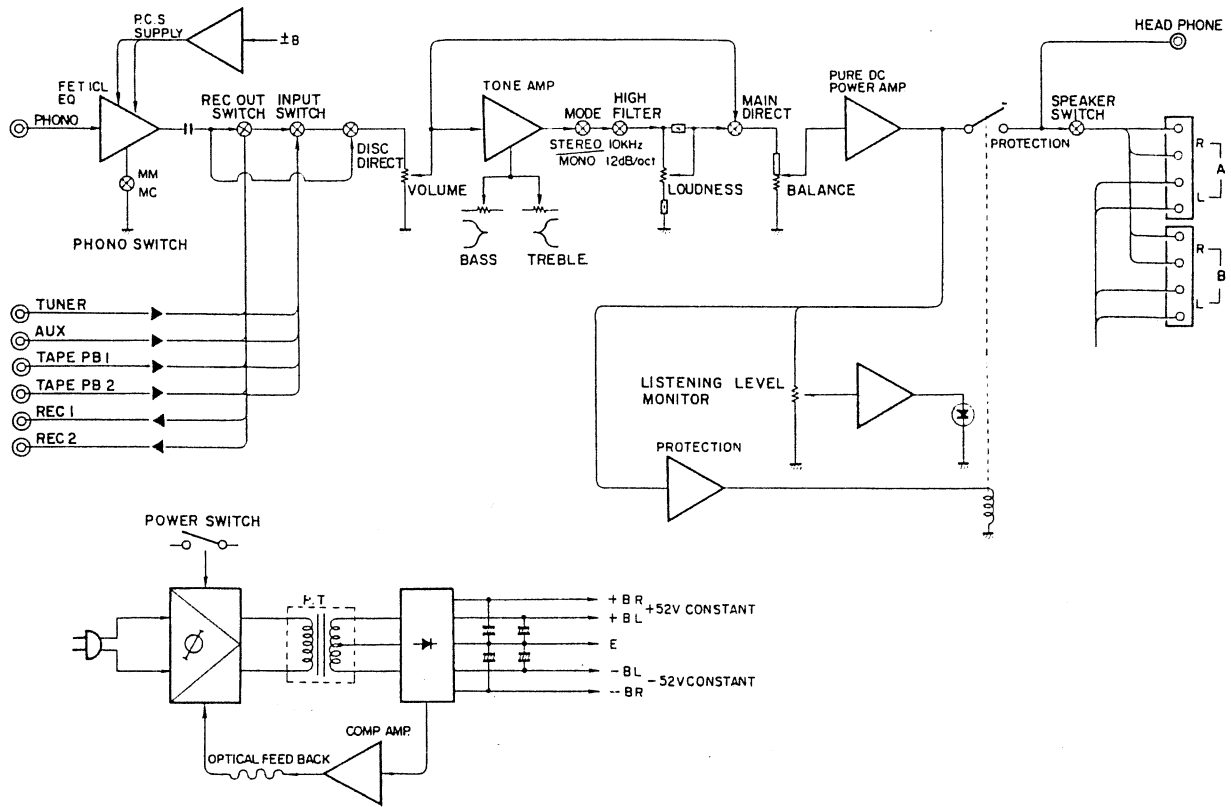

**■ SPECIFICATIONS**

**Minimum RMS Output Power**  
 8 ohms, 20 to 20,000Hz 0.01% THD  
 (DIN) . . . . . 80 W + 80 W  
 . . . . . 100 W + 100 W

**Total Harmonic Distortion**  
 (20 to 20,000 Hz)  
 Phono MM to Rec Out (5 V output)  
 . . . . . 0.003%  
 Phono MC to Rec Out (5 V output)  
 . . . . . 0.006%  
 Aux/Tape/Tuner to Sp Out (40 W)  
 . . . . . 0.005%

**IM Distortion Ratio (60 Hz : 7 kHz = 4 : 1)**  
 Aux/Tape/Tuner to Sp Out  
 8 ohms, 40 W . . . . . 0.002%  
 8 ohms, 1 W . . . . . 0.01%

**Power Bandwidth**  
 (8 ohms, 40 W, 0.02% THD)  
 . . . . . 10 to 50,000 Hz

**Damping Factor**  
 (8 ohms, 1 kHz) . . . . . Better than 55

**Frequency Response**  
 (Aux/Tape/Tuner to Sp Out, 8 ohms)  
 . . . . . 20 to 20,000 Hz ( $\pm \frac{0}{2}$  dB)

**RIAA Deviation**  
 Phono MM . . . . .  $\pm 0.2$  dB  
 Phono MC . . . . .  $\pm 0.3$  dB

**Input Sensitivity/Impedance**  
 Phono MM . . . . . 2.5 mV/47 k ohms  
 Phono MC . . . . . 250  $\mu$ V/100 ohms  
 Aux/Tape/Tuner . . . . . 150 mV/47 kohms

**Maximum Input Level (1 kHz)**  
 Phono MM . . . . . 180 mV RMS  
 Phono MC . . . . . 18 mV RMS

**Tone Control Characteristics**  
 Bass . . . . .  $\pm 10$  dB at 20 Hz  
 Treble . . . . .  $\pm 10$  dB at 20 kHz  
 Turnover Frequencies Bass . . . . . 500 Hz  
 Treble . . . . . 3.5 kHz

**Output Level/Impedance**  
 Rec Out . . . . . 150 mV/550 ohms

**Signal-to-Noise Ratio**  
 (IHF A Network, Input Shorted)  
 Phono MM (10 mV) . . . . . 98 dB  
 Phono MC (500  $\mu$ V) . . . . . 76 dB  
 Aux/Tape/Tuner (150 mV) . . . . . 103 dB

**Residual Noise**  
 (IHF A Network) . . . . . 165  $\mu$ V

**Filter Characteristics**  
 High . . . . . 10 kHz, 12 dB/oct.

**Channel Separation**  
 (1 kHz, vol. -30 dB, Shorted)  
 Tuner to Sp Out . . . . . 70 dB  
 Phono MM to Sp Out . . . . . 70 dB  
 Phono MC to Sp Out . . . . . 70 dB

**Continuous Loudness Control**  
 (Level-Related Equalization)  
 Max. Attenuation . . . . . 20 dB at 1 kHz

**Gain Tracking Error (0 to -60 dB)**  
 . . . . . 2 dB

**Headphone Output** . . . . . 6.5 mW (8 ohms, 0.01% THD)

**Semiconductors** . . . . . 47 Transistors, 4 ICs, 8 FETs, 54 Diodes, 3 LEDs

**Power Supplies**  
 U.S. and Canada . . . . . 120 V, 60 Hz  
 General . . . . . 110-120 V/220-240 V, 50/60 Hz  
 Northern Europe . . . . . 220 V, 50 Hz  
 Britain and Australia . . . . . 240 V, 50 Hz

**Power Consumption**  
 U.S. and Canada . . . . . 350 W/850 VA  
 General . . . . . 350 W  
 Britain, Australia and North European . . . . . 520 W

**Dimensions (W x H x D)** . . . . . 435 x 112 x 365 mm (17-1/8" x 4-7/16" x 14-3/8")

**Weight** . . . . . 9.1 kg (20 lbs., 7 oz.)

*Specifications subject to change without notice.*

# WIRING

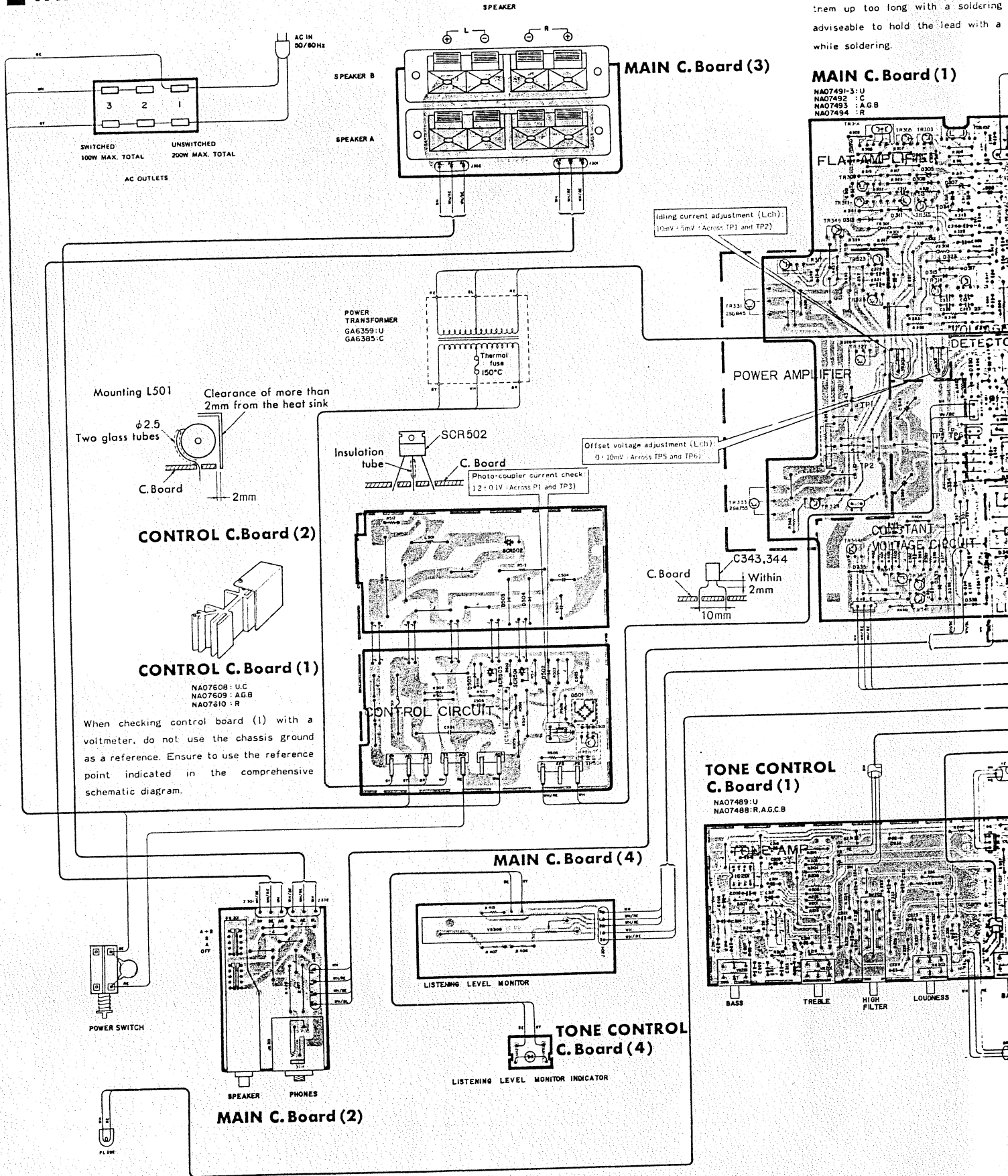

TH301 and 302 are thermistors (thermal resistors). When replacing, avoid them up too long with a soldering iron. It is advisable to hold the lead with a tweezers while soldering.



istors (thermo-sensitive  
 en replac.ng, avoid heating  
 a soldering iron. It is  
 lead with a radio pliers

(1)

**FUNCTION C. Board**

NA07487 :U  
 NA07486 :R.A.G.C.B

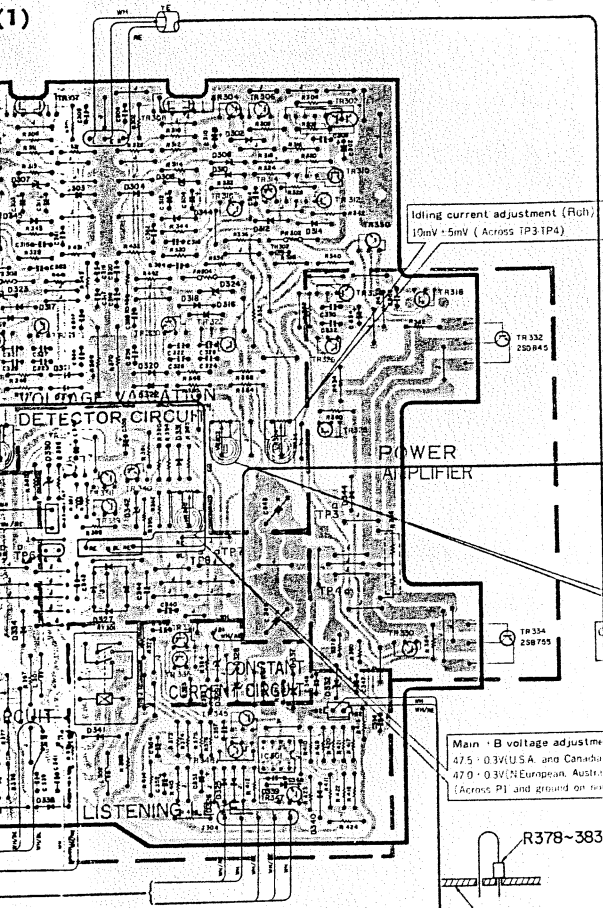
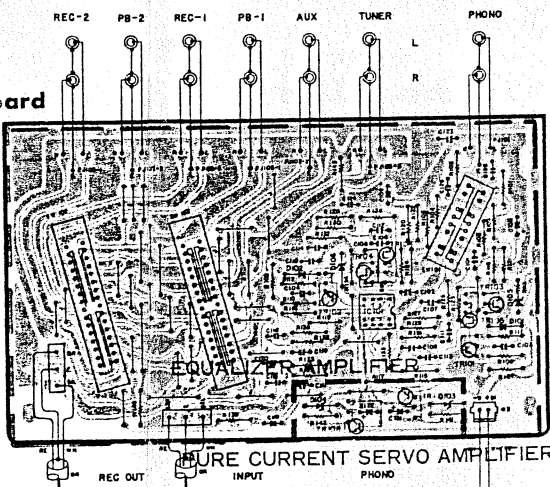

**TONE CONTROL C. Board (2)**

NA07488-2: C  
 NA07489: U

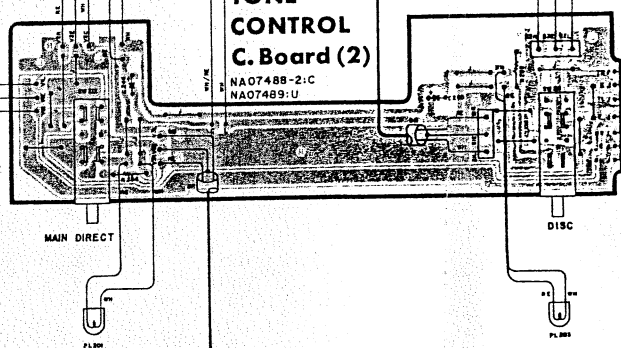

**TONE CONTROL C. Board (3)**

NA07489-3: U  
 NA07489-3: C

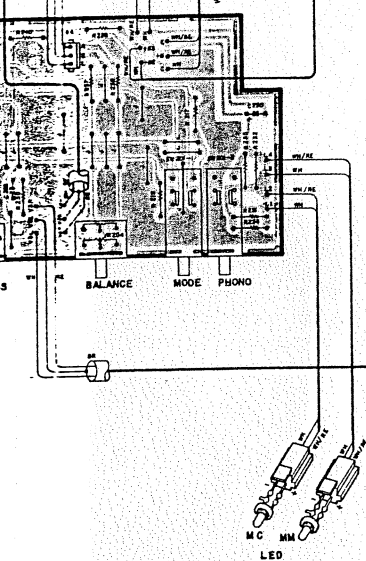
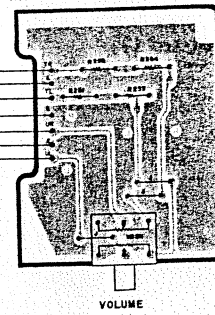

LEIDER NICHT BESSER MÖGLICH,  
 DA KOPIE VON KOPIE!

CONTROL C. BOARD / SCHEMATIC DIAGRAM (General model)

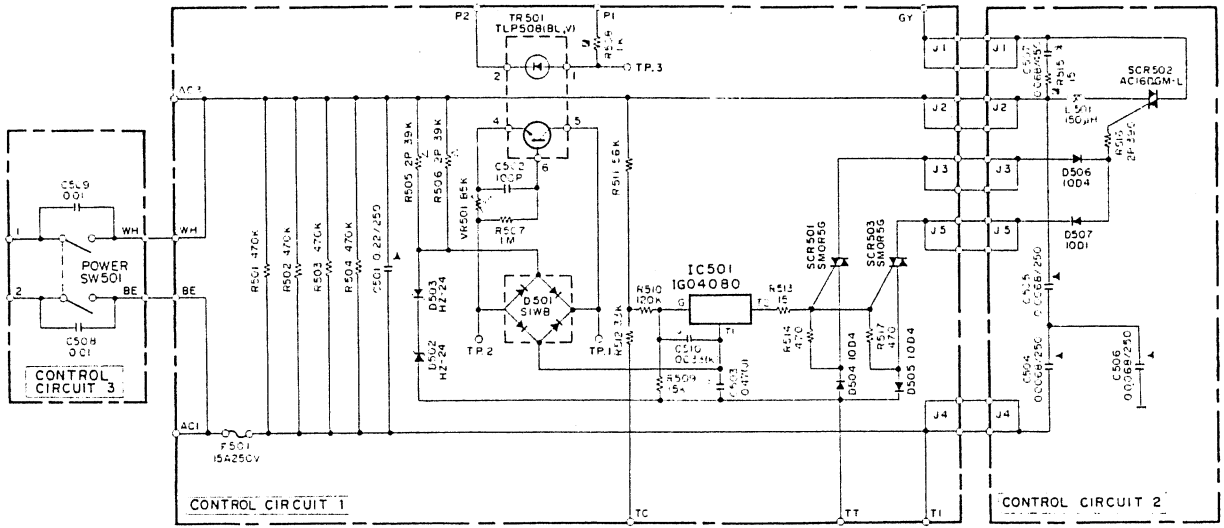

CONTROL C. BOARD 1

CONTROL C. BOARD 3

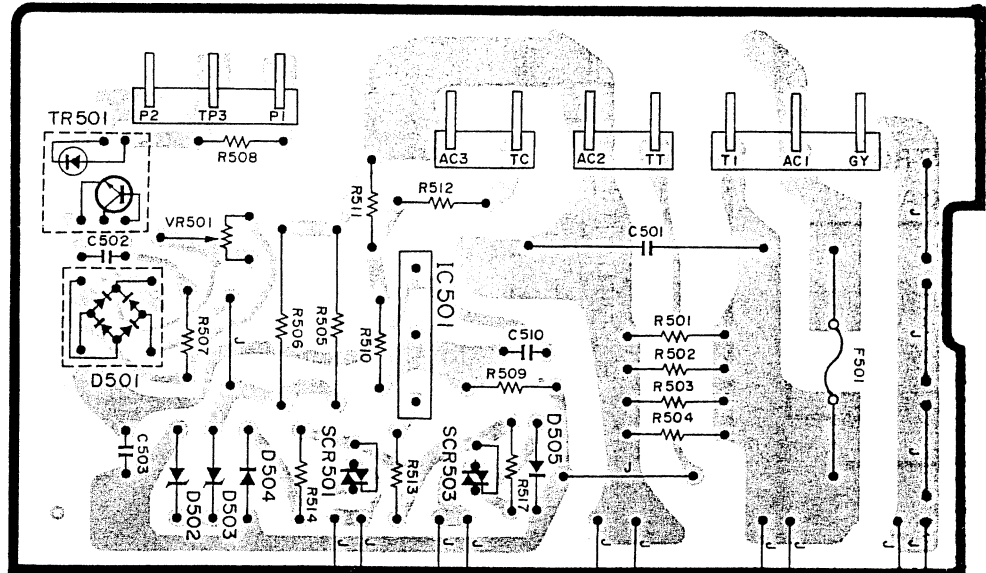
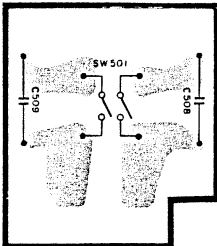

CONTROL C. BOARD 2

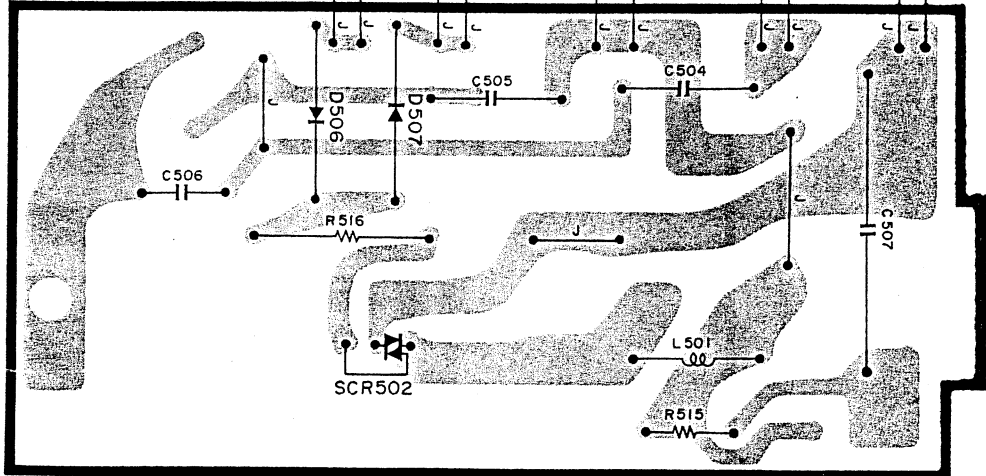

■ CONTROL C. BOARD / SCHEMATIC DIAGRAM

(British, Australian, North European models)

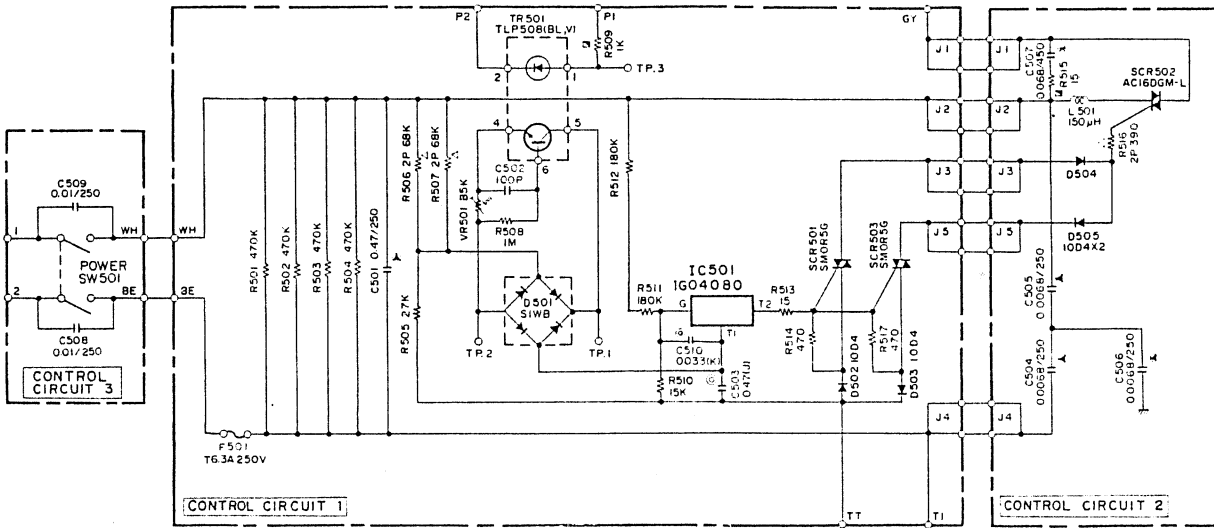

CONTROL C. BOARD 1

CONTROL C. BOARD 3

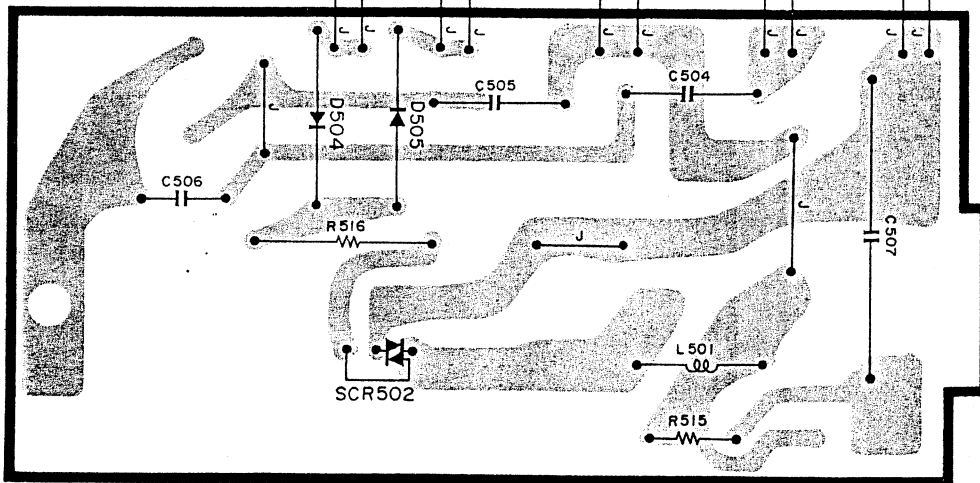
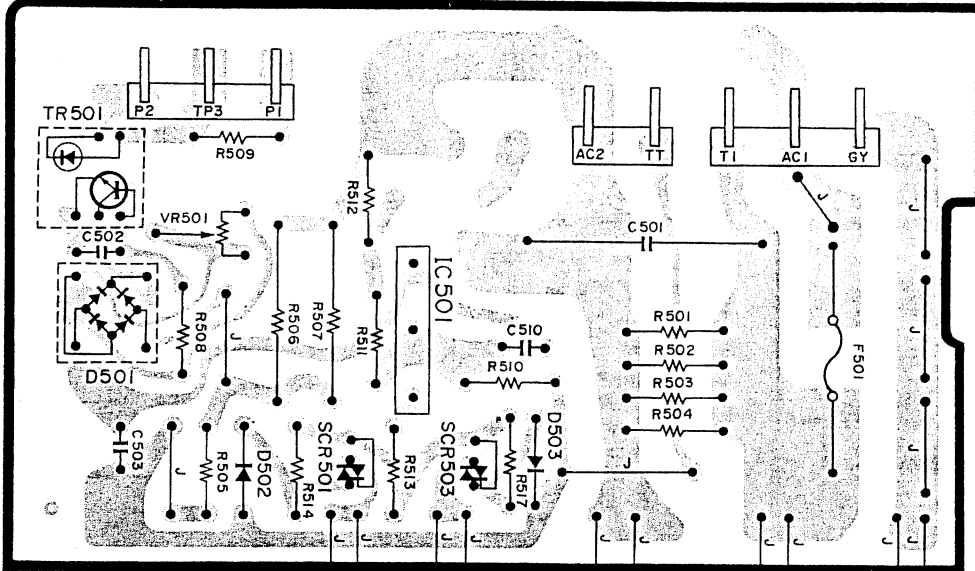
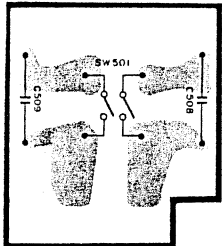

FUNCTION

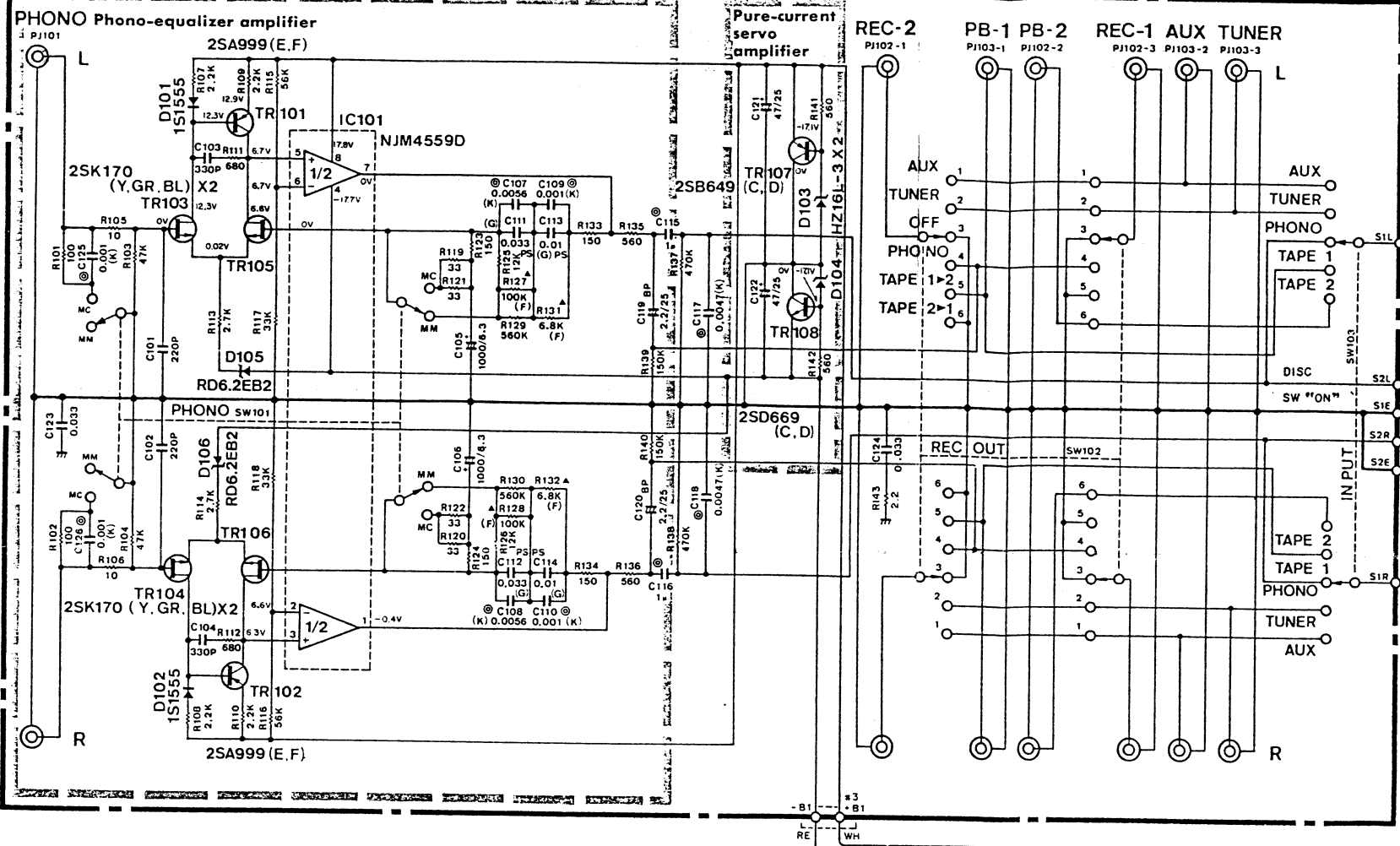

MAIN 1

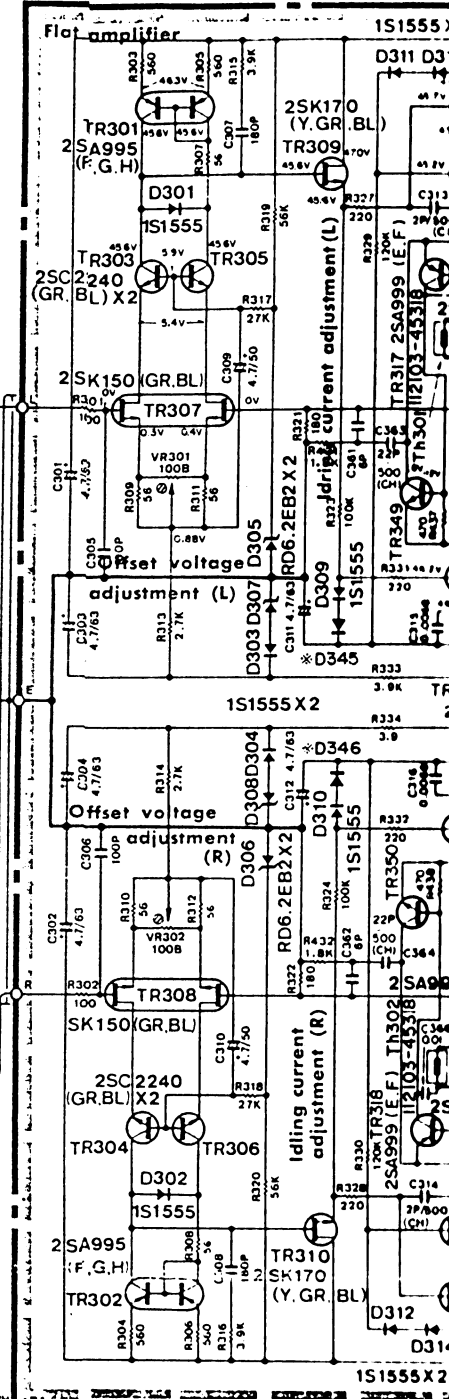

TONE CONTROL 1

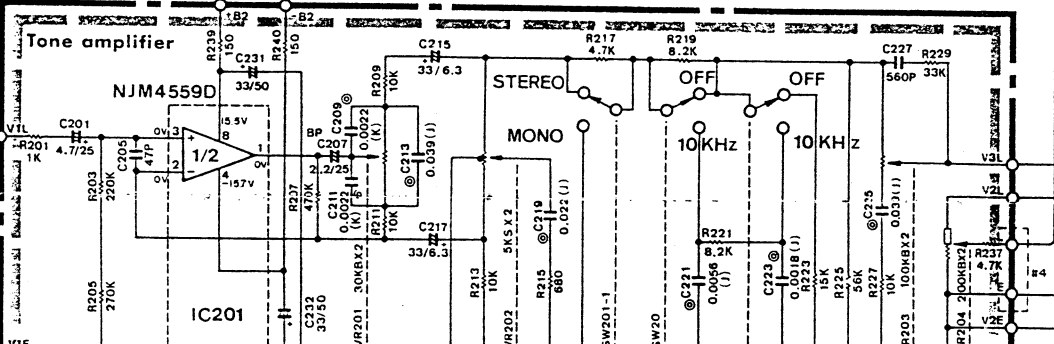

MAIN DIRECT "OFF"

TONE CONTROL 3

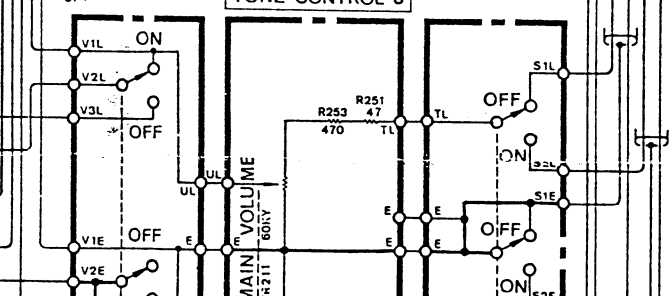



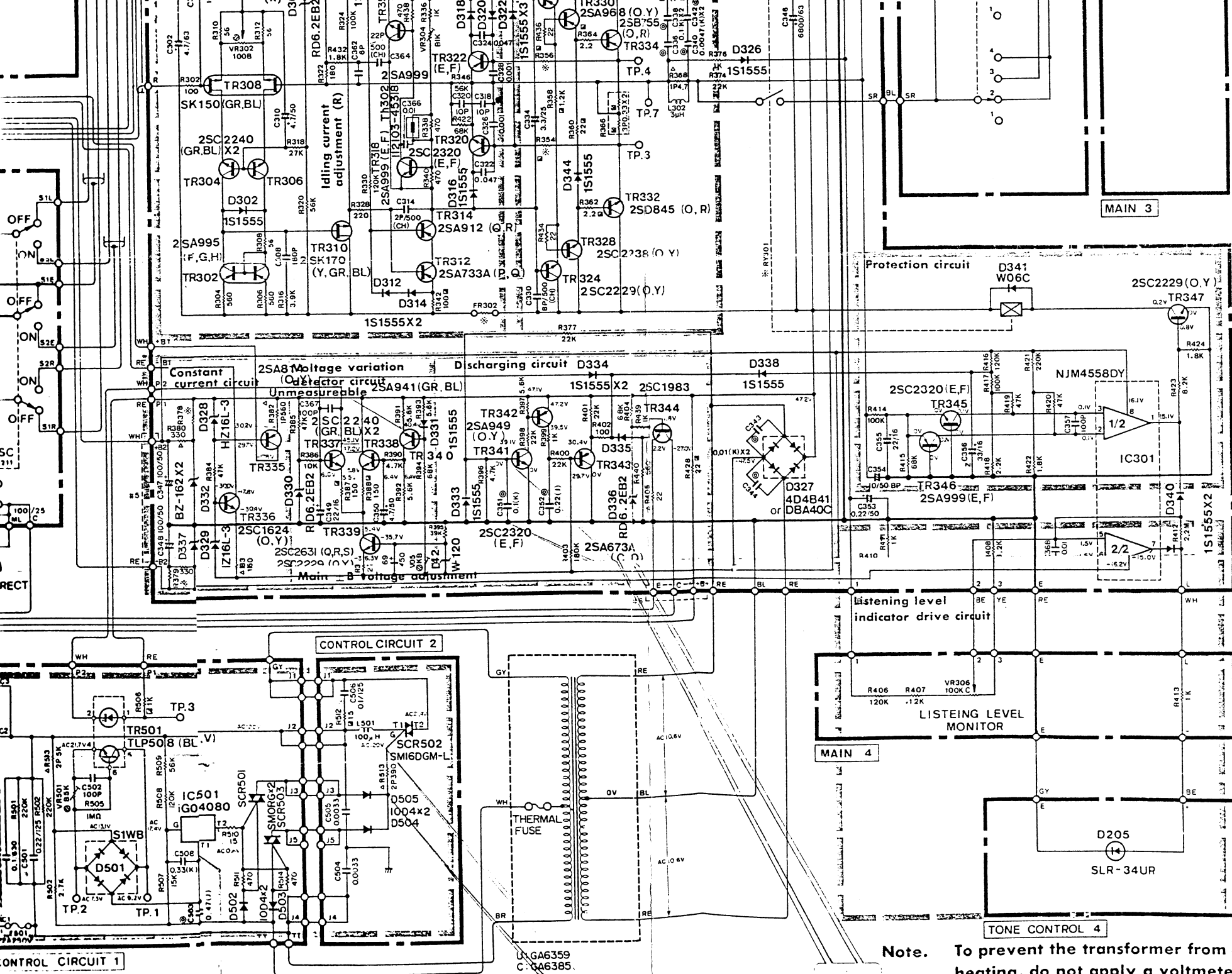

25B755  
25D845

1G04080

4D4B41

SLB-26UUIIN

SMI2G41

RESIST R

REMARKS	CARBON RES	PAPER CAP
NO MARK		
△	METAL OXIDE	
▲	METALIZED	
⊗	METAL PLATED	
⊠	FIRE PROOF	
⊙	SEMI VARIABLE	
□	CEMENT MOUNTED	

CAPACITOR

REMARKS	CERAMIC CAP	PAPER CAP
NO MARK		
⊙	MYLAR CAP	
⊗	POLYSTYRENE	
*	PAPER CAP	
PS	P.S. CAPACITOR	

Note. To prevent the transformer from overheating, do not apply a voltmeter lead to the emitter of TR340 in the main

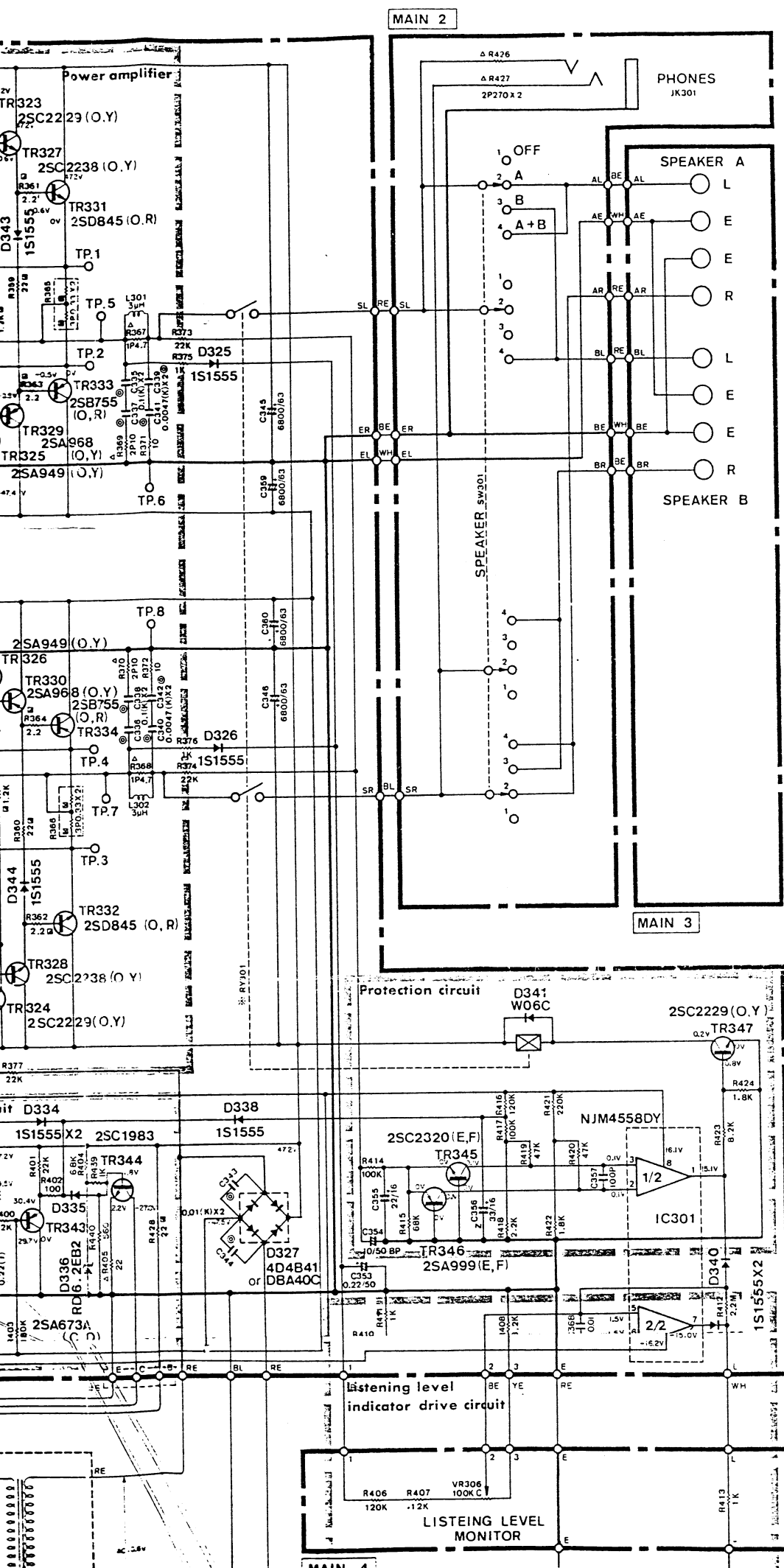

2SA733A 2SA912 2SA941 2SA949 2SA999 2SC458 2SC1885 2SC2229 2SC2240 2SC2320	2SK170
2SA814 2SC1624 2SC1983	
2SA673	
2SA968 2SC2238	2SB649 2SD669
2SA995	2SK150
2SB755 2SD845	NJM4558DY NJM4559D
1G04080	TLP508
ALL DIODE	SIWB
4D4B41	SLR-34UR
SLB-26UUIIN	
SMI2G41	MOR56

RESIST R

REMARKS	PART NAME
NO MARK	CARBON RESISTOR
△	METAL OXIDE FILM RESISTOR
▲	METALIZED FILM RESISTOR
⊠	METAL PLATE RESISTOR
⊞	FIRE PROOF CARBON RESISTOR
⊙	SEMI VARIABLE RESISTOR
□	CEMENT MOLDED RESISTOR

CAPACITOR

REMARKS	PART NAME
---------	-----------

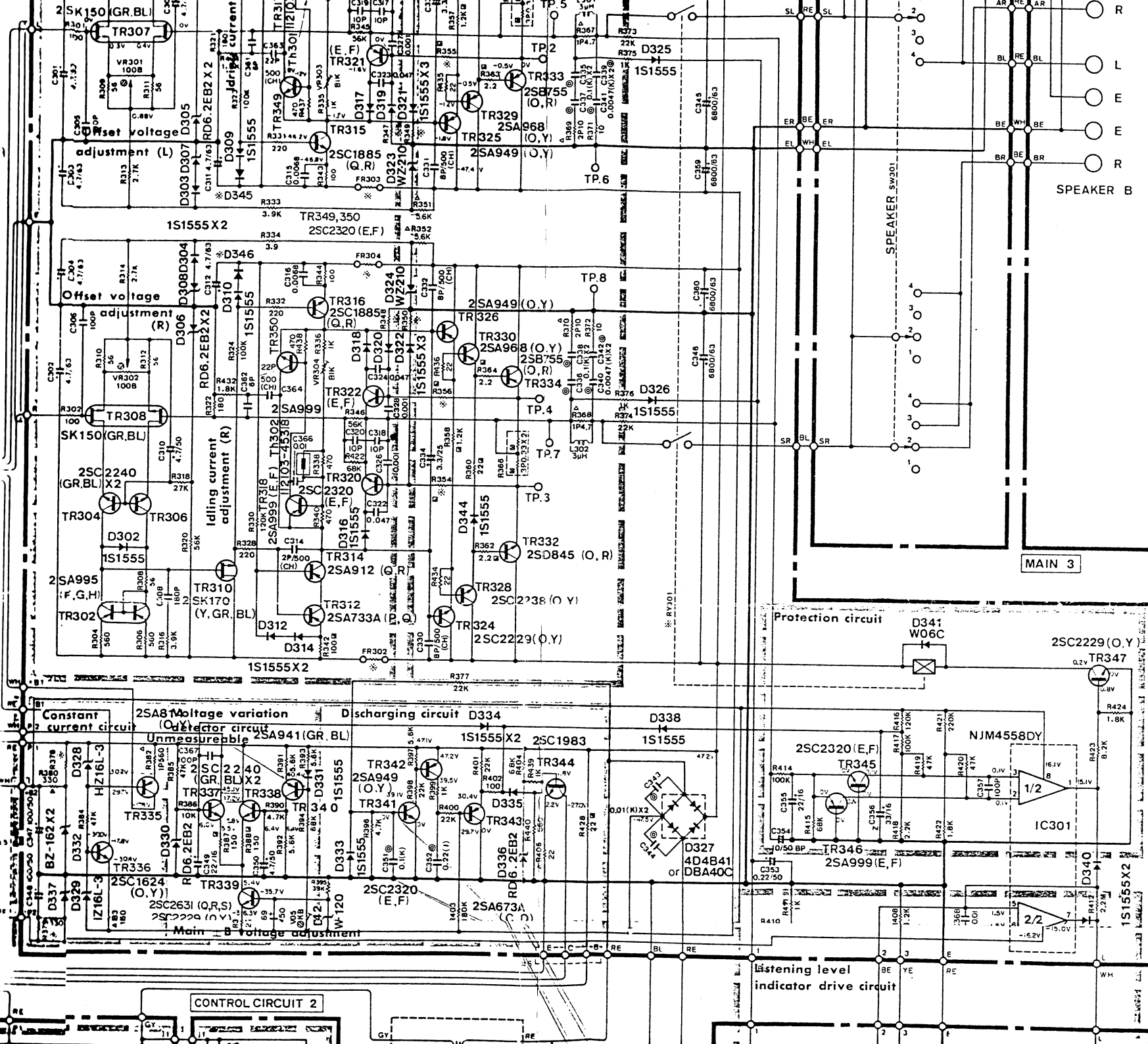

	2SA673		2S8649
	2SA968		2SD669
	2SC2238		
	2SA995		2SK150
	2SB755		NJM4558DY
	2SD845		NJM4559D
	iG04080		TLP508
	All DIODE		SIWB
	4D4B41		SLR-34UR
	SLB-26UUIIN		
	SMI2G41		MOR5G

REMARKS	PART NAME
NO MARK	CARBON RESISTOR
△	METAL OXIDE FILM RESISTOR
▲	METALIZED FILM RESISTOR
⊙	METAL PLATE RESISTOR
□	FIRE PROOF CARBON RESISTOR



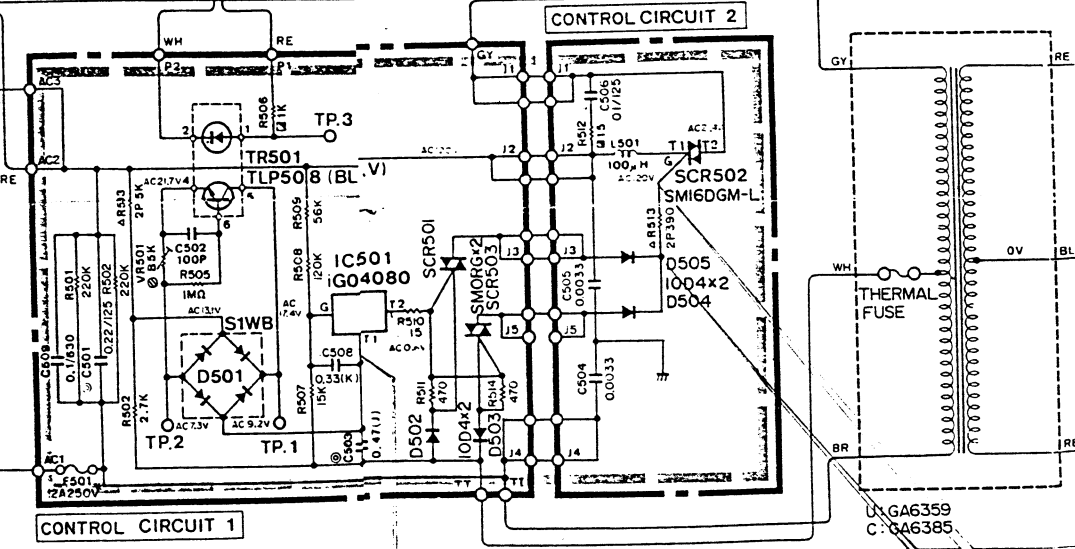
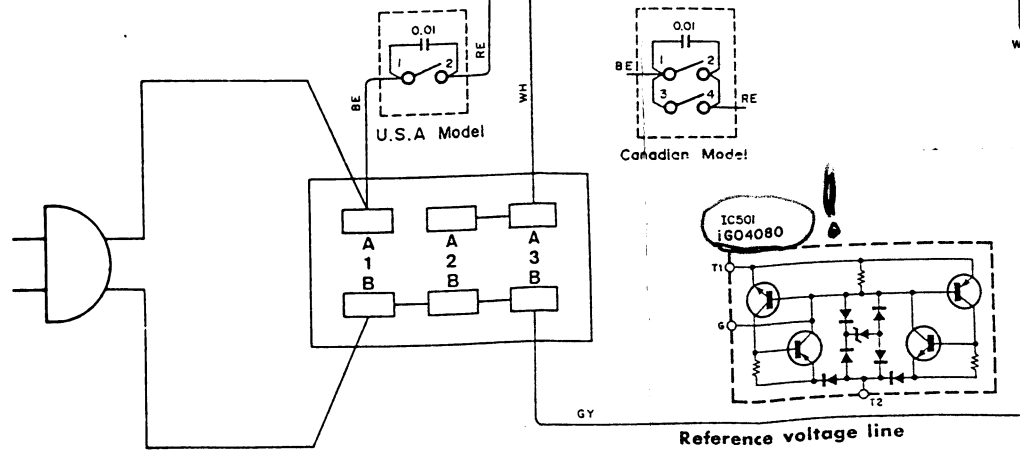
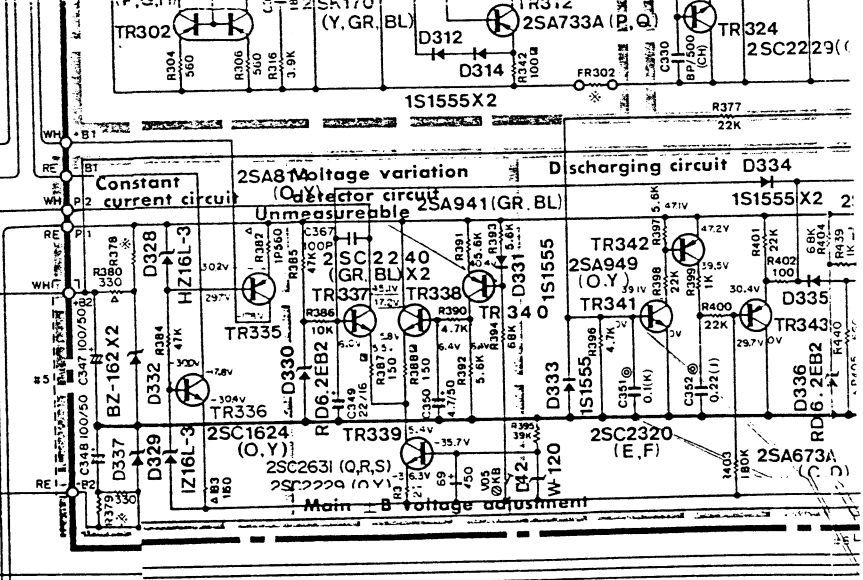
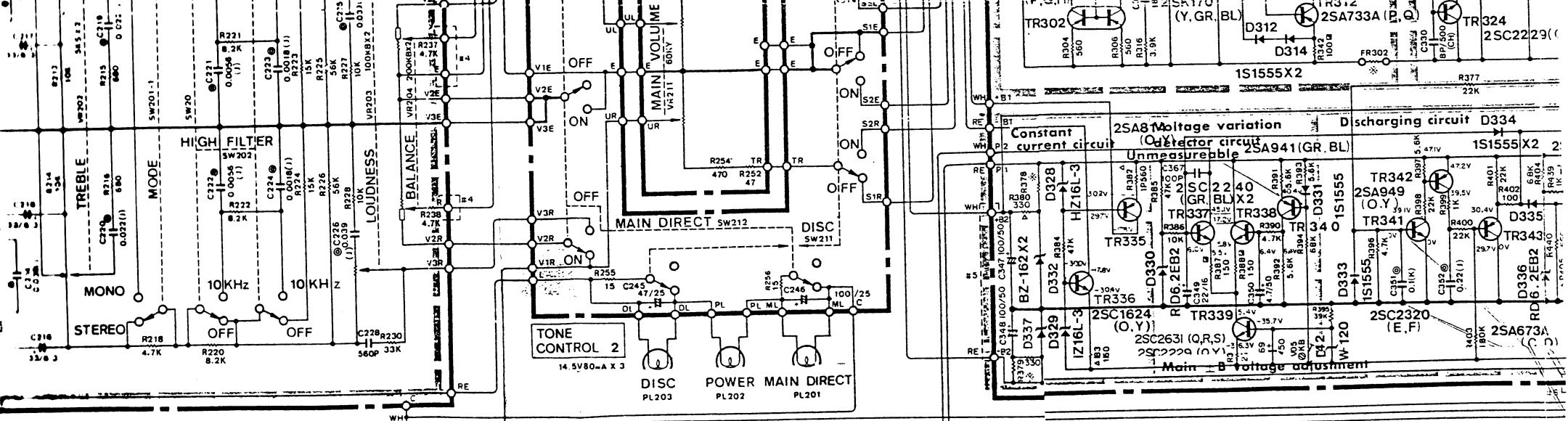

**Note 1.** When observing signal waveforms on the control circuit boards, avoid physical contact on the oscilloscope body since a hazardous voltage might develop on it. Do not connect the unit to the earth ground.

**Note 2.** Ensure to check voltages on the control circuit with reference to the reference voltage line.

**Note 3.** Check the triac integrity by observing the signal across R513(UC; 2P 390Ω, A,G,B; 15Ω) for the specified waveform.

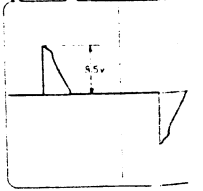
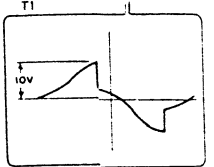

# PARTS LIST

## A-760

■ CONTENTS	
■ EXPLODED VIEW .....	1
■ PARTS LIST (Mechanism) .....	2
■ PARTS LIST (Circuit Board)	
Function C. Board .....	4
Tone Control C. Board .....	5
Main C. Board .....	6
Control C. Board .....	10

004417

SINCE 1887



**YAMAHA**

NIPPON GAKKI CO., LTD. HAMAMATSU, JAPAN

A-760 ■ EXPLODED VIEW

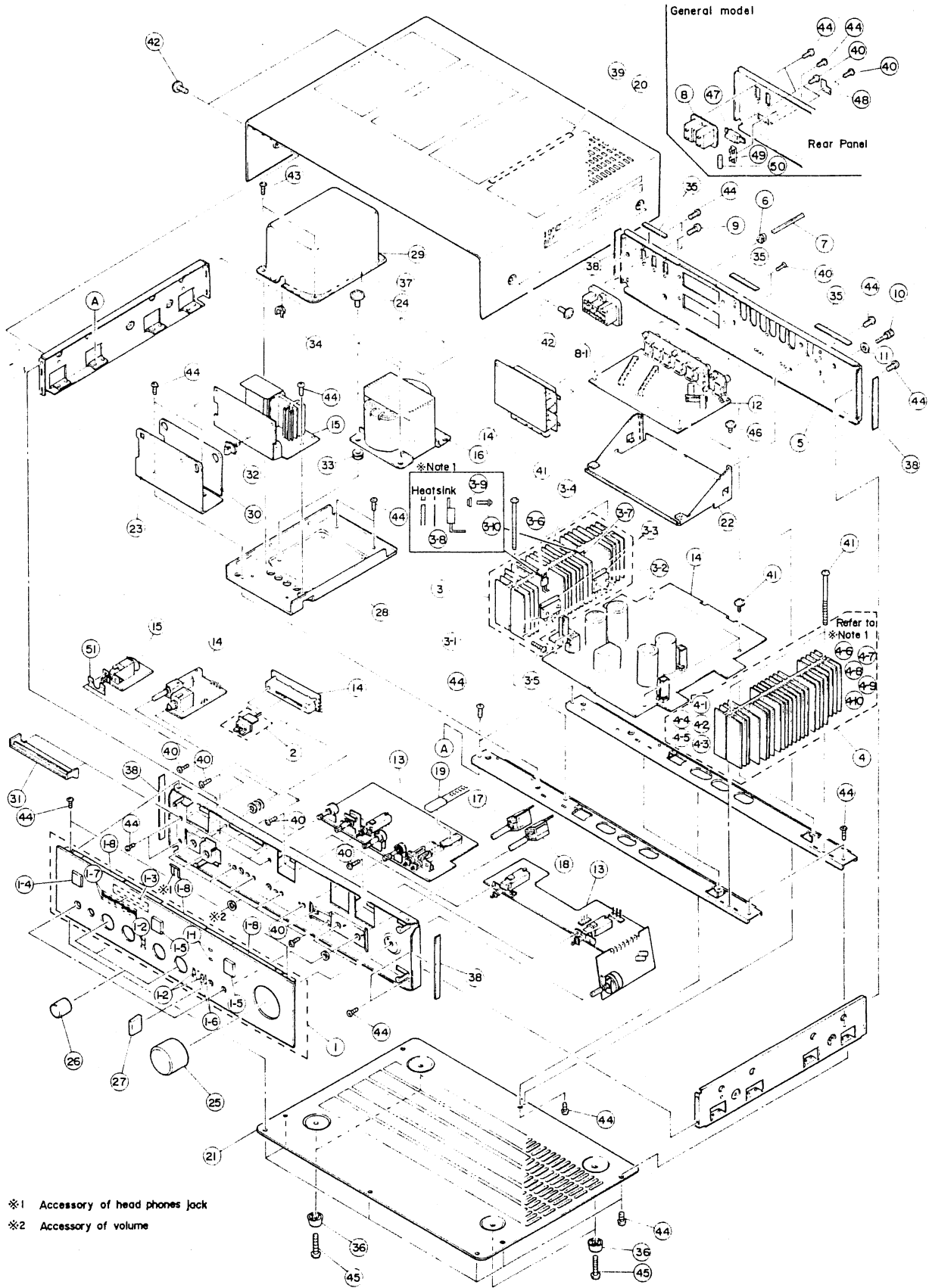

# ■ PARTS LIST (Mechanism)

A-760

Ref. No.	Part No.	Description	(部 品 名)	Remarks	Common model	Markets
※ 1	32:00:00 NB:09:88:90	Panel Unit	パネルユニット			
1-1	42:00:00 i F:00:12:40	LED (Orange) SLB-26UU1N	LED角形(オレンジ)			
1-2	32:00:00 NB:09:39:20	Push Button Ass'y #9392	プッシュボタンAss'y		CR-440	
※ 1-3	32:00:00 CB:09:97:50	Frame. Slit #9975	スリット枠			
1-4	32:00:00 NB:09:14:30	Push Button Ass'y #9143	プッシュボタンAss'y		A-550	
1-5	32:00:00 NB:09:14:50	" #9145	"		"	
1-6	42:00:00 CB:07:41:90	Adhesive Tape 5×30	ダブルタックテープ			
1-7	42:00:00 CB:07:41:90	" 5×80	"			
1-8	42:00:00 CB:08:50:50	Tape (Anti-vibration) 3×7×50	防振テープ			
※ 2	32:00:00 NB:09:79:40	LED Knob Ass'y	LEDツマミ Ass'y			R,A,G,C,B
※ "	32:00:00 NB:09:89:00	"	"			U
※ 3	32:00:00 NB:09:89:10	Radiator (L) Unit	ラジエター(L)ユニット			
※ 3-1	42:00:00 i B:07:55:00	Transistor 2SB755 (R,O)	ベアトランジスタ	TR333		
※ 3-2	42:00:00 i D:08:45:00	" 2SD845 (R,O)	"	TR331		
3-3	42:00:00 i L:00:05:10	Mica Base AC-243	マイカベース			
※ 3-4	32:00:00 BA:07:94:50	Heat Sink	放熱板			
3-5	42:00:00 EK:09:50:50	Bind Head Tap Tight Screw 3×12 (ZMC2-Y)	鉄バインドタップタイトネジ	(B-tyte)		
3-6 (4-6)	42:00:00 i A:09:68:00	Transistor 2SA968 (O,Y)	ベアトランジスタ	TR329(TR330)		
3-7 (4-7)	42:00:00 i C:22:38:00	" 2SC2238 (O,Y)	"	TR327(TR328)		Radiator (R)
3-8 (4-8)	42:00:00 i L:00:02:70	Mica Base AC-229	マイカベース			" (L)
3-9 (4-9)	32:00:00 CB:07:28:80	Bush	絶縁ブッシュ			Unit
3-10 (4-10)	42:00:00 EK:03:00:30	B,W Head Tapping Screw 2.6×12 (ZMC2-Y)	鉄BWヘッドタッピングネジ			
※ 4	32:00:00 NB:09:89:20	Radiator (R) Unit	ラジエター(R)ユニット			
※ 4-1	42:00:00 i B:07:55:00	Transistor 2SB755 (R,O)	ベアトランジスタ	TR334		
※ 4-2	42:00:00 i D:08:45:00	" 2SD845 (R,O)	"	TR332		
4-3	42:00:00 i L:00:05:10	Mica Base AC-243	マイカベース			
※ 4-4	32:00:00 BA:07:94:50	Heat Sink #7945	放熱板			
4-5	42:00:00 EK:09:50:50	Bind Head Tap Tight Screw 3×12 (ZMC2-Y)	鉄バインドタップタイトネジ			
※ 5	32:00:00 AA:60:35:90	Rear Panel	リアパネル			U,C
※ "	32:00:00 AA:60:35:80	"	"			R
※ "	32:00:00 AA:60:36:00	"	"			A,B
※ "	32:00:00 AA:60:36:10	"	"			G
6	42:00:00 CB:07:27:50	Cord Stopper SR-4N-4	コードストッパー			
7	42:00:00 MG:00:08:90	Power Cord (Black) 2m 13A 125V	電源コード			U,C
"	42:00:00 MG:00:07:80	" " 6A 250V	"			R
"	42:00:00 MG:00:09:10	" " "	"			G
"	42:00:00 MG:00:09:20	" (Gray) 2.5m 7.5A 250V	"			A
"	42:00:00 MG:00:10:00	" (Black) 2m 6A 300/500V	"			B
8	42:00:00 LB:40:06:50	AC Outlet M7013-A	ACアウトレット			R
8-1	42:00:00 LB:60:29:80	" M7017-A	"		CR-640	U,C
9	42:00:00 EN:03:00:20	Bind Head Tapping Screw 3×8 (ZMC2-Y)	鉄バインドタッピングネジ	Type-2		
10	42:00:00 EZ:00:14:00	Screw (for Earth Terminal) 3×13.5 (MFNi-II)	アース端子ネジ			
11	42:00:00 EW:40:36:50	Sems Flat Washer φ3.6×φ10×t0.8 (FNM3-38)	鉄セムス平座金			
※ 12	32:00:00 NA:07:48:70	Function Circuit Board	ファンクションシート			U
※ "	32:00:00 NA:07:48:60	"	"			R,A,G,C,B
※ 13	32:00:00 NA:07:48:90	Tone Control Circuit Board	トーンコントロールシート			U
※ "	32:00:00 NA:07:48:80	"	"			R,A,G,C,B
※ 14	32:00:00 NA:07:49:10	Main Circuit Board	メインシート			U
※ "	32:00:00 NA:07:49:20	"	"			C
※ "	32:00:00 NA:07:49:30	"	"			A,G,B
※ "	32:00:00 NA:07:49:40	"	"			R

※ : New Part (新部品)

Ref. No.	Part No.		Description	(部 品 名)	Remarks	Common model	Markets
※ 15	32:00:00	NA:07:60:80	Control Circuit Board	制御シート			U,C
※ "	32:00:00	NA:07:60:90	"	"			A,G,B
※ "	32:00:00	NA:07:61:00	"	"			R
※ 16	42:00:00	GA:63:59:00	Power Transformer	電源トランス			U
※ "	42:00:00	GA:63:60:00	"	"			G
※ "	42:00:00	GA:63:61:00	"	"			A,B
※ "	42:00:00	GA:63:62:00	"	"			R
※ "	42:00:00	GA:63:85:10	"	"			C
※ 17	42:00:00	KA:90:16:40	Remote Rotary Switch	リモートロータリーSW	Control + Wire		
※ 18	42:00:00	KA:90:16:50	"	"	"		
※ 19	42:00:00	KA:90:16:70	Remote Push Switch	リモートプッシュSW	Wire		
※ 20	32:00:00	AA:60:38:70	Top Cover	トップカバー			
※ 21	32:00:00	AA:60:36:20	Bottom Cover	ボトムカバー			
※ 22	32:00:00	AA:60:36:50	Holder, P.C Board	シートホルダー			
※ 23	32:00:00	AA:60:41:90	Holder, CS	C.Sホルダー			
※ 24	32:00:00	AA:60:38:50	Tight Screw (with Steps)	段付ネジ			
※ 25	32:00:00	BA:07:33:80	VOL Knob	VOLツマミ			
※ 26	32:00:00	BA:07:72:80	T.C Knob	T.Cツマミ		CR-240	
※ 27	32:00:00	BA:07:94:60	Knob SW	SWツマミ			
※ 28	32:00:00	BA:07:96:40	Holder, Power Transformer	トランスホルダー			
※ 29	32:00:00	BA:07:95:70	Cover, Transformer	トランスカバー			
※ 30	42:00:00	CA:07:05:80	Isolation Plate	絶縁板			
※ 31	32:00:00	CB:09:97:40	Cover, Slit	スリットカバー			
※ 32	32:00:00	CB:09:98:30	Support, P.C	P.Cサポート			
※ 33	32:00:00	CB:09:99:10	Rubber, Antivibration	防振ゴム			
※ 34	32:00:00	CB:60:05:70	Bush	リードブッシュ			
※ 35	42:00:00	CB:09:98:10	Rubber, Antivibration	防振ゴム			
※ 36	42:00:00	CB:09:86:00	Leg	脚			
※ 37	42:00:00	CB:60:05:60	Packing Cover	カバーパッキン			
※ 38	42:00:00	CB:60:06:40	Damper	ダンパー			
※ 39	42:00:00	CB:60:05:80	Tape Antivibration 1.5×10×110	防振テープ			
※ 40	42:00:00	ED:03:00:80	Bind Head Screw 3×6 (ZMC2-Y)	鉄バインド小ネジ			
※ 41	42:00:00	ED:04:07:50	" 4×75 ( " )	"			
※ 42	42:00:00	EK:13:00:20	B.W Head Screw 4×8 φ9 (FNM3-3g)	鉄プレザークラッチャー ヘッド小ネジ			
※ 43	42:00:00	EN:33:00:10	Bind Head Tapping Screw 3×8 (ZMC2-BI)	鉄バインドタッピンネジ	Type-2		
※ 44	42:00:00	EN:03:00:20	" 3×8 (ZMC2-Y)	"	"		
※ 45	42:00:00	EN:02:00:40	" 3×12 ( " )	"	"		
※ 46	42:00:00	EK:93:00:10	B.W Head Tapping Screw 3×8 φ10 (ZMC2-Y)	鉄B.Wヘッドタッピンネジ	"		
※ 47	42:00:00	KA:40:07:40	Slide Switch (Voltage Selector)	スライドSW			R
※ 48	32:00:00	CB:60:14:40	Switch Guard	VSストッパー			R
※ 49	42:00:00	LB:20:13:00	Fuse Holder	ヒューズホルダー			R
※ 50	42:00:00	KB:00:13:00	Fuse T7A 250V	ヒューズタイラッシュ			R
※ 51	42:00:00	CB:60:29:20	Spacer, Switch	SWスペーサー			
※	32:00:00	MZ:07:90:30	Connector (Tone,C.Board) Ass'y	トーンコントロール コネクターAss'y			
※	42:00:00	BB:00:44:30	Connect Pin 2.5Pitch (SHF-001T-08CS)	2.5ピッチコンタクトピン			
※	42:00:00	LB:20:13:80	Housing 2.5 Pitch (H2P-SHF)	2.5ピッチハウジング	Connector		
※	42:00:00	LB:30:07:20	" 2.5 " (H3P-SHF)	"	Tone Control		
※	42:00:00	CB:07:21:70	Shield Cap	シールドキャップ			
※	42:00:00	CB:07:78:60	" 344325	"			
※	42:00:00	CB:07:78:70	" 324332	"			
※	32:00:00	MZ:07:93:70	Connector (Main C.Board) Ass'y	メインコネクターAss'y			
※	32:00:00	NB:07:62:40	Accessories Assembly	付属品Ass'y		CA-410	
※	42:00:00	TX:90:07:80	Hexagonal Wrench	六角レンチ1.5φ			

※ : New Part (新部品)