

USER'S HANDBOOK

Model 1281

Selfcal Digital Multimeter

User's Handbook

For

The Model 1281 Selfcal Digital Multimeter

(for maintenance procedures
refer to the Calibration and Servicing Handbook)

© 1999 Wavetek Ltd

850090

Issue 6.0 (February 1999)

WAVETEK

ISO 9002

Wavetek Ltd

CERTIFICATE
No. FM 29700



For any assistance contact your nearest Wavetek Sales and Service Center. Addresses can be found at the back of this handbook.

Due to our policy of continuously updating our products, this handbook may contain minor differences in specification, components and circuit design to the instrument actually supplied. Amendment sheets precisely matched to your instrument serial number are available on request.

WAVETEK is a US registered trademark of Wavetek Corporation.

Wavetek Corporation

Standard Warranty Policy

Wavetek warrants that all Products manufactured or procured by Wavetek conform to Wavetek's published specifications and are free from defects in materials and workmanship for a period of one (1) year from the date of delivery to the original Buyer, when used under normal operating conditions and within the service conditions for which they were designed. This warranty is not transferrable and does not apply to used or demonstration products.

The obligation of Wavetek arising from a Warranty claim shall be limited to repairing, or at its option, replacing without charge, any assembly or component (except batteries) which in Wavetek's sole opinion proves to be defective within the scope of the Warranty. In the event Wavetek is not able to modify, repair or replace nonconforming defective parts or components to a condition as warranted within a reasonable time after receipt thereof, Buyers shall receive credit in the amount of the original invoiced price of the product.

Wavetek must be notified in writing of the defect or nonconformity within the Warranty period and the affected Product returned to Wavetek's factory, designated Service Provider, or Authorized Service Center within thirty (30) days after discovery of such defect or nonconformity. Buyer shall prepay shipping charges and insurance for Products returned to Wavetek or its designated Service Provider for warranty service. Wavetek or its designated Service Provider shall pay costs for return of Products to Buyer.

Wavetek shall have no responsibility for any defect or damage caused by improper storage, improper installation, unauthorized modification, misuse, neglect, inadequate maintenance, accident or for any Product which has been repaired or altered by anyone other than Wavetek or its authorized representative or not in accordance with instructions furnished by Wavetek.

The Warranty described above is Buyer's sole and exclusive remedy and no other warranty, whether written or oral, expressed or implied by statute or course of dealing shall apply. Wavetek specifically disclaims the implied warranties of merchantability and fitness for a particular purpose. No statement, representation, agreement, or understanding, oral or written, made by an agent, distributor, or employee of Wavetek, which is not contained in the foregoing Warranty will be binding upon Wavetek, unless made in writing and executed by an authorized representative of Wavetek. Under no circumstances shall Wavetek be liable for any direct, indirect, special, incidental, or consequential damages, expenses, or losses, including loss of profits, based on contract, tort, or any other legal theory.

April 1, 1994

Wavetek Corporation reserves the right to amend specifications without notice.

CONTENTS

	Page
SAFETY ISSUES	
READ THIS ENTIRE SECTION THOROUGHLY BEFORE ATTEMPTING TO INSTALL, OPERATE OR SERVICE THE MODEL 1281 SELFCAL DIGITAL MULTIMETER	iv
PART 1 INTRODUCTION TO THE 1281	
SECTION 1 INTRODUCTION AND GENERAL DESCRIPTION	
Standard and Optional Measurement Facilities	1-1
Accessories	1-5
Principles of Operation	1-7
SECTION 2 INSTALLATION AND OPERATING CONTROLS	
Unpacking and Inspection	2-1
Storage	2-1
Preparation for Shipment	2-1
Calibration Enable Switch	2-1
Introduction to the Front and Rear Panels	2-2
Preparation for Operation	2-4
Connectors and Pin Designations	2-8
SECTION 3 BASIC MEASUREMENTS	
The Measurement Task	3-1
Introduction to the Front Panel	3-1
Menu Keys	3-2
Major Function Keys: DCV, ACV, Ohms, DCI, ACI	3-4
Initial State at Power On	3-5
Soft Key Conventions	3-6
Quick Tour of the Major Function Menus	3-7
'Input' and 'Status' Keys	3-37
Conclusion	3-46
PART 2 OPERATION OF THE 1281	
SECTION 4 USING THE 1281	
Preliminaries	4-1
Safety	4-1
Interconnections - General Guidelines	4-2
Functions	4-4
Facilities	4-21
Calibration	4-40
Direct Action Keys	4-57
'Numeric Keyboard' Keys	4-60
Appendix A: Error Detection and Meanings of Error Codes	4-A1

	Page
SECTION 5 SYSTEMS APPLICATION VIA THE IEEE 488 INTERFACE	
Introduction	5-1
Interface Capability	5-1
Interconnections	5-3
Typical System	5-4
Using the 1281 in a System	5-6
Retrieval of Device Status Information	5-19
Descriptions of Commands and Queries	5-30
Appendix A: IEEE 488.2 Device Documentation Requirements	5-A1
Appendix B: 1281 Device Settings at Power On	5-B1
PART 3 1281 PERFORMANCE	
SECTION 6 SPECIFICATIONS	
General	6-1
Maximum RMS inputs	6-2
Accuracy	6-5
Other Specifications	6-11
SECTION 7 SPECIFICATION VERIFICATION	
Introduction	7-1
Verification Report Sheets	7-3
SECTION 8 ROUTINE CALIBRATION	
Introduction	8-2
Equipment requirements	8-6
Preparation	8-7
DC Voltage	8-8
AC Voltage	8-10
Resistance	8-13
DC Current	8-17
AC Current	8-19
Entry of User's Calibration Uncertainties	8-22

SAFETY ISSUES

READ THIS ENTIRE SECTION THOROUGHLY BEFORE ATTEMPTING TO INSTALL, OPERATE OR SERVICE THE MODEL 1281 SELF CAL DIGITAL MULTIMETER

General Safety Summary

This instrument has been designed and tested in accordance with the British and European standard publication EN61010:1993/A2:1995, and has been supplied in a safe condition.

This manual contains information and warnings that must be observed to keep the instrument in a safe condition and ensure safe operation. Operation or service in conditions or in a manner other than specified could compromise safety. For the correct and safe use of this instrument, operating and service personnel must follow generally accepted safety procedures, in addition to the safety precautions specified.

To avoid injury or fire hazard, **do not** switch on the instrument if it is damaged or suspected to be faulty. **Do not** use the instrument in damp, wet, condensing, dusty, or explosive gas environments.

Whenever it is likely that safety protection has been impaired, make the instrument inoperative and secure it against any unintended operation. Inform qualified maintenance or repair personnel. Safety protection is likely to be impaired if, for example, the instrument shows visible damage, or fails to operate normally.

WARNING THIS INSTRUMENT CAN DELIVER A LETHAL ELECTRIC SHOCK. NEVER TOUCH ANY LEAD OR TERMINAL UNLESS YOU ARE ABSOLUTELY CERTAIN THAT NO DANGEROUS VOLTAGE IS PRESENT.



Explanation of safety related symbols and terms

DANGER electric shock risk

The product is marked with this symbol to indicate that hazardous voltages (>30 VDC or AC peak) may be present.



CAUTION refer to documentation

The product is marked with this symbol when the user must refer to the instruction manual.



Earth (Ground) terminal

Functional Earth (Ground) only - must not be used as a Protective Earth.



WARNING WARNING STATEMENTS IDENTIFY CONDITIONS OR PRACTICES THAT COULD RESULT IN INJURY OR DEATH.

CAUTION CAUTION STATEMENTS IDENTIFY CONDITIONS OR PRACTICES THAT COULD RESULT IN DAMAGE TO THIS OR OTHER PROPERTY.

Protective Earth (Ground)

Protection Class I:

The instrument **must** be operated with a Protective Earth/Ground connected via the power cable's protective earth/ground conductor. The Protective Earth/Ground connects to the instrument before the line & neutral connections when the supply plug is inserted into the power socket on the back of the instrument.

WARNING ANY INTERRUPTION OF THE PROTECTIVE GROUND CONDUCTOR INSIDE OR OUTSIDE THE INSTRUMENT IS LIKELY TO MAKE THE INSTRUMENT DANGEROUS.



To avoid electric shock hazard, make signal connections to the instrument after making the protective ground connection. Remove signal connections before removing the protective ground connection, i.e. **the power cable must be connected whenever signal leads are connected.**

Do Not Operate Without Covers

To avoid electric shock or fire hazard, **do not** operate the instrument with its covers removed. The covers protect users from live parts, and unless otherwise stated, must only be removed by qualified service personnel for maintenance and repair purposes.

WARNING REMOVING THE COVERS MAY EXPOSE VOLTAGES IN EXCESS OF 1.5KV PEAK (MORE UNDER FAULT CONDITIONS).



Safe Operating Conditions

Only operate the instrument within the manufacturer's specified operating conditions. Specification examples that must be considered include:

- ambient temperature
- ambient humidity
- power supply voltage & frequency
- maximum terminal voltages or currents
- altitude
- ambient pollution level
- exposure to shock and vibration

To avoid electric shock or fire hazard, **do not** apply to or subject the instrument to any condition that is outside specified range. See Section 6 of this manual for detailed instrument specifications and operating conditions.

CAUTION CONSIDER DIRECT SUNLIGHT, RADIATORS AND OTHER HEAT SOURCES WHEN ASSESSING AMBIENT TEMPERATURE.



CAUTION BEFORE CONNECTING THE INSTRUMENT TO THE SUPPLY, MAKE SURE THAT THE REAR PANEL AC SUPPLY VOLTAGE CONNECTOR IS SET TO THE CORRECT VOLTAGE AND THAT THE CORRECT FUSES ARE FITTED.



Fuse Requirements

To avoid fire hazard, use only the fuse arrangements that appear in the fuse specification table below. Additionally, the supply network must be fused at a maximum of 16A, and in the UK, a 5A fuse must be fitted in the power cable plug.

Power Input Fuse F1

Supply (Line) Voltage Selection	Fuse Action	Fuse Rating IEC (UL/CSA)	Wavetek Part No.	Manufacturer & Type No.
115 VAC	T Time delay	1.25 A (2 A)	920204	Schurter 001.2505
230 VAC	TH Time delay HBC	630 mA (1 A)	920203	Schurter 001.2502

Current Function Fuse F2

Fuse Action	Fuse Rating IEC (UL/CSA)	Wavetek Part No.	Manufacturer & Type No.
F Fast acting	1.6 A (2 A)	920071	Beswich S501

Rear Panel Detail

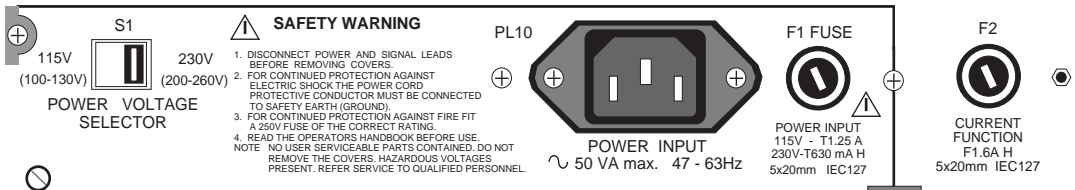

The Power Cable and Power Supply Disconnection

The intended power supply disconnect device is the ON/OFF switch that is located on the instrument's front panel. The ON/OFF switch **must** be readily accessible while the instrument is operating. If this operating condition cannot be met, the power cable plug or other power disconnecting device **must** be readily accessible to the operator.

To avoid electric shock and fire hazard, make sure that the power cable is not damaged, and that it is adequately rated against power supply network fusing.

If the power cable plug is to be the accessible disconnect device, the power cable must not be longer than 3 metres.

Instrument Terminal Connections

Make sure that the instrument is correctly protectively earthed (safety grounded) via the power cable before and while any other connection is made.

WARNING THIS INSTRUMENT CAN DELIVER A LETHAL ELECTRIC SHOCK. NEVER TOUCH ANY LEAD OR TERMINAL UNLESS YOU ARE ABSOLUTELY CERTAIN THAT NO DANGEROUS VOLTAGE IS PRESENT.



YOU ARE STRONGLY ADVISED TO FIT THE REAR TERMINAL COVER PLATE WHEN THE REAR INPUTS ARE NOT IN USE.

Installation Category I:

Measurement and/or guard terminals are designed for connection at Installation (Overvoltage) Category I. To avoid electric shock or fire hazard, the instrument terminals must not be directly connected to the AC line power supply, or to any other voltage or current source that may (even temporarily) exceed the instrument's peak ratings.

WARNING TO AVOID INJURY OR DEATH, DO NOT CONNECT OR DISCONNECT SIGNAL LEADS WHILE THEY ARE CONNECTED TO A HAZARDOUS VOLTAGE OR CURRENT SOURCE.



MAKE SURE THAT SIGNAL LEADS ARE IN A SAFE CONDITION BEFORE YOU HANDLE THEM ANY WAY.

Maintenance and Repair

Observe all applicable local and/or national safety regulations and rules while performing any work. First disconnect the instrument from all signal sources, then from the AC line supply before removing any cover. Any adjustment, parts replacement, maintenance or repair should be carried out only by the manufacturer's authorised service personnel.

WARNING FOR PROTECTION AGAINST INJURY AND FIRE HAZARD, USE ONLY MANUFACTURER SUPPLIED PARTS THAT ARE RELEVANT TO SAFETY. PERFORM SAFETY TESTS AFTER REPLACING ANY PART THAT IS RELEVANT TO SAFETY.



Moving and Cleaning

First disconnect the instrument from all signal sources, then from the AC line supply before moving or cleaning. Use only a damp, lint-free cloth to clean fascia and case parts.

Observe any additional safety instructions or warnings given in this manual.

PART 1

Introduction to the 1281

Section 1 Introduction and General Description

Section 2 Installation and Operating Controls

Section 3 Basic Measurements

SECTION 1 INTRODUCTION AND GENERAL DESCRIPTION

Standard and Optional Facilities

Basic Configuration	1-1
Options	1-1
'Hard' and 'Soft' Keys - Menus	1-2
Calibration	1-3
Message Readout	1-4
Processor	1-4
Computing	1-4
Self Test	1-4
System Use	1-4
Accessories	1-5
Additional Documentation	1-5

Principles of Operation

Precision DMM Design	1-7
Basics	1-7
Analog to Digital Converter	1-8
A-D Master Reference	1-10
DC Amplifier	1-11
AC Voltage - Option 10	1-12
Resistance - Option 20	1-14
Current - Option 30	1-14

SECTION 1

Introduction and General Description

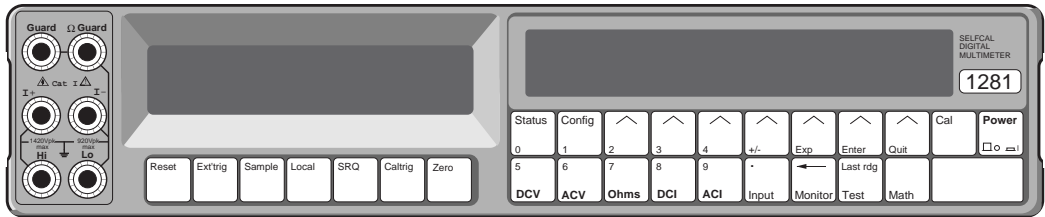

Designed for the most demanding measurement applications, the model 1281 DMM provides extremely high measurement precision in both stand-alone and systems use.

Standard and Optional Measurement Facilities

Basic Configuration

When purchased without any options, the 1281 is a very high-precision DC voltmeter that suits stand-alone (benchtop) and automated systems use. The basic configuration offers the following measurement capabilities:

- Selectable 4¹/₂ to full 8¹/₂ digits resolution at high read rates.
- DC Voltage in five ranges from 1nV to 1100V, 1-year specifications to ± 5 ppm.
- Two identical rear input channels (A and B) with comprehensive ratio measurements.
- External trigger.
- Flexible and easy to use Menu Control.
- Extensive Math, Limit testing, Specification and Max/Min computations.
- Selfcal internal calibration.
- Autocal external calibration.
- Fully IEEE-488.2 programmable.

Options

To extend its functional range beyond DC Voltage measurement, the instrument can be expanded by adding purchasable options, providing further measurement capability:

- 10** True RMS AC Voltage, from 100nV to 1100V; 1-year specifications to ± 70 ppm; simultaneous true RMS ACV and frequency displays; plus spot-calibrated ACV 1-year performance to ± 65 ppm.
- 20** 2-wire and 4-wire Resistance from $1\mu\Omega$ to $2G\Omega$, 1-year specifications to ± 6 ppm. True Ω and Low Current Ω modes.
- 30** DC and AC Current option.
(DC Current requires Option 20).
(AC Current requires Option 10).
- 70** Analog output.
- 90** Rack mounting.

'Hard' and 'Soft' Keys - Menus

The use of hard keys (labels printed on the keys themselves) and soft keys (labels appear on the separate menu display) allows programming of the instrument into a wide range of configurations. Pressing the hard key of one of the main functions (DCV, ACV, Ohms, DCI or ACI) alters the instrument circuitry to the selected function, at the same time displaying its own menu. Each soft key, marked with an arrowhead (\wedge), is labelled by the legend above it on the display. Whenever a main function key is pressed, the soft keys in its menu select only its ranges or autorange.

Once a main function is active, the **Status** hard key allows a check of configured parameters. Or alternatively, the **Config** hard key can be used to alter the configuration. The **Monitor** key permits access to such information as: the uncertainties associated with the active measurement; signal frequency of an AC input signal being measured; and whether set limits have been exceeded.

The menus are arranged in tree structures, the ultimate aim being to lead through their branches to an end node, at which the physical circuitry of the instrument can be changed to suit the required parameters.

When the instrument power is switched on, all functions are forced into a safety default state. Once a function is configured to a required state it remains in that state, regardless of subsequent configurations in other functions, until either the state is changed or the instrument power is switched off.

As an easy introduction to the main function keys and their associated menus, users can follow a guided tour through the tree structures, sequenced in Part 1, Section 3. The full range of facilities, together with access information, is detailed in Part 2, Section 4; and remote control information is given, for the IEEE 488 interface, in Section 5.

Calibration

Autocal

The 1281 is an 'Autocal' instrument, providing full external calibration of all ranges and functions from the front panel; thus making the removal of covers unnecessary.

Periodically, the DMM is electronically calibrated against traceable external standards, where any differences in the DMM's readings compared to the value of the external calibration sources can be used to derive calibration constants, which are stored by the instrument in non-volatile memory. These external calibration corrections later serve to correct all readings taken by the DMM.

Selfcal

The 1281 is also a 'Selfcal' instrument. Selfcal is a totally automatic internal calibration. Once accessed, a single keystroke initiates the process. The calibration uses the accuracy of a very stable 'Selfcal Module' which provides calibration sources, so that the errors in the measurement circuits can be determined. The microprocessor then automatically corrects for these errors.

The Selfcal Process

After the external calibration of the DMM, the performance of the internal calibrator can also be calibrated. This is done by comparing the readings taken by the DMM on any particular range against external standards, with those made using its internal Selfcal sources.

These Selfcal characterization factors are stored in the DMM's non-volatile memory alongside the normal external calibration corrections.

At a later date, when the DMM's user decides to self-calibrate the 1281, another set of internal measurements is made but using only the internal calibrator. This is performed using the identical configurations and sequences that derived the characterizations, to avoid any differences due to settling and thermal effects.

The new set of readings is then compared against the corresponding characterized values, and any differences between the two are defined as errors to be compensated by the microprocessor in all subsequent measurements.

In effect; a third set of calibration constants - the Selfcal corrections - are stored alongside the original external calibration constants and the Selfcal characterization factors. The performance of the instrument immediately after Selfcal then depends only on the stability of the internal calibrator and the noise which was present when making the internal measurements.

Calibration Security

A key-operated switch on the rear panel prevents accidental or unauthorized use of Autocal. Optionally, Selfcal can be protected by the switch and/or the passnumber.

Calibration Routines

The Selfcal and Routine Autocal procedures are described in Part 3, Section 8 of this handbook, and also in Part 1, Section 1 of the Calibration and Servicing Handbook.

Message Readout

Generally, the selections offered in the menus reflect the availability of facilities, incompatible combinations being excluded. Nevertheless, the menu display doubles as a message screen, giving a clear readout of information to the user such as unsuitable attempts at configuration, test failures and some other conditions which would need to be reported to a Wavetek service center.

Processor

The instrument is internally controlled by a 68000 series microprocessor. It ultimately translates all information from the front panel keys, according to its program in firmware, into control signals which determine the instrument's operation.

Computing

Measurements can be compared with manually-input data (or the most-recent measurement). Some of the keys under the Menu display double as a keyboard for setting:

- measurement limits
 - the bus address
 - math constants
 - a passnumber
 - calibration uncertainties
- etc.

Full details of these facilities are given in Part 2, Section 4.

Self Test

The **Test** key displays a menu which provides access to a comprehensive series of self-tests. Among these are:

- A **Full** selftest, which includes a check of accuracy on all functions and ranges.
- A less exhaustive **Fast** selftest, with wider accuracy tolerances and reduced resolution so that the speed of testing can be increased.
- A test of the front panel keys.
- A test of the displays.

Details of these selftests can be found in Part 2, Section 4.

System Use

The 1281 is designed as standard to form part of a system, conforming to IEEE 488.2 Standard Digital Interface. The Device Documentation Requirements of this standard are fulfilled by the information given in Part 2, Section 5 (summarized in Section 5 Appendix A).

Accessories

The instrument is supplied with the following accessories:

Description	Part Number
Power cable	920012
Set of 2 calibration keys	700117
Power fuse (230V) 630mA	920203
Power fuse (115V) 1.25A	920204
Current fuse 1.6A	920071
Hex key 1.5mm AF (for handle removal)	630284
2 x 50-way 'Amp' socket shells	605177
16 x socket bucket pins	605178
2 x 50-way backshells	606026
'Amp' insertion/extraction tool	606030
15-way 'D' plug	604062
15-way 'D' backshell	606031
User's Handbook	850090

In addition, the following accessories are available for use with the 1281 instrument:

Description	Part Number
Rack Mounting Kit (Option 90)	440153
1501 De Luxe Lead Kit	440070
Calibration and Servicing Handbook (2 Volumes):	
Volume 1	850091
Volume 2	850092

Additional Documentation

The Calibration and Servicing Handbook contains information required to adjust and service the 1281, in two volumes:

Volume 1: full descriptions of the circuits, diagnostic data and calibration procedures.

Volume 2: parts lists and circuit diagrams.

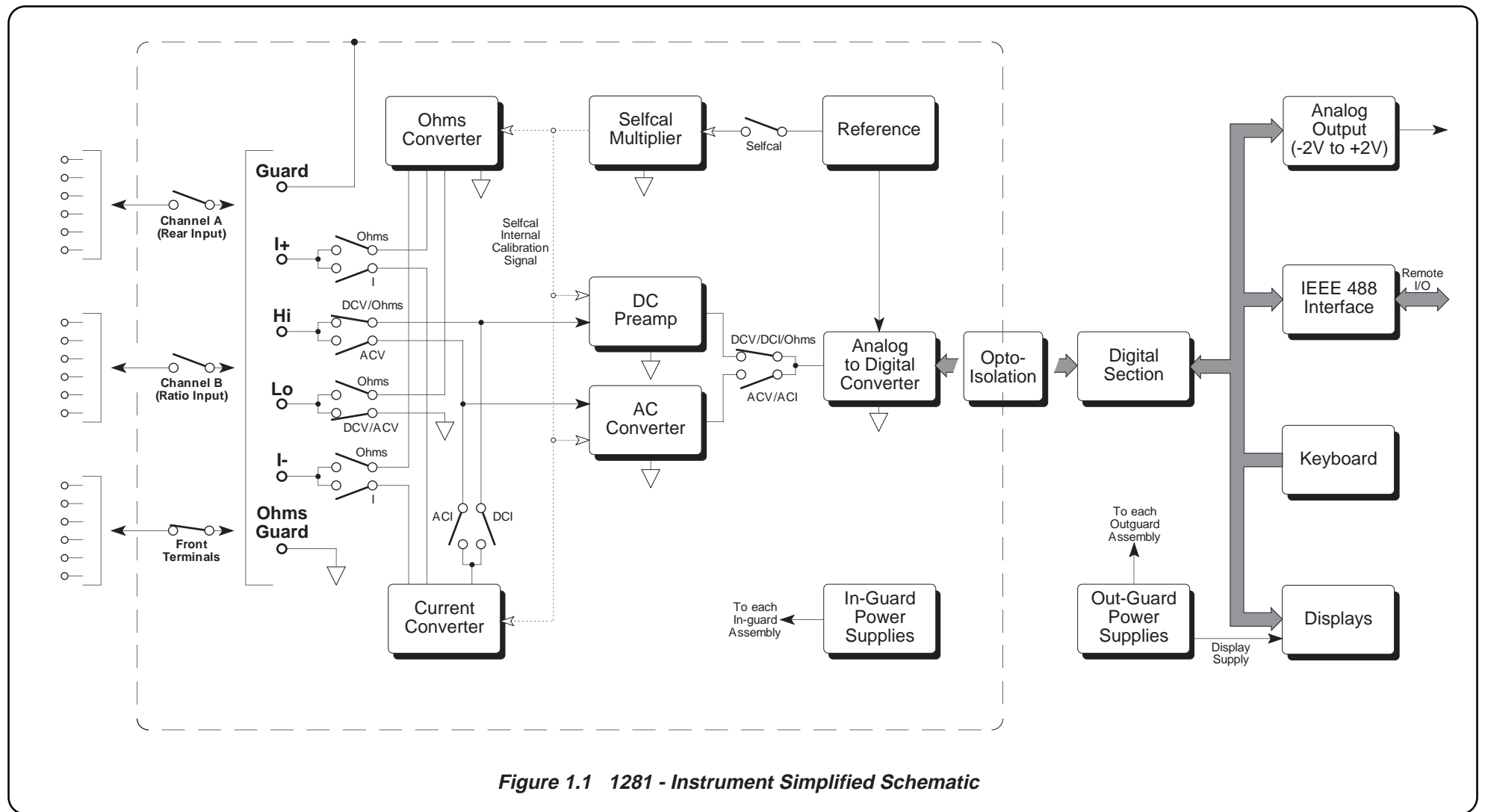

Figure 1.1 1281 - Instrument Simplified Schematic

Principles of Operation

Figure 1.1 shows how the instrument achieves its basic measurement functions.

Precision DMM Design

The 1281 Digital Multimeter is designed for calibration and standards laboratory applications, and so takes full advantage of the inherent qualities of critical accuracy-defining components to

achieve its high performance. It also employs a method of internal calibration which is designed to enhance performances across the entire range of its functions.

Basics

DC Voltage measurements are made by passing the input signal to a DC amplifier, which amplifies or attenuates the signal to a level compatible with the input requirements of the Analog to Digital converter (A-D). The reading from the A-D is then transferred to the instrument's microprocessor for calibration and display.

AC voltages are conditioned by the AC preamp, full wave precision-rectified and passed through an electronic RMS converter, producing a DC level which represents the RMS value of the applied signal. This DC level is then digitized by the A-D converter.

Resistance is measured by passing a constant current through the resistor under test and measuring the DC voltage that develops across it, using the DC Voltage circuits of the instrument.

DC or AC currents pass through precision internal shunts; the voltages that develop are measured using the DCV or ACV sections of the instrument.

Analog to Digital Converter

Introduction

The instrument's A-D converter takes the form of a highly linear, low noise, fast and flexible multislope integrator.

Timing, counting and control are executed by a

custom 'Application-Specific Integrated Circuit' (ASIC), resulting in a design which offers both variable integration times and user-selectable resolutions.

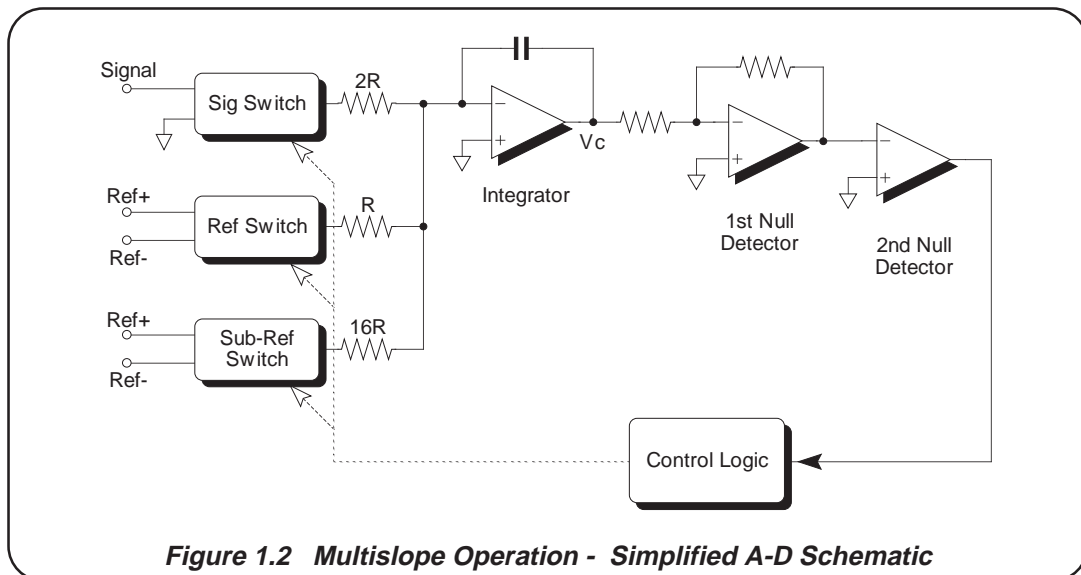

Figure 1.2 Multislope Operation - Simplified A-D Schematic

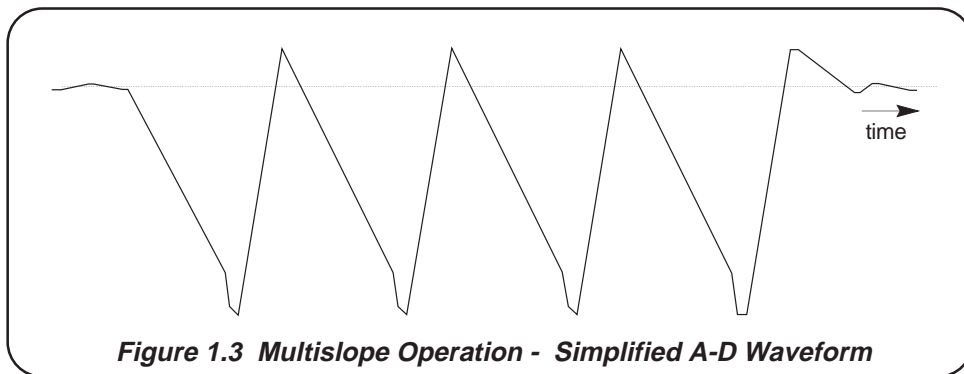

Figure 1.3 Multislope Operation - Simplified A-D Waveform

Multislope Operation (Fig. 1.2)

This employs multiple cycling of the voltage on the integrator capacitor, greatly reducing linearity errors caused by dielectric absorption. The design ensures that any reference switching errors are reduced to a single constant value, which is then subtracted from the reading by the instrument's microprocessor. As a further benefit this design obtains large reductions in conversion time, by enabling both the signal and the reference to be applied to the integrator simultaneously. A digital autozero system is employed.

The timing and counting considerations with this design of A-D are quite complex. Programmable delay timers, a ramp timer and a counter for the number of completed ramps exercise great control flexibility over its performance. These timers and counters are integrated into a custom ASIC which has a 32 bit control register, programmed by the instrument's microprocessor via a special serial interface. The same serial loop is used to transmit the reading from the ASIC to the processor for calibration and display.

A simplified A-D waveform is given in Figure 1.3.

Features

The result is a highly flexible and compact A-D which has the following features:

- Selectable resolutions and speeds; capabilities range from more than 150 readings per second at 4.5 digits resolution, to one full-accuracy 8.5-digit reading every 25 seconds.
- Excellent linearity of 0.1 ppm of full scale.
- Low noise of <0.02 ppm of full scale.
- 100% overrange - maximum discrimination of 1 part in 200 million.

A-D Master Reference

Reference Module

The reference for the A-D conversion is derived from two specially conditioned zener reference modules. Each contains the reference device and its associated buffer circuits, hermetically sealed to ensure constant temperature across the module. The modules are stable to within ± 3 ppm per root-year, produce noise of < 0.1 ppm, with a temperature coefficient of < 0.1 ppm/ $^{\circ}\text{C}$. This performance holds over a very wide temperature span of 0°C to 50°C . These references exhibit negligible temperature shock hysteresis. The master reference is obtained by summing the outputs of both reference modules.

Module History

Extensive evaluation of the reference modules has resulted in a burn-in process which equates to an ageing of 1 year, reducing infant mortalities and hysteresis effects. Following this process, all reference modules are checked over a temperature span of 0°C to 70°C for temperature performance, and then monitored for long term drift over a period of three months minimum.

DC Amplifier

Basic Design

The required input characteristics are achieved by using a differential FET input to give low input current and high frequency response characteristics, coupled with a synchronous chopping amplifier to reduce offset and low-frequency noise. A second amplifier stage provides most of the forward gain, with the frequency/gain compensation necessary for an effective amplifier bandwidth of 1 MHz.

Ranges

Extremely stable resistance units configure the DC amplifier gain to define the DC Voltage ranges. To ensure that no spurious leakage currents cause linearity, temperature coefficient or drift problems in the attenuator chains, the pcb tracks connecting the resistor units to the circuit are carefully guarded.

Effects of Bootstrap

To give a high input impedance, the DC amplifier also drives a bootstrap buffer. This forces the potential of guarding tracks (that surround the Hi track) to follow the input voltage. Also, each in-guard supply used to power the DC amplifier is made to track the input signal level by reference to bootstrap. The DC amplifier thus sees no change in input signal relative to its supplies, so achieving a very high common-mode rejection, eliminating any potential common-mode non-linearities.

Protection

The instrument can measure up to 1000V and can withstand a continuous overload of 1000V on all DCV ranges. Back-to-back zener diodes and a series resistor provide protection for the DC amplifier. Further dynamic protection is provided in the form of larger series resistors, which switch in when the signal exceeds a certain threshold.

AC Voltage - Option 10

AC Preamp

The inverting preamp provides good flatness from DC to 1MHz, with minimum offset voltage at its output to ensure good DC-coupled performance. The design uses several gain elements operating in conjunction, some adding, some multiplying.

The closed loop gain at low frequencies is set by input and feedback resistors. These resistors are shunted by compensating capacitors which determine the closed loop gain at high frequencies, swamping the stray capacitance around the preamp. The feedback capacitance on each range is effectively trimmed at calibration using a ladder network digital-to-analog converter driven from the microprocessor, to control the channel

resistance of FETs in the gain defining network. Extensive bootstrapping of components in the preamp feedback area also greatly reduces the effects of stray capacitance on the measurements.

Electronic RMS

The principles behind the RMS conversion technique are shown in Figure 1.4.

With the instrument set to its 'normal' mode, the signal from the preamp is full-wave rectified by the Halfwave Rectifier and its bypass, appearing as unipolar current pulses at the input to the squaring log amp (V_{in}).

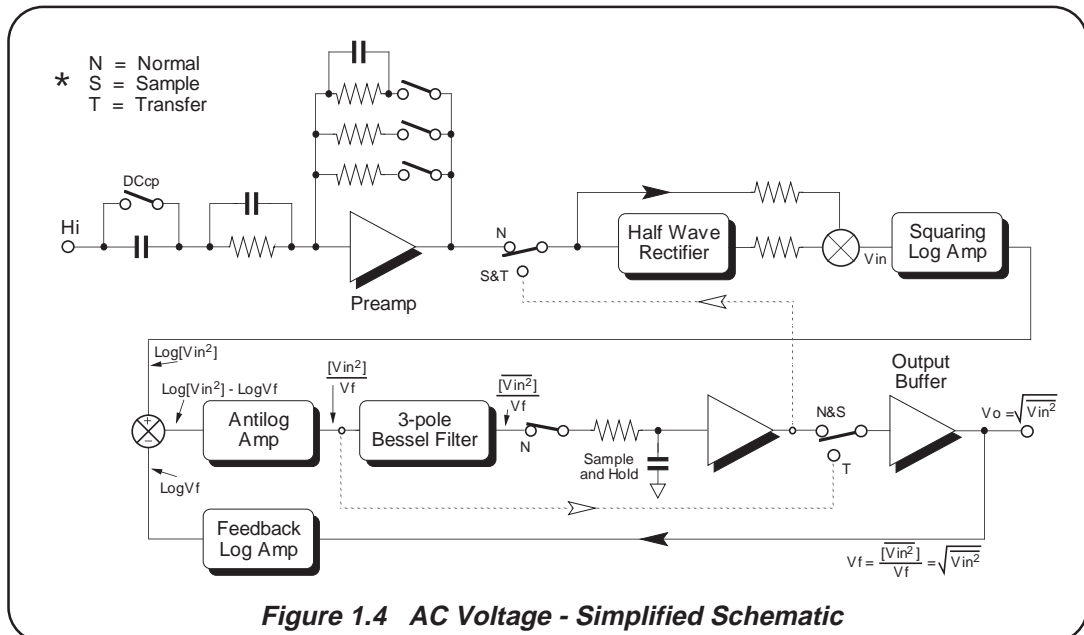

Figure 1.4 AC Voltage - Simplified Schematic

The Log Amp squares instantaneous values of its input by converting them into logarithmic values, then multiplying by two. Its instantaneous log output currents have a DC current proportional to $\log V_f$ subtracted from them. The result is a current (proportional to $\log[V_{in}^2] - \log V_f$) which is fed to an 'exponential' stage.

This current is thus 'anti-logged', then converted to a voltage and smoothed by a 3-pole Bessel filter, producing a DC voltage - the mean of V_{in}^2 divided by V_f (V_f is already DC and equal to its mean).

Root-Mean-Square Value

The Bessel filter is chosen for its optimum settling time, and offers user-selectable configurations to permit operation down to 1 Hz.

A sample-and-hold circuit with isolating buffer provides further filtering at high frequencies, after which the smoothed signal is taken to an amplifying buffer that drives the instrument's analog-to-digital converter. Because the DC output signal $V_f = [\overline{V_{in}^2}] / V_f$, and is fed back into the RMS converter, this means that the square of the output voltage $V_f^2 = [\overline{V_{in}^2}]$, i.e V_f is the normalized root-mean-square value of V_{in} .

The chosen RMS technique exhibits the following advantages over other designs based on thermal techniques:

- Faster response - high accuracy $6^{1/2}$ digit ACV readings at a rate of 1 per second.
- Higher accuracy - it achieves better than ± 70 ppm 1-year uncertainties.

- Wider dynamic range - the span from 100nV to 1000V RMS can be covered in fewer ranges, saving cost and space. Measurement accuracies are specified for all inputs between 2% and 200% of each nominal range.
- Good crest factor performance for non-sinusoidal signals.

AC-DC Transfer Mode

The circuit described so far is a straightforward electronic RMS measurement system. In its alternative 'transfer' (Tfer) mode, the AC circuit employs a refined AC-DC transfer mechanism that improves linearity.

In the transfer mode, two more readings are taken using only the DC sample-and-hold voltage, virtually eliminating linearity errors in the RMS conversion while avoiding the introduction of peak waveform errors.

Spot Frequency Enhancements

To further enhance AC measurement performance, each ACV range can be spot-calibrated at up to six independent, user-defined frequencies. When the instrument measures signals that lie at frequencies within $\pm 10\%$ of these spots, corrections reduce flatness errors to improve 1-year accuracy to ± 65 ppm.

A reciprocal counter function within one of the instrument's custom ASICs can display the frequency of an ACV signal at the same time as its RMS value being shown on the main display.

Resistance - Option 20

The wide selection of floating current source ranges provided by the resistance function means that a variety of resistance measurement modes can be offered to suit many different application areas. For example, when operating in its normal mode, the instrument's current source is selected to optimize for low noise and highest accuracy. However, where low compliance or low open circuit voltages across the DMM's terminals are needed, a low current mode (LoI) can be selected.

Useful applications include in-circuit testing of components connected across diode junctions; and measurement of temperature using Platinum Resistance Thermometers, where the self-heating effects of the current passing through the resistive element are important.

In addition, for those applications where external thermal emfs present measurement problems, a mode is provided where a zero reference reading is automatically taken with the measurement current turned off (Tru Ω). This zero measurement is subtracted from that made with current flowing, to give a resultant value where the effect of any thermal emfs have been eliminated.

External errors produced by specific connections can be reduced using four-wire sensing and Ohms guarding techniques. Four-wire sensed measurement can be made with up to 100 Ω in any lead with negligible degradation in accuracy. Furthermore, errors caused in external leakage paths can be eliminated using an Ohms Guard terminal which may also be used for in-circuit measurement of components in parallel with other resistive elements.

Current - Option 30

For Current measurement, switched precision shunts are fitted internally. The unknown current passes through one of these, and the resulting voltage is measured. The shunts and the source of the current are protected both electronically and by a 1.6A fuse, accessible on the rear panel.

Option 30 requires Option 20 to be fitted.

For AC Current measurement, Option 10 must also be present.

SECTION 2 INSTALLATION AND OPERATING CONTROLS

Unpacking and Inspection	2-1
Storage	2-1
Preparation for Shipment	2-1
Calibration Enable Switch	2-1
Introduction to the Front Panel	2-2
Introduction to the Rear Panel	2-3
Preparation for Operation	
Power Cable	2-4
Fuses	2-4
Line Voltage	2-5
Line Frequency	2-5
Mounting	2-6
Connectors and Pin Designations	
Front Terminals	2-8
PL11 and PL12 - Rear Inputs	2-8
SK9 - External Trigger Input	2-8
SK7 - IEEE 488 Input/Output	2-9
SK8 - I/O Port	2-10

SECTION 2

Installation and Operating Controls

This section contains information and instructions for unpacking, installing, storing and preparing to ship your instrument. It also introduces the instrument's control layout.

Unpacking and Inspection

Every care is taken in the choice of packing material to ensure that your equipment will reach you in perfect condition.

If the equipment has been subject to excessive handling in transit, the fact will probably be visible as external damage to the shipping carton.

In the event of damage, the shipping container and cushioning material should be kept for the carrier's inspection.

Carefully unpack the equipment and check for external damage to the case, sockets, keys etc. If the shipping container and cushioning material are undamaged, they should be retained for use in subsequent shipments. If damage is found notify the carrier and your sales representative immediately.

Standard accessories supplied with the instrument should be as described in Section 1.

Storage

The instrument should be stored under cover. The shipping container provides the most suitable receptacle for storage, as it provides the necessary shock isolation for normal handling operations.

Place the instrument with an active desiccant sachet inside a sealed bag. Fit the bag into the cushioning material inside the shipping container, and locate the whole package within the storage environment described in Section 6.

Preparation for Shipment

The instrument should be transported under cover. The original shipping container should be used to provide shock isolation for normal handling operations. Any other container should provide similar shock isolation to the following approximate internal packing dimensions (the front terminals should be free):

	Length	Width	Depth
Box	630mm	550mm	230mm
Cushioned	480mm	440mm	100mm

Place the instrument with an active desiccant sachet inside a sealed bag. Fit the bag into the cushioning material inside the shipping container, and secure the whole package.

Calibration Enable Switch

IMPORTANT

This two-position, key operated switch on the rear panel protects the instrument calibration memory.

The instrument was initially calibrated at the factory, so under no circumstances should the key be inserted into the switch, until immediate recalibration is intended.

For Recalibration:

If the external calibration menu is selected while the key is not in the enabling position, the menu is replaced by the warning message:

CALIBRATION DISABLED

Introduction to the Front Panel

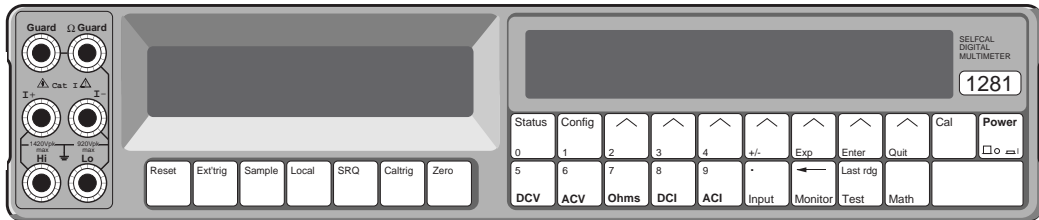

The two displays on the front panel deal with different aspects of operation. We set up the instrument's configuration using menus shown in the right-hand (dot-matrix) display, then readings appear in the left-hand (main) display.

Beneath the dot matrix display, all keys other than the Power key are associated with menus. The keys beneath the main display are direct action keys, associated with triggers, remote control, and instrument reset.

Menu Keys

There are two classes of front panel menu keys, those that lead to an immediate change of instrument state (i.e the major function keys DCV, ACV, Ohms, DCI, ACI), and those that do not (Status, Config, Cal, Input, Monitor, Test, Math).

Major Function Keys:

DCV, ACV, Ohms, DCI, ACI

Each of these function keys defines a separate measurement state and activates its corresponding menu on the dot matrix display. Changing a selection alters the measurement state.

Numeric Keyboard

Seventeen of the menu and soft function keys also act as a keyboard for entry of parameters such as math constants, limits, bus address, etc. The data entered is purely numeric, and can consist of either a keyboard-entered value or the value of the most recent reading.

Instrument Options

Finally it is necessary to point out that although the keys for all the functions are present on the front panel, certain options (ACV, Ω or I) may not have been purchased.

Introduction to the Rear Panel

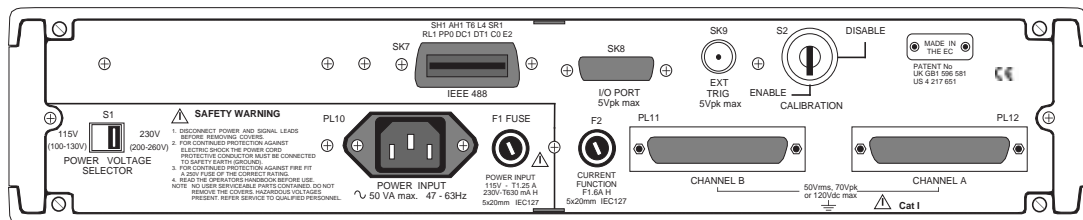

Mechanical Access

The top or bottom cover is released for removal by undoing two screws visible at the rear. A single screw retains the corner block which covers the handle mechanism on each side panel.

Labels

The rear panel displays the identification label for the instrument, and a modification strike label.

External Connections

Apart from the front input terminals, connections to the internal circuitry enter via the rear panel.

Two identical 50-way D-type plugs, PL11 and PL12 each reduced to six pins, are used for rear inputs channels A and B.

SK7 is the standard IEEE 488 connector. A list of interface function subsets is printed next to the connector.

An I/O Port, SK8, provides flag outputs for some defined internal conditions. SK8 also permits a hold to be placed on measurement triggers, and provides the connections for an analog output if Option 70 is incorporated.

SK9 provides a coaxial BNC trigger input.

Fuses

The fuse F1, adjacent to the power input plug, protects the power input line. The other, F2, protects the current measuring circuitry when Option 30 is fitted.



SEE THE SAFETY ISSUES SECTION AT THE FRONT OF THIS MANUAL.

Voltage Selector

The recessed power line voltage selector adapts the instrument to either 115V or 230V line inputs. Note that adaptation to 50Hz or 60Hz supply frequency is switched from the front panel, via a calibration menu.

Calibration Keyswitch

To calibrate the instrument externally, special menus are available from the front panel. But to enter these menus it is necessary to set the calibration keyswitch on the rear panel to CAL ENABLE. The key is removed to prevent unauthorized or accidental access to the calibration procedures.

Preparation for Operation

WARNING THIS INSTRUMENT CAN DELIVER A LETHAL ELECTRIC SHOCK. NEVER TOUCH ANY LEAD OR TERMINAL UNLESS YOU ARE ABSOLUTELY CERTAIN THAT NO DANGEROUS VOLTAGE IS PRESENT.



YOU ARE STRONGLY ADVISED TO FIT THE REAR INPUT TERMINAL COVER PLATE WHEN THE REAR INPUTS ARE NOT IN USE.

Power Cable

The detachable supply cable comprises two metres of 3-core PVC sheath cable permanently moulded to a fully-shrouded 3-pin cable socket. It fits into a plug (PL10 - incorporates a filter) at the rear of the instrument and must be pushed firmly home.

The supply lead **MUST** be connected to a grounded outlet ensuring that the Ground lead is connected.

Fuses

Power Fuse:

Looking from the rear of the instrument, the power fuse F1 is the left-hand fuse of the two on the rear panel.

Option 30 - Current Fuse:

The current fuse is the right-hand fuse of the two.



SEE THE SAFETY ISSUES SECTION AT THE FRONT OF THIS MANUAL.

Rear Panel Detail

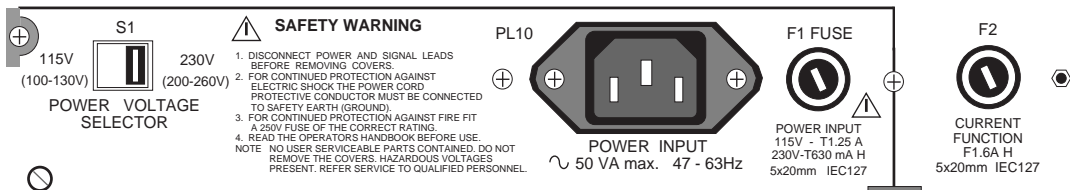

Line Voltage

Power Voltage Selector and Fuses

If neither Option 80 nor Option 81 was specified at the time of ordering, the instrument is packed ready for use with 200V to 260V 50Hz supplies. '230' will be visible in the voltage selector window on the rear panel, and the fuse F1 will be rated at 630mA.

If the 100V to 130V supply Option 80 or 81 was specified at the time of ordering; '115' will be visible in the window and the fuse rating will be 1.25A. Fuses of both ratings are supplied; the one that corresponds to the set line voltage will be fitted in the instrument, the other will be contained in the wallet.

Changing Supply Voltage Only

To change from one voltage to the other, move the voltage selector switch to the opposite position and fit the corresponding fuse.

Line Frequency

Option 80 - 60Hz Status Inspection

For 115V 60Hz supplies, Option 80 should have been specified at the time of ordering, and then the instrument would have been set to 60Hz at manufacture. Once the instrument is switched on, the frequency to which it has been set can be displayed in a **Status** menu (refer to pages 3-41 and 3-43).

The frequency should have been set up, before delivery, for the line supply to be used. If for any reason this is not the case, contact your nearest Service Centre.

Mounting

Bench Use:

The instrument is fitted with rubber-soled plastic feet and tilt stand. It can be placed flat on a shelf or tilted upwards for ease of viewing.

Rack Mounting:

Option 90 permits the instrument to be mounted in a standard 19 inch rack. The method of fitting this option is described below, the locations being shown in the diagram opposite.

N.B. The top or bottom cover should not be removed for this purpose.

Procedure

1. Remove each of the two rear corner blocks by undoing its single crosspoint screw, and store safely for possible future use.
2. Invert the instrument, and remove each handle as follows (detail 1):
 - a. Pull out the handle until the two 1.5mm socket-headed screws are visible in the handle locking bar.
 - b. Loosen the two locking screws using the 1.5mm hex key provided. Leave the screws in the bar.
 - c. Slide the whole handle assembly to the rear, out of the side extrusion.
 - d. Prize off the two catch plates from the extrusion, and place on the handle magnets as keepers.
3. Fit each front rack mounting ear as follows:
 - a. With its bracket to the front, slide the ear into the side extrusion from the rear.
 - b. Loosely fasten the ear to the extrusion at the front, using the four socket grubscrews provided.
- c. Assemble the front plate and handle to the front ear as shown in the diagram, and clamp them together using the two counter-sunk screws provided.
- d. Tighten all six screws.
4. Remove the feet and tilt stand as follows:
 - a. Prize off the rubber pads from the four feet.
 - b. Undo the two securing screws from each foot. This releases the feet, washers and tilt stand so that they can be detached and stored safely for possible future use.
5. Fit the instrument to the rack as follows:
 - a. Attach the two rear ears to the back of the rack, ready to receive the instrument.
 - b. With assistance, slide the instrument into the rack, locating the rear ears in the side extrusions. Push the instrument home, and secure the front ears to the front of the rack.

1 Grubscrews in Handle

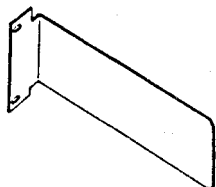
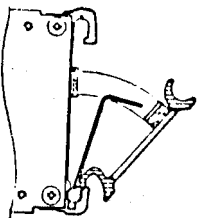

Rear Ear

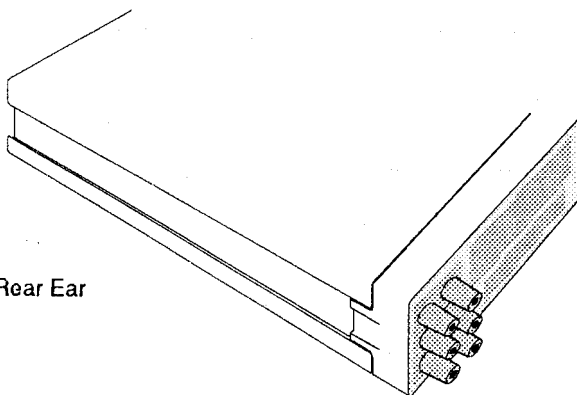

2 Front Ear in Extrusion

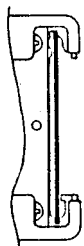

Grubscrews
(4 per side)

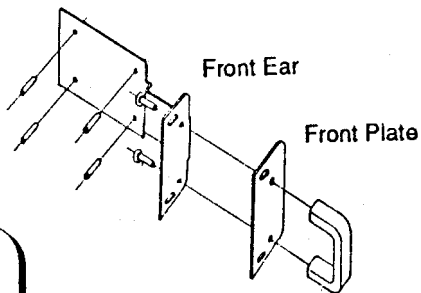

Front Ear

Front Plate

3 Final View from Top

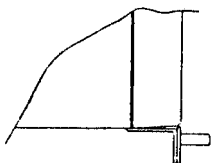

Rack Mounting Kit - Fitting

Connectors and Pin Designations

WARNING USING THIS INSTRUMENT CAN DELIVER A LETHAL ELECTRIC SHOCK. NEVER TOUCH ANY LEAD OR TERMINAL UNLESS YOU ARE ABSOLUTELY CERTAIN THAT NO DANGEROUS VOLTAGE IS PRESENT. FOR CONTINUED PROTECTION AGAINST ELECTRIC SHOCK WHILST THE FRONT INPUT TERMINALS ARE IN USE, DISCONNECT THE REAR INPUT TERMINALS AND FIT THE COVER PLATE.



Front Terminals

Three pairs of 4mm ‘banana’ terminals are fitted on the left of the front panel. Their functions are as follows:

Guard	General Guard
ΩGuard	Ohms Guard
I+	Ohms Current Source (4-Wire) Current Input High
I-	Ohms Current Sink (4-Wire) Current Input Low
Hi	Voltage Input - High Ohms High (2-Wire) Ohms Sense High (4-Wire)
Lo	Voltage Input - Low Ohms Low (2-Wire) Ohms Sense Low (4-Wire)

The block of terminals is extended forward by pressing the release catch at the top left-hand corner of the rear panel (viewing from the front). To retract the block for transit, hold the release catch pressed, slide the block back into the body of the instrument, then release the catch.

PL11 and PL12 - Rear Inputs

The two rear panel input channels incorporate two identical 50-way Cannon ‘D’ type plugs, each reduced to six pins, and fitted with screw locks for strain relief. Channel A is connected via PL12, and Channel B via PL11. The layout of the pins and their designations are shown below.

Two sets of socket parts are provided with the instrument, so that users can make up input sockets to fit these plugs to suit their own installations. Refer to Section 1, page 1-5.

Pin Layout and Designations

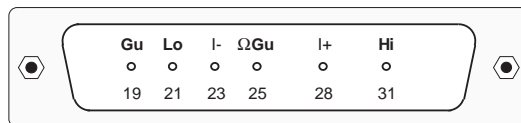

SK9 - External Trigger Input

This co-axial BNC socket can be used to trigger a measurement when external triggers are enabled. The single pin is pulled up internally to +5V, and requires a negative-going TTL edge to initiate the reading.

SK7 - IEEE 488 Input/Output

Compatibility

The IEEE input/output is a 24-way Amphenol connector which is directly compatible with the IEEE 488 interface and the IEC 625 Bus.

Note that the Bus Address is set from the front panel (refer to Section 5).

Pin Layout

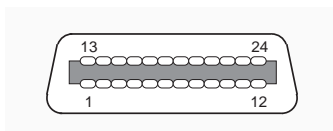

Pin Designations

Pin No.	Name	Description
1	DIO 1	Data Input/Output Line 1
2	DIO 2	Data Input/Output Line 2
3	DIO 3	Data Input/Output Line 3
4	DIO 4	Data Input/Output Line 4
5	EOI	End or Identify
6	DAV	Data Valid
7	NRFDF	Not Ready For Data
8	NDAC	Not Data Accepted
9	IFC	Interface Clear
10	SRQ	Service Request
11	ATN	Attention
12	SHIELD	Screening on cable (connected to 1281 safety ground)
13	DIO 5	Data Input/Output Line 5
14	DIO 6	Data Input/Output Line 6
15	DIO 7	Data Input/Output Line 7
16	DIO 8	Data Input/Output Line 8
17	REN	Remote Enable
18	GND 6	Gnd wire of DAV twisted pair
19	GND 7	Gnd wire of NRFDF twisted pair
20	GND 8	Gnd wire of NDAC twisted pair
21	GND 9	Gnd wire of IFC twisted pair
22	GND 10	Gnd wire of SRQ twisted pair
23	GND 11	Gnd wire of ATN twisted pair
24	GND	1281 Logic Ground (internally connected to 1281 Safety Ground)

SK8 - I/O Port

This is a 15-way Cannon ‘D’ type socket, fitted with screw locks for strain relief. It provides for inputs and outputs as listed below; for more information refer to Section 4.

A spare D type socket is provided with each new instrument, so that users can make up a connector to fit this plug to suit their own installations. Refer to Section 1, page 1-5.

Pin Layout

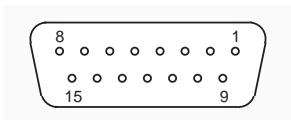

Pin Designations

Pin	Name	Function
1	SHIELD	
2	HIGH LIMIT_L	Flag - low true
3	LOW LIMIT_L	Flag - low true
4	DATA VALID_L	Flag - low true
5	SAMPLING_H	Flag - high true
6	TRIG. TOO FAST_L	Flag - low true
7	DIGITAL COMMON	
8	ANALOG OUTPUT	(Option 70 only)
9	SPARE	
10	SPARE	
11	SPARE	
12	SPARE	
13	HOLD_L	Input - low true
14	DIGITAL COMMON	
15	ANALOG O/P 0V	(Option 70 only)

SECTION 3 BASIC MEASUREMENTS

The Measurement Task	3-1
Introduction to the Front Panel	3-1
Menu Keys	3-2
Numeric Keyboard	3-3
Major Function Keys: DCV, ACV, Ohms, DCI, ACI.	3-4
Instrument Options	3-4
Initial State at Power On	3-5
Soft Key Conventions	3-6
Quick Tour of the Major Function Menus	3-7
DCV Menu	3-7
AC Voltage (Option 10)	3-10
Resistance (Option 20)	3-15
DC Current (Option 30 with Option 20)	3-28
AC Current (Option 30 with Options 10 and 20)	3-32
'Input ' and 'Status' Keys	3-37
Conclusion	3-48

SECTION 3

Basic Measurements

This section introduces the basic ‘User Interface’ of the 1281, describing how to make straightforward measurements without recourse to the more advanced features of the instrument. Descriptions of these other features can be found in Part 2, Section 4.

The Measurement Task

With the external circuit properly connected, any measurement requires us to take two actions:

1. Configure the instrument;
2. Trigger the measurement and read the result.

The 1281 allows us to choose from many actions to control these processes. As an introduction, we shall concentrate on the selections for taking basic measurements of AC and DC Voltage, AC and DC Current; and Resistance. These are not complicated - all we need to do is to work through the instrument’s selection menus.

Introduction to the Front Panel

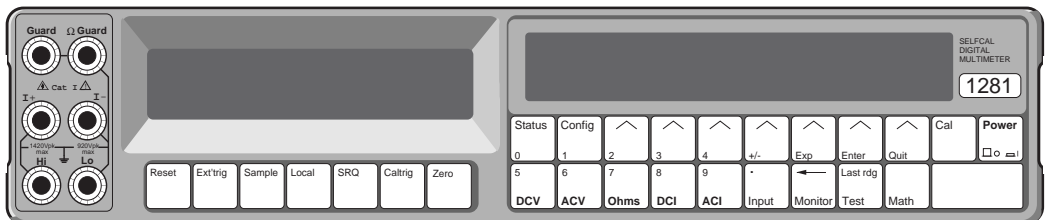

The two displays on the front panel deal with different aspects of operation. We set up the instrument’s configuration using menus shown in the right-hand (dot-matrix) display, then readings appear in the left-hand (main) seven-segment display.

Beneath the dot matrix display, all keys other than the Power key are associated with menus. The keys beneath the main display are direct action keys, associated with triggers, remote control, and instrument reset.

Menu Keys

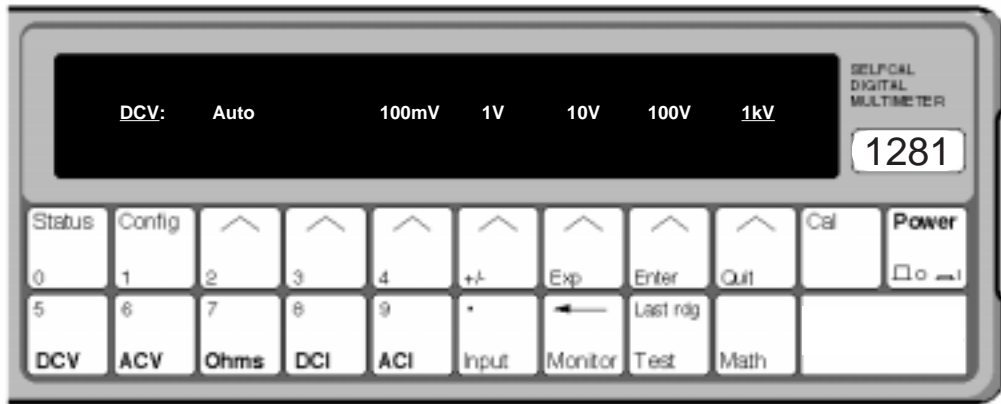

There are two classes of front panel menu keys; those that lead to an immediate change of instrument state (i.e the major function keys DCV, ACV, Ohms, DCI, ACI), and those that do not (Status, Config, Cal, Input, Monitor, Test, Math).

As well as the menu selection keys, there are seven soft function selection keys which have different actions depending on the selected menu. An arrowhead printed on each soft key lines up with a label which defines the action of the key (DCV menu version shown above).

Also, system messages (all in capitals) may appear, these assist to clarify operation.

The labelled soft keys have actions which fall into the following classes:

- Select another menu.
- Enable or disable a facility (e.g. 2 or 4-wire in Ohms). When enabled, the soft key label is underlined by a cursor.
- Trigger a direct action (e.g. 'Full' in the TEST menu activates a full selftest).

An error message appears if a selection cannot be executed (e.g. option not fitted).

Numeric Keyboard

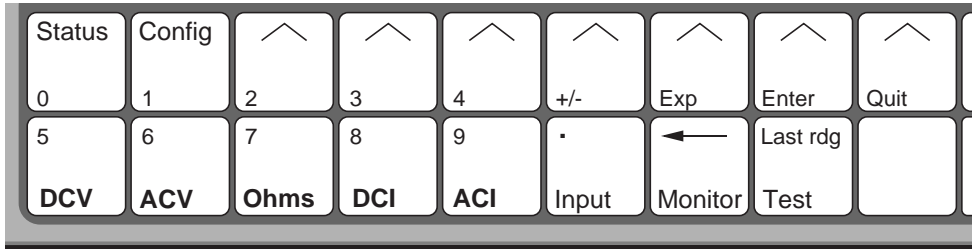

Some menu and soft function keys, shown above, also act as a keyboard for entry of parameters such as math constants, limits, bus address, etc. The data entered is purely numeric, and can consist of either a keyboard-entered value or the value of the most recent reading.

Exit from Menus

We can generally exit from any menu by selecting another menu key. For those menus where the keyboard is active, we can exit by pressing either **Enter** or **Quit**. For some menus, a special soft key permits exit by a single keystroke.

Major Function Keys: DCV, ACV, Ohms, DCI, ACI.



Each of these function keys defines a separate measurement state and activates its corresponding menu on the display. Changing a selection therefore commands a change of measurement state.

Each function has its associated **CONFIG** (Configuration) menu, which we can use to set up 'function-dependent' parameters such as resolution and filter settings. Once set up, the instrument remembers the pattern of parameter conditions in that function, so that when we reselect it on a later occasion, it remains set up as before until we change it or turn off the instrument power.

Instrument Options

Finally it is necessary to point out that although the keys for all the functions are present on the front panel, certain options (ACV, Ω or I) may not have been purchased. In these cases, the following tour is not disrupted by missing out a whole sequence related to one of those options. For this purpose a reminder is attached to the heading of each of the optional function sequences in the form of the option number.

Initial State at Power On

To see this condition, ensure that the instrument has been correctly installed in accordance with Section 2, and **operate the power switch** on the front panel.

The instrument is forced into the following state:

<i>Function</i>	DCV
<i>Range</i>	1kV
<i>Resolution</i>	6 ¹ / ₂ digits
<i>Input</i>	Front
<i>Filter</i>	Off
<i>Fast</i>	Off
<i>Remote Guard</i>	Off
<i>Ratio</i>	Off
<i>Monitor</i>	Off
<i>Math</i>	Off

Observe the **DCV Menu**:

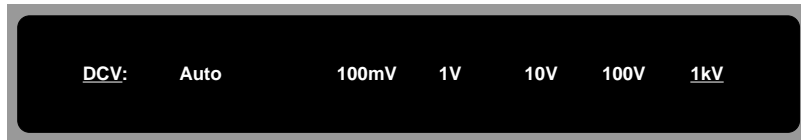

The 1kV range is underlined, showing the active selection. Autorange can be selected, the range it makes active also being underlined. It can be cancelled by any range selection, or by pressing the AUTO key a second time (in this case it reverts to the auto-selected range). Ranges themselves cross-cancel.

Leave the power switched on. We have to distinguish between three main types of action built into the operation of the soft keys. These are defined overleaf, together with the shorthand conventions we use in the quick tour to refer to them.

Soft Key Conventions

Now look at the soft keys (the ones with the arrowheads) to make some distinctions in a little more detail. Each soft key's action is defined by the legend presented above it on the display. The legends usually define three different types of soft key:

Choice key Chooses one of several possible states. Deselection is by cross-cancelling, i.e. by selecting another state.

(The ranges on the DCV menu are *Choice* keys).

cursor underline indicates 'active',

no cursor indicates 'not active'.

Toggle key Activates a particular facility - a second press when its state is active will cancel it.

(‘Filt’ on the DCV CONFIG menu is a *Toggle* key).

cursor underline indicates 'active',

no cursor indicates 'not active'.

Menu key Activates another menu - cursor not used. The whole aim of branching via a menu is to gain access to further grouped state keys at an end of the branch.

(‘Res1’ on the DCV CONFIG is a *Menu* key).

N.B. When introducing soft keys in this text we shall differentiate between the three types (to avoid lengthy paragraphs) as follows:

<i>Choice</i> key	Underlined	e.g. <u>100mV</u>
<i>Toggle</i> key	Underlined italic	e.g. <u><i>Filt</i></u>
<i>Menu</i> key	Not underlined	e.g. Res1

Note that this is purely a short method of identifying the type, and bears no relation to its physical appearance on the instrument.

Quick Tour of the Major Function Menus

The following introduction takes the form of a quick tour of the main functions, starting from Power On. To relate the descriptions to the physical appearance, process through the sequence as indicated by the pointer: 

DCV Menu (See the figures on pages 3-2 and 3-5)

This menu defines the following *choice* keys.

Auto The range it makes active is also underlined. As well as being cancelled by any range selection, it can also be cancelled by re-pressing the **Auto** key itself (in this case the instrument reverts to the auto-selected range).

Ranges: 100mV 1V 10V 100V 1kV

DCV Configuration

(Resolution, LP Filtering and Fast)



Press the **Config** key to see the DCV CONFIG menu:

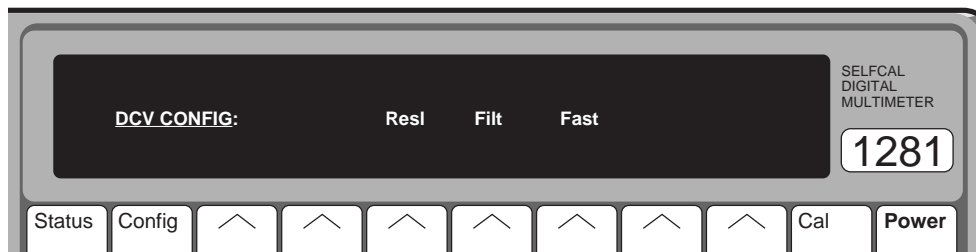

- Resl:** Displays the DCV RESL menu, to select the resolution for the reading.
- Filt:** Selects a two-pole analog filter for increased noise rejection; when active, the **Filt** annunciator is lit on the main display. Cancel by pressing the **Filt** key a second time. **Filt** is not selected at Power On.
- Fast:** Provides higher read rates at some increase in uncertainty due to noise. Cancel by pressing the **Fast** key a second time. **Fast** is not selected at Power On.

DCV Resolution



Press the Resl key to see the DCV RESL menu:

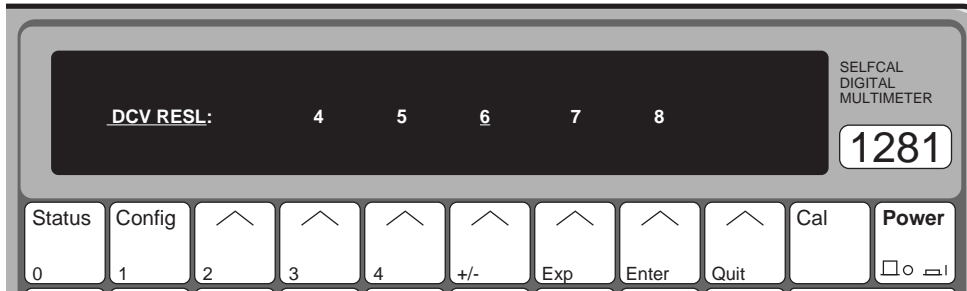

This menu defines the following *choice* keys:

- 4 4¹/₂ digits resolution
- 5 5¹/₂ digits resolution
- 6 6¹/₂ digits resolution
- 7 7¹/₂ digits resolution
- 8 8¹/₂ digits resolution

As you can see, this permits the choice of any resolution between 4¹/₂ and 8¹/₂ digits. Power On setting is 6¹/₂ digits.

Transferring from the DCV RESL menu back to the DCV CONFIG menu is by pressing the Config key.

Transferring from either menu back to the DCV menu is by pressing the DCV key.

DC Voltage - Movement between Menus

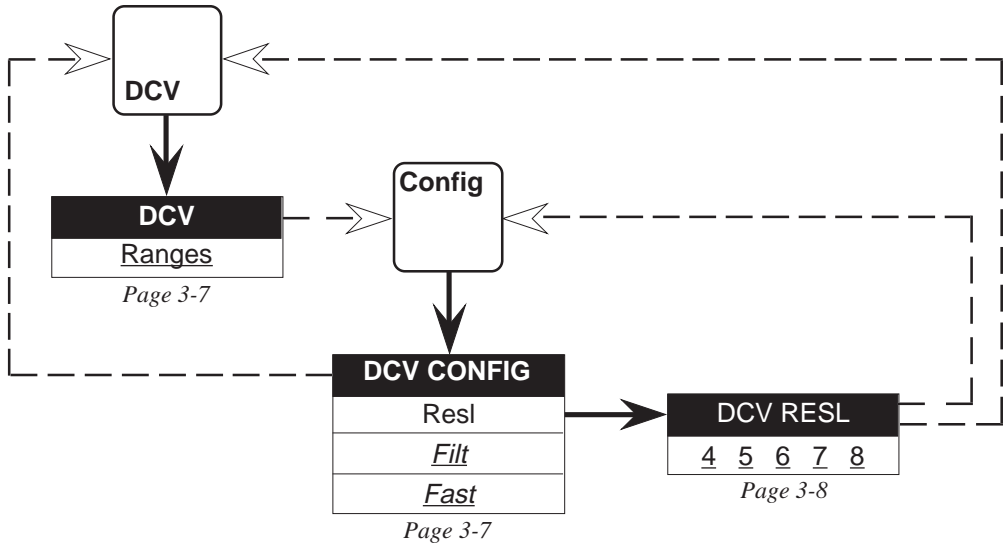

AC Voltage (Option 10)



Press the ACV key to see the ACV menu:

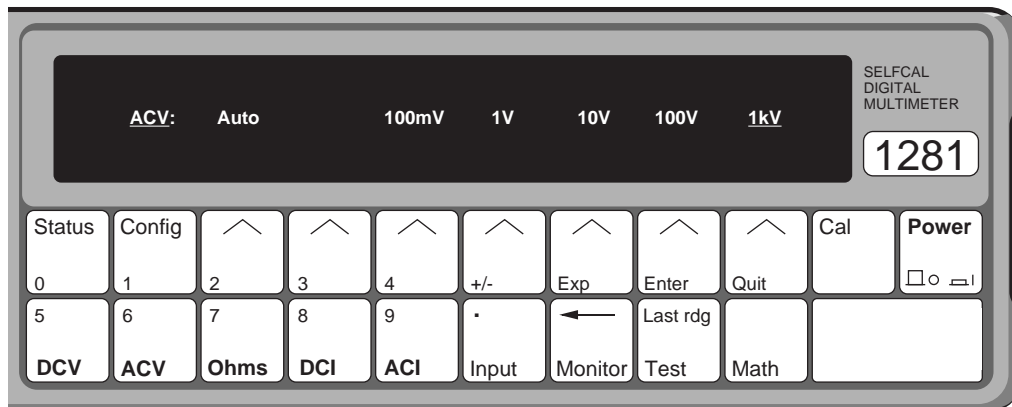

This menu defines the following *choice* keys.

Auto The range it makes active also being underlined.
As well as being cancelled by any range selection, it can also be cancelled by re-pressing the Auto key (in this case it reverts to the auto-selected range).

Ranges: 100mV 1V 10V 100V 1kV

ACV Configuration

(Resolution, LP Filtering, AC/DC Transfer, DC Coupled and Spot Frequency)



Press the Config key to see the ACV CONFIG menu:

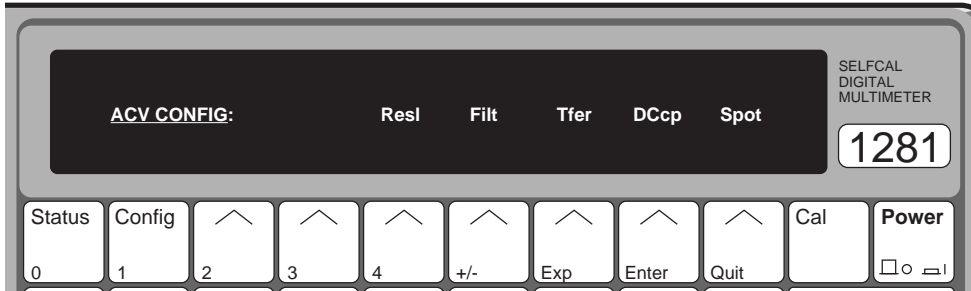

This menu defines the following soft keys.

Resl and Filt are *menu* keys, but Tfer and DCcp and Spot are *toggle* keys.

- Resl:** Displays the ACV RESL menu, where the resolution for the reading can be selected.
- Filt:** Displays the ACV FILT menu, to extend the LF bandwidth to the lowest frequency to be input.
- Tfer:** Selects electronic AC-DC transfer for AC measurement, improving linearity and temperature performance. Tfer is selected at Power On. **N.B.** Measurement results are invalid when using internal triggers in Transfer mode with the 1 Hz filter selected. For valid results, use Ext Trig and Sample, or trigger via the IEEE-488 interface.
- DCcp:** Selects DC coupled measurement configuration. We can therefore choose to measure either the RMS of a combined AC and DC signal (DC Coupled - DCcp On), or just the RMS of the AC component (AC Coupled - DCcp Off). DCcp is not selected at Power On.
- Spot:** Selects a Spot Frequency measurement mode, where the calibration constants derived for previously calibrated spots are applied for frequencies within $\pm 10\%$ of a spot frequency. This reduces flatness errors. Spot is not selected at power on.

ACV Resolution



Press the Resl key to see the ACV RESL menu:

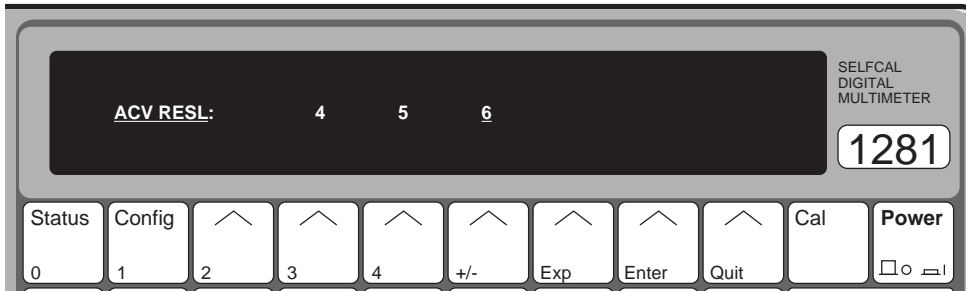

This menu defines the following *choice* keys:

- 4 4¹/₂ digits resolution
- 5 5¹/₂ digits resolution
- 6 6¹/₂ digits resolution

Power On setting is 6¹/₂ digits.



Transfer back to the ACV CONFIG menu by pressing the Config key.

ACV Filter



Press the Filt key to see the ACV FILTER menu:

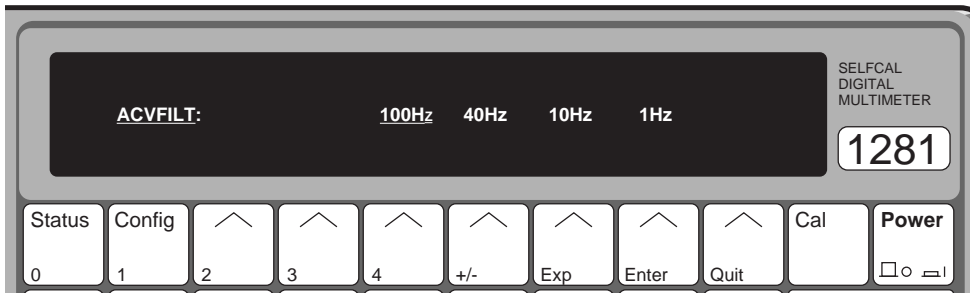

This menu permits any one of four LF filters to be used for AC Voltage measurement. Each *choice* key selects a filter whose lowest pass frequency is as shown.

Power On setting is 100 Hz.

N.B. Measurement results are invalid with the 1 Hz filter selected when using internal triggers in Transfer mode. For valid results, use **Ext Trig** and **Sample**, or trigger the instrument via the IEEE-488 interface.

AC Voltage - Movement between Menus

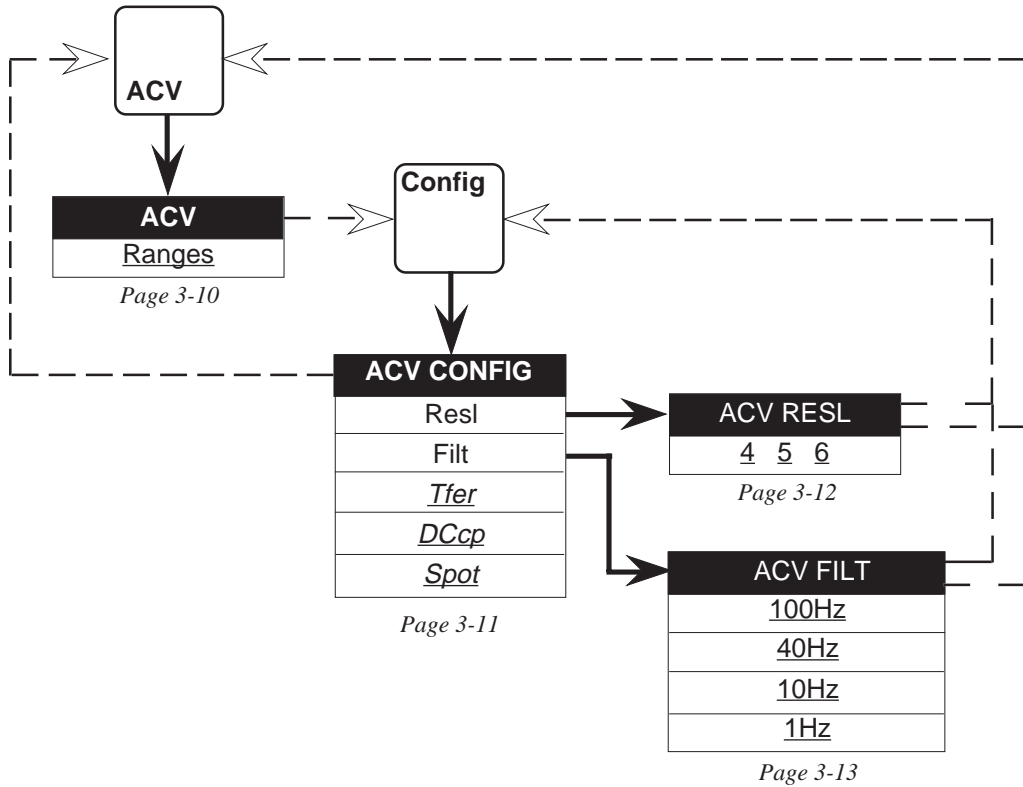

Broken lines indicate use of soft keys

Resistance (Option 20)



Transfer to the OHMS menu by pressing the Ohms key.

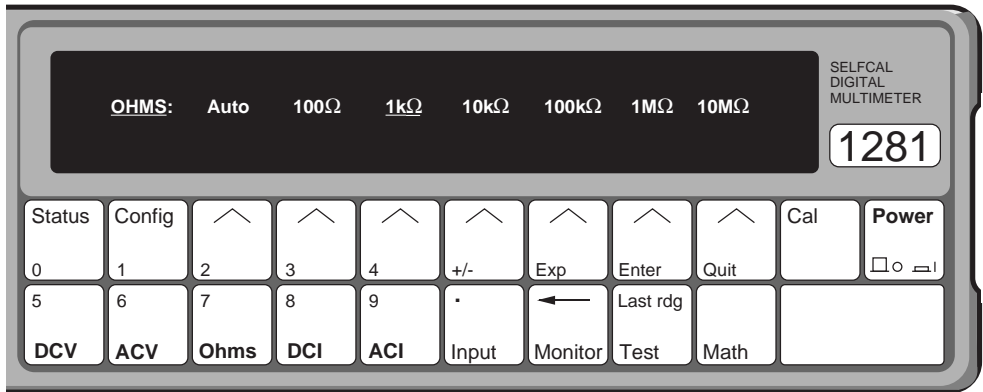

One of three possible menus will be displayed by pressing this key, depending on the most recent earlier selection in the Ohms function.

OHMS This is the normal resistance mode, offering both 2-wire and 4-wire measurements, in decade ranges from 100Ω to 10MΩ. The two higher ranges 100MΩ and 1GΩ are the subject of the HIΩ menu, and the 10Ω range is included in the TRUΩ menu; both are described later.

Auto The range it makes active is also underlined. As well as being cancelled by any range selection, Auto can also be cancelled by re-pressing the Auto key (in this case it reverts to the auto-selected range).

The OHMS menu is selected On at Power On.

OHMS Configuration

(Change Ω Mode, Resolution, Filter, Fast, Low Current and 4-Wire Operation)



Press the Config key to see the OHMS CONFIG menu:

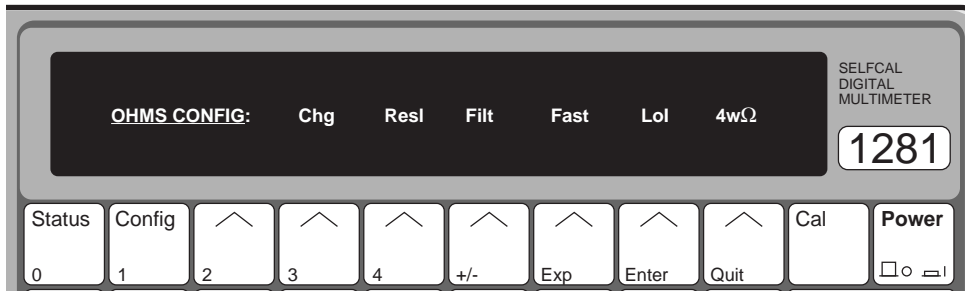

Chg and Resl are *menu* keys, but Filt, Fast, LoI, and 4w Ω are *toggle* keys.

- Chg:** Displays the CHANGE menu, which gives the choice of selecting either the OHMS, HI Ω or TRU Ω menus.
- Resl:** Displays the OHMS RESL menu, where the resolution for the reading can be selected.
- Filt:** Selects a two pole analog filter for increased noise rejection. When selected, the Filt annunciator on the main display is lit. Filt is not selected at Power On.
- Fast:** Selects higher read rates at some increase in uncertainty due to noise. Fast is not selected at Power On.
- LoI:** Selects a set of lower value measurement currents necessary for certain applications such as PRTs. LOI is not selected at Power On.
- 4w Ω :** Selects 4-wire resistance measurements; where the constant current is fed through the test resistance from the instrument's I+ and I- terminals. The resulting potential difference is sensed by the Hi and Lo terminals. When selected, the 4w annunciator is lit on the main display. Otherwise all measurements are 2-wire, current being sourced from the Hi and Lo terminals. 4w Ω is not selected at Power On.

OHMS Resolution



Press the Resl key to see the OHMS RESL menu:

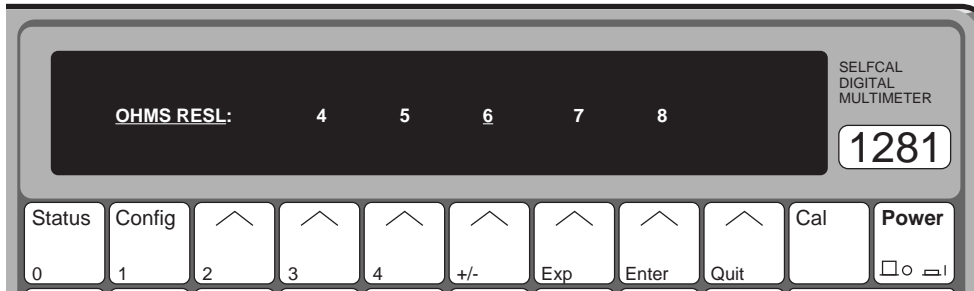

This menu defines the following *choice* keys:

- 4 4^{1/2} digits resolution
- 5 5^{1/2} digits resolution
- 6 6^{1/2} digits resolution
- 7 7^{1/2} digits resolution
- 8 8^{1/2} digits resolution

This permits the choice of any resolution between 4^{1/2} and 8^{1/2} digits.
Power On setting is 6^{1/2} digits.



Transfer from the OHMS RESL menu back to the OHMS CONFIG menu by pressing the Config key.

CHANGE Ω Menu



Press the Chg key to see the CHANGE Ω menu:

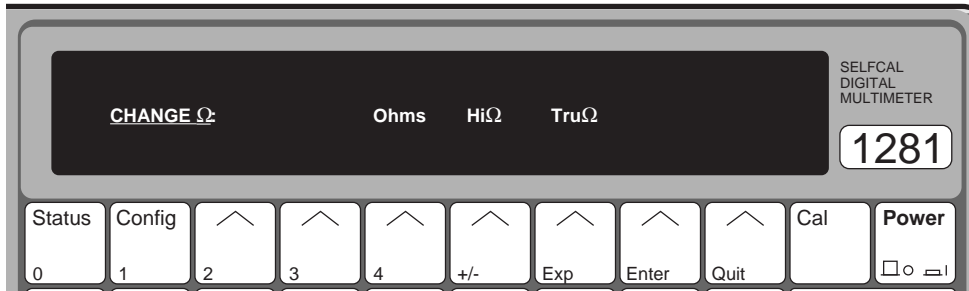

The CHANGE Ω menu is accessible from all three Ohms modes, and itself gives access to all three modes. It defines the following menu keys, each selecting a different Ohms mode menu:

- Ohms Selects the OHMS menu described above for the normal Ohms ranges.
- Hi Ω Selects the HI Ω menu.
- Tru Ω Selects the TRU Ω menu.

Ohms - Movement between Menus

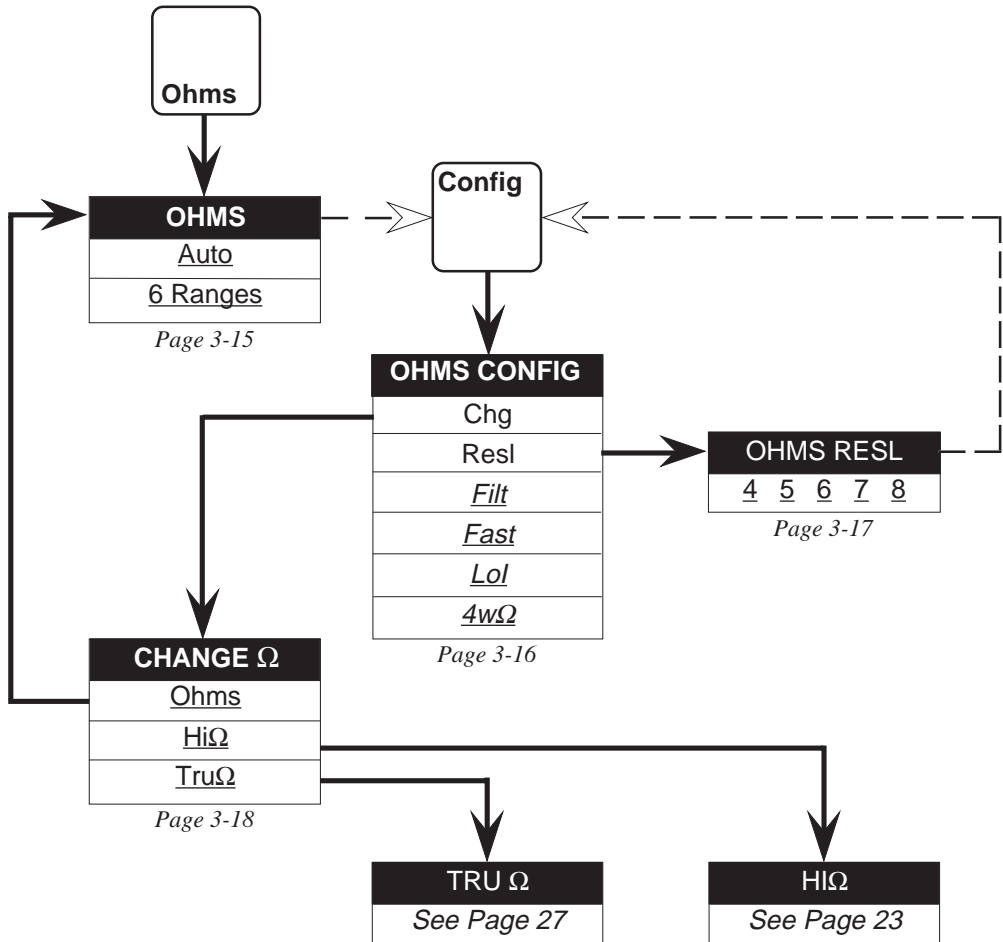

Higher Ohms Ranges ($100M\Omega$ and $1G\Omega$)



Press the $Hi\Omega$ key to see the $HI\Omega$ menu:



The $HI\Omega$ menu gives access to the two higher ranges not present on the normal OHMS menu. The ‘Autorange’, ‘Fast’ and ‘Low Current’ facilities are not available, and the range of resolutions is restricted. It defines the following keys:

$100M\Omega$ and $1G\Omega$ are *choice* keys that each cause the instrument to enter the selected range. Ohms is a *menu* key.

$100M\Omega$ Puts the instrument into its $100M\Omega$ range.

$1G\Omega$ Puts the instrument into its $1G\Omega$ range.

Ohms Selecting Ohms in this menu causes the display to revert to the normal OHMS menu.

The $HI\Omega$ menu is not selected at Power On.

N. B. Whenever $Hi\Omega$ is active, in any menu, pressing the hard Ohms function key will display this $HI\Omega$ menu.

HIΩ Configuration

The HIΩ facility has its own configuration menu:



Press the Config key to see the HIΩ CONFIG menu:

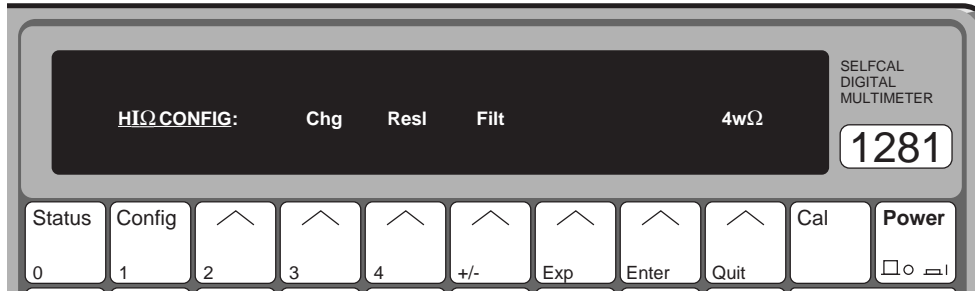

Chg and Resl are *menu* keys, but Filt and 4wΩ are *toggle* keys.

- Chg:** Displays the CHANGE menu, which gives the choice of selecting either the OHMS, HIΩ or TRUΩ menus, as described earlier.
- Resl:** Displays the HIΩ RESL menu, where the resolution for the reading can be selected.
- Filt:** Selects a two pole analog filter for increased noise rejection. When selected, the Filt annunciator on the main display is lit. Filt is not selected at Power On.
- 4wΩ:** Selects 4 wire resistance measurements; where the constant current is fed through the resistance-under-test from the I+ and I- terminals of the instrument, and the resulting potential difference is sensed by the Hi and Lo terminals. When selected, the 4W annunciator is lit on the main display. When not selected, all measurements are 2-wire with current being sourced from the Hi and Lo terminals. 4WΩ is not selected at Power On.

HIΩ Resolution



Press the Resl key to see the HIΩ RESL menu:



This menu defines the following *choice* keys:

- 4 4^{1/2} digits resolution
- 5 5^{1/2} digits resolution
- 6 6^{1/2} digits resolution

Power On setting is 6^{1/2} digits.



Transfer from the HIΩ RESL menu back to the HIΩ CONFIG menu by pressing the Config key.

CHANGE to TRUΩ



Press the Chg key to see the CHANGE Ω menu:



Press the TruΩ key to see the TRUΩ menu:

HIΩ - Movement between Menus

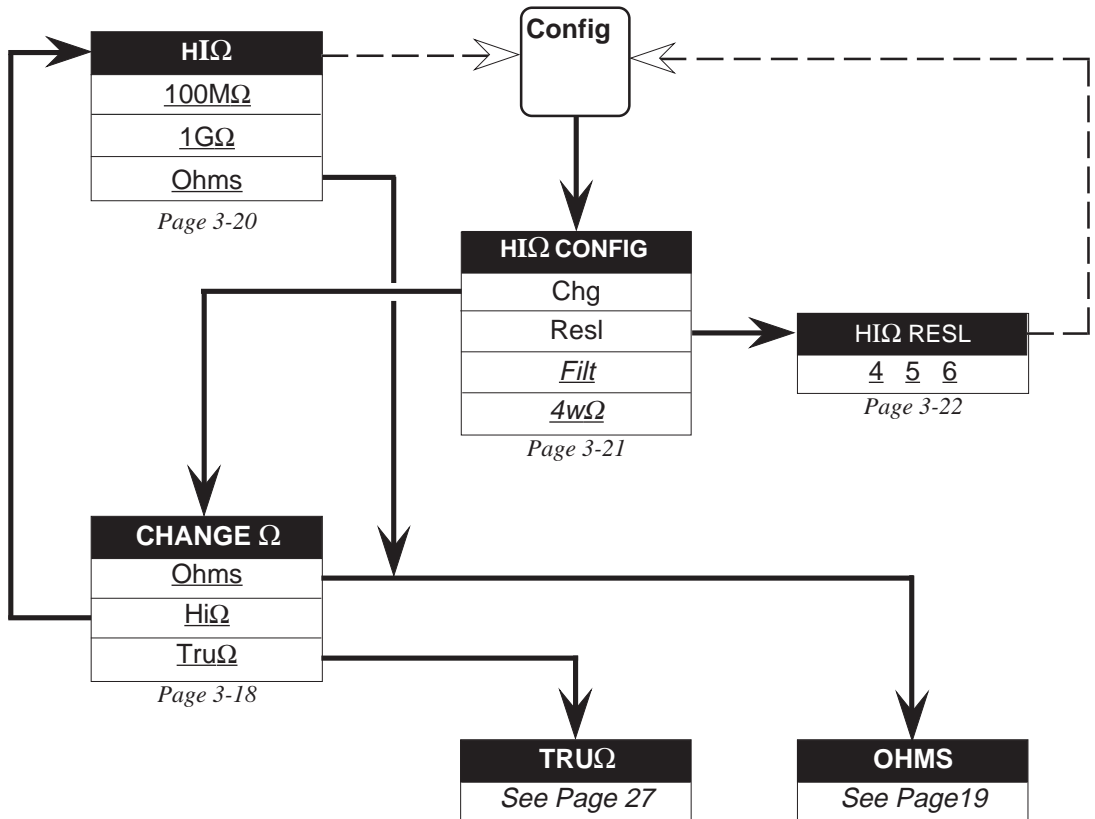

True Ohms Facility

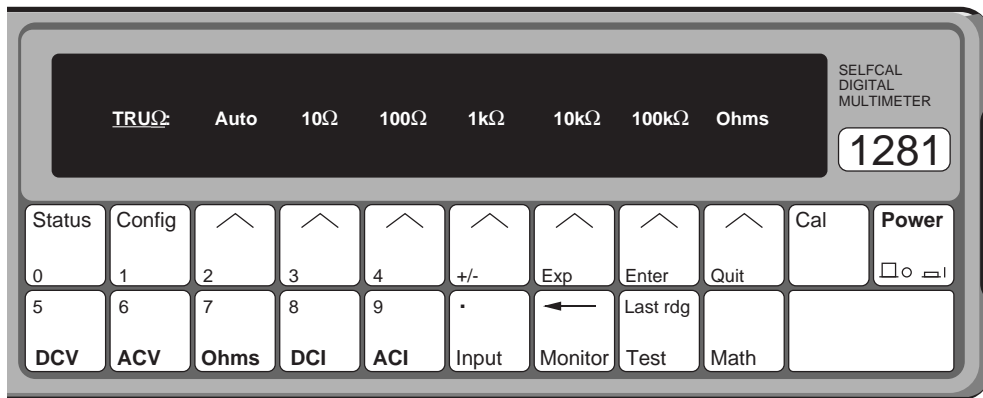

The TRUΩ mode generates two readings per measurement. The first is taken with the constant current flowing; the second without the current, measuring any external EMFs that may be present. The difference between the two readings is then calculated, giving an offset-corrected measurement.

Note that this mode provides an additional 10Ω range.

The menu defines the following keys:

The Range keys are *choice* keys, but Ohms is a *menu* key.

Auto, and the 10Ω - 100kΩ range keys act normally to set the instrument range.

Ohms Selecting Ohms in this menu causes the display to revert to the normal OHMS menu.

The TRUΩ menu is not selected at Power On.

N. B. Whenever TruΩ is active, in any menu, pressing the hard Ohms function key will display this TRUΩ menu.

TRUΩ Configuration



Press the Config key to see the TRUΩ CONFIG menu:

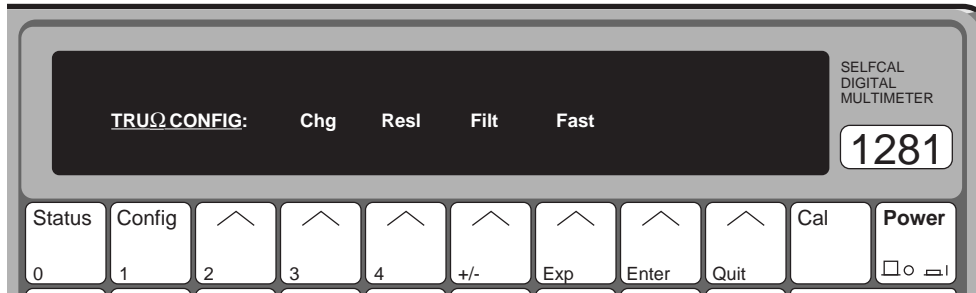

This menu defines the following keys:

Chg and Resl are *menu* keys, but Filt and Fast are *toggle* keys.

- Chg: Displays the CHANGE menu, which gives the choice of selecting either the OHMS, HIΩ or TRUΩ menus, as described earlier.
- Resl: Displays the TRUΩ RESL menu, where the resolution for the reading can be selected.
- Filt: Selects a two pole analog filter for increased noise rejection. When selected, the Filt annunciator on the main display is lit. Filt is not selected at Power On.
- Fast: Selects higher read rates at some increase in uncertainty due to noise. Fast is not selected at Power On.

TRUΩ Resolution



Press the Resl key to see the TRUΩ RESL menu:



This menu defines the following *choice* keys:

- 4 4^{1/2} digits resolution
- 5 5^{1/2} digits resolution
- 6 6^{1/2} digits resolution
- 7 7^{1/2} digits resolution
- 8 8^{1/2} digits resolution

This permits the choice of any resolution between 4^{1/2} and 8^{1/2} digits.

Power On setting is 6^{1/2} digits.



Transfer from the TRUΩ RESL menu back to the TRUΩ CONFIG menu by pressing the Config key.

CHANGE back to Ohms



Press the Chg key to see the CHANGE Ω menu:



Press the Ohms key to revert to the OHMS menu:

We have now moved through all the resistance menus, and back to the basic OHMS menu.

TRUΩ - Movement between Menus

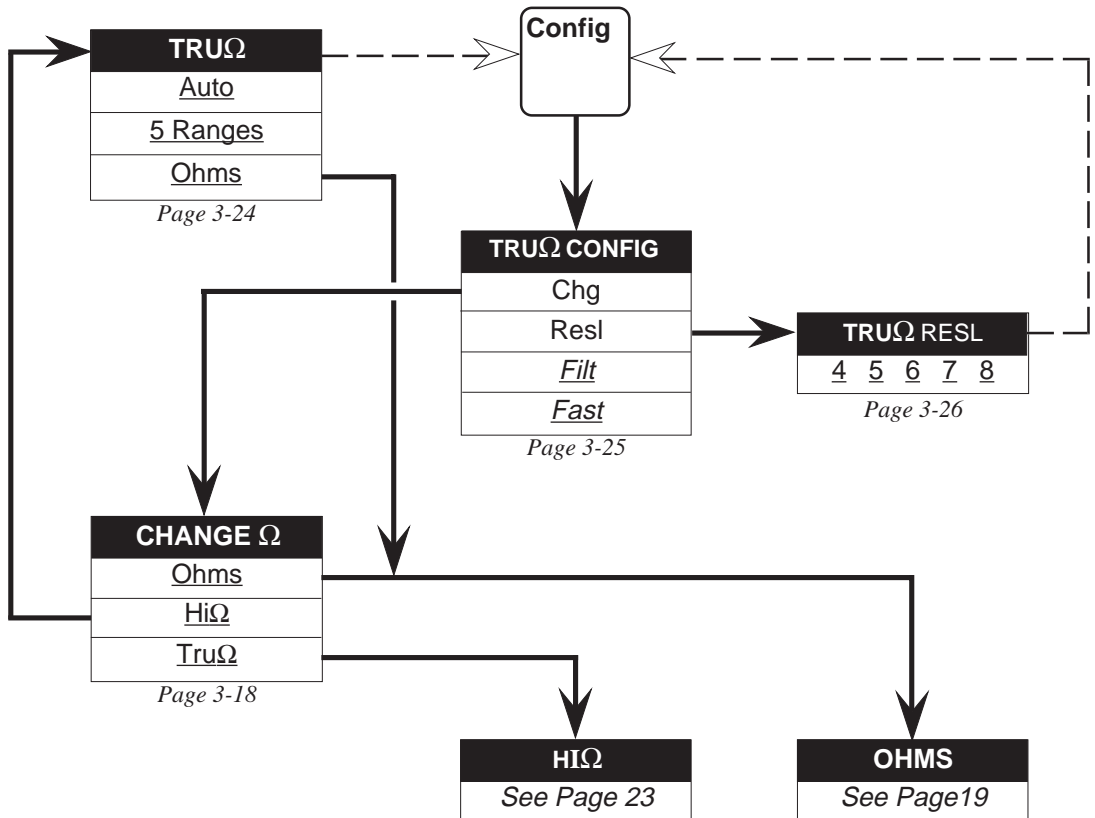

DC Current (Option 30 with Option 20)



Press the DCI key to Transfer from OHMS to the DCI menu.

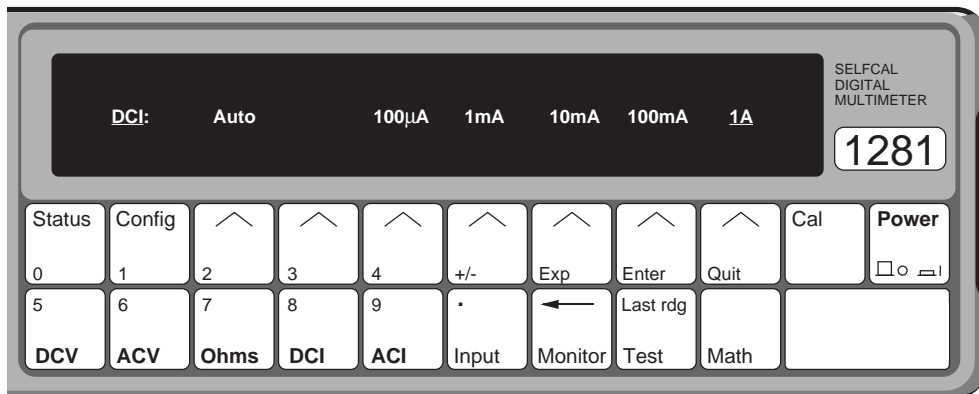

DCI Menu

This menu defines the following *choice* keys.

Auto The range it makes active also being underlined.
As well as being cancelled by any range selection, it can also be cancelled by re-pressing the Auto key (in this case it reverts to the auto-selected range).

Ranges: 100µA 1mA 10mA 100mA 1A

DCI Configuration

(Resolution, LP Filtering and Fast)



Press the **Config** key to see the DCI CONFIG menu:



- Resl:** Displays the DCI RESL menu, where the resolution for the reading can be selected.
- Filt:*** Selects a two pole analog filter for increased noise rejection. When selected, the **Filt** annunciator on the main display is lit.
Filt is not selected at Power On.
- Fast:*** Selects higher read rates at some increase in uncertainty due to noise.
Fast is not selected at Power On.

DCI Resolution



Press the Resl key to see the DCI RESL menu:

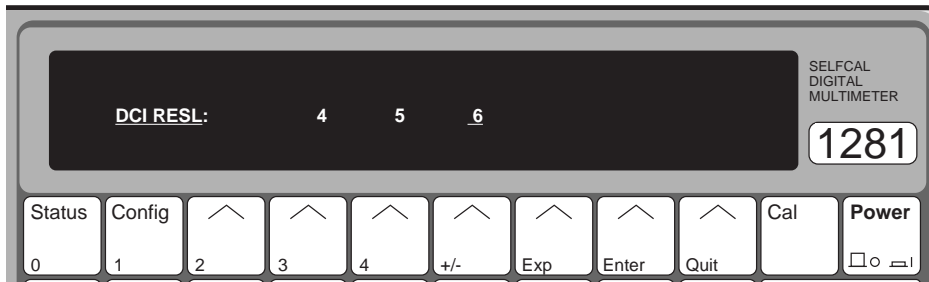

This menu defines the following *choice* keys:

- 4 4¹/₂ digits resolution
- 5 5¹/₂ digits resolution
- 6 6¹/₂ digits resolution

As you can see, this permits the choice of any resolution between 4¹/₂ and 6¹/₂ digits. Power On setting is 6¹/₂ digits.

Transferring from the DCI RESL menu back to the DCI CONFIG menu is by pressing the Config key.

Transferring from either menu back to the DCI menu is by pressing the DCI key.

DC Current - Movement between Menus

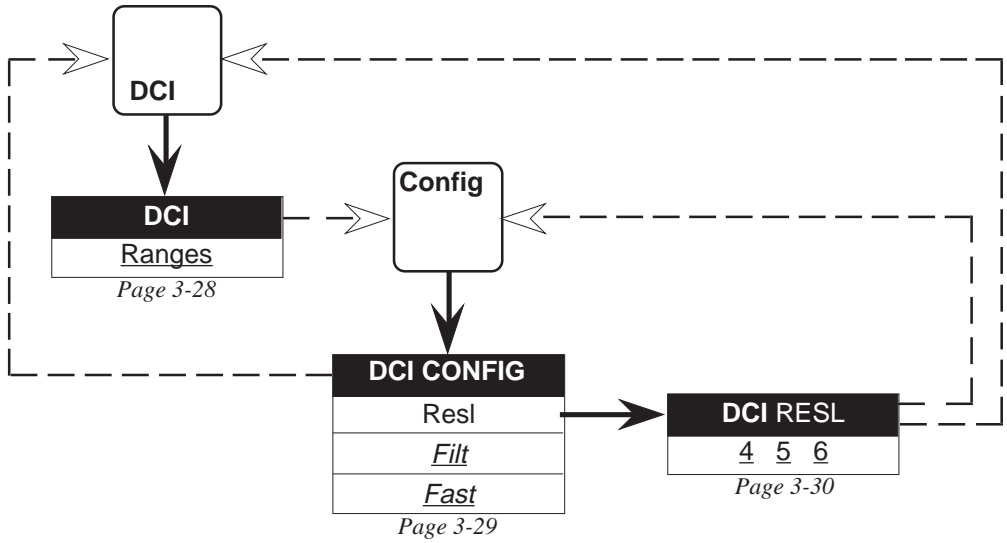

AC Current (Option 30 with Options 10 and 20)



Press the ACI key to see the ACI menu:

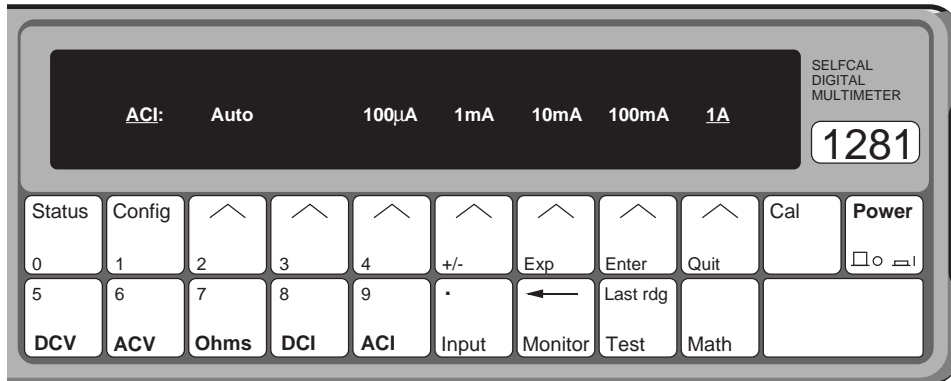

This menu defines the following *choice* keys.

Auto The range it makes active also being underlined.
As well as being cancelled by any range selection, it can also be cancelled by re-pressing the Auto key (in this case it reverts to the auto-selected range).

Ranges: 100µA 1mA 10mA 100mA 1A

ACI Configuration

(Resolution, LP Filtering and DC Coupled)



Press the Config key to see the ACI CONFIG menu:

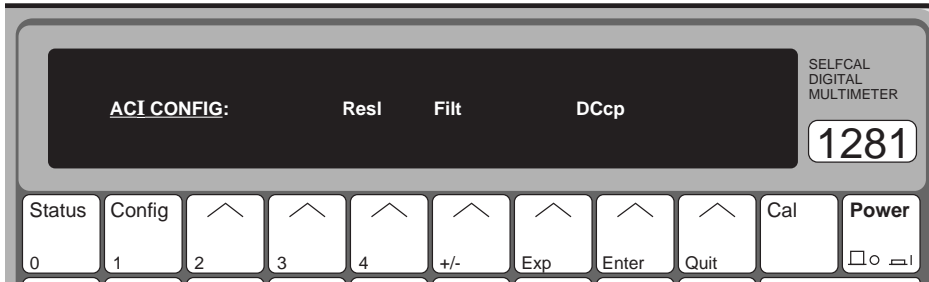

This menu defines the following keys.

Resl and Filt are *menu* keys, but DCcp is a *toggle* key.

- Resl: Displays the ACI RESL menu, where the resolution for the reading can be selected.
- Filt: Displays the ACI FILT menu, where the integration filter appropriate to the signal frequency can be selected.
- DCcp: Selects DC coupled measurement configuration. We can therefore choose to measure either the RMS of a combined AC and DC current (DC Coupled - DCcp On), or just the RMS value of the AC component (AC Coupled - DCcp Off). DCcp is not selected at Power On.

ACI Resolution



Press the Resl key to see the ACI RESL menu:



This menu defines the following *choice* keys:

4 4¹/₂ digits resolution

5 5¹/₂ digits resolution

Power On setting is 5¹/₂ digits.



Press the Config key to transfer back to the ACI CONFIG menu.

ACI Filter

Press the Filt key to see the ACI FILT menu:

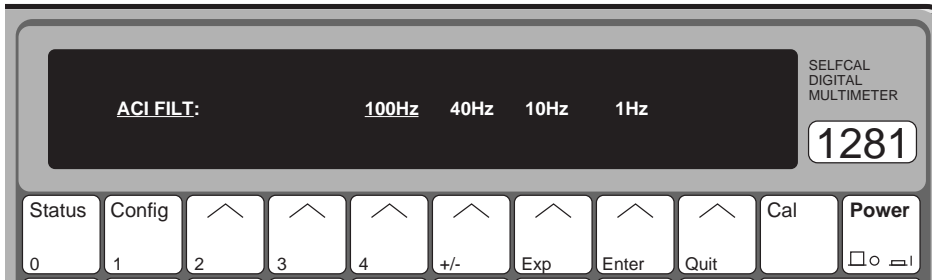

This menu permits any one of four integration filters to be used for the AC Current measurement. It defines the following *choice* keys, each selecting a filter with recommended lowest frequency as shown below and on the dot-matrix display:

100Hz, 40Hz, 10Hz and 1Hz

Power On setting is 100Hz.

AC Current - Movement between Menus

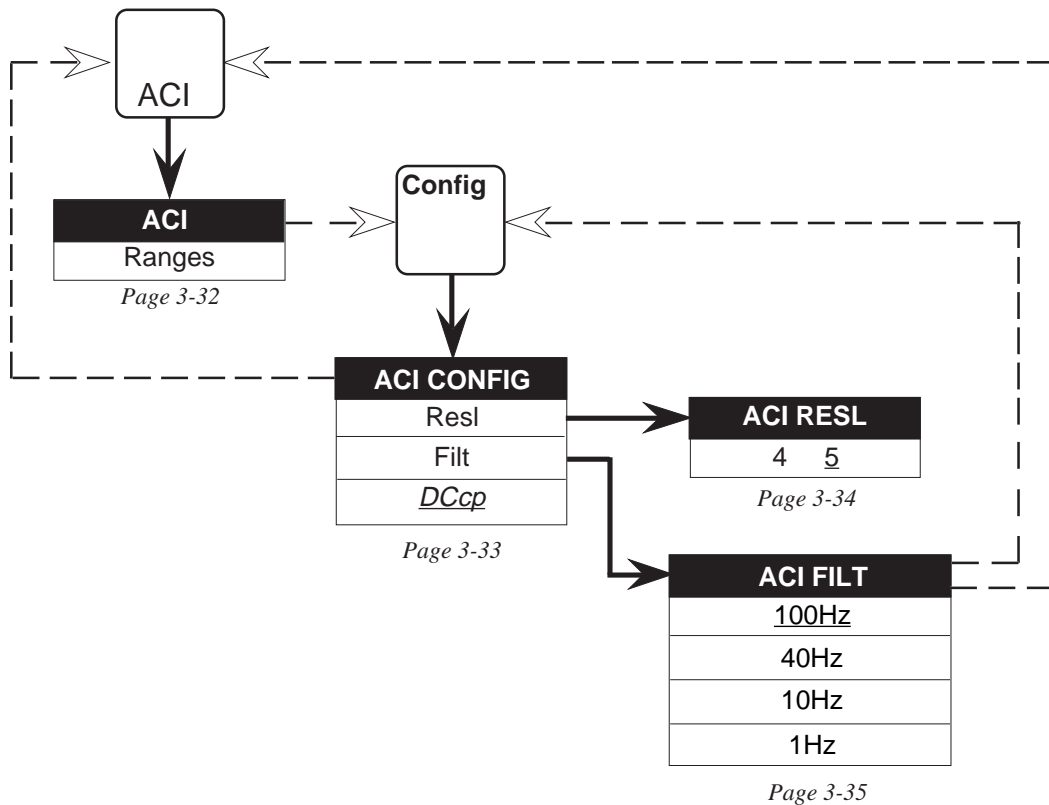

'Input' and 'Status' Keys

So far in this section, we have concentrated on the menus of the keys that select the type of physical quantity to be measured - we call them the Main Function keys. With these, we can configure the functions so that basic measurements conform to our requirements. Obviously the instrument is capable of more sophisticated operation than just taking straightforward measurements.

These are discussed in subsequent sections, but there are two keys which are relevant to basic measurements.

Input Key

The Input key and its menu permit us to select any one of the three external connections into the multimeter. These are: the Front terminals; and the two input connectors on the back panel: Channel A and Channel B. The Input key also allows us to scan Channels A and B alternately, performing two simple calculations on the resulting readings:

A-B: the absolute difference between the two readings, is useful to compare an unknown signal at Channel A with a reference signal at Channel B.

A/B: the ratio between the two readings, permits such measurements as AC-to-DC transfers at speeds well in excess of those attainable by thermal transfer.

We can also combine the two calculations. With both selected, the result of the normalized 'deviation' calculation ($\{A-B\} \div B$) is produced on the Main display.

Status Key

Using the Status key, we can review the instrument parameters that are currently set up, over and above those indicated by the annunciators on the main display.

In addition, the IEEE 488 bus address can be displayed and changed if required.

INPUT Menu



Press the Input key to see the INPUT menu:

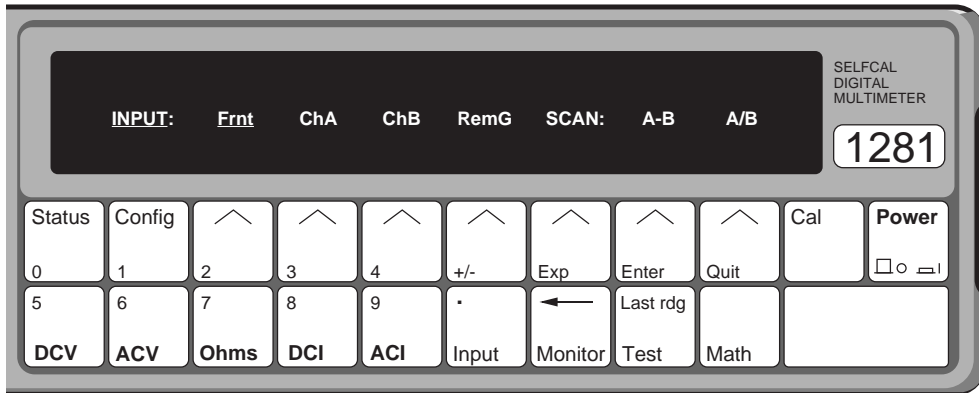

SCAN is a menu that defines only the two keys A-B and A/B. They interact with the other keys of the INPUT menu, so six soft keys are defined. When all six are unselected, an isolated-input state is defined. There is **no** INPUT CONFIG menu.

RemG is a straightforward *toggle* key. The other five interact (see the opposite page) but first here are their facilities:

Frnt Activates Front Input terminals only.

ChA Activates Rear Input Channel A only.

ChB Activates Rear Input Channel B only.

RemG This activates Remote Guard configuration, decoupling the internal guards from LO and connecting them to the Guard terminal. It can be applied to any of the other selections in the two menus. When selected, the RemG annunciator on the main display is lit.

A-B Activates the Rear Input Channels A and B.

Readings are taken alternately from each channel; then the Channel B reading value is subtracted from the Channel A value to produce the measurement shown on the main display.

A/B Activates the Rear Input Channels A and B. Readings are taken alternately from each channel; then the Channel A reading value is divided by the Channel B value to produce the measurement shown on the main display.

A-B with A/B

Activates the Rear Input Channels A and B. Readings are taken alternately from each channel; the Channel B value is subtracted from the Channel A value; then the Result is divided by the Channel B value to produce the measurement shown on the main display. This is the normalized 'deviation' value: $[(A - B) \div B]$.

Power-On Input Default

Frnt (Front Input) is selected **On** at Power on. All other selections are **Off**.

Soft Keys - Interaction

Frnt, ChA and ChB act as *choice* keys, also cross-cancelling A-B and A/B.

However; when one of these three inputs is selected, a second press will deselect it, as if its key were a *toggle* key.

A-B and A/B act as *toggle* keys, as a second press cancels and they can both be selected together. **However**; either will cross-cancel Frnt, ChA or ChB.

RemG is a normal *toggle* key.

Total Isolation State

All facilities on these two menus can be deselected, whereupon the DMM has no input. This state is useful in a remote control system, to isolate the DMM from the system's analog bus.

Instrument Status Reporting



Press the **Status** key to see the **STATUS** report:

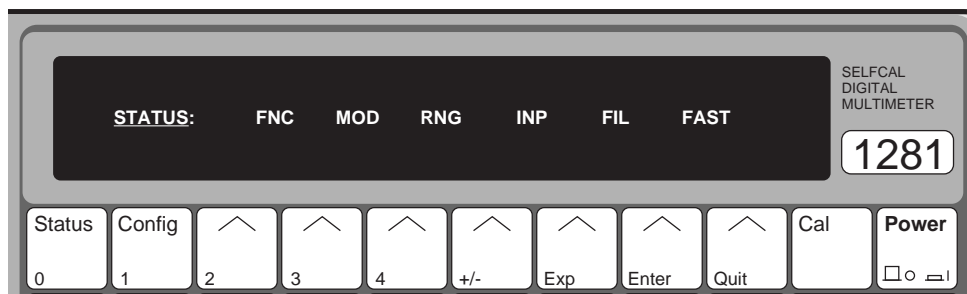

Status is a complete report of the most recent selections made using any of the various menus. It can be used at any time as a fast means of checking that the DMM selections are suitable for the measurement being made.

The legends shown in the above diagram do **not** actually appear, they only mark the approximate positions for legends that can appear. Each is an abbreviation which merely acts as a key to the list below. The meaning and possible parameters which appear in each position are given in the list:

Abbr.	Meaning	Possible Parameters
FNC	Function	DCV, ACV, OHMS, TRUΩ, HIΩ, DCI, ACI, SPOTF.
MOD	Modifier	DCcp, LoI.
RNG	Range	Auto; 100mV, 1V, 10V, 100V, 1kV; 10Ω, 100Ω, 1kΩ, 10kΩ, 100kΩ, 1MΩ, 10MΩ, 100MΩ, 1GΩ; 100μA, 1mA, 10mA, 100mA, 1A.
INP	Input	Frnt, ChA, ChB, Open, A-B, A/B, Devn.
FIL	Filter	100Hz, 40Hz, 10Hz, 1Hz.
FAST	Fast/Tfer	Fast, Transfer.

Status Configuration

(IEEE 488 Bus Address, Power Line Frequency, Spot Frequencies and Serial Number/Software Issue)



Press the Config key to see the STATUS CONFIG menu:

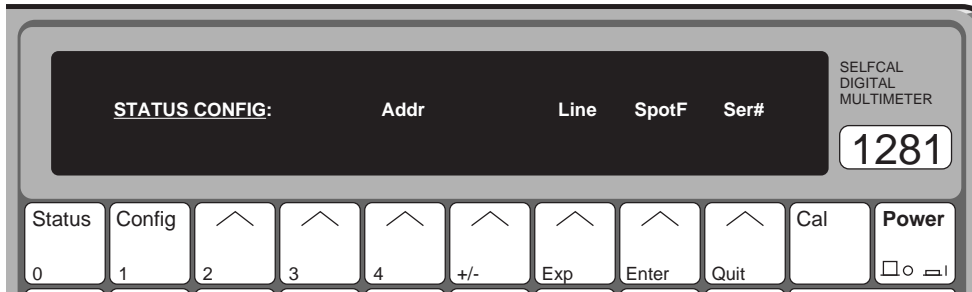

This is a menu, defining the following *menu* keys.

- Addr: displays the ADDRESS menu, to review and change the IEEE-488 bus address of the instrument.
- Line: displays the LINE menu, to review the power line frequency setting for the instrument.
- SpotF: displays the SPOTF menu, to review the spot frequencies at which the instrument has been calibrated.
- Ser#: displays the SER# menu, to review the serial number and software issue of the instrument.

IEEE 488 ADDRESS



Press the Addr key to see the IEEE 488 ADDRESS:



This menu permits entry of a value to be used as an IEEE-488 bus address.

Initially, the menu displays the present address value, and the numeric-keyboard keys are activated. Any valid numeric value (0-30) may be entered.

Pressing **Enter** stores the new value (or restores the old value if unchanged), but pressing **Quit** leaves the old value intact.

Either **Enter** or **Quit** causes exit back to the **STATUS CONFIG** menu.



Transfer from the **ADDRESS** menu back to the **STATUS CONFIG** menu by pressing the **Config** key.

LINE Frequency



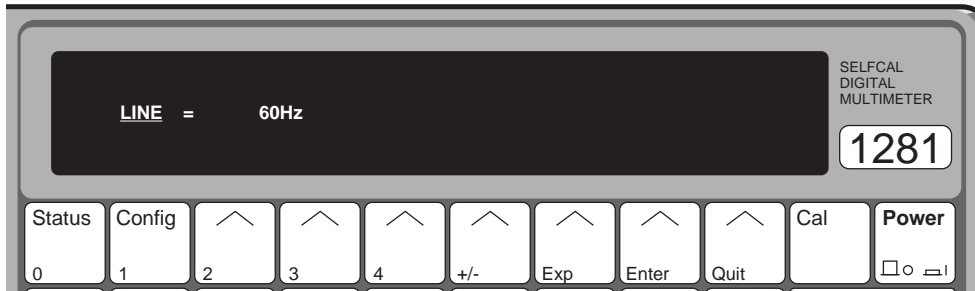

Press the Line key to see the LINE frequency:



This displays the power-line frequency to which the instrument has been adapted. Only two settings are possible: **50Hz** or **60Hz**. The adaptation cannot be altered except in one of the calibration menus. Once adapted, the setting is not lost when the instrument power is turned off.

SPOTF Menu

-  Press the ACV key to select an AC Voltage range.
-  Press the Status then Config keys for the STATUS CONFIG display.
-  Press the SpotF soft key to see the SPOTF menu:

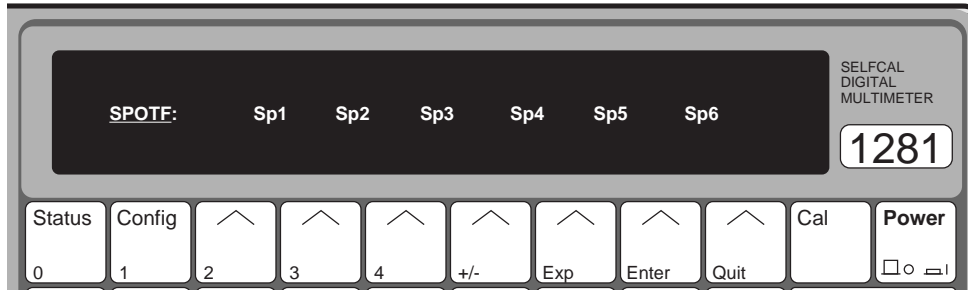

This menu is obtained by selecting SpotF from the STATUS CONFIG menu when the instrument is in ACV - Spot Frequency mode.

It defines six soft *menu* keys, each associated with one of the six possible spot frequencies that the user could have calibrated for the currently active ACV range. Pressing any of the six keys gives entry to its related SPOT FREQUENCY display, which shows the calibration frequency for the selected spot. For example:

SP1 shows the SPOT FREQUENCY 1 display, reporting the frequency at which Spot Frequency 1 was calibrated on the active ACV Range.

Other spot frequencies work in the same way.



Press the **Sp1** soft key to see the **SPOT FREQUENCY 1** display and the spot frequency. Zero indicates that the spot has not been calibrated.



Press the **Quit** key to revert to the **SPOTF** menu.

By pressing the front panel **ACV** key, and then changing range, you can inspect as many spot frequencies as you wish using the **STATUS**, **STATUS CONFIG** and **SPOTF** menus.



Transfer from the **SPOTF** menu back to the **STATUS CONFIG** menu by pressing the **Config** key.

SER# Display



Press the **Ser#** soft key to see the **SER#** display.

Inspect the instrument serial number and software issue number (the latter is given by the last four digits).



This display is for information only. The serial number cannot be altered except in one of the calibration menus, and this facility is only provided for use during manufacture. Once changed, the number is not lost when the instrument power is turned off. The software issue number (last four digits) is embedded in the software itself, and is not user-alterable.

Status Reporting - Movement between Menus

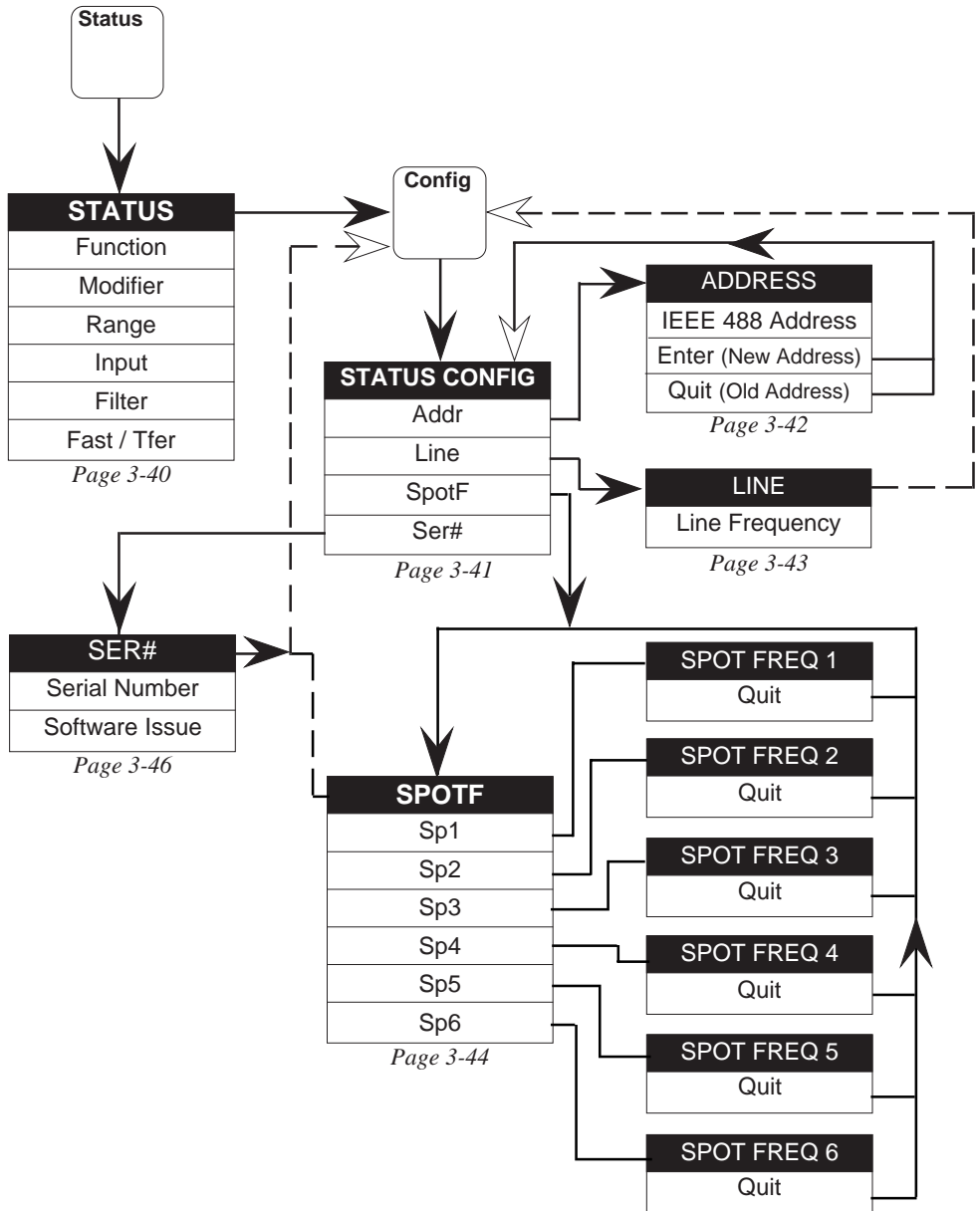

Conclusion

We have now come to the end of our introductory tour of the main menu keys. This is, however, far from the end of the instrument's facilities. Now you are more familiar with the operation of the front panel, it is not necessary to continue in the same sort of programmed way.

You will find that the information in Part 2 is presented in a more concise and accessible form than here in Section 3. Your familiarity with the instrument will allow you to progress rapidly to the facilities you wish to investigate.

In Part 2, Section 4 deals with the manual selection of the facilities not covered here, and Section 5 is devoted to the operation of the instrument via the IEEE 488 Interface.

PART 2

Operating the 1281

Section 4 Using the 1281

**Section 5 Systems Application via the IEEE-488
Interface**

SECTION 4 Using the 1281

Preliminaries	4-1
Safety	4-1
Interconnections - General Guidelines	4-2
Functions	
DC Voltage	4-4
AC Voltage (Option 10)	4-8
Resistance (Option 20)	4-11
DC Current (Option 30 with Option 20)	4-17
AC Current (Option 30 with Options 10 and 20)	4-19
Facilities	
Input Control	4-21
Status Reporting	4-22
Monitoring	4-23
Test	4-30
Math	4-32
Calibration	4-40
See Index on page 4-40	
Direct Action Keys	4-61
Keys	4-61
SK8 - Input/Output Port	4-62
Numeric Keyboard	4-64
Appendix A: Error Detection and Messages	4-A1

SECTION 4 Using the 1281

Preliminaries

This section details the methods of using the instrument, divided so as to provide an easy reference for particular functions and facilities. The divisions are as follows:

Functions

DC Voltage,
AC Voltage,
Resistance,
DC Current,
AC Current

Facilities

Input Control,
Status Reporting,
Monitoring,
Math, Test,
Calibration

The descriptions include: methods of connection, input limits, types of configurations, methods of access to facilities, and calculations available.

Where appropriate, examples of procedures are given in a format similar to that used in Section 3. Although the menus for external and self calibration are shown, all routine calibration should be referred to Section 8; or Section 1 of the Calibration and Servicing Handbook.

Installation

Before using the instrument, it is important that it has been correctly installed as detailed in Section 2.

Limiting Characteristics

Maximum inputs are detailed in Section 6.

Safety

The 1281 is designed to meet the safety requirements of EN61010-1:1993/A2:1995, UL1244, ANSI C39.5 (Draft 5), and BSI4743. Protection is provided by a protective earth (ground) connection via the power cable to exposed metal parts and internal ground screens. The power cable line connection **must** only be inserted in a socket outlet provided with a protective ground contact, and continuity of the ground conductor **must** be assured between the socket and the instrument.

WARNING ANY INTERRUPTION OF THE PROTECTIVE GROUND CONDUCTOR INSIDE OR OUTSIDE THE INSTRUMENT IS LIKELY TO MAKE THE INSTRUMENT DANGEROUS.



USING THIS INSTRUMENT CAN DELIVER A LETHAL ELECTRIC SHOCK. NEVER TOUCH ANY LEAD OR TERMINAL UNLESS YOU ARE ABSOLUTELY CERTAIN THAT NO DANGEROUS VOLTAGE IS PRESENT.



YOU ARE STRONGLY ADVISED TO FIT THE REAR TERMINAL COVER PLATE WHEN THE REAR INPUTS ARE NOT IN USE.



SEE THE SAFETY ISSUES SECTION AT THE FRONT OF THIS MANUAL.

Interconnections - General Guidelines

Importance of Correct Connections

When calibrated, the 1281 is capable of providing highly accurate traceable measurements. To attain this, it is necessary to make connection to any external circuitry or load, correctly. A few general guidelines for correct external connection are given in the following paragraphs.

Sources of Error

Thermal EMFs

These can give rise to series (Normal) mode interference, particularly where large currents have a heating effect at junctions. In otherwise thermoelectrically-balanced measuring circuits, cooling caused by draughts can upset the balance. The disturbances can be magnified by the user's hand capacitance. Electrical interference has greatest effect in high impedance circuits. Separation of leads and creation of loops in the circuit can intensify the disturbances.

E-M Interference

Noisy or intense electric, magnetic and electromagnetic effects in the vicinity can disturb the measurement circuit. Some typical sources are:

- Proximity of large static electric fields.
- Fluorescent lighting.
- Inadequate screening, filtering or grounding of power lines.
- Transients from local switching.
- Induction and radiation fields of local E-M transmitters.
- Excessive common mode voltages between source and load.

Lead Resistance

The resistance of the connecting leads can drop significant voltages between the source and load, especially at high load currents.

Lead Insulation Leakage

This can cause significant errors in measurement circuits at high voltages. Some insulating materials suffer greater losses than others, e.g. PVC has more leakage than PTFE.

Avoidance Tactics

Thermal EMFs:

- Screen thermal junctions from draughts.
- Allow time for thermal equilibrium to be reached before taking readings.
- Use conductors, joints and terminals with a good margin of current-carrying capacity.
- Avoid thermoelectric junctions where possible:
 - Use untinned single-strand copper wire of high purity.
 - Avoid making connections through Nickel, Tin, Brass and Aluminium. If oxidation is a problem use gold-plated copper terminals, and replace the terminals before the plating wears off.
 - If joints must be soldered, low-thermal solders are available, but crimped joints are preferred.
 - Use low-thermal switches and relays where they form part of the measuring circuit.
 - Balance one thermal EMF against another in opposition, where possible. (Switch and relay contacts, terminals etc.)

E-M Interference:

- Choose as “quiet” a site as possible (a screened cage may be necessary if interference is heavy). Suppress as many sources as possible.
- Always keep interconnecting leads as short as possible, especially unscreened lengths.
- Run leads together as twisted pairs in a common screen to reduce loop pick-up area, but beware of leakage problems and excessive capacitance.
- Where both source and load are floating, connect Lo to ground at the source to reduce common mode voltages.

Lead Resistance:

- Keep all leads as short as possible.
- Use conductors with a good margin of current-carrying capacity.
- Use Remote Guard or 4-wire connections where necessary.

Lead Insulation Leakage:

Choose low loss insulated leads - PTFE is preferred to PVC. When running leads together in screened pairs, avoid large voltages between leads in the same screen, especially if using PVC insulation.

Functions

Measurement of DC Voltage

Generalized Procedure

DCV Key and Menus

A description of the User Interface is given in Section 3 for the main functions. If you are unfamiliar with the front panel controls, you should complete the quick tour which starts on Page 3-5. Specific reference to DC Voltage measurement

appears on Pages 3-5 to 3-9. If you are familiar with the controls, but need a reminder of the way a particular facility can be selected; movement among the DCV group of menus is described by the following diagram:

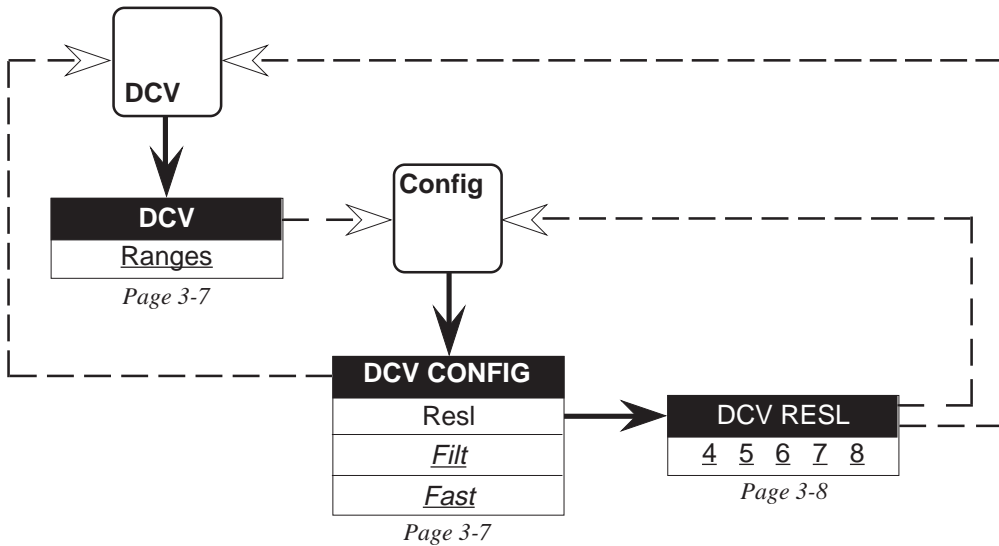

Setup Sequence

The sequence of operations below is arranged to configure a DC voltage measurement rapidly from the power on default state. In general, it is quicker to use toggle or choice soft keys on one menu before selecting another menu key.

Obviously, once the instrument has been set up to one configuration, that becomes the starting point.

- Press the DCV key - the power-on default range state is shown on the DCV menu.

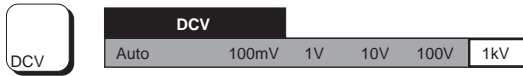

- Select a range or Auto, as required.
- Press the Config key.
- Choose Filt and/or Fast, if required.



- Press the Resl key if you wish to change the resolution of the Main display.



The display changes to DCV RESL menu showing '6', the power-on default state.



- Press the soft key for the required resolution.

Input Connections

Simple Lead Connection

For the majority of applications the simple lead connection shown (without selecting remote guard) will be adequate. The disadvantage of this simple arrangement is that the connecting leads form a loop. If a stray alternating magnetic field (e.g. from the line transformer of a neighbouring instrument) passes through the loop, it will behave as a single turn secondary winding inducing unwanted AC voltages into the measuring circuit.

Use of a twisted pair will reduce the loop area and adjacent twists will cancel any induced voltages. If problems with stray pick-up are encountered, it is recommended that a screened twisted-pair cable be used with the screen connected to the LO terminal.

Common Mode Rejection - Use of Remote Guard Connection

The Guard terminal should be used with Remote Guard selected when the source to be measured presents an unbalanced impedance to the measuring terminals, and common mode voltages are present. Regardless of how the Hi and LO terminals are connected, the Guard terminal should be referred to the source of common mode voltage, as shown in the examples below. This ensures that errors caused by common mode currents in the measuring circuit are minimized by providing a separate common mode current path.

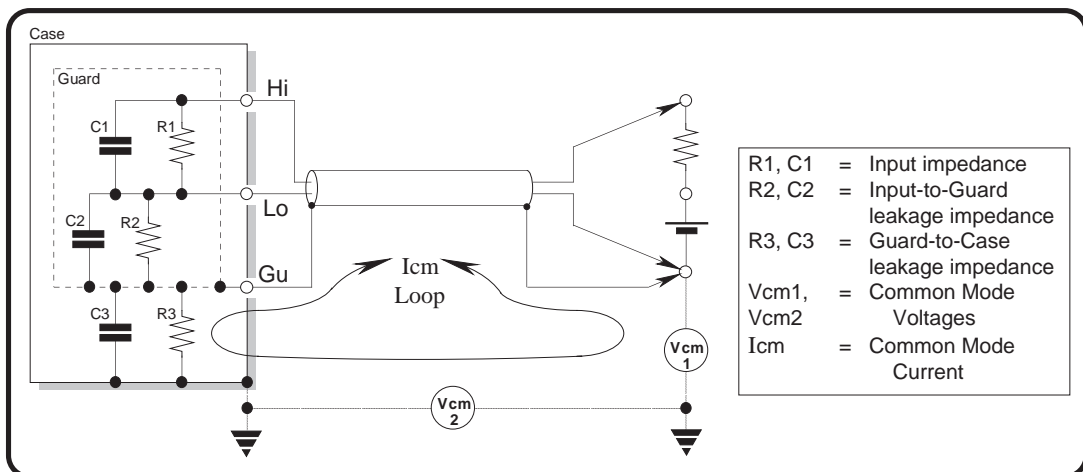
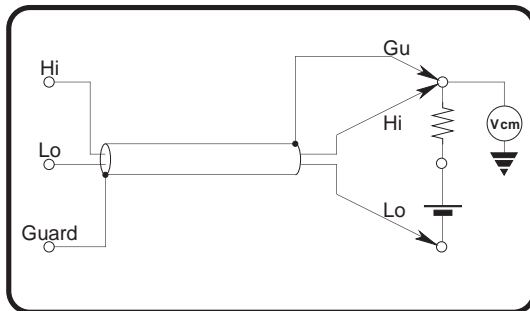
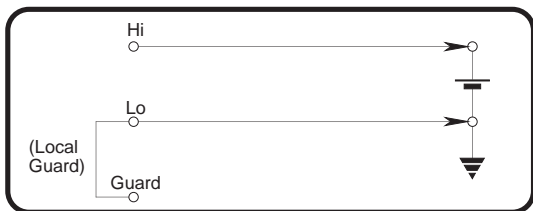

Internal Guard Connections

Remote Guard not selected: All Guard inputs are internally connected to Lo. This includes the Guard terminal on the front panel and pin 19 of each of the two rear input plugs, as connected using the Input menu.

Remote Guard selected: The shields and tracks are disconnected from Lo and connected to the Guard terminal, or pin 19 of one or both of the rear input plugs, whichever combination is in use.

The simplified diagram below illustrates the switching arrangement:

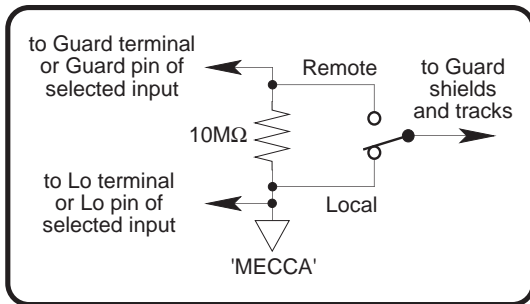

Selection of Remote Guard (RemG)

To switch to Remote Guard, we enter the INPUT menu:

- Press the Input key. The INPUT menu is displayed:



- Press the soft key under RemG on the menu display to set the instrument into Remote Guard.



The key acts as a toggle, so a second press deselects RemG, reverting to Local Guard.

Measurement of AC Voltage (Option 10)

Generalized Procedure

ACV Key and Menus

A description of the User Interface is given in Section 3 for the main functions. If you are unfamiliar with the front panel controls, you should complete the quick tour which starts on Page 3-5. Specific reference to AC Voltage measurement

appears on Pages 3-10 to 3-14. If you are familiar with the controls, but need a reminder of the way a particular facility can be selected; movement among the ACV group of menus is described by the following diagram:

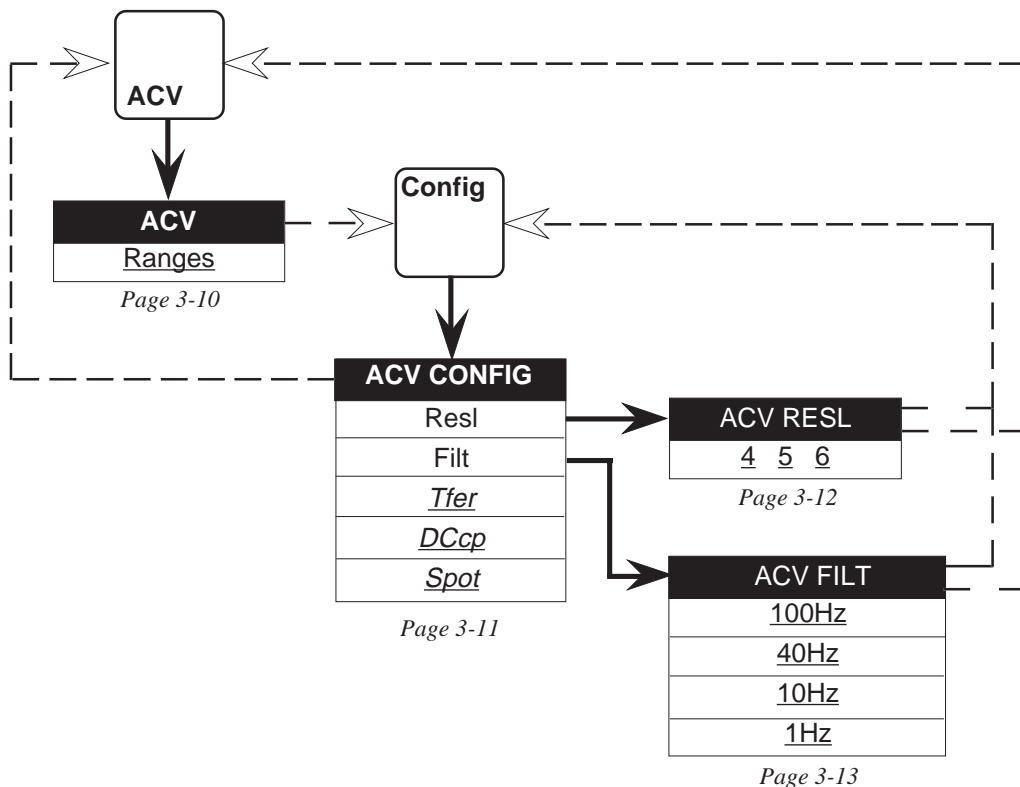

Setup Sequence

The following sequence of operations is arranged so as to configure an AC voltage measurement rapidly from the power on default state. In general, it is quicker to use toggle or choice soft keys on one menu before selecting another menu key. Obviously, once the instrument has been set up to one configuration, that is the starting point.

- Press the ACV key - the power-on default range state is shown on the ACV menu.

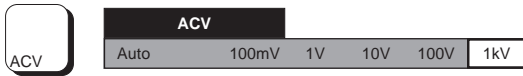

- Choose a range or Auto, as required.
- Press the Config key - Tfer is already selected.



- Deselect Tfer if not required. Select DCcp and/or Spot, if required.
- DCcp should be selected for input frequencies of less than 40Hz.

N.B.

Measurement results are invalid in Transfer mode when using internal triggers with the 1 Hz filter selected. For valid results, use Ext Trig and Sample, or trigger via the IEEE-488 interface.

To Alter the Main Display Resolution:

- Press the Resl key.



The display changes to ACV RESL menu showing '6', the power-on default state.



- Press one soft key to choose the required resolution.

To Alter the Filter Frequency:

- Press the Config key.
- Press the Filt key.



The display changes to ACV FILT menu '100Hz', the power-on default state.

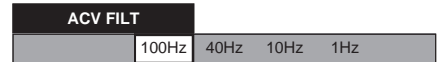

- Press one soft key to choose the required filter frequency.

Input Connections

Lead Capacitance

Whereas for DC voltage measurement the resistance of the connecting lead is generally unimportant; with AC voltage measurement the capacitance can give rise to an appreciable shunting effect, causing source loading as well as voltage drop in the leads. In the model 1501 Lead Kit, the approximate Hi and LO capacitance of the low thermal emf lead with spade terminals is 65pF; for other leads it is 160pF. In extreme cases, using separate leads can reduce capacitance (dependent upon spacing but typically 4pF) but at the risk of adding induced signals.

Induced Interference

With DC measurement, any induced (normal or 'series' mode) component can usually be removed by low-pass filtering. But with AC measurement, the relative frequencies of both the required and induced signals carry more significance, as any filtering must be selective to avoid degrading the required signal. It is generally more effective to reduce the interference before it is induced, by operating in a quiet environment, e.g a screened cage, if possible.

Common Mode Rejection

The principles of remote guarding, outlined in the description of DC voltage measurement, apply generally to AC voltage measurement. But for AC, a further advantage can be gained by using the remote guard as a screen for the input leads, if the source impedance is low enough not to be shunted by the extra capacitance.

Lead Length

In all cases, AC voltage measurement accuracy is enhanced by shortening the leads to the minimum practicable length, to reduce lead capacitance and loop area.

Lead Impedances

The table below gives the approximate impedances of the leads in the kit at different frequencies:

Frequency	Impedance for lead capacitance =		
	4pF	65pF	160pF
100Hz	400M Ω	20M Ω	10M Ω
1kHz	40M Ω	2M Ω	1M Ω
10kHz	4M Ω	200k Ω	100k Ω
100kHz	400k Ω	20k Ω	10k Ω
1MHz	40k Ω	2k Ω	1k Ω

Measurement of Resistance

Ohms Key and Menus

A description of the User Interface is given in Section 3 for the main functions. If you are unfamiliar with the front panel controls, you should complete the quick tour which starts on Page 3-5. Specific reference to Resistance measurement appears on Pages 3-15 to 3-27. If you need a reminder of the way a particular facility can be selected;

movement among the Ohms group of menus is described by the diagram below.

Note: Once activated, a resistance mode (normal Ohms, TruΩ or HiΩ) stays active until it is changed, or the instrument power is removed. Thus the Ohms key always selects the active mode's title menu; and the Config key selects the active CONFIG menu.

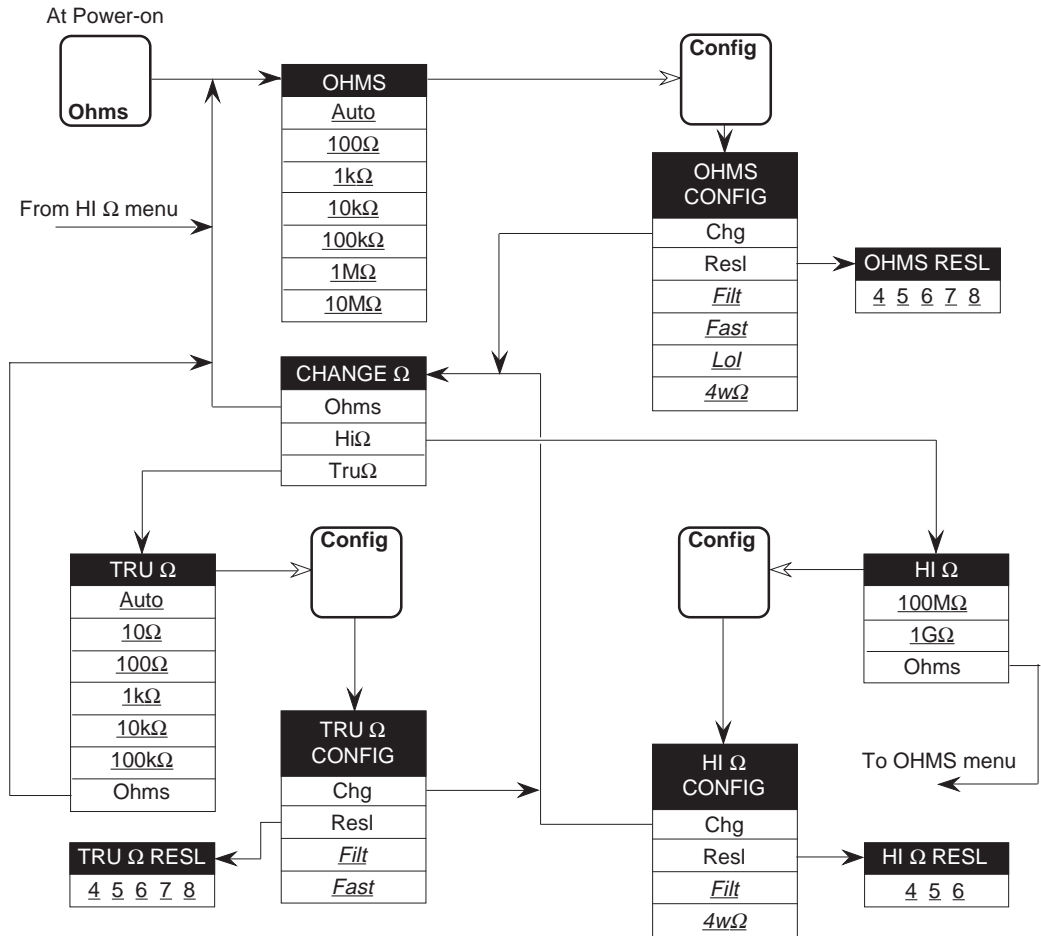

Setup Sequence

The following three sequences of operations are arranged so as to configure a Resistance measurement rapidly from the power on default state. In general, it is quicker to use toggle or choice soft keys on one menu before selecting another menu key. Obviously, once the instrument has been set up to one configuration, that is the starting point.

Three modes are available for resistance measurements: normal Ohms; HiΩ for the two highest ranges; or TruΩ in which two successive readings are taken (the second with no activation current flowing, being subtracted from the first to cancel thermal EMFs in the measuring circuit). Each of these has different ranges and facilities available, hence each also has its own Config menu.

First decide which mode to use, then choose the applicable setup sequence from the following three.

To operate in normal Ohms mode

- Press the Ohms key - the power-on default range state (1kΩ) is shown on the OHMS menu.

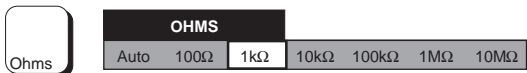

- Choose a range or Auto, as required.
- Press the Config key.



- Select any of Filt, Fast, LoI and/or 4wΩ, if required.

To Alter the Main Display Resolution:

- Press the Resl key.



The display changes to OHMS RESL menu showing '6', the power-on default state.



- Press one soft key to choose the required resolution.

To operate in HiΩ mode

- Press the Ohms key - the power-on default range state (1kΩ) is shown on the OHMS menu.

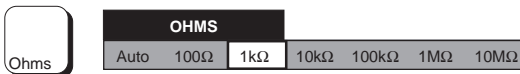

- Press the Config key.
- Select Chg.



The display changes to the CHANGE Ω menu.

- Press the HiΩ soft key.

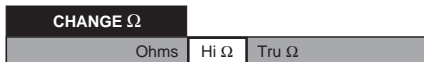

- Select the required higher range.



- Press the Config key.
- Select Filt and/or 4wΩ, if required.



To Alter the Main Display Resolution:

- Press the Resl key.



The display changes to HiΩ RESL menu showing '6', the power-on default state.



- Press one soft key to choose the required resolution.

To operate in TruΩ mode

- Press the Ohms key - the power-on default state (1kΩ) is shown on the OHMS menu.

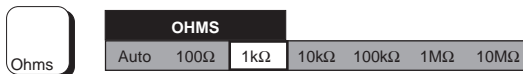

- Press the Config key.
- Select Chg.



- Press the TruΩ soft key.

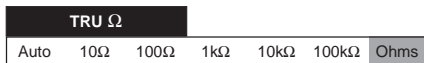

- Choose a range or Auto, as required.
- Press the Config key.
- Select Filt or Fast, (or both) if required.



To Alter the Main Display Resolution:

- Press the Resl key.



The display changes to TruΩ RESL menu showing '6', the power-on default state.



- Press one soft key to choose the required resolution.

Subsequent Reselection of 'Ohms' and 'Config' keys

If after operating in either HiΩ or TruΩ mode, a measurement is carried out in another (non-Resistance) function; then if the instrument has not meanwhile been powered off, it will reactivate the previously-selected HiΩ or TruΩ when the Ohms key is next pressed. Moreover, once the mode is activated pressing the Config key will show the mode to be configured as before.

Reverting to normal Ohms mode

When operating in HiΩ or TruΩ, pressing the Ohms hard key does **not** revert to normal Ohms mode. But each has 'Ohms' as a selection on its Config menu. By first pressing the Config key then selecting Ohms from the Config menu, it is unnecessary to pass through the Chg menu to reactivate the normal Ohms mode.

External Connections

2-Wire Measurements

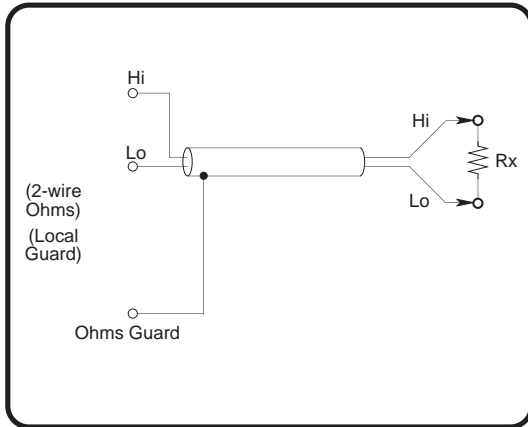

4-wire Measurements

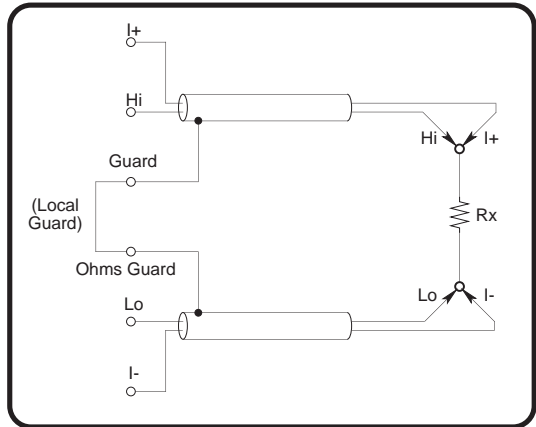

For the majority of applications the simple 2-wire arrangement will be adequate. However, the value displayed will include the resistance of the connecting leads.

Use a screened twisted pair cable to reduce induced voltages, particularly where R_x is high.

2-wire resistance measurements are not available when in Tru Ω mode.

With a 4-wire connection the lead resistances have negligible effect and only the value of R_x is displayed. The 4-wire connection, as shown above, is also suitable for measuring high resistances with long cables since the effects of leakage and capacitance between leads are eliminated.

4-wire High Resistance Measurements

True 4-wire Zero

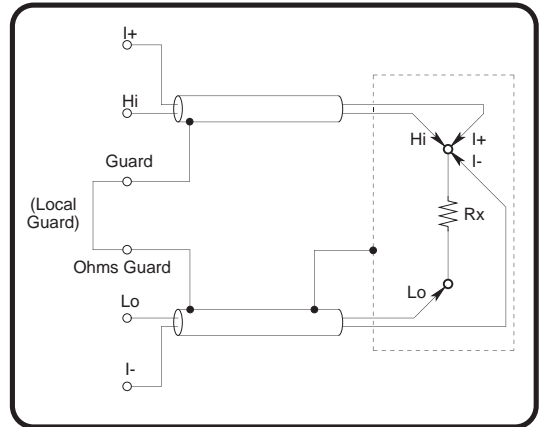
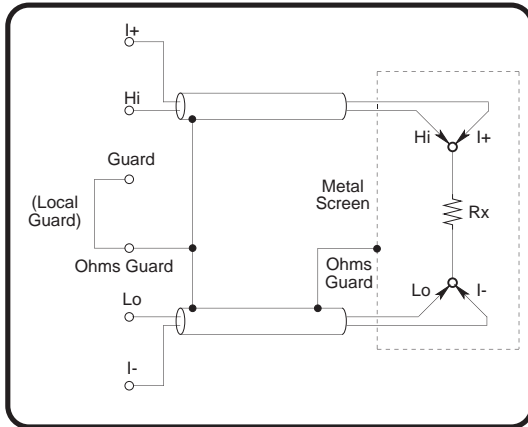

When making very high resistance measurements above about $1M\Omega$, a metal screen can be wrapped around the resistor to reduce noise. Connecting the Ω Guard terminal to the screen will intercept leakage via the screen (in parallel with the unknown resistor). The resistor under test should not be grounded, as this will make the measurement noisier.

For accurate measurements of resistance it is **Essential** that a correctly connected zero source be used when operating the **Zero** key before making a series of measurements. The preferred arrangement, shown above, ensures that thermal and induced EMF effects, and bias current effects, are eliminated.

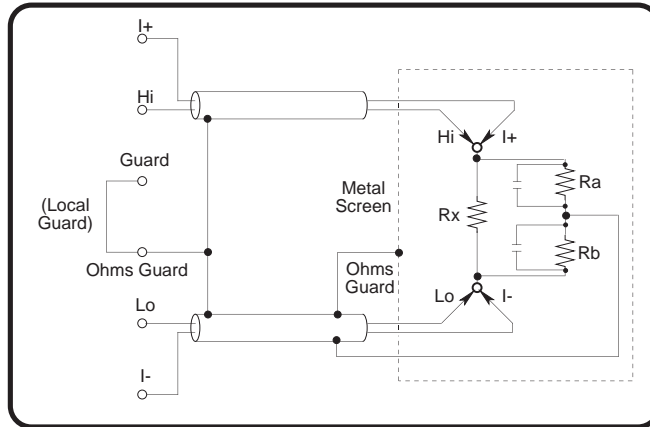
Ω Guard

'Ω Guard' can be used to make 'in-circuit' resistance measurements by guarding out parallel resistance paths so that only the value of R_x will be displayed.

Similarly, 'Ω Guard' can be used to reduce the settling time if R_x is shunted by any capacitance and a suitable tapping point is available.

Providing that R_a and R_b are no less than $1k\Omega$ ($10k\Omega$ on $1M\Omega$ range and above), and the Ω Guard resistance (R_g) is less than 1Ω ; the actual value can be calculated from the displayed value R_d by:

$$R_x = R_d \times (1 + E)$$

Deviation fraction 'E' can be found within 1% by the simplified formula:

$$E = \frac{(R_d \cdot R_g)}{(R_a \cdot R_b)}$$

(Where R_g is the Ω Guard lead-resistance from the junction of R_a and R_b)

Example:

If $R_d = 100\Omega$, $R_g = 1\Omega$, $R_a = R_b = 10k\Omega$, then the value of E is given by:

$$E = \frac{(100 \cdot 1)}{(10k \cdot 10k)} = 10^{-6} \text{ (1ppm of reading);}$$

The value of R_x is thus given by:

$$\begin{aligned} R_x &= 100 \cdot (1 + 10^{-6}) \text{ Ohms,} \\ &= 100.0001 \text{ Ohms} \end{aligned}$$

Measurement of DC Current

(Option 30 with Option 20)

Generalized Procedure

DCI Key and Menus

A description of the User Interface is given in Section 3 for the main functions. If you are unfamiliar with the front panel controls, you should complete the quick tour which starts on Page 3-5. Specific reference to DC Current measurement appears on Pages 3-28 to 3-31.

If you are familiar with the controls, but need a reminder of the way a particular facility can be selected; movement among the DCI group of menus is described by the following diagram:

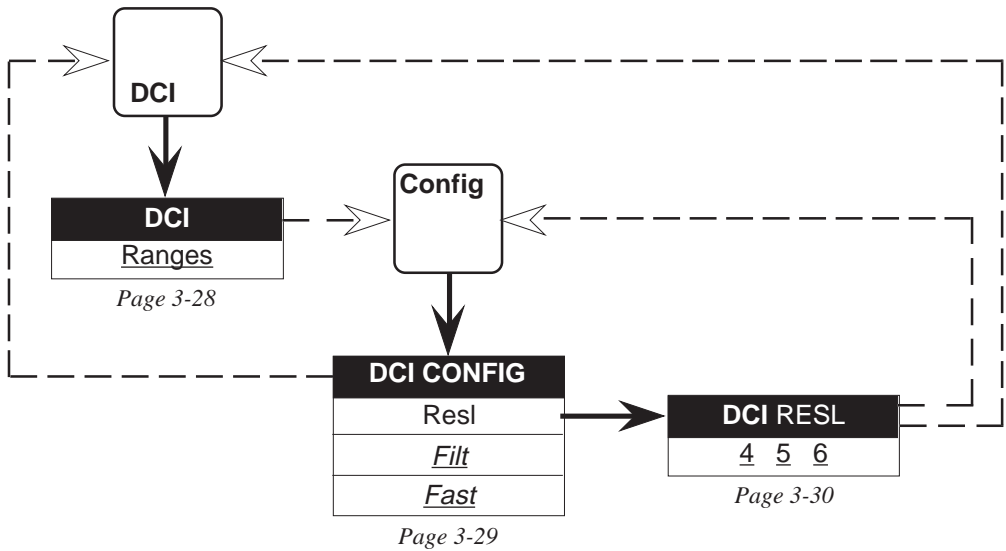

Input Connections

Setup Sequence

The following sequence of operations is arranged so as to configure a DC voltage measurement rapidly from the power on default state. In general, it is quicker to use toggle or choice soft keys on one menu before selecting another menu key.

Obviously, once the instrument has been set up to one configuration, that is the starting point.

- Press the DCI key - the power-on default range state is shown on the DCI menu.



- Choose a range or Auto, as required.
- Press the Config key.
- Select Filt and/or Fast, if required.

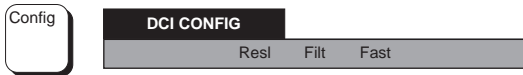

To Alter the Main Display Resolution:

- Press the Resl key.

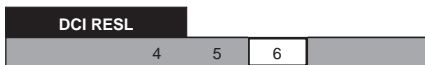

The display changes to DCI RESL menu showing '6', the power-on default state.

- Press one soft key to choose the required resolution.

Lead Connection

The instrument is inserted into the current path via its I+ and I- terminals, so that conventional current flows from +ve into the instrument's I+ terminal, and to -ve out of the I- terminal.

Similar connection considerations are required for DC current measurement as for DC voltage measurement. Use screened twisted pair cable to reduce induced voltages, and connect Guard to the source of common mode voltage, to provide a separate common mode current path.

Measurement of AC Current

(Option 30 with Options 10 and 20)

Generalized Procedure

ACI Key and Menus

A description of the User Interface is given in Section 3 for the main functions. If you are unfamiliar with the front panel controls, you should complete the quick tour which starts on Page 3-5. Specific reference to AC Current measurement appears on Pages 3-32 to 3-36.

If you are familiar with the controls, but need a reminder of the way a particular facility can be selected; movement among the ACI group of menus is described by the following diagram:

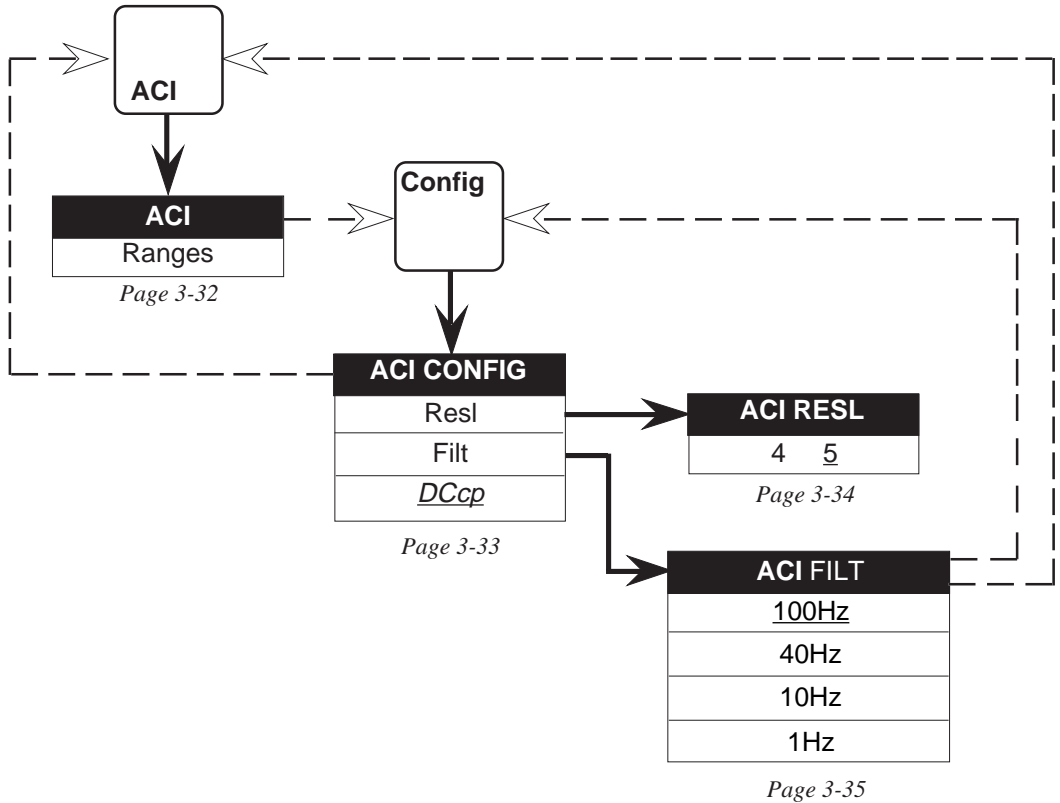

Setup Sequence

The following sequence of operations is arranged so as to configure an AC current measurement rapidly from the power on default state. In general, it is quicker to use toggle or choice soft keys on one menu before selecting another menu key.

Obviously, once the instrument has been set up to one configuration, that is the starting point.

- Press the ACI key - the power-on default range state is shown on the ACI menu.



- Choose a range or Auto, as required.
- Press the Config key.
- Select DCcp if required.



- DCcp should be selected for input frequencies of less than 40Hz.

To Alter the Main Display Resolution:

- Press the Resl key.



The display changes to ACI RESL menu showing '5', the power-on default state.

- Press one soft key to choose the required resolution.

To Alter the Filter Frequency:

- Press the Config key.
- Press the Filt key.



The display changes to ACV FILT menu showing '100Hz', the power-on default state.

- Press one soft key to choose the required filter frequency.

Input Connections

The instrument is inserted into the current path via its I+ and I- terminals.

Similar connection considerations are required for AC current measurement as for AC voltage measurement. Use screened twisted pair cable to reduce induced voltages, and connect Guard to the source of common mode voltage via the screen, to provide a separate common mode current path.

Lead Impedance

When making AC current measurements pay particular attention to the lead impedance (see AC voltage measurement) especially at high frequencies on the lower current ranges.

Facilities

Input Control Facilities

Input Key

Pressing the Input key activates the INPUT menu (see pages 3-38 to 3-39 for available selections).

Front Panel Terminals

Three pairs of 4mm 'banana' terminals are fitted on the left of the front panel. Their functions are as follows:

Guard	General Guard
ΩGuard	Ohms Guard
I+	Ohms Current Source (4-Wire) Current Input High
I-	Ohms Current Sink (4-Wire) Current Input Low
Hi	Voltage Input - High Ohms High (2-Wire) Ohms Sense High (4-Wire)
Lo	Voltage Input - Low Ohms Low (2-Wire) Ohms Sense Low (4-Wire)

The block of terminals is extended forward by pressing the release catch at the top left-hand corner of the rear panel (veiwing from the front). To retract the block, hold the release catch pressed, push the block back into the body of the instrument, then release the catch.

PL11 and PL12 - Rear Inputs

The two input channels on the rear panel incorporate two identical 50-way Cannon 'D' type plugs, each with only six pins present, and fitted with screw locks for strain relief. Channel A is connected via PL12, and Channel B via PL11. The layout of the pins and their designations are given in Section 2.

Maximum Input Limits

Refer to Section 6.

WARNING YOU ARE STRONGLY ADVISED TO FIT THE REAR TERMINAL COVER PLATE WHEN THE REAR INPUTS ARE NOT IN USE.



SEE THE SAFETY ISSUES SECTION AT THE FRONT OF THIS MANUAL.

Status Reporting Facilities

Status reporting is described in Section 3, pages 3-40 to 3-46. Movement among the STATUS group of menus is described by the following diagram:

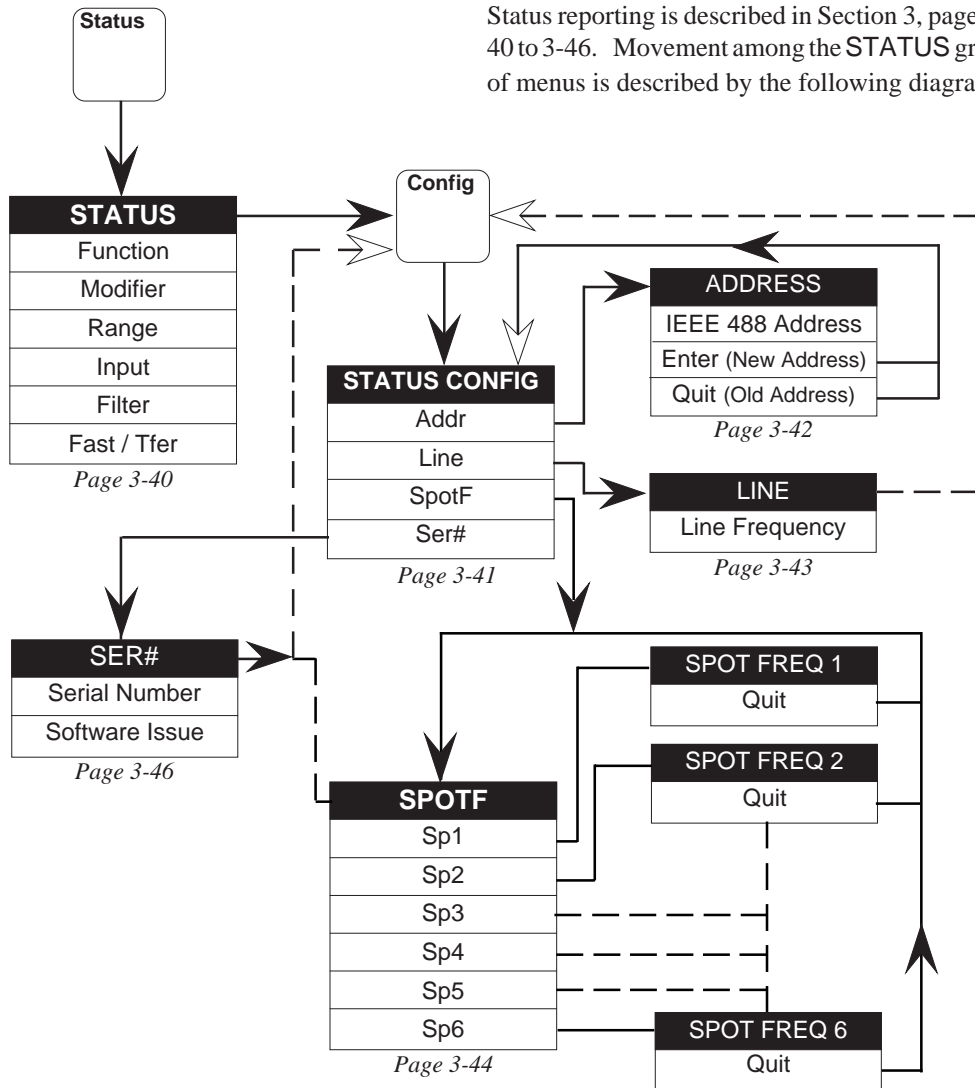

Monitoring Facilities

Monitor Menus

A description of the User Interface is given in Section 3 for the main functions. If you are unfamiliar with the front panel controls, you should complete the quick tour which starts on Page 3-5.

The Monitoring facilities are not covered specifically in Section 3, so to give an overall view of the monitoring facilities, movement among the MONITOR group of menus is described by the following diagram:

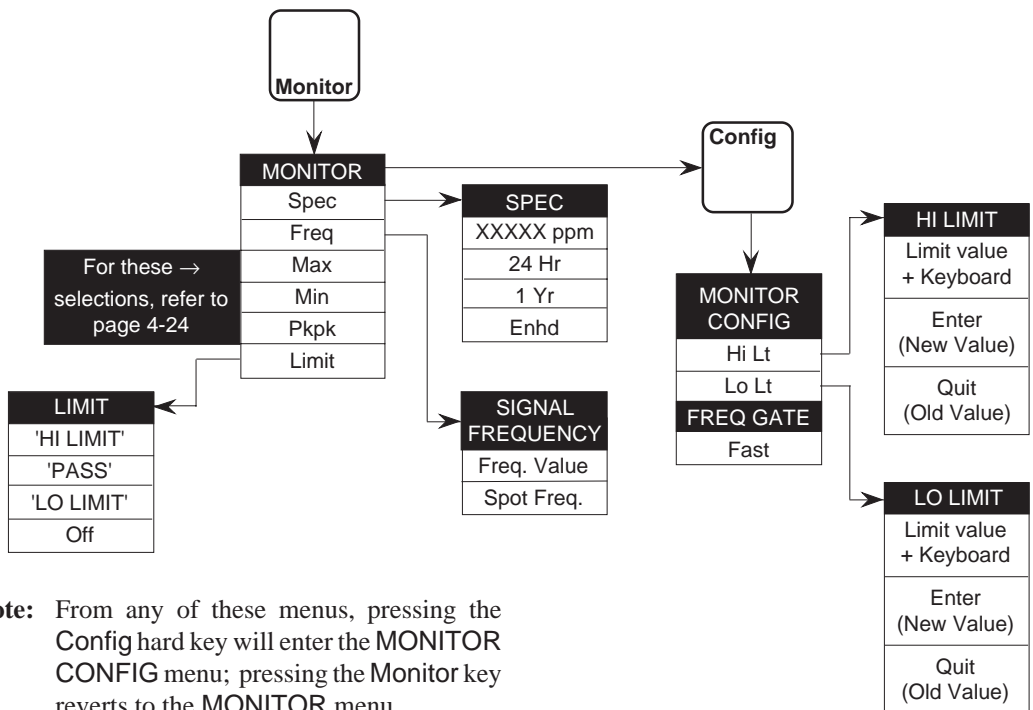

Note: From any of these menus, pressing the Config hard key will enter the MONITOR CONFIG menu; pressing the Monitor key reverts to the MONITOR menu

Monitor Key

Pressing the Monitor front panel key causes the MONITOR menu to be displayed:



This menu defines six *menu* keys:

- Spec:** The SPEC menu presents a readout of the uncertainty associated with the particular measurement being taken.
- Freq:** Displays the SIGNAL FREQUENCY if ACV or ACI function has been selected. This shows the frequency corresponding to the RMS measurement shown in the main display. If ACV or ACI is not selected an error message results. For frequencies <40Hz the message NOT VALID appears in place of the frequency value.
- Max:** The MAX menu indicates the maximum value for any reading taken since the Max store was last reset.
- Min:** The MIN menu indicates the minimum value for any reading taken since the Min store was last reset.
- Pkpk:** The PKPK menu indicates the peak to peak (ie Max minus Min) value for any reading taken since the Max and Min stores were last reset.
- Limit:** Indicates whether the current reading has exceeded the user-defined high and low limits.

SPEC Menu

Selected by the Spec key in MONITOR, this menu displays the uncertainty associated with the current reading shown on the main display. Two selections are available to indicate the type of specification relevant to the user's application.



This menu defines three *choice* keys:

- 24Hr** Displays the instrument uncertainty, calculated on the basis of the instrument's 24 hour $\pm 1^\circ\text{C}$ spec, relative to calibration standards. The default and Power-On selection is 24Hr.
- 1Yr** Displays the instrument uncertainty, calculated on the basis of the instrument's 1 year specification, including whatever uncertainty has been entered in the EXT CAL SPEC ENTRY menus (see 'Calibration' later in this section). 1Yr is not selected at Power On.
- Enhd** Displays the instrument uncertainty, calculated on the basis of the instrument's Enhanced $\pm 5^\circ\text{C}$ spec, including whatever calibration uncertainty has been entered in the EXT CAL SPEC ENTRY menus (see 'Calibration' later in this section). Enhd is not selected at power on.

SIGNAL FREQUENCY Display

Selected by the Freq key in MONITOR and ACV, this gives the frequency corresponding to the RMS value shown on the main display.



There are no selections to be made, exit is by pressing a hard key.

MAX, MIN, and PKPK Menus

These three menus share the same format, presenting information derived from measurements taken since the individual facility was last reset.

Once one of the three menus has been entered, a user can select either of the other two without recourse to the MONITOR menu.

Within the MAX or MIN menu, its own memory store can be cleared by its own Reset soft key; but the PKPK menu Reset soft key clears **both** the Max and Min memory stores.

There is no Pkpk store except as a result of calculating max minus min. Thus if only one of the max or min stores is cleared independently, the PKPK menu value is cleared until the first measurement enters the cleared store. After this, the PKPK menu value reflects the change by showing the new difference between the two stores.

To avoid confusion, the instrument has been programmed **not** to clear the max or min stores for Function, Range etc. changes. They can be cleared **only** by pressing the appropriate Reset key.

MAX Menu

Selected by the Max key in MONITOR, this menu displays the 'maximum' value for all readings taken since the Max store was last reset.



It shows the maximum measurement value attained during all the measurements taken since the Reset key **in this menu** was pressed.

'Maximum' is defined, for all the measurements which qualify, as:

for DCV and DCI:

The most positive (or least negative) measurement.

for ACV and ACI:

The largest RMS value measurement.

for Ohms:

The largest resistance measurement.

Three *menu* keys and a soft *direct-action* key have the following effects:

Max: No change - the MAX menu continues.

Min: Causes the MIN menu to be displayed.

Pkpk: Causes the PKPK menu to be displayed.

'Reset' Pressing Reset in the MAX menu clears the Max store. The instrument then begins searching for a new maximum.

MIN Menu

Selected by the Min key in MONITOR, this menu displays the 'minimum' value for all readings taken since the Min store was last reset.

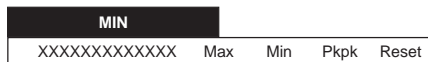

It shows the minimum measurement value attained during all the measurements taken since the **Reset** key **in this menu** was pressed.

'Minimum' is defined, for all the measurements which qualify, as:

for DCV and DCI:

The most negative (or least positive) measurement.

for ACV and ACI:

The smallest RMS value measurement.

for Ohms:

The smallest resistance measurement.

Three *menu* keys and a soft *direct-action* key have the following effects:

Max: Causes the MAX menu to be displayed.

Min: No change - the MIN menu continues.

Pkpk: Causes the PKPK menu to be displayed.

'Reset' Pressing Reset in the MIN menu clears the Min store. The instrument then begins searching for a new minimum.

PKPK Menu

Selected by the Pkpk key in MONITOR, this menu displays the 'max minus min' value.

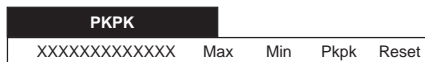

It shows the **difference** between the maximum and minimum measurement values, attained during all the measurements taken since a **Reset** key **in any of the three menus** was pressed.

'PKPK' is defined, for all the measurements which qualify, as:

for DCV and DCI:

The difference between the most positive (or least negative), and the least positive (or most negative) measurement.

for ACV and ACI:

The difference between the largest and smallest RMS value measurements.

for Ohms:

The difference between the largest and smallest resistance measurements.

Three *menu* keys and a soft *direct-action* key have the following effects:

Max: Causes the MAX menu to be displayed.

Min: Causes the MIN menu to be displayed.

Pkpk: No change - the PKPK menu continues.

'Reset' Pressing Reset in the PKPK menu clears both the Max and Min stores. The instrument then begins calculating a new difference between max and min.

LIMIT Menu

Selected by the Limit key in MONITOR, this displays whether high and low limits (previously entered via the MONITOR CONFIG menu) have been crossed by the **most recent** measurement. The display indicates accordingly:
 HI LIMIT, LO LIMIT, or PASS.

The reading is updated as soon as each measurement is complete.

If the Hi Limit is crossed:



If the Lo Limit is crossed:



If no Limit is crossed:



Only one *state toggle* key is provided in this menu.

Off: This determines whether limits-checking is activated or not. Selection turns limits-checking off. It is automatically selected Off at Power On.

MONITOR CONFIG Menu

When in MONITOR, selection of the Config key causes the MONITOR CONFIG menu to be displayed. This permits entry of Hi and Lo limits and selection of frequency gate settings for the ACV function frequency measurements.



This menu defines two *menu* keys and Fast, which is a *toggle* key:

Hi Lt: Displays the HI LIMIT menu. This permits entry of a value to be used as the high limit for when limits-checking is activated.

Lo Lt: Displays the LO LIMIT menu. This permits entry of a value to be used as the Low limit for when limits-checking is activated.

Fast: Causes all frequency measurements to be made with a 50ms gate at 4.5 digits resolution.

With **Fast** not selected the frequency measurements are made with a 1 second gate at 6.5 digits resolution. The 1s gate mode will slow the ACV read rate down.

Fast is selected On at Power On.

HI LIMIT Menu

Selection of Hi Lt in MONITOR CONFIG will cause the HI LIMIT menu to be displayed. This permits entry of a value to be used as the high limit when limits-checking is activated.

HI LIMIT =	
XXXXXXXXXXXXX	Enter Quit

On entry to the menu, the last Hi Limit value is shown and the keyboard is activated.

The most-recent reading can be entered by pressing the Last Rdg keyboard key, or a numeric value can be entered.

This menu also defines two *menu* keys:

Enter: Causes the new value to be stored (or restore the old value if unchanged).

Quit:: Leaves the old value intact.

Either **Enter** or **Quit** causes exit from the menu back to the MONITOR CONFIG menu.

LO LIMIT Menu

Selection of Lo Lt in MONITOR CONFIG will cause the Lo LIMIT menu to be displayed. This permits entry of a value to be used as the high limit when limits-checking is activated.

LO LIMIT =	
XXXXXXXXXXXXX	Enter Quit

On entry to the menu, the last Lo Limit value is shown and the keyboard is activated.

The most-recent reading can be entered by pressing the Last Rdg keyboard key, or a numeric value can be entered.

This menu also defines two *menu* keys:

Enter: Causes the new value to be stored (or restore the old value if unchanged).

Quit:: Leaves the old value intact.

Either **Enter** or **Quit** causes exit from the menu back to the MONITOR CONFIG menu.

Example of Limit-Setting Sequence

The following sequence of operations commences with the DMM set to measure DC Voltage, with the DCV menu showing on the display. It continues first to set up a high limit, then a low limit, and finally to view the results of inputting a DC Voltage.

- Press the Monitor key.



- Press the Config key.



- Press the Hi Lt key.



The HI LIMIT menu is displayed.

- Use the keyboard keys to set an upper limit value, and then press Enter.



The display reverts to the Monitor Config menu.

- Press the LO Lt key.



The LO LIMIT menu is displayed.

- Use the keyboard keys to set a lower limit value, and then press Enter.



The display reverts to the Monitor Config menu.

- Press the Monitor hard key.

The MONITOR display appears.

- Press the Limit key.



The display changes to the LIMIT menu.

- Activate limit-checking by pressing the Off key (at power-on, Off is selected).

By adjusting the input to the DMM above and below the limits, it is possible to view each of the following versions of the LIMIT menu.



Test Facilities

Test Menus

A description of the User Interface is given in Section 3 for the main functions.

If you are unfamiliar with the front panel controls, you should complete the quick tour which starts on Page 3-5.

The Test facilities are not covered specifically in Section 3, so to give an overall view, movement among the TEST group of menus is described by the following diagram:

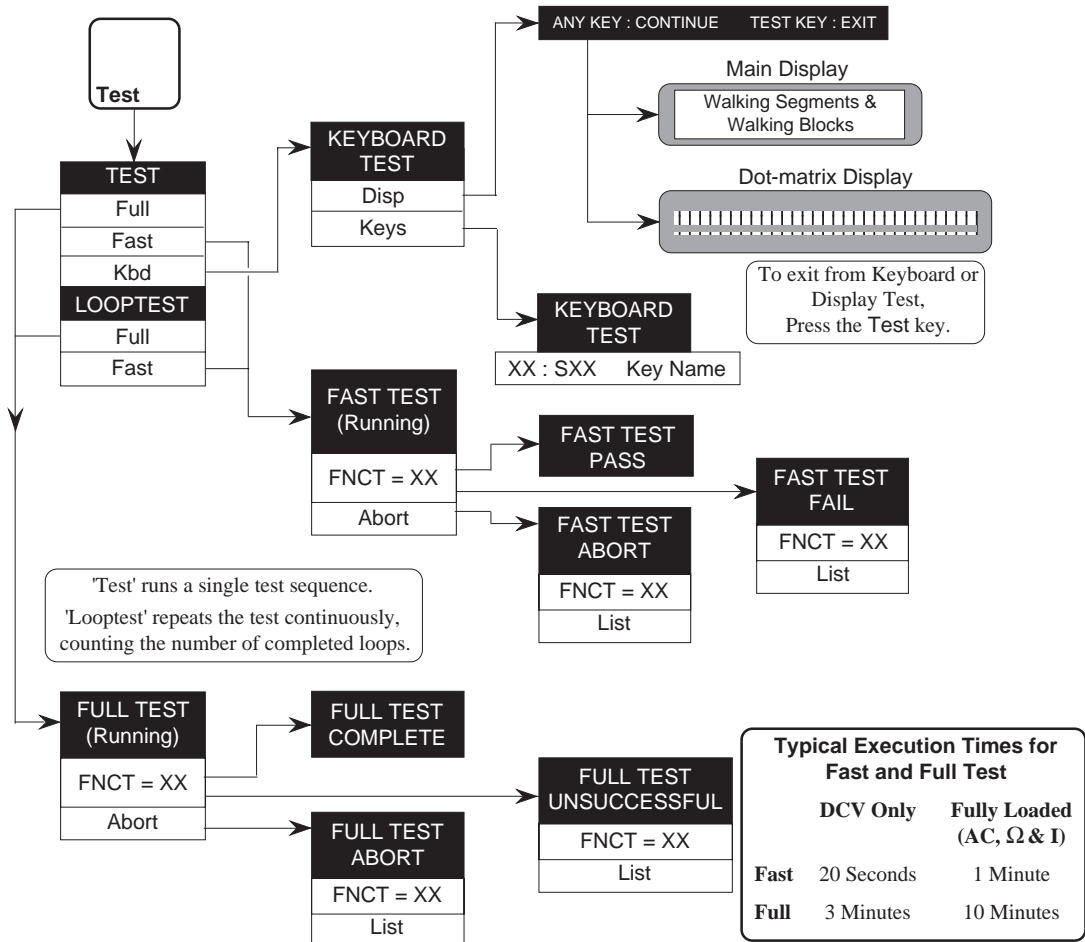

Test Key

The front panel Test key causes the TEST menu to be displayed. Different types of selftest can be chosen from this menu.



LOOPTEST defines the two succeeding keys, therefore the TEST menu defines four *test initiation* keys and kbd, which is a *menu* key:

N.B.

Full Selftest cannot be selected unless a successful 'Internal Source Calibration' has been carried out since the most-recent External Calibration.

Caution

The success of Full Selftest can be inhibited by:

- temperature not in the range: 13°C to 33°C;
- more than 1 year since Internal Source Calibration executed;
- temperature more than 10degC different from Internal Source Calibration; or
- presence of excessive RFI or Line noise.

Full

Full starts a full selftest, disabling all other function keys, signal inputs and normal trigger sources. This test includes a calibration memory check. While full selftest is running, the display shows a reference number, the test currently being performed, plus a pass or fail comment. Once a failure is noted, the comment persists to the end of the test sequence. Pressing the ABORT key aborts the test.

List

In the FULL TEST ABORTED and FULL TEST UNSUCCESSFUL menus, repeated pressing of the List key reads out the failures in turn. The memory of each failure is destroyed as it is read.

Appendix A to this section contains a list of the failure-message numbers.

Fast

A more rapid check begins. This is similar to a full selftest operation but the resolution of readings is cut to 5.5 digits, and the check limits are widened to increase the speed of testing. Fast test also carries out a calibration memory check.

Kbd

Displays the KBD TEST menu, where checks can be made on the displays and front panel keys.



Disp

A reminder menu appears first, noting the actions of the keys. Repeatedly pressing any key **other** than Test increments both displays through a sequence of 'walking strobos', which allow a user to inspect segments and complete blocks.

Keys

All keys **other** than the Test key can be tested by pressing. The key's hexadecimal matrix position appears to the left of a colon, an 'S' is followed by the key's switch number, and the name of the key is given on the right of the display.

Exit

During 'Disp' or 'Keys' checks, pressing the Test key **terminates the sequence**.

LOOPTEST (Full or Fast)

Causes the selected selftest to begin and keep repeating until either the user aborts the process, or a failure is noted. In all other respects it is identical to Full or Fast selftest.

The number of completed tests is shown on the right of the dot-matrix display. This number increments to 99, and then starts again.

Mathematical Facilities

Math Menus

A description of the User Interface is given in Section 3 for the main functions.

If you are unfamiliar with the front panel controls, you should complete the quick tour which starts on Page 3-5.

The Math facilities are not covered specifically in Section 3, so to give an overall view, movement among the MATH group of menus is described by the following diagram:

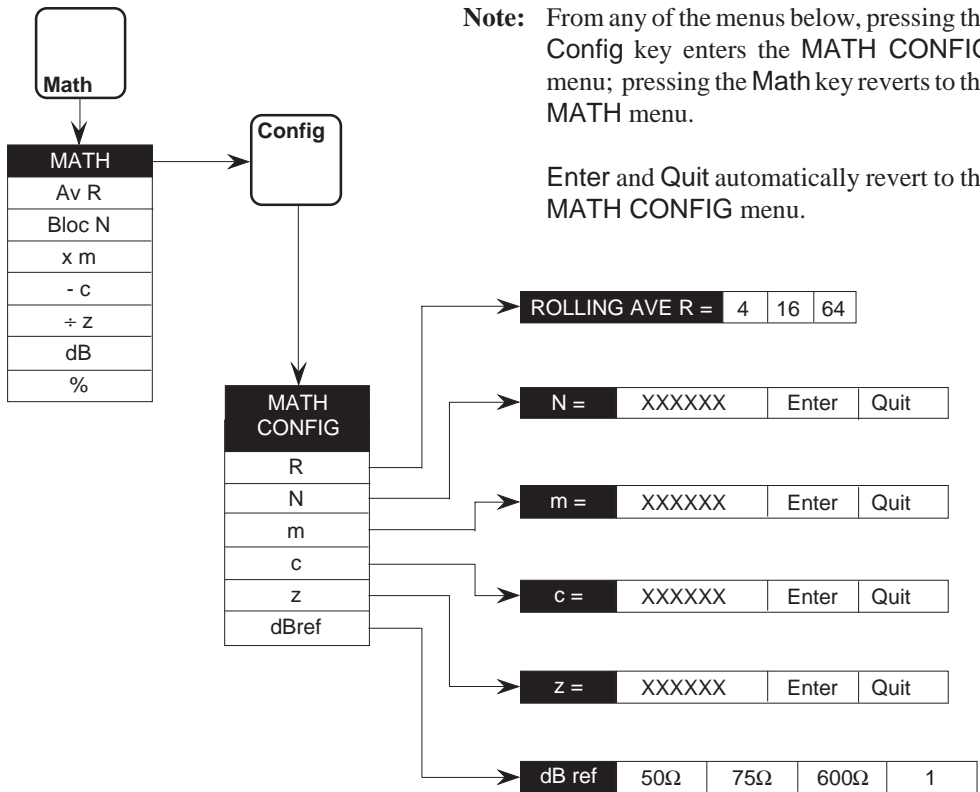

Math Key

The Math front panel key causes the MATH menu to be displayed. This menu can activate a wide choice of linear and logarithmic calculations, as well as averaging in rolling or block modes.

All constants used in the operations are entered via the MATH CONFIG menu.

Operations are performed on the readings obtained from the main measurement function in strict left to right order.

All operations are independently selectable; any activated operation causes the Math annunciator on the main display to be lit.

MATH Menu

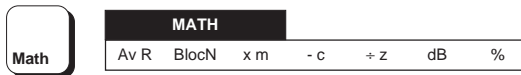

This menu defines seven *toggle* keys, all keys are not selected at Power On. Except for $\%$, the constants are defined via the MATH CONFIG menu.

AvR Causes a rolling average of **R** readings to be made. AvR cross-cancels with BlocN.

BlocN Causes a block average of **N** readings to be made. BlocN cross-cancels with AvR.

x m The measurement is multiplied by a constant **m**.

- c A constant **c** is subtracted from the measurement.

÷ z The measurement is divided by constant **z**.

dB The measurement is expressed in dB relative to **1**, or to **z**, or to **dBref**. Constants **dBref** and **z** are defined via the MATH CONFIG menu.

% The measurement is multiplied by **100**. For this selection the $\%$ annunciator on the main display is also lit.

Rolling Averaging

MATH CONFIG Menu

Selection of the **Config** key in **MATH** will cause this menu to be displayed. This menu allows the user to access the various stores for the constants used by the math operations.



The **MATH CONFIG** menu defines six *menu* keys:

- R** Displays the **ROLLING AV** menu, where the number of readings for the ‘moving window’ used in rolling average can be selected.
- N** Displays **N**, a numeric entry menu, where the value for **N** can be entered.
- m** Displays **m**, a numeric entry menu, where the value for **m** can be entered.
- c** Displays **c**, a numeric entry menu, where the value for **c** can be entered.
- z** Displays **Z**, a numeric entry menu, where the value for **Z** can be entered.
- dBref** Causes the **dBREF** menu to be displayed, where the reference used for **dB** calculations can be selected.

ROLLING AV Menu

This menu is obtained by selecting **R** from the **MATH CONFIG** menu.



It gives access for selection of the number of readings for the ‘moving window’ used in rolling average (**AvR**). The last selected value is underlined with a cursor.

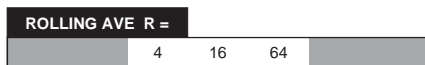

This menu defines three *choice* keys:

- 4 Selects a rolling average of 4 readings. 4 is selected **On** at Power On.
- 16 Selects a rolling average of 16 readings. 16 is not selected at Power On.
- 64 Selects a rolling average of 64 readings. 64 is not selected at Power On.

Block Averaging

N Menu

This menu is obtained by selecting N from the MATH CONFIG menu. It permits entry of a value to be used as N when BlocN is activated.



On entry to the menu, the most-recent N value is shown and the keyboard is activated.



The required size for the block can be changed by changing the block number, using the keyboard.

This menu also defines two *menu* keys:

Enter: Causes the new value to be stored (or restore the old value if unchanged).

Quit: Leaves the old value intact.

Both **Enter** and **Quit** cause exit from the menu back to the MATH CONFIG menu.

DeciBel Reference

dBREF Menu

This menu is obtained by selecting dBref from the MATH CONFIG menu.



It allows the reference used for dB calculations to be selected. The last selected value is underlined with a cursor.



This menu defines four *choice* keys, which can also be cancelled by re-pressing the selected key:

50Ω: Selects a reference of 1mW in 50Ω. 50Ω is not selected at Power On.

75Ω: Selects a reference of 1mW in 75Ω. 75Ω is not selected at Power On.

600Ω: Selects a reference of 1mW in 600Ω. 600Ω is not selected at Power On.

1: Selects a unity reference value. 1 is selected On at Power On.

Math Constants

m, c, or z Menus

The math constant menus are obtained by selecting m, c, or z from the MATH CONFIG menu. It permits entry of a value, to be used when the corresponding constant is activated on the MATH menu.

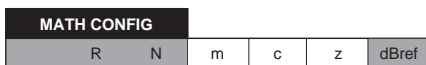

On entry to one of the menus, the most recent value is shown and the keyboard is activated.



The most-recent reading can be entered by pressing the Last Rdg keyboard key, or a numeric value can be entered.

These menus also define two *menu* keys:

Enter: Causes the new value to be stored (or restore the old value if unchanged).

Quit: Leaves the old value intact.

Both **Enter** and **Quit** cause exit from the menu back to the MATH CONFIG menu.

Example using Math Facility

Dimensional Flexibility

To obtain greater flexibility when performing calculations, it is assumed that the user is aware of the nature of the calculation being programmed. No dimensional checking is incorporated in the operations.

For instance: it is possible to enter a number as Z in the MATH CONFIG menu and program \div z on the MATH menu; then the reading on the main display is the input divided by z, with the legend on the main display indicating the units of the input.

But if the % key on the MATH display is pressed as well, then it is assumed that the user intends the number z to be in the same units as the input. The result is that the '%' legend is lit on the main display, and the units legend is deleted. The calculated measurement is multiplied by 100 and reverts to a dimensionless number, which represents the input as a percentage of z.

In the following sequence of operations, a reading (x) is multiplied by 1.5 (m), then 10 (c) is added and the whole is divided by 7 (z). This represents a linear equation of the form:

$$y = \frac{mx + c}{z}$$

The sequence starts with the DMM set to measure DC Voltage, and the DCV menu showing on the display. It continues first to set the values of math constants, then to set up a math formula, and finally to view the results of inputting a DC Voltage.

- Press the Math key.

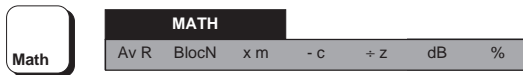

- Press the Config key.
- Press the m key.



The M menu is displayed.

- Press the keyboard keys: '1' ; '.' ; '5' ; and then press Enter.



The display reverts to the MATH CONFIG menu.

- Press the c key.



The C menu is displayed.

- Press the keyboard keys: '±' ; '1' ; and '0' ; (the '±' because the 'minus' operation is included in the selection of - c in the MATH menu formula) and then press Enter.



The display reverts to the MATH CONFIG menu.

- Press the z key.



The Z display appears.

- Press the keyboard key: '7' ; and then Enter.



The constants for our formula are now established. The next stage is to program the formula itself, using the MATH menu.

- Press the Math key.



- Press the soft x m, - c and ÷ z keys (the order of pressing does not matter, as each operation can only be performed in left-to-right sequence, and we have constructed our formula to correspond).

The values appearing successively on the main display give the results of operating on each measurement input with the formula. This will continue until we cancel the x m, - c and ÷ z selections on the MATH menu.

The generalized sequence above is developed overleaf to provide a specific application; the percentage deviation of a series of readings from a previously-noted single reading.

A simpler method is used, and the constants refer to the earlier measurement.

Further Example using Math Facility

To Calculate the Percentage Deviation from a Previously-Noted Measurement

In this example, a series of readings is compared with a standard reading (j) taken earlier on the same channel. The required form of display is for each reading in the series (k) to be presented as a percentage deviation from the standard value.

The percentage deviation for each reading is given theoretically by:

$$[(k - j) \div j] \times 100 \%$$

This can be obtained using the % key in the MATH menu, which automatically multiplies by 100.

The sequence starts in the DCV function.

The instrument is placed into hold by pressing the Ext' Trig direct-action key, then Sample is pressed to take the single standard reading (j).

The formula is set up (the form of the MATH facility makes this a simple process); the instrument mode is changed to take readings (k) with an internal trigger, and the deviation of each reading is presented on the main display as a percentage of the earlier single measurement.

- Press the Ext' Trig key.
- Set up an input into the instrument terminals at about the nominal full range value.
- Press the Sample key to take one reading of the source voltage.

- Press the Math key.

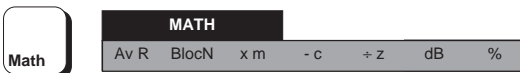

- Press the Config key.
- Press the c key.

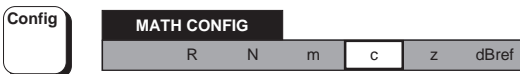

The C menu is displayed.

- Press the Last Rdg key, then press Enter.



The display reverts to the MATH CONFIG menu.

continued next page

- Press the Z key.



The Z menu appears.

- Press the Last Rdg key, then press Enter.



The constants for our formula are now established. The next stage is to program the formula itself, using the MATH menu.

- Press the Math key.

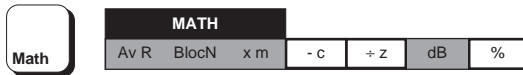

- Press the soft - c, ÷ z and % keys (the order of pressing does not matter, as each operation can only be performed in left-to-right sequence, and we have constructed our formula to correspond).

- Repress the Ext' Trig key for internal triggers, taking successive readings.

The values appearing successively on the main display give the results of operating the formula on each reading. They will appear as percentage deviations of the earlier single input, changing as the source voltage is varied. This will continue until we cancel the selections on the MATH menu.

Calibration Facilities

Important

This description is intended only as a guide to the menus and facilities available to calibrate the instrument. It contains no examples nor calibration routines, and should NOT be used directly as a basis for calibrating any part of the instrument.

For routine calibration refer to Section 8 of this handbook.

Calibration Menus

A description of the User Interface is given in Section 3 for the main functions. If you are unfamiliar with the front panel controls, you should complete the quick tour which starts on Page 3-5.

To give an overall view of the calibration facilities, movement among the CAL group of menus is described by the diagrams on the following pages.

Index to Calibration Menus and Descriptions

Menus	Page	Descriptions (contd)	Page
Calibration Overview	4-41	Menus Originating from Ext. Cal.	4-50
External Calibration	4-42	Line Frequency	4-51
'Spec'	4-43	Serial Number	4-51
Spot Frequency Calibration	4-44	SET Value	4-52
Spot Frequency 'Spec'	4-45	STD Value	4-54
Special Calibration and 'Lock'	4-46	SPEC (DCV, DCI or Ohms)	4-54
		Freq Band	4-55
		SPEC (ACV , ACI)	4-55
Descriptions		SPOT SPEC	4-56
Entry into the Calibration Menus	4-47	'LOCK' (Access Protection)	4-57
Protection for the Calibration Memory	4-48	Passnumber	4-57
External Calibration	4-49	Self Calibration	4-58
Internal Source Calibration	4-49	CAL Menu	4-58
EXT CAL DUE? (date setting)	4-49	PASS # = ? Menu	4-58
		SELFCAL Menu	4-59
		SELFCAL Running Menu	4-59
		SELFCAL ABORTED Menu	4-60
		SELFCAL UNSUCCESSFUL Menu	4-60
		SELFCAL COMPLETE Menu	4-60

External Calibration

Cardinal points - all ranges.

Non-Cardinal Points: **Set** - not ACV spot frequency.

Std - Only DCV 1V or 10V Range recommended.

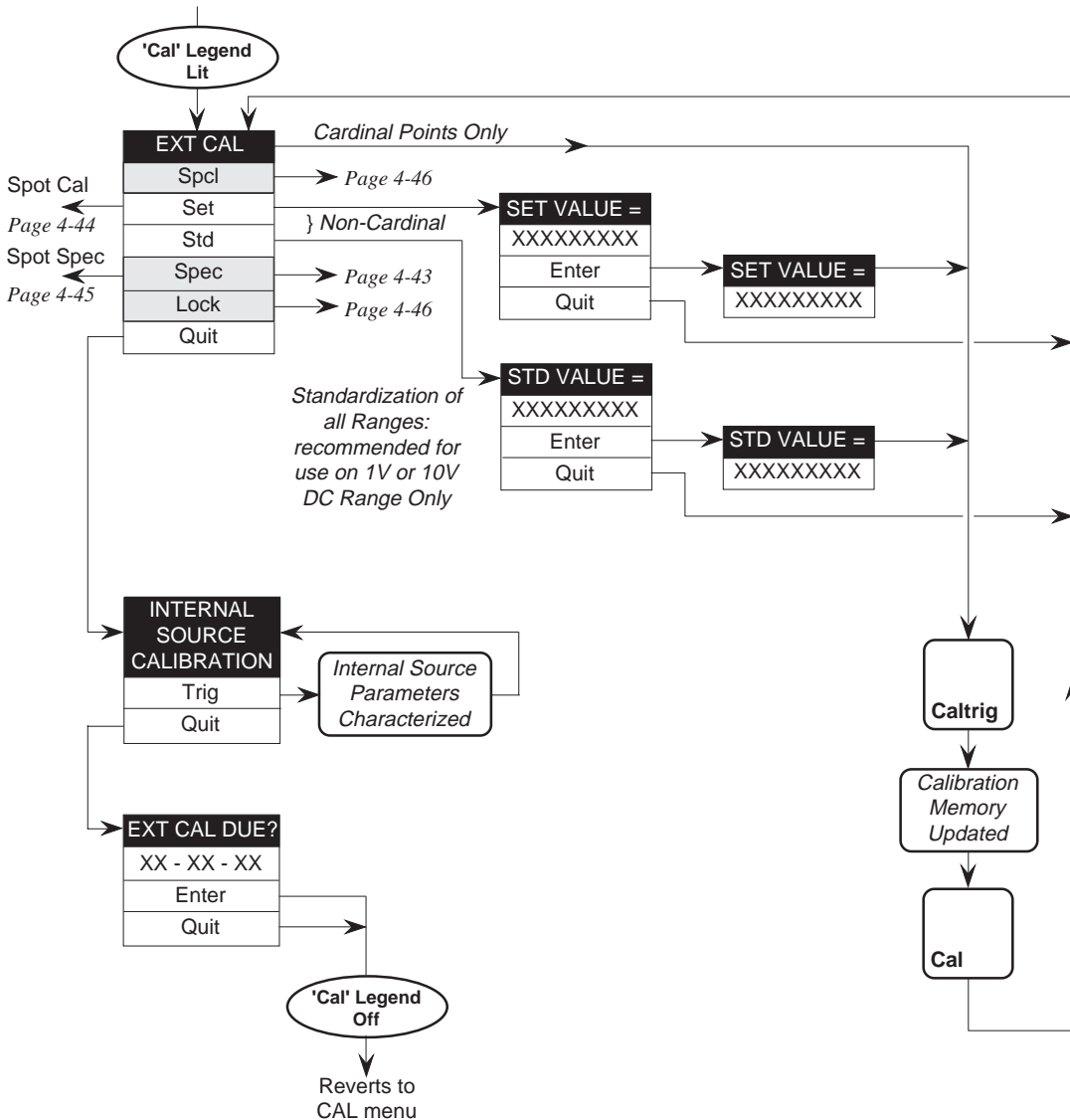

'Spec'

Entry of calibration uncertainties - not ACV spot frequency.

Menu route after pressing **Spec** key is automatically determined by Function selection.

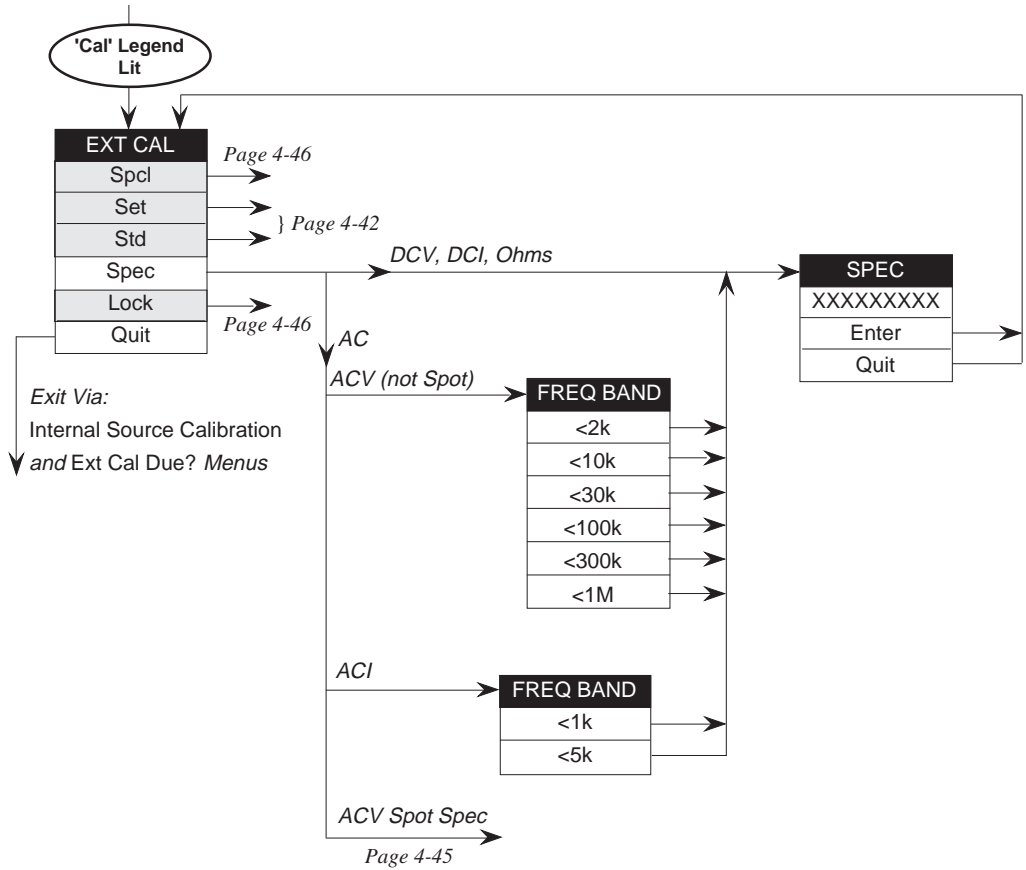

Spot Frequency Calibration Menus

'Spot' already selected in the ACV menu. Six spots available per ACV range.

Menu route to SPOT CAL menu, after pressing Set key is automatically determined by having selected ACV - Spot. Exit from SPOT CAL menu by pressing any hard key.

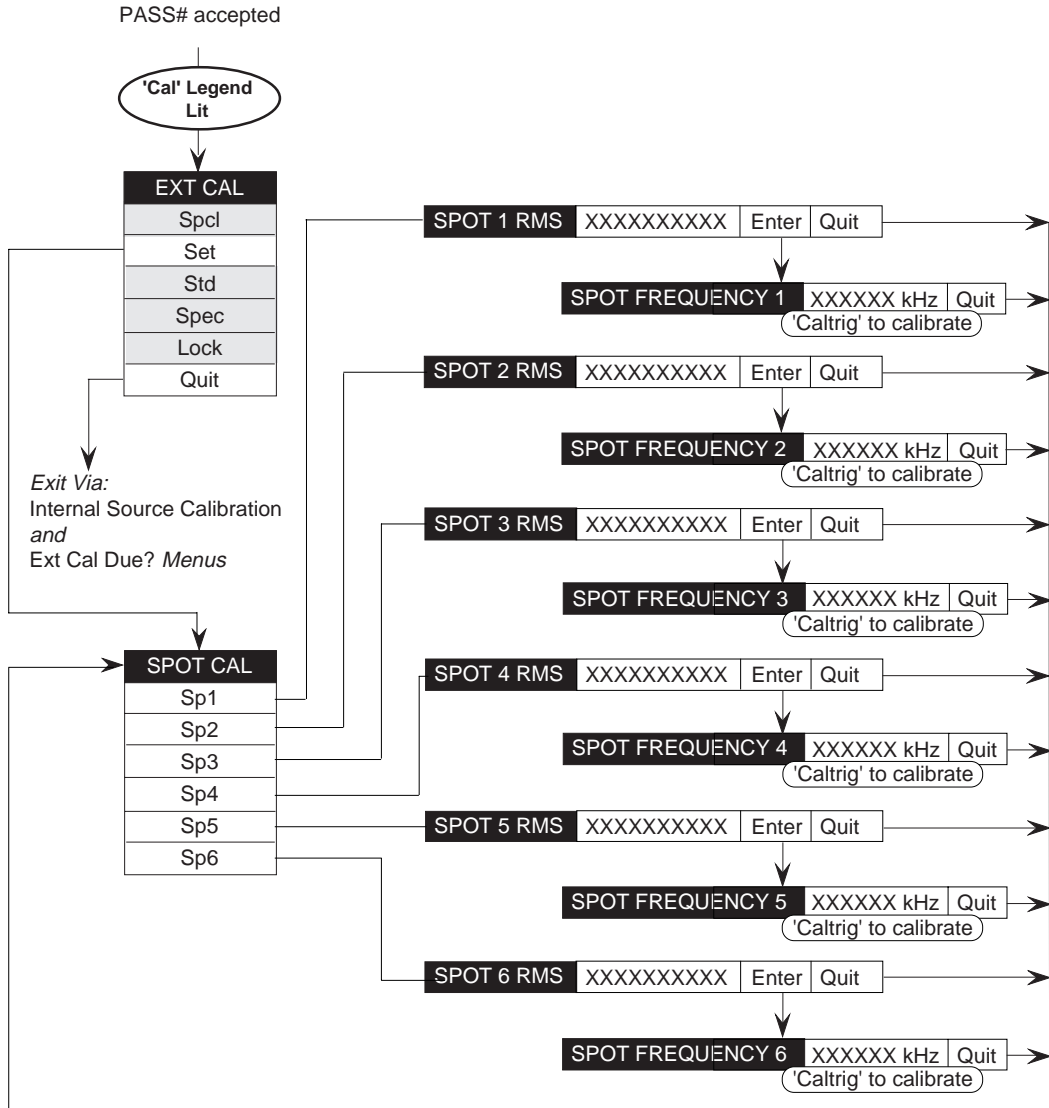

Spot Frequency 'Spec'

Calibration uncertainty entry. Spot already selected in the ACV menu. Six spots available per ACV range. Menu route to SPOT SPEC menu after pressing Spec key is automatically determined by having selected ACV - Spot.

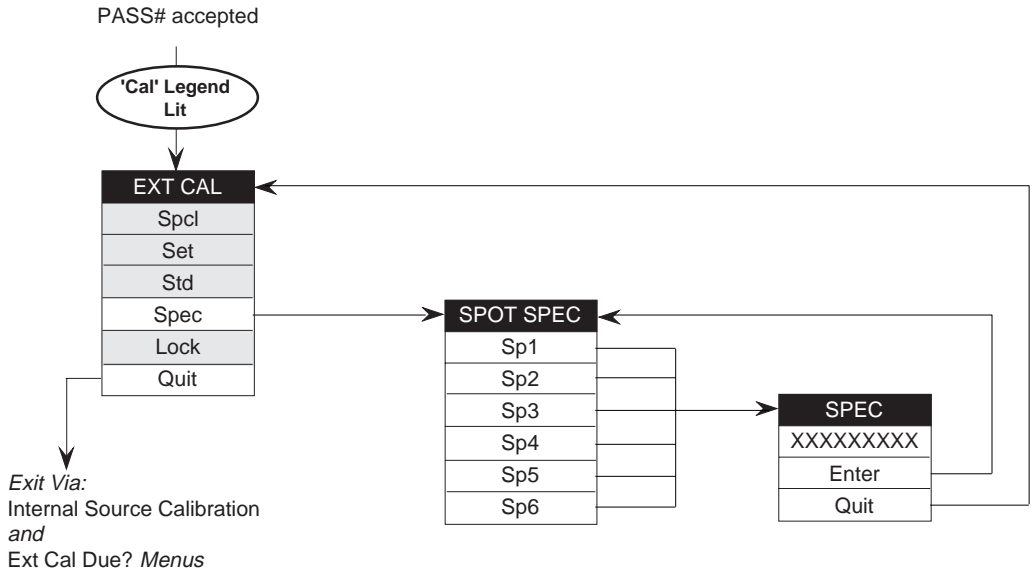

Special Calibration and 'Lock' Menus

'SPCL' permits the main ADC, the Analog-Output DAC and the frequency sensor to be calibrated. It also allows a section of the Non-Volatile RAM to be cleared for test purposes.

here for completeness; operations are described in the Calibration and Servicing Handbook.

These facilities are used in the factory for initial pre-calibration processes, and should need no further access during the life of the instrument unless repairs have been carried out. They appear

The menu also allows line frequency to be set; and a serial number for the instrument to be registered.

'LOCK' is used to set physical and/or passnumber restraints on access to external and self calibration, to protect the calibration memories.

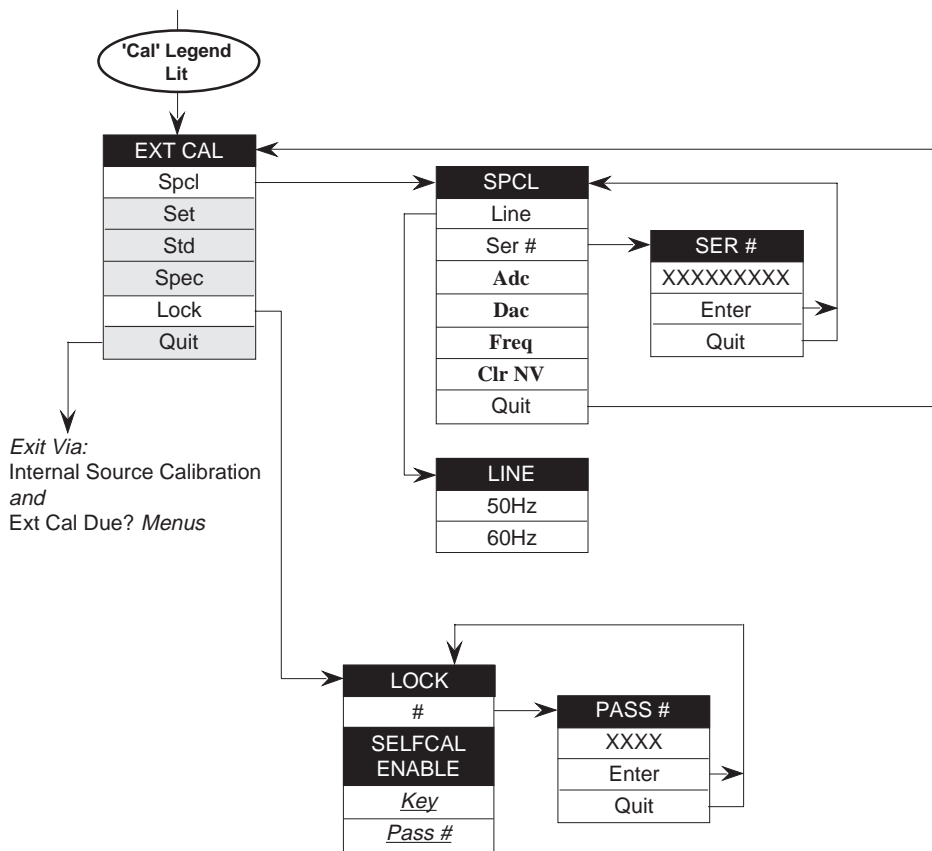

Entry into the Calibration Menus

Front Panel Cal Key

The Cal key on the front panel causes the CAL menu to be displayed in the dot matrix display, so long as the instrument is not already in Cal mode. This menu provides access to the external calibration menus, the selfcal menus, and the calibration due date menu. It also indicates whether the current set of selfcal corrections are being applied to the instrument's readings.

CAL Menu



This menu defines three *menu* keys, all keys are not selected at Power On:

- Due** Displays the EXT CAL DUE menu. This shows the user-entered recommended date for recalibration of the instrument.
- Ext** This key, in conjunction with the correct rear panel key lock position, displays the EXT CAL menu; which allows a user to proceed with calibration of the instrument.
- Self** This key, in conjunction with the correct combination of passnumber and rear panel key lock position, displays the SELFCAL menu; from which the user can then activate selfcal.

EXT CAL DUE menu



This menu is obtained by pressing the Due key from the CAL menu, showing the recommended date for recalibration of the instrument. It is accessible without using the calibration keyswitch or the passnumber, but the due date cannot be changed. After quitting the EXT CAL menu following a calibration, the menu is presented again, this time for possible alteration.

Protection for the Calibration Memory

Access Conditions

Access to the non-volatile calibration memory is restrained by two devices:

- A key-operated switch on the rear panel, always required for external calibration, and optionally installed for selfcal.
- A user-installed passnumber, which can be enabled for selfcal.

When the instrument is delivered new from Datron, access to selfcal is by keyswitch alone - the passnumber requirement has been disabled.

The options for selfcal can only be set or cleared from the LOCK menu, which is unavailable until access has been gained to the EXT CAL menu.

Once a passnumber is enabled, the passnumber menu (PASS # =) denies access to the SELFCAL menu to anyone who does not know the correct number. The locks can be set to protect the SELFCAL menu by either the keyswitch or passnumber (or both), or to leave it unprotected, at the authorizer's discretion.

PASS # = ? Menu

If the passnumber option has been selected for selfcal in the LOCK menu; then this menu appears when Self is selected in the CAL menu.

On entry to the menu the keyboard is activated and a numeric value (6 digits maximum) can be keyed in. None of the digits are displayed. Unless the number is the same as was installed, no further access to calibration menus is possible.



This menu also defines two *menu* keys:

Quit: Reverts to the CAL menu.

Enter: The passnumber is checked.

If it is invalid, an error message appears on the PASS# = ? menu, and entry to the SELFCAL menu is prohibited.

If it is valid, the keyboard is deactivated and effect is given to the Self command given in the CAL menu.

Important:

A valid Enter command also lights the 'Cal' legend on the main display, and enables the **Caltrig** key, which when pressed can alter the calibration memory.

External Calibration

EXT CAL Menu

This menu allows direct zero and full range cardinal point calibration, or selection of the non-cardinal point calibration operations of **Set** and **Std**. It also offers a means of entering user-defined calibration uncertainties, which are applied to the spec readout function. Finally it allows access to define the passnumber and the selfcal access restraints.

Important:

In this menu the **Caltrig** key is enabled, and when pressed alters the calibration memory. To reduce the possibility of inadvertently obliterating the previous calibration, the menu should only be used during a genuine recalibration. Refer to Section 8.

Once the 'Cal' legend is lit, the major function hard keys can be selected and the various ranges calibrated at zero and full range cardinal points, using the **Caltrig** direct action key. If the full range values are not exactly at the cardinal points, then **Set** in the EXT CAL menu can be used to inform the instrument of the exact value. For as long as the 'Cal' annunciator remains lit, the front panel **Cal** key accesses the EXT CAL menu directly - not forcing the repeated use of the passnumber.



This menu defines six *menu* keys:

Spcl: Both the **Cal** and **Spcl** annunciators on the main display are lit. The **SPCL** menu is displayed which allows pre-calibration of the instrument. Refer to Section 1 of the Calibration and Servicing handbook.

Set: Displays the **SET VALUE** menu. Both these menus provide a means to calibrate the instrument against non-cardinal calibration points.

Std: Displays the **STD VALUE** menu. This permits restandardization of the instrument's reference to a new value.

Spec: If the DMM is in DCV, DCI, or Ohms, the **SPEC** menu is activated. If in ACV or ACI then the **FREQ BAND** menu is displayed. All of these menus lead to entry of user-defined calibration uncertainties which are applied to the **spec** readout function.

Lock: Displays the **LOCK** menu. It allows access to change both the passnumber and the selfcal enable conditions.

Quit: Exits from the EXT CAL mode; the **Cal** legend on the main display turns off.

Quit from the EXT CAL menu exits via the **INTERNAL SOURCE CALIBRATION** menu, where by pressing **Trig**, the **Selfcal** source can be characterized if required.

From the **INTERNAL SOURCE CALIBRATION** menu, quitting exits via the **EXT CAL DUE ?** menu, where the recommended next calibration date can be entered, before finally quitting to the **CAL** menu.

Menus Originating from the EXT CAL Menu

SPCL Menu

This menu is obtained by pressing the Spcl key in the EXT CAL menu.

EXT CAL						
Spcl	Set	Std	Spec	Lock	Quit	

It permits special calibration of the DMM's different analog to digital converter resolutions, the DAC used for analog output, the frequency detector device, and also provides a means to set up the instrument's line frequency and serial number. A 'ClrNv' facility clears a section of the non-volatile RAM for 'test purposes only'. Refer to Section 1 of the Calibration and Servicing handbook.

SPCL						
Line	Ser #	Adc	Dac	Freq	Clr NV	Quit

The SPCL menu defines three *menu* keys and three *toggle* keys:

Line: Displays the LINE menu, where the line frequency can be set.

Ser#: Permits entry of the instrument's serial number.

Adc: This key calibrates the different resolutions which are available from the instrument's main analog-to-digital converter, so that there are no significant differences in readings seen when changing resolutions with a constant input value.

Dac: Calibrates the digital-to-analog converter used in the analog output option.

Freq: Calibrates the frequency counter against an external source.

ClrNv: Clears a section of the non-volatile RAM for 'test purposes only'.

Quit: Reverts to the EXT CAL MODE menu.

LINE Menu

This menu is obtained by pressing **Line** in the SPCL menu. It permits selection of either 50Hz or 60Hz operation.

This setting is not lost at power down.

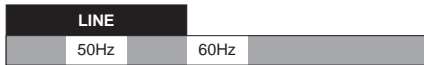

This menu defines two *choice* keys:

50Hz: Causes line operation to be set at 50Hz nominal.

60Hz: Causes line operation to be set at 60Hz nominal.

To exit from the **Line** menu it is necessary to select another function or facility hard key.

SER # = Menu

This menu is obtained by pressing **Ser#** in the SPCL menu. On entry to the menu, the most-recently entered serial number is shown and the keyboard is activated. A numeric value can be entered. The last four characters (the instrument's software issue) cannot be changed.



This menu also defines two *menu* keys:

Enter: Stores the new serial number, de-activates the keyboard, and reverts to the SPCL menu.

Quit: Reverts to the SPCL menu, leaving the old serial number intact.

SET VALUE Menu

This menu is obtained by pressing the **Set** key in the EXT CAL menu on all functions except ACV Spot Frequency.



When this menu appears, it shows the nominal full range value. It provides a means to calibrate the DMM against non-cardinal calibration points. The keyboard is activated (locking out all other keys) so that a new set value can be used to represent the calibration source value. It must be keyed in as a decimal fraction of full range, followed by an exponent to convert it to units of volts, amps or ohms. The **Caltrig** key has no effect until the set value is stored by pressing the **Enter** key. The DMM always chooses the most-recently stored **Set** value when calibrating.

The menu also defines the two soft keys:

Caution:

Pressing the **Enter** key enables the **Caltrig** key.

Enter: The new value is stored and the keyboard is de-activated. The set value remains on the dot-matrix display for comparison with the reading on the main display after the **Caltrig** key has been pressed.

Quit: Reverts to the EXT CAL menu, deleting the set value from store.

SPOT CAL Menu

This menu is obtained by pressing the **Set** key in the EXT CAL menu when the DMM is in ACV Spot Frequency mode. It provides a means of calibrating the DMM at any of six user-specific spot frequencies, at non-cardinal calibration values for each ACV range. The DMM will already be set to an ACV range on entry to the menu.



This menu allows a user to select a spot frequency (**Sp_x**) for the selected range. It defines six *menu* keys:

Sp1: displays the SPOT 1 RMS menu, where users define the RMS value for the Spot Frequency 1 calibration point on the currently selected range.

Sp2: displays the SPOT 2 RMS menu, where users define the RMS value for the Spot Frequency 2 calibration point on the currently selected range.

Sp3 - 6: as for Sp1 and Sp2, but permitting their own RMS values to be defined.

SPOT (1 to 6) RMS Menus

On entry to one of the six SPOT ($x = 1$ to 6) RMS menus, the nominal full range value is displayed and the keyboard is activated. A numeric value can be entered that represents the RMS value of the calibration source signal.



This menu defines two *menu* keys:

Important:

Pressing the **Enter** key enables the **Caltrig** key.

Enter: Stores the displayed RMS value and deactivates the keyboard.

The dot-matrix display moves to the SPOT FREQUENCY (1 to 6) menu, showing the calibration signal frequency. Pressing the **Caltrig** key calibrates the Spot selected in the SPOT CAL menu.

Quit: Reverts to the SPOT CAL menu, not storing any new Spot value.

Important:

The **Caltrig** key is still enabled in the next menu.

SPOT FREQUENCY(1 to 6) Menu

Enter this menu by pressing **Enter** in the SPOT (1 to 6) RMS menu, which also stores the RMS value keyed in during this menu. The value in the SPOT FREQUENCY (1 to 6) menu is the **measured** frequency of the present calibration input signal.

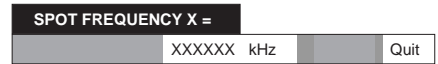

Possible actions in this menu:

Caltrig: Pressing the **Caltrig** key causes the selected ACV range to be spot calibrated at the calibration signal frequency. The frequency value is stored and can be viewed from the STATUS CONFIG menu. Any subsequent measurement on this range whose frequency is within $\pm 10\%$ of the stored frequency is accuracy enhanced by reducing flatness errors.

Calibrate the spot at a new frequency:

The keyboard cannot be activated because the displayed value constantly updates to reflect the measured input signal frequency.

To calibrate the spot at a new frequency, change the input signal to the desired new frequency and press **Caltrig** as before.

Quit: Escapes from the menu without pressing **Caltrig** to calibrate. The original Spot calibration remains intact and transfers to the SPOT CAL menu.

STD VALUE Menu

This menu is obtained by selection of the **Std** key in the **EXT CAL** menu. It provides a means of restandardizing all ranges of the DMM against a single non-cardinal calibration point.

It is recommended that this be carried out only on DCV 1V and 10V ranges.

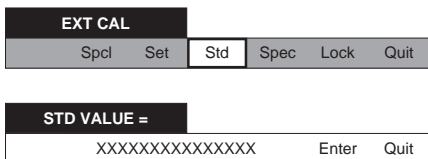

When this menu appears, it shows the nominal full range value. It activates the keyboard (locking out all other keys) so that a new Std value can be used to represent the calibration source value. This must be keyed in as a decimal fraction of full range, followed by an exponent to convert it to volts. The **Caltrig** key is inactive until the Std value is stored by pressing the **Enter** key. The DMM always chooses the most-recently stored Std value for the Std calibration.

The menu also defines the two soft keys:

Important:

Pressing the **Enter** key enables the **Caltrig** key.

Enter: The new value is stored and the keyboard is deactivated. The Std value remains on the dot-matrix display for comparison with the DMM reading on the main display after pressing the **Caltrig** key.

Quit: Reverts to the **EXT CAL** menu, not storing any new Std value.

SPEC Menu (DCV, DCI or Ohms)

For these functions the **SPEC** menu is obtained directly by pressing the **Spec** key in the **EXT CAL** menu. It permits entry of calibration uncertainties which are used in the **Spec** readout calculations.

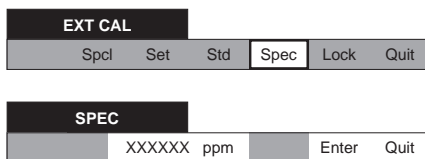

On entry to the menu, the most-recently entered calibration uncertainty value is shown and the keyboard is activated. A numeric value can be entered.

This menu also defines two *menu* keys:

Enter: Stores the new value, de-activates the keyboard, and reverts to the **EXT CAL** menu.

The new calibration uncertainty value is subsequently incorporated, instead of the previous one, into the CPU's calculations of DMM accuracies for the (MONITOR) **SPEC** menu display.

Quit: Reverts to the **EXT CAL** menu, leaving the old spec value intact.

FREQ BAND

This menu is obtained by selecting the Spec key from the EXT CAL menu when the DMM is in either ACV or ACI function. It permits selection of the various frequency bands relevant to the entry of calibration uncertainties which are used in the spec readout calculations.



If ACI is selected:



This menu defines two keys: <1k; <5k: For each of these selections, the SPEC menu is displayed, and the calibration uncertainty for this frequency range can be entered.

If ACV is selected

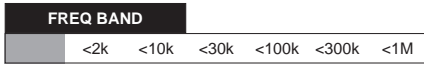

The table shows how the uncertainties will be applied over the frequency bands.

Selection Key	Frequency Band
<2k	100Hz to 2kHz
<10k	{ 2kHz to 10kHz 40Hz to 100Hz
<30k	
<100k	30kHz to 100kHz
<300k	100kHz to 300kHz
<1M	300kHz to 1MHz

For each selection, the calibration uncertainty can be entered in the SPEC menu, which appears next.

Note that when an uncertainty value is entered via the <10k key for the 2kHz - 10kHz band, the same value is applied both when the input frequency is between 2kHz and 10kHz, and when it is between 40Hz and 100Hz.

SPEC Menu - ACV (not Spot) or ACI - Frequency Band Specifications

For these functions the SPEC menu is obtained by pressing a band selection key in the FREQ BAND menu when the DMM is in either ACV (not Spot) or ACI function. It permits entry of calibration uncertainties to be used for Spec calculations.

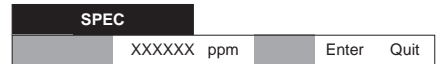

On entry to the menu, the most-recently entered calibration uncertainty value is shown and the keyboard is activated. A numeric value can be entered.

This menu also defines two menu keys:

Enter: Stores the new value, de-activates the keyboard, and reverts to the FREQ BAND menu.

The new calibration uncertainty value is subsequently incorporated, instead of the previous one, into the CPU's calculations of DMM accuracies for the (MONITOR) SPEC menu display.

Quit: Reverts to the EXT CAL menu, leaving the old spec value intact.

SPOT SPEC Menu

This menu is obtained by pressing the **Spec** key in the **EXT CAL** menu when the DMM is in Spot Frequency function. It permits selection of the spot frequencies relevant to the selected range, for entering the calibration uncertainties that will be used in spec calculations.

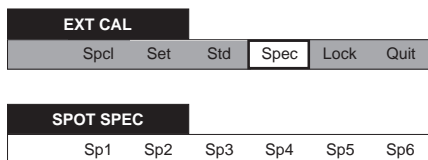

This menu defines six *menu* keys:

SP1, Sp2, Sp3, Sp4, Sp5, & Sp6:

Pressing any one of these keys displays the **SPEC** menu, where the calibration uncertainty for the selected Spot Frequency on the active range can be entered.

SPEC Menu

(ACV Spot Frequency Band Specifications)
For this purpose the **SPEC** menu is obtained by pressing an **Sp(1 to 6)** key in the **SPOT SPEC** menu when the DMM is in ACV Spot Frequency function.

It permits entry of calibration uncertainties that will be used for **Spec** calculations.

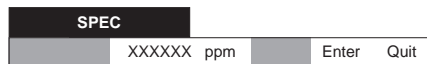

On entry to the menu, the most-recently entered calibration uncertainty value is shown and the keyboard is activated. A numeric value can be entered.

This menu also defines two *menu* keys:

Enter: Stores the new value, de-activates the keyboard, and reverts to the **SPOT SPEC** menu.

The new calibration uncertainty value is subsequently incorporated, instead of the previous one, into the CPU's calculations of DMM accuracies for the (MONITOR) **SPEC** menu display.

Quit: Reverts to the **EXT CAL** menu, leaving the old spec value intact.

LOCK Menu

This menu is obtained by pressing **Lock** in the **EXT CAL** menu. It provides access to define the passnumber, and is also used to set the selfcal enable conditions.



This menu defines one *menu* key and two *state toggle* keys:

Note that the rear panel key lock must always be turned to **CAL ENABLE** before External Calibration can proceed. New instruments are shipped with **Key** selected; **#** and **Pass #** not selected.

#: Displays the **PASS #** menu, where the DMM's passnumber can be defined.

Key: When selected, the rear panel key lock must be turned to the **CAL ENABLE** position before a selfcal can proceed. This setting is not lost at Power Off.

Pass #: When selected, a passnumber must be entered before a selfcal can proceed. This setting is not lost at Power Off.

PASS # Menu

This menu is obtained by pressing **#** in the **LOCK** menu. On entry to the menu, the most recently entered passnumber is shown and the keyboard is activated. A numeric value can be entered.



This menu also defines two *menu* keys:

Enter: Stores the new passnumber, de-activates the keyboard, and reverts to the **LOCK** menu.

Quit: Reverts to the **LOCK** menu, leaving the old passnumber intact.

Self Calibration

CAL Menu

Self-calibration starts by pressing the hard Cal key.



This menu defines three *menu* keys, all keys are not selected at Power On. For self-calibration we are interested in the soft **Self** key:

- Due** Displays the EXT CAL DUE menu. This shows the user-entered recommended date for the recalibration of the instrument.
- Ext** This key, in conjunction with the correct combination of passnumber and rear panel key lock position, displays the EXT CAL MODE menu; which allows a user to proceed with calibration of the instrument.
- Self** This key, in conjunction with the correct combination of passnumber and rear panel key lock position, displays the SELFCAL menu; from which the user can then activate selfcal.

Rear Panel Keyswitch

If selfcal access has been protected during external calibration (LOCK menu) by activating the **ENABLE/DISABLE** keyswitch on the rear panel, then to access the selfcal menus, the switch must be turned to the **ENABLE** position.

PASS # = ? Menu

If a passnumber is installed to protect the selfcal operation, this menu appears prior to the SELFCAL menu, when **Self** is selected from the CAL menu.



On entry to the menu the keyboard is activated and a numeric value (6 digits maximum) can be entered. None of the digits are displayed as they are keyed in.

This menu also defines two *menu* keys:

Enter: The passnumber is checked.

If it is valid, the keyboard is deactivated and the **Self** command given in the CAL menu is effected by displaying the SELFCAL menu.

If invalid, an error message appears on the PASS # = ? menu, and entry to the SELFCAL menu is prohibited.

Quit: Reverts to the CAL menu.

Important:

The next menu enables the soft trigger key **Trig**, which when pressed alters the calibration memory.

SELF CAL Menu

This menu is obtained by pressing the **Self** key in the **CAL** menu, in conjunction with the correct combination of passnumber and key lock setting. It permits activation of a Selfcal operation.



This menu defines one *direct action/menu* soft key and two *choice* keys:

N.B. Self Calibration is valid within 23°C ± 10°C and within one year of internal source calibration.

Trig: Causes a complete selfcal operation to begin, progress being indicated.

Typical durations are:
 1 minute (DCV-only instrument);
 10 minutes (When fully loaded with DCV, ACV, Ohms, DCI and ACI).

CORRECTNS On:
 Applies selfcal corrections to the DMM's readings. This setting is not lost at power down, and new instruments are shipped with corrections On.

CORRECTNS Off:
 Causes the selfcal corrections to be disabled and not applied to the DMM's readings.

SELF CAL (Running)

This display results from pressing the **Trig** key in the **SELF CAL** menu. It indicates that a Selfcal operation is in progress, with a note of the current test being performed followed by a pass or fail comment.



Once any failure is noted, the fail message remains on the display to the end of the test sequence.

This menu also defines one *direct action/menu* key:

Abort: The Selfcal operation is aborted, and transfers the dot-matrix display to the **SELF CAL ABORTED** menu.

If the **Abort** key is not pressed, the Selfcal operation will run to its conclusion, and then transfer to either the **SELF CAL COMPLETE** menu, or the **SELF CAL UNSUCCESSFUL** menu, depending on whether any failures were noted during the test.

SELFICAL ABORTED Menu

This menu is obtained by pressing the Abort key in the running SELFICAL menu, to stop the Selfcal operation. It permits a list of any failures to be viewed.



This menu defines one soft key:

List: Any failures during the test are noted in software, and these can be listed out on the dot matrix display by repeatedly pressing the List key.

N.B! Repeated pressing of the List key reads out the failures in turn. The memory of each failure is destroyed as it is read.

Appendix A to this section contains a list of the failure-message numbers.

To exit, press any function hard key.

SELFICAL UNSUCCESSFUL Menu

If the completed Selfcal operation has detected a failure (ie the Selfcal operation has not been not aborted), the SELFICAL UNSUCCESSFUL menu appears after the running SELFICAL menu. It permits a list of any failures to be viewed.



his menu defines one soft key:

List: Any failures during the test are noted in software, and these can be listed out on the dot matrix display by repeatedly pressing the List key.

N.B! Repeated pressing of the List key reads out the failures in turn. The memory of each failure is destroyed as it is read.

Appendix A to this section contains a list of the failure-message numbers.

To exit, press any function hard key.

SELFICAL COMPLETE Display

This display merely registers the completion of selfcal. It appears after the running SELFICAL menu when the Selfcal operation has not been aborted, if the operation has detected no failures.



No soft keys are defined. To exit from this display, press any function hard key.

Direct Action Keys

These seven keys are located beneath the main display. They allow the operator to act as follows:

Reset

Provides a quick means of resetting the instrument to the power-up state, as far as local operation is concerned.

The instrument default states for Power On are given in Appendix B to Section 5. Pressing **Reset** provides the same result, except that any settings directly concerned with remote operation are not altered.

Ext'trig

Disables internal triggers, and enables all external trigger sources.

The 'Ext' annunciator on the main display is lit.

Ext'trig can be self-cancelled by a second press, to enable internal triggers. The Ext annunciator is turned off when internal triggers are enabled.

Sample

Triggers a single-shot measurement if the DMM is in Ext'trig mode. All 'Sample' measurements are subject to the standard internal time delays before A-D conversion. These are listed on page 5-71 of Section 5.

During the measurement the 'Busy' annunciator on the main display is lit.

Local

Returns the DMM to front panel control when operating on the IEEE-488 bus, provided that it is not disabled by remote command. It will cause the Rem annunciator on the main display to turn off.

While in Local, any delays set up during remote programming are suspended, and the standard internal delays are reinstated.

Local can be disabled by a controller using the LLO (Local Lockout) function.

SRQ

If set to remote in IEEE 488 system operation, with 'URQ' and 'ESB' bits enabled; manually generates a Service Request (SRQ) on the IEEE 488 bus and causes the SRQ annunciator on the main display to light, and remain lit until the request is serviced.

SRQ can be disabled via the IEEE 488 bus using the 'Event Status Enable' or 'Service Request Enable' register commands.

For further information refer to Section 5.

Caltrig

This key is only active when the Cal annunciator is lit in the main display. It is used for all zero, gain, and AC hf cal triggers.

Zero

Causes an Input Zero operation to take place, ending with a corrected reading being shown on the main display. If Auto-range is selected, then each range for the selected function will be zeroed in turn, one after the other. The main display will track each range change. Independent zero corrections are available for Front, Channel A, and Channel B inputs. Neither Power On nor Reset affect the settings stored in the input zero memory.

SK8 - Input/Output Port

This is a 15-way Cannon 'D' type socket, fitted on the Rear Panel. It provides for the following inputs and outputs:

Analog Output (Option 70 only)

Analog Output is only available when Option 70 is fitted, and the Analog Output Enable line (SK8 - pin 10) is shorted to Digital Common (SK8 - pin 7). When enabled, the Analog Output signal on pin 8 can vary between +2V and -2V, with a source impedance of 1k Ω , referred to pin 15.

When measuring normally, or scanning Channel A minus Channel B, the signal expresses the displayed reading as a fraction of Full Range.

e.g. -500V on the 1kV range codes to
-0.5V DC of Analog Output.

When SCAN A/B, (A - B)/A or MATH is selected, then the output is as follows:

100%	= +1V DC	} Linear with dBs
0%	= 0V DC	
100dB	= +1V DC	
0dB	= 0V DC	

No Units:

+1.000000E0 = +1V
-0.500000E0 = -0.5V

Any reading which codes to >+2V or <-2V is represented by +2V or -2V as appropriate.

HOLD_L

This input at pin 13, when *true*, inhibits external triggers from any source, including Hi-Lo transitions on the Ext Trig. line. The pin is pulled to +5V via 10k Ω , and responds to TTL levels, being *false* when high, and *true* when low.

Flags

The outputs at pins 2 to 6 are typically at +3V when high, and at +0.5V when low. Maximum drive available via pins 2, 3, 4, 6 and 9 (when low) is 24mA. Maximum drive via pin 5 is 3mA.

HIGH LIMIT_L

This flag output at pin 2 is at low level (*true*) only when the most-recent measurement was above the limit programmed via the front panel or remote command.

LOW LIMIT_L

This flag output at pin 3 is at low level (*true*) only when the most-recent measurement was below the limit programmed via the front panel or remote command.

DATA VALID_L

This flag output at pin 4 goes to low level (*true*) to indicate that both the HIGH LIMIT_L and LOW LIMIT_L flag states are valid, and are not an invalid hangover from an earlier trigger.

When a valid trigger is received DATA VALID_L is asserted *false* (high level).

SAMPLING_H

This flag output at pin 5 goes to high level (*true*) when a valid trigger is received to start a measurement, returning to low level (*false*) when the measurement is complete.

TRIGGER TOO FAST_L

This flag output at pin 6 is latched to low level (*true*) when any trigger originating as EXT TRIG, REMOTE COMMAND or 'SAMPLE' (front panel key) is received; **and** the measurement cycle initiated by the previous such trigger is in progress.

Under normal circumstances, the second trigger will be implemented when the measurement is complete.

This flag line is reset to high level (*false*) when HOLD_L is asserted; or when any Function, Range, Resolution, Filter or Trigger Mode change is implemented.

OVERLOAD_L

The flag output at pin 9 goes to low level (*true*) when an overscale signal is applied to the input, returning to high level (*false*) when the overload is removed. This flag represents the 'Error OL' message given on the front panel display.

SHIELD, DIGITAL COMMON, and ANALOG O/P 0V

Pins 1, 7, 14 and 15 are internally connected together.

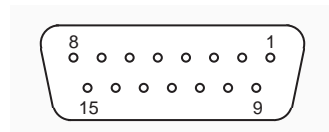
Pin Layout**Pin Designations**

Pin	Name	Function
1	SHIELD	
2	HIGH LIMIT_L	Flag - low true
3	LOW LIMIT_L	Flag - low true
4	DATA VALID_L	Flag - low true
5	SAMPLING_H	Flag - high true
6	TRIG. TOO FAST_L	Flag - low true
7	DIGITAL COMMON	
8	ANALOG OUTPUT	(Option 70 only)
9	SPARE	
10	AN. O/P ENABLE_L	Input - low true
11	SPARE	
12	SPARE	
13	HOLD_L	Input - low true
14	DIGITAL COMMON	
15	ANALOG O/P 0V	(Option 70 only)

'Numeric Keyboard' keys

Keyboard Facility

Seventeen of the menu keys double as numeric keyboard keys when certain menus appear on the dot-matrix display, and in most cases all other keys are locked out. As well as the numbers 0 to 9, the decimal point and the polarity changeover (+/-) keys, five other functions are represented.

Exp

The number appearing on the numeric display to the right of 'E' is a power of ten, by which the number to the left of the E is multiplied. The Exp key is used to enter E into the expression.

Enter

After assembling the number within a menu, the Enter key is pressed to confirm that it is to be used. Usually the word Enter also appears in the menu. In some cases the Enter command enables another key, or presents another menu.

Quit

For a few menus (associated with 'Cal') the Quit key is provided for convenient exit, without activating any process.

When a selftest or selfcal operation is in progress, the word Abort appears above the Quit key to exit from the process.

← ('Monitor' key)

Deletes the previous numerical character.

Last rdg

When a reading from the main display is required to be incorporated into a process, the Last rdg key can be used to enter the value of the most-recent measurement on to the dot-matrix menu.

Note to users: For the sake of completeness, this appendix collects together the error codes which might be generated either on the instrument front panel, or via the IEEE 488 system bus.

Error Detection

All errors, which cannot be recovered without the user's knowledge, result in some system action to inform the user via a message, and where possible restore the system to an operational condition. Errors are classified by the method with which they are handled. Recoverable errors report the error

and then continue. System errors which cannot be recovered cause the system to halt with a message displayed. Restarting the instrument from Power On may clear the error, but generally such messages are caused by hardware or software faults, which require user action.

Error Messages

Fatal System Errors

For all fatal system errors, the error condition is reported only via the front panel. The processor stops after displaying the message. A user must respond by retrying operation from power on, and

initiate repair if the fault persists. The following is a list of error numbers displayed, with their associated fault descriptions:

- 9000 - System Kernel Fault
- 9001 - Run Time System Error
- 9002 - Unexpected Exception
- 9003 - PROM Sumcheck Failure
- 9004 - RAM Check Failure
- 9005 - Serial Interface Fault
- 9006 - Option Test Failure
- 9007 - Unknown Engine Instruction
- 9099 - Undefined Fatal Error

Recoverable Errors

These consist of **Command Errors**, **Execution Errors** and **Device-Dependent Errors**. Command Errors can only be generated due to incorrect remote programming. Some Execution Errors and all Device-Dependent Errors can all be generated by manual operation as well. Each of the reportable Execution and Device-Dependent Errors are identified by a code number.

Command Errors (CME)

(Remote operation only)

Command Errors are generated when the remote command does not conform, either to the device command syntax, or to the IEEE 488.2 generic syntax. The CME bit (5) is set *true* in the Standard-defined Event Status Byte, but there is no associated queue.

The error is reported by the mechanisms described in the sub-section of Section 5 which deals with status reporting.

Errors generated due to incorrect front panel manipulation are not reported to the bus; and vice versa.

Execution Errors (EXE)

An Execution Error is generated if a received command cannot be executed because it is incompatible with the current device state, or because it attempts to command parameters which are out-of-limits.

In remote operation, the EXE bit (4) is set *true* in the Standard-defined Event Status Byte, and the error code number is appended to the Execution Error queue.

The error is reported by the mechanisms described in the sub-section of Section 5 which deals with status reporting, and the queue entries can be read destructively as LIFO by the Common query command *EXQ?.

There is no queue when execution errors are generated during manual operation, the description of the error being presented directly on the Menu display.

The Execution Error numbers are given on the opposite page, with their associated descriptions.

List of Execution Errors

- 1000 - EXE queue empty when recalled
- 1001 - Option not installed
- 1002 - Calibration disabled
- 1003 - Ratio/Function combination not allowed
- 1004 - Filter incompatible with Function
- 1005 - Input Zero not allowed in Ratio
- 1006 - Calibration not allowed in Ratio
- 1007 - Data entry error
- 1008 - Must be in AC Function
- 1009 - Pass Number entry error
- 1010 - Divide-by-zero not allowed
- 1012 - No more errors in list
- 1013 - Data out of limit
- 1014 - Illegal Range/Function combination
- 1015 - Command allowed only in Remote
- 1016 - Not in Special Calibration
- 1017 - Calibration not allowed with Math
- 1018 - Key not in the Cal Enabled position
- 1019 - Spec not compatible with Function
- 1020 - Internal Source Cal required
- 1021 - Test not allowed when Cal enabled
- 1022 - No parameter for this Function
- 1023 - Input zero not allowed in ACI

Recoverable Errors (*contd*)**Device-Dependent Errors (DDE)**

A Device-Dependent Error is generated if the device detects an internal operating fault (eg. during self-test). The DDE bit (3) is set *true* in the Standard-defined Event Status Byte, and the error code number is appended to the Device-Dependent Error queue.

In Remote, the error is reported by the mechanisms described in the sub-section of Section 5 which deals with status reporting, and the queue entries can be read destructively as LIFO by the Common query command *DDQ?.

In Local, the DDE status is checked at the end of the operation (eg. Cal, Zero, Test). If *true*, an error has occurred, and the content of the last entry in the queue is displayed on the front panel.

If both bus and front panel users attempt to read the queue concurrently, the error data is read out destructively on a first-come, first-served basis. Thus one of the users cannot read the data on one interface as it has already been destroyed by reading on the other. This difficulty should be solved by suitable application programming to avoid the possibility of a double readout. Ideally the IEEE 488 interface should set the instrument into REMS or RWLS to prevent confusion. The bus can ignore the queue, but the front panel user will have to read it to continue.

Device-Dependent Error Lists

Device-dependent errors are associated mainly with test and calibration operations. The error numbers in the following pages are therefore listed in these categories. There is some overlap.

The error list for external calibration operations, with their associated descriptions, are given on the opposite page. The self-calibration and internal source calibration error list commences overleaf.

External Calibration Operations

Correction Errors

- 2000 - Zero Correction Error
- 2001 - Gain+ Correction Error
- 2002 - Gain- Correction Error
- 2003 - HF trim Correction Error
- 2004 - Input Correction Error
- 2005 - LoI Zero Correction Error
- 2006 - LoI Gain Correction Error
- 2008 - A to D Correction Error
- 2009 - Reference Error
- 2010 - Frequency Correction Error
- 2011 - DAC Correction Error
- 2012 - Standardise Error

Corruptions

- 2013 - Key/Pass# flags Corrupt
- 2014 - Serial Number Corrupt
- 2015 - Cal Due Date Corrupt
- 2016 - Self-corrections Flag Corrupt
- 2017 - Bus Address Corrupt
- 2018 - Line Frequency Corrupt
- 2020 - Measurement Corrections Corrupt
- 2021 - Measurement Corrections Invalid
- 2022 - NV RAM Write Failure

Non-volatile RAM Checksum Errors

- 2110 - Primary NV Checksum Error
- 2111 - Secondary NV Checksum Error
- 2112 - Input Zero NV Checksum Error
- 2113 - Frequency NV Checksum Error

Others

- 2114 - Switches not optimum
- 2115 - Requires internal source calibration

Self Calibration and Internal Source Calibration Operations

The codes for these operations are related to steps in the sequence of calibrations implemented by the processor. They will appear only if the calibration has not been successful, and should be reported for interpretation to your local Wavetek service center, so that the fault can be analyzed.

In the following table, the error allocated to each step appears against its step number. A short description of the test step is also given.

For measurements of noise and magnitude, a series of readings is taken. Some early readings are discarded to allow for settling; and of the others, the highest and the lowest readings are also discarded. The remainder are used to calculate:

- the standard deviation for noise measurement, and
- the mean for magnitude measurement.

* All the steps are included in 'Full Selftest', 'Selfcal' and 'Internal Source Cal'. But not all are included in 'Fast Selftest'; so to distinguish those that are, their step numbers in the sequence are followed by an asterisk (*). For these steps, the Fast Selftest limits are wider than for Full Selftest, Selfcal or Internal Source Cal. Also, because of the lower resolution in Fast Selftest, more readings can be taken in the same number of line cycles.

The methods of reporting unsuccessful tests are described under the paragraphs dealing with the tests or self calibrations. The generation of an error code accompanies an unsuccessful test. Its results will be, at the least, out of test limits.

Step Function**Fuse Tests**

- 2101* Fuse is open circuit.
- 2102* Fuse fault other than o/c

Memory Tests

The following NV memory checksums do not agree with their stored values.

- 2110* Primary.
- 2111* Secondary.
- 2112* Input Zero.
- 2113* Frequency.

Reference Ratio Tests

- 2121* Reference zero noise.
- 2122* Reference zero magnitude.
- 2131* Ref 2 noise.
- 2132* Ref 2 magnitude.
- 2141* Ref 1 noise.
- 2142* Ref 1 magnitude.
- 2143* Ref 1 : Ref 2 Magnitude Ratio drift.
- 2151* Positive Reference noise.
- 2152* Positive Reference magnitude.
- 2153* Negative Reference noise.
- 2154* Negative Reference magnitude.
- 2155 Ref+ : Ref- Magnitude Ratio.
- 2156 Ref+ : Ref- Magnitude Ratio drift.

* = Also included in Fast Test

DC Voltage Tests

True Zero Measurements

- 2161 DC 10V range zero noise.
- 2162 DC 10V range zero magnitude.
- 2163 DC 10V range zero drift.

- 2171 DC 1V range zero noise.
- 2172 DC 1V range zero magnitude.
- 2173 DC 1V range zero drift.

- 2181* DC 100mV range zero noise.
- 2182* DC 100mV range zero magnitude.
- 2183 DC 100mV range zero drift.

- 2191 DC 100V range zero noise.
- 2192 DC 100V range zero magnitude.
- 2193 DC 100V range zero drift.

- 2201 DC 1000V range zero noise.
- 2202 DC 1000V range zero magnitude.
- 2203 DC 1000V range zero drift.

Negative Gain Measurements

(Offsets {Zero} and References)

- 2211 -1V offset noise.
- 2212 -1V offset magnitude.
- 2213 -1V reference noise.
- 2214 -1V reference magnitude.
- 2215 -10V offset noise.
- 2216 -10V offset magnitude.

Positive Gain Measurements

(Offsets {Zero} and References)

- 2221 10V offset noise.
- 2222 10V offset magnitude.
- 2223 10V loaded offset noise.
- 2224 10V loaded offset magnitude.

- 2231 1V offset noise (atten. 10V).
- 2232 1V offset magnitude (atten. 10V).

- 2233 100mV offset noise (atten. 10V).
- 2234 100mV offset magnitude (atten. 10V).

- 2241 1V offset noise.
- 2242 1V offset magnitude.

- 2251 10V +Ref noise.
- 2252 10V +Ref magnitude.
- 2253 10V +Ref magnitude drift.

- 2261 10V loaded gain noise.
- 2262 10V loaded gain magnitude.
- 2263 10V loaded gain magnitude drift.

- 2271 1V Range - 100mV signal noise.
- 2272 1V Range - 100mV signal magnitude.
- 2273 1V Range - 100mV signal magnitude drift.

- 2281 100mV Range - 100mV signal noise.
- 2282 100mV Range - 100mV signal magnitude.
- 2283 100mV Range - 100mV signal magnitude drift.

- 2291 1V reference noise.
- 2292 1V reference magnitude.
- 2293 1V reference drift.

* = Also included in Fast Test

AC Voltage Tests**1V AC Range Selected**

- 2301 1VAC Input noise.
- 2302 1VAC Input magnitude.

- 2311* 1VAC preamp output noise.
- 2312* 1VAC preamp output magnitude.

- 2321* +RMS output noise.
- 2322* +RMS output magnitude.

100mV AC Range Selected

- 2331 100mVAC Input noise.
- 2332 100mVAC Input magnitude.

- 2341* 100mVAC preamp output noise.
- 2342* 100mVAC preamp output magnitude.

10V AC Range Selected

- 2351 10VAC Input noise.
- 2352 10VAC Input magnitude.

- 2361 10VAC preamp output noise.
- 2362 10VAC preamp output magnitude.

100V AC Range Selected

- 2371 100VAC Input noise.
- 2372 100VAC Input magnitude.

- 2381 100VAC preamp output noise.
- 2382 100VAC preamp output magnitude.

1kV AC Range Selected

- 2391 1kVAC Input noise.
- 2392 1kVAC Input magnitude.

- 2401 1kVAC preamp output noise.
- 2402 1kVAC preamp output magnitude.

* = Also included in Fast Test

AC Voltage Tests (Contd.)**1V AC Range Selected**

- 2411 1VAC Input noise.
- 2412 1VAC Input magnitude.

- 2421* 1VAC preamp output noise.
- 2422* 1VAC preamp output magnitude.

- 2431* -RMS output noise.
- 2432* -RMS output magnitude.
- 2433 1V offset magnitude.
- 2434 1V preamp gain drift.
- 2435 +RMS gain.
- 2436 +RMS gain drift.
- 2437 -RMS gain.
- 2438 -RMS gain drift.

100mV AC Range Selected

- 2441 100mVAC Input noise.
- 2442 100mVAC Input magnitude.

- 2451 100mVAC preamp output noise.
- 2452 100mVAC preamp output magnitude.
- 2453 100mV preamp gain drift.

10V AC Range Selected

- 2461 10VAC Input noise.
- 2462 10VAC Input magnitude.

- 2471* 10VAC preamp output noise.
- 2472* 10VAC preamp output magnitude.
- 2473 10V preamp gain drift.

100V AC Range Selected

- 2481 100VAC Input noise.
- 2482 100VAC Input magnitude.

- 2491* 100VAC preamp output noise.
- 2492* 100VAC preamp output magnitude.
- 2493 100V preamp gain drift.

1kV AC Range Selected

- 2501 1kVAC Input noise.
- 2502 1kVAC Input magnitude.

- 2511* 1kVAC preamp output noise.
- 2512* 1kVAC preamp output magnitude.
- 2513 1kV preamp drift.

* = Also included in Fast Test

DC Current Tests**10mA DC Range Selected**

- 2521 10mA range zero noise.
- 2522 10mA range zero magnitude.
- 2523 10mA range zero magnitude drift.
- 2524 10mA range zero offset drift.
- 2525 10mA range zero offset magnitude drift.

- 2531* 10mA range gain noise.
- 2532* 10mA range gain magnitude.
- 2533 10mA range gain drift.

100mA DC Range Selected

- 2541 100mA range zero noise.
- 2542 100mA range zero magnitude.
- 2543 100mA range zero drift.

- 2551* 100mA range gain noise.
- 2552* 100mA range gain magnitude.
- 2553 100mA range gain drift.

1A DC Range Selected

- 2561 1A range zero noise.
- 2562 1A range zero magnitude.
- 2563 1A range zero drift.

- 2571* 1A range gain noise.
- 2572* 1A range gain magnitude.
- 2573 1A range gain drift.

1mA DC Range Selected

- 2581 1mA range zero noise.
- 2582 1mA range zero magnitude.
- 2583 1mA range zero drift.

- 2591* 1mA range gain noise.
- 2592* 1mA range gain magnitude.
- 2593 1mA range gain drift.

100µA DC Range Selected

- 2601 100µA range zero noise.
- 2602 100µA range zero magnitude.
- 2603 100µA range zero drift.

- 2611* 100µA range gain noise.
- 2612* 100µA range gain magnitude.
- 2613 100µA range gain drift.

* = Also included in Fast Test

AC Current Tests

10mA AC Range Selected

- 2621 10mA range gain noise (10mA Input).
- 2622 10mA range gain magnitude (10mA Input).

- 2631 100mA range gain noise (100 μ A Input).
- 2632 100mA range gain magnitude (100 μ A Input).

Resistor Ratio Tests

1k Ω Standard Resistor Tests

True Zero

- 2721 1k Ω resistor true zero noise.
- 2722 1k Ω resistor true zero magnitude.
- 2723 1k Ω resistor true zero drift.

Normal measurement

- 2724 1k Ω resistor gain noise.
- 2725 1k Ω resistor gain magnitude.
- 2726 1k Ω resistor gain drift.

100k Ω Standard Resistor Tests

True Zero

- 2731 100k Ω resistor true zero noise.
- 2732 100k Ω resistor true zero magnitude.
- 2733 100k Ω resistor true zero drift.

Normal measurement

- 2734* 100k Ω resistor gain noise.
- 2735* 100k Ω resistor gain magnitude.
- 2736 100k Ω resistor gain drift.

Standard Resistors Ratio

Ratio Drift Calculation

- 2737 Standard resistor ratio drift.

* = Also included in Fast Test

Normal and LOI Ohms Ranges Tests

100Ω Range Selected

- 2741 100Ω range high-current true zero noise.
- 2742 100Ω range high-current zero magnitude.
- 2743 100Ω range high-current zero drift.
- 2751* 100Ω range high-current gain offset noise.
- 2752* 100Ω range high-current offset magnitude.
- 2753* 100Ω range high-current gain noise.
- 2754* 100Ω range high-current gain magnitude.
- 2755 100Ω range high-current gain drift.
- 2761 100Ω range low-current true zero noise.
- 2762 100Ω range low-current zero magnitude.
- 2763 100Ω range low-current zero drift.

1kΩ Range Selected

- 2771 1kΩ range high-current true zero noise.
- 2772 1kΩ range high-current zero magnitude.
- 2773 1kΩ range high-current zero drift.
- 2781* 1kΩ range high-current gain noise.
- 2782* 1kΩ range high-current gain magnitude.
- 2783 1kΩ range high-current gain drift.

10kΩ Range Selected

- 2791 10kΩ range high-current true zero noise.
- 2792 10kΩ range high-current zero magnitude.
- 2793 10kΩ range high-current zero drift.
- 2801 10kΩ range low-current true zero noise.
- 2802 10kΩ range low-current zero magnitude.
- 2803 10kΩ range low-current zero drift.

100kΩ Range Selected

- 2811 100kΩ range low-current true zero noise.
- 2812 100kΩ range low-current zero magnitude.
- 2813 100kΩ range low-current zero drift.
- 2821* 100kΩ range low-current gain noise.
- 2822* 100kΩ range low-current gain magnitude.
- 2823 100kΩ range low-current gain drift.

1MΩ Range Selected

- 2831 1MΩ range high-current true zero noise.
- 2832 1MΩ range high-current zero magnitude.
- 2833 1MΩ range high-current zero drift.
- 2841 1MΩ range high-current gain offset noise.
- 2842 1MΩ range high-current offset magnitude.
- 2843* 1MΩ range high-current gain noise.
- 2844* 1MΩ range high-current gain magnitude.
- 2845 1MΩ range high-current gain drift.
- 2851 1MΩ range low-current true zero noise.
- 2852 1MΩ range low-current zero magnitude.
- 2853 1MΩ range low-current zero drift.
- 2861 1MΩ range low-current gain noise.
- 2862 1MΩ range low-current gain magnitude.
- 2863 1MΩ range low-current gain drift.

* = Also included in Fast Test

Hi Ohms Ranges Tests

10M Ω Range Selected

- 2871 10M Ω range high-current true zero noise.
- 2872 10M Ω range high-current zero magnitude.
- 2873 10M Ω range high-current zero drift.

- 2881 10M Ω range low-current true zero noise.
- 2882 10M Ω range low-current zero magnitude.
- 2883 10M Ω range low-current zero drift.

- 2891 10M Ω range low-current gain noise.
- 2892 10M Ω range low-current gain magnitude.
- 2893 10M Ω range low-current gain drift.

100M Ω Range Selected

- 2901 100M Ω range true zero noise.
- 2902 100M Ω range zero magnitude.
- 2903 100M Ω range zero drift.

1G Ω Range Selected

- 2911 1G Ω range true zero noise.
- 2912 1G Ω range zero magnitude.
- 2913 1G Ω range zero drift.

* = Also included in Fast Test

SECTION 5 SYSTEMS APPLICATION

via the IEEE 488 INTERFACE

Alphabetical Index of IEEE 488.2 Codes used in the 1281	Overleaf
Introduction	5-1
Interface Capability	5-1
Interconnections	5-3
Typical System	5-4
Using the 1281 in a System	5-6
Addressing the 1281	5-6
Remote Operation	5-7
Programming Guidance	5-8
Message Exchange	5-14
Service Request (SRQ)	5-18
Retrieval of Device Status Information	5-19
The 1281 Status Reporting Structure	5-19
1281 Status Reporting - Detail (see also page 5-78)	5-23
1281 Commands and Queries - Syntax Diagrams	5-30
DC Voltage	5-30
AC Voltage (Option 10)	5-32
Resistance (Option 20)	5-36
DC Current (Option 30 with Option 20)	5-42
AC Current (Option 30 with Options 10 and 20)	5-44
Input Control	5-46
Monitor Messages	5-48
Math	5-54
Test	5-64
Triggers and Readings	5-68
Delay Default Tables	5-71
Internal Operations	5-76
Status Reporting (see also page 5-23)	5-78
Instrument I/D and Setup	5-86
Calibration Commands and Messages	5-88
(See Notes on page 5-88)	
Internal Buffer	5-109
Appendix A: IEEE 488.2 Device Documentation Requirements	5-A1
Appendix B: 1281 Device Settings at Power On	5-B1

Alphabetical Index of IEEE 488.2 Codes used in the 1281

Common Command/Query Code	Description	Page 5-
*CAL?	Performs 1281 Selfcal: returns '0' if OK, otherwise '1'	98
*CLS	Clears event registers and Queues (not O/P queue)	83
*ESE Nrf	Enables standard-defined event bits	81
*ESE?	Returns ESE register mask value	81
*ESR?	Reads Event Status register	80
*IDN?	Reports manufacturer, model, etc.	86
*OPC	Conforms, but not relevant to 1281 application	77
*OPC?	Conforms, but not relevant to 1281 application	77
*OPT?	Recalls option configuration information	87
*PSC 0/1	Sets/resets power-on status control flag	84
*PSC?	Returns power-on status control flag value	84
*PUD	Allows entry of user data to protected store	94
*PUD?	Recalls user-entered data	95
*RST	Resets instrument to power on condition	76 / App B
*SRE Nrf	Enables Service Request Byte bits	82
*SRE?	Returns Service Request Byte mask value	82
*STB?	Non-destructively reads Service Request Byte	83
*TRG	Causes a single reading to be taken	69
*TST?	Full Selftest: returns '0' if OK, otherwise '1'	64
*WAI	Conforms, but not relevant to 1281 application	73

Command/Query Code	Description	Page 5-
ACCP	Selects AC-coupled measurements	32; 44
ACI	Selects AC Current Function	44
ACV	Selects AC Voltage Function	32
AUTO	Automatic range selection	30; 32; 36; 40; 42; 44
AVG AV4/8/16/32/64	Rolling average	54
AVG BLOC_N	Block Averaging of N readings	54
AVG OFF	Deselects averaging mode	54
BLOCK (Nrf)	Sets and arms Block mode & stores (Nrf) readings	109
BLOCK? (Nrf),(Nrf)	Recalls stored readings between (Nrf),(Nrf)	111
C (Nrf)	Sets subtraction constant to Nrf value	58
C LAST_RDG	Puts most-recent reading to C store	58
C?	Recalls subtraction constant C	59
CAL?	Triggers external calibration to nominal or zero	90
CAL? Nrf	Triggers external 'SET' gain calibration	90
CHSE? ADC	Triggers special calibration of the A-D converter	96
CHSE? DAC	Triggers special calibration of the analog output	96
CHSE? FREQ	Triggers special calibration of the frequency counter	96
CLR MAX	Clears MAX store	51
CLR MIN	Clears MAX store	51
CLR PKPK	Clears MAX and MIN stores	51
CLRMEM ALL	Clears all calibration memories	106
CLRMEM EXT	Clears external calibration memories only	106
CLRMEM HFTRIM	Clears AC HF calibration memories only	106
CLRMEM SELF	Clears self-calibration memories only	106
CNFTST?	Fast Test: returns '0' if OK, otherwise '1'	65
COUNT?	Recalls number of readings in Block mode store	110
DB OFF	Cancels dB calculations	62
DB ON	Selects dB calculation for subsequent readings	62
DB_REF R50	Sets reference level of 1mW in 50Ω	62
DB_REF R75	Sets reference level of 1mW in 75Ω	62
DB_REF R600	Sets reference level of 1mW in 600Ω	62
DB_REF UNITY	Sets reference level of unity	62
DB_REF?	Recalls the set reference level	63
DCCP	Selects (DC+AC)-coupled measurements	32; 44
DCI	Selects DC Current Function	42
DCV	Selects DC Voltage Function	30
DDQ?	Recalls most-recent device error from queue	66
DELAY DFLT	Sets default delay for reading	70/71
DELAY Nrf	Sets settle delay of Nrf seconds	70
DIV_Z OFF	Cancels division of readings by Z	60
DIV_Z ON	Divides subsequent readings by Z	60

Section 5 - System Operation

Command/Query Code	Description	Page 5-
ENBCAL EXTNL,Nrf	Enables external calibration	89
ENBCAL SELF,Nrf	Checks Selfcal interlocks	89
ENBCAL SPECIAL,Nrf	Accesses special calibration mode	89
EXITCAL (date string)	Exits external cal with due date option	99
EXQ?	Recalls most-recent execution from queue	85
EXT_DUE?	Recalls calibration-due date	93
FAST_OFF	Deselects fast mode	30; 36; 40; 42
FAST_ON	Selects fast mode	30; 36; 40; 42
FILT 1000HZ/360HZ/40HZ/10HZ	Inserts analog filter (Option 10)	32; 44
FILT_OFF	Removes analog filter (DC & Ω)	30; 36; 38; 40; 42
FILT_ON	Inserts analog filter (DC & Ω)	30; 36; 38; 40; 42
FREQ? (ACV & ACI only)	Recalls frequency of most-recent reading	75
FWR	Selects four-wire ohms connection	36; 38
GATE FAST_OFF (AC only)	Selects gate width (Freq rdgs) 1s	49
GATE FAST_ON (AC only)	Selects gate width (Freq rdgs) 50ms	49
GUARD LCL	Selects Local Guard	47
GUARD REM	Selects Remote Guard	47
HI_OHMS	Selects High Ohms Function	38
HILT (Nrf)	Sets high limit, (Nrf) to 8.5 digits	52
HILT?	Returns value of high limit	52
INPUT CH_A	Selects Rear Input Ch A only	46
INPUT CH_B	Selects Rear Input Ch B only	46
INPUT DEVTN	Selects Rear Input Chs A & B with (A-B)/B	46
INPUT DIV_B	Selects Rear Input Chs A & B with A/B	46
INPUT FRONT	Selects Front Input only	46
INPUT OFF	Isolates all inputs	46
INPUT SUB_B	Selects Rear Input Chs A & B with A-B	46
LIMIT OFF	Disables limit checking	53
LIMIT ON	Enables limit checking	53
LINEF 50	Selects 50Hz line frequency operation	97
LINEF 60	Selects 60Hz line frequency operation	97
LINEF?	Recalls line frequency operation setting	97
LOCK NUM_ON/OFF,KEY_ON/OFF	Determines interlocks required for Selfcal	104
LOI_OFF	Deselects low current Ohms mode	36
LOI_ON	Selects low current Ohms mode	36
LOLT (Nrf)	Sets low limit, (Nrf) to 8.5 digits	52
LOLT?	Returns value of low limit	52
M (Nrf)	Sets multiplier M to Nrf value	56

Codes in **Bold** type are Command Program Headers; those in normal type are Program Data Elements

Command/Query Code	Description	Page 5-
M LAST_RDG	Puts most-recent reading into M store	56
M?	Recalls multiplier M	57
MAX?	Recalls maximum reading	50
MESE Nrf	Enables measurement event bits	79
MESE?	Returns MESE register mask value	79
MESR?	Reads Measurement Event Status register	80
MIN?	Recalls minimum reading	50
MUL_M OFF	Cancels multiplication of readings by M	56
MUL_M ON	Multiplies subsequent readings by M	56
N (Nrf)	(Nrf) is No. of rdgs for AVG BLOC_N	55
N?	Recalls active No. of rdgs for AVG BLOC_N	55
OHMS	Selects Normal Ohms Function	36
PASS_NUM Nrf	Pass number entry for calibration	104
PKPK?	Recalls MAX?-MIN? difference	50
RDG?	Recalls most-recent reading	74
RESL4/5 (ACI)	Sets A-D mode and resolution	44
RESL4/5/6 (ACV; Hi Ω ; DCI)	Sets A-D mode and resolution	32; 38; 42
RESL5/6/7/8 (DCV; OHMS; Tru Ω)	Sets A-D mode and instrument resolution	30; 36; 40
SELFCORR OFF	Cancels selfcal corrections	107
SELFCORR ON	Applies selfcal corrections	107
SERIAL (12 ASCII chars)	Allows access to change the serial number	105
SPEC_DAY?	Recalls 24 hour spec. for reading	48
SPEC_YR?	Recalls 1 year spec. for reading	48
SPEC_EHD?	Recalls Enhanced spec. for reading	48
SPOT_OFF (ACV only)	Disables Spot Frequency mode	32
SPOT_ON (ACV only)	Enables Spot Frequency mode	32
SPOT? 1/2/3/4/5/6 (ACV only)	Recalls the frequency of the selected spot number	34
SRCE_CAL?	Triggers intl source char: returns '0' if OK, or else '1'	108
STD? Nrf	Triggers 'Standardize' external calibration	92
SUB_C OFF	Cancels subtraction of C from readings	58
SUB_C ON	Subtracts C from subsequent readings	58
TFER_OFF	ACV: Disables Transfer mode	32
TFER_ON	ACV: Enables Transfer mode	32
TRG_SRCE EXT	Enables external triggers as source	68
TRG_SRCE INT	Selects internal interval counter as source	68
TRUE_OHMS	Selects True Ohms Function	40
TWR	Selects two-wire ohms connection	36; 38
UNC FREQ...	Allows entry of user's calibration uncertainty	100
UNC?	Recalls calibration uncertainty for the reading	102
X?	= *TRG;RDG?	69
Z (Nrf)	Sets divisor Z to Nrf value	60
Z LAST_RDG	Puts most-recent reading into Z store	60
Z?	Recalls divisor Z	61
ZERO?	Initiates 'Input Zero' and response (not ACI)	72

SECTION 5 SYSTEMS APPLICATION VIA THE IEEE 488 INTERFACE

Introduction

This first part of Section 5 gives the information necessary to put the 1281 into operation on the IEEE 488 bus. As some operators will be first-time users of the bus, the text is pitched at an introductory level. For more detailed information, refer to the standard specification, which appears in the publications ANSI/IEEE Std. 488.1-1987 and IEEE Std. 488.2-1988.

Section Contents

The section is divided so as to group certain types of information together. These divisions are:

Interface Capability - IEEE 488.1 subsets which are implemented in the model 1281, satisfying IEEE 488.2.

Interconnections - the rear panel IEEE 488 connector and its pin designations.

Typical System - a brief view of a typical process using the 1281 to measure the output from a programmable DC voltage source.

Using the 1281 in a System - addressing, remote operation and programming guidance - introduction to syntax diagrams.

Message Exchange - a simplified model showing how the 1281 deals with incoming and outgoing messages.

Service Request - why the 1281 needs the controller's attention and how it gets it.

Retrieval of Device Status Information - how the IEEE 488.2 model is adapted to the 1281.

Programming Messages - detailed descriptions of both common and device-specific commands and queries.

Interface Capability

IEEE Standards 488.1 and 488.2

The 1281 conforms to the Standard Specification IEEE 488.1-1987: 'IEEE Standard Digital Interface for Programmable Instrumentation', and to IEEE 488.2-1988: 'Codes, Formats, Protocols and Common Commands'.

The 1281 in IEEE 488.2 Terminology

In IEEE 488.2 terminology the 1281 is a **device** containing a **system interface**. It can be connected to a **system** via its **system bus** and set into programmed communication with other bus-connected **devices** under the direction of a **system controller**.

Programming Options

The instrument can be programmed via the IEEE Interface, to:

- Change its operating state (Function, Range etc).
- Transmit results of measurements, and its own status data, over the bus.
- Request service from the system controller.

Capability Codes

To conform to the IEEE 488.1 standard specification, it is not essential for a device to encompass the full range of bus capabilities.

But for IEEE 488.2, the device must conform exactly to a specific subset of IEEE 488.1, with a minimal choice of optional capabilities.

The IEEE 488.1 document describes and codes the standard bus features, for manufacturers to give brief coded descriptions of their own interfaces' overall capability. For IEEE 488.2, this description is required to be part of the device documentation. A code string is often printed on the product itself.

The codes which apply to the 1281 are given in table 5.1, together with short descriptions. They also appear on the rear of the instrument next to the interface connector. These codes conform to the capabilities required by IEEE 488.2.

Appendix C of the IEEE 488.1 document contains a fuller description of each code.

IEEE 488.1 Subset	Interface Function
SH1	Source Handshake Capability
AH1	Acceptor Handshake Capability
T6	Talker (basic talker, serial poll, unaddressed to talk if addressed to listen)
L4	Listener (basic listener, unaddressed to listen if addressed to talk)
SR1	Service Request Capability
RL1	Remote/Local Capability (including Local Lockout)
PP0	No Parallel Poll Capability
DC1	Device Clear Capability
DT1	Device Trigger Capability
C0	No Controller Capability
E2	Open-Collector and Three-State Drivers

Table 5.1 IEEE Interface Capability

Bus Addresses

When an IEEE 488 system comprises several instruments, a unique 'Address' is assigned to each to enable the controller to communicate with them individually.

Only one address is required for the 1281, as the controller adds information to it to define either 'talk' or 'listen'. The method of setting the address,

and the point at which the user-initiated address is recognized by the 1281, is detailed on page 5-6.

The 1281 has a single primary address, which can be set by the user to any value within the range from 0 to 30 inclusive. It cannot be made to respond to any address outside this range.

Secondary addressing is not programmed.

Interconnections

Instruments fitted with an IEEE 488 interface communicate with each other through a standard set of interconnecting cables, as specified in the IEEE 488.1 Standard document.

The interface socket, SK7, is fitted on the rear panel. It accommodates the specified connector, whose pin designations are also standardized as shown in Fig. 5.1 and Table 5.2

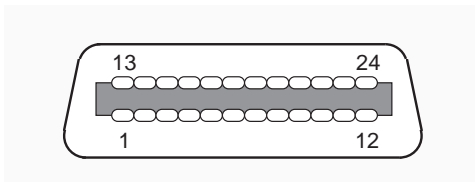

Fig 5.1 Connector SK7 - Pin Layout

Pin No.	Name	Description
1	DIO 1	Data Input/Output Line 1
2	DIO 2	Data Input/Output Line 2
3	DIO 3	Data Input/Output Line 3
4	DIO 4	Data Input/Output Line 4
5	EOI	End or Identify
6	DAV	Data Valid
7	NRFD	Not Ready For Data
8	NDAC	Not Data Accepted
9	IFC	Interface Clear
10	SRQ	Service Request
11	ATN	Attention
12	SHIELD	Screening on cable (connected to 1281 safety ground)
13	DIO 5	Data Input/Output Line 5
14	DIO 6	Data Input/Output Line 6
15	DIO 7	Data Input/Output Line 7
16	DIO 8	Data Input/Output Line 8
17	REN	Remote Enable
18	GND 6	Gnd wire of DAV twisted pair
19	GND 7	Gnd wire of NRFD twisted pair
20	GND 8	Gnd wire of NDAC twisted pair
21	GND 9	Gnd wire of IFC twisted pair
22	GND 10	Gnd wire of SRQ twisted pair
23	GND 11	Gnd wire of ATN twisted pair
24	GND	1281 Logic Ground (internally connected to 1281 Safety Ground)

Table 5.2 Socket SK7 - Pin Designations

Typical System

A typical system is shown in Fig. 5.2. The system is directed by a controlling device able to: a. **‘Control’** (Issue commands) b. **‘Listen’** (Receive data) and c. **‘Talk’** (Transmit data)

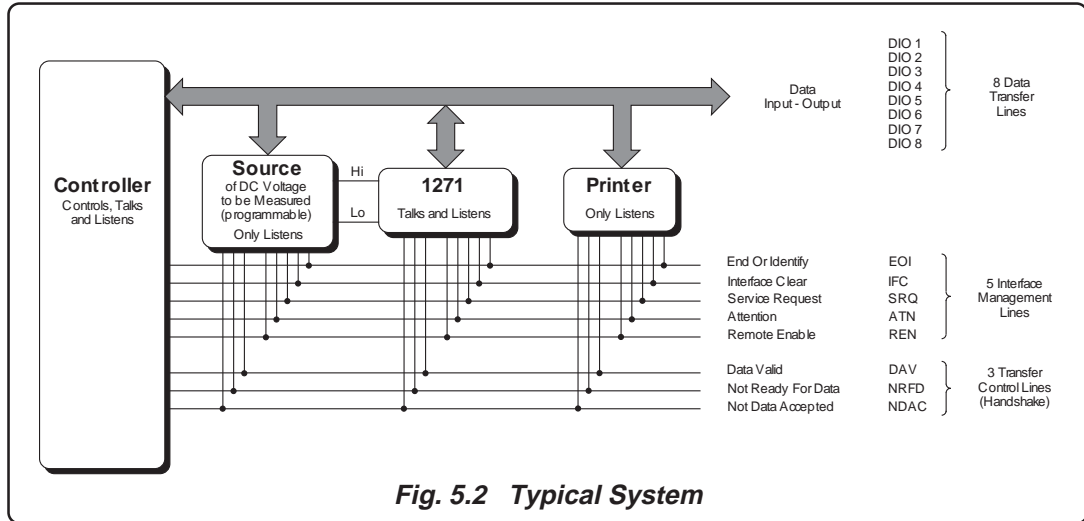

Fig. 5.2 Typical System

Example of a System in Operation

In the system example (Fig. 5.2), a simple programmed task could be to take a series of measurements of DC voltage on the 1281, and print out the results. The following is a typical sequence of events:

1. The controller needs to instruct the Source to output its voltage. These commands must not be received by the printer, so the controller sends the general bus message ‘Unlisten’. When sending general messages, the controller holds the ATN line true to make all bus devices interpret any Data Transfer Line information as configuration or data-flow commands.
2. The controller then sends the Source’s listen address to force it to receive, followed by configuration commands which set up its voltage output level, but leaving its output off. The instructions are passed along the DIO (data input-output) lines as coded messages (bytes).
3. Although the Source accepts the instructions as they are passed, their implementation takes a short time. The controller would perform other tasks during this period. In the example, after ‘Unlisten’ and the 1281 listen address have been sent, it would pass configuring commands to set the 1281’s function and range etc.
4. The 1281 also needs time to settle into stable operation, so the controller can perform other tasks while waiting, such as configuring the printer.

5. The controller next generates 'Unlisten', addresses the source, and sets its analog output on. The Source sets its output on immediately, or as soon as its previous instructions have been executed. The Source sends a message back to the controller via the SRQ (Service Request) management line, if programmed.
6. As the SRQ facility is available to all bus devices (Wired-OR function), the controller needs to discover which one sent the 'SRQ'. It therefore asks all devices one by one ('serial poll'), finds out that the DC Voltage Source originated the SRQ and that its output is on.
7. It next addresses the 1281 as a listener; sends (via the DIO lines) the Group Execute Trigger message (GET, or *TRG to conform to IEEE 488.2) to initiate the reading, and RDG? to recall the reading. After a short delay for measurement, the 1281 prepares output data and SRQ's the controller when it is ready for transfer.
8. The controller identifies the 1281 by a serial poll. It sends the 1281's talk address, and sets the ATN line false, releasing the 1281 to start the transfer.
9. The 1281 sends its data, byte by byte via the DIO lines, to the controller. To ensure orderly transfer, a 'Handshake' transfers each byte. The handshake signals occupy the three Transfer-Control lines.
10. The controller receives the data and when it is complete, the transmission is terminated. As an aid to the controller, the 1281 can send another message with the last byte to be transferred (EOI - 'End or Identify', using another bus management line).
11. The controller prepares the data, sets up a link to the printer (having programmed it earlier to prepare to print) then passes the prepared data for printing. This transmission also obeys the rules of protocol of IEEE 488 (.1 and .2).
12. The measurement is now complete, and the controller could set up another reading.

The controller holds the REN line true when taking remote control. It can send an addressed command GTL, or some controllers can set REN false, to permit temporary manual control of a specific device. The IFC line is used at the discretion of the controller, to clear any activity off the bus.

Sequences such as this are often assembled into programs to check sources at many calibration points; changing functions, ranges and output levels as designed by the user. The program would also include 'display' messages to complete the printout in a recognisable form for the user's convenience.

Programs must also cater for ERROR SRQs.

This process of checking the source against the 1281 can be reversed, to calibrate the 1281 against a more accurate source. Using a multifunction standard such as the Model 4808, sequences can be programmed to cause any 1281 errors to be reduced until they are within specification using its 'external calibration' facility. Our 'PORTOCAL-II' package is an example of a pre-programmed automatic calibration system.

Using the 1281 in a System

Addressing the 1281

Address Recognition

With an address selected in the range 0 to 30; control may be manual, or remote as part of a system on the Bus. The address must be the same as that used in the controller program to activate the 1281. The 1281 is always aware of its stored address, responding to Talk or Listen commands from the controller at that address. When the address is changed by the user, the 1281 recognizes its new address and ignores its old address as soon as it is stored, by the user pressing the **Enter** key in the **ADDRESS** menu.

Setting the Bus Address

The instrument address can only be set manually; using the ADDRESS menu, which is accessed via the STATUS and STATUS CONFIG menus.

To change the address, proceed as follows:

- Press the **Status** key to see the **STATUS** menu:



This menu defines six positions on the dot-matrix display (refer to Section 3 for details). The soft keys are deactivated, and play no part in setting the address.

- Press the **Config** key to see the **STATUS CONFIG** menu:



This menu defines three soft *menu* keys; at present we are interested only in the Addr key.

Addr: displays the ADDRESS menu, to review and change the IEEE-488 bus address of the instrument.

ADDRESS Menu

- Press the **Addr** key to see the **ADDRESS** menu:



This menu permits entry of a value to be used as an IEEE-488 bus address. Initially, the menu displays the present address value (in the position shown above by XX), and the numeric-keyboard keys are activated. Any valid numeric value (0-30) may be entered, an invalid address resulting in the display message '1007: data entry error'.

Pressing **Enter** stores the new value (or restores the old value if unchanged), but pressing **Quit** leaves the old value intact. Either **Enter** or **Quit** causes exit back to the STATUS CONFIG menu, then press any required function key to escape.

Remote Operation

General

When the 1281 is operating under the direction of the controller, the legend **rem** appears on the Main display, and all front panel controls are disabled except **Power**.

The power-up sequence is performed as for manual operation. The 1281 can be programmed to generate an SRQ at power-up, also preparing a status response for transmission to the controller when interrogated by a subsequent serial poll.

Calibration Enable

A 'Calibration Enable' command via the bus is required to set the instrument into its Remote Calibration mode (the CALIBRATION ENABLE keyswitch on the rear panel must already be set at ENABLE). If a passnumber has been installed to protect access; this can also be programmed so that an operator, or the controller, is required to input the correct number. The Calibration Enable command (ENBCAL) is accompanied by a code which chooses between External, Self or Special calibration.

Transfer to Local Operation (GTL)

The 1281 can be switched temporarily into 'Local' operation (Command GTL), permitting a user to take manual control from the front panel. The system controller regains 'Remote' control by sending the following overriding commands:

Listen Address with *REN* true

The controller addresses the 1281 as a listener with the Remote Enable management line true (Low). This returns the 1281 from local to remote control.

DCL or *SDC*

Either of the 'Device Clear' commands will force the following instrument states:

- all IEEE 488 input and output buffers cleared;
- parser reset to the beginning of a message;
- any device-dependent message bus holdoffs cleared.

These commands will not:

- change any settings or stored data within the device except as listed above;
- interrupt analog input;
- interrupt or affect any functions of the device not associated with the IEEE 488 system;
- change the status byte.

Levels of Reset

Three levels of reset are defined for IEEE 488.2 controllers, a complete system reset being accomplished by resetting at all three levels, in order, to every device. In other circumstances they may be used individually or in combination:

- IFC** Bus initialization;
- DCL** Message exchange initialization;
- *RST** Device initialization.

The effects of the *RST command are described on page 5-76.

Programming Guidance

Programming Strings

From the example given earlier in this section it is evident that the 1281 requires an address code followed by general or device-dependent messages or commands to alter its configuration.

A series of these commands can be sent together as a 'program string', each programming instruction being position-dependent.

Each string will contain at least one programming instruction (detailed later in this section), but the 1281 must receive a message unit separator (;) or a message 'terminator' before it can activate any instructions. The message terminator for the 1281 is the Hex number 0A, characterized in IEEE 488.2 as 'NL'. Alternatively, the 'End or Identify' (EOI) line can be set true with the last byte to be sent; this is represented on the syntax diagram by /[^]END/.

To assist in eliminating incorrect programming instructions, the 1281 checks for errors in the string, and can generate a service request (SRQ) if a syntax error occurs or if an option is called for but not fitted. To ensure that the programming string does not set up a prohibited state, it also checks each program message unit for validity. If it finds any errors in this phase, the message unit is ignored.

For Example:

With the 1281 set in 100mV Range, a string is received which contains an unacceptable command to switch FAST ON in AC volts. The user needs to set up a completely new, valid string; so an execution error is generated and the message unit is discarded.

Conformance to IEEE 488.2

IEEE 488.2 defines sets of Mandatory Common Commands and Optional Common Commands along with a method of Standard Status Reporting. The 1281 conforms with all Mandatory Commands but not all Optional Commands, and conforms with the defined Status Reporting method.

Note: Commands prefaced by asterisk, eg *TRG, are standard-defined 'Common' commands.

In addition to these Common Commands, the 1281 has a set of Device-Dependent Commands. These are English-language-like instructions, defined by the manufacturer to program the instrument into its various functions and ranges. Although IEEE 488.2 does not lay down exactly what the commands should be, it does define how they should be linked or separated (ie the syntax is defined). The device-dependent commands have therefore been designed to be self-explanatory, while conforming to the standard-defined syntax.

The IEEE 488.2 also requires certain 'Device Documentation' to be supplied by its manufacturer. This data is included within the text of this section, and is indexed by Appendix A at the back of the section.

Command Formation

The following paragraphs describe the commands that are used to program the 1281 via its IEEE 488 interface.

A command (or 'Program Message Unit') can merely comprise a simple alphabetic code. But if there are alternative ways of programming within a command, this is signified by using a 'Command Program Header', followed by the appropriate 'Program Message Elements'.

An example of a simple command is the query header 'ZERO?', which activates an Input Zero.

An example of a more complex command is:

'DCV 10,RESL6,FILT_ON'

which will program the instrument to DCV function, 10V range, 6.5 digits resolution and filter selected. In this example, DCV is the Command Program Header, while 10,RESL6, and FILT_ON are all Program Message Elements.

Note that:

- Message Elements are separated by commas (,)
- Program Headers are separated from their following Message Elements by 'white space' - (i.e non-printing ASCII characters in the ranges Hex 00 to 09 and 0B to 20) - denoted here by {phs}.

- Multiple Message Units going to make up a complete Program Message may be separated by semi-colons (;).
- Program Messages can be terminated by a Line Feed - (ie the ASCII character at Hex A0) - denoted by {NL} (Newline), or by EOI true with the last byte.

An example of a complete Program Message is:

DCV{phs}10,RESL6,FILT_ON;ZERO?{NL}

IEEE 488.2 Syntax Diagrams

To standardize the approach to programming, the IEEE 488.2 Standard has introduced a form of ‘Syntax Diagram’, in which the possible command formation for particular messages can be given. The IEEE 488.2 syntax has been adhered to, so in the following descriptions of device-dependent commands, we have adopted the standard syntax diagram, with modified style to fit this handbook. A word of explanation about the notation is needed, and the diagrams are defined, although they are virtually self-explanatory.

Notation

- Syntactic elements are connected by lines with directional symbols to indicate the flow, which generally proceeds from left to right.
- Repeatable elements have a right-to-left reverse path shown around them, which can also contain a separator such as a comma.
- When it is possible to bypass elements, a left-to-right path is shown around them.
- When there is a choice of elements, the path branches to the choices.

The example program message:

‘DCV{phs} I0,RESL6,FILT_ON;ZERO?{NL}’, mentioned earlier, is a syntactic string derived from the DCV function and Input Zero diagrams, which appear in the range of diagrams described below. Note that ‘phs’ means ‘program header separator’, a white-space character as mentioned earlier.

Syntax Diagrams in this Handbook

The following paragraphs describe the syntax diagrams used in this handbook.

Hierarchy of Syntactic Elements

All messages are subject to the protocols of addressing and handshake defined in the IEEE 488.1 Standard document. Within these protocols, messages are characterized by the presence of terminators, each of which seals the set of syntactic elements sent since the previous terminator to form a ‘Program Message’.

The Program Message

Each Program Message may consist of only one syntactic element plus its terminator, or may be subdivided into many ‘Program Message Units’, separated by semi-colons (;) which are known as ‘Program Message Unit Separators’. Thus the semi-colon cannot be used for any other purpose.

As you can see from the diagram, multiple Program Message Units can be sent if they are separated using semi-colons (shown in the repeat path). The block named ‘Program Message Unit’ therefore represents **either** repeats of the same unit, **or** a set of different units, **or** a mixture of both. The starting circle is a device used only for the diagram; there is no requirement to use a special character to start a message, providing the previous message was correctly terminated. It is possible to send only the terminator as a complete Program Message (as shown by the forward bypass path), but this feature has little use when programming the 1281.

Syntax Diagram of a Simple Program Message

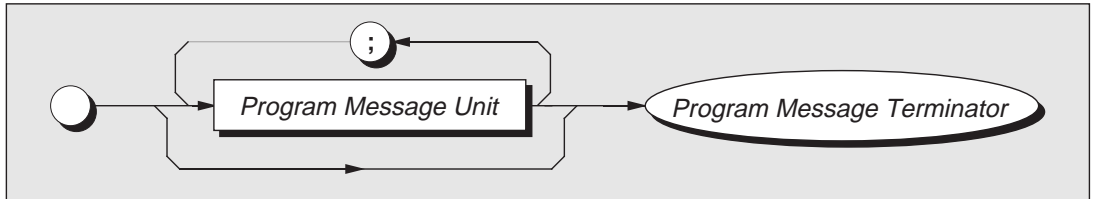

Character Usage

Notice that the names of some elements are shown here in italics. This agrees with the convention used on the syntax diagrams in this handbook, which sets 'non-literal' text (names given to particular elements) in italics, whereas 'literal' text (the actual characters to be sent, such as the semicolon in the diagram) is shown in plain-text capitals.

Upper/Lower Case Equivalence

The plain-text capitals are not demanded by the standard, and the 1281 will not differentiate between upper and lower case characters in literal program text. Either or both can be used, mixed upper and lower case if this conveys an advantage.

Numeric Representation

Several commands and queries used for the 1281 require transmission and reception of numbers. Decimal formats are generally used.

The IEEE 488.2 document specifies formats which ensure that a device is 'forgiving' when receiving program or query commands, but 'precise' when transmitting responses to queries.

For program data it insists that a device must accept the decimal 'Flexible Numeric Representation (*Nrf*)', which is a flexible version of three numeric representations (*Nr1*, *Nr2* and *Nr3*) defined by ANSI X3.42-1975 [2]. The 1281 complies.

Decimal numeric response data from the 1281 employs either *Nr1* or *Nr3* format, usage depending on the particular response. In this handbook, all syntax diagrams for query messages are accompanied by a paragraph which spells out the response format. Users are left in no doubt as to the construction of the response.

The Program Message Unit

Program Message Units (PMUs) can be ‘Terminal’ or ‘Non-terminal’. The final PMU in any Program Message is always Terminal (includes the terminator), whereas all preceding PMUs within

the Program Message are obviously Non-terminal. Most of the commands in this handbook are described in the form of non-terminal message units:

Non-Terminal Program Message Unit

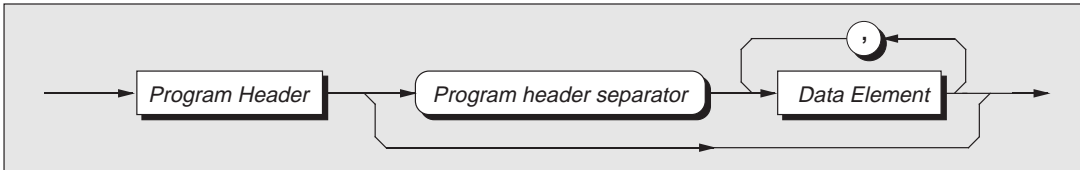

To save space, the name ‘program header separator’ is abbreviated to ‘phs’.

Use of *phs*

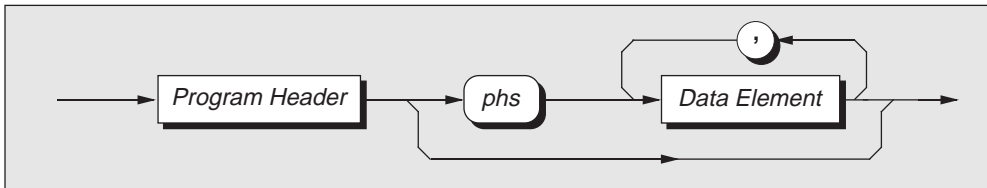

The Command Program Header

Several versions are defined by the IEEE 488.2 Standard document. The ‘Simple’, ‘Common’ and ‘Query’ headers are designed into the 1281, but not ‘Compound’ headers.

block as the program mnemonic. For example: the command for Full Selftest (*TST?) is shown in abbreviated, rather than full format.

The asterisk (Common) and question mark (Query) are defined separately by the standard document, but as they are inseparable from the command, they are shown on the 1281 syntax diagrams in the same

Common Query - Abbreviated Format



Program Data Elements

Four versions of the defined program data elements are employed. They are emphasized in the following syntax diagrams, which are examples from the list of commands available for the 1281:

Character

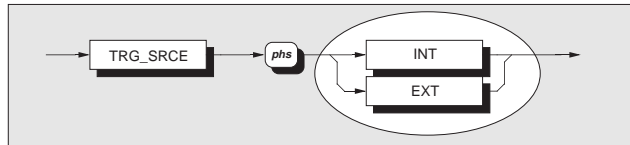

Decimal Numeric

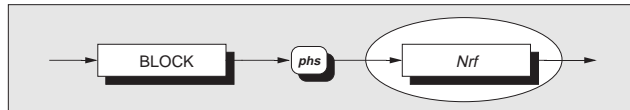

(*Nrf* can be expressed in any of the ways defined by the Standard document)

String

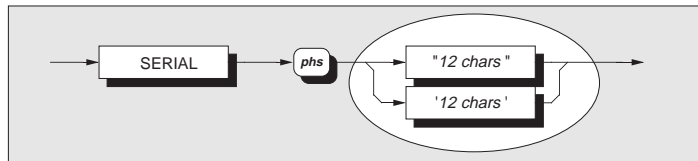

(The string size is defined)

Arbitrary Block Data Elements

Both the 'Definite' and 'Indefinite' forms specified in the Standard document are used, as shown in the Syntax diagram below. The *user message* must be limited to a maximum of 63 bytes.

program message must be terminated to inform the instrument that the block is complete.

The definite form can be fitted into a string of message units, but the indefinite form (lower path) has no exit to further message units. In this case the

Note that the slash-delimited `/^END/` box is not outlined. This is to draw attention to the fact that it is not a data element, but represents the EOI line being set true with the last byte 'NL' to terminate the program message.

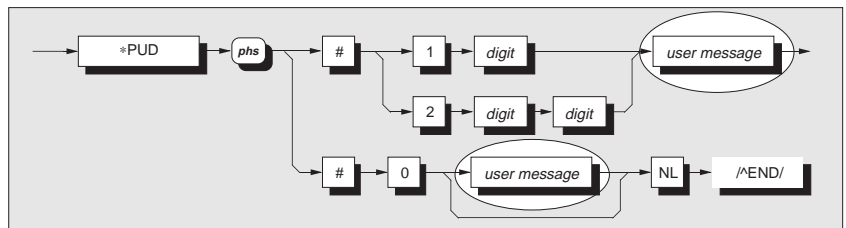

Message Exchange

IEEE 488.1 Model

The 1281 conforms to the requirements of the IEEE 488.1 Standard, in respect of the interactions between its device system interface and the system bus. Its conformance is described by the interface

capability codes listed in Table 5.1 on page 5-2. In addition, the 1281 is adapted to the protocols described by the IEEE 488.2 model, as defined in that standard's specification.

IEEE 488.2 Model

The IEEE 488.2 Standard document illustrates its Message Exchange Control Interface model at the detail level required by the device designer. Much of the information at this level of interpretation (such as the details of the internal signal paths etc.) is transparent to the application programmer.

However, because each of the types of errors flagged in the Event Status Register are related to a particular stage in the process, a simplified 1281 interface model can provide helpful background. This is illustrated in Fig. 5.3, together with brief descriptions of the actions of its functional blocks.

1281 Message Exchange Model

Input/Output Control transfers messages from the 1281 output queue to the system bus; and conversely from the bus to either the input buffer, or other predetermined destinations within the device interface. Its interaction with the controller, via the system bus, is subject to the IEEE 488.1 management and handshake protocol. It receives

the Status Byte from the status reporting system, as well as the state of the request service bit which it imposes on bit 6 of the Status Byte (ultimately on bus line DIO 7) in the event of a serial poll. Bit 6 reflects the 'Request Service state *true*' condition of the interface.

Incoming Commands and Queries

The **Input Buffer** is a first in - first out queue, which has a maximum capacity of 128 bytes (characters). Each incoming character in the I/O Control generates an interrupt to the instrument processor which places it in the Input Buffer for examination by the Parser. The characters are removed from the buffer and translated with appropriate levels of syntax checking. If the rate of programming is too fast for the Parser or Execution Control, the buffer will progressively fill up. When

the buffer is full, the handshake is held.

The **Parser** checks each incoming character and its message context for correct Standard-defined generic syntax, and correct device-defined syntax. Offending syntax is reported as a **Command Error**, by setting *true* bit 5 (CME) of the Standard-defined Event Status register (refer to the subsection 'Retrieval of Device Status Information').

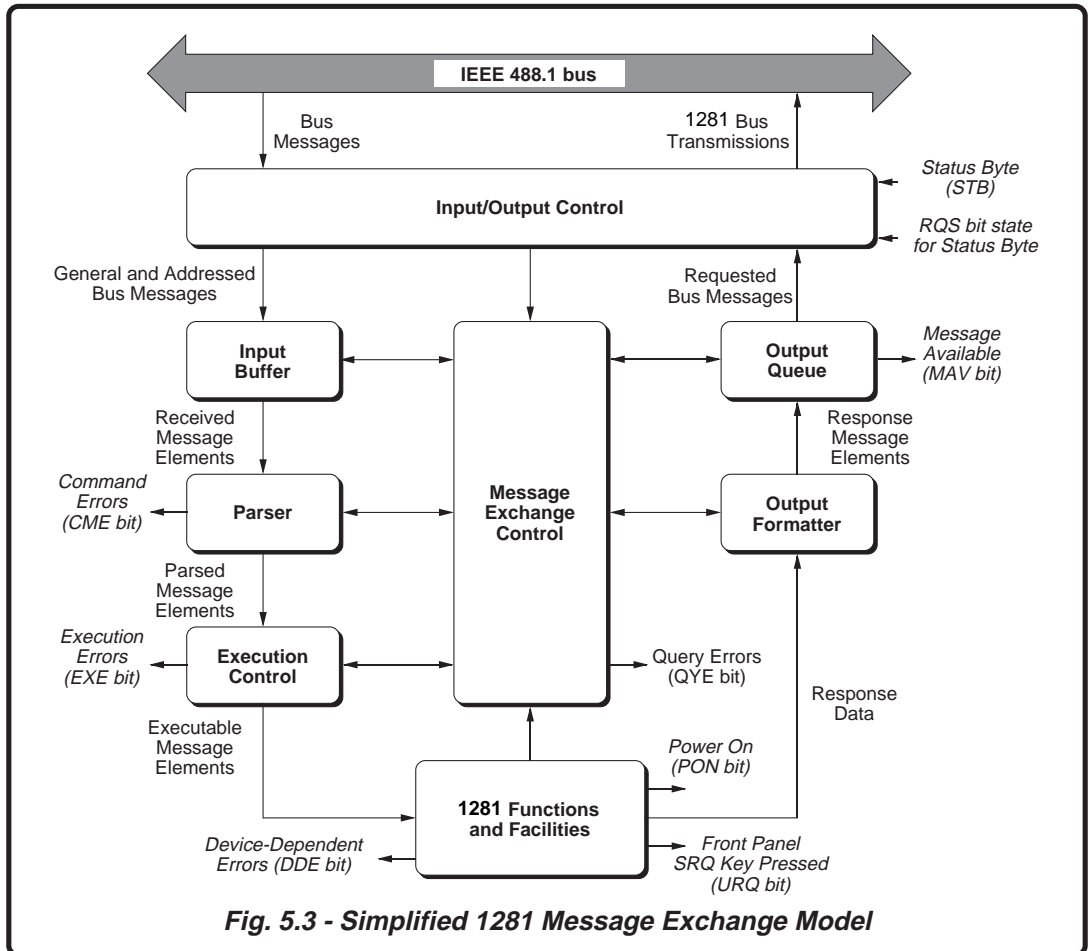

Execution Control receives successfully parsed messages, and assesses whether they can be executed, given the currently-programmed state of the 1281 functions and facilities. If a message is not viable (eg the selftest common query: *TST? when calibration is successfully enabled); then an Execution Error is reported, by setting *true* bit 4 (EXE) of the Standard-defined Event Status

register, and placing an error description number in a queue associated with the EXE bit. Viable messages are executed in order, altering the 1281 functions, facilities etc. Execution does not ‘overlap’ commands; instead, the 1281 Execution Control processes all commands ‘Sequentially’ (ie. waits for actions resulting from the previous command to complete before executing the next).

1281 Functions and Facilities

The 1281 Functions and Facilities block contains all the device-specific functions and features of the 1281, accepting Executable Message Elements from Execution Control and performing the associated operations. It responds to any of the elements which are valid Query Requests (both IEEE 488.2 Common Query Commands and 1281 Device-specific Commands) by sending any required Response Data to the Response Formatter (after carrying out the assigned internal operations).

Device-dependent errors are detected in this block. Bit 3 (DDE) of the Standard-defined Event Status register is set true when an internal operating fault is detected, for instance during a self test. Each reportable error has a listed number, which is appended to an associated queue as the error occurs.

This block also originates a local power-on message by the action of the 1281 line power being applied. Bit 7 (PON) of the Standard-defined Event Status register is set true when the instrument power transits from off to on (refer to the subsection 'Retrieval of Device Status Information').

The front-panel **SRQ** key allows users to initiate an SRQ (providing the appropriate status register bits are enabled). Bit 6 (URQ) of the Standard-defined Event Status register is set true when the key is pressed, and set to false by reading the Event Status register or if the registers are cleared by *CLS.

Trigger Control

Two types of message are used to trigger the 1281 A-D into taking a measurement:

GET (IEEE 488.1-defined)
***TRG** (IEEE 488.2-defined)

In the 1281 both GET and *TRG messages are passed through the Input Buffer, receiving the same treatment as program message units, being parsed and executed as normal.

Outgoing Responses

The **Response Formatter** derives its information from Response Data (being supplied by the Functions and Facilities block) and valid Query Requests. From these it builds Response Message Elements, which are placed as a Response Message into the Output Queue.

The **Output Queue** acts as a store for outgoing messages until they are read over the system bus by the Controller. For as long as the output queue holds one or more bytes, it reports the fact by setting *true* bit 4 (Message Available - MAV) of the Status Byte register. Bit 4 is set *false* when the output queue is empty (refer to the sub-section 'Retrieval of Device Status Information').

Example of 1281 Reading Output

The following example represents the form of output obtained for a 1281 measurement in the 8.5 digit DCV Mode:

```
± 1. 8 8 8 8 8 8 8 8 E ± 8 8 Lf
      EOI
```

'Query Error'

This is an indication that the controller is following an inappropriate message exchange protocol, resulting in the following situations:

- **Interrupted Action.** When the 1281 has not finished outputting its **Response Message** to a **Program Query**, and is interrupted by a new **Program Message**.
- **Unterminated Action.** When the controller attempts to read a **Response Message** from the 1281 without having first sent the complete **Query Message** (including the **Program Message Terminator**) to the instrument.

The Standard document defines the 1281's response, part of which is to set *true* bit 2 (QYE) of the Standard-defined Event Status register.

Service Request (SRQ)

IEEE 488.1 Model

The IEEE 488.1 model provides for a separate line (SRQ line) on the system bus, to be set true (Low) by the device to request service of the controller. The model defines the subsequent action by the controller, and in the 1281 the serial poll facility has been incorporated.

The controller polls each device on the system bus in sequence, reading a 'Status Byte' onto DIO lines 8-1, whereby the bit on the DIO 7 line (Request Service bit) indicates whether that device was the originator of the request for service.

Reasons for Requesting Service

There are two main reasons for the 1281 to request service from the controller:

- When the 1281 message exchange interface discovers a system programming error;
- When the 1281 is programmed to report significant events by SRQ.

The significant events vary between types of devices; thus there is a class of events which are known as 'Device-Specific'. These are determined by the device designer and included in the device operating program.

IEEE 488.2 Model

The application programmer can enable or disable the event(s) which are required to originate an SRQ at particular stages of the application program. The IEEE 488.2 model incorporates a flexible extended status reporting structure in which the requirements of the device designer and application programmer are both met.

This structure is already described in the next sub-section, dealing with 'Retrieval of Device Status Information'. As SRQ provision is integral to the structure, the description of the implementation of SRQ features is covered in that sub-section rather than in this.

Retrieval of Device Status Information

Introduction

For any remotely-operated system, the provision of up-to-date information about the performance of the system is of major importance. This is particularly so in the case of systems which operate under automatic control, as the controller requires the necessary information feedback to enable it to progress the programmed task, and any break in the continuity of the process can have serious results.

When developing an application program, the programmer needs to test and revise it, knowing its effects. Confidence that the program elements are couched in the correct grammar and syntax (and that the program commands and queries are thus being accepted and acted upon), helps to reduce the number of iterations needed to confirm and develop the viability of the whole program. So any assistance which can be given in closing the information loop must benefit both program compilation and subsequent use.

The 1281 Status Reporting Structure

In a closely-specified Standard such as the IEEE 488.2, we should expect to find a well-defined and comprehensive status reporting facility, and this is indeed the case. Not only does the Standard establish regular methods of retrieving the information, but it also provides the means for the device designer to build a status-reporting structure which is pertinent to the nature of the device. Within this structure the application programmer is then given a wide choice to decide on the sort of information required at each stage in the program.

Note: The registers are binarily weighted - the numbers in the boxes are bit numbers, not weighted values.

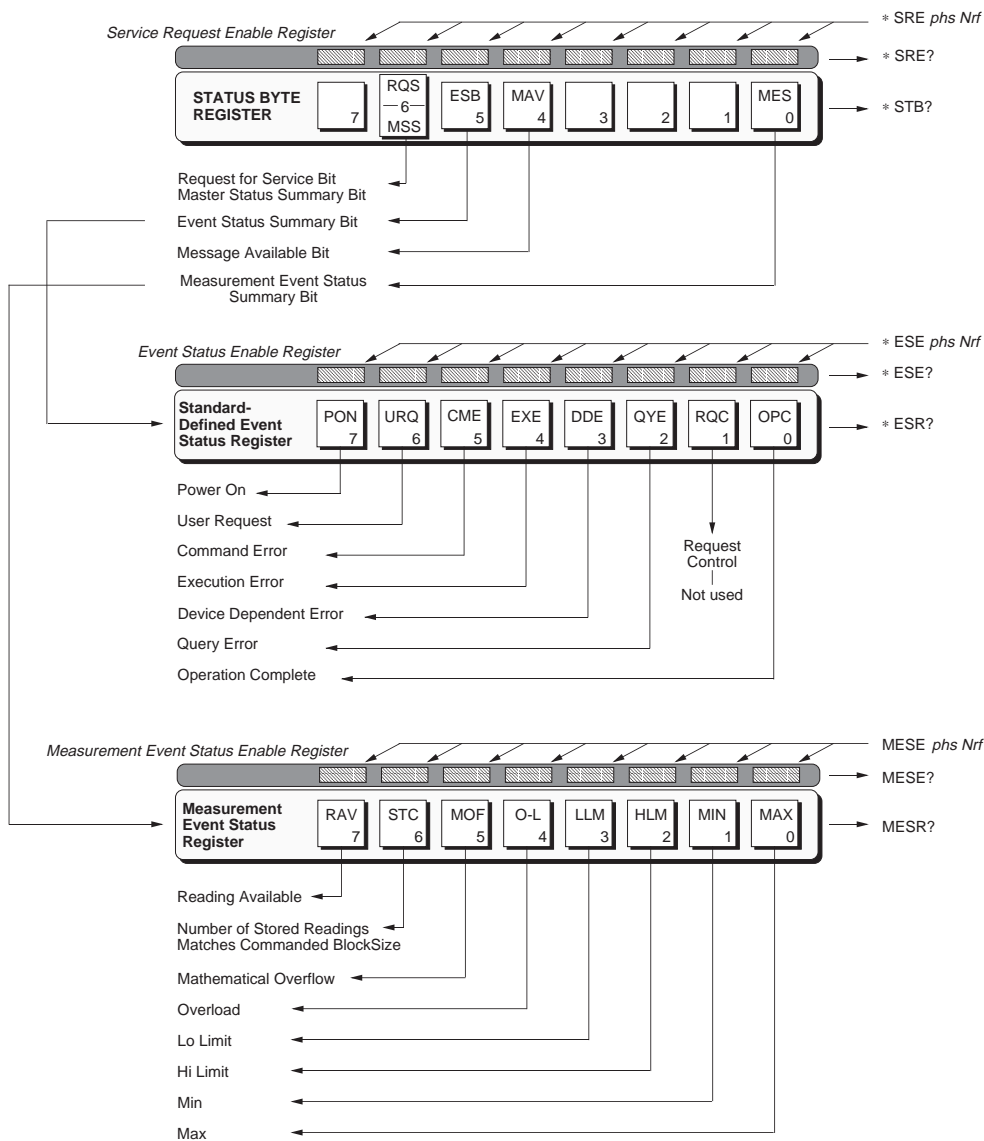

Fig. 5.4 - 1281 Status Reporting Structure

Standard-Defined and Device-Specific Features

In the 1281, the structure has been developed into three main registers, as follows:

- **The ‘Status Byte Register’**
contains the ‘**Status Byte**’, which summarizes the remainder of the structure. Bits 6-4 are Standard-defined, but bits 3-0 and 7 are provided for the device designer to define.
- **The ‘Event Status Register’**
Defined by the standard, contains the ‘**Event Status Byte**’, whose component bits report Standard-defined types of events. This register is summarized by the ‘ESB’ bit 5 in the Status Byte.
- **The ‘Measurement Event Status Register’**
Up to five Device-Specific Event Status Registers or queues can be defined by the device designer; in this case only one register is defined, for the ‘**Measurement Event Status Byte**’, whose component bits are device-specific (i.e. to the 1281). It is summarized by the ‘MES’ bit 0 in the Status Byte.

Although the Event Status Byte bits are defined by the Standard, they are permitted to summarize device-specific events (eg. EXE is associated with a list of execution errors related to the 1281 programmed condition, and DDE is associated with a list of device-dependent errors related to 1281 internal faults). These extensions, with the structures based on bits 3-0 and 7 of the Status Byte, allow the device designer a wide latitude to match status reporting to the requirements of the device.

Access via the Application Program

The application designer has access to three enable registers (one for each main register - Fig. 5.4). The application program can enable or disable any individual bit in these registers.

Each bit in the two event status registers remains in *false* condition unless its assigned event occurs, when its condition changes to *true*. If an event is to be reported, the application program sets its corresponding enable bit *true*, using the number *Nrf* (defined as a decimal numeric from 0 to 255 in any common format). Then when the enabled event occurs and changes the enabled bit from *false* to *true*, the appropriate summary bit in the Status Byte (ESB or MES) is also set true. If this summary bit is also enabled, then the 1281 will generate an SRQ by causing the SRQ line on the system bus to be set *true* (low).

Thus the application programmer can decide which assigned events will generate an SRQ, by enabling their event bits and then enabling the appropriate summary bit(s) in the Status Byte. The controller can be programmed to read the Status Byte during a resulting serial poll, and be directed to the appropriate Event Register to discover which event was responsible for originating the SRQ.

The Status Byte Register is the only one of the six which can be read *bitwise* on to the DIO lines of the system bus, and then only by a serial poll to which special conditions are attached. All registers can be read by suitable commands, but as an ASCII decimal numeric, which when rounded and expressed in binary, represents the bit pattern in the register. This form is also used to set the enabling registers to the required bit-patterns. The detail for each register is expanded in the following paragraphs, and in the command descriptions.

Types of Status Information Available

Three main categories of information are provided for the controller:

Status Summary Information

Contained within the 'Status Register', the 'Status Byte' (STB) consists of flag bits which direct the controller's attention to the type of event which has

occurred. Four bits are employed in the 1281; these are described in detail later, but two ('ESB' and 'MES') are mentioned in the following paragraphs.

Standard-defined events:

- Power On - the instrument's power supply has been switched on.
- User Request - the 'SRQ' key on the front panel has been pressed.
- Command Error - a received bus command does not satisfy the syntax rules programmed into the instrument interface's parser, and so is not recognized as a valid command.
- Execution Error - a received command has been successfully parsed, but it cannot be executed owing to the current programmed condition of the instrument.
- Device-Dependent Error - a reportable internal operating fault has been detected.
- Query Error - the controller is following an inappropriate message exchange protocol, in attempting to read data from the output queue.
- Request Control - provided for devices which are able to assume the role of controller. This capability is not available in the 1281.
- Operation Complete - initiated by a message from the controller, indicates that the 1281 has completed all selected pending operations.

These events are flagged in the 8-bit latched 'Event Status Register' (ESR), read-accessible to the controller. The user's application program can also access its associated enabling register, to program the events which will be eligible to activate the ESB summary bit in the Status Byte.

Measurement events:

- When the instrument has been commanded to store a number of measurements in a block, and the specified number of measurements in the block has been stored.
- Mathematical Overflow
- Overload
- Low Limit Reached
- High Limit Reached
- New Minimum Value Established
- New Maximum Value Established

These events are flagged in another 8-bit latched register, called the 'Measurement Event Status Register' (MESR), which is read-accessible to the controller. The user's application program can also access its associated enabling register, to program the events which will be eligible to activate the MES summary bit in the Status Byte.

A Note about Queues

Some of the event bits are summaries of queues of events. These are 'historical' (Last-in - Last Out) stacks, and when the queue stack is full the eldest entries are discarded. It is good practice to program the application to read the queue as soon as its summary bit is set true, particularly the error bits, otherwise the original cause of the error can be discarded as subsequent dependent errors fill up the stack.

1281 Status Reporting - Detail

IEEE 488.1 Model

Provides for two major forms of status reporting:

- Specific device-dependent commands from the controller, to generate status responses which have been previously programmed into the device to represent specific device conditions.
- Serial-polling of devices on the bus following a Service Request (the device pulling the SRQ line *true*). As a response to the serial poll, the controller can be programmed to read a 'Status Byte' set up in the device (when it issues the SRQ), and interpret the number represented by the byte as event messages. These numbers are previously coded into the device's firmware to represent specific device conditions, and application programmers are thus able to program alarms or other actions to occur when such messages are received by the controller.

IEEE 488.2 Model

This incorporates the two aspects of the IEEE 488.1 model into an extended structure with more definite rules. These rules invoke the use of standard 'Common' messages and provide for device-dependent messages. A feature of the structure is the use of 'Event' registers, each with its own enabling register as illustrated in Fig. 5.4.

1281 Model Structure

The IEEE 488.2 Standard provides for a more extensive hierarchical structure with the Status Byte at the apex, defining its bits 4, 5 and 6 and their use as summaries of a *Standard*-defined event structure which must be included, if the device is to claim conformance with the Standard. The 1281 employs these bits as defined in the Standard.

Bits 0, 1, 2 and 3 and 7 are made available to the device designer, to act as summaries of *device*-specific events. In the 1281, only bit 0 is necessary in order to summarize its device-specific events.

It must be recognized by the application programmer that whenever the controller reads the Status Byte, it can only receive summaries of types of events, and further query messages are necessary to dig deeper into the detailed information relating to the events themselves.

Thus two further bytes are used to expand on the summaries at bits 0 and 5 of the Status Byte.

Status Byte Register

In this structure the Status Byte is held in the 'Status Byte Register'; the bits being allocated as follows:

Bit 0 (DIO1) Device-specific Measurement Event Summary Bit (MES)

Summarizes the byte held in a Device-defined 'Measurement Event Status Register' (MESR), whose bits represent reportable conditions in the device. In the 1281 these are overload, math overflow, Hi and Lo limits reached or new maximum or minimum achieved. It can also signal the completion of a block of measurements. The MES bit is *true* when the byte in the MESR contains one or more enabled bits which are *true*; or *false* when all the enabled bits in the byte are *false*. The Measurement Event Status Register, its enabling register and byte are described later.

Bits 1 (DIO2), 2 (DIO3) and 3 (DIO4) are not used in the 1281 status byte. They are always *false*.

Bit 4 (DIO5) IEEE 488.2-defined Message Available Bit (MAV)

The MAV bit helps to synchronize information exchange with the controller. It is *true* when the 1281 message exchange interface is ready to accept a request from the controller to start outputting bytes from the Output Queue; or *false* when the Output Queue is empty.

The common command *CLS can clear the Output Queue, and the MAV bit 4 of the Status Byte Register, providing it is sent immediately following a 'Program Message Terminator'.

Bit 5 (DIO6) IEEE 488.2-defined Standard Event Summary Bit (ESB)

Summarizes the state of the 'Event Status byte', held in the 'Event Status register' (ESR), whose bits represent IEEE 488.2-defined conditions in the device. The ESB bit is *true* when the byte in the ESR contains one or more enabled bits which are *true*; or *false* when all the enabled bits in the byte are *false*. The byte, the Event Status Register and its enabling register are defined by the IEEE 488.1 Standard; they are described later.

Bit 6 (DIO7) This bit has a dual purpose:

When the controller is conducting a serial poll (as a result of receiving a Service Request via the SRQ line), the 1281 is placed into 'serial poll active state' and bit 6 is the Request Service Message (RQS bit). If the 1281 had been the device which originated the SRQ, its output control will set DIO 7 (bit 6's channel) *true*, but if not, then DIO 7 is set *false*. By reading the Status Byte *bitwise*, the controller identifies the device which originated the SRQ; and in the case of it being the 1281, also receives any enabled summary bits to allow further investigation of the originating event.

If the controller reads the Status Byte using the common query *STB?, then bit 6 is the Master Status Summary Message (MSS bit), and is set *true* if one of the bits 0 to 4 or bit 5 is *true* (bits 1 to 3 are always *false* in the 1281).

Bit 7 (DIO8) is not used in the 1281 status byte. It is always *false*.

Reading the Status Byte Register

There are two ways of reading the Status Byte register: by serial poll or by common query *STB?

Serial Poll

When the controller conducts a serial poll, the 1281 is placed into 'serial poll active state' by the IEEE 488.1 command SPE, and is addressed as a talker. The enabled contents of the Status Byte register are transferred in binary form into the 1281 I/O control, which sets the RQS bit 6 *true* if the 1281 had originated the preceding SRQ, or *false* if it had not. The binary values of bits 1, 2, 3 and 7 are always zero. The resulting byte is placed in binary onto the system bus on the corresponding DIO 8-1 lines. When the serial poll is disabled by the command SPD, the 1281 enters 'serial poll inactive state', and the I/O control relinquishes control of RQS bit 6 on the DIO 7 line.

*STB?

The common query: *STB? reads the binary number in the Status Byte register. The response is in the form of a decimal number which is the sum of the binary weighted values in the enabled bits of the register. In the 1281, the binary-weighted values of bits 1, 2, 3 and 7 are always zero. The query *STB? is provided mainly for controllers with no serial poll capability, and for those users who are using the device interface for RS232-type communication.

Service Request Enable Register

The SRE register is a means for the application program to select, by enabling individual Status Byte summary bits, those types of events which are to cause the 1281 to originate an SRQ. It contains a user-modifiable image of the Status Byte, whereby each programmably *true* bit (0, 4, and 5) acts to enable its corresponding bit in the Status Byte.

Bit Selector: *SRE *phs Nrf*

The program command: *SRE *phs Nrf* performs the selection, where *Nrf* is a decimal numeric, which when decoded into binary produces the required bit-pattern in the enabling byte.

For example:

If an SRQ is required only when a Standard-defined event occurs and when a message is available in the output queue, then *Nrf* should be set to 48. Bit 6, the Master Status Summary bit, becomes set whenever SRQ is asserted. The binary decode is 00110000 so bit 4 or bit 5, when *true*, will generate an SRQ; but when bit 0 is *true*, no SRQ will result. The 1281 always sets the Status Byte bits 1, 2, 3 and 7 *false*, so they can never originate an SRQ whether enabled or not.

Reading the Service Request Enable Register

The common query: *SRE? reads the binary number in the SRE register. The response is in the form of a decimal number which is the sum of the binary-weighted values in the register. The binary-weighted values of bits 1, 2, 3 and 7 are always zero.

IEEE 488.2-defined Event Status Register

The ‘Event Status Register’ holds the Event Status Byte, consisting of event bits, each of which directs attention to particular information. All bits are ‘sticky’; ie. once *true*, cannot return to *false* until the register is cleared. This occurs automatically when it is read by the query: *ESR?. The common command *CLS clears the Event Status Register and associated error queues, but not the Event Status Enable Register. The bits are named in mnemonic form as follows:

Bit 0 Operation Complete (OPC)

This bit is *true* only if *OPC has been programmed and all selected pending operations are complete. As the 1281 operates in serial mode, its usefulness is limited to registering the completion of long operations, such as self-test.

Bit 1 Request Control (RQC)

This bit would be *true* if the device were able to assume the role of controller, and is requesting that control be transferred to it from the current controller. This capability is not available in the 1281, so bit 1 is always *false*.

Bit 2 Query Error (QYE)

QYE *true* indicates that an attempt is being made to read data from the output queue when no output is present or pending, or data in the output queue has been lost. The Standard document defines the conditions under which a query error is generated, as a result of the controller failing to follow the message exchange protocol.

Bit 3 Device Dependent Error (DDE)

DDE is set *true* when an internal operating fault is detected, for instance during a self test. Each reportable error has been given a listed number,

which is appended to an associated queue as the error occurs. The queue is read destructively as a First In Last Out stack, using the query command DDQ? to obtain a code number. The DDE bit is not a summary of the contents of the queue, but is set or confirmed *true* concurrent with each error as it occurs; and once cleared by *ESR? will remain *false* until another error occurs. The query DDQ? can be used to read all the errors in the queue until it is empty, when the code number zero will be returned.

The common command *CLS clears the queue.

Bit 4 Execution Error (EXE)

An execution error is generated if the received command cannot be executed, owing to the device state or the command parameter being out of bounds. Each reportable execution error has been given a listed number, which is appended to an associated queue as the error occurs. The queue is read destructively as a First In Last Out stack, using the query command EXQ?. The EXE bit is not a summary of the contents of the queue, but is asserted *true* as each error occurs; and once cleared by *ESR? will remain *false* until another error occurs. The query EXQ? can be used to read all the errors in the queue until it is empty, when the code number zero will be returned.

The common command *CLS clears the queue.

Bit 5 Command Error (CME)

CME occurs when a received bus command does not satisfy the IEEE 488.2 generic syntax or the device command syntax programmed into the instrument interface’s parser, and so is not recognized as a valid command. Command errors do not have an associated queue.

Bit 6 User Request (URQ)

This bit is set *true* by the action of pressing the front panel SRQ key. If the URQ bit and the ESB bit are enabled, an SRQ is generated and the SRQ legend on the main display lights. During a subsequent serial poll the controller reads the Status Byte, the RQS bit in the I/O control is destroyed, and the front panel legend is extinguished. The ESB and URQ bits remain *true*, returning to *false* when the controller destructively reads the Event Status register by *ESR?, or clears status by *CLS.

Bit 7 1281 Power Supply On (PON)

This bit is set *true* by the action of the 1281 line power being applied. Whether this generates an SRQ or not is dependent on the decimal numeric value previously programmed as part of the 'Power On Status Clear' message *PSC *phs Nrf*. If *Nrf* was zero, the Event Status Enable register would have been cleared at power on, so PON would not generate the ESB bit in the Status Byte register, and no SRQ would occur at power on. For an *Nrf* of 1, **and** the Event Status Enabling register bit 7 *true*, **and** the Service Request Enabling register bit 5 *true*; a change from Power Off to Power On generates an SRQ. This is only possible because the enabling register conditions are held in non-volatile memory, and restored at power on.

This facility is included to allow the application program to set up conditions so that a momentary Power Off followed by reversion to Power On (which could upset the 1281 programming) will be reported by SRQ. To achieve this, the Event Status register bit 7 must be permanently *true* (by *ESE *phs Nrf*, where $Nrf \geq 128$); the Status Byte Enable register bit 5 must be set permanently *true* (by command *SRE *phs Nrf*, where $Nrf \geq 32$); Power

On Status Clear must be disabled (by *PSC *phs Nrf*, where $Nrf = 0$); and the Event Status register must be read destructively immediately following the Power On SRQ (by the common query *ESR?).

Standard Event Status Enable Register

The ESE register is a means for the application program to select, from the positions of the bits in the standard-defined Event Status Byte, those events which when *true* will set the ESB bit *true* in the Status Byte. It contains a user-modifiable image of the standard Event Status Byte, whereby each *true* bit acts to enable its corresponding bit in the standard Event Status Byte.

Bit Selector: *ESE *phs Nrf*

The program command: *ESE *phs Nrf* performs the selection, where *Nrf* is a decimal numeric, which when decoded into binary, produces the required bit-pattern in the enabling byte.

For example:

If the ESB bit is required to be set *true* only when an execution or device-dependent error occurs, then *Nrf* should be set to 24. The binary decode is 00011000 so bit 3 or bit 4, when *true*, will set the ESB bit *true*; but when bits 0-2, or 5-7 are *true*, the ESB bit will remain *false*.

Reading the Standard Event Enable Register

The common query: *ESE? reads the binary number in the ESE register. The response is in the form of a decimal number which is the sum of the binary-weighted values in the register.

Measurement Event Status Register

In this structure a ‘Measurement Event Status Register’ holds the Measurement Event Status Byte, consisting of event bits, specific to the 1281. All bits are ‘sticky’; ie. once *true*, and can only return to *false* when the register is cleared. This register is automatically cleared when it is read by

the query: MESR?. The common command *CLS clears the Measurement Event Status Register but not the Measurement Event Status Enable Register. Each of the bits is named in mnemonic form; they are described below.

Bit 0 New Maximum Reading (MAX)

The 1281 automatically stores each new maximum reading, which destroys its predecessor. The store is cleared at power on, reset or function change. The store can be read by the query: MAX?, or cleared by: CLR *phs* MAX. Bit 0 is asserted *true* when a new maximum reading has been stored.

Bit 1 New Minimum Reading (MIN)

The 1281 automatically stores each new minimum reading, which destroys its predecessor. The store is cleared at power on, reset or function change. The store can be read by the query: MIN?, or cleared by: CLR *phs* MIN. Bit 1 is asserted *true* when a new minimum reading has been stored.

Bit 2 High Limit (HLM)

The controller can instruct the 1281 (via command: HILT *phs Nrf*; where *Nrf* represents the value to be used in limit checking) to report readings which algebraically exceed a preset limit. Limit-checking is enabled by the command: LIMIT *phs* ON, and disabled by: LIMIT *phs* OFF. The limit is saved in non-volatile memory, and can be reviewed by the query: HILT? Bit 2 is asserted *true* when a reading exceeds the limit.

Bit 3 Low Limit (LLM)

The controller can instruct the 1281 (via command: LOLT *phs Nrf*; where *Nrf* represents the value to be used in limit checking) to report readings which algebraically fall below a preset limit. Limit-checking is enabled by the command: LIMIT *phs* ON, and disabled by: LIMIT *phs* OFF. The limit is saved in non-volatile memory, and can be reviewed by the query: LOLT? Bit 3 is asserted *true* when a reading falls below the limit.

Bit 4 Overload (O-L)

Bit 4 is asserted *true* whenever a signal, applied to the analog input for any measurement, has exceeded the selected range; or if on Auto, has exceeded the highest autorange. The value recalled by the query: RDG? is $\pm 200.0000E+33$.

Bit 5 Mathematical Overflow (MOF)

Bit 5 is asserted *true* whenever the modulus of the result of an internal math calculation has a value which is too large to be represented.

A divide-by-zero command will automatically be rejected as an execution error, but a very large number could result from trying to divide by (say) a reading which is very close to zero.

Bit 6 Diversion to Store Completed (STC)

The measurement system incorporates a facility to divert a number of measurements into a separate internal buffer. The facility is armed, and the number of measurements is specified, by the 'BLOCK *phs Nrf*' command. Diversion to store commences as soon as this command is executed.

Once the specified number of measurements has been diverted, the BLOCK? query can be sent to recall part or all of the block, and the COUNT? query can be used to recall the block size (number of measurements taken). Sending either of these queries, before the instrument has completed the specified number of measurements, aborts the diversionary action. It is therefore desirable to inform the controller as soon as the specified number of measurements has been diverted.

Bit 6 of the MESR is asserted *true* when this completion point is reached. So having set the diversion in operation, and enabled both this STC bit and the MES bit in the Status Byte Register, the controller can await an SRQ to announce the completion of the task.

Bit 7 Reading Available (RAV)

Bit 7 is asserted *true* whenever the result of a measurement is available (when the A-D cycle is completed). If command RDG? is sent, the result will be placed in the output queue.

Measurement Event Status Enable Register

The application program uses the MESE register to select, from the positions of the bits in the Measurement Event Status Byte, those events which when *true* will assert the MES bit *true* in the Status Byte. It contains a user-modifiable image of the Measurement Event Status Byte, whereby each *true* bit acts to enable its corresponding bit in the Measurement Event Status Byte.

Bit Selector: MESE *phs Nrf*

The program command: MESE *phs Nrf* performs the selection, where *Nrf* is a decimal numeric, which when decoded into binary, produces the required bit-pattern in the enabling byte.

For example:

If the MES bit is required to be asserted *true* only when a new minimum or maximum measurement occurs, then the value of *Nrf* should be set to 3. The binary decode is 00000011 so bit 0 or bit 1, when *true*, will assert the MES bit *true*; but when bits 2-6 are *true*, the MES bit will not be asserted.

Reading the Standard Event Enable Register

The device-specific query: MESE? reads the binary number in the MESE register. The response is in the form of a decimal number which is the sum of the binary-weighted values in the register.

1281 COMMANDS AND QUERIES - Syntax Diagrams

MAJOR FUNCTIONS

DC Voltage

The following commands are used to select DCV function along with its associated configuration.

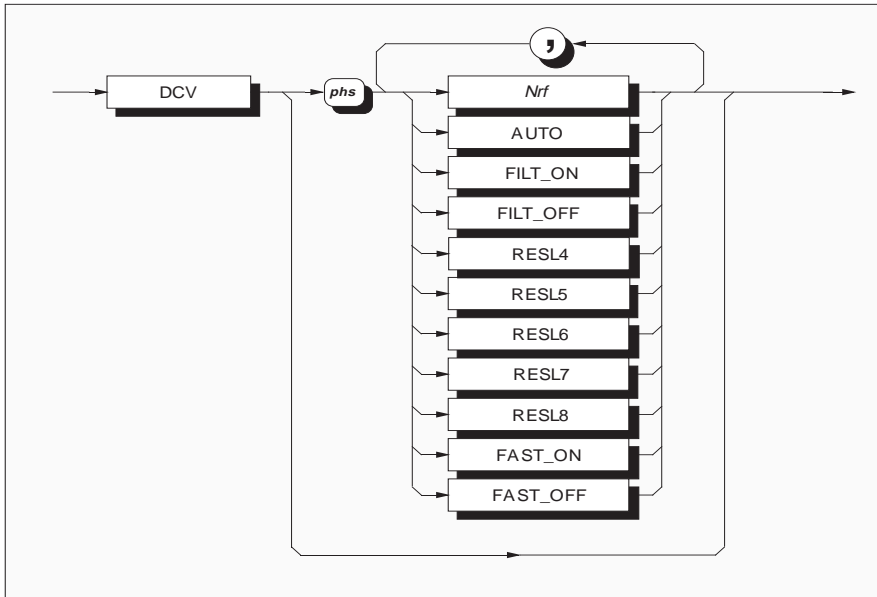

Nrf is a decimal numeric value.

It is meant to represent the expected signal amplitude, so that the instrument will go to the most relevant range. For example, an Nrf of 2, 10, or even 15.6789, will select the 10V range. Any valid numeric value cancels autorange.

0 to 0.19999999	selects the 100mV range.
0.2 to 1.9999999	selects the 1V range.
2.0 to 19.999999	selects the 10V range.
20 to 199.99999	selects the 100V range
>200	selects the 1000V range.

Note that numbers exceeding the defined data element resolution of 8.5 digits are rounded to that resolution.

AUTO selects the autorange facility.

A measured signal which exceeds the maximum value for the active range will activate the next range upwards and trigger a new measurement. If it exceeds this range, the process continues until the signal value is in range. If the signal exceeds the maximum capability then 'error overload' appears on the front panel. The relevant query command invokes the 'invalid number response', and the appropriate bit is set in the device status registers.

For signals smaller than 18% of full range, the measured value determines the new range, which is selected, then a new measurement is triggered.

FILT_ON inserts a hardware analog filter into the signal path.

FILT_OFF removes the filter.

RESLX sets the resolution.

Where X is in the range 5 to 8: sets the resolution of the measurement in the corresponding range 5.5 to 8.5 digits, together with the associated A-D converter configurations.

FAST_ON selects fast mode.

Reduces the number of power line cycles to which the A-D process is related, for faster conversions. It may also alter the associated A-D converter configuration.

FAST_OFF deselects fast mode.

The A-D reverts to its default configuration.

Example: DCV 10,FILT-ON,RESL7 would program the instrument to the DCV 10V range with filter on and a resolution of 7.5 digits.

Execution Errors

None.

Reversion from Remote to Local

No Change.

Exit from DCV Function

All parameters saved on exit; restored on re-entry.

Power On and Reset Conditions

DCV	Selected active.
Range	1kV
Analog Filter	FILT_OFF
Resolution	RESL6 (max. is 8.5 digits)
A-D Resolution	FAST_OFF

AC Voltage

The following commands are used to select ACV function along with its associated configuration.

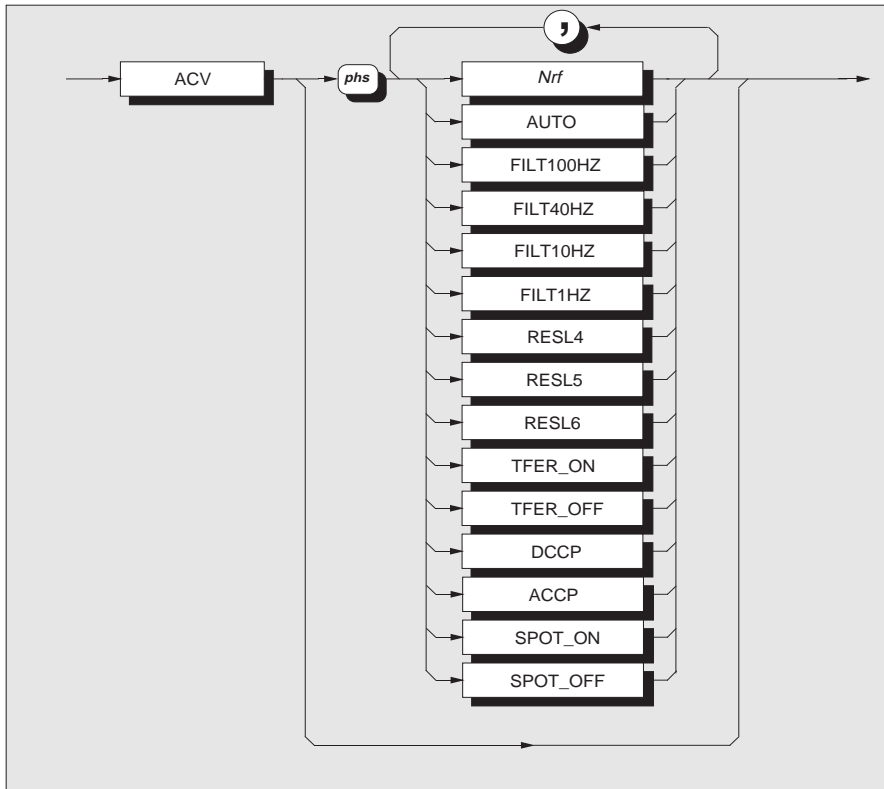

Nrf is a decimal numeric value which is meant to represent the expected signal amplitude, so that the instrument will go to the most relevant range.

If Nrf is 2, 10, or even 15.6789, then the 10V range is automatically selected. Any valid numeric value cancels autorange.

0 to 0.1999999	selects the 100mV range.
0.2 to 1.999999	selects the 1V range.
2.0 to 19.99999	selects the 10V range.
20 to 199.9999	selects the 100V range.
>200	selects the 1000V range.

Note that numbers exceeding a resolution of 6.5 digits will be rounded to that resolution.

AUTO selects the autorange facility. A measured signal which exceeds the maximum value for the active range will activate the next range upwards and trigger a new measurement. If it exceeds this range, the process continues until the signal value is in range. If the signal exceeds the maximum capability then an error overload is displayed on the front panel. The 'invalid number response' is given in response to the relevant query command, and the appropriate bit is set in the device status registers.

For signals smaller than 18% of full range, the range to be used is determined from the measured value. The new range is selected and a new measurement is triggered.

FILT...HZ:

inserts the appropriate analog filter into the signal path. One of the four available filters is always in circuit.

TFER_ON enables transfer mode.
(Option 12 only)

This selects an electronic AC-DC transfer facility for AC measurement which improves linearity and temperature performance.

TFER_OFF disables transfer mode.
(Option 12 only)

The instrument can take faster readings at some penalty in accuracy.

DCCP selects DC-coupled measurements.
(Note: DC-coupled should be selected for signal frequencies less than 40Hz)

ACCP selects AC-coupled measurements.

RESLX: where X is in the range 4 to 6: sets the corresponding resolution of the measurement in the range 4.5 to 6.5 digits, together with associated A-D converter configurations.

SPOT_ON: enables Spot Frequency mode. Applies corrections when the signal frequency is within 10% of the calibrated spot frequencies.

SPOT_OFF: disables Spot Frequency mode.

Measurements of RMS Value and Frequency - Recall

For each RMS measurement trigger, a parallel measurement of signal frequency is also triggered (4.5 or 6.5 digit frequency resolution depending on gate width selection). For recall of these two parameters refer to RDG? and FREQ? commands.

Execution Errors

The ACV function is optional. Execution errors are generated when Option 10 is not present.

Reversion from Remote to Local

No Change.

Exit from ACV Function

All parameters saved on exit; restored on re-entry.

Power On and Reset Conditions

Range	1kV
Analog Filter	FILT100Hz
Resolution	RESL6 (max. is 6.5 digits)
AC-DC Transfer	TFER_ON
Coupling	ACCP (DC isolated)
Spot Corrections	SPOT_OFF
ACV not active (DCV active).	

Recall of Spot Frequency Value

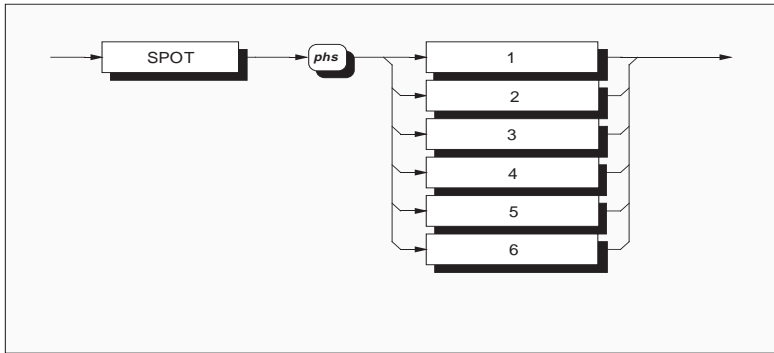

Example: "SPOT? 5' recalls the frequency value for Spot Frequency 5 on the active ACV range.

Response Format:

Character position

```
1 2 3 4 5 6 7 8 9 10 11 12 13 14  
s n x x x n n n n E sg p p nl
```

Where:

s = + or - or space

n = 0 to 9

x = n or decimal point

E = ASCII character delimiting the exponent

sg = sign (+ or-)

p = 0 to 9 (exponent value is in engineering units)

nl = newline with EOI

Response Decode:

The value returned is the frequency at which the spot was calibrated on the active range.

Resistance

Normal OHMS

The following commands are used to select OHMS function along with its associated configuration.

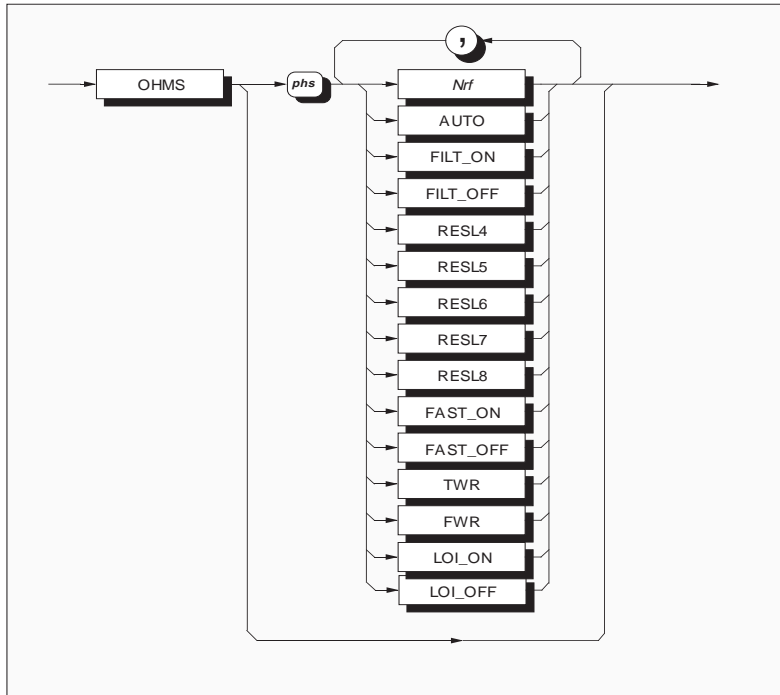

Nrf is a decimal numeric value.

It represents the expected signal amplitude, so that the instrument will go to the most relevant range. Any valid numeric value cancels autorange.

Note that numbers exceeding the defined data element resolution of 8.5 digits will be rounded to that resolution.

0 to 199.999999	selects the 100 Ω range.
200 to 1999.99999	selects the 1k Ω range.
2000 to 19999.9999	selects the 10k Ω range.
20000 to 199999.999	selects the 100k Ω range.
200000 to 1999999.99	selects the 1M Ω range.
> 2000000	Use HI_OHMS.

AUTO selects the autorange facility.

A measured signal which exceeds the maximum value for the active range will activate the next range upwards and trigger a new measurement. If it exceeds this range, the process continues until the signal value is in range. If the signal exceeds the maximum capability then an error overload is displayed on the front panel. The 'invalid number response' is given in response to the relevant query command, and the appropriate bit is set in the device status registers.

For signals smaller than 18% of full range, the range to be used is determined from the measured value. The new range is selected and a new measurement is triggered.

FILT_ON inserts a hardware analog filter into the measurement signal path.

FILT_OFF removes the filter.

RESLX sets the resolution.

Where X is in the range 4 to 8: sets the resolution of the measurement in the range 4.5 to 8.5 digits, together with the associated A-D configurations.

FAST_ON selects fast mode.

This reduces the number of power line cycles to which the A-D conversion is related for faster conversions. It may also alter the associated A-D converter configuration.

FAST_OFF deselects fast mode.

The A-D reverts to its default configuration.

TWR selects 2-wire Ohms (use Hi and Lo terminals).

FWR selects 4-wire Ohms.

LOI_ON selects low current mode.

LOI_OFF deselects low current mode (i.e sets normal current mode).

Example: 'OHMS 10000,FWR,RESL8' selects 8.5 digits on the 10k Ω range', in 4-wire Ohms.

Measurement Recall

For recall of the most-recent measurement value refer to RDG? command.

Execution Errors

The Ohms function is optional. Execution errors will be generated when Option 20 is not present.

Reversion from Remote to Local

No Change

Exit from Ohms Function

All parameters saved on exit, restored on re-entry.

Power On and Reset Conditions

Range	10M Ω
Analog Filter	FILT_OFF
Resolution	RESL6 (max. is 8.5 digits)
A-D Resolution	FAST_OFF
Connection	TWR (two wire)
Low Current Source	LOI_OFF
OHMS not active (DCV active).	

HI OHMS

The following commands are used to select HI OHMS function along with its associated configuration.

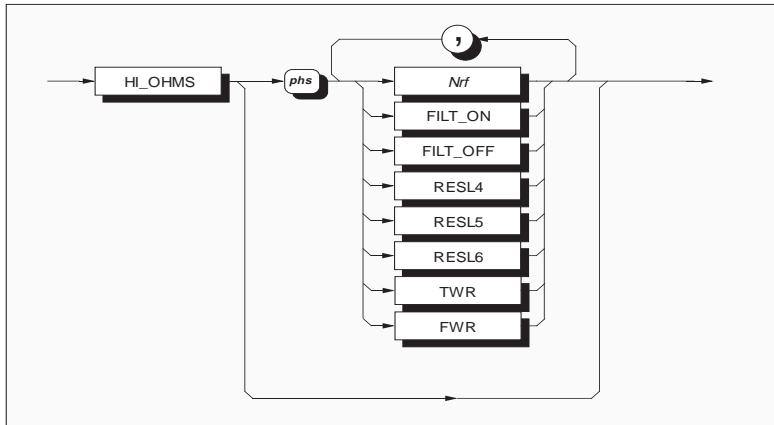

Nrf is a decimal numeric value.

It is meant to represent the expected signal amplitude, so that the instrument will go to the most relevant range. Any valid numeric value cancels autorange.

20000000 to 199999900

selects the 100M Ω range.

>200000000

selects the 1G Ω range.

Note that numbers exceeding the defined data element resolution of 8.5 digits will be rounded to that resolution.

FILT_ON inserts a hardware analog filter into the measurement signal path.

FILT_OFF removes the filter.

RESLX where X is in the range 5 to 6: sets the resolution of the measurement in the range 5.5 to 6.5 digits, together with the associated A-D configurations.

TWR selects 2-wire Ohms (use Hi and Lo terminals).

FWR selects 4-wire Ohms.

Example:

'HI_OHMS 10000000,FILT_ON,RESL5'

sets the instrument to 5.5 digits on the 1G Ω range of the Hi Ohms sub-function, with filter selected.

Measurement Recall

For recall of the most-recent measurement value refer to RDG? command.

Execution Errors

The High Ohms function is optional. Execution errors are generated when Option 20 is not present.

Reversion from Remote to Local

No Change

Exit from Ohms Function

All parameters saved on exit; restored on re-entry.

Power On and Reset Conditions

Range 100M Ω

Analog Filter FILT_OFF

Resolution RESL6 (maximum is 6.5 digits)

Connection TWR (two wire)

Hi Ω not active (DCV active).

True OHMS

The following commands are used to select TRUE OHMS function and its associated configuration.

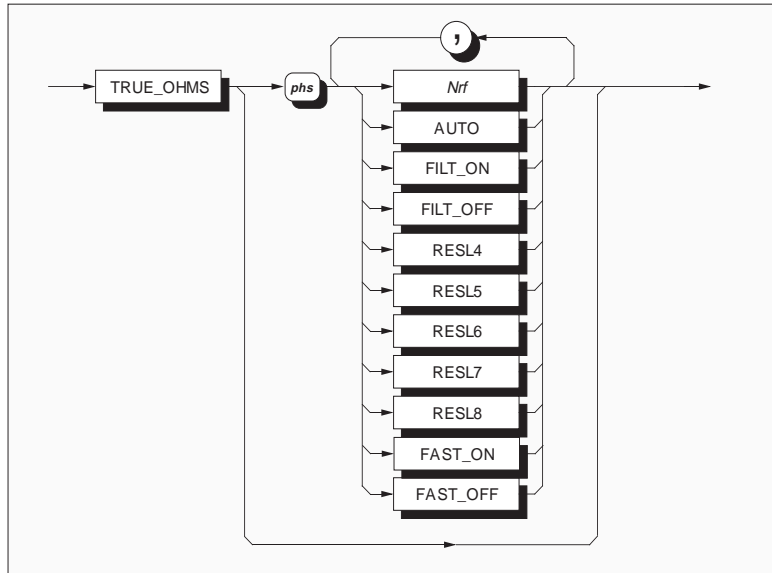

Nrf is a decimal numeric value which is meant to represent the expected signal amplitude, so that the instrument will go to the most relevant range. Any valid numeric value cancels autorange.

0 to 19.999999	selects the 10 Ω range.
20 to 199.999999	selects the 100 Ω range.
200 to 1999.99999	selects the 1k Ω range.
2000 to 19999.9999	selects the 10k Ω range.
>20000	selects the 100k Ω range.

Note that numbers exceeding the defined data element resolution of 8.5 digits will be rounded to that resolution.

AUTO selects the autorange facility.

A measured signal which exceeds the maximum value for the active range will activate the next range upwards and trigger a new measurement. If it exceeds this range, the process continues until the signal value is in range. If the signal exceeds the maximum capability then an error overload is displayed on the front panel. The 'invalid number response' is given in response to the relevant query command, and the appropriate bit is set in the device status registers.

For signals smaller than 18% of full range, the range to be used is determined from the measured value. The new range is selected and a new measurement is triggered.

FILT_ON inserts a hardware analog filter into the measurement signal path.

FILT_OFF removes the filter.

RESLX sets the resolution.

Where X is in the range 4 to 8: sets the resolution of the measurement in the range 4.5 to 8.5 digits, together with the associated A-D converter configurations.

FAST_ON selects fast mode.

It reduces the number of power line cycles to which the A-D conversion is related for faster conversions. It may also alter the associated A-D converter configuration.

FAST_OFF deselected fast mode.

The A-D converter reverts to its default configuration.

Example:

```
'TRUE_OHMS 10,FILT_ON,RESL6'
```

sets 6.5 digits resolution on the 10Ω range of the True Ohms sub-function, with filter on.

Measurement Recall

For recall of the most-recent measurement value refer to RDG? command.

Execution Errors

The True Ohms function is optional. Execution errors are generated when Option 20 is not present.

Reversion from Remote to Local

No Change

Exit from Ohms Function

All parameters saved on exit; restored on re-entry.

Power On and Reset Conditions

Range	100kΩ
Analog Filter	FILT_OFF
Resolution	RESL6 (max. is 8.5 digits)
A-D Resolution	FAST_OFF
Connection	TWR (two wire)
TruΩ not active (DCV active).	

DC Current

The following commands are used to select DCI function along with its associated configuration.

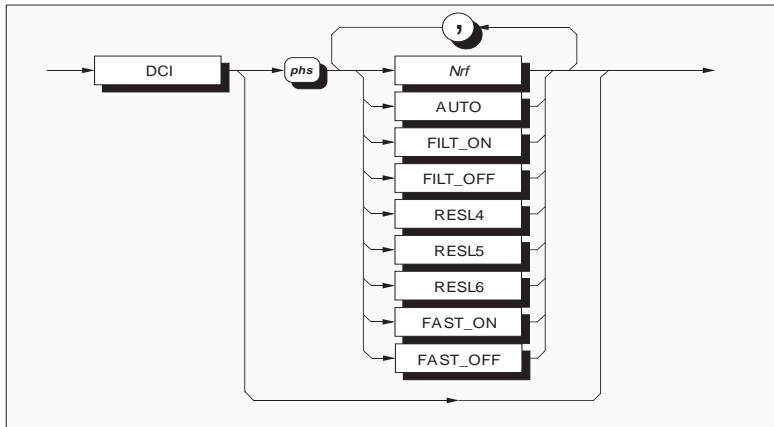

Nrf is a decimal numeric value.

It is meant to represent the expected signal amplitude, so that the instrument will go to the most relevant range. Any valid numeric value cancels autorange.

0 to 0.0001999999	selects the 100 μ A range.
0.0002 to 0.0019999999	selects the 1mA range.
0.002 to 0.019999999	selects the 10mA range.
0.02 to 0.19999999	selects the 100mA range.
>0.2	selects the 1A range.

Note that numbers exceeding the defined data element resolution of 6.5 digits will be rounded to that resolution.

AUTO selects the autorange facility.

A measured signal which exceeds the maximum value for the active range will activate the next range upwards and trigger a new measurement. If it exceeds this range, the process continues until the signal value is in range. If the signal exceeds the maximum capability then an error overload is displayed on the front panel. The 'invalid number response' is given in response to the relevant query command, and the appropriate bit is set in the device status registers.

For signals smaller than 18% of full range, the range to be used is determined from the measured value. The new range is selected and a new measurement is triggered.

FILT_ON inserts a hardware analog filter into the measurement signal path.

FILT_OFF removes the filter.

RESLX sets the resolution.

Where X is in the range 4 to 6: sets the resolution of the measurement in the range 4.5 to 6.5 digits, together with the associated A-D configurations.

FAST_ON selects fast mode.

It reduces the number of power line cycles to which the A-D conversion is related, for faster conversions. It may also alter the associated A-D converter configuration.

FAST_OFF deselected fast mode.

The A-D converter reverts to default configuration.

Example:

`'DCI 0.1,FILT_ON,RESL5'`

sets the instrument to 5.5 digits resolution on the 100mA DC range, with filter selected.

Measurement Recall

For recall of the most-recent measurement value refer to RDG? command.

Execution Errors

The DCI function is optional (Option 30 with Option 20). Execution errors will be generated when these options are not present.

Reversion from Remote to Local

No Change

Exit from DCV Function

All parameters saved on exit; restored on re-entry.

Power On and Reset Conditions

Range	1A
Analog Filter	FILT_OFF
Resolution	RESL6 (max. is 6.5 digits)
A-D Resolution	FAST_OFF
DCI not active (DCV active).	

AC Current

The following commands are used to select ACI function along with its associated configuration.

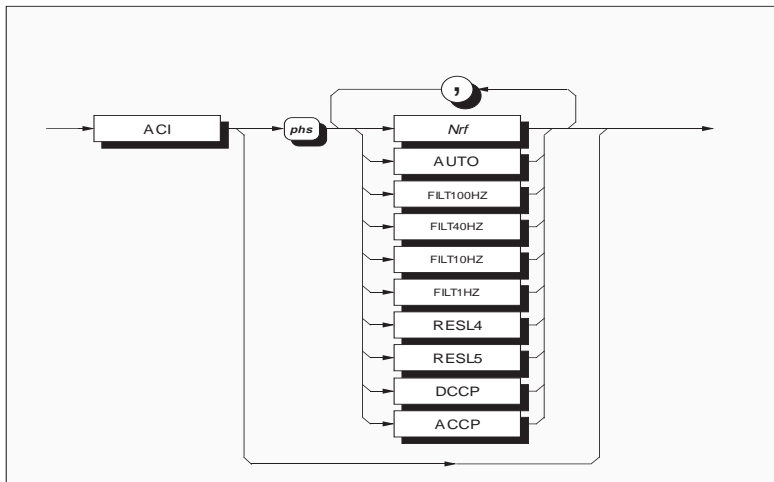

Nrf is a decimal numeric value.

It is meant to represent the expected signal amplitude, so that the instrument will go to the most relevant range. Any valid numeric value cancels autorange.

0 to 0.000199999	selects the 100 μ A range.
0.0002 to 0.00199999	selects the 1mA range.
0.002 to 0.0199999	selects the 10mA range.
0.02 to 0.199999	selects the 100mA range.
0.2 to 1.99999	selects the 1A range.

Note that numbers exceeding the defined data element resolution of 5.5 digits will be rounded to that resolution.

AUTO selects the autorange facility.

A measured signal which exceeds the maximum value for the active range will activate the next range upwards and trigger a new measurement. If it exceeds this range, the process continues until the signal value is in range. If the signal exceeds the maximum capability then an error overload is displayed on the front panel. The 'invalid number response' is given in response to the relevant query command, and the appropriate bit is set in the device status registers.

For signals smaller than 18% of full range, the range to be used is determined from the measured value. The new range is selected and a new measurement is triggered.

FILT...Hz:

inserts the appropriate analog filter into the signal path. One of the four available filters is always in circuit.

DCCP selects DC-coupled measurements.

(Note: DC-coupled should be selected for signal frequencies less than 40Hz)

ACCP selects AC-coupled measurements.

Example:

`'ACI AUTO,FILT40Hz'`

sets autorange on ACI, with the 40Hz integration filter selected.

Measurements of RMS Value and Frequency - Recall

For each RMS measurement trigger, a parallel measurement of signal frequency is also triggered (4.5 or 6.5 digit frequency resolution depending on gate width selection). For recall of these two parameters refer to RDG? and FREQ? commands.

Execution Errors

The ACI function is optional (Option 30 with options 20 and 10). Execution errors will be generated when these options are not present.

Reversion from Remote to Local

No Change.

Exit from ACV Function

All parameters saved on exit; restored on re-entry.

Power On and Reset Conditions

Range	1A
Analog Filter	FILT100Hz
Coupling	ACCP (DC isolated)
ACI not active (DCV active).	

INPUT

The following commands are used to select the various inputs; and also the Ratio, Difference and Deviation measurement modes.

Input and Ratio Configurations

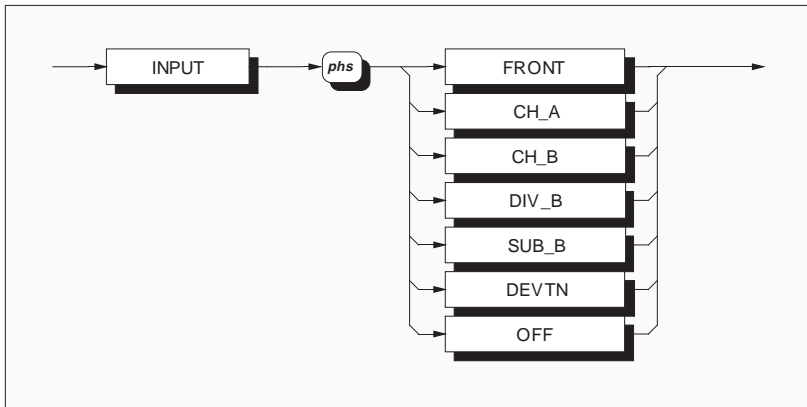

INPUT FRONT	selects front input.
INPUT CH_A	selects Channel A
INPUT CH_B	selects Channel B
INPUT DIV_B	selects Channels A and B with Ratio (A/B).
INPUT SUB_B	selects Channels A and B with Difference (A-B).
INPUT DEVTN	selects Channels A and B with Deviation $[(A-B)/B]$
INPUT OFF	isolates all inputs.

Reversion from Remote to Local

No Change.

Exit from a Scanning Mode

Achieved by selecting one of the three inputs or INPUT OFF.

Power On and Reset Conditions

Input Channel INPUT FRONT

All of the above selections are mutually exclusive.

Remote Guard

Selection of independent guarding for all functions.

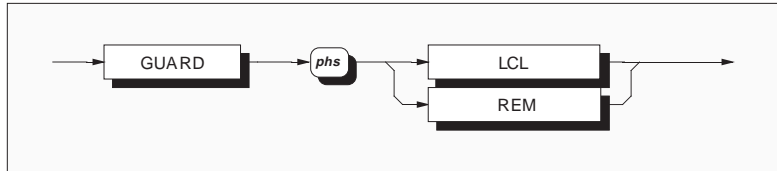

GUARD LCL selects Local Guard.
GUARD REM selects Remote Guard.

For scan operations, the guard selection is applied to the channel currently being applied to the A-D converter.

Both selections are mutually exclusive.

Reversion from Remote to Local

No Change.

Power On and Reset Conditions

Guard Selection GUARD LCL (local)

Monitor Messages

As the Monitor facilities are designed to provide information to the user, a response is given via the system bus, as a series of ASCII characters. In the following descriptions, the format for the response is also shown.

Specification Readout

Obtains the specification for the most-recently triggered measurement.

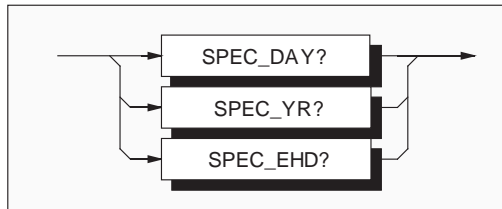

SPEC_DAY?

recalls the 24 hour spec readout for the current range, function and reading.

SPEC_YR?

recalls the 1 year spec readout for the current range, function and reading.

SPEC_EHD?

recalls the 1 year enhanced spec readout for the current range, function and reading.

Response Format:

Character position

1	2	3	4	5	6	7	8	9	10	11
s	n	x	x	x	n	E	sg	p	p	nl

Where:

s = + or - or space

n = 0 to 9

x = either n or decimal point (.)

E = ASCII character identifying the exponent

sg = + or -

p = 0 to 9 (exponent is in engineering units)

nl = newline with EOI

All selections are mutually exclusive.

If no trigger has been received to generate an A-D conversion of the input signal, the response will be the specification of the most-recent reading. If no triggers are available the invalid response is given. If a trigger has been received, but the A-D conversion is still in progress; this query will wait for the completion of the measurement, then place the specification of this result in the output queue.

Continued next page

Response Decode:

The value returned represents the specification of the reading as a fraction of the reading.

The responses include the calibration uncertainty values which were most-recently entered either manually (via the EXT CAL and SPEC menus) or remotely (by 'UNC' command) during an external calibration of the instrument.

These uncertainty values can be recalled by Monitor command 'UNC?'.

When shipped from manufacture, it is the manufacturer's calibration uncertainties that are included, relative to National Standards, as listed in the appropriate columns of Section 6.

If the specification is not valid, a value of +200.0E+33 is returned to indicate this error.

Power On and Reset Conditions

All previous results are cleared, thus an invalid response is given until after the first trigger.

Measurement Gate Width

This command selects the gate width for frequency readings during measurements.

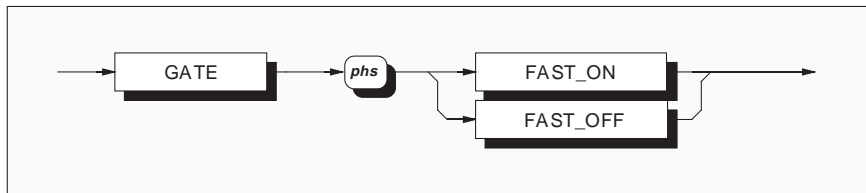
**FAST_ON**

selects a gate width of 50ms, and a frequency resolution of 4.5 digits.

FAST_OFF

selects a gate width of 1s, and a frequency resolution of 6.5 digits.

Both selections are mutually exclusive.

The use of the longer gate width results in a 6.5 digit frequency measurement. The frequency gate is triggered at the same point as the A-D conversion which could be significantly shorter than 1 second. This may reduce the read-rate, as the measurement processing cannot begin until both the frequency gate and the A-D conversion are complete.

Power On and Reset Conditions

The short gate: FAST_ON is selected.

Maximum, Minimum and Peak-Peak

Recall Stored Values

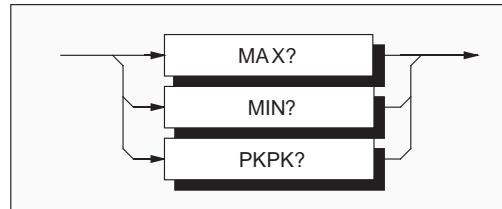

MAX?

recalls the stored value of the maximum signal value to be measured since the most-recent general reset, store reset or function change.

PKPK?

obtains the stored value representing the difference between the maximum and minimum signal values to be measured since the most-recent general reset, store reset or function change.

MIN?

recalls the stored value representing the minimum signal value to be measured since the most-recent general reset, store reset or function change.

Response Format:

Character position

1	2	3	4	5	6	7	8	9	10	11	12	13	14	15	16
s	n	x	x	x	n	n	n	n	n	n	E	sg	p	p	nl

Where:

s	=	+ or - or space
n	=	0 to 9
x	=	either n or decimal point (.)
E	=	ASCII character identifying the exponent
sg	=	+ or -
p	=	0 to 9 (exponent is in engineering units)
nl	=	newline with EOI

Continued next page

Response Decodes**Max or Min:**

The returned value represents the signal with two exceptions:

- When an overload has occurred, and thus the maximum is not measurable, the response is $+200.000000E+33$.
- When no measurement has been made since a reset, the response is $-20.000000E+36$.

PKPk:

The returned value represents the difference between the max and min signals with two exceptions:

- When an overload occurs in one or both stores, the computation is still performed and thus the response indicates a numeric difference which has an obviously overlarge exponent.
- When no measurement has been made since a reset, the response is $-40.0000000E+36$.

Reversion from Remote to Local

No Change.

Function Change, Power On and Reset:

These automatically clear Max, Min, and thus PKPk values.

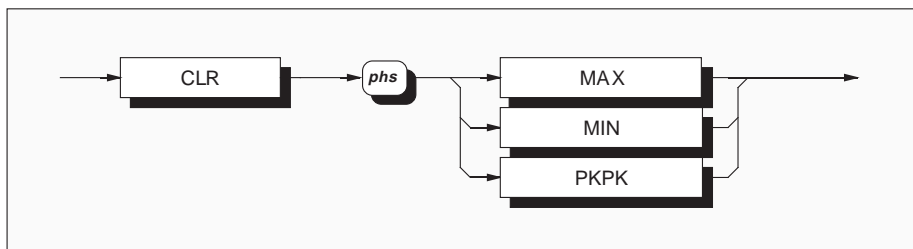
Reset Max and Min Stores

CLR MAX resets the MAX store only.
 CLR MIN resets the MIN store only.
 CLR PKPK resets both the MAX and MIN stores.

Reversion from Remote to Local

No Change.

Function Change, Power On and Reset:

These automatically clear Max, Min, and thus PKPk values.

Limits

Setting Hi and Lo Limits

Each command sets its corresponding limit, for comparison with each measurement when enabled.

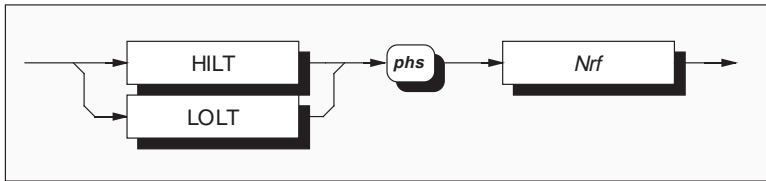

Nrf is a Decimal Numeric Data element which represents the mathematical value to be used for limit-checking. Its resolution is 8.5 significant digits; numbers in excess of this resolution will be rounded to it.

Execution Errors:

None

Reversion from Remote to Local

No Change

Examples:

HILT 2.356 sets the Hi Limit store to +2.356.

LOLT -0.9E-3 sets the Lo Limit store to -0.0009.

Power On and Reset Conditions

No Change

NB. Limits are saved at Power Off.

Recall Limits

Each of these queries recalls its corresponding current limit check value.

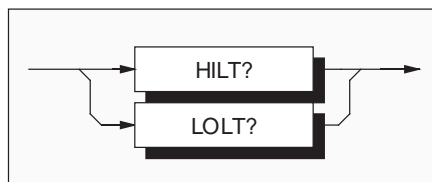

HILT? recalls the set Hi Limit value.

LOLT? recalls the set Low limit value.

Continued next page

Response Format:

Character position
 1 2 3 4 5 6 7 8 9 10 11 12 13 14 15 16
 s n x x x n n n n n n E sg p p nl

Where:

s = + or - or space
 n = 0 to 9
 x = either n or decimal point (.)
 E = ASCII character identifying the exponent
 sg = + or -
 p = 0 to 9 (exponent is in engineering units)
 nl = newline with EOI

Execution Errors:

None

Reversion from Remote to Local

No Change

Power On and Reset Conditions

Values are saved at Power Off.

Response Decode:

The value returned has identical limit to the SET option for this parameter.

Enable Limits

These commands enable and disable the checking of measurements against preset limits.

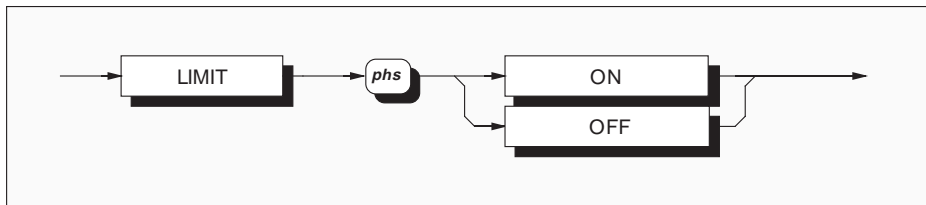

LIMIT ON enables limit testing.

LIMIT OFF disables limit testing.

The limits are not destroyed.

Execution Errors:

None

Reversion from Remote to Local

No Change

The selections are mutually exclusive.

Power On and Reset Conditions

The default condition is LIMIT_OFF.

NB. Limit calculations are performed after all math operations are complete. Thus the choice of limit values should be relevant to the result of the math operation on the measured signal.

Mathematical Operations

Averaging

Two forms of averaging are available:

Rolling Average: processes successive readings to provide a measurement which is the arithmetic mean of the most-recent 'R' (4, 8, 16, 32 or 64) readings. When the window has filled with the selected number of readings, the earliest reading is discarded as each new reading is added. The mean is updated with every new reading.

Block Average: continuously calculates the arithmetic mean of successive readings until a block of 'N' readings is complete, then presents the mean of the whole block. A new block of N readings is started, but the old block's mean remains on the display until the new block is completed, when the new mean is presented.

NB. Combinations of math operations are allowed, but a sequence of application is imposed, so that they must be performed in the following order:

Averaging (AVG); Multiplication (MUL_M); Subtraction (SUB_C);
Division (DIV_Z); Decibels (DB).

Enable Averaging

All selections are mutually exclusive.

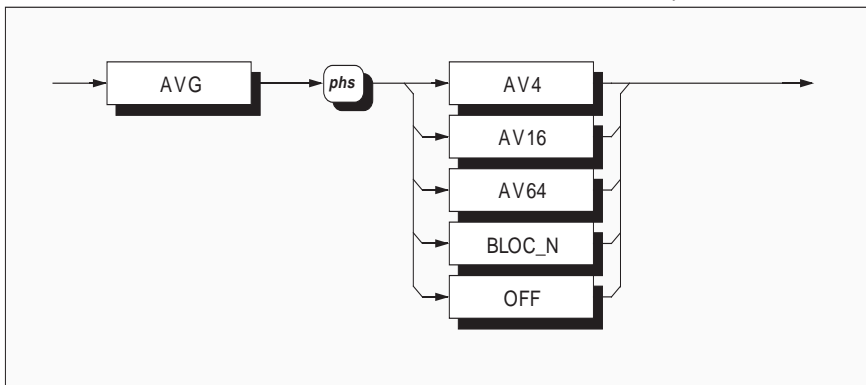

Rolling Average

AVG AV... averages the number of readings requested (4, 16, or 64).

Note:

From a cleared average store the average is the mean of the number of readings to date, until the selection window number is reached. The average stores are cleared on each command update.

Block Average

AVG BLOC_N selects N readings.

Note:

The parameter BLOC_N selects the average of N readings, where only one result is obtained after the required number of triggers has been obtained.

Averaging Off

AVG OFF deselects averaging; the number N is not destroyed.

Continued next page

Execution Errors:

None.

Power On and Reset Conditions

The default condition is AVG_OFF.

Reversion from Remote to Local

No Change.

Set Block Size

Sets the integer constant N for use with the averaging maths capability.

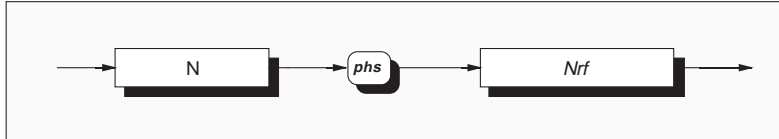

Nrf is a decimal numeric value which represents an integer value to be used in counting the number of readings to be averaged in each block, and is hence regarded as the block size. The 'interval counter' is used to provide the correct number of reading triggers.

Execution Errors:

Execution errors will be generated when $N > 10,000$.

Reversion from Remote to Local

No Change.

Example:

N 15 sets the value of N to 15. Thus each block to be averaged will consist of 15 readings.

Power On and Reset Conditions

No Change. The number N is saved at Power Off.

Recall Block Size

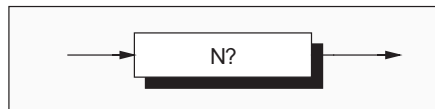

N? recalls the active value of N, which always has identical limits to that used to set block size.

Response Format:

Character position
 1 2 3 4 5 6
 n n n n n nl

Execution Errors:

None

Power On and Reset Conditions

No Change. The number N is saved at Power Off.

Where:

n = 0 to 9
 nl = newline with EOI

Multiplication

Each signal value is multiplied by a user-defined factor 'M'.

Enable Multiplication

Selects the multiplication operation to be performed on the measurement. The corrected A-D result is multiplied by the stored constant M.

NB. Combinations of math operations are allowed, but a sequence of application is imposed, so that they must be performed in the following order:

Averaging (AVG); Multiplication (MUL_M); Subtraction (SUB_C);
Division (DIV_Z); Decibels (DB).

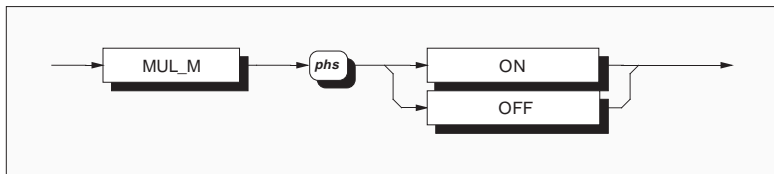

MUL_M ON

multiplies each reading value by the factor M. The display and bus output are modified according to the result of the computation.

MUL_M OFF

deselects the calculation. The constant M is not destroyed.

Execution Errors:

None.

Reversion from Remote to Local

No Change.

Power On and Reset Conditions

The default condition is MUL_M Off.

Set Multiplication Constant

The user defines the value of the factor M, to be used as the multiplication factor.

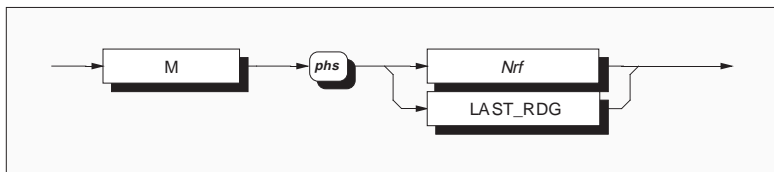

Continued next page

Nrf is a decimal numeric value which represents the mathematical constant required for use in the MUL_M processing. The decimal data resolution is 8.5 digits; numbers exceeding this resolution will be rounded to 8.5 digits.

Example:

M 1.23 sets the M store to +1.23.

M -3E+2 sets M at -300.

LAST_RDG is used to place the most recent reading into the numeric store.

The mathematical processing capability is limited in the range of numbers which it can successfully

handle. The maximum resolution of the mantissa is 8.5 digits, and the exponent is limited to ± 15 . Calculations which result in values outside this range will produce an error indicated by the invalid response when accessed by a query command.

Execution Errors:

None.

Reversion from Remote to Local

No Change.

Power On and Reset Conditions

No change, as the value of M is saved at Power Off.

Recall Multiplication Constant

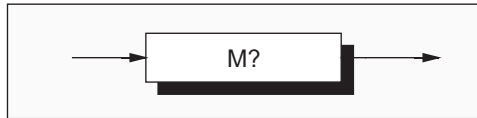

M? recalls the defined value of m.

Response Format:

Character position

1	2	3	4	5	6	7	8	9	10	11	12	13	14	15	16
s	n	x	x	x	n	n	n	n	n	n	E	sg	p	p	nl

Where:

s = + or - or space

n = 0 to 9

x = either n or decimal point (.)

E = ASCII character identifying the exponent

sg = + or -

p = 0 to 9 (exponent is in engineering units)

nl = newline with EOI

Response Decode:

The value returned has identical limits to the SET option for this parameter.

Execution Errors:

None.

Power On and Reset Conditions

No change. The value is saved at Power Off.

Subtraction

A user-defined constant 'C' is subtracted from each signal value.

Enable Subtraction

Selects the subtraction operation to be performed on the measurement. The stored constant C is subtracted from the corrected A-D result.

NB. Combinations of math operations are allowed, but a sequence of application is imposed, so that they must be performed in the following order:

Averaging (AVG); Multiplication (MUL_M); Subtraction (SUB_C);
Division (DIV_Z); Decibels (DB).

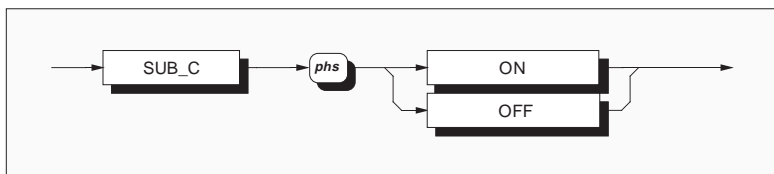

SUB_C ON

subtracts the factor c from each reading value.
The display and bus output are modified according to the result of the computation.

SUB_C OFF

deselects the calculation.
The constant C is not destroyed.

Execution Errors:

None.

Reversion from Remote to Local

No Change.

Power On and Reset Conditions

The default condition is SUB_C Off.

Set Subtraction Constant

The user defines the value of the constant C.

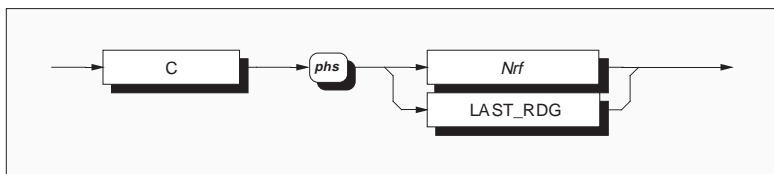

Continued next page

Nrf is a decimal numeric value which represents the mathematical constant required for use in the SUB_C processing. The decimal data resolution is 8.5 digits; numbers exceeding this resolution will be rounded to 8.5 digits.

Example:

C 10E2 sets the c store to 1000.

LAST_RDG is used to place the most recent reading into the numeric store.

The mathematical processing capability is limited in the range of numbers which it can successfully

handle. The maximum resolution of the mantissa is 8.5 digits, and the exponent is limited to ± 15 . Calculations which result in values outside this range will produce an error indicated by the invalid response when accessed by a query command.

Execution Errors:

None.

Reversion from Remote to Local

No Change.

Power On and Reset Conditions

No change. The value of C is saved at Power Off.

Recall Subtraction Constant

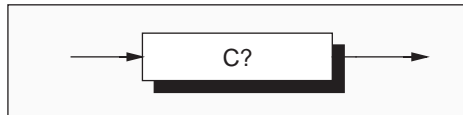

C? recalls the defined value of c.

Response Format:

Character position

1	2	3	4	5	6	7	8	9	10	11	12	13	14	15	16
s	n	x	x	x	n	n	n	n	n	n	E	sg	p	p	nl

Where:

s = + or - or space
 n = 0 to 9
 x = either n or decimal point (.)
 E = ASCII character identifying the exponent
 sg = + or -
 p = 0 to 9 (exponent is in engineering units)
 nl = newline with EOI

Response Decode:

The value returned has identical limits to the SET option for this parameter.

Execution Errors:

None.

Power On and Reset Conditions

The value is saved at Power Off, so there is no change.

Division

Each signal value is divided by a user-defined factor 'z'.

Enable Division

Selects the division operation to be performed on the measurement. The corrected A-D result is divided by the stored constant Z.

NB. Combinations of math operations are allowed, but a sequence of application is imposed, so that they must be performed in the following order:

Averaging (AVG); Multiplication (MUL_M); Subtraction (SUB_C);
Division (DIV_Z); Decibels (DB).

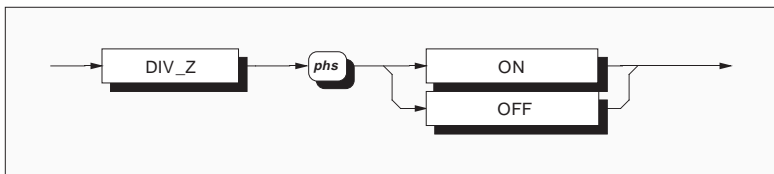

DIV_Z ON

divides the reading by the factor z.
The display and bus output are modified according to the result of the computation.

DIV_Z OFF

deselects the calculation.
The constant Z is not destroyed.

Execution Errors:

None.

Reversion from Remote to Local

No Change.

Power On and Reset Conditions

The default condition is DIV_Z Off.

Set Division Constant

The user defines the factor Z, to be used as the divisor.

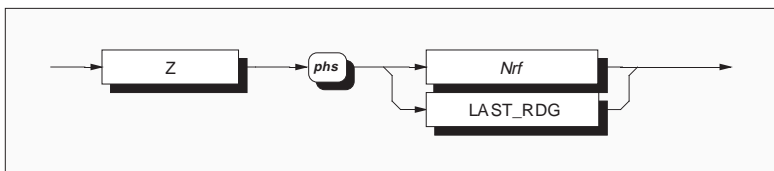

Continued next page

Nrf is a decimal numeric value which represents the mathematical constant required for use in the DIV_Z processing. The decimal data resolution is 8.5 digits; numbers exceeding this resolution will be rounded to 8.5 digits. Divide by zero will set bit 5 (MOF) of the Measurement Event Status Byte.

Example:
Z -56.999 sets the Z store to -56.999.

range will produce an error indicated by the invalid response when accessed by a query command.

LAST_RDG is used to place the most recent reading into the numeric store.

Execution Errors:
None.

The mathematical processing capability is limited in the range of numbers which it can successfully handle. The maximum resolution of the mantissa is 8.5 digits, and the exponent is limited to ± 15 . Calculations which result in values outside this

Reversion from Remote to Local
No Change.

Power On and Reset Conditions
No change. The value of Z is saved at Power Off.

Recall Division Constant

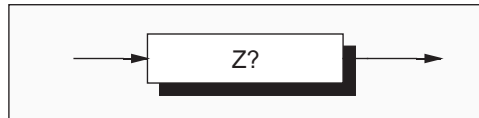

Z? recalls the defined value of z.

Response Format:

Character position															
1	2	3	4	5	6	7	8	9	10	11	12	13	14	15	16
s	n	x	x	x	n	n	n	n	n	n	E	sg	p	p	nl

Where:

- s = + or - or space
- n = 0 to 9
- x = either n or decimal point (.)
- E = ASCII character identifying the exponent
- sg = + or -
- p = 0 to 9 (exponent is in engineering units)
- nl = newline with EOI

Response Decode:

The value returned has identical limits to the SET option for this parameter.

Execution Errors:
None.

Power On and Reset Conditions
The value is saved at Power Off, so there is no change.

Decibel Calculations

These operations calculate, and express in decibels, the ratio of the reading to one of four standard references: unity, and 1mW in either 50Ω, 75Ω or 600Ω. As the dB calculation is set as the final part of any calculation, it is also possible to use the other Math operations to alter the effective reference value.

Enable dB Calculation

Selects the decibel operation to be performed on the measurement. This operation computes the dB ratio of a corrected A-D result and a stored reference value R.

NB. Combinations of math operations are allowed, but a sequence of application is imposed, so that they must be performed in the following order:

Averaging (AVG); Multiplication (MUL_M); Subtraction (SUB_C);
Division (DIV_Z); Decibels (DB).

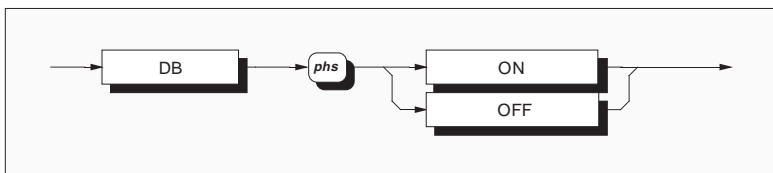

DB ON

calculates $20\log[(\text{Reading})/\text{dB Ref}]$.

The display and bus output are modified according to the result of the computation.

DB OFF

deselects the calculation.

The reference R is not destroyed.

Execution Errors:

None.

Reversion from Remote to Local

No Change.

Power On and Reset Conditions

The default condition is DB OFF.

Set dB Reference Value

The user defines the value of the reference R, to be used in dB calculation.

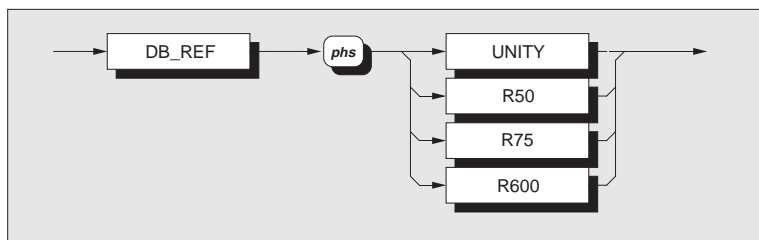

*Continued
next page*

DB_REF UNITY selects a dB reference of unity, in whole units of the active function.

Execution Errors:
None.

Each of the following commands selects the dB reference voltage (as shown in parenthesis), which corresponds to 1mW in the given impedance.

DB_REF R50 50Ω (i.e 0.223606800V).

DB_REF R75 75Ω (i.e 0.273861280V).

DB_REF R600 600Ω (i.e 0.774596670V).

Reversion from Remote to Local
No Change.

Power On and Reset Conditions
The default condition is DB_REF UNITY.

All selections are mutually exclusive.

Recall dB Reference Value



DB_REF? recalls the current value of the DB_REF voltage.

Response Format:

Character position

1	2	3	4	5	6	7	8	9	10	11	12	13	14	15	16
s	n	x	x	x	n	n	n	n	n	n	E	sg	p	p	nl

Where:

s = + or - or space
 n = 0 to 9
 x = either n or decimal point (.)
 E = ASCII character identifying the exponent
 sg = + or -
 p = 0 to 9 (exponent is in engineering units)
 nl = newline with EOI

Response Decode:

The value returned is the voltage value assigned to the program data elements:

The element UNITY: +1.00000000E+00.

The element R50: +223.606800E-03.

The element R75: +273.861280E-03.

The element R600: +774.596670E-03.

Execution Errors:

None.

Power On and Reset Conditions

The default condition is DB_REF UNITY.

Test Operations

Full Selftest

This command conforms to the IEEE 488.2 standard requirements.

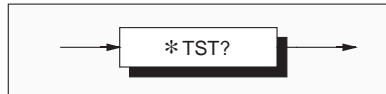

*TST?

executes a full selftest. It is equivalent to a full selfcal, but without applying the calibration corrections. A response is generated after the test is completed.

N.B.

Full Selftest cannot be selected unless a successful 'Internal Source Calibration' has been carried out since the most-recent External Calibration.

The success of Full Selftest can be inhibited by:

- temperature not in the range: 13°C to 33°C;
- more than 1 year since Internal Source Calibration executed;
- temperature more than 10°C different from Internal Source Calibration; or
- presence of excessive RFI or Line noise.

Response Format:

Character position

1 2

n nl

Where:

n = 0 or 1

nl = newline with EOI

Response Decode:

The value returned identifies pass or failure of self test:

ZERO indicates test complete with no errors detected.

ONE indicates test complete with errors detected. The errors can be found in the device dependent error queue.

Execution Errors:

Selftest is not permitted when calibration is successfully enabled.

Reversion from Remote to Local

Not applicable.

Power On and Reset Conditions

Not applicable.

Confidence Test

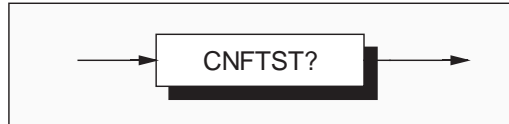

CNFTST?

initiates a rapid confidence check. It is equivalent to a full selftest, but with reduced resolution (and consequently reduced accuracy) to increase the checking speed. A response is generated after the test is completed (approx 1 minute).

Response Format:

Character position

1 2

n nl

Where:

n = 0 or 1

nl = newline with EOI

Response Decode:

The value returned identifies pass or failure of the confidence test:

ZERO indicates test complete with no errors detected.

ONE indicates test complete with errors detected. The errors can be found in the device dependent error queue.

Execution Errors:

Confidence test is not permitted when calibration is successfully enabled.

Reversion from Remote to Local

Not applicable.

Power On and Reset Conditions

Not applicable.

Recall Device Errors

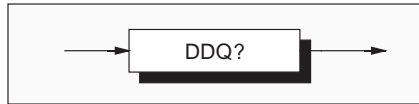

DDQ?

recalls the last error from the queue of device dependent errors (e.g errors recorded during a failed selftest or confidence test). The queue is organized as a last-in - first-out stack, its individual entries being destructively read. If there are no entries in the queue, then use of this command generates a result of Ø.

Read the Queue until Empty

It is good practice to read the queue until empty on each occurrence of device-dependent error, to prevent unrelated history of errors being retained.

Response Format:

Character position

1 2 3 4 5

n n n n nl

Where:

n = 0 to 9

nl = newline with EOI

Response Decode:

The value returned is a specified integer value indicating the fault. Refer to the opposite page, and for the meanings of specific codes to Appendix A of Section 4.

Execution Errors:

None.

Reversion from Remote to Local

Not applicable.

Power On and Reset Conditions

Not applicable.

Error Detection

All errors which cannot be recovered transparently result in some system action to inform the user via a message, and where possible restore the system to an operational condition. Errors are classified by the method with which they are handled.

Recoverable errors report the error and continue.

System errors which cannot be recovered cause the system to halt with a message displayed.

Restarting the system from power on may clear the error, but generally such messages are caused by hardware or software faults.

Device-Dependent Errors (DDE)

A Device-Dependent Error is generated if the device detects an internal operating fault (eg. during self-test). The DDE bit (3) is set *true* in the Standard-defined Event Status Byte, and the error code number is appended to the Device-Dependent Error queue.

In Remote, the error is reported by the mechanisms described in the sub-section which deals with status reporting, and the queue entries can be read destructively as LIFO by the query command DDQ?. The Remote user can ignore the queue, but it is good practice to read the errors as they occur.

In Local, the DDE status is checked at the end of the operation (eg. Cal, Zero, Test). If *true*, an error has occurred, and the content of the last entry in the queue is displayed on the front panel. The Local user cannot continue until the queue has been read.

If both bus and front panel users attempt to read the queue concurrently, the error data is read out destructively on a first-come, first-served basis.

Thus one of the users cannot read the data on one interface as it has already been destroyed by reading on the other. This difficulty should be solved by suitable application programming to avoid the possibility of a double readout. Ideally the IEEE 488 interface should set the instrument into REMS or RWLS to prevent confusion.

The code numbers for device dependent errors, with their associated descriptions, are given in Appendix A to Section 4.

Triggers and Readings Operations

Trigger Control

Trigger Source Selector

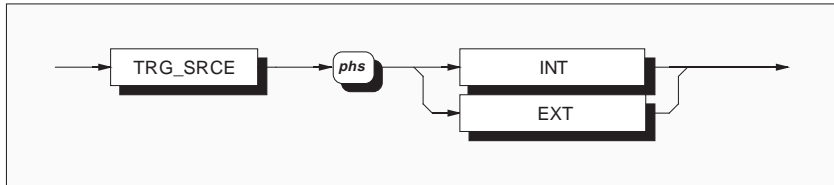

TRG_SRCE INT

selects the internal interval counter as the source, and disables external trigger sources.

TRG_SRCE EXT

disables internal triggers and enables three external trigger sources. These are:

- Rear panel trigger socket,
- Controller-generated GET/*TRG commands.
- Front panel **Sample** key. This will have been disabled when the instrument was transferred from Local to Remote Control

Both selections are mutually exclusive.

Important:

The use of internal triggers or uncontrolled rear panel triggers can produce unexpected results, due to the time required for the A-D conversion, and the A-D triggers being unsynchronized with the IEEE 488 bus operations. Such triggers should be avoided unless they form an essential ingredient of the required measurement.

Execution Errors:

None.

Reversion from Remote to Local

No Change.

Power On and Reset Conditions

The default condition is TRG_SRCE INT.

Execute Trigger

This command conforms to the IEEE 488.2 standard requirements.

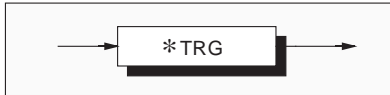

*TRG

is equivalent to a Group Execute Trigger (GET), and will cause a single reading to be taken.

Execution Errors:

None

Reversion from Remote to Local

Not applicable.

Power On and Reset Conditions

Not applicable.

Execute Trigger and Take a Reading

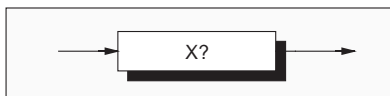

X?

is equivalent to performing an Execute Trigger followed by a reading query (Refer to page 5-72).

$X? \equiv *TRG;RDG?$

X? is intended for high speed use.

Settling Delay

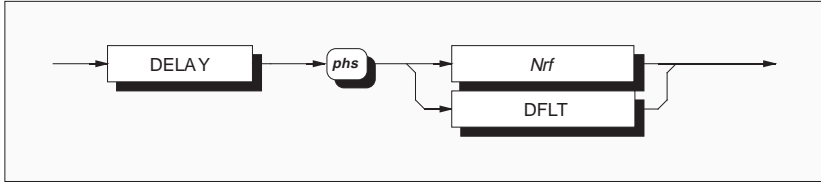

Nrf is a decimal numeric value which represents the required settle delay. The minimum period allowed is 0, and the maximum is 65,000 seconds.

Examples:

DELAY 0.001 sets a settle delay after trigger of 1ms before the reading begins

DELAY DFLT sets the default delay for the selected function, range, filter etc.

The programmed delay is active with TRG_SRCE EXT selected, although delays may be programmed whilst unit is in Remote with default (internal) triggers selected. They will then become active upon the selection of the external trigger.

Tables of default delays, as shown on the opposite page, are stored in the instrument. These tables can be supplanted for the active function and range by setting a delay using a specific timed DELAY command, but they are restored by the DELAY DFLT command.

The resolution of the intervals between delay time settings is dependent on the size of the memory used to store the delay time data. For the range of delays permitted, the resolutions of bands of times is as follows:

Delay Selection	Resolution
≤0.01s	10μs
0.01s to 0.1s	100μs
0.1s to 1s	1ms
1s to 10s	10ms
>10s	100ms

Numbers exceeding the defined resolution will be rounded to that resolution.

Execution Errors:

Execution errors are generated if an attempt is made to program the delays when the instrument is not in remote control.

An execution error is generated if the selected value of Nrf exceeds the limiting value.

Reversion from Remote to Local, also Power On and Reset Conditions

The default condition DELAY DFLT is imposed (relative to function, range and resolution).

1281 Delay Default Tables

- The delays listed in the following tables are active unless a specific delay is programmed.
- Once programmed, a specific delay will be applied to all subsequent readings providing External Trigger mode is selected until either the DELAY DFLT command is received, or the instrument is returned to local control. Delays then return to their default values.

DCV, DCI, ACV & ACI

Funct	Filt.	Active Resolution				
		4	5	6	7	8
DCV	Out	.06s	.08s	.1s	1s	5s
	In	.6s	.8s	1s	5s	10s
DCI	Out	.06s	.08s	.1s	-	-
	In	.6s	.8s	1s	-	-
ACV	100Hz	.15s	.25s	.3s	-	-
	40Hz	.4s	.6s	.75s	-	-
	10Hz	1.5s	2s	2.5s	-	-
	1Hz	15s	20s	25s	-	-
ACI	100Hz	.15s	.25s	-	-	-
	40Hz	.4s	.6s	-	-	-
	10Hz	1.5s	2s	-	-	-
	1Hz	15s	20s	-	-	-

Ohms, TruΩ & HiΩ

Range	Filt.	Active Resolution				
		4	5	6	7	8
10Ω - 100kΩ	Out	.06s	.08s	.1s	1s	5s
	In	.6s	.8s	1s	5s	10s
1MΩ	Out	.3s	.4s	.5s	3s	10s
	In	2s	2.5s	3s	5s	10s
10MΩ	Out	2s	2.5s	3s	5s	10s
	In	6s	8s	10s	30s	30s
100MΩ	Out	6s	8s	10s	-	-
	In	20s	25s	30s	-	-
1GΩ	Out	10s	10s	10s	-	-
	In	30s	30s	30s	-	-

N. B. A-D Modes are used as follows:

	Fast on	Fast off
resIn4+	C	D
resIn5+	C	D
resIn6+	D	F
resIn7+	G	4 x G
resIn8+	4 x G	16 x G

A-D Mode	Power Line Cycles
C	3.3ms
D	1
F	16
G	64

Input Zero

Determines and stores any measured offset at the signal source.



ZERO?

causes an Input Zero operation to be executed if DCV, ACV, DCI or Ohms function is selected, and the instrument is not in a calibration mode.

An Input Zero is stored only for the input channel selected. Each of the three input channels has its own set of Input Zero stores, for all of the applicable range/function combinations.

If autorange is selected then all ranges are zeroed, starting at the highest range.

A response is generated after the process is completed or if an error is detected.

Response Format:

Character position

1 2

n nl

Where:

n = 0 or 1

nl = newline with EOI

Response Decode:

The value returned identifies pass or failure of input zero:

ZERO indicates Input Zero completed with no errors detected.

ONE indicates error detected. The error can be found in the device dependent error queue.

If autorange is selected, further zeroing ceases as soon as an error is detected.

Execution Errors:

An execution error is generated if ACI function is selected, or if calibration is successfully enabled.

Reversion from Remote to Local

No Change.

Power On and Reset Conditions

No Change.

Wait

This command conforms to the IEEE 488.2 standard requirements.

***WAI**

prevents the instrument from executing any further commands or queries until the *No Pending Operations Flag* is set true. This is a mandatory command for IEEE-488.2 but has no relevance to this instrument as there are no parallel processes requiring Pending Operation Flags.

Execution Errors:

None.

Power On and Reset Conditions

Not applicable.

Reading Recall

Voltage, Current and Resistance Readings



RDG? recalls the most recently triggered reading taken by the instrument.

Response Format:

Character position - 8.5 digit response

1	2	3	4	5	6	7	8	9	10	11	12	13	14	15	16
s	n	x	x	x	n	n	n	n	n	n	E	sg	p	p	nl

Character position - 4.5 digit response

1	2	3	4	5	6	7	8	9	10	11	12
s	n	x	x	x	n	n	E	sg	p	p	nl

NB. Other resolutions give responses of corresponding lengths

Where:

s = + or - or space

n = 0 to 9

x = either n or decimal point (.)

E = ASCII character identifying the exponent

sg = + or -

p = 0 to 9 (exponent is in engineering units)

nl = newline with EOI

The value represents the applied signal together with any mathematical modifications selected with the Math facility. Overload is represented by a value of $\pm 200.0000E+33$ along with a set flag bit in the measurement qualifying byte of the status data.

Response Decode:

If no signal has been received to generate a conversion of the input signal, then the response to this command will represent the most-recent measurement. If no triggers are available, the invalid response is given. If a trigger has already been received, this query will wait for the completion of the measurement and place its result in the output queue.

Execution Errors:

None

Power On and Reset Conditions

All previous results are cleared at Power On and Reset, thus an overload response is given until after the first trigger.

Frequency Readings



FREQ? recalls the frequency associated with the most-recently triggered measurement.

Response Format:

Character position - 6.5 digit response

1	2	3	4	5	6	7	8	9	10	11	12	13	14
s	n	x	x	x	n	n	n	n	E	sg	p	p	nl

Character position - 4.5 digit response

1	2	3	4	5	6	7	8	9	10	11	12
s	n	x	x	x	n	n	E	sg	p	p	nl

Where:

- s = + or - or space
- n = 0 to 9
- x = either n or decimal point (.)
- E = ASCII character identifying the exponent
- sg = + or -
- p = 0 to 9 (exponent is in engineering units)
- nl = newline with EOI

A value of 200.0000E+33, $\pm 10\%$ is returned if the measurement circuits cannot produce a result.

If no signal has been received to generate a conversion of the input signal, then the response to this command will be the frequency of the most-recent measurement. If no triggers are available, the invalid response is given. If a trigger has already been received, this query will wait for the completion of the measurement and place its result in the output queue.

Execution Errors:

None

Power On and Reset Conditions

All previous results are cleared at Power On and Reset, thus an invalid response is given until after the first trigger.

Internal Operations Commands

All of the commands under this heading are common commands defined in the IEEE-488.2 standard.

Reset

This command conforms to the IEEE 488.2 standard requirements.



*RST

will reset the instrument to a defined condition, detailed in Appendix B to this section.

Execution Errors:

None.

Power On and Reset Conditions

The reset condition is independent of past-use history of the instrument except as noted below: Not applicable.

*RST does not affect the following:

- the selected address of the instrument;
- calibration data that affect specifications;
- SRQ mask conditions;
- contents of the Status Byte Register and Event Status Register;
- the state of the IEEE 488 interface;
- stored math constants.

The action of the front panel **Reset** key is **not** equivalent to *RST, but is a subset of it.

Operation Complete

This command conforms to the IEEE 488.2 standard requirements.

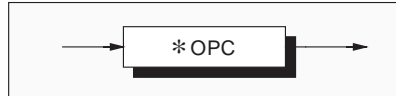
***OPC**

is a synchronization command which will generate an operation complete message in the standard Event Status Register when all pending operations are complete.

Execution Errors:

None.

Power On and Reset Conditions

Not applicable.

Operation Complete?

This command conforms to the IEEE 488.2 standard requirements.

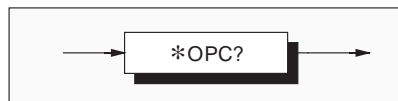
**Response Format:**

Character position

1 2

n nl

Where:

n = 1

nl = newline with EOI

Response Decode:

The value returned is always 1, which is placed in the output queue when all pending operations are complete.

Status Reporting

Most of the commands in this sub-section are standard reporting commands defined in the IEEE-488.2 standard.

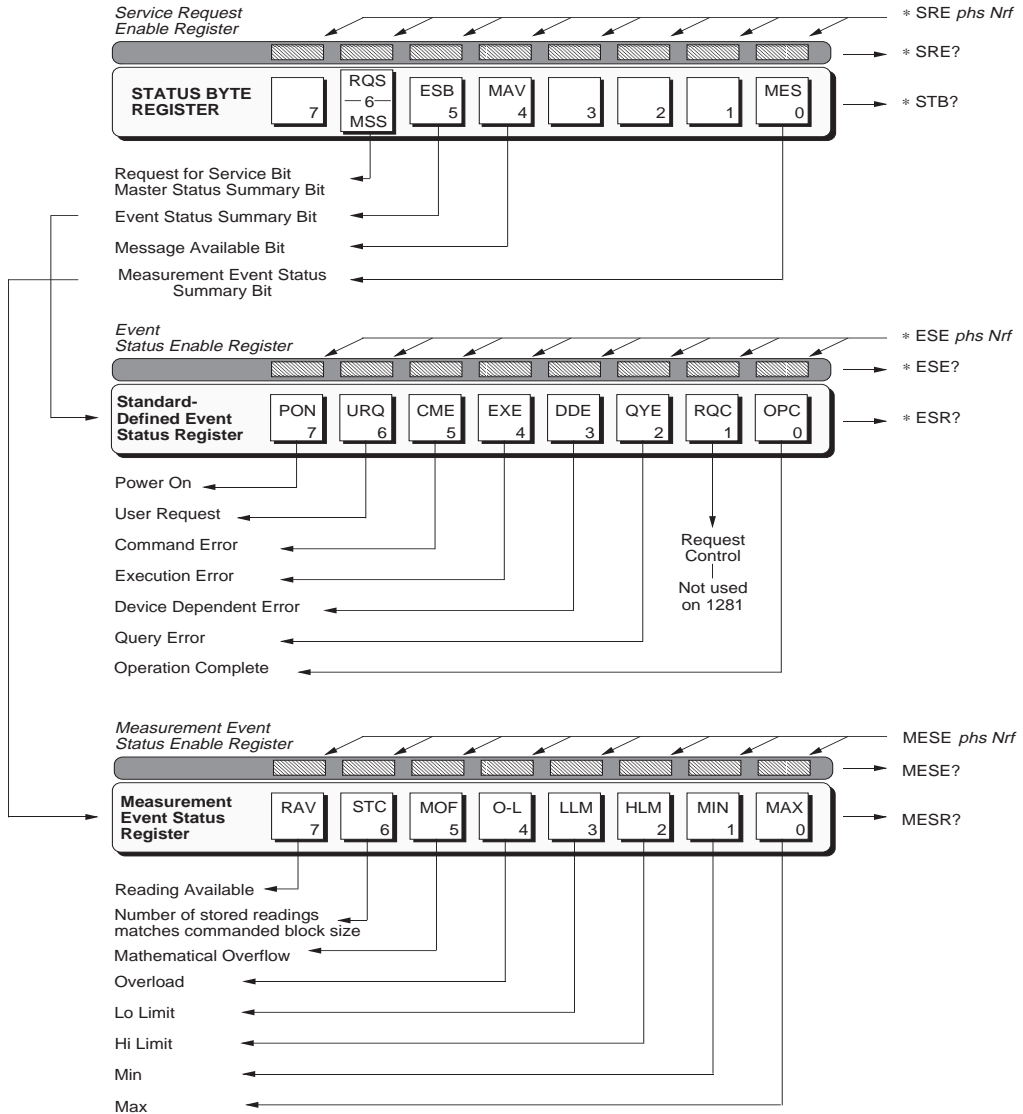

Recall Measurement Event Enable

This measurement event status data structure conforms to the IEEE 488.2 standard requirements for this structure.

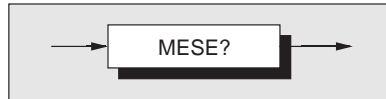
**MESE?**

recalls the measurement status register enable mask.

Response Format:

Character position

1 2 3 4
n n n nl

Where:

n = 0 to 9
nl = newline with EOI

Response Decode:

The value returned, when converted to base 2 (binary), identifies the enabled bits which will generate a summary message in the service request byte, for this data structure. See the device status reporting model for detail.

Execution Errors:

None

Power On and Reset Conditions

Cleared (ie. nothing enabled).

Measurement Event Enable

This measurement event status data structure conforms to the IEEE 488.2 standard requirements for this structure.

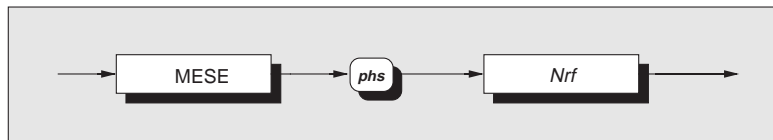
**MESE**

enables the measurement event bits which will generate a summary message in the standard defined service request byte.

Nrf is a Decimal Numeric Data Element representing a value which, when rounded to an integer and expressed in base 2 (binary), enables the appropriate bits in this event enable register. The detail is to be defined. Note that numbers **will** be rounded to an integer.

Execution Errors:

None.

Power On and Reset Conditions

Not applicable.

Read Measurement Event Register

This measurement event status data structure conforms to the IEEE 488.2 standard requirements for this structure.



MESR?

reads the event register for measurement qualifiers destructively. The register is also cleared by the common command *CLS.

Response Format:

Character position

```
1 2 3 4
n n n nl
```

Where:

```
n = 0 to 9
nl = newline with EOI
```

Response Decode:

The value returned, when converted to base 2 (binary), identifies the events that have occurred since the most-recent read or general clear of this register. The detail is contained in the status data structure description.

Execution Errors:

None.

Power On and Reset Conditions

The register is cleared.

Read Event Status Register

This event status data structure conforms to the IEEE 488.2 standard requirements for this structure.

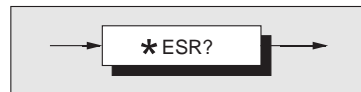

*ESR?

recalls the standard defined events.

Response Format:

Character position

```
1 2 3 4
n n n nl
```

Where:

```
n = 0 to 9
nl = newline with EOI
```

Response Decode:

The value returned, when converted to base 2 (binary), identifies the bits as defined in the IEEE 488.2 standard.

Execution Errors:

None

Power On and Reset Conditions

The Power On condition depends on the condition stored by the common *PSC command - if 0 then it is not cleared; if 1 then the register is cleared. Reset has no effect.

Event Status Enable

This event status data structure conforms to the IEEE 488.2 standard requirements for this structure.

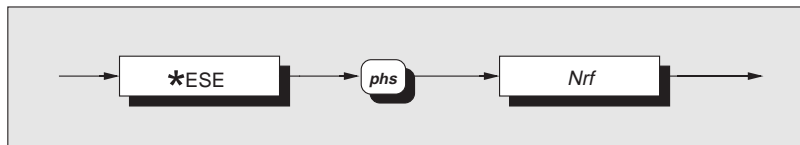

***ESE** enables the standard defined event bits which will generate a summary message in the status byte.

Nrf is a Decimal Numeric Data Element representing an integer decimal value equivalent to the Hex value required to enable the appropriate bits in this 8-bit register. The detail definition is contained in the IEEE 488.2 document, section 11. Note that numbers **will** be rounded to an integer.

Execution Errors:

None.

Power On and Reset Conditions

Not applicable.

Recall Event Status Enable

This event status data structure conforms to the IEEE 488.2 standard requirements for this structure.

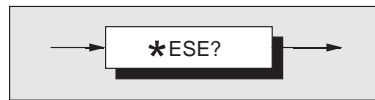
***ESE?**

recalls the enable mask for the standard defined events.

Response Format:

Character position				
	1	2	3	4
	n	n	n	nl

Where:

n = 0 to 9
nl = newline with EOI

Response Decode:

The value returned, when converted to base 2 (binary), identifies the enabled bits which will generate a summary message in the service request byte, for this data structure. The detail definition is contained in the IEEE 488.2 document, section 11.

Execution Errors:

None

Power On and Reset Conditions

The Power On condition depends on the condition stored by the common *PSC command - if 0 then it is not cleared; if 1 then the register is cleared. Reset has no effect.

Service Request Enable

This measurement event status data structure conforms to the IEEE 488.2 standard requirements for this structure.

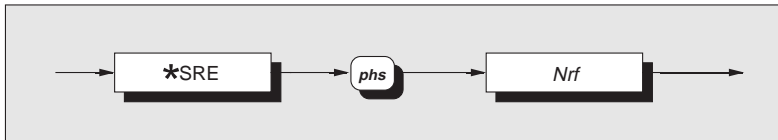

***SRE** enables the standard and user-defined summary bits in the service request byte, which will generate a service request.

Nrf is a Decimal Numeric Data Element representing an integer decimal value equivalent to the Hex value required to enable the appropriate bits in this 8-bit register. The detail definition is contained in the IEEE 488.2 document. Note that numbers **will** be rounded to an integer.

Execution Errors:

None.

Power On and Reset Conditions

Not applicable.

Recall Service Request Enable

This measurement event status data structure conforms to the IEEE 488.2 standard requirements for this structure.

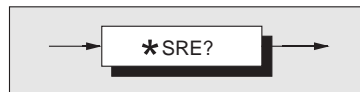

*SRE?

recalls the enable mask for the standard defined events.

Response Format:

Character position

1	2	3	4
n	n	n	nl

Response Decode:

The value returned, when converted to base 2 (binary), identifies the enabled bits which will generate a service request. The detail is contained in the IEEE 488.2 document, section 11.

Execution Errors:

None.

Where:

n = 0 to 9
nl = newline with EOI

Power On and Reset Conditions

None.

Read Service Request Register

This measurement event status data structure conforms to the IEEE 488.2 standard requirements for this structure.

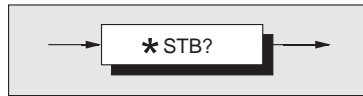
***STB?**

recalls the service request register for summary bits.

Response Format:

Character position				
	1	2	3	4
	n	n	n	nl

Where:

n = 0 to 9
nl = newline with EOI

Response Decode:

The value returned, when converted to base 2 (binary), identifies the summary bits for the current status of the data structures involved. For the detail definition see Section 11 of the IEEE 488.2 standard document (11.2.2.2). There is no method of clearing this byte directly. Its condition relies on the clearing of the overlying status data structure.

Execution Errors:

None.

Power On and Reset Conditions

Not applicable.

Clear Status

This measurement event status data structure conforms to the IEEE 488.2 standard requirements for this structure.

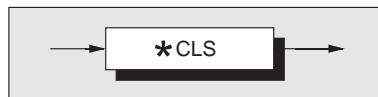
***CLS**

clears all the event registers and queues except the output queue. The output queue and MAV bit will be cleared if *CLS immediately follows a 'Program Message Terminator'; see the IEEE 488.2 standard document, Sect. 10.3.

Execution Errors:

None.

Power On and Reset Conditions

Not applicable.

Power On Status Clear

This common command conforms to the IEEE 488.2 standard requirements.

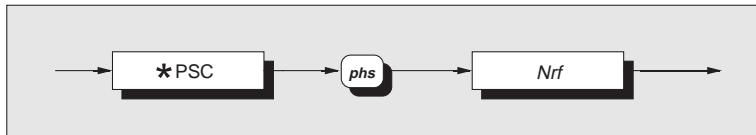

*PSC

sets the flag controlling the clearing of defined registers at Power On.

Nrf is a decimal numeric value which, when rounded to an integer value of zero, sets the *power on clear flag false*. This allows the instrument to assert SRQ at power on.

When the value rounds to an integer value other than zero it sets the *power on clear flag true*, which clears the standard *event status enable* and *service request enable* registers so that the instrument will not assert an SRQ on power up.

Examples:

*PSC 0 or *PSC 0.173 sets the instrument to **assert** an SRQ at Power On, providing the appropriate bits have been enabled in the Service Request Enable Register (bit 5) and the Event Status Enable Register (bit 7).

*PSC 1 or *PSC 0.773 sets the instrument to **not assert** an SRQ on Power On, and allows the three status reporting Enabling registers to be reset.

Execution Errors:

None.

Power On and Reset Conditions

Not applicable.

Recall Status Clear Flag

This common command conforms to the IEEE 488.2 standard requirements.

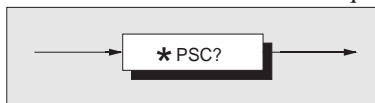

*PSC?

will recall the Power On status condition.

Response Format:

Character position

1 2

n nl

Where:

n = 0 or 1

nl = newline with EOI

Response Decode:

The value returned identifies the state of the saved flag:

Zero indicates **false**.

One indicates **true**.

Execution Errors:

None

Power On and Reset Conditions

No Change. This data is saved at Power Off for use at Power On.

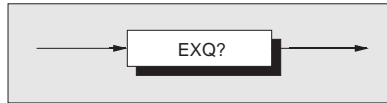
Recall Execution Errors**EXQ?**

recalls the last error from the queue of execution errors. An execution error occurs when a command cannot be complied with (e.g. calling up an option which is not fitted).

Read the Queue until Empty

It is good practice to read the queue until empty on each occurrence of execution error, to prevent unrelated history of errors being retained.

Response Format:

Character position

1	2	3	4	5
n	n	n	n	nl

Where:

n = 0 to 9
nl = newline with EOI

Response Decode:

The value returned is a specified integer value indicating the fault. For details of the number/fault relationship refer to Appendix A to Section 4 of this handbook. Execution Errors are reported as required by Section 11 of the IEEE 488.2 standard document (11.5.1.1.5).

The execution error queue operates as a last in - first out stack, and individual entries are read destructively. If there are no entries in the queue, then use of this command produces a result of zero.

Execution Errors:

None

Power On and Reset Conditions

The queue is cleared.

Instrument I/D and Setup

I/D (Identification)

This command conforms to the IEEE 488.2 standard requirements.



*IDN?

will recall the instrument's manufacturer, model number, serial number and firmware level.

Response Format:

Character position

1	2	3	4	5	6	7	8	9	10	11	12	13	14	15	16	17	18	19	
D	A	T	R	O	N			I	N	S	T	R	U	M	E	N	T	S	,
20	21	22	23	24															
1	2	7	1	,															
25	26	27	28	29	30	31	32	33	34	35	36	37							
4	5	6	7	8	9	-	0	1	.	0	9	,							
38	39	40	41	42	43	44	45	46	47	48	49	50							
8	9	0	1	4	4	/	0	0	.	0	0	nl							

Where:

The data contained in the response consists of four comma-separated fields, the last two of which are instrument-dependent.

nl = newline with EOI

The data element type is defined in the IEEE 488.2 standard specification.

Response Decode:

The data contained in the four fields is organized as follows:

- First field - manufacturer
- Second field - model

- Third field - serial number - can be altered via a calibration operation - see page 5-102.
- Fourth field - firmware level (will possibly vary from one instrument to another).

Execution Errors:

None.

Power On and Reset Conditions

Not applicable.

Note: Some controllers may not accept strings of this length unless programmed to do so. Refer to the appropriate programming manuals in case of difficulty.

Options

This command conforms to the IEEE 488.2 standard requirements.

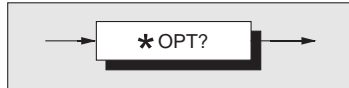
***OPT?**

will recall the instrument's option configuration.

Response Format:

Character position

1	2	3	4	5	6	7	8	9	10	11	12
x1	,	x2	,	x3	,	x4	,	x5	,	x6	,
13	14										
x7	nl										

Where:

The data in the response consists of comma-separated characters, each being either 1 or 0.

nl = newline with EOI

The data element type is defined in the IEEE 488.2 standard specification.

Response Decode:

The character positions represent the following options:

- x1 - AC (Option 10)
- x2 - Current (Option 30)
- x3 - Resistance (Option 20)
- x4 - not yet allocated
- x5 - not yet allocated
- x6 - Analog Output
- x7 - not yet allocated

In each position, 1 indicates that the option is fitted, 0 indicates not fitted.

Execution Errors:

None.

Power On and Reset Conditions

Not applicable.

Calibration Commands and Messages

Important!

The descriptions in the following pages are intended only as a guide to the messages available to calibrate the instrument. They contain neither examples nor calibration routines, and should NOT be used directly as a basis for calibrating any part of the instrument. Some of the commands, if used unwisely, will obliterate an expensive calibration or recalibration.

For remote calibration routines refer to Section 1 of the Calibration and Servicing handbook.

Calibration Sequences

Remote calibration via the IEEE 488 system bus generally follows similar sequences (and is subject to similar constraints) as for local calibration. But because the remote method does not require a human operator to gain access to a sequence of commands via a single menu screen, it is possible to group commands together within bus message units.

For this reason we should not always expect to find a one-to-one correspondence between the local and remote calibration commands.

Enable Calibration

The ENBCAL command allows access to the calibration operations, provided the calibration keyswitch on the instrument rear panel is set to 'ENABLE', and the correct passnumber is entered (see **Nrf** below). It also permits a choice between three types of calibration process.

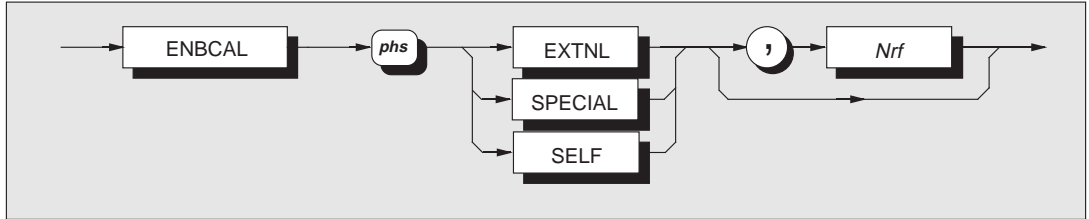

Nrf is a decimal numeric data element reserved for the passnumber, if required.

The user selects the requirement for a passnumber for self calibration by a software flag (see LOCK operation later). The passnumber must be an integer in the range 0 to 999999.

EXTNL

selects the external calibration facility where the user supplies the calibration source signals and the calibration trigger commands.

SPECIAL

allows access to a mode for 'special' calibrations and entry of protected data.

SELF

checks the selfcal interlocks to allow a subsequent selfcal trigger command.

Execution Errors:

EXTNL

An execution error is generated if the rear panel key is not in the ENABLE position, or if the passnumber is incorrect or missing when required.

SPECIAL

An execution error is generated if the rear panel key is not in the ENABLE position.

SELF

An execution error is generated if the LOCK feature requires the rear panel key and it is not in the ENABLE position; or if the LOCK feature requires the passnumber and it is incorrect or missing.

Power On and Reset Conditions

Calibration disabled.

Trigger 'External Calibration'

The CAL? command triggers an external calibration event, including the 'SET' feature used for local calibration.

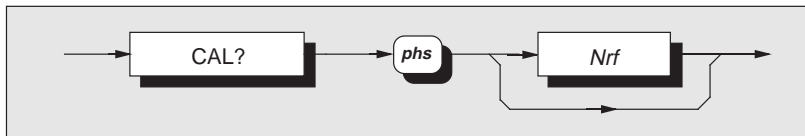

Nrf

is a decimal numeric data element representing the 'SET' calibration value used as the target for the actual measured value. The difference between these two values is used to determine the calibration factors. The *Nrf* value is rounded to 8.5 digits resolution.

If the *Nrf* data element is included then *phs* is required. The number must conform to the limits required for the function being calibrated.

If the program header separator (*phs*) and *Nrf* are omitted, the instrument assumes that the nominal value is the target for the actual measured value.

Response Format:

Character position

1 2
n nl

Where:

n = 0 or 1
nl = newline with EOI

Response Decode:

The value returned identifies the success or failure of the calibration exercise:

Zero indicates **complete** with **no error** detected.
One indicates **error detected**. The error can be found in the device-dependent error queue.

Execution Errors

occur if calibration is not enabled, or if the number used is incompatible with the setting being calibrated.

Power On and Reset Conditions

Not applicable.

Select Spot Frequency

Selects the spot frequency store to be used by the calibration trigger (ACV only).

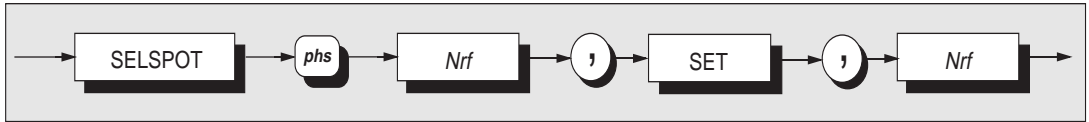

SELSPOT

allows the user to select a spot frequency on the active ACV range by entering the spot number. The user then enters the target value that calibrates the selected spot.

1st *Nrf*

is a decimal numeric data element representing the selected spot frequency store, from 1 to 6.

2nd *Nrf*

is a decimal numeric element that represents the SET value to be applied. This value is preceded by the 'SET' element .

The 2nd *Nrf* value is the value that calibrates the DMM at the selected spot number. The frequency band that will be assigned is allocated by the DMM's frequency detector. The new spot frequency is not applied until calibration is triggered.

Numbers that exceed the required resolution will be rounded.

Execution Errors

occur if calibration is not enabled, or if the first *Nrf* is out of range.

Power On and Reset Conditions

Not applicable.

Trigger 'Standardize Calibration'

The `STD?` command triggers a standardize calibration event, equivalent to the 'STD' feature used for local calibration. Available only in the 1V and 10V DC ranges, it affects all ranges of the instrument. It is intended principally for normalising the instrument to a new standard for example, as may be found when transporting the DMM between different National calibration authorities.

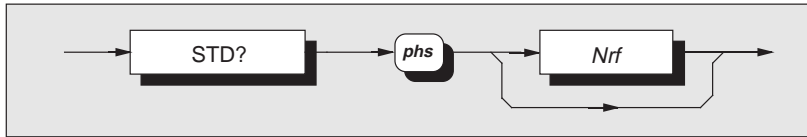

Nrf

is a decimal numeric data element representing the 'STD' calibration value used as the target for the actual measured value. The difference between these two values is used to determine the factors for standardization. The *Nrf* value is rounded to 8.5 digits resolution.

If the *Nrf* data element is included then *phs* is required. The number must conform to the limits required for the function being calibrated.

If the program header separator (*phs*) and *Nrf* are omitted, the instrument assumes that the nominal value is the target for the actual measured value.

Response Format:

Character position

1 2
n nl

Where:

n = 0 or 1
nl = newline with EOI

Response Decode:

The value returned identifies the success or failure of the standardization exercise:

Zero indicates **complete** with **no error** detected.

One indicates **error detected**. The error can be found in the device-dependent error queue.

Execution Errors occur if calibration is not enabled, if DCV is not selected, or if the number used is incompatible with the setting being calibrated.

Power On and Reset Conditions

Not applicable.

Calibration Due Date

This facility returns the user-entered recommended date for the recalibration of the instrument.

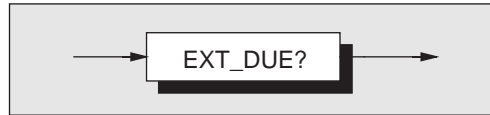

EXT_DUE?

returns the relevant date previously entered by the user.

Response Syntax

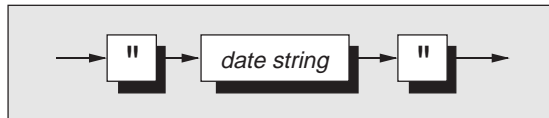

Response Format:

Character position										
1	2	3	4	5	6	7	8	9	10	11
"	u	u	u	u	u	u	u	u	"	nl

Where:

u = users date string
nl = newline with EOF

Response Decode

The value returned is the date most-recently entered either as a parameter of EXITCAL, or when calibration mode exited from the front panel.

Execution Errors:

None

Power On and Reset Conditions

No Change. The date is saved in non-volatile memory.

Protected User Data

Entry of User Data

This command conforms to the IEEE 488.2 standard requirements.

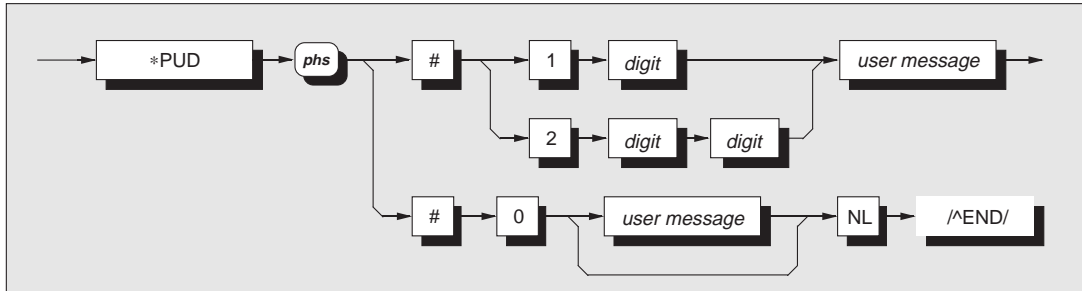

where:

phs = Program Header Separator,

digit = one of the ASCII-coded numerals,

user message = any message up to 63 bytes maximum.

*PUD

allows a user to enter up to 63 bytes of data into a protected area to identify or characterize the instrument. The two representations above are allowed depending on the message length and the number of 'digits' required to identify this. The instrument must be in the external calibration mode for this command to execute.

Execution Errors:

Execution errors are generated if the instrument is not in the external calibration mode.

Power On and Reset Conditions

Data area remains unchanged.

Recall of User Data

This common command conforms to the IEEE 488.2 standard requirements.

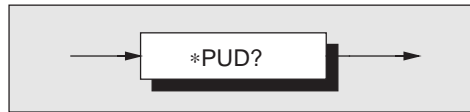

***PUD?** recalls previously entered user data:

Response Syntax:

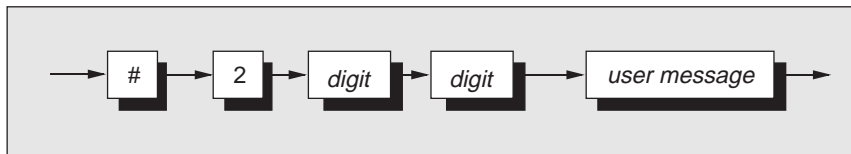

where:

digit = one of the ASCII-coded numerals,
user message = the saved user message.

Response Decode:

The previously-saved message is recalled.
 If no message is available, the value of the two digits is 00.

The data area contains 63 bytes of data.

Execution Errors:

None.

Power On and Reset Conditions

Data area remains unchanged.

Note: Some controllers may not accept strings of this length unless programmed to do so. Refer to the appropriate programming manuals in case of difficulty.

Special Calibrations

Perform a 'Special' Calibration

This facility is obtained using CHSE?. It triggers special calibration of either: the DMM's different analog-to-digital converter resolutions; or the digital-to-analog converter used for analog output; or the frequency detector device. Refer to Section 1 of the Calibration and Servicing handbook.

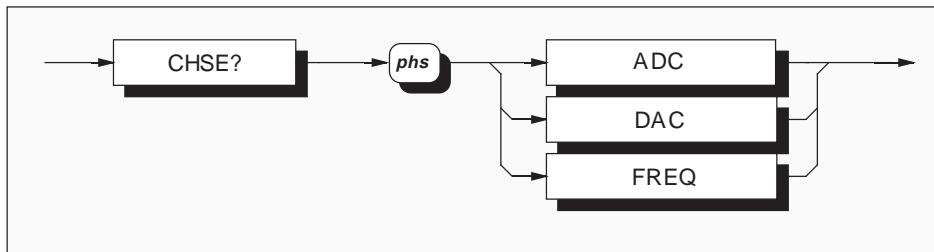

ADC

Calibrates the different resolutions available from the analog to digital converter, so that there are no significant differences in readings seen when changing resolutions with a constant input value.

DAC

Calibrates the DAC used in the analog output option. The analog output must be connected to the instrument analog input.

FREQ

Calibrates the frequency counter against an external frequency standard, by correcting an internal frequency 'gain' factor.

Response Format:

Character position

1 2
n nl

Where:

n = 0 or 1
nl = newline with EOI

Response Decode:

The value returned identifies the success or failure of the calibration step:

Zero indicates **complete** with **no error** detected.
One indicates **error detected**. The error can be found in the device-dependent error queue.

Execution Errors

ADC If special calibration is not enabled.
DAC If special calibration is not enabled.
FREQ If special calibration is not enabled, or if calibration is attempted and AC is not a fitted option.

Power On and Reset Conditions

Not applicable.

Setting Line Frequency

(Available only if 'Special' Calibration is enabled - see page 5-87)

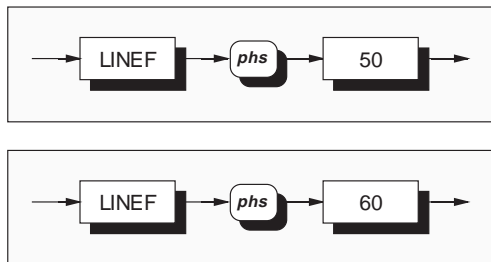

LINEF 50 selects a line frequency operation of 50Hz.

LINEF 60 selects a line frequency operation of 60Hz.

The only allowed values of Nrf are 50 for 50Hz, and 60 for 60Hz.

Numbers exceeding the defined data element resolution will be rounded to that resolution. The operation is allowed only in special calibration mode.

Execution Errors:

Execution errors are generated if the instrument is not in the special calibration mode.

Reversion from Remote to Local

No Change

The choice of line frequency setting affects the synchronization of the A-D, for improved line frequency rejection.

Power On and Reset Conditions

The chosen data element is stored at Power Off and reactivated at Power On.

Recall of Line Frequency Setting

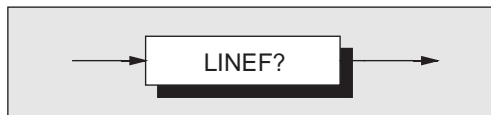

LINEF? recalls the active setting for line frequency.

Response Format:

Character position

1 2 4

n n nl

Where:

n = 0 to 9

nl = newline with EOI

Execution Errors:

None.

Power On and Reset Conditions

The selection is non-volatile so that a value is always returned.

Self Calibration Trigger

This command conforms to the IEEE 488.2 standard requirements.

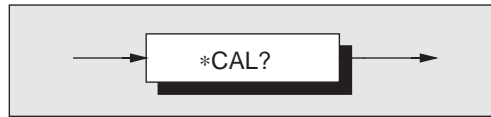

***CAL?** performs the instrument self-calibration. **Execution Errors** occur if self calibration is not enabled, or if the internal source characterization was not done at the most-recent external calibration.

N.B. Self Calibration is valid only at temperatures: $23^{\circ}\text{C} \pm 10^{\circ}\text{C}$ and within one year of internal source calibration.

Power On and Reset Conditions

Calibration disabled.

Response Format:

Character position

	1		2	
	n		nl	

Where:

n = 0 or 1
nl = newline with EOI

Response Decode:

The value returned identifies the success or failure of the calibration step:

Zero indicates **complete** with **no error** detected.

One indicates **error detected**. The error can be found in the device-dependent error queue.

Exit from Calibration

The next due external calibration date can be installed before exiting.

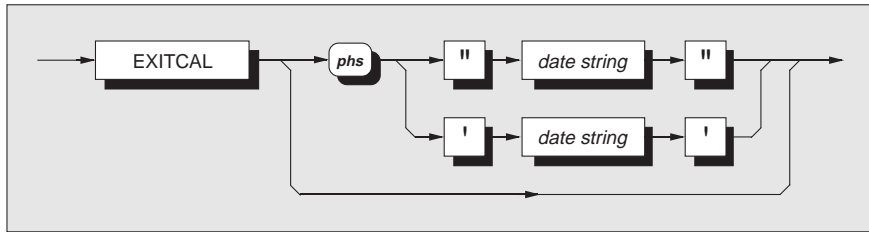

EXITCAL gives the operator the option of entering a due date, or bypassing it as shown in the syntax diagram. After exiting, any programmed keyswitch/passnumber protections are reimposed for further access to the calibration modes.

Date string represents a string which should contain 8 ASCII characters, indicating the date next due for external calibration. Any format is suitable, and the date can be returned using the EXT_DUE? facility. It can also be displayed by a front panel user, who can enter a new date only via the (protected) external calibration mode menu.

Execution Errors occur if the calibration keyswitch is not in the enabled position.

Power On and Reset Conditions

The date is saved in non-volatile memory, so is not destroyed at Power Off.

Set User Calibration Uncertainty

Sets the constant, relative to the active function and range, which accounts for the user's calibration uncertainty as incorporated into the specification error for the measurement. If calibration is enabled, the calibration uncertainty value can be recalled for the current measurement using the UNC? message. The appropriate specification error can similarly be recalled using the SPEC_DAY/YR message, or by a front panel user via the MONITOR - SPEC menus.

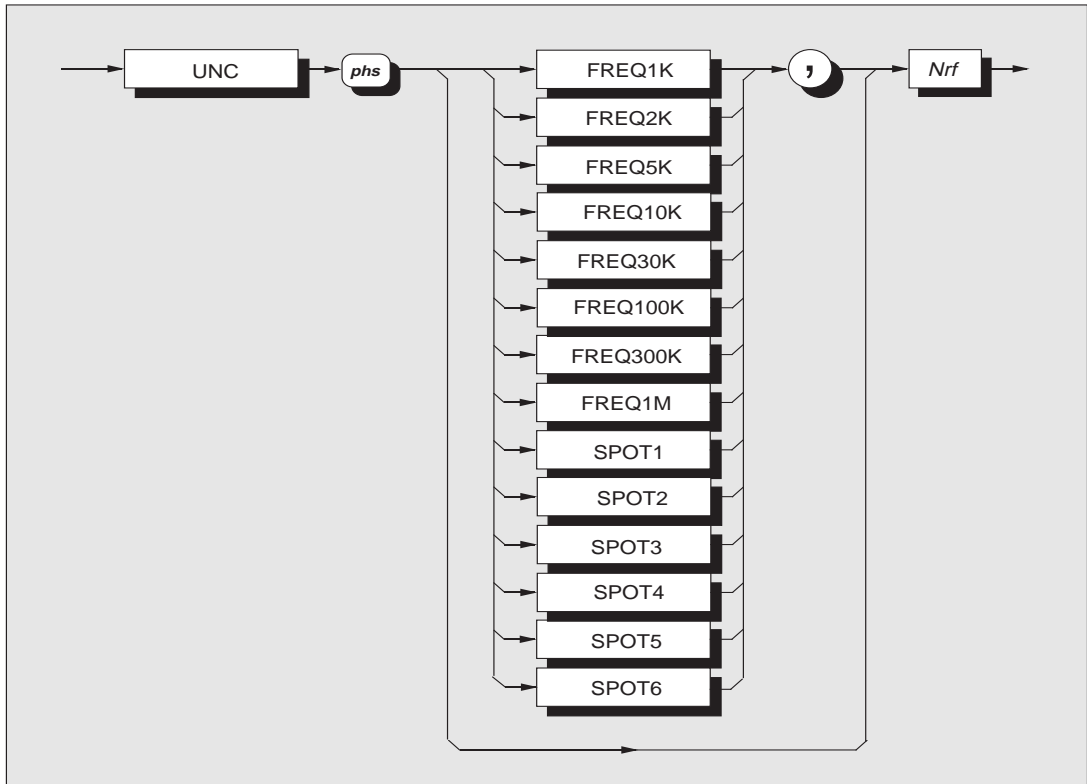

continued next page

Set User Calibration Uncertainty (Contd.)**Data element usage**

When the indicated uncertainty is dependent only on the function and range currently active, **no parameter** should be specified (see Execution Errors, below).

A data element, identified by **FREQ** and a number, can be selected to represent the frequency bandwidth for the uncertainty to be entered. Note that the **FREQ10K** element doubles for two voltage bandwidths whose uncertainties are likely to be similar:

AC Voltage

40Hz	to 100Hz	FREQ10K
100Hz	to 2kHz	FREQ2K
2kHz	to 10kHz	FREQ10K
10kHz	to 30kHz	FREQ30K
30kHz	to 100kHz	FREQ100K
100kHz	to 300kHz	FREQ300K
300kHz	to 1MHz	FREQ1M

AC Current

40Hz	to 1kHz	FREQ1K
1kHz	to 5kHz	FREQ5K

When a **FREQ**uency element is specified the function must be ACV or ACI, and the relevant element for voltage or current entered.

All selections are mutually exclusive.

Nrf

is a decimal numeric data element which represents the uncertainty value. This number should be expressed as a decimal fraction of the nominal full range value.

The number should not be greater than 1.

Examples:

$\pm 10\mu\text{V}$ uncertainty on the 1V range should be entered as 10E-6;

$\pm 24\mu\text{V}$ uncertainty on the 100V range should be entered as 24E-8.

The decimal data element resolution is 4.5 significant figures, and numbers exceeding this resolution will be rounded to it.

Execution Errors

occur if external calibration is not enabled, or if the numeric value exceeds 1, or when the element used is not compatible with the selected function.

Reversion from Remote to Local

No Change.

Power On and Reset Conditions

No Change. The value is saved in non-volatile memory relative to the active function and range.

Recall Calibration Uncertainties

The `UNC?` command recalls the constant, relative to the active function and range, which accounts for the calibration uncertainty used in the calculation of the specification error for the measurement. The appropriate specification error can similarly be recalled using the `SPEC_DAY/YR` message, or by a front panel user via the `MONITOR - SPEC` menus.

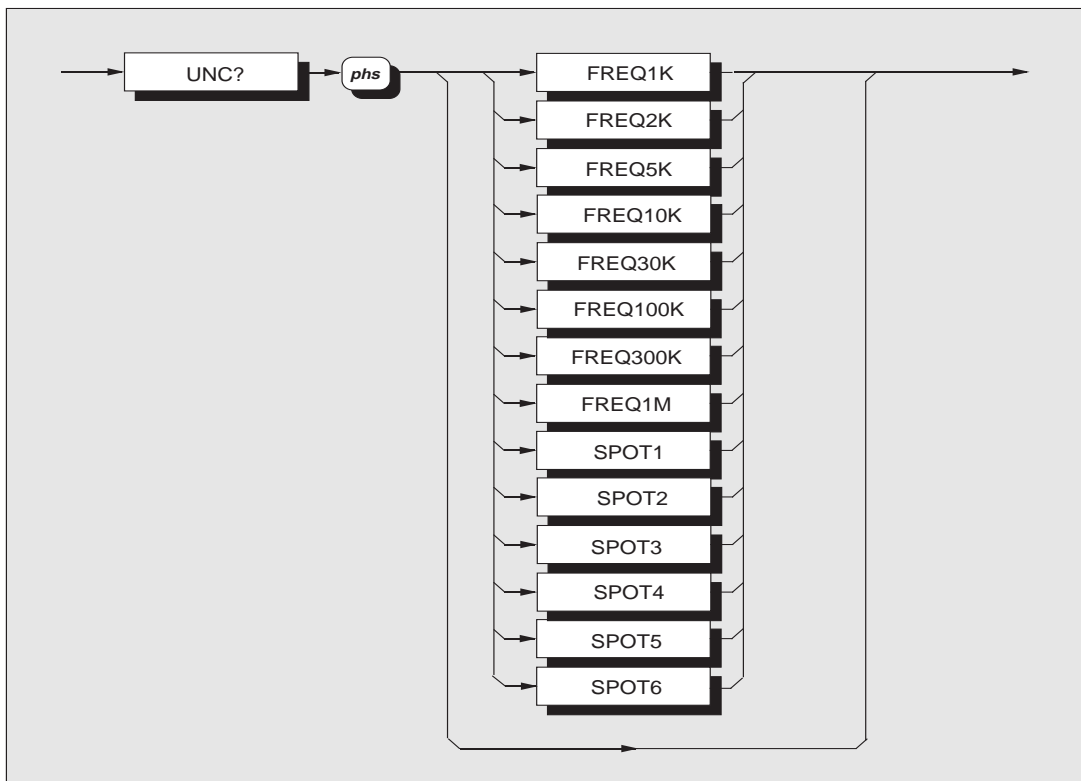

Data element usage

When **no parameter** is specified, the indicated uncertainty recall is dependent only on the function and range currently active.

A data element beginning with **FREQ** indicates the frequency bandwidth for the uncertainty. The number represents the band as follows:

continued next page

Recall Calibration Uncertainties (Contd.)

AC Voltage

40Hz	to	100Hz	FREQ10K
100Hz	to	2kHz	FREQ2K
2kHz	to	10kHz	FREQ100K
10kHz	to	30kHz	FREQ30K
30kHz	to	100kHz	FREQ100K
100kHz	to	300kHz	FREQ300K
300kHz	to	1MHz	FREQ1M

AC Current

40Hz	to	1kHz	FREQ1K
1kHz	to	5kHz	FREQ5K

When a **FREQ**uency element is specified, the function must be ACV or ACI and the relevant element for voltage or current entered.

No data element is required for DC or Ohms.

All selections are mutually exclusive.

Response Format:

Character position												
1	2	3	4	5	6	7	8	9	10	11	12	
13	14	15	16									
s	n	x	x	x	n	n	n	n	n	n	n	E
sg	p	p	nl									

Where:

- s = + or - or space
- n = 0 to 9
- x = either n or decimal point (.)
- E = ASCII character identifying the exponent
- sg = + or -
- p = 0 to 9 (exponent is given in engineering units)
- nl = newline with EOI

Response Detail

The responses to UNC? are the calibration uncertainty values which were most-recently entered either manually (via the 'EXT CAL' and 'SPEC' menus) or remotely (by 'UNC' command) during an external calibration of the instrument.

When shipped from manufacture, it is the manufacturer's calibration uncertainties (relative to National Standards) that are stored, as listed in the appropriate columns of Section 6.

Execution Errors

These occur if the element used is not compatible with the selected function.

Reversion from Remote to Local

No Change

Power On and Reset Conditions

No Change

Enter Passnumber

To enter the passnumber which may be required by the entry system to self calibration.

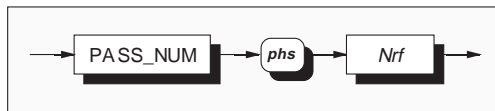

Nrf is a decimal numeric data element which represents the passnumber. This number should, when expressed as an integer, be in the range 0 to 999999. Numbers exceeding the required resolution will be rounded.

Execution Errors:

None

Reversion from Remote to Local

No Change

Execution Errors occur if external calibration is not enabled, or if the numeric value is out of range.

Power On and Reset Conditions

The number is saved in non-volatile RAM, and so is not destroyed at power off.

Set Calibration Entry Conditions

To determine the interlocks required for entry to self calibration.

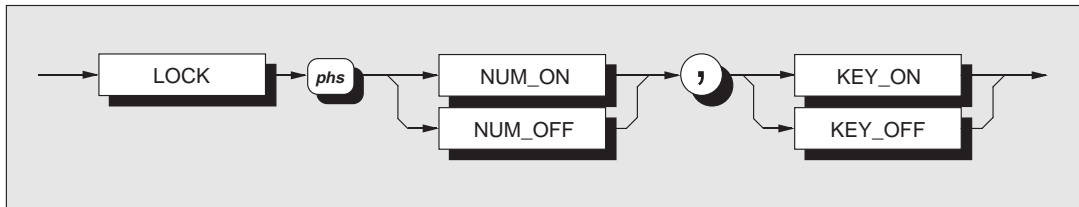

NUM_ON passnumber **required** as a condition of entry.

NUM_OFF passnumber **not** required as a condition of entry.

KEY_ON rear panel keyswitch at the enable position **required** as a condition of entry to self-calibration.

KEY_OFF rear panel keyswitch at the enable position **not** required as a condition of entry to self-calibration.

Execution Errors occur if external calibration is not enabled.

Power On and Reset Conditions

Not applicable.

Set Instrument Serial Number

This number is originally set at manufacture to match the serial number on the rear panel plate. The information is stored in non-volatile RAM and is separately sum-checked against an appropriate individual error message. It can be changed only when in external calibration enabled state and in special calibration mode. User-access has been provided so that an inventory or asset number can be used to replace the manufacturer's serial number.

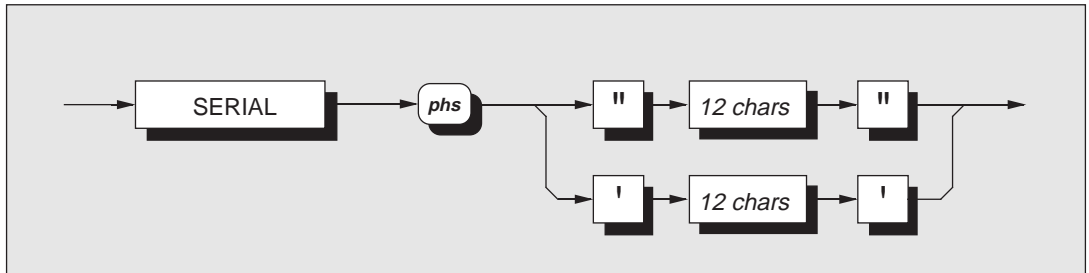

SERIAL allows access to change the serial number.

chars are ASCII printing characters.

The number is encapsulated in quotes to allow a free format to be used for the serial number itself. It can be recalled together with the manufacturer's name, model number and firmware level, using the standard IEEE 488 identification message *IDN?

Execution Errors occur if special calibration is not enabled.

Reversion from Remote to Local

No Change

Power On and Reset Conditions

No Change

Clear Calibration Stores

To allow the calibration correction memories to be cleared.

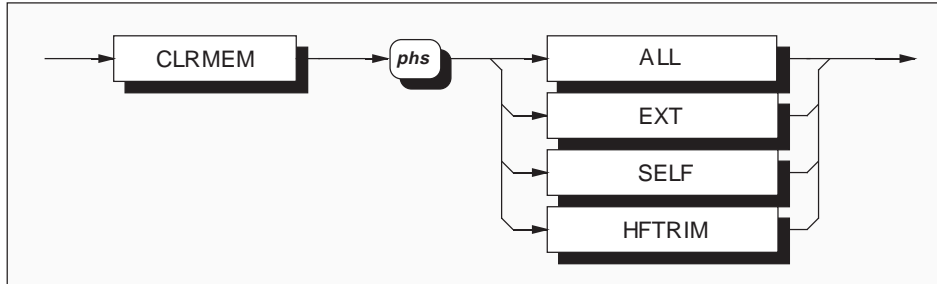

IMPORTANT!

This command can **obliterate** the results of an **expensive** original calibration or recalibration!

Extent of Clear

The extent of clear is defined by programming the following options:

- ALL** applies to all;
- EXT** applies to the External Calibration corrections;
- SELF** applies to all Selfcal corrections;
- HFTRIM** applies to the AC HF frequency response correction.

Execution Errors occur if calibration is not enabled via the rear panel keyswitch.

Power On and Reset Conditions

Not applicable.

Enable Selfcal Corrections

Once the internal source has been characterized, it is optional whether or not the corrections are applied. The SELFCORR command permits users to decide on this option.

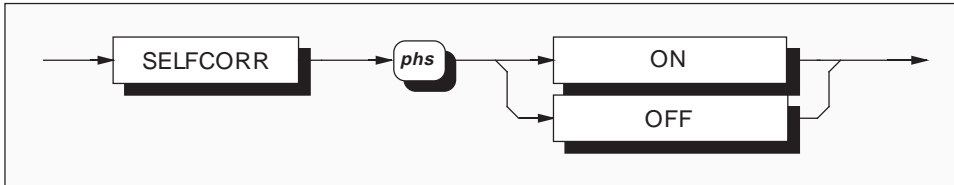

ON applies the set of constants determined from the most-recent **self** calibration;

OFF applies the set of constants determined from the most-recent **external** calibration.

NB. If the internal source was not characterized at the most-recent external calibration, then these two sets of constants have the same value.

The On/Off state is saved in non-volatile RAM, and so is not destroyed at power off.

Instruments are shipped from the manufacturer with Corrections On.

Execution Errors:

None

Power On and Reset Conditions

Not applicable.

Trigger Internal Source Characterization

To trigger the internal (self calibration) source calibration event.

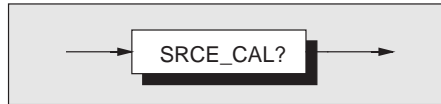

SRCE_CAL?

performs the internal source characterization.
The process takes approx. 12 minutes.

N.B. This calibration should be performed only after all external calibrations have been completed. The results of the external calibrations are used to determine the internal source calibration constants.

Response Decode:

The value returned identifies the success or failure of the calibration step:

Zero indicates **complete** with **no error** detected.

One indicates **error detected**. The error can be found in the device-dependent error queue.

Execution Errors occur if calibration is not enabled.

Response Format:

Character position

1 2
n nl

Power On and Reset Conditions

Not applicable.

Where:

n = 0 or 1

nl = newline with EOI

Access to the Internal Buffer Store

Set and Arm Block Measurement Mode

Arms the measurement system diversion of measurements to the internal buffer store, and enters the required number of diverted results.

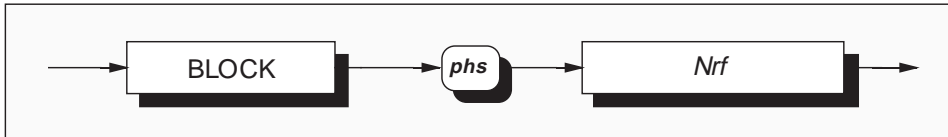

Nrf

is a Decimal Numeric Data element representing a decimal integer, whose value is the number of measurements to be stored. This value must lie between 1 and 6000 measurements inclusive. Note that numbers will be rounded to an integer.

Putting Readings into Memory

Readings are placed into consecutive stores numbered from 1 to 6000. An example for a block of 16 readings is given below:

Example:

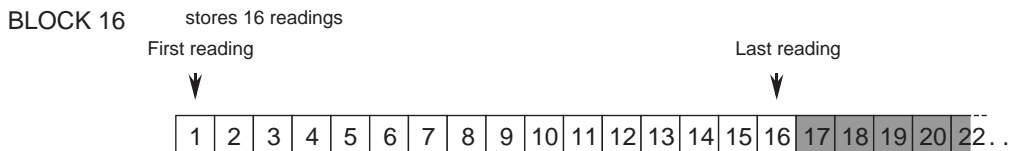

Response

At the completion of the block of measurements, bit 0 of the 1281 Status Byte is set, providing the appropriate bits of the Service Request Enable register (bit 0) and Measurement Event Status Enable register (bit 6) are set. Use of commands associated with this internal buffer will abort the diversion of results to the buffer.

Execution Errors

occur when the numeric value entered exceeds the specified limits.

Power On and Reset Conditions

Diversion to the buffer is inoperative.

Note: If BLOCK *phs* *Nrf* is selected in external trigger mode, *Nrf* triggers will be required to complete this sequence.

Recall the Number of Results

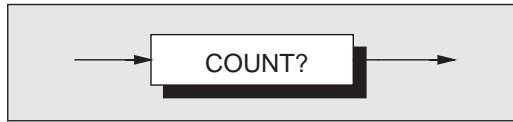

COUNT? recalls the number of measurements contained in the internal store.

If this command is used before a commanded block is complete, the diversion of measurements to store is aborted.

This number is set to zero when **BLOCK** command is executed.

Response Format:

Character position
 1 2 3 4 5
 n x x x nl

Where:

n = 0 to 9
 x = either n or space
 nl = newline with EOI

Response Decode

The value returned is the number of measurements saved in store.

Execution Errors:

None.

Power On and Reset Conditions

The value is zero.

Recall Measurements from Internal Store

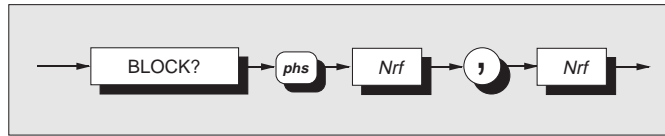

BLOCK?

recalls a series of readings between two store locations in the reading buffer.

Nrf

is a Decimal Numeric Data element representing a decimal integer value, whose value is a block store location in the reading buffer. Note that numbers will be rounded to an integer.

Example:

Locations of readings stored by **BLOCK 16**

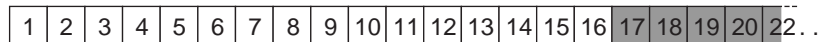

BLOCK? 6,11 recalls selected readings consecutively from the stored block:

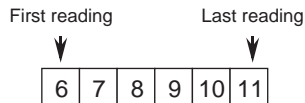

Response Format

Each individual reading is given in the same format as for the RDG? command. Refer to *page 5-72*.

The readings will be output consecutively from the first store location to the last. Consecutive readings will be separated by commas.

Store Locations

The first *Nrf* represents the location of the first reading of the series in the buffer, and the second *Nrf* represents the last reading of the series. All readings between these locations (including these two) are recalled. An example based on the example on *page 5-106* is given below:

Execution Errors

occur when the start point number is greater than the finish point number, or when the finish point number is greater than the number of readings actually saved. An execution error will also result from either of the numbers being zero.

Power On and Reset Conditions

No stored readings are available.

IEEE 488.2 Device Documentation Requirements

IEEE 488.2 requires that certain information be supplied to the user about how the device has implemented the standard. The Device Documentation Requirements are detailed in Section 4.9 of the Standard document. In this handbook, the required information is already contained within the descriptions of the system, and this appendix provides cross-references to those descriptions in which it is presented. The following paragraphs have the same numbers as the paragraphs of Section 4.9 in the Standard document to which they refer.

1. Table 5.1 on page 5-2, or the list on the rear of the instrument.
2. The instrument address is set manually, and the instrument firmware refuses to set any address outside the range 0-30. It responds instead with a Data Entry Error, displayed on the front panel.
3. This is described on page 5-6, where the (manual only) method of setting the address is detailed.
4. Appendix B to Section 5 describes the active and non-active settings at power-on.
5. Message Exchange Options:
 - a. The Input Buffer is a first in - first out queue, which has a maximum capacity of 128 bytes (characters). Each character generates an interrupt to the instrument processor which places it in the Input Buffer for examination by the Parser. The characters are removed from the buffer and translated with appropriate levels of syntax checking. If the rate of programming is too fast for the Parser or Execution Control, the buffer will progressively fill up.
When the buffer is full, the handshake is held.
 - b. Two queries: DUMP? and BLOCK?
 - c. All queries.
 - d. None.
 - e. None.
6. Command Program Header
Query Program Header
Character Program Data
Decimal Numeric Program Data.
String Program Data (EXITCAL and SERIAL)
Arbitrary Block Program Data (*PUD)

Compound Command Program Headers are not used

7. *PUD blocks are limited to 63 bytes.
8. Expression Program Data elements are not used.
9. The syntax for each command is described in the general list of commands on pages 5-30 to 5-108. This list includes all queries, for which the response syntax is also described.
10. None
11. The only command which elicits a Block Data response is the query *PUD?
Its response consists of #, 2, two digits and a data area of 63 bytes; 67 bytes in all.
12. A description of every implemented Common Command and Query is included in the general list on pages 5-30 to 5-108.
13. After self-calibration the instrument is returned to the same condition as when the command was implemented.
14. *DDT is not implemented.
15. Macro commands are not implemented.
16. *IDN? is described on page 5-84.
17. Neither *RDT nor *RDT? are implemented.
18. The states affected by *RST are described for each command in the list of commands and queries on pages 5-30 to 5-108.
Commands *LRN?, *RCL and *SAV are not implemented.
19. *TST? invokes the full self-test which is equivalent to the self-calibration commanded by *CAL?, but checking the errors against specification limits rather than applying corrections. *CAL? is described in Section 1 of the Calibration and Servicing Handbook for the instrument. The response to *TST? is described on page 5-62, with a list of possible errors detailed in Appendix A to Section 4 of this handbook.
20. The additional status data structures used in the instrument's status reporting are fully described on pages 5-19 to 5-29.
21. All commands are sequential - overlapped commands are not used.
22. As all commands are sequential, there are no pending parallel operations. The functional criterion which is met, therefore, is merely that the associated operation has been completed.

1281 Device Settings at Power On

Active Function:

Funct.	Range	Filter	Resol.	A-D Resol.
DCV	1kV	FILT_OFF	RESL6	FAST_OFF

Inactive Functions:

Funct.	Range	Filter	Resol.	A-D Resol.	Conn.	Other
ACV	1kV	FILT100HZ	RESL6		ACCP	TFER_ON
Ohms	10M Ω	FILT_OFF	RESL6	FAST_OFF	TWR	LOI_OFF
Hi Ω	100M Ω	FILT_OFF	RESL6		TWR	
Tru Ω	100k Ω	FILT_OFF	RESL6	FAST_OFF	TWR	
DCI	1A	FILT_OFF	RESL6	FAST_OFF		
ACI	1A	FILT100HZ	RESL5		ACCP	

Analog Connections

Input	Front
Guard	Local

Analog Processes and Conditioning

Trigger Source	Internal
Delay	Default values
Input Zero	Setting retained in non-volatile memory

Post A-D Processes

Frequency Measurement-Gate Width	FAST_ON (Inactive)
Max/Min/PkPk	Stores cleared
Limits Checking	OFF
Hi and Lo Limits Settings	As previously entered

Math

AVG	OFF	N as previously entered
MUL_M	OFF	M as previously entered
SUB_C	OFF	C as previously entered
DIV_Z	OFF	Z as previously entered
DB	OFF	DB_REF UNITY

Calibration Processes

Calibration	Disabled
External Calibration Corrections	Applied
Internal Source Characterizations	Applied
Selfcal Corrections On/Off	Previous condition preserved
External Calibration Due Date	Previous date preserved
Line Frequency 50/60 Hz	Previous selection preserved
Calibration Uncertainty Entries	Previous entries preserved

Device Monitoring

Last Reading Value Recall	Invalid until after first trigger
Last Reading Frequency Recall	Invalid until after first trigger
Device I/D (Serial Number)	Previous entry preserved
Options Fitted Data	As fitted
Protected User Data	Previous entry preserved

Status Reporting Conditions

Status Byte Register	Depends on state of *PSC
Event Status Register	Depends on state of *PSC
Event Summary Register	Depends on state of *PSC
*PSC Condition	Previous state preserved
Output Queue	Empty until after first trigger or unless error detected

PART 3

1281 Performance

Section 6 Specifications

Section 7 Specification Verification

Section 8 Routine Calibration

SECTION 6 SPECIFICATIONS

General	6-1
Maximum RMS Inputs	
Front Terminals	6-2
Channel A	6-3
Channel B	6-3
Notes to Maximum Input Tables	6-4
Accuracy	
DC Voltage	6-5
DC Current (Option 30)	6-5
AC Voltage (Option 10)	6-6
AC Current (Option 30)	6-7
Resistance (Option 20)	6-8
Notes to Accuracy Specifications	6-9
Ten Minute Stability Specifications	6-10
Additional Errors as a Function of Mode	6-11
Other Specifications	
DCV	6-12
DCI	6-12
Resistance	6-12
ACV	6-13
ACI	6-13

SECTION 6 SPECIFICATIONS

GENERAL

POWER SUPPLY	Voltage: 100V-130V or 200V-260V (Selectable from Rear Panel). Line Frequency: 47Hz to 63Hz. Power: 50 VA max.
MECHANICAL	Height: 88mm (3.46ins). Width: 427mm (16.8ins). Overall Depth: 488mm max (19.2ins), which includes 18mm (0.71ins) of extended terminals. Rack Depth: 467mm (18.4ins) excluding Rear Panel connectors. Rack Mounting: Rack mounting ears to fit standard 19inch rack (ANSI-E1A-310-C). Conversion to accept 0.5ins wide slides, including MATE standard (Drg. No. 2806701, Sperry). Weight: 13.5kg (30 lbs) approx.
TEMPERATURE	Operating: 0°C to 50°C. Storage: -40°C to 75°C.
HUMIDITY RANGE	Operating (non-condensing): 0°C to 30°C : < 95% ± 5% RH. 30°C to 40°C : <75% ± 5% RH. 40°C to 50°C : < 45% ± 5% RH.
ALTITUDE	Operating: 0-3,050m (10,000 feet). Non-Operating: 0-12,000m (40,000 feet)
SHOCK AND VIBRATION	Meets the requirements of: MIL-T-28800C, Type III, Class 5, Style E equipment
SAFETY	Meets the requirements of : UL 1244 • ANSI C39.5 Draft 5 • • EN61010-1:1993/A2:1995 • BSI 4743.
WARM UP	4 hours to full accuracy.
AUTORANGE	Range Up: 200% of nominal range. Range Down: 18% of nominal range.
DIGITAL ERROR	Computation: ±1 digit (assumes no error in stored value). Spec. readout: <1% of displayed spec.
MEASUREMENT ISOLATION	'Guard' to Safety Ground: <300pF, >10GΩ; 'Lo' to 'Guard' in Remote Guard : <700pF, >10MΩ. In Local Guard, the 'Lo' and 'Guard' terminals are internally short circuited.

Maximum RMS Inputs

N.B. Refer to page 6-4 for notes to these tables.

Front Terminals

DC and AC Voltage

Hi							
1000V	Lo						
250V	1000V	I+					
1000V	250V	1000V	I-				
1000V	250V	1000V	250V	Guard			
1000V	250V	1000V	250V	250V	Ω Guard		
1000V	650V	1000V	650V	650V	650V	Safety Ground	
1000V	650V	1000V	650V	650V	650V	0V	Logic Ground

DC and AC Current

Hi							
250V	Lo						
250V	250V	I+					
250V	250V	250V	I-				
250V	250V	250V	250V	Guard			
250V	250V	250V	0V	250V	Ω Guard		
900V	650V	900V	650V	650V	650V	Safety Ground	
900V	650V	900V	650V	650V	650V	0V	Logic Ground

Resistance

Hi							
250V	Lo						
250V	250V	I+					
250V	250V	250V	I-				
250V	250V	250V	250V	Guard			
250V	250V	250V	250V	250V	Ω Guard		
900V	650V	900V	650V	650V	650V	Safety Ground	
900V	650V	900V	650V	650V	650V	0V	Logic Ground

Maximum RMS Inputs

N.B. Refer to page 6-4 for notes to these tables.

Channels A and B (Rear Inputs)

DC and AC Voltage

Hi								
50V	Lo							
50V	50V	I+						
50V	50V	50V	I-					
50V	50V	50V	50V	Guard				
50V	50V	50V	50V	50V	Ω Guard			
50V	50V	50V	50V	50V	50V	Safety Ground		
50V	50V	50V	50V	50V	50V	0V	Logic Ground	

DC and AC Current

Hi								
50V	Lo							
50V	50V	I+						
50V	50V	50V	I-					
50V	50V	50V	50V	Guard				
50V	50V	50V	0V	50V	Ω Guard			
50V	50V	50V	50V	50V	50V	Safety Ground		
50V	50V	50V	50V	50V	50V	0V	Logic Ground	

Resistance

Hi								
50V	Lo							
50V	50V	I+						
50V	50V	50V	I-					
50V	50V	50V	50V	Guard				
50V	50V	50V	50V	50V	Ω Guard			
50V	50V	50V	50V	50V	50V	Safety Ground		
50V	50V	50V	50V	50V	50V	0V	Logic Ground	

Maximum RMS Inputs

Notes to Maximum Input Tables

- [1] Maximum RMS inputs specified assume a peak of $< \text{RMS} \times 1.414$
- [2] Maximum differential 'stand off' voltage between channels must not exceed the maximum specified voltage of the Front Terminals.
Maximum 'switched' voltage between channels must not exceed the maximum specified voltage of either channel (whichever is the lower input limit).
- [3] All 'In-Guard' inputs are flash-tested with respect to 'Safety Ground' at 2.5kV in accordance with UL 1244.
- [4] Maximum slew rate of 'Guard' with respect to 'Safety Ground' or 'Logic Ground' is:

Transient immunity (no corruption):	1kV/ μ s
Transient protection (no damage):	10kV/ μ s
- [5] With 'Remote Guard' not selected, 'Guard' is internally linked to 'Lo', so for the selected channel(s), all limits between these terminals reduce to zero.
- [6] 'Logic Ground' is internally connected to 'Safety Ground'.
- [7] Current ranges are protected against overload by a rear panel fuse.

ACCURACY

DC Voltage

Range [1]	Accuracy Relative to Calibration Standards [2][3] ± [ppmR + ppmFS] [4]			Calibration Uncertainty [ppm] [7]	Temperature Coefficient [ppm/°C] 13°C - 18°C 28°C - 33°C	
	24 hour 23°C ± 1°C	1 Year			Normal	Enhanced[5]
		Normal 23°C ± 5°C	Enhanced 23°C ± 5°C [5][6]			
100.000 00mV	1 + 0.5	7 + 0.5	6 + 0.5	6.5	0.6	0.3
1.000 000 00V	0.5 + 0.2	6 + 0.2	3 + 0.2	3.5	0.5	0.25
10.000 000 0V	0.5 + 0.1	6 + 0.1	3 + 0.1	2.5	0.5	0.25
100.000 000V	1 + 0.2	10 + 0.2	6 + 0.2	3.5	0.8	0.4
1000.000 00V	1 + 0.2	10 + 0.2	6 + 0.2	3.5	0.8	0.4

DC CURRENT (Option 30)

Range [1]	Accuracy Relative to Calibration Standards [2][3] ± [ppmR + ppmFS] [4]			Calibration Uncertainty [ppm] [7]	Temperature Coefficient [ppm/°C] 13°C - 18°C 28°C - 33°C	
	24 hour 23°C ± 1°C	1 Year			Normal	Enhanced[5]
		Normal 23°C ± 5°C	Enhanced 23°C ± 5°C [5][6]			
100.000 0µA	20 + 2	100 + 2	25 + 2	35	12	8
1.000 000mA	20 + 2	100 + 2	25 + 2	20	12	8
10.000 00mA	20 + 2	100 + 2	25 + 2	20	12	8
100.000 0mA	30 + 5	100 + 5	50 + 5	25	12	8
1.000 000A	100 + 10	200 + 10	150 + 10	40	12	10

AC VOLTAGE - Option 10 [8][9][10]

Range [1] and Frequency	Accuracy Relative to Calibration Standards [2][3] ± [ppmR + ppmFS] [4]			Calibration Uncertainty [ppm] [7]	Temperature Coefficient [ppm/°C] 13°C - 18°C 28°C - 33°C	
	24 hour 23°C ± 1°C	1 Year			Normal	Enhanced
		Normal 23°C ± 5°C	Enhanced 23°C ± 5°C [5] [6]			
100.000 0mV 1Hz - 10Hz [16] 10Hz - 40Hz 40Hz - 100Hz 100Hz - 2kHz 2kHz - 10kHz 10kHz - 30kHz 30kHz - 100kHz	80 + 70 80 + 20 60 + 20 40 + 10 60 + 20 250 + 30 400 + 100	100 + 70 120 + 20 100 + 20 100 + 10 100 + 20 300 + 40 700 + 100	100 + 70 120 + 20 100 + 20 100 + 10 100 + 20 300 + 40 700 + 100	155 155 155 155 220 430	20 20 15 15 20 50	10 10 5 5 10 40 40
1.000 000V to 100.000 0V 1Hz - 10Hz [16] 10Hz - 40Hz 40Hz - 100Hz 100Hz - 2kHz 2kHz - 10kHz 10kHz - 30kHz 30kHz - 100kHz 100kHz - 300kHz 300kHz - 1MHz	70 + 60 70 + 10 50 + 10 30 + 10 50 + 10 100 + 20 250 + 100 0.15% + 0.1% 1% + 0.5%	100 + 60 100 + 10 80 + 10 60 + 10 80 + 10 200 + 20 500 + 100 0.3% + 0.1% 1% + 1%	100 + 60 100 + 10 80 + 10 60 + 10 80 + 10 200 + 20 500 + 100 0.3% + 0.1% 1% + 1%	80 75 35 35 50 70 180 1400	15 15 10 10 10 15 50 100	10 10 5 5 10 40 40 40
1000.000V[11] 1Hz - 10Hz [16] 10Hz - 40Hz 40Hz - 10kHz 10kHz - 30kHz 30kHz - 100kHz	70 + 35 70 + 10 50 + 10 100 + 20 250 + 100	100 + 35 100 + 10 80 + 10 200 + 20 500 + 100	100 + 35 100 + 10 80 + 10 200 + 20 500 + 100	75 75 250 700	20 15 10 15 50	15 10 10 10 40

SPOT FREQUENCY - AC VOLTAGE [8][9][10][12][13]

Range [1] and Frequency	Accuracy Relative to Calibration Standards [2][3] ± [ppmR + ppmFS] [4]			Calibration Uncertainty [ppm] [7]	Temperature Coefficient [ppm/°C] 13°C - 18°C 28°C - 33°C	
	24 hour 23°C ± 1°C	1 Year			Normal	Enhanced [5]
		Normal 23°C ± 5°C	Enhanced 23°C ± 5°C [5] [6]			
100.000 0mV						
40Hz - 10kHz	40 + 10	200 + 10	100 + 10	155	15	5
10kHz - 30kHz	60 + 25	250 + 25	150 + 25	220	20	10
30kHz - 100kHz	100 + 100	500 + 100	500 + 100	430	50	40
1.000 000V to 100.000 0V						
40Hz - 10kHz	30 + 5	130 + 5	60 + 5	75	10	5
10kHz - 30kHz	50 + 15	200 + 15	150 + 15	50	15	10
30kHz - 100kHz	100 + 50	400 + 50	400 + 50	70	50	40
100kHz - 300kHz	0.1% + 0.05%	0.2% + 0.05%	0.2% + 0.05%	180	75	40
300kHz - 1MHz	0.2% + 0.3%	0.5% + 0.3%	0.5% + 0.3%	1400	100	40
1000.000V[11]						
40Hz - 10kHz	30 + 5	130 + 5	60 + 5	75	10	10
10kHz - 30kHz	50 + 15	200 + 15	150 + 15	250	15	10
30kHz - 100kHz	100 + 50	400 + 50	400 + 50	700	50	40

AC CURRENT(Option 30) [8]

Range [1]	Freq. (Hz)	Accuracy Relative to Calibration Standards [2][3] ± [ppmR + ppmFS] [4]			Calibration Uncertainty [ppm] [7]	Temperature Coefficient [ppm/°C] 13°C - 18°C 28°C - 33°C	
		24 hour 23°C ± 1°C	1 Year			Normal	Enhanced [5]
			Normal 23°C ± 5°C	Enhanced 23°C ± 5°C [5] [6]			
100.000µA	10 - 5k	150 + 50	300 + 100	200 + 100	200	20	15
1.000 00mA	10 - 5k	150 + 50	300 + 100	200 + 100	200	20	15
10.000 0mA	10 - 5k	150 + 50	300 + 100	200 + 100	200	20	15
100.000mA	10 - 5k	150 + 50	300 + 100	200 + 100	200	20	15
1.000 00A	10 - 1k	400 + 100	600 + 200	500 + 200	200	20	15
	1k - 5k	0.1% + .03%	0.2% + .04%	0.15% + .04%	350	20	15

RESISTANCE (Option 20) [14]

Range [1]	Constant Current Value	Relative to Calibration Standards [2][3] ± [ppmR + ppmFS] [4]			Calibration Uncertainty [ppm] [7]	Temperature Coefficient [ppm/°C]	
		24 hour 23°C ± 1°C	1 Year			13°C - 18°C	28°C - 33°C
			Normal 23°C ± 5°C	Enhanced 23°C ± 5°C			

NORMAL MODE

10.000 000Ω [15]	10mA	3 + 1	15 + 1	12 + 1	15	1.2	0.8
100.000 000Ω	10mA	1.5 + 0.3	11 + 0.3	8 + 0.3	7.5	1	0.5
1.000 000 00kΩ	1mA	1 + 0.3	9 + 0.3	6 + 0.3	6	1	0.5
10.000 000 0kΩ	100μA	1 + 0.3	9 + 0.3	6 + 0.3	5.5	1	0.5
100.000 000kΩ	100μA	1 + 0.3	9 + 0.3	6 + 0.3	10	1	0.8
1.000 000 00MΩ	10μA	2 + 0.7	14 + 0.7	10 + 0.7	20	1.5	1
10.000 000 0MΩ	1μA	4 + 4	30 + 4	20 + 4	30	2	1.5
100.000 0MΩ	100nA	30 + 45	300 + 45	200 + 45	140	20	15
1.000 000GΩ	10nA	300 + 450	0.3% + .045%	0.2% + .045%	350	200	150

LOW CURRENT MODE

10.000 000Ω [15]	10mA	3 + 1	15 + 1	12 + 1	15	1.2	0.8
100.000 000Ω	1mA	5 + 1	15 + 1	12 + 1	7.5	1.2	0.8
1.000 000 00kΩ	100μA	5 + 1	15 + 1	12 + 1	6	1.2	0.8
10.000 000 0kΩ	10μA	5 + 1	20 + 1	15 + 1	5.5	1.5	1
100.000 000kΩ	1μA	50 + 3	80 + 3	70 + 3	10	2.5	2
1.000 000 00MΩ	100nA	200 + 10	500 + 10	400 + 10	20	20	15

Notes to Accuracy Specifications

- [1] 100% overrange on all ranges (except 1kV DC & AC).
- [2] Combined uncertainties to 95% minimum confidence level for maximum resolution in each function, normal read mode, internal trigger, zero offsets corrected (DCV, DCI, Ohms), optimum filter selected (ACV, ACI).
- [3] Assumes 4 hour warm up period.
- [4] FS = 2 x Full Range.
- [5] Valid for 24 hours after Selfcal and within $\pm 1^{\circ}\text{C}$ of Selfcal temperature.
- [6] Specification equivalent to 90 day performance ($23^{\circ}\text{C} \pm 1^{\circ}\text{C}$) without Selfcal.
- [7] Relative to National Standards. Better uncertainties are available - contact factory for details.
- [8] Valid for signals $>1\%$ FS. Signal must be DC coupled $<40\text{Hz}$.
- [9] Assumes transfer mode on.
- [10] Max Volt x Hertz: 3×10^7 .
- [11] $>300\text{V}$, add $\pm 0.0024(R-300)^2$ ppm of reading.
- [12] Valid within $\pm 10\%$ of calibrated RMS value and Spot Frequency.
- [13] Instrument normally shipped with Spot Frequencies uncalibrated. Please contact the factory for available Spot Frequency calibration prices.
- [14] True Ohms mode available from 10Ω to $100\text{k}\Omega$ ranges.
- [15] 10Ω range available only in True Ohms mode.
- [16] Measurement results are invalid when using internal triggers in Transfer mode with the 1Hz filter selected. Results are valid using external triggers and 'Sample', and when triggering via the IEEE-488 interface.

TEN MINUTE STABILITY SPECIFICATIONS

FUNCTION and RANGE	FREQUENCY (Hz)	STABILITY AFTER SETTLING ±(ppmR + ppmFS)
DCV		
100.000 00mV		0.2 + 0.25
1.000 000 00V		0.2 + 0.075
10.000 000 0V		0.2 + 0.05
100.000 000V		0.2 + 0.075
1000.000 00V		0.2 + 0.05
ACV		
100.000 0mV	100Hz - 2kHz	20 + 2.5
	40Hz - 10kHz	20 + 5
	10Hz - 30kHz	40 + 5
	1Hz - 100kHz	60 + 5
1.000 000V	100Hz - 2kHz	20 + 2.5
	40Hz - 10kHz	20 + 2.5
	10Hz - 30kHz	40 + 2.5
	1Hz - 100kHz	60 + 2.5
1000.000V	40Hz - 10kHz	40 + 10
	10Hz - 30kHz	80 + 10
RESISTANCE		
10.000 000Ω		0.2 + 1
100.000 000Ω		0.2 + 0.1
1.000 000 00kΩ		0.2 + 0.1
10.000 000 0kΩ		0.2 + 0.1
100.000 000kΩ		0.2 + 0.05
1.000 000 00MΩ		0.3 + 0.05
10.000 000 0MΩ		2 + 0.05
100.000 0MΩ		40 + 1
1.000 000GΩ		400 + 1

NOTES

- [1] The specifications above do not include any noise or drift in the source being measured.
- [2] Valid for temperatures of 23°C ± 1°C.

ADDITIONAL ERRORS AS A FUNCTION OF MODE

FUNCTION	DIGITS	READ RATE (Readings/s) [5]				ADDITIONAL ERRORS \pm (ppmR + ppmFS)		
		Normal		Fast		Normal	Fast	
DCV Resistance [1]	8	1/25		1/6		0 + 0	0 + 0.1	
	7	1/6		1/2		0 + 0.1	0 + 0.4	
	6	2		35		0 + 0.5	0 + 3	
	5	35		150		0 + 5	0 + 30	
	4	35		150		0 + 50	0 + 50	
ACV [3] ACI [4]	Transfer Off	6	3	1	1/2.5	1/25	200 + 20	
		5	4	1	1/2.5	1/25	200 + 20	
		4	4	1	1/2.5	1/25	200 + 20	
	Transfer On	6	1	1/2	1/5	1/50	0 + 0	
		5	2	1/2	1/5	1/50	0 + 5	
		4	2	1/2	1/5	1/50	0 + 50	
			100Hz	40Hz	10Hz	1Hz		

NOTES

- [1] True Ohms - varies between 1 reading/sec and 1 reading/20 secs, depending on Filter and Range selections.
- [2] Maximum DCI resolution is 6.5 digits.
- [3] Assumes frequency monitor is set to Fast Gate.
- [4] Maximum ACI resolution is 5.5 digits. Read rate same as ACV Transfer Off. Additional error is 0 + 0.
- [5] Choice of system controller, algorithm and language can affect these figures.

OTHER SPECIFICATIONS

DCV	Type	Multi-slope, multi-cycle A-D converter.
	CMRR (1k Ω unbalanced):	140dB at DC >80dB + NMRR at 1-60Hz
	NMRR:	filter out 60dB at 50/60Hz \pm 0.9%
		filter in 110dB at 50/60Hz
	Protection:	all ranges 1kV rms
	Input Impedance:	
		0.1V to 10V ranges >10,000M Ω
		100V & 1000V ranges 10M Ω \pm 0.1%
	Max Input Current:	50pA
	Ratio Accuracy:	\pm (Net ChA Accuracy + Net ChB Accuracy)
Settling Time:		
	To 10ppm step size	
	filter out	<50ms
	filter in	<1s

DCI	Type:	Multi-slope, multi-cycle A-D converter.
	Protection:	<2A, internally clamped; >2A, rear panel fuse.
	Ratio accuracy:	\pm (Net ChA accuracy + Net ChB accuracy).
	Settling time:	As DVC.

RESISTANCE

Type:	True 4-wire with Ohms guard. 2-wire selectable.
Max Lead Resistance:	100 Ω in any or all leads
Protection: all ranges	250Vrms
Ratio Accuracy:	\pm (Net ChA Accuracy + Net ChB Accuracy)
Settling Time:	Up to 100k Ω range generally the same as DCV, but depends on external connections.

OTHER SPECIFICATIONS (Contd.)

ACV	Type: CMRR (1k Ω unbalanced): Crest Factor: Protection: all ranges Input Impedance: DC Accuracy: (DC coupled) Ratio Accuracy: Settling Time: To 100ppm step size 100Hz 40Hz 10Hz 1Hz Frequency Resolution and Accuracy: Normal Mode: Frequency Range: Accuracy: (1 year, 13°C - 33°C) Fast Gate Mode: Frequency Range: Accuracy: (1 year, 13°C - 33°C)	True RMS, AC coupled measures AC component with up to 1000V DC bias on any range. DC coupled gives $\sqrt{(AC^2 + DC^2)}$ >90dB at DC-60Hz 5:1 at Full Range (10:1 at 25% of range) 1kV rms 1M Ω in parallel with 150pF Add $\pm(50\text{ppmR} + 20\text{ppmFS} + 20\mu\text{V})$ $\pm(\text{Net ChA Accuracy} + \text{Net ChB Accuracy})$ <500ms <1.25s <5s <50s 6.5 digits 10Hz - 1.999 900MHz $\pm 10\text{ppm}$ of reading ± 2 digits 4.5 digits 200Hz - 1.999 9MHz ± 2 digits
------------	--	--

ACI	Type: Crest Factor: Protection: Ratio Accuracy: Settling Time:	True RMS AC coupled. DC coupled gives $\sqrt{(AC^2 + DC^2)}$ 3:1 at Full Range <2A, internally clamped >2A, rear panel fuse $\pm(\text{Net ChA Accuracy} + \text{Net ChB Accuracy})$ As ACV
------------	--	--

SECTION 7 SPECIFICATION VERIFICATION

Introduction

Introduction	7-1
Equipment Requirements	7-1
User's Uncertainty Calculations	7-2
The 'Validity Tolerance'	7-2
Abbreviations Used	7-2

Verification Report Sheets

Implementation on Receipt	7-3
Implementation after User Calibrator	7-3
Preparation	7-3
DC Voltage	7-4
AC Voltage	7-5
Resistance	7-6
DC Current	7-7
AC Current	7-8

SECTION 7 SPECIFICATION VERIFICATION

Introduction

The factory calibration of the 1281 ensures traceable accuracy to national standards. Its performance is quoted in the specifications of Section 6, related to time since calibration.

On receipt, it is recommended that the instrument is thoroughly checked. This section deals with user verification of the 1281 performance to specification. Tables and calculations are provided enabling the user to verify each of the parameters listed below.

Equipment Requirements

1281 CONFIGURATIONS^[1]	EQUIPMENT REQUIRED^[2]
No Options fitted (DCV only)	Model 4708 (Option 10) or Model 4000A
+ Option 10 (DCV & ACV)	Model 4708 (Options 10 & 20) or Model 4000A & Model 4200A (Option 10)
+ Option 20 & 30 (DCV, Ω & DCI)	Model 4708 (Options 10 & 30) or Model 4000A (Option 20) } PLUS 100M Ω (4000A only) & 1G Ω Resistance Standards
+ Option 10, 20 & 30	Model 4708 (Options 10, 20 & 30) or Model 4000A (Option 20) & Model 4200A (Option 10 & 30) } PLUS 100M Ω (4000A only) & 1G Ω Resistance Standards

[1] Although the keys for all the functions are present on the front panel, certain options (ACV, Ohms, DCI and ACI) may not have been purchased. Check the option numbers quoted on the rear panel.

[2] To give the desired traceability on AC the 4200 or 4708 may require characterization.

User's Uncertainty Calculations

The accuracy and traceability of a user's standards affects the manner in which the performance of any new equipment can be verified. Users will need to evaluate the effects of the uncertainties associated with their own equipment, in conjunction with those of the instrument, therefore calculations for total tolerance limits (Validity Tolerance) are required.

The 'Validity Tolerance'

It is impossible to verify the specification of an instrument with absolute certainty, even using the original calibration equipment to make the measurements. All measurements carry a degree of uncertainty, this being quantified by the traceability of the measuring equipment to National Standards.

The measurements which follow are intended to establish that the instrument performs within its specifications, meaning it operates within the tolerance of its accumulated uncertainties. As the measurements to be taken have their own accumulated uncertainties, these must be added to those of the instrument in order to set a 'Validity Tolerance'.

The Validity Tolerance is obtained by adding together all the intervening uncertainties at the time the measurement is made. The specification sets out the worst-case allowances (relative tolerances) for the instrument's performance. For the standards equipment used, worst-case tolerances must also be assumed. Complete the following tables and calculate the validity tolerance limits using the formulae provided. If any range fails to verify and the instrument is to be returned, please be certain to include copies of the verification report sheets and give as much detail as possible.

Abbreviations Used

Hr	1281 upper relative accuracy tolerance limit
Lr	1281 lower relative accuracy tolerance limit
Uf	Factory calibration standard uncertainty relative to National Standards
Um	Sum of uncertainties from 1281 terminals through the user's measurement system to National Standards

Verification Report Sheets

Model 1281

Serial Number.....

Calibration Interval --- 90days---

Date.....

Checked by.....

Company/Dept.....

Note: It is advisable to make duplicate copies of the report sheets for future use. Check at the values shown in the tables. Contact your authorized Service Centre if the instrument fails to verify and please include copies of the completed verification report sheets if the instrument is returned.

Implementation on Receipt of Instrument

The tables in this report document provide columns to enter both the user's calculations of tolerance limits and the results of measurements made. Guidance is given in the form of calculation equations and tables to simplify the calculations. The relative accuracy tolerance figures (90 day Specification) and the factory's calibration standards uncertainty are already entered in the columns.

Implementation after User-calibration

Once the instrument has been re-calibrated against the user's standards, as in Section 8, the factory's calibration uncertainties can be ignored. Validity tolerance limits should then be recalculated to include the user's uncertainties in place of factory values.

Preparation

1. Turn on the instrument to be checked and allow at least 4 hours warm-up in the specified environment.
 2. Ensure that the calibration switch (S2) is left in the disable position.
 3. Consult the appropriate manufacturers' handbooks before connecting and operating any of their equipment.
 4. Press the 'Test' key to enter the test menu. Select 'Full'. (Full test is valid between 13°C and 33°C). Should the instrument fail, contact your local authorised Service Center, ensuring that the full circumstances of the failure are reported.
 5. If 'Spec' mode is required, select Monitor and press 'Spec'. If the instrument was last calibrated by the factory, the figures displayed in Spec Mode are relative to factory calibration standards.
 6. Although the checks are carried out with 'Corrections Off', the figures given in the tables are based on the 'Enhanced' 1 year specification. This specification is equivalent to the 1281's performance up to 90 days from the most recent external calibration, or, if the instrument has been self-calibrated, for 24 hours after Selfcal.
- Self-calibration can be repeated up to 1 year from external calibration (see page 4-58).

Section 7 - Verification

1. DC VOLTAGE Full Range Checks

1281 RANGE & 4708 output	Relative Accuracy Tolerance Limits		Factory Cal. Std Uncert'y $\pm U_f$	User's Measurement Tolerance $\pm U_m$	Validity Tolerance Limits		1281 READING
	Lower(Lr)	Higher(Hr)			Lower	Higher	
+ 100mV	+99.99930	+100.00070	0.00065mV				
- 100mV	-100.00070	-99.99930	0.00065mV				
+ 1V	+0.99999660	+1.00000340	0.00000350V				
- 1V	-1.00000340	-0.99999660	0.00000350V				
+ 10V	+9.9999680	+10.0000320	0.0000250V				
- 10V	-10.0000320	-9.9999680	0.0000250V				
+100V	+99.999360	+100.000640	0.000350V				
-100V	-100.000640	-99.999360	0.000350V				
+1000V	+999.99360	+1000.00640	0.00350V				
-1000V	-1000.00640	-999.99360	0.00350V				

On receipt from factory, Validity Tolerance Calculations:

Higher Limit = Hr + Uf + Um

Lower Limit = Lr - Uf - Um

Following User Calibration, Validity Tolerance Calculations:

Higher Limit = Hr + Um

Lower Limit = Lr - Um

2. AC VOLTAGE Full Range Checks

1281 RANGE (Tfer Mode)	4708 FREQ	Wideband Relative Accuracy Tolerance Limits		Factory Cal. Std. Uncert'y $\pm Uf$	User's Measurement $\pm Um$	Validity Tolerance Limits		1281 READING
		Lower(Lr)	Higher (Hr)			Lower	Higher	
100mV	1kHz	99.9860	100.0140	0.0155mV				
100mV	60kHz	99.9100	100.0900	0.0430mV				
1V	1kHz	0.999920	1.000080	0.000035V				
1V	60kHz	0.999300	1.000700	0.000070V				
10V	1kHz	9.99920	10.00080	0.00035V				
10V	60kHz	9.99300	10.00700	0.00070V				
100V	1kHz	99.9920	100.0080	0.0035V				
100V	60kHz	99.9300	100.0700	0.0070V				
1000V	1kHz	999.900	1000.100	0.075V				
1000V	30kHz	999.300	1000.700	0.250V				

AC VOLTAGE Linearity Checks (Performed on 10V Range)

1V	1kHz	0.99974	1.00026	0.00035V				
10V	1kHz	9.99920	10.00080	0.00035V				
19V	1kHz	18.99866	19.00134	0.00035V				

On receipt from factory, Validity Tolerance Calculations:

Higher Limit = Hr + Uf + Um

Lower Limit = Lr - Uf - Um

Following User Calibration, Validity Tolerance Calculations:

Higher Limit = Hr + Um

Lower Limit = Lr - Um

Section 7 - Verification

3. RESISTANCE Full Range Checks

1281 RANGE (4708 nom. value)	4708 Resistance Value (Vr)	δR (Vr - Nom.)	Relative Accuracy Tolerance Limits		Factory Cal. Std Uncerty $\pm U_f$	User's Measurement Tolerance $\pm U_m$	Validity Tolerance Limits		1281 READING
			Lower(Lr)	Higher(Hr)			Lower	Higher	

Normal current mode, 4 wire connection $\leq 1M\Omega$, 2 wire $\geq 10M\Omega$

10 Ω			9.999860	10.000140	0.000150				
100 Ω			99.999140	100.000860	0.000750				
1k Ω			0.99999340	1.00000660	0.00000600				
10k Ω			9.9999340	10.0000660	0.0000550				
100k Ω			99.999340	100.000660	0.001000				
1M Ω			0.99998860	1.00001140	0.00002000				
10M Ω			9.9996700	10.0003300	0.0003000				
100M Ω			99.9610	100.0390	0.0140				
1G Ω			0.996100	1.003900	0.000350				

On receipt from factory, Validity Tolerance Calculations:

$$\text{Higher Limit} = Hr + \delta R + U_f + U_m$$

$$\text{Lower Limit} = Lr + \delta R - U_f - U_m$$

Following User recalibration, Validity Tolerance Calculations:

$$\text{Higher Limit} = Hr + \delta R + U_m$$

$$\text{Lower Limit} = Lr - \delta R - U_m$$

4. DC CURRENT Full Range Checks

1281 RANGE & 4708 output	Relative Accuracy Tolerance Limits		Factory Cal. Std Uncert'y $\pm U_f$	User's Measurement Tolerance $\pm U_m$	Validity Tolerance Limits		1281 READING
	Lower(Lr)	Higher(Hr)			Lower	Higher	
+100 μ A	+99.9971	+100.0029	0.0035 μ A				
-100 μ A	-100.0029	-99.9971	0.0035 μ A				
+1mA	+0.999971	+1.000029	0.000020mA				
-1mA	-1.000029	-0.999971	0.000020mA				
+10mA	+9.99971	+10.00029	0.00020mA				
-10mA	-10.00029	-9.99971	0.00020mA				
+100mA	+99.9940	+100.0060	0.0025mA				
-100mA	-100.0060	-99.9940	0.0025mA				
+1A	+0.999830	+1.000170	0.000040A				
-1A	-1.000170	-0.999830	0.000040A				

On receipt from factory, Validity Tolerance Calculations:

$$\text{Higher Limit} = Hr + U_f + U_m$$

$$\text{Lower Limit} = Lr - U_f - U_m$$

Following User recalibration, Validity Tolerance Calculations:

$$\text{Higher Limit} = Hr + U_m$$

$$\text{Lower Limit} = Lr - U_m$$

Section 7 - Verification

5. AC CURRENT Full Range Checks

1281 RANGE (Tfer Mode)	4708 FREQ	Wideband Relative Accuracy Tolerance Limits		Factory Cal. Std. Uncert'y $\pm U_f$	User's Measurement $\pm U_m$	Validity Tolerance Limits		1281 READING
		Lower(Lr)	Higher (Hr)			Lower	Higher	
100 μ A	300Hz	99.960	100.040	0.020 μ A				
	5kHz	99.960	100.040	0.020 μ A				
1mA	300Hz	.99960	1.00040	0.00020mA				
	5kHz	.99960	1.00040	0.00020mA				
10mA	300Hz	9.9960	10.0040	0.0020mA				
	5kHz	9.9960	10.0040	0.0020mA				
100mA	300Hz	99.960	100.040	0.020mA				
	5kHz	99.960	100.040	0.020mA				
1A	300Hz	.99910	1.00090	0.00020A				
	5kHz	.99770	1.00230	0.00035A				

On receipt from factory, Validity Tolerance Calculations:

Higher Limit = Hr + Uf + Um

Lower Limit = Lr - Uf - Um

Following User recalibration, Validity Tolerance Calculations:

Higher Limit = Hr + Um

Lower Limit = Hr - Um

SECTION 8 ROUTINE EXTERNAL CALIBRATION

Introduction

Read This First	8-2
Autocal	8-2
Accuracy	8-2
Time taken to Calibrate	8-2
Internal Source Characterization	8-2
The EXT CAL Menu	8-3
General Sequence for Full Instrument Calibration	8-5
Equipment Requirements	8-6
Preparation	8-7

Calibration Routines

DC Voltage	8-8
AC Voltage (Option 10)	8-10
Resistance (Option 20)	8-14
DC Current (Option 30 with Option 20)	8-18
AC Current (Option 30 with Options 10, 12, and 20)	8-22

Entry of User's Calibration Uncertainties

Introduction	8-25
DC Voltage	8-26
DC Current	8-26
Resistance	8-26
AC Voltage	8-27
AC Current	8-30

SECTION 8 ROUTINE EXTERNAL CALIBRATION

Introduction

Read This First

To verify the instrument specification without affecting the calibration memory, please refer to Section 7 of this handbook.

For information on other forms of calibration, such as the types of repairs which must be followed by calibration, refer to Section 1 of the Calibration and Servicing handbook.

The instrument should be thoroughly checked before attempting calibration (See Section 7, Verification).

Autocal

The autocal feature allows full external calibration of all 1281 functions from the front panel (or remotely via the IEEE 488.2 Interface). Thus thermal disturbance is avoided and recalibration on a regular basis (24 hrs, if desired) is possible.

For each combination of function and range, an appropriate calibration standard is input. At each setting, one keystroke immediately calibrates to the standard by updating an internal memory. The instrument automatically determines whether the operation is to be a Zero or Nominal Full Range (range-gain) calibration; or for AC ranges whether it is to be a Zero, LF gain or HF gain calibration.

The Autocal process can operate only when the rear panel lockswitch is in the 'Enable' position.

Accuracy

In order to meet the published specification, a required resolution is given with each procedure. Lower resolutions can be used which speed up the process, but will lead to loss of accuracy.

Only one type of process (HF calibration in ACV or ACI) benefits from iteration. For other processes, allowing adequate settling time (before pressing the 'Caltrig' key) is all that is required.

A facility is provided to enter the calibration uncertainty associated with each source; this figure will be incorporated into the MONITOR SPEC readout calculation. The instrument allows one entry for each range on any function except for AC, where three uncertainties can be entered (to cover the frequency range).

Time Taken to Calibrate

It is advisable that any calibration procedure be completed within a period of 24 hours. If this is not done, full use cannot be made of the high-accuracy self-test or self-calibration.

Internal Source Characterization

The internal calibration sources used for self-calibration can be characterized only after a full external calibration. This procedure is carried out at manufacture, before the instrument is shipped.

The EXT CAL Menu



Features

N.B. It is emphasized that it is not necessary, on every occasion, to perform the full range of procedures detailed in this section. If, for instance, it is required to recalibrate a DC range every 24 hours for a particular purpose, then this does not invalidate the calibration of other functions.

The EXT CAL menu is central to the routines which are detailed in this section. It allows nominal zero and full range calibration directly, or selection of the non-nominal calibration operations of **Set** and **Std**.

The menu also offers a means of entering the user's calibration uncertainties, which are applied to calculate the specification readout function which is accessible during normal operation via the MONITOR menu.

Finally it allows access to define the passnumber and the selfcal access restraints via the LOCK selection.

Important:

In this menu the **Caltrig** key is enabled, and when pressed alters the calibration memory. To reduce the possibility of inadvertently obliterating the previous calibration, the key should only be used during a genuine recalibration.

Menu Selections

No Selection:

Once the 'Cal' annunciator on the main display is lit, the major function hard keys can be selected and the various ranges calibrated at nominal zero and full range, using the **Caltrig** direct action key.

For as long as the 'Cal' annunciator remains lit, the front panel **Cal** key accesses the EXT CAL menu directly - it does not force the repeated use of the passnumber.

Spcl:

The **Spcl** key accesses other procedures which are not required for a routine calibration. It should **only** be used as detailed in Section 1 of the Calibration and Servicing Handbook.

Set:

The **Set** feature is available in all functions, allowing the user to enter the true value of the calibration standard where it differs from nominal full range or zero.

Pressing **Set** displays the SET VALUE menu except in ACV Spot Frequency mode, when the SPOT CAL menu is displayed. Spot Frequency calibration reduces flatness errors within $\pm 10\%$ of the spot frequency.

continued overleaf

Menu Selections (continued)**Std:**

This allows the instrument to be re-standardized against a new reference value (for instance: when the International Volt is redefined). Std affects all functions and ranges.

Re-standardization should be performed using the function and range which carries the highest accuracy. It is therefore highly recommended that Std be used only on the 10V DC range or, if more convenient, on the 1V DC range.

Pressing **Std** displays the STD VALUE menu.

Spec:

This feature leads to entry of user's calibration uncertainties which are used in calculating the spec readout function.

The next menu after **Spec** is pressed depends on the function which is active:

Active Function	Menu
DCV, DCI, or Ohms:	SPEC
ACV or ACI:	FREQ BAND
ACV Spot Frequency:	SPOT SPEC

Lock:

This allows access to change both the passnumber and the selfcal enable conditions.

Pressing **Lock** displays the LOCK menu

Quit:

Exits from the EXT CAL mode; the Cal legend on the main display turns off.

Quitting from the EXT CAL menu exits via the INTERNAL SOURCE CALIBRATION menu, where, by pressing Trig, the Selfcal source can be characterized if required.

Next, quitting from the INTERNAL SOURCE CALIBRATION menu exits via the EXT CAL DUE? menu, where the next calibration date can be entered if required, before finally quitting to the CAL menu.

General Sequence for Full Instrument Calibration

(NB. to meet user's need, just one range on one function can be calibrated)

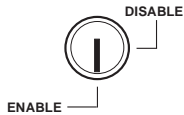

ENABLE Calibration.
Access EXT CAL menu via Passnumber (if set).



Zeros and Full Ranges (100mV to 1kV).



Zeros: 100mV to 1kV ranges (Tfer On @ 1kHz).
Gain: 10V FR @ 1kHz. Check DCcp and Tfer.
Complete all FRs @ 1kHz and 60kHz (not 1kV range).
1kV range: 500V @ 1kHz and 30kHz.



Ohms: 100Ω Range to 10MΩ Range; then LoI Ohms.
TruΩ: 10Ω Range only.
HiΩ: 100MΩ and 1GΩ Ranges.



Zeros and Full Ranges



Zeros (10% of range on 100μA range - 1% for all other zeros).
Full Ranges at 300Hz (LF).

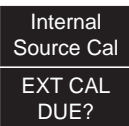

Quit the EXT CAL menu.
Characterize the instrument's internal calibration source for Selfcal?
Set the date for the next external calibration?

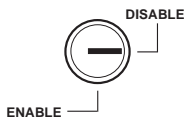

Turn the rear panel lockswitch to DISABLE.

Equipment Requirements

The equipment required for calibration is dependent on the options fitted:

1281 CONFIGURATIONS	*EQUIPMENT REQUIRED	
No Options fitted	Model 4708 (Opt. 10) or Model 4000A	
+ Option 10 (DCV & ACV)	Model 4708 (Opt. 10 & 20) or Model 4000A & Model 4200/A (Opt. 10)	
+ Option 20 & 30 (DCV, Ω & DCI)	Model 4708 (Opts. 10 & 30) or Model 4000A (Opt. 20)	PLUS 100M Ω & 1G Ω Resistance Standards
+ Option 10, 20 & 30 (DCV, ACV, Ω , DCI & ACI)	Model 4708 (Opts. 10, 20 & 30) or: Model 4000A (Opt. 20) and Model 4200/A (Opts. 10 & 30)	PLUS 100M Ω & 1G Ω Resistance Standards

*To give the desired traceability, the 4200 or 4708 used may require characterization.

Preparation

NB. The following procedures represent the recommended order of calibration, giving all the necessary setting-up commands.

1. Leave the instrument to warm-up in the specified environment for at least 4 hours.

2. Set the rear panel keyswitch to 'Enable'.

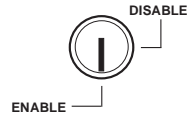

3. Press the **Reset** key; this forces the power-on-state defaults (the input zero stores are unaffected) and displays the DCV menu.

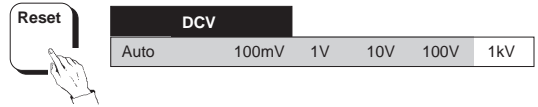

4. Press the **Cal** key.
The CAL menu is displayed.



6. Press **Ext** to select the external calibration menu. If the instrument is passnumber protected, the PASS# menu appears (see page 4-48). You must supply a valid passnumber to proceed.

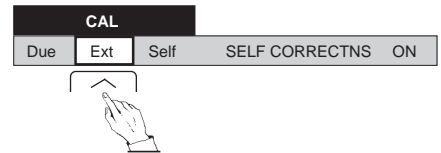

The external calibration menu appears as shown, and the **cal** annunciator lights on the main display.



DC VOLTAGE CALIBRATION (Zero and Full Range)**Initial 1281 Setup**

1. Press the **DCV** key; select the **100mV** range.

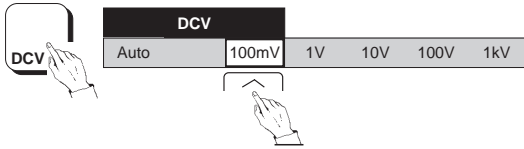

2. Press the **Config** key; select **Filt.**
3. Press the **Resl** key and select the resolution that you desire (default is 7 for full published specification).
4. Reselect **DCV**.

Connect 1281 to Calibrator

WARNING THIS INSTRUMENT CAN DELIVER A LETHAL ELECTRIC SHOCK. NEVER TOUCH ANY LEAD OR TERMINAL UNLESS YOU ARE ABSOLUTELY CERTAIN THAT NO DANGEROUS VOLTAGE IS PRESENT.



MAKE SURE THAT SIGNAL LEADS ARE IN A SAFE CONDITION BEFORE YOU HANDLE THEM ANY WAY.



FIT THE REAR TERMINAL COVER PLATE WHEN THE REAR INPUTS ARE NOT IN USE.



1. Ensure that the calibrator **OUTPUT** is **OFF** and **Local Guard** is selected.
2. Connect the Calibrator to the 1281 (Refer to pages 4-2 and 4-6 in Section 4)

To Calibrate DC Voltage at Nominal or Non-Nominal Values

After the initial setup and connecting up, use the following general sequence to calibrate zero, then positive and negative full range on all DCV ranges. Just one range can be calibrated if required, but for a full calibration start with the 100mV range and work up to the 1kV range.

Nominal: To calibrate at Nominal values, **omit** the operations in the shaded boxes .

Non-Nominal: The **Set** feature allows a user to enter the true output value of the calibration standard where it differs from nominal full range or zero. In this case **include** the shaded operations .

Zero Point

1281

Ensure that the required Range is selected.

Calibrator

Select Range, Zero Output and Output ON.

1281

Press the **Cal** key to see the EXT CAL menu.
Select **Set**.

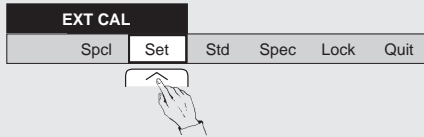

The SET VALUE menu always shows 8.5 digits resolution.



Using the **numeric** keys, **key in** the true output value of the standard, then press the **Enter** key.

1281

Press **Caltrig**. Calibration is complete when the **Busy** legend goes out.

Full Range Point

Calibrator

Select Full Range Output.

1281

Press the **Cal** key to revert to EXT CAL menu.
Select Set. Use the **numeric** keys with the SET VALUE menu to **key in** the true output value of the calibrator (as for the zero point, but now at its full range value), then press **Enter**.

1281

Press **Caltrig**. Calibration is complete when the **Busy** legend goes out.

Calibrator

Set Output OFF.

Press the **DCV** key to revert to the ranges menu.

AC VOLTAGE CALIBRATION (Nominal)**Initial 1281 Setup**

1. Press the **ACV** key; select the **100mV** range.

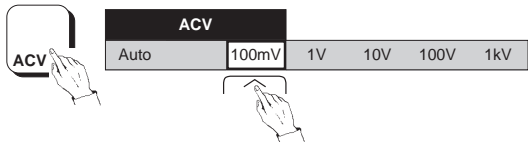
**Note:**

- When entering Cal mode, AC-DC transfer defaults to On for enhanced performance. Resolution defaults to '6' and the appropriate low frequency filter is automatically selected.

Connect 1281 to Calibrator

WARNING THIS INSTRUMENT CAN DELIVER A LETHAL ELECTRIC SHOCK. NEVER TOUCH ANY LEAD OR TERMINAL UNLESS YOU ARE ABSOLUTELY CERTAIN THAT NO DANGEROUS VOLTAGE IS PRESENT.



MAKE SURE THAT SIGNAL LEADS ARE IN A SAFE CONDITION BEFORE YOU HANDLE THEM ANY WAY.



FIT THE REAR TERMINAL COVER PLATE WHEN THE REAR INPUTS ARE NOT IN USE.



1. Ensure that the calibrator **OUTPUT** is **OFF** and **Local Guard** is selected.
2. Connect the Calibrator to the 1281 (Refer to pages 4-2, 4-6 and 4-10 in Section 4).

To Calibrate at Nominal Values (For Non-Nominal see page 8-12)

Using the following general sequence, starting with the 100mV range, calibrate all ranges at the frequencies and nominal values detailed in the table.

Note:

On each range, the 1281 recognizes either 10% or 1% of Full Range value as range zero (see table).

1281

Select the required Range.

Calibrator

Select Range, Frequency and Output Voltage.
Set Output ON.

1281

Press **Caltrig**. Calibration is complete when the **Busy** legend goes out.

Calibrator

Set Output OFF.

1281

Press the **ACV** key to revert to the ranges menu.

1281 Range	CALIBRATOR	
	Output	Frequency

LF

100mV	10mV (10%FR)	1kHz
100mV	Full Range	1kHz
1V	10mV (1%FR)	1kHz
1V	Full Range	1kHz
10V	100mV (1%FR)	1kHz
10V	Full Range	1kHz
100V	1V (1%FR)	1kHz
100V	Full Range	1kHz
1000V	10V (1%FR)	1kHz
1000V	Full Range	1kHz

HF (Iteration can improve the result)

100mV	Full Range	60kHz
1V	Full Range	60kHz
10V	Full Range	60kHz
100V	Full Range	60kHz
1000V	Full Range	30kHz

AC VOLTAGE CALIBRATION (contd.)**To Calibrate at Non-Nominal Values (not in Spot Frequency mode)**

The **Set** feature allows a user to enter the true RMS value of the calibration standard where it differs from nominal full range or zero.

After the initial setup and connecting up, use the following general sequence, starting with the 100mV range, to calibrate all ACV ranges at the frequencies detailed in the table.

It is also preferable to choose calibration values close to those in the table.

All Points**1281**

Select the required Range.

Calibrator

Select Range, Output value and Output ON.

1281

Select **Set** from the EXT CAL menu.

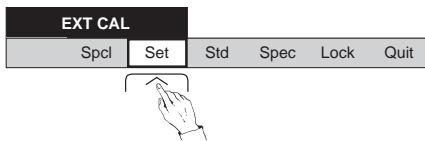

The SET VALUE menu always shows 8.5 digits resolution.



Using the **numeric** keys, **key in** the normalized true RMS output value of the standard, then press the **Enter** key.

Press **Caltrig**. Calibration is complete when the **Busy** legend goes out.

Calibrator

Set Output OFF.

1281	CALIBRATOR	
Range	Output	Frequency

LF

100mV	10mV (10%FR)	1kHz
100mV	Full Range	1kHz
1V	10mV (1%FR)	1kHz
1V	Full Range	1kHz
10V	100mV (1%FR)	1kHz
10V	Full Range	1kHz
100V	1V (1%FR)	1kHz
100V	Full Range	1kHz
1000V	10V (1%FR)	1kHz
1000V	Full Range	1kHz

HF (Iteration can improve the result)

100mV	Full Range	60kHz
1V	Full Range	60kHz
10V	Full Range	60kHz
100V	Full Range	60kHz
1000V	Full Range	30kHz

AC VOLTAGE CALIBRATION (contd.)

To Calibrate at Spot Frequencies

Spot Calibration is available only when in AC Voltage function with Spot already selected on the ACV CONFIG menu. Each spot (six per range) can be calibrated at a valid input frequency to a non-nominal RMS value. In subsequent use, flatness errors are reduced within $\pm 10\%$ of the calibrated spot frequency.

Assuming that the instrument is in external calibration mode and the setup is connected as described on page 8-10, configuration defaults to **Tfer** and **RESL6** (both required). Proceed as follows:

Re-select **ACV** and select the required Range.

The SPOT ($x = 1$ to 6) RMS menu is displayed.

Press the **Config** key and select **Spot**.

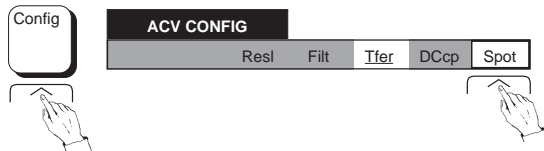

Key in the true RMS output value of the standard, then select **Enter**. The SPOT FREQUENCY menu is displayed, showing the frequency at which the spot will be calibrated.

Press the **Cal** key. The EXT CAL menu is displayed. Select **Set**.

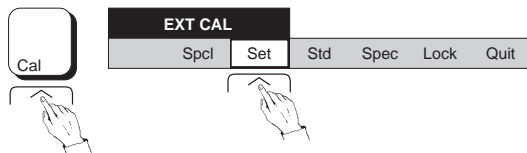

Press **Caltrig**. Calibration is complete when the **Busy** legend goes out. The display reverts to the SPOT CAL menu.

The SPOT CAL menu is displayed. Select the soft key for the required spot, 1 to 6 (**Sp1** to **Sp6**).



Calibrator - set output OFF.

1281 - select other spots as required, repeating the process for each selection. Exit from the SPOT CAL menu by pressing any hard key.

RESISTANCE CALIBRATION

Normal 'Ohms' Sub-Function

Initial 1281 Setup

1. Press the **OHMS** key and select the **100Ω** range.
2. Press the **CONFIG** key and select **Filt** and **4wΩ**.

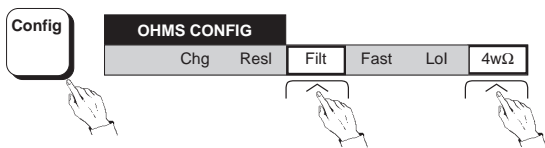

3. Press the **RESL** key and select the resolution that you desire (7 digits for full published specification).
4. Reselect **OHMS**.

Connect 1281 to Calibrator

1. Ensure that the calibrator **OUTPUT** is **OFF** and **Local Guard** is selected.
2. Connect the Calibrator or standard 100Ω resistor in '4-wire' to the 1281.
(Refer to pages 4-2 and 4-14 in Section 4)

Note: In a noisy environment, it may be advisable to use the '4-Wire High Resistance' connections on page 4-15 for the higher Ohms ranges.

To Calibrate Normal Ohms at Nominal or Non-Nominal Values

After the initial setup and connecting up, use the following general sequence, starting with the 100Ω range, to calibrate zero and full range on all normal Ohms ranges.

'Resistance Standard'

The 1281 can be calibrated using the ohms ranges of a calibrator such as the Wavetek 4000A or 4708, or against Standard Resistors. In the procedure, a general term (Resistance Standard) is used to refer to either of these.

Refer to the manufacturers' handbooks for the specifics of operating these items.

LoI Facility Calibration

This procedure automatically calibrates the low-current facility on each range as it performs the normal calibration.

continued next page

Nominal (only valid if the Calibrator or Standard Resistor is known to be at the Nominal Full Range value): **omit** the operations in the shaded boxes.

Non-Nominal: The **Set** feature allows a user to enter the true value of the Resistance Standard where it differs from nominal full range or zero.

In this case **include** the shaded operations.

Zero Point

1281

Ensure that the required Range is selected.

Resistance Standard

Connect as a true 4-wire zero (page 4-15).

1281

Press the **Cal** key to see the EXT CAL menu.
Select **Set**.

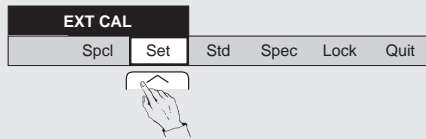

The SET VALUE menu always shows 8.5 digits resolution.



Using the **numeric** keys, **key in** the true zero value of the Standard, then press the **Enter** key.

1281

Press **Caltrig**. Calibration is complete when the **Busy** legend goes out.

Full Range Point

Resistance Standard

Connect in '4-Wire' (page 4-14).

1281

Press the **Cal** key to revert to EXT CAL menu.
Select **Set**. Use the **numeric** keys with the SET VALUE menu to **key in** the true value of the Resistance Standard (as for the zero point, but now at its full range value), then press **Enter**.

1281

Press **Caltrig**. Calibration is complete when the **Busy** legend goes out.

Press the **Ohms** key for the ranges menu.

Other Normal Ohms Ranges

Repeat the calibration for the other Ohms ranges, selecting the appropriate value of Resistance Standard for the range being calibrated, and using the 'Set' facility as required.

Note: The identical ranges in **TruΩ** sub-function are automatically calibrated at the same time as those of the **Ohms** sub-function.

HiΩ Sub-Function

This procedure assumes that Normal Ohms calibration has been successfully completed (page 8-14)

Connect 1281 to Standard Resistor

It would be unusual for a calibrator to have a sufficiently accurate 100MΩ or 1GΩ range, so this procedure calibrates against Standard Resistors.

- 1. If a calibrator is already connected:**
Ensure that the calibrator OUTPUT is OFF and Local Guard is selected. Disconnect the calibrator from the 1281.
- Connect a standard resistor to the 1281 in '4-Wire High Resistance'.
(Refer to pages 4-2 and 4-15 in Section 4)

1281 Setup in HiΩ (from Normal Ohms)

Press the **Config** key. The OHMS CONFIG menu appears. Press the **Chg** key.

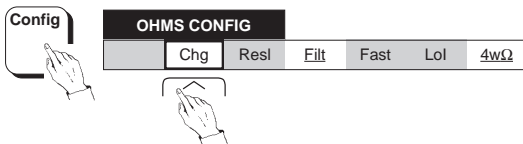

The CHANGE Ω menu appears;
Select **HiΩ**.

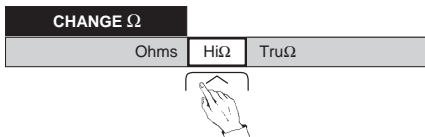

The HI Ω menu appears;
Select **100MΩ**.



Press the **Config** key. The HIΩ CONFIG menu appears. Select **Filt** and **4wΩ**.

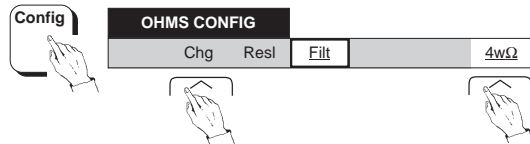

Reselect **HIΩ** using **OHMS** key.



continued next page

To Calibrate Hi Ω at Nominal or Non-Nominal Values

Nominal (only valid if the Resistance Standard is known to be at Nominal Zero or Full Range value): **omit** the operations in the shaded boxes.

Non-Nominal: The **Set** feature allows a user to enter the true value of the Resistance Standard where it differs from nominal full range or zero.

In this case **include** the shaded operations.

Zero Point

1281

Ensure that the 100M Ω range is selected.

Resistance Standard

Connect as a true 4-wire zero (page 4-15).

1281

Press the **Cal** key to see the EXT CAL menu.
Select **Set**.

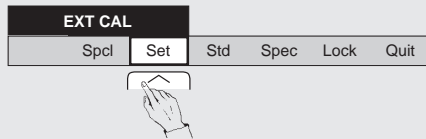

The SET VALUE menu always shows 8.5 digits resolution.



Using the **numeric** keys, **key in** the true zero value of the Standard, then press the **Enter** key.

1281

Press **Caltrig**. Calibration is complete when the **Busy** legend goes out.

Full Range Point

Resistance Standard

Connect in '4-Wire High Resistance' (page 4-15).

1281

Press the **Cal** key to revert to EXT CAL menu.
Select **Set**. Use the **numeric** keys with the SET VALUE menu to **key in** the true value of the Resistance Standard (as for the zero point, but now at its full range value), then press **Enter**.

1281

Press **Caltrig**. Calibration is complete when the **Busy** legend goes out.
Press the **Ohms** key for the HI Ω ranges menu.

1 G Ω Range

Repeat the calibration for the 1G Ω range using a 1G Ω Resistance Standard, using the 'Set' facility as required.

TruΩ Sub-Function

This procedure assumes that Normal Ohms calibration has been successfully completed (page 8-14)

If normal Ohms calibration is successfully completed, all the TruΩ ranges other than the 10Ω range will have been calibrated automatically. The following procedure calibrates the 10Ω range.

On entry to Cal mode, resolution defaults to 6 digits. Select RESL 7 for full published specification:

1281 Setup in TruΩ

Press the **Config** key. The OHMS CONFIG or HIΩ CONFIG menu appears. Press the **Chg** key.

The CHANGE Ω menu appears;
Select **TruΩ**.

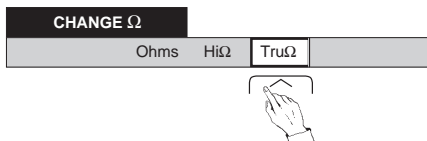

The TRU Ω menu appears;
Select **10Ω**.

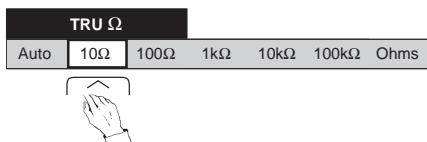

Press the **Config** key for the TRUΩ CONFIG menu and select **Filt**.

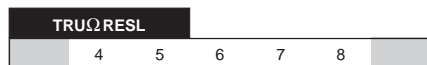
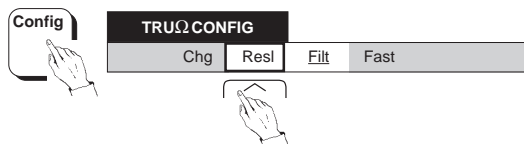
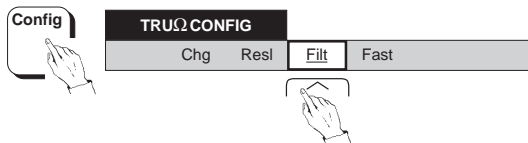

Reselect **TRUΩ** using **OHMS** key.

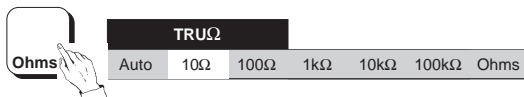

Connect 1281 to Standard Resistor

1. **If a calibrator is already connected:**
Ensure that the calibrator OUTPUT is OFF and Local Guard is selected.
2. Connect the calibrator or a standard resistor to the 1281 in '4-Wire'.
(Refer to pages 4-2 and 4-14 in Section 4)

continued next page

To Calibrate Tru Ω at Nominal or Non-Nominal Values

Nominal (only valid if the Resistance Standard is known to be at Nominal Zero or Full Range value): **omit** the operations in the shaded boxes.

Non-Nominal: The **Set** feature allows a user to enter the true value of the Resistance Standard where it differs from nominal full range or zero.

In this case **include** the shaded operations.

Zero Point

1281

Ensure that the 10 Ω range is selected.

Resistance Standard

Connect as a true 4-wire zero (page 4-15).

1281

Press the **Cal** key to see the EXT CAL menu.
Select **Set**.

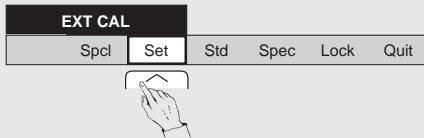

The SET VALUE menu always shows 8.5 digits resolution.



Using the **numeric** keys, **key in** the true zero value of the Standard, then press the **Enter** key.

1281

Press **Caltrig**. Calibration is complete when the **Busy** legend goes out.

Full Range Point

Resistance Standard

Connect in '4-Wire' (page 4-14).

1281

Press the **Cal** key to revert to EXT CAL menu.
Select **Set**. Use the **numeric** keys with the SET VALUE menu to **key in** the true value of the Resistance Standard (as for the zero point, but now at its full range value), then press **Enter**.

1281

Press **Caltrig**. Calibration is complete when the **Busy** legend goes out.

To Calibrate other TRU Ω Ranges

This is **not necessary** if the normal Ohms sub-function has just been calibrated, because the matching Tru Ω ranges will have been calibrated at the same time.

To calibrate individual Tru Ω ranges, repeat the steps above for each range using the appropriate resistance standard.

DC CURRENT CALIBRATION (Zero and Full Range)**Initial 1281 Setup**

1. Press the **DCI** key; select the **100 μ A** range.

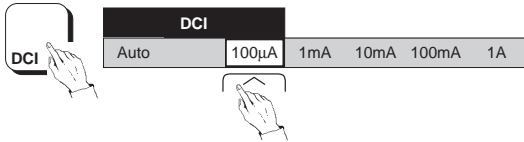

Note: When entering Cal mode, the resolution defaults to '6'.

Connect 1281 to Calibrator

WARNING THIS INSTRUMENT CAN DELIVER A LETHAL ELECTRIC SHOCK. NEVER TOUCH ANY LEAD OR TERMINAL UNLESS YOU ARE ABSOLUTELY CERTAIN THAT NO DANGEROUS VOLTAGE IS PRESENT.



MAKE SURE THAT SIGNAL LEADS ARE IN A SAFE CONDITION BEFORE YOU HANDLE THEM ANY WAY.



FIT THE REAR TERMINAL COVER PLATE WHEN THE REAR INPUTS ARE NOT IN USE.



1. Ensure that the calibrator OUTPUT is OFF and Local Guard is selected.
2. Connect the Calibrator to the 1281 (Refer to pages 4-18 and 4-2 in Section 4)

continued next page

To Calibrate DC Current at Nominal or Non-Nominal Values

After the initial setup and connecting up, use the following general sequence to calibrate zero, then positive and negative full range on all DCI ranges. Just one range can be calibrated if required, but for a full calibration start with the 100 μ A range and work up to the 1A range.

Nominal: To calibrate at Nominal values, **omit** the operations in the shaded boxes .

Non-Nominal: The **Set** feature allows a user to enter the true output value of the calibration standard where it differs from nominal full range or zero. In this case **include** the shaded operations .

Zero Point

1281

Ensure that the required Range is selected.

Calibrator

Select Range, Zero Output and Output ON.

1281

Press the **Cal** key to see the EXT CAL menu.
Select **Set**.

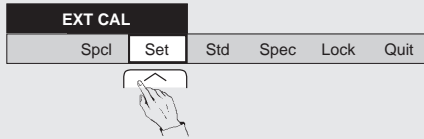

The SET VALUE menu always shows 8.5 digits resolution.



Using the **numeric** keys, **key in** the true output value of the standard, then press the **Enter** key.

1281

Press **Caltrig**. Calibration is complete when the **Busy** legend goes out.

Full Range Point

Calibrator

Select Full Range Output.

1281

Press the **Cal** key to revert to EXT CAL menu.
Select Set. Use the **numeric** keys with the SET VALUE menu to **key in** the true output value of the calibrator (as for the zero point, but now at its full range value), then press **Enter**.

1281

Press **Caltrig**. Calibration is complete when the **Busy** legend goes out.

Calibrator

Set Output OFF.

Press the **DCI** key to revert to the ranges menu.

AC CURRENT CALIBRATION (Nominal)

Initial 1281 Setup

1. Press the **ACI** key; select the **100 μ A** range.

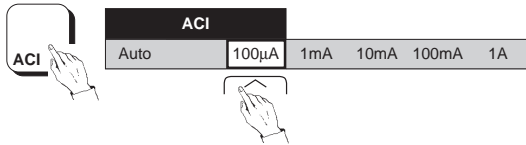

Notes:

- When entering Cal mode, resolution defaults to '5', and an appropriate low frequency filter is automatically selected.

Connect 1281 to Calibrator

WARNING THIS INSTRUMENT CAN DELIVER A LETHAL ELECTRIC SHOCK. NEVER TOUCH ANY LEAD OR TERMINAL UNLESS YOU ARE ABSOLUTELY CERTAIN THAT NO DANGEROUS VOLTAGE IS PRESENT.



MAKE SURE THAT SIGNAL LEADS ARE IN A SAFE CONDITION BEFORE YOU HANDLE THEM ANY WAY.



FIT THE REAR TERMINAL COVER PLATE WHEN THE REAR INPUTS ARE NOT IN USE.



1. Ensure that the calibrator OUTPUT is OFF and Local Guard is selected.
2. Connect the Calibrator to the 1281 (Refer to pages 4-20 and 4-2 in Section 4).

continued next page

AC CURRENT CALIBRATION (contd.)**To Calibrate at Nominal Values** (For Non-Nominal see next page)

Use the following general sequence to calibrate zero and full range. Just one range can be calibrated if required, but for a full calibration on all ACI ranges follow the order detailed in the table.

Note:

On each range, the 1281 recognizes either 10% or 1% of Full Range value as range zero (see table).

1281

Select the required Range.

Calibrator

Select Range, Frequency and Output Current.
Set Output ON.

1281

Press **Caltrig**. Calibration is complete when the **Busy** legend goes out.

Calibrator

Set Output OFF.

1281

Press the **ACI** key to revert to the ranges menu.

1281 Range	CALIBRATOR	
	Output	Frequency

LF

100μA	10μA (10%FR)	300Hz
100μA	Full Range	300Hz
1mA	10μA (1%FR)	300Hz
1mA	Full Range	300Hz
10mA	100μA (1%FR)	300Hz
10mA	Full Range	300Hz
100mA	1mA (1%FR)	300Hz
100mA	Full Range	300Hz
1A	10mA (1%FR)	300Hz
1A	Full Range	300Hz

HF

100μA	Full Range	5kHz
1mA	Full Range	5kHz
10mA	Full Range	5kHz
100mA	Full Range	5kHz
1A	Full Range	5kHz

To Calibrate at Non-Nominal Values

The **Set** feature allows a user to enter the true RMS value of the calibration standard where it differs from nominal full range or zero.

After the initial setup and connecting up, use the following general sequence to calibrate zero and full range. Just one range can be calibrated if required, but for a full calibration on all ACI ranges follow the order detailed in the table.

It is also preferable to choose calibration values close to those in the table.

All Points

1281

Select the required Range.

Calibrator

Select Range, Output value and Output ON.

1281

Select **Set** from the EXT CAL menu.

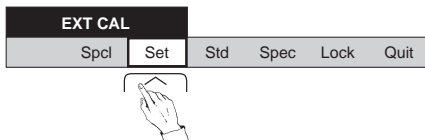

The SET VALUE menu always shows 8.5 digits resolution.



Using the **numeric** keys, **key in** the normalized true RMS output value of the standard, then press the **Enter** key.

Press **Caltrig**. Calibration is complete when the **Busy** legend goes out.

Calibrator

Set Output OFF.

1281	CALIBRATOR	
Range	Output	Frequency

LF

100μA	10μA (10%FR)	300Hz
100μA	Full Range	300Hz
1mA	10μA (1%FR)	300Hz
1mA	Full Range	300Hz
10mA	100μA (1%FR)	300Hz
10mA	Full Range	300Hz
100mA	1mA (1%FR)	300Hz
100mA	Full Range	300Hz
1A	10mA (1%FR)	300Hz
1A	Full Range	300Hz

HF

100μA	Full Range	5kHz
1mA	Full Range	5kHz
10mA	Full Range	5kHz
100mA	Full Range	5kHz
1A	Full Range	5kHz

ENTRY OF USER'S CALIBRATION UNCERTAINTIES**Introduction**

In normal use, the 1281 is able to provide a readout of the accuracy of its currently-displayed measurement. This readout appears on the dot-matrix display when accessed via the MONITOR menu, and includes elements accounting for calibration uncertainty. When the instrument is delivered from manufacture, these elements represent the manufacturer's traceability, relative to National Standards.

Recalibration invalidates the SPEC readout unless the manufacturer's uncertainties are replaced by those of the calibration standards used. For those users wishing to restore the validity of the readout, the following procedures detail the steps in entering user's calibration uncertainties in place of manufacturer's.

As the requirements can vary between functions, ranges, specification period and the uncertainties of the individual items of standards equipment in the traceability path; several procedural routes have been provided (refer to Section 4, page 4-43 - 4-45). Therefore each function has its own appropriate instructions to enter the relevant uncertainties. In the following pages, similar versions are grouped.

Entry of User's Calibration Uncertainties - DC Voltage or DC Current Functions

The starting point is the EXT CAL menu (any range).

Press the **Spec** key.

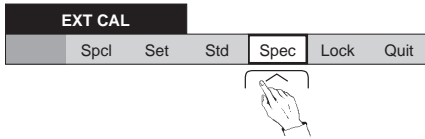

The SPEC menu appears.

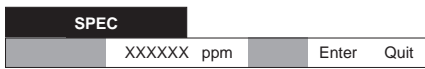

To escape from the SPEC menu to the EXT CAL menu without affecting the stored uncertainty, press **Quit**.

To change the stored uncertainty:

Using the **numeric** keys, **key in** the requisite calibration uncertainty in parts per million, then press the **Enter** key. As the figures are stored, the display reverts to the EXT CAL menu.

Repeat for the other DCV or DCI ranges.

Entry of User's Calibration Uncertainties - Resistance Function

For the resistance ranges, calibrating on the normal Ohms ranges also calibrates LoI and the identical Tru Ω ranges. Similarly, by entering the calibration uncertainties for the Ohms ranges, the same figures are employed in calculating the uncertainty element for corresponding LoI and Tru Ω ranges. After entering the figures for normal Ohms, only the two Hi Ω ranges and the Tru Ω 10 Ω range are not covered, so the uncertainties for these should be entered separately.

Enter the appropriate uncertainties, selecting the relevant resistance modes for the ranges as listed below, using the same procedure as for DCV and DCI:

Ohms: 100 Ω , 1k Ω , 10k Ω , 100k Ω , 1M Ω & 10M Ω . **Hi Ω :** 100M Ω & 1G Ω . **Tru Ω :** 10 Ω .

Entry of User's Calibration Uncertainties - AC Voltage or Current Functions**AC Voltage Frequency Bands**

For AC Voltage, the procedure for entry of user's calibration uncertainties (given on page 8-28) employs the FREQ BAND menu. There are six soft keys, each labelled with a frequency value. These labels should be regarded only as symbols, each representing the highest frequency in a band.

The specification readout, accessed in normal use via the MONITOR menu, is valid only between the frequencies of 40Hz and 1MHz. Thus the calibration uncertainties are not required (and cannot be entered) outside this range.

As can be seen from Section 6, the uncertainties inherent in the measurement of AC Voltage are minimized between 100Hz and 2kHz. It is expected that user's equipment used to verify the accuracy of the 1281, or calibrate it, will possess a similar uncertainty spectrum.

So the uncertainties to be entered by the user will naturally fall into frequency bands. The seven bands provided via the six keys of the menu (listed in the table opposite) should prove the most useful for this purpose.

The bands are indexed in the table by their selection symbols from the menu. Uncertainties entered in the SPEC menu after selecting a particular key will apply only to that band (with the one exception - <10k - see the table).

Spot Frequency Calibration Uncertainties

Each spot (from six per range) can be calibrated at a valid input frequency. In subsequent use, flatness errors are reduced within $\pm 10\%$ of the calibrated spot frequency. See page 8-29 for the calibration procedure.

AC Current Frequency Bands

For AC Current, the procedure for entry of user's calibration uncertainties (given on page 8-30) employs the FREQ BAND menu.

The specification readout is valid only between 40Hz and 5kHz for AC Current.

Two soft keys are used, for the two bands provided in the menu:

- <1k = 40Hz to 1kHz;
- <5k = 1kHz to 5kHz.

Uncertainties entered in the SPEC menu after selecting a key will apply only to that key's band.

Entry of Uncertainties - AC Voltage Function (not Spot)

The starting point is the EXT CAL menu (any range).

Press the **Spec** key.

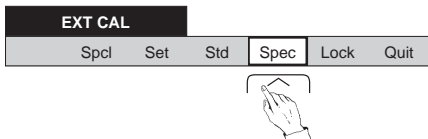

For each of the selections, the **SPEC** menu is displayed, and the calibration uncertainty for that frequency band can be entered.

The **FREQ BAND** menu appears, defining six *band selection* keys:



Press the <2k frequency band key.
The **SPEC** menu appears.

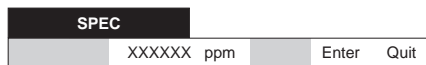

The table shows how the six soft keys select seven frequency bands over which the uncertainties will be applied.

To escape from the **SPEC** menu to the **EXT CAL** menu without affecting the stored uncertainty: Press **Quit**.

Selection Key	Frequency Band
<2k	100Hz to 2kHz
<10k	{ 2kHz to 10kHz 40Hz to 100Hz
<30k	10kHz to 30kHz
<100k	30kHz to 100kHz
<300k	100kHz to 300kHz
<1M	300kHz to 1MHz

To change the stored uncertainty: Using the **numeric** keys, **key in** the requisite calibration uncertainty in parts per million, then press the **Enter** key. As the figures are stored, the dot-matrix display reverts to the **EXT CAL** menu.

Repeat for each of the six band selection keys.

Note that when an uncertainty value is entered via the **<10k** key for the 2kHz to 10kHz band; the same value is applied both when the input frequency is between 2kHz and 10kHz, and when it is between 40Hz and 100Hz.

Entry of Uncertainties - AC Voltage Spot Frequency Function

The starting point is the EXT CAL menu with Spot already selected (any range).

Press the **Spec** key.

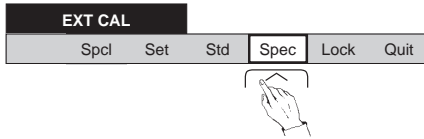

The SPOT SPEC menu appears, defining six *spot selection* keys:

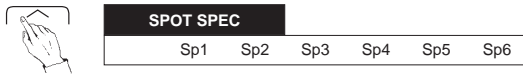

Select the spot that you wish to calibrate.

The SPEC menu appears.

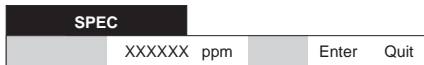

To escape from the SPEC menu to the EXT CAL menu without affecting the stored uncertainty:

Press **Quit**.

To change the stored uncertainty:

Using the **numeric** keys, **key in** the requisite calibration uncertainty in parts per million, then press the **Enter** key. As the figures are stored, the dot-matrix display reverts to the EXT CAL menu.

Repeat for each spot that you wish to calibrate.

Entry of Uncertainties - AC Current Function

The starting point is the EXT CAL menu (any range).

Press the **Spec** key.

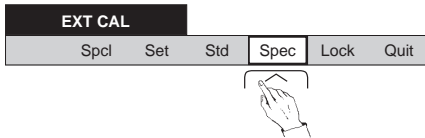

The **FREQ BAND** menu appears, defining two *band selection* keys:



For each selection, the **SPEC** menu is displayed, and the calibration uncertainty for that frequency band can be entered.

Press the <1k frequency band key.

The **SPEC** menu appears.

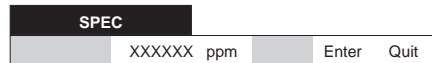

To escape from the **SPEC** menu to the **EXT CAL** menu without affecting the stored uncertainty: Press **Quit**.

To change the stored uncertainty:

Using the **numeric** keys, **key in** the requisite calibration uncertainty in parts per million, then press the **Enter** key. As the figures are stored, the dot-matrix display reverts to the **EXT CAL** menu.

Repeat for the <5k band selection key.

Wavetek's Regional Sales and Service Offices

CHINA

Wavetek Corporation

*Room 2701, Citic Building,
No. 19 Jianguomenwai Dajie,
Beijing 100004,
PRC*

Tel: 86 10 6592 8044

Fax: 86 10 6500 8199

UNITED KINGDOM

Wavetek Test & Measurement Division

*52 Hurricane Way,
Norwich Airport,
Norwich NR6 6JB,
England*

Tel: 44 1603 256 600

Fax: 44 1603 483 670

GERMANY

Wavetek GmbH

*Gutenbergstrasse 2-4,
85737 Ismaning
Germany*

Tel: 49 89 996 41 0

Fax: 49 89 996 41 160

UNITED STATES of AMERICA

Wavetek Corporation Sales & Service

*9045 Balboa Avenue,
San Diego,
CA 92123 USA*

Tel: 619 279 2200

Fax: 619 450 0325

www.wavetek.com