

OPERATION MANUAL

WITHSTANDING VOLTAGE TESTER

TOS5052

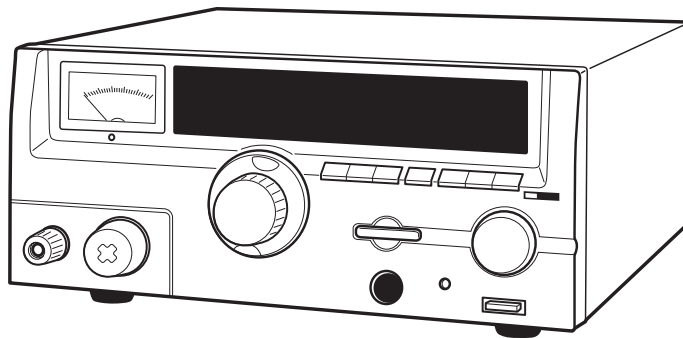

DANGER

This Tester generates high voltage.

- Any incorrect handling may cause death.
- Read Chapter 2 “WARNINGS AND CAUTIONS FOR OPERATION THE TESTER” in this manual to prevent accident.
- Keep this manual near the tester for easy access of the operator.

Use of Operation Manual

- Please read through and understand this Operation Manual before operating the product. After reading, always keep the manual nearby so that you may refer to it as needed. When moving the product to another location, be sure to bring the manual as well.
- If you find any incorrectly arranged or missing pages in this manual, they will be replaced. If the manual it gets lost or soiled, a new Operation Manual can be purchased. In either case, please contact your Kikusui agent, and provide the "Part No." given on cover.
- This manual has been prepared with the utmost care; however, if you have any questions, or note any errors or omissions, please contact your Kikusui distributor/agent.

Reproduction and reprinting of this operation manual, whole or partially, without our permission is prohibited. Both unit specifications and manual contents are subject to change without notice.

Copyright©1998-2004 Kikusui Electronics Corporation

Printed in Japan.

Power Requirements of this Product

Power requirements of this product have been changed and the relevant sections of the Operation Manual should be revised accordingly.

(Revision should be applied to items indicated by a check mark)

Input voltage

The input voltage of this product is _____ VAC,
and the voltage range is _____ to _____ VAC. Use the product within this range only.

Input fuse

The rating of this product's input fuse is _____ A, _____ VAC, and _____.

WARNING

- To avoid electrical shock, always disconnect the AC power cable or turn off the switch on the switchboard before attempting to check or replace the fuse.
- Use a fuse element having a shape, rating, and characteristics suitable for this product. The use of a fuse with a different rating or one that short circuits the fuse holder may result in fire, electric shock, or irreparable damage.

AC power cable

The product is provided with AC power cables described below. If the cable has no power plug, attach a power plug or crimp-style terminals to the cable in accordance with the wire colors specified in the drawing.

WARNING

- The attachment of a power plug or crimp-style terminals must be carried out by qualified personnel.

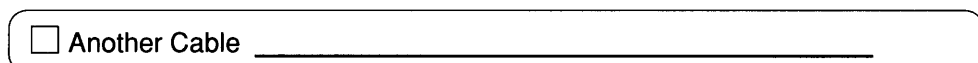
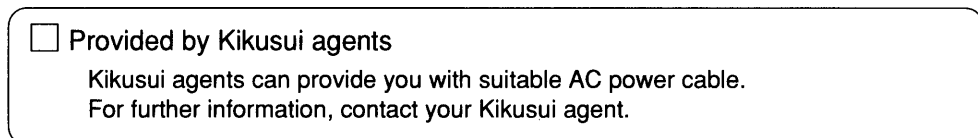
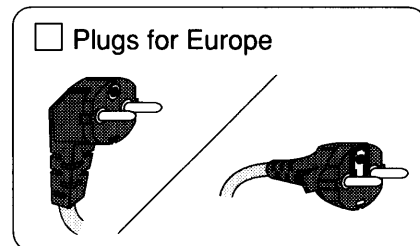
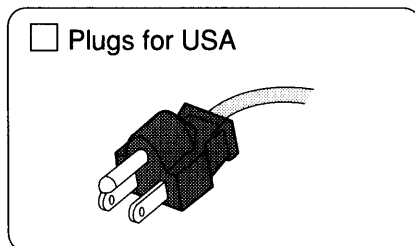
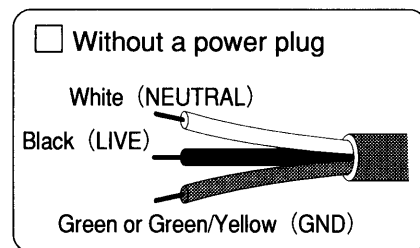
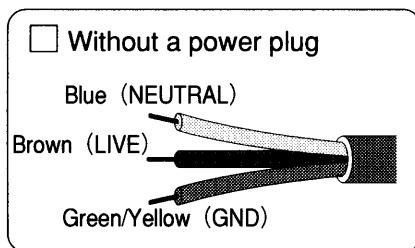

- PROGRAM Version Number -

This manual is applicable to the Tester whose PROGRAM version number is:

1.0X

When you contact us for any information about the Tester, please indicate the PROGRAM version number and the serial number of the Tester. The serial number is shown on the rear panel of the Tester. To find the PROGRAM version number, refer to Section 3.3 "Checking the Tester Operation."

- Interlock Protection -

The Tester has an interlock protection. When the Tester has arrived you and you have unpacked it, the function is effective. Therefore the Tester will not start its operation. Before operation, you must release the interlock protection. For details, see the Section entitled "Interlock Function."

To supervisor in charge of operation

- If the operator does not read the language used in this manual, translate the manual into appropriate language.
- Help the operator in understanding this manual before operation.
- Keep this manual near the Tester for easy access by the operator.

For your own safety (to avoid electrification)

While the Tester is delivering its test voltage, never touch the following areas, or else, you will be electrified, and run the risk of death by electric shock.

- the output terminal
- the test leadwires connected to the output terminal
- the Device Under Test (DUT)
- any part of the tester, which is electrically connected to the output terminal.

Also, electric shock or accident may arise in the following cases:

- the tester being operated without grounding.
- if the gloves for electrical job are not used.
- approach to any part connected to the output terminal while the power of the tester is turned on.

⚠ Safety Precautions

The following safety precautions must be observed to avoid fire hazard, electrical shock, accidents, and other failures. Keep them in mind and make sure that all of them are observed properly. Kikusui assumes no liability against any damages or problems resulting from negligence of the precautions.



Users

- This product must be used only by qualified personnel who understand the contents of this operation manual.
- If it is handled by disqualified personnel, personal injury may result. Be sure to handle it under supervision of qualified personnel (those who have electrical knowledge.)

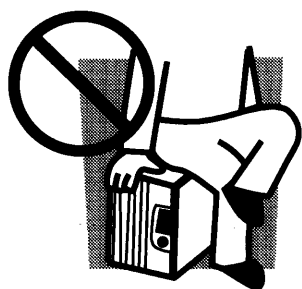

Purposes of use

- If the product is to be used for purposes not described in this manual, contact your Kikusui agent in advance.

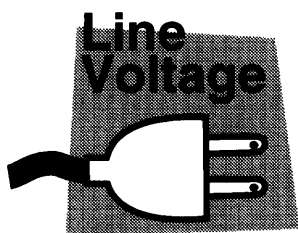

Input power

- Use the product with the specified input power voltage.
- For applying power, use the AC power cable provided. The shape of the plug differs according to the power voltage and areas. Use the cable which is suitable for the line voltage used.



Fuse

- With products with a fuse holder on the exterior surface, the fuse can be replaced with a new one. When replacing a fuse, use the one which has appropriate shape, ratings, and specifications.

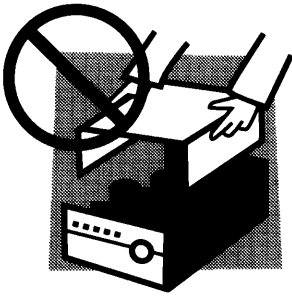

Cover

- There are parts inside the product which may cause physical hazards. Do not remove the external cover. If the cover must be removed, contact your Kikusui agent in advance.

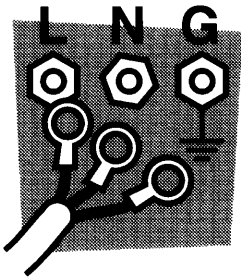

Installation

- When installing products be sure to observe "Conditions at the Installation Location" described in this manual.
- To avoid electrical shock, connect the protective ground terminal to electrical ground (safety ground).
- When applying power to the products from a switchboard, be sure work is performed by a qualified and licensed electrician or is conducted under the direction of such a person.
- Be sure to use the AC power cable provided. Consult your Kikusui agent if other cable than included is to be used for some reason.
- When installing products with casters, be sure to lock the casters.



Relocation

- Turn off the power switch and then disconnect all cables when relocating the product.
- Use two or more persons when relocating the product which weights more than 20 kg. The weight of the products can be found on the rear panel of the product and/or in this operation manual.
- Use extra precautions such as using more people when relocating into or out of present locations including inclines or steps. Also handle carefully when relocating tall products as they can fall over easily.
- Be sure the operation manual be included when the product is relocated.



Operations

- Check that the AC input voltage setting and the fuse rating are satisfied and that there is no abnormality on the surface of the AC power cable. Be sure to unplug the AC power cable or stop applying power before checking.

- If any abnormality or failure is detected in the products, stop using it immediately. Unplug the AC power cable or disconnect the AC power cable from the switchboard. Be careful not to allow the product to be used before it is completely repaired.
- For output wiring or load cables, use connection cables with larger current capacity.
- Do not disassemble or modify the product. If it must be modified, contact your Kikusui agent.



Maintenance and checking

- To avoid electrical shock, be absolutely sure to unplug the AC power cable or stop applying power before performing maintenance or checking.
- Do not remove the cover when performing maintenance or checking. If the cover must be removed, contact your Kikusui agent in advance.
- To maintain performance and safe operation of the product, it is recommended that periodic maintenance, checking, cleaning, and calibration be performed.



Service

- Internal service is to be done by Kikusui service engineers. If the product must be adjusted or repaired, contact your Kikusui agent.





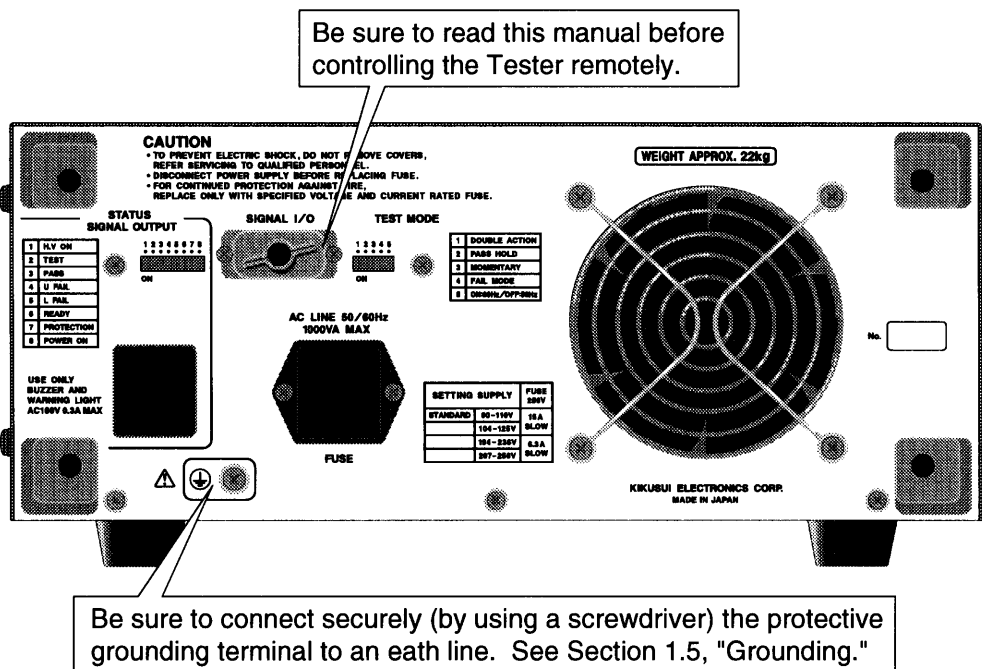
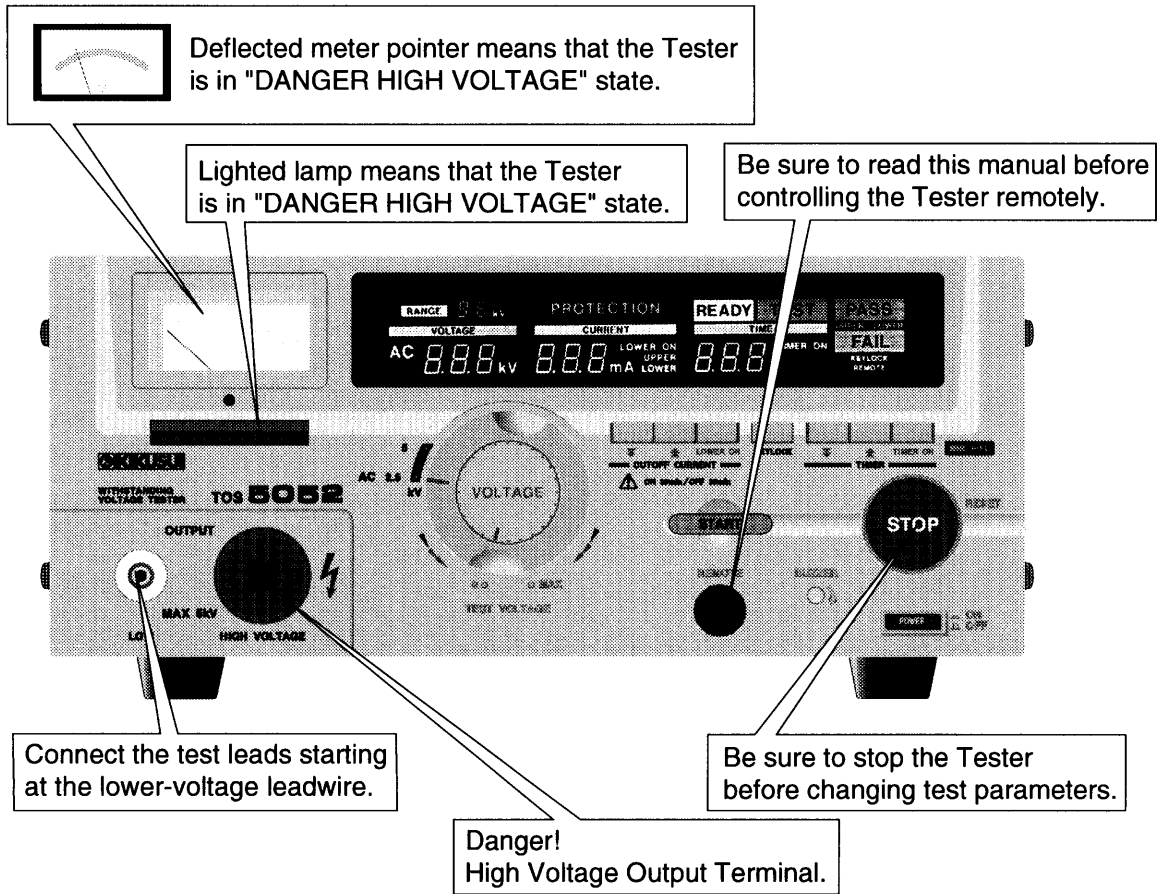

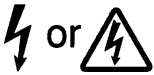

Front and Rear Panel Controls

- Read Chapter 2, "WARNINGS AND CAUTIONS FOR OPERATION THE TESTER," before manipulating any controls on the front and rear panels.

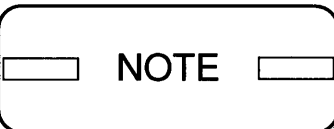

Safety Symbols

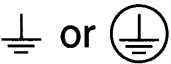
This operation manual and this product use the following safety symbols. Note the meaning of each of the symbols to ensure safe use of the product. (As using symbols depend on the product, all of symbols may not be used.)

	Indicates the presence of 1000V or higher. Inadvertently touching such a part may cause electrical shock resulting in death. If it is necessary to touch such a part to conduct work, <u>first make sure no voltage is being supplied.</u>
	Indicates the possibility of personal injury or death. Never fail to follow the operating procedure. Do not proceed beyond a WARNING sign until the noted conditions are fully understood and met.
	Indicates the existence of damage to the product or connected equipment. Always follow the operating procedure. Do not proceed beyond a CAUTION sign until the indicted conditions are fully understood and met.
	Indicates additional information such as operating procedure.
	Describes technical terms used in this manual.
	Indicates action prohibited.
	Indicates general warning, caution, risk of danger. When this mark is indicated on the product, refer the relevant section of the Operation Manual.
	Indicates a grounding (earth) terminal.
	Indicates a chassis grounding terminal.

Organization of This Manual

This manual consists of seven chapters.

1

"SETUP,"

contains the basic precautions you must observe before unpacking or using the TOS5052.

2

"WARNINGS AND CAUTIONS FOR OPERATION THE TESTER,"

describes the precautions you must observe when handling your TOS5052. Read this chapter thoroughly before using your TOS5052.

3

"OPERATIONG PROCEDURE,"

explains the procedures for running withstand voltage tests as well as the procedures for manipulating the remote controls of the TOS5052.

4

"NAMES AND FUNCTIONS OF CONTROLS,"

describes the controls and indicators of the TOS5052.

5

"OPERATING PRINCIPLE,"

describes the principles of operation of the TOS5052 with block diagrams.

6

"MAINTENANCE,"

explains how to maintain and calibrate the TOS5052.

7

"SPECIFICATIONS,"

contains the electrical and mechanical specifications for the TOS5052 and description of the TOS5052's options.

Contents

⚠ Safety Precautions	iii
Safety Symbols	vii
Organization of This Manual	viii
Introduction	xii
TOS5052 Overview	xii
Features	xii
Chapter 1 SETUP	1-1
1.1 Unpacking and Packing	1-2
1.2 Precautions for Installation	1-3
1.3 Checking AC Line Voltage	1-5
1.4 Checking the Fuse	1-6
1.5 Grounding	1-7
Chapter 2 WARNINGS AND CAUTIONS FOR OPERATION THE TESTER	2-1
2.1 Inhibitions	2-2
1) Inhibition of Rapid ON/OFF Repetitions	2-2
2) Inhibition of Shorting to Earth Ground	2-2
3) Applying an External Voltage	2-2
2.2 Action When in Emergency	2-3
2.3 Test-Time Precautions	2-3
1) Wearing Insulation Gloves	2-3
2) Precautions for Pausing Tests	2-3
3) Items Charged Up to Dangerous High Voltages	2-4
4) Matters to be Sure of After Turning-OFF Power	2-4
5) Warnings for Remote Control	2-4
2.4 Dangerous States of Failed Tester	2-5
2.5 To Use Your TOS5052 for an Extended Period of Time Without a Trouble ...	2-6
2.6 Start-Time Inspection	2-6
Chapter 3 OPERATING PROCEDURE	3-1
3.1 Manipulating the POWER Switch	3-2
3.2 Initial Setup	3-3
1) Setup Values	3-3
2) Initial Setup Procedure	3-4
3.3 Checking the Tester Operation	3-4
3.4 Pretest Zero Adjustment	3-6

3.5	Setting Up for a Withstanding Voltage Test	3-6
3.5.1	Selecting the Test Voltage Range	3-7
3.5.2	Setting the Test Voltage	3-8
3.5.3	Setting the Upper Cutoff Current	3-8
3.5.4	Setting the Lower Cutoff Current	3-9
3.5.5	Setting the Voltage Rise Time and Test Time	3-11
1)	Setting the Voltage Rise Time	3-11
2)	Setting the Test Time	3-12
3.6	Connecting The Test Leadwires	3-14
3.6.1	Connecting the Test Leadwires to the TOS5052	3-14
1)	Connecting the Low-Voltage Side Test Leadwire	3-14
2)	Connecting the High-Voltage Side Test Leadwire	3-14
3.6.2	Connecting the DUT	3-15
3.7	Executing a Test	3-16
1)	If the Test Result is PASS	3-17
2)	If the Timer is Set to OFF	3-18
3)	If the Test Result is FAIL	3-19
4)	Stop the Test and Reset the Tester	3-20
5)	Repeating the Test	3-21
3.8	Remote Control	3-22
3.8.1	REMOTE	3-22
3.8.2	SIGNAL I/O	3-24
1)	SIGNAL I/O Specifications	3-24
2)	Interlock Function	3-27
3)	Start/stop Control	3-28
4)	Output Signals	3-30
3.9	STATUS SIGNAL OUTPUT	3-32
3.10	Setting for Special Test Mode	3-34
3.10.1	Start Double Action Mode	3-34
3.10.2	Pass Hold Mode	3-34
3.10.3	Start Momentary Mode	3-35
3.10.4	FAIL Mode	3-35
3.10.5	50/60 Hz Frequency Selection Mode	3-35
Chapter 4 Names and Functions of Control		4-1
4.1	Front Panel	4-2
4.2	Display	4-6
4.3	Rear Panel	4-9
Chapter 5 OPERATING PRINCIPLE		5-1
5.1	Block Diagram	5-2
5.2	Rise Time Control Function	5-4

Chapter 6 MAINTENANCE	6-1
6.1 Cleaning	6-2
1) Cleaning the Main Unit	6-2
6.2 Inspection	6-2
6.3 Overhaul	6-3
1) High Voltage Relay	6-3
2) Cooling Fan	6-3
6.4 Calibration	6-3
 Chapter 7 SPECIFICATIONS	 7-1
7.1 Specifications	7-2
7.2 Overall Dimensions	7-9
7.3 Options	7-10
1) Model RC01-TOS/RC02-TOS Remote Control Box	7-10
2) Model HP01A-TOS/HP02A-TOS High Voltage Test Probe	7-11
3) Model PL01-TOS Warning Light Unit	7-12
4) Model BZ01-TOS Buzzer Unit	7-12
5) High voltage Test Leadwires	7-12
 INDEX	 I-1

Introduction

TOS5052 Overview

The TOS5052 is a 5 kVAC/100 mA withstanding voltage tester which functions output voltage presetting, output frequency selection (50/60 Hz), and the rise time control function which can control the rise time up to the preset voltage.

Features

1. For test complying with major industrial standards

Each of the TOS5052 allows you to conduct withstanding voltage tests (dielectric strength tests) of electrical and electronic devices and components, complying with major industrial standards including UL, CSA, BS, and JIS (Japanese Industrial Standards) and Electrical Equipment Control Ordinances of Japan.

2. Rise-time control function

The UL's type certification test and IEC standard require that the test voltage be raised gradually up to the preset level. The rise-time control function of the TOS5052 can automatically raise the test voltage to the prespecified level.

3. Improved test voltage waveform quality

- (a) Generates a test voltage waveform which is independent of the waveform of the AC line voltage.
- (b) Generates a 50 or 60 Hz low-distortion test voltage waveform.

4. Stabilized test voltage

- (a) Allows the test voltage to be preset.
- (b) Generates a test voltage that is independent of the AC line voltage.
- (c) Assures a voltage regulation of 9% or less (maximum rated load to no load)

5. High voltage output

- (a) Provided with a large-capacity high-voltage power supply which supplies the maximum rated voltage of 5 kV/100 mA (500 VA) (for 30-minute test time) or 2.5 times higher than that of our preceding models.
- (b) Generates a momentary short circuit current of 200 mA (for a test voltage is 1 kV and UPPER current of 100 mA) which is required in an IEC standard. (Cannot generate this current continuously because the output is automatically shut off by an over current protection mechanism.)

6. Rational layouts of keys and switches

The keys have a slant-plane for easy viewing and convenient operation. The switch for test voltage range select and the control for test voltage adjustment are installed concentrically, allowing you to operate them conveniently with two concentric knobs. For adjustment of pass/fail-judgment limit current setting and that of timer setting, respective increment/decrement keys are provided. These keys and switches, together with the large display easy to view, are laid out rationally and will assist you to conduct your tests accurately and efficiently.

7. A large color display

The TOS5052 has a large color VACUUM FLUORESCENT DISPLAY. It is a wide viewing angle type of display with high intensity, and clearly indicates information in clearly readable large letters and in color annunciators. The indicated information includes test conditions, instrument status, readback current, result of pass/fail judgement, etc., assisting you to conduct your tests accurately and efficiently.

8. Analog/digital voltmeters

The TOS5052 is furnished with an analog voltmeter ($\pm 5\%$ full-scale) and a digital voltmeter ($\pm 1.5\%$ full-scale). The analog voltmeter serves as an output indicator and the digital voltmeter as a high-precision output voltmeter for accurate and prompt testing.

(Neither analog nor digital voltmeters can be used to measure any external voltages that are present outside the TOS5052. An attempt to apply an external voltage to their output terminal would cause fatal damage to the TOS5052.)

9. A digital ammeter

The TOS5052 has a digital ammeter to measure the current that flows through the DUT (device under test).

10. A window comparator for pass/fail judgement

The TOS5052 has a window comparator for pass/fail judgment with reference to both upper (U) and lower (L) criteria (cutoff current). The comparator generates a FAIL signal when the measured current that flows through the DUT is greater than the preset upper limit criterion or even when it is less than the preset lower limit criterion. The L FAIL detection function contributes to improve the test reliability by detecting open-circuiting or imperfect contacting of the test leadwires. Separately for each of U type and L type of fail, the TOS5052 indicates a fail annunciator message on its display and delivers a fail event signal, allowing you to immediately find out the type of the fail.

You can preset the upper limit and lower limit currents (cutoff currents) mutually independently of each other (0.1mA to 110mA, AC).

11. A digital timer

The timer allows you to preset the period during which the test voltage is to be applied to the DUT. The preset range is 0.3 to 999 seconds. When the timer function is ON, the preset period is decremented and the timer indicates the remaining period; when it is OFF, time is incremented and the timer indicates the elapsed period.

12. Remote control provision

The tester has provisions for remote start/stop control operation. That is, it has a 5-pin DIN connector (for the optional Remote Control Box or High Voltage Test Probe) on its front panel and a 14-pin Amphenol connector on its rear panel. The remote control function, together with the status signal function, will help you conduct efficient automatic labor-saving tests.

13. Status signals

Seven status signals, namely H.V ON, TEST, PASS, U FAIL, L FAIL, READY, and PROTECTION, are present through the 14-pin Amphenol connector (shared by the remote control signals) on the rear panel. The signal from is open collector. The TOS5052 is also provided with an AC100V output to the optional alarming light or buzzer unit which is turned on when one of the eight states, H.V ON, TEST, PASS, U FAIL, L FAIL, READY, PROTECTION, and POWER ON, is notified. As used in conjunction with the remote control function, these status signals will help you to conduct still more efficient automatic labor-saving tests.

14. Resume of test state by nonvolatile memory

When you turn the Tester power OFF, the Tester stores its existing test state in its nonvolatile memory. As you turn the Tester power ON for the next time, by recalling the conditions of test from the nonvolatile memory the Tester automatically restores the test state that existed when you turned OFF power last time.

15. Safe high-voltage output terminals

The leadwire inlet for the high-voltage output terminal is made narrower to preclude the insertion of foreign substances.

16. DANGER lamp

A large highly bright lamp is employed to ensure operator safety.

17. Interlock provision

The Tester has an interlock provision to ensure that the Tester cannot deliver its output voltage and the Tester shutdown its output voltage under test condition unless a certain external condition is met. This interlock signal is available if there is open-circuiting or imperfect contacting in the signal line, thereby enhancing further the operation safety.

18. Keylock function

The key lock function prevents the test conditions from inadvertently altered. When the key lock function is on, any key except the START and STOP keys are disabled so that the operator can alter none of the test conditions. This brings about a highly reliable test environment.

19. Switches for safer operation

A rotary switch is used for test voltage range selection. The START switch is of a recessed type. These features, together with the keylock function, enhance operation reliability and safety.

20. Noise-resistant circuits

The internal circuits of the Tester are designed to be highly resistant against noise, thereby enhancing the operation reliability.

1

Chapter 1 SETUP

This chapter contains the basic precautions you must observe before unpacking or using the TOS5052.

1.1 Unpacking and Packing	1-2
1.2 Precautions for Installation	1-3
1.3 Checking AC Line Voltage	1-5
1.4 Checking the Fuse	1-6
1.5 Grounding	1-7

1.1 Unpacking and Packing

■ Unpacking

Whenever you receive a TOS5052, check it for any physical damages which might occur during transportation or for any missing accessories. If your TOS5052 is found damaged or have missing items, contact your Kikusui agent.

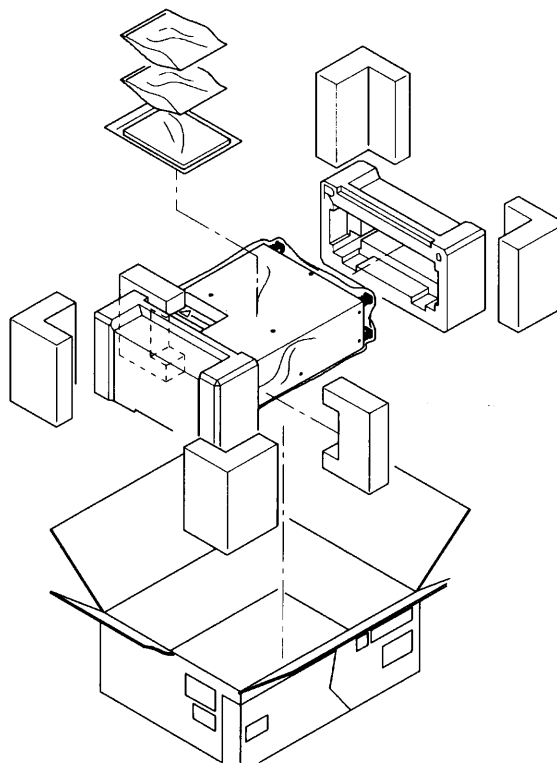

Figure 1-1 Unpacking and Packing

Accessories			
	Name	Q'ty	Check
1	AC power cable	1	
2	TL01-TOS HV test leadwire (approx. 1.5 m)	1	
3	14-pin Amphenol plug (assembly type)	1	
4	AC power fuse (One in present use and the other as spare in the fuse holder cap)	2	
5	"DANGER HIGH VOLTAGE" sticker	1	
6	Operation manual	1	

Table 1-1 Accessories

NOTE

- Put the "DANGER HIGH VOLTAGE" sticker on a prominent place on the TOS5052 main unit.

■ Packing

CAUTION

- When transporting the TOS5052, be sure to use the original packing materials. If they are missing, contact your Kikusui agent.
- Disconnect the AC power cable and other connection cables when packing the TOS5052.

1.2 Precautions for Installation

Be sure to observe the following precautions when installing the TOS5052.

CAUTION

- Observe the following precautions when relocating or installing the TOS5052.

The TOS5052 weighs approximately 22 kg. Two persons are required to carry the TOS5052.

Heavy parts are centered around the front panel side of the TOS5052. Take extreme care when relocating or installing the TOS5052.

■ Do not use the TOS5052 in a flammable atmosphere.

To prevent explosion or fire, do not use the TOS5052 near alcohol or thinner, or in an atmosphere containing such vapors.

■ Avoid locations where the TOS5052 is exposed to high temperature or direct sunshine.

Specification temperature range : 5°C to 35°C

Operation temperature range : 0°C to 40°C
Storage temperature range : -20°C to 70°C

■ **Avoid locations of high humidity.**

Do not locate the TOS5052 in high-humidity locations, i.e., near a boiler, humidifier, water supply, etc.

Specification humidity range : 20% to 80% RH
Operation humidity range : 20% to 80% RH
Storage humidity range : 90% RH or less

Dew condensation may take place even in the operation humidity range. In such a case, do not use the TOS5052 until the dew drips up completely.

■ **Do not place the TOS5052 in a corrosive atmosphere.**

Do not install the TOS5052 in a corrosive atmosphere or one containing sulfuric acid mist, etc. This may cause corrosion of various conductors and imperfect contact with connectors, malfunction and failure, or in the worst case, a fire.

■ **Do not locate the TOS5052 in a dusty location.**

■ **Do not use the TOS5052 where ventilation is poor.**

The TOS5052 employs a forced air cooling system. Allow an adequate work space near the vent holes in the side panel and the exhaust on the rear panel so that air flow through them smoothly.

■ **Do not use the TOS5052 in an unstable place.**

Do not install the TOS5052 in sloped places or in places that are subject to vibrations.

■ **Do not use the TOS5052 in locations affected by strong magnetic and/or electric fields.**

■ **Do not use the TOS5052 near an instrument or receiver of high sensitivity.**

Do not operate the TOS5052 near highly sensitive measuring instruments such as communication receivers lest the noise generated by the TOS5052 should interfere with such devices. Above 3kV test voltage the TOS5052 may produce corona discharge between its test leadwire clips which will generate a significant amount of broadband RF emission. To minimize this effect, support the alligator clips and leadwires away from each other and from conducting surfaces, especially from sharp metal edges.

Secure adequate space around the power plug.

Do not insert the power plug to an outlet where accessibility to the plug is poor. And, do not place objects near the outlet that would result in poor accessibility to the plug.

1.3 Checking AC Line Voltage

The AC line requirements of the TOS5052 are as follows.

- Voltage tolerance range : 90 V to 110 VAC
- Allowable frequency range : 45 Hz to 65 Hz

The TOS5052 might not only malfunction but also develop a mechanical breakdown at AC line voltage outside the above range. Make sure that the TOS5052 is run within the specified AC line voltage range.

- **Do not use the AC power cable that comes with the product as a AC power cable for other equipment.**

The TOS5052 is available in three models with different AC line requirements. Contact your Kikusui agent.

1. 104 to 125 VAC (110/120VAC model)
2. 194 to 236 VAC (220VAC model)
3. 207 to 250 VAC (230/240VAC model)

WARNING

- The AC line voltage must be adjusted only by the Kikusui-qualified service engineer.

Before turning on the TOS5052, make sure that the AC line voltage is set up correctly. The AC line voltage setting (labeled SETTING SUPPLY) is indicated on the rear panel. No mark indicates the default 90/110 VAC setting.

The AC line voltage of the TOS5052 is set at the factory or by a qualified service engineer. If the AC line voltage range is altered, a mark is placed on the left of the voltage label.

SETTING SUPPLY		FUSE 250V
STANDARD	90V-110V	15A SLOW
	104V-125V	
	194V-236V	6.3A SLOW
	207V-250V	

Table 1-2 SETTING SUPPLY Label (90/110 VAC Model)

1.4 Checking the Fuse

WARNING

- To avoid electric shock, be sure to set the POWER switch to OFF and unplug the AC power cable or turn off the switch on the switchboard before replacing a fuse.
- Select a fuse element of external design, rating and characteristics suitable for the TOS5052. Use of a fuse of different rating or a short circuit of the fuse holder may damage the TOS5052.

1. — Set the POWER switch to OFF and unplug the AC power cable.
2. — Remove the fuse holder as shown in Figure 1-2.

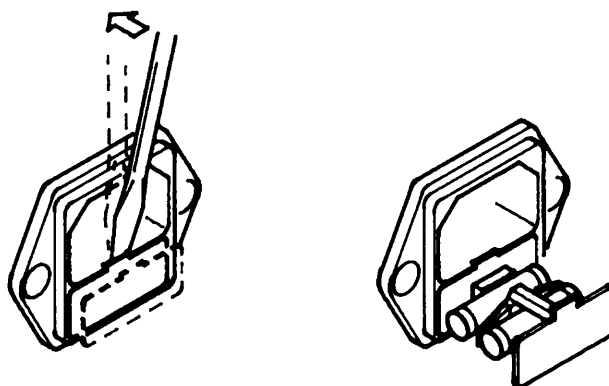

Figure 1-2 Removing the Fuse Holder

3. — Make sure that a fuse of the correct AC line voltage rating. Also check its rating and fusing characteristics. If a fuse of an incorrect rating or a blown fuse is found, replace it with a new one.

AC line voltage	Fuse ratings
90V-110V	250V 15A SLOW
104V-125V	
194V-236V	250V 6.3A SLOW
207V-250V	

Table 1-3 Fuses

4. — After checking the ratings, put back the fuses into the cap and insert the cap into the fuse folder sufficiently — that is, until the cap clicks.

1.5 Grounding

WARNING

- Improper or no grounding may cause electrical shock.
- Connect the protective grounding terminal to electrical ground (Safety ground).
- There are two methods of grounding the TOS5052. Select one of them, and securely ground the TOS5052.
 1. Connect the 3-P plug to a grounded 3-P receptacle.
 2. Grounding not the AC power cable but the protective grounding terminal on the rear panel.

Be sure to connect the protective grounding terminal on the TOS5052 rear panel to the ground using a tool. Unless the TOS5052 is securely grounded, when the TOS5052 output is shorted to an earth line or to a conveyor or other device which is connected to an earth line or when it is shorted to the AC line, the Tester chassis can be charged up to the high voltage that can cause electric shock hazard.

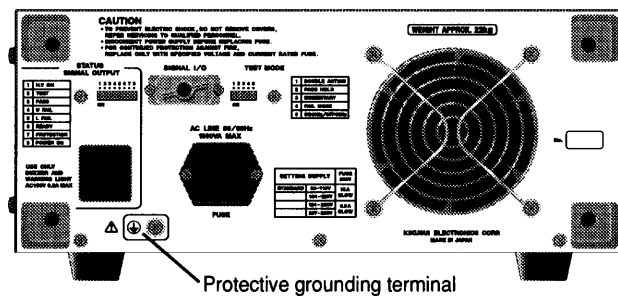

Figure 1-3 Protective Grounding Terminal

Description

- The term "AC line" here means the line on which the Tester is operating. That is the line to whose outlet the AC power cable of the Tester is connected. It may be of a commercial AC power line or of a private-generator AC power line.

2

Chapter2 WARNINGS AND CAUTIONS FOR OPERATION THE TESTER

This chapter describes the precautions you must observe when handling your TOS5052. Read this chapter thoroughly before using your TOS5052.

2.1 Inhibitions	2-2
2.2 Action When in Emergency	2-3
2.3 Test-Time Precautions	2-3
2.4 Dangerous States of Failed Tester	2-5
2.5 To Use Your TOS5052 for an Extended Period of Time Without a Trouble	2-6
2.6 Start-Time Inspection	2-6

WARNING

- The TOS5052 delivers a 5kV test voltage which can cause human injury or death. When operating the TOS5052, be extremely careful and observe the cautions, warnings, and other instructions given in this chapter.

2.1 Inhibitions

1) Inhibition of Rapid ON/OFF Repetitions

After turning OFF the power switch, be sure to allow several seconds or more before turning it ON again. Do not repeat turning ON/OFF the power switch rapidly — if you do this, the protectors of the Tester may not be able to render their protective functions properly. Do not turn OFF the power switch when the TOS5052 is delivering its test voltage— you may do this only in case of emergency.

2) Inhibition of Shorting to Earth Ground

Pay attention so that the high test voltage line is not shorted to a nearby AC line or nearby devices (such as conveyors) which are connected to an earth ground. If it is shorted, the TOS5052 chassis can be charged up to the hazardous high voltage.

Be sure to connect the protective grounding terminal of the TOS5052 to an earth line. If this has been securely done, even when the HIGH VOLTAGE terminal is shorted to the LOW terminal, the TOS5052 will not be damaged and its chassis will not be charged up to the high voltage.

Be sure to use a dedicated tool when grounding the protective grounding terminal. See 1.5 "Grounding," for details.

3) Applying an External Voltage

Do not apply a voltage from any external device to the output terminals of the TOS5052. The built-in voltmeters cannot be used as stand-alone voltmeters. They may be damaged if their output terminals are subject to an external voltage.

2.2 Action When in Emergency

In case of an emergency (such as electric shock hazard or burning of DUT), take the following actions. You may do either (a) or (b) first. But be sure to do both.

- (a) Turn OFF the power switch of the TOS5052.
- (b) Disconnect the AC power cable of the TOS5052 from the AC line receptacle.

2.3 Test-Time Precautions

1) Wearing Insulation Gloves

When handling the TOS5052, be sure to wear insulation gloves in order to protect yourself against high voltages. If no insulation gloves are available on your market, please order your Kikusui agent for them.

2) Precautions for Pausing Tests

When changing test conditions, press the STOP switch once to take precautions. If you are not going to resume the test soon or if you are leaving the Test area, be sure to turn-OFF the POWER switch.

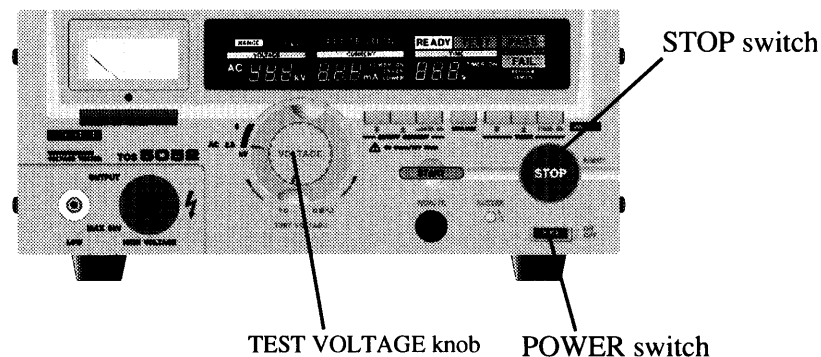

Figure 2-1 TOS5052 Front Panel

3) Items Charged Up to Dangerous High Voltages

When in test, the DUT, test leadwires, probes, and output terminals and their vicinities can be charged up to dangerous high voltages. Never touch them when in test.

WARNING

- The vinyl sheaths of the alligator clips of the test leadwires which are supplied accompanying the TOS5052 have no sufficient insulation for the high test voltages. Never touch them when in test.

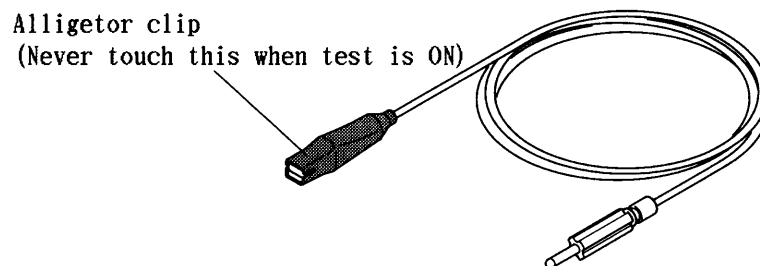

4) Matters to be Sure of After Turning-OFF Power

If you have to touch the DUT, test leadwires, probes, and/or output terminals and their vicinities for re-connections or other reasons, be sure of the following two matters.

- (a) The analog voltmeter indicates "zero."
- (b) The DANGER lamp has gone out.

5) Warnings for Remote Control

Be extremely careful when operating the TOS5052 in the remote control mode in which the dangerous high test voltage is ON/OFF-controlled remotely. Provide protective means as follows:

- Provide means to assure that the test setup does not become the test voltage is being delivered by inadvertent operation.
- Provide means to assure that none can touch the DUT, test leadwires, probes, output terminals and their vicinities when the test voltage is being delivered.

2.4 Dangerous States of Failed Tester

Typical possible dangerous states of the TOS5052 are as shown below and in which cases the most dangerous situation that "the high test voltage remains delivered and won't be turned off!" may occur. When this situation has occurred, immediately turn OFF the power switch and disconnect the AC power cable from the AC line receptacle.

- The DANGER lamp does not go out despite you have pressed the STOP switch.
- The DANGER lamp does not light up despite the pointer of the analog voltmeter is deflected indicating that the output voltage is being delivered.

Also when the TOS5052 is in other malfunctioning states than the above, there is a possibility that the output voltage is delivered irrespective of your proper operating procedure. Never use the TOS5052 when it has failed.

WARNING

- Keep the TOS5052 away of other people until you call our service engineer for help.
- Immediately call your Kikusui agent for servicing. It is hazardous for an unqualified person to attempt to troubleshoot any TOS5052 problem.

2.5 To Use Your TOS5052 for an Extended Period of Time Without a Trouble

The heat dissipation of the high voltage transformer is one-half of the normal wattage with respect to the rated output from the viewpoint of size, weight, and cost of the TOS5052. Due to this, when operating the TOS5052 with its UPPER CUTOFF CURRENT higher than 50mA, provide pause times at least identical with test times. The allowable maximum continuous test time is 30 minutes (at ambient temperature not higher than 40 °C (104 °F)). If you operate the TOS5052 in the TEST-ON state continuously for a period longer than this, the thermal fuse in the high voltage transformer may blow out.

The above does not apply when the CUTOFF CURRENT is less than 50mA.

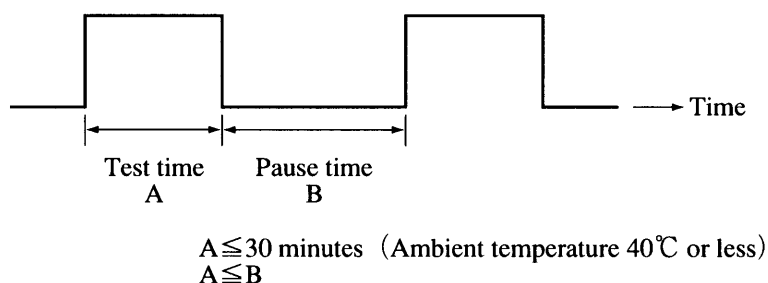

Figure 2-2. Test and Pause Time

2.6 Start-Time Inspection

Make the following checks before starting a test to preclude any accident:

- The TOS5052 is grounded.
- The high-voltage test leadwire covering is free of cracks or tears.
- The high-voltage leadwire is not broken.
- The TOS5052 signals a failure when the low- and high-voltage test leadwires are shorted.

3

Chapter 3 OPERATING PROCEDURE

WARNING

- Be sure to check the AC line voltage, fuses, and grounding condition of the TOS5052 while referring to the instructions given in Chapter 1, "SETUP."
- Read Chapter 2, "WARNINGS AND CAUTIONS FOR OPERATION THE TESTER," before using the TOS5052.

This chapter explains the procedures for running withstanding voltage tests as well as the procedures for manipulating the remote controls of the TOS5052.

3.1 Manipulating the POWER Switch	3-2
3.2 Initial Setup	3-3
3.3 Checking the Tester Operation	3-4
3.4 Pretest Zero Adjustment	3-6
3.5 Setting Up for a Withstanding Voltage Test	3-6
3.6 Connecting The Test Leadwires	3-14
3.7 Executing a Test	3-16
3.8 Remote Control	3-22
3.9 STATUS SIGNAL OUTPUT	3-32
3.10 Setting for Special Test Mode	3-34

3.1 Manipulating the POWER Switch

WARNING

- The TOS5052 will generate no output unless you release protection using the interlock function for the SIGNAL I/O connector on the rear panel. You can tentatively run your TOS5052 using the attached 14-pin Amphenol plug. Before making a practical withstanding voltage test, release the interlock function while referring to the paragraphs on the interlock function.

When you turn on the POWER switch, the TOS5052 checks its internal memory for several seconds. During this period, the TOS5052 displays its version number and model name on the vacuum fluorescent display.

When the TOS5052 ends the memory check successfully, it starts up using the test conditions that were established when the POWER switch was turned off and enters the READY state (state that the READY message appears).

The TOS5052 will not enter the READY state in the following cases:

- The TOS5052 is in the PROTECTION state.
- The lower cutoff current is greater than the upper cutoff current and the lower pass/fail judgment function is turned on.
- The TEST VOLTAGE switch is in an awkward position.

NOTE

- The TOS5052 will not start a test when you press the START switch while "PROTECTION" is displayed on the vacuum fluorescent display. The TOS5052 enters the PROTECTION state and keeps its output off when one of the actions listed in Table3-1 is taken. To release the TOS5052 from the PROTECTION state, remove the factor that actuated the protection mechanism and press the STOP switch.

Cause	Resetting Action
A plug is inserted to or removed from the REMOTE connector.	Enter STOP.
The state of the REMOTE ENABLE terminal in the SIGNAL I/O connector is changed.	Enter STOP.
The INTERLOCK signal in the SIGNAL I/O connector goes high.	Set the INTERLOCK signal low and enter STOP.
The temperature inside the TOS5052 rises to actuate overheat protection.	Lower the temperature and enter STOP.
A voltage that is higher than the preset voltage by +200V is detected.	Enter STOP.
A current of 50 mA or more is detected for 30 minutes or longer during the test.	Suspends the test for longer than 30 minutes and enter STOP.

Table 3-1 Causes of Protection States and Resetting Actions

3.2 Initial Setup

CAUTION

- You can enter the initial setup mode by turning on the POWER switch while holding down the SHIFT key. In this case, the currently stored settings are all lost.

1) Setup Values

The test parameters are set to the following default values when initial setup is carried out:

Item	Value
Voltage	0.00kV
Upper cutoff current	0.2mA
Lower cutoff current	0.1mA
Lower pass/fail judgment	OFF
Test time	0.5s
Timer function	ON
Voltage rise time	0.1s
Keylock function	OFF

Table 3-2 Initial Setup Values

2) Initial Setup Procedure

- 1.- Make sure that the POWER switch is in the OFF position.
- 2.- Connect the AC input power cable (supplied as an accessory) to the AC LINE connector on the rear panel.
- 3.- Connect other end of the AC input power cable to an AC line outlet of the correct voltage.
- 4.- Keeping the SHIFT key pressed, press the POWER switch. The Vacuum Fluorescent Display will start illuminating, indicating that power has been turned ON.
(The DC illuminator turns on but it has nothing to do with the operation of the TOS5052.)
- 5.- Release both SHIFT key and POWER switch.
- 6.- Within several tens seconds from the above, the Version Number and Model Number of the TOS5052 will appear on the display screen. The three digits on the left hand side indicate the version number; those on the light hand side are of the three least-significant digits of the model number.

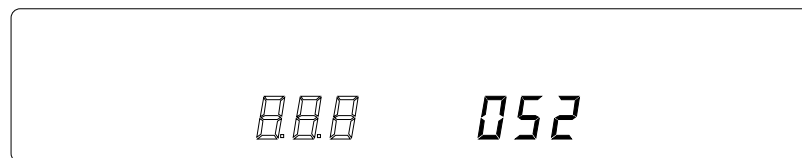

- 7.- The initial test setup data will appear on the screen.
If no messages at all appear on the screen when more than 60 seconds has elapsed from the above, repeat the procedure all over again from its beginning.

3.3 Checking the Tester Operation

The TOS5052 will generate no output unless you reset protection using the interlock function for the SIGNAL I/O connector on the rear panel. Run your TOS5052 tentatively using the attached 14-pin Amphenol plug.

WARNING

- Pins 9 and 14 of the 14-pin Amphenol plug are short-circuited to reset protection. Before making a practical withstanding voltage test, reset the interlock function. For details, see the section entitled "Interlock Function."

CAUTION

- This operation check initializes the setup data. Any existing setup values are lost.

1. — Make sure that the POWER switch is in the OFF position.
2. — Make sure that no cable is connected to the SIGNAL I/O connector on the rear panel.
3. — Connect the AC input power cable (supplied as an accessory) to the AC LINE connector on the rear panel.
4. — Connect other end of the AC input power cable to an AC line outlet of the correct voltage.
5. — Keeping the SHIFT key pressed, press the POWER switch. The Vacuum Fluorescent Display will start illuminating, indicating that power has been turned ON.

(The DC illuminator turns on but it has nothing to do with the operation of the TOS5052.)

6. — Release both SHIFT key and POWER switch.
Within several tens seconds from the above, the Version Number and Model Number of the TOS5052 will appear on the display screen.

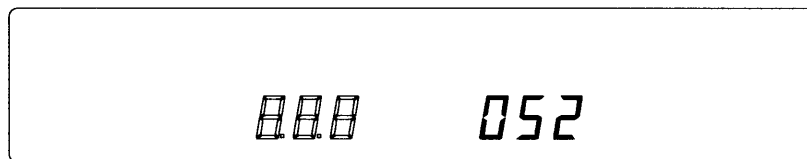

Within several seconds from the above, the initial test setup data will appear and the TOS5052 will become the PROTECTION status due to the interlock function.

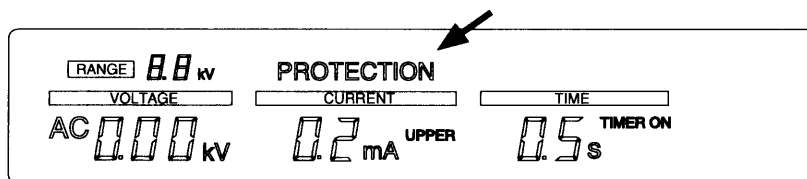

7. — Turn OFF the POWER switch.
8. — Connect the 14-pin amphenol connector (supplied as an accessory) to the SIGNAL I/O connector.
9. — Wait for 60 seconds or more. Turn ON again the POWER switch.

Within several tens seconds from the above, the Version Number and Model Number of the TOS5052 will appear on the display screen.

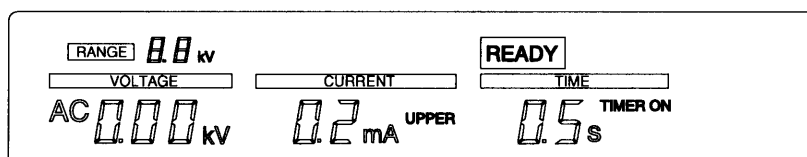
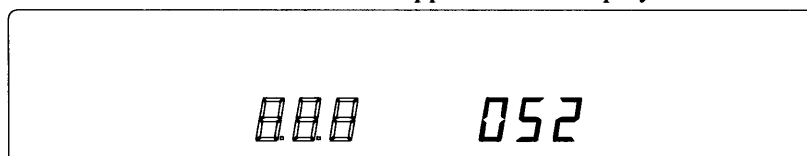

Within several tens seconds from the above, the initial test setup data will appear again.

NOTE

- Do not position the TEST VOLTAGE switch at a midway between 2.5kV and 5kV. The setup items will not be saved normally if the TOS5052 is turned on with the TEST VOLTAGE switch positioned between two indexes. If such a condition occurs, a blinking test voltage range value of 0kV appears and the READY message appears, notifying you that the TOS5052 cannot perform a test. The TOS5052 enters the READY state when the TEST VOLTAGE switch is set to the desired index.

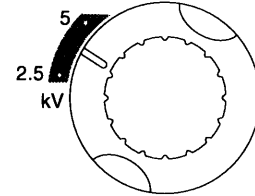

3.4 Pretest Zero Adjustment

Zero-adjust the analog voltmeter before starting a withstanding voltage test. Follow the procedure shown below to perform a zero adjustment.

1. — Set the POWER switch to OFF.
2. — Check that the pointer of the analog voltmeter indicates the "0" position. If the pointer is off the "0" position, adjust it using the zero adjuster of analog voltmeter .

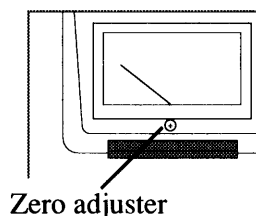

3.5 Setting Up for a Withstanding Voltage Test

Set the test parameters as you may require to test your DUT. The ranges of test parameters available with the TOS5052 are as follows:

Test voltage	: 0 to 2.95 kV/0 to 5.45 kV
Upper cutoff current	: 0.1 to 110 mA
Lower cutoff current	: 0.1 to 110 mA, with lower pass/fail judgment function held off
Voltage rise time	: 0.1 to 99.9 s
Test time	: 0.3 to 999 s, with timer function held off

3.5.1 Selecting the Test Voltage Range

- 2.5 kV range : The test voltage range is from 0 to 2.95 kV.
- 5 kV range : The test voltage range is from 0 to 5.45 kV.

Select the TEST VOLTAGE switch to the desired test voltage range. The voltage value in the corresponding test voltage range blinks, indicating that the test voltage range has been selected.

Blinking stops when you press the STOP or START switch.

WARNING

- The TOS5052 ignores any change in the test voltage range during a test but sets the new test voltage range when the test ends. You may encounter unexpected test results in the next test.

NOTE

- Do not position the TEST VOLTAGE switch at a midway between 2.5kV and 5kV. The setup items will not be saved normally if the TOS5052 is turned on with the TEST VOLTAGE switch positioned between two indexes. If such a condition occurs, a blinking test voltage range value of 0kV appears and the READY message appears, notifying you that the TOS5052 cannot perform a test. The TOS5052 enters the READY state when the TEST VOLTAGE switch is set to the desired index.
- The TOS5052 will not accept any change in the test voltage range while it is in the KEYLOCK state or executing a test. The change in the test voltage range you make when the TOS5052 is in the KEYLOCK state will be reflected when the TOS5052 is reset from the KEYLOCK state.
- If you switch the test voltage range to the 2.5 kV range after setting a voltage value greater than 2.95 kV (maximum 2.5 kV range value) in the 5 kV range, the test voltage is set to 2.95 kV.

3.5.2 Setting the Test Voltage

The test voltage is the one that is to be applied to the DUT. Set the test voltage according to the specifications for the DUT.

- 2.5 kV range : The output voltage range is from 0 to 2.95 kV.
5 kV range : The output voltage range is from 0 to 5.45 kV.

Setting procedure

1. — Make sure that the test voltage you want to set falls within the selected test voltage range.
2. — Set the test voltage using the TEST VOLTAGE control according to the specifications for the DUT. You can increase or decrease the test voltage value in 10-time increments when you manipulate the TEST VOLTAGE control while holding down the SHIFT key. The set voltage is shown in the VOLTAGE readout of the display.

NOTE

- The output voltage of the TOS5052 drops approximately 40V at 10 mA and approximately 400V at 100 mA. Consequently, you may have to reset the test voltage depending on the output current. When the TOS5052 measures a voltage that is smaller than the set voltage by more than 100V, it flashes "kV" to notify that the test voltage is too low. "kV" may also flash when you raise the set voltage too rapidly. This is not a problem, however.
- The TOS5052 will not accept any test voltage setting when it is in the KEYLOCK state.

3.5.3 Setting the Upper Cutoff Current

CAUTION

- The internal temperature fuse may be blown off if you set the upper cutoff current to not less than 50 mA. When testing under such conditions, do not carry out a test for 30 minutes or more and take a pause time for longer than the test time.

You set the upper cutoff current for leak current.

The TOS5052 judges FAIL when the measured leak current is greater than the upper cutoff current .

The upper cutoff current setting range is from 0.1 to 110 mA.

Upper cutoff current range	Basic resolution	Display format
0.1 to 9.9mA	0.1mA	<input type="checkbox"/> . <input type="checkbox"/> mA
10 to 110mA	1mA	<input type="checkbox"/> <input type="checkbox"/> <input type="checkbox"/> mA

Table 3-3 Upper Cutoff Current Resolutions and Display Formats

Setting procedure

1. — Select the upper cutoff current setting mode with the UP/LOW key and the UPPER message will appear and the preset upper cutoff current will be indicated on the CURRENT readout.
2. — Adjust the preset upper cutoff current value as you may require, with the Δ / ∇ keys. You can increase or decrease the upper cutoff current value in 10-time increments when you manipulate the Δ / ∇ while holding down the SHIFT key.

In either case, the set value changes continually when you keep the Δ or ∇ key down.

NOTE

- The TOS5052 will not accept any upper cutoff current setting when it is in the KEYLOCK state.
- The upper and lower cutoff current can be set mutually independently. When you set the lower cutoff current value to a value that is greater than the upper cutoff current value and turn on the lower pass/fail judgment function, the "mA" illuminator in the unit field blinks and the READY message disappears, indicating that the test in this condition cannot be done. When you reset the lower cutoff current value to a value smaller than the upper cutoff current value or when you turn off the lower pass/fail judgment function, the blink stops and the TOS5052 returns to the READY state.

3.5.4 Setting the Lower Cutoff Current

You set the lower cutoff current for leak current.

The TOS5052 judges FAIL when the measured leak current is greater than the lower cutoff current .

The lower cutoff current setting range is from 0.1 to 110 mA or OFF.

Lower cutoff current range	Basic resolution	Display format
0.1 to 9.9mA	0.1mA	<input type="checkbox"/> . <input type="checkbox"/> mA
10 to 110mA	1mA	<input type="checkbox"/> <input type="checkbox"/> <input type="checkbox"/> mA

Table 3-4 Lower Cutoff Current Resolutions and Display Formats

Setting procedure

1. — Select the lower cutoff current setting mode with the UP/LOW key and the LOWER message will appear and the preset lower cutoff current will be indicated on the CURRENT readout.
2. — Adjust the preset lower cutoff current value as you may require, with the Δ / ∇ keys. You can increase or decrease the lower cutoff current value in 10-time increments when you manipulate the Δ / ∇ while holding down the SHIFT key.
In either case, the set value changes continually when you keep the Δ or ∇ key down.
3. — Keeping the SHIFT key pressed, press the UP/LOW key and the lower pass/fail judgment function will be brought into effect and the LOWER ON message will appear.

NOTE

- If dispersion of leak current of DUTs is within a predictable range and their lowest values are within the range detectable with the TOS5052, you may set the low cutoff current at a value slightly less than the lowest leak currents. By this setting, you can discriminate DUTs whose leak currents are exceptionally small and can guard against open-circuiting of the test leadwires, thereby improving the reliability of test. If this setting is inconvenient for your test, you can turn OFF the lower pass/fail judgment function.
- As noted in Chapter 7 "Specifications" (*3), when a test is done with a high AC voltage and a high sensitivity, the lower pass/fail judgment may not be correctly done in a particular case that the output current that flows due to the stray capacitances of the output circuit (such as test leadwires, etc.) is larger than the preset lower cutoff current. Normally, if no DUT is connected, since no end-load current is drawn, the output current should be smaller than the preset lower cutoff current and the TOS5052 should deliver a FAIL judgment. In the above particular case, however, as the output current is larger than the preset lower cutoff current, the TOS5052 will give a PASS judgment even when no DUT is connected. Be careful when using the pass/fail judgment function — take into consideration the various factors that can affect the reliability of judgment. Before starting a test, disconnect the DUT and be certain that the FAIL judgment is correctly done.
- The TOS5052 will not accept any upper cutoff current setting when it is in the KEYLOCK state.
- The upper and lower cutoff current can be set mutually independently. When you set the lower cutoff current value to a value that is greater than the upper cutoff current value and turn on the lower pass/fail judgment function, the "mA"

illuminator in the unit field blinks and the READY message disappears, indicating that the test in this condition cannot be done. When you reset the lower cutoff current value to a value smaller than the upper cutoff current value or when you turn off the lower pass/fail judgment function, the blink stops and the TOS5052 returns to the READY state.

- Although you can set the lower cutoff current value independently of the upper cutoff current value, the accuracy of the lower cutoff current value depends on the upper cutoff current value such that "the lower cutoff current value is \pm (5% of the upper cutoff current value + 20 μ A)." This may bring about a case in which the TOS5052 can make a judgment. Before starting a test, disconnect the DUT and be certain that the FAIL judgment is correctly done.
- The TOS5052 will not perform a lower pass/fail judgment while the voltage is being raised and for approximately 0.2 seconds after it becomes constant.

3.5.5 Setting the Voltage Rise Time and Test Time

You can set the voltage rise time and test time separately.

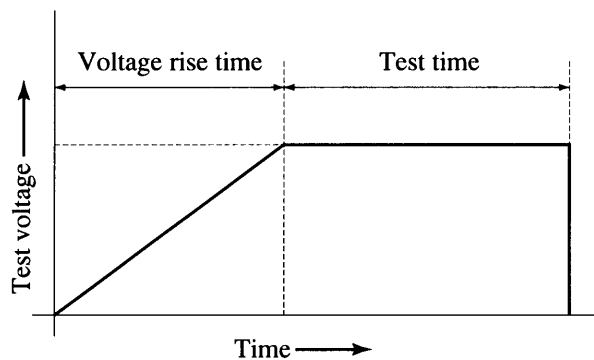

Figure 3-1 Voltage Rise Time and Test Time

1) Setting the Voltage Rise Time

Set the time up to the test voltage.

The voltage rise time range is from 0.1 to 99.9 seconds.

Voltage rise time	Basic resolution	Display format
0.1 to 99.9s	0.1s	□□.□

Table 3-5 Voltage Rise Time Resolutions and Display Formats

Setting procedure

1. — Press the TEST/RISE key to turn on the green LED (RISE) at below and right of the key.
2. — Adjust the preset the voltage rise time value as you may require, with the \triangle / ∇ keys. You can increase or decrease the voltage rise time value in 10-time increments when you manipulate the \triangle / ∇ while holding down the SHIFT key. In either case, the set value changes continually when you keep the \triangle or ∇ key down. The voltage rise time value is displayed on the TIME display.

NOTE

- The TOS5052 will not accept any voltage rise time setting when it is in the KEYLOCK state.
- You cannot turn off the voltage rise time.

2) Setting the Test Time

CAUTION

- The internal temperature fuse may be blown off if you set the upper cutoff current value to not less than 50 mA. When testing under such conditions, do not carry out a test for 30 minutes or more and take a pause time for longer than the test time.

The test time is the time during which the TOS5052 carries out a withstanding voltage test. When this test time elapses with no FAIL judgment being done by the timer function, the TOS5052 terminates the test and judges PASS.

You can disable the test time by turning off the timer function.

The TIME display represents the remaining test time when the timer function is on and the elapsed time when the timer function is off.

The test time range is from 0.3 to 999 seconds.

There function : ON or OFF

Test time	Basic resolution	Display format
0.3 to 99.9s	0.1s	□□.□
100 to 999s	1s	□□□

Table 3-6 Test Time Resolutions and Display Formats

Setting procedure

1. — Press the TEST/RISE key to turn off the green LED (RISE) at below and right of the key.

- 
2. — Adjust the preset the test time value as you may require, with the Δ ∇ keys. You can increase or decrease the test time value in 10-time increments when you manipulate the Δ ∇ while holding down the SHIFT key. In either case, the set value changes continually when you keep the Δ or ∇ key down. The test time value is displayed on the TIME display.
 3. — To turn on or off the timer function, press the TEST/RISE key while holding down the SHIFT key. The TIMER ON message lights when the timer function is turned on.

————— NOTE —————

- The TOS5052 will not accept any test time setting when it is in the KEYLOCK state.
- The timer function is not enabled even if a value is displayed in the TIME display unless the TIMER ON message is on.
- The accuracy of the test time is ± 20 ms. Set a test time value that is greater than the intended one by one digit in case even a smallest shortage of test time will cause a serious problem.

3.6 Connecting The Test Leadwires

WARNING

- A poorly connected test leadwire would expose the DUT to high voltage. Connect the test leadwires securely.

3.6.1 Connecting the Test Leadwires to the TOS5052

1) Connecting the Low-Voltage Side Test Leadwire

1. — Check for broken test leadwire.
2. — Connect the low-voltage side test leadwire to the LOW terminal on the TOS5052.

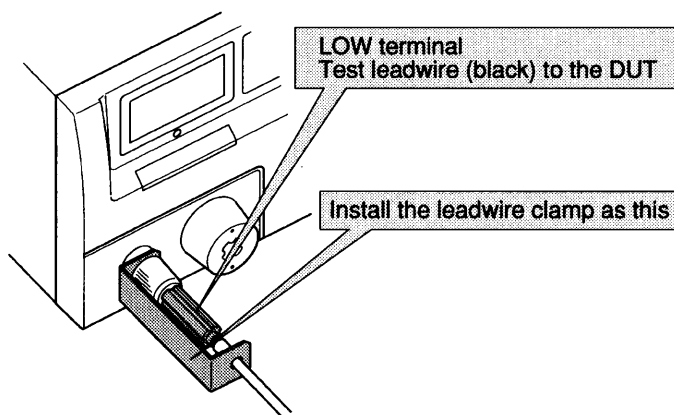

Figure 3-2 Connecting the low-voltage side test leadwire

2) Connecting the High-Voltage Side Test Leadwire

Connect the high-voltage side test leadwire only after connecting the low-voltage side test leadwire.

Connecting procedure

1. — Press the STOP switch.
2. — Check that the analog voltmeter reading is zero.
3. — Check that the DANGER lamp is OFF
4. — Check that the READY message appears.
5. — Connect the high-voltage side test leadwire to the HIGH VOLTAGE terminal.
6. — Short between the low- and high-voltage side test leadwires and make sure that no high voltage is generated.

3.6.2 Connecting the DUT

Connect the DUT only after connecting the low- and high-voltage side test leadwires.

Connecting procedure

1. – Press the STOP switch.
2. – Check that the analog voltmeter reading is zero.
3. – Check that the DANGER lamp is off.
4. – Check that the READY message appears.
5. – Short between the low- and high-voltage side test leadwires and make sure that no high voltage is generated.
6. – Connect the low-voltage side test leadwire to the DUT.
7. – Connect the high-voltage side test leadwire to the DUT.

WARNING

- Never touch the HIGH VOLTAGE terminal, test leadwires, or DUT during the test.

Description

- Shorting the High Voltage output terminals of the TOS5052 may generate noise that can cause interference to peripheral devices. If you need to suppress the interference, connect a resistor (470 ohms or thereabout) between the end of the HIGH test leadwire and the DUT and another resistor of the same resistance between the end of the LOW test leadwire and the DUT (in positions as close to the DUT as possible). These resistors are very effective for suppression of the noise interference. Pay attention to the wattage and the maximum working voltage of the resistors. When the upper cutoff current is not greater than 10 mA, resistors of 470 ohms (Rated Power : 3 W, Impulse Withstanding Voltage : 30 kV) will be appropriate.

When you have connected these resistors, the test voltage that is actually applied to the DUT will be slightly lower (approximately 10 V when the current that flows through the DUT is 10 mA) than the output terminal voltage due to the voltage drops caused by the resistors. This measure is highly useful for minimizing the noise influence.

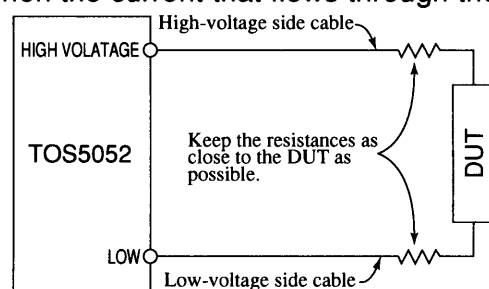

3.7 Executing a Test

This procedure is to execute a test. Let's assume that the parameters are as shown in the following table. The test parameters displayed when in the READY state will be shown below.

Test voltage range	2.5kV
Test voltage	1.2kV
Upper cutoff current	10mA
Lower pass/fail judgment function	OFF
Voltage rise time	0.1 s
Test time	1 s
Timer function	ON

Table 3-7 Test parameters

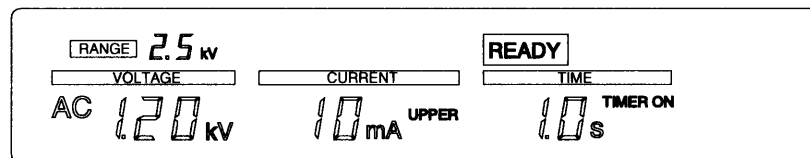

Test procedure

1. — To start the test, press the START switch when the TOS5052 is in the READY state (state that the READY message appears). The TOS5052 will commence the test and the following actions will take place.
 - The DANGER lamp lights up.
 - The H.V ON signal of the SIGNAL I/O connector is turned ON.
 - The TEST message appears.
 - Turns and holds on the RISE LED while the voltage is rising.
 - The TEST signal of the SIGNAL I/O connector is turned ON when the required voltage is reached.
 - The test voltage is delivered between the HIGH VOLTAGE terminal and the LOW terminal.
 - The analog voltmeter indicates the test voltage. (The voltmeter indicates the voltage even when the TOS5052 is not in the TEST-ON state.)
 - The VOLTAGE readout displays the measured output voltage.
 - The CURRENT readout displays the measured output current.
 - The TIME display shows the elapsed test time when the required voltage is reached.

The test items are displayed as shown below.

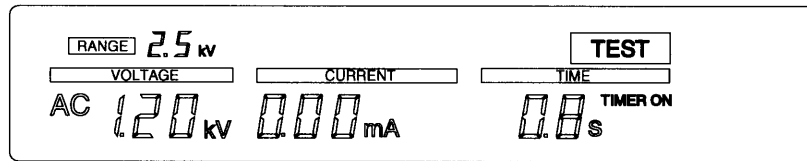

This display indicates that the measured voltage is 1.20 kV, that the measured current is 0.00 mA, and that the remaining test time is 0.8 s (The elapsed time is indicated in the TIME display when the timer function is held off).

NOTE

- The START switch on the panel is disabled when the REMOTE message appears. See Section 3.8, "Remote Control."
- When DOUBLE ACTION is on, the TOS5052 starts a test only when you press the START switch within approximately 0.5 seconds after releasing the STOP switch. See Section 3.10, "Settings for Special Test Modes."
- When MOMENTARY is on, the TOS5052 starts a test only when the START switch is being pressed. See Section 3.10, "Settings for Special Test Modes."
- The TOS5052 will not start a test when it is in the PROTECTION state. See the section entitled "PROTECTION" for details.
- The TOS5052 will not start a test when the STOP switch is pressed (including the case when a remote control stop input is present).

1) If the Test Result is PASS

When the preset test time has elapsed, the TOS5052 will make a PASS judgment. If the test result is a PASS, the following actions will take place.

- The TOS5052 shuts off the high-voltage output.
- The TEST message disappears.
- The TEST signal of the SIGNAL I/O connector is turned OFF.
- The DANGER lamp goes out.
- The H.V ON signal of the SIGNAL I/O connector is turned OFF.
- The PASS message appears.
- Sounds the buzzer.
- The PASS signal of the SIGNAL I/O connector is turned ON.
- Holds and displays the voltage that is measured when PASS is appeared in the VOLTAGE readout.
- Holds and displays the current that is measured when PASS is appeared in the CURRENT readout.

The Vacuum Fluorescent Display in this case will be as follows:

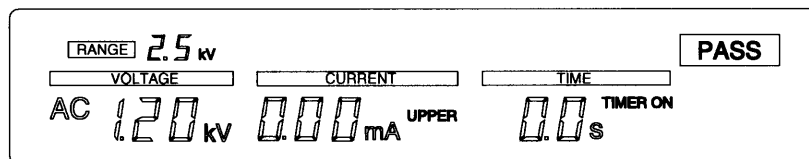

This display indicates that the measured voltage is 1.20 kV, that the measured current is 0.00 mA, and that PASS is appeared.

When in the normal state, the TOS5052 will automatically reset to the READY state (state that the READY message appears) within approximately 0.2 seconds from the PASS state and the following actions will take place.

- The PASS message disappears.
- The buzzer stops.
- The PASS signal of the SIGNAL I/O connector is turned OFF.

NOTE

- The TOS5052 will not automatically reset to the READY state when in any of the following cases:
 - * PASS HOLD is on
In this case, the PASS state is held continuously. To reset it, press the STOP switch. See Section 3.10, "Setting for Special Test Mode," for details.
 - * There remains the cause of the PROTECTION state.
See the section entitled "PROTECTION message" for details.
 - * The STOP switch is pressed .
(Including the case when a remote control stop input is present).
 - * The START switch is held pressed.
(Including the case when a remote control stop input is present).

2) If the Timer is Set to OFF

If the timer function is OFF and the TIMER ON message has disappeared, the test does not terminate automatically. You must manually stop the test by pressing the STOP switch. In this case the TOS5052 does not make the PASS judgment and the following action will take place.

- Shuts off the high-voltage output.
- The TEST message disappears.
- The DANGER lamp goes out.
- The H.V ON signal of the SIGNAL I/O connector is turned OFF.
- The TEST signal of the SIGNAL I/O connector is turned OFF.

3) If the Test Result is FAIL

When the leak current that is measured during the test exceeds the upper cutoff current value or falls below the lower cutoff current value, the TOS5052 will give a FAIL judgment and terminates the test after shutting off the high-voltage output.

When the measured current is larger than the upper cutoff current.

The UPPER FAIL message lights as shown below.

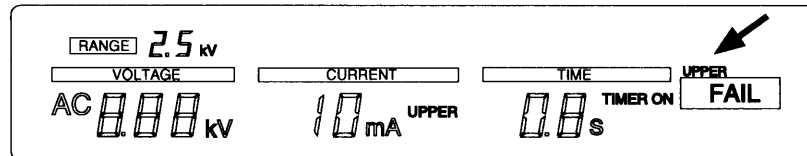

When the measured current is less than the upper cutoff current.

The LOWER FAIL message appears as shown below when the lower cutoff current is set to 1 mA and the lower pass/fail judgment function is on.

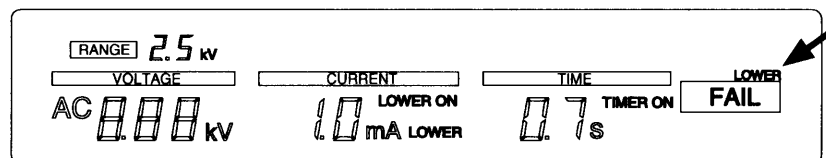

When the TOS5052 has made UPPER FAIL or LOWER FAIL judgment, the following actions will take place.

- The TOS5052 shuts off the high-voltage output.
- The TEST message disappears.
- The TEST signal of the SIGNAL I/O connector is turned OFF.
- The DANGER lamp goes out.
- The H.V ON signal of the SIGNAL I/O connector is turned OFF.
- The UPPER FAIL or LOWER FAIL appears.
- The U FAIL or L FAIL signal of the SIGNAL I/O connector is turned ON.
- Sounds the buzzer.
- Holds and displays the voltage that is measured when the FAIL is judged in the VOLTAGE readout.

To reset the FAIL judgment, press the STOP switch.

4) Stop the Test and Reset the Tester

The STOP switch is to stop the test and reset the TOS5052.

Reset from TEST state (TEST message is appears)

The TOS5052 will stop the test and act as followings:

- The TOS5052 shuts off the high-voltage output.
- The TEST message disappears.
- The DANGER lamp goes out.
- The H.V ON signal of the SIGNAL I/O connector is turned OFF.
- The TEST signal of the SIGNAL I/O connector is turned OFF.

Reset from PASS state (PASS message is appears)

The TOS5052 will reset from the PASS state and act as followings:

- The PASS message disappears.
- The PASS signal of the SIGNAL I/O connector is turned OFF.

Reset from FAIL state (FAIL message is appears)

The TOS5052 will reset from the FAIL state and act as followings:

- The UPPER FAIL or LOWER FAIL message disappears.
- The U FAIL or L FAIL signal of the SIGNAL I/O connector is turned OFF.

Reset from PROTECTION state (PROTECTION message is appears)

The TOS5052 will reset from the PROTECTION state and act as followings:

- The PROTECTION message disappears.
- The PROTECTION signal of the SIGNAL I/O connector is turned OFF.

However, the TOS5052 will not reset the PROTECTION state if the INTERLOCK pins of the SIGNAL I/O connector is held open. To reset the TOS5052 from the PROTECTION state, disable the interlock signal and press the STOP switch. See the section entitled "Interlock Function" for details.

Reset from READY state (READY message is appears)

The TOS5052 will reset from the READY state and act as followings while the STOP switch is held pressed:

- The READY message disappears.
- The READY signal of the SIGNAL I/O connector is turned OFF.

NOTE

- When the STOP switch is pressed, the TOS5052 normally will become the READY state (READY message appears) in which it can start a test. It will not become the READY state, however, in the following cases:
 1. The cause of PROTECTION state remaining un-eliminated
See the section entitled "PROTECTION" for details.
 2. A period of approximately 0.5 seconds has elapsed after releasing the STOP switch when the DOUBLE ACTION switch of the TEST MODE switch is set for ON.
See the section entitled "Setting for Special Test Modes" for details.
 3. The START switch is held pressed (or in the remote control mode).

5) Repeating the Test

When the test is successfully terminated with a PASS judgment, the TOS5052 automatically resets the PASS judgment in approximately 0.2 seconds and returns to the READY state (when PASS HOLD is held off). In this case, you can execute the next test simply by pressing the START switch. The same applies also when the TOS5052 is controlled remotely.

When the test is terminated with a FAIL judgment, press the STOP switch to reset the TOS5052 to the READY state and then press the START switch. The same applies also when the TOS5052 is controlled remotely.

NOTE

- The TOS5052 will not return to the READY state automatically when PASS HOLD is on. See Section 3.10, "Setting for Special Test Modes."

3.8 Remote Control

WARNING

- Be extremely careful when operating the TOS5052 in the remote control mode which the dangerous high test voltage is ON/OFF-controlled remotely. Provide means to assure that the TOS5052 does not become the TEST-ON state (state that the test voltage is being delivered) by inadvertent operation. Provide means to assure that none can touch the DUT, test leadwires, probes, output terminals and their vicinities when in the TEST-ON state. When any of these protective provisions are unavailable, do not attempt to control the TOS5052 .

3.8.1 REMOTE

The REMOTE connector is used to turn on and off the high test voltage under control of a signal from the optional remote control box (RC01-TOS or RC02-TOS) or high-voltage test probe (HP01A-TOS or HP02A-TOS).

Control procedure

1. — Set the POWER switch to OFF.
2. — Connect between the REMOTE connector on the front panel and the optional device with a dedicated cable (5-pin DIN cable).
3. — Set the POWER switch to ON. The REMOTE message then appears, the start input from the optional device is enabled, and the START switch on the panel is disabled. You can stop the TOS5052 using either the STOP switch on the panel or via the stop input from the optional device. For further information, refer to the operation manual for the optional device.
4. — To return control to the panel, set the POWER switch to OFF.
5. — Disconnect the dedicated cable (5-pin DIN cable) from the REMOTE connector on the front panel.
6. — Set the POWER switch to ON. The REMOTE message disappears and the START switch on the panel is enabled.

NOTE

- Plugging or unplugging the REMOTE connector with the POWER switch held on places the TOS5052 into the PROTECTION state (PROTECTION message appears) and shuts off the high-voltage output. If a forced stop has been

presented by the optional remote control box, however, the PROTECTION state is reset when the REMOTE connector is plugged in. The PROTECTION state is also reset when the high-voltage test probe is plugged in because a forced stop is always present in the high-voltage test probe.

- The TOS5052 cannot reset from the FAIL or PROTECTION state on a remote stop input when the FAIL MODE is on. Use the STOP switch on the panel. See Section 3.10, "Setting for Special Test Mode," for details.
- When remote control signals are presented from both REMOTE and SIGNAL I/O at the same time, the remote control signal from the SIGNAL I/O connector takes precedence over the signal from the REMOTE connector.

WARNING

- Use the optional high-voltage test probes (HP01A-TOS and HP02A-TOS) at a test voltage of 4 kV or less.

CAUTION

- Keep the high-voltage probe, the DUT, and signal lines away from one another at least 50 cm. Never short the test voltage to any signal line. Shorting the test voltage to a signal line might incur a fatal damage to the entire internal circuitry.

3.8.2 SIGNAL I/O

The SIGNAL I/O connector provides the three functions that are listed below. The attached 14-pin Amphenol plug may be used to connect to the SIGNAL I/O connector.

1. Shuts off the output in conjunction with an external device.
2. Turns on and off (start and stop) the high voltage at the HIGH VOLTAGE terminal under control of a control device other than the options.
3. Generates state information about the TOS5052.

WARNING

- Pins 9 and 14 of the 14-pin Amphenol plug are short-circuited to reset protection. Before making a practical withstanding voltage test, reset the interlock function. See the section entitled "Interlock Function" for details.

1) SIGNAL I/O Specifications

Input Signal Control Block	
High level input voltage	11 to 15V
Low level input voltage	0 to 4V
Low level input current	-5 mA max.
Input time duration	5 ms min.
Isolation	Photocoupler (30 V DC/30 Vrms AC max.)

Table 3-8 Input Signal Control Block (Pins 9 through 12)

Output Signal Control Block	
Type of output	Open collector output (4.5 to 30 V DC)
Output withstanding voltage	30V DC
Output saturation voltage	Approx. 1.1V, at 25°C (77°F)
Maximum output current	400mA (TOTAL)
Isolation	Photocoupler (30 V DC/30 Vrms AC max.)

Table 3-9 Output Signal Control Block (Pins 2 through 8)

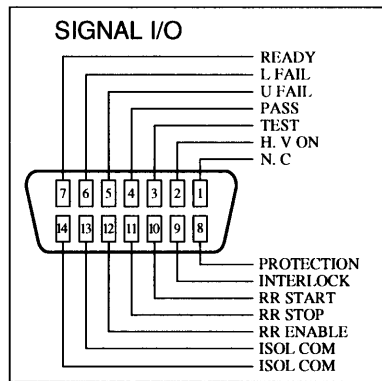

Figure 3-3 SIGNAL I/O Pin Configuration

SIGNAL I/O Pin Configuration			
Pin No.	Signal Name	I/O	Output Condition and Description
1	N.C		Not used with this Tester.
2	H.V ON	O	Held on while a high voltage is being applied across the output terminals during the test.
3	TEST	O	Held on during the test (except when the voltage is rising).
4	PASS	O	Set and held on for approx. 0.2 s when a PASS judgment is made. Delivered continuously if PASS HOLD has been set to ON.
5	U FAIL	O	When a current larger than the preset upper cutoff current is detected and the DUT is judged to be a failure. Delivered continuously.
6	L FAIL	O	When a current less than the preset lower cutoff current is detected and the DUT is judged to be a failure. Delivered continuously.
7	READY	O	Held on in the READY state.
8	PROTECTION	O	Held on when the PROTECTION function is active.
9	INTERLOCK	I	Interlock signal input pin (high active)
10	RR START	I	Start signal input pin (low active)
11	RR STOP	I	Stop signal input pin (low active)
12	RR ENABLE	I	Remote control enable signal input pin (low active)
13	ISOL COM		Circuit common pin
14	ISOL COM		Circuit common pin

Table 3-10 SIGNAL I/O Pin Configuration

Internal configuration

The SIGNAL I/O outputs are of the open-collector type and insulated from the internal circuit through photo couplers. The circuit common line is shared by the input signal lines.

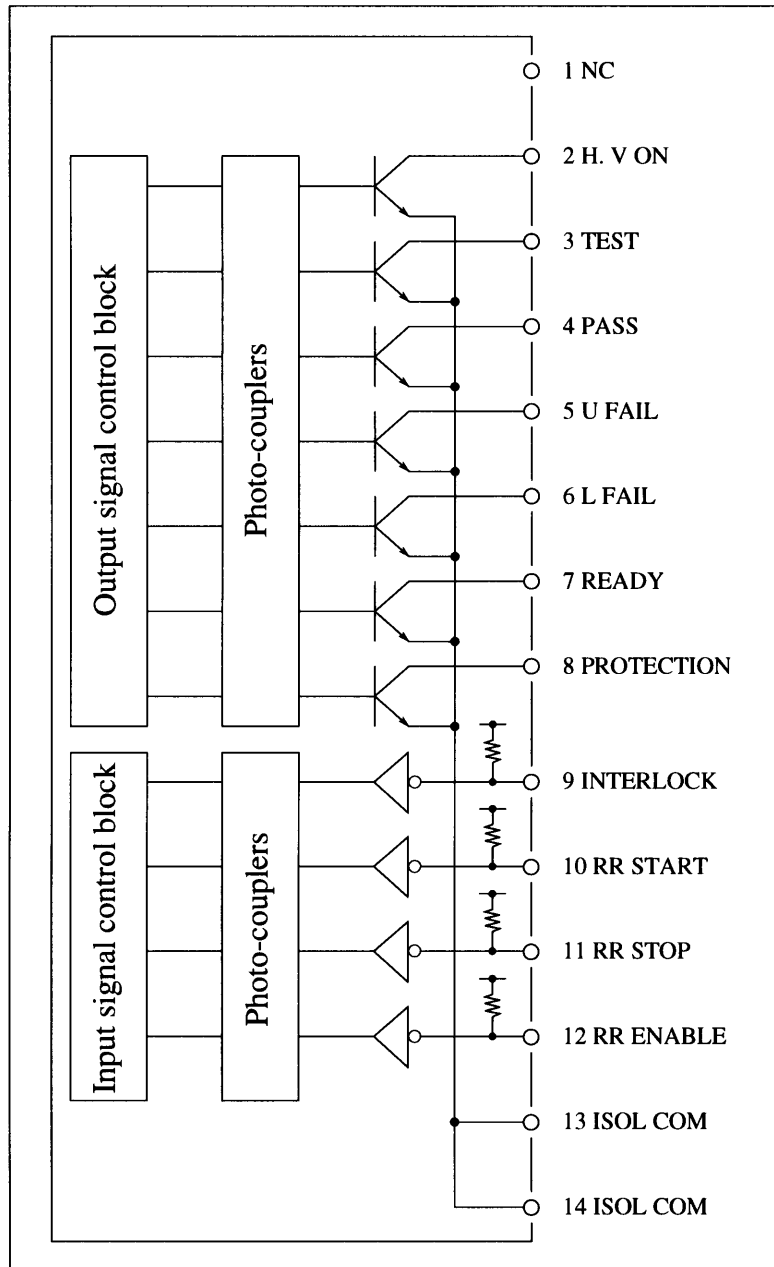

Figure 3-4 SIGNAL I/O Internal Configuration

2) Interlock Function

The TOS5052 is provided with the interlock function that shuts off its output in conjunction with an external device, whereby ensuring operator's safety. When this function is activated, the TOS5052 enters the PROTECTION state (PROTECTION message appears) in which it shuts off its output and disables any test. You cannot reset this state using either the STOP switch on the panel or stop signal from the SIGNAL I/O connector while the interlock signal is held high.

This function provides a safety means since it allows you to remotely control the test.

Using the interlock function

Pin 9 of the SIGNAL I/O connector is the input pin for the interlock signal. When pin 9 is opened, the signal at pin 9 goes high to actuate the interlock function, which places the TOS5052 into the PROTECTION state.

To reset the PROTECTION state that is entered through the interlock function, short pin 9 to pin 13 or 14 (ISOL COM) to set the interlock signal low, then press the STOP switch on the panel or issue a stop signal from the SIGNAL I/O connector.

Reference circuit

When the door opens, its contacts open, setting the interlock signal high. This activates the interlock function.

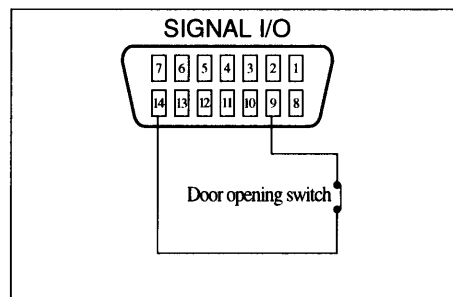

WARNING

- If you switch on your TOS5052 immediately after unpacking it, its interlock function starts, preventing you from performing functional checks. A 14-pin Amphenol plug is provided whose pin 9 is connected to pin 14 so that the protection state can be reset. When making a practical withstanding voltage test, be sure to run the TOS5052 using the interlock function.

3) Start/stop Control

Start/stop remote control is accomplished using pins 10, 11, and 12 of the SIGNAL I/O connector.

Control procedure

1. — Set the Remote Control Enable (RR ENABLE) signal low by shorting pin 12 to pin 13 or 14 (ISOL COM). This disables the START switch on the panel. You can still stop the test using the STOP switch on the panel or the stop signal (RR STOP).
2. — Set the Start signal (RR START) low by shorting pin 10 to pin 13 or 14 (ISOL COM) when the Ready signal (READY) at pin 7 is on. This start the TOS5052.
3. — Setting the Stop signal (RR STOP) low by shorting pin 11 to pin 13 or 14 (ISOL COM) stops the TOS5052.
4. — To reset the remote control mode, set the Remote Control Enables (RR ENABLE) to the high level. The REMOTE message disappear, the START switch on the panel is enabled, and the Start signal (RR START) at the SIGNAL I/O connector is disabled.

NOTE

- The TOS5052 temporarily enters the PROTECTION state (PROTECTION message appears) when the level of the Remote Control Enable signal (RR ENABLE) is changed. Reset the PROTECTION state using the STOP switch on the panel or Stop signal (RR STOP).
- The TOS5052 cannot reset from the FAIL or PROTECTION state on a remote stop input when the FAIL MODE is on. Use the STOP switch on the panel. See Section 3.10, "Setting for Special Test Modes," for details.
- The input terminals are pulled up to +15V through resistors. When an input terminal is opened, it becomes equivalent to be presented with a high level.
- The internal control circuit in the TOS5052 is designed not to cause malfunction when exposed to noises from the peripheral devices. Routing the SIGNAL I/O cable with its pins un-shielded would be an equivalent of building up an antenna and cause equipment malfunctions. Use a metal 14-pin Amphenol plug with a shielding capability, shielded cables, and external circuits that are housed in a shielded container. Connect those components to the frame of the TOS5052. (Do not connect the ISOL COM pins to the shilding line or an earth ground.) This isolates the SIGNAL I/O related circuits from the external environment and makes them immune to noise.
- When remote control signals are supplied from both REMOTE and SIGNAL I/O connectors at the same time, the remote

control signal from the SIGNAL I/O connector takes precedence.

CAUTION

- Keep the high-voltage test leadwire, the DUT, and signal lines away from one another at least 500 mm. Never short the test voltage to any signal line. Shorting the test voltage to a signal line might incur a fatal damage to the entire internal circuitry.

■ Sample start/stop circuits

When using make contacts

Consider the sample circuit shown below when using make contacts such as relays and switches. The contacts in this circuit may be substituted by logic element transistors, FETs, or photo-couplers.

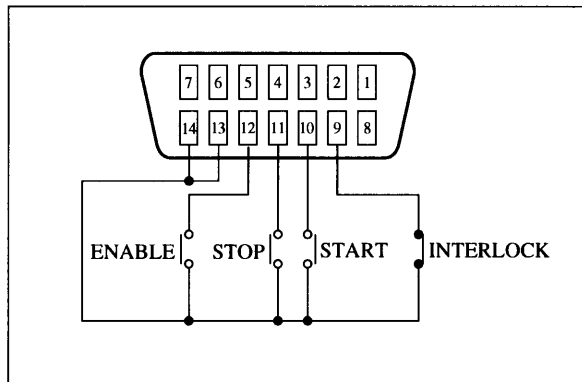

When using logic elements

Consider the sample circuit shown below when using logic elements (low active control).

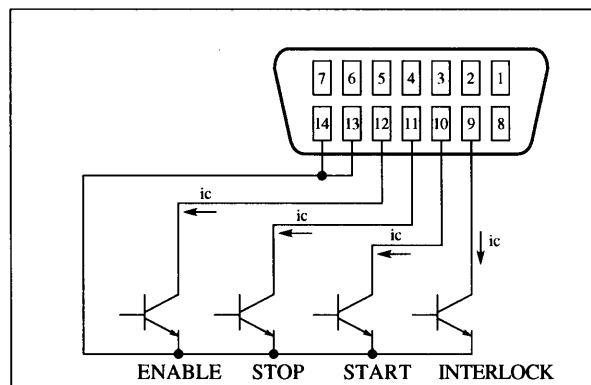

NOTE

- Make sure that each ic line can draw a current of 5 mA or more.

4) Output Signals

The state of the TOS5052 is present at output pins 2 through 8 of the SIGNAL I/O connector. Refer to the pin configuration chart in Table 3-8 and the sample circuits shown below when configuring a circuit for receiving the state signals.

Sample circuit for driving a relay

Use the H.V ON signal to drive a relay.

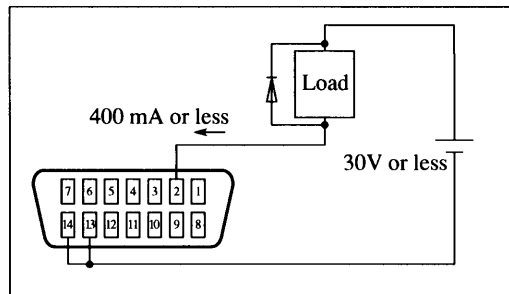

Sample circuit for obtaining a low-level digital signal.

Use the H.V ON signal to obtain a low-level digital signal.

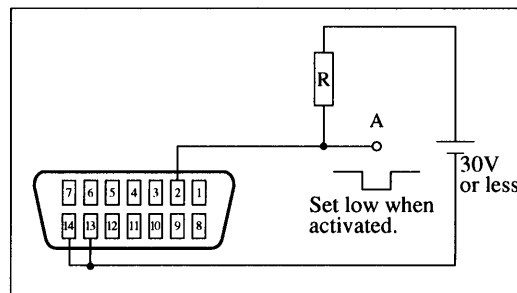

NOTE

- When driving an inductive load (such as a relay), be sure to connect a diode in parallel to the coil of the load.
- The open-collector circuit elements and board can be damaged if the output circuit is shorted. It is recommended to provide a protective fuse in the output circuit.
- The internal control circuit in the TOS5052 is designed not to cause malfunction when exposed to noises from the peripheral devices. Routing the SIGNAL I/O cable with its pins un-shielded would be an equivalent of building up an antenna and cause equipment malfunctions. Use a metal 14-pin Amphenol plug with a shielding capability, shielded cables, and external circuits that are housed in a shielded container. Connect those components to the chassis of the TOS5052. (Do not connect the ISOL COM pins to the shilding)



line or an earth ground.) This isolates the SIGNAL I/O related circuits from the external environment and makes them immune to noise.

----- CAUTION -----

- Keep the high-voltage test leadwire, the DUT, and signal lines away from one another at least 500 mm. Never short the test voltage to any signal line. Shorting the test voltage to a signal line might incur a fatal damage to the entire internal circuitry.

3.9 STATUS SIGNAL OUTPUT

STATUS SIGNAL OUTPUT is a 100 VAC output signal that is used to drive the optional Warning Light Unit and Buzzer unit. It can indicate eight TOS5052 states, namely, H.V ON, TEST, PASS, U FAIL, L FAIL, READY, PROTECTION, and POWER ON. You can use these states using the DIP switch block located on the rear panel. The output terminal generates a 100 VAC signal when the TOS5052 enters the selected state.

NOTE

- When two or more states are selected, STATUS SIGNAL OUTPUT is made up of the logical sum of the selected states. For example, when DIP switch Nos. 4 and 5 are set to ON simultaneously, a 100 VAC signal is generated when both UPPER FAIL and LOWER FAIL conditions occur. When DIP switch No. 8 is set to ON in this case, the 100 VAC output stays on while power is being supplied to the TOS5052.
- The output terminal generates a 100 VAC signal even the AC line input range was changed.

STATUS SIGNAL OUTPUT Generating Output		
	Signal Name	Conditions for signal delivery
1	H.V ON	Held on while a high voltage is being applied across the output terminals during the test.
2	TEST	Held on during the test (except when the voltage is rising).
3	PASS	Set and held on for approx. 0.2 s when a PASS judgment is made. Delivered continuously if PASS HOLD has been set to ON.
4	U FAIL	When a current larger than the preset upper cutoff current is detected and the DUT is judged to be a failure. Delivered continuously.
5	L FAIL	When a current less than the preset lower cutoff current is detected and the DUT is judged to be a failure. Delivered continuously.
6	READY	Held on in the READY state.
7	PROTECTION	Held on when the PROTECTION function is active.
8	POWER ON	Turned on when the POWER switch is set to ON.

Table 3-11 STATUS SIGNAL OUTPUT Signals

STATUS SIGNAL OUTPUT	
Type of output	Triode AC switch output signal
Output voltage	Approx. 100V AC
Leak current	1mA or less
Maximum output current	0.3A
Isolation	Photocoupler (1200V AC, for 1 second)
Rear panel view	

Table 3-12 STATUS SIGNAL OUTPUT Specifications

STATUS SIGNAL OUTPUT circuit

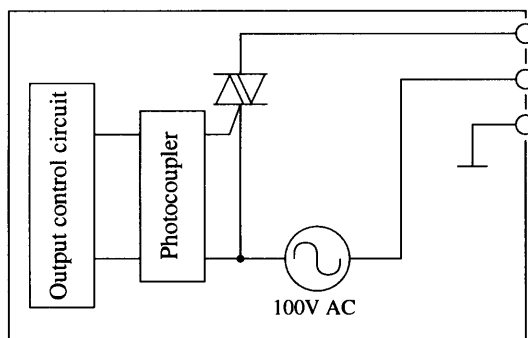

3.10 Setting for Special Test Mode

You can set up one of the five test modes using the TEST MODE switches on the TOS5052 rear panel. These modes can be used in arbitrary combinations.

The TOS5052 reads in the TEST MODE switch information when it is powered on. Whenever you make a mode change, turn off and on the TOS5052 again.

The factory-default setting of these switches as the TOS5052 is shipped from the factory are as shown below.

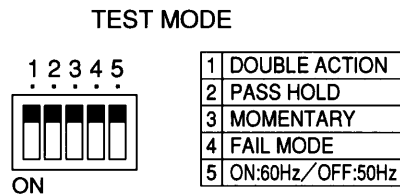

3.10.1 Start Double Action Mode

In the double action mode, the TOS5052 will not start a test unless you press the START switch within approximately 0.5 second after releasing the STOP switch. After the 0.5 second, you cannot start a test using only the START switch. The TOS5052 starts a test only when you press the STOP and START switches in the double-action mode. This provides a certain degree of safety, though the operating procedure is rather complicated.

This mode works in the same way when the TOS5052 is controlled remotely.

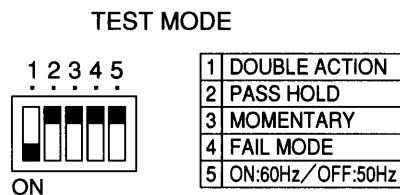

3.10.2 Pass Hold Mode

When PASS HOLD is set to ON, the TOS5052 will not return to the READY state automatically after making a PASS judgment. You must press the STOP switch or use the remote control stop input to restore the TOS5052 into the READY state.

To hold the current measurement at the PASS, set to ON the PASS HOLD.

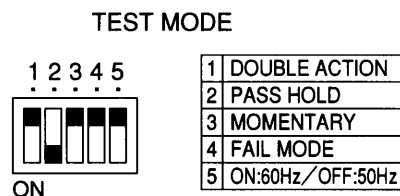

3.10.3 Start Momentary Mode

When **MOMENTARY** is set to **ON**, the TOS5052 performs the test only when the **START** switch is held pressed. The test is suspended when you release the **START** switch. This keeps the operator's hands confined on the TOS5052 panel, ensuring safe operation.

This mode works in the same way when the TOS5052 is controlled remotely. Further safety operation is assured by using the optional dual-hand type remote control box (RC02-TOS).

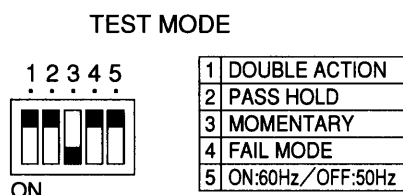

3.10.4 FAIL Mode

When **FAIL MODE** is set to **ON**, the TOS5052 become unable to reset the **FAIL** or **PROTECTION** state with the remote control stop signal. The **STOP** switch on the TOS5052 must be used to reset those state.

This mode should be used when you are going to use an optional high-voltage test probe (HP01A-TOS or HP02A-TOS) to confirming the **FAIL** or **PROTECTION** state.

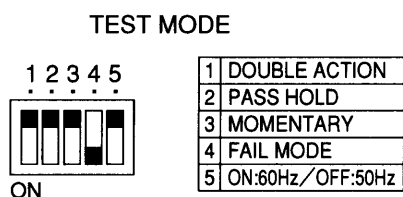

3.10.5 50/60 Hz Frequency Selection Mode

Setting the **ON:60 Hz/OFF:50 Hz** switch to **ON** sets the test voltage's frequency to 60 Hz and setting it to **OFF** sets the test voltage's frequency to 50 Hz.

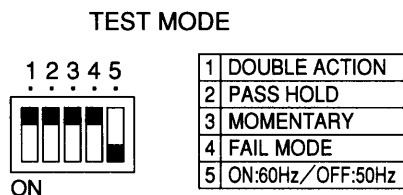

4

Chapter 4 Names and Functions of Control

This chapter describes the controls and indicators of the TOS5052.

4.1 Front Panel	4-2
4.2 Display	4-6
4.3 Rear Panel	4-9

4.1 Front Panel

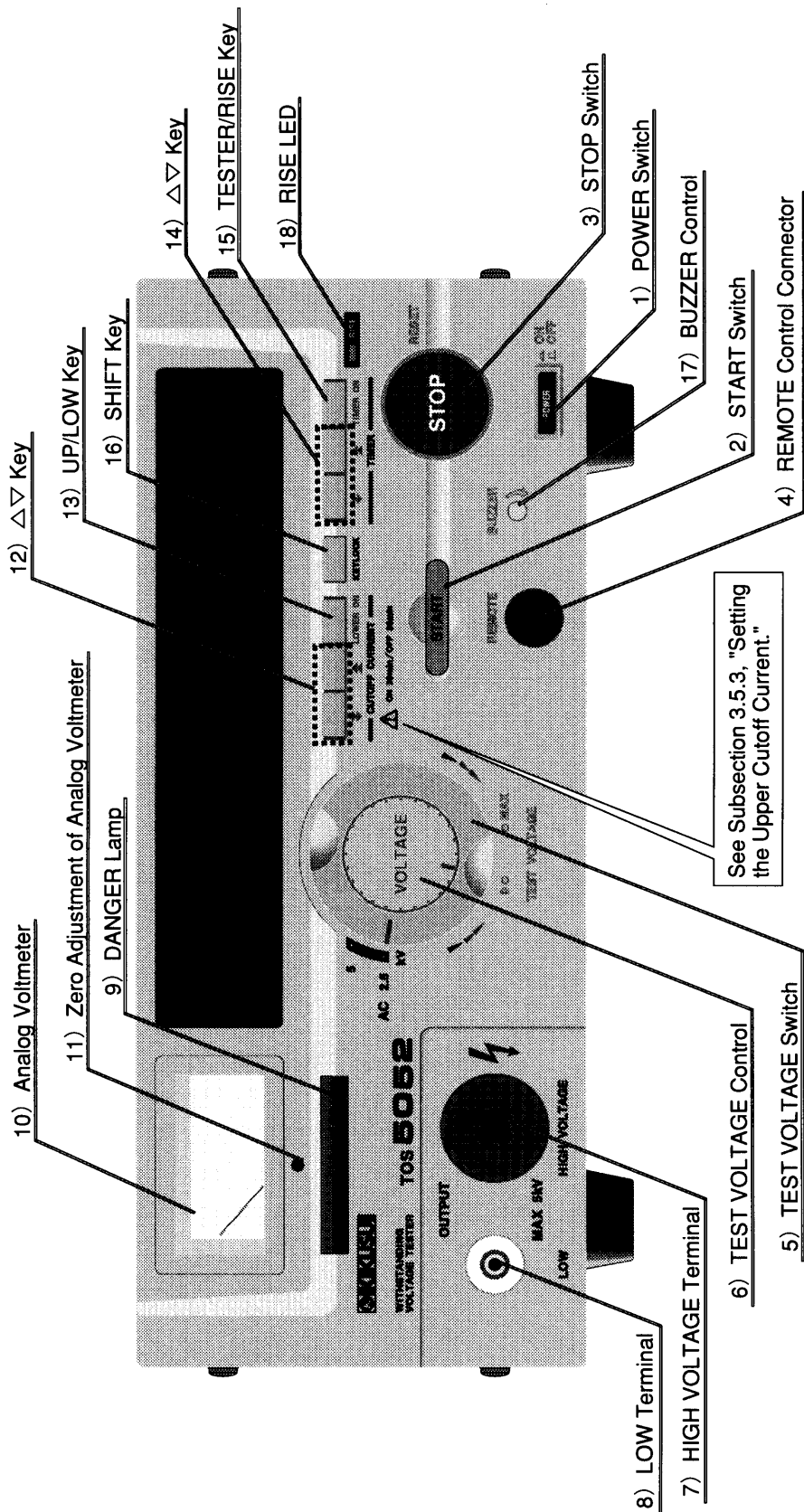

1) POWER Switch

The POWER switch turns on and off the TOS5052.

When the TOS5052 is turned on, it starts up with the parameters that are set up the last time it was turned off.

Turning on the POWER switch while holding down the SHIFT key initializes the TOS5052 parameters to the factory-set values. In this case, the currently stored settings are all lost.

For details, refer to Section 3.2, "Initial Setup".

2) START Switch

Pressing this switch when the TOS5052 is in the READY state starts a test.

This switch is disabled when the REMOTE message is on, in which case the start input through the REMOTE connector or through the SIGNAL I/O connector on the rear panel takes precedence.

When DOUBLE ACTION is set to ON, the TOS5052 will start a test only when you press the START switch within approximately 0.5 second after releasing the STOP switch. See Section 3.10, "Setting the Test Mode."

When MOMENTARY is set to ON, the TOS5052 performs the test only when the START switch is held pressed. See Section 3.10, "Setting the Test Mode."

3) STOP Switch

The STOP switch stops the current test or resets the TOS5052 state.

It is used to reset the TEST, PASS, FAIL, PROTECTION, and READY states.

For details, see the paragraph on "Stop the Test and Reset the Tester."

4) REMOTE Control Connector

This terminal is used only to connect the optional remote control box or high voltage test probe. When one of these options is connected, the REMOTE message turns on and enables the TOS5052 to start remotely. In this case, the START switch on the panel is disabled.

5) TEST VOLTAGE Switch

This switch is used to set the test voltage range.

Select either the 2.5 kV or 5 kV range.

6) TEST VOLTAGE Control

This knob is used to set the test voltage. You can use this control throughout the test except when the TOS5052 is in the READY state or when the voltage is rising. Turning this knob while holding down the SHIFT key increases or decreases the set value in increments that is 10 times greater than when using the knob alone.

7) HIGH VOLTAGE Terminal

This terminal carries the higher-voltage side of the test voltage output. The test voltage is presented across this terminal and the LOW terminal.

WARNING

- Never touch this terminal while the TOS5052 is running a test.

CAUTION

- The TOS5052 may be damaged if an external voltage is applied to this terminal.

8) LOW Terminal

This terminal carries the lower-voltage side of the test voltage output. This terminal is connected directly to the TOS5052's chassis.

9) DANGER Lamp

This red lamp illuminates to indicate that the test voltage is being delivered.

WARNING

- Never touch the HIGH VOLTAGE terminal, test leadwires, and DUT while this lamp is on.

10) Analog voltmeter

This voltmeter indicates the output voltage. It directly reads the level of voltage across the HIGH VOLTAGE and LOW terminals.

WARNING

- Never touch the HIGH VOLTAGE terminal, test leadwires, and DUT while the voltmeter's pointer is off the 0 level.

CAUTION

- This voltmeter cannot be used as a standalone voltmeter. It may be damaged if an external voltage is applied to its output terminal.

11) Zero adjustment of analog voltmeter

This mechanical control is used to zero adjust the analog voltmeter.

CAUTION

- Be sure to set the POWER switch to OFF when making a zero adjustment.

12) ▽△ keys

These keys are used to set the upper cutoff current and lower cutoff current. Turning these keys while holding down the SHIFT key increases or decreases the set value in increments that is 10 times greater than when using the keys alone. Keep these keys pressed continuously increases or decreases the set value.

13) UP/LOW key

This key is used to select either the upper cutoff current and lower cutoff current. Pressing this key while holding down the SHIFT key turns on and off the lower pass/fail judgment function.

14) ▽△ keys

These keys are used to set the test time of time. Turning these keys while holding down the SHIFT key increases or decreases the set value in increments that is 10 times greater than when using the keys alone. Keep these keys pressed continuously increases or decreases the set value.

15) TEST/RISE key

This key selects either the test time or voltage rise time (RISE LED is lit). You can turn on and off the timer function by pressing this key while holding down the SHIFT key.

16) SHIFT key

Pressing and holding down this key for 3 seconds turns on and off the keylock function (KEYLOCK message is lit). When the keylock function is on, you can neither turn on nor off the test voltage, upper cutoff current, lower cutoff current, voltage rise time, test time, or timer function.

When used with the keys from 12) through 15), the SHIFT key augments the function of the respective key. Turning the TEST VOLTAGE control knob while holding down this key increases or decreases the set value in increments that is 10 times greater than when using the knob alone.

Turning on the POWER switch while holding down the SHIFT key initializes the TOS5052 parameters to the factory-set values. See Section 3.2, "Initial Setup," for details.

17) BUZZER control

This control is a common variable resistor for controlling the volume of the buzzer which notifies a PASS or FAIL condition. This control is set to the maximum value at the factory.

18) RISE LED

This LED is lit when the voltage rise time (rise time control function) is selected. It is also held on during the voltage rise time, until the test voltage is reached.

NOTE

- The TOS5052 will not accept any input entered through keys 12) through 15) when it is in the TEST state (TEST message appears), PASS state (PASS message appears), or FAIL state (FAIL message appears).

4.2 Display

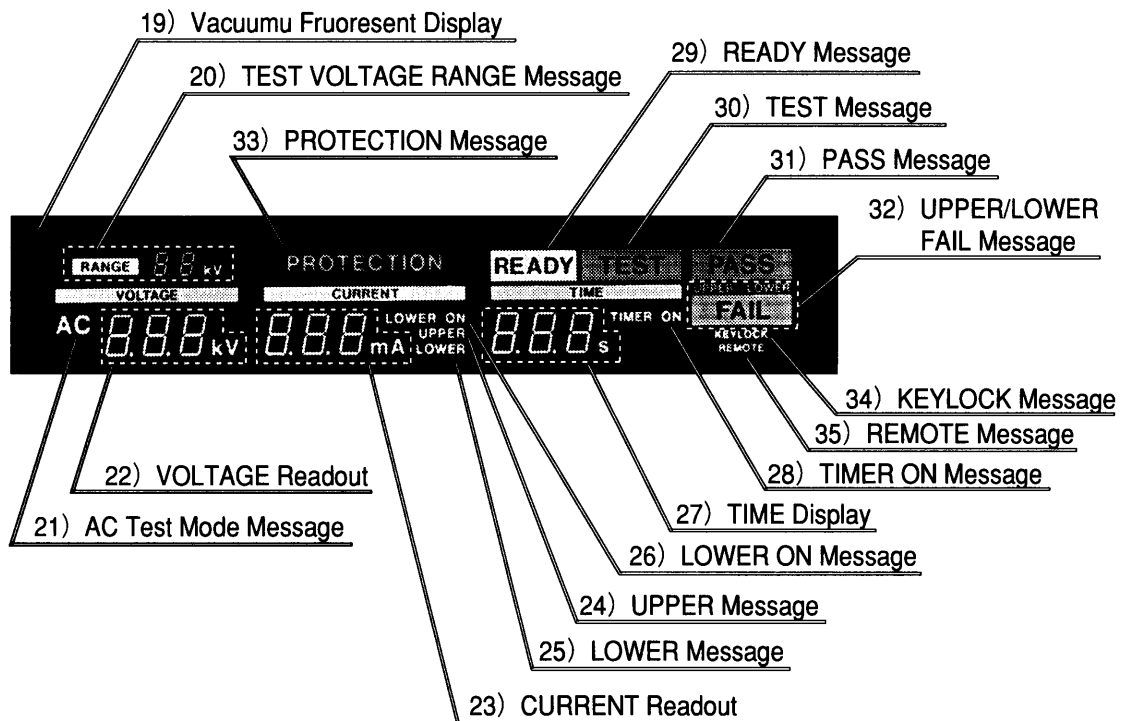

19) Vacuum Fluorescent Display

The vacuum fluorescent display indicates the test conditions and test results.

20) TEST VOLTAGE RANGE Message

Indicates the 2-digit test voltage range.

21) AC Message

Identifies an ac output voltage.

22) VOLTAGE Readout

Indicates the 3-digit output voltage level except in the following cases:

- During the test when the voltage measured at the output terminal is displayed.
- PASS or FAIL state in which case the measured voltage is displayed.

CAUTION

- This voltmeter cannot be used as a standalone voltmeter. It may be damaged if an external voltage is applied to its output terminal.

23) CURRENT Readout

Indicates the 3-digit cutoff current setting (upper or lower) except in the cases listed below. The ammeter range and resolution are determined by the UPPER value.

- During the test when the current that is flowing through the output terminal is displayed
- PASS state in which case the measured current is displayed.

24) UPPER Message

Appear when the upper cutoff current is displayed in the CURRENT readout.

25) LOWER Message

Appear when the lower cutoff current is displayed in the CURRENT readout.

26) LOWER ON Message

Appear when the lower pass/fail judgment function is enabled.

27) TIME Display

Indicates the 3-digit elapsed time during the test and the test time or voltage rise time in the other periods.

28) TIMER ON Message

Appear when the test time timer function is on.

29) READY Message

Appear when the TOS5052 is ready for testing.

30) TEST Message

Appear when the TOS5052 is performing a test.

31) PASS Message

This message appears for approximately 0.2 second when the DUT passes the test. This message stays on when the PASS HOLD mode is on. This message is reset by pressing the STOP switch.

32) UPPER and FAIL Message

Set and held on when FAIL is judged during the upper pass/fail judgment. This message is reset by pressing the STOP switch.

LOWER and FAIL Message

Set and held on when FAIL is judged during the lower pass/fail judgment. This message is reset by pressing the STOP switch.

33) PROTECTION Message

Appear when one of the protection functions listed below is actuated. When this message appears, remove the source that actuated the protection function and press the STOP switch.

Cause	Resetting Action
A plug is inserted to or removed from the REMOTE connector.	Enter STOP.
The state of the REMOTE ENABLE terminal in the SIGNAL I/O connector is changed.	Enter STOP.
The INTERLOCK signal in the SIGNAL I/O connector goes high.	Set the INTERLOCK signal low and enter STOP.
The temperature inside the TOS5052 rises to actuate overheat protection.	Lower the temperature and enter STOP.
A voltage that is higher than the preset voltage by +200V is detected.	Enter STOP.
A current of 50 mA or more is detected for 30 minutes or longer during the test.	Suspends the test for longer than 30 minutes and enter STOP.

Table 4-1 Causes of PROTECTION Conditions and Resetting Procedures

34) KEYLOCK Message

Appear when the TOS5052 is in the KEYLOCK state. In this state, you cannot change the test voltage, upper cutoff current, lower cutoff current, lower pass/fail judgment ON/OFF, voltage rise time, test time, and timer function ON/OFF. To reset the KEYLOCK state, press and hold down the SHIFT key for approximately 3 seconds.

35) REMOTE Message

Appear when the TOS5052 is ready for remote control via the REMOTE or SIGNAL I/O connector.

4.3 Rear Panel

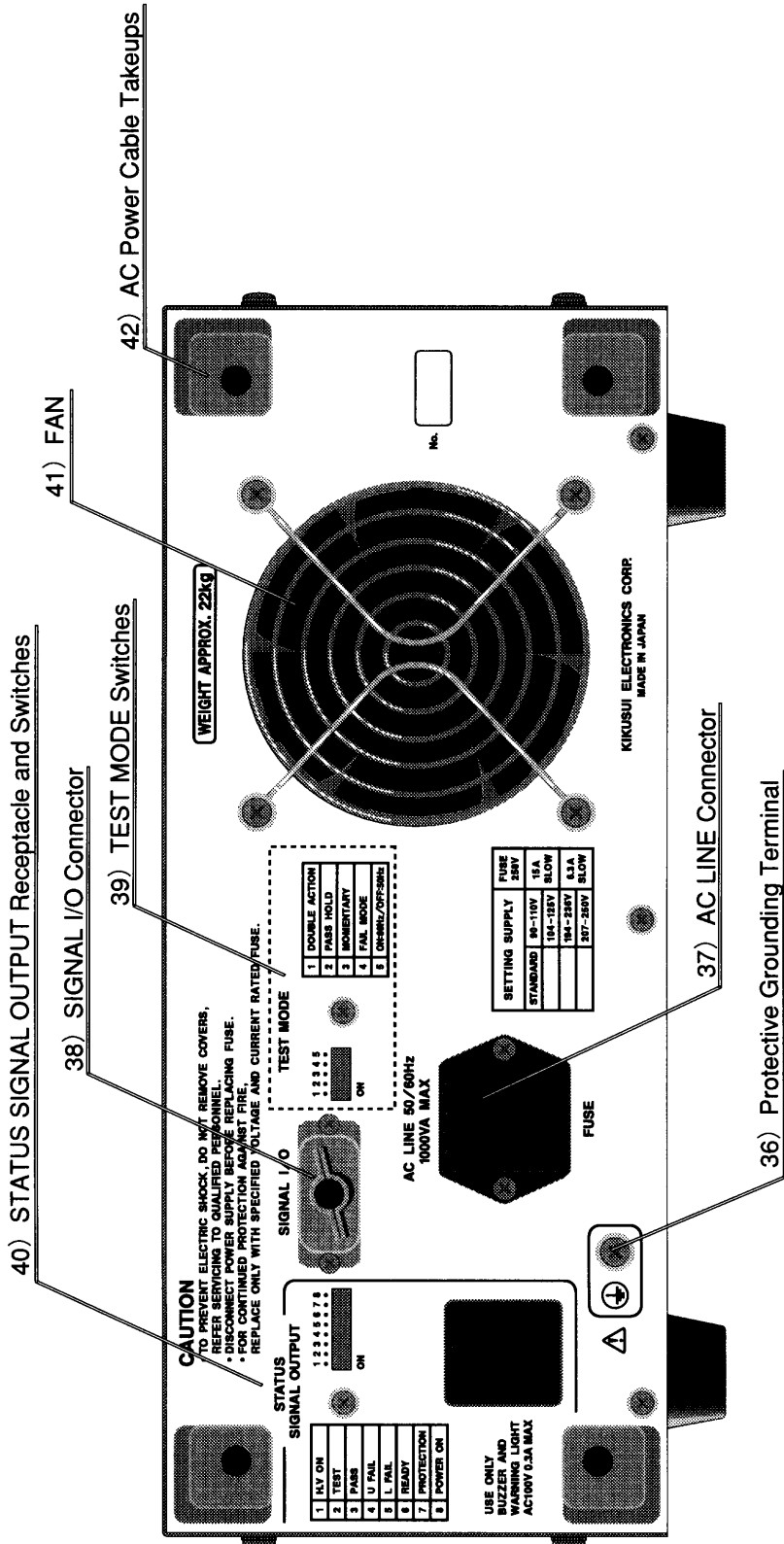

36) Protective Grounding Terminal

This terminal is for grounding the TOS5052 to an earth ground.

WARNING

- Be sure to connect securely (by using a screwdriver) an earth ground line to Protective grounding terminal. Unless the TOS5052 is securely grounded, when the TOS5052 chassis can be charged up to the high voltage than can cause electric shock hazard.

37) AC LINE Connector

A connector used to connect the AC power cable. It serves also as an input power fuse holder.

38) SIGNAL I/O Connector

Is a 14-pin Amphenol connector that carries the interlock input signal, start/stop remote control signal, and test status output signals.

39) TEST MODE Switch

This DIP switch is used to select the five modes, namely, DOUBLE ACTION, PASS HOLD, MOMENTARY, FAIL MODE, and 50/60 Hz.

40) STATUS SIGNAL OUTPUT Receptacle and Switches

This output receptacle delivers a 100 VAC signal to drive an optional warning light unit or a buzzer unit. 100 VAC is delivered when the TOS5052 enters the mode(s) that are selected with the DIP switches.

NOTE

- The receptacle delivers a 100 VAC signal even the AC line input range was changed.

41) FAN

A cooling fan used to cool the high voltage generator circuit.

42) AC Power cable Takeups

Used to store the AC power cable when it is not in use.

5

Chapter 5 OPERATING PRINCIPLE

This chapter describes the principles of operation of the TOS5052 with block diagrams.

5.1 Block Diagram	5-2
5.2 Rise Time Control Function	5-4

5.1 Block Diagram

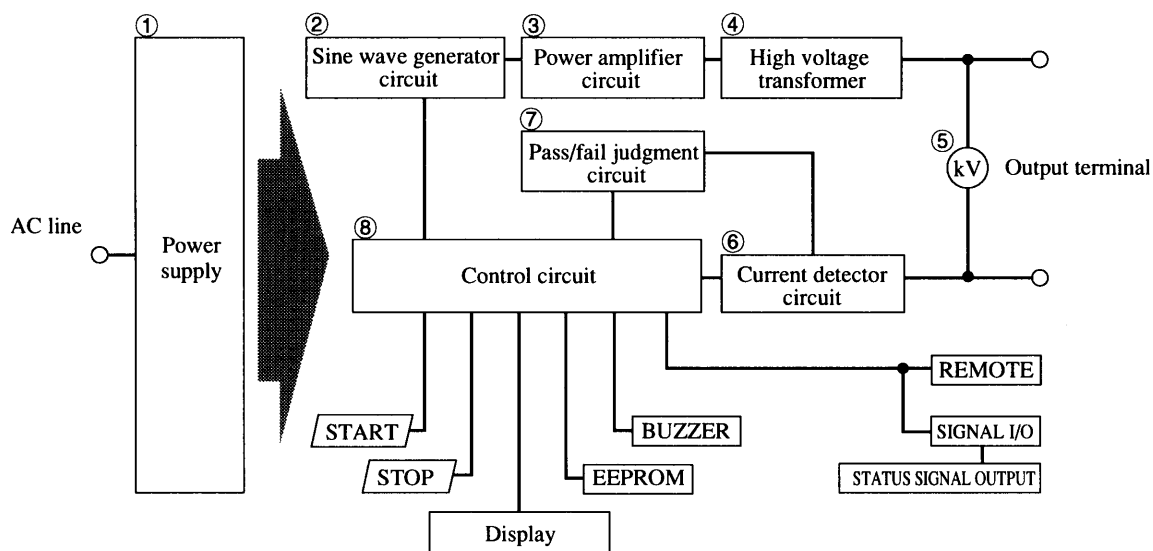

Figure 5-1 TOS5052 Block Diagram

① Power supply

Converts the AC power voltage from the AC line to DC power voltages. This DC power voltage is supplied each circuits. This power supply also generates the 100 VAC power to STATUS SIGNAL OUTPUT.

② Sine wave generator circuit

Generates a stable, low-distortion 50 or 60 Hz sine wave whose amplitude is proportional to the output voltage. This circuit generates a smooth output voltage during the voltage rise time so that it applies no transient voltage to the DUT.

③ Power amplifier circuit

Amplifies the output from the sine wave generator circuit up to a maximum of 100V. Using a high-power, high-efficiency (500 VA) PWM inverter, this circuit provides stable test voltages of lower distortion and higher efficiency than the conventional voltage regulator which use a slide transformer.

The high-voltage generator block including the high-voltage transformer can yield a maximum rated output of 5 kV/100 mA (500 VA) for a limited period. At a test voltage of approximately 1 kV or higher, this power amplifier circuit has the capacity to supply a instantaneous current of 200 mA or more.

④ High voltage transformer

This transformer boosts the output voltage of the power amplifier circuit up to 5kV with a ratio of approximately 1 to 50.

The high voltage transformer has a capacity of 500 VA.

Voltmeters

The TOS5052 is furnished with a digital voltmeter ($\pm 1.5\%$ full-scale) and an analog voltmeter ($\pm 5\%$ full-scale).

(a) Digital voltmeter

This digital voltmeter divides the output voltage with high-precision high-voltage resistors and supplies the output to the AC/DC converter circuit where DC voltage is generated. This DC voltage is sent to the A/D converter and indicate the display during the test.

(b) Analog voltmeter

The analog voltmeter rectifies the current that flows through the divider resistors to drive the DC ammeter.

Current detector circuit

The current detector circuit converts the current flowing over the output terminal to develop a voltage across the reference resistor. This voltage is converted in the AC/DC converter circuit to a DC voltage.

The digital ammeter takes in this voltage using its A/D converter and indicate it on the display. The ammeter range and resolution are determined by the UPPER value.

Upper cutoff current		0.1-7.5mA	7.6-30mA	31-110mA
Resolution		4 μ A	16 μ A	64 μ A
Current Display Format	i < 10mA	. mA	. mA	. mA
	10mA i < 31mA		. mA	. mA
	31mA i < 100mA			. mA
	100mA i			mA

Table 5-1 Relationship between the Ammeter Ranges/Resolutions and Upper cutoff current

Pass/fail judgment circuit

The DC voltage from the current detector circuit is compared against the reference voltage that corresponds to the predefined upper or lower cutoff current. When the current proves to be greater than the upper cutoff current, the judgment circuit flags a withstanding voltage error and shuts off the test voltage. It also signals a broken high-voltage test leadwire or poor connection condition and shuts off the test voltage when the current proves to be smaller than the lower cutoff current.

Control circuit

The control circuit contains a 8-bit single-chip CPU that provides voltage and current measurement control, pass/fail judgment, test time and test voltage rise time management, and sequence control. It saves the test voltage, cutoff current values, and test time in EEPROM before the CPU is reset following the detection of the POWER switch off condition.

5.2 Rise Time Control Function

The distortion of the output waveform gets heavier as the primary side of the high-voltage transformer is switched on and off using a contact switch during a withstanding voltage test. As the result, a voltage of higher than necessary is likely to be applied to the DUT, resulting in damage to the DUT or taking a good product as a defective one. To solve this problem, a general-purpose withstanding voltage tester uses a semiconductor-made zero crossing switch to close the circuit near zero volt at the beginning of the test and to open the circuit near zero volt at the end of the test when there is no flowing current.

The TOS5052 not only closes the circuit near zero volt at the beginning of the test but also opens the circuit near zero volt at the end of the test when there is no flowing current. In this case, the TOS5052 gradually raises the test voltage from near zero volt up to the specified voltage level and, after the lapse of the test period, it opens the circuit, whereby generating a test voltage with a minimum waveform distortion.

Safety standard stipulates that the DUT shall not be subject to any transient voltage that exceeds the peak test voltage. The UL's type certification test and IEC standard stipulate that the test voltage be raised gradually and smoothly up to the preset level. The TOS5052 meets these requirements and can automatically raise the test voltage gradually and smoothly up to the prespecified level.

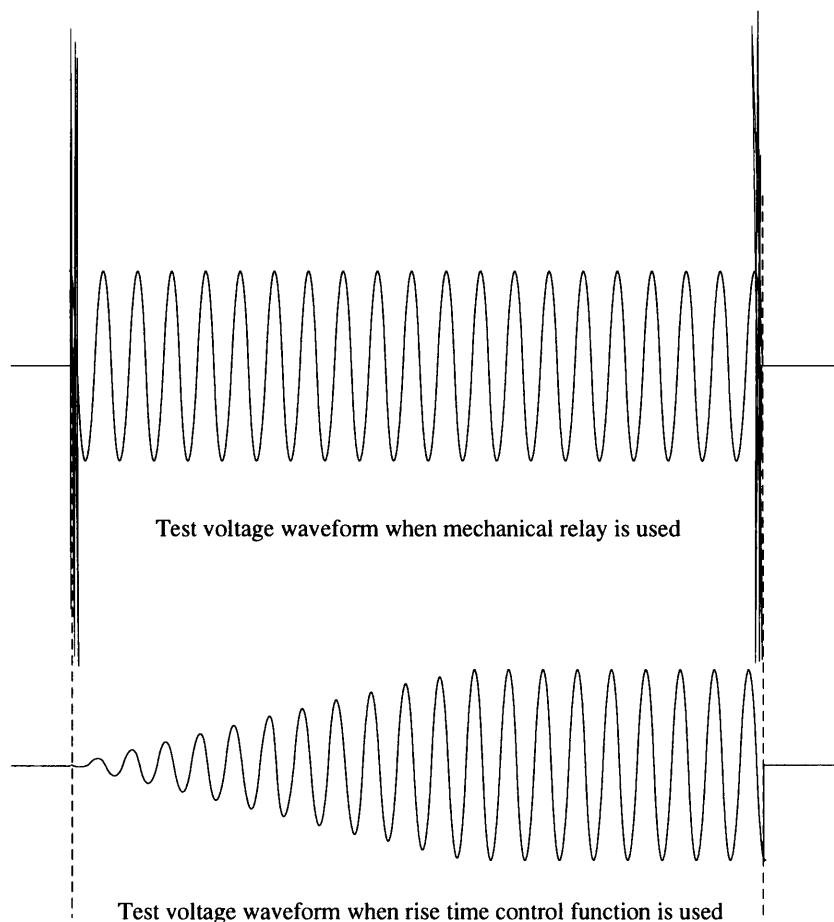

CAUTION

- When using an optional high-voltage test probe (HP01A-TOS or HP02A-TOS), do not connect it while keeping the test voltage present at the probe. Do not disconnect the probe from the DUT while keeping the test voltage present at the probe.
- The waveform of the test voltage may be distorted heavily, causing fatal damage to the DUT if you repeat the connection and disconnection of the probe to and from the DUT while keeping the high voltage output present at the probe. Be sure connect the probe to the DUT before starting a test and disconnect it from the DUT after the test ends.

6

Chapter 6 MAINTENANCE

This chapter provides information on maintaining and calibrating this product. To maintain the TOS5052 is original performance as long as possible, conduct periodic checks and maintenance.

6.1 Cleaning	6-2
6.2 Inspection	6-2
6.3 Overhaul	6-3
6.4 Calibration	6-3

6.1 Cleaning

WARNING

- After cleaning the TOS5052, do not use the TOS5052 until it dries out. Using a poorly dried TOS5052 may result in electric shock or fatal damage to the TOS5052.

CAUTION

- Be sure to set the POWER switch to OFF before cleaning.
- Do not use volatile solvents such as thinner or benzine. They may discolor the unit surface coating, erase printed characters.

1) Cleaning the Main Unit

When the panel or cover gets soiled, wet a piece of soft cloth with a water-diluted neutral detergent, and wipe the panel softly.

6.2 Inspection

Checking the AC power cable

Check the AC input power cable for broken sheath and for loose or cracked plug.

Checking the High and Low Test Leadwire

Check the high and low test leadwire for broken sheath and open-circuited (by using a circuit tester or other instrument).

WARNING

- Breaks in the insulation coating may cause electric shock. If a break is found, immediately stop using the TOS5052.

To purchase accessories, contact your Kikusui agent.

6.3 Overhaul

WARNING

- The TOS5052 generates a hazardously high voltage of 5kV. Never attempt to overhaul the TOS5052 for yourself. For such service, contact your Kikusui agent.

1) High Voltage Relay

The high voltage relay used in the TOS5052 is a consumable part. It is recommended that you replace the high voltage relay every 1 million runs of withstanding voltage test (this may vary depending on how the TOS5052 is used) when you make internal check or cleaning.

2) Cooling Fan

The cooling fan used in the TOS5052 is a consumable part. It is recommended that you replace the cooling fan every 30,000 hours of operation (this may vary depending on how the TOS5052 is used) when you make internal check or cleaning.

6.4 Calibration

This product was calibrated at shipment. However, recalibration is required after long-term usage.

WARNING

- The TOS5052 generates a hazardously high voltage of 5kV. Never attempt to calibrate the TOS5052 for yourself. For such service, contact your Kikusui agent.

7

Chapter 7 SPECIFICATIONS

This chapter contains the electrical and mechanical specifications from the TOS5052 and description of the TOS5052's options.

7.1 Specifications	7-2
7.2 Overall Dimensions	7-9
7.3 Options	7-10

7.1 Specifications

Item		Specification
Output block		
Output voltage range		0.50 kV to 5.00 kVAC (100 mA output possible range)
Voltage setting range		0.00 to 2.95 kV/0.00 to 5.45 kV, 2 ranges (3-digit digital setting)
Setting accuracy		±(2% of setting + 2 digits) at 0.20 kV or higher with no load
Resolution		10V
Maximum rated output (*1)		500VA (5kV/100mA)
Transformer capacity		500VA
Output voltage waveform (*2)		Sine wave
Short-circuit current		200 mA to 300 mA (when the output voltage is 1.1 kV or more)
Distortion factor		Output voltage of 0.5 kV or higher: 2% or less (under no load or resistive load)
Frequency		50 or 60 Hz selectable (±0.5% of setting, except during voltage rise)
Voltage regulation		9% or less (maximum rated load to no load)
Output type		PWM switching
Output voltage monitoring function		Output is shut off and protection is effected when the output voltage exceeds the set value plus 200V. "kV" blinks when the output voltage falls below the set voltage minus 100V.
Output voltmeter		
Analog	Scale	5kV f.s
	Accuracy	±5% f.s
	Indication	Mean-value response/rms-value
Digital	Scale	2.5kV/ 5kV f.s
	Accuracy	±(1.5% f.s) when the measured voltage does not change within the digital voltmeter's response time.
	Response	Mean-value response/rms-value (400 ms response time)
	Hold function	The voltage measured at the end of test is held during the PASS or FAIL interval.
Ammeter		
Digital	Measuring range	0.00 to 110mA
	Accuracy	±(5% of upper cutoff current + 20 μA) when the measured current does not change within the digital ammeter's response time.
	Response	Mean-value response/rms-value (400 ms response time)
	Hold function	The current measured at the end of test is held during the PASS interval.

Item		Specification
Judgment function		
Judgment system		Window comparator system <ul style="list-style-type: none"> • FAIL is judged when a current greater than the upper cutoff current is detected. • FAIL is judged when a current smaller than the lower cutoff current is detected. • OUTPUT is shut off and FAIL SIGNAL is generated when FAIL is judged. • PASS SIGNAL is generated when no anomaly is found within the set time.
Upper cutoff current range		0.1 to 110mA
Lower cutoff current range		0.1 to 110mA The TOS5052 makes no lower pass/fail judgment while the voltage is rising and for approximately 0.2 s after the voltage is made constant.
Judgment accuracy (*3)		$\pm(5\%$ of upper cutoff current $+20\ \mu\text{A})$
Current detection method		Absolute value of current is integrated and compared against the reference value.
Calibration		The root mean square value of sine wave is calibrated using the pure resistive load.
Illuminators and LEDs	PASS	Lit for approximately 0.2 s when PASS is judged. Held on when PASS HOLD is enabled.
	UPPER FAIL	Lit when a current greater than the upper cutoff current is detected and FAIL is judged.
	LOWER FAIL	Lit when a current smaller than the lower cutoff current is detected and FAIL is judged.
Buzzer		<ul style="list-style-type: none"> • Turned on for approximately 0.2 s when PASS is judged. • Held on in the following cases: <ul style="list-style-type: none"> PASS is judged when PASS HOLD is enabled. UPPER FAIL is judged. LOWER FAIL is judged. The volume of the FAIL or PASS buzzer may be adjusted. The volume setting is common to both FAIL and PASS conditions because the same adjuster is used.
Time		
Voltage rise time	Range	0.1 to 99.9s 0.1s step
	Accuracy	$\pm 20\text{ms}$
Test time	Range	0.3 to 999 s (TIMER OFF function available)
	Accuracy	$\pm 20\text{ms}$

- *1 Pay attention to the limitations on output voltage delivery time as follows: The heat dissipation of the high voltage generator section of the TOS5052 is one-half of the normal wattage with respect to the rated output from the viewpoints of size, weight, and cost of the TOS5052. Be sure to operate the TOS5052 within the limits shown in the below tables. If you operate the TOS5052 exceeding limits, the thermal fuse in the TOS5052 may blow out.

Ambient temperature t (°C)	Upper cutoff current I (mA)	Pause time	Maximum allowable continuous test time
$t \leq 40^\circ\text{C}$ ($t \leq 104^\circ\text{F}$)	$50 < I \leq 100$	No less than test time	≤ 30 minutes
	$I \leq 50$	Not required	Infinite

- *2 Test voltage waveform

When an AC test voltage is applied to a capacitive load, it is possible that the voltage becomes higher even than that when in the no load state. Furthermore, waveform distortion also may occur if the capacitance of the load is voltage-dependent (such as of ceramics capacitors). When the test voltage is not higher than 1.5 kV and the capacitance is not larger than 1000 pF, such test voltage changes are only of negligible levels.

As the output type of the high-voltage generator block of the TOS5052 is PWM switching, switching noise and spike noise that the test voltage includes increase when the test voltage is 500 V or less. The lower the test voltage is, the more the waveform distortion increases.

- *3 A current that flows through the stray capacitance on the measurement leads or fixtures may cause measurement errors. The total judgment accuracy is sum of this current and the above-mentioned judgment accuracy.

Approximate values of such currents are shown in the following table. Note that, in high-sensitivity high-voltage test, the current which flows through the stray capacitances may become larger than the preset lower cutoff current and the lower pass/fail judgment may not be successfully done.

Output voltage	1kV	2kV	3kV	4kV	5kV
When 350-mm-long test leadwires are used being suspended in air	$2 \mu\text{A}$	$4 \mu\text{A}$	$6 \mu\text{A}$	$8 \mu\text{A}$	$10 \mu\text{A}$
When accessory test leadwires TL01-TOS are used (typical)	$16 \mu\text{A}$	$32 \mu\text{A}$	$48 \mu\text{A}$	$64 \mu\text{A}$	$80 \mu\text{A}$

When other test leadwires than the above are used, the values of the currents may differ depending on the conditions.

Item	Specification																																																																		
REMOTE	5-pin DIN connector on the front panel Start/stop control is achieved remotely using options. <ul style="list-style-type: none"> • Remote controller: RC01-TOS, RC02-TOS • High-voltage test probe: HP01A-TOS, HP02A-TOS (Valid only when the test voltage is 4 kVAC.)																																																																		
SIGNAL I/O (*4)	14-pin Amphenol connector on the rear panel Output signal control pin Nos. 2 to 8 <ul style="list-style-type: none"> • Indicate the state of the TOS5052. Input signal control pin Nos. 9 to 12 <ul style="list-style-type: none"> • Shut off the output in conjunction with an external device via the INTERLOCK function. • Turns on and off the output using a make contact such as a relay or switch. 																																																																		
	<table border="1"> <thead> <tr> <th>No.</th> <th>Signal Name</th> <th>Description</th> </tr> </thead> <tbody> <tr> <td>1</td> <td>N.C</td> <td>Not used</td> </tr> <tr> <td>2</td> <td>H.V ON</td> <td>Held on while a high voltage is being applied across the output terminals during the test.</td> </tr> <tr> <td>3</td> <td>TEST</td> <td>Held on during the test (except when the voltage is rising).</td> </tr> <tr> <td>4</td> <td>PASS</td> <td>Set and held on for approx. 0.2 s when PASS is judged. Stays on in the PASS HOLD mode.</td> </tr> <tr> <td>5</td> <td>U FAIL</td> <td>Held on when a current greater than the upper cutoff current is detected and FAIL is judged.</td> </tr> <tr> <td>6</td> <td>L FAIL</td> <td>Held on when a current smaller than the lower cutoff current is detected and FAIL is judged.</td> </tr> <tr> <td>7</td> <td>READY</td> <td>Held on in the standby state.</td> </tr> <tr> <td>8</td> <td>PROTECTION</td> <td>Held on when the PROTECTION function is active.</td> </tr> <tr> <td>9</td> <td>INTERLOCK</td> <td>When the interlock signal is input, the TOS5052 enters the PROTECTION state and cannot start a test.</td> </tr> <tr> <td>10</td> <td>RR START</td> <td>Start signal input pin (low active)</td> </tr> <tr> <td>11</td> <td>RR STOP</td> <td>Stop signal input pin (low active)</td> </tr> <tr> <td>12</td> <td>RR ENABLE</td> <td>Remote control enable signal input pin (low active)</td> </tr> <tr> <td>13</td> <td>ISOL COM</td> <td>Circuit common terminal</td> </tr> <tr> <td>14</td> <td>ISOL COM</td> <td>Circuit common terminal</td> </tr> </tbody> </table>	No.	Signal Name	Description	1	N.C	Not used	2	H.V ON	Held on while a high voltage is being applied across the output terminals during the test.	3	TEST	Held on during the test (except when the voltage is rising).	4	PASS	Set and held on for approx. 0.2 s when PASS is judged. Stays on in the PASS HOLD mode.	5	U FAIL	Held on when a current greater than the upper cutoff current is detected and FAIL is judged.	6	L FAIL	Held on when a current smaller than the lower cutoff current is detected and FAIL is judged.	7	READY	Held on in the standby state.	8	PROTECTION	Held on when the PROTECTION function is active.	9	INTERLOCK	When the interlock signal is input, the TOS5052 enters the PROTECTION state and cannot start a test.	10	RR START	Start signal input pin (low active)	11	RR STOP	Stop signal input pin (low active)	12	RR ENABLE	Remote control enable signal input pin (low active)	13	ISOL COM	Circuit common terminal	14	ISOL COM	Circuit common terminal	<table border="1"> <tbody> <tr> <td>Output type</td> <td>Open collector output (4.5 to 30 VDC)</td> </tr> <tr> <td>Output withstanding voltage</td> <td>30 VDC</td> </tr> <tr> <td>Output saturation voltage</td> <td>Approx. 1.1 V (at 25 °C)</td> </tr> <tr> <td>Maximum output current</td> <td>400 mA (TOTAL)</td> </tr> <tr> <td>Isolation type</td> <td>Photocoupler (30 VDC/30 VAC rms max.)</td> </tr> <tr> <td>High level input voltage</td> <td>11 V to 15 V</td> </tr> <tr> <td>Low level input voltage</td> <td>0 V to 4 V</td> </tr> <tr> <td>Low level input current</td> <td>-5 mA max.</td> </tr> <tr> <td>Input time width</td> <td>5 ms min.</td> </tr> <tr> <td>Isolation type</td> <td>Photocoupler (30 VDC/30 VAC rms max.)</td> </tr> </tbody> </table>	Output type	Open collector output (4.5 to 30 VDC)	Output withstanding voltage	30 VDC	Output saturation voltage	Approx. 1.1 V (at 25 °C)	Maximum output current	400 mA (TOTAL)	Isolation type	Photocoupler (30 VDC/30 VAC rms max.)	High level input voltage	11 V to 15 V	Low level input voltage	0 V to 4 V	Low level input current	-5 mA max.	Input time width	5 ms min.	Isolation type	Photocoupler (30 VDC/30 VAC rms max.)
No.	Signal Name	Description																																																																	
1	N.C	Not used																																																																	
2	H.V ON	Held on while a high voltage is being applied across the output terminals during the test.																																																																	
3	TEST	Held on during the test (except when the voltage is rising).																																																																	
4	PASS	Set and held on for approx. 0.2 s when PASS is judged. Stays on in the PASS HOLD mode.																																																																	
5	U FAIL	Held on when a current greater than the upper cutoff current is detected and FAIL is judged.																																																																	
6	L FAIL	Held on when a current smaller than the lower cutoff current is detected and FAIL is judged.																																																																	
7	READY	Held on in the standby state.																																																																	
8	PROTECTION	Held on when the PROTECTION function is active.																																																																	
9	INTERLOCK	When the interlock signal is input, the TOS5052 enters the PROTECTION state and cannot start a test.																																																																	
10	RR START	Start signal input pin (low active)																																																																	
11	RR STOP	Stop signal input pin (low active)																																																																	
12	RR ENABLE	Remote control enable signal input pin (low active)																																																																	
13	ISOL COM	Circuit common terminal																																																																	
14	ISOL COM	Circuit common terminal																																																																	
Output type	Open collector output (4.5 to 30 VDC)																																																																		
Output withstanding voltage	30 VDC																																																																		
Output saturation voltage	Approx. 1.1 V (at 25 °C)																																																																		
Maximum output current	400 mA (TOTAL)																																																																		
Isolation type	Photocoupler (30 VDC/30 VAC rms max.)																																																																		
High level input voltage	11 V to 15 V																																																																		
Low level input voltage	0 V to 4 V																																																																		
Low level input current	-5 mA max.																																																																		
Input time width	5 ms min.																																																																		
Isolation type	Photocoupler (30 VDC/30 VAC rms max.)																																																																		

Item	Specification											
STATUS SIGNAL OUTPUT	<p>The following modes are selected using the DIP switches on the rear panel (logical sum is taken when two or more modes are selected):</p> <p>1. H.V ON 5. L FAIL 2. TEST 6. READY 3. PASS 7. PROTECTION 4. U FAIL 8. POWER ON</p>	<p>100 VAC is generated when the TOS505 enters the selected state (100 VAC is generated even the AC line input range was changed).</p> <table border="1" data-bbox="903 488 1370 808"> <tr> <td data-bbox="903 488 1131 562">Output type</td> <td data-bbox="1131 488 1370 562">Triode AC switch output</td> </tr> <tr> <td data-bbox="903 562 1131 600">Output voltage</td> <td data-bbox="1131 562 1370 600">Approx. 100 V AC</td> </tr> <tr> <td data-bbox="903 600 1131 638">Leak current</td> <td data-bbox="1131 600 1370 638">1 mA or less.</td> </tr> <tr> <td data-bbox="903 638 1131 712">Maximum output current</td> <td data-bbox="1131 638 1370 712">0.3A</td> </tr> <tr> <td data-bbox="903 712 1131 808">Isolation</td> <td data-bbox="1131 712 1370 808">1200 V AC, 1 second</td> </tr> </table>	Output type	Triode AC switch output	Output voltage	Approx. 100 V AC	Leak current	1 mA or less.	Maximum output current	0.3A	Isolation	1200 V AC, 1 second
Output type	Triode AC switch output											
Output voltage	Approx. 100 V AC											
Leak current	1 mA or less.											
Maximum output current	0.3A											
Isolation	1200 V AC, 1 second											

*4 SIGNAL I/O

- The circuit common pins are shared by the signal output and input circuits.
- The input terminals are pulled up to +15V with resistors. To make the input terminals open is equivalent to that the high level signals are applied to the terminals.

Item	Specification	
TEST MODE	<p>The following special modes are selected using the DIP switches on the rear panel:</p> <ol style="list-style-type: none"> 1. DOUBLE ACTION The TOS5052 starts a test only when the START switch is pressed within approximately 0.5 seconds after the STOP switch is reset. 2. PASS HOLD The TOS5052 retains the PASS state. 3. MOMENTARY The TOS5052 starts a test only when the START switch is being pressed. 4. FAIL MODE The instruction to reset the FAIL or PROTECTION state is cancelled by the stop signal through the remote control connector. 5. ON: 60 Hz/OFF: 50 Hz Switches the test voltage frequency. ON: 60 Hz OFF: 50 Hz 	
Environment		
Warranty range	Temperature	5 °C to 35 °C
	Humidity	20 % to 80 % RH (non condensing)
Operating range	Temperature	0 °C to 40 °C
	Humidity	20 % to 80 % RH (non condensing)
Storage range	Temperature	-20 °C to 70°C
	Humidity	90 % RH or less (non condensing)
Power requirement		
Allowable voltage range	90 V to 110 V The following power voltage options are factory options: (104 V to 125 V) (194 V to 236 V) (207 V to 250 V)	
Power consumption	No load time (READY)	150 VA or less
	Rated load time	1000 VA max.
Allowable frequency range	45 Hz to 65 Hz	
Insulation resistance	30 MΩ min. (500 VDC), between AC line and chassis	
Withstanding voltage	1390 V AC (2 seconds), between AC line and chassis	
Ground continuity	25 A AC/0.1 Ω max.	

Item	Specification
Safety (*5, *6)	Conforms to the requirements of the following directive and standard. Low Voltage Directive 73/23/EEC EN61010-1 Class I Pollution degree 2
Electromagnetic compatibility (EMC) (*5)	Conforms to the requirements of the following directive and standard. EMC Directive 89/336/EEC EN61326 EN61000-3-2 EN61000-3-3 Under following conditions 1. Used HV test leadwires which is supplied. 2. No discharge in testing. 3. Used the shielded cable which length is less than three meters when the SIGNAL I/O is used.
Physical dimensions (maximum)	320 (330) W X 132 (150) H X 420 (490) D mm
Weight	Approx. 22 kg
Accessories	
AC Power cable	1 piece.
High-voltage test leadwire TL01-TOS (1.5 m)	1 set
14-pin Amphenol plug	1 piece., assembly type
"DANGER HIGH VOLTAGE" sticker	1 sheet
AC power fuse	2 pieces. (One in present use and the other as spare in the fuse holder cap)
Operation manual	1 copy

*5 Only on models that have CE marking on the panel.
Not applicable to custom order models.

*6 This instrument is a Class I equipment. Be sure to ground the protective conductor terminal of the instrument. The safety of the instrument is not guaranteed unless the instrument is grounded properly.

7.2 Overall Dimensions

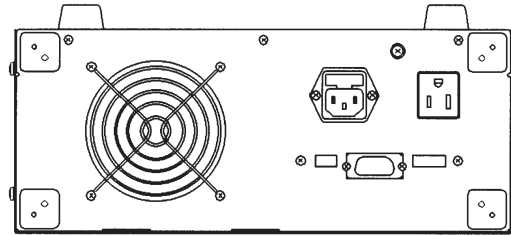

Unit: mm

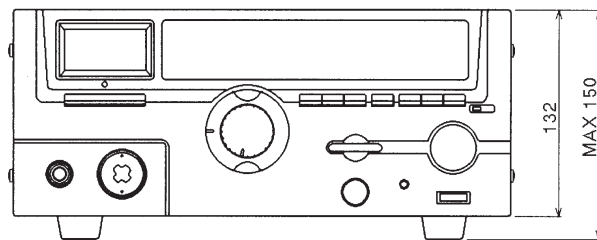
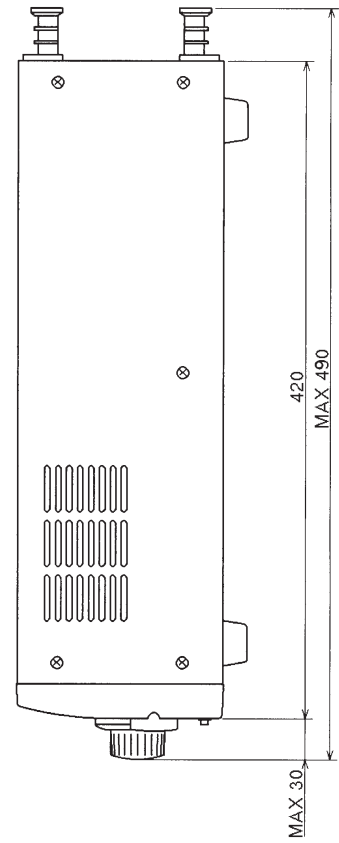
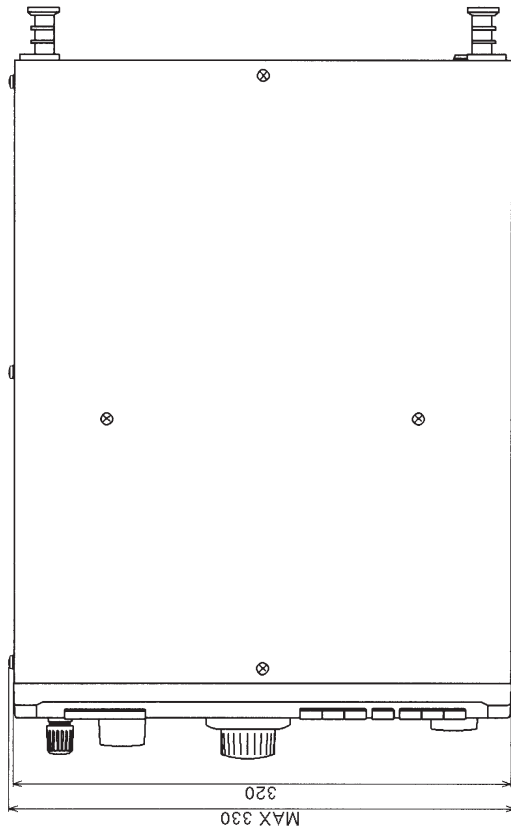

7.3 Options

The following optional devices for the TOS5052 are available.

1) Model RC01-TOS/RC02-TOS Remote Control Box

Model RC01-TOS or RC02-TOS Remote Control Box is for remote control of start/stop of test operation of the TOS5052. For remote control, connect the Control Box to the REMOTE connector on the front panel of the TOS5052.

The RC01-TOS has one START switch; RC02-TOS has two START switches and the test starts as you press both switches at the same time with your both hands, thereby enhancing the operating safety.

■ Functions of switches

OPERATE switch:

This switch enables (when ON) or disables (when OFF) the START switch or switches.

START switch:

The test starts as you press this switch (or switches) when the OPERATE switch is ON and the TOS5052 is in the READY state.

STOP switch:

This switch terminates the test (cuts off the test voltage or resets the TOS5052 from the FAIL or other particular status — its functions are the same with those of the STOP switch on the front panel of the TOS5052.

■ Dimensions

RC01-TOS : 200 W × 70 H × 39 D mm (7.9 W × 2.8 H × 1.5 D in.)

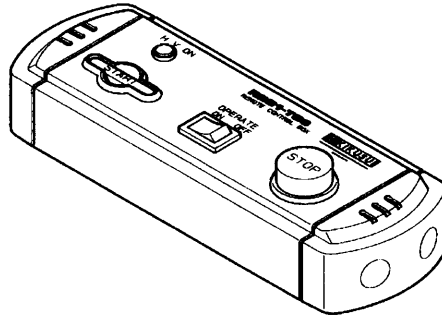

RC02-TOS : 330 W × 70 H × 39 D mm (13 W × 2.8 H × 1.5 D in.)

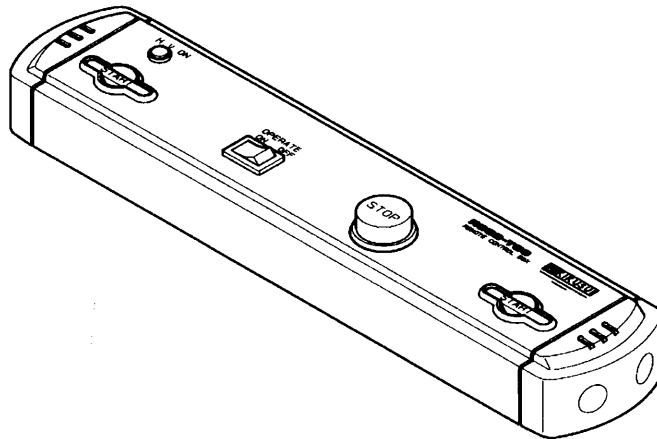

2) Model HP01A-TOS/HP02A-TOS High Voltage Test Probe

The High Voltage Test Probe renders a three-fold operating safety, namely, the test voltage is not delivered unless you squeeze with one hand the slide lever of the grip of the probe and pull the trigger and you press with the other hand the switch on top of the probe, thereby occupying your both hands. As you release even a single one of these, the probe immediately and forcefully delivers the STOP signal to cut off the test voltage.

Voltage ratings:

4kV (rms) AC, 50/60Hz
5kV DC

Length of cable:

Approx. 1.8m (HP01A-TOS)
Approx. 3.5m (HP02A-TOS)

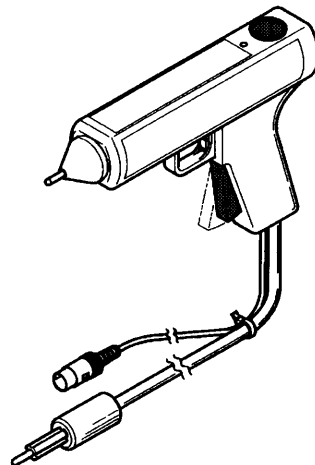

WARNING

- The maximum voltage ratings of the probe is 4kV rms AC or 5kV DC. Never let it subjected to voltages higher than these limits.
- Do not connect the probe to or disconnect it from the DUT while letting it deliver the test voltage — if you do this, the DUT may be damaged. If you disconnect the probe from the DUT while letting it deliver the test voltage, the items of the tested circuit may remain charged up to the high test voltage. Before connecting the probe to the DUT, be sure that the test voltage is OFF (the LED on top of the probe is OFF); before disconnecting the probe from the DUT, be sure that the test voltage is OFF (the LED is OFF).

CAUTION

- If you do need a test in compliance to the UL standard by using the probe, set the FAIL MODE switch (DIP switch on the rear panel) of the TOS5052 to ON. If you have set this switch to ON, the TOS5052 is not reset from the FAIL state has gone out or PROTECTION state even when you have released your hand from the probe. To reset it, you have to press the STOP switch of the TOS5052. Thus, you will be securely informed of the FAIL judgment. For details, refer to Section "FAIL Mode Switch."

3) Model PL01-TOS Warning Light Unit

This unit indicates that the TOS5052 is in the TEST-ON state (delivering the test voltage).

4) Model BZ01-TOS Buzzer Unit

This unit may be used when the sound generated by the buzzer housed in the TOS5052 is insufficient.

This unit can be driven by the FAIL state signal of the tester.

5) High voltage Test Leadwires

Model	Voltage rating	Length
TL01-TOS	5kV (rms) AC, 50/60Hz 5kV DC	Applox. 1.5m
TL02-TOS		Applox. 3m

INDEX

SYMBOL

- ▽△ keys 4-5
- 14-pin Amphenol plug 3-2, 3-4, 3-24
- 50/60 Hz Frequency Selection 3-35

A

- AC LINE Connector 4-10
- AC line voltage 1-5
- AC Message 4-6
- Analog voltmeter 4-4

B

- BUZZER control 4-5
- Buzzer unit 3-32

C

- CURRENT Readout 4-7

D

- DANGER Lamp 4-4
- default values 3-3
- Double Action 3-34
- DUT 3-15

E

- Emergency 2-3

F

- FAIL 3-19, 3-35
- FAN 4-10
- Fuse 1-6

H

- HIGH VOLTAGE Terminal 4-4
- HP01A-TOS 3-22
- HP02A-TOS 3-22

I

- Insulation Glove 2-3
- Interlock Function 3-27
- interlock function 3-2, 3-4

K

- KEYLOCK 3-7, 3-8, 3-9,
3-10, 3-12, 3-13
- KEYLOCK Message 4-8

L

- LOW Terminal 4-4
- LOWER Message 4-7
- LOWER ON Message 4-7

P

- PASS 3-17
- Pass Hold 3-34
- PASS Message 4-7
- Pause Time 2-6
- POWER Switch 4-3
- PROGRAM version i
- PROTECTION 3-2, 3-5
- PROTECTION Message 4-8
- Protective Grounding Terminal 4-10
- protective grounding terminal 1-7

R

- RC01-TOS 3-22
- RC02-TOS 3-22
- READY Message 4-7
- REMOTE 3-22
- REMOTE Control Connector 4-3
- REMOTE Message 4-8
- RISE LED 4-6
- Rise Time 5-4
- rise time 3-11

S

SHIFT key	4-5
SIGNAL I/O Connector	4-10
Start Momentary	3-35
START Switch	4-3
STATUS SIGNAL OUTPUT Receptacle	4-10
STOP Switch	4-3

T

Test Leadwires	3-14
TEST Message	4-7
TEST MODE Switch	4-10
test time	2-6, 3-11, 3-12
TEST VOLTAGE Control	4-3
TEST VOLTAGE RENG Message	4-6
TEST VOLTAGE Switch	4-3
TEST VOLTAGE switch	3-7
TEST/RISE key	4-5
TIME Display	4-7
TIMER ON Message	4-7
TIMER ON message	3-13

U

UP/LOW key	4-5
UPPER and FAIL Message	4-7
UPPER Message	4-7

V

version number	3-2
VOLTAGE Readout	4-7

W

Warning Light Unit	3-32
--------------------------	------

Z

zero adjuster	3-6
---------------------	-----