

AUTOMATIC W/I TESTER

# TOS9000

INSTRUCTION MANUAL

**DANGER**



**HIGH VOLTAGE**

- This Tester generates high voltage.
- Any incorrect handling may cause death.
- Read Section3 "WARNINGS" in this manual to prevent accident.
- This manual should be placed within the reach of the operator so that he or she may read it whenever necessary.



Part No. Z1-212-420, IB002432

## **Interlock Function**

The TOS9000 has an interlock protection. When the TOS9000 has arrived you and you have unpacked it, the function is effective. Therefore the TOS9000 will not start its operation. Before operation, you must release the interlock protection. For details, see Chapter 4.11 “Interlock Function” of this manual.

All or any parts of this manual may not be reproduced in any forms, without express written permission of Kikusui Electronics Corporation.

The contents of this manual, including the specifications of the instrument, are subject to change without notice.

©1991-2002 Copyright Kikusui Electronics Corporation.  
Printed in Japan. All rights reserved.

# Power Requirements of this Product

Power requirements of this product have been changed and the relevant sections of the Operation Manual should be revised accordingly.

(Revision should be applied to items indicated by a check mark )

Input voltage

The input voltage of this product is \_\_\_\_\_ VAC,  
and the voltage range is \_\_\_\_\_ to \_\_\_\_\_ VAC. Use the product within this range only.

Input fuse

The rating of this product's input fuse is \_\_\_\_\_ A, \_\_\_\_\_ VAC, and \_\_\_\_\_.

### WARNING

- To avoid electrical shock, always disconnect the AC power cable or turn off the switch on the switchboard before attempting to check or replace the fuse.
- Use a fuse element having a shape, rating, and characteristics suitable for this product. The use of a fuse with a different rating or one that short circuits the fuse holder may result in fire, electric shock, or irreparable damage.

AC power cable

The product is provided with AC power cables described below. If the cable has no power plug, attach a power plug or crimp-style terminals to the cable in accordance with the wire colors specified in the drawing.

### WARNING

- The attachment of a power plug or crimp-style terminals must be carried out by qualified personnel.

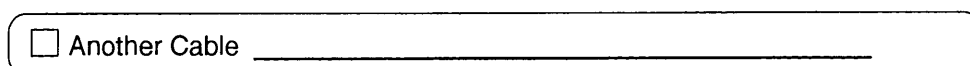
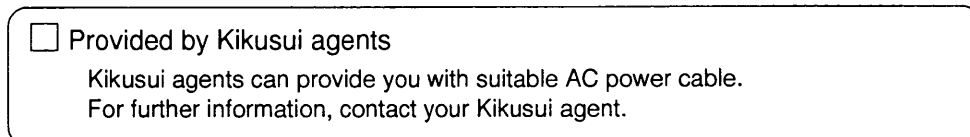
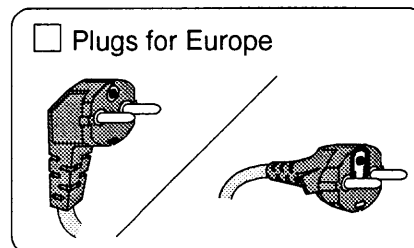
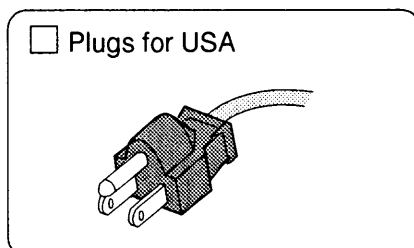
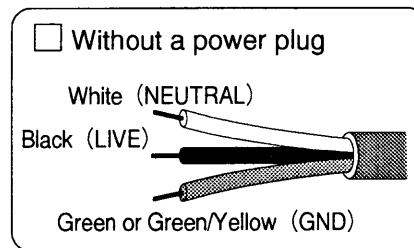
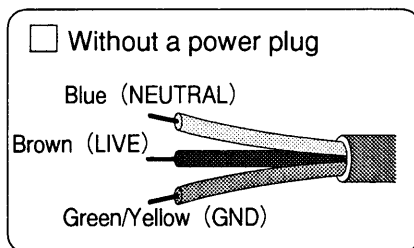

**- To supervisor in charge of operation -**

- (1) If the operator does not read the language used in this manual, translate the manual into appropriate language.*
- (2) Help the operator in understanding this manual before operation.*
- (3) Keep this manual near the W/I tester for easy access of the operator.*

**- Receiving inspection -**

Prior to the shipment from our factory, the W/I tester has been subjected to electric and mechanical testing and guaranteed of satisfactory quality and performance. Nevertheless, you are kindly requested to make a receiving inspection to see if the tester has any in-transit damage. If you find any, please inform our local dealer of such a damage.



- For your own safety (How to avoid electrification) -

(1) *While the tester is generating the output, do not touch the following areas, or else, you will be electrified, and run the risk of death by electric shock.*

- *the output terminal*
- *the test lead-wire connected to the output terminal*
- *the Device Under Test (D.U.T.)*
- *any part of the tester, which is electrically connected to the output terminal*
- *the same part as above immediately after the output has been cut off. (in case of insulation resistance test)*

(2) *Also, electric shock or accident may arise in the following cases:*

- *the tester being operated without grounding*
- *if the gloves for electrical job are not used*
- *approach to any part connected to the output terminal while the power of the tester is turned on*
- *the same action as above immediately after the power of tester has been turned off (in case of insulation resistance test)*

**– ATTENTION –**

*Pay attention to the following instructions and those warnings given in the Section 3 "WARNINGS" as well.*

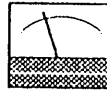

Pointing not zero means "high voltage warning."

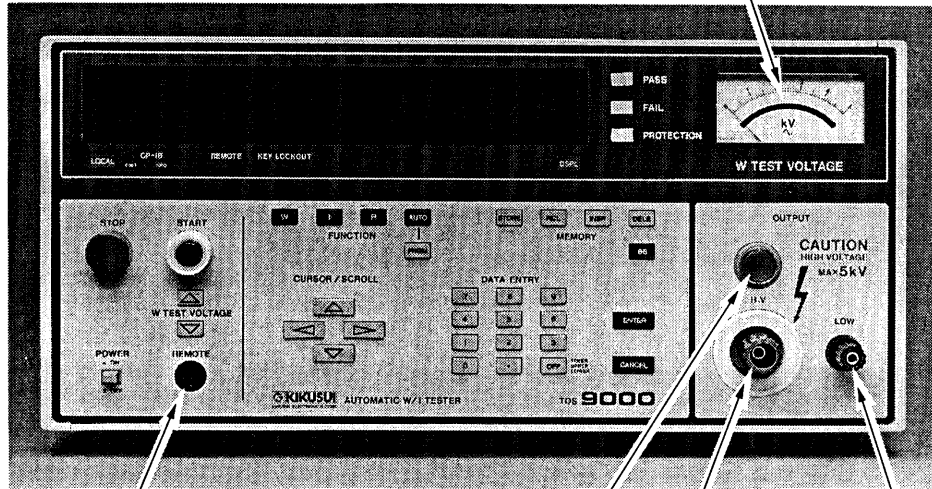

Read Instruction Manual Page 4-63 before remote operation.

If the lamp comes on, it warns "high voltage."

Dangerous high-voltage output terminal

Connect with the lead wire on LOW side.

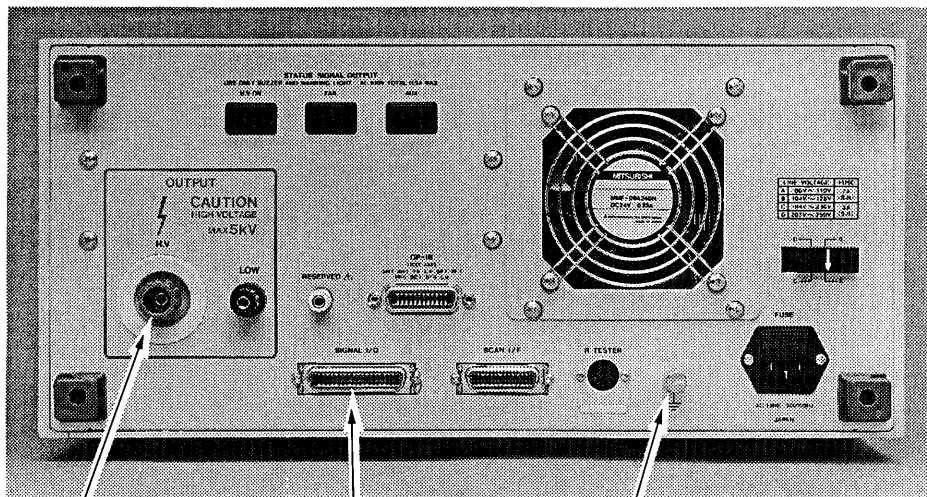

Dangerous high-voltage output terminal

Read Instruction Manual Page 4-63 before remote operation.

The rear-side of the tester casing and the protective grounding terminal must be connected to the earth, using an applicable tool.

2011.11.25

9126504

# Contents

1.	GENERAL .....	1-1
	1.1 Outline .....	1-1
	1.2 Features .....	1-2
2.	SPECIFICATIONS .....	2-1
3.	WARNINGS .....	3-1
4.	OPERATION METHOD .....	4-1
	4.1 Description of Front Panel Items .....	4-1
	4.2 Description of Rear Panel .....	4-11
	4.3 Notes and Precautions Before Tests .....	4-15
	4.4 Single W Test .....	4-16
	4.5 Single I Test .....	4-29
	4.6 Single R Test (AC LOW Ohm Test) .....	4-35
	4.7 Store/Recall of Test Parameters .....	4-39
	4.8 AUTO Mode .....	4-41
	4.9 Initial Setting .....	4-50
	4.10 Signal Output Function .....	4-56
	4.11 Interlock Function .....	4-62
	4.12 Remote Control Function .....	4-63
	4.13 Protective Functions .....	4-72
	4.14 Summary of Messages .....	4-76
5.	GPIB Interface Function .....	5-1
	5.1 General Description .....	5-1
	5.2 GPIB Specification .....	5-3
	5.3 Operation Method .....	5-4
	5.4 Table of Commands .....	5-11
	5.5 Example of Test Procedure .....	5-18
6.	MAINTENANCE .....	6-1
7.	PERIPHERAL AND OPTIONAL DEVICES .....	7-1
	7.1 Peripheral Devices .....	7-1
	7.2 Cables .....	7-2
	7.3 Model RC01-TOS / RC02-TOS Remote Control Box .....	7-3
8.	CONNECTIONS OF TEST INSTRUMENTS OF A FULL LINE UP .....	8-1
9.	BLOCK DIAGRAM .....	9-1

# 1. GENERAL

## 1.1 Outline

Model TOS9000 Automatic W/I Tester has been designed for automatic evaluation of withstanding voltages and insulation resistances of electrical and electronic devices. As used with Model TOS6100 AC low ohm tester, the TOS9000 allows also to measure low resistances of devices.

As a W Teter (withstanding voltage tester), the TOS9000 has a rated output power of 200VA (5kV, 40mA) and a rated transformer power of 500VA, and can be used for withstanding voltage tests (dielectric strength tests) of electrical and electronic devices and parts complying with the major electrical standards and codes, including UL, CSA, BS, and JIS.

As an I Tester (insulation resistance tester), the TOS9000 has a test range of 1 - 9999M $\Omega$  with a test voltage of 50 - 1000V (can be preset as required).

[When Model TOS6100 AC low ohm tester is used with a TOS9000, the TOS9000 controls the TOS6100.]

You can program the three types of tests (W, I, R) flexibly into a series of test steps. And you can execute the test automatically.

The TOS9000 has a fluorescent display screen for 40 characters  $\times$  2 lines on the front panel. It provides easy confirming to set test conditions, measured data, and display of machine messages visually.

The TOS9000 has a window comparator function for PASS/FAIL decision, an output signal function for fourteen signals, a remote- control function for programmed tests, and a GPIB function for interfacing with a fully automatic computerized system. With these functions the TOS9000 can be used for highly efficient, flexible, labor-saving tests of electrical and electronic devices and parts.

The TOS9000 has provisions against noise, therefore its internal circiuts operate with a high reliability against noise.

***The TOS9000 has various protective features for the safety of the operator. And yet, since a hazardously high voltage is delivered from the TOS9000 output terminals, test cables and probes and to the D.U.T. never touch these items which are charged to the high voltage. Provide rope fences or other appropriate means to seclude the unauthorized persons from the test area.***

## 1.2 Features

### (1) Flexibility in configuration of automatic test system

The TOS9000, as used with its peripheral devices and/or optional devices and/or a computer, can make up a W/I/R test system with a high flexibility—ranging from a simple single-function test system to a full-scale automatic test system. Several examples are shown in the following.

Example 1: A system with the TOS9000 and its peripheral device “Model TOS9020 H.V Scanning Unit”—it tests the objects which have two or more test points, such as switching power supply units. (Figure 1.1)

#### Features of the System

- All the tests for each test point can be accomplished within single test process, without requiring to change the cable connections each time the test points are changed.
- Even if the contents of tests differ by test points, all the tests can be accomplished within a single programmed test process.

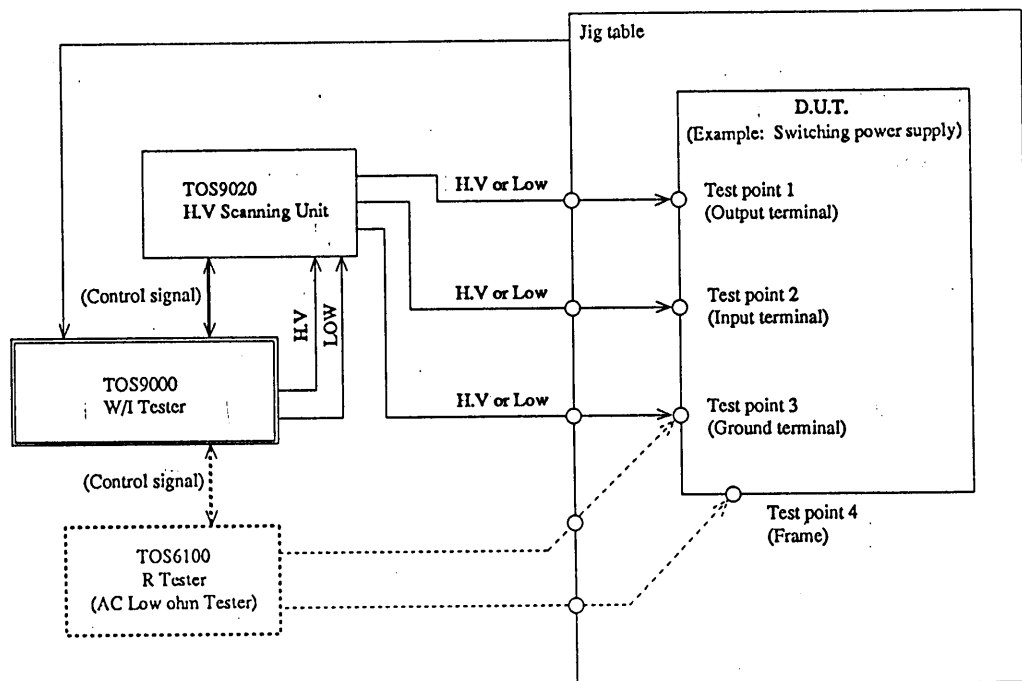

Figure 1.1

Note: Model TOS6100 R Tester (AC low ohm tester) may be added to the system as required. However, the test parameters for the R Tester cannot be programmed. They must be controlled manually (locally).

**Example 2:** An unmanned automatic test system is made with using the programming function, remote control function and signal output function of the TOS9000, in addition to the functions of the system of Example 1. (Figure 1.2)

Features of the System

- You can construct a small scale unmanned-automatic test system with less investment without requiring a computer or other sophisticated devices.
- You can select different test programs which fit to individual object with using the program and the remote control functions of TOS9000.
- The signal output function of the TOS9000 provides information on the D.U.T. The information includes the results of PASS/FAIL judgements on the D.U.T., allowing to sort the objects between accepted ones and rejected ones.

**Note:** Such an unmanned automatic test system requires a certain level of automatic material handling installation (such as a conveyor, pallets, etc.)

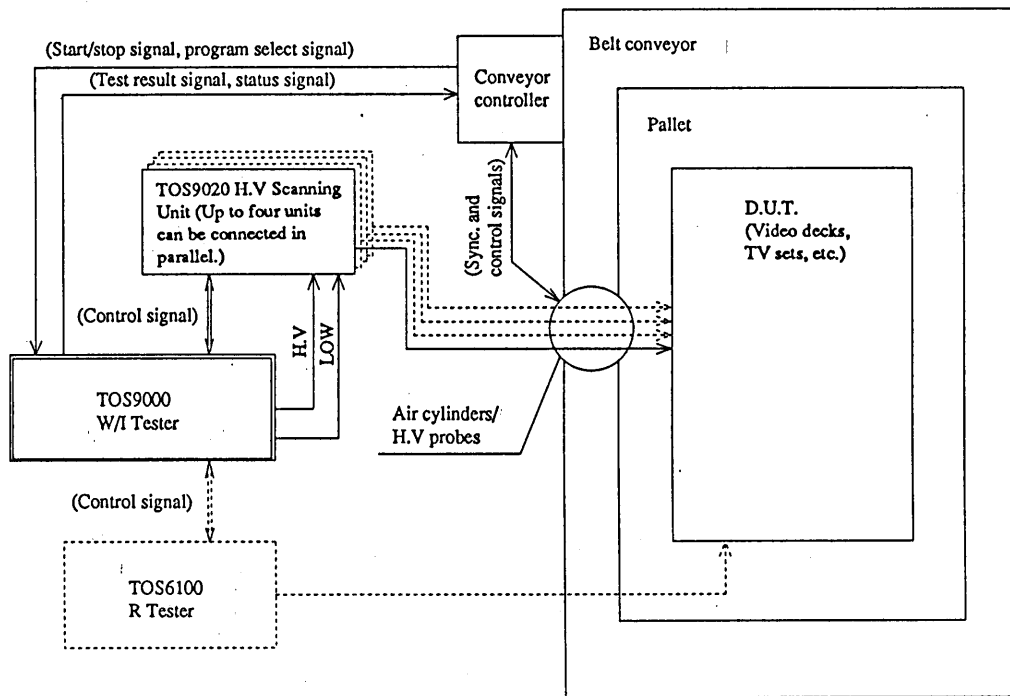

Figure 1.2

**Note:** Model TOS9000 R Tester (AC low ohm tester) can be added to the system as required. However, the test parameters for the R Tester cannot be programmed and must be set manually (locally).

Example 3: A computerized unmanned automatic test system can be constructed by adding a computer .

### Features of the System

- Since the TOS9000 has a GPIB interface as a standard provision, you can execute the programmed tests with control from the computer.
- The test results are returned to and managed by the computer.

Note: To construct computerized tests system, the programs for your tests must be prepared on your side.

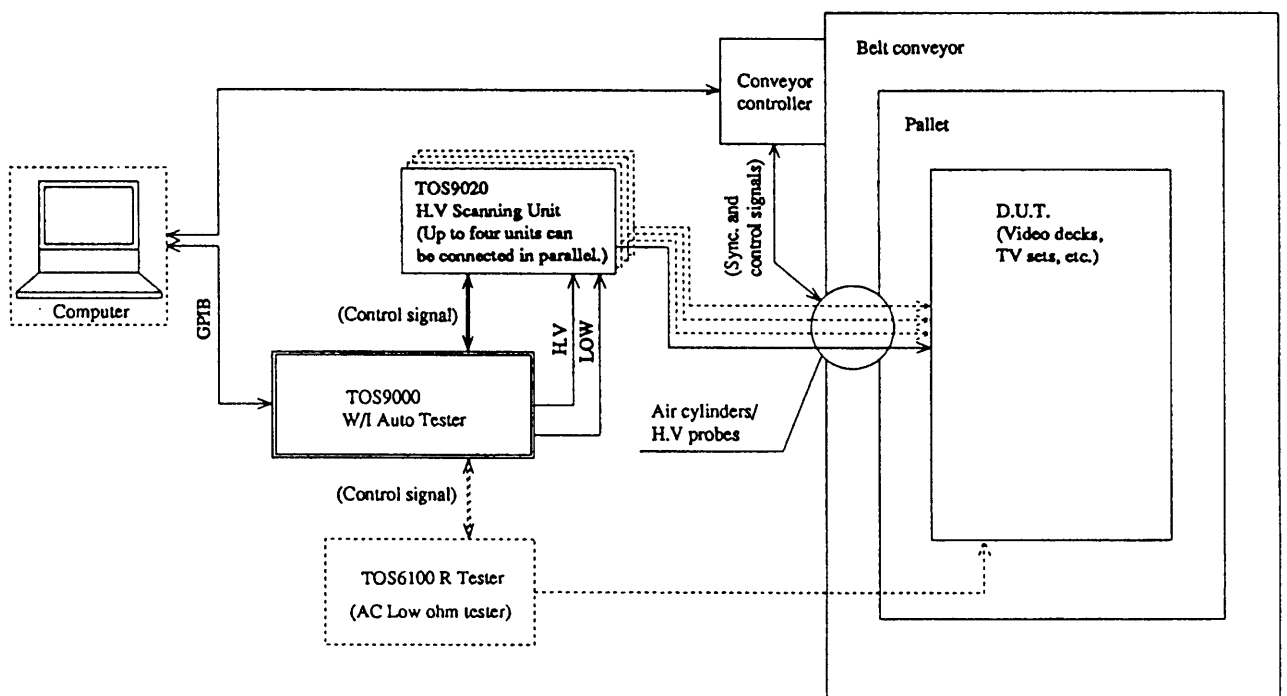

Figure 1.3

Note: Model TOS6100 R Tester (AC low ohm tester) can be added to the system as required. However, the test parameters for the R Tester cannot be programmed and must be set manually (locally).

Example 4: A computerized robotic unmanned automatic test system which can automatically handle even different models of D.U.T. by adding a robot (X-Y table for distribution of the high test voltage to the test points) to the system of Example 3. (Figure 1.4)

Features of the System

- Automatic tests of even different models of devices on the same manufacturing line can be done by controlling the system which includes a robot also.
- Since the TOS9000 has a GPIB interface as a standard provision, you can execute the programmed tests with control from the computer.
- The test results are returned to and managed by the computer.

Note: To construct computerized tests system, the programs for your tests must be prepared on the your side.

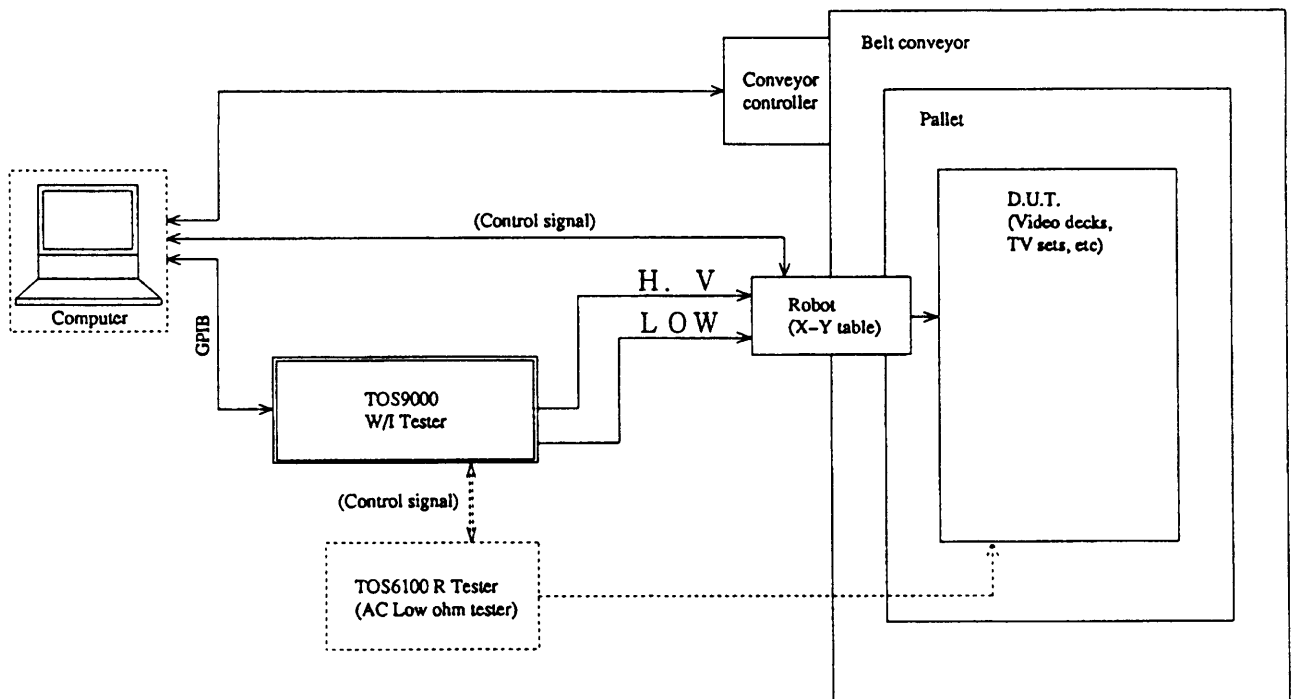

Figure 1.4

Note: Model TOS6100 R Tester (AC low ohm tester) can be added to the system as required. However, the test parameters for the R Tester cannot be programmed and must be set manually (locally).



(2) Flexibility in programming of test sequence

Other than for single withstanding voltage test or single insulation resistance test, you can program the TOS9000 for a sequence of tests, such as withstanding voltage test→insulation resistance test→withstanding voltage test→AC low ohm test→insulation resistance test.

Note: For the AC low ohm test, a Model TOS6100R Tester (AC low ohm tester) is required.

(3) Fluorescent display screen

The TOS9000 has a fluorescent display screen for 40 characters × 2 lines for readout of test parameters, test data and other messages. Being a fluorescent type, the screen provides good readability.

(4) Operability

Test parameters can be conveniently set with the cursor keys and numerical data entry keys on the front panel, observing the parameters and other test data on the display screen.

(5) Store/recall of test settings

Each setting of the test parameters and step sequences can be stored in memory and be recalled. When you want to repeat the different test setting already stored, the required setting can be easily recalled from the memory, without repeating the setting procedure all over again.

(6) Memory backup

Data on the test currently executed is stored in the internal memory of the TOS9000. It is backed up during the power off. Thereby, you do not need to repeat the setting procedure again when the power is turned on.

(7) PASS/FAIL decisions with a window comparator

The TOS9000 has a window comparator function for PASS/FAIL decisions in withstanding voltage test and insulation resistance test. The function allows, although within certain limitations, to check also for open-circuiting of test leadwires and for contact failures.

(8) Remote control function

The TOS9000 has a remote control function for test START/STOP and program selection. The TOS9000 provides an isolated +15V power for this purpose.

(9) GPIB interface function (a standard provision)

The TOS9000 has a GPIB interface function as a standard provision, allowing to start/stop-control the tests or to set the single-test parameters by using simple GPIB commands. If the TOS9010 I/O Unit (optional GPIB parallel interface unit) is provided, a fully automatic system including a conveyor robot can be operated via GPIB.

(10) Various types of output signals

Total fourteen output signals such as PASS, FAIL, and READY, are provided. They are available in total four types, open collector, lamp, buzzer, and 100V AC, although the available types differ by signals. These output signals can be used, with the above-mentioned remote control functions, to construct an efficient automatic test system for labor-saving.

(11) Key lockout function

The TOS9000 has a key lockout function. When this function is in effect, all the keys but the START/STOP switches are disabled. Thus, the function prevents inadvertent pressing of wrong keys and guards against entry of wrong test parameters or other wrong test conditions which can lead to wrong tests.

(12) Output voltage limit function

The TOS9000 has an output voltage setting limit function. Even if a voltage higher than the preset upper limit output voltage is inadvertently attempted to be set, this function automatically denies such an attempt.

(13) Control of peripheral devices

The TOS9000 can control its optional peripheral devices, such as Model TOS6100 R Tester (AC low ohm tester) and Model TOS9020 H.V Scanning Unit.

## 2. SPECIFICATIONS

W Tester Section		
Test Voltage	Output Voltage:	0.20 to 5.00kV AC. Digital setting (3 digits), 10V-steps, adjustable with UP/DOWN keys
	Output Rating:	200VA/5kV, 40mA. With time limit (refer to Note 1.)
	Transformer:	500VA
	Voltage Setting Accuracy:	± (2% of setting + 2 digits). (without load)
	Waveform and its Distortion Fator:	Sine wave. Distortion factor ≤5% (when in maximum output with pure resistance load, refer to Note 2.)
	Voltage Regulation:	5% or better, against change from maximum rated load (5kV/40mA) to no load (refer to Note 3.)
	Output Circuit:	Linear amplifier
	Voltage Limiter:	Output voltage trip function
Output Voltmeter (analog voltmeter)	Scale:	5kV full scale, linear scale
	Class:	JIS Class 1.5
	Accuracy:	±3% of full scale
	Indication:	Mean-value response, effective-value scale graduation
Output Voltmeter (digital voltmeter)	Accuracy:	±(5% of reading + 10V)
Output Milliammeter	Accuracy:	±(5% of upper limit value + 20μA)
PASS/FAIL Decision Function	Decision System:	<ul style="list-style-type: none"> <li>•Window comparator system</li> <li>• A FAIL decision is made when a current greater than the upper limit value or smaller than the lower limit value is detected.</li> <li>•When a FAIL decision is made, the output voltage is cut out and a FAIL alarm signal is delivered.</li> <li>•If no abnormal state is detected during the test time, a PASS decision is made and a PASS signal is delivered.</li> </ul>
	Limit Value Setting Ranges:	Upper limit: 0.10 to 40.0mA Lower limit: 0.05 to 39.0mA Digital setting (3 digits)
	Decision Accuracy:	±(5% of upper limit value + 20μA)(refer to Notes 4 and 5.)
	Measurement:	By integration of absolute value of current
	Calibration:	With rms value of sine wave, by using a pure resistive load
Test Time:	0.5 to 99.9 sec (±10 msec). (Timer-off function provided)	

191.10.31

912560A

Note 1: Allowable output delivery time (test time)

- When the upper limit current for PASS/FAIL decision is not greater than 20mA:  
Can be continuously delivered at ambient temperature not higher than 40°C (104°F)
- When the upper limit current for PASS/FAIL decision is 20.1mA to 30mA:  
Up to 100 sec. at ambient temperature not higher than 40°C (104°F)
- When the upper limit current for PASS/FAIL decision is 30.1mA to 40mA:  
Up to 50 sec. at ambient temperature not higher than 35°C (95°F)

The heat dissipation capacity of the high voltage generator section of the W/I Tester is only one-half with respect to the rated output. That is, the Tester is designed overratedly in order to reduce its size, weight and cost, and therefore it must be run deratedly. When using the W/I Tester with a decision limit-current of 20mA or more, allow a pause period equal to or more than the test period. The allowable limit of output delivery time (test time) is as shown in the above for ambient temperatures up to 40°C (105°F) when the upper limit current is not greater than 30mA or for ambient temperatures up to 35°C (95°F) when the upper limit current is greater than 30mA.

Note 2: It takes 15 to 20 msec for the waveform to become stabilized after the instrument has started delivering the test voltage.

Note 3: Assuming that the voltage regulation is 5%, the voltage change for 50kV/40mA to no load is 250V. This is equivalent to that the output resistance is 6.25kΩ. Therefore, even when the output voltage is set at 200V and the output terminals are shorted, the current which flows in the output circuit will not be greater than 32mA. In this case, if the upper limit value for PASS/FAIL decision is set at a value greater than 32mA, no FAIL decision will result.

Note 4: When the TOS9020 H.V Scanning Unit is used in conjunction, the accuracy of decision is as follows:

- Decision accuracy:  $\pm(5\%$  of upper limit value + 100μA)

Note 5: The stray capacity of the test wiring setup (leadwires, jigs, etc.) will cause an inaccuracy of leak current measurement. For the overall decision accuracy of test, the factor reflecting above inaccuracy should be added to the decision accuracy given in the specification column. Typical values of leak currents which flow through stray capacities of test leadwires are shown in the below table. Note that, when tests are done with a high test voltage and high sensitivity, the low-limit decisions may become meaningless as the leak current which flows through the stray capacity of the test leadwires is larger than that flows through the tested object.

Test voltage	1kV	2kV	3kV	4kV	5kV
When 350mm-long test cables are hung in air (typical)	4μA	8μA	12μA	16μA	20μA
When HTL-1.5W accessory test cables are used (typical)	20μA	40μA	60μA	80μA	100μA

The values shown in the above are typical values and those are for your information only. The values may largely vary depending on individual cases.

## Test voltage waveform

When the AC test voltage (output voltage of the W/ITester) is applied to a capacitive load, such state can occur that the output voltage rises higher than that it was when no load was applied to it. Moreover, if the capacitance of the load is voltage-dependent (such as of ceramics capacitors), the test voltage waveform may be distorted. When the test voltage is not higher than 1.5kV, however, capacitances of less than 1000pF will cause no substantial effects.

I Tester Section		
Measuring Voltage	Voltage Setting Range:	50 to 1000V DC, negative polarity. (Digital setting, 1V-steps)
	Setting Accuracy:	$\pm(2\%$ of nominal setting voltage + 2V)
	Measuring Terminal Voltage:	Constant voltage satisfying the setting accuracy
Measuring Range:		1-9999M $\Omega$
Measuring Accuracy:		$\geq 500V$ , 1 - 2000M $\Omega$ : $\pm 5\%$ of rdg. $\geq 500V$ , 2001 - 9999M $\Omega$ : $\pm 10\%$ of rdg. $< 500V$ , 1 - 200M $\Omega$ : $\pm 10\%$ of rdg. $< 500V$ , 201 - 1000M $\Omega$ : $\pm 20\%$ of rdg.
PASS/FAIL Decision	Decision System:	<ul style="list-style-type: none"> <li>•Window comparator system</li> <li>•A FAIL decision is made when a resistance less than the lower limit value or greater than the upper limit value is detected.</li> <li>•When a FAIL decision is made, the output voltage is cut out and a FAIL alarm signal is delivered.</li> <li>•If no abnormal state is detected during the test time, a PASS decision is made and a PASS signal is delivered.</li> </ul>
	Limit Value Setting Range:	Both upper and lower limit values can be set within the measuring range.
	Decision Accuracy:	$\geq 500V$ , 1 - 1000M $\Omega$ : Same as measuring accuracy $\geq 500V$ , 1001 - 2000M $\Omega$ : $\pm 10\%$ of rdg. $\geq 500V$ , 2001 - 9999M $\Omega$ : $\pm 15\%$ of rdg. $< 500V$ , 1 - 1000M $\Omega$ : Same as measuring accuracy. Note : When the lower limit value is greater than 2000M $\Omega$ , a decision wait time of 1 second or more is necessary.
	Decision Waiting-time:	0.3 sec (adjustable for 0.3 - 10 sec)
Test Time	Test Time:	0.5 to 99.9 sec ( $\pm 20$ msec). (Timer-off function provided) Note: The test time must be longer than the decision waiting-time.

Test Modes		
Types of Test Modes	AUTO:	<ul style="list-style-type: none"> <li>•Up to 98 test steps with different test parameters for respective steps can be programmed for each test program.</li> <li>•Up to 15 test programs can be stored. (Total 480 steps)</li> </ul>
	MANU. W:	<ul style="list-style-type: none"> <li>•Execution of withstanding voltage test alone (The test voltage can be changed with the UP/DOWN keys when in test.)</li> <li>•Up to 10 withstanding voltage tests can be stored in memory.</li> </ul>
	MANU. I:	<ul style="list-style-type: none"> <li>•Execution of insulation resistance test alone. Up to 10 insulation resistance tests can be stored in memory</li> </ul>
	MANU. R:	<ul style="list-style-type: none"> <li>•Test commands (start/stop command) can be given to the TOS6100 R Tester (AC low ohm tester).</li> <li>•The test time can be specified.</li> </ul>

Remote Control Functions		
Remote Control 1	START/STOP Control:	Tests can be START/STOP-controlled with the remote control functions of the optional devices (Model 913A, Model 914A, HTP-1.5A, or HTP-3A).
Remote Control 2	START/STOP Control:	Low-active control Input requirements <ul style="list-style-type: none"> <li>• High level input voltage : 11 - 15V</li> <li>• Low level input voltage : 0 - 4V</li> <li>• Low level output current: <math>\leq 1\text{mA}</math></li> <li>• Input time duration : <math>\geq 20\text{msec}</math></li> </ul> Note 1 : The above input circuits are isolated from other internal circuits. Note 2 : To make the input terminal open is equivalent to that the high level signal is applied to the terminal.
	Program Selection:	Programs which have been stored for AUTO mode of tests can be selected.
	Interlock Function:	The test voltage cannot be generated unless the interlock input terminal is short-circuited.
	Power Supply for Remote Control:	+15V DC supply for remote control, isolated from other internal power supplies.

29 / 10 / 21

912663A

GPIB Interface Functions	
ANSI/IEEE-488-1978, IEC625	SH1: Full source handshake function AH1: Full acceptor handshake function T6: Talker function L4: Listener function SR1: Full service request function RL1: Full remote/local function PP0: No parallel polling function DC1: Full device clear function DT0: No device trigger function CO: No controller function
Controllable Items:	<ul style="list-style-type: none"> <li>•Start/stop control</li> <li>•Setting of test conditions for single test</li> </ul>
Data Codes:	ASCII
Delimiter:	CR+LF(+EOI)

Signal Output Functions		
Signal Name	Condition for Generation	Type
H.V ON	During the test time	Open collector, lamp, 100V AC
PASS	For PASS decision. Delivered for approximately 0.2 sec (can be specified by initial setting).	Open collector, LED, buzzer
FAIL	For FAIL decision. Continuously delivered	Open collector, LED, buzzer, 100V AC
WU/FAIL(WUF)	For FAIL decision as the detected value is greater than the upper limit value when in withstanding voltage test. Continuously delivered.	Open collector
WL/FAIL(WLF)	For FAIL decision as the detected value is less than the lower limit value when in withstanding voltage test. Continuously delivered.	Open collector
IU/FAIL(IUF)	For FAIL decision as the detected value is greater than the upper limit value when in insulation resistance test. Continuously delivered.	Open collector
IL/FAIL(ILF)	For FAIL decision as the detected value is less than the lower limit value when in insulation resistance test. Continuously delivered.	Open collector
R/FAIL	For FAIL decision when in R test (AC low ohm test). Continuously delivered.	Open collector
CONTACT FAIL(CNTF)	For FAIL decision due to abnormally large contact resistance. Continuously delivered.	Open collector
READY	When in the READY status	Open collector
STEP END(STEP)	For the end of one step of test in the AUTO mode. Continuously delivered until the next step starts.	Open collector
CYCLE END(END)	For the end of one program of test in the ATUO mode. Delivered for approx. 0.2 sec (can be specified by initial setting)	Open collector
PROTECTION(PROT)	For the trip of a protective circuit, continuously delivered	Open collector
Reserved one	One of the following signals can be selected by initial setting: END, WUF, WLF, IUF, ILF, CNTF, PASS, PROT, STEP	100V AC



Note 1: The allowable supply voltage range for the open-collector circuit is 5 to 30V DC and the rated current is 400mA in total. (When the built-in isolated power supply of this instrument is used, the available current is 100mA in total.)

Note 2: The rating of the 100V AC signal is 0.3A (maximum) in total.

Note 3: The CONTACT FAIL signal is available only when Model TOS9020 H.V Scanning Unit is provided.

Note 4: The names indicated being enclosed in the parentheses in the signal name column are abbreviations.

Ambient Temperature and Relative Humidity	Specifications range:	5 to 35°C(41 to 95°F),20 to 80% RH
	Operable range:	0 to 40°C(32 to 104°F),20 to 80% RH
	Storage range:	-20 to 70°C(-4 to 158°F) ,≤ 80% RH
Power Raquirements	Line Voltage:	A: 90 to 110V B: 104 to 125V C: 194 to 236V D: 207 to 250V
	Frequency:	50 or 60 Hz
	Power Consumption	When no-load (Ready state) : ≤ 80VA When with Rated Load: Approx. 650VA
	Insulation Resistance:	≥30MΩ, with 500V DC
	Withstanding Voltage:	1000V AC, for 1 minute
Dimensions:	Excluding Protrusions: 430 W x199 H x 370 D mm (16.93 x 7.83 x 1.57 in.) Including Protrusions: 430 W x 214 H x 435 D mm (16.93 x 8.46 x 17.13 in.)	
Weight:	Approx. 29kg (64lbs.)	
Accessories:	<ul style="list-style-type: none"> <li>•TL01-TOS high voltage test lead wires, approx. 1.5m(4.9ft.)long, 1 set</li> <li>•Power cord set 1</li> <li>•3P-2P AC adaptor plug 1*</li> <li>•36P Amphenol connector plug(assembly type) 1</li> <li>•5P DIN cable 1</li> <li>•5P DIN cable(assembly type) 1</li> <li>•“DANGER! HIGH VOLTAGE” warning sticker 1</li> <li>•Operation Manual 1</li> <li>•Fuse, 7A, slow blow. (in fuse holder) 1</li> <li>•Fuses, 3A, slow blow 2</li> </ul>	

\*: The 3P-2P AC adaptor plug is provided only for the Testers shipped for use within Japan.

Peripheral and Optional Devices	Peripheral Devices:	<ul style="list-style-type: none"> <li>• TOS9020 H.V Scanning Unit</li> <li>• TOS6100 R Tester (AC low ohm tester)</li> </ul>
	Cables:	<ul style="list-style-type: none"> <li>• HC03-TOS H.V Cable*</li> <li>• 408JIP5 GP-IB Cable, 50 cm (1.6 ft.)</li> <li>• 408J101 GP-IB Cable, 1 m (3.3 ft.)</li> <li>• 408J102 GP-IB Cable, 2 m (6.6 ft.)</li> <li>• 408J104 GP-IB Cable, 4 m (13.1 ft.)</li> </ul>
	Optional Devices Available in Common for Kikusui's Withstanding Voltage Testers:	<ul style="list-style-type: none"> <li>• RC01-TOS Remote Control Box</li> <li>• RC02-TOS Remote Control Box</li> <li>• HP01A-TOS H.V Test Probe, approx. 1.5m (4.9 ft.) long</li> <li>• HP02A-TOS H.V Test Probe, approx. 3m (9.8 ft.) long</li> <li>• TL02-TOS Test Load wires, approx. 3m (9.8 ft.) long</li> <li>• PL01-TOS Warning Light Unit</li> <li>• BZ01-TOS Buzzer Unit</li> </ul>
	Rack Mount Brackets:	<ul style="list-style-type: none"> <li>• BH4M-TOS Rack Mount Brackets (JIS Type)</li> <li>• BH5-TOS Rack Mount Brackets (EIA Type)</li> </ul>

### 3. WARNINGS

*The tester supplies high voltage up to 5kV to the outside connection. Thus any incorrect handling of the tester may bring the risk of death to the operator. For safe operation of the tester, strictly observe the following instructions.*

#### 1. Electrification

Be sure to wear a pair of rubber gloves for electrical job, before operating the tester, to prevent electric shock.

#### 2. Grounding:

The protective grounding terminal, on the rear of the tester casing, shall be positively grounded using the applicable tool. If not properly grounded, the casing of this tester is charged with high voltage when the power is short-circuited to the ground or conveyer or any devices connected to the ground or to the commercial power line (Note i). It is very risky that anyone who touches the casing under such a condition will be subject electric shock.

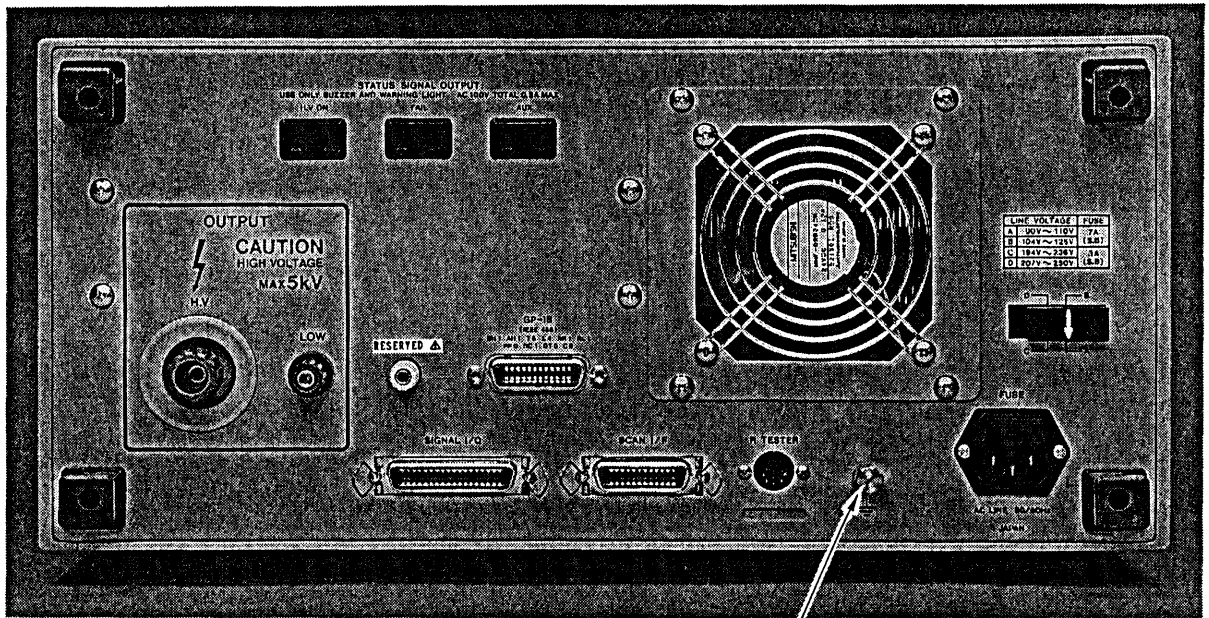

Protective GND terminal

Figure 3.1

(Note i) Generally a commercial power line means a line leading to the AC cord socket of the tester, from which the rated power is supplied into the tester. This manual also covers the power supply line from a private power generator.

### 3. Connecting of test lead-wire on GND side:

Figure 3.2 shows the connection of the test lead-wire on LOW side. Every time the tester is used, check if the lead wire is not damaged or disconnected. The lead-wire connection to the D.U.T. shall be made LOW side first. If the connection is incomplete, it is hazardous that the entire D.U.T. may be charged with high voltage.

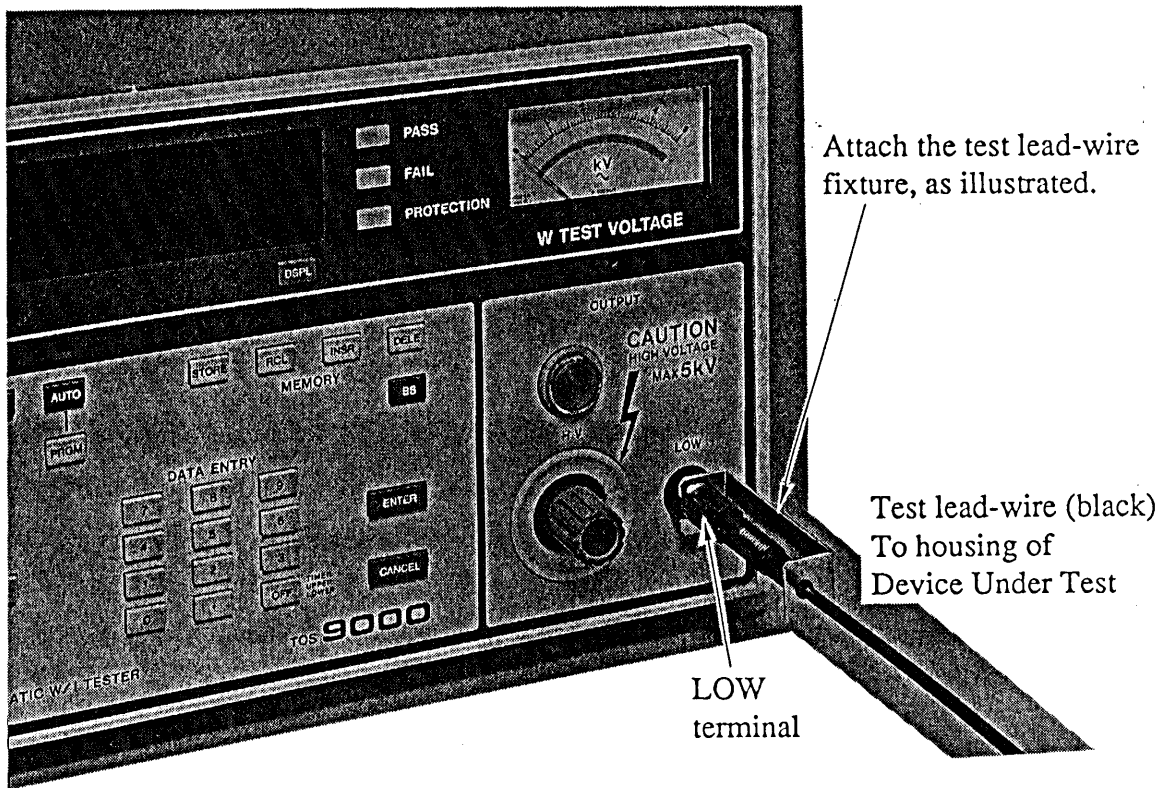

Figure 3.2

### 4. Connection of test lead-wire on high-voltage output side:

After connecting the lead-wire on LOW side, take the following procedure.

- Press the STOP switch.
- Confirm if the indicator of the output voltmeter is at "0."
- Confirm if the H.V ON lamp has been off.
- Short the high-voltage output terminal with the LOW test lead-wire once, and confirm that no high voltage is output.
- Connect the high-voltage test lead-wire with the high-voltage output terminal.
- Lastly, connect the LOW test lead-wire and then the high-voltage output test lead-wire to the D.U.T.

5. Suspension of testing:

The power switch shall be turned off, if the tester is not used for some time or the operator is to leave the tester.

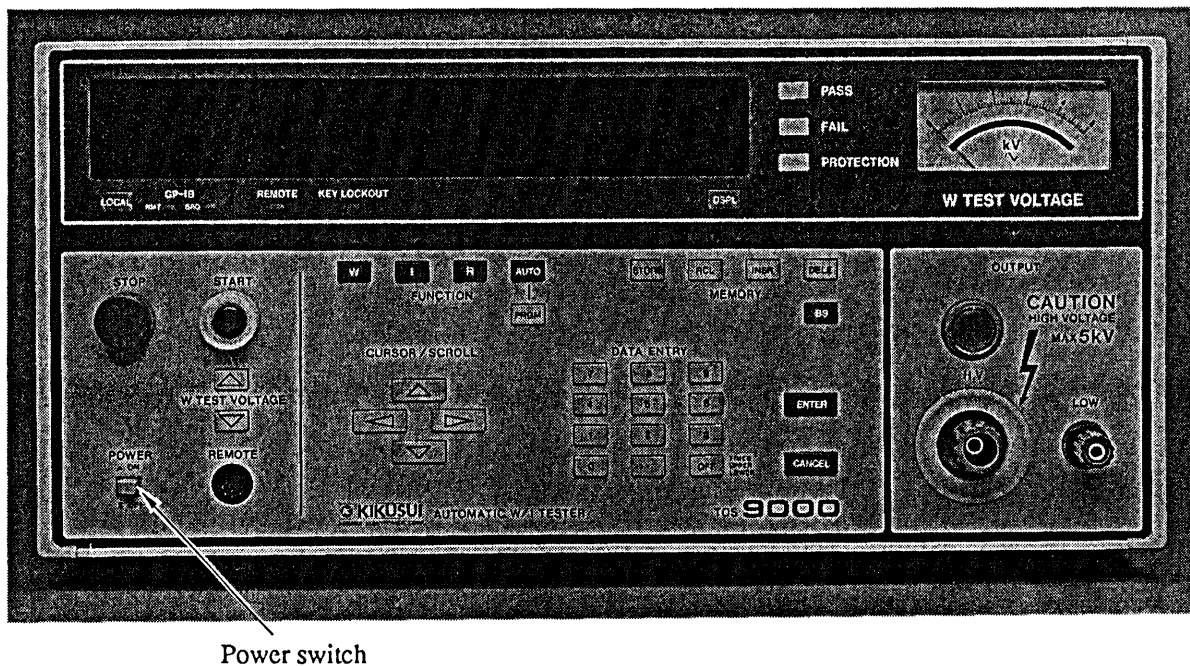

Figure 3.3

6. Critical areas of the tester under operation:

*It is dangerous to touch such high voltage areas as the D.U.T., the test lead-wire, probe, and output terminal while the tester is under operation.*

Never touch this area! →

*NEVER touch the alligator of the test lead wire and the vinyl-cover of the clip because they are NOT insulation proof.*

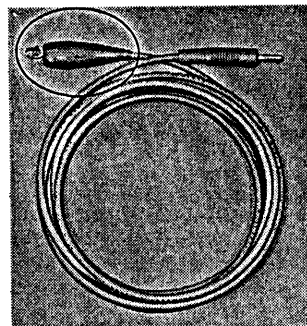

Figure 3.4

- Warning after the output has been cut off -

**7. Confirmation on completion of testing:**

*You may touch the D.U.T. and the high-voltage areas (test lead-wire, probe and output terminal) for correction of the wiring or any other purpose provided that the following confirmation has been made;*

*The power switch is turned off.*

*In the case of insulation resistance test, D.U.T. is charged after testing. Therefore, a particular attention must be paid to the succeeding paragraphs, 3-8 and 3-9.*

- Cautions in electric charging in insulation resistance test -

**8. Electric charging:**

*In case of insulation resistance test, the D.U.T. and the capacitor, test lead-wire, probe and output terminal, embodied in the tester, are charged with high voltage.*

*And it takes some time to discharge such an electric charge after the power has been cut off.*

*Accordingly, you should not touch such areas to prevent electric shock for a while after the power has been turned off.*

**9. Confirmation on discharge of electric charge:**

The time required to discharge electric charge depends on the characteristic of the D.U.T. and the test voltage. Suppose that the high-voltage areas such as the D.U.T and the test lead-wire are an equivalent circuit and that it can be expressed as a capacity of  $0.01 \mu\text{F}$  and a parallel resistance of  $100\text{M}\Omega$ , then the time required to attenuate the voltage of the D.U.T. down to 30V will be about 3.5 sec. at the test voltage of 1000V, and about 2.8 sec. at 500V. If the time constant of the D.U.T. is known, the attenuation time down to 30V, after the power has been cut off, of the D.U.T. can be determined by multiplying the attenuation time given above with such a time constant.

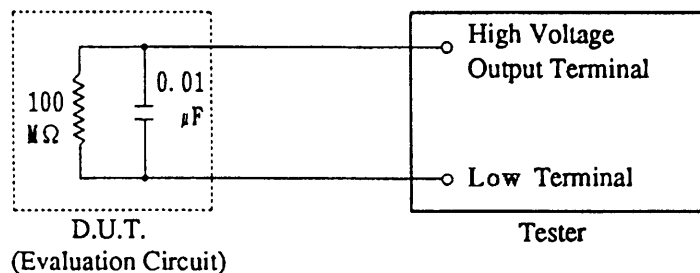

Figure 3.5

## 10. Remote control of tester:

*In the case this tester is to be remote controlled, the application of high voltage to the tester will be controlled by an external signal. Take the following safety precautions to prevent accident. Also, shall be maintained the safety precaution under positive control.*

- *NOT to permit unexpected output of high voltage from the tester (that is, to prevent this tester from being put in H.V ON condition).*
- *NOT to permit operator and any other come into contact with D.U.T. test lead-wire, probe, output terminal, etc. while the tester is generating high test voltage.*

## 11. Re-turn on of POWER switch:

Once the Power switch of the tester has been turned off, leave at least several seconds before it is turned on again. Do not repeat ON-OFF switching of the Power switch particularly when the tester is generating the out-put voltage. In such a case, the safety protection of the tester may not work properly, and the operator is endangered. The power switch shall not be turned off while the tester is generating the output voltage except in the case of emergency.

## 12. Other precautions:

Do not short-circuit the tester output with the ground or a conveyer or any device connected to the ground, or with the commercial power-line around tester location. Such a short-circuit may cause high-voltage charging on the tester casing. It is very dangerous. However, such a risky condition will not arise if only the casing has been grounded. The grounded casing will not be electrically charged nor will cause the damage on the tester even when the LOW terminal has been short-circuited with the high-voltage terminal. The protective grounding terminal shall be positively grounded using applicable tool.

If the high voltage output is shorted to the LOW terminal (or other object which is connected to the LOW terminal), noise which may cause interference to nearby electronic systems may be produced. To reduce the noise, connect the resistors ( $1\text{k}\Omega$ ,  $3\text{W}$ , Impulse Dielectric Withstanding Voltage:  $30\text{kV}$ ), at positions as close to the D.U.T. as possible, between the high-voltage-side cable and the D.U.T. and between the low-voltage-side cable and the D.U.T. as shown in Figure 3.6. When the resistors are connected as above, due to the voltage drops across the resistors, the voltage at the D.U.T. will be slightly lower than the voltage at the output terminal. For example, if the output current is  $10\text{mA}$ , the voltage at the D.U.T. will be lower by approximately  $20\text{V}$  than that at the output terminal).

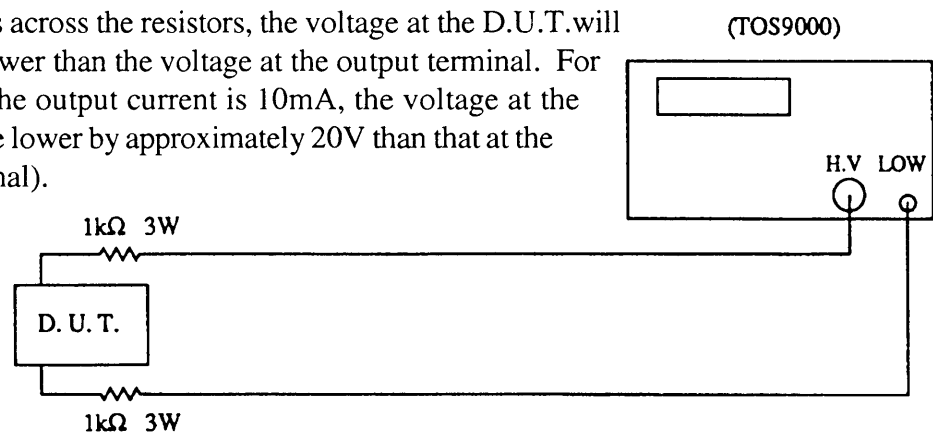

Figure 3.6

**- In case of Emergency -**

**13. Emergency handling:**

In the case of any accident such as an electric shock or burn-down of the D.U.T. resulting from the failure of the tester or D.U.T., take the following actions promptly;

- cut off the POWER switch, and
- pull out the plug of AC cable from the outlet of the power source.

It does not make any difference whichever action of the above two is taken first, but be sure to take both actions.

**- Trouble-shooting -**

**14. In case of trouble:**

In the following cases of trouble, it is very hazardous that the power of the tester may not be cut off while the tester continues to generate high voltage:

- H.V ON lamp keeps on lighting even when the STOP switch has been pushed.
- H.V ON lamp is turned off but the indicator of the output voltmeter continues swinging.
- The protective circuit has tripped and a message "Cut off the Power..." has appeared on the display.

The immediate action to take, in the above cases, is to pull out the plug of AC cord from the the socket of the power source, and suspend the operation of the tester. Thereafter, entrust us with the trouble-shooting and repair of your defective tester. If the tester shows any irregular performance, it is possible that a high voltage may be output irrespective of the operator's will. Suspend the operation of the tester immediately.

**15. Trouble of H.V ON lamp:**

When the H.V ON lamp does not work, it may cause erroneous operation of the tester, which in turn give rise to dangerous electrification.

Please entrust us with the repair of such a defective tester.

)  
,  
)  
)  
)  
)  
)



◆ ◆ Attention for Trouble-Free Operation. ◆ ◆

16. The heat dissipation capacity of the high voltage generator section of the W/I Tester is only one-half with respect to the rated output. That is, the Tester is designed overratedly in order to reduce its size, weight, and cost. When using the Tester, therefore, run it deratedly.

When using the Tester with a decision limit-current of 20mA or more, allow a pause period equal to or more than the test period. The allowable limit of output delivery duration (test duration) is as shown below for ambient temperatures up to 40°C (104°F) when the upper limit current is not greater than 30mA or for ambient temperatures up to 35°C (95°F) when the upper limit current is greater than 30mA.

Allowable output delivery duration (test duration):

- When the upper limit current for PASS/FAIL decision is not greater than 20mA:

Can be continuously delivered (at ambient temperature not higher than 40°C)

- When the upper limit current for PASS/FAIL decision is 20.1mA to 30mA:

Up to 100 sec. (at ambient temperature not higher than 40°C, with suspension of testing as shown in Figure 3.7)

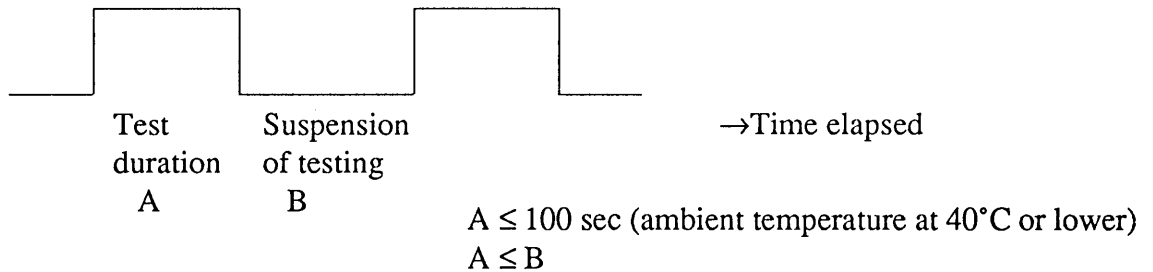

Figure 3.7

- When the upper limit current for PASS/FAIL decision is 30.1mA to 40mA:

Up to 50 sec. (at ambient temperature not higher than 35°C, with suspension of testing as shown in Figure 3.8)

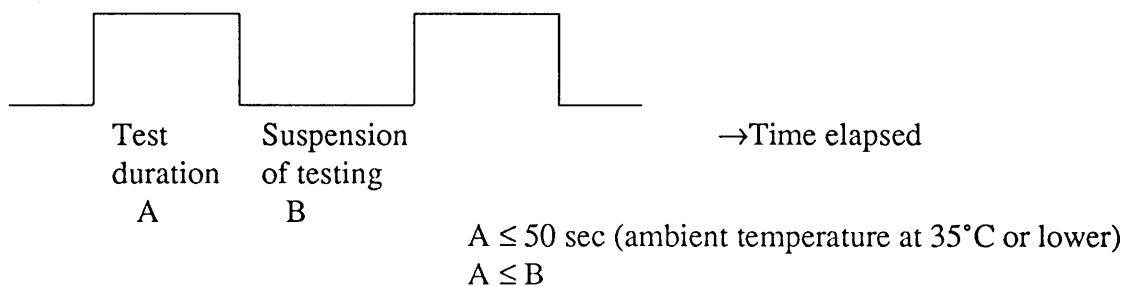

Figure 3.8

72. H. 27

912674A

17. The W/I Tester can be operated on one of the AC line voltages shown in the below table. The required voltage can be selected with the voltage selector plug on the rear panel.

Before connecting the AC power cable of the Tester to an AC line receptacle, be sure that the voltage selector plug is correctly set for the voltage. Also be sure to use a correct fuse which is shown in below table.

Note that the Tester may malfunction or may be damaged if it is operated on a wrong AC line voltage.

Selector	Nominal	Operable range	Fuse
A	100V	90 - 110V	7A (slow blow)
B	115V	104 - 125V	
C	215V	194 - 236V	3A (slow blow)
D	230V	207 - 250V	

18. The operation and storage of the tester under exposure to the direct sun-shine, high temperature and humidity or dusty environment should be avoided.
19. This tester is incorporated with a transformer of high output voltage up to 500VA. A considerably large current (in scores of amperes) may flow through the commercial power line, which is connected with the tester in the following two cases:
- In the duration of scores of milli-sec., in which the tester detects that a D.U.T. has failed the testing.
  - At an instant when the test is executed.

Also it is important to determine the capacities of the power line and of any electronic device connected to the same line, taking into consideration of such a large current.

## 4. OPERATION METHOD

### 4.1 Description of Front Panel Items

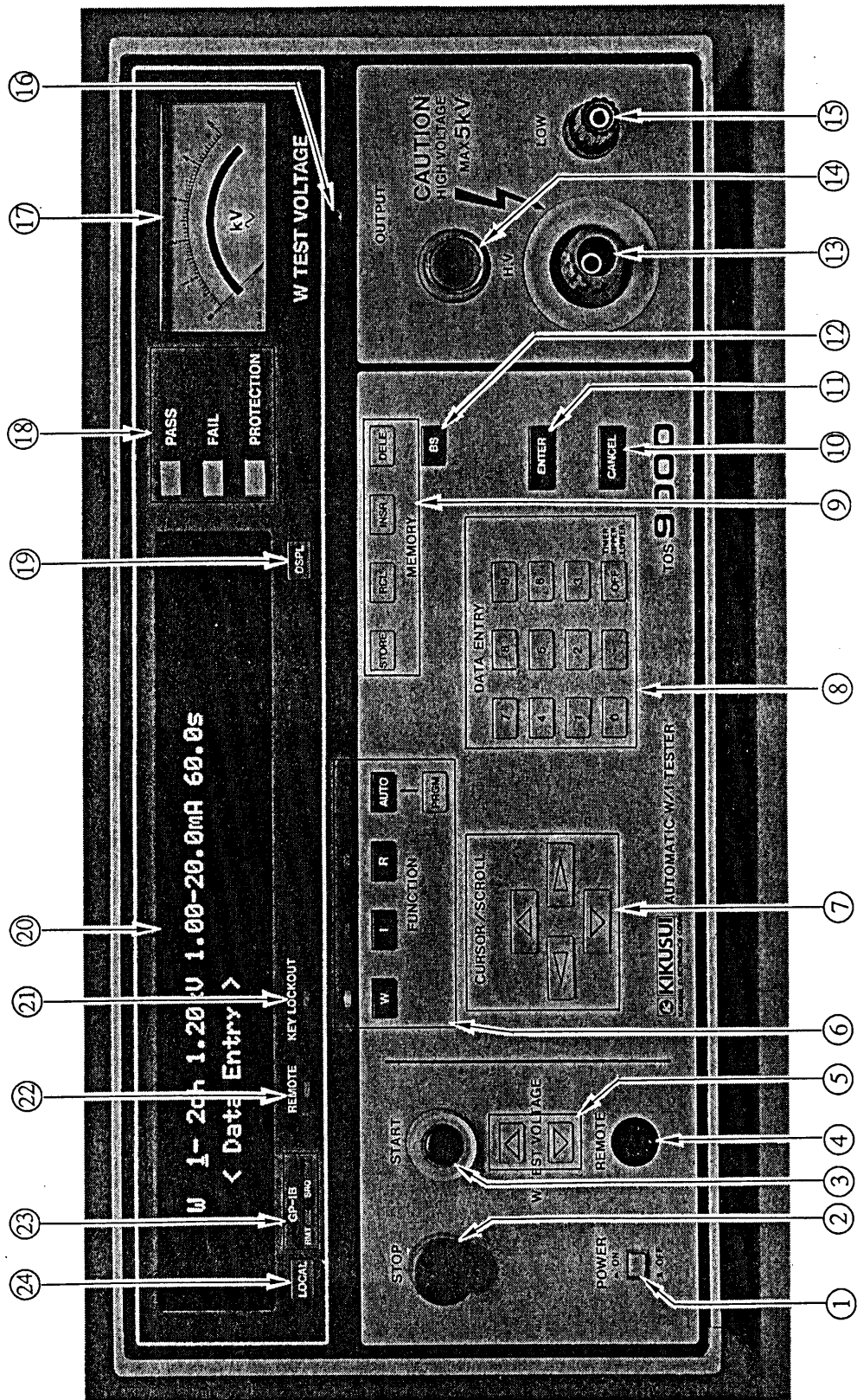

Figure 4.1

① POWER ON/OFF switch

This switch is for ON/OFF-control of main power of the W/I Tester. Be sure to read Chapter 3 “WARNINGS” before turning on the switch.

② STOP switch

This switch stops delivering the test output voltage of the W/I Tester. The switch should be pressed to turn off the test output voltage or to finish or abort the test execution.

This switch also resets the signals such as, a FAIL warning, a PROTECTION signal or a PASS signal. The PROTECTION signals may not be reset by pressing this switch. In this case, see Chapter 4.13 “Protective Functions.”

③ START switch





This switch starts delivering the high test voltage. As you press this switch when the W/I Tester is in the READY state, the H.V ON lamp ⑭ lights and the test selected by the Function key ⑥ starts. (The “READY state” means that all the required test conditions are satisfied and the W/I Tester is ready to start.)



Note: The H.V ON lamp ⑭ does not light when you execute a single AC low ohm test from the W/I Tester.

④ REMOTE connector

This connector is used for remote control of the W/I Tester with Model RC01-TOS or RC02-TOS remote control box or with Model HP01A-TOS or HP02A-TOS H.V test probe. Be sure to read Chapter 4.12 “Remote Control Function” before remote-controlling the W/I Tester.

⑤ W TEST VOLTAGE keys

These keys are to change the test voltage when in a single withstanding voltage test. The  key raises the voltage and the  key lowers it. Each time as you press the  or  key, the test voltage is raised or lowered by 10 volts. If you keep pressing each key, the test voltage goes on changing.

These keys also act as function shift keys. If you press the  key together with the **LOCAL** key, the KEY LOCKOUT function is effected. If you press the  key together with the **LOCAL** key when turning power on, the INITIAL SETTING mode appears.

## ⑥ FUNCTION keys

These keys select the test modes for the single and automatic tests.

- **W** key

This key selects the single withstanding voltage test mode. When this mode is active, the LED above the key lights and the display screen ②① shows the setting of the withstanding voltage test (W test).

- **I** key

This key selects the single insulation resistance test mode. When this mode is active, the LED above the key lights and the display screen ②① shows the setting of the insulation resistance test (I test).

- **R** key

This key selects the single AC low ohm test mode. When this mode is active, the LED above the key lights and the display screen ②① shows the setting of the AC low ohm test (R test).

Note: The R test cannot be done with the W/I Tester alone.

The **W/I/R** keys also select the test modes to be programmed for individual steps of a test sequence in AUTO test.

- **AUTO** key

This key selects the AUTO test mode. When this mode is active, the LED above the key lights and the display screen ②① changes to that for the AUTO mode.

- **PRGM** key

When in the AUTO test mode, this key selects the PRGM mode, which allows you to edit your program. As you press this key again, the system exits from the PRGM mode.

## ⑦ CURSOR/SCROLL keys

- CURSOR keys (◀/▶ keys)

These keys move the cursor on the display screen ⑳. Each time as you press the ◀ or ▶ key, the cursor moves to leftward or rightward parameter.

These keys also act for entry of a numerical value for a parameter. As you press either ◀ key or ▶ key, the value indicated by the cursor is entered and the cursor moves to the position for entry of a numerical value for the previous or next parameter.

When in the INITIAL SETTING mode, the keys enter a numerical value or select a function for initial setting items selected by the SCROLL keys (▲/▼ keys)

- SCROLL keys (▲/▼ keys)

When in the AUTO test mode, these keys change backward or forward the test steps displayed on the screen. Each time as you press the ▲ or ▼ key, the screen displays the preceding test step or the subsequent test step.

When in the INITIAL SETTING mode, the keys are used to select an initial-setting item.

## ⑧ DATA ENTRY keys

These keys are used to type a numerical value for a test parameter.

The OFF key disables the channel number of the H.V Scanning Unit, the lower limit of the withstanding voltage test, the upper limit of the insulation resistance test, and the test time.

⑨ MEMORY keys

- **STORE** key

This key stores the test parameter data on to memory. When in the single test mode, you can store up to ten test patterns for each of W, I, and R tests.

When in the INITIAL SETTING mode, this key acts as an exit key. As you press this key, the INITIAL SETTING mode finishes and the regular test mode resumes.

- **RCL** key

This key recalls the test parameter data which has been stored in memory.

For the AUTO test mode, the key is used to change the program numbers.

- **INSR** key

This key inserts a new test step between two existing test steps when you edit your program in the AUTO test sequence.

- **DELE** key

This key deletes a test step when you edit your program in the AUTO test sequence.

⑩ **ENTER** key

This key enters the numerical data (for memory number or program number) which have been typed on the display screen.

This key is used also to acknowledge the entire test conditions and drive the W/I Tester into the READY state (the state ready to start the actual test).

This key is used also to acknowledge and enter the test parameters for each of the test steps when programming an automatic test sequence.

92. 9. 21

912680A

⑪ **CANCEL** key

This key deletes the numerical value (such as for a test parameter) typed on the display screen. As you press this key, the value on the cursor is deleted. After that, you can type a new value.

This key is also used to return from the READY state to the ENTRY state (state for entry of test parameters for programming).

You can use this key to reset an invalid-value error (error caused by a value out of valid range). When a message “!!! Incorrect !!!” has appeared, you should press this keys to reset it, then enter a valid value.

Note: To change from the READY state to any other state, you must press the **CANCEL** key to return the W/I Tester once to the ENTRY state. It is unavailable to change directly from the READY state to any other state but the ENTRY state.

⑫ **BS** key

This key deletes a charactor on the cursor on the display screen. All the characters on the left hand side of the deleted charactor are moved rightward one character space.

⑬ H.V terminal

This terminal is the hot-line side of the high voltage generated by the W/I Tester. This terminal is directly connected in parallel with the H.V terminal on the rear panel.

Warning: Never touch the H.V terminals when the W/I Tester is in active operation.

⑭ H.V ON lamp

This lamp lights during the period the high test voltage is delivered to the H.V terminal. In the AUTO test, it keeps lighting untill all the test are over.

Note: This lamp does not light when the W/I Tester is used to control the R Tester for a single AC low ohm test.

⑮ LOW terminal

This terminal is the neutral-line side of the high voltage generated by the W/I Tester. This terminal is connected to the Tester chassis.

0  
1  
2  
3  
4  
5  
6  
7  
8  
9



⑩ ZERO control of W TEST VOLTAGE meter

This control adjusts the mechanical zero point of the W TEST VOLTAGE meter.

Warning: Before adjusting the zero point, be sure that the POWER switch of the W/I tester is off.

⑪ W TEST VOLTAGE meter

This voltmeter indicates the test voltage for withstanding voltage test.

Warning: Note that the voltmeter does not indicate the test voltage when in the insulation resistance test.

⑫ Indicator LEDs

- PASS LED

This LED lights to indicate that the test result is PASS.

When in the single test mode, the LED lights at the each test is over. When in the AUTO test mode, the LED lights after the final step of test is over. The lighting period of the LED can be preset with the initial setting "pass hold time" (see Chapter 4.9 "Initial Settings Page 4-50").

- FAIL LED

This LED lights to indicate that the test result is FAIL. Regardless of whether in the single test mode or in the AUTO test mode, once the LED lights, it remains lighting until it is manually turned off. To turn off the light, press the STOP switch ②.

- PROTECTION LED

This LED lights when one of the protective circuits of the W/I Tester has tripped. For the protective circuits, see Chapter 4.13 "Protective Functions" Page 4-72.

⑬  key

This key is for digital display of test data on the screen when in the single withstanding voltage test or in the single insulation resistance test. As you press this key when in the test state or the READY state, you can see the actual measured values. When in the single withstanding voltage test, the measured voltage value and leak current value appear on the screen display. When in the single insulation resistance test, the measured insulation resistance value appears on the screen display.

As you press this key again, the regular display mode resumes.

② Display

This display has a fluorescent screen of 40 characters × 2 lines. The displayed items are test modes, test parameters, test results, measured values, and messages.

- When in SINGLE test mode

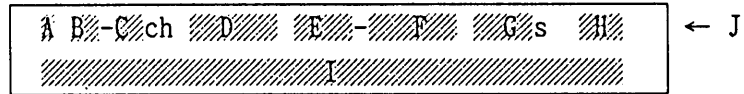

- Area A : Displays the test mode.
- Area B : Displays the channel number of the LOW-line side of the TOS9020 H.V Scanning Unit (optional) connected to the W/I Tester.
- Area C : Displays the channel number of the HIGH-line side of the TOS9020 H.V Scanning Unit (optional) connected to the W/I Tester.
- Area D : Displays the test voltage and the measured voltage for withstanding voltage test or insulation resistance test.
- Area E : Displays the LOWER limit value for PASS/FAIL decision in withstanding voltage test or insulation resistance test.
- Area F : Displays the UPPER limit value for PASS/FAIL decision in withstanding voltage test or insulation resistance test.
- Area G : Displays the test time.
- Area H : Displays the memory number of data. The “→” mark means STORE and the “←” mark means RECALL.
- Area I : Displays the test result or status, or a message.
- Area J : Displays the measured value (on the top line of the screen) when the (First line) **DSPL** key is pressed.

Note 1 : When in the single AC low ohm test mode, the test parameters for the items Area B through F cannot be specified. When in this test mode, therefore, the display format is as shown below.

Display format when in single AC low ohm test

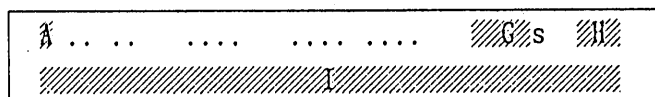

Note 2 : “You can select OFF for the test parameters Areas B, C, E, F and G. When you press the OFF key, the corresponding display areas are as “\*” or “\* \*.” For example, when OFF is entered for Areas B, C, E and G, the screen is shown as follows:

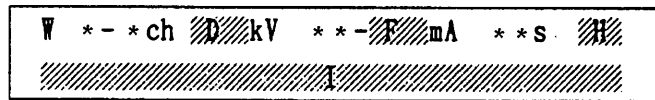

- When in AUTO test mode

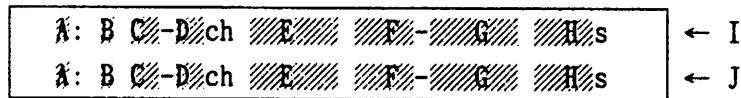

- Area A : Displays the test step number.
- Area B : Displays the test mode.
- Area C : Displays the channel number of the LOW-line side of the TOS9020 H.V Scanning Unit (optional) connected to the W/I Tester.
- Area D : Displays the channel number of the HIGH-line side of the TOS9020 H.V Scanning Unit (optional) connected to the W/I Tester.
- Area E : Displays the test voltage and the measured voltage for withstanding voltage test or insulation resistance test.
- Area F : Displays the LOWER limit value for PASS/FAIL decision in withstanding voltage test or insulation resistance test.
- Area G : Displays the UPPER limit value for PASS/FAIL decision in withstanding voltage test or insulation resistance test.
- Area H : Displays the test time. You cannot select OFF for AUTO test mode.
- Area I : Displays the program number when all program steps are scrolled up.  
(First line)
- Area J : Displays “END” when all the program steps are scrolled down. When in the  
(Second line) PRGM mode or in the test execution mode, this area displays the test result, status, or message.

## ②① KEY LOCKOUT LED

This LED lights to indicate that the W/I Tester is in the KEY LOCKOUT state. In this state, all the keys are locked out. The START and STOP switches, however, are available. The purpose of the KEY LOCKOUT provision protects the programmed test parameters and other entered data against alterations by inadvertent handling or unauthorized meddling.

You can set the KEY LOCKOUT state by pressing the LOCAL key ②④ and the  key (of the W TEST VOLTAGE keys ⑤) simultaneously. As the two keys are again pressed simultaneously, the W/I Tester exits from the KEY LOCKOUT state.

Note 1: Even if in the KEY LOCKOUT state, the START/STOP signals for remote control are available.

Note 2: If the POWER switch is turned off in the KEY LOCKOUT state, the W/I Tester will start up in the KEY LOCKOUT state. All the keys including the START/STOP keys will be in the locked state. To operate the Tester, reset from the KEY LOCKOUT state.

## ②② REMOTE LED

This LED lights to indicate that the W/I Tester is in the remote control mode with the REMOTE 1 or REMOTE 2 function.

## ②③ GPIB LEDs

- RMT



This LED lights to indicate that the W/I Tester is in the remote control mode with the GPIB function.

- SRQ

This LED lights to indicate that the W/I Tester is originating an SRQ signal.

## ②④ LOCAL key

This key allows you to change the W/I Tester into the LOCAL mode when it is operating on the GP-IB bus.

It also acts as a function shift key. As you press the key together with the W TEST VOLTAGE  or  key ⑤, the W/I Tester is driven into the KEY LOCKOUT mode or INITIAL SETTING mode, respectively.

Note: Entry to the INITIAL SETTING mode is available only when the power is turned on.

## 4.2 Description of Rear Panel

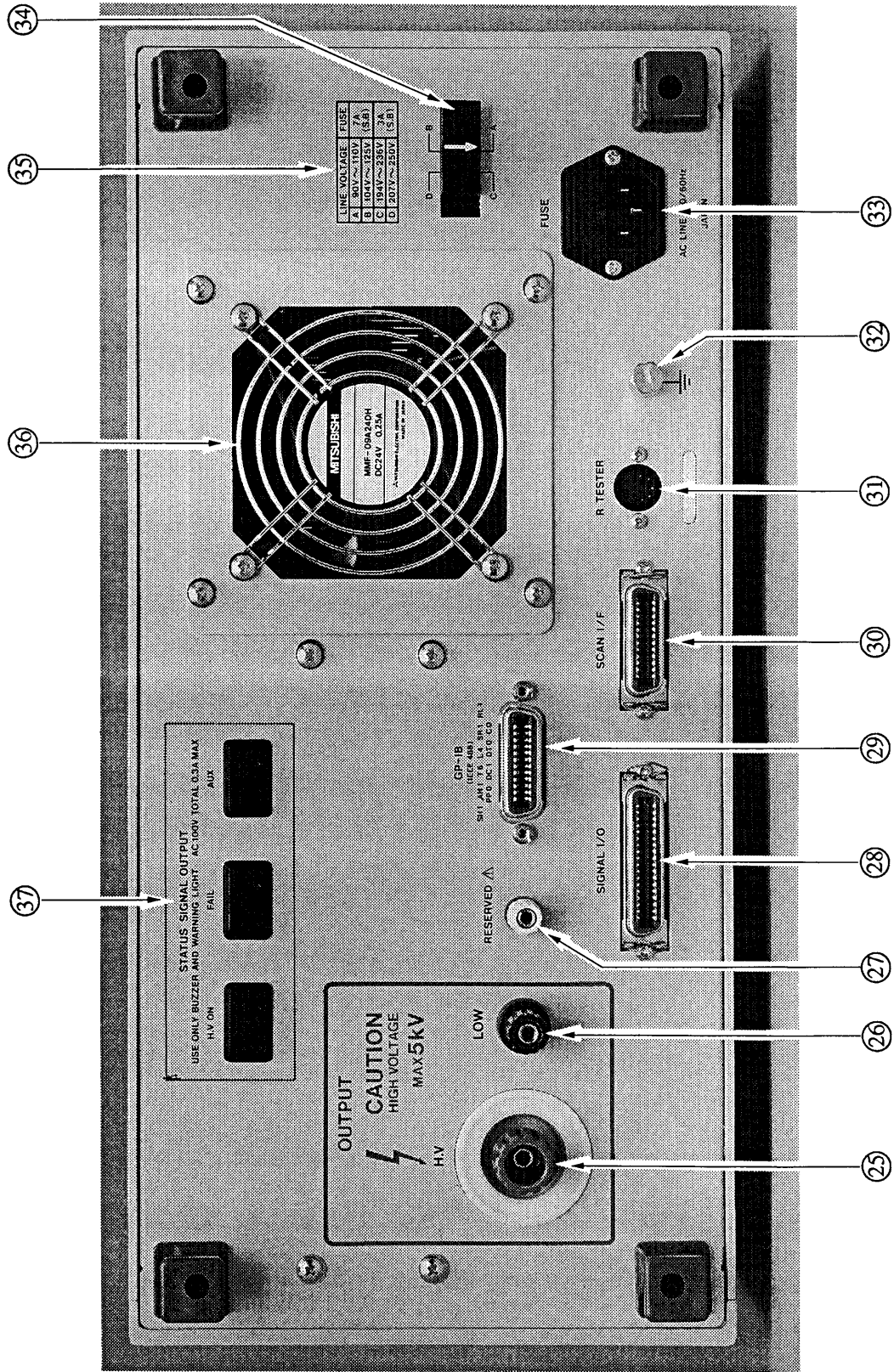

Figure 4.2

72. H. 25

912686A

②5 H.V terminal

This terminal is the hot-line side of the high voltage generated by the W/I Tester. This terminal is directly connected in parallel with the H.V terminal ①3 on the front panel.

Warning: Never touch the H.V terminals when the W/I Tester is in the active operation.

②6 LOW terminal

This terminal is the neutral-line side of the high voltage generated by the W/I Tester. This terminal is connected to the Tester chassis.

②7 RESERVED terminal

This terminal is for future system expansion. Do not use this terminal for regular tests.

**Caution!**

*Exercise care so that no cables are brought into contact with the RESERVED terminal. Especially, never let the HIGH-line side be shorted to the RESERVED terminal because the shorting may cause serious results.*

②8 SIGNAL I/O connector (36 pins, Amphenol)

This connector controls the output signals, the interlock input signal, and the remote-control (RMT2) input signal. For these signals, refer to Chapter 4.10 "Signal Output Function" Page 4-56 Chapter 4.11 "Interlock Function" Page 4-62, and Chapter 4.12 "Remote Control Function" Page 4-63, respectively.

②9 GPIB connector

This connector is used for the GPIB (IEEE-488-1978). Refer to Chapter 5 "GPIB INTER-FACE FUNCTION" Page 5-1.

③0 SCAN I/F connector (24 pins, Amphenol)

This connector is connected to the TOS9020 H.V Scanning Unit (optional). For this connection, be sure to use the cable which accompanies the TOS9020.

③① R TESTER connector (5 pins, DIN type)

This connector is connected to the TOS6100 R Tester for AC low ohm test.

③② Protective GND terminal

This terminal is used for a protective grounding of the W/I Tester to the earth potential. Be sure to securely connect a ground line to the terminal by using an applicable tool.

③③ AC LINE 50/60 Hz inlet

This inlet is a 3-pin AC power inlet connector with a fuse holder. Be sure to use the input power cable (an accessory of the W/I tester). You must use a correct fuse according to the AC LINE VOLTAGE Table ③⑤. To replace the fuse, disconnect the AC power cable, pry the nail section which is inside of this inlet with a screwdriver or other pointed tool. And remove the holder section to this side.

③④ AC LINE VOLTAGE selector plug

This plug selects the AC line voltage on which the W/I Tester is to be operated. Align the arrowhead mark of the plug with the corresponding voltage symbol as shown in the AC LINE VOLTAGE table ③⑤.

③⑤ LINE VOLTAGE table

This table indicates the AC line voltages and suitable fuses.

③⑥ Fan air outlet

This outlet is a ventilation air exit of the cooling fan. Pay attention so that the ventilation air flow is not impeded.

0  
1  
2  
3  
4  
5  
6  
7  
8  
9

## ③⑦ STATUS SIGNAL OUTPUT

- H.V ON signal outlet

This outlet delivers an H.V ON status signal (100V AC signal) during the period identical with that of lighting of the H.V ON lamp on the front panel, or during the period the high voltage is delivered to the H.V terminal. When in the AUTO test mode, however, this outlet delivers 100VAC signal until all the test finish.

- FAIL signal outlet

This outlet delivers a FAIL status signal (100V AC signal) when a FAIL decision has been made similarly to the FAIL LED on the front panel.

- AUX signal outlet

This outlet delivers an AUX signal (100V AC signal) depending on eight events. For the AUX signal, you can select one of the following signals with the INITIAL SETTING procedure.

Selectable events:

CYCLE END	(END)
WU/FAIL	(WUF)
WL/FAIL	(WLF)
IU/FAIL	(IUF)
IL/FAIL	(ILF)
CONTACT FAIL	(CNTF)
PASS,	
PROTECTION	(PROT)
STEP END	(END)

(The event names enclosed in the parentheses are abbreviations.)

Note: Above three outlets are dedicated to Model PL01-TOS Warning light Unit (optional) and Model BZ01-TOS Buzzer Unit (optional). Do not use them for other purposes. The outlet voltage is nominal 100V AC, irrespective of setting of the AC LINE VOLTAGE selector plug ③④ .



### 4.3 Notes and Precautions Before Tests

- (1) Before turning on the power switch, be sure that the analog meter pointer is indicating the zero scale position. If it has been deviated, adjust it with the ZERO control ⑩. If the power has been turned on, turn it off once to check and adjust this.
- (2) Be sure to read Chapter 3 "WARNINGS" before turning on the power. When you execute a test, observe the instructions given in Chapter 4.4 and thereafter.
- (3) For several seconds after the power is turned on, the W/I Tester checks its internal memory. During this period, the following message appears on the display screen.

— KIKUSUI ELECTRONICS CORP. — BLS ver x.xx.xxx    TOS ver x.xx.xxx
---

When checking of the internal memory is successfully completed, the W/I Tester is automatically driven into the test mode which existed when its power was turned off last time.

- (4) When the PROTECTION LED is lighting up, you cannot start the test. For the causes of lighting of the LED, see Chapter 4.13 "Protective Functions" Page 4-72. Eliminate the cause and then press the STOP switch to exit from the PROTECTION state.
- (5) For a short period after the power is turned on or off, the W TEST VOLTAGE meter pointer may irregularly deflect. The deflections are not abnormal indications. No voltage is delivered through the H.V terminal.



① H.V Scanning Unit LOW-line channel number

Specify a LOW-line channel number of the TOS9020 H.V Scanning Unit. At executing the test, the test voltage (LOW-line side) is delivered onto the terminal of specified channel.

For the single-scanning operation, specify “OFF” for this parameter. For details of the single-scanning operation of tests, refer to the instruction manual for the H.V Scanning Unit.

The available channel numbers are 1 - 16. However, the HIGH-line channel number must not conflict with the LOW-line.

Note that the available channel number depends on the number of H.V Scanning Units connected in parallel. For details, refer to the instruction manual for the H.V Scanning Unit.

② H.V Scanning Unit HIGH-line channel number

Specify a HIGH-line channel number of the TOS9020 H.V Scanning Unit. At executing the test, the test voltage (HIGH-line side) is delivered onto the terminal of specified channel.





The available channel numbers are 1 - 16. However, the LOW-line channel number must not conflict with the HIGH-line.

Note that the available channel number depends on the number of H.V Scanning Units connected in parallel. For details, refer to the instruction manual for the H.V Scanning Unit.

Note: When you execute a test without TOS9020 H.V Scanning Unit, specify “OFF” for both channels. Then, the display on the screen will be as “\* - \* ch.”

③ Test voltage

Specify the voltage to be applied to the D.U.T. The range of the test voltage which you can specify is 0.20 to 5.30kV in 10V-steps. The voltage cannot exceed Maximum High Voltage, which you had specified in the INITIAL SETTING mode.

You can adjust the test voltage finely with the W TEST VOLTAGE (  /  ) keys during the test operation. Each time as you press the  or  key, the test voltage changes by 10V. If you hold the key pressed, the test voltage changes continuously.

④ Lower limit for PASS/FAIL decision

Specify a lower limit of leak current for PASS/FAIL decision. If the detected leak current is smaller than the lower limit value, the W/I Tester will judge that the D.U.T. is failed and will generate a FAIL alarm signal.

When the deviations of leak currents of the D.U.T. are predictable and are within the range of PASS/FAIL decision, set the lower limit to a value slightly smaller than the predicted smallest of the D.U.T. This setting will allow you to discriminate the D.U.T. whose leak currents are unreasonably small or to detect failures in test cable wiring such as open-circuiting of test leadwires or imperfect contacting of test connections. Thereby you can enhance the reliability of your test.

The range available for lower limit setting is 0.05 - 39.0mA. Within a range of 0.05 - 9.99mA, the set value is adjustable in 0.01mA steps; within a range of 10.0 - 39.0mA, it is adjustable in 0.1mA steps. The lower limit value cannot exceed the upper limit value of ⑤.

When it is undesirable to set the low limit value, specify "OFF" for this test parameter. When this is done, the display on the screen will be as " \* \* ."

Note: As mentioned in Note 3 of Chapter 2 "SPECIFICATIONS," when the tests are made with a high AC test voltage and a high sensitivity, the lower-limit PASS/FAIL decisions may become meaningless because the current which flows in the stray capacity of the test leadwires and other test connections may become larger than the lower limit value.

Assume that the test wiring has been open-circuited. Since no current flows in the tested object and the leak current which flows through the tested object is smaller than the lower limit value, the decision should be a FAIL. However, since a current which is larger than the lower limit value flows through the stray capacity, the W/I Tester will make a PASS decision.

Pay thorough attention when preparing a test setup and making a test wiring. For verification, disconnect the tested object from the test wiring in the fully prepared test setup state and be sure that the FAIL decision is done correctly.

⑤ Upper limit for PASS/FAIL decision

Specify an upper limit of leak current for PASS/FAIL decision. If the detected leak current is larger than the upper limit value, the W/I Tester will judge that the D.U.T. is failed and will generate a FAIL alarm signal.

The range available for upper limit setting is 0.10 - 40.0mA. Within a range of 0.10 - 9.99mA, the set value is adjustable in 0.01mA steps; within a range of 10.0 - 40.0mA, it is adjustable in 0.1mA steps. The upper limit value cannot be smaller than the lower limit value of ④.

⑥ Test time (test duration)

Specify a period during which the test voltage is to be delivered. The available range is 0.50 - 99.9 seconds. Within a range of 0.50 - 9.99 seconds, the set value is adjustable in 0.01-sec steps; within a range of 10.0 - 99.9 seconds, it is adjustable in 0.1-sec steps.

If no test duration setting is required, specify “OFF” for this test parameter. Then the display on the screen will show “ \* \* .”

Note: Allowable test time (output delivery duration)









- When the upper limit current for PASS/FAIL decision is not greater than 20mA:  
Can be continuously delivered at ambient temperature not higher than 40°C (104°F)
- When the upper limit current for PASS/FAIL decision is 20.1mA to 30mA:  
Up to 100 seconds at ambient temperature not higher than 40°C (104°F)
- When the upper limit current for PASS/FAIL decision is 30.1mA to 40mA:  
Up to 50 seconds at ambient temperature not higher than 35°C (95°F)

The heat dissipation capacity of the high voltage generator section of the W/I Tester is only one-half with respect to the rated output in order to reduce its size, weight and cost, and therefore it must be run derated. When using the W/I Tester with a decision limit-current of 20mA or more, allow a pause time equal to or more than the test time. The allowable limit of output delivery duration (test time) is as shown in the above for ambient temperatures up to 40°C when the upper limit current is not greater than 30mA or for ambient temperatures up to 35°C when the upper limit current is greater than 30mA.

⑦ Frequency of test voltage

Specify 50 Hz or 60 Hz for the frequency of the test voltage. You can select either frequency irrespective of the AC line frequency. The W/I Tester is set at 50 Hz as default. For the selecting procedure, see Chapter 4.9 “Initial Settings” Page 4-50.

<Setting Procedure>

- (1) Select the required test parameter with the CURSOR (  /  ) keys ⑦ .
- (2) Type a numerical value or OFF with the DATA ENTRY keys ⑧ . The data is over-written automatically on the screen. When the message "<Data Entry>" appears on the second line of the screen, you can enter the data. If you have typed a wrong character by mistake, delete it by pressing the  key. If you want to cancel all the typed characters entirely, press the  key.
- (3) After you have typed the data, press the  or  key. The data will be entered and set so far as it is within the valid range. And, proceed to entry of the subsequent test parameter.
- (4) If the data is invalid, the W/I Tester will not accept the data, and a message "!!!Incorrect!!!" will appear on the screen. When this message has appeared, press the  key, and the message will disappear. And, delete the invalid data with the  or  key and then enter a valid data.
- (5) Enter the test parameters by repeating the procedure of Steps (1) through (4). You don't have to enter the new parameters which are not required to be altered. Some examples of the test parameter settings are introduced below.

92. 7. 21

9 1 2 6 9 5 A

Example 1. Setting for a single withstanding voltage test:

- ① H.V Scanning Unit LOW-line channel number Channel 1
- ② H.V Scanning Unit HIGH-line channel number Channel 2
- ③ Test voltage 1.2kV
- ④ Lower limit for PASS/FAIL decision OFF
- ⑤ Upper limit for PASS/FAIL decision 20mA
- ⑥ Test time (test duration) 60 sec

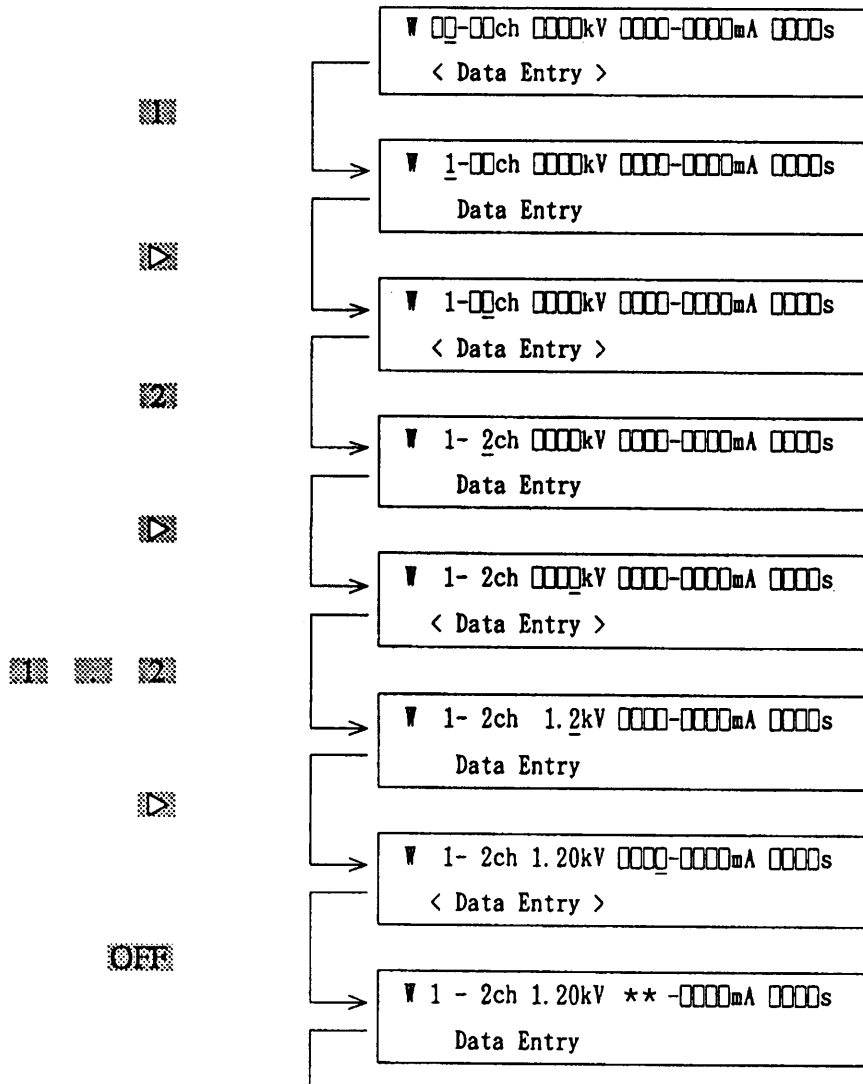

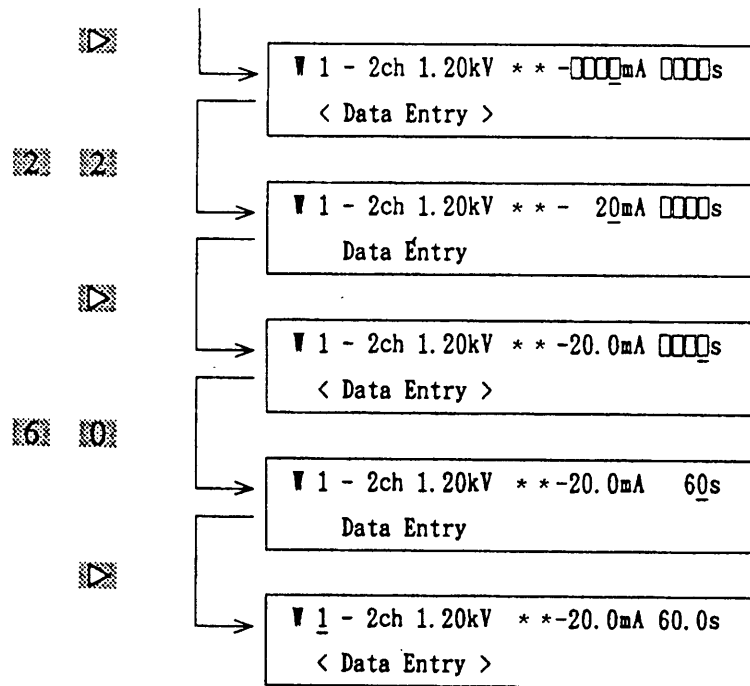

The setting is complete by the above procedure.

Examples of entry procedure, correcting procedure for a wrong value, and correcting procedure for an invalid value are introduced below in Examples 2, 3 and 4, respectively.



Example 2. To set the test voltage for a withstanding voltage test at 1.25kV:

Key operation	Indication on display screen
	□□□□ kV
	□□□ <u>1</u> kV
	□□1. <u>  </u> kV
	□1. <u>2</u> kV
	1. 2 <u>5</u> kV
(or )	1. 2 5 kV

Example 3. To correct a wrongly typed data when entering 10.5mA for upper limit value for PASS/FAIL decision in withstanding voltage test:

Key operation	Indication on display screen
	-□□□□ mA
	-□□□ <u>1</u> mA
	-□□1 <u>0</u> mA
Type  by mistake for	-□10 <u>5</u> mA
	-□□1 <u>0</u> mA
(or )	-□10. <u>  </u> mA
	-10. <u>5</u> mA
(or )	-10. 5 mA



## 4.4.2 Procedure for Single Withstanding Voltage Test

- (1) Connect the D.U.T., observing the instructions given below.

Confirm that the W TEST VOLTAGE meter reads zero, and that the H.V ON lamp has gone out. Connect the LOW-line test leadwire to the LOW terminal of the W/I Tester. Contact the leadwire to the H.V terminal to check that there exists no voltage between the H.V terminal and the LOW terminal. Then, connect the HIGH-line leadwire to the H.V terminal.

Connect the LOW-line leadwire to the D.U.T. first, and the HIGH-line leadwire last.

When you use the TOS9020 H.V Scanning Unit, refer to its instruction manual.

- (2) Press the **ENTER** key to drive the W/I Tester to the READY state.

When in the READY state the indication on the display screen is shown as follows:

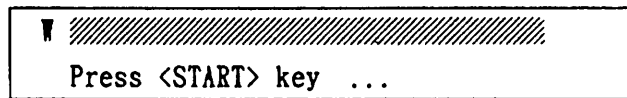

Indicates that the W/I Tester is in the READY state for a single withstanding voltage test

Although you have pressed the **ENTER** key, a message “!!!Incorrect!!!” may appear on the screen and the W/I Tester may not change to the READY state. This state occurs because you have one or more of the four mistakes ① through ④ mentioned below.

- ① The HIGH-line channel number of the H.V Scanning Unit is conflicting with the LOW-line channel number. (Example: 1 - 1 ch)
- ② “OFF” is specified for the HIGH-line channel of the H.V Scanning Unit. (Example: 3 - \* ch)
- ③ The test voltage is higher than the Maximum High Voltage of INITIAL SETTING. This state may occur when the Maximum High Voltage of INITIAL SETTING is altered to lower than the test voltage after the test voltage has been set.
- ④ The lower limit value for PASS/FAIL decision is not smaller than the upper limit value. (Example: 10.0 - 5.00mA)

Press the **CANCEL** key, and the message !!!Incorrect!!! will disappear. Then, enter a valid data.

- (3) Press the START switch ③ to start the test.

When you have started a test, the H.V ON lamp ⑭ on the front panel lights up to indicate that the high voltage is delivered. And a message "<High Voltage ON>" appears on the display screen.

Indications on front panel during test

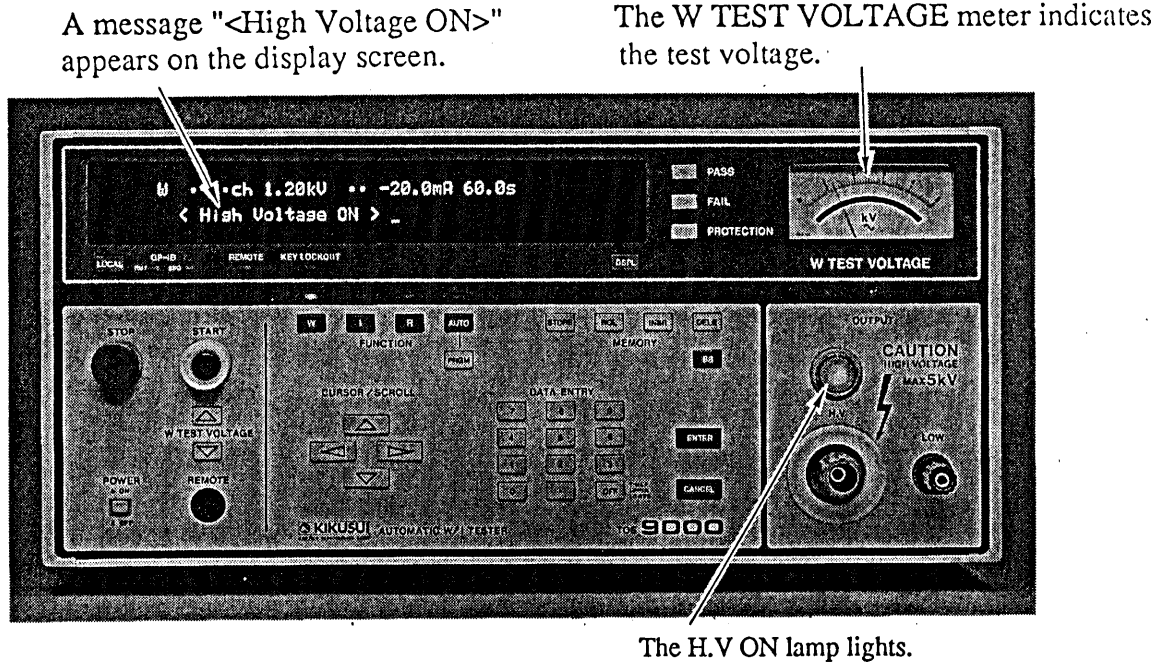
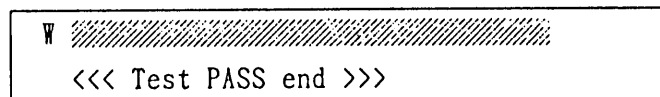

Figure 4.3

- (4) When the test time has elapsed, the test finishes and the W/I Tester will generate PASS signals, such as an open-collector signal, a lamp signal, and a buzzer signal. The signal duration is approximately 0.2 seconds. The duration is adjustable as "Pass hold time" of INITIAL SETTING. When the signal duration is over, the W/I Tester automatically returns to the READY state. When the W/I Tester has made a PASS decision, it displays the following message on its display screen.

A message displays when the test is PASS



- (5) If "OFF" has been specified for the test time, the high voltage keeps being delivered. Press the STOP switch to abort the test. Then the W/I Tester does not make any PASS/FAIL decision.

- (6) If the leak current detected during the test time is as that of (a) or (b) shown below, the W/I Tester makes a FAIL decision and cuts off the test voltage. And, the FAIL alarms are generated.

- (a) The detected leak current is larger than the upper limit.

Indications on display screen

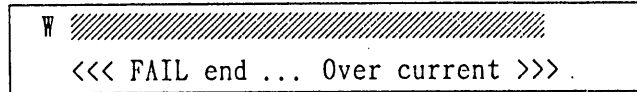

- (b) The detected leak current is smaller than the lower limit.

Indications on display screen

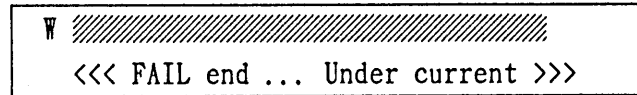

The FAIL alarms have four types such as, open-collector, LED, buzzer, and 100V AC signals. For the open-collector signal, the WU/FAIL signal is also delivered in the case of (a), and the WL/FAIL signal is also delivered in the case of (b).

Once the FAIL alarms are generated, they are not automatically reset. To reset them, press the STOP switch.

Note: The FAIL alarms are also reset when a protective circuit has tripped and the W/I Tester has been driven into the PROTECTION mode.

- (7) To advance to the subsequent test:

If the test result is a PASS, the W/I Tester generates the PASS signals for the "Pass Hold Time" duration and, it returns to the READY state. Then, the subsequent test can be started simply by pressing the START switch. If the test result is a FAIL, press the STOP switch to return the W/I Tester to the READY state once. Then advance to the subsequent test by pressing the START switch.

- (8) To change to the test condition setting mode:

When the W/I Tester is in the READY state, press the **CANCEL** key (11).

- (9) To monitor the test voltage and leak current:

You can monitor the test voltage at the H.V terminal of the W/I Tester and the leak current during a single withstanding voltage test by pressing the **DSPL** key ①9. The voltage and the current are digitally displayed on the display screen. To return to the test condition data display, press the **DSPL** key or the **CANCEL** key again.

Indications on display screen

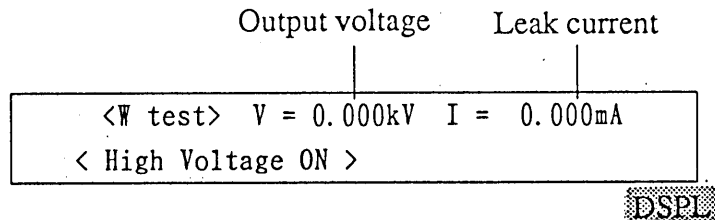

If the test has finished in the state that the screen displays the test voltage and leak current, the display will hold the values at the end of the test.

**Note:** The value displayed after PASS/FAIL decision may not be the value at the time when the decision has been made, due to the response time of the digital display.

## 4.5 Single I Test

To select the Single I Test mode, press the FUNCTION  key ⑥ on the front panel. When in this mode, the display screen is shown as follows:

I -ch V -MΩ s  
 < Data Entry >



### 4.5.1 Entry of Test Parameters

Enter the test parameters by using the DATA ENTRY keys and CURSOR keys. The parameters which you can enter are as follows:

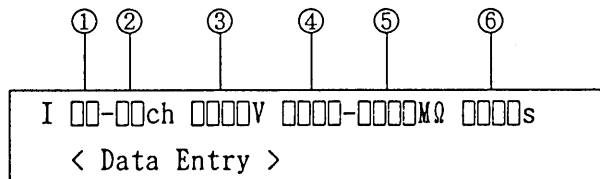

- ① H.V Scanning Unit LOW-line channel number (1 - 16, OFF)
- ② H.V Scanning Unit HIGH-line channel number (1 - 16, OFF)
- ③ Test voltage (50 - 1000V)
- ④ Lower limit for PASS/FAIL decision (1 - 9999MΩ)
- ⑤ Upper limit for PASS/FAIL decision (1 - 9999MΩ, OFF)
- ⑥ Test duration time (0.50 - 99.9 sec, OFF)
- ⑦ Wait time for PASS/FAIL decision (0.3 - 10 sec)  
(You can change in INITIAL SETTING mode)

Note: When you use the TOS9020 H.V Scanning Unit, you should enter a numeric value for each parameter, ① and ②. If not necessary, specify "OFF" for both parameters.

- ① H.V Scanning Unit LOW-line channel number

The same as that for Single W Test. (Refer to Chapter 4.4.1)

- ② H.V Scanning Unit HIGH-line channel number

The same as that for Single W Test. (Refer to Chapter 4.4.1)

- ③ Test voltage

Specify the voltage to be applied to the D.U.T. (according to the safety standard or the test purpose). The range of the test voltage which you can specify is 50 to 1000V, in 1V steps. The voltage cannot exceed the Maximum High Voltage, which you had specified in INITIAL SETTING mode.

- ④ Lower limit for PASS/FAIL decision

Specify a lower limit of resistance for PASS/FAIL decision. If the measured resistance is smaller than the lower limit resistance, the W/I Tester will judge that the D.U.T. is failed and will generate a FAIL alarm signal. The range of available lower limit resistance setting is 1 - 9999MΩ. The lower limit value cannot exceed the upper limit value of ⑤.

- ⑤ Upper limit for PASS/FAIL decision

Specify an upper limit of resistance for PASS/FAIL decision. If the measured resistance is larger than the upper limit resistance, the W/I Tester will judge that the D.U.T. is failed and will generate a FAIL alarm signal. The range of available upper limit resistance setting is 1 - 9999MΩ. The upper limit value cannot be smaller than the lower limit value of ④.

When the deviations of leak currents of the D.U.T. are predictable and are within the range of PASS/FAIL decision, set the upper limit to a value slightly larger than the predicted largest values of the D.U.T. This setting may allow you to discriminate the D.U.T. whose insulation resistances are unreasonably large or to detect failures in test cable wiring such as open-circuiting of test leadwires or imperfect contacting of test connections, thereby you can enhance the reliability of your test.

When it is undesirable to set an upper limit value, enter "OFF" for this test parameter. Then, the display on the screen will be as "\* \*."



⑥ Test time (test duration)

Specify a period during which the test voltage is to be delivered. The available range is 0.50-99.9 seconds. Within a range of 0.50- 9.99 seconds, the set value is adjustable in 0.01-sec steps; within a range of 10.0 - 99.9 seconds, it is adjustable in 0.1-sec steps. If no test duration is required, specify “OFF” for this test parameter. Then the display on the screen will show “\* \* .”

The test time must always be longer than the decision wait time of ⑦ .

⑦ Wait time for PASS/FAIL decision

For a short period immediately after the beginning of the test, the W/I tester may not measure the correct insulation resistance values due to a charge current for the capacitances of the test leadwires and of the D.U.T. Lest no PASS/FAIL decision should be made within this period, you should set a sufficient wait time.

The higher the insulation resistance of the tested object, the longer is the wait time required. When the lower limit value for PASS/FAIL decision is set at 2000M $\Omega$  or more, you should set a wait time of 1 second or more for PASS/FAIL decision.

When the W/I Tester is shipped from the factory, the wait time is set at approximately 0.3 seconds. The wait time is adjustable within a range of 0.3 to 10.0 seconds by the INITIAL SETTING procedure (see Chapter 4.9, page 4-50).

<Setting Procedure>

The setting procedure of test parameters are identical with that for the Single W Test. An example of parameter setting is introduced here assuming the following test conditions:

- |  |                |
|--|----------------|
| ① H.V Scanning Unit LOW-line channel number  | Ch 1           |
| ② H.V Scanning Unit HIGH-line channel number | Ch 3           |
| ③ Test voltage                               | 1000V          |
| ④ Lower limit for PASS/FAIL decision         | 50M $\Omega$   |
| ⑤ Upper limit for PASS/FAIL decision         | 2000M $\Omega$ |
| ⑥ Test duration time                         | 10 sec.        |

Key operation

Indication on display screen

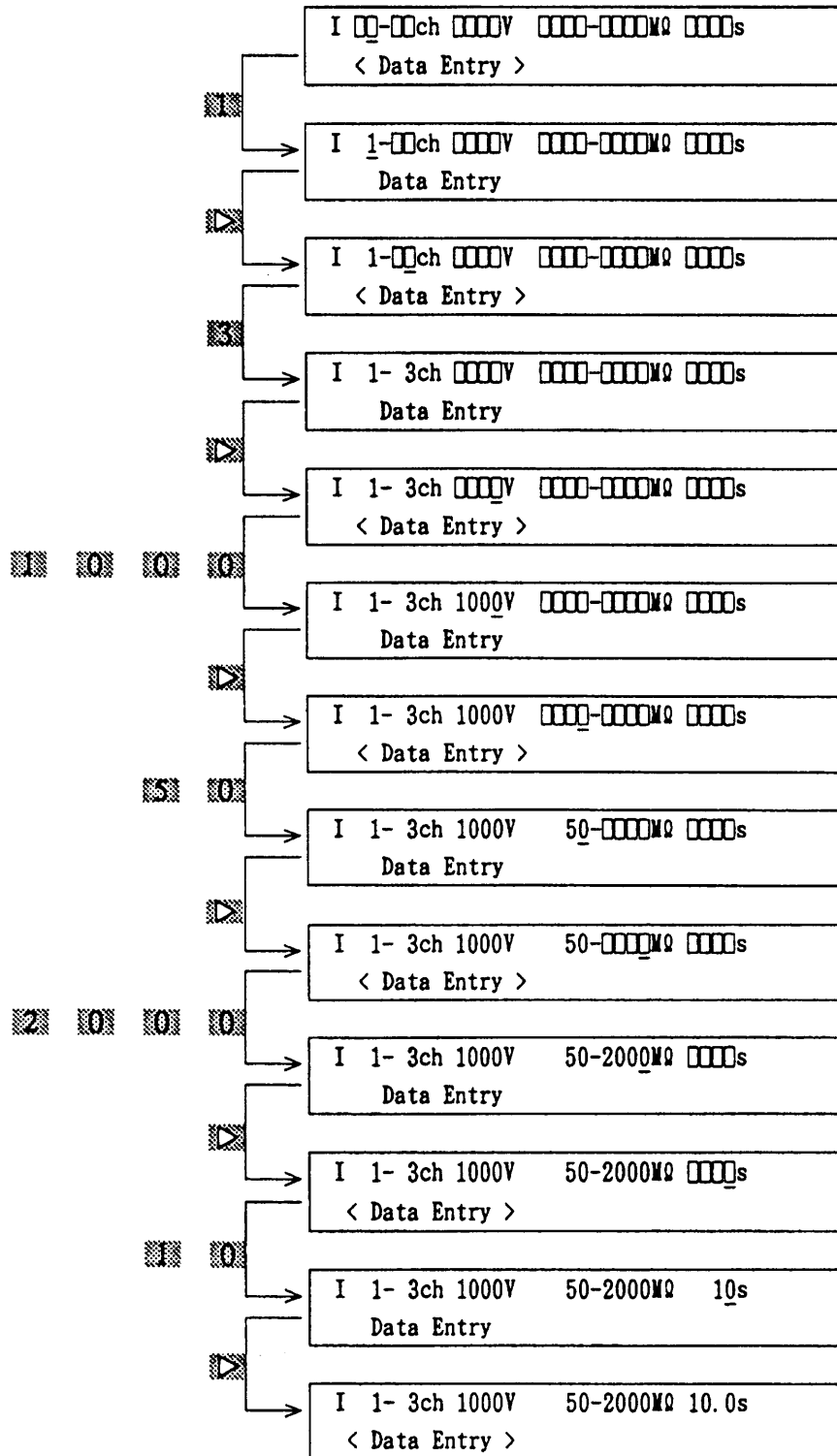

The setting procedure is complete by the above.

## 4.5.2 Procedure for Single Insulation Resistance Test

For single insulation resistance test, proceed as described in the following.

- (1) Connect the D.U.T., observing the instructions identical with those given for the single withstanding voltage test.
- (2) Press the **ENTER** key to drive the W/I Tester to the READY state.
- (3) Press the START switch ③ to start the test.

When you have started a test, the H.V ON lamp ⑭ on the front panel lights up to indicate that the high voltage is delivered and a message "<High Voltage ON>" appears on the display screen.

- (4) When the pre-defined test time has elapsed, the test finishes and the W/I Tester will generate PASS signals. The types of the signals are identical with those for the single withstanding voltage test.
- (5) If "OFF" has been specified for the test time, the high voltage keeps being delivered. Press the STOP switch to finish the test. Then, the W/I Tester does not make any PASS/FAIL decision.
- (6) If the leak current detected during the test time is as that of (a) or (b) shown below, the W/I Tester makes a FAIL decision and cuts off the test voltage. And the FAIL alarms are generated.
  - (a) The measured resistance is smaller than the lower limit.

Indications on display screen

I   
<<< FAIL end ... Under resistance >>>

- (b) The measured resistance is larger than the upper limit.

Indications on display screen

I   
<<< FAIL end ... Over resistance >>>

The FAIL alarms have four types, such as, open-collector, lamp, buzzer, and 100V AC signals. For the open-collector signal, the IL/FAIL signal is also delivered in the case of (a), the IU/FAIL signal is also delivered in the case of (b).

Once the FAIL alarms are generated, They are not automatically reset. To reset them, press the STOP switch.

Note: The FAIL alarms are also automatically reset when a protective circuits trips and the W/I Tester is driven into the PROTECTION mode.

- (7) To advance to the next test:

The procedure to be followed is identical with that to be followed when in the withstanding voltage test.

- (8) To change to the test condition setting mode:

The procedure to be followed is identical with that to be followed when in the withstanding voltage test.

- (9) To monitor the measured insulation resistance:

Press the **DSPL** key  $\text{\textcircled{19}}$  when in a single insulation resistance test, and the measured resistance is displayed on the screen. As you press the **DSPL** key again, the screen returns to display of the test conditions.

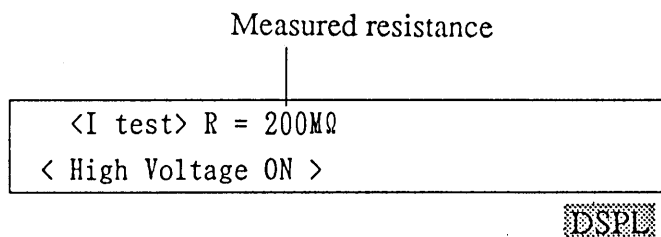

When the measured resistance is 1M $\Omega$  or greater, it is displayed. However, it is greater than the highest value measurable with the W/I Tester, it is indicated as "OVER."

The unit is "M $\Omega$ " for resistances up to 1000M $\Omega$  or "G $\Omega$ " for resistances greater than 1000M $\Omega$ .

Examples:	Measured resistance	→	Indication display
	2300M $\Omega$	→	2.30G $\Omega$
	58M $\Omega$	→	58.0M $\Omega$

If the test has finished with the display left in the measured resistance monitor mode, the display holds the value at the end of the test.

Note: The value displayed after PASS/FAIL decision may not be the value at the time when decision has been made, due to the response time of the digital display.



## 4.6.2 Procedure for Single AC Low Ohm Test

For single AC low ohm test, proceed as follows:

- (1) Connect the TOS6100 R Tester and the D.U.T.

For the AC low ohm test, connect the TOS6100 R Tester to the W/I Tester.

Note: It is possible to perform AC low ohm tests by using the TOS6100 R Tester alone without using the W/I Tester. For the explanation of the test control with the W/I tester, a procedure is explained by assuming that tests are done by using both W/I Tester and R Tester.

- ① Connect the R TESTER connector on the rear panel of the W/I Tester to the REMOTE connector on the front panel of the R Tester by using the 5P DIN cable.

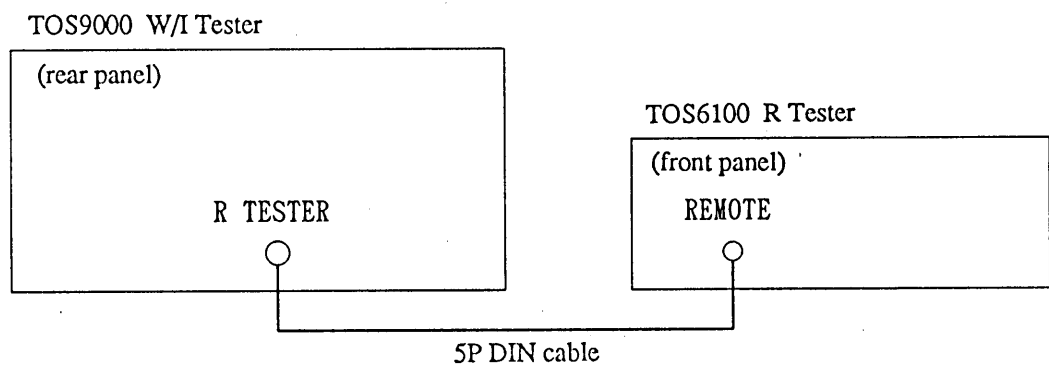
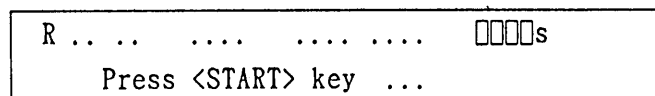

Figure 4.4

- ② According to the instruction manual of the R Tester, set the test conditions such as test current, PASS/FAIL decision limit, and other test parameters and connect the D.U.T. to the R Tester.
- (2) Press the **ENTER** key to drive the W/I Tester to the READY state.

Display when in the READY state



- (3) Press the START switch ③ to start the test.

As the test starts normally, the TEST lamp of the R Tester lights up and a message "<AC Low Ohm Tester ON>" appears on the display screen of the W/I Tester. The H.V ON lamp ⑭ of the W/I Tester, however, does not light unlike a withstanding voltage test or an insulation resistance test.



(9) Protective functions when in R Test mode:

If one or more of the below-mentioned states occur at the AC low ohm test mode, the W/I Tester aborts the test and assumes the PROTECTION state.

- ① While the TEST MODE switch of the R Tester is set to NORMAL, the test current has deviated by approximately  $\pm 10\%$  or more from the reference value. (The TOS6100 R Tester is driven into the WARNING state.)
- ② The 5P DIN cable between the W/I Tester and the R Tester is disconnected.
- ③ The R Tester power is turned off.
- ④ The STOP switch of the R Tester has been pressed.



## 4.7 Store/Recall of Test Parameters

The test parameters which you have specified for a single test can be stored into or recalled from the memory easily. You can store up to ten test settings for each single test.

<Operating Procedure>

### (1) To store a test parameter

- ① After you have completed to enter the test conditions and parameters, press the **STORE** key ⑨.
- ② A prompt “→□□” will appear on the right end of the display screen. Type a memory number (1 - 10) which you want to store the parameters on to.
- ③ Press the **ENTER** key.

### (2) To recall a test program

- ① At the test condition entry mode, press the **RCL** key ⑨.
- ② A prompt “←□□” will appear on the right end of the display screen. Type a memory number (1 - 10) which you want to recall the parameters from.
- ③ Press the **ENTER** key.

**Note:** To recall a test program of different type of test, the W/I Tester must be changed once to the corresponding type.

Example: To store a withstanding voltage test condition onto the memory number 3:

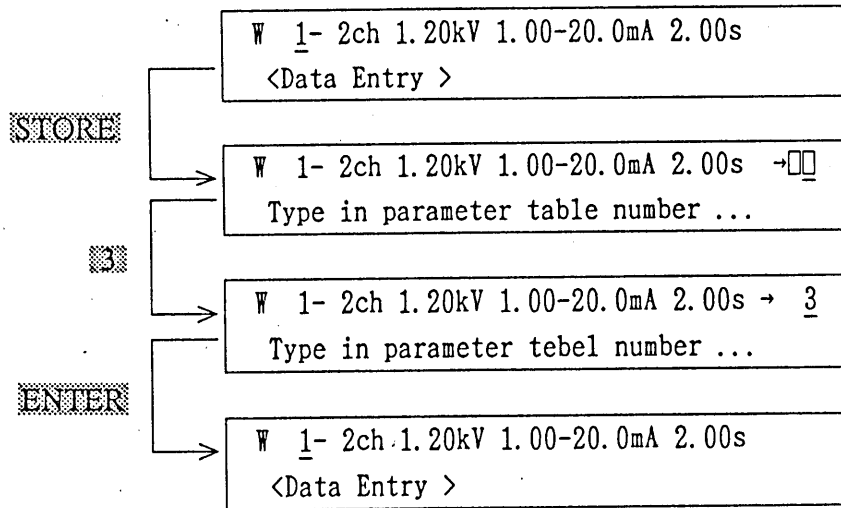

Example: To recall a withstanding voltage test condition from the memory number 2:

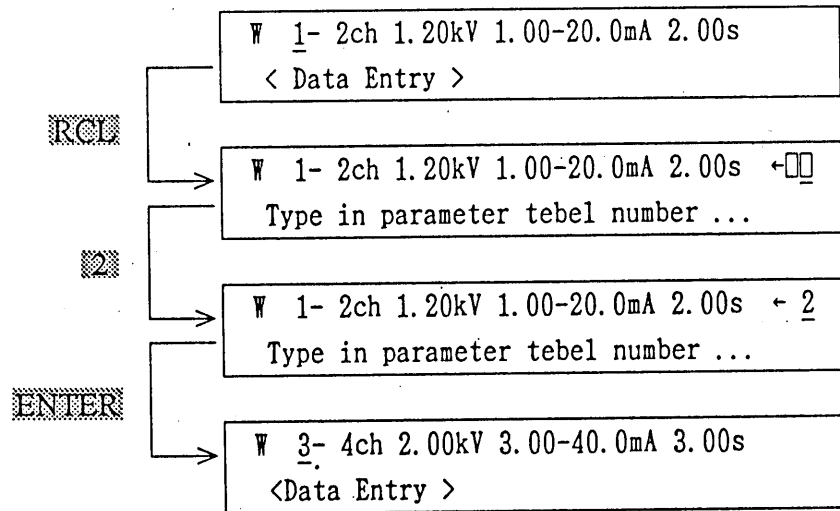







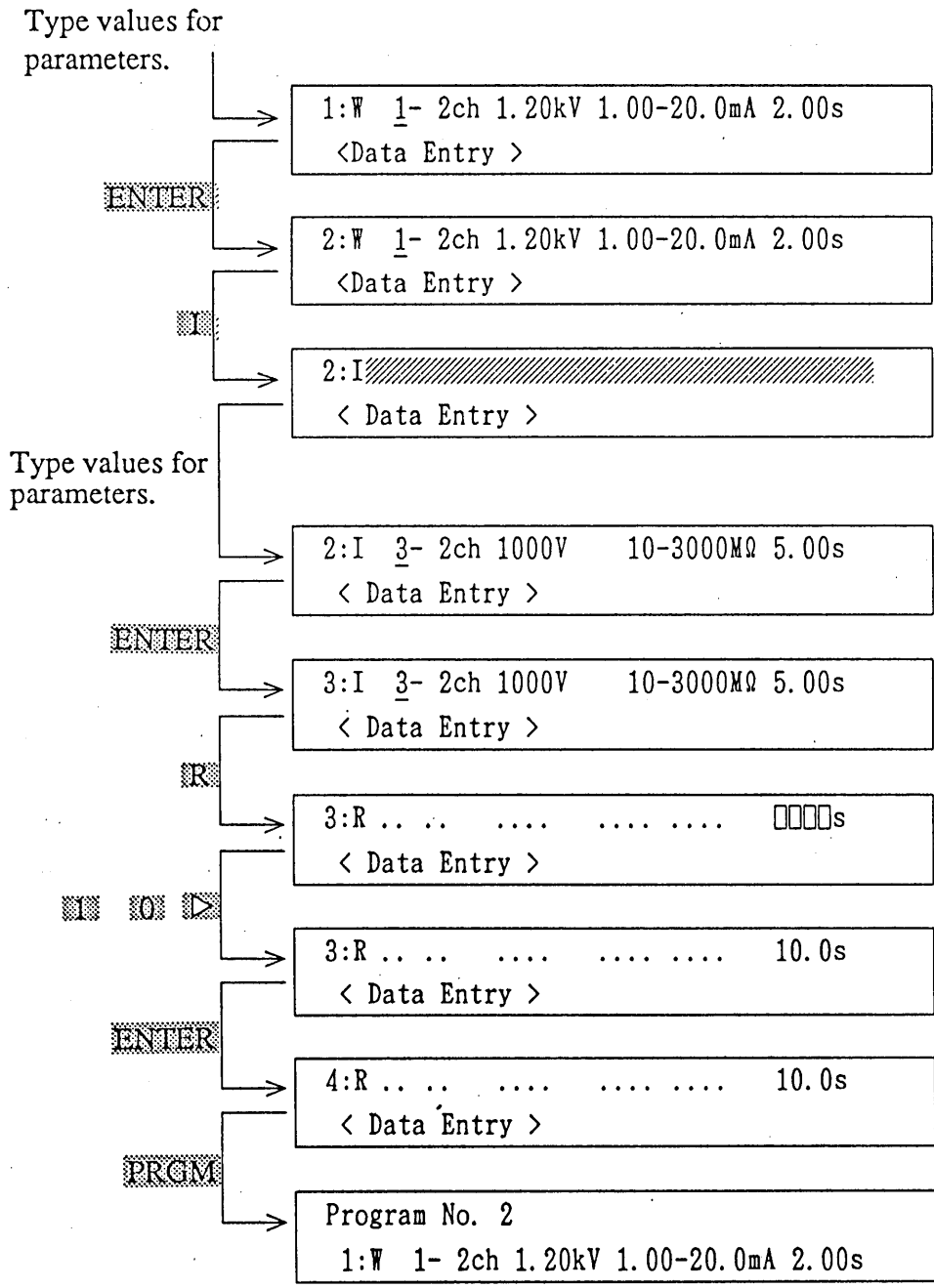







The one test program is complete by the above procedure.

### 4.8.3 Modifying a Program

To modify a program, select the program with the procedure described in Chapter 4.8.1 "Selecting a Program Number" and then proceed as follows:

<To change a parameter value of a test step>

- (1) Press the PRGM key to select the PRGM mode.

- (2) Select the required test step with the CURSOR ( / ) keys ⑦.
- (3) Select the required test parameter with the CURSOR ( / ) keys ⑦.
- (4) Type a new value for the parameter to be modified with the DATA ENTRY keys. After that, press the CURSOR (  or  ) key.
- (5) Press the **ENTER** key to enter and set the modified program.
- (6) Press the **PRGM** key to exit from the PRGM mode.

Example: To change the test voltage 1.00kV of W test of Step 3 to 1.20kV

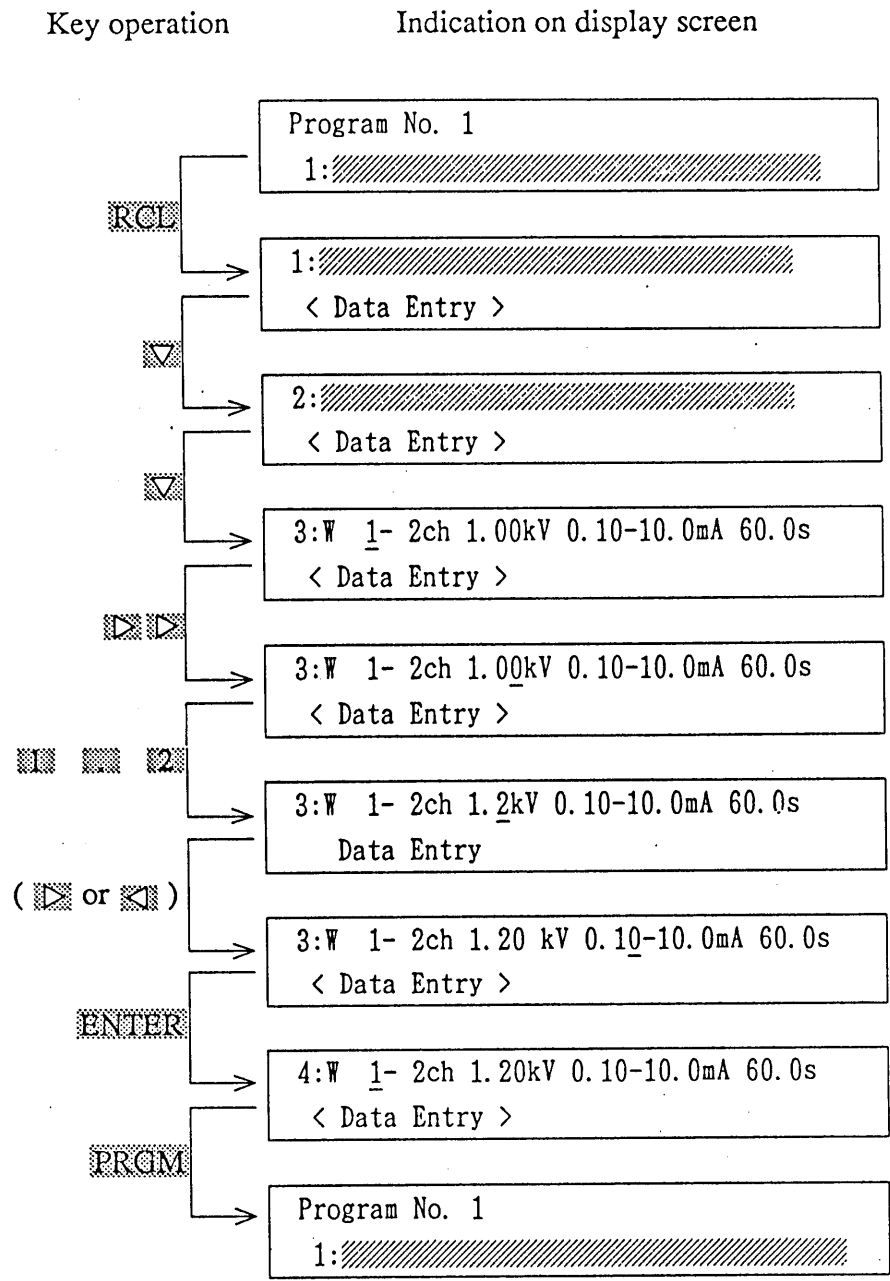

<To insert a new test step>



- (1) Press the **PRGM** key to select the PRGM mode.
- (2) Select the test step in which you want to insert with the SCROLL ( **▲/▼** ) keys 7.
- (3) Select the test parameter with the CURSOR ( **◀/▶** ) keys.
- (4) Type the parameter values. Press the **INSR** key ⑨ .
- (5) Press the **PRGM** key to exit from the PRGM mode.

Note: The new test step is inserted immediately before the currently displayed step. Therefore, all the step numbers of the currently displayed step and subsequent steps are incremented by 1.

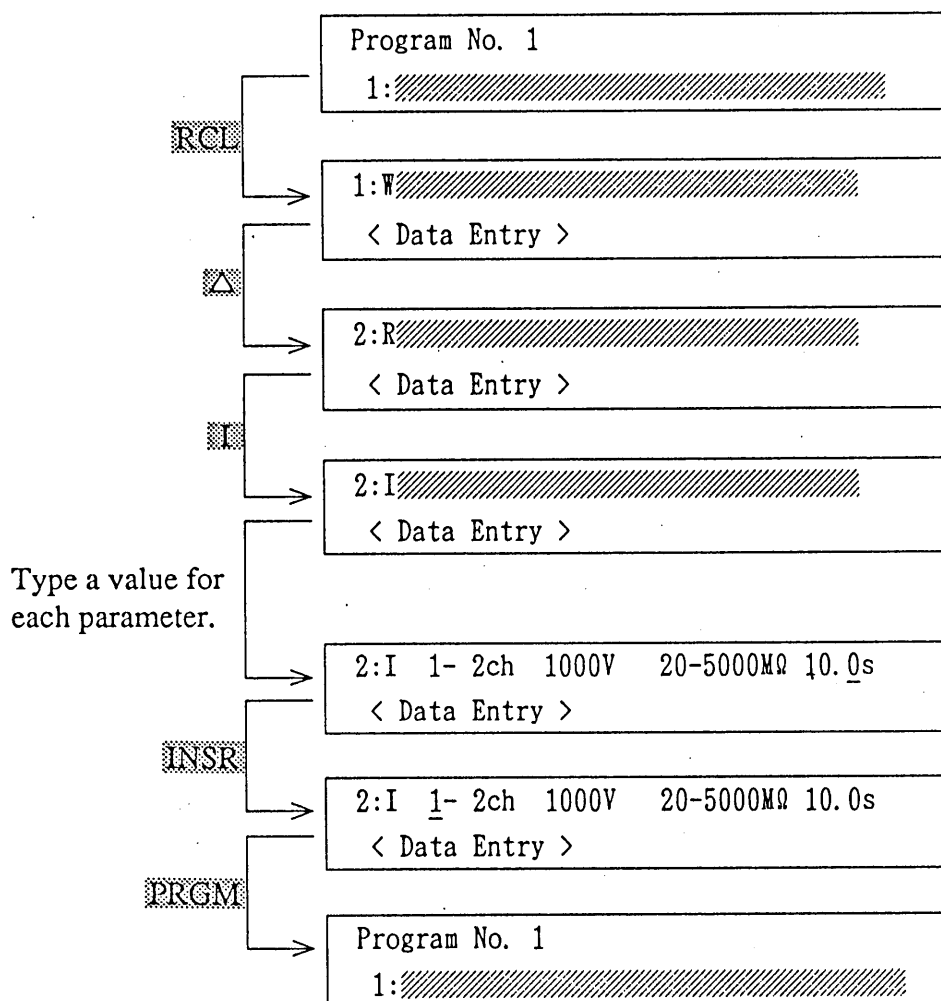
Example: To insert an I test between Step 1 (W test) and Step 2 (R test)







After the above procedure, the test step numbers will be as shown below. Check them with the SCROLL (  /  ) key ⑦.

1 : W   
 2 : I   
 3 : R 

<To delete a test step>

- (1) Press the **PRGM** key to select the PRGM mode.
- (2) Select the test step to be deleted, with the SCROLL (  /  ) keys ⑦.
- (3) Press the **DELE** key ⑨ .
- (4) Press the **PRGM** key to exit from the PRGM mode.

Note: All the step numbers of the steps subsequent to the deleted step are decremented by 1.

Example: To delete the W test of Step 4

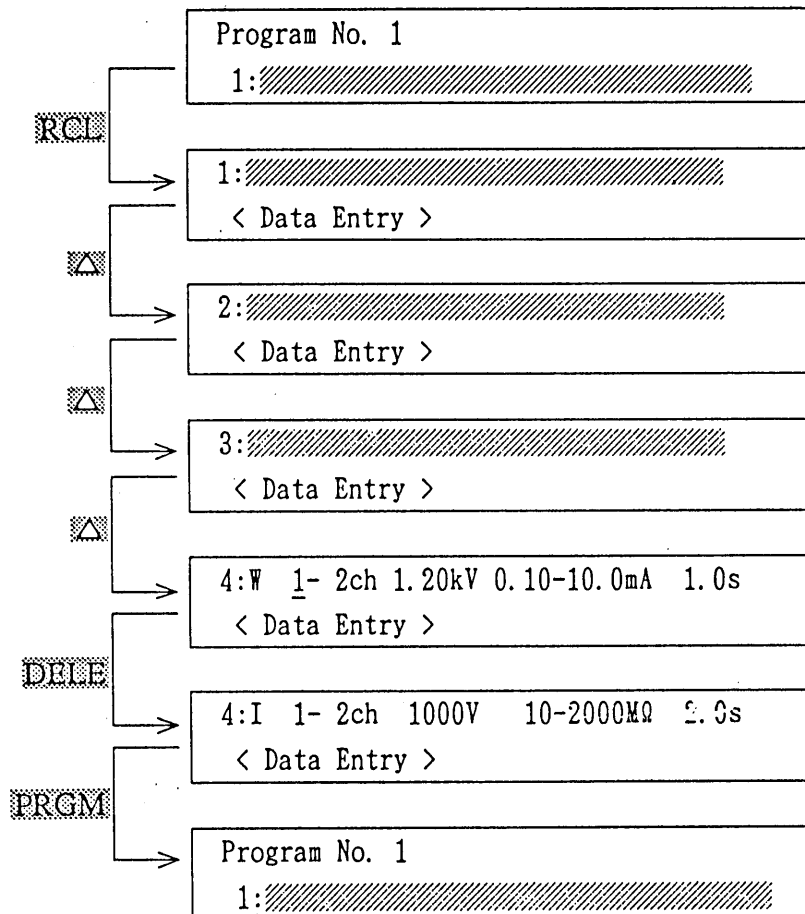

#### 4.8.4 Procedure for AUTO Test

For the AUTO test, proceed as follows:

- (1) Be sure that the test devices and the D.U.T. are correctly connected. Especially for the automatic test system, make it double sure that the connections are correct. For the connection method, refer to the corresponding paragraphs of Single test and to the instruction manuals of individual test devices.
- (2) Select a test program according to Chapter 4.8.1 "Selecting a Program Number" (Page 4-38).
- (3) Press the **ENTER** key to drive the W/I Tester to the READY state.

Display at the READY state

Selected program number

Program No. 1

Press <START> key ...

Then, the W/I Tester will deliver a READY signal.

- (4) After checking that the connections are normal, press the START switch ③ to start the test.
- (5) After the test starts, the following message appears on the display screen.

1: 

<<< Step Test Execute >>>

Data of the current test step appears on the display screen. The H.V ON lamp ⑭ lights up to indicate that the AUTO test is in progress. The lamp holds until the test finishes.

- (6) After the first step is over, the W/I Tester generates a STEP END signal (open collector signal) and the following message appears on the display screen.

1: 

<<< Step PASS end >>>

The period of the above signal delivery and message display is as set by the INITIAL SETTING parameter "Step interval time." When this period has elapsed, the W/I Tester automatically advances to the next test step.

- (7) When all the test steps are over, the W/I Tester generates a PASS signal. The signal has three types, such as, in open collector, lamp, and buzzer.

When a PASS decision is done, a CYCLE END signal as well as a PASS signal is delivered as an open collector signal.

All of the three signals are delivered during the period set by the INITIAL SETTING parameter "Pass hold time."

Message when all the test steps are over

// : //  
<<< Program PASS end >>>

- (8) To abort the test which is in progress in the AUTO mode, press the STOP switch ②. The test will be immediately aborted and the W/I Tester will assume the READY mode. No PASS decision is done in this case.
- (9) If a FAIL decision is done for one of the test steps while in the AUTO test, the W/I Tester cuts off its test output voltage and generates a FAIL alarm signal. Hereafter, any steps are no longer executed.

The conditions for FAIL decisions and the types of FAIL alarms are identical with those of the Single test.

Once the FAIL alarms generated, they are automatically reset. To reset them, press the STOP switch.

Note: The FAIL alarms are also reset when a protective circuit has tripped and the W/I Tester has been driven into the PROTECTION mode.

- (10) To advance to the subsequent test:

When a test step has finished with a PASS decision, the W/I Tester generates a PASS signal during the period set by the INITIAL SETTING parameter "Pass hold time," and then returns to the READY state. Now the subsequent test can be started simply by pressing the START switch.

When a test step has finished with a FAIL decision, press the STOP switch to reset the W/I Tester once to the READY state, and then press the START switch.

- (11) To change to the test condition setting mode:

To change to the test condition setting mode, press the CANCEL key ⑪ when the W/I Tester is in the READY state.

## 4.9 Initial Setting

The W/I Tester allows settings of eleven test parameters to cope with various test conditions for various purposes.

Table of INITIAL SETTING parameters

Test Parameter	Setting Range	When shipped
① Frequency of high voltage	50/60Hz	50Hz
② Maximum high voltage	0.5-5kV, max.	max.
③ I test wait time	0.3-10 sec	0.3 sec
④ Contact check	ON/OFF	OFF
⑤ Pass hold time	0.2-10 sec, Hold	0.2 sec
⑥ Step increment mode	MANU/CONT	CONT
⑦ Step interval time	0.2-10 sec	0.2 sec
⑧ Remote 1 stop sequence	EXT/NOR	NOR
⑨ Volume of buzzer	1-10	10
⑩ GP-IB address	0-30	2
⑪ AUX signal select	END/WUF/WLF/IUF/ILF/CNTF/ PASS/PROT/STEP	END

## 4.9.1 INITIAL SETTING Parameters

- ① Frequency of high voltage: 50Hz/60Hz

You can specify either 50Hz or 60Hz for the test voltage of the W/I Tester. It is irrespective of the frequency of the AC line.

- ② Maximum high voltage: 0.5kV/1.00kV/1.50kV/2.00kV/2.50kV/3.00kV/ 3.50kV/ 4.00kV/4.50kV/5.00kV/Max.

This parameter limits the highest voltage which is delivered by the W/I Tester for W test or I test. Once the limit voltage is set, even if you attempt inadvertently to set a test voltage higher than the limit voltage, the W/I Tester automatically limits its output voltage at the limit.

You can specify the limit voltage within a range of 0.5kV to 5.00kV in 0.5kV steps. When this parameter is set at the Max., you can set any test voltage of the W/I Tester.

- ③ I test wait time: 0.3sec/0.5sec/1.0sec/2.0sec/5.0sec/10.0sec

For a short period at the test operation, a charge current for the capacitances of the test cables and the D.U.T. will flow. During this period, the insulation resistance might be measured lower than the actual resistance due to the charge current. In order to avoid this erroneous evaluation, a certain wait time should be allowed before making a PASS/ FAIL decision. This parameter sets an appropriate wait time depending on the capacitance of the object to be tested.

- ④ Contact check: ON/OFF

This parameter is available only when the TOS9020 H.V Scanning Unit is provided.

This parameter selects whether the contact check function is to be active or not. The contact check function allows you to check the state of contacting by using a contacting device, such as a probe or a jig to apply a test voltage. This function also allows to check the test cables for open-circuiting and the electrical connection failures.

The check is done just before the W or I test starts, at either Single or AUTO test.

If a contact failures is detected by this check, the W/I Tester displays a message "<CONTACT FAIL>" on the screen and generates a FAIL alarm. The types of the FAIL alarms are similar to the regular modes of test. The open collector signal, however, is for the CONTACT FAIL signal.

If above FAIL decision is done at the Single test, the actual test does not start. If it is done at the AUTO test, the test aborts at this time and the subsequent steps do not start any longer.

Message on screen when "Contact check FAIL"

<<< CONTACT FAIL >>>

- ⑤ Pass hold time: 0.2sec/0.5sec/1.0sec/2.0sec/5.0sec/10.0sec/Hold

This parameter specifies the period which the PASS signal is to be delivered at a PASS decision. If "Hold" is specified, the PASS signal is delivered continuously.

- ⑥ Step increment mode: MANU/CONT

This parameter selects either the MANU mode or CONT mode for progression of test steps at the AUTO test operation. If the MANU mode is selected, the next test step does not start unless the START switch is manually pressed; If the CONT mode is selected, the next test step starts automatically.

- ⑦ Step interval time: 0.2sec/0.5sec/1.0sec/2.0sec/5.0sec/10.0sec

This parameter specifies the interval time from the end of a test step to the start of the next test step at the AUTO test operation. This parameter is valid only when the CONT mode is selected for the "Step increment mode" parameter.

⑧ Remote 1 stop sequence: EXT/NOR

This parameter is effective for the remote control (Remote 1) of the W/I Tester. It allows to select either the EXT mode or NOR mode for stop sequence. If the NOR mode is selected, the remote STOP signal is identical in effect with pressing of the STOP switch on the front panel. If the EXT mode is selected, the remote STOP signal does not reset the FAIL alarm and PROTECTION state. However it resets the PASS signal.

To reset from the FAIL alarm and PROTECTION state, the STOP switch on the front panel must be pressed at EXT mode.

⑨ Volume of buzzer: 1-10

This parameter specifies the loudness of the buzzer sound for PASS or FAIL decisions. The sound for FAIL decisions is louder than that for PASS decisions. Parameter value 1 is for minimum loudness and 10 for maximum.

⑩ GPIB address: 0-30

This parameter specifies an GPIB address number for the W/I Tester.

⑪ AUX signal select: END/WUF/WLF/IUF/ILF/CNTF/PASS/PROT/STEP

This parameter selects one of the output signals mentioned below, in order that the 100V AC alarm signal be delivered through the AUX receptacle ③⑦ depending on the selected signal.

- END : In synchronization with CYCLE END signal.
- WUF : In synchronization with WU/FAIL signal.
- WLF : In synchronization with WL/FAIL signal.
- IUF : In synchronization with IU/FAIL signal.
- ILF : In synchronization with IL/FAIL signal.
- CNTF : In synchronization with CONTACT FAIL signal.
- PASS : In synchronization with PASS signal.
- PROT : In synchronization with PROTECTION signal.
- STEP : In synchronization with STEP END signal.

For details of the signals, see Chapter 4.10 "Signal Output Function" (Page 4-56).

## 4.9.2 Initial Setting Procedure

<To change to the INITIAL SETTING mode>

- (1) Turn the power off once.
- (2) Keep pressing both LOCAL key (24) and WTEST VOLTAGE key (5) simultaneously, turn the power on. Hold pressing both keys for about 1 second.
- (3) The W/I Tester is driven into the INITIAL SETTING mode and, the following message appears on the display screen.

Message displayed on screen when W/I Tester is changed to INITIAL SETTING mode

Frequency of High Voltage ... 50Hz
------------------------------------

<Setting Procedure>

- (1) Select an INITIAL SETTING item with the SCROLL (▲/▼) keys (7).
- (2) Select a condition with the CURSOR (←/→) keys (7). You cannot enter a numerical value with the DATA ENTRY keys.
- (3) Repeat the procedures of (1) and (2) for other items also.
- (4) Press the STORE key (9). The W/I Tester exits from the INITIAL SETTING mode and returns to the regular test mode.

Note: Do not turn off the main power of the W/I Tester when in the INITIAL SETTING mode. Otherwise, you will lose any alternation.



Example: To set the INITIAL SETTING parameter "Volume of buzzer" at 6:

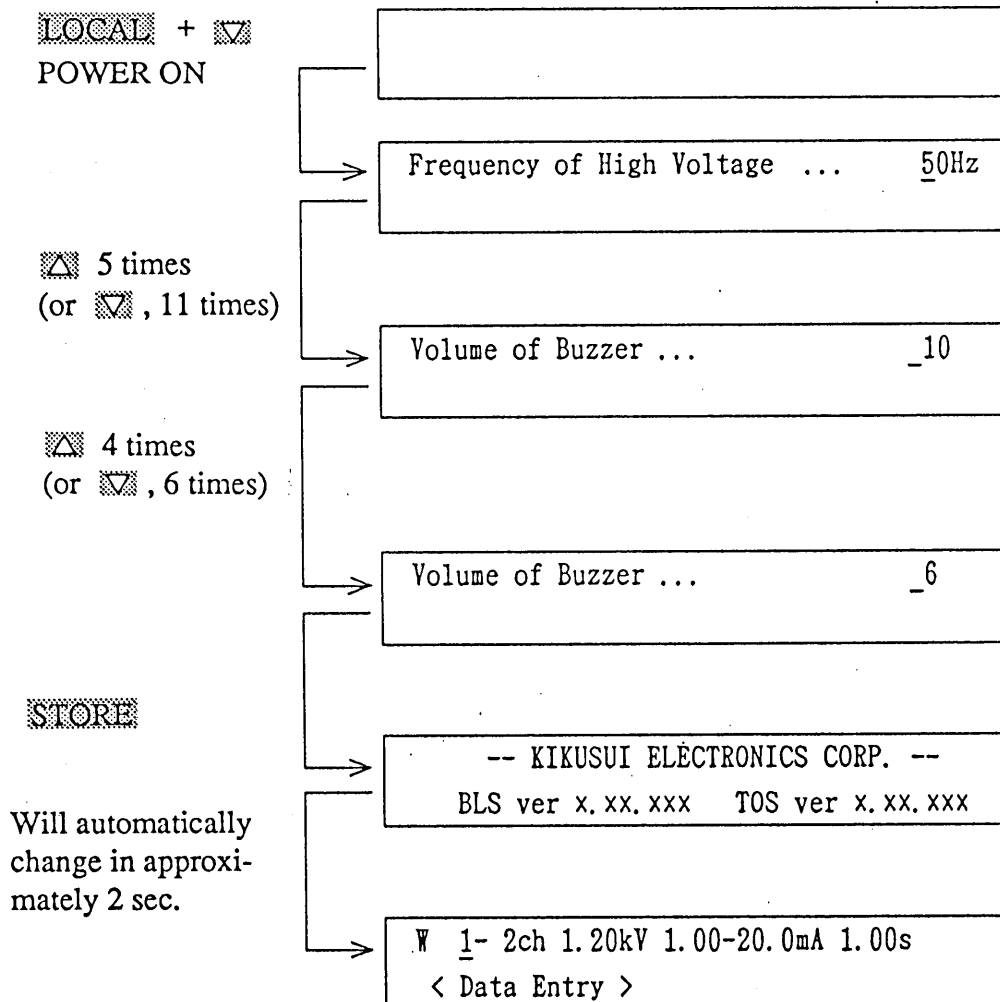

The W/I Tester will return to the mode which existed when the Tester power was turned off last time.

## 4.10 Signal Output Function

The W/I Tester provides fourteen output signals as shown below. They provide status information on the W/I Tester or make the W/I Test system enhanced.

Signal Output Functions		
Signal Name	Condition for Generation	Type
H.V ON	During the test time	Open collector, lamp, 100V AC
PASS	For PASS decision. Delivered for approximately 0.2 sec (can be specified by initial setting).	Open collector, LED, buzzer
FAIL	For FAIL decision. Continuously delivered	Open collector, LED, buzzer, 100V AC
WU/FAIL(WUF)	For FAIL decision as the detected value is greater than the upper limit value when in withstanding voltage test. Continuously delivered.	Open collector
WL/FAIL(WLF)	For FAIL decision as the detected value is less than the lower limit value when in withstanding voltage test. Continuously delivered.	Open collector
IU/FAIL(IUF)	For FAIL decision as the detected value is greater than the upper limit value when in insulation resistance test. Continuously delivered.	Open collector
IL/FAIL(ILF)	For FAIL decision as the detected value is less than the lower limit value when in insulation resistance test. Continuously delivered.	Open collector
R/FAIL	For FAIL decision when in R test (AC low ohm test). Continuously delivered.	Open collector
CONTACT FAIL(CNTF)	For FAIL decision due to abnormally large contact resistance. Continuously delivered.	Open collector
READY	When in the READY status	Open collector
STEP END(STEP)	For the end of one step of test in the AUTO mode. Continuously delivered until the next step starts.	Open collector
CYCLE END(END)	For the end of one program of test in the ATUO mode. Delivered for approx. 0.2 sec (can be specified by initial setting)	Open collector
PROTECTION(PROT)	For the trip of a protective circuit, continuously delivered	Open collector
Reserved one	One of the following signals can be selected by initial setting: END, WUF, WLF, IUF, ILF, CNTF, PASS, PROT, STEP	100V AC

- Note 1: The allowable supply voltage range for the open-collector circuit is 5 to 30V DC and the rated current is 400mA in total. (When the built-in isolated power supply of this instrument is used, the available current is 100mA in total.)
- Note 2: The rating of the 100V AC signal is 0.3A (maximum) in total.
- Note 3: The CONTACT FAIL signal is available only when Model TOS9020 H.V Scanning Unit is provided.
- Note 4: The signal names enclosed in the parentheses are abbreviations.
- Note 5: The internal control circuits are incorporated with various measures to prevent operation errors that could be caused by noise. However, do not connect non-shielded wires to the SIGNAL I/O terminals. The non-shielded wires will act as antennas and will pick up noise, thereby causing operation errors. For the 36P Amphenol connectors, cables and external circuits, use shielded components -- such as metallic 36P Amphenol connectors, shielded cables, and circuits fabricated in a shielded chassis. Connect the shielding wires of these components to the chassis of the main unit (do not connect the shielding wires to the ISOL GND terminal) and isolate overall SIGNAL I/O circuit from the external environments.

#### 4.10.1 Conditions and Timings of Output Signals

##### ① H.V ON signal

The H.V ON signal is delivered during the period the W/I Tester delivers its high output voltage. At the AUTO test, the signal is delivered until the end of the final test step or the test is aborted.

##### ② PASS signal

The PASS signal is delivered when the result of the test is judged to be PASS. At the AUTO mode, it is delivered when all test steps are judged to be PASS. The signal duration is as specified with the INITIAL SETTING parameter "Pass hold time."

Note: The signal is not delivered when the result of one test step is a PASS and operation is advancing to the next test step in the Auto test, although a message as shown below appears on the display screen.

<<<Step PASS end>>>

##### ③ FAIL signal

The FAIL signal is generated when a FAIL decision is made when in any test or contact check. Once generated, the signal is continuously delivered until the STOP switch is pressed or a STOP signal is applied. It is continuously delivered also until a protective circuit trips at the PROTECTION state.

72 11.25

912732B

④ WU FAIL (WUF) signal

The WU FAIL signal is generated when a measured leak current exceeds the upper limit in a W test (withstanding voltage test) and a FAIL decision is made. Once generated, the signal is continuously delivered until the STOP switch is pressed or a STOP signal is applied. During this period the following message appears on the display screen.

<<<FAIL end...Over current>>>

⑤ WL FAIL (WLF) signal

The WL FAIL signal is generated when a leak current is smaller than the lower limit in a W test (withstanding voltage test) and a FAIL decision is made. Once generated, the signal is continuously delivered until the STOP switch is pressed or a STOP signal is applied. During this period the following message appears on the display screen.

<<<FAIL end...Under current>>>

⑥ IU FAIL (IUF) signal

The IU FAIL signal is generated when a measured resistance is larger than the upper limit in an I test (insulation resistance test) and a FAIL decision is made. Once generated, the signal is continuously delivered until the STOP switch is pressed or a STOP signal is applied. During this period the following message appears on the display screen.

<<<FAIL end...Over resistance>>>

⑦ IL FAIL (ILF) signal

The IL FAIL signal is generated when a measured resistance is smaller than the lower limit in an I test (insulation resistance test) and a FAIL decision is made. Once generated, the signal is continuously delivered until the STOP switch is pressed or a STOP signal is applied. During this period the following message appears on the display screen.

<<<FAIL end...Under resistance>>>

⑧ R FAIL signal

The R FAIL signal is generated when a FAIL decision is made in an R test (low resistance test). Once generated, the signal is continuously delivered until the STOP switch is pressed or a STOP signal is applied. During this period the following message appears on the display screen.

<<<FAIL end...Over resistance>>>

92.11.25

912733A

⑨ CONTACT FAIL (CNTF) signal

The CONTACT FAIL signal is generated when a contact failure is detected by the connection check function of the W/I Tester operating with the TOS9020 H.V Scanning Unit. Once generated, the signal is continuously delivered until the STOP switch is pressed or a STOP signal is applied.

⑩ READY signal

The READY signal is continuously delivered during the period the W/I Tester is in the READY state. The READY state is that the T/I Tester is ready to start the test operation at the instant you press the START switch or apply a START signal. When the HP01A-TOS or HP02A-TOS H.V Test Probe is used, however, the READY signal is not delivered due to the structure of the probe.

⑪ STEP END (STEP) signal

The STEP END signal is continuously delivered during the period from the end of one test step to the start of the next test step in the AUTO test.

⑫ CYCLE END (END) signal

The CYCLE END signal is generated to indicate that all the tests have finished at PASS in the AUTO test. It is generated during the period specified by the INITIAL SETTING parameter "Pass hold time."

⑬ PROTECTION (PROT) signal

The PROTECTION signal is generated when a protective circuit of the W/I Tester has tripped and it has been driven into the PROTECTION state. The signal is continuously delivered until it is reset.

⑭ Reserved signal (AUX signal)

You can select one of the signals mentioned below for the reserved signal by the INITIAL SETTING procedure. Being synchronized with the selected signal, a nominal 100V AC signal is delivered through the AUX receptacle ③⑦ on the rear panel of the W/I Tester.

Selectable signals: END, WUF, WLF, IUF, ILF, CNTF, PASS, PROT, STEP

## 4.10.2 Detail of Signals

### (1) Open Collector Signals

The open collector signals are delivered through the SIGNAL I/O connector (28) on the rear panel. The connector pin assignment is shown in Figure 4.5 and a schematic open-collector signal circuit diagram in Figure 4.6.

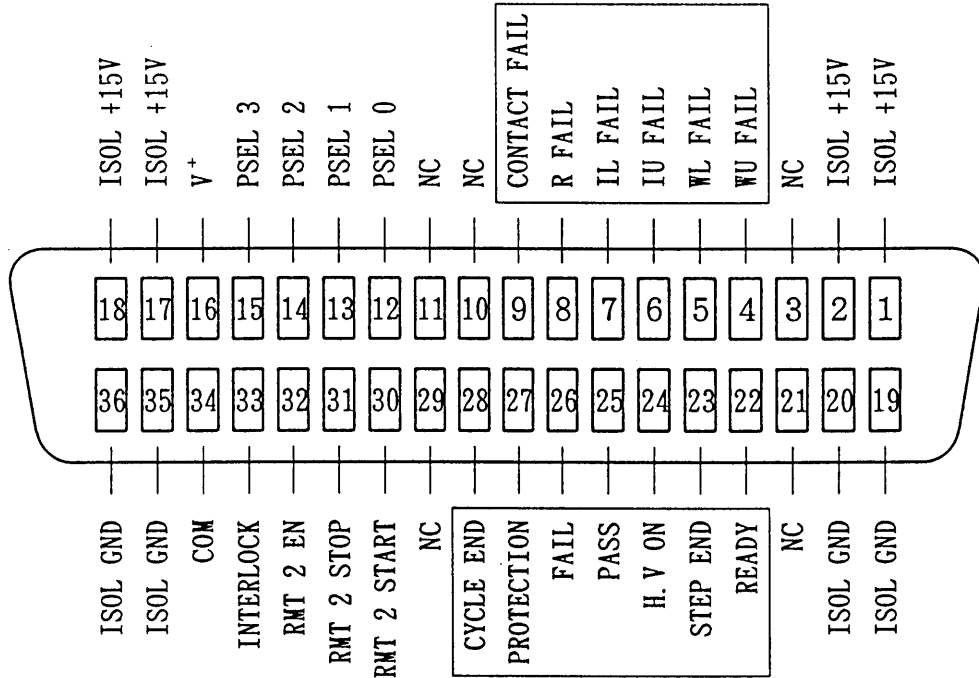
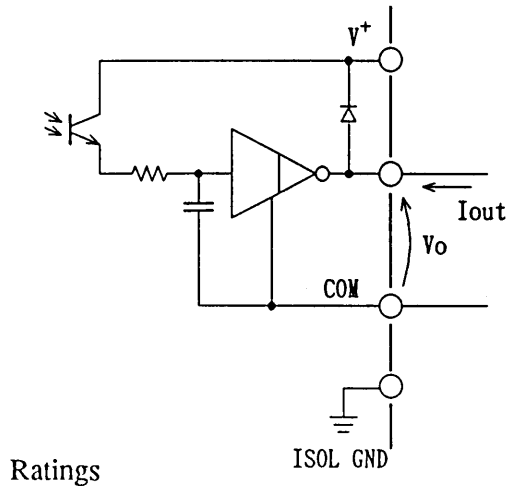

Figure 4.5 Open-collector Signal Pin Assignment



Ratings

- Output current ( $I_{out}$ ): 400mA (total)
- Allowable maximum output voltage ( $V_o$ ): 30V DC
- Allowable voltage range of external power supply ( $V^+$ ): 5~30V DC

Figure 4.6 Open-collector Signal Circuit Diagram

18.01.16.

912735A

(2) Lamp Signals

The lamp signals drive the respective lamps on the front panel.

(3) Buzzer Signal

The buzzer signal drives the internal buzzer of the W/I Tester. The loudness can be set with the INITIAL SETTING parameter “Volume of buzzer.”

(4) 100V AC Signal

The 100V AC signal is delivered through the STATUS SIGNAL OUTPUT outlet (37) on the rear panel. The signal voltage is always 100V irrespective of setting of the VOLTAGE SELECTOR plug (34). The rated signal current is 0.3A. The signal is exclusively for driving MODEL PL01-TOS Warning Light Unit or BZ01-TOS Buzzer Unit. Do not use the signal for other purposes—do not attempt to use the signal as an AC power source for an electronic device or others.

## 4.11 Interlock Function

The W/I Tester has an interlock function as a safety feature. When the interlock circuit is made open, the W/I Tester falls into the PROTECTION state which makes any operation disabled and, generates a PROTECTION signal. If this event occurs when a test is in progress, the test voltage is cut off and the test is aborted.

To make use of the interlock function, proceed as follows:

Pin No.33 on the SIGNAL I/O connector (28) on the rear panel is the input terminal for the interlock signal. The interlock function is effective if the pin circuit is made open; it is released if the pin circuit is made a low level. The pin circuit can be made the low level by connecting to an ISOL GND pin (Pin No.19, 20, 35, or 36).

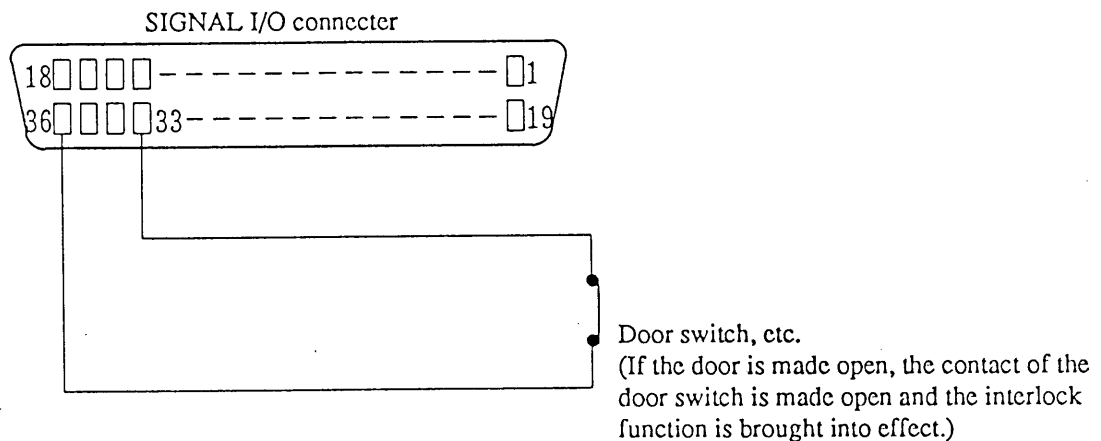

Figure 4.7

**Note:** When W/I Tester power is turned on directly without doing any procedure regarding the interlock function, the W/I Tester will not operation. To enable tentatively the W/I Tester operation, an Amphenol plug (36-pin) is supplied as an accessory. The interlock function can be tentatively released by capping the SIGNAL I/O connector (28) with the plug. Do not use it when you use the W/I Tester for routine test. For the routine use, you should provide a proper external interlock circuit.



## 4.12 Remote Control Function

The W/I Tester allows the remote control of START/STOP operation and AUTO test program selection. In addition to the remote control via GPIB .

### Warning!

*Be extremely careful when using the Remote Control Function, because the high voltage is ON/OFF-controlled with an external signal. If the high voltage is delivered by an inadvertent handling of the remote control circuit, electric shock hazards may result. When operating the W/I Tester in the remote control mode, provide full safety measures to ensure that nobody is contacted with D.U.T., test leadwires, probe, output terminals, or other parts which should be charged up to the high voltage. Never operate the W/I Tester in the remote control mode unless full safety measures are available.*

### 4.12.1 “Remote 1” Function

The Remote 1 function is dedicated to remote control of the W/I Tester with the MODEL RC01-TOS/ RC02-TOS Remote Control Box or the HP01A-TOS/ HP02A-TOS H.V Test Probe.

To use the Remote 1 function, connect the control box or the test probe to the REMOTE connector ④ with the 5-pin DIN cable. When the box or the probe is properly connected and the W/I Tester has become the remote control function, the REMOTE LED ② on the front panel of the W/I Tester lights up. When in the remote control mode, the START switch ③ on the front panel is disabled. The STOP function, however, remains enabled and you can stop the W/I Tester either remotely or locally.

Note: If both Remote 1 function and Remote 2 function are made use of simultaneously, the Remote 2 function has a priority.  
When the HP01A-TOS / HP02ATOS H.V Test Probe is connected, however, the start control operation with the Remote 2 function is unavailable due to the structure of the prob.

## 4.12.2 “Remote 2” Function

The Remote 2 function is dedicated to remote control of the W/I Tester from the test jigs or conveyors. In the Single test, you can control the START/STOP operation remotely, and, in the AUTO test, you can control the START/STOP operation and the program selection remotely.

**Note:** The internal control circuits are incorporated with various measures to prevent operation errors that could be caused by noise. However, do not connect non-shielded wires to the SIGNAL I/O terminals. The non-shielded wires will act as antennas and will pick up noise, thereby causing operation errors. For the 3P Amphenol connectors, cables and external circuits, use shielded components--such as metallic 36P Amphenol connectors, shielded cables, and circuits fabricated in a shielded chassis. Connect the shielding wires of these components to the chassis of the main unit (do not connect the shielding wires to the ISOL GND terminal) and isolate overall SIGNAL I/O circuit from the external environments.

### (1) Remote Control of Single Test

Similarly to the Remote 1 function, you can control the START/STOP operation remotely.

To use this function, prepare a setup as shown in Figure 4.8. For this setup, the 36-pin Amphenol connector which is supplied as an accessory may be used—pay your attention to the interlock signal.

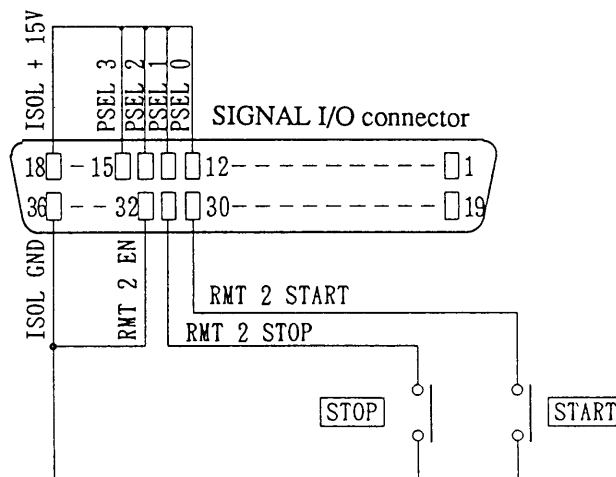

**Note:** Be sure to keep the RMT2 EN signal at the low level.

Figure 4.8

- ① Set all of the PSEL 0 through PSEL 3 to high level (ISOL +15V) or open.
- ② With the START/STOP contacts shown in Figure 4.8, you can control the W/I Tester similarly to the START/STOP switches on the W/I Tester front panel in the local operation.
- ③ Then, the START switch on the front panel is disabled. The stop operation, however, remains effective and you can stop the W/I Tester either locally or remotely.
- ④ The mechanical switches shown in Figure 4.8 can be replaced with logical circuit elements (transistors, FETs, photocouplers, or other switching devices). An example is shown in Figure 4.9. The requirements of the input circuits of the W/I Tester are as follows.

- High level input voltage: 11 - 15V
- Low level input voltage: 0 - 4V
- Low level sweep out current: 1mA or below
- Input time duration: 20 msec or more

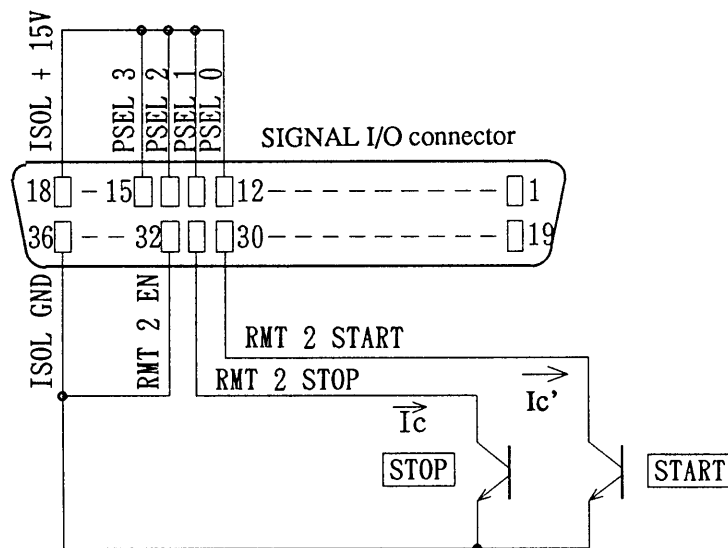

Figure 4.9

Note 1: Making the input terminals open is identical in effect with applying a high level signal.

Note 2: Each of the START and STOP circuits must be able to draw a current of 0.5 mA or more ( $I_c \geq 0.5\text{mA}$ ,  $I_c' \geq 0.5\text{mA}$ ).

72, 11, 25

9 1 2 7 4 0 A

(2) Remote Control of AUTO Test

In the AUTO test, you can control not only the START/STOP but also the program selection.

To use this function, prepare a setup as shown in Figure 4.10.

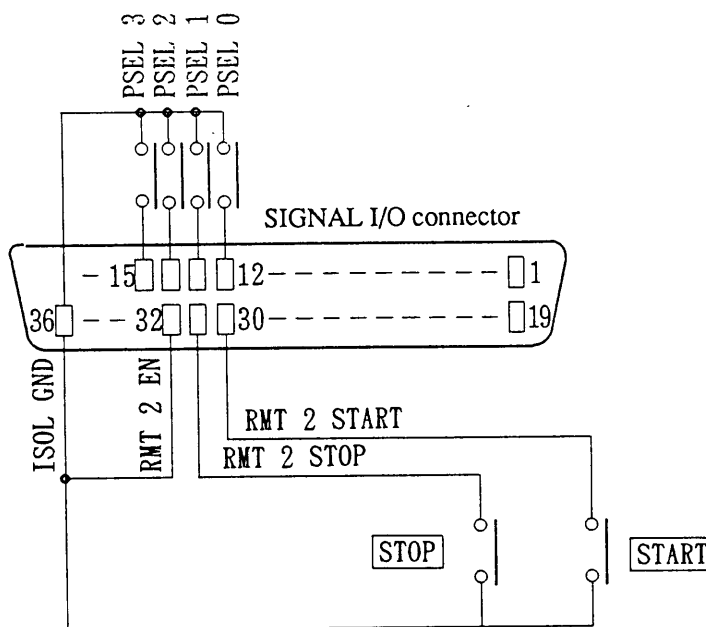

Figure 4.10

- ① Select a program number with PSEL 0 through PSEL 3, in a form of 4-bit low-active binary inputs as shown in Table 4.1.

Table 4.1 Program number with PSEL 0 - PSEL 3

PSEL 3	PSEL 2	PSEL 1	PSEL 0	Program No.
H	H	H	L	1
H	H	L	H	2
H	H	L	L	3
H	L	H	H	4
H	L	H	L	5
H	L	L	H	6
H	L	L	L	7
L	H	H	H	8

PSEL 3	PSEL 2	PSEL 1	PSEL 0	Program No.
L	H	H	L	9
L	H	L	H	10
L	H	L	L	11
L	L	H	H	12
L	L	H	L	13
L	L	L	H	14
L	L	L	L	15

H: High level L: Low level

- ② The remote control of START/STOP operation in the AUTO test is similar to the Single test.

### (3) Isolated Power Supply

For the Remote 2 function, a +15V power supply which is isolated from other internal circuits of the W/I Tester is provided. The power supply is delivered between the ISOL GND pin and the ISOL +15V pin.

The power supply may be used for a logic IC which is used to make up a logic circuit to handle the output signals of the W/I Tester and other signals or for a circuit to control the W/I Tester with signals fed from conveyors or robots.

The specifications of the isolated power supply are as follows.

ISOL +15V : Pin 1, 2, 17, or 18

ISOL GND : Pin 19, 20, 35, or 36

Maximum current : 100mA

Example of use: The power supply is used for a control circuit as shown in Figure 4.11. This circuit provides a start signal for the W/I Tester upon a logical AND (logical product) of a conveyor pallet arrival signal and a jig start signal.

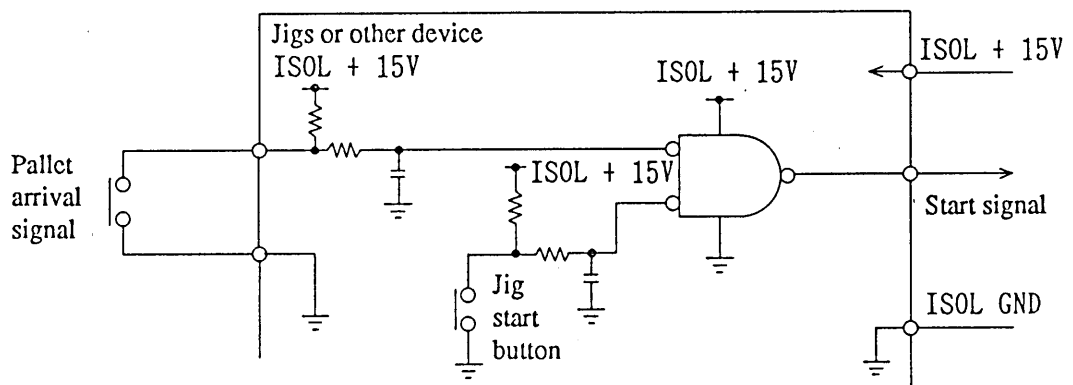

Figure 4.11

□ “Remote 2” Connector Pin Assignment and Functions

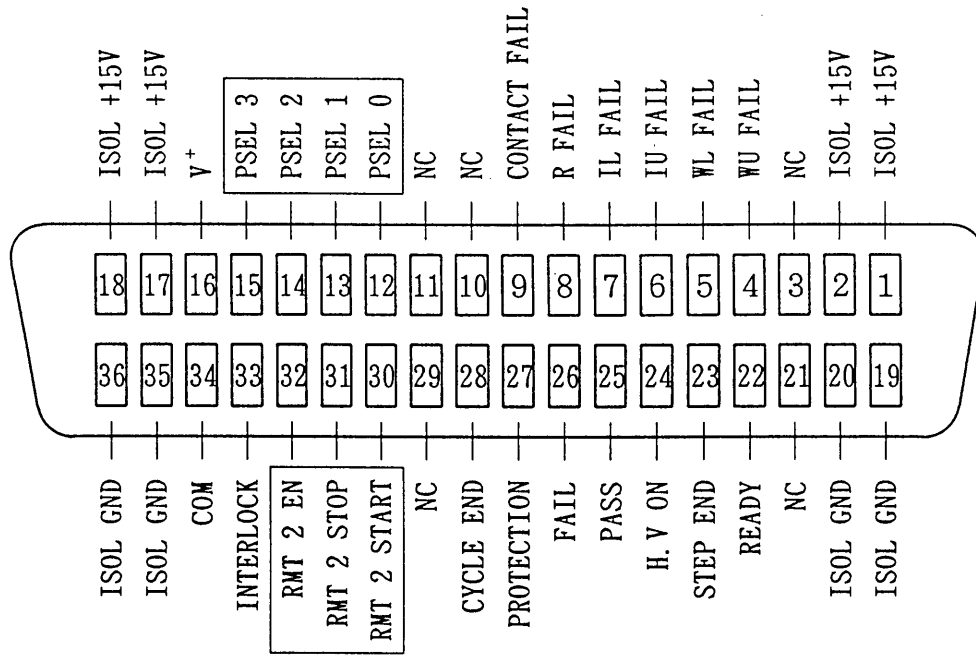

Figure 4.12

- PSEL 0 - PSEL 3 pins

These pins are the input terminals for the signal which select a test program number for an AUTO test. The signal is a 4-bit low-active binary. For example, when all of PSEL 0 through PSEL 3 are set to the low level, the program number 15 is selected. For another example, when PSEL 0 is set to the low level (ISOL GND) and PSEL 1 through PSEL 3 to open, the program number 1 is selected. (See Table 1.)

Note 1: When all the PSEL pins are set to the high level or to open, none of the program numbers can be selected.

Note 2: For a Single test, be sure to set all of the PSEL 0 through PSEL 3 to the high level (ISOL +15V) or open.

- RMT 2 START pin

This pin accepts the START signal when you control the W/I Tester with the Remote 2 function. The low level (ISOL GND) is for start.

- RMT 2 STOP pin

This pin accepts the STOP signal when you control the W/I Tester with the Remote 2 function. The low level (ISOL GND) is for stop.

- RMT 2 EN pin

This pin accepts the ENABLE signal when you control the W/I Tester with the Remote 2 function. The low level (ISOL GND) is for enabling the Remote 2 function.

Note: If this pin is open or at the high level (ISOL +15V), the Remote 2 function is disabled and the W/I Tester cannot be remote controlled with this function.

□ SIGNAL I/O Connector Pin Assignment and Layout

The pin assignment and layout of the SIGNAL I/O connector are as shown in the below table and Figure 4.13.

Pin No.	Signal name	Internal circuit	Assignment
1, 2, 17, 18	ISOL +15V	-	Isolated power supply (+15V, 100mA)
4	WU FAIL	A	Output signal
5	WL FAIL	A	Output signal
6	IU FAIL	A	Output signal
7	IL FAIL	A	Output signal
8	R FAIL	A	Output signal
9	CONTACT FAIL	A	Output signal
12	PSEL 0	B	Remote 2 input signal (for program selection)
13	PSEL 1	B	Remote 2 input signal (for program selection)
14	PSEL 2	B	Remote 2 input signal (for program selection)
15	PSEL 3	B	Remote 2 input signal (for program selection)
16	V+	A	Power supply pin for all open-collector circuits (Refer to Figures 4.15A and 4.15B.)
19, 20, 35, 36	ISOL GND	-	Isolated power supply
22	READY	A	Output signal
23	STEP END	A	Output signal
24	H.V ON	A	Output signal
25	PASS	A	Output signal
26	FAIL	A	Output signal
27	PROTECTION	A	Output signal
28	CYCLE END	A	Output signal
30	RMT 2 START	B	Remote 2 input signal (for START signal)
31	RMT 2 STOP	B	Remote 2 input signal (for STOP signal)
32	RMT 2 EN	B	Remote 2 input signal (for ENABLE signal)
33	INTERLOCK	B	
34	COM	A	Common-line pin for all open-collector circuits (Refer to Figures 4.15A and 4.15B.)
3, 10, 11, 16, 21, 29, 34	-	None	Not connected

191. 10. 31

912744A

191.10.21

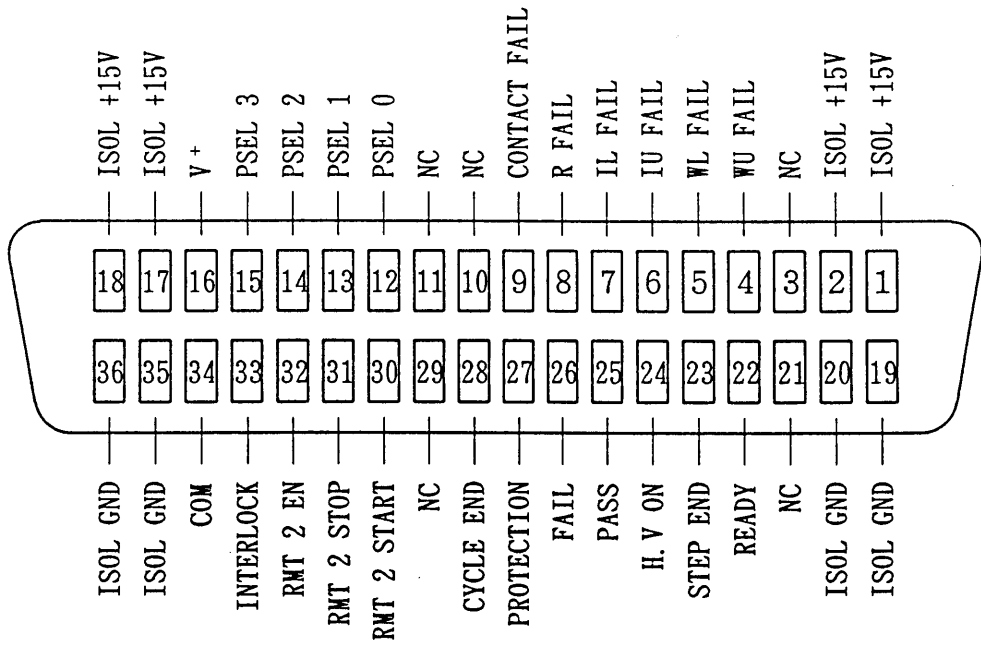

NC: Not connected

Figure 4.13 SIGNAL I/O Connector Pin Assignment and Layout

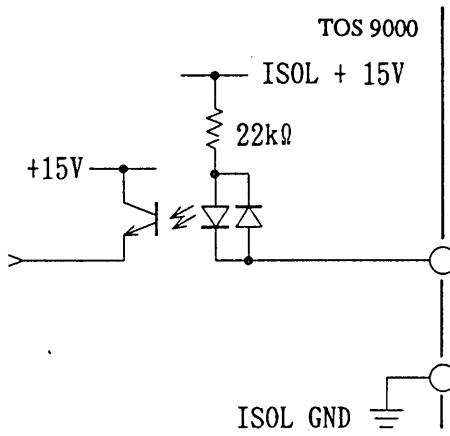
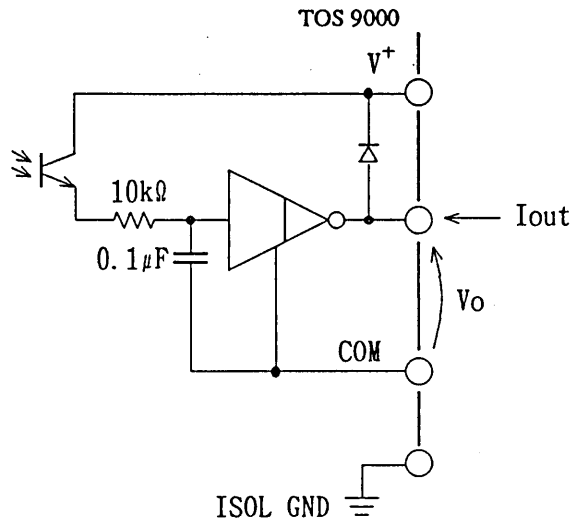

Figure 4.14 Internal circuit B (Input circuit)

912745A





Output current ( $I_{out}$ ): 400mA (in total)

Sustainable maximum output voltage ( $V_o$  sus): 30V DC

Output saturation voltage ( $V_o$  sat): 1.1V (at 25°C or 77°F)

Allowable voltage range of external power supply ( $V^+$ ): 5~30V DC

Figure 4.15 Internal circuit A (Output circuit)

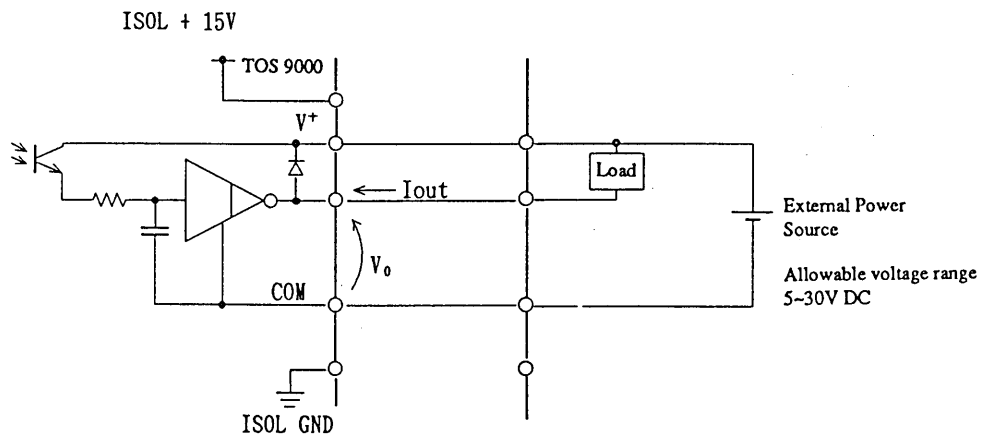

Figure 4.15A Connections When using an External Power Source

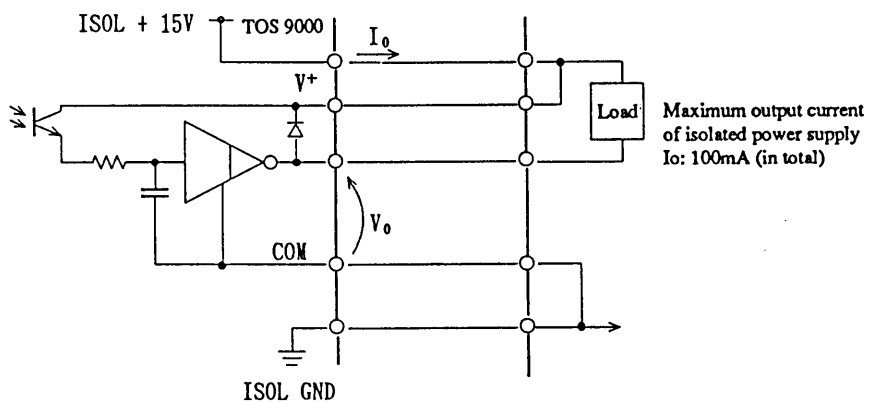

Figure 4.15B Connections When using the Internal Isolated Power Source of the Instrument

191.1c.31

912746A

## 4.13 Protective Functions

The W/I Tester has the various protective circuits as mentioned below. When one of these circuits has tripped, the W/I Tester assumes the PROTECTION state and generates a PROTECTION signal. If this event occurs when executing a test, the W/I Tester stops delivering the test voltage and aborts the test.

Once generated, the PROTECTION signal is delivered continuously and is not reset for itself. To reset it, eliminate the cause of the protection and then press the STOP switch. When the W/I Tester is in the PROTECTION state, all the other operations are disabled.

*Note: Depending on the type of the protection signal, a message may appear on the display screen to urge you to turn off. This means that the W/I Tester has failed. Then, immediately turn off the W/I Tester power and disconnect its AC power cable from the AC power line.*

Protective Circuit	Effective Time	Corrective Measure
1 VOLTAGE TRIP	Constantly	Immediately turn off power (W/I Tester has failed.)
2 H.V RELAY EMERGENCY PROTECTION	Constantly	
3 THERMAL PROTECTION	Constantly	Turn off power. (Wait for cooling off.)
4 INTERLOCK	Constantly	Eliminate the cause of trip. Press the STOP switch.
5 RMT 1	Constantly	
6 RMT 2 CONFUSE	Constantly	
7 SCAN UNIT CONFUSE	For W or I test	
8 R TESTER CONFUSE	For R test	

### ① VOLTAGE TRIP

Message on display

!!! Voltage Trip !!!  
Cut off the POWER ...

The high voltage generator section of the W/I Tester has a trouble. Immediately turn off the power and disconnect the AC power cable from the AC line and stop using the tester.

77. 10. 31

912748A 7

② H.V RELAY EMERGENCY

Message on display

!!! H.V relay error !!!  
Cut off the POWER ...

The high voltage relay section of the W/I Tester has a trouble. Immediately turn off the power and disconnect the AC power cable from the AC line and stop using the tester.

③ THERMAL PROTECTION

Message on display

!!! Overheat High Voltage AMP !!!  
Cut off the POWER ...

The amplifier is overheated. Turn off the power and wait until it is cooled off. The tester may restore its normal operation when it has been cooled off. If this protection signal is generated in spite of the amplifier temperature is within the allowable temperature range, the W/I Tester may have a trouble. Immediately turn off the power and disconnect the AC power cable from the AC line and stop using the tester.

④ INTERLOCK

Message on display

!!! Interlock occurred !!!  
Check machine condition ...

The interlock signal is effected. For the interlock signal, see Chapter 4.11 "Interlock Function" (Page 4-62).

Note: If nothing is connected to the SIGNAL I/O connector ②⑧ on the rear panel, this is equivalent to interlock. So, the above message appears on the display screen.

19/10/31

912748A

⑤ RMT 1 CONFUSE

Message on display

```
!!! Remate-1 line Confused !!!  
Check machine condition ...
```

The Remote-1 line is confused. Check the cable connections.

Note: If you construct the connection for remote control while the power is on, this message appears.

⑥ RMT 2 CONFUSE

Message on display

```
!!! Remote-2 line Confused !!!  
Check machine condition
```

The Remote-2 line is confused. Check the cable connections.

Note: If you construct the connection for remote control while the power is on, this message appears.

⑦ SCAN UNIT CONFUSE

Message on display

```
!!! Scan unit line Confused !!!  
Check machine condition
```

The TOS9020 H.V Scanning Unit is malfunctioning. Check the Scanning Unit number setting, cable connections, and other machine conditions.

⑧ R TESTER CONFUSE

Message on display

!!! R tester line Confused !!!  
Check machine condition ...

The TOS6100 R Tester circuit is malfunctioning. Check the setting conditions of the R Tester, cable connections, and other machine conditions.

## 4.14 Summary of Messages

### (1) Status Messages

①

```
-- KIKUSUI ELECTRONICS CORP. --  
BLS ver X.XX.XXX  TOS ver X.XX.XXX
```

This message appears when the W/I Tester power is turned on or when the operation is changed from the INITIAL SETTING mode to the regular mode.

②

```
< Data Entry >
```

This message appears when the W/I Tester is in the DATA ENTRY mode which allows you to type test parameters.

③

```
Data Entry
```

This message appears when the W/I Tester is in the DATA ENTRY mode.

④

```
Press <START> key ...
```

This message appears to indicate that the W/I Tester is ready to start. You can start your test by pressing the START switch, reception of a START signal, or a "START" command.

⑤

```
< High Voltage ON >
```

This message appears to indicate that the W/I Tester is delivering the high output voltage for Single W or I test.

⑥

< AC Low Ohm Tester ON >

This message appears to indicate that the R test (AC low ohm test) is being executed.

⑦

<<< Step Test Execute >>>

This message indicates that test steps are being executed in the AUTO test.

## (2) Messages for Test Results

①

<<< Test PASS end >>>

This message means that the test result is PASS.

②

<<< Step PASS end >>>

This message means that the test result of each of the test steps in the AUTO test is PASS.

③

<<< Program PASS end >>>

This message means that all the test results are PASS in the AUTO test.

④

<<< FAIL end ... Over current >>>

This message means that the test result is FAIL because a current greater than the upper limit was detected in the W test.

⑤

<<< FAIL end ... Under current >>>

This message means that the test result is FAIL because a current smaller than the lower limit was detected in the W test.

⑥

<<< FAIL end ... Over resistance >>>

This message means that the test result is FAIL because a resistance larger than the upper limit was detected in the I test. The same message also appears when a FAIL decision is made when in the R test.

⑦

<<< FAIL end ... Under resistance >>>

This message means that the test result is FAIL because a resistance smaller than the lower limit was detected in the I test.

⑧

<<< CONTACT FAIL >>>

This message indicates that the result of contact check is FAIL.

### (3) Messages Related to Use of Memory

①

Type in parameter table number ... → -

This message appears after pressing the **STORE** key in the single test. Type the memory number, which you want to store the test conditions on to.

②

Type in parameter table number ... ← -

This message appears after pressing the **RCL** key in the single test. Type the memory number, which you want to recall the test conditions from.



③

Enter Recall program number. \_  
<Ten key> Number. <CANCEL> Abort.

This message appears when you change the program number in the AUTO test. Type the program number to be selected. The original display is restored by pressing the **CANCEL** key.

(4) Messages Related to Protective Functions

For details of protective functions, see Chapter 4.13.

①

!!! Voltage Trip !!!  
Cut off the POWER ...

This message appears when the VOLTAGE TRIP protector circuit has tripped. When this message has appeared, immediately turn off the power.

②

!!! H.V relay error !!!  
Cut off the POWER ...

This message appears when the H.V RELAY EMERGENCY protector circuit has tripped. When this message has appeared, immediately turn off the power.

③

!!! Overheat High Voltage AMP !!!  
Cut off the POWER ...

This message appears when the THERMAL PROTECTION circuit has tripped. When this message has appeared, immediately turn off the power.

④

!!! Interlock occurred !!!  
Check machine condition ...

This message appears when the interlock function is brought into effect. For the interlock function, see Chapter 4.11 "Interlock Function" (Page 4-60).

7/1. 10.31

912754A

⑤

!!! Remote -1 line Confused !!!  
Check machine condition ...

This message appears when the Remote-1 circuit is confused and the RMT 1 CONFUSE protector circuit has tripped.

⑥

!!! Remoto -2 line Confused !!!  
Check machine condition ...

This message appears when the Remote-2 circuit is confused and the RMT 2 CONFUSE protector circuit has tripped.

⑦

!!! Scan unit line Confused !!!  
Check machine condition ...

This message appears when the H.V Scanning Unit circuit is malfunctioning and the SCAN UNIT CONFUSE protector circuit has tripped.

⑧

!!! R tester line Confused !!!  
Check machine condition ...

This message appears when the AC Low Ohm Tester is malfunctioning and the R TESTER CONFUSE protector circuit has tripped.

(6) Error Message

!!! Incorrect !!!

This message appears when the parameter data for the Single test or the AUTO test is invalid, or the values of mutually related parameters are illegal.

## 5. GPIB Interface Function

### Precautions!

- 1. Before starting the test system, be sure that the programs and commands are correct.*
- 2. Before starting the actual test, perform a trial test without connecting the object to be tested in order to be sure that the test voltage is correctly delivered.*

### 5.1 General Description

This chapter describes an outline of the GPIB (IEEE 488-1978) interface function for computerized control of the W/I Tester. The function allows to control the panel settings of the W/I Tester remotely from a computer and to read back the test data to the computer on the bus. The major functions available are as follows:

- (1) To control the START/STOP of a Single test with the computer.
- (2) To set the test parameters of Single test with the computer.
- (3) To read back the W/I Tester status or test results to the computer.
- (4) To read back the measured values to the computer.
- (5) To originate and send a service request to the computer.

The term "GPIB" stands for "General Purpose Interface Bus." The GPIB is an international standard system which provides interface functions to operate various devices – even from different manufacturers – on the same bus and to control them with a computer.

The GPIB signals are transferred through a bit-parallel (8 bits) byte-serial bi-directional bus line. Data is transferred through a 3-wire handshake system.

Also, the signals among the instruments are connected in parallel on common signal lines. Each device connected on the bus can have one or more of the functions of talker, listener, and controller.

Data is transferred from a talker device to other listener devices. The controller controls data transfer direction and management of the interface.

The bus has eight data lines, three handshake lines, five bus management lines (total sixteen lines), and eight ground lines.

See the following illustration DIO1-DIO8 are data lines; NDAC, NRFD and DAV are handshake lines; ATN, EOI, IFC, SRQ and REN are bus management lines.

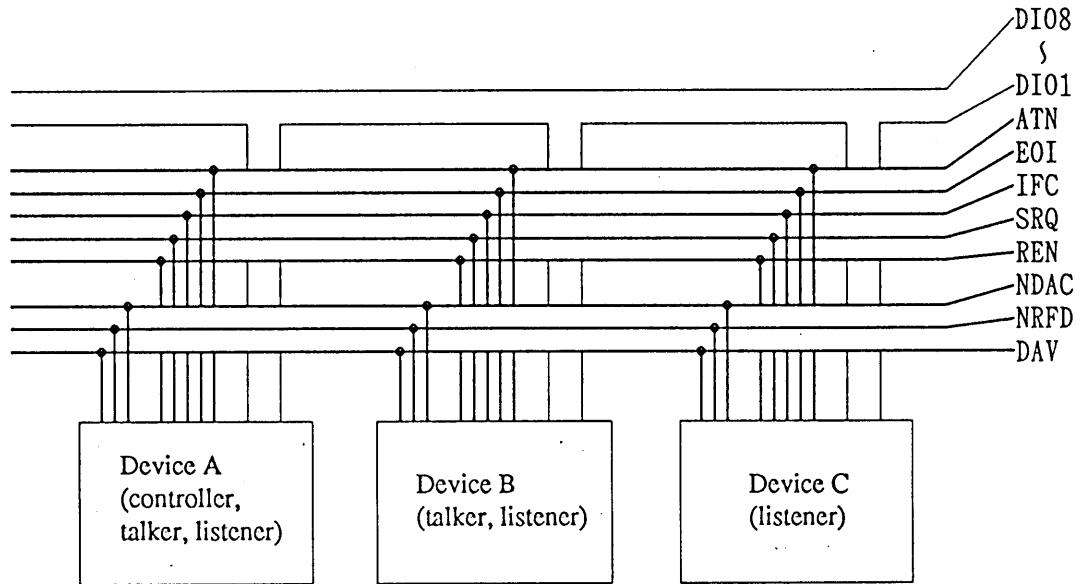

## 5.2 GPIB Specification

### 5.2.1 Type of Standard

ANSI/IEEE 488-1978

### 5.2.2 Interface Functions

Code	Function
SH1	With full SH function
AH1	With full AH function
T6	With basic talker function, serial polling, and talker release by listener designation
L4	With basic listener function
SR1	With service request function
RL1	With remote/local change function
PP0	Without parallel polling function
DC1	With device clear function
DT0	Without device trigger function
CO	Without controller function

## 5.3 Operation Method

### 5.3.1 Remote Mode and Local Mode

#### (1) Front Panel

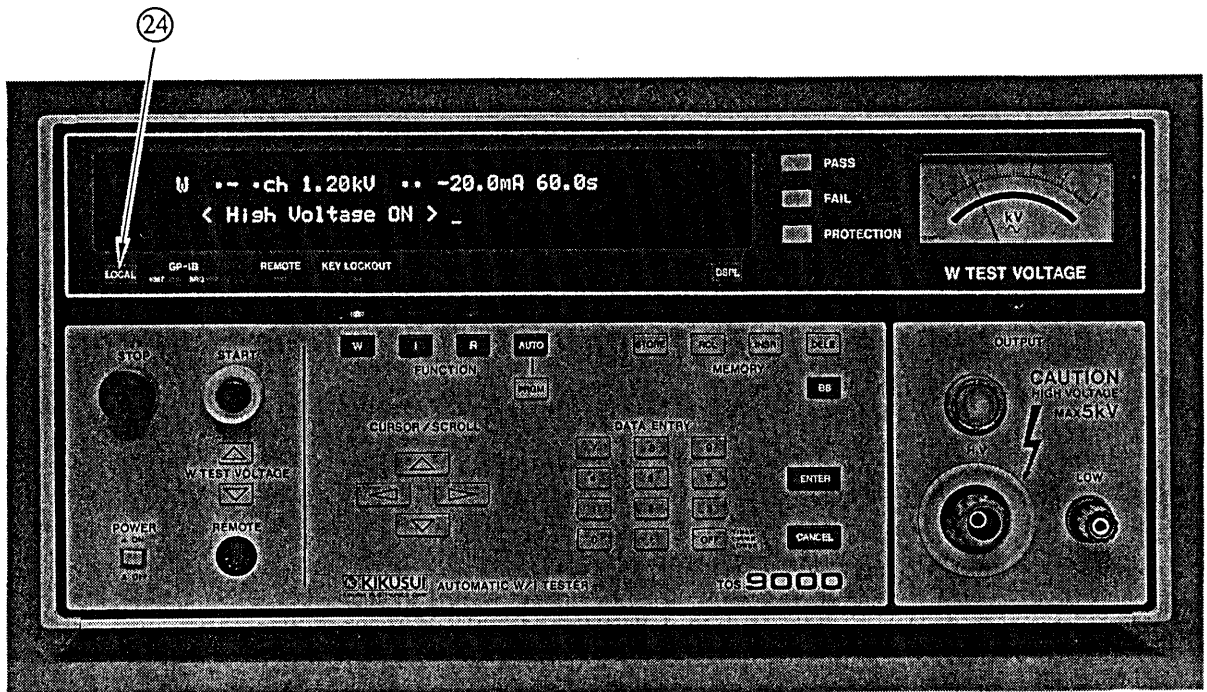
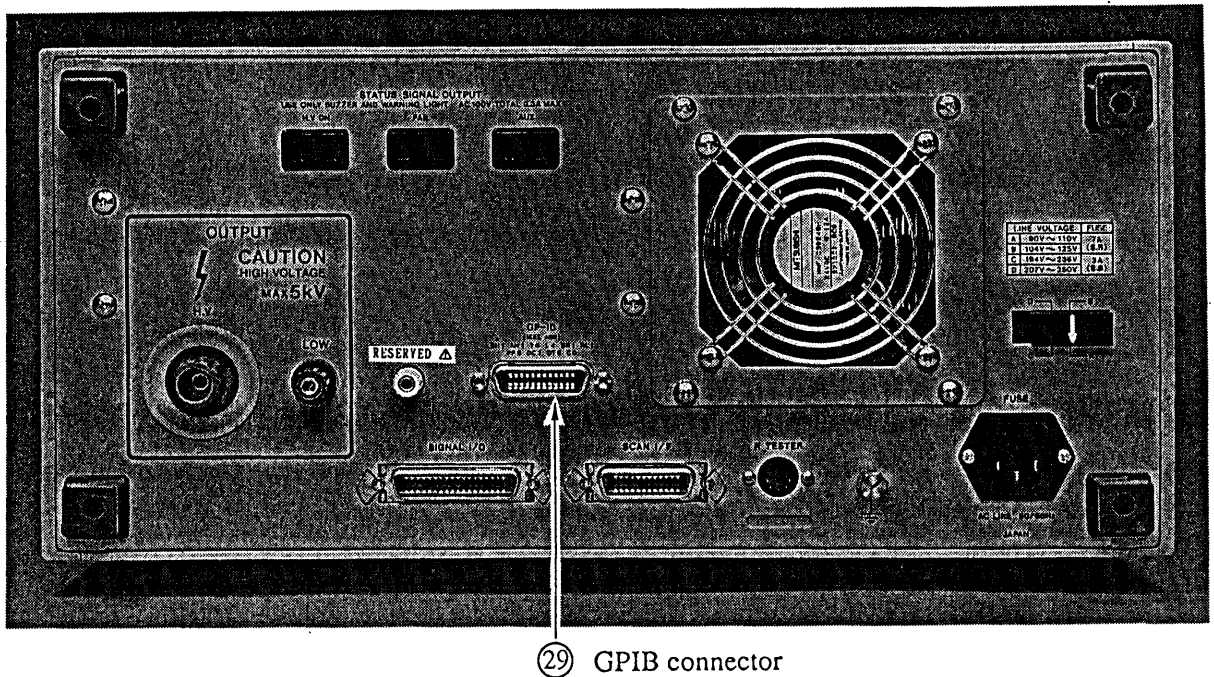

Figure 5.1

②4 LOCAL: This key returns the W/I Tester from the remote state to the local state.

When the W/I Tester is set to the remote state by external controller via the GPIB bus, all the front panel keys except the STOP switch are disabled. Even if in this state, the keys can be enabled by pressing the LOCAL key. The RMT LED lights in the remote state and it goes out in the local state.

(2) Rear Panel



②⑨ GPIB connector

Figure 5.2

②⑨ GPIB connector: A 24-pin connector for GPIB bus cable.

Note: Up to three connectors can be stacked up in one position by using piggy back connectors.

(3) Address Setting

You should specify the GPIB address for the W/I Tester with the INITIAL SETTING parameter "GPIB address." The available address numbers are 0 to 30.

(4) Controllable Items

Command and data transfer

- ① Control of START/STOP of a Single test, from a computer.
- ② Setting of test parameters for a Single test, from a computer.
- ③ Reading back of W/I Tester status or test results, to a computer.
- ④ Reading back of measured value, to a computer.
- ⑤ Flagging of service request signal to a computer.

① Control of START/STOP of Single test, with a computer

When you execute a Single test, you can control the START/STOP operation of the W/I Tester via the GPIB bus. Then, the START switch on the front panel is disabled. However, the STOP can be controlled either remotely or locally.

② Setting of test parameters for Single test, with a computer

You can remotely control all the test parameter which can be locally entered from the front panel keys via the GPIB bus.

For a setting of "1-2ch 1.20kV 1.00-20.0mA 60.0s" for W test for example, a string "W 1,2,1.2,1,20,60" should be sent from the controller to the W/I Tester. The W/I Tester will interpret the string and will make a test setting for "W 1-2ch 1.20kV 1.00-20.0mA 60.0s" similarly to controlling with the front panel keys locally.

③ Reading back of W/I Tester status or test results, with a computer

You can read back the W/I Tester status or test results with your computer.

For example, you send a command string "STATUS?" to the W/I Tester. Then, the W/I Tester will interpret the string and will write the W/I Tester status and test results on to a sending queue. By designating the W/I Tester to be a talker, the information is answered back to your computer .

④ Reading back of measured value with a computer

The W/I Tester has a function of monitoring the measured values. You can read back the values with your computer.

For example, assume that you want to read back the leak current value in W test. Then you should send a command string "CDATA?" to the W/I Tester. The W/I Tester will write the leak current data on to the sending queue. As the W/I Tester is designated to be a talker, the data is answered back to your computer.

⑤ Flagging of service request to a computer

The W/I Tester is able to flag a service request (SRQ) to an external controller in order to inform an event which occurred in the W/I Tester.

In order to discriminate the causes of SRQ origination, the bits of a status byte are assigned to respective events. When an SRQ is flagged, the corresponding bit of the status byte is set to "1." This allows the controller to discriminate the types of events by reading back the status bytes.



### 5.3.2 Commands and Data Formats

To control the W/I Tester via the GPIB bus, commands and data must be sent from the computer (controller) in the following format:

Command (train) + Delimiter

#### (1) Format of Commands

The command is an ASCII string. The command consists of a header and an argument. A separator separates a header and an argument.

Command (train)

Header + Separator + Argument + Separator + Argument

- Header

The header identifies the type of command, such as for "START" or "W."

- Separator

Either a space code (ASCII code 20h) or a comma (ASCII code 2Ch) can be used for the separator. The space code must be used between a header and an argument. The space code must be used between a header and an argument.

Header SP Argument

The comma (,) must be used between argument and argument.

The comma (,) alone must be used among two arguments.

Header SP Argument , Argument

- Argument

The argument must be a numerical value, such as "15" or "200." No space code must be placed between the end of an argument and a comma.

#### (2) Delimiter

The delimiter is "CR+LF(+EOI)."

### (3) SRQ and Status Byte

The W/I Tester is able to flag and send an SRQ to notify an event occurrence of the W/I Tester to the computer (controller).

In order to discriminate the causes of SRQ origination, the bits of a status byte are assigned to respective events. When an SRQ is flagged, the corresponding bit of the status byte is set to "1." This allows the controller to discriminate the types of events by reading the status byte.

SRQ is disabled at the power-on default state of the W/I Tester. To enable it, an "SRQMASK" command must be provided.

The relationships between the bits of status byte and the causes of SRQ originations are as shown below.

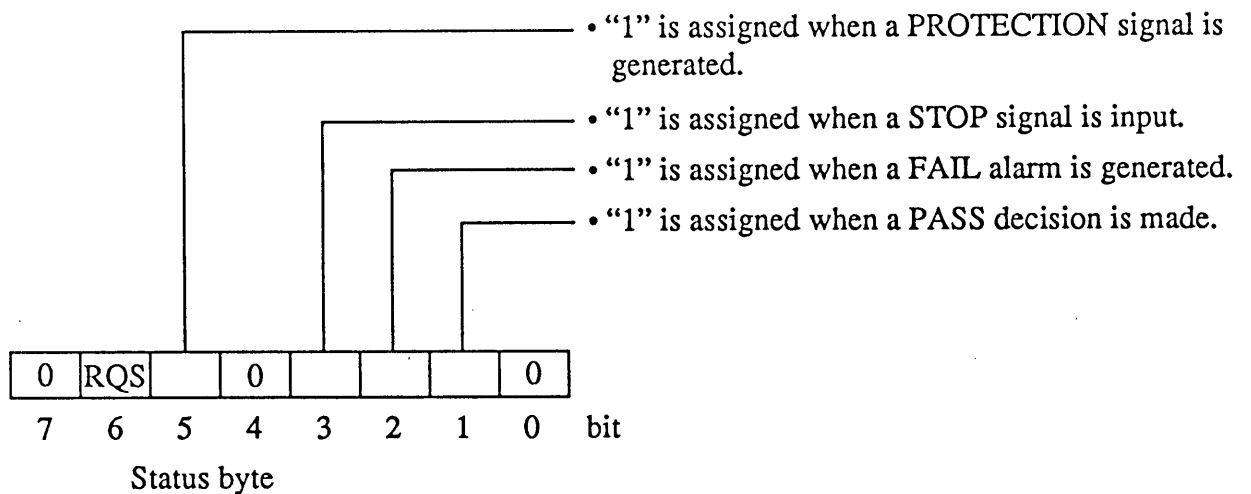

The status byte is cleared and all the bits are set to "0" with one or more of the following conditions.

- ① The W/I Tester power is turned on.
- ② The W/I Tester has originated an SRQ and the controller has read the status byte of the W/I Tester by serial polling.
- ③ The W/I Tester has received an SDC or DCL multi-line message.

(4) Actions after SDC or DCL Reception

When the W/I Tester has received an SDC or DCL, it acts as follows:

- ① The W/I Tester returns to the test condition setting mode irrespective of the state of the W/I tester.
- ② The W/I Tester clears the status byte. However, it holds the SRQ masking condition.

### 5.3.3 Data Sending/Receiving Sequence

The basic sequence for controlling the W/I Tester via the GPIB bus is shown below:

(1) To set data

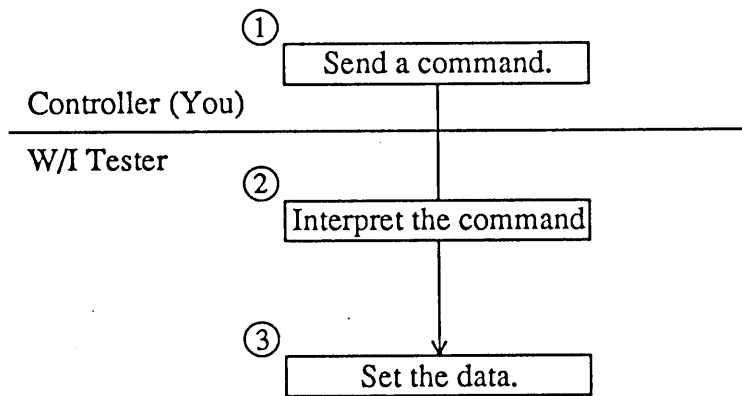

- ① Send a command to the W/I Tester.
- ② The W/I Tester interprets the command.
- ③ The data is set.

(2) To read data

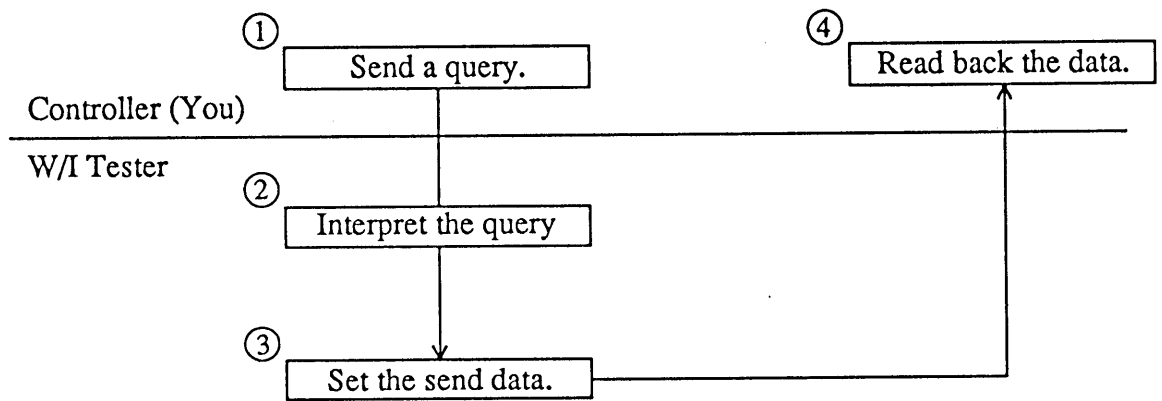

- ① Send a query to the W/I Tester.
- ② The W/I Tester interprets the query.
- ③ The W/I Tester sets the specified data onto the sending queue.
- ④ Read back the data from the W/I Tester.

## 5.4 Table of Commands

Precautions!		
1. Before starting the test system, be sure that the programs and commands are correct.		
2. Before starting the actual test, perform a trial test without connecting the object to be tested in order to be sure that the test voltage is correctly delivered.		

The commands for the W/I Tester are shown in Table 5.1.

Table 5.1

Header	Argument	Function
SRQMASK	0-46	Masks the SRQ occurrence for each event.
SRQMASK?	0-46	Reads the current SRQMASK state.
START	-	Starts the test with the conditions indicated.
STOP	-	Stops the test.
W	*1	Changes to the Single W test and to set conditions for the test.
I	*2	Changes to the Single I test and to set conditions for the test.
R	0.50-99.9	Changes to the Single R test and to set conditions for the test.
STATUS?	-	Reads the W/I Tester status and test result.
VDATA?	-	Reads the W test output voltage .
CDATA?	-	Reads the W test leak current.
RDATA?	-	Reads the resistance measured in R test.

\*1: Consists of the following:

① Scanning Unit Low-line channel number, ② Scanning Unit HIGH-line channel number, ③ Test voltage, ④ Lower limit value, ⑤ Upper limit value, ⑥ Test duration time

\*2: Consists of the following:

① Scanning Unit Low-line channel number, ② Scanning Unit HIGH-line channel number, ③ Measuring voltage, ④ Lower limit value, ⑤ Upper limit value, ⑥ Test duration time

## 5.4.1 SRQ Mask Command

Header	Argument	Function
SRQMASK	0-46	Masks the SRQ occurrence for each event.

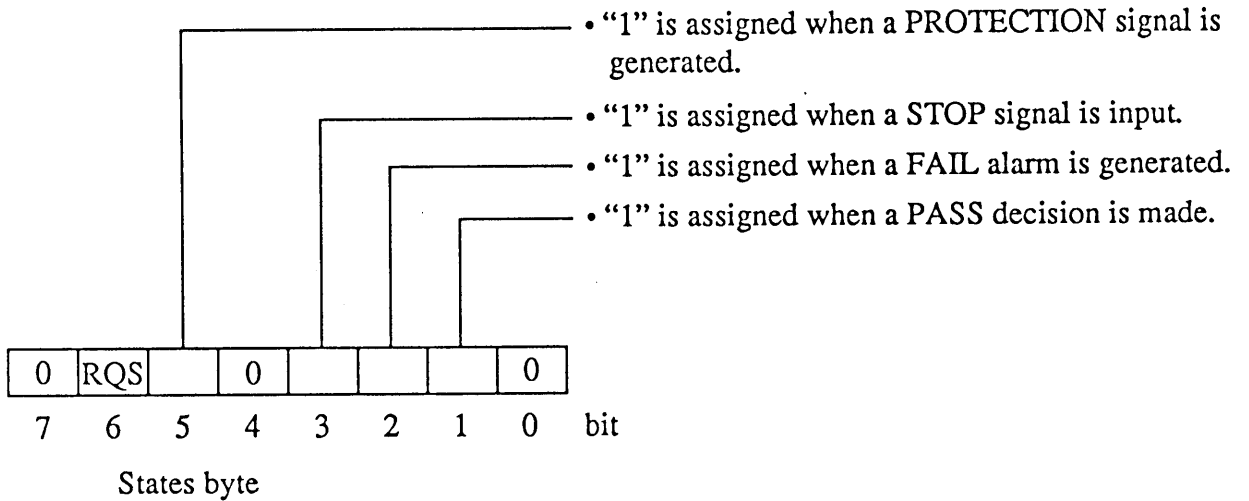

For the argument, assign a decimal value of the bit-combination of “0” and “1”. To mask an event, assign “1”. To unmask an event, assign “0”.

Example:

To mask the generation of FAIL alarm

“SRQMASK 4”

00000100 (B)

## 5.4.2 SRQMASK? Command

Header	Argument	Function
SRQMASK?	-	Read backs the masking condition of SRQ occurrence.

This command is for reading back the masking condition of the SRQ occurrence. The readback value is identical with that which was set as an argument for the SRQMASK command.

Example: You read back the masking condition of the SRQ occurrence.

"SRQMASK?"

Readback value; 8

"8" means that only the third bit is assigned or, SRQ is disabled for "STOP switch event."

## 5.4.3 START/STOP Commands

Header	Argument	Function
START	-	Starts the test with the conditions indicated
STOP	-	Stops the test, or to reset signals and alarms

Examples:

"START" for starting a test.

"STOP" for stopping a test.





## 5.4.5 Test Condition Setting Command (for Single I Test)

Header	Argument					
	①	②	③	④	⑤	⑥
W	1~16 OFF	1~16 OFF	50~1000	1~9999	1~9999 OFF	0.50~99.9 OFF

- Procedure

Select the Single I test and set the values for the following test parameters. The units must be the same as in local operation.

① Scanning Unit Low-line channel number, ② Scanning Unit HIGH-line channel number, ③ Measuring voltage, ④ Lower limit value, ⑤ Upper limit value, ⑥ Test duration time

- Example

Write a command for the following test conditions:

- ① Scanning Unit Low-line channel number: Ch 1
- ② Scanning Unit HIGH-line channel number: Ch 2
- ③ Measuring voltage: 1000V
- ④ Lower limit value: 20MΩ
- ⑤ Upper limit value: 3000MΩ
- ⑥ Test duration time: 4.00sec

"I 1,2,1000,20,3000,4.00"  
 └──────────────────────────────────┘ Space

Note 1: Do not use any decimal points for the arguments of parameter ①, ②, ④, and ⑤.

Note 2: Do not place any space character in front of a comma character. If a space character is placed, the command will be ignored as a syntax error.

## 5.4.6 Test Condition Setting Command (for Single R Test)

Header	Argument	Function
R	0.50-99.9 OFF	Selects the R test mode and set a value for test duration parameter

- Example

“R\_99”  
 |  
 \_\_\_\_\_ space

## 5.4.7 Status and Test Result Read Command

Header	Argument	Function
STATUS?	-	Reads back the W/I Tester status and test results

- The relationships between the readback value and the W/I Tester status or test results are shown in the following table.

Readback value	Status or Results
128	STOP signal input state
64	PROTECTION state
32	UPPER FAIL
16	LOWER FAIL
8	CONTACT FAIL
4	PASS
2	Executing test
1	READY

## 5.4.8 Commands to Readback Measured Values

Header	Argument	Function
VDATA?	-	Reads the output test voltage value of W test
CDATA?	-	Reads the leak current in W test
RDATA?	-	Reads the insulation resistance in I test

- The formats of the readback values are as shown in the following table.

Query	Measured Value	Data Format
VDATA?	d.ddd [kV]	d.dddE3
CDATA?	d.ddd [mA]	d.dddE-3
	dd.ddd [kV]	dd.dddE-3
RDATA?	1M $\Omega$ or below	UNDER
	d.dd [M $\Omega$ ]	d.ddE6
	dd.d [M $\Omega$ ]	dd.dE6
	ddd [M $\Omega$ ]	dddE6
	d.dd [G $\Omega$ ]	d.ddE9
	dd.d [G $\Omega$ ]	dd.dE9
	OVER	OVER

Note : "d" denotes 0 to 9.

## 5.5 Example of Test Procedure

An example of test procedure is introduced here. Assume a case that switching power supply units are to be tested consecutively at various test points.

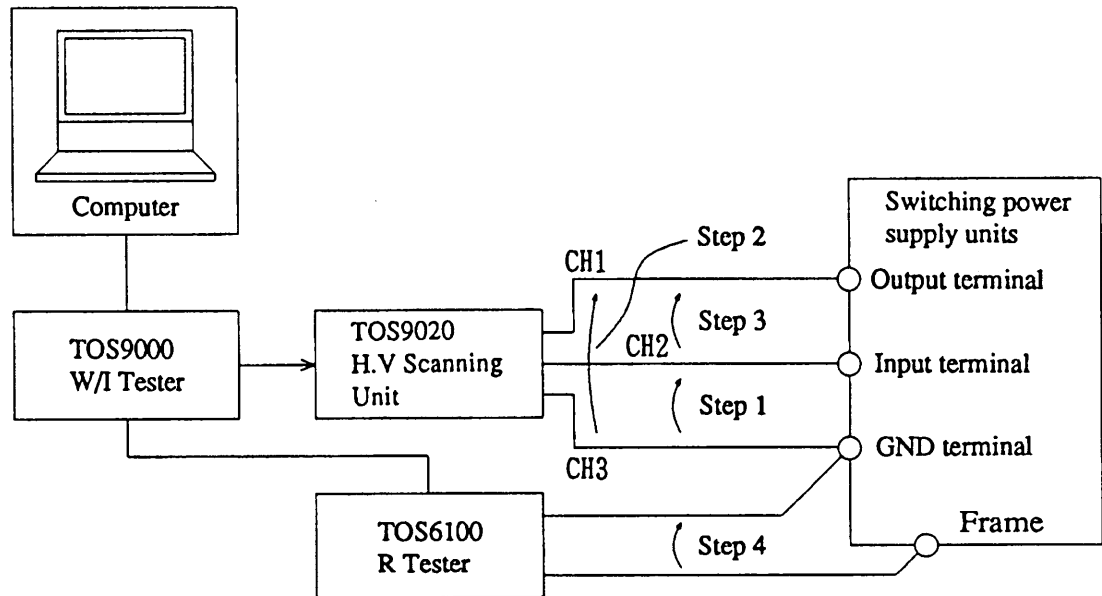

Figure 5.3 Test System for Switching Power Supply Units

- Test Parameters

Step 1:	W	3-2ch	1.00kV	1-10mA	2.00s
Step 2:	I	3-1ch	500V	100-2000M $\Omega$	2.00s
Step 3:	W	2-1ch	1.20V	* * - 2mA	2.00s
Step 4:	R				2.00s

("\* \*" denotes "OFF.")

- Initial Setting

To execute the following sample program, set the GPIB address of the W/I Tester at 2.

## Sample Program

This is example program for above-mentioned test. It runs on an HP 9000 series Desktop Computer.

```
10 ABORT 7
20 REMOTE 7
30 ON INTR 7 GOSUB 500
40 ENABLE INTR 7;2
50 '-----
60 OUTPUT 702;"SRQMASK 0"
70 '-----
80 REM STEP 1
90 OUTPUT 702;"W 3,2,1,0,1,10,2"
100 OUTPUT 702;"START"
110 IF PASS=0 THEN 110
120 PRINT "STEP 1 : PASSED"
130 PASS=0
140 '-----
150 REM STEP 2
160 OUTPUT 702;"I 3,1,500,100,2000,2"
170 OUTPUT 702;"START"
180 IF PASS=0 THEN 180
190 PRINT "STEP 2 : PASSED"
200 PASS=0
210 '-----
220 REM STEP 3
230 OUTPUT 702;"W 2,1,1,2,OFF,2,2"
240 OUTPUT 702;"START"
250 IF PASS=0 THEN 250
260 PRINT "STEP 3 : PASSED"
270 PASS=0
280 '-----
290 REM STEP 4
300 OUTPUT 702;"R 2"
310 OUTPUT 702;"START"
320 IF PASS=0 THEN 320
330 PRINT "STEP 4 : PASSED"
340 '-----
350 STOP
500 '-----
510 REM SRQ
520 A=SPOLL(702)
530 IF A=66 THEN
540     PASS=1
550 END IF
560 IF A=68 THEN
570     PRINT "FALL OCCURRED"
580     STOP
590 END IF
600 IF A=72 THEN
610     PRINT "STOP SIG INPUTTED"
620     STOP
630 END IF
640 IF A=96 THEN
650     PRINT "PROTECTION OCCURRED"
660     STOP
670 END IF
780 ENABLE INTR 7
790 RETURN
700 END
```

912774

Outline of the program:

You execute the tests sequentially from Step 1 to Step 4. At the end of each test step, a message "STEP X: PASSED" appears on your computer display. If a FAIL signal, a STOP signal or a PROTECTION signal is generated when in test, the event is indicated and the program is aborted.

## 6. MAINTENANCE

A hazardously high voltage of a level of 5 kV is generated within this Tester. Never attempt to repair the Tester for yourself.

For such service, contact Kikusui agent.

## 7. PERIPHERAL AND OPTIONAL DEVICES

To assist with various test needs, peripheral and optional devices for the W/I Tester are available as introduced in this chapter.

### 7.1 Peripheral Devices

#### TOS9020 H.V Scanning Unit

The TOS9020 is a high-voltage 4-channel scanning unit incorporated with a contact check function. Being controlled by the TOS9000 W/I Tester, the TOS9020 can receive the W/I Tester output voltage and distribute it to up to four channels in order to apply the test voltage up to four different test points. Up to four TOS9020 units can be operated in parallel, thereby making up a 16-channel scan system.

#### Basic Specifications

- Number of channels: 4
- Maximum Test voltage: 4kV AC
- Number of test steps: Any (depends on the program by TOS9000)

Note: Even if the maximum output voltage of the TOS9000 W/I Tester is 5kV, that of the TOS 9020 is 4kV due to the withstanding voltage (dielectric strength) of the high voltage shielded cables and the high voltage connectors.

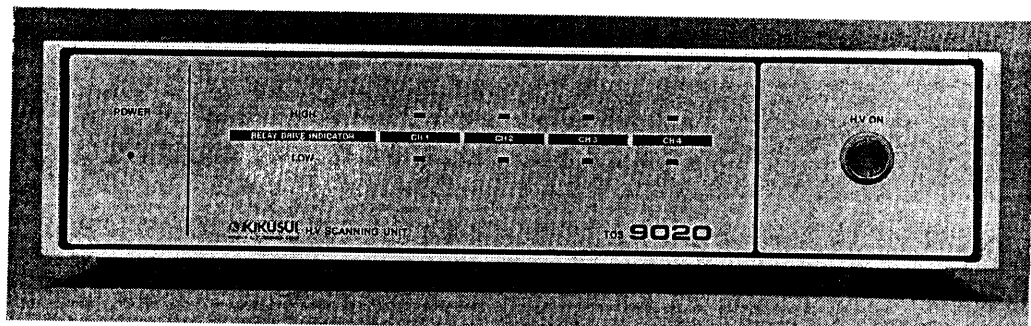



TOS6100 R Tester (AC Low Ohm Tester)

The TOS6100 is an AC low ohm tester. It measures resistances of electrical devices of Class 1, based on the safety codes of IEC, BS, VDE, CEE and other standards, with the measuring currents specified by these standards.

Basic Specifications

- Resistance measuring ranges: Two ranges (0 to 0.12 ohm range and 0 to 0.6 ohm range)
- Measuring current: 3 to 30A AC
- Maximum current/voltage: 30A/8V (these values cannot be obtained at same time.)

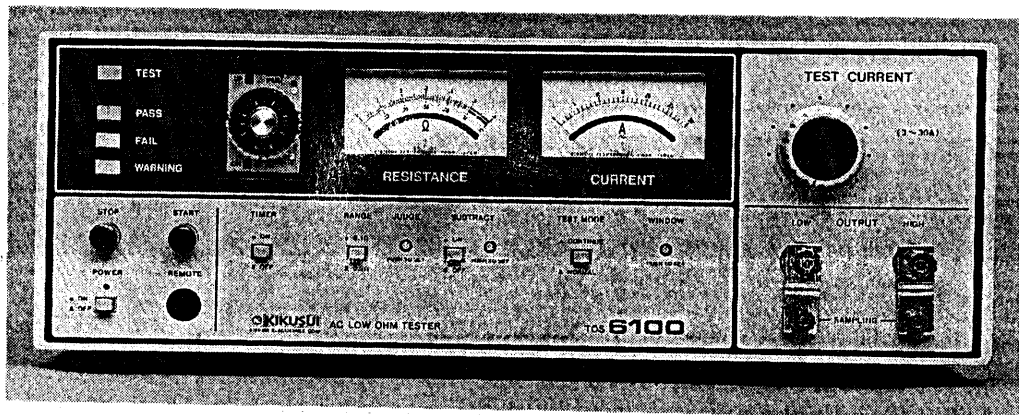

## 7.2 Cables

- 408J-1P5 A GPIB cable which complies with IEEE-STD-488-1978. Approximately 50 cm (1.6 ft.) long.
- 408J-101 A GPIB cable which complies with IEEE-STD-488-1978. Approximately 1 meter (3.3 ft.) long.
- 408J-102 A GPIB cable which complies with IEEE-STD-488-1978. Approximately 2 meters (6.6 ft.) long.
- 408J-104 A GPIB cable which complies with IEEE-STD-488-1978. Approximately 4 meters (13.1 ft.) long.

## 7.3 Model RC01-TOS/RC02-TOS Remote Control Box

Model RC01-TOS or RC02-TOS Remote Control Box is for remote control of start/stop of test operation of the Tester. For remote control, connect the Control Box to the REMOTE connector on the front panel of the Tester. The RC01-TOS has one START switch; RC02-TOS has two START switches and the test starts as you press both switches at the same time with your both hands, thereby enhancing the operating safety.

Functions of switches:

**OPERATE switch:** This switch enables (when ON) or disables (when OFF) the START switch or switches.

**START switch** : The test starts as you press this switch (or switches) when the OPERATE switch is ON and the Tester is in the READY status.

**STOP switch** : This switch terminates the test (cuts off the test voltage or resets the Tester from the FAIL or other particular status — its functions are the same with those of the STOP switch on the front panel of the Tester.

Dimensions

RC01-TOS : 200 W × 70 H × 39 D mm (7.9 W × 2.8 H × 1.5 D in.)

RC02-TOS : 330 W × 70 H × 39 D mm (13 W × 2.8 H × 1.5 D in.)

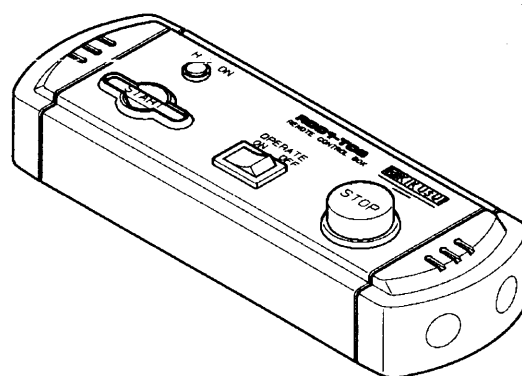

RC01-TOS

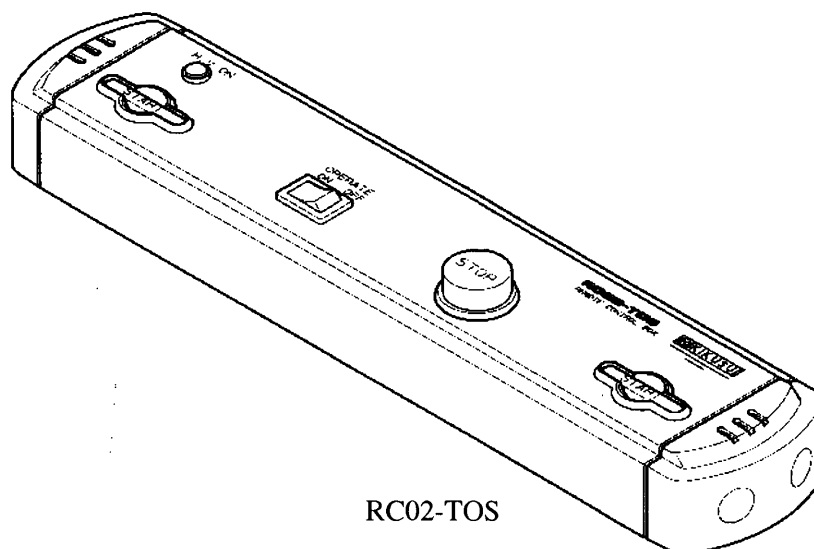

RC02-TOS

### 7.3.1 Model HP01A-TOS/HP02A-TOS High Voltage Test Probe

The High Voltage Test Probe renders a three-fold operating safety, namely, the test voltage is not delivered unless you squeeze with one hand the slide lever of the grip of the probe and pull the trigger and you press with the other hand the switch on top of the probe, thereby occupying your both hands. As you release even a single one of these, the probe immediately and forcefully delivers the STOP signal to cut off the test voltage.

Voltage ratings : 4kV (rms) AC, 50/60 Hz;  
5kV DC

Length of cable: Approx. 1.8 m (HP01A-TOS)  
Approx. 3.5 m (HP02A-TOS)

**WARNING:**

- *The maximum voltage ratings of the probe is 4kV rms AC or 5kV DC. Never let it subjected to voltages higher than these limits.*
- *Do not connect the probe to or disconnect it from the DUT while letting it deliver the test voltage — if you do this, the DUT may be damaged. If you disconnect the probe from the DUT while letting it deliver the test voltage, the items of the tested circuit may remain charged up to the high test voltage. Before connecting the probe to the DUT, be sure that the test voltage is OFF (the LED on top of the probe is OFF); before disconnecting the probe from the DUT, be sure that the test voltage is OFF (the LED is OFF).*

**CAUTION:**

- *If you need a test in compliance to the UL Standard by using the probe, set the FAIL MODE switch (DIP switch on the rear panel) of the Tester to ON. If you have set this switch to ON, the Tester is not reset from the FAIL status has gone out or PROTECTION status even when you have released your hand from the probe. To reset it, you have to press the **STOP** switch of the Tester. Thus, you will be securely informed of the FAIL judgement. For details, refer to Section 6.5.4 “FAIL MODE Switch.”*

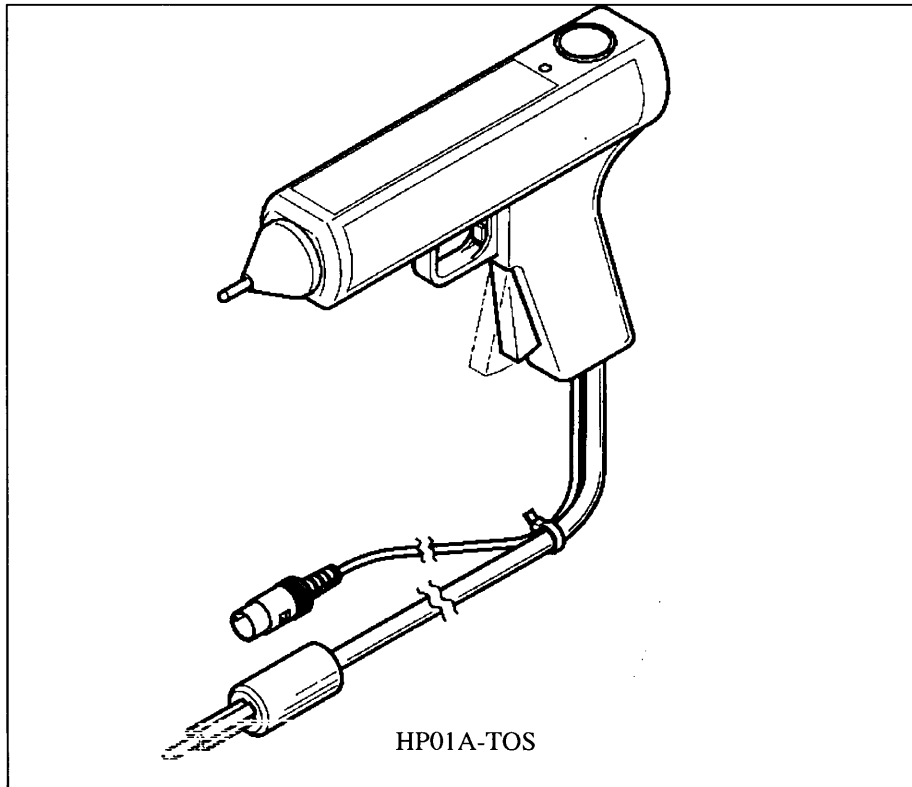

### Model PL01-TOS Warning Light Unit

This unit indicates that the Tester is in the TEST-ON status (delivering the test voltage).

### Model BZ01-TOS Buzzer Unit

This unit may be used when the sound generated by the buzzer housed in the Tester is insufficient. This unit can be driven by the FAIL status signal of the tester.

### High Voltage Test Leadwires

Model	Voltage rating	Length
TL01-TOS	AC: 5kV rms, 50/60 Hz DC: 5kV	Approx. 1.5 m
TL02-TOS	AC: 5kV rms, 50/60 Hz DC: 5kV	Approx. 3.0 m

### BH4M-TOS Rack Mount Brackets (JIS type)

The brackets are used to install the W/I Tester on an instrument rack of JIS Standard. (unit: mm)

### BH5-TOS Rack Mount Brackets (EIA type)

The brackets are used to install the W/I Tester on an instrument rack of EIA Standard. (unit: inch)

□ HP01-TOS/HP02-TOS High-Voltage Test Probe

Each of the HP01-TOS and HP02-TOS is a gun-type high-voltage test probe. Until you squeeze its grip, the START switch is disabled, thereby preventing unintentional delivery of the test voltage by an inadvertent pressing of the START switch. At the instant you release the START switch, the probe sends the STOP signal to the W/I Tester.

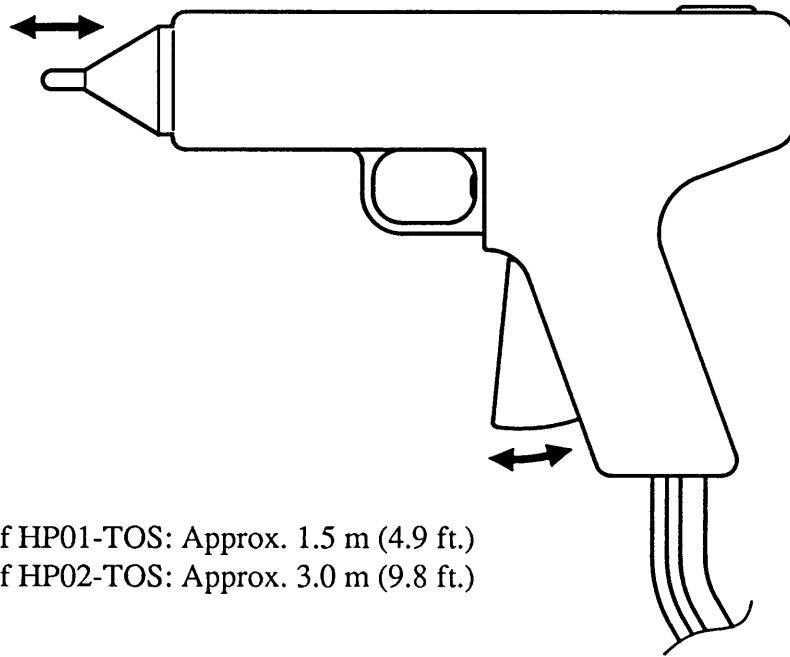

Cable length of HP01-TOS: Approx. 1.5 m (4.9 ft.)  
Cable length of HP02-TOS: Approx. 3.0 m (9.8 ft.)

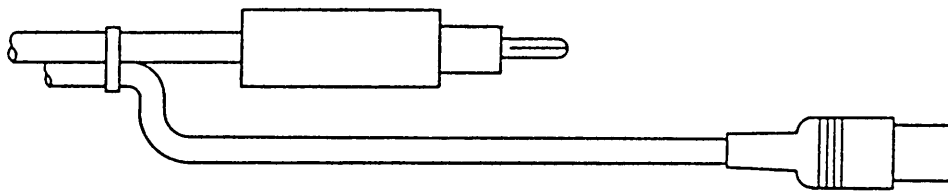

Figure 7.3

**Warning!**

- (1) *The maximum rated voltage of the HP01-TOS/HP02-TOS is 4kV AC or 5kV DC. Never apply to the probe a voltage higher than these. Make it double sure that the test voltage is lower than these.*
- (2) *If you want to use the probe for tests complying with the UL Standard, set the Remote 1 Stop sequence function to EXT. For details, refer to Section 4.9 "Initial Settings" (page 4-50).*

HTL-3W High Voltage Test Cable

The HTL-3W is a 3-meter-long (9.9 ft.) high voltage test cable.

**Caution!** The maximum sustainable voltage of the cable is 5kV. Never use the cable with voltages higher than 5kV.

Model 9202S Alarm Unit

The 9202S is a signal light unit to indicate that the test is being executed. It is driven by the H.V ON signal (100V AC signal).

Model 9203S Buzzer Unit

The 9203S is an annunciator which can be driven by the FAIL signal (100V AC signal).

BH4M-TOS Rack Mount Brackets (JIS type)

The brackets are used to install the W/I Tester on an instrument rack of JIS Standard. (unit: mm)

BH5-TOS Rack Mount Brackets (EIA type)

The brackets are used to install the W/I Tester on an instrument rack of EIA Standard. (unit: inch)

# 8. CONNECTIONS OF TEST INSTRUMENTS OF A FULL LINE UP

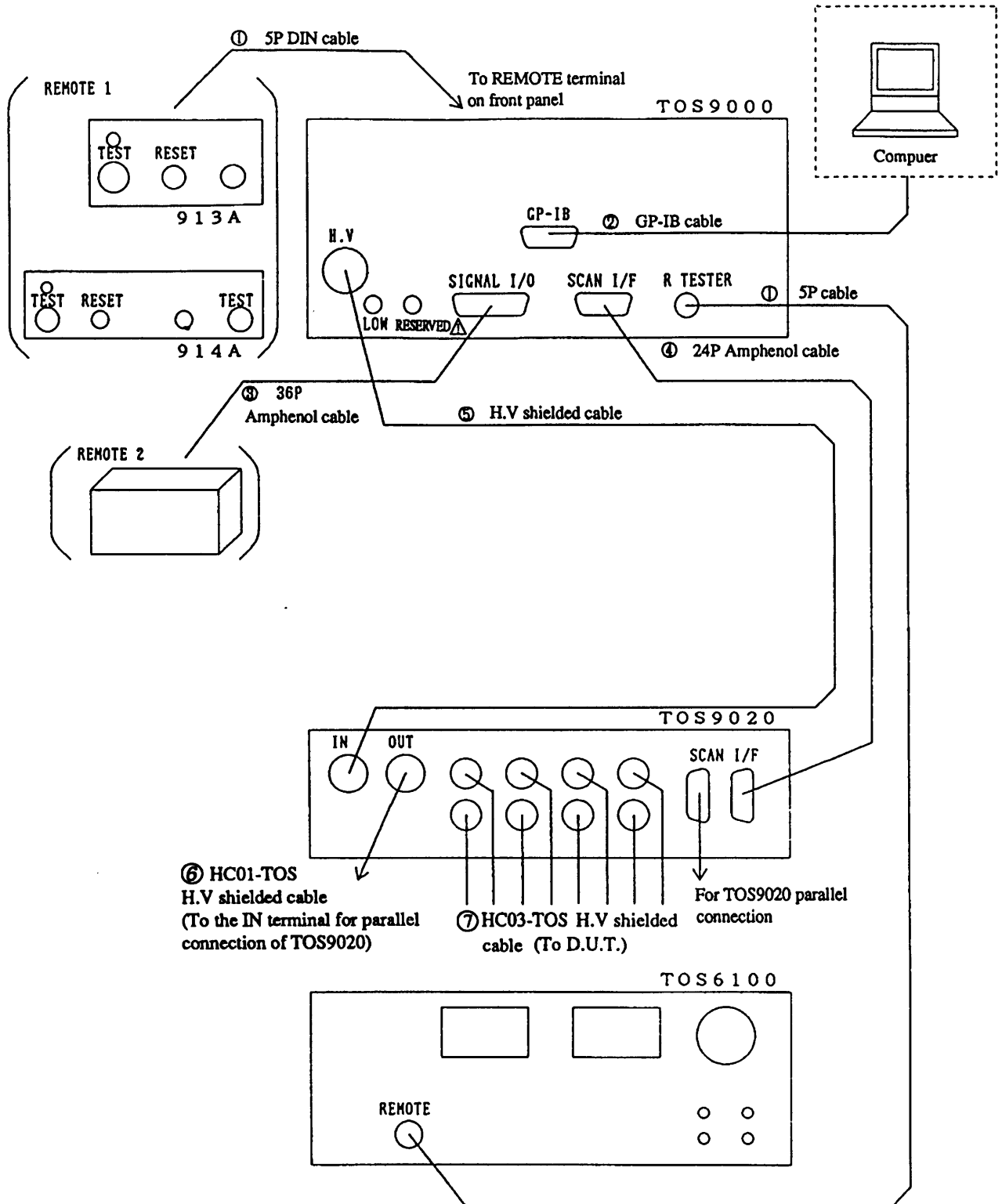

- Notes for Cables

- ① 5P DIN cable

- Use a cable with 5-pin connector which complies with the DIN Standard.

- ② GPIB cable

- Four different lengths (50cm to 4m or 1.6 to 13.1 ft.) of GPIB cables are available as optional items. See Chapter 7.2 P “Cables” (Page 7-4).

- ③ 36P Amphenol cable

- Be sure to use a shielded cable to prevent introduction of noise.

- ④ 24P Amphenol cable

- Use the cable which is an accessory of the TOS9020.

- ⑤ H.V shielded cable

- Be sure to use the cable which are accessories of the TOS9020.

- ⑥ HC01-TOS H.V shielded cable

- The cable is for parallel connections of TOS9020 units. Be sure to use the ones which is an accessory of the TOS9020 units.

- ⑦ HC03-TOS H.V shielded cable

- The cable is to connect the TOS9020 to D.U.T. When a single unit of TOS9020 is used, use the cable which are accessories of the TOS9020. When two or more TOS9020 units are used, use the optional HC03-TOS cable(s).



# 9. BLOCK DIAGRAM

