

INSTRUCTION MANUAL
REGULATED DC POWER SUPPLY
PAD-L, TYPE III

APPLICABLE MODELS

PAD16-100L

PAD20-80L

PAD35-50L

PAD35-60L

PAD55-35L

PAD110-20L

PAD250-8L

KIKUSUI ELECTRONICS CORPORATION

58. 5.27

80441A

On Power Supply Source, it is requested to replace the related places in the instruction manual with the following items.

(Please apply the item of \checkmark mark)

- Power Supply Voltage: toV AC
- Line Fuse: toA
- Power Cable: to 3-core cable (See Fig. 1 for the colors)

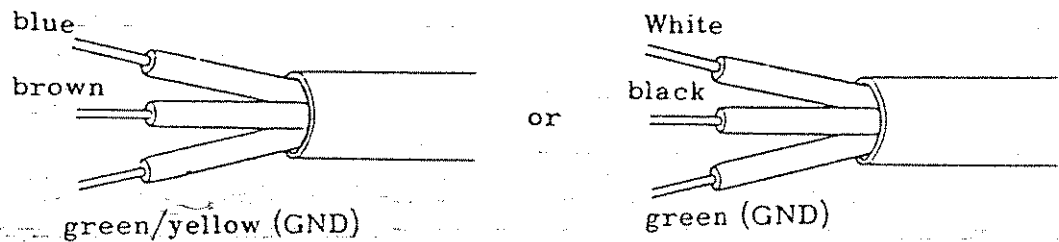

Fig. 1

Please be advised beforehand that the above matter may cause some alteration against explanation or circuit diagram in the instruction manual.

* AC Plug : In case of the Line Voltage 125V AC or more, AC Plug is in principle taken off and delivered, in view of the safety.

(AC Plug on 3-core cable is taken off in regardless of input voltages.)

Before using the instrument, it is requested to fix a suitable plug for the voltage used.

TABLE OF CONTENTS

	<u>PAGE</u>
SECTION 1. GENERAL	1
1-1. Description	1
1-2. Specifications	3
* Power Consumption Chart	5
* Mechanical Outline Drawing	7
SECTION 2. OPERATION	8
2-1. Precaution for Operation (Installation)	8
2-2. AC Input Requirements	13
* Front and Rear Panel	14
2-3. Explanation of Front and Rear	15
2-4. Constant-voltage Operation	19
2-5. Constant-current Operation	20
SECTION 3. PROTECTORS	21
3-1. Description	21
3-2. Explanation of Protective Circuits	22
3-3. Operation Method of Overvoltage Protector (OVP)	23
SECTION 4. APPLICATIONS	25
4-1. Remote Sensing	25
4-2. Output-voltage Control with an External Voltage or Resistance	26
4-3. On-off Control of Output	31
4-4. Output-current Control with an External Voltage or Resistance	32
4-5. One-control Parallel Operation	35
4-6. One-control Series Operation	37
4-7. Constant-current Charge/Discharge of Battery or Capacitor	40
4-8. Remote Turning Off of The Power Switch	42

88
8
7c
8
708

SECTION 5. THEORY OF OPERATION 43

- 5-1. Description of Preregulation Circuit 43
- 5-2. Controlled Rectifier Circuit and Filter Circuit 45
- 5-3. Phase Control Circuit 46
- 5-4. Constant-voltage Circuit 47
- 5-5. Constant-current Circuit 49
- 5-6. Differences from Ideal Power Supply 51
- * Block diagram 54

SECTION 6. MAINTENANCE 55

- 6-1. Inspection and Adjustment 55
- 6-2. Troubleshooting 60

8044

SECTION 1. GENERAL

1-1. Description

The PAD-L Power supply is designed for high operation reliability and excellent electrical performance. It is a universal-purpose industrial power supply which can be used as a variable power source for research and development, or as a fixed power source for long time aging test. Features of the PAD-L Power Supply can be summarized as follows:

1. Improved power factor at low output voltage:

A choke input system is used for the rectifier filter circuit, thereby reducing the apparent input current and improving the power factor. This led to a smaller power transformer and consequently to a compact and light power supply.

2. Less waveform distortion caused to the AC input line:

As the choke input system is used, the input current waveform is less distorted with harmonics, thereby reducing waveform distortion to the AC input line.

3. Excellent temperature coefficient:

Very low temperature drift characteristics of 50 ppm/°C is attained by using premium-quality parts, improved circuits, and forced air cooling. Time-elapse drift (aging drift) also is very low.

4. Fast transient response:

A wide-band error amplifier is used to ensure stable frequency - gain, phase characteristics.

5. Low ripple and noise voltages:

Ripple and noise voltages are low, both in rms and peak values.

The output voltage is finely adjustable from 0 V to the rated voltage with a 10-turn potentiometer.

The power supply has a current/voltage limit switch to preset a current/voltage value. The set value of constant-voltage/constant-current operation can be checked when in operation.

The power supply has internal protection such as voltage detector, current detector and temperature detector circuits. An overvoltage protector (OVP), voltage adjustable from the front panel, also is incorporated as a standard feature. A high speed overvoltage protector (a thyristor crowbar protection circuit) is available as an option.

The power supply is housed in a casing for bench top use. It can be installed on a standard EIA (JIS) rack.

The user is requested to read thoroughly this instruction manual before operating the power supply.

- * It is highly recommended to use the thyristor crowbar high-speed overvoltage protector (OVP: option) for a load whose allowable voltage range is very narrow and which could be damaged when a slight overvoltage is applied.

804A18B

7617700

1-2. Specifications

Input	Model	PAD 16-100L	PAD 20-80L	PAD 35-50L	PAD 35-60L	PAD 55-35L	PAD 110-20L	PAD 250-8L
Input supply		120V/240V ± 10%, 50Hz/60Hz AC, 1 φ						
Power consumption	240V AC Rated load	Approx. 3.3kVA	Approx. 3.0kVA	Approx. 3.3kVA	Approx. 3.8kVA	Approx. 3.3kVA	Approx. 3.8kVA	Approx. 3.4kVA
Output								
Output voltage range	10 turns	0-16V	0-20V	0-35V	0-35V	0-55V	0-110V	0-250V
Voltage resolution (theoretical value)		3mV	3.6mV	6.3mV	6.3mV	10mV	20mV	45mV
Output current range	1 turn	0-100A	0-80A	0-50A	0-60A	0-35A	0-20A	0-8A
Current resolution (theoretical value)		47mA	38mA	140mA	170mA	120mA	68mA	27mA
Constant voltage characteristics								
Regulation	*1	0.005% + 1mV						
Source effect (line regulation) (For ±10% change of line voltage)		0.005% + 2mV						
Load effect (load regulation) (For 0 to 100% change of output current)		50µsec. (5 - 100% change)						
Ripple and noise (5 Hz - 1 MHz) rms	*2	500µV	500µV	500µV	500µV	500µV	1mV	5mV
Transient response (typical)	*3	50 ppm/°C						
Temperature coefficient (typical)		Approx. 0 - 10kΩ, 0 - 10V						
Remote control resistance and voltage								
Constant current characteristics								
Regulation								
Source effect (line regulation) (For ±10% change of line voltage)		3mA	3mA	3mA	3mA	3mA	1mA	1mA
Load effect (load regulation) (For 0 to 100% change of output voltage)		5mA	5mA	5mA	5mA	5mA	3mA	3mA
Ripple and noise (5 Hz - 1 MHz) rms	*2	100mA	100mA	10mA	10mA	8mA	4mA	4mA
Remote control resistance/voltage, approx. [kΩ/V]		0.55/0.3	0.55/0.3	1/0.6	1/0.6	1/1.3	1/1.1	1/0.88
Operating ambient temperature range		0 - 40°C (32 - 104°F)						
Operating ambient humidity range		10% - 90% RH						
Cooling method		Forced air cooling with fan						
Polarity of output voltage		Positive or negative grounded						
Isolation from ground		±250V DC						

Notes: *1. Measured using the sensing terminals.

*2. Measured with the positive or negative output grounded.

*3. Recovery time within 0.05% + 10 mV of the output voltage.

		PAD	PAD	PAD	PAD	PAD	PAD	PAD	PAD
		16-100L	20-80L	35-50L	35-60L	55-35L	110-20L	250-8L	
Model									
Protections:									
Operation									
Trip temperature of thermal protector									
100/120°C(212/248°F) 100°C (212°F) at cooling package									
Overvoltage protection (OVP)									
Voltage setting range *4									
6-18V 6-22V 6-38V 6-38V 11-60V 20-129V 50-280V									
Trigger pulse width *4									
50msec.									
Input fuse rating									
φ20 - 75L									
At 240V AC source									
30A									
At 120V AC source									
50A 50A 50A 60A 50A 50A 50A									
Output fuse rating									
100A 80A 50A 60A 40A 20A 10A									
Meters									
Voltmeter, Full scale, Class 2.5 (JIS)									
10V 20V 35V 35V 60V 110V 250V									
Ammeter, Full scale, Class 2.5 (JIS)									
110A 80A 60A 60A 35A 22A 8A									
Constant voltage mode indication									
C.V : With green lamp									
Constant current mode indication									
C.C : With red lamp									
Insulation resistances									
Between chassis and line									
500V DC, more than 30MΩ									
Between chassis and output terminal									
500V DC, more than 20MΩ									
Dimensions									
*5									
Maximum dimensions									
430W × 241H × 450D mm (16.9W × 9.5H × 17.7D in)									
431W × 291H × 562D mm (17.0W × 11.5H × 22.2D in)									
Weight									
Approx. 63 kg									
Approx. 58 kg									
Approx. 61 kg									
Approx. 62 kg									
Approx. 60 kg									
Approx. 60 kg									
Accessories (in carton)									
Instruction manual									
1 ea.									
Input line fuse (spare)									
30A, 1 ea.									
For 240V AC									
50A, 1 ea.									
60A, 1									
50A, 1 ea.									
For 120V AC									
3-core chhtr/crd 3 m									
Input cord									
Voltage check chips 2 , Lamp 12V, 40mA 2									
Others									
Guard cap 1									

Notes: *4. Typical value

*5. With rack mount brackets (option), can be mounted on a standard 19-inch or 500-mm rack.

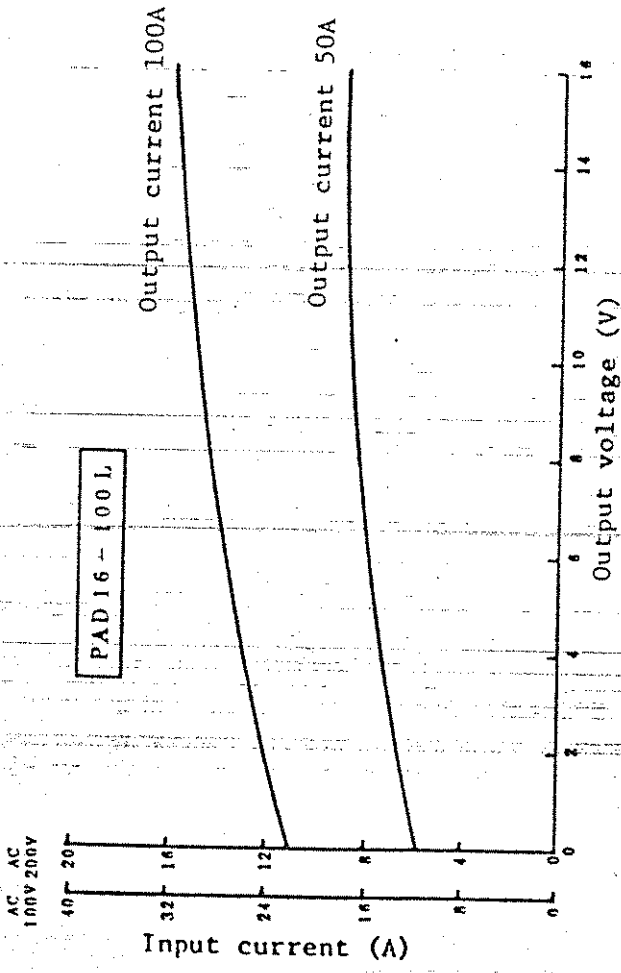

Power Consumption Chart

100V/200V, 50Hz/60Hz AC

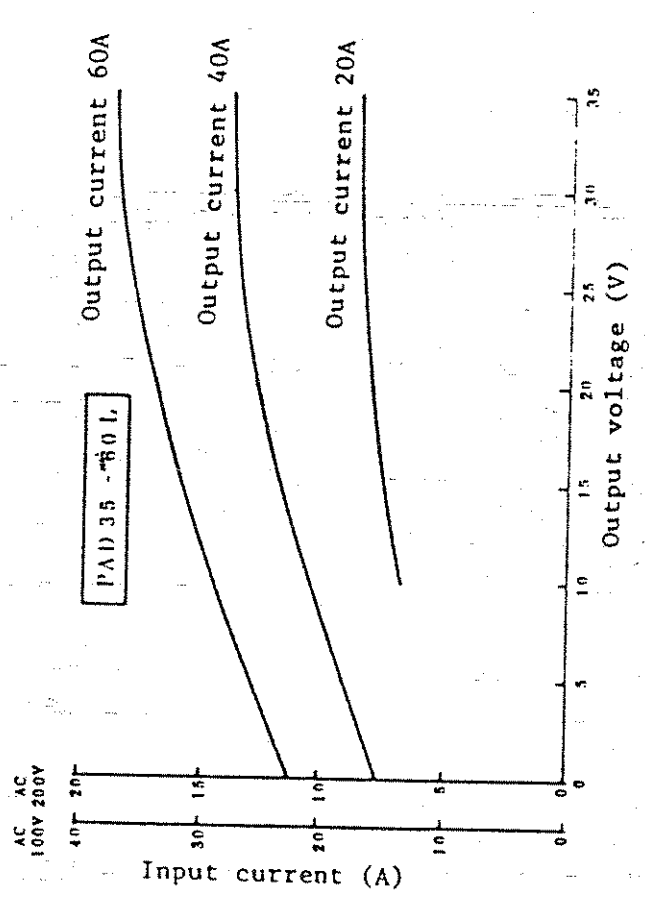
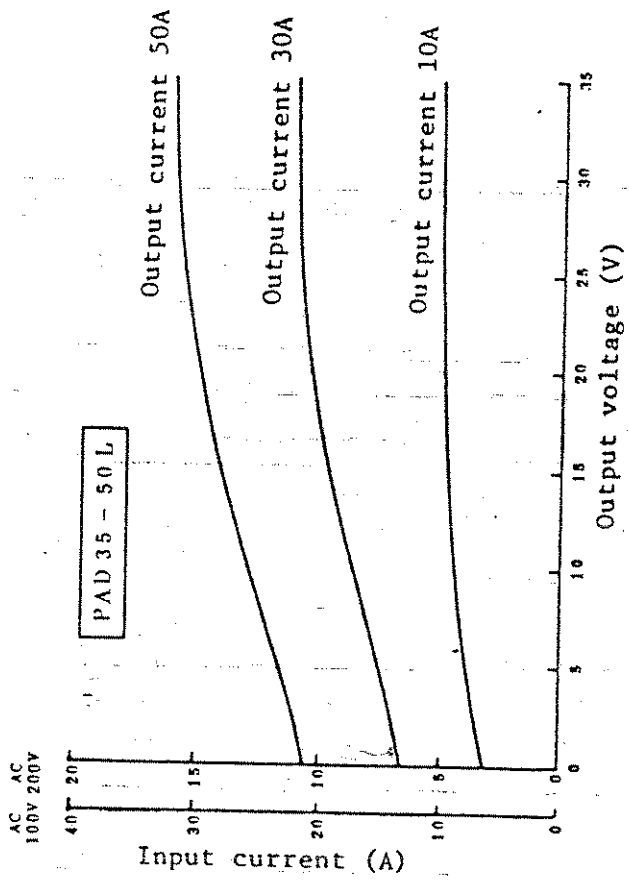
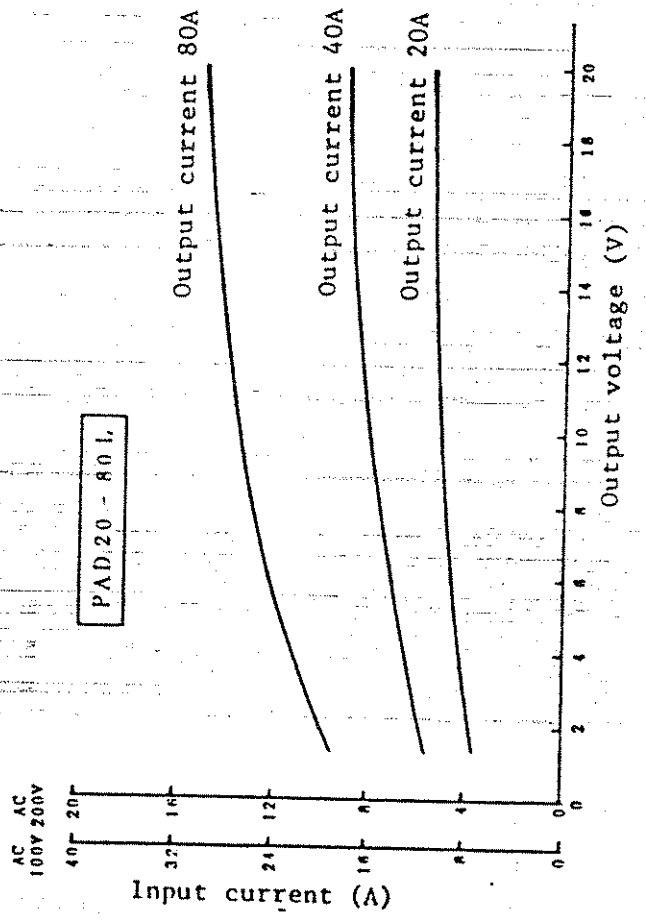

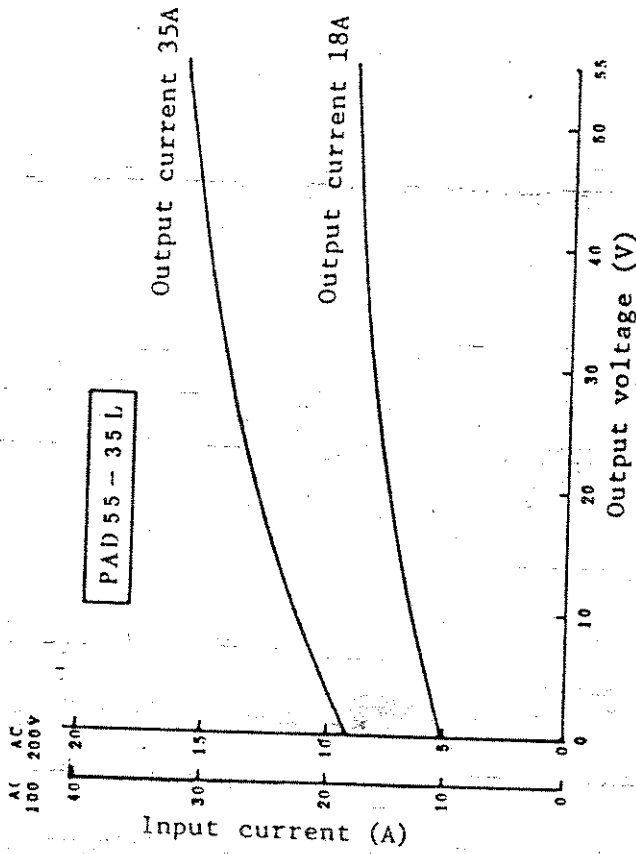

Power Consumption Chart 100V/200V, 50Hz/60Hz AC

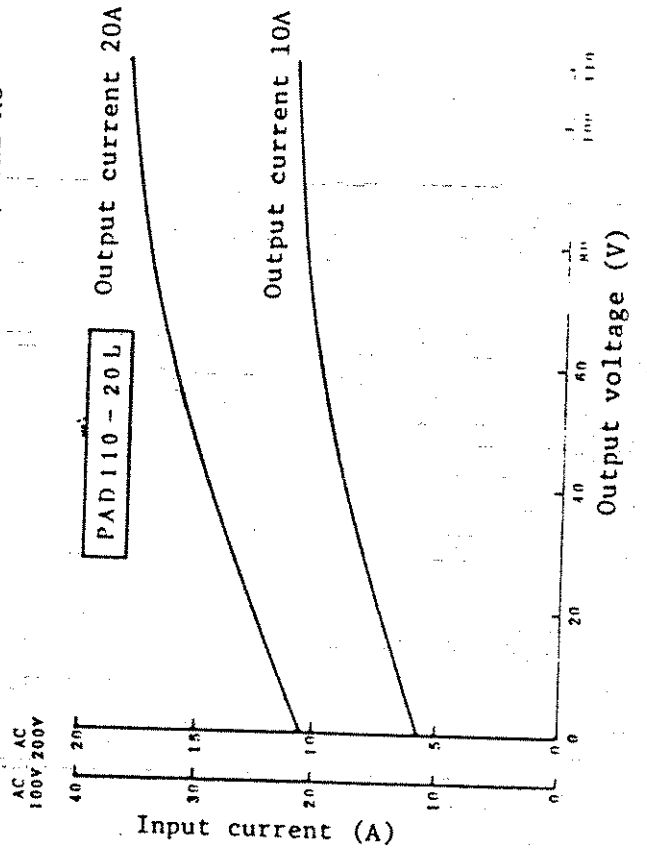

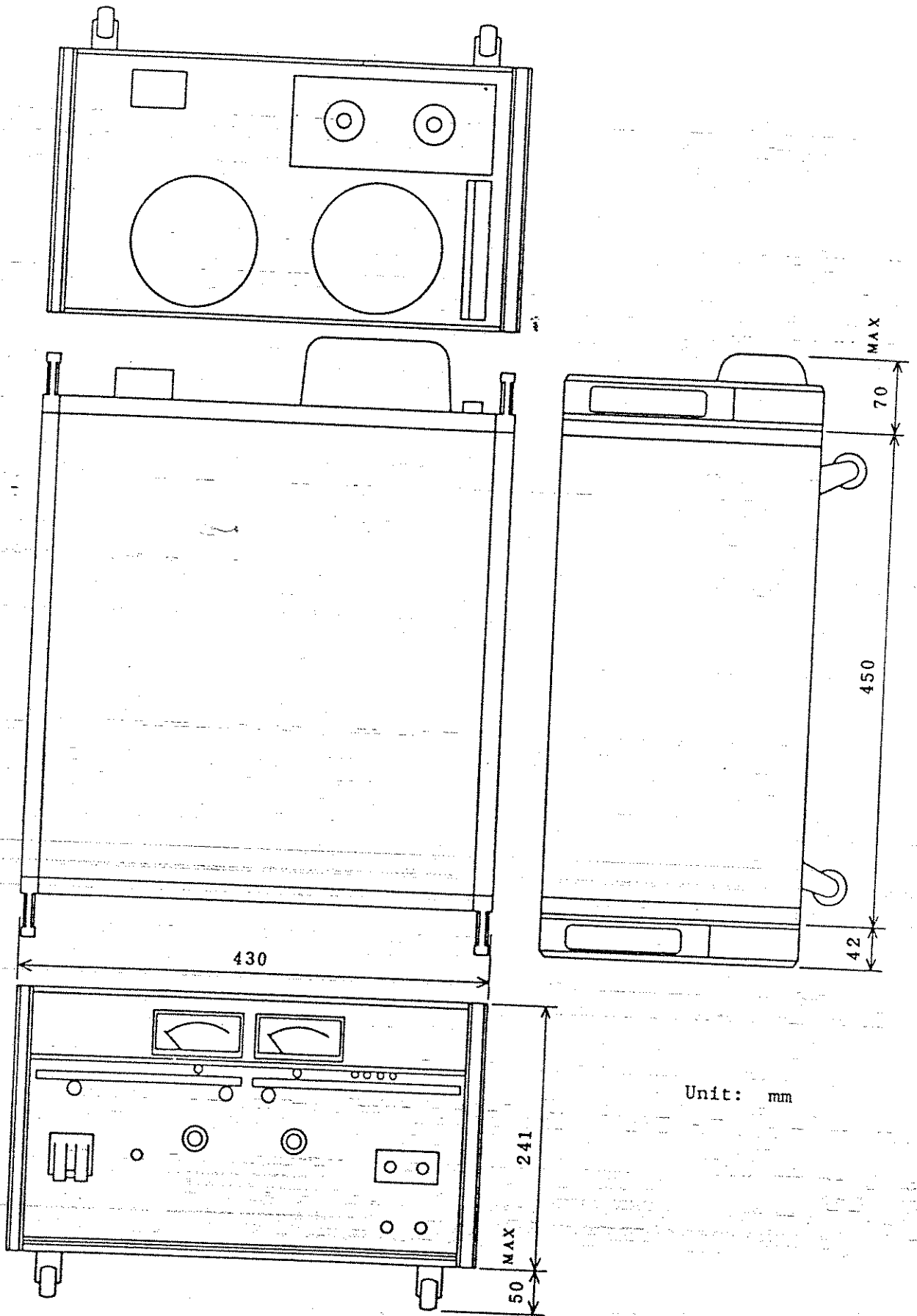

Unit: mm

Figure 1-1. Mechanical Outline Drawing

8
D
A
O
8

SECTION 2. OPERATION

2-1. Precaution for Operation (Installation)

1. Input power

- o The input voltage range is 216 - 264 V (108 - 132 V *), 48 - 62 Hz single-phase AC.

- o The input power fuse rating is

* 50A for 120 V (*60 A for PAD35-60L only)
30A for 240 V

- o For current consumption, see the power consumption charts.

2. Power cord

- o The power cord supplied accompanying this instrument is for 240 V AC. Its conductor wire cross section area is 3.5 mm².

- o To operate on a 120 V AC line power, use a cable of cross section area 8 mm² or over and connect its wires securely with crimping terminals.

- o The green wire supplied is for grounding. Be sure to connect the GND terminal of the instrument to a good earth ground for safety.

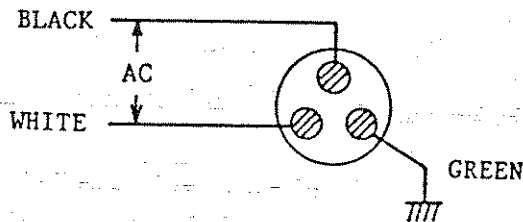

Figure 2-1. Cross section of cable

3. Output

- o Make sure that the jumpers of the terminal blocks on the rear panel are securely connected as shown in Figure 2-2.

8000

- o The output power is available either at the front panel (binding post terminals) or at the rear panel (terminal blocks).

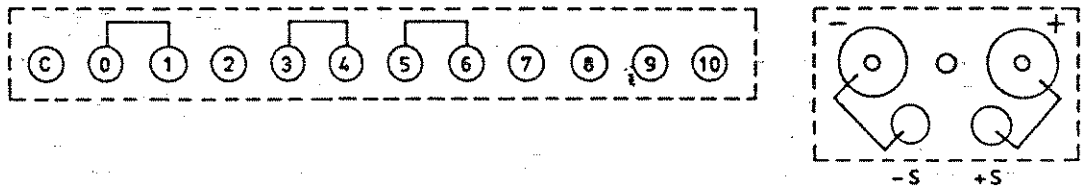

Figure 2-2

- o Normally, connect either one of the output terminals to the GND terminal with the shorting bar.
- o For connecting the output to a load, use wires of a sufficient current rating referring to Table 2-1. If wires of an insufficient current rating is used, the voltage at the load may become unstable due to voltage drop in the wires, or the wires may be overheated in an extreme case.

4. Ambient temperature

- o The ambient temperature range for the power supply to satisfy the specification performances is 0°C to 40°C (32°F to 104°F). The power supply should be used within this range. If it is operated at a high ambient temperature, the internal temperature detector circuit trips and the input power switch is turned off. If this has happened, cool it and then turn on the power again. There is an exponential relationship between ambient temperature and semiconductor life, electrolytic capacitor life and transformer insulation life. Note that components are rapidly deteriorated at high temperatures. It is important not to operate the power supply at an abnormally high ambient temperature also from the viewpoint of its life.

8448

- o If the power supply is used at a temperature lower than -10°C , its operation may become unstable. If the power supply is to be used at low temperatures, specify so when ordering.

5. Place for use

- o Pay attention so that the ventilation ports (top and bottom) and the fan air outlet are not blocked.
- o Hot air comes out of the fan air outlet. Do not place near the outlet an object which is not heat resistant.
- o Do not use the power supply in a highly humid or dusty place as such can cause failures.
- o Select a place where is reasonably free from vibration.
- o Do not place a high sensitivity instrument on or near the power supply which produces a strong electric and magnetic fields.

6. Note for carrying

- o The center of gravity of the power supply is at a forward position. Be careful when raising the power supply.

7. Note for load

Note that the output may become unstable depending on characteristics of loads as follows:

- (a) When the meter reading (average value) is less than the preset value, if the current has peaks which exceed the preset value, the operation is driven into the constant current domain for the short periods of time and the output voltage falls. Observing carefully, it can be seen that the constant-current indicator lamp becomes dim.

227008

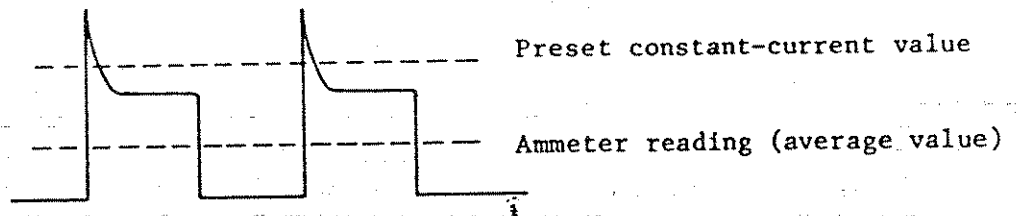

Figure 2-3. Load current with peaks

In this case, raise the preset value or increase the current rating.

- (b) When a regenerative load (such as inverter, converter, or transformer) is connected to the power supply, as it cannot absorb the reverse current fed from the load, the output voltage increases and becomes unstable. In such a case, connect a bypass resistor (R) in parallel with the load and feed in this resistor a current larger than the maximum reverse current.

$$R [\Omega] \leq \frac{E_0 [V]}{I_{RP} [A]}$$

where, E_0 : Output voltage

I_{RP} : Maximum reverse current

S044274

Table 2-1. Wire gauges and current ratings

Ta=30°C (86°F)

Nominal cross section	Maximum current recommended by Kikusui	Maximum current designated by Electrical Installation Technical Ordinance (Article 29) JAPAN
2 mm ²	10 A	27 A
5.5 mm ²	20 A	49 A
8 mm ²	30 A	61 A
14 mm ²	50 A	88 A
22 mm ²	80 A	115 A
30 mm ²		139 A
38 mm ²	100 A	162 A
50 mm ²		190 A
60 mm ²		217 A
80 mm ²	200 A	257 A
100 mm ²		298 A
125 mm ²		344 A
150 mm ²	300 A	395 A
200 mm ²		469 A

8000

2-2. AC Input Requirements

By changing internal connections, this instrument can be operated either on a 120 V $\pm 10\%$ line or a 240 V $\pm 10\%$ line.

1. Change connections of the main power transformer as shown in Figure 2-3.
2. Change the input power fuse: For 120 V AC 50 A*
For 240 V AC 30 A
(* For PAD35-60L at 120 V AC 60 A)
3. Change the input voltage markplate. (See Figure 2-4.)
4. Change the power cord.

120 V AC: Use a cable of nominal cross section area 8 mm² or over.

240 V AC: Use the power cord which accompanies the instrument. (3.5 mm² cable)

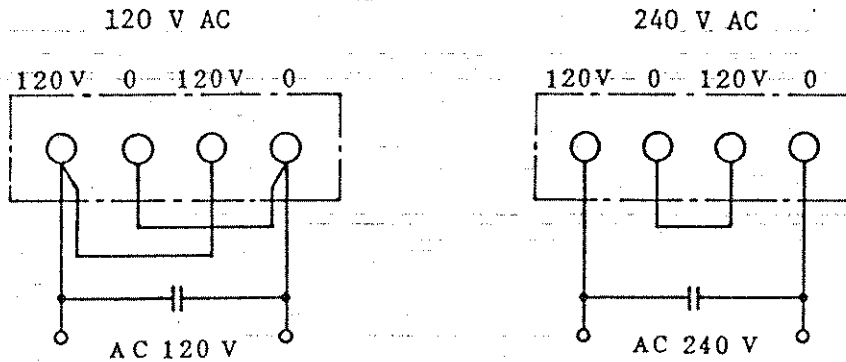

Figure 2-4



Figure 2-5

80443

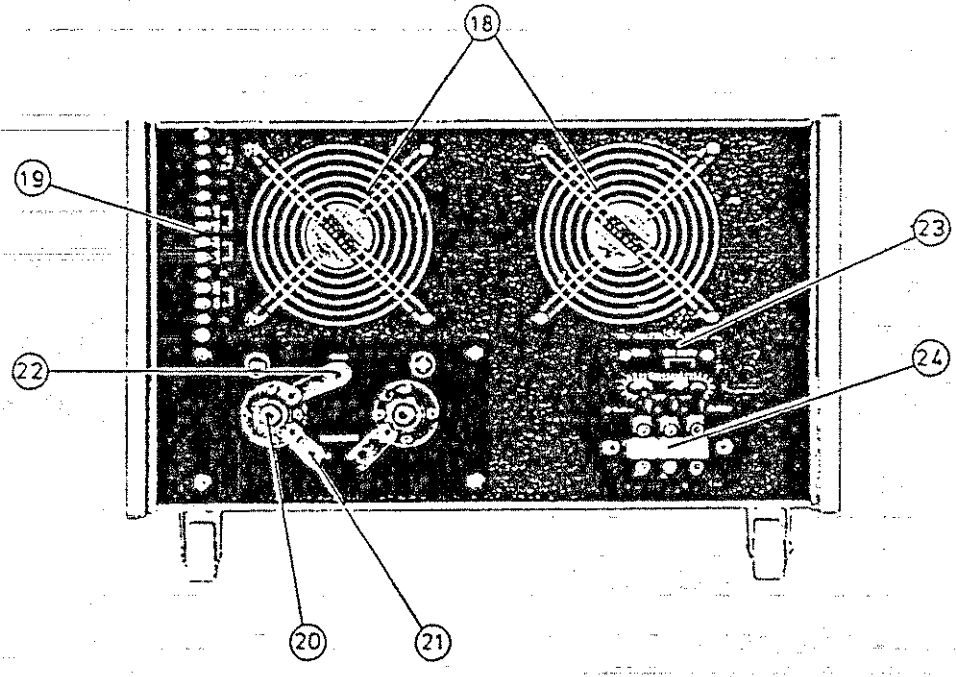
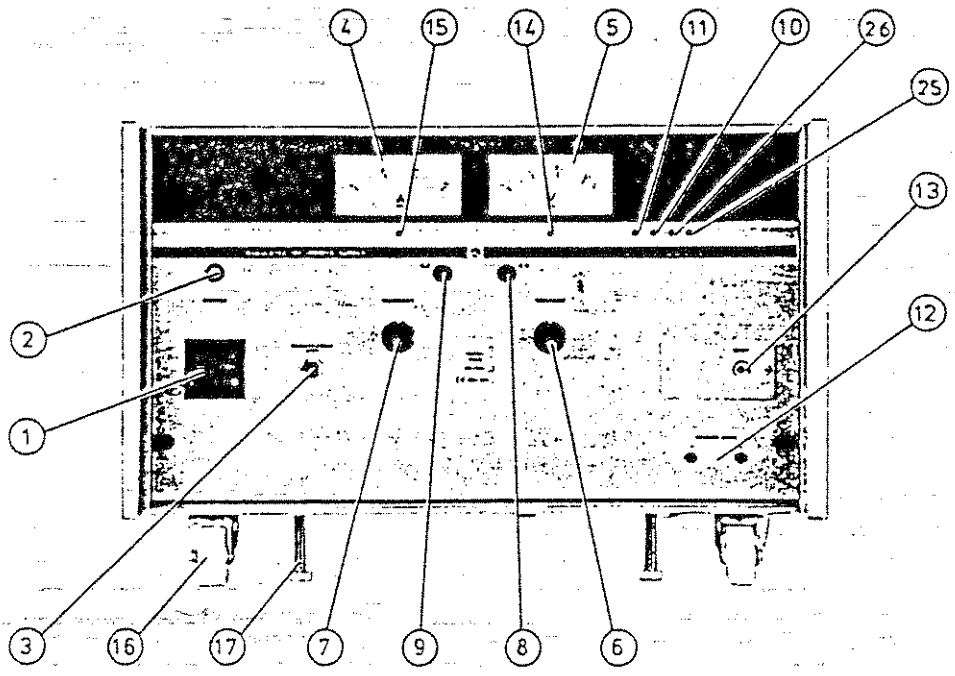

Figure 2-6. Front and Rear Panel

88.8.26

80445

2-3. Explanation of Front and Rear

Nomenclature and description of panel items

1. POWER switch: Serves as AC power switch. When this switch is thrown to the upper position, the instrument power is turned on and the power indicator lamp lights.

Note: When any one of the internal protectors (overvoltage protector, voltage detector, current detector, and temperature detector) has tripped, this switch is automatically turned off. Once it has been turned off, it cannot be immediately turned on. Wait about 60 minutes before turning on the switch again. Be sure to eliminate the cause of switch trip before turning on the switch again.

2. POWER indicator lamp: Indicates that the instrument power is on.
Color: Amber. Type: 0L-394 (12 V, 40 mA)

3. CURRENT/VOLTAGE LIMIT switch: Push to set crossover point of C.C/C.V.
The ammeter indicates the set constant-current value and the voltmeter indicates the set constant-voltage value.

4. Ammeter: Monitors output current. JIS Class 2.5

5. Voltmeter: Monitors output voltage. JIS Class 2.5

6. Voltage setting knob: Adjusts output voltage for constant-voltage operation. 10-turn potentiometer. (See Figure 2-7.)

804431A

7. Current setting knob: Adjusts output current for constant-current operation. 1-turn potentiometer. (The PAD16-100L and PAD20-80L have dual knobs: -outer one for coarse adjustment and inner one for fine adjustment.)
8. C.V (constant-voltage mode indicator lamp): Energizes in constant-voltage mode. Color: green.
Type: OL-394 (12 V, 40 mA)
9. C.C (constant-current mode indicator lamp): Energizes in constant-current mode. Color: red.
Type: OL-394 (12 V, 40 mA)
10. Voltmeter calibration (R101): For periodic calibration of voltmeter. (See the section for maintenance.)
11. Ammeter calibration (R102): For periodic calibration of ammeter. (See the section for maintenance.)
12. Voltage check terminal: To check the output voltage on the front panel. May be used to set accurately the output voltage, using the tip connector supplied. A 0.1-ampere fuse is incorporated.

(Note): When a guard cap (accessory) used, the potentiometer is fixed or semi-fixed as shown under.

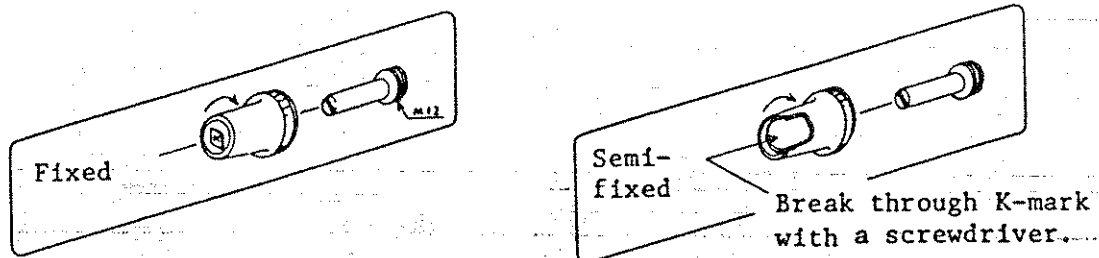

Figure 2-7

8044321

13. OVP (overvoltage protector):

Setting the overvoltage protection voltage. At the instant the output voltage has exceeded this voltage due to erroneous operation, instrument failure or any other cause, the power switch is cut off in order to protect the load. (Refer to the overvoltage protection function of section 3-3.)

14. Voltmeter zero-adjustment : For zero-adjustment of voltmeter.
voltmeter.

15. Ammeter zero-adjustment : For zero-adjustment of ammeter.

16. Casters: For moving the instrument

17. Stopper: For fixing the instrument. Turn the bolt, slightly raise the front caster, and fix the stopper.

18. Fan exhaust area: The air outlet of the cooling package.

Hot air comes out of this hole. Do not obstruct. Lest the air flow should be impeded, keep the hole apart from the wall by 30 cm or more.

19. Terminal block: Terminals for remote control, parallel operation, etc. (Refer to the section for applications.)

20. Output terminal: Provides the output. Terminal section M10.

8044331

21. Sensing terminal:

- o When operated in the constant-voltage mode, this terminal provides the signal for regulating the output.
- o When operated in the remote sensing mode, disconnect the jumper from between output terminal and sensing terminal, and connect the sensing signal wires to the load point where the voltage is to be regulated. (Refer to the section for applications.)
- o Do not connect any load to the sensing terminal.

22. GND terminal: Be sure to connect this terminal to a good earth ground.

23. Input voltage markplate: Indicates the input voltage requirements.

24. Input terminal board: For input power connection. For 240 V AC power, use the power cord supplied accompanying the instrument. For 120 V AC, use a cable the conductor wire size of which is cross section area 8 mm^2 or over.

25. Output voltage offset control (V.os):

For adjustment of output voltage when the voltage setting knob is turned to the counterclockwise extreme position or for adjustment of input offset voltage when in remote control with voltage signal.

26. Output current offset control (I.os):

For adjustment of output current when the current setting knob is turned to the counterclockwise extreme position or for adjustment of input offset voltage when in remote control with voltage signal.

28-8-26
2744

2-4. Constant-voltage Operation

Check first that the AC line voltage is 240 V (120 V) $\pm 10\%$ AC.

Then, proceed as follows:

- (1) Turn the current setting knob to the extremely counterclockwise position.
- (2) Turn on the input power switch. The C.C. lamp (red LED) will light indicating that the instrument power is on.
- (3) Keeping depressed the current/voltage limit switch, set the output voltage at the required value with the voltage setting knob. By this procedure, setting of the output voltage is complete. (At this stage, the output power is not delivered to the output terminals yet.)
- (4) Gradually turn clockwise the current setting knob to the point where the C.V. lamp (green) lights and the output power is delivered to the output terminals.

Setting of current limit

- (5) Keeping depressed the current/voltage limit switch, set the required constant current value with the current setting knob. Once this setting is done, no output current larger than the set value flows even when the load is rapidly changed. (The load is protected by automatically changing the instrument operation from the constant-voltage mode to the constant-current mode. This function is called "crossover".)

Notes: 1. Pay attention when setting the O.V.P. voltage. At the instant the O.V.P. circuit operates, the input power switch is cut off. Set the O.V.P. voltage with an allowance of approximately 10%.

88
75
88
88
88

Note: 2. When the load resistance is unpredictable or it is predicted to vary largely or when it has a large inductance and rapid voltage application is undesirable, gradually increase the output current by increasing the output voltage or by gradually turning the current setting knob from the counterclockwise position in the clockwise direction.

2-5. Constant-current Operation

- (1) Make sure that the AC line voltage is 240 V (120 V) $\pm 10\%$. Then, connect the input power.
- (2) Turn on the input power switch. The C.V. or C.C. lamp will turn on indicating that the power supply is in the operating state.
- (3) Keeping depressed the current/voltage limit switch, set the current at the required value with the constant-current knob and, at the same time, set the voltage limit value with the constant-voltage knob. Once this setting is done, the load is protected against overvoltage.
- (4) Turn off the input power switch. Connect the load to the output terminals of the power supply and, then, turn on the input power switch.

- Notes:
1. If the load has a large inductance and it is undesirable to apply rapidly a large current, set the current setting knob in the extremely counterclockwise position and, then, turn on the power switch and gradually increase the current.
 2. If the current/voltage limit switch is depressed when in the constant-current mode, the output current is reduced by approximately 2 mA from the preset value. Pay attention if the load is of such nature that this 2 mA change is critical.

28.8.26
2-4-36

SECTION 3. PROTECTORS-

3-1. Description

Regulated DC power supplies are used, as their name indicates, to supply regulated powers to loads of various types of electronic equipment. Demands for regulated DC power supplies have rapidly increased in recent years. As is the case for other types of electronic equipment, these instruments are required to include features of fast response, high reliability, high efficiency, high power factor, compactness, light weight, and economical price. Various types of power supplies are available on the market today. When selecting regulated DC power supplies, in addition to satisfying the required performances, special attention must be paid to some particular requirements which are slightly different from those required by other types of electronic equipment which handle electronic signals.

The above difference comes from the fact that regulated DC power supplies handle "powers." Malfunctioning or erroneous operation of the power supply leads to shut down of the overall system, damage to the power supply equipment and expensive load equipment, or to a fire in an extreme case. As the power supply provides the base for the entire electric and electronic circuits of the system to which it supplies the power, its reliability is very important. Protective features, which prevent serious damage when the power supply should fail, are important factors to be taken into consideration when selecting a power supply.

The PAD-L Regulated Power Supplies have been designed fully taking the above matters into consideration, as instruments of very high reliability. They employ premium quality components, with sufficient derating. They are incorporated with protector which lead them to "the safer side" should they fail. Individual protectors are explained in this section.

3-2. Explanation of Protective Circuits

(1) Overvoltage protector:

A limiting voltage can be set from the instrument front panel. If the output voltage exceeds the preset voltage, the input power switch is cut off. The operation time is approximately 50 msec.

(2) Voltage detection circuit:

When the rated voltage of the electrolytic filter capacitor is exceeded due to such erroneous operation as disconnected jumper of the terminal block on the rear panel or due to a failure of the rectifier circuit, the input power switch is instantaneously cut off.

(3) Current detection circuit:

When in such erroneous operation as that the jumper of the terminal block of the rear panel is inadvertently left disconnected or when the current limiting circuit has failed, the control transistors are cut off and at the same time the input power switch is cut off or the current is limited at approximately 120% of the rated current.

(4) Temperature detection circuit:

Detects temperature of the cooling package (semiconductor cooling unit). When temperature of the cooling fins have become higher than approximately 100°C due to ambient temperature rise or cooling fan failure, the input power switch is cut off.

(5) High-speed overvoltage protector (option):

When the output voltage has exceeded the preset voltage due to erroneous operation or an external pulse voltage,

a thyristor circuit connected between the output terminals instantaneously conducts to short-circuit the output and, at the same time, the input power switch is instantaneously cut off. The operation time is selectable from a range of several microseconds to several hundreds microseconds.

Model PAD-		16-100L	20-80L	35-50L	35-60L
OVP type		OVP 16-100LN	OVP 35-100LN	OVP 35-60LN	OVP 35-60LN

Model PAD-	55-35L		110-20L		250-8L
OVP type	OVP 55-35LN		OVP 110-20LN		OVP 250-8LN

Table 3-1

(6) Power fuse:

Limits the input current.

(7) Output fuse:

Limits the output current.

Both fuses are current limiting type of fuses meeting the requirements of JIS and model-approved by the Electrical Appliance Control Ordinance. The fuses employ a ceramic insulation tube and silica sand arc killer, and are free of flame when blown out.

3-3. Operation Method of Overvoltage Protector (OVP)

Setting procedure

- (1) Turn the OVP potentiometer to the extreme clockwise position with a screwdriver.
- (2) Set the output voltage at the required operating point of the OVP.

(3) Gradually turn counterclockwise the OVP potentiometer to the point where the input power switch is cut off.

(4) Lower the output voltage and turn on the input power again and check once more the operating point of the OVP circuit before using the power supply for its load. (Once the OVP circuit has tripped, the input power switch can not be turned on again until a period of several seconds elapses.)

SECTION 4. APPLICATIONS

4-1. Remote Sensing

Voltage drop caused by the load connection wire resistance and contact resistance can be compensated for.

1. Turn off the input power switch.
2. Disconnect the jumper wires from between +S and (+) terminals and between -S and (-) terminals on the instrument rear panel.
3. Connect the +S and -S wires to the point where the output voltage drop is required to be compensated for. (Use a shielded cable in order to prevent induction of ripple voltage. Connect the external shielding wire to the (+) line of the output.)

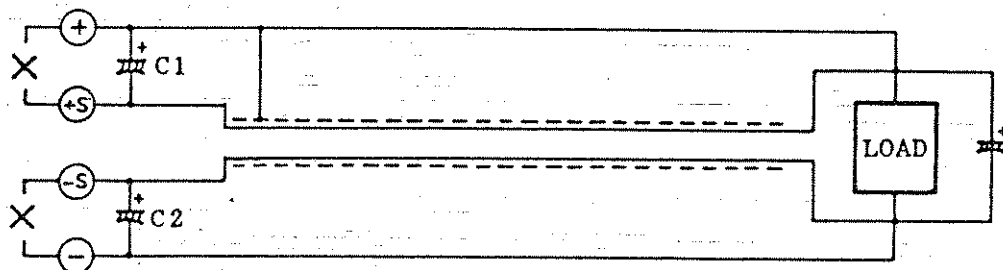

C1, C2: 100 μ F, 16WV

Figure 4-1

- Notes: 1. By this remote sensing feature, up to approximately 1.2 V of voltage drop per one-way of connection wire can be compensated for. Note that, if the voltage drop is larger than 0.3 V, the maximum rated voltage is reduced by the corresponding amount.

V177708

2. If the load connection cable is longer than 3 - 5 meters, phase shift caused by inductance and capacitance of the cable wires becomes noticeable and the circuit may oscillate. In such a case, connect capacitors C1 and C2 and connect an electrolytic capacitor of several hundred microfarads in parallel with the load as shown in Figure 4-1.

4-2. Output Voltage Control with an External Voltage or Resistance

o Control with an external resistance - I

1. Turn off the input power switch. (Be sure to turn off the input power switch whenever connecting or disconnecting wires of the rear terminals.)
2. Disconnect the jumper from between terminal ③ and ④.
3. Connect a 100-ohm potentiometer and another potentiometer (R1) between terminals ④ and ⑤.
4. Set R1 at zero and so adjust the 100-ohm potentiometer that the output voltage becomes zero.

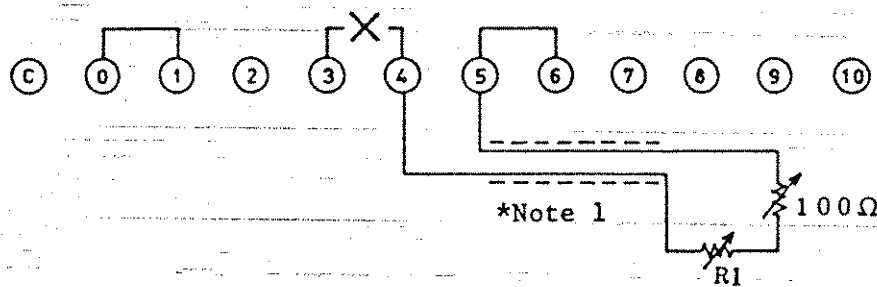

Figure 4-2

1204421

$$\text{Output voltage } E_o = \frac{E_{\text{max}} \cdot R_1}{10} \text{ [V]}$$

Where, $10 \geq R_1$ [k Ω]

E_{max} : Rated output voltage [V]

*Note 1: Use a 2-core shielded cable or a pair of stranded wires. Connect the shield wire to the "+" output terminal.

o Application

o By using a fixed resistor and a potentiometer, the voltage can be varied by plus or minus several percent of the set voltage.

o Resolution of the output voltage depends on resistor R_1 . Therefore, required resolution can be obtained by using an appropriate value of potentiometer for R_1 .

o A programmed voltage can be obtained by varying the resistance with switch setting. (For this purpose, use switches of a closed circuit type or continuous type which do not cause momentary open circuit.)

o Control with an external resistance - II

(This method is a fail-safe method free from overshoots even when resistors are switched.)

1. Turn off the input power switch.
2. Disconnect the jumper from between terminals ⑤ and ⑥.
3. Connect the resistor (potentiometer R_2) between terminals ⑤ and ⑥.

8044437

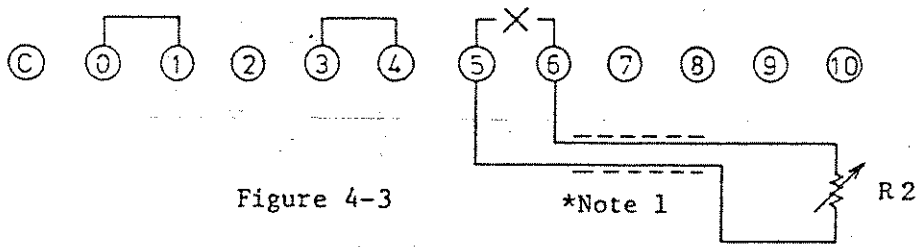

Figure 4-3

$$E_o = \frac{b}{a + R_2} \times E_{ref} \text{ [V]}$$

- E_o: Output voltage
- E_{ref}: Reference voltage, 0 to 10 V
- R₂: 0 ≤ R₂ ≤ ∞ (infinite)
- a, b: Constants (depend on model)

The output voltage (E_o) is inversely proportional to the resistance (R₂) as shown below. Therefore, when the circuit has become open due to switching of resistors or a failure, the resistance becomes infinity and the output is reduced to zero.

PAD -		16-100L	20-80L	35-50L	35-60L
a [kΩ]		3.3	3.0	3.4	3.4
b [kΩ]		5.2	6.0	12	12

PAD -	55-35L		110-20L		250-8L
a [kΩ]	5.5		9.8		9.9
b [kΩ]	30		108		248

Table 4-1

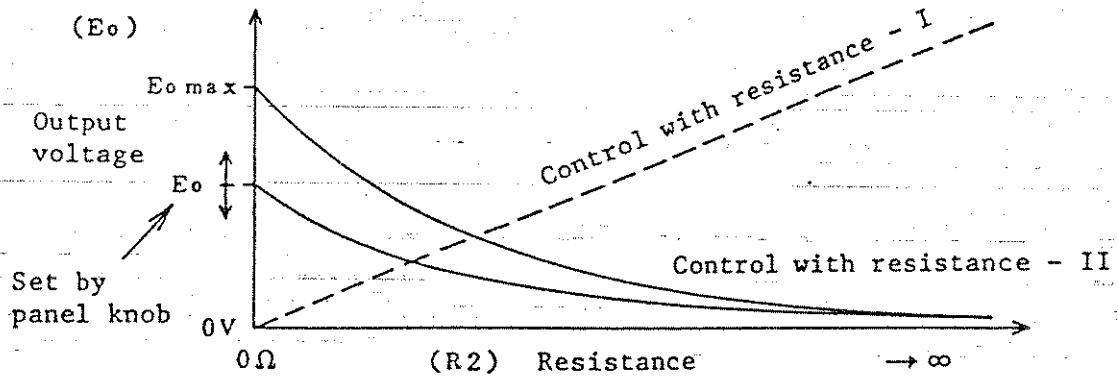

Figure 4-4

o Output voltage E_o can be calculated from R_2 and E_{ref} , using the above equation. E_{ref} can be set by means of the voltage setting knob on the front panel. (When the knob on the front panel is to be made ineffective, disconnect the shorting bar from between terminals ③ and ④ and connect a 10-k Ω resistor of good temperature coefficient between terminals ④ and ⑤ as when in "control with resistance - I.")

o The primary objective of this mode of operation is to attain such a fail-safe feature that the output voltage drops when the output circuit is inadvertently made open. A disadvantage of this mode of operation is that a high resistor is required when programming for operation at low voltages. In general, a potentiometer of 0 - 200 k Ω or thereabout is used. (When using a high resistor, pay attention to its temperature coefficient and noise property.)

o Control with an external voltage

1. Turn-off the input power switch.

2. Disconnect the jumper from between terminals ⑤ and ⑥.

3. Apply an external control voltage between terminals ⑥ and $\oplus S$. (Pay attention to the polarity.)

The terminal for the common line of the control voltage signal is $\oplus S$. The external control voltage signal must be of an isolated type. Note that the power supply may be damaged if the control voltage signal is not of an isolated type. When the output is controlled for both constant-current and constant-voltage simultaneously, the respective control voltage signals must be of an isolated type because the common lines of the two control circuits are not connected in common.

* The instrument may be damaged if there is a wrong connection or an abnormally large voltage is applied. Check for them once more before turning on the instrument power.

88.8-1

8C 1/4

o There is an offset voltage between the input control voltage and the output voltage as shown below.

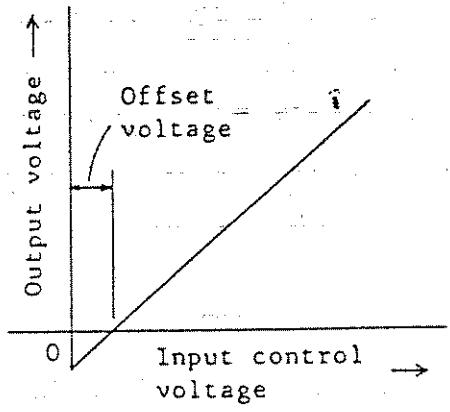

The input offset voltage can be adjusted with the output voltage offset control.

88
8
26
8708

4-3. On-off Control of Output

A. For voltage preset with voltage limit switch when output is off

1. Turn off the input power switch.
2. Connect an external switch between terminals ① and ②.
3. Turn on the input power switch. If the external switch is turned on, the output becomes almost zero. If it is turned off, the output power is delivered.

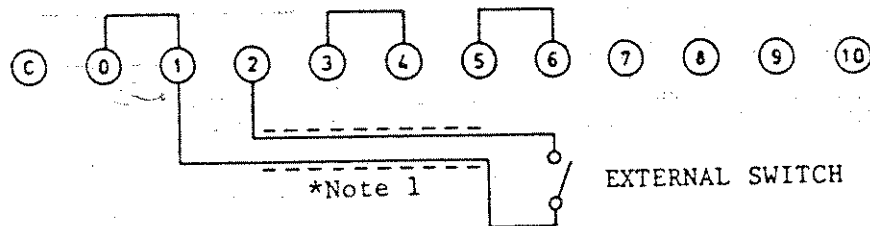

Figure 4-6

Note: When the output is in the off state, the output voltage of less than 0.6 V in the reverse polarity may be produced and a current of approximately 10 mA may flow depending on the type of the power supply. If such remaining voltage is not allowable, use method B explained in the subsequent paragraph. When the output is off, the current limit switch cannot be used.

B. To make the output voltage accurately zero volts

1. Turn off the power switch.
2. Connect an external switch and a 100-ohm potentiometer between terminals ④ and ⑤.
3. Turn on the input power switch. Next, turn on the external switch.

4. Adjust the output voltage to zero volts with the potentiometer.
5. If the external switch is turned on, the output voltage becomes zero; if it is turned off, the output power is delivered.

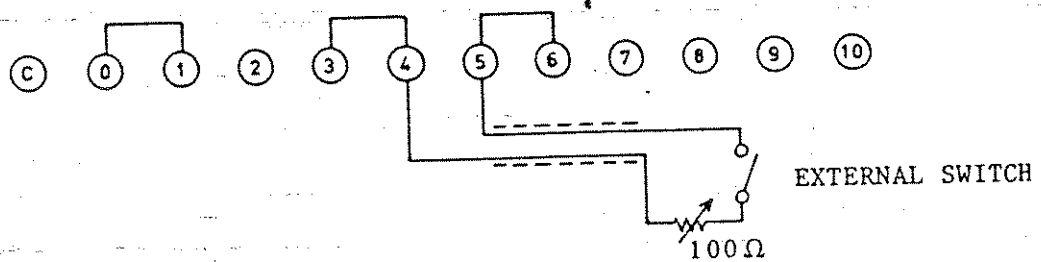

Figure 4-7

Note: When the output is off, the voltage limit switch cannot be used.

4-4. Output Current Control with an External Voltage or Resistance

o Control with an external resistance

1. Turn off the input power switch. (Be sure to turn off the power switch whenever connecting or disconnecting wires of the rear terminals.)
2. Disconnect the jumper from between terminals ① and ②.
3. Connect R2 and R3 potentiometers between terminals ① and ②.
4. Adjust the 10-ohm potentiometer so that the output current becomes zero when R2 is zero.

804448A

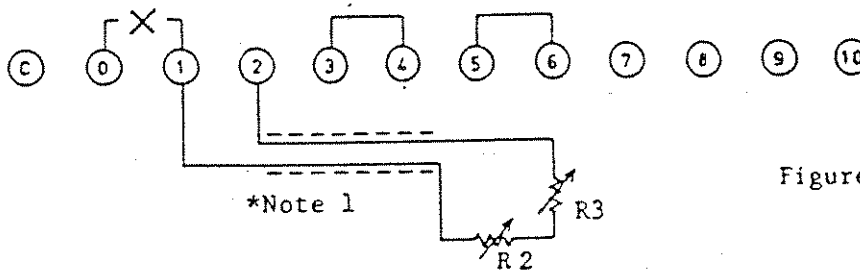

Figure 4-8

$$\text{Output current } I_o = \frac{R_2 \cdot I_{\text{omax}}}{A} \text{ [A]}$$

*Note 2

Where, $R_2 \leq A$ [Ω]

I_{omax} : Rated output current [A]

R_3 : Approx. 10 - 30 Ω

Model PAD-		16-100L	20-80L	35-50L	35-60L
A		550	550	1000	1000

Model PAD-	55-35L		110-20L		250-8L
A	1000		1000		1000

Table 4-2

*Note 1: Use a 2-core shielded cable. Connect the shield wire to the "+" output terminal.

*Note 2: Linearity between R_2 and I_o is approximately 5%.

o Control with an external voltage

1. Turn off the power switch.
2. Disconnect the jumper from between terminals ① and ②.
3. Throw switch SW1 on PCB A-200 board to the upper position as shown in Figure 4-10. For location of the PCB, see Figure 6-1.
4. Connect electrolytic capacitor between terminals ① and ②.
5. Apply the external control voltage between terminals ① and ②. The potential of control common terminal ② is almost identical with that of output terminal ⊕. The external control voltage signal must be of an isolated type.

70000
7706

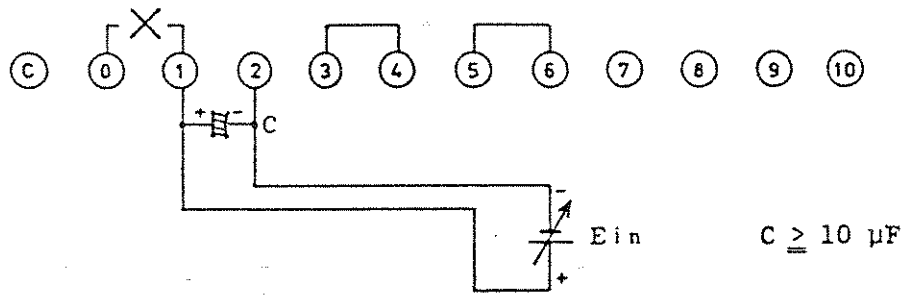

Figure 4-9

$$I_{out} = \frac{E_{in}}{R} \text{ [A]}$$

Where, $E_{in} \text{ [V]} \leq E_{inmax}$

I_{out} : Output current

E_{in} : Input current

R: Detecting resistor

E_{inmax} : Maximum input voltage

Model PAD-		16-100L	20-80L	35-50L	35-60L
R [Ω]		0.003	0.003	0.01	0.0083
E_{inmax} [mV]		330	265	550	550

Model PAD-	55-35L		110-20L		250-8L
R [Ω]	0.033		0.05		0.1
E_{inmax} [mV]	1270		1100		880

Table 4-3

- Notes:
1. Make sure that the output current does not exceed the maximum rated current.
 2. The input voltage (external control voltage) must be within a range of 0 V to the maximum input voltage.
 3. Noise included in the input voltage is amplified and reflected on the output voltage. Sufficiently reduce the noise component of the input signal.

4. Be sure to throw switch SW1 to the original state (lower position) after the operation in the remote control mode is over.

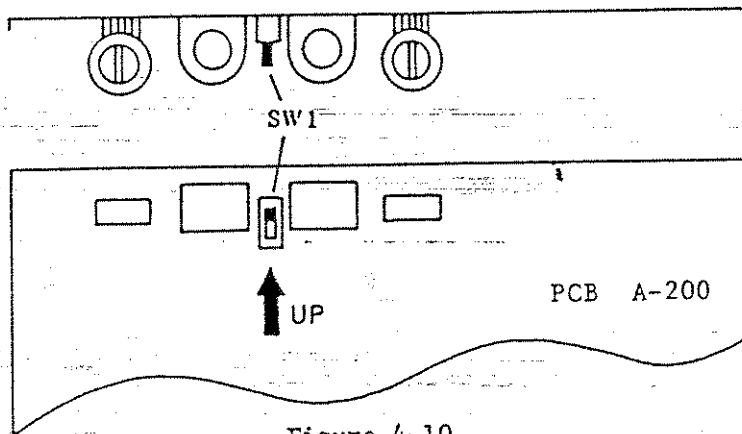
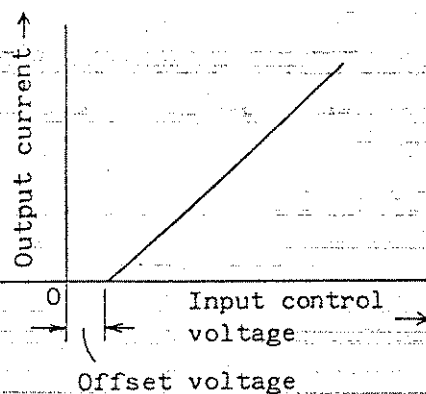

Figure 4-10

- o There is an offset voltage between the input control voltage and the output current as shown below.



For particular applications which do not tolerate this offset voltage, adjust it with the output current offset control.

4-5. One-control Parallel Operation

One master unit and any number of slave units can be operated in parallel to increase the current capacity, controlled by one unit (master unit) for operation.

1. Turn off the input power switch.
2. Disconnect the jumper from between terminals ① and ② of each slave unit.
3. Connect terminal ③ of the master unit to terminals ① of all slave units.
4. Connect parallel the output terminals of all units, for each polarity.

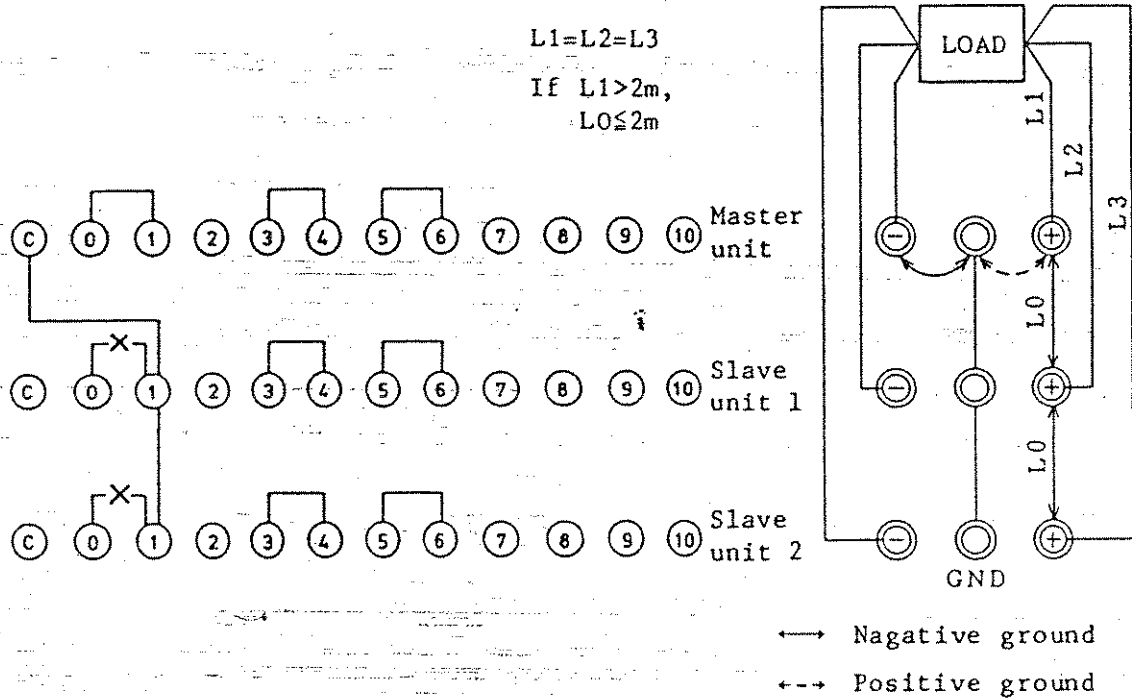

Set the constant-voltage setting knobs of all slave units to maximum position. Of the master unit, the green lamp lights to indicate the constant-voltage mode; of the slave units, the red lamps light to indicate the constant-current mode.

Figure 4-11

5. For one-control parallel operation, connect the GND terminals as shown in Figure 4-11.
6. For one control parallel operation with remote sensing, disconnect the jumper wires from between +S and + terminals and -S and - terminals of the master unit, and make required connections for the master unit as explained in 4-1 "remote sensign".

Note: Set the constant-voltage setting knobs of the slave units to the maximum position. For the wire gauges for the required currents, see Table 2-1.

4-6. One-control Series Operation

One master unit and any number of slave units can be operated in series to obtain a higher output voltage (up to 250 V), controlled by one unit (master unit) for operation.

1. Turn off the input power switch.
2. Disconnect the jumper from between terminals ⑤ and ⑥ of each slave unit.
3. Connect external resistors as shown in Figure 4-12.
4. Connect the rear output terminal as shown in Figure 4-13.
5. Set the current setting knobs of all slave unit to maximum position.

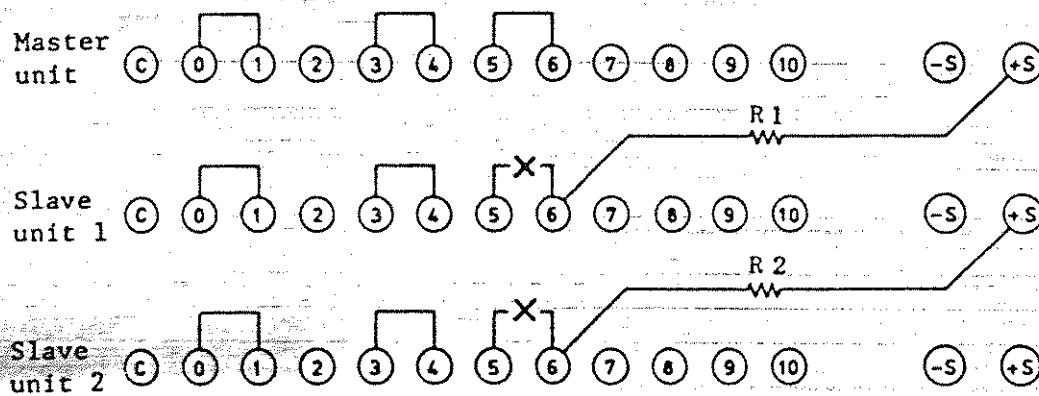

Figure 4-12. Rear terminal connections

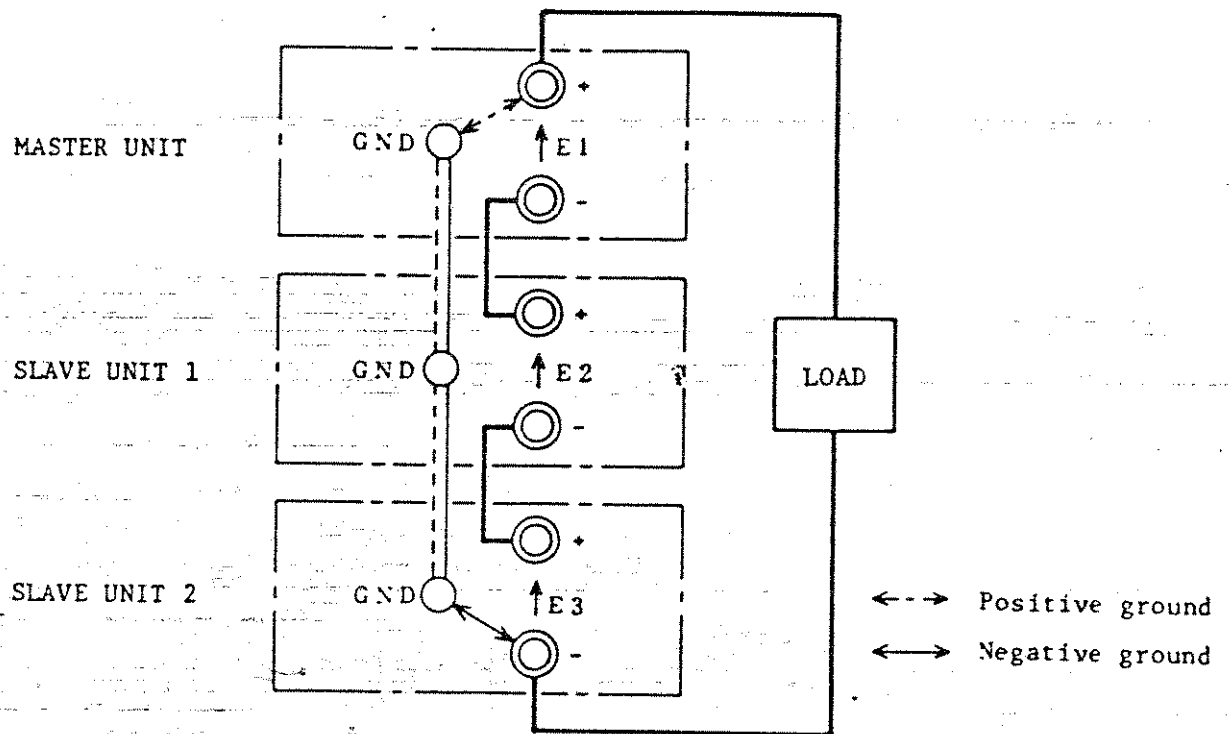

Figure 4-13. Output terminal connections

Resistance Calculation for External Resistor R1 (R2)

$$R1 = \left(\frac{E1}{E2} \times A \right) - B$$

where, $R1 \geq 0$ [k Ω]

E1 [V]: Master instrument output voltage

E2 [V]: Output voltage of slave instrument 1 when master instrument output voltage is E1

A, B: Constants of slave instrument 1. (See Table 4-3.)

$$E2 \leq \frac{A}{B} E1 \dots\dots \text{condition of range for } E2$$

Resistance R2 can be calculated in a similar manner as above, using E2 for E1 and E3 for E2. In this case, slave instrument 1 operates as the master instrument and slave instrument 2 operates as slave instrument 1.

PAD		16-100L	20-80L	35-50L	35-60L
A [kΩ]		5.2	6	12	12
B [kΩ]		3.3	3	3.4	3.4

PAD	55-35L		110-20L		250-8L
A [kΩ]	30		108		248
B [kΩ]	5.5		9.8		9.9

Table 4-4

- Notes:
- o Make the maximum voltage when in series operation not greater than the allowable voltage of the instruments with respect to the ground.
 - o Set to maximum the constant-current setting knob of the slave instruments.
 - o For external resistor R1 (R2), use one with a sufficient wattage allowance. Use a resistor of good temperature coefficient and aging characteristics.
 - o The actual value of R1 may be slightly different from the calculated value. In such a case, adjust the value of R1 (R2).

Applications

1. For one-control series operation with remote sensing, disconnect the jumper wires from the "+S ↔ -" terminals of the master instrument and the "-S ↔ +" terminals of slave instrument 2 (the last instrument), and connect the sensing wires to these terminals. (Refer to the sections for remote sensing.)
2. One-control series operation with other models of this series of instruments also can be done. In such case, the output current is limited by the model of the smallest current rating and, therefore, it is recommended to use as the master instrument the one the current rating of which is the smallest.

4-7. Constant-current Charge/Discharge of Battery or Capacitor

- o Charge (constant current)

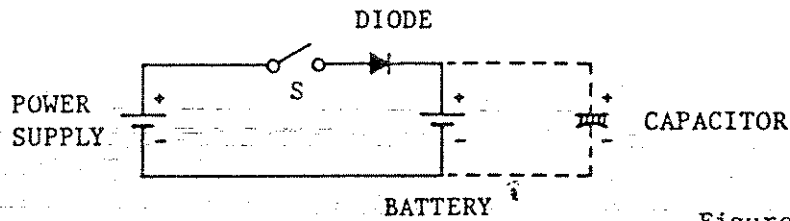

Figure 4-14

1. Keeping depressed the current/voltage limit switch, set the charge end voltage with the constant voltage setting knob and the charge current with the constant-current setting knob.
2. Close switch S so that the charging operation starts. When the charge end voltage is reached, the charging operation stops automatically. (The power supply employs a potentiometer burn protection circuit.)

Notes: 1. Connect the battery in the same polarity with the power supply. (If it is connected in the reverse polarity, the power supply may be damaged.)

2. If the output voltage of power supply is lower than the battery voltage or if the power switch is off, a current of several hundreds milliamperes flows from the battery into the power supply. If this current is not allowable, connect a diode in series with the battery as shown in Figure 4-14.

3. When the PAD16-100L or 20-80L is connected to a battery, the current may flow into the instrument in the reverse direction. This, however, is only for a very short period and causes no problems. (This current does not flow if the instrument is set at a voltage the same with the battery voltage and then the instrument is connected to the battery.)

80445-6

o Discharge (constant current)

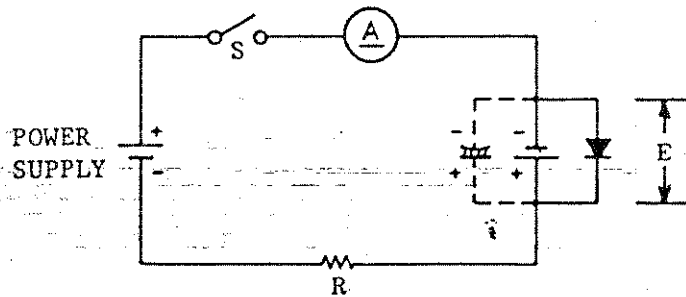

Figure 4-15

Resistance of R: $R = \frac{E[V]}{I[A]}$

Power consumption by R: $P = I^2R [W]$

where, E: Terminal voltage of battery or capacitor when starting discharge

R: Discharge resistor

I: Discharge current (constant current)

D: Reverse current blocking diode

1. Set the output voltage of the power supply with the constant-voltage setting knob to a voltage higher by several volts than the terminal voltage of the battery or capacitor which is to be discharged. (Once this setting is done, constant-current discharge is done until the voltage of the battery or capacitor becomes zero.)
2. Calculate the resistance of the discharge load resistor (R). Pay attention to the wattage of the resistor.
3. Keeping depressed the current/voltage limit switch, set the discharge current with the constant-current setting knob.

00000

4. Close switch S. Constant-current discharge operation will start.

- Notes:
1. To stop discharge, open switch S. (Even when the input power switch of the power supply is cut off, the discharge current flows through the diode which is connected in parallel with the output circuit of the power supply.)
 2. Be sure to connect the discharge load resistor (R). (If the battery or capacitor is directly connected, the power supply may be damaged.)
 3. Be sure to connect the reverse current blocking diode.

4-8. Remote Turning Off of The Power Switch

To turn off the power switch, short-circuit between terminals ⑦ and ⑧ on the rear terminal board.

Note: As terminals ⑦ and ⑧ are at the potential of the "+" terminal of the filter capacitor, a floated (isolated) external contact signal is required for the remote control signal.

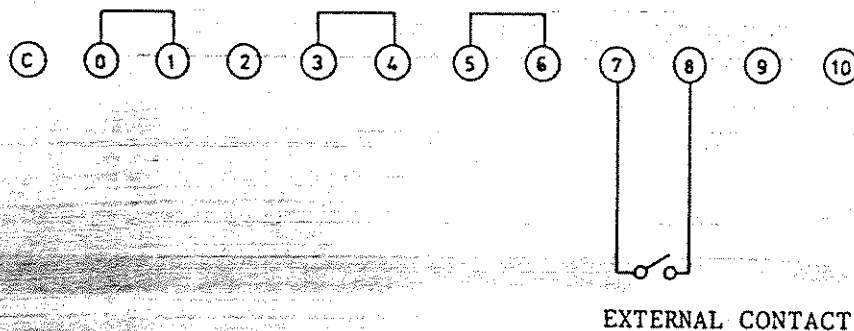

Figure 4-16

SECTION 5. THEORY OF OPERATION

5-1. Description of Pre-regulation Circuit

Before describing the operating principles of individual circuits of the power supply, history of variable regulated DC power supplies are very briefly introduced in the following.

Figure 5-1 shows a series control circuit. This circuit, as compared with other types of control circuits, has a higher control accuracy and provides an output of higher quality. The output voltage is variable for a wide range. Therefore, this circuit is widely used for variable DC power supplies. This circuit, however, has a disadvantage that, when the output power is supplied to a load at a low voltage, V_{CE} increases and consequently collector loss P_C ($P_C = V_{CE} \times I_C$) increases and, therefore, rectifier voltage V_C is required to be varied with respect to the output voltage.

Figure 5-2 shows a power supply circuit which employs a relay system. Variation of the output voltage is detected and transformer taps are switched with a relay circuit to compensate for

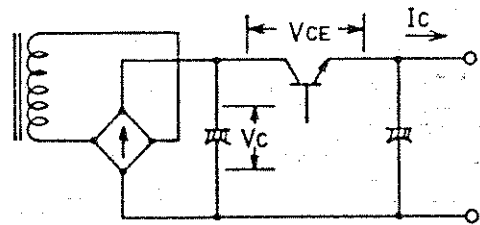

Figure 5-1
Series-controlled power supply

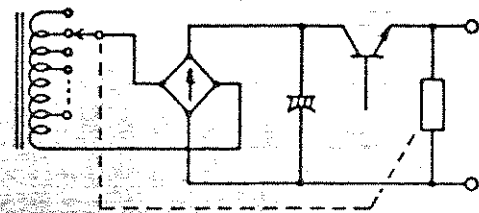

Figure 5-2
Variable regulated DC power supply circuit with relay switching.

output variation. The PAC Series Power Supplies employs this system. This system provides excellent power supplies up to approximately 200 watts. For larger power supplies, however, this relay system has such disadvantages that mechanical contacts have limited life and require maintenance, a number of relays are required to reduce the collector loss, and consequently the reliability falls and the cost rises. To solve the problem, solid-state switching circuit has become most common.

Figure 5-3 shows the SCR system employed by the PAD Series Power Supplies. This system provides a fast response and V_{CE} can be maintained almost constant by phase control and, therefore, it enables high-accuracy large-rating variable power supplies. Thus, a large number of this type of power supplies have been manufactured by Kikusui. However, problems have risen regarding increase of ripple current of the electrolytic capacitor as the filter circuit is a capacitor input type, the surge current of SCRs, and overheating due to copper loss of the transformer when the power factor has become poor.

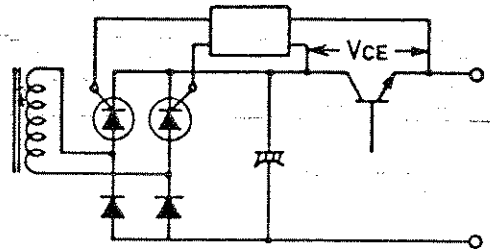

Figure 5-3
Variable regulated DC power supply with SCRs

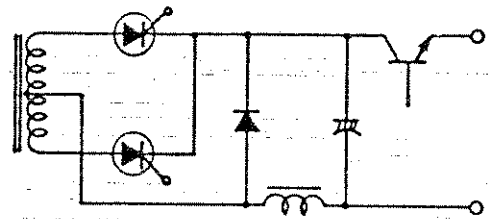

Figure 5-4
Principle of PAD-L Series Power Supplies

100977008

The PAD-L Series Power Supplies have solved the above problems by using a choke-input type filter circuit, and are the most reliable variable regulated DC power supplies available.

5-2. Controlled-Rectifier Circuit and Filter Circuit

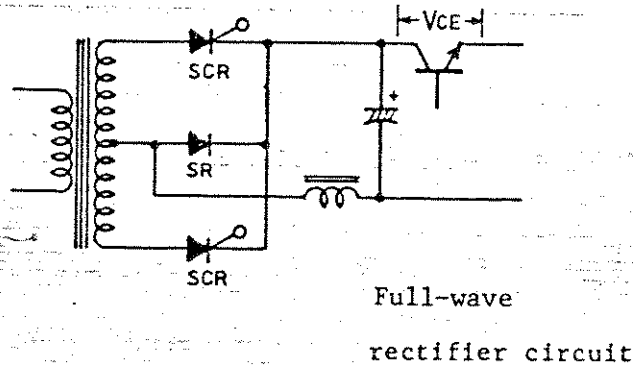

Figure 5-5

- o This circuit rectifies the current with phase-controlled SCRs and the collector-emitter voltage of the series control transistor is maintained constant to reduce the collector loss.
- o The filter circuit is a single-stage inersed-L choke input type.
- o SR is a freewheeling diode, which is used as the load (filter circuit) of the rectifier circuit, is inductive in order to commutate the energy stored in the reactor and turn off the SCRs.
- o This circuit, when the conducting angle of SCRs has become narrower, can prevent degradation of power factor (which is inherent to the phase-controlled circuit) more effectively as compared with the capacitor-input filter circuit. It also

solves the problems of ripple current of electrolytic filter capacitor and overheating of the transformer, and reduces the rectified output ripples. The PAD-L Series Power Supplies also employ a bridge rectifier circuit.

5-3. Phase Control Circuit

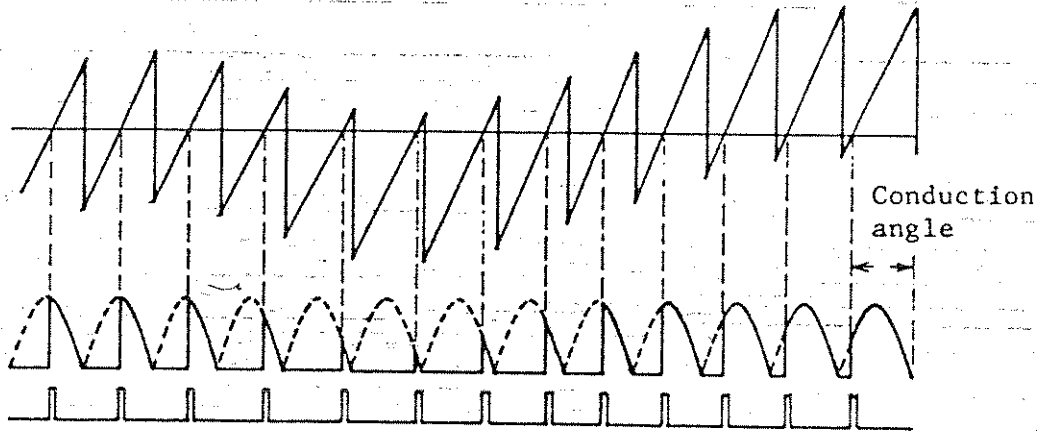
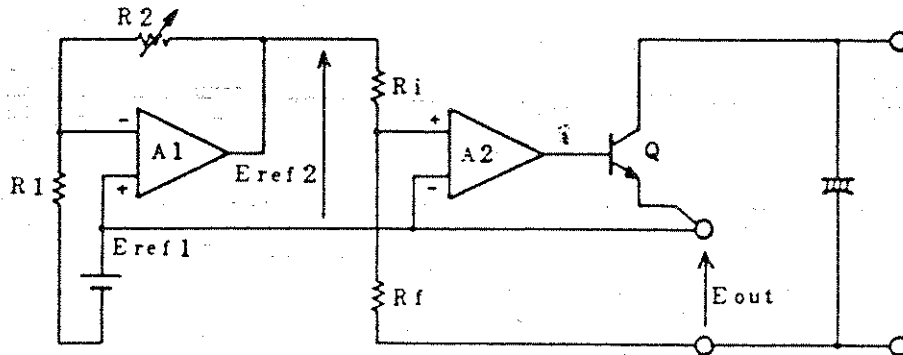

Figure 5-6

This circuit is a pulse phase modulator which operates in synchronization with the AC line frequency. When the collector-emitter voltage (V_{CE}) is large, the generated pulse signal is for a wider conduction angle and, when the voltage is lower, the signal is for a narrower conduction angle and, thus, the circuit so controls SCRs that V_{CE} becomes constant.

5-4. Constant-voltage Circuit



- Eref 1: Reference voltage 1
- Eref 2: Reference voltage 2
- Ri: Input resistance
- Rf: Feedback resistance

Figure 5-7

Output voltage E_{out} can be expressed as follows (A1 is an ideal amplifier):

$$E_{out} = - \frac{R_f}{R_i} E_{ref\ 2}$$

Thus, the output voltage depends only on $E_{ref\ 2}$, R_i and R_f . The output voltage is linearly proportional to R_f and $E_{ref\ 2}$. For this power supply, $E_{ref\ 2}$ is varied to control the output voltage. $E_{ref\ 2}$ is produced by amplifying $E_{ref\ 1}$, and this voltage is linearly varied by R_2 .

To obtain a stable output voltage, such components as $E_{ref\ 1}$ Zener diode, R_1 , R_2 , R_i , R_f , A1 and A2 must be sufficiently stable against change in external conditions. This power supply employs for the $E_{ref\ 1}$ diode a zener diode of excellent temperature

characteristics. The resistors are metal-film resistors and wound-wire resistors of excellent temperature coefficient and aging characteristics. Amplifiers A1 and A2 employ monolithic ICs which ensure high gain, wide band and low drift.

The major factors caused by line voltage variation are variation of the operating point of the error amplifier and variation of the reference voltage due to dynamic resistance of the reference diode. To guard against these variations, a stabilized internal auxiliary voltage source is used. Load variation ($\partial V_o / \partial I_o$: output variation caused by output current variation) is affected by output impedance (internal resistance) Z_o . (See Figure 5-8.)

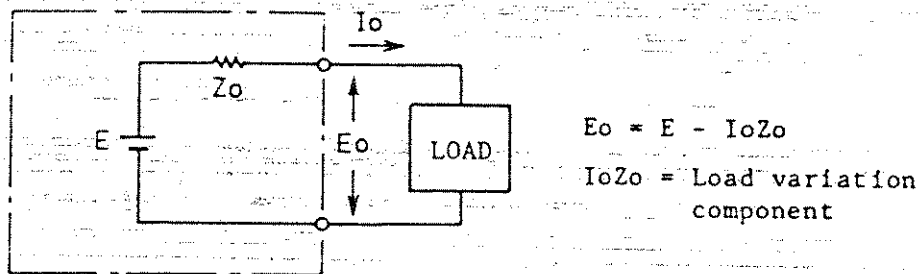

Figure 5-8

Denoting by A the open loop gain attained by error amplifier A2 and power transistor Q, output impedance Z_o can be expressed as follows:

$$Z_o = \frac{R_o}{1 + AB}$$

where, $B = \frac{R_i}{R_f + R_i}$

R_o : Output impedance of the circuit when no error amplifier is connected

The above equation indicates that the output impedance is improved to $1/(1+AB)$ by connecting amplifier A2 and effecting a feedback circuit.

5-5. Constant-current Circuit

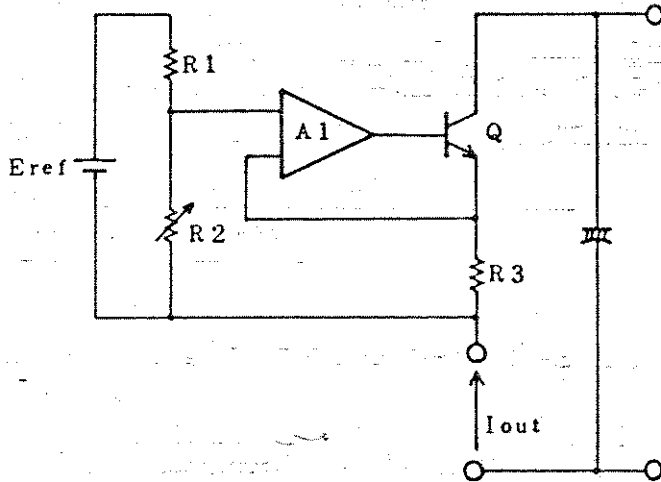

Figure 5-9

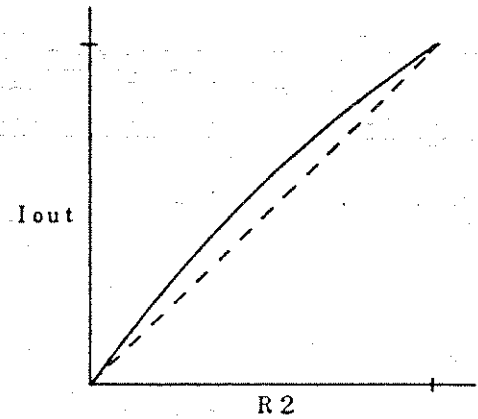

Figure 5-10

Eref: Reference voltage for constant current

R2: Output current control potentiometer

R3: Output current detection resistor

Output current I_{out} can be expressed as follows (A1 assumes an ideal amplifier):

$$I_{out} = \frac{R2}{R3(R1 + R2)} \times E_{ref}$$

This equation indicates that the output current depends on E_{ref} , $R1$, $R2$ and $R3$. Of this power supply, the output current is controlled by varying $R2$. Note that the relationship between $R2$ and I_{out} is not linear as indicated with a solid line in Figure 5-10.

To ensure a stable output current, E_{ref} , $R1$, $R2$ and $R3$ must be sufficiently stable against change in external conditions (line voltage change, ambient temperature change, aging, and load change). Error amplifier A1 must be a high-gain wide-band DC amplifier with less drift.

804465

Of the constant-current circuit, the larger the output impedance (Z_{out}), the smaller is the load variation ($\partial I_o / \partial V_o$: output current variation caused by output voltage variation). (See Figure 5-11).

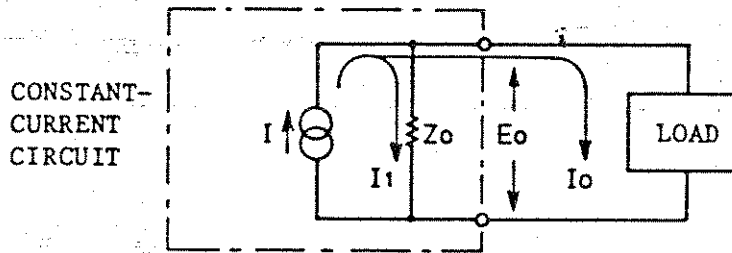

$$I_o = I - I_1$$

where, $I_1 = E_o / Z_o =$ Load current variation component

Figure 5-11

Denoting by g_m the mutual conductance attained by error amplifier A2 and power transistor Q, output impedance Z_o can be written as follows:

$$Z_o = (1 + g_m R_3) R_o$$

In this equation, R_o is the output impedance of the circuit before connecting the error amplifier. This equation indicates that the output impedance is improved by $(1 + g_m R_3)$ times by connecting amplifier A2 and providing negative feedback.

5-6A. Differences from Ideal Constant-voltage Supply

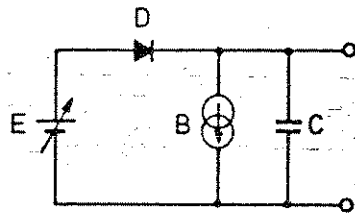

E: Ideal constant-voltage supply

D: Ideal diode

B: Internal bleeder circuit

C: Capacitor

Figure 5-12. Equivalent circuit of series-controlled constant-voltage DC power supply

o Cannot sink current:

Figure 5-12 shows an equivalent circuit of a series-controlled constant-voltage power supply of the type used for this and other power supplies. An ideal diode is connected in series. This type of power supply is for a load of such type that it simply drains the current and does not send back the current. For such load as a battery which sends back a current, however this power supply cannot sink such current.

This problem can be solved by using a parallel-controlled power supply or one which has a bi-polarity output. Such power supplies, however, will provide less efficiency and high cost for the same power.

The problem can be solved by connecting a resistor in parallel with the load and feeding in the resistor a current larger than the maximum reverse current. When the reverse current is small, the problem may be solved by connecting an electrolytic capacitor in parallel with the load. When the load is an inverter, a filter circuit may be provided in the input circuit to reduce the reverse current.

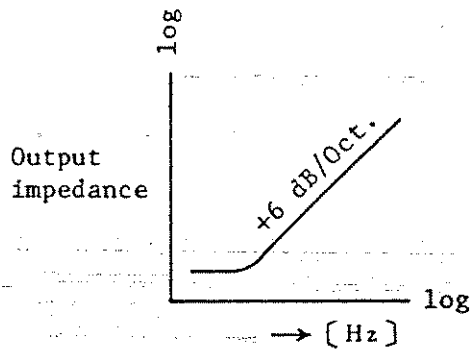

Figure 5-13

Frequency vs output impedance characteristics

- o Output impedance is not infinity, with certain frequency characteristics:

Figure 5-13 shows that the output impedance (internal resistance) of this power supply increases as the frequency increases. This is because the gain of the loop including the error amplifier decreases. Better frequency characteristics, as well as DC output impedance characteristics such as for load variation, are a desirable feature for the power supply.

This feature must be such that not only the high gain region of the error amplifier is extended to a higher frequency range but also the phase characteristics are correct.

A shorter transient response time means better frequency characteristics of output impedance. Transient response time is an index for evaluation at the time range and output impedance is that at the frequency range.

5-6B. Difference from Ideal Constant-current Power Supply

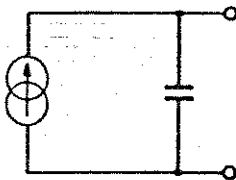

Figure 5-14

393308

Figure 5-14 shows an equivalent circuit of this power supply operating as a constant-current source. A capacitor is connected in parallel with an ideal power supply.

There is no problem when the load is resistive. However, if the load is of such nature that it varies rapidly, pay attention to the fact that the output voltage also varies rapidly and the charge/discharge current of the capacitor is superimposed on the output current.

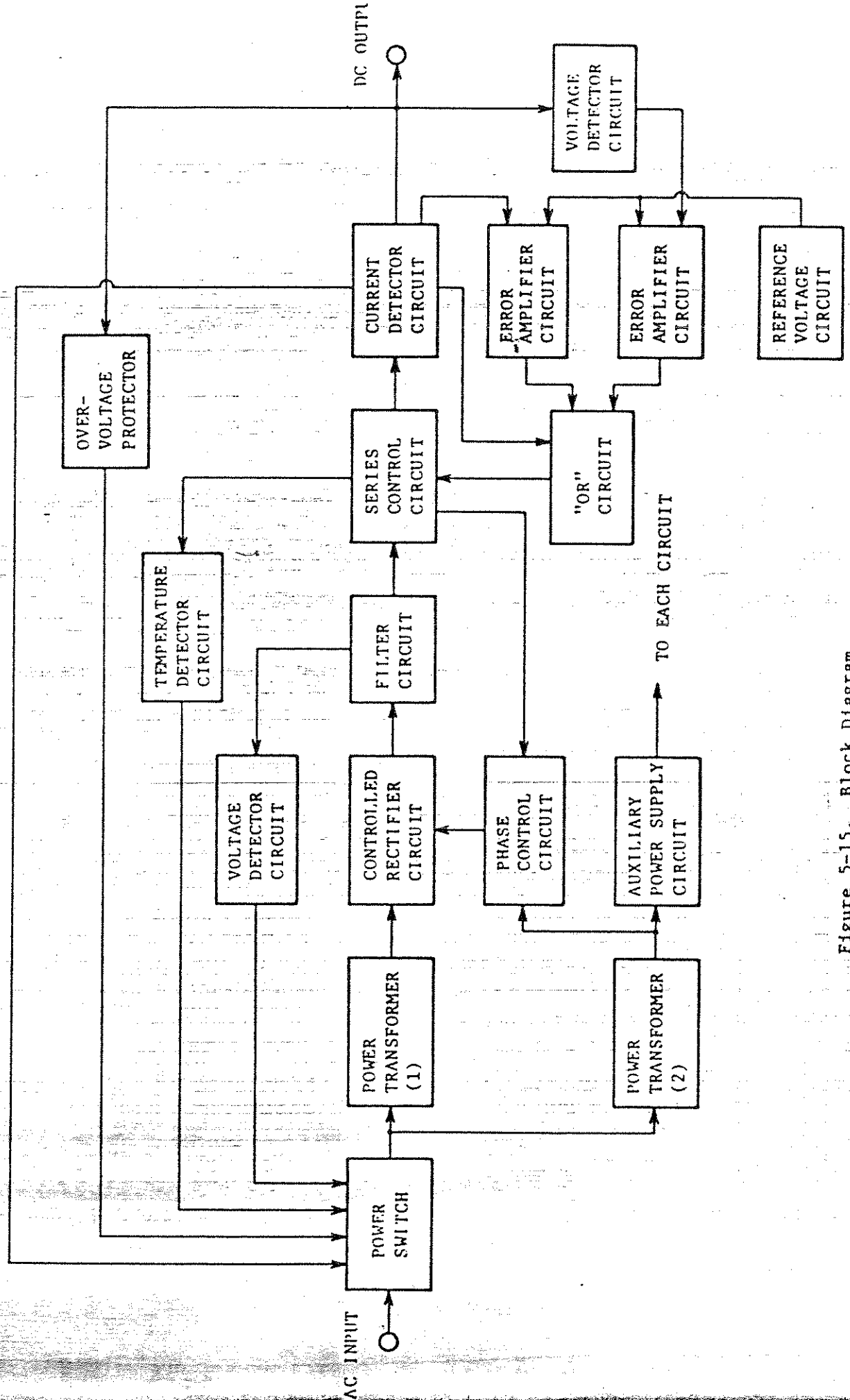

Figure 5-15. Block Diagram

SECTION 6. MAINTENANCE

6-1. Inspection and Adjustment

Periodically inspect and adjust the power supply so that it maintains its initial performance for a long time.

6-1-1. Removing Dust and Dirt

6-1-2. Inspecting the Power Cord and Plug

6-1-3. Calibrating the Voltmeter

6-1-4. Calibrating the Ammeter

6-1-5. Calibrating the Current/Voltage Limit Switch

6-1-6. Adjusting the Maximum Variable Constant-voltage Range

6-1-7. Adjusting the Maximum Variable Constant-current Range

6-1-1. Removing Dust and Dirt

When the instrument panel has become dirty, lightly wipe it with a cloth moistened with diluted-neutral soapsuds or alcohol and, then, wipe it with a dry cloth. Do not use benzine or thinner. Blow away dust collected inside the instrument and in the ventilation holes of the casing, using a compressed air or a vacuum cleaner.

6-1-2. Inspecting the Power Cord and Plug

Check for that the vinyl cover of the cord is not damaged.

Check the plug for play, loose screws and damage.

6-1-3. Calibrating the Voltmeter

Connect an external voltmeter of an accuracy of 0.5% or better to the output terminals, set the output voltage at the value indicated on Table 6-1, and calibrate the instrument voltmeter

with R101 at the right-hand section on the front panel.
(See the panel illustration on page 14.)

6-1-4. Calibrating the Ammeter

Connect an external ammeter of an accuracy of 0.5% or better in the output circuit, set the output current at the value indicated on Table 6-1, and calibrate the instrument ammeter with R102 at the right-hand section on the front panel. (See the panel illustration on page 14.)

6-1-5. Calibrating the Current/Voltage Limit Switch

o Calibration of limit current

Set the output current at the value indicated on Table 6-1. Press the current/voltage limit switch and so adjust R253 that the ammeter indicates the set current value.

o Calibration of limit voltage

Set the output voltage at the value indicating on Table 6-1. Press the current/voltage limit switch and so adjust R209 that the voltmeter reads the set voltage value. (See Table 6-1.)

6-1-6. Adjustment of Maximum Variable Constant-voltage Range

Connect to the output terminals an external voltmeter of an accuracy of 0.5% or better, set the constant-voltage setting knob in the maximum position (extremely clockwise position), and so adjust R220 on PCB A-200 that the instrument voltmeter reads the value indicated on Table 6-1.

6-1-7. Adjustment of Maximum Variable Constant-current Range

Connect in the output circuit an external ammeter of an accuracy of 0.5% or better, set the constant-current setting knob in the maximum position (extremely clockwise position), and so adjust R249 on PCB A-200 that the instrument ammeter reads the value indicated on Table 6-1. (See Figure 6-1.)

6-1-8. Adjustment of VCE of Series Transistor

Set the input voltage constant at 200 V AC (100 V AC). Connect the load and feed the rated voltage and rated current. Connect a mean-value-indicating voltmeter between collector and emitter of the series transistor and so adjust R326 that the voltmeter reads the value shown in Table 6-1. For the PAD110-20L, so adjust that the voltage between TP1 and TP3 becomes 12 V. In this case, make it sure that the voltage difference between TP2 and TP3 is less than 2 V. (See Figure 6-1.)

For the PAD250-8L, so adjust that the voltage between TP1 and TP6 becomes 30 ± 1 V. In this case, make sure that the voltage difference between TP1, TP2, TP3, TP4, TP5 and TP6 are the same value of Table 6-2.

PAD		16-100L	20-80L	35-50L	35-60L
Voltmeter adj	R101	16 V	20 V	35 V	35 V
Ammeter adj	R102	100 A	80 A	50 A	60 A
Current limit adj	R253	100 A	80 A	50 A	60 A
Voltage limit adj	R209	16 V	20 V	35 V	35 V
Maximum voltage adj	R220	16.5 V	20.5 V	35.6 V	35.6 V
Maximum current adj	R249	105 A	85 A	51 A	61 A
VCE adj	R326	3.0 V	3.75 V	5.0 V	5.0 V

PAD		55-35L	110-20L	250-8L
Voltmeter adj	R101	55 V	110 V	250 V
Ammeter adj	R102	35 A	20 A	8 A
Current limit adj	R253	35 A	20 A	8 A
Voltage limit adj	R209	55 V	110 V	250 V
Maximum voltage adj	R220	56 V	112 V	260 V
Maximum current adj	R249	36 A	20.5 A	8.2 A
VCE adj	R326	6.0 V	12 V	± 30 V

Table 6-1

PAD250-8L VCE - Adjustment

TP	TP1 - TP2	TP2 - TP3	TP3 - TP4	TP4 - TP5	TP5 - TP6
VCE [V]	9 ± 1	5 ± 1	5 ± 1	5 ± 1	6 ± 1

Table 6-2

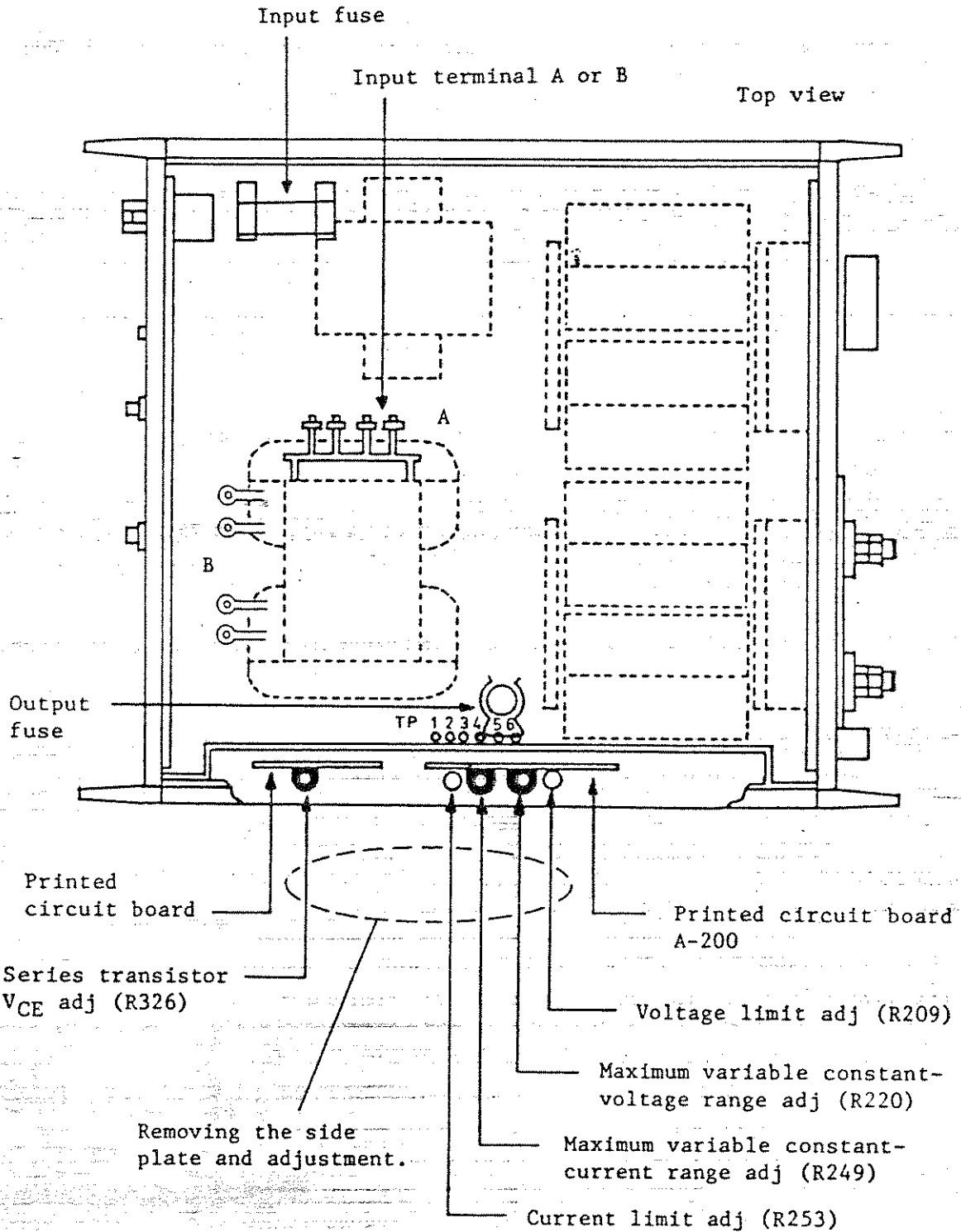

Figure 6-1

6-2. Troubleshooting

The most probable causes of troubles are shown in the following table. When a failure of the power supply is found, contact Kikusui agent in your area.

Symptom	Check item	Probable cause
Power switch cannot be turned off (or turns off soon).	1. Has the overvoltage protector tripped?	o Set voltage too low
	2. Shorting bar disconnected?	o Disconnected or loose shorting-bar
	3. Is fan stalled?	o Trip of overheat protector (Replace fan.)
	4. Other than the above	o Trip of protector due to a failure of rectifier circuit
No output (No output is produced at all or only a slight output is produced.)	1. Is the input power fuse blown?	o Input line voltage too high (Replace fuse.) o Failure of rectifier circuit
	2. Is lamp lighted?	If not lighted, o Open-circuiting of power cord
	3. Are the lamps alternately lighting, indicating rapid transitions of operating domains	o Too narrow constant-voltage and constant-current setting ranges

167708

Symptom	Check item	Probable cause
	4. Are the shorting-bars correctly connected?	o Wrong connection of shorting-bar(s)
	5. Is the output power fuse blown out?	o Output current flowed exceeding the rated value o Power transistor failure
	6. Is the circuit oscillating?	o Phase inversion caused by remote sensing circuit (Connect an electrolytic capacitor at the load end.) Refer to 4.1. o (Re-adjust)
	7. Is a current flowing despite no load?	If flowing, o Failure of the protective diode connected in parallel with the output (This diode may be damaged if such load as battery is connected in the reverse polarity.)
	8. Other than the above	o Circuit failure
Abnormally high output	1. Is the shorting-bar disconnected? (Between 3 and 4.)	o Disconnected or loose shorting-bar o Malfunctioning OVP circuit

Symptom	Check item	Probable cause
	2. Output voltage (current) cannot be reduced	<ul style="list-style-type: none"> o Power transistor failure o Bleeder circuit failure
Unstable output	1. Is the shorting-bar(s) loose?	o Incorrect connection of the shorting-bar(s)
	2. Is the AC line voltage correct?	o AC line voltage not within the specified range
	3. Special type of load	o See 2-4.
	4. When matter of drift is critical	o Allow approximately 30 minutes of stabilization time.
	5. Other than the above	o Circuit failure
Large ripple voltage	1. Is the AC line voltage correct?	o Input voltage too low
	2. Are the sensing terminals securely connected to the output terminals?	o Securely connect the sensing terminals
	3. Is a strong source of magnetic or electric field present near the power supply? (Is there no nearby auto-transformer, power transformer, or an oscillating source?) (Especially when in the constant-current mode)	o Electromagnetic induction (Move the source of trouble. Strand the wires.)
	4. Other than the above	<ul style="list-style-type: none"> o Circuit failure o (Re-adjust)