



# Crystal Clear Electronics

The development of the Crystal Clear Electronics curriculum was supported by the European Commission in the framework of the Erasmus + programme in connection with the “Developing an innovative electronics curriculum for school education” project under “2018-1-HU01-KA201-047718” project number.



## Erasmus+

The project was implemented by an international partnership of the following 5 institutions:

- Xtalin Engineering Ltd. – Budapest
- ELTE Bolyai János Practice Primary and Secondary Grammar School – Szombathely
- Bolyai Farkas High School – Târgu Mureş
- Selye János High School – Komárno
- Pro Ratio Foundation working in cooperation with Madách Imre High School – Šamorín



**XTALIN**



### Copyrights

This curriculum is the intellectual property of the partnership led by Xtalin Engineering Ltd., as the coordinator. The materials are designed for educational use and are therefore free to use for this purpose; however, their content cannot be modified or further developed without the written permission of Xtalin Engineering Ltd. Re-publication of the materials in an unchanged content is possible only with a clear indication of the authors of the curriculum and the source of the original curriculum, only with the written permission of Xtalin Engineering Ltd.

**Contact** <http://crystalclearelectronics.eu/en/>  
[info@kristalytisztaelektronika.hu](mailto:info@kristalytisztaelektronika.hu)

# 03 - Electronic Symbols

Written by Károly Póka

English translation by Xtalín Engineering Ltd.

Revised by Gergely Lágler, Gábor Proksa

By the end of the chapter, no one will have any trouble recognising a symbol in a simple wiring diagram.

## PREAMBLE

The goal of this part is to get to know the basic features of electronic parts, as well as their symbols used in wiring diagrams.

The wiring diagram is a „map”, which can be used to understand the structure of a circuit. Electrical engineers use such drawings to precisely describe the circuits that they designed, in other words, the relationship between the parts. The wiring diagram can be considered as a common language between professionals that makes the joint work as well as individual work easier. The symbols were created in such a way, that they describe some essential properties of the physical component. Despite the efforts to create a unified system, there are two kind of standards:

- IEC (International Electrotechnical Commission)
- ANSI (American National Standards Institute).

For the parts included in this chapter, we aim to demonstrate both standards.

## WIRE AND NODE

You may have seen very complicated wiring diagrams, where lot of wires crossed each other. To make the wiring diagram clear, we have to distinguish those parts, where wires cross each other and connected, and those where they just cross but are not connected. In Figure 1, you can see the wiring diagram of an astable multivibrator. The dots in the figure play an important role. They are showing wires which are connected to each other. These dots are called as nodes.

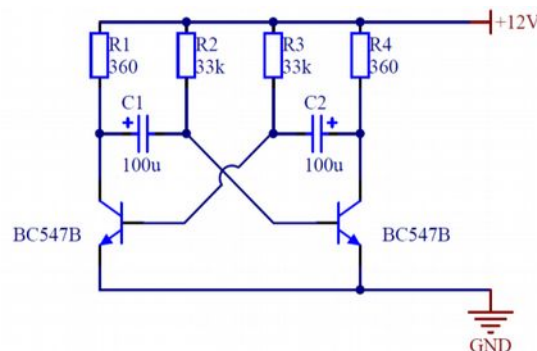

Figure 1 – Examples for node and crossing (Bistable multivibrator)



This project was supported by the European Commission. The content of this publication does not reflect the official opinion of the European Union. Responsibility for the information and views expressed therein lies entirely with the author(s).

This is xxx personal copy - distribution is strictly prohibited.

<http://crystalcleelectronics.eu> | All rights reserved Xtalín Engineering Ltd.

In the figure above, this doesn't seem so important to emphasize, because there are only a few crossing wires. However, let's imagine the circuit below without the markings of the nodes (internal wiring diagram of 555 integrated circuit, in Figure 2). Ignore the fact that there may be several unknown symbols in this figure.

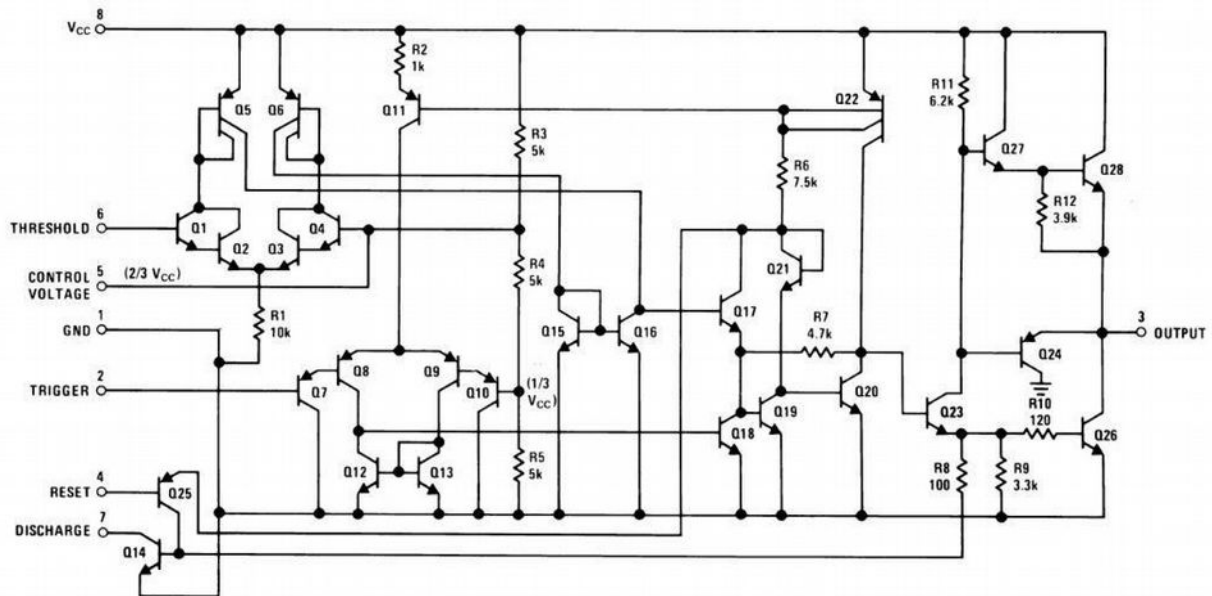

Figure 2 - Internal wiring diagram of 555 integrated circuit  
(Source: LM555 datasheet - Texas Instruments)

The markings of the nodes make the wiring diagram clear, it's easier to find your way with them. In some cases, not only the nodes are marked, but the crossings, where no physical connection is made, are also marked with an arch.

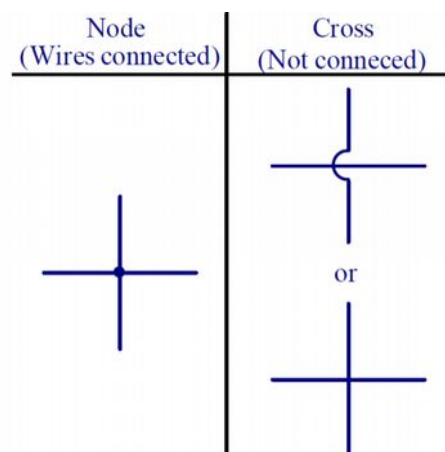

Figure 3 - Node and crossing



This project was supported by the European Commission. The content of this publication does not reflect the official opinion of the European Union. Responsibility for the information and views expressed therein lies entirely with the author(s).

## OPEN CIRCUIT AND SHORT CIRCUIT

In wiring diagrams, the open circuit emphasizes that there is no conductor in the marked section which would ensure the flow of charges, so current cannot flow. At an open circuit, the current is considered zero, and in turn the resistance is considered infinite.

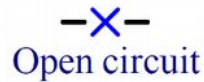

Figure 4 - Symbol of open circuit

The opposite of the open circuit is the short circuit, where the way of the current is shorted in the circuit. Figure 5 shows the example of a short circuit, marked with red. The ideal short circuit should be regarded as a connection with a resistance of zero Ohms.

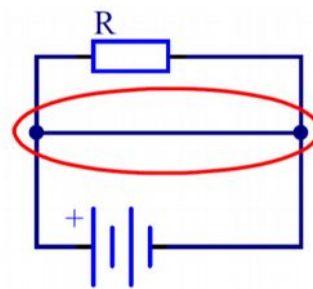

Figure 5 - Symbol of short circuit

It is important to mention, that short circuiting a battery like shown above can cause fire and explosion, so it must be avoided.

## GROUPING OF COMPONENTS

Parts used in the circuits can be divided into two different groups, accordingly whether they are the so-called „active” or „passive” components. The determination of these two groups can be done from different viewpoints, so the classifications of different scientific sources can be variant.

We will distinguish the electronic components by the following definitions:

- **Active** electronic parts are those which can change any of their electrical properties in case of an external control signal. Some examples: photoresistors, transistors, MOSFET, light controlled transistors. The control signal can be current, voltage, heat, light or any other physical parameter. Components including active elements, like the integrated circuits as well as the memory or the processor are also considered to be an active part.
- Every other component is listed in the class of **passive** components. Such components are for example the resistor, the capacitor, crystal, diode, inductor.

Initially, you will deal with passive components mainly, these are simpler. In order to understand the function of active components you may need deep physical knowledge, but in return you may find some very exciting things in this field.



This project was supported by the European Commission. The content of this publication does not reflect the official opinion of the European Union. Responsibility for the information and views expressed therein lies entirely with the author(s).

## CELL AND BATTERY

In Figure 6, you can see the symbol of a cell, which you may know as galvanic cell available in stores. These are manufactured in several forms; its most common form is the AA cell.



Figure 6 – Cell and its symbol

In most wiring diagrams or schematics, the polarity is not marked with a + sign. The long line represents the positively charged anode, the shorter one represents the negatively charged cathode, therefore the polarity is clear.

In electronics, batteries are mostly used instead of single cells. Batteries are produced from several elements (cells) usually connected in series, which creates a higher voltage level (Figure 7).



Figure 7 – Battery and its symbol

Source: Lead holder [CC BY-SA 3.0 (<https://creativecommons.org/licenses/by-sa/3.0/>)]  
<https://commons.wikimedia.org/wiki/File:9V-NiMH-opened-battery.jpg>

The galvanic batteries derive electrical energy from chemical energy. When used, the materials inside are transformed, and eventually the battery is discharged. Since the electrical equipment are not always operated from battery, other energy sources may also be involved. Therefore, the terms current and voltage source are used more often. The question may arise, what does this mean in fact?

The ideal voltage source (Figure 8) is a circuit element with two terminals. It ensures constant voltage between its terminals regardless the current that flows through it. Based on these, the definition of the ideal current source (Figure 9) can be fabricated: it is a circuit element, which drives constant value of current through its terminals, regardless the voltage measured across them.

Contrary to the common language the battery can be described as a voltage source rather than a current source. It is true that voltage and the current walk hand in hand, but it does matter which one is constant. On the battery, available in stores, the value of the voltage measured between its terminals is marked. Ideally the battery can supply this constant value of voltage while it is used, and the required current by the supplied circuit which can even vary in intensity. So, it must be called a voltage source correctly.



This project was supported by the European Commission. The content of this publication does not reflect the official opinion of the European Union. Responsibility for the information and views expressed therein lies entirely with the author(s).

The voltage in the wiring diagrams is marked with a  $U$ , its unit is volt, and signed by [V]. The current that flows through the circuit, is usually indicated with an  $I$  in the wiring diagram. Its unit is amper and signed by [A].

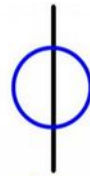

Ideal voltage source

Figure 8 – Symbol of ideal voltage source

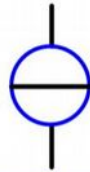

Ideal current source

Figure 9 – Symbol of ideal current source

## Internal resistance

Unfortunately, there isn't any battery which behaves as an ideal voltage source. The reason of the difference to the ideal case can be described with a so-called internal resistance (Figure 10), which is caused by chemical and physical properties.

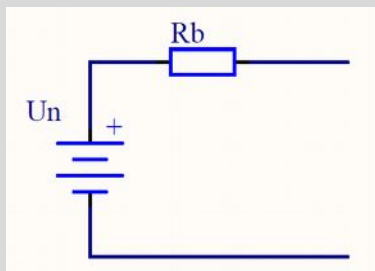

Figure 10 – Internal resistance of voltage source

The bigger the current that loads the battery, the smaller the voltage will be measured between its terminals, because of the internal resistance. The value of the internal resistance depends on the state of charge of the battery, the chemical components of the battery and the internal structure as well.

## EXPLANATION OF VOLTAGE AND CURRENT IN SCHEMATICS

The voltage and current are usually marked on the schematics for better understanding. Some examples are shown in Figure 11. Both of them are marked by an arrow. The arrow, which marks the direction of the current, shows the opposite direction of the electron-flow. This can be confusing, but it has historical reasons. Back in the day, physicist thought that positive charges are moving the wires, so they mark the positive direction of current based on this supposition. Later it was discovered that negative charges move



This project was supported by the European Commission. The content of this publication does not reflect the official opinion of the European Union. Responsibility for the information and views expressed therein lies entirely with the author(s).

in the wires, not positives, but the marking was not changed. In the end it does not really matter. In case of the voltage, the arrow points from the higher potential point to the lower potential point.

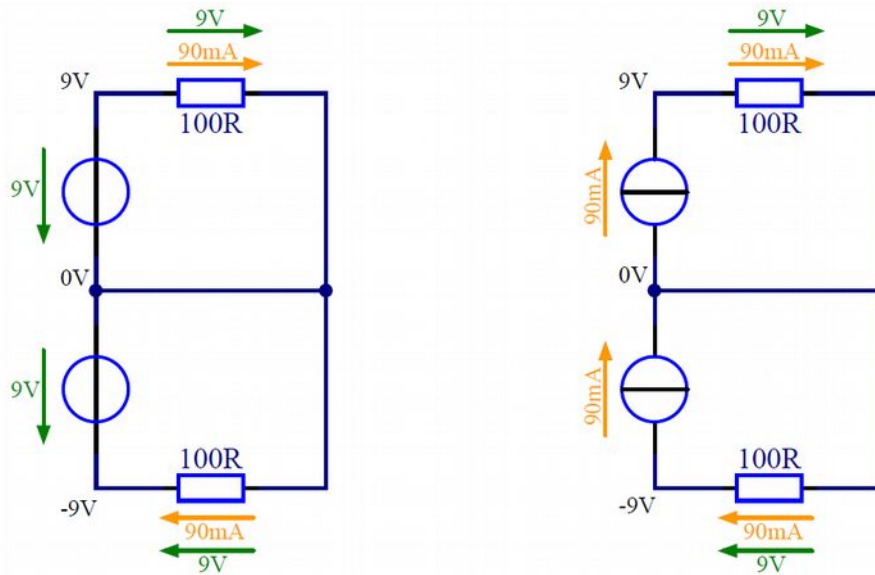

Figure 11 – Marking of directions of voltage and current

## RESISTOR

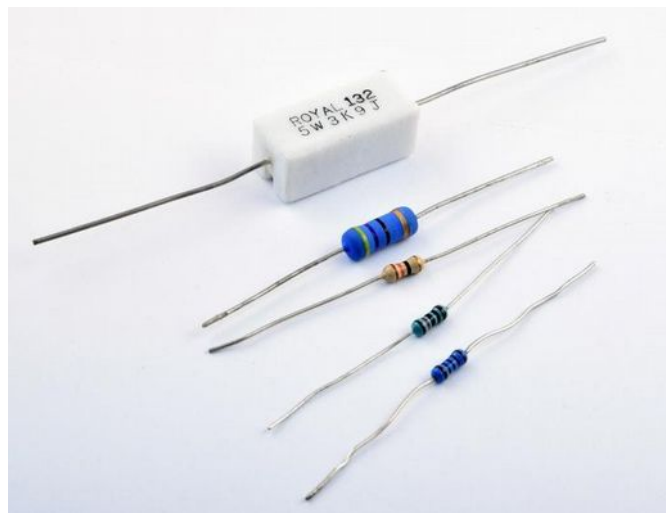

Figure 12 – Resistor with trough-hole mounted (THT: Trough-Hole Technology) casing

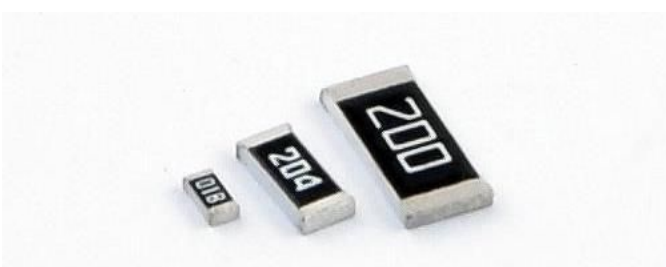

Figure 13 – Resistor with surface mounted (SMD: Surface-mount device) casing



This project was supported by the European Commission. The content of this publication does not reflect the official opinion of the European Union. Responsibility for the information and views expressed therein lies entirely with the author(s).



The resistors are fundamental parts of every circuit, you will also be certain after a thorough study of the curriculum.

A resistor can be imagined as a „pipe”, which interior is not completely empty, but full of obstacles. When current flows through the resistor, then some of the electrons, passing through, collide with the obstacles in the pipe, and after the collision, they move slower. When the collision occurs, a sudden change in the kinetic energy of electrons creates heat, which warms the resistance.

If we force too much current through the resistor, then lot of electrons will collide and it may generate a huge amount of heat, which may cause the resistor to burn. Each resistor has a parameter which shows how much electrical power it can absorb without damage at a given ambient temperature. If it is exceeded, then the resistor can warm up so much, that it will cause permanent damage in its material.



Figure 14 - Symbol of resistor (IEC and ANSI)

There are two different symbol standards: IEC (International Electrotechnical Commission) and ANSI (American National Standards Institute). These are representing the components from a different approach. Based on the example, the IEC symbol can be imagined as a figure of a pipe, viewed from the top. You can see the ANSI symbol of the resistor on the right side of Figure 14, which is similar to a wire-wound resistor. Wire resistors can be made by winding any conductor; however it is important during the manufacturing process that it must be sealed (for this purpose usually lacquer coating is used). If the layers weren't separated, then short-circuit would develop, and the current wouldn't flow through the whole length of the conductor.

If we know the specific electrical resistance of the material, then depending on the length and cross-section area of the winded material, any resistance value can be created. The conductor's resistance is directly proportional to its length and inversely proportional to its cross-section. Resistors could not only be made by winding a wire, but also for example coating an insulator material (like ceramics) with metal or carbon layers.

The measurement unit of resistance is Ohm [ $\Omega$ ]. Often the letter  $R$  derived from the word Resistance is used instead of the  $\Omega$  symbol. Furthermore, the letter  $R$  can be used to mark resistors in wiring diagrams.

If there is a decimal comma in the expression, then the prefixes can be used instead of the comma as it is shown in the table below.

Value	Prefix symbol	Example
< 1000 $\Omega$	$\Omega$ or R	330 $\Omega$ or 330R
1k $\Omega$ - 1000k $\Omega$	k $\Omega$ or k	33k $\Omega$ or 33k
1M $\Omega$ - 1000M $\Omega$	M $\Omega$ or M	1M $\Omega$ or 1M

Value	Example
3.3 $\Omega$	3R3
2.2k $\Omega$	2k2
4.7M $\Omega$	4M7



This project was supported by the European Commission. The content of this publication does not reflect the official opinion of the European Union. Responsibility for the information and views expressed therein lies entirely with the author(s).



## ADJUSTABLE AND VARIABLE RESISTORS

There are some special kind of resistors, which resistance values are not fixed. Their resistance can be adjusted between certain limits or their values may vary based on other physical properties. The construction of such components can also be different.

**Adjustable** value resistors are the potentiometers for example. These components' resistance values can be set manually by the user, between limited intervals.

The resistance of the **variable** resistor does not depend on the value that the user sets, it varies by the physical impacts on the component. Such component is the fuse and the thermistor (Figure 15), the photoresistor (Figure 16) etc. The fuse and the thermistor change their resistance as a result of temperature changes, while the photoresistor's resistance depends on the intensity of the light on its surface. There are such designs, where mechanical changes like strain/elongation cause different resistance. These are used, for example, in strain gauges or force sensing resistors (Figure 17). These can be used for investigating bridges' structure, measuring compressing force etc.



Figure 15 - Thermistor and its symbol

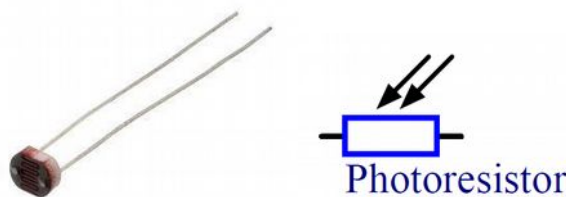

Figure 16 - Photoresistor and its symbol

Source: oomlout [CC BY-SA 2.0 (<https://creativecommons.org/licenses/by-sa/2.0/>)]  
[https://commons.wikimedia.org/wiki/File:Photoresistor\\_2.jpg](https://commons.wikimedia.org/wiki/File:Photoresistor_2.jpg)



Figure 17 - Force Sensing Resistor

Source: Bomazi [CC BY-SA 2.0 (<https://creativecommons.org/licenses/by-sa/2.0/>)]  
[https://commons.wikimedia.org/wiki/File:Force\\_Sensing\\_Resistor\\_cropped.jpg](https://commons.wikimedia.org/wiki/File:Force_Sensing_Resistor_cropped.jpg)



This project was supported by the European Commission. The content of this publication does not reflect the official opinion of the European Union. Responsibility for the information and views expressed therein lies entirely with the author(s).

## POTENTIOMETER

In schematics, the potentiometer is symbolised similarly as a normal resistor, the only difference is that the third output of the potentiometer is marked with an arrow.

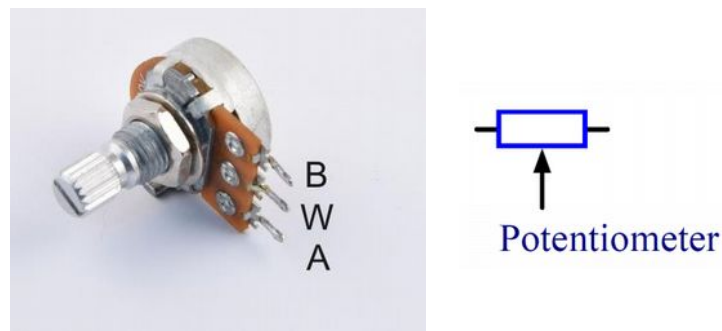

Figure 18 - Potentiometer and its symbol

The operation of the potentiometer is based on the fact that the resistance of the conductor is proportional to its length. A resistive track connects the two sidealong outputs of the component. A contact, called the wiper, is mounted on the end of the axis which makes an electrical contact between the middle output of the potentiometer and the resistive track. The position of the contact can be changed by rotating the axis.

If we use one of the sidealong outputs (A or B) and the middle output (W) of the potentiometer, then we get a resistor with alterable resistance. The length of the conducting track can be changed by the position of the wiper. The potentiometer can be used as a so-called voltage divider as well. If we connect voltage to its outer legs, then the voltage, that is measured on its middle leg is proportional to the position of the potentiometer. In the 5th chapter, you can read more about voltage divider.

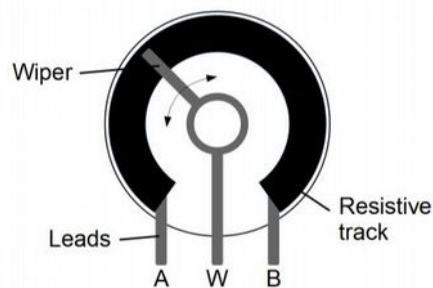

Figure 19 - Internal structure of potentiometer



This project was supported by the European Commission. The content of this publication does not reflect the official opinion of the European Union. Responsibility for the information and views expressed therein lies entirely with the author(s).

## Voltage dividers and current dividers

Those circuits, where the used voltage or current is divided by the help of resistors, are called voltage or current dividers. These realizations can be achieved using serial or parallel connection or combinations thereof, as it was described in the chapter of Revision of Basic Physics.

## Logarithmic potentiometers

Apart from linear potentiometers, there are logarithmic potentiometers as well, of which resistance is not linear, their resistance changes in logarithmic steps. As an example, these are commonly used in sound technology.

## FUSE

If a circuit fails or it is not used properly by the user (for example by connecting inadequate voltage to it) overcurrent may develop, which can cause the circuit to go wrong or the wire that provides the power, can catch on fire.

The fuse is connected to the circuit in a serial way, and it heats until melting if the current is bigger than its rated current. Because the fuse itself melts, the conduction is ceased. After changing of fuse, our equipment can be functional again, but only if the fault has already disappeared in the circuit.

Multiple symbols exist to mark the fuse, which are presented by Figure 20.



Figure 20 – Fuse in several makes and its symbol

## CAPACITOR

The capacitor, which is known from the revisioning chapter of basic physics, can be found in most circuits. In the component, an insulating layer (dielectric) can be found (it can be air as well) between the two conducting layers (electrode). The capacitors got a symbol which refers to their physical structure, and they can be divided into two big groups.

There are capacitors where the polarity of the terminals is marked obviously, these are called polarized capacitors. When connecting these parts, you have to make sure, the positive terminal voltage is always bigger than the other terminal voltage. Otherwise the capacitor can pop, explode, catch fire, which is



This project was supported by the European Commission. The content of this publication does not reflect the official opinion of the European Union. Responsibility for the information and views expressed therein lies entirely with the author(s).

dangerous! For example, if we charge a capacitor from a galvanic battery, the battery's positive terminal has to be connected to the positive terminal of the capacitor.



Figure 21 – Symbols of capacitors (unipolar and polarized)

Whether a capacitor is polarized or not, depends mostly on the material it is made from. For example, the polarity is important at electrolytic and tantalum capacitors, however the ceramic and foil capacitors are not polarized. It also changes, whether the positive or negative terminal is marked on the component. For example, on the tantalum capacitor the positive, while on the electrolytic capacitor the negative terminal is marked. If there is no marking on the capacitor, then the polarity is irrelevant.

Capacitor is marked with a letter C in a wiring diagram, the unit of capacity is Farad [F].



Figure 22 – Several designs of capacitors

Source (middle): Mataresephotos [CC BY 3.0 (<https://creativecommons.org/licenses/by/3.0/>)  
[https://commons.wikimedia.org/wiki/File:Tantalum\\_capacitors.jpg](https://commons.wikimedia.org/wiki/File:Tantalum_capacitors.jpg)]

You have already seen that resistors with variable value of resistance exist, the same way capacitors with variable capacity exist as well. The symbol is slightly similar to the potentiometer symbol, with only a small difference: under the arrow, the symbol of the capacitor is visible instead of the resistor. Perhaps it's easier to remember that the arrow shows the variability on every symbol.

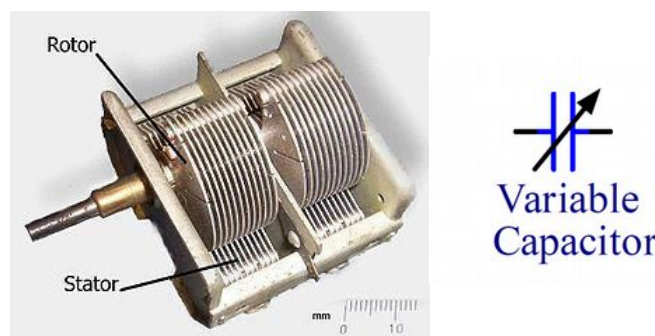

Figure 23 – Capacitor with variable capacity and its symbol

Source: Fabian\_R [CC BY-SA 3.0 (<http://creativecommons.org/licenses/by-sa/3.0/>)]  
[https://commons.wikimedia.org/wiki/File:Tuning\\_capacitor.jpg](https://commons.wikimedia.org/wiki/File:Tuning_capacitor.jpg)

In Figure 23, you can see a variable capacity rotating capacitor, which, for example, was used in radios (detector radio) for tuning the channels. Its capacity can be adjusted by the relative position of the



This project was supported by the European Commission. The content of this publication does not reflect the official opinion of the European Union. Responsibility for the information and views expressed therein lies entirely with the author(s).

rotatable electrodes (by the size of the overlapping surfaces). Between the electrodes, there is air as dielectric, which is known to be insulating.

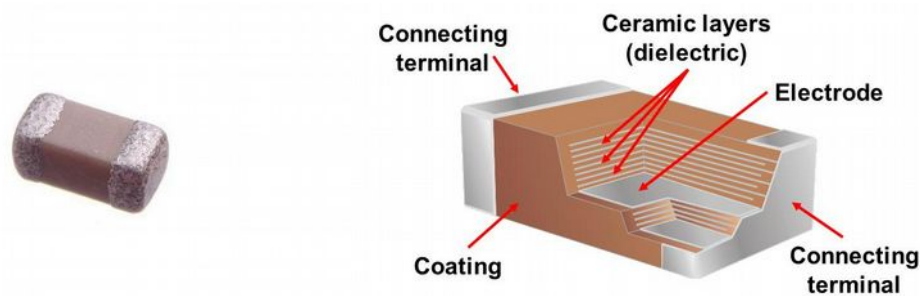

Figure 24 – SMD cased ceramic capacitor and its structure

Source (left): oomlout [CC BY-SA 2.0 (<https://creativecommons.org/licenses/by-sa/2.0>)] <https://commons.wikimedia.org/wiki/File:CAPC-0603-X-NF1-01.jpg>

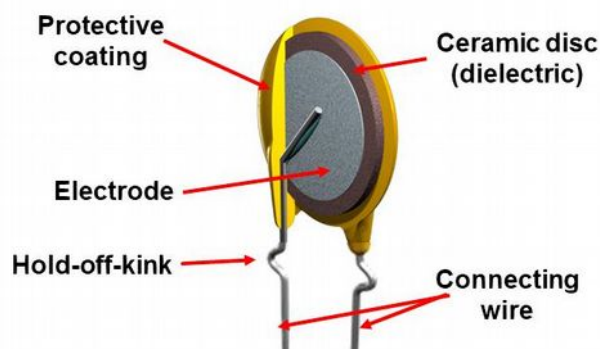

Figure 25 – Ceramic capacitor with through-hole mounted casing and its structure

## SWITCH

We have already learned more about several components in detail, but what happens, if we would like to control their operation, or we would like to interrupt the path of the current? A situation can occur, when we have to turn off our circuit, but we do not want to do that by eliminating the power supply. In most circuits, a switch or button is used, which is marked in wiring diagrams the way as the Figure 26 shows.

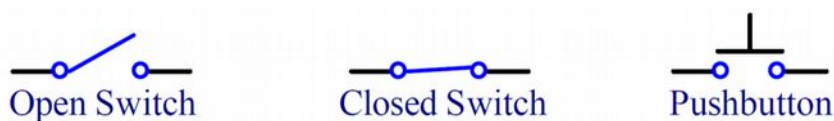

Figure 26 – Symbols of switch and push button

The symbols here, can be also connected to the operation of the components. The essence, of the switch is the fact that the electrical conduction can be interrupted. As the symbols shows it as well, by separating the conducting contacts from each other which are in the switch, the route of the current can be interrupted. Opening and closing the ideal switch can also be interpreted as: at the moment of closing, its resistance is zero and conduction is infinite, in turn, when it is opened its conduction is zero and its



This project was supported by the European Commission. The content of this publication does not reflect the official opinion of the European Union. Responsibility for the information and views expressed therein lies entirely with the author(s).



resistance is infinite. The push-button is a little bit different, it only holds its opened or closed state while we are pushing it.

There are switches, which can be tilted into several states. The classical example of multistate switches is the so-called lever switch (Figure 27).



Figure 27 - Two state lever switch

## Mercury Switch

A remarkable technical solution is the so-called mercury switch, in which the physical contact is created with the help of mercury. This is a device which closes if its whole structure is rotated to a certain direction, like this the mercury can flow between the two electrodes, and thanks to its conductivity, it closes the circuit.



Figure 28 - Mercury switch

Source: Medvedev [CC BY-SA 3.0 (<https://creativecommons.org/licenses/by-sa/3.0/>)]  
[https://commons.wikimedia.org/wiki/File:Mercury\\_Switch\\_without\\_housing.jpg](https://commons.wikimedia.org/wiki/File:Mercury_Switch_without_housing.jpg)











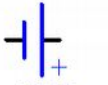

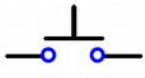







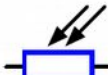

## SUMMARY

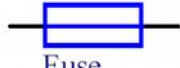
Throughout the curriculum, we learned number of basic components, their properties and circuit symbols. In the following parts of the curriculum, you will learn more interesting components. In order to be able to easily and quickly navigate through the symbols later, we present a comprehensive chart which you can easily look back to at any time later.

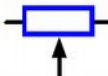

This project was supported by the European Commission. The content of this publication does not reflect the official opinion of the European Union. Responsibility for the information and views expressed therein lies entirely with the author(s).

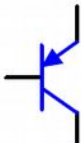
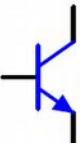
## SUMMARY TABLE

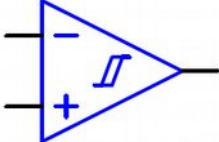
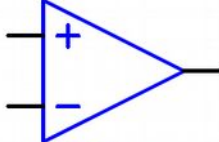
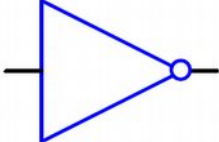
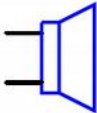
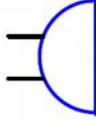
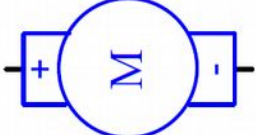
 Cell	 Capacitor	 Zener Diode	 Pushbutton
 Battery	 Polarized Capacitor	 Schottky Diode	 Switch
 Resistor	 Variable Capacitor	 Diode	 Crystal Oscillator
 Photoresistor	 Inductor	 LED	 Suppressor Diode
 Thermistor	 Fuse	 Open circuit	
 Potentiometer	 Voltmeter	 Ammeter	 Ground
 PNP Bipolar Transistor		 NPN Bipolar Transistor	
 P-channel MOSFET		 N-channel MOSFET	
 Comparator	 Amplifier	 Inverter	
 Loudspeaker	 Buzzer	 Motor	



This project was supported by the European Commission. The content of this publication does not reflect the official opinion of the European Union. Responsibility for the information and views expressed therein lies entirely with the author(s).