

SN75174 QUADRUPLE DIFFERENTIAL LINE DRIVER

SLLS039B – OCTOBER 1980 – REVISED MAY 1995

- Meets or Exceeds the Requirements of ANSI Standards EIA/TIA-422-B and RS-485 and ITU Recommendation V.11.
- Designed for Multipoint Transmission on Long Bus Lines in Noisy Environments
- 3-State Outputs
- Common-Mode Output Voltage Range of -7 V to 12 V
- Active-High Enable
- Thermal Shutdown Protection
- Positive- and Negative-Current Limiting
- Operates From Single 5-V Supply
- Low Power Requirements
- Functionally Interchangeable With MC3487

description

The SN75174 is a monolithic quadruple differential line driver with 3-state outputs. It is designed to meet the requirements of ANSI Standards EIA/TIA-422-B and RS-485 and ITU Recommendation V.11. The device is optimized for balanced multipoint bus transmission at rates up to 4 megabaud. Each driver features wide positive and negative common-mode output voltage ranges making it suitable for party-line applications in noisy environments.

The SN75174 provides positive- and negative-current limiting and thermal shutdown for protection from line fault conditions on the transmission bus line. Shutdown occurs at a junction temperature of approximately 150°C . This device offers optimum performance when used with the SN75173 or SN75175 quadruple differential line receivers.

The SN75174 is characterized for operation from 0°C to 70°C .

FUNCTION TABLE
(each driver)

INPUT	ENABLE	OUTPUTS	
		Y	Z
H	H	H	L
L	H	L	H
X	L	Z	Z

H = TTL high level, X = irrelevant,
L = TTL low level, Z = high impedance (off)

N PACKAGE
(TOP VIEW)

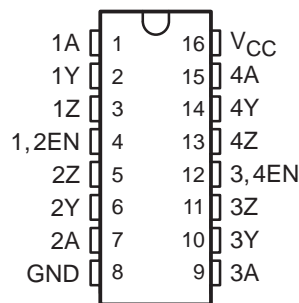

DW PACKAGE
(TOP VIEW)

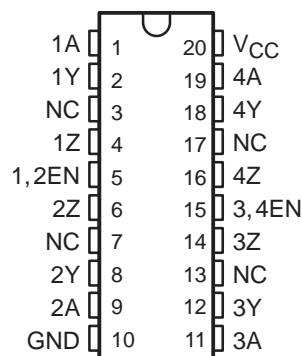

NC – No internal connection



Please be aware that an important notice concerning availability, standard warranty, and use in critical applications of Texas Instruments semiconductor products and disclaimers thereto appears at the end of this data sheet.

PRODUCTION DATA information is current as of publication date. Products conform to specifications per the terms of Texas Instruments standard warranty. Production processing does not necessarily include testing of all parameters.

**TEXAS
INSTRUMENTS**

POST OFFICE BOX 655303 • DALLAS, TEXAS 75265

Copyright © 1995, Texas Instruments Incorporated

SN75174 QUADRUPLE DIFFERENTIAL LINE DRIVER

SLLS039B – OCTOBER 1980 – REVISED MAY 1995

logic symbol†

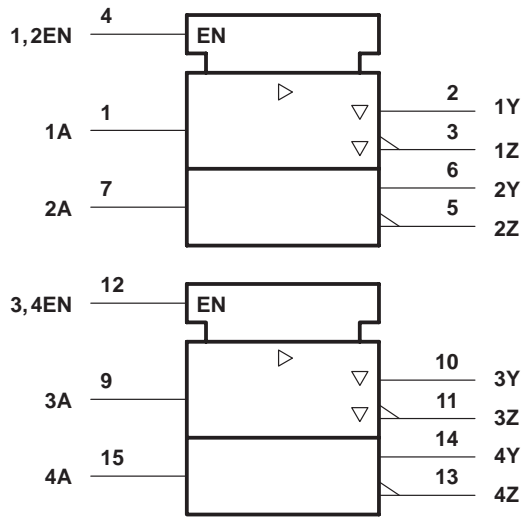

logic diagram, each driver (positive logic)

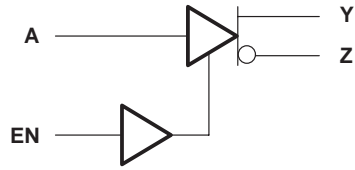

† This symbol is in accordance with ANSI/IEEE Std 91-1984 and IEC Publication 617-12.

schematics of inputs and outputs

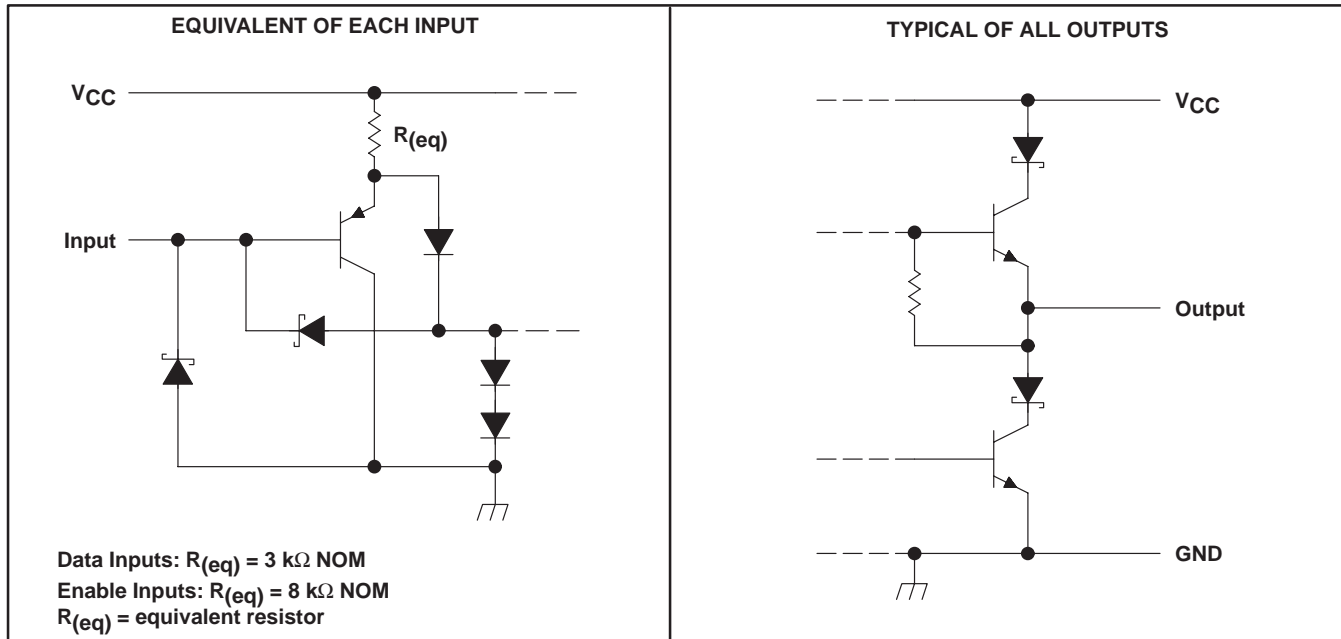

SN75174 QUADRUPLE DIFFERENTIAL LINE DRIVER

SLLS039B – OCTOBER 1980 – REVISED MAY 1995

absolute maximum ratings over operating free-air temperature (unless otherwise noted)†

Supply voltage, V_{CC} (see Note 1)	7 V
Output voltage range, V_O	–10 V to 15 V
Input voltage, V_I	5.5 V
Continuous total dissipation	See Dissipation Rating Table
Operating free-air temperature range, T_A	0°C to 70°C
Storage temperature range, T_{stg}	–65°C to 150°C
Lead temperature 1,6 mm (1/16 inch) from case for 10 seconds	260°C

† Stresses beyond those listed under “absolute maximum ratings” may cause permanent damage to the device. These are stress ratings only, and functional operation of the device at these or any other conditions beyond those indicated under “recommended operating conditions” is not implied. Exposure to absolute-maximum-rated conditions for extended periods may affect device reliability.

NOTE 1: All voltage values are with respect to the network ground terminal.

DISSIPATION RATING TABLE

PACKAGE	$T_A \leq 25^\circ\text{C}$ POWER RATING	DERATING FACTOR ABOVE $T_A = 25^\circ\text{C}$	$T_A = 70^\circ\text{C}$ POWER RATING
DW	1125 mW	9.0 mW/°C	720 mW
N	1150 mW	9.2 mW/°C	736 mW

recommended operating conditions

	MIN	NOM	MAX	UNIT
Supply voltage, V_{CC}	4.75	5	5.25	V
High-level input voltage, V_{IH}	2			V
Low-level input voltage, V_{IL}			0.8	V
Common-mode output voltage, V_{OC}		–7 to 12		V
High-level output current, I_{OH}			–60	mA
Low-level output current, I_{OL}			60	mA
Operating free-air temperature, T_A	0		70	°C



SN75174 QUADRUPLE DIFFERENTIAL LINE DRIVER

SLLS039B – OCTOBER 1980 – REVISED MAY 1995

electrical characteristics over recommended ranges of supply voltage and operating free-air temperature (unless otherwise noted)

PARAMETER		TEST CONDITIONS		MIN	TYP†	MAX	UNIT
V _{IK}	Input clamp voltage	I _I = -18 mA				-1.5	V
V _{OH}	High-level output voltage	V _{IH} = 2 V, I _{OH} = -33 mA	V _{IL} = 0.8 V,		3.7		V
V _{OL}	Low-level output voltage	V _{IH} = 2 V, I _{OL} = 33 mA	V _{IL} = 0.8 V,		1.1		V
V _O	Output voltage	I _O = 0		0		6	V
V _{OD1}	Differential output voltage	I _O = 0		1.5	6	6	V
V _{OD2}	Differential output voltage	R _L = 100 Ω,	See Figure 1	1/2 V _{OD1} or 2‡			V
		R _L = 54 Ω,	See Figure 1	1.5	2.5	5	V
V _{OD3}	Differential output voltage	See Note 2		1.5		5	V
Δ V _{OD}	Change in magnitude of differential output voltage§					±0.2	V
V _{OC}	Common-mode output voltage¶	R _L = 54 Ω or 100 Ω, See Figure 1				+3 -1	V
Δ V _{OC}	Change in magnitude of common-mode output voltage§					±0.2	V
I _O	Output current with power off	V _{CC} = 0, V _O = -7 V to 12 V				±100	μA
I _{OZ}	High-impedance-state output current	V _O = -7 V to 12 V				±100	μA
I _{IH}	High-level input current	V _I = 2.7 V				20	μA
I _{IL}	Low-level input current	V _I = 0.5 V				-360	μA
I _{OS}	Short-circuit output current	V _O = -7 V				-180	mA
		V _O = V _{CC}				180	
		V _O = 12 V				500	
I _{CC}	Supply current (all drivers)	No load	Outputs enabled		38	60	mA
			Outputs disabled		18	40	

† All typical values are at V_{CC} = 5 V and T_A = 25°C.

‡ The minimum V_{OD2} with a 100-Ω load is either 1/2 V_{OD1} or 2 V, whichever is greater.

§ Δ|V_{OD}| and Δ|V_{OC}| are the changes in magnitude of V_{OD} and V_{OC}, respectively, that occur when the input is changed from a high level to a low level.

¶ In ANSI Standard EIA/TIA-422-B, V_{OC}, which is the average of the two output voltages with respect to ground, is called output offset voltage, V_{OS}.

NOTE 2: See EIA Standard RS-485.

switching characteristics, V_{CC} = 5 V, T_A = 25°C

PARAMETER		TEST CONDITIONS		MIN	TYP	MAX	UNIT
t _d (OD)	Differential-output delay time	R _L = 54 Ω,	See Figure 2		45	65	ns
t _t (OD)	Differential-output transition time				80	120	ns
t _{pZH}	Output enable time to high level	R _L = 110 Ω,	See Figure 3		80	120	ns
t _{pZL}	Output enable time to low level	R _L = 110 Ω,	See Figure 4		55	80	ns
t _{pHZ}	Output disable time from high level	R _L = 110 Ω,	See Figure 3		75	115	ns
t _{pLZ}	Output disable time from low level	R _L = 110 Ω,	See Figure 3		18	30	ns



SN75174 QUADRUPLE DIFFERENTIAL LINE DRIVER

SLLS039B – OCTOBER 1980 – REVISED MAY 1995

SYMBOL EQUIVALENTS

DATA SHEET PARAMETER	EIA/TIA-422-B	RS-485
V_O	V_{oa}, V_{ob}	V_{oa}, V_{ob}
$ V_{OD1} $	V_o	V_o
$ V_{OD2} $	$V_t (R_L = 100 \Omega)$	$V_t (R_L = 54 \Omega)$
$ V_{OD3} $		V_t (Test Termination Measurement 2)
$\Delta V_{OD} $	$ V_t - \bar{V}_t $	$ V_t - \bar{V}_t $
V_{OC}	$ V_{os} $	$ V_{os} $
$\Delta V_{OC} $	$ V_{os} - \bar{V}_{os} $	$ V_{os} - \bar{V}_{os} $
I_{OS}	$ I_{sa} , I_{sb} $	
I_O	$ I_{xa} , I_{xb} $	I_{ia}, I_{ib}

PARAMETER MEASUREMENT INFORMATION

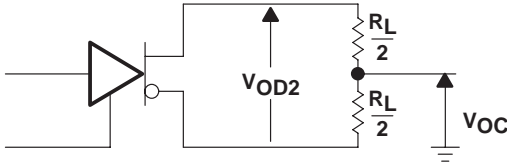
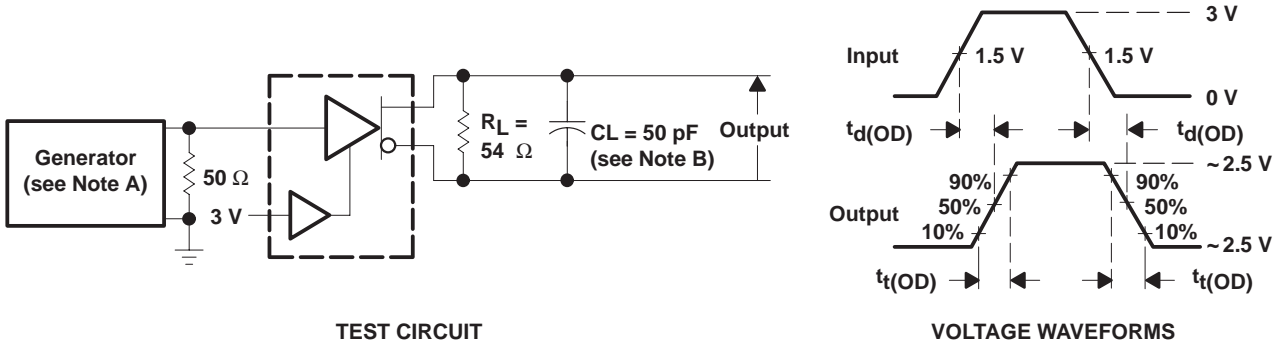

Figure 1. Differential and Common-Mode Output Voltages



- NOTES: A. The input pulse is supplied by a generator having the following characteristics: $t_r \leq 5 \text{ ns}$, $t_f \leq 5 \text{ ns}$, $\text{PRR} \leq 1 \text{ MHz}$, duty cycle = 50%, $Z_O = 50 \Omega$.
 B. C_L includes probe and stray capacitance.

Figure 2. Differential-Output Test Circuit and Voltage Waveforms



SN75174 QUADRUPLE DIFFERENTIAL LINE DRIVER

SLLS039B – OCTOBER 1980 – REVISED MAY 1995

PARAMETER MEASUREMENT INFORMATION

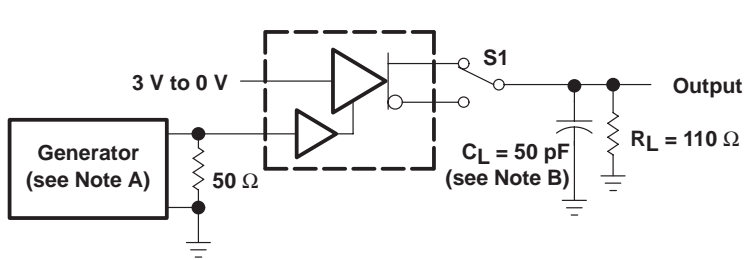

TEST CIRCUIT

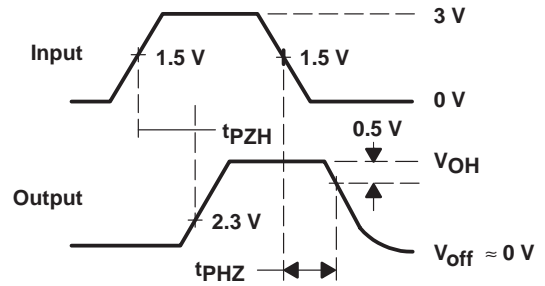

VOLTAGE WAVEFORMS

- NOTES: A. The input pulse is supplied by a generator having the following characteristics: PRR \leq 1 MHz, duty cycle = 50%, $t_r \leq$ 5 ns, $t_f \leq$ 5 ns, $Z_O = 50 \Omega$.
 B. C_L includes probe and stray capacitance.

Figure 3. Test Circuit and Voltage Waveforms

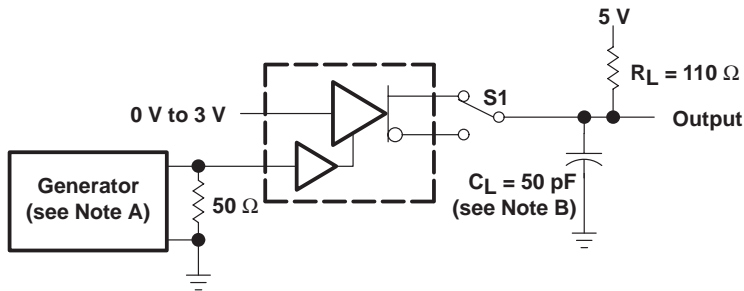

TEST CIRCUIT

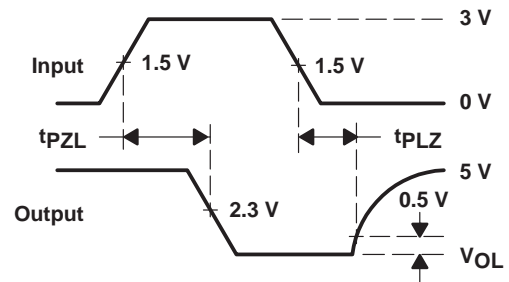

VOLTAGE WAVEFORMS

- NOTES: A. The input pulse is supplied by a generator having the following characteristics: PRR \leq 1 MHz, duty cycle = 50%, $t_r \leq$ 5 ns, $t_f \leq$ 5 ns, $Z_O = 50 \Omega$.
 B. C_L includes probe and stray capacitance.

Figure 4. Test Circuit and Voltage Waveforms

TYPICAL CHARACTERISTICS

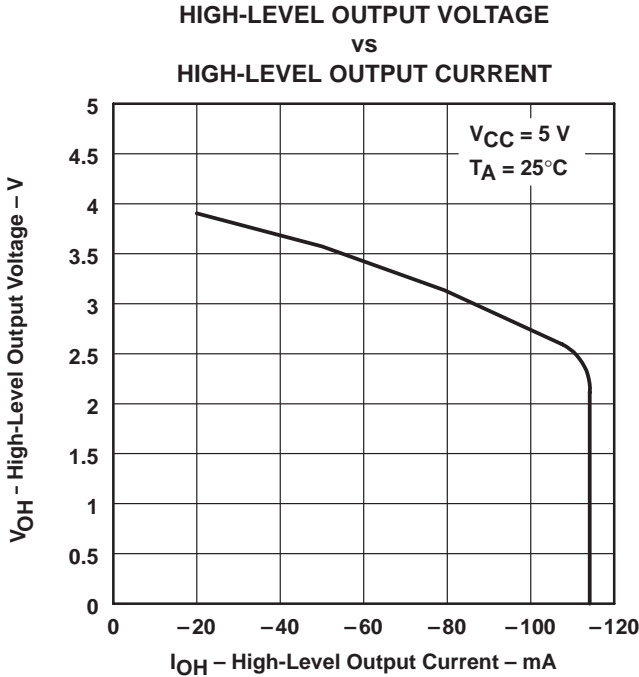

Figure 5

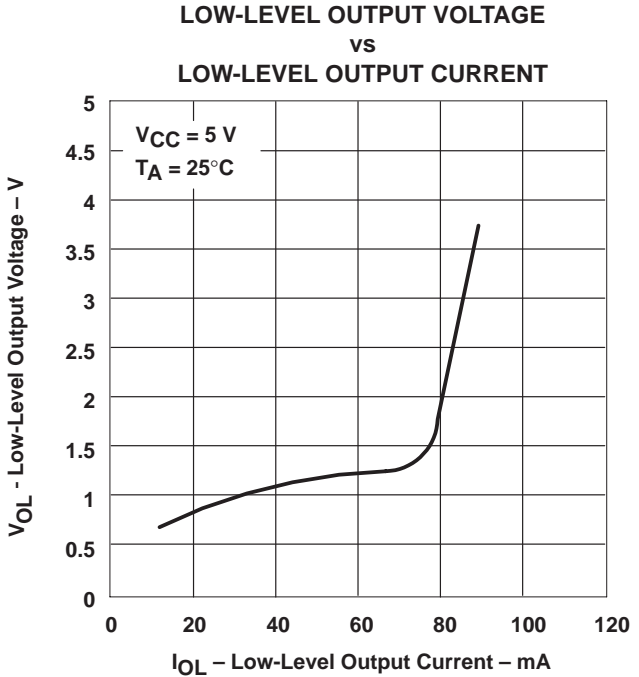

Figure 6

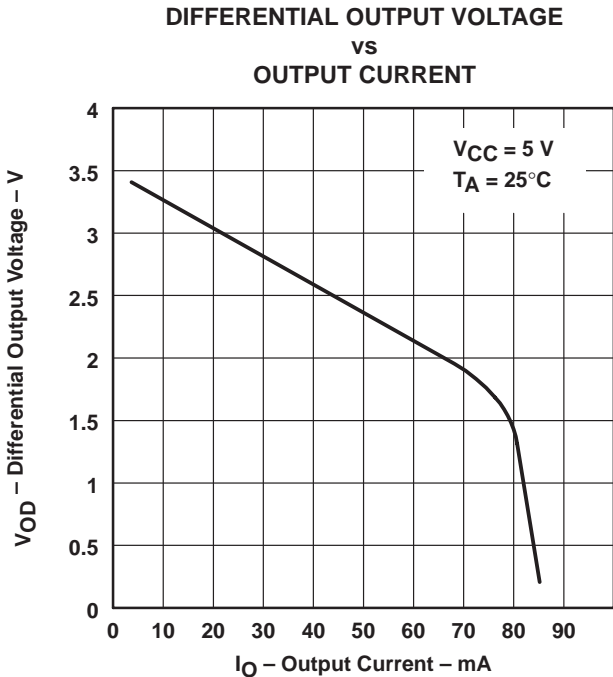

Figure 7

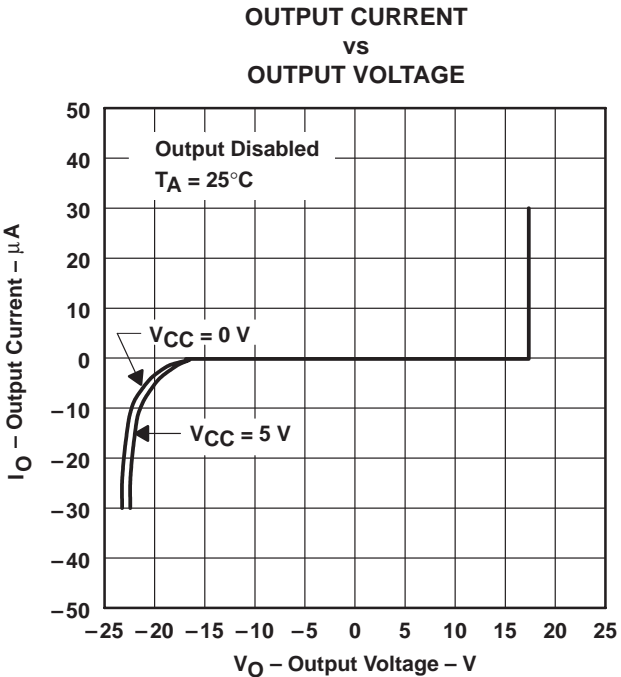

Figure 8

SN75174 QUADRUPLE DIFFERENTIAL LINE DRIVER

SLLS039B – OCTOBER 1980 – REVISED MAY 1995

TYPICAL CHARACTERISTICS

**SUPPLY CURRENT
vs
SUPPLY VOLTAGE**

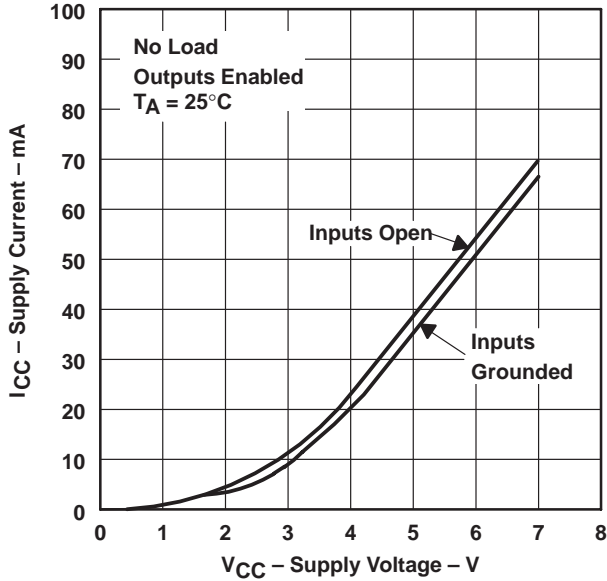

Figure 9

**SUPPLY CURRENT
vs
SUPPLY VOLTAGE**

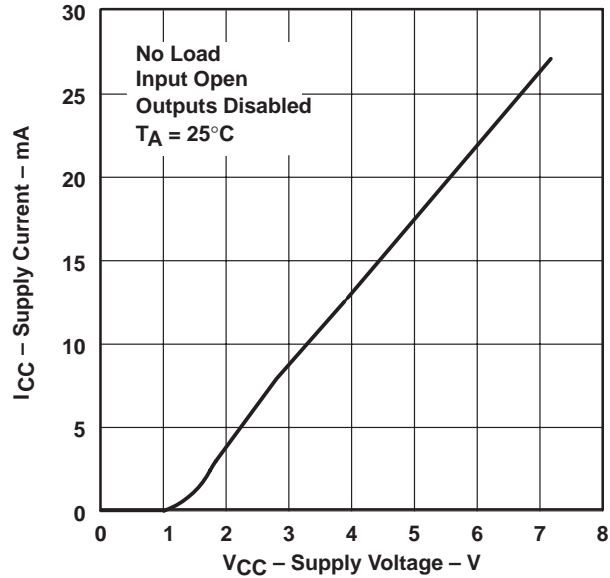
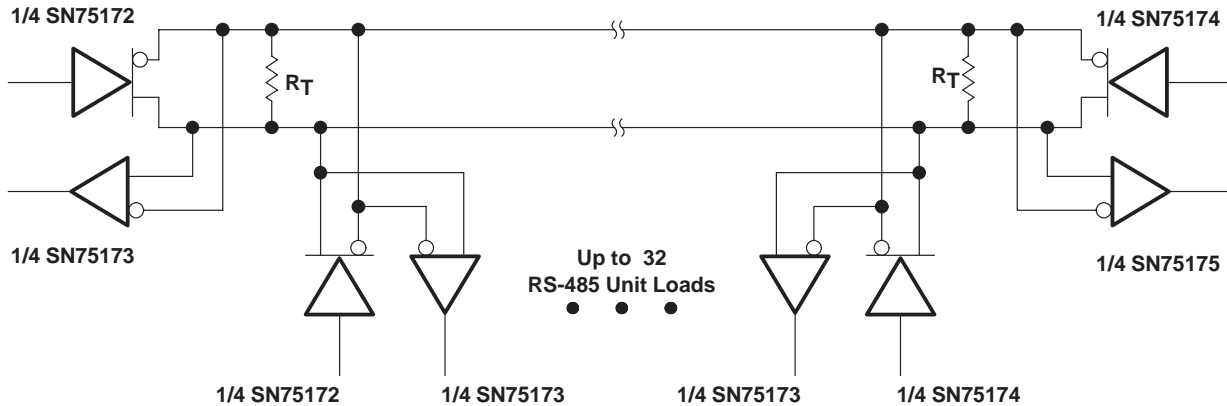

Figure 10

APPLICATION INFORMATION



NOTE: The line length should be terminated at both ends in its characteristic impedance ($R_T = Z_0$). Stub lengths off the main line should be kept as short as possible.

Figure 11. Typical Application Circuit

PACKAGING INFORMATION

Orderable Device	Status ⁽¹⁾	Package Type	Package Drawing	Pins	Package Qty	Eco Plan ⁽²⁾	Lead/Ball Finish	MSL Peak Temp ⁽³⁾
SN75174DW	ACTIVE	SOIC	DW	20	25	Pb-Free (RoHS)	CU NIPDAU	Level-2-250C-1 YEAR/ Level-1-235C-UNLIM
SN75174DWR	ACTIVE	SOIC	DW	20	2000	Pb-Free (RoHS)	CU NIPDAU	Level-2-250C-1 YEAR/ Level-1-235C-UNLIM
SN75174J	OBSOLETE	CDIP	J	16		None	Call TI	Call TI
SN75174N	ACTIVE	PDIP	N	16	25	Pb-Free (RoHS)	CU NIPDAU	Level-NC-NC-NC

⁽¹⁾ The marketing status values are defined as follows:

ACTIVE: Product device recommended for new designs.

LIFEBUY: TI has announced that the device will be discontinued, and a lifetime-buy period is in effect.

NRND: Not recommended for new designs. Device is in production to support existing customers, but TI does not recommend using this part in a new design.

PREVIEW: Device has been announced but is not in production. Samples may or may not be available.

OBSOLETE: TI has discontinued the production of the device.

⁽²⁾ Eco Plan - May not be currently available - please check <http://www.ti.com/productcontent> for the latest availability information and additional product content details.

None: Not yet available Lead (Pb-Free).

Pb-Free (RoHS): TI's terms "Lead-Free" or "Pb-Free" mean semiconductor products that are compatible with the current RoHS requirements for all 6 substances, including the requirement that lead not exceed 0.1% by weight in homogeneous materials. Where designed to be soldered at high temperatures, TI Pb-Free products are suitable for use in specified lead-free processes.

Green (RoHS & no Sb/Br): TI defines "Green" to mean "Pb-Free" and in addition, uses package materials that do not contain halogens, including bromine (Br) or antimony (Sb) above 0.1% of total product weight.

⁽³⁾ MSL, Peak Temp. -- The Moisture Sensitivity Level rating according to the JEDEC industry standard classifications, and peak solder temperature.

Important Information and Disclaimer: The information provided on this page represents TI's knowledge and belief as of the date that it is provided. TI bases its knowledge and belief on information provided by third parties, and makes no representation or warranty as to the accuracy of such information. Efforts are underway to better integrate information from third parties. TI has taken and continues to take reasonable steps to provide representative and accurate information but may not have conducted destructive testing or chemical analysis on incoming materials and chemicals. TI and TI suppliers consider certain information to be proprietary, and thus CAS numbers and other limited information may not be available for release.

In no event shall TI's liability arising out of such information exceed the total purchase price of the TI part(s) at issue in this document sold by TI to Customer on an annual basis.

J (R-GDIP-T**)

14 LEADS SHOWN

CERAMIC DUAL IN-LINE PACKAGE



DIM \ PINS **	14	16	18	20
A	0.300 (7,62) BSC	0.300 (7,62) BSC	0.300 (7,62) BSC	0.300 (7,62) BSC
B MAX	0.785 (19,94)	.840 (21,34)	0.960 (24,38)	1.060 (26,92)
B MIN	—	—	—	—
C MAX	0.300 (7,62)	0.300 (7,62)	0.310 (7,87)	0.300 (7,62)
C MIN	0.245 (6,22)	0.245 (6,22)	0.220 (5,59)	0.245 (6,22)



4040083/F 03/03

- NOTES:
- All linear dimensions are in inches (millimeters).
 - This drawing is subject to change without notice.
 - This package is hermetically sealed with a ceramic lid using glass frit.
 - Index point is provided on cap for terminal identification only on press ceramic glass frit seal only.
 - Falls within MIL STD 1835 GDIP1-T14, GDIP1-T16, GDIP1-T18 and GDIP1-T20.

N (R-PDIP-T**)

PLASTIC DUAL-IN-LINE PACKAGE

16 PINS SHOWN



- NOTES:
- A. All linear dimensions are in inches (millimeters).
 - B. This drawing is subject to change without notice.
 - Falls within JEDEC MS-001, except 18 and 20 pin minimum body length (Dim A).
 - The 20 pin end lead shoulder width is a vendor option, either half or full width.

DW (R-PDSO-G20)

PLASTIC SMALL-OUTLINE PACKAGE



- NOTES:
- A. All linear dimensions are in inches (millimeters).
 - B. This drawing is subject to change without notice.
 - C. Body dimensions do not include mold flash or protrusion not to exceed 0.006 (0,15).
 - D. Falls within JEDEC MS-013 variation AC.

IMPORTANT NOTICE

Texas Instruments Incorporated and its subsidiaries (TI) reserve the right to make corrections, modifications, enhancements, improvements, and other changes to its products and services at any time and to discontinue any product or service without notice. Customers should obtain the latest relevant information before placing orders and should verify that such information is current and complete. All products are sold subject to TI's terms and conditions of sale supplied at the time of order acknowledgment.

TI warrants performance of its hardware products to the specifications applicable at the time of sale in accordance with TI's standard warranty. Testing and other quality control techniques are used to the extent TI deems necessary to support this warranty. Except where mandated by government requirements, testing of all parameters of each product is not necessarily performed.

TI assumes no liability for applications assistance or customer product design. Customers are responsible for their products and applications using TI components. To minimize the risks associated with customer products and applications, customers should provide adequate design and operating safeguards.

TI does not warrant or represent that any license, either express or implied, is granted under any TI patent right, copyright, mask work right, or other TI intellectual property right relating to any combination, machine, or process in which TI products or services are used. Information published by TI regarding third-party products or services does not constitute a license from TI to use such products or services or a warranty or endorsement thereof. Use of such information may require a license from a third party under the patents or other intellectual property of the third party, or a license from TI under the patents or other intellectual property of TI.

Reproduction of information in TI data books or data sheets is permissible only if reproduction is without alteration and is accompanied by all associated warranties, conditions, limitations, and notices. Reproduction of this information with alteration is an unfair and deceptive business practice. TI is not responsible or liable for such altered documentation.

Resale of TI products or services with statements different from or beyond the parameters stated by TI for that product or service voids all express and any implied warranties for the associated TI product or service and is an unfair and deceptive business practice. TI is not responsible or liable for any such statements.

Following are URLs where you can obtain information on other Texas Instruments products and application solutions:

Products		Applications	
Amplifiers	amplifier.ti.com	Audio	www.ti.com/audio
Data Converters	dataconverter.ti.com	Automotive	www.ti.com/automotive
DSP	dsp.ti.com	Broadband	www.ti.com/broadband
Interface	interface.ti.com	Digital Control	www.ti.com/digitalcontrol
Logic	logic.ti.com	Military	www.ti.com/military
Power Mgmt	power.ti.com	Optical Networking	www.ti.com/opticalnetwork
Microcontrollers	microcontroller.ti.com	Security	www.ti.com/security
		Telephony	www.ti.com/telephony
		Video & Imaging	www.ti.com/video
		Wireless	www.ti.com/wireless

Mailing Address: Texas Instruments
Post Office Box 655303 Dallas, Texas 75265

This datasheet has been download from:

www.datasheetcatalog.com

Datasheets for electronics components.