

Cisco IP Telephony Introduction

Overview

Cisco IP Telephony (CIPT) is an instructor-led course presented by Cisco Systems, Inc. training partners to their end-user customers. This five-day course focuses on using Cisco CallManager and other IP telephony components connected in local area networks (LANs) and wide area networks (WANs).

Upon completion of this training course, you will be able to select, connect, configure, and troubleshoot the various Cisco IP telephony devices.

This chapter highlights the course prerequisites and course highlights as well as some administrative issues. It includes the following topics:

- Objectives
- Prerequisites
- General Administration
- Sources of Information
- Course Syllabus
- Graphic Symbols

Course Objectives

This section lists the course objectives.

Objectives

Upon completion of this course, you will be able to perform the following tasks:

- **Understand CIPT architecture, hardware, and software**
- **Build three CIPT deployment models**
- **Access the online documentation**
- **Use the tools within the Cisco CallManager server for troubleshooting**

© 2000, Cisco Systems, Inc. www.cisco.com CIPT v2.0? -3

Upon completion of this course, you will be able to perform the following high-level tasks:

- Given the components of a Cisco IP telephony (CIPT) solution, identify and describe the CIPT architecture, hardware, and software.
- Given hardware and software of a CIPT network solution, install one of the three recommended CIPT deployment models.
- Given a Cisco CallManager server, access the online administration guide to configure CIPT components within Cisco CallManager administration.
- Given an installed Cisco CallManager server, enable and use the tools in the Cisco CallManager server to troubleshoot the CIPT deployment solutions.

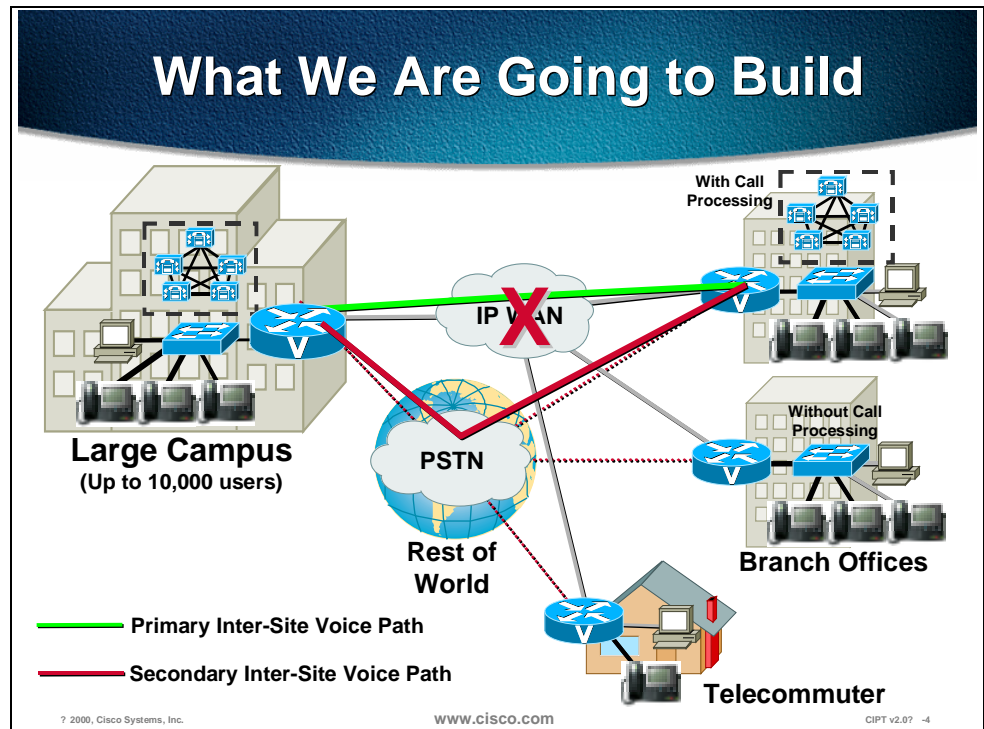

The figure shows a high-level overview of a CIPT network that you should be able to build at the end of this class. To accomplish this course goal, you will be taught how to install Cisco CallManager and configure other IP telephony devices in a LAN and WAN environment. This includes the following tasks:

- Install Cisco CallManager software and supporting services.
- Cluster Cisco CallManagers to establish redundancy.
- Select and connect Cisco access gateways for analog, WAN, and PSTN access.
- Connect and configure digital signal processor (DSP) resources for a CIPT solution.
- Configure the dial plan architecture to control IP telephony traffic.
- Build three Cisco IP telephony deployments: isolated Campus LAN, WAN with distributed call processing, and WAN with centralized call processing.
- Configure IP telephony access through the IP WAN and then the PSTN for backup.
- Install and configure Cisco uOne for voice messaging for the Cisco IP telephony solution.

Configuration, verification, and troubleshooting are done with Cisco CallManager, Windows 2000 NT Server, and Cisco IOS software.

Prerequisites

This section lists the course's prerequisites.

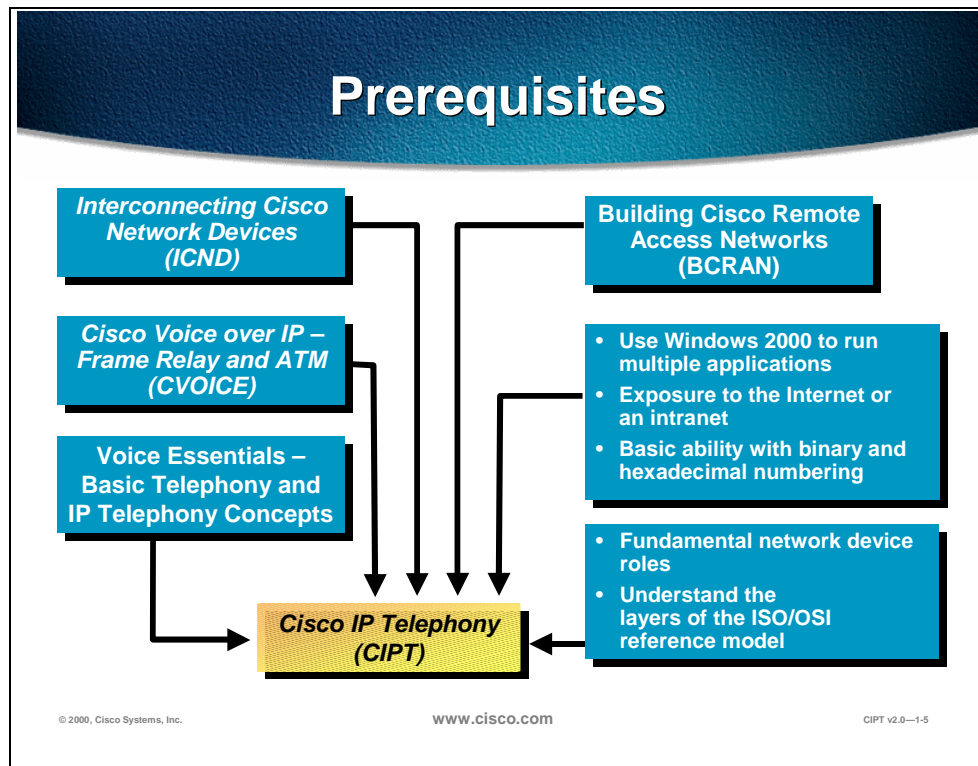

To fully benefit from CIPT, you should already possess certain prerequisite skills. The skills are presented in the figure. These skills can be gained from completing the *Internetworking Technology Multimedia (ITM)* CD-ROM or through work experience. These prerequisites are highlighted in the figure and are outlined below. You should have a working knowledge of the following:

- Commonly used networking terms and topologies
- The basic functions of a network protocol
- Fundamental network device roles (for example, hub, bridge, router, and switch)
- The Open System Interconnection (OSI) reference model
- The ability to use Windows 2000 to run multiple applications
- Exposure to accessing the Internet or an intranet
- Basic knowledge of binary and hexadecimal numbering
- Telephony and IP telephony basic concepts
- Building VoIP networks—gained from the Cisco course, *Cisco Voice Over Frame Relay, ATM, and IP v2.0 (CVOICE)*.

Participant Role

This section discusses your responsibilities as a student.

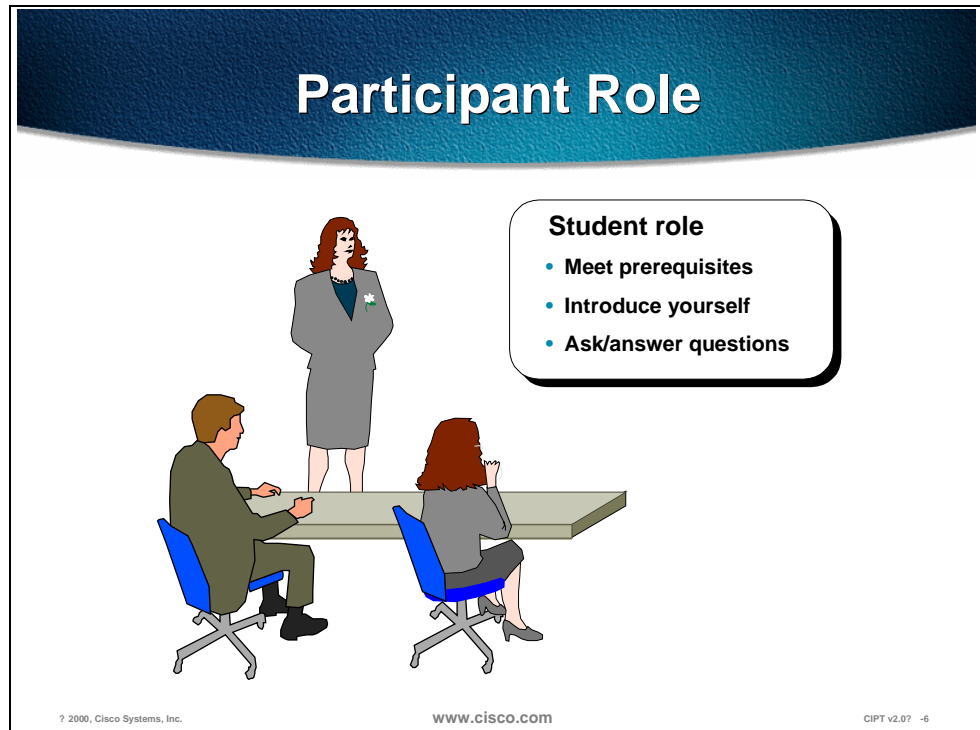

To take full advantage of the information presented in this course, you should meet the prerequisites for this class.

Introduce yourself to the instructor and other students who will be working with you during the five days of this course.

You are encouraged to ask any questions relevant to the course materials.

If you have pertinent questions concerning other Cisco features and products not covered in this course, please discuss these topics during breaks or after class, and the instructor will try to answer the questions or direct you to an appropriate information source.

Welcome: Please Introduce Yourself

- **Your name and work location**
- **Your job responsibilities**
- **Your internetworking experience**
- **Your objectives for this week**

© 2000, Cisco Systems, Inc.

www.cisco.com

CIPT v2.07 -7

Introduce yourself by stating your name and describing your job function.

Briefly describe your experience with installing and configuring Cisco network devices and with internetworking in general, and also how your experience helped you meet the prerequisites for this course.

You should also state what you expect to learn from this course.

General Administration

This section highlights miscellaneous administrative tasks that must be addressed.

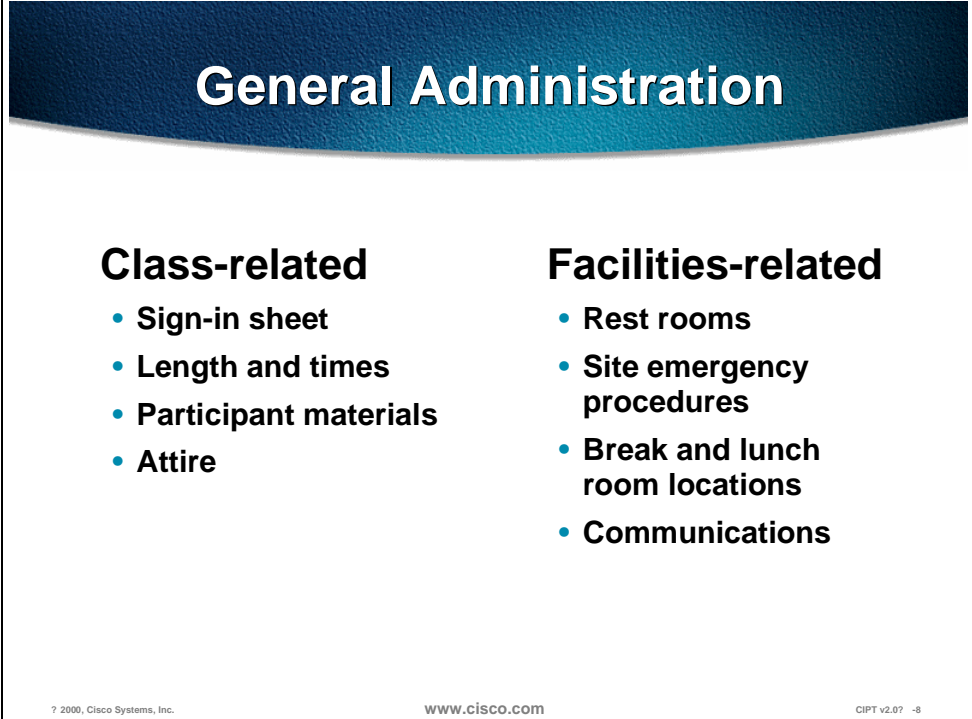
A slide titled "General Administration" with a dark blue header. The slide is divided into two columns: "Class-related" and "Facilities-related". Each column contains a bulleted list of administrative tasks. At the bottom of the slide, there is a footer with the text "© 2000, Cisco Systems, Inc.", "www.cisco.com", and "CIPT v2.07 -8".

Class-related	Facilities-related
<ul style="list-style-type: none">• Sign-in sheet• Length and times• Participant materials• Attire	<ul style="list-style-type: none">• Rest rooms• Site emergency procedures• Break and lunch room locations• Communications

The instructor will discuss the administrative issues in detail so you will know exactly what to expect from both the class and facilities. The following items will be discussed:

- Recording your name on a sign-in sheet
- The starting and anticipated ending time of each class day
- What materials you can expect to receive during the class
- The appropriate attire during class attendance
- Rest room locations
- What to do in the event of an emergency
- Class breaks and lunch facilities
- How to send and receive telephone, email, and fax messages

Sources of Information

This section identifies additional sources of information.

Sources of Information

- **www.cisco.com**
- **CD-ROM**
- **Cisco Press**

© 2000, Cisco Systems, Inc. www.cisco.com CIPT v2.07 -9

Most of the information presented in this course can be found on the Cisco Systems web site or on CD-ROM. These supporting materials are available in HTML format, and as manuals and release notes.

To learn more about the subjects covered in this course, feel free to access the following sources of information:

- *Cisco Documentation CD-ROM* or www.cisco.com
- *ITM CD-ROM* or www.cisco.com
- *Cisco IOS 12.0 Configuration Guide and Command Reference Guide*
- *Catalyst 1900 Series Installation and Configuration Guide*

All of these documents can all be found at <http://www.cisco.com>.

Course Syllabus

This section discusses the week's schedule.

Course Syllabus		
Module 1	Module 2	Module 3
Cisco IP Telephony Introduction	Cisco CallManager Services	Campus Infrastructure
Introduction to Cisco AVVID	Dial Plan Architecture	WAN Deployment – Distributed Call Processing
Primary CIPT Components	Cisco Access Gateways	WAN Deployment – Centralized Call Processing
Understanding DHCP and TFTP	Catalyst Digital Signaling Processor Resources	Troubleshooting
Cisco CallManager	Cisco IP Phones	Cisco uOne
	Cisco CallManager Architecture	

© 2000, Cisco Systems, Inc. www.cisco.com CIPT v2.0—1-10

The following schedule reflects the recommended structure for this course. This structure allows enough time for your instructor to present the course information to you and for you to work through the laboratory exercises. The exact timing of the subject materials and labs depends on the pace of your specific class.

Module 1, Getting Started with Cisco IP Telephony

The purpose of the module is to introduce you to the training room and the CIPT network environment. This section provides a review of networking fundamentals.

Module 1 includes the following chapters:

- Chapter 1—Cisco IP Telephony Introduction
- Chapter 2—Introduction to Cisco AVVID
- Chapter 3—Primary CIPT Components
- Chapter 4— Understanding DHCP and TFTP
- Chapter 5— Cisco CallManager

Module 2, Building a CIPT Campus Solution

The purpose of the module is to introduce you to CIPT fundamentals. You will learn to configure Cisco CallManager and other primary CIPT components in a LAN environment.

Module 2 includes the following chapters:

- Chapter 6— Cisco CallManager Services
- Chapter 7— Dial Plan Architecture
- Chapter 8— Cisco Access Gateways
- Chapter 9— Catalyst Digital Signaling Processor Provisioning
- Chapter 10— Cisco IP Phones
- Chapter 11— Cisco CallManager Architecture

Module 3, Cisco IP Telephony Scalable Options

The purpose of the module is to introduce the student to scalable options of Cisco IP telephony. You will also learn to install and configure Cisco uOne for voice messaging and how to use the IP WAN effectively.

Module 3 includes the following chapters:

- Chapter 12— Campus Infrastructure
- Chapter 13—Distributed Call Processing
- Chapter 14—Centralized Call Processing
- Chapter 15—Troubleshooting a CIPT Solution
- Chapter 16— Cisco uOne 4.1E—Corporate

Graphic Symbols

This section illustrates symbols that are used throughout the course.

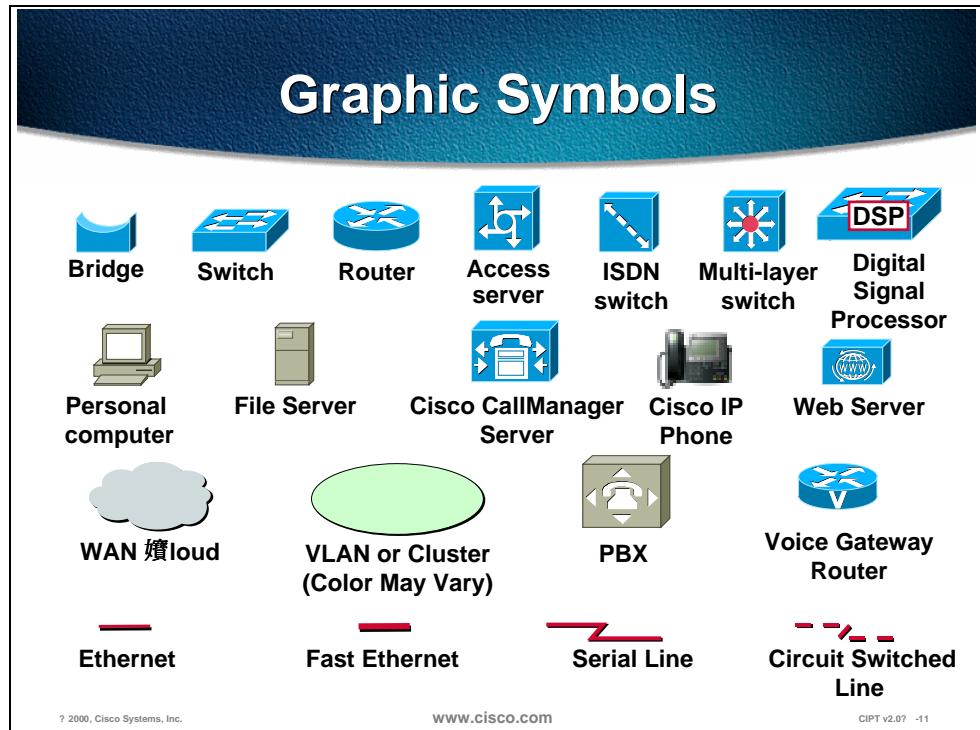

These symbols are used in the graphical presentations of this course to represent device or connection types.

Note The addressing schemes and telephone numbers used in this course are reserved and not to be used in the public network. They are used in this course as examples to facilitate learning. When building your network, use only the addresses and telephone numbers assigned by your network designer and service provider.

Introduction to Cisco AVVID

Overview

This chapter will provide introductory information about the Cisco Architecture for Voice, Video, and Integrated Data (AVVID) strategy. The Cisco IP Telephony solution is within the AVVID strategy. The architecture delivers an Internet ecosystem, which thrives on open standards, encouraging the development and interoperability of multi-vendor, multi-product solutions.

The following topics are in this chapter:

- Objectives
- Cisco AVVID Architecture
- Convergence
- End-to-End Architecture
- IP Telephony Design Goals
- Deployment Models
- Written Exercises
- Summary
- Review Questions

Objectives

This section lists the chapter objectives.

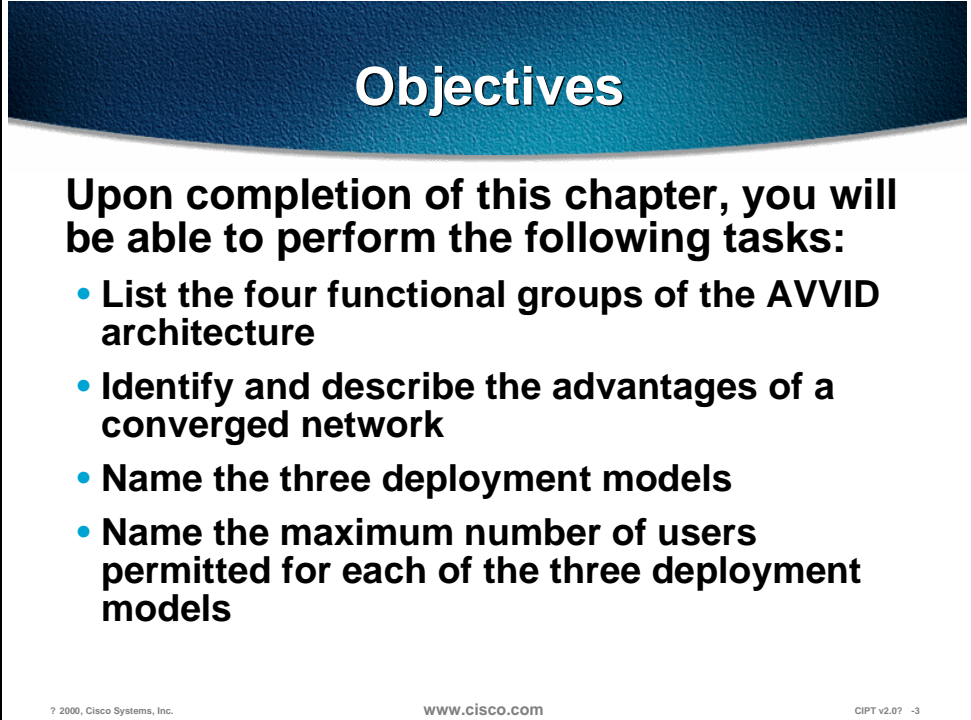
A slide with a dark blue header containing the word "Objectives" in white. Below the header, the text "Upon completion of this chapter, you will be able to perform the following tasks:" is followed by a bulleted list of four objectives. At the bottom of the slide, there is small text: "© 2000, Cisco Systems, Inc.", "www.cisco.com", and "CIPT v2.0? -3".

Objectives

Upon completion of this chapter, you will be able to perform the following tasks:

- **List the four functional groups of the AVVID architecture**
- **Identify and describe the advantages of a converged network**
- **Name the three deployment models**
- **Name the maximum number of users permitted for each of the three deployment models**

© 2000, Cisco Systems, Inc. www.cisco.com CIPT v2.0? -3

Upon completion of this chapter you will be able to perform the following tasks:

- List the four functional groups of the AVVID architecture.
- Identify and describe the advantages of a converged network.
- Name the three deployment models.
- Name the maximum number of users permitted for each of the three deployment models.

Cisco AVVID Architecture

This section describes the Cisco Architecture for Voice, Video, and Integrated Data (AVVID).

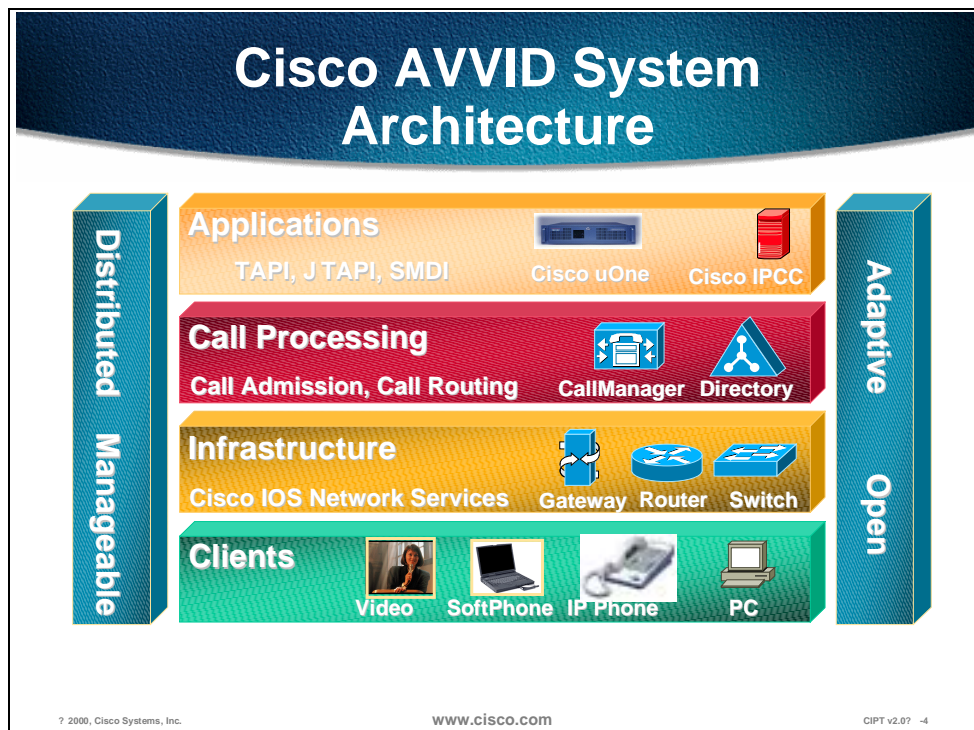

This figure above represents the four functional groups:

- Infrastructure
- Clients
- Call Processing
- Applications

The use of open standards and the promotion of multi-vendor collaboration and interoperability are an important benefit of the Cisco AVVID architecture. The architecture creates an environment that fosters competition; this in turn lowers prices for the consumer. It also allows the integration of products from multiple vendors to create a customized solution.

No single vendor can provide a solution that fits all requirements for data, voice, and video. Often specialized applications are designed and implemented only by a single company and need to be integrated with the overall solution. The adoption of open standards creates an ecosystem that actively promotes a model of integration.

Convergence

This section introduces the concept of converged networks.

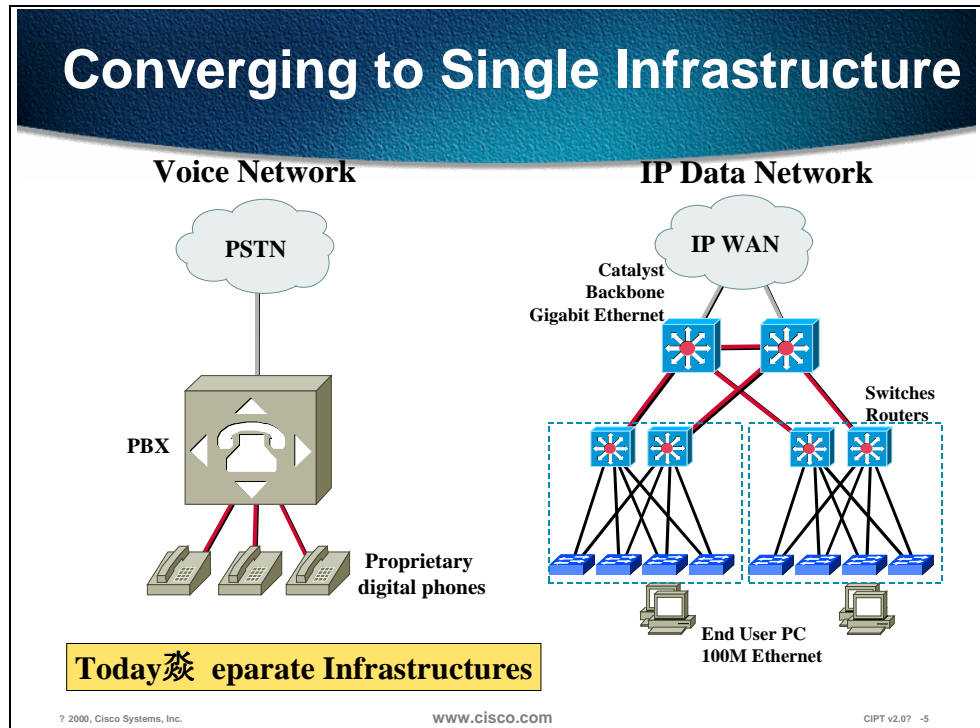

In the figure above you see two separate networks, one for voice and one for data. Today most voice and data networks are separate. This involves two separate skill sets to support each network, which implies that there are two departments, each supporting a company's voice and data network.

Classic PBX Architecture

PBX Functionality Breaks Down Into Four Categories:

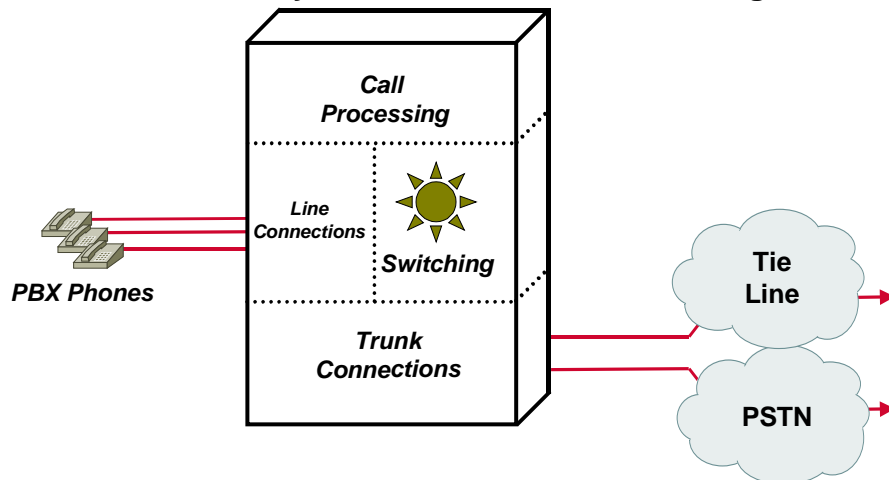

© 2000, Cisco Systems, Inc.

www.cisco.com

CIPT v2.0--2-6

The Private Branch Exchange (PBX) consist of four categories:

- Call Processing
- Line Connections
- Switching
- Trunk Connections

The Call Processing in a PBX does the digit analysis, routing and other call processing functions. The line connections connect to clients (PBX Phones or end point devices). The switching in the PBX allows for clients to be switched and connected to each other for communication. The trunk connections connect the PBX to the Public Switched Telephone Network (PSTN) or other telephony devices.

IP Telephony Architecture

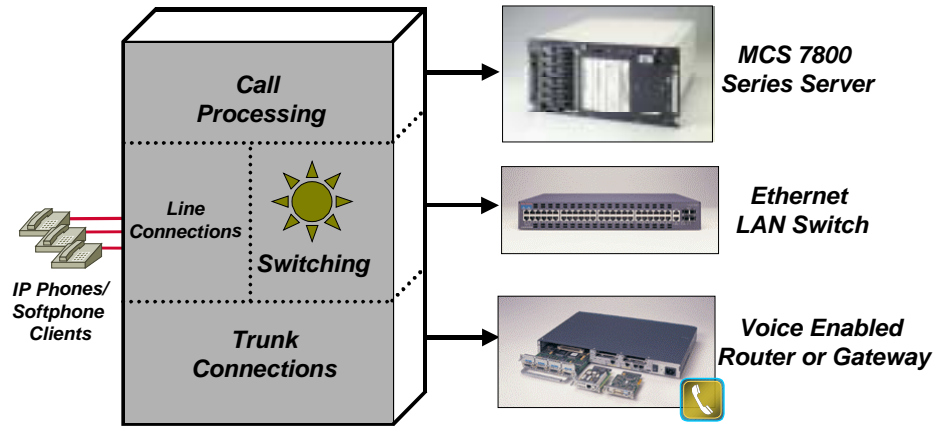

© 2000, Cisco Systems, Inc.

www.cisco.com

CIPT v2.0-2-7

IP Telephony Architecture also has four categories:

- Call Processing
- Line Connections
- Switching
- Trunk Connections

In the IP Telephony architecture, the Cisco CallManager does the call processing of digit analysis, routing and other call processing functions. IP telephony the line connections uses connects to IP Phones, Softphones and other IP telephony clients or endpoints. Ethernet LAN switching products performed the switching functions are by and the trunk connections use voice enabled router and other IP telephony gateways.

Choices...

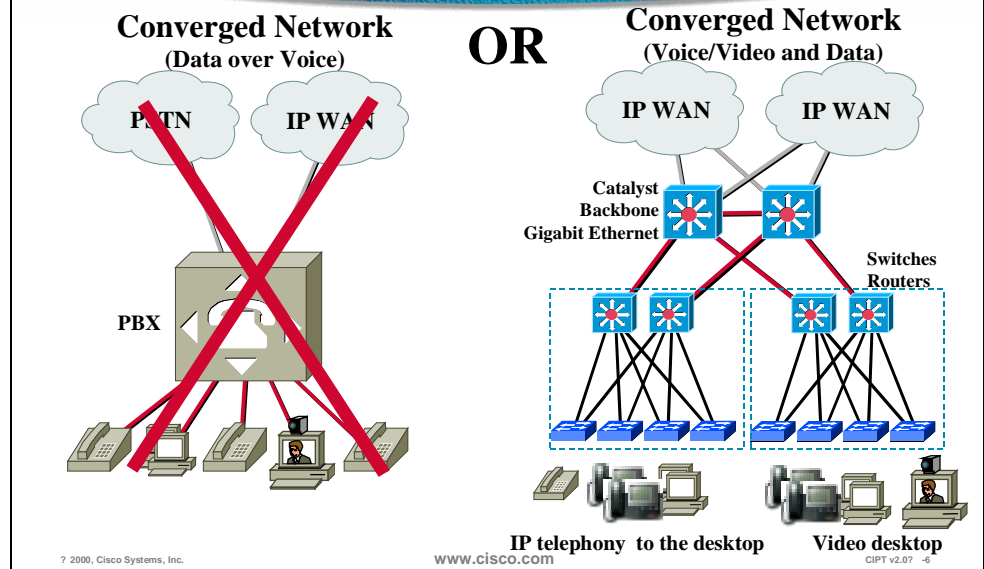

Now there are choices: a converged network of data over voice or the more preferred voice/video and data. The following advantages are part of the converged network:

- One network managed by one department
- Scalable
- Open Architecture
- Adaptive and Available

Convergence with Cisco AVVID

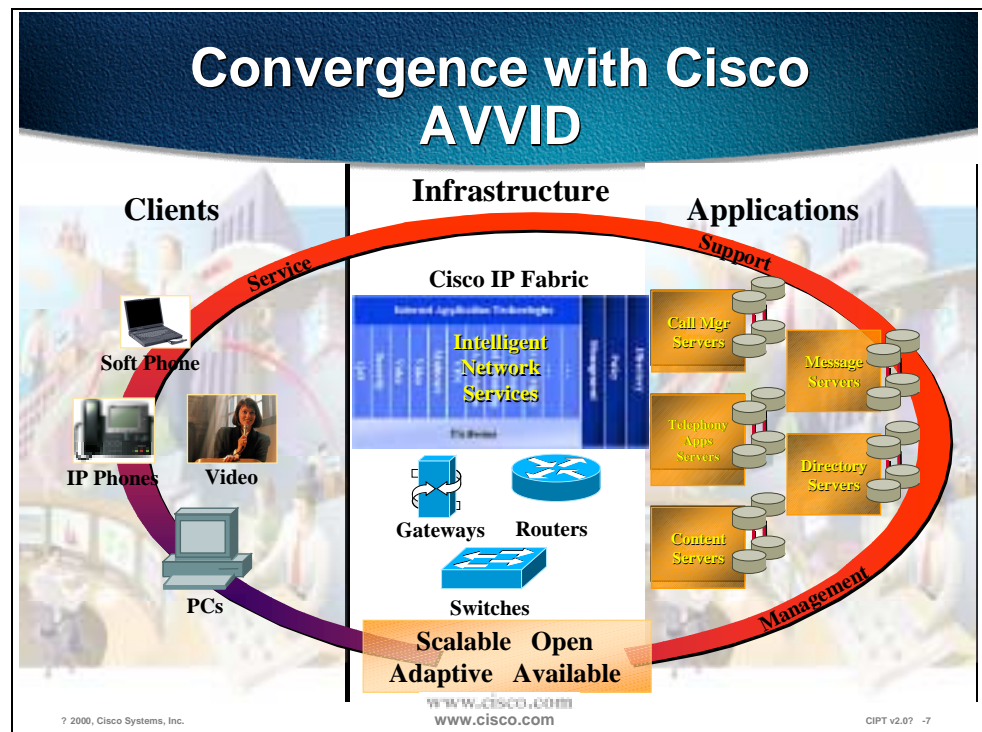

Cisco AVVID is an end-to-end architecture that includes three distinct components: infrastructure, clients, and applications. In the three components, there are four functional components (Infrastructure, Clients, Call Processing, Applications). The figure above depicts the components of the architecture.

Infrastructure

As with any architecture, Cisco AVVID relies upon a strong and stable foundation. This foundation is built upon the multi-protocol routers and multi-layer LAN switches that are used as building blocks for enterprise networks.

Clients

Clients are the end devices that are able to take advantage of the converged IP infrastructure such as, IP phones, PCs, video and soft phones.

Applications

The most exciting facet of converged networking is the emerging applications, such as desktop IP telephony, unified messaging and the Cisco IP Contact Center. The converged network offers a framework that permits rapid deployment of these new technologies and innovative applications.

End-to-End Architecture

This section introduces the Cisco AVVID end-to-end architecture model.

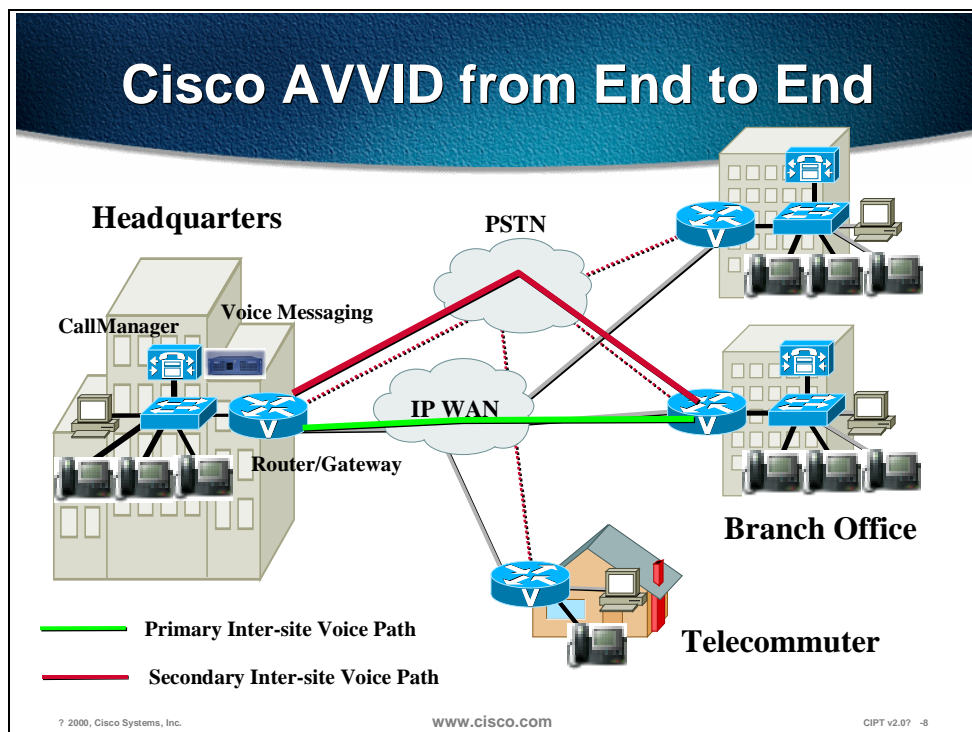

The figure depicts the components of the Cisco AVVID end-to-end architecture model. Ideally the Cisco AVVID end-to-end architecture will not have a Public Switched Telephone Network (PSTN) for backup, only redundant IP WAN networks. For initial deployment and interoperability the IP WAN is the *primary* Inter-site Voice Path and the PSTN is the *secondary* Inter-site Voice Path.

The next section describes how the IP WAN and PSTN are used in a Cisco IP telephony network design.

IP Telephony Design Goals

This section introduces IP telephony design.

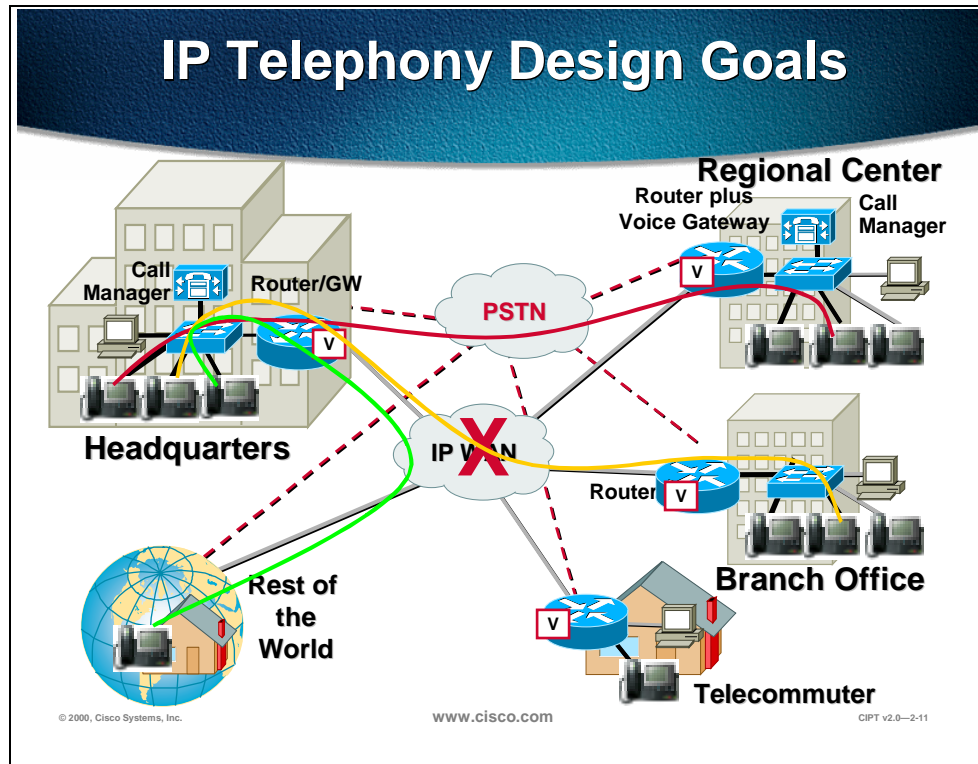

A CallManager cluster is located at the headquarters and the Regional Center. The design goal of IP telephony is to have primary connectivity to the regional center, branch office, and telecommuter through the IP WAN and in the future to the rest of the world. The PSTN is for back up use if the IP WAN should go down or bandwidth is unavailable.

The branch office call processing is done at headquarters and phone calls between the branch office and headquarters will be placed over the IP WAN. If the IP WAN goes down, then the calls can use the PSTN to connect using the voice enabled access routers.

With the abundance of IP to the home, now the rest of the world would access the IP WAN to call headquarters.

Deployment Models

In the AVVID designs based on a CallManager 3.0 environment, three basic deployment models are recommended. This section will give a high level overview of each model and the boundaries in which these designs should be kept. This will provide you with some guidance as to when and why to select a particular design. Subsequent chapters and sections will delve into much more detail of each deployment model. The flow of this section is structured to emulate the labs in this course where each of the deployment models build upon each of these as it progresses.

Three Deployment Models

- **Isolated deployment**
- **Multi-site IP WAN deployments—
(distributed call processing model)**
- **Multi-site IP WAN deployments—
(centralized call processing)**

© 2000, Cisco Systems, Inc. www.cisco.com CIPT v2.0? -10

The three deployment models are listed below and are all based on the guidelines of limiting no more than 2500 users per CallManager at any time. These models are:

- Isolated deployment
- Multi-site IP WAN deployments—(distributed call processing model)
- Multi-site IP WAN deployments—(centralized call processing)

Individual Campus Deployments

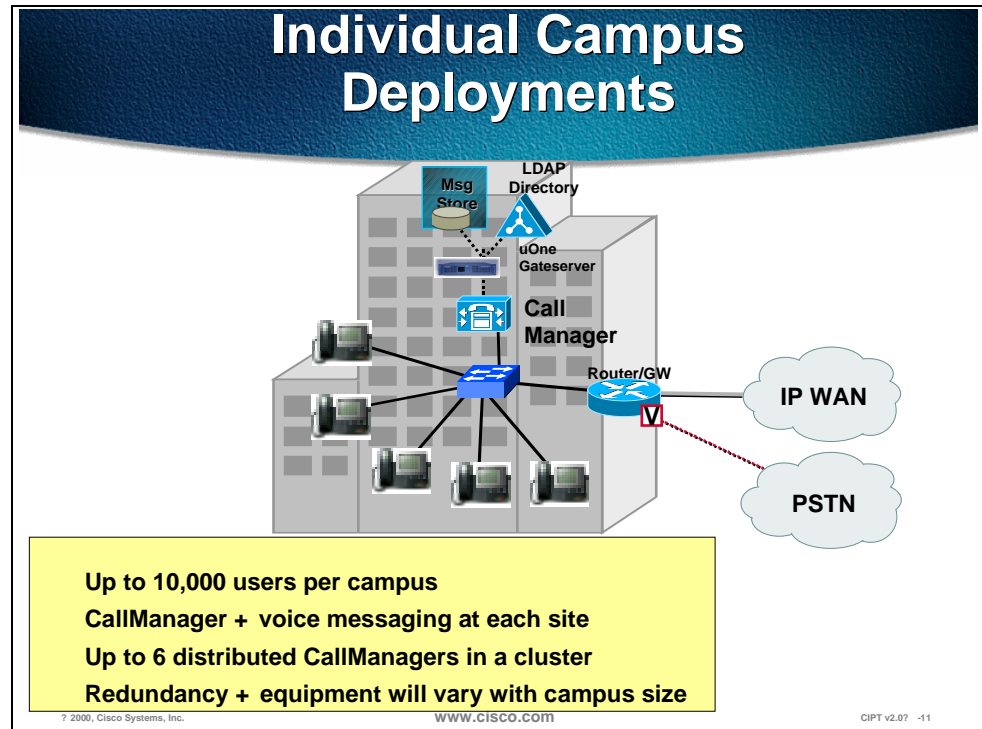

The above figure is of an individual or isolated deployment. This deployment model must adhere to the following design characteristics:

- CallManager/CallManager cluster at each campus to provide scalable call control
- Maximum of 10,000 users per cluster
- Maximum of 6 CallManagers in a cluster (with specific design requirements)
- Maximum of 2500 users registered with a CallManager at any time (after failover)
- Use of PSTN only for networking multiple sites and all external calls
- DSP (Digital Signal Processor) resources for conferencing at each site
- Voice/unified messaging components at each site
- G.711 (uncompressed) for all IP phone calls—80kbps of IP BW per call

Multi-site IP WAN (Distributed Call Processing)

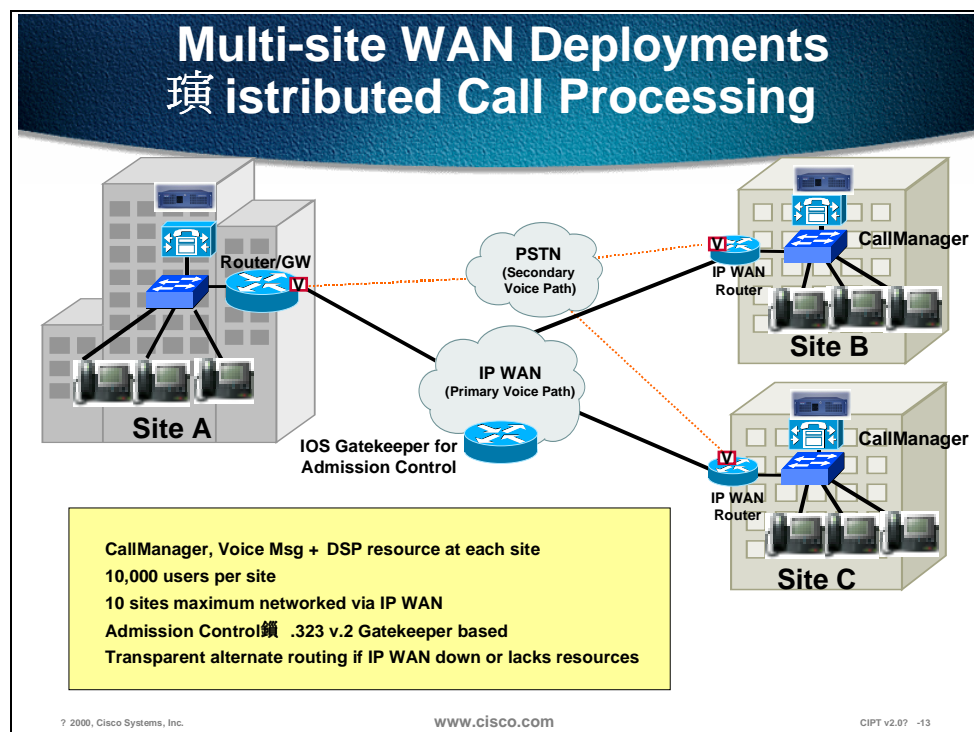

The above figure is of multi-site WAN deployment that uses Distributed Call Processing and must adhere to the following design characteristics:

- CallManager/CallManager cluster at each location (10,000 users maximum per site)
- CallManager clusters are confined to a campus and may *not* span the WAN
- Primary inter-site voice path over IP WAN, secondary path over PSTN
- Transparent use of PSTN if IP WAN unavailable
- Use of Cisco IOS Gatekeeper for admission control of IP WAN
- Maximum of 10 sites networked across the IP WAN (hub and spoke topologies)
- Compressed voice calls supported across the IP WAN
- DSP resources for conferencing and WAN transcoding at each site
- Voice/unified messaging components at each site
- The minimum requirements for voice, video, and data should not exceed 75% of the link/VC's bandwidth (56kbps is the minimum link speed supported)
- The customer has a QoS (Quality of Service)/voice enabled network able to support voice transport

Multi-site IP WAN (Centralized Call Processing)

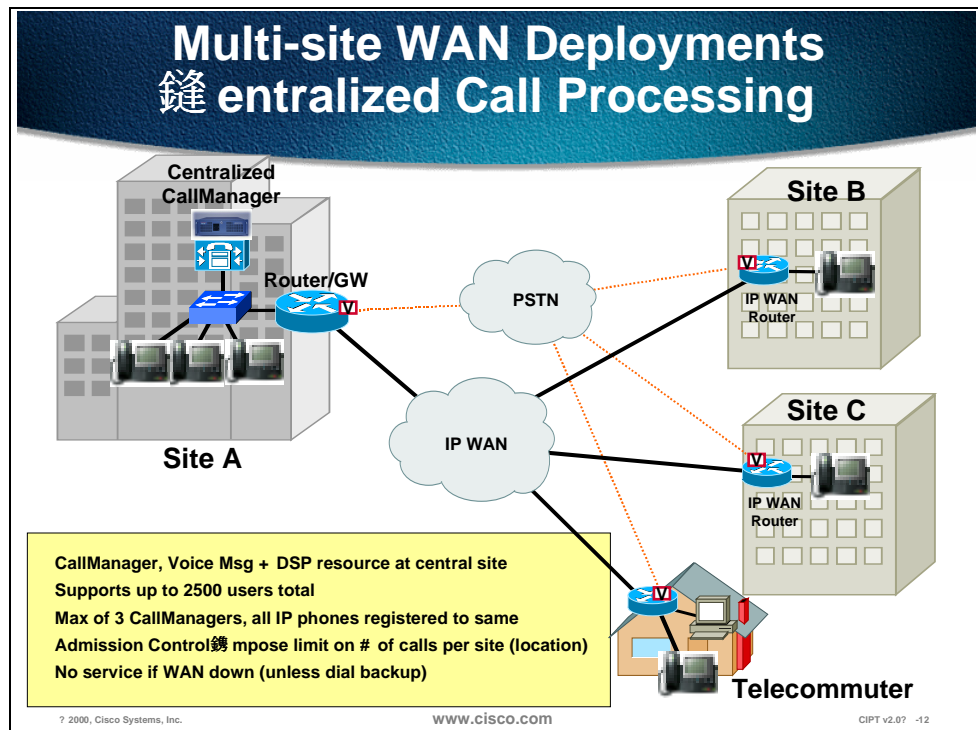

The above figure is of multi-site WAN deployment that uses centralized call processing that must adhere to the following design characteristics:

- To support Admission Control only one active CallManager is supported at the central site. May have a second and tertiary CallManager in a cluster of three as long as all IP phones in the cluster are registered to the same Call Manager at any given time. This is called a centralized call processing cluster.
- Maximum of 2500 users can be supported per centralized call processing cluster in this deployment model (no limit on number of remote sites). May have multiple centralized call processing.
- Cisco CallManagers of 2500 at a central site that interconnects via H.323.
- IP phones only at remote sites without a local CallManager.
- Call admission control mechanism is “bandwidth limits by location” (hub and spoke WAN topology).
- Compressed voice calls across the IP WAN are supported.
- Manual use of PSTN if IP WAN is unavailable (get a busy signal and dial PSTN access code).
- If IP WAN is down then there is no IP phone service unless dial backup exists.
- Voice/unified messaging and DSP resource components at central site only. The minimum requirements for voice, video, and data should not exceed 75% of the link/VC’s bandwidth (56kbps is the minimum link speed supported).

- Remote sites may use IOS as well as skinny based gateways.

Written Exercise 1: Identifying Functional Groups of Cisco AVVID

Complete the following written exercise to practice what you learned in this chapter.

Objective

In this exercise, you will complete the following tasks:

- Identify the four functional groups of Cisco AVVID
- Write an example of each functional group

Task: Identify the four functional groups of Cisco AVVID

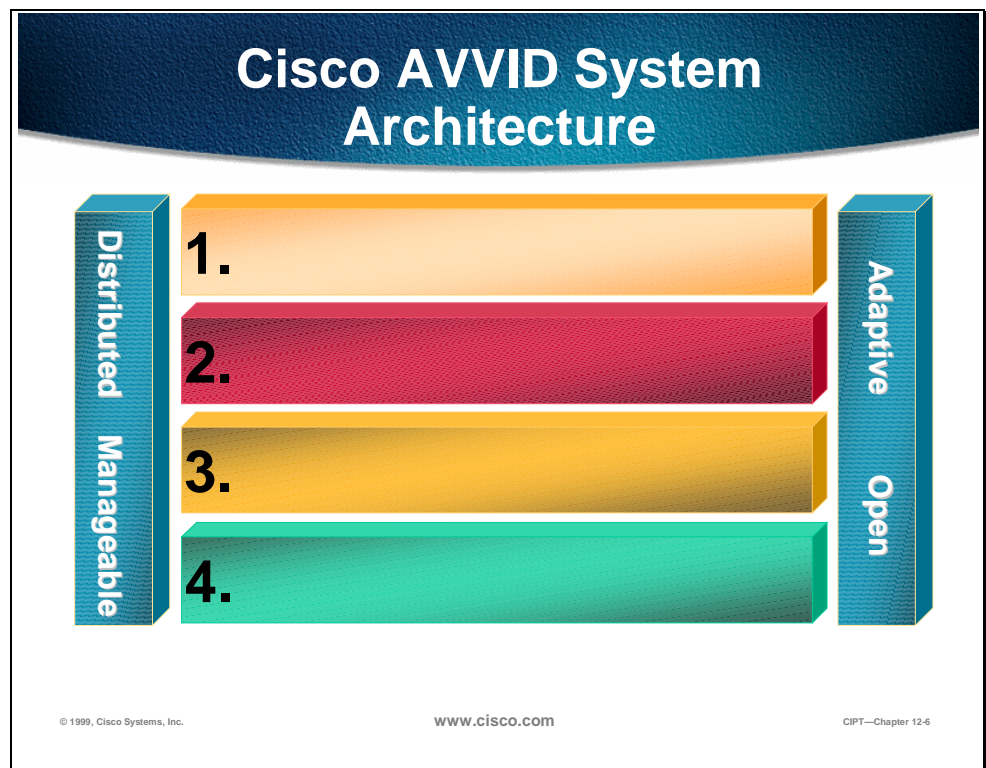

Example of 1: _____

Example of 2: _____

Example of 3: _____

Example of 4: _____

Completion Criteria

You have completed the exercise when you have filled in the four functional groups of Cisco AVVID in the figure and listed examples of each functional group on the lines below.

Written Exercise 2: Identify the three recommended Cisco AVVID Deployments

Complete the following Exercise to practice what you learned in this chapter.

Objective

In this Exercise you will identify the three recommended Cisco AVVID deployments.

Task: Label the three figures below with the correct recommended Cisco AVVID deployment.

Given what you know about the Cisco AVVID Deployment models, identify the deployment models and list some recommended design characteristics of each deployment.

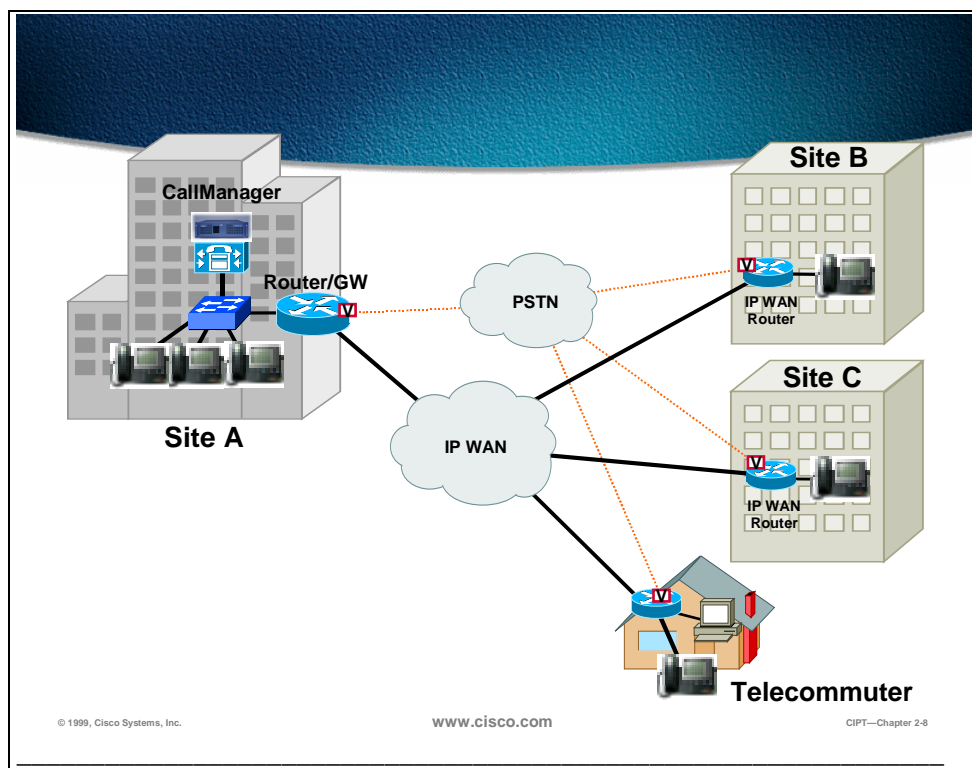

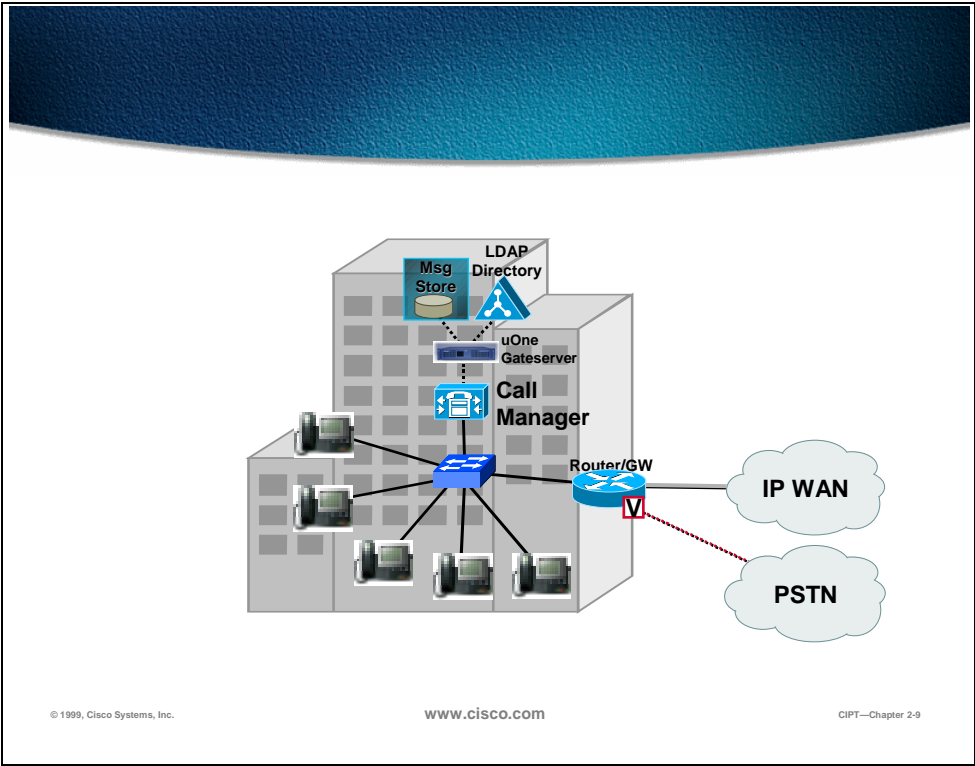

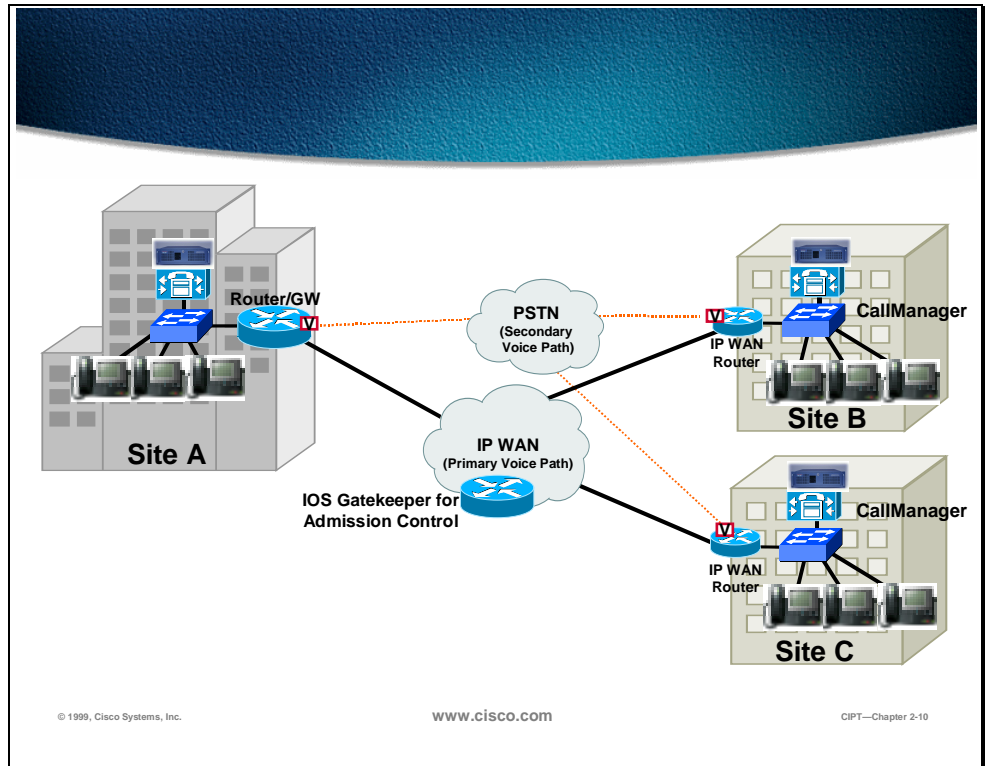

Completion Criteria

You have completed this exercise when you have identified which Cisco AVVID deployment the figure represents and listed design recommendations for each deployment model.

Summary

This section summarizes the concepts you learned in this chapter.

Summary

- **The Cisco AVVID system architecture has four functional groups.**
- **Convergence of networks has advantages.**
- **Cisco IP telephony is within the Cisco AVVID system architecture.**
- **There are three deployment models for the Cisco IP Telephony Solution.**

? 2000, Cisco Systems, Inc. www.cisco.com CIPT v2.07 -14

Cisco AVVID architecture has the following four functional groups:

- Applications—TAPI, JTAPI SMDI; Cisco uOne and Cisco IP Call Center
- Call processing—call admission, call routing; Cisco CallManager and directory
- Infrastructure—Cisco IOS network services; gateways, routers, switches
- Clients—video, softphone, Cisco IP phones, PC

The following advantages are part of a converged network:

- One network managed by one department
- Scalable
- Open
- Adaptive
- Available

Cisco IP telephony is within the Cisco AVVID architecture. The Cisco CallManager, Cisco IP phones, and Cisco access gateways are part of the Cisco IP telephony solution. The following deployment models are recommended:

- Isolated deployment
- Multi-site IP WAN deployment with centralized call processing

- Multi-site IP WAN deployment with distributed call processing

Review Questions

Answer the following questions.

Review Questions

- 1. Which Cisco AVVID architecture functional group does the Cisco CallManager belong to?**
- 2. What is the primary inter-site voice path in the Cisco AVVID end-to-end architecture?**
- 3. What is the maximum number of users per Cisco CallManager after failover?**

© 2000, Cisco Systems, Inc.www.cisco.comCIPT v2.07 -15

- Q1) The Cisco AVVID architecture has four functional groups. Which functional group does the Cisco CallManager belong to?
- Q2) The Cisco AVVID end-to-end architecture has a primary and secondary inter-site voice path. Which is the primary inter-site voice path?
- Q3) In the three deployment models (isolated, multi-site IP WAN centralized call processing, and multi-site IP WAN distributed call processing), what is the maximum number of users a Cisco CallManager can have registered to it after failover?

Primary CIPT Components

Overview

This chapter describes the primary Cisco IP Telephony (CIPT) components at a high level. Each component introduced in this chapter will be discussed later in the course in more detail.

The following topics will be discussed in this chapter:

- Objectives
- Visual Objective
- Call Processing
- IP Phones
- DSP Resources
- PSTN Gateway/Router
- Voice Messaging
- Written Exercise
- Summary
- Review Questions

Objectives

This section lists the chapter objectives.

Objectives

Upon completion of this chapter, you will be able to perform the following tasks:

- **Identify and place the primary CIPT components within a network topology**
- **Define the functions of the primary CIPT components**
- **Establish a dial tone, given two IP phones, a switched network, and a Cisco CallManager**

© 2000, Cisco Systems, Inc. www.cisco.com CIPT v2.0? -3

Upon completion of this chapter you will be able to perform the following tasks:

- Identify and place the primary CIPT components in a network topology.
- Define functions of the primary CIPT components.
- Establish dial tone, given two IP phones, a switched network, and Cisco CallManager server.

Visual Objective

This section shows the visual objective of a CIPT solution.

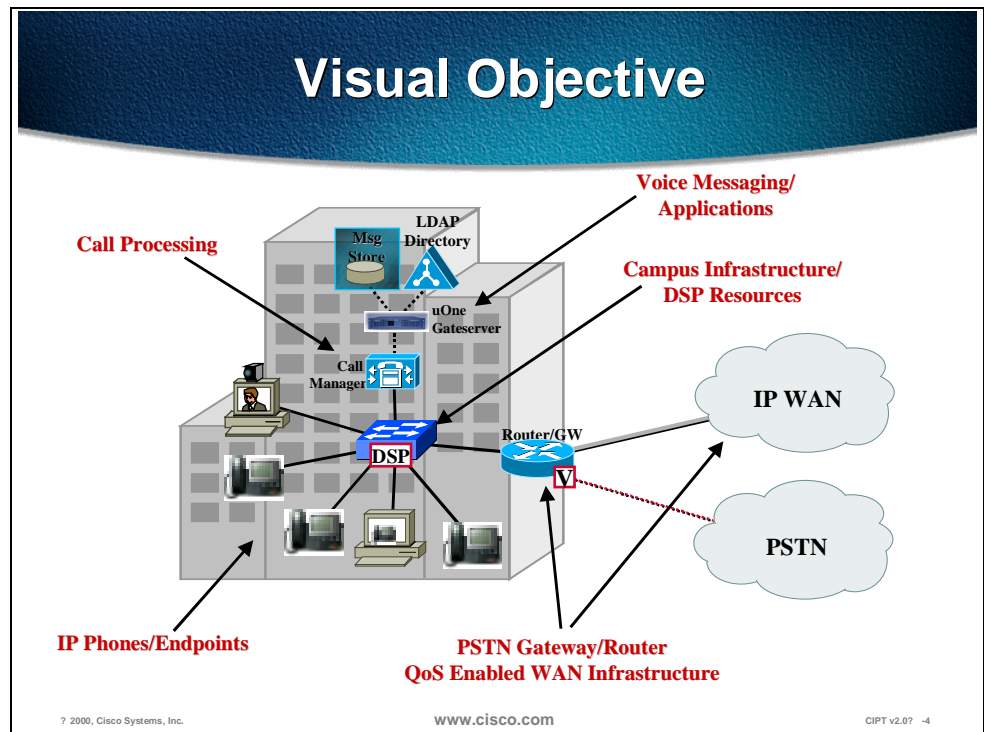

The following sections in this chapter provide a brief description of the primary components of the CIPT solution. Greater detail will be given throughout the course.

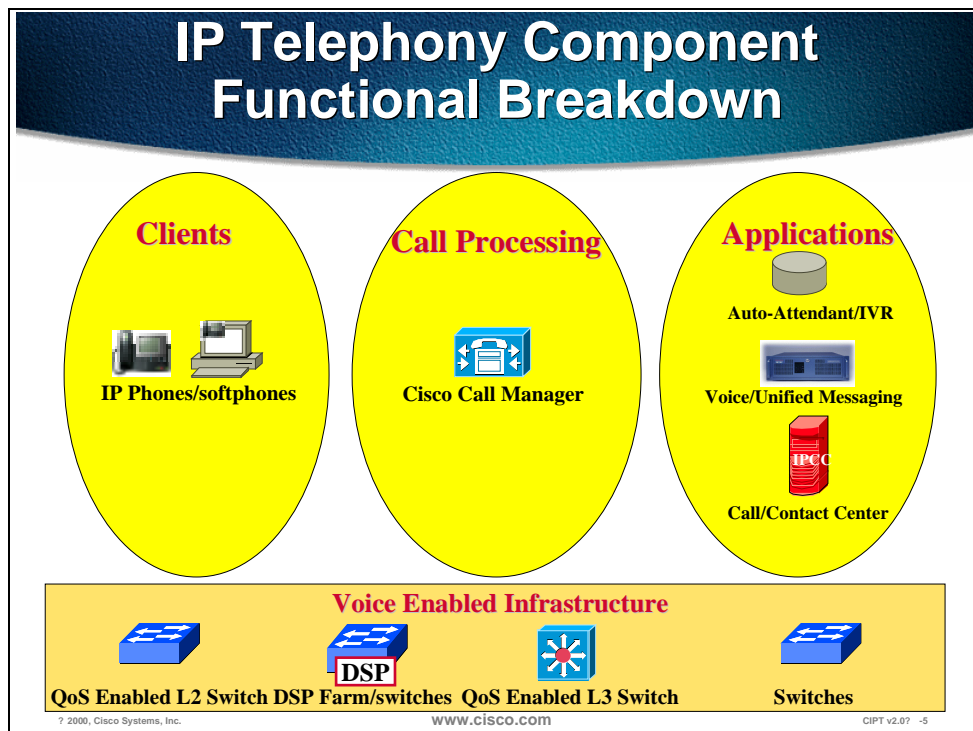

In a CIPT Network topology there is a functional breakdown of the CIPT components. The functional part of the CIPT solution is in the following four parts:

1. Call Processing—This is the main component of the CIPT solution. The Cisco CallManager server hardware and software are part of this functional component. As of now, there are no other IP telephony call processing engines.
2. Endpoints—The endpoints are represented by hardware where call streams either terminate or get summed. The following are considered endpoints:
 - Cisco IP phones
 - Computer terminals
 - Wireless IP phones
 - DSP resources
 - Routers and gateways
3. Applications (available after Cisco CallManager 3.0(2))—Applications are the extra added features and software that work with Cisco CallManager to supply robust IP telephony solutions within Cisco AVVID. Applications include the following:
 - Auto attendant/interactive voice response (IVR)
 - Voice messaging
 - Call/contact center

4. Voice enabled infrastructure—The voice-enabled infrastructure is the foundation for a reliable and available IP telephony solution. The voice enabled infrastructure includes the following:
 - Quality of Service (QoS) enabled Layer 2 switch
 - QoS enabled Layer 3 switch
 - Router

Call Processing

This section describes the components that provide the call processing function within the Cisco IP telephony solution.

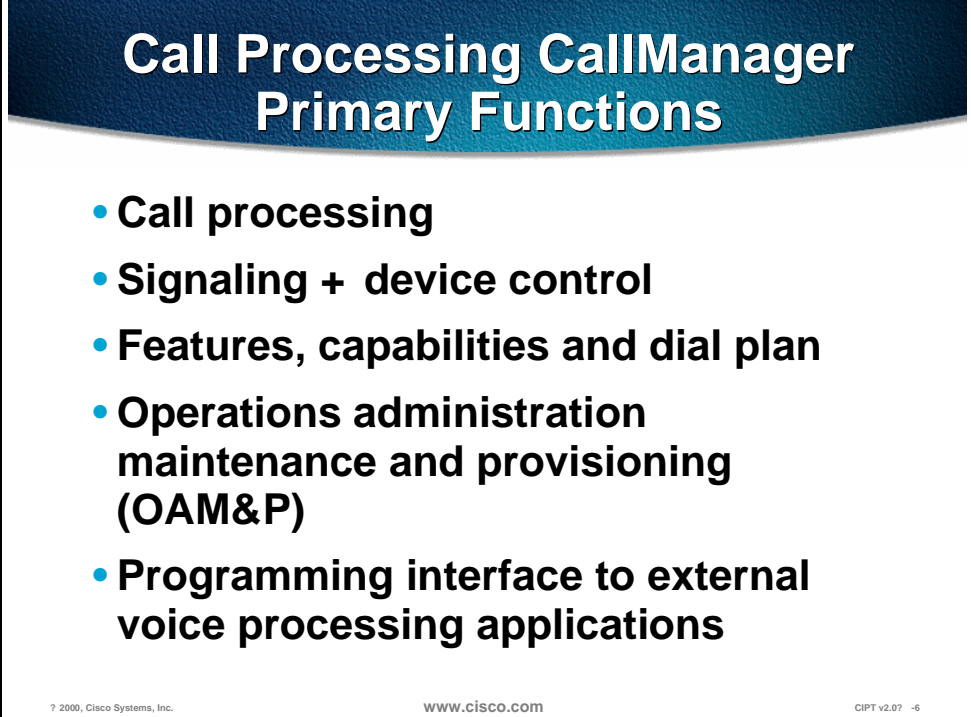

**Call Processing CallManager
Primary Functions**

- **Call processing**
- **Signaling + device control**
- **Features, capabilities and dial plan**
- **Operations administration maintenance and provisioning (OAM&P)**
- **Programming interface to external voice processing applications**

© 2000, Cisco Systems, Inc. www.cisco.com CIPT v2.07 -6

Cisco CallManager provides the call processing functionality in the CIPT solution. The two parts of the Cisco CallManager are the hardware and the software. The Cisco CallManager provides the following functions:

- Call processing
- Signaling and device control
- Features, capabilities, and dial plan
- Operations administration maintenance and provisioning (OAM&P)
- Programming interface to external voice processing applications

Cisco CallManager Clustering

This section discusses the Cisco CallManager clustering and the recommendations for clusters and users.

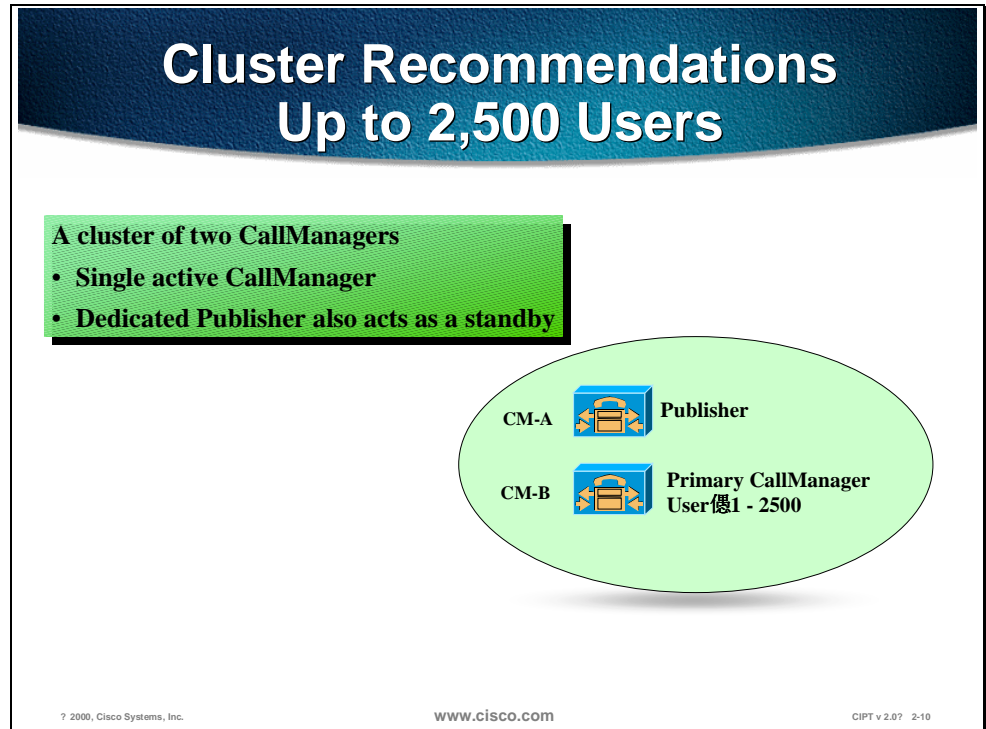

A cluster of two Cisco CallManagers can support up to 2,500 users. Use one of the Cisco CallManagers as the active CallManager and the other as the dedicated backup.

In this example the publisher would be the backup and the subscriber would be the active “primary” CallManager.

A Cisco CallManager cluster is composed of database and call processing servers of a CIPT solution. Publisher and Subscriber are terms used for database issues in a Cisco CallManager cluster, primary, secondary and tertiary are terms used for call processing and redundancy for IP telephony devices.

Cluster Recommendations Up to 5,000 Users

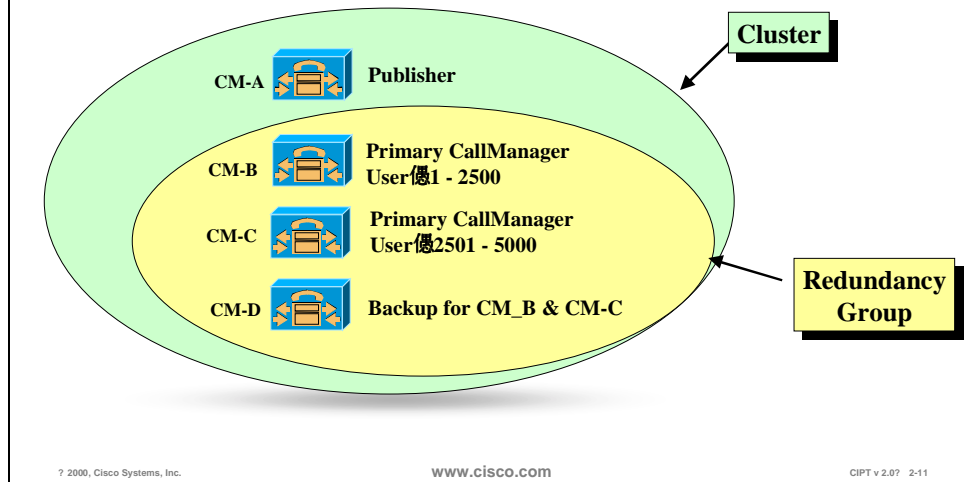

To support up to 5,000 users the recommendation is to use four Cisco CallManagers in one cluster. One Cisco CallManager is the publisher and tertiary Cisco CallManager for redundancy. Two Cisco CallManagers are the primary CallManagers for 2,500 users and both will use the fourth Cisco CallManager as the dedicated backup.

Should Glass House be on a machine by itself?

If you have three Cisco CallManagers, the Glass House should be by itself. The name of a machine should not change if SQL Server 7.0 is on it and one database should be in every island of survivability. There is no automated method for moving the Glass House to another machine.

Cluster Recommendations Up to 10,000 Users

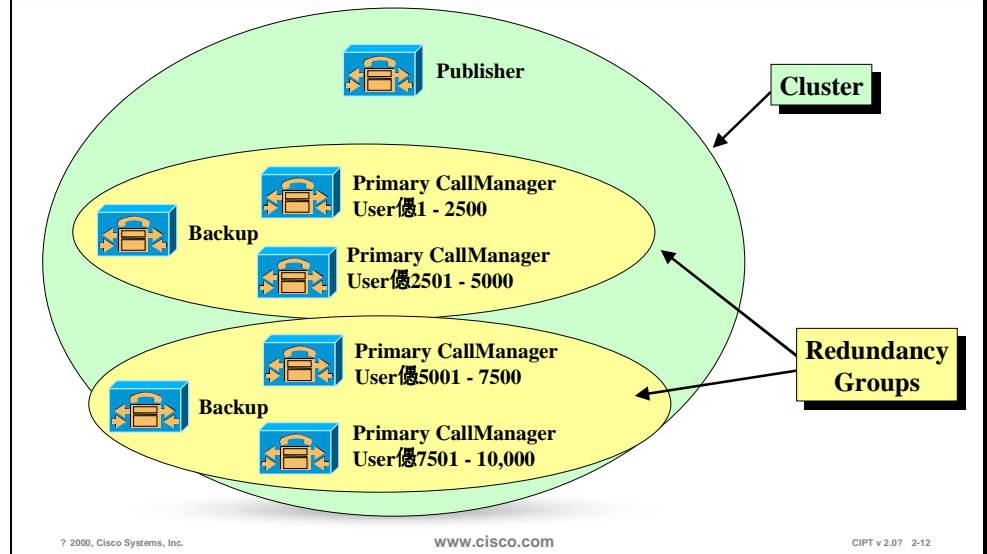



To support up to 10,000 users the recommendation is to use seven Cisco CallManagers in a cluster. One Cisco CallManager would be the publisher for database configurations. Two redundancy groups will be created each supporting up to 5,000 users. The redundancy groups have two active “primary” Cisco CallManagers and one dedicated backup. This model allows to scalability and reliability.

IP Phones

Cisco IP telephones bring state of the art technology to voice communication solutions. Cisco Systems, the worldwide leader of networking for the Internet, now brings to market new opportunities for rapid deployment of classic and new world voice applications by providing high-quality voice instruments that leverage IP as the transport technology. This allows the consolidation of voice and data into a single network infrastructure, including a single cable plant; a single switched Ethernet fabric for campus or branch offices; and unified operational systems for operations administration and management (OA&M) for voice and data.

Cisco IP Phones

- **Cisco IP phone 12 SP+**
- **Cisco IP phone 30 VIP**
- **Cisco IP phone 7960**



© 2000, Cisco Systems, Inc. www.cisco.com CIPT v2.0-3-10

12 SP+

The Cisco IP telephone model 12 SP+ is an IP telephone targeting the busy office user. This voice instrument supports 12 programmable line and feature buttons, an internal, high-quality two-way speakerphone, and microphone mute. The Cisco 12 SP+ also features a two-line LCD display (20 characters per line) for call status and identification. An LED associated with each of the 12 features indicates feature and line status and line buttons.

30 VIP

The Cisco 30 VIP voice instrument is a full-featured IP telephone for executives and managers. It provides 26 programmable line and feature buttons, an internal, high-quality, two-way speakerphone with microphone mute, and a transfer

feature button. The 30 VIP also provides a large 40-character LCD display consisting of two lines of 20 characters each. The display provides features such as date and time, calling party name, calling party number, and digits dialed. An LED associated with each of the 30 feature and line buttons provides feature and line status.

Cisco IP Phone 7960

The Cisco IP Phone 7960 includes an information button, six programmable line or feature buttons, and four soft key buttons providing access to features such as additional call detail or access to web-based information, such as stock quotes. The Cisco IP Phone 7960 includes an LCD display, which is used to display call detail and soft key functions.

The Cisco IP Phone 7960 includes two RJ 45 connectors:

- One connector can be used to connect the phone to a switch that provides 10/100 MBit connectivity and receive power from that switch.
- Another connector can be used for network connectivity to a desktop device, such as a computer.

Because of the complexity of these new features, Cisco CallManager does not directly control all phone features.

Making a Call IP Telephone to IP Telephone

- 1 Off-hook and digit stimulus
- 2 Play tone commands
- 3 Ring command
- 4 Off-hook stimulus
- 5 Setup media stream command
- 6 Audio stream established

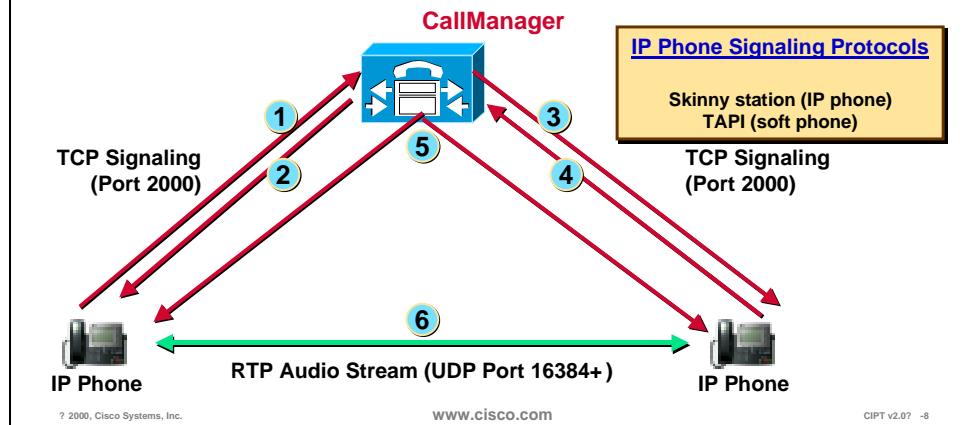

When you actually make a telephone call from an IP telephone to an IP telephone, it is a client/server model. The CallManager handles the call control pieces as follows:

1. When you lift the handset on the IP telephone, it goes off-hook.
2. CallManager tells the phone to play a dial tone. The .wav file is in the phone. You enter the digits and dial the number in this case, dialing the phone across the street.
3. Once CallManager has recognized the telephone number, it dials that extension and the phone rings.
4. When the called party answers, the called phone generates an off-hook stimulus to CallManager.
5. CallManager informs the two telephones to set up the media stream between the two phones. Once the audio stream is established, using the Real-Time Transport Protocol (RTP), the CallManager is effectively out of the picture and the two telephones can communicate directly.
6. As of CallManager 2.3, the RTP audio stream uses User Datagram Protocol (UDP) ports 16,384 through 32,767.

This is an important point as these UDP port ranges are synergistic with those used on the Cisco IOS™ gateways. Consequently, IP/RTP priority can now be used to prioritize traffic for both Cisco IOS gateways and the IP telephones.

Note As of Cisco CallManager 2.4, all DTMF from the phone is “out-of-band.”

DSP Resources

The Digital Signaling Processor (DSP) resources can perform conferencing and media termination point (MTP)/transcoding services in addition to their PSTN gateway functionality.

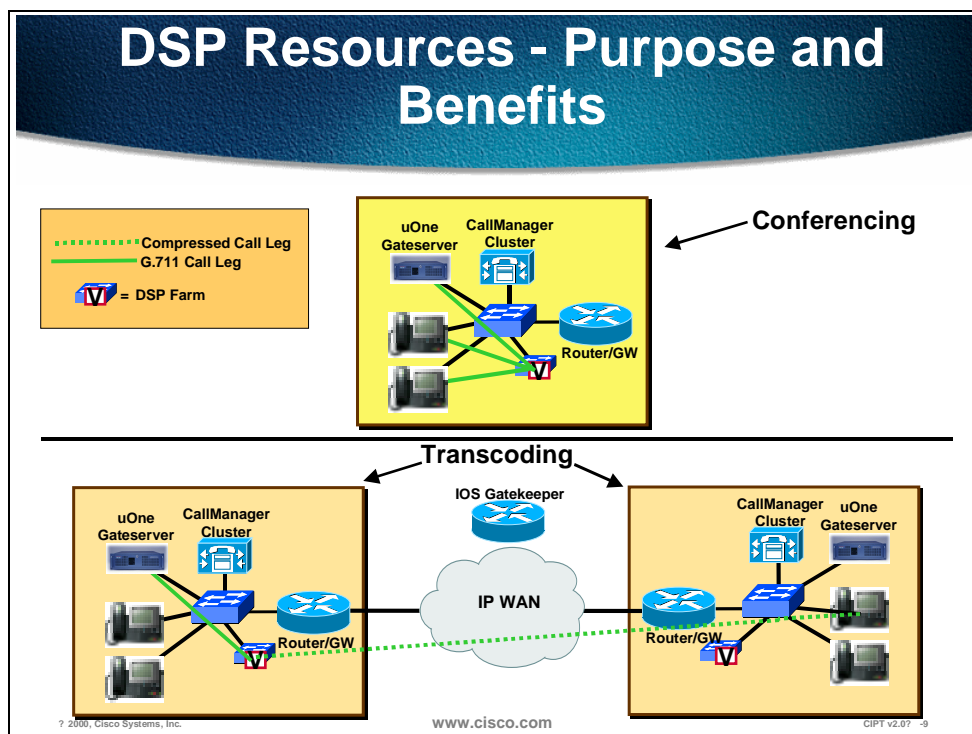

Catalyst enabled conferencing is the ability to support voice conferences in hardware. Digital Signaling Processors (DSPs) are used to convert G.711 voice sessions into time-division multiplexing (TDM) streams that can then be “mixed” into a conference call by another DSP.

The transcoding application can either act as a traditional AVVID MTP resource or as a transcoding resource.

- A traditional AVVID MTP service is the ability to provide supplementary services like hold, transfer, and conference when using gateways that don't support the H.323.v2 feature of open/close logical channel.
- Transcoding application is in effect an IP-to-IP voice gateway service. A transcoding node can convert a G.711 voice stream in to a low bite-rate (LBR) compressed voice stream, such as G.729a. This is critical for enabling applications such as IVR, uOne Messaging, and Conference Calls over an IP WAN.

PSTN Gateway/Router

The Cisco AVVID telephony solution offers multiple methods of connecting an IP telephony network to the PSTN or legacy PBX and key systems.

Cisco Voice Gateways

Integrated digital and analog gateways for Catalyst 6000 family switches

8 Port T1/E1

24 Port FXS (Telco)

AS5800

7200

New

AS5300

MC3810

3600

2600

1750

VG200

Standalone analog and digital gateway (Modular, IOS based)

New

Standalone Digital Gateways DT-24+, DE-30+

Standalone Analog Gateways AS & AT

© 2000, Cisco Systems, Inc. www.cisco.com CIPT v2.07 -11

There are 20 Cisco voice gateway candidates to choose from. Gateways range from specialized, entry-level stand-alone voice gateways to the high-end, feature rich integrated router and Catalyst gateways.

Gateway Selection Criteria

Standalone vs integrated router/gateway

- Cost vs flexibility, functionality, and manageability

Required voice port density

Support for required PSTN signaling types

Gateway protocol

- SGCP (skinny gateway) DT24+ , DT 30+ , Catalyst 6000 Blades
- H.323 (IOS based gateways) 1700/2600/3600/3800/AS5X00/7200
- MGCP based gateway VG-200 (can be used as H.323 gateway also)

Support for required WAN interface(s) & QoS

Remote sites likely to add voice ports to existing voice enabled router

© 2000, Cisco Systems, Inc.

www.cisco.com

CIPT v2.0? -11

Every gateway selection is made by combining common or core requirements with site and implementation specific features. The three core requirements for an AVVID CIPT gateway are dual tone multifrequency (DTMF) relay capabilities, support for supplementary services and the ability to handle clustered CallManagers. Any gateway selected for a large campus deployment should have the ability to support these features. Additionally, every AVVID CIPT implementation will have it's own site-specific feature requirements.

There are three types of protocols that are supported. The first are the skinny-gateways. These are a series of digital gateways that include the DT-24+, the DE-30+, and the WS-X6608x1 Catalyst Voice Module. Another type of gateway protocol is traditional H.323. Cisco IOS integrated router gateways use H.323 to communicate with CallManager. The last type of gateway protocol is the new Media Gateway Control Protocol (MGCP). Cisco CallManager uses MGCP to control the new stand-alone gateway, the VG200 analog gateway. Each of these protocols follows a slightly different methodology to provide support for the three core gateway features.

Voice Messaging

Voice messaging is a key component to any type of telephony deployment. Cisco's uOne Gateserver with messaging software will deliver the voice-messaging component for the CIPT solution.

uOne GateServer

G.711 only 

- **Telephony application server platform**
- **Orchestrates message playback, delivery, and creation**
- **uOne UMS application services execute on this platform**
- **RTP streaming interface agent**
- **Multiple GateServers can be utilized to add capacity and resiliency**
- **Microsoft Windows NT server**

© 2000, Cisco Systems, Inc.www.cisco.comCIPT v2.07 -12

Often you may hear the uOne product called the application server and/or the gate server. Both terms can be useful to understand what it does. The uOne Gateserver manages message playback, message delivery, and the message creation process. The server/gateway uses an RTP transport-streaming interface and runs on Windows NT.

Scaling and reliability can be accomplished by use of multiple uOne GateServers.

There will be more details available later in this course.

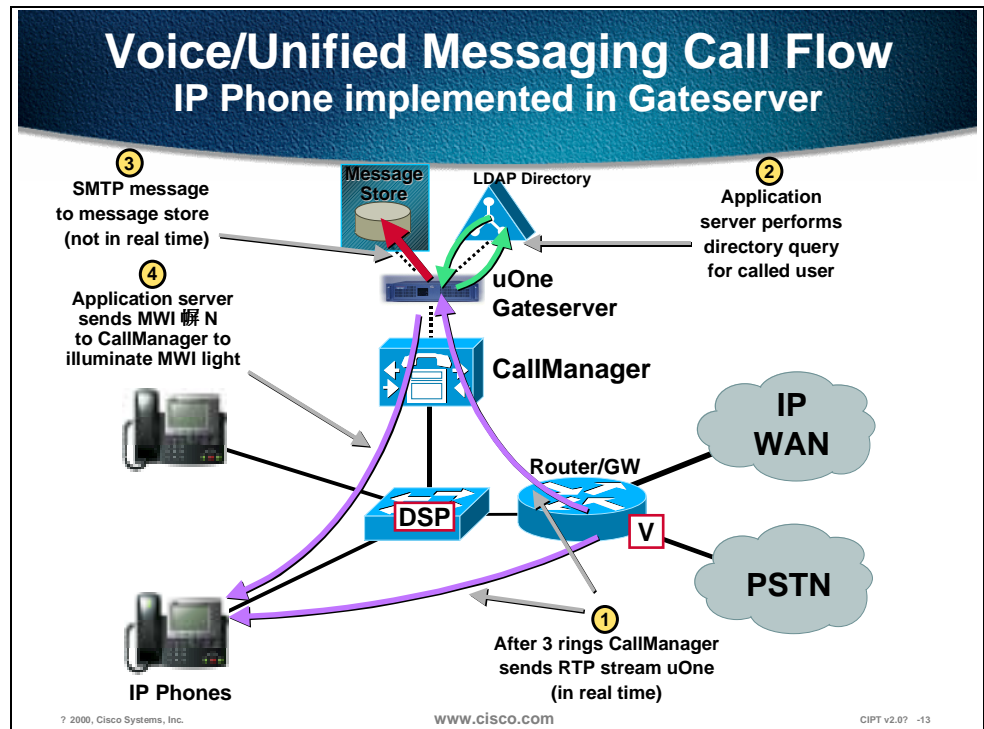

The voice messaging call flow in the above diagram is described below:

1. After three rings the CallManager sends a RTP stream to uOne.
2. The application server (uOne) performs directory query for the called user.
3. The SMTP message is sent to the message store.
4. The application server sends the message waiting indicator (MWI) of "On" to the CallManager to illuminate the MWI light on the phone.

Written Exercise 1: IP Telephony Functional Components

Complete the following exercise to practice what you learned in this chapter.

Objectives

In this exercise you will complete the following task: match the functional component with its definition.

Task: Match the functional component with the correct definition.

Given what you know about the four functional components of IP Telephony, match the definition to the correct IP Telephony functional component.

1. Represented by hardware where call streams get terminated. The following are examples of this functional component:
 - Cisco IP Phones
 - Computer terminals
 - Wireless IP Phones
2. The foundation for a reliable and available IP Telephony solution. The following are examples of this functional component:
 - QoS enabled Layer 2 Switch
 - QoS enabled Layer 3 Switch
 - Router
3. Extra added features and software that work with Cisco CallManager to supply robust IP Telephony solutions within AVVID. The following are examples of this functional component:
 - Web Attendant/Interactive Voice Response (IVR)
 - Voice Messaging
 - Call/Contact Center
4. The main component of the CIPT solution. The Cisco CallManager server hardware and software are part of this functional component.

- _____ 1. Call Processing
- _____ 2. Clients
- _____ 3. Applications
- _____ 4. Voice Enabled Infrastructure

Completion Criteria

You have completed this exercise when you have matched the four functional component definitions to the four functional component headings of IP Telephony.

Summary

This section summarizes the concepts you learned in this chapter.

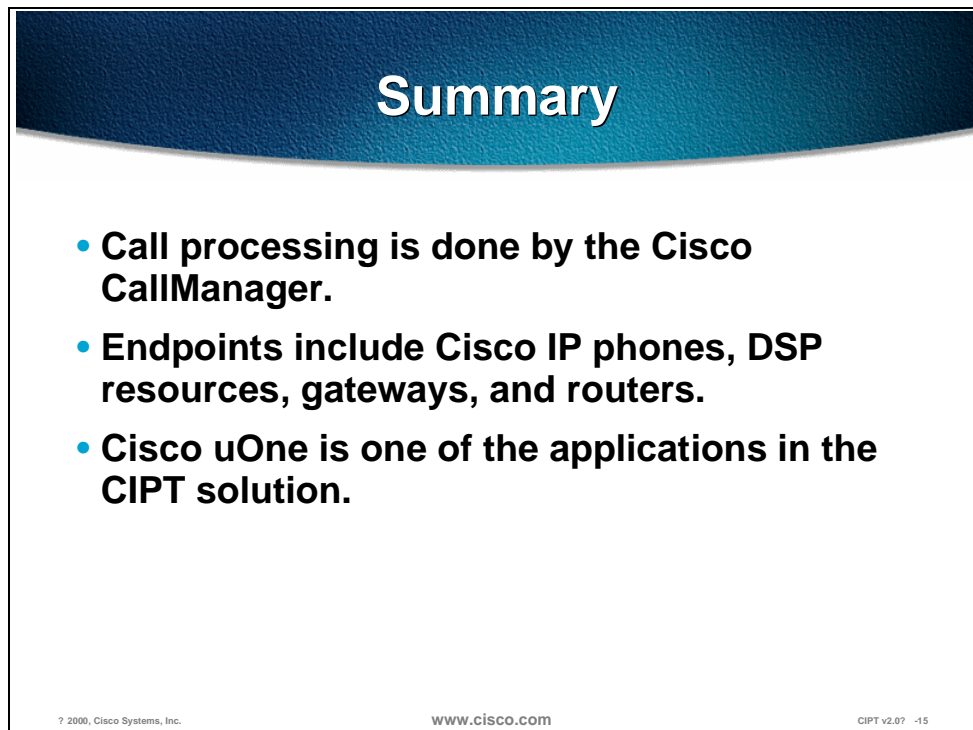

Summary

- **Call processing is done by the Cisco CallManager.**
- **Endpoints include Cisco IP phones, DSP resources, gateways, and routers.**
- **Cisco uOne is one of the applications in the CIPT solution.**

© 2000, Cisco Systems, Inc. www.cisco.com CIPT v2.07 -15

Cisco CallManager is the call processing engine of a Cisco IP telephony solution. In a Cisco IP telephony solution, the endpoints include the Cisco IP phones, DSP resources, gateways and routers. The Cisco IP phones include the 12 SP+, 30 VIP, Cisco IP Phone 7910, and Cisco IP Phone 7960.

Cisco uOne is one of the applications in a Cisco IP telephony solution and the Cisco uOne application is the messaging application providing voice mail services for a Cisco IP telephony solution.

Review Questions

Answer the following questions.

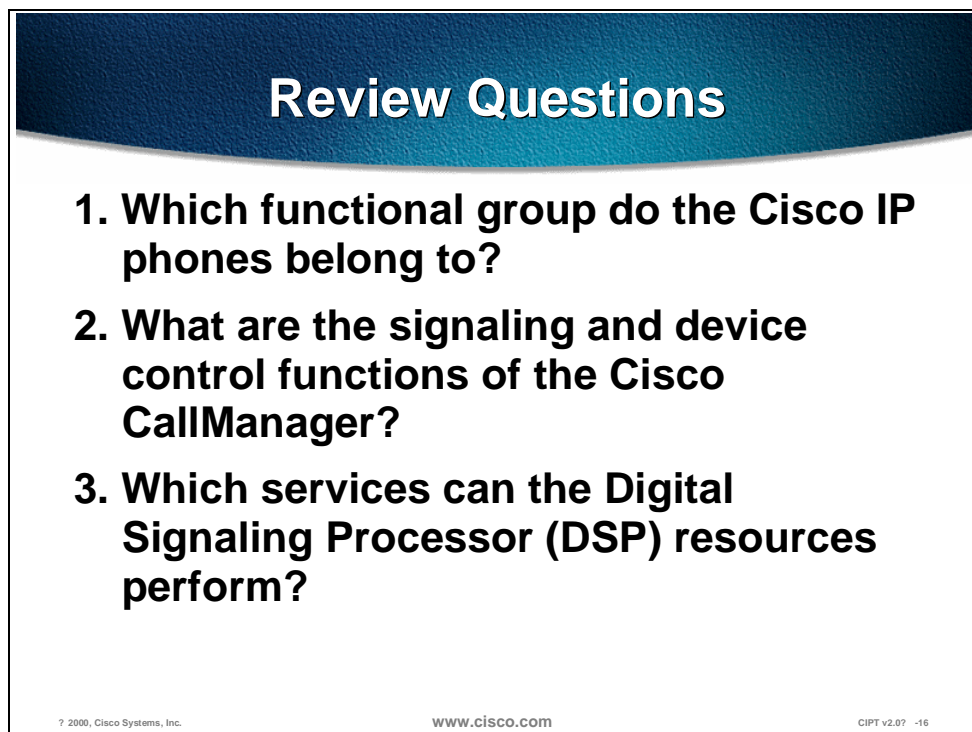
A slide titled "Review Questions" with a blue gradient header. It contains three numbered questions in bold black text. At the bottom, there is small text: "© 2000, Cisco Systems, Inc.", "www.cisco.com", and "CIPT v2.0? -16".

Review Questions

- 1. Which functional group do the Cisco IP phones belong to?**
- 2. What are the signaling and device control functions of the Cisco CallManager?**
- 3. Which services can the Digital Signaling Processor (DSP) resources perform?**

© 2000, Cisco Systems, Inc. www.cisco.com CIPT v2.0? -16

- Q1) There are four functional groups within the Cisco IP telephony solution. Which functional group are the Cisco IP phones a part of?
- Q2) The Cisco CallManager is part of the call processing functional group of the Cisco IP telephony solution. What are the signaling and device control functions that the Cisco CallManager performs?
- Q3) In addition to the PTSN gateway functionality, which services can the Digital Signaling Processor (DSP) resources perform?

Understanding DHCP and TFTP

Overview

This section provides you with an understanding of how Cisco IP telephony devices can use the optional Windows 2000 server service's Dynamic Host Configuration Protocol (DHCP) and Domain Name System (DNS) to communicate with the Cisco CallManager. You will also understand the relationship between the Cisco IP phones and Cisco Access gateways and the Trivial File Transfer Protocol (TFTP) server.

This chapter includes the following topics:

- Objectives
- Understanding DHCP and TFTP
- Understanding TFTP
- Understanding Microsoft DHCP Options
- Summary
- Review Questions

Objectives

This section lists the chapter objectives.

Objectives

Upon completion of this chapter, you will be able to perform the following tasks:

- **Identify and chart the flow of a CIPT device with DHCP, DNS and TFTP running**
- **Describe the DHCP and DNS options within Windows 2000**
- **Configure TFTP servers for use with Cisco IP phones and Cisco access gateways**

© 2000, Cisco Systems, Inc. www.cisco.com CIPT v2.0? -3

Upon completion of this chapter, you will be able to complete the following tasks:

- Identify and chart the flow of a CIPT device with DHCP, DNS, and TFTP.
- Describe and identify the DHCP and DNS options within Windows 2000.
- Configure TFTP servers for use with Cisco IP phones and Cisco access gateways.

Understanding DHCP and TFTP

This section describes how you use DHCP and TFTP.

DHCP (Dynamic Host Configuration Protocol) service is a client/server system available with the Windows NT server. DHCP automatically assigns IP addresses to devices whenever you plug them in. For example, this allows you to connect multiple phones anywhere on the IP network and DHCP automatically assigns IP addresses to them.

By default, Cisco IP phones are DHCP-enabled. If you are not using DHCP, you need to disable DHCP on the phone and manually assign it an IP address.

When the devices connect to the DHCP server, the DHCP server provides them with the default TFTP server information. The IP phones and gateways must access the Trivial File Transfer Protocol (TFTP) server to retrieve their configuration file.

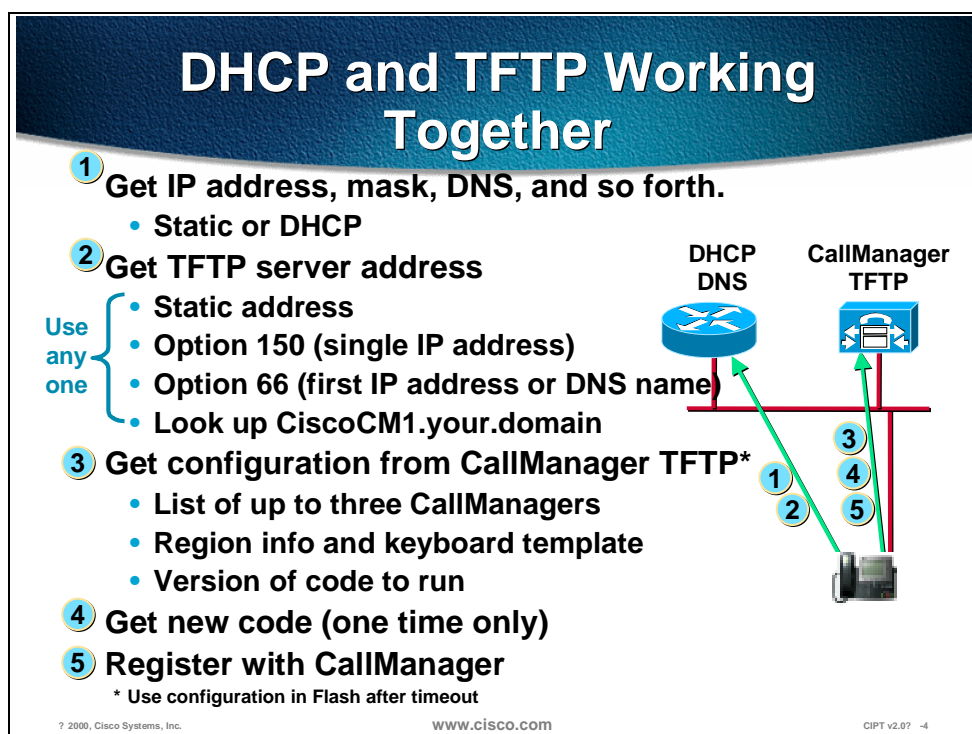

The figure shows how a Cisco IP phone or Cisco access device contacts the Cisco CallManager when you are running DHCP, DNS, and TFTP services within your network.

1. When you plug a telephone into an Ethernet jack, assuming the prerequisite infrastructure and a CallManager, the first thing that will happen is the telephone will request an IP address from a Dynamic Host Configuration Protocol (DHCP) server. In general, this is the recommended mode of operation. Static addressing can be supplied to the telephone, and you can enter the IP address manually, but this would prevent mobility.

2. As part of that DHCP request, when an IP address is supplied to the telephone, it is also possible to supply the address of the TFTP server, or the CallManager from which the telephone will get its configuration. Once again, the TFTP server address could be specified manually but this would limit adds, moves, and changes and remove some of the benefits. This TFTP server address can be given in one of two forms: either Option 150, which is what you would recommend, or Option 66 or the Bootstrap Protocol (BOOTP), which you may be familiar with. BOOTP would not be recommended, although it is a viable option, since it is already in general use by other devices already.
3. Once that address has been given, the telephone itself will register with the CallManager and download its configuration, which can contain a list of up to five CallManagers that the telephone can use for call control. This creates an extremely resilient system. You will get your region information and also the features or functionality that each of your keys will produce for you.
4. You also receive any new code you are to run. If, for example, the firmware or the code that each telephone runs is changed, this can be added to the CallManager. Once restarted, each telephone will automatically reload that code, once again making maintenance very simple. The telephones can be configured to auto register.
5. An administrator rolling out the phones would plug each one in and then assign a number. New entries will appear by Media Access Control (MAC) address, which is how the CallManager ties the actual instrument to a telephone number. An alternate, not the normal operation, would occur when you plug in the telephone; CallManager would automatically give that telephone a line number, however, this would make things like directories very difficult to set up.

Understanding TFTP

This section describes how to connect a Cisco IP phone to CallManager.

The phones and gateways have an order of preference that they use for selecting the address of the TFTP server. If it receives conflicting or confusing information from the DHCP server, the phone uses the following sequence to determine what information is valid.

1. You can configure the phone (but not a gateway) with a TFTP server address through keypad configuration.
 - This address overrides any TFTP address sent by the DHCP server.
 - The phone always tries to resolve the DNS name CiscoCM1.
2. If this name is resolved, then this information overrides all information sent by the DHCP server. It is not necessary to name the TFTP server CiscoCM1, but you must enter a DNS name record to associate CiscoCM1 with the address or name of the TFTP server.
3. The phone uses the value of *Next-Server* in the boot processes—This DHCP configuration parameter has traditionally been used as the address of the TFTP server. When configuring BootP servers, this field is typically referred to as the address of the TFTP server. This information is returned in the *siaddr* field of the DHCP header. You should always use this option, if available, because some DHCP servers will place their own IP address in this field when it is not configured.
4. The phone uses the site-specific option 150—This option resolves the issue that Microsoft 2000 or NT servers do not allow the *Next-Server* configuration parameter. The 2000 or NT servers allow access to the *Next-Server* parameter only when IP address are statically assigned.
5. The phone also accepts the *Optional Server Name* parameter. This DHCP configuration parameter is the DNS name of a TFTP server. Currently only a DNS name can be configured in this parameter. A dotted decimal IP address should not be used.
6. The phone also accepts the 066 option, which is the name of the boot server.
 - Option 066 is normally used to replace the *name* field when option overloading occurs. It can be used on Windows 2000 or NT DHCP servers and functions like the 150 option. This *name* field can contain a DNS name or a dotted decimal IP address.
 - The 066 option should NOT be used with the 150 option. If they are sent together, then the phone prefers the IP address to the name given by the 066 option. However, if both a dotted decimal IP address and a 150 option are sent, then order of preference is dependent on the order that they appear in the option list. The phone chooses the last item in the option list. To reiterate, option 066 and option 150 are mutually exclusive.

See the flowchart on the following page.

Flowchart of Cisco IP phone connecting to Cisco CallManager

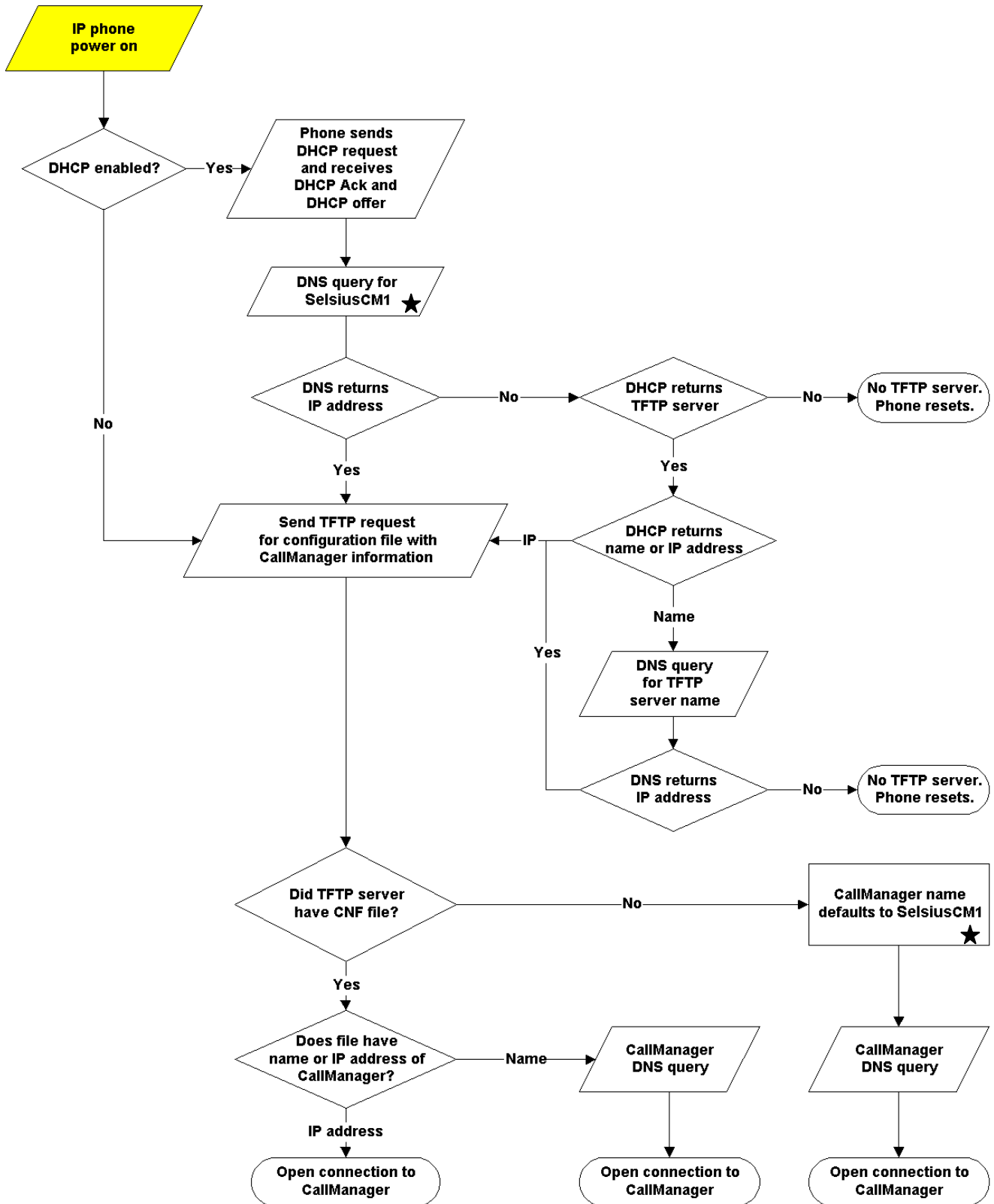

★ SelsiusCM1 is now CiscoCM1

Understanding Microsoft DHCP Options

This section describes the Microsoft DHCP options.

Microsoft DHCP Options

Understanding Microsoft DHCP options:

- TFTP server (150 boot server IP address or 066 boot server host name)
- Default gateway (003 router)

Additionally, you may need:

- DNS server (006 DNS servers optional)
- Domain name (015 Domain Name optional)

Note: Use DNS and domain name only if needed

© 2000, Cisco Systems, Inc. www.cisco.com CIPT v2.07 -6

Understanding Microsoft DHCP options:

- TFTP Server (066 boot server host name or 150 boot server IP address)
- Default gateway (003 router)

Additionally, you may need:

- DNS server (006 DNS servers—optional, *use only if needed*)
- Domain name (015 domain name—optional, *use only if needed*)

Creating and Defining DHCP Scope

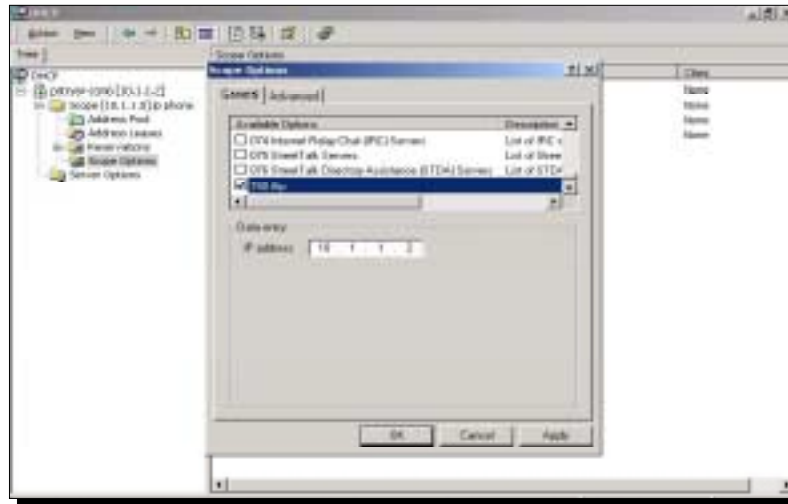

© 2000, Cisco Systems, Inc.

www.cisco.com

CIPT v2.0-4-7

A DHCP scope must be defined for CIPT device registration. The path to DHCP is Start>Programs>Administrative Tools>DHCP. To create and define a new scope, select the server you are on and select “New Scope” using a right mouse click. DHCP scopes can be created, defined or deleted from this DHCP window.

Accessing the TFTP Server

Accessing the TFTP Server

- Gateways and phones use the DHCP custom option 150 or option 066 (boot server host name)
- Gateways and phones query CiscoCM1
- Phones receive static IP
- Phones configured with IP address of the TFTP server

DHCP option 150 or 066 燻 o not use both

© 2000, Cisco Systems, Inc. www.cisco.com CIPT v2.07 -7

You can enable the IP phones and gateways to access the TFTP server in any one of the following ways, depending on the device type:

- Gateways and phones can use DHCP custom option 150 or option 066 (boot server host name), but not both.
- Gateways and phones can query CiscoCM1. DNS must be able to resolve this name to the IP address of the Cisco CallManager server.
- Phones can receive a static IP.
- Phones can be configured with the IP address of the TFTP server.

Summary

This section summarizes the concepts you learned in this chapter.

Summary

- **Cisco CallManager, DHCP TFTP, and DNS work together.**
- **The TFTP default server name is CiscoCM1.**
- **Phones and gateways have an order of preference they use for selecting the address of the TFTP.**

? 2000, Cisco Systems, Inc. www.cisco.com CIPT v2.0? -8

DHCP automatically assigns IP addresses to devices whenever you plug them in and by default the Cisco IP phones are DHCP-enabled. Cisco IP telephony devices retrieve their configuration file from the TFTP server. DNS enables devices to resolve IP addresses of DHCP and TFTP using names rather than IP addresses.

The Cisco IP telephony devices attempt to TFTP to the default server name “CiscoCM1.” If an IP address or name is not received, the default name “CiscoCM1” is used.

Review Questions

Answer the following questions.

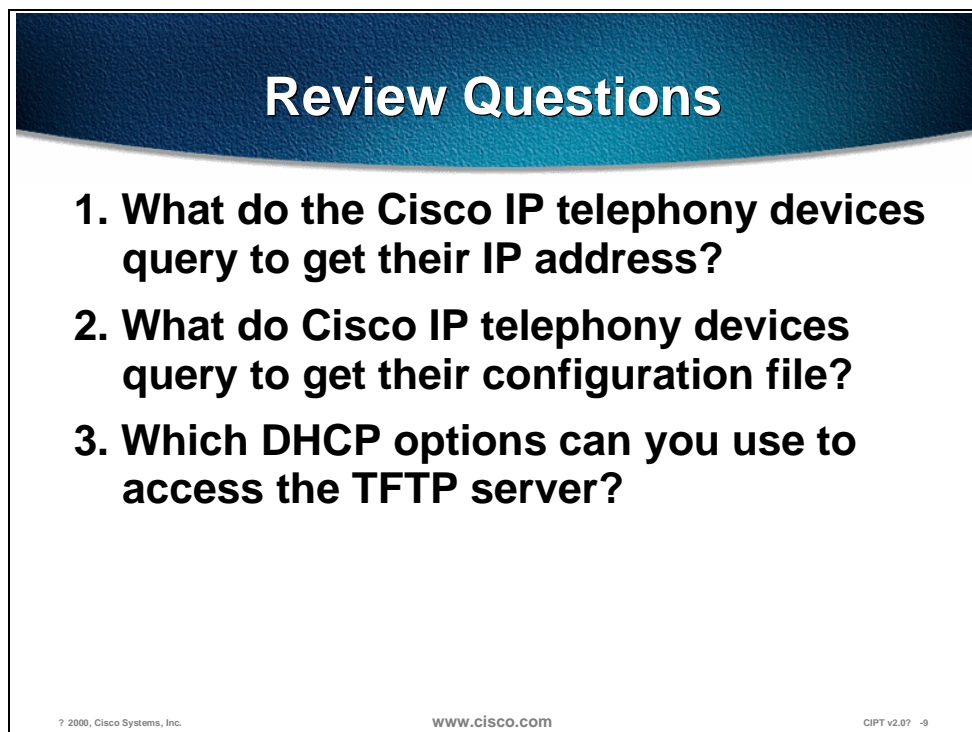
A slide titled "Review Questions" with a dark blue header and a white body. It contains three numbered questions. At the bottom, there is a footer with the text "© 2000, Cisco Systems, Inc.", "www.cisco.com", and "CIPT v2.07 -9".

Review Questions

- 1. What do the Cisco IP telephony devices query to get their IP address?**
- 2. What do Cisco IP telephony devices query to get their configuration file?**
- 3. Which DHCP options can you use to access the TFTP server?**

© 2000, Cisco Systems, Inc. www.cisco.com CIPT v2.07 -9

- Q1) The Cisco IP telephony devices (IP phones and gateways) need an IP address. What do the devices query to get an IP address?
- Q2) In order for Cisco IP telephony devices to register with the Cisco CallManager, they must have configuration files. What do the devices query to get their configuration files?
- Q3) Cisco IP telephony devices need to access the TFTP server. Which DHCP options are used to notify the devices where the TFTP server is located?

Cisco CallManager

Overview

Cisco CallManager on the Cisco Media Convergence Server (MCS) is a network business communications system providing high-quality telephony over IP networks. Cisco CallManager and the MCS enable the conversion of conventional, proprietary circuit-switched telecommunication systems to multi-service open LAN systems.

The following topics are discussed in this chapter:

- Objectives
- Primary Functions
- Hardware
- Cisco CallManager Administration
- Installable Components
- Installation
- Laboratory Exercises
- Summary
- Review Questions

Objectives

This section lists the chapter objectives.

Objectives

Upon completion of this chapter, you will be able to perform the following tasks:

- **Identify the hardware components and operating system requirements of the MCS-7830 and MCS-7835**
- **Describe and identify CallManager cluster requirements and guidelines**
- **Configure system parameters in the Cisco CallManager software that will enable dial tone to a Cisco IP phone when connected**

© 2000, Cisco Systems, Inc. www.cisco.com CIPTV2.0? -3

Upon completion of this chapter, you will be able to complete the following tasks:

- Given an MCS-7830 and MCS-7835, identify the hardware components and operating system.
- Given an IP telephony network, describe and identify Cisco CallManager cluster requirements and guidelines.
- Given a Cisco CallManager Server, configure system parameters in the Cisco CallManager administration to enable dial tone to a connected Cisco IP phone.

Primary Functions

This section describes the primary functions of the CallManager.

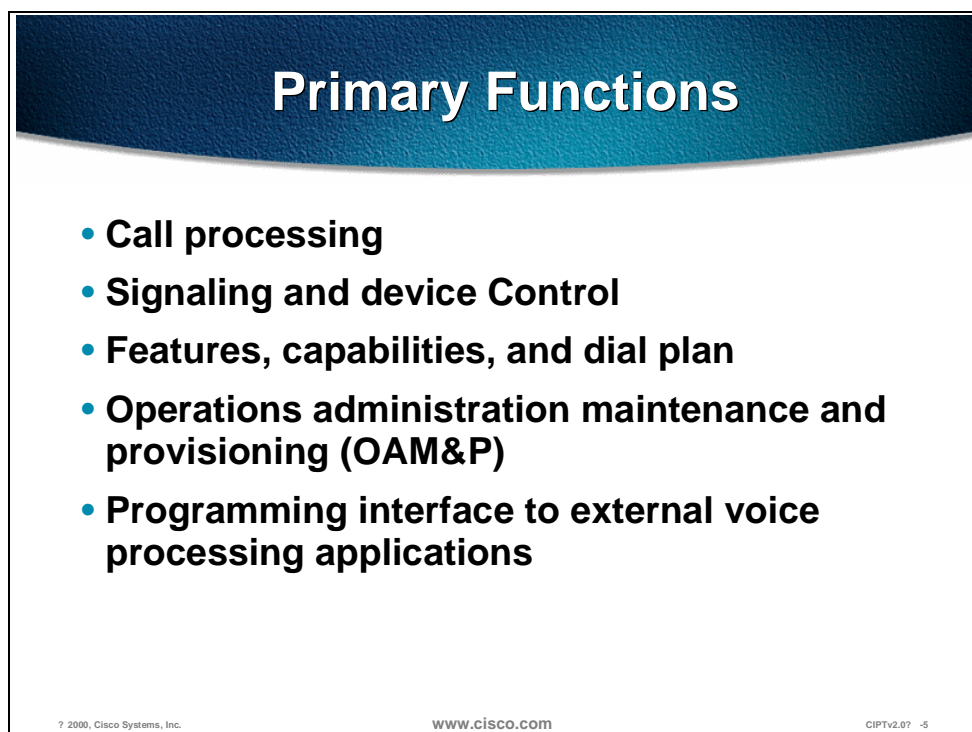
A slide titled "Primary Functions" with a blue gradient header. The slide lists five bullet points: Call processing, Signaling and device Control, Features, capabilities, and dial plan, Operations administration maintenance and provisioning (OAM&P), and Programming interface to external voice processing applications. At the bottom, there is a copyright notice for 2000, Cisco Systems, Inc., the website www.cisco.com, and the code CIPTV2.07 -5.

- **Call processing**
- **Signaling and device Control**
- **Features, capabilities, and dial plan**
- **Operations administration maintenance and provisioning (OAM&P)**
- **Programming interface to external voice processing applications**

© 2000, Cisco Systems, Inc. www.cisco.com CIPTV2.07 -5

The primary functions of the Cisco CallManager are the following:

- Call processing (digit analysis and resolution)
- Signaling and device control
- Features, capabilities, and dial plan
- Operations administration maintenance and provisioning (OAM&P)
- Programming interface to external voice processing applications

Note Some functions may be covered later in this course, because they work in conjunction with other CIPT components.

Cisco CallManager extends enterprise telephony features and functions to packet telephony network devices such as IP phones, software phones, and Voice over IP (VoIP) gateways.

Supplementary and enhanced services such as hold, transfer, forward, conference, multiple line appearances, automatic route selection, speed dial, last-number redial, and other features are extended by Cisco CallManager to IP phones and gateways. Because CallManager is a software application, enhancing Cisco CallManager is a matter of upgrading software, thereby avoiding expensive hardware upgrade costs. Further, Cisco CallManager configuration

allows all phones, gateways, and applications to be distributed across a routable IP network, providing a single, distributed, virtual telephony network.

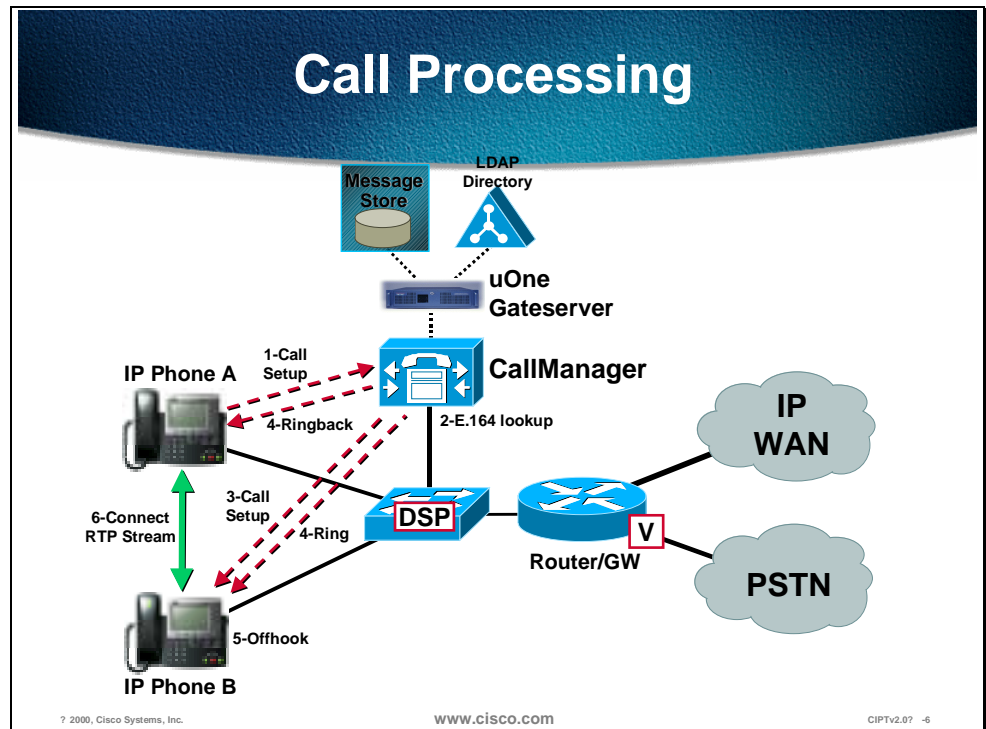

Cisco CallManager does the call processing in an IP telephony network. The following describes how the call processing works:

1. Call setup request, which includes off-hook signaling, digit collection, and digit analysis, from phone A
2. E.164 lookup for phone B
3. Call setup request sent to phone B
4. Ring played to phone B and ring back played to phone A
5. Phone B goes “off-hook”
6. Connect RTP stream between phone A and B

Hardware

This section describes the Media Convergence Server 7800 series hardware platforms.

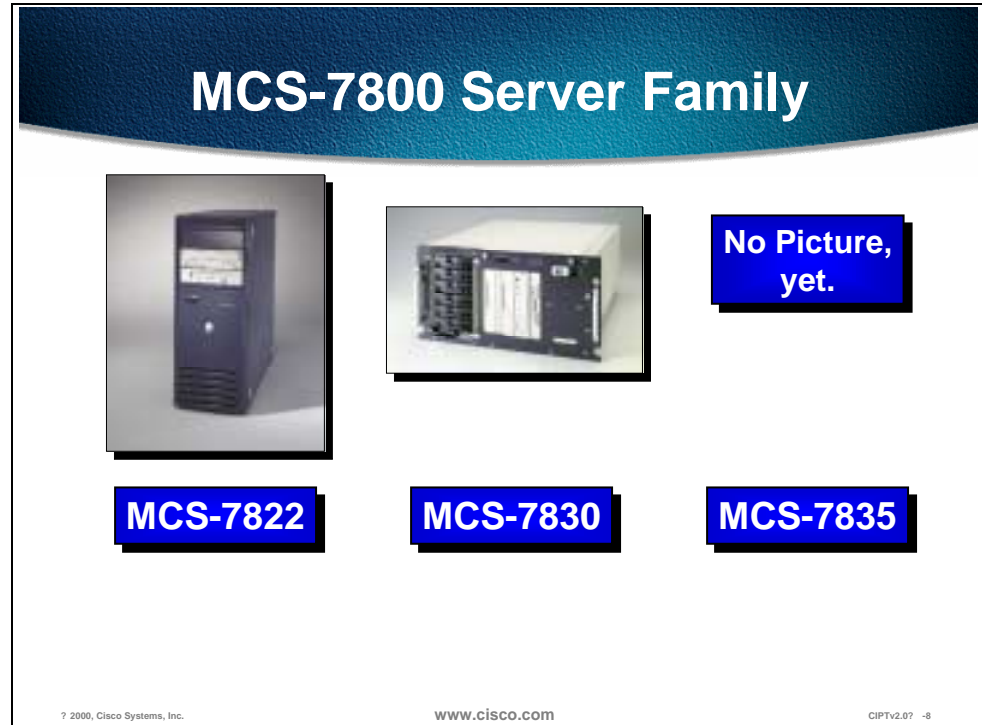

The Media Convergence Server 7800 series (MCS-7800) are the supported hardware platforms for Cisco CallManager that provide for scalable hardware architecture:

- The Cisco MCS-7822 is intended to be a pilot-test platform as a standalone server, or a production-level server when two MCS-7822s are deployed in a primary/backup role.
- The Cisco MCS-7830 is an integral part of a complete, scalable architecture for a new generation of high-quality IP voice solutions that run on the enterprise data network.
- The MCS-7835 is engineered to run a variety of Cisco AVVID applications, such as Cisco CallManager and Cisco Unified Open Network Exchange voice messaging.

Note No third-party software applications to run on a Media Convergence Server series platforms.

MCS-7822

MCS-7822

Compaq Prosignia 720
550MHz Pentium III Processor
512 MB Ram
Single 9.1 GB Hard Drive



© 2000, Cisco Systems, Inc.www.cisco.comCIPV2.07 -9

Performance

The Cisco MCS-7822 includes Intel's next-generation Pentium III, delivers 550-MHz performance, and ships with 512 MB of Error-Correcting Code (ECC) RAM, extending the high performance you will require to roll out IP telephony applications.

Availability

In a single-server configuration, the Cisco MCS-7822 lacks the redundant components that most customers will desire to run the MCS-7822 in a production environment. Two MCS-7822s operating in a "primary" and "secondary" mode will provide a robust fail-over mechanism so customers can run in a production environment. As part of its configuration, each IP telephone will store the IP address of the primary and secondary server so that if the primary server fails the phone will get instructions from the secondary server. The availability of many servers is compromised because of software conflicts that result when many applications are installed on a single server.

Note Since there are NO customer-provided third-party software applications approved to run co-resident on the MCS-7822, a higher level of availability is achieved.

Scalability

The Cisco AVVID architecture allows for a great deal of scalability to meet the requirements of almost any enterprise. Currently, customers can have a primary

and secondary server that will support small to medium-sized facilities and large branch offices. In future releases of Cisco CallManager, users will be able to add additional Cisco MCS-7800 series servers to scale their IP telephony solution significantly.

MCS-7830

MCS-7830

Compaq Proliant 1600R
550MHz Pentium III
Processor
512 MB Ram (Optional
upgrade to 1 GB Ram)
Dual 9.1 GB Hard Drives
(Raid 1 mirrored)



© 2000, Cisco Systems, Inc.www.cisco.comCIPTv2.0-5-10

Performance

The MCS-7830 includes Intel's next generation Pentium III, delivers 550-MHz performance, and ships with 512 MB RAM, with an option of upgrading to 1 GB RAM, of 100-MHz registered SDRAM, extending the high performance you will require to roll out current and future Cisco AVVID applications. All of this power is delivered in a space-saving rack-mountable form factor (5U). The MCS-7830 is intended to run only Cisco CallManager software.

Note Other third-party applications are not supported.

Availability

Availability, or the percentage of time that a system is available to provide service, was assumed in old world networks. Availability is a key requirement in the New World networks Cisco is building today. The high-availability design of the MCS-7830 will deliver a robust platform for your mission-critical Cisco AVVID applications. The MCS-7830 comes standard with two hot-plug redundant power supplies and two redundant 9.1GB SCSI hot-plug hard drives running RAID-1 disk mirroring to ensure maximum availability. A remote management board (RMB) is also included to provide a robust fail-safe solution for server management. The RMB operation is fully independent from the host hardware (self-contained processor, memory, and battery), host operation system, and network connection. This high level of independence ensures that regardless

of server state, administrators and the Cisco Technical Assistance Center (TAC) engineers have access to the MCS-7830 from virtually anywhere.

Scalability

Whether you start your Cisco IP telephony network with five telephones or hundreds, the MCS-7830 server seamlessly allows customers to grow their network at their own pace. Cisco CallManager may be installed to one or more MCS-7830 servers. In multi-server environments, the Cisco CallManagers are logically coupled through an H.323 signaling interface. Individual MCS-7830s may be backed up by a duplicate, hot-standby MCS-7830, providing complete call processing redundancy. The Cisco CallManager provides redundancy through automated fail-over of gateways and phones to secondary MCS-7830s in the event of primary server failure. Currently, the Cisco CallManager scales to a single server. The base Cisco CallManager architecture allows for a natural progression to a scalable network of multiple, redundant MCS-7830s with inter-CallManager feature transparency, known better as clustering.

MCS-7835

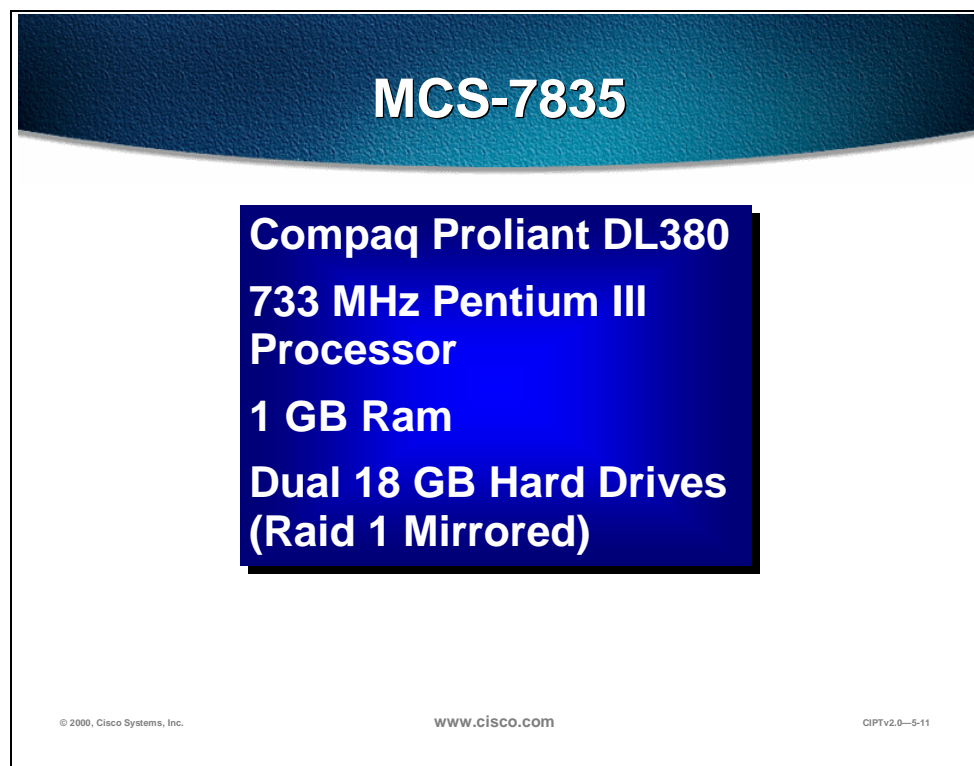

The graphic features a dark blue header with the text 'MCS-7835' in white. Below this, a dark blue box contains the following specifications in white text: 'Compaq Proliant DL380', '733 MHz Pentium III Processor', '1 GB Ram', and 'Dual 18 GB Hard Drives (Raid 1 Mirrored)'. At the bottom of the graphic, there are three small lines of text: '© 2000, Cisco Systems, Inc.', 'www.cisco.com', and 'CIPTv2.0-5-11'.

Performance

The MCS-7835 features a 733-MHz Intel Pentium III processor, and is expandable up to 4 GB of 133-MHz registered SDRAM, extending the high performance you will require to roll out current and future Cisco AVVID applications. There is hardware RAID support for dual 18.2-GB Ultra2 small computer serial interface hot-plug hard drives to improve overall system performance. All of this power is delivered in a space-saving rack-mountable form factor (3U), smaller than the MCS-7830, designed to save precious rack space in your data center.

Note Other third-party applications are not supported.

High Availability

Availability, or the percentage of time that a system is available to provide service, was assumed in old-world networks. Availability is a key requirement in the New World networks Cisco is building today. The high-availability design of the MCS-7835 will deliver a robust platform for your mission-critical Cisco AVVID applications. The MCS-7835 comes standard with a redundant hot-plug power supply and two redundant 18.2-GB SCSI hot-plug hard drives running RAID-1 disk mirroring to ensure maximum availability. If a hard drive or power supply fails, it can be replaced without powering down the server, and the failure will not affect service. In the case of the SCSI drive, as soon as the replacement

drive is inserted, the integrated RAID controller will restore the image to the new drive, without any user intervention.

Scalability

Whether you start your Cisco IP telephony network with five telephones or 5000, the MCS-7835 server allows the customer's network to grow at a manageable pace. A MCS-7835 server can serve as a Cisco CallManager server or a Cisco uOne voice-messaging server. Additional applications are planned for the platform in the future. As a Cisco CallManager 3.0 server, each MCS-7835 can handle up to 2500 IP telephones (total number of IP phones dependent on N+1 redundancy configuration). Remote sites can also be interconnected through an H.323 interface, using an H.323 gatekeeper.

Flexibility

The MCS-7835 is configurable to run either Cisco CallManager software or Cisco uOne voice messaging software. The MCS-7835 was also designed to run future Cisco application packages that will become part of the Cisco AVVID solution. The MCS-7835 has an optional internal 12/24-GB DAT tape drive to back up critical data, and also offers the flexibility of saving important user data to a separate server located elsewhere on the IP network.

Cisco CallManager Administration

This section describes CallManager administration.

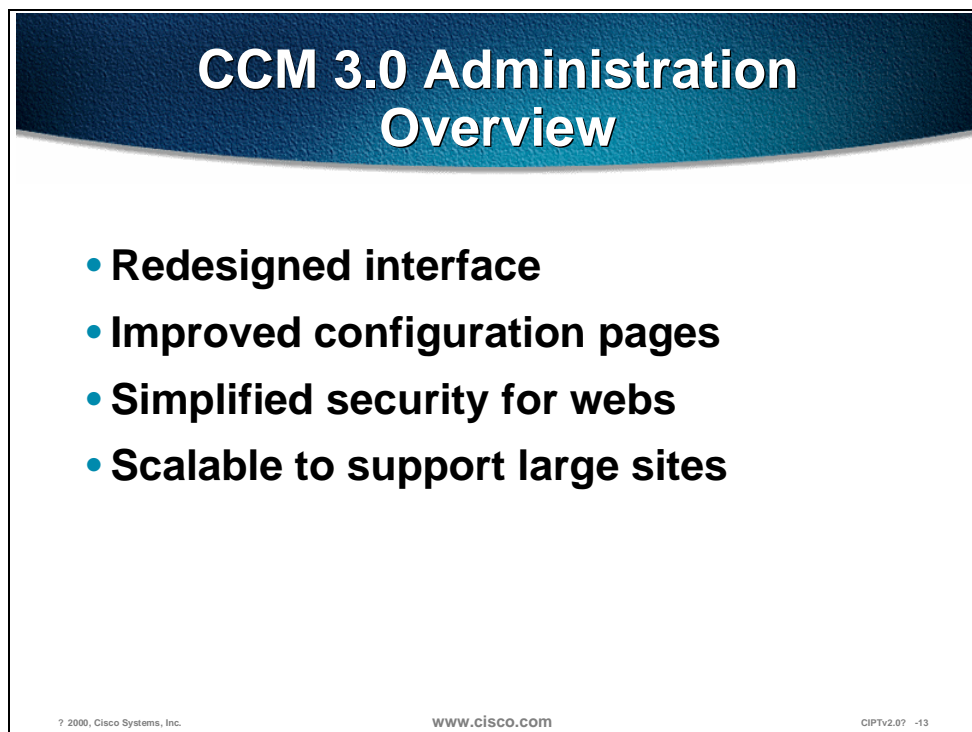

CCM 3.0 Administration Overview

- **Redesigned interface**
- **Improved configuration pages**
- **Simplified security for webs**
- **Scalable to support large sites**

© 2000, Cisco Systems, Inc. www.cisco.com CIPTv2.0? -13

The following are the new features of CallManager 3.0 administration:

- **Redesigned interface:** Started with a clean slate and designed the interface to work for the requirements of the Cisco CallManager 3.0. Navigation is simpler and individual pages are cleaner than before.
- **Improved configuration pages:** Pages are designed for the task of configuring the current item (for example, a phone). Most items can be configured on a single page, while others use a set of related pages. With few exceptions, all data validation occurs before the data is submitted for the update. (This is a change from 2.x, where errors in data entry often required re-entering all data.)
- **Simplified security for webs:** The Cisco CallManager 3.0 administration web is installed separately from related webs (for example, the User Web Pages for configuring speed dial buttons). This makes it much easier to secure the web from unauthorized access using standard Windows NT and IIS security.
- **Scalable to support large sites:** The administration pages are designed to be efficient even for organizations with 1000s or 10,000s of users/devices. Data transfer and page load times are minimized to keep the interface responsive.

Cisco CallManager Administration Is for

- **System definition**
- **System control**
- **Adding devices (IP phones, gateways?)**
- **Dial plan administration**

© 2000, Cisco Systems, Inc.

www.cisco.com

CIPTv2.07 -14

The Cisco CallManager administration web pages are designed specifically for the task of creating and maintaining the configuration database. These tools are being developed separately and will be available concurrent with or shortly after FCS.

If reports are an issue, customers can use any report package that connects to SQL databases (for example, Microsoft Access or Crystal Reports) to create their own reports.

In no case should customers attempt to update the database directly.

Installation

- **Administration web is installed by default with Cisco CallManager 3.0 software.**
- **Installed files for the web are now located outside wwwroot in *C:\Cisco\Webs\Admin*.**
- **The files for the user web pages (for configuring speed dial and forward) are installed in *C:\Cisco\Webs\User*.**
- **Installation creates virtual directories on the web server called **CCMAdmin** and **CCMUser**.**

© 2000, Cisco Systems, Inc.

www.cisco.com

CIPTv2.0? -15

In version 2.x all the web page files for Cisco CallManager were installed under the default web site root folder (*c:\inetpub\wwwroot*). The User Web Pages were a subdirectory of the administration pages. This made setting security on the site easy for labs, but difficult for production systems.

In Cisco CallManager 3.0, the web files are installed outside the root web for better security. The user web pages have been broken out into a separate location to make security easier. Security is setup and maintained using NT's directory and file permissions in combination with the permissions for the virtual directories on the web server. The virtual directories correspond to URLs of <http://hostname/CCMAdmin> and <http://hostname/CCMUser>, respectively (where *hostname* is the domain name or address of the web server).

Menus and Navigation



Components of the Cisco CallManager 3.0 database are organized into a simple menu structure

© 2006, Cisco Systems, Inc.

www.cisco.com

CIPTv2.07 -16

The menus are used to organize and navigate the web pages for configuring the system. Click on a menu name to see contents (click on the name again to hide the menu). The menu content is organized as follows:

- **System**—Items on this menu are used or available for the configuration of other items throughout the system. For example, the device pools used to group devices and associate devices with particular defaults.
- **Route Plan**—Items used to configure routing and trunking for the system. This includes setting up partitions, partition (calling) search spaces, route groups and lists, and so forth. The External Route Plan Wizard is also available.
- **Services**—Processes (applications and services) related to Cisco CallManager 3.0 run on the same or different machines (nodes) than a Cisco CallManager.
- **Features**—Phone system features such as Call Park and Call Pickup Groups.
- **Devices**—Hardware and software devices (phones and gateways) that carry or terminate calls. Also the keypad templates for phones.
- **Users**—LDAP directory items for associating users and phones.
- **Applications**—Plug-ins and other external applications that integrate with Cisco CallManager. For example, the Bulk Administration Tool, Voice Mail, CDR reporting and other applications that are installed separately from the main Cisco CallManager installation.
- **Help**—The online help for Cisco CallManager and installed components.

System Configuration

- **First configure system items**
- **Second configure gateways**
- **Third configure route plan**
- **Then add features, services, phone button templates, devices, and so forth**

© 2000, Cisco Systems, Inc.

www.cisco.com

CIPTv2.0? -17

When setting up new or expanded systems, the general flow of the configuration is system, gateways, route plan, services and devices. This is also a good way to get to know a customer's system:

- Have the Cisco CallManagers and Cisco CallManager groups been set up properly? Check system>servers or Cisco CallManager groups.
- Have regions and date/time settings been configured?
- Are locations being used?
- Are gateways configured with correct port types?
- Is route plan defined (with or without the External Route Plan Wizard):
 - Partitions, calling search spaces
 - Route groups, route lists
 - Route patterns and filters
- Are call park and pick up numbers defined?
- Has the configuration of individual services and devices been set up?

Locating Items to Configure

Locating Low- to Medium Count Items to Configure



Low- to Medium-Count items

© 2000, Cisco Systems, Inc. www.cisco.com CIPV2.07 -18

Low- to medium-count items such as Cisco CallManagers, device pools, and analog stations are listed on the left column of the configuration page.

Select an item from the left column to edit, update, or delete that item.

In Cisco CallManager Administration, select system from the tool bar and device pool from the drop down menu to get to the page shown above.

Locating High-Count Items to Configure



High-count items are located using a separate search page to list relevant items.

© 2000, Cisco Systems, Inc.

www.cisco.com

CIPTV2.07 -19

Use the search options at the top of the page to create a query for devices. Phones and users are considered high-count items. Click on the links for a listed item to edit it, or click on one of its icons to perform actions (copy, delete, reset) from the list.

In Cisco CallManager Administration, select Device from the tool bar and Phones from the drop down menu. When you select “Find” without establishing any search criteria, all registered phones will be listed.

Inserting and Updating Items

Inserting and Updating Items



The screenshot shows the Cisco CallManager Administration interface for Phone Configuration. The page title is "Phone Configuration" and it includes a "Back to First Out Phones" link. The phone number is 100100001230 (SEP100100001230) and its status is "Ready". There are buttons for "New", "Copy", "Update", "Delete", "Reset Phone", and "Cancel". The "Device Information" section includes fields for MAC Address (188100001230), Description (SEP100100001230), Device Pool (Default), Location (None), Calling Search Space (None), and Button Template (Default 7902). There are also links for "View details" and "View button list".

Validating and updating data is done using Remote Scripting? to access data on the server without leaving the current page.

© 2000, Cisco Systems, Inc. www.cisco.com CIPV2.07 -20

One of the changes in 3.0 is the consolidation of information on a single page. Settings that the user can't or shouldn't modify are removed so that more related items are on the same page. The change is most noticeable on the device pages.

Another change is the use of remote scripting to reduce the amount of processing done by the server. A key benefit of this technology is that the database can be accessed without leaving the current page. The ability to quickly validate against large databases (for example, detect a duplicate device name or directory number in a system with 1000s of stations) and give the user feedback.

Most updates are done using remote scripting so the server only has to process the data. The older form submission method sometimes required more processing for the HTML than the data. Another advantage is that we can now give the user error messages without requiring them to navigate between pages and re-enter data.

Remote Scripting (Diagram)

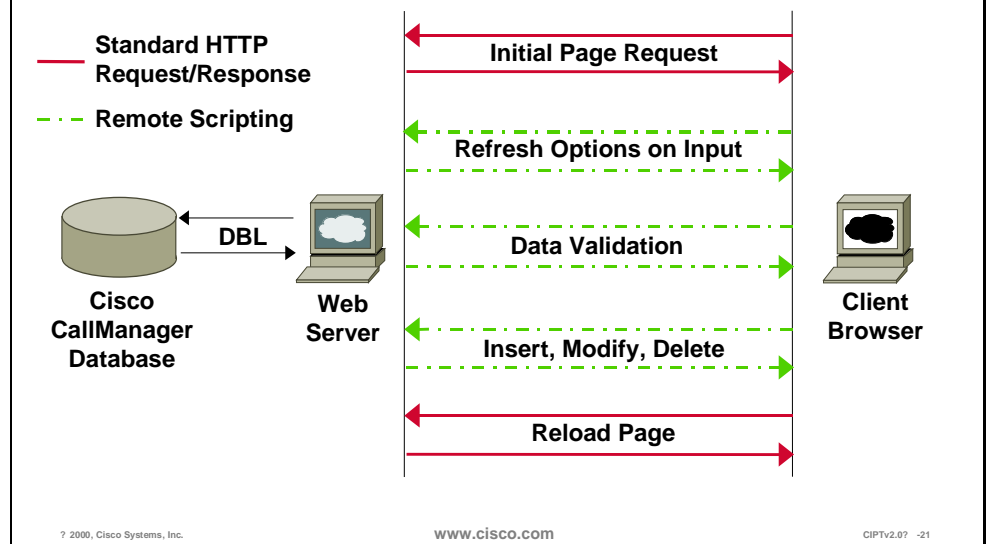

Remote scripting is Microsoft's name for accessing objects and data on a web server without reloading an entire page.

There are standards under development to make this functionality available in a non-proprietary way and across platforms.

Remote scripting lets us efficiently provide administrators with immediate feedback. For example, when an administrator enters the directory number for a line being added to a phone, we can tell them immediately if that directory number is already assigned to another device. This brings us closer to the performance expected in an application.

Supported and Tested Browsers

Supported/Tested Browsers

- **Microsoft Internet Explorer 4.01 - 5.01 (32-bit Windows only)**
- **Netscape Navigator 4.08 - 4.7 (Windows, Linux, Solaris)**

© 2000, Cisco Systems, Inc. www.cisco.com CIPV2.07 -22

The Dynamic HTML (for example, menus) and remote scripting require a browser that supports style sheets, DHTML, JavaScript, and scriptable Java applets. Currently, these are the browsers we know that meet our requirements.

This will not work on Mac, or IE under UNIX.

External Route Plan Wizard

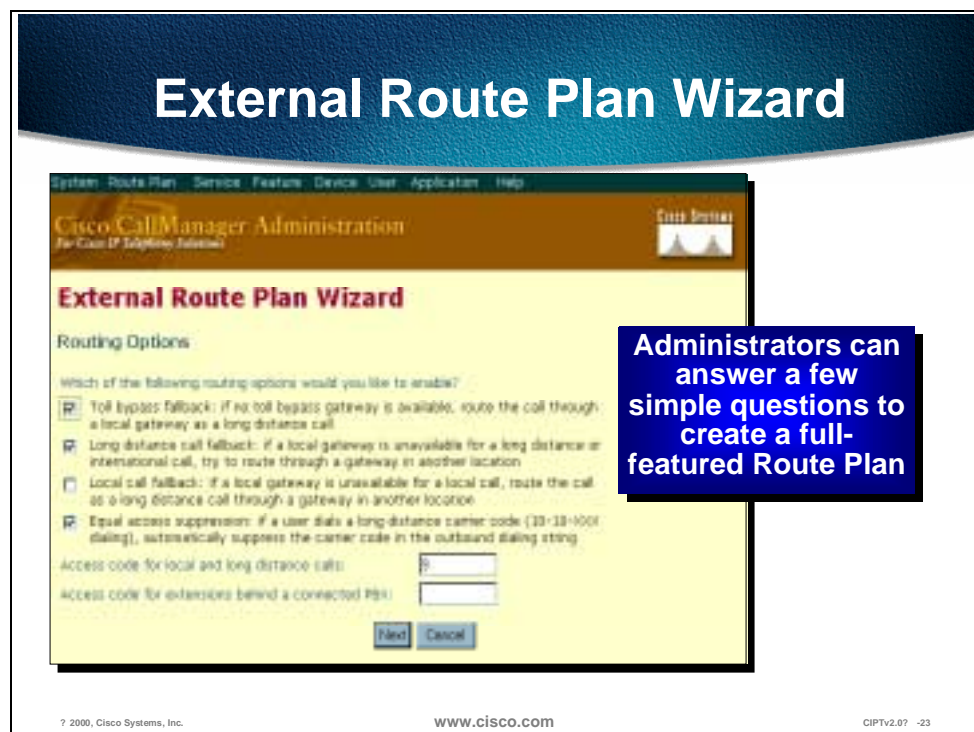

The Wizard provides a way to set up specific information about the way calls are handled in the system without having to know all the details for Cisco CallManager 3.0's implementation of call routing.

A route plan determines how a call placed from a station in the Cisco CallManager system is routed to its destination. The External Route Plan Wizard has been designed to allow a user with a limited amount of experience setting up route plans to quickly create and assign the items necessary for:

- Controlling access to long distance calling
- Provide emergency (911) access to all phones
- Enabling toll bypass between multiple locations (use private network instead of PSTN)
- Integrating the Cisco CallManager system with an existing PBX's route plan
- Additional information is shown on the Wizard's first screen. Note in particular that the Wizard is for the North American Numbering Plan, and will not work for sites/customers in locations that require different numbering plans (for example, Europe, Asia, and so forth).

The Wizard creates all the necessary items, which can then be used to configure other devices (for example, phones). Items created by the wizard can be modified, and additional items can be added (for example, additional filters for blocking 900 services or directory assistance). However, once the items created by the Wizard are applied to devices or modified, you can no longer delete the dial plan without first undoing other changes.

Installable Components

This section describes the CallManager installable components.

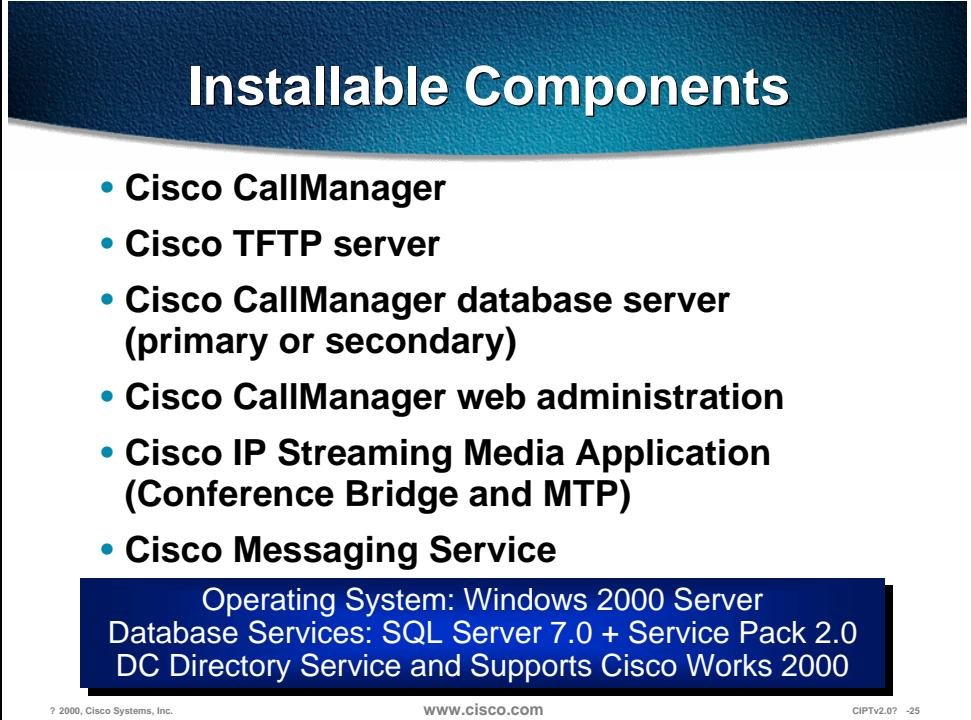

Installable Components

- **Cisco CallManager**
- **Cisco TFTP server**
- **Cisco CallManager database server (primary or secondary)**
- **Cisco CallManager web administration**
- **Cisco IP Streaming Media Application (Conference Bridge and MTP)**
- **Cisco Messaging Service**

Operating System: Windows 2000 Server
Database Services: SQL Server 7.0 + Service Pack 2.0
DC Directory Service and Supports Cisco Works 2000

© 2000, Cisco Systems, Inc. www.cisco.com CIPTV2.07 -25

The MCS-7800 series comes with the following installable components:

- Cisco CallManager
- Cisco TFTP server
- Cisco CallManager database server (primary or secondary)
- Cisco CallManager web administration
- Cisco IP Streaming Media Application (Software Conference Bridge and Software Media Termination Point)
- Cisco messaging Service

The operating system is a Windows 2000 server and the database server uses SQL Server 7.0 plus Service Pack 2.0. The server also uses DC Directory Service and will support Cisco Works 2000.

Software License Keys

Software License Keys

- Files on CDs are encrypted
- Unique license key per application
- Installation flow controlled by license key

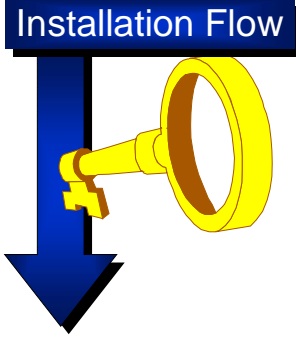

**You cannot install partial software pieces. For example; Win2k, or SQL Server only.
You cannot install Cisco CallManager 3.0 on rogue Win2K install.**

© 2000, Cisco Systems, Inc.www.cisco.comCIPTv2.07 -26

All files of the installable components CD's are encrypted and each application has its own unique license key. Each application's license key controls the flow of installation.

You are unable to install partial software. For example, you are unable to install only a Windows 2000 server or SQL server on a machine. The keys and encrypted files prevent partial installs of the software.

Because of the unique keys per application and the CD encryption, you are unable to install Cisco CallManager on a rogue Windows 2000 server installation.

Note In order to maintain the integrity of the system performance, no other third party applications can be installed or run on the system.

Application Considerations

Application Considerations

- **Browsers:**
 - **Must support both JavaScript and Active Server Pages (ASP)**
 - **Microsoft Internet Explorer 4.01 or later**
 - **Netscape 4.5 or later**
- **Dynamic Host Configuration Protocol (DHCP)**
- **Domain Name System (DNS) used for name resolution when DHCP options provide names**

© 2000, Cisco Systems, Inc. www.cisco.com CIPV2.07 -27

Several utilities are necessary for using Cisco CallManager. The Browser used must support both JavaScript and Active Server Pages (ASP). The browser must also be Microsoft Internet Explorer 4.01 or later or Netscape 4.5 or later.

The Dynamic Host Configuration Protocol (DHCP) is used to provide an IP address lease and the location of the TFTP server. If DHCP is not available, a BOOTP server may be used.

The Domain Name System (DNS) is required for name resolutions. When a centralized DNS is used with a distributed clustered environment, a single point of failure to resolve Domain names could be an issue. If a link to DNS is down, phones may not be able to resolve CallManager Domain names and without registration to a CallManager, phones are out of service.

Service Requirements

Service Requirements

- **DHCP:**
 - IP address range
 - Subnet
 - Option 003 默认网关 (router)
 - Option 006 名称服务器 (optional)
 - Option 015 域名 (optional)
 - Option 066 TFTP, 或 option 150 FTP 服务器 (NOT both)
- **DNS only if name resolution services are required**

© 2000, Cisco Systems, Inc. www.cisco.com CIPTv2.07 -28

Cisco Network Registrar can be used to provide these services from any supported host. If used, option 150 must be created within the DHCP table since it is a custom option.

The IP address of the TFTP server may also be placed in the *siaddr* field of the DHCP manager. You may choose this if option 066 is already in use and you do not want a custom option. Some DHCP servers will populate this field with their own IP address. If this happens, the TFTP server address should be entered in the *siaddr* field.

DHCP

- Initial registration process uses DHCP
- **Strongly recommended** that DHCP services run on a different system than the CallManager
- DHCP allows you to move a phone without configuring CallManager or manually assigning a new IP address
- With DHCP and autoregistration, a user can plug and play and dial with no administration intervention

© 2000, Cisco Systems, Inc.

www.cisco.com

CIPTv2.07 -29

DHCP automatically assigns IP addresses to Cisco IP phones whenever plugged in. For example, this allows connecting multiple phones anywhere on the IP network and DHCP will automatically assign IP addresses to them.

When the phone or access device turns on, the following happens:

- It automatically queries DHCP if configured (phones can be manually configured from the touch pad on the phone).
- DHCP responds by assigning an IP address to the phone or access device. The name or IP address of the TFTP server is also provided if it is available. If DHCP doesn't provide the TFTP name or IP, the phone uses the default server name *CiscoCMI*.
- The phone contacts the TFTP server and requests a configuration (*.cnf*) file. The *.cnf* file contains the CallManager's name or IP address.
- If the CallManager's name is received, the phone resolves the name using DNS and a CallManager connection is opened.

Database

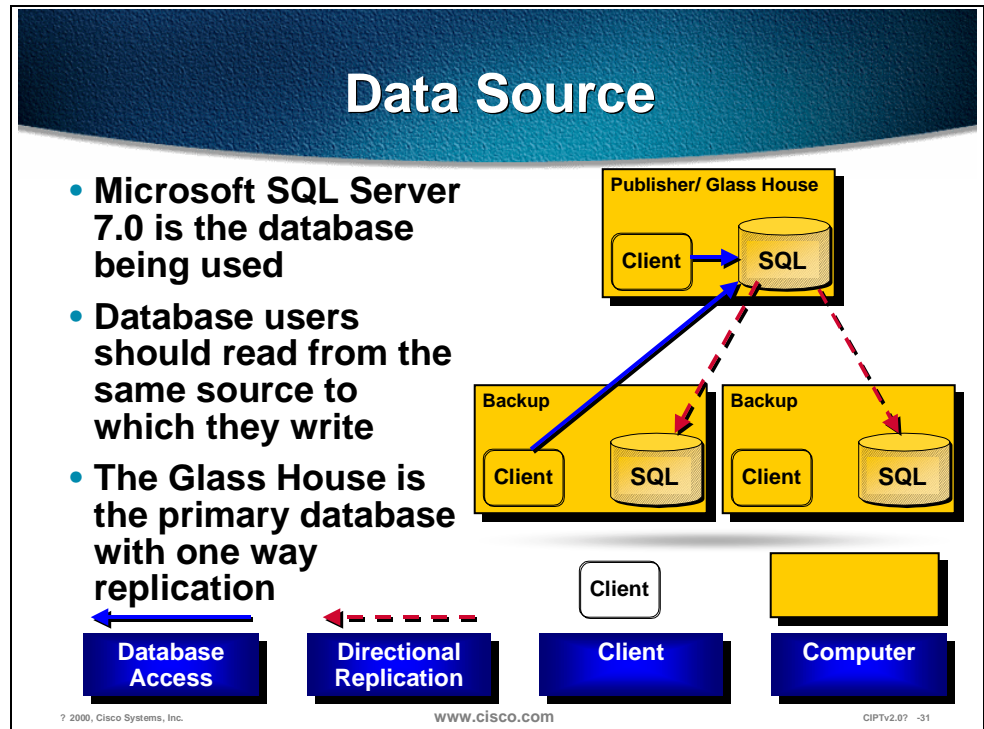

The database used is Microsoft SQL Server 7.0 plus Service Pack 2.0. The database users should read from the same source that is written to. The “Glass House” is the primary database with one-way replication or directional replication.

The database writes to the database only occur at the Glass House and Call Detail Records are not replicated.

Layer Boot Sequence

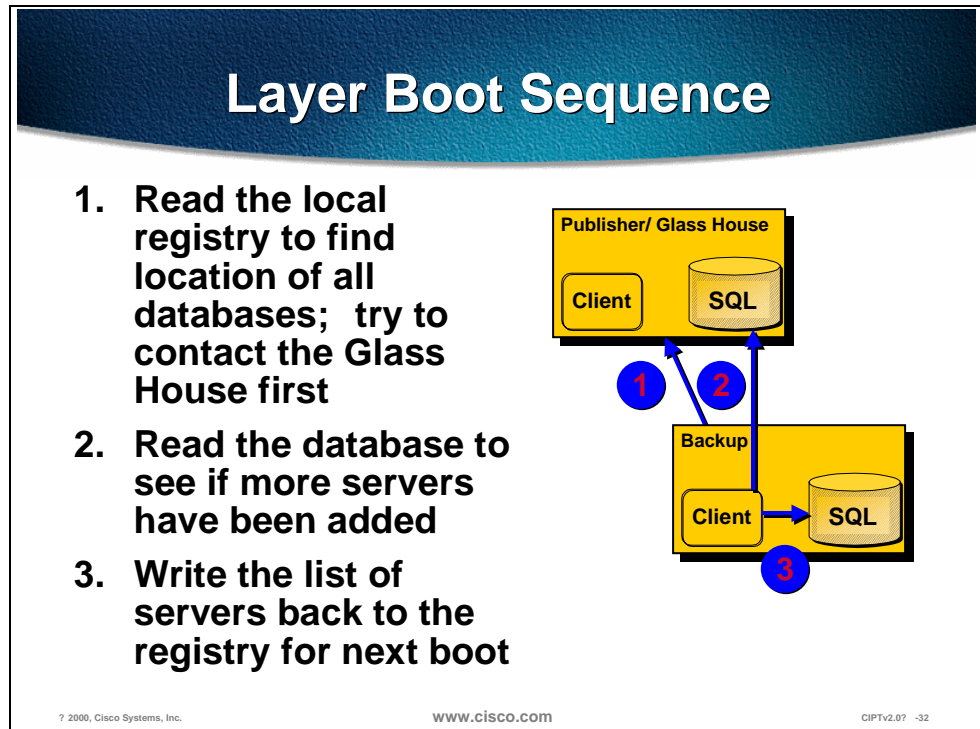

Layer boot is the process used by the database to keep in sync. The layer boot sequence uses the following steps:

1. A backup (subscriber) will read its local registry to find the location of all databases. It will try to contact the Glass House (publisher) first.
2. Then the subscriber will read the database to see if more servers have been added.
3. Then the subscriber will write the list of servers back to the registry for the next boot.

Hiding the Data Source and Failover

1. The database layer first tries to use the Glass House (read and write)
2. If Glass House is not available, try a replicated database; if one exists on the local machine, try it before any other

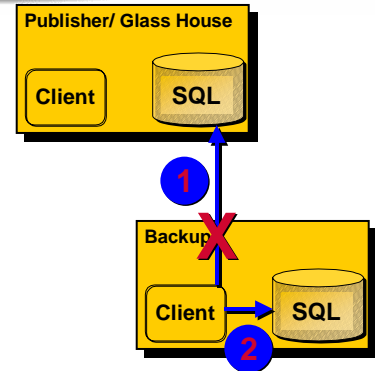

During a failover, the database layer prevents writes to the database except for Call Detail Records.

© 2000, Cisco Systems, Inc.

www.cisco.com

CIPT v2.0-5-33

The data source on the local machine is hidden so that it will try to use the Glass House (Glass House = publisher) (read and write) database. If the Glass House is not available the local machine will try a replicated database on its own machine. If it does not have a database on the local machine, the local machine will try other subscribers for a database.

Installation

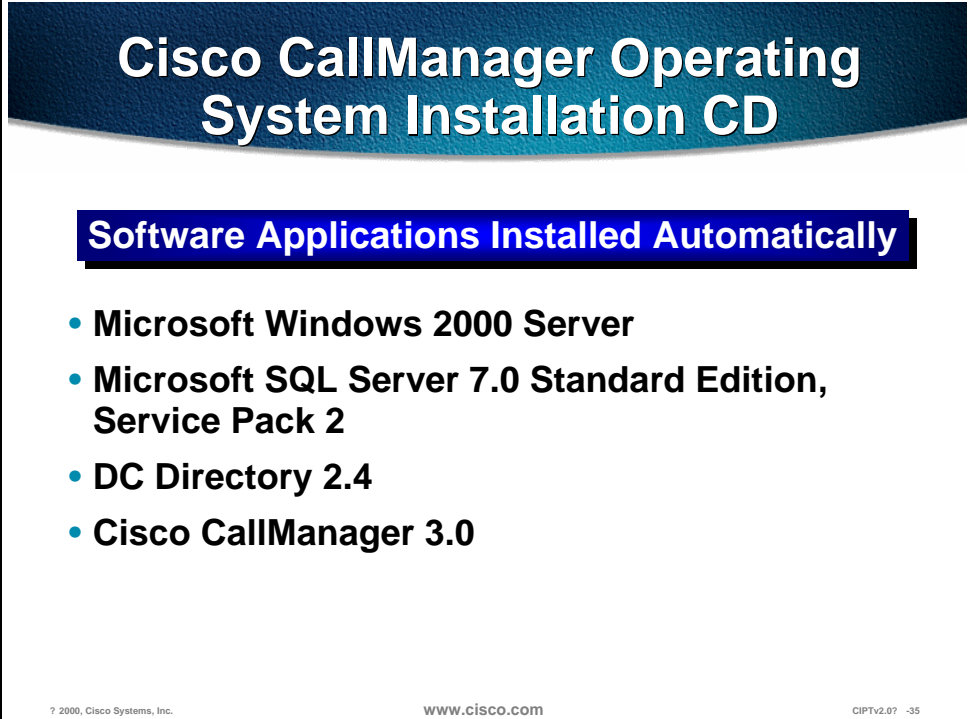

The graphic shows the front cover of a CD case. At the top, a dark blue banner with a textured background contains the text "Cisco CallManager Operating System Installation CD" in white, bold, sans-serif font. Below this, a white rectangular box with a blue border contains the text "Software Applications Installed Automatically" in blue, bold, sans-serif font. Underneath, a bulleted list in black text lists four items: "Microsoft Windows 2000 Server", "Microsoft SQL Server 7.0 Standard Edition, Service Pack 2", "DC Directory 2.4", and "Cisco CallManager 3.0". At the bottom of the graphic, there is a thin white line with small text: "© 2000, Cisco Systems, Inc." on the left, "www.cisco.com" in the center, and "CIP1V2.07 -35" on the right.

The Cisco CallManager Operating System Installation CD must be inserted into the Cisco Media Convergence Server before powering up the server. After the system boots, the MCS QuickBuilder installation utility, located on the CD, loads automatically and guides you through the installation process. MCS QuickBuilder performs several pre-installation tasks, including preparing your server's hard drive and loading server configuration information, and then automatically installs the following software applications:

- Microsoft Windows 2000 Server
- Microsoft SQL Server 7.0 Standard Edition, Service Pack 2
- DC Directory 2.4—is an LDAP Compliant Directory
- Cisco CallManager 3.0

Note During installation, the server reboots several times. ***Do not power off the server any time during this process, unless instructed.*** Any unexpected power interruption during the installation process could prevent proper completion of the configuration and might prevent the operating system from restarting.

Installed Components

- **Cisco CDR Database Monitor service**
- **SQL Server 7.0**
- **MTS package for DBLR.DLL**
- **MS DTC (part of Microsoft Windows NT 2000)**
- **DBL.DLL and DBLX.DLL**
- **Registry settings for boot**

© 2000, Cisco Systems, Inc.

www.cisco.com

CIPTV2.07 -36

During the installation of the Cisco CallManager and supporting services CDs, the following components are installed:

- Cisco CDR Database Monitor service
- SQL Server 7.0
- MTS package for DBLR.DLL—used for transactions and security
- MS DTC (part of Microsoft Windows NT 2000)—used for transactions and security
- DBL.DLL and DBLX.DLL
- Registry settings for boot

These services are installed with the auto install CD.

Migration

2.4 Migration

- Requires path to MDB file
- Same machine upgrade requires more memory

3.0 Migration

- Changes database name
- Three previous versions kept on server

© 2000, Cisco Systems, Inc.

www.cisco.com

CIPTv2.07 -37

Migration from Cisco CallManager 2.4 to 3.0 it requires a path to the MDB file. The Migration from 2.4 to 3.0 does require a memory upgrade if using a MCS-7820 to 512 MB RAM or MCS-7830 requires 512 MB to 1 GB RAM.

If migrating from a Cisco CallManager 3.0 to Cisco CallManager 3.0 the database name changes.

Starting and Stopping Cisco CallManager

Three Methods

- **Control Center in Cisco CallManager Administration**
- **Windows Control Panel for Services**
- **Reset button in Cisco CallManager Administration**

Stopping Cisco CallManager stops call processing for all devices controlled by that Cisco CallManager. If you have not configured a backup Cisco CallManager for those devices, any calls in progress on those devices are dropped.

© 2000, Cisco Systems, Inc. www.cisco.com CIPTv2.07 -39

Stopping Cisco CallManager stops call processing for all devices controlled by that Cisco CallManager. If a backup Cisco CallManager is not configured for those devices, any call in progress on those devices is dropped. There are the following three methods for stopping a Cisco CallManager:

- Control Center in the Cisco CallManager Administration
- Windows control panel for services
- Reset button in Cisco CallManager Administration

Note If a screen on the CallManager Administration page has a reset button, you only need to reset the device. If the screen does not have a reset button, you must restart the Cisco CallManager.

Parameter Settings that Require a Restart

- IP Address of the Cisco CallManager server
- Partition for auto-registration
- External phone number mask for auto-registration
- TCP port settings for the Cisco CallManager server

Tip: Make as many configuration changes as possible at one time, and restart Cisco CallManager only once after completing the changes

© 2000, Cisco Systems, Inc.

www.cisco.com

CIPTv2.07 -40

It is better to make as many configuration changes as possible at one time, and restart Cisco CallManager only once after completing the changes. The following system parameter settings require a restart:

1. IP Address of the Cisco CallManager server
2. Partition for auto-registration
3. External phone number mask for auto-registration
4. TCP port settings for the Cisco CallManager server

Troubleshooting

Troubleshooting (Version Information)

The screenshot shows the Cisco CallManager Administration web interface. A red arrow points from the 'Details' button on the 'About' page to a pop-up window titled 'Microsoft Internet Explorer'. The pop-up window contains the following information:

```
When reporting or troubleshooting a problem, please give the following information to Technical Assistance:  
  
Cisco CallManager System version: 3.0(1)EE3(1)  
Cisco CallManager Administration version: 3.0E(2)  
  
Database Information:  
Driver: SQL Server  
Server: (mssql02)  
Database: CDR4333  
  
Database DLL version:  
DWL: 3.0(1)A0  
DBLP: 3.0(1)A0  
DBUC: 3.0(1)A0
```

Details button on About page shows database connection and DBL version information

© 2000, Cisco Systems, Inc. www.cisco.com CIPTv2.07 -41

When supporting a customer, the first thing to check is the information listed in the Details. This includes system and Cisco CallManager administration versions, database connection information, and DBL versions. Errors in displaying this information can be a sign of errors in the general system setup or configuration.

If the database connection information is missing, refresh the page and check again. If the information is still missing, there's a good chance that a problem exists in the connection to or configuration of the Cisco CallManager(s) and SQL server(s).

If the DBL information is missing, there is a problem with the DBL. Try re-registering the DBL DLLs and refreshing MTS components.

Troubleshooting (Remote Scripting)

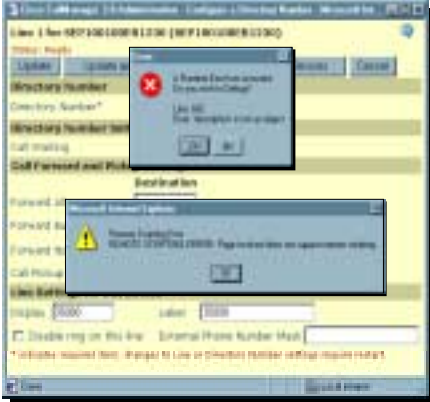

The screenshot shows the Cisco CallManager Administration web interface. A JavaScript alert dialog box is displayed in the foreground with a red 'X' icon and the text: "A Runtime Error occurred. Do you wish to Debug?". Below it, a yellow warning message is visible: "Error: 'xyz' is not an object (or 'Error: 'xyz' is undefined").

Microsoft Script compilation error: 'xyz' is not an object (or 'Error: 'xyz' is undefined')

Expected: '...'

ICCMAdmin2_02_Local_RemoteScripting_scripting_line 47

'I made this break on purpose'

...

Remote Scripting errors may trigger additional error messages

This information is needed for debugging errors

© 2000, Cisco Systems, Inc. www.cisco.com CIPV2.07 -42

In the unlikely event that there are bugs in the code for the Cisco CallManager 3.0 Administration web pages, an error during a remote scripting call can cause one or more dialogs to be displayed. The information that is useful for debugging these errors is the message that indicates the page on which the error occurred. Other messages that appear at simultaneously can be ignored. Examples of these extra error messages are:

- Page invoked does not support remote scripting
- A Runtime Error has occurred, for example; Do you wish to Debug?
Line 482
Error: 'xyz' is not an object (or "Error: 'xyz' is undefined")

Debugging information may appear in a window as shown in this figure, or it may be shown in a slightly different form in a JavaScript alert (dialog box). In some cases the error message will appear on the page itself. If there is an error on the page itself, the other messages that pop up in dialogs are probably side effects of the original error. Always look for error messages in the browser window first before working on other error messages.

Laboratory Exercises

Summary

This section summarizes the concepts you learned in this chapter.

Summary

- **The MCS-7800 platforms are the hardware platforms for the Cisco CallManager.**
- **The primary function of the Cisco CallManager is call processing.**
- **Cisco CallManager Administration is used to establish parameters and configuring devices.**
- **Inter-cluster communication is provided via H.323.**

? 2000, Cisco Systems, Inc. www.cisco.com CIPTV2.07 -43

The MCS-7830 and the MCS-7835 are the hardware platforms for the Cisco CallManager. Each server is a high availability server that comes with the following software:

- Cisco CallManager and all of its components and plug-ins
- Windows 2000
- SQL 7.0
- SQL 7.0 Service Pack 2
- Compaq Remote Insight Manager
- Windows 2000 Resource Kit (components)
- Executive Software Diskeeper Server (defrag software)

Cisco CallManager Administration is used for setting parameters, adding and configuring devices, and updating user information.

Inter-cluster communication is provided via H.323 that permits a subset of the features to be extended between clusters.

Review Questions

Answer the following questions.

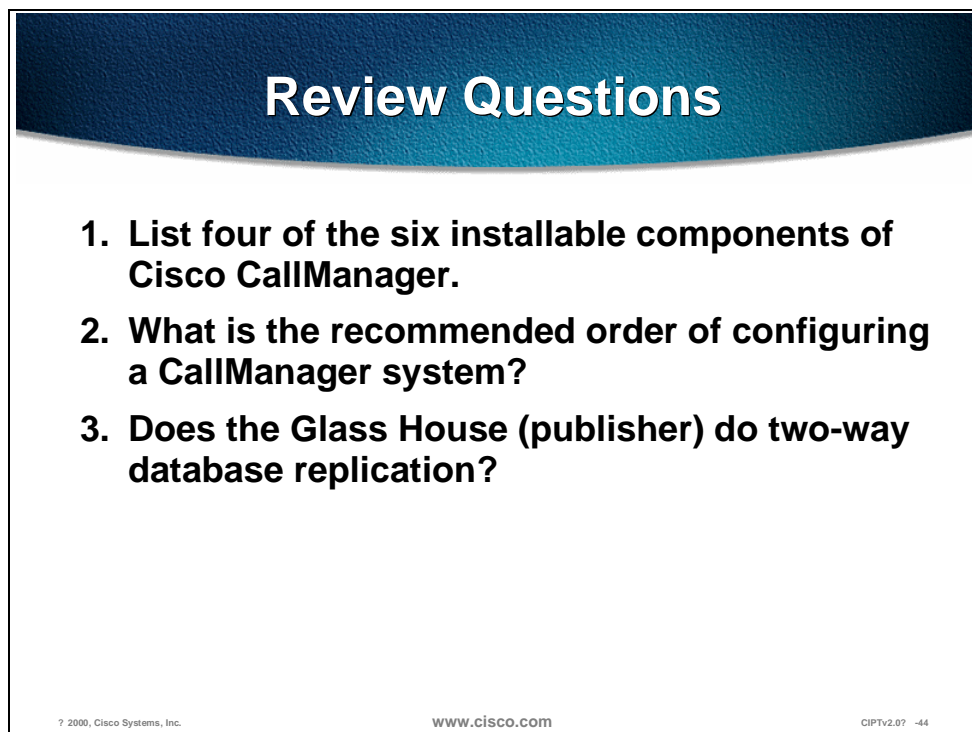
A slide titled "Review Questions" with a blue gradient header. The slide contains three numbered questions. At the bottom, there is a footer with the text "? 2000, Cisco Systems, Inc.", "www.cisco.com", and "CIPTv2.0? -44".

Review Questions

- 1. List four of the six installable components of Cisco CallManager.**
- 2. What is the recommended order of configuring a CallManager system?**
- 3. Does the Glass House (publisher) do two-way database replication?**

? 2000, Cisco Systems, Inc. www.cisco.com CIPTv2.0? -44

- Q1) There are six installable components that come with an order of Cisco CallManager. List four of the six.
- Q2) After the Cisco CallManager is installed, in Cisco CallManager Administration, what is the recommended order for configuration?
- Q3) In a Cisco CallManager cluster there are publishers and subscribers for the database entries. Does the Glass House (publisher) do a two-way database replication?

Cisco CallManager Services

Overview

Cisco CallManager Services are the services that are optionally enabled on every Cisco CallManager in a cluster. These services provide configuration files, connecting to a third party voice mail system, and conferencing and media terminating functions.

In this chapter, the following topics will be discussed:

- Objectives
- Cisco TFTP
- Cisco Messaging Interface
- Cisco IP Voice Media Streaming Application
- Summary
- Review Questions

Objectives

This section lists the chapter objectives.

Objectives

Upon completion of this chapter, you will be able to perform the following tasks:

- **Identify and describe the Cisco TFTP in a CIPT solution**
- **Describe the function of Cisco IP Media Streaming application**
- **Identify when and when not to use the Cisco IP Media Streaming application**
- **List the steps to install and configure Cisco Messaging Interface**

© 2000, Cisco Systems, Inc. www.cisco.com CIPT v2.0? -3

Upon completion of this chapter, you will be able to perform the following tasks:

- Given a Cisco IP telephony solution, identify and describe where and how the Cisco TFTP fits in to the network topology.
- Given a list of service functions, identify and describe the functions of the Cisco IP Media Streaming application.
- Given a case study, identify when and when not to use the Cisco IP Media Streaming application.
- Given a Cisco CallManager Server and a third party voice mail system, list the steps used to install and configure the Cisco Messaging Interface.

Cisco TFTP

This section describes the Cisco Trivial File Transfer Protocol (TFTP).

What Is Cisco Trivial File Transfer Protocol (TFTP)?

- **Cisco TFTP is a Windows NT 2000 service**
- **Cisco TFTP builds configuration files from information found in the database**
- **Cisco TFTP Serves configuration, executable, and ringer files consistent with ITU RFC 1350**

? 2000, Cisco Systems, Inc. www.cisco.com CIPT v2.07 -5

Cisco Trivial File Transfer Protocol (Cisco TFTP) is a Windows NT 2000 service. The Cisco TFTP service builds configuration files from information found in the database. Cisco TFTP serves configuration, executable, and ringer files consistent with ITU RFC 1350.

The configuration files are device specific with the name format SEP, SAA, SDA, CFB, or MTP + MAC, for example, *SEP001002003004.cnf*.

- SEP—Selsius Ethernet Phone (Cisco 12 SP+, 30 VIP and 7960)
- SAA—Selsius Analog Access (AT-2,4,8 and AS-2,4,8)
- SDA—Selsius Digital Access (DT-24+, DE-30+)
- CFB—Conference Bridge
- MTP—Media Termination Point

Configuration files also contain a list of CallManagers in priority order. Network addresses are either the fully qualified domain name “cm1.cisco.com” or dotted IP address “172.116.21.12” plus a TCP Port (see Call Manager Group Configuration). The configuration files for a 7960 include URL’s for four buttons (Messages, Directories, Services, and Information).

Configuration File Request

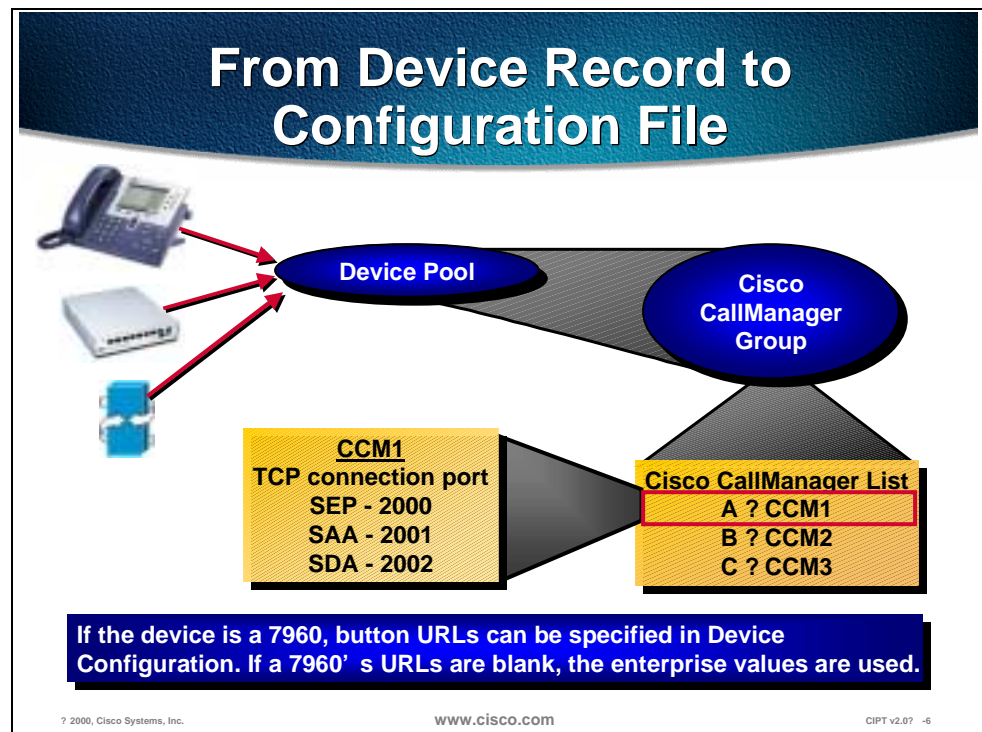

A device has a communication request record that needs to download a configuration file. The following is the process used by a device to get to the configuration file:

- A device specifies a device pool.
- A device pool specifies a CallManager group.
- A CallManager group specifies a list of CallManagers.
- CallManagers contain the TCP connection port for the three device types (telephone, analog gateway, and digital gateway).

If the device is a 7960, button URLs can be specified in device configuration. If a 7960's URLs are blank, the enterprise values are used.

Phone Boot Process

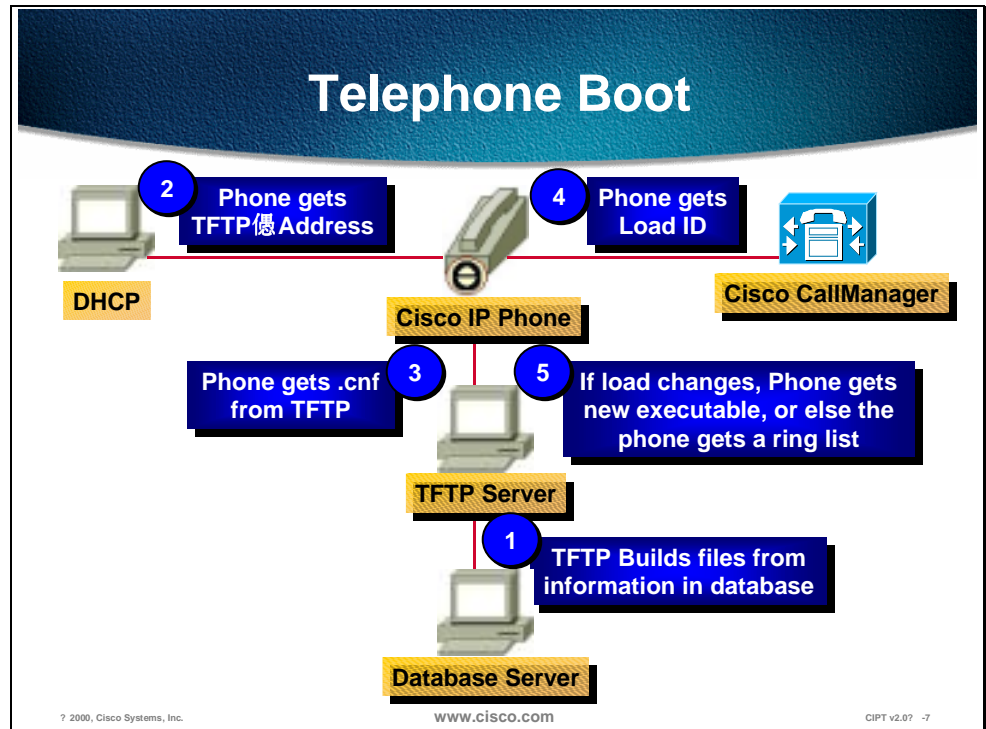

Skiny devices typically get their IP configuration and the network address of the TFTP server from the DHCP server (see NT help on DHCP options). Some devices allow the TFTP server to be set locally.

The device requests a MAC-based configuration file from the TFTP server.

The device will use the configuration file to make a TCP connection to the highest priority Cisco CallManager in the list.

Once the device has connected and registered with a Cisco CallManager, the Cisco CallManager will tell the device which executable version to run. If the specified version does not match the executing version, it will request the new executable from the TFTP server and reset itself.

Once a telephone is ready to make a call, it will request an available ringer list from the TFTP server. If the telephone user changes the ring type, the new ring type will be sent from the TFTP server.

Cisco TFTP Architecture

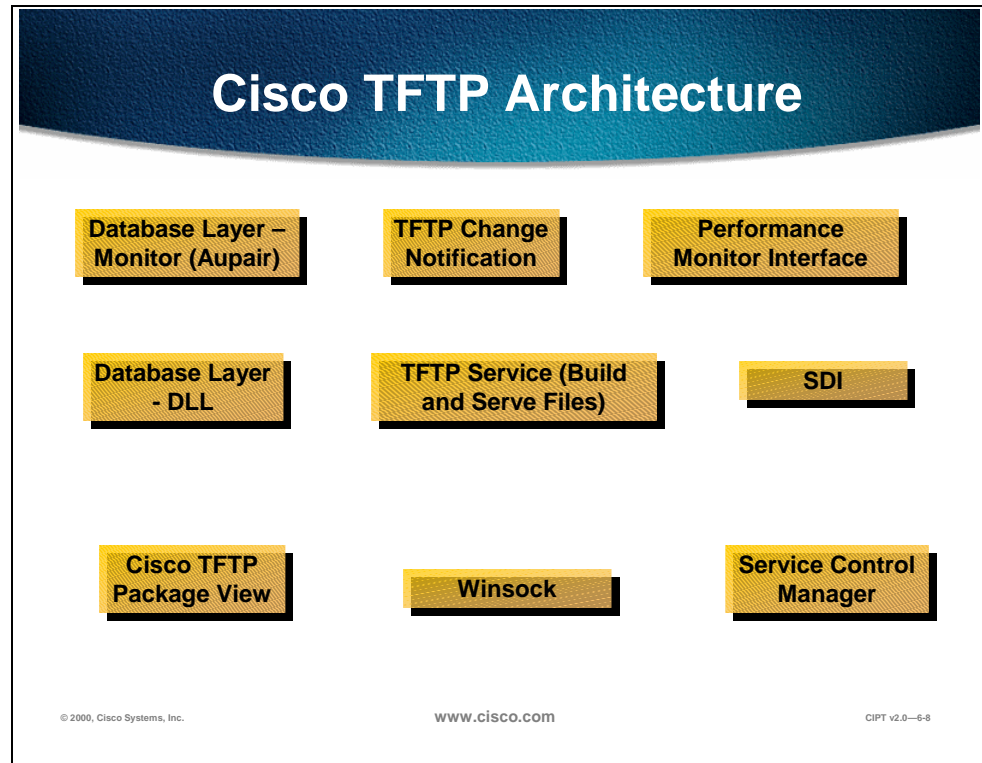

The Cisco TFTP external interfaces include the following:

- NT's Service Control Manager
 - Cisco TFTP is an auto start NT 2000 service so it runs even before any one logs in.
 - The NT Service Control Manager can start, stop, or get status (starting, running, stopping, or stopped).
- NT's Winsock
 - NT's Winsock provides Cisco TFTP with a C interface to the IP network.
 - Winsock is used to receive TFTP requests.
 - Winsock is used to send file segments and receive acknowledgments for those file segments.
- Selsius Diagnostic Interface (SDI) trace
 - This library provides Cisco TFTP with a C interface to trace and alarms.
 - SDI Trace can be directed to local files, NT Event Log, and Cisco Works.
 - Trace allows the developer to know that the code is functioning properly or to find the cause of an error.

- Alarms are used to inform the administrator of an unexpected event (unable to access a file, unable to access the database, unable to access Winsock, or unable to allocate other operating system resources).
- Performance monitor
 - This DLL provides Cisco TFTP with a C interface to NT PerfMon.
 - TotalTftpPreBuilt has changed to TotalTftpOverflow.
- Database layer DLL
 - This DLL provides Cisco TFTP with a C++ interface to the Cisco Call Manager enterprise database (for the cluster). The database could be local or remote. If the primary database fails, the Layer handles the details transparently.
 - Process configuration information includes trace information, alternate path information, and whether to delete files in the primary directory.
 - Building file configuration includes device and CallManager information.
- Database layer monitor (Aupair)
 - This NT service provides Cisco TFTP with change notification through two call backs. One call back for process configuration changes and one for any other change that the TFTP server is interested in.
 - This service is located with the database server objects.

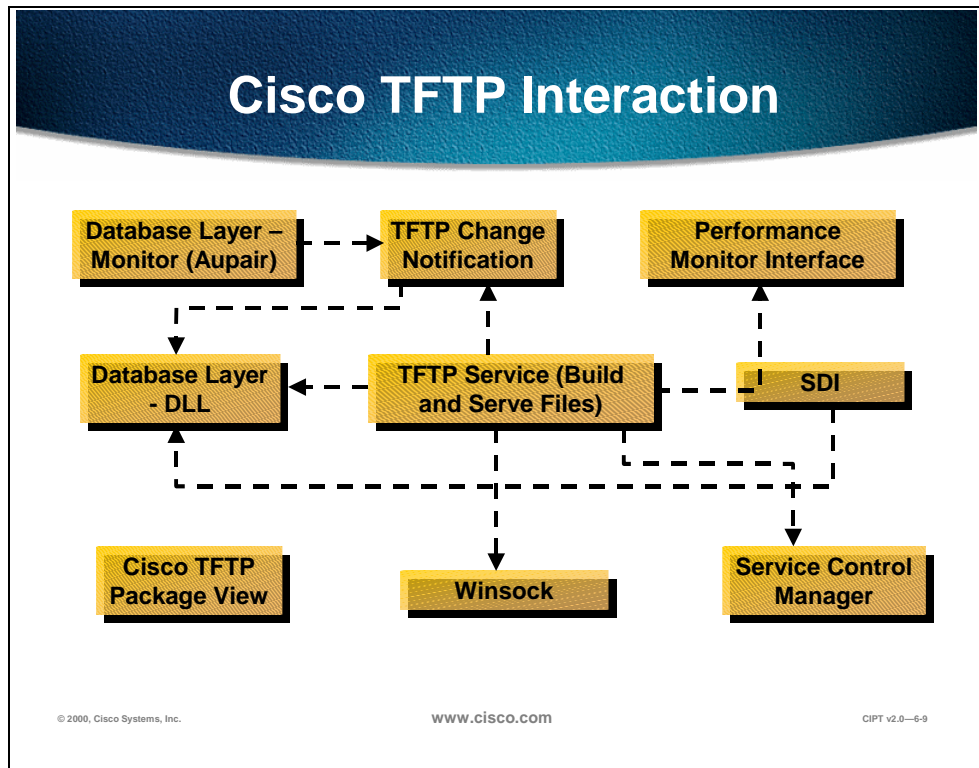

The Cisco TFTP internal interaction include the following:

- Serving files

- Cisco TFTP uses an independent thread waiting for TFTP requests on the ITU standard port.
- It validates packets and sends an informational alarm denoting the request is received.
- If the maximum serving count is exceeded, the overflow count is incremented and the requestor is sent a special error (instructing it to wait and repeat).
- If the maximum count is not exceeded, the file is served from an independent thread.
- When a request is processed, the primary directory and each alternate path (if specified) is searched. Then file segments are sent 512 bytes (maximum) at a time.
- If segment acknowledgments are not received in four seconds, the segments are retransmitted up to five times.

- Building files

- Files are built on service start or on change notification.
- Path information is read from the process configuration table.
- Get the TFTP default list of Cisco CallManagers. Write the five default files based on the three types (CFB and MTP use the TCP port as the telephone).
- Enterprise URL information is saved.

- For every device pool in the system, the list of CallManagers is retrieved and three prototype configuration files are built.
- For every device in the system, find the prototype configuration file, add the URL information as appropriate, and write out that file to the primary TFTP path.
- Change notification
 - For a process configuration change, all process configuration parameters are read and all the configuration files are rebuilt.
 - For a Cisco CallManager change, the CallManager information is reread and if the information TFTP uses has changed, all configuration files are rebuilt.
 - For group information change, all configuration files are rebuilt.
 - For device change, only the affected device's configuration file is rebuilt unless the device is deleted, and then all configuration files are rebuilt.

Change Notification

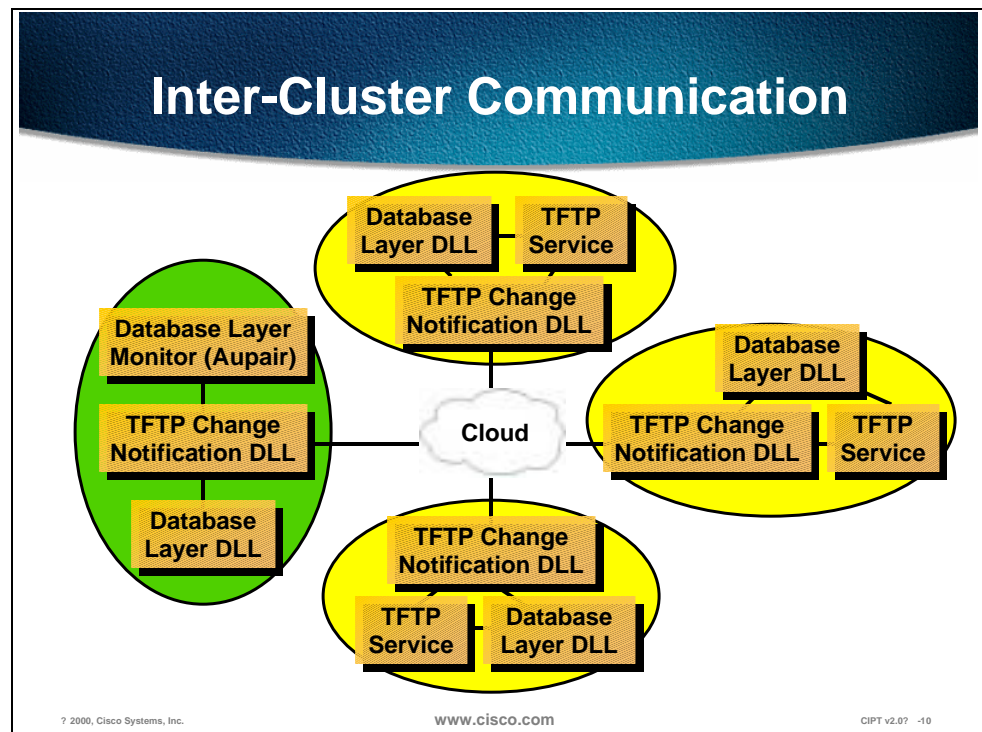

The Cisco TFTP Change Notification DLL must exist on both the database server and where the Cisco TFTP server exists. The Change Notification DLL provides call-backs to the Database Monitor. Notifications are sent from the database server node to the TFTP server node using UDP. The TFTP server node receives the notification on a port specified in the database.

Device and Cisco CallManager changes are sent to all the TFTP servers immediately. Non-enterprise wide process configuration changes are debounced then sent to that particular server. Debouncing means if several changes of the same type occur in a specified amount of time the notification is delayed until changes stop occurring for that period.

Enterprise wide process configuration change, device pool changes, and call manager group changes are debounced in a similar way but notifications are sent to all TFTP servers.

Installation and Configuration

The standard install CD is used to install or reinstall the Cisco TFTP service. Make sure the TFTP check box is selected. This copies the files to the system (*ctftp.exe*, *tftpservermon.dll*, and *CtftpChangeNotify.dll*). This installs the database servers and clients, such as, the service *ctftp.exe*, and PerfMon for TFTP (add registry entries and *lodctr tftpservermon.ini*).

Most of the configuration is provided by the install defaults. It is recommended to use DNS names for your Cisco CallManager server names unless in a laboratory environment. Devices must be pointed at the TFTP server using option 150 in a DHCP server. The Trace options are configurable and the levels and output receptacles can be individually selected.

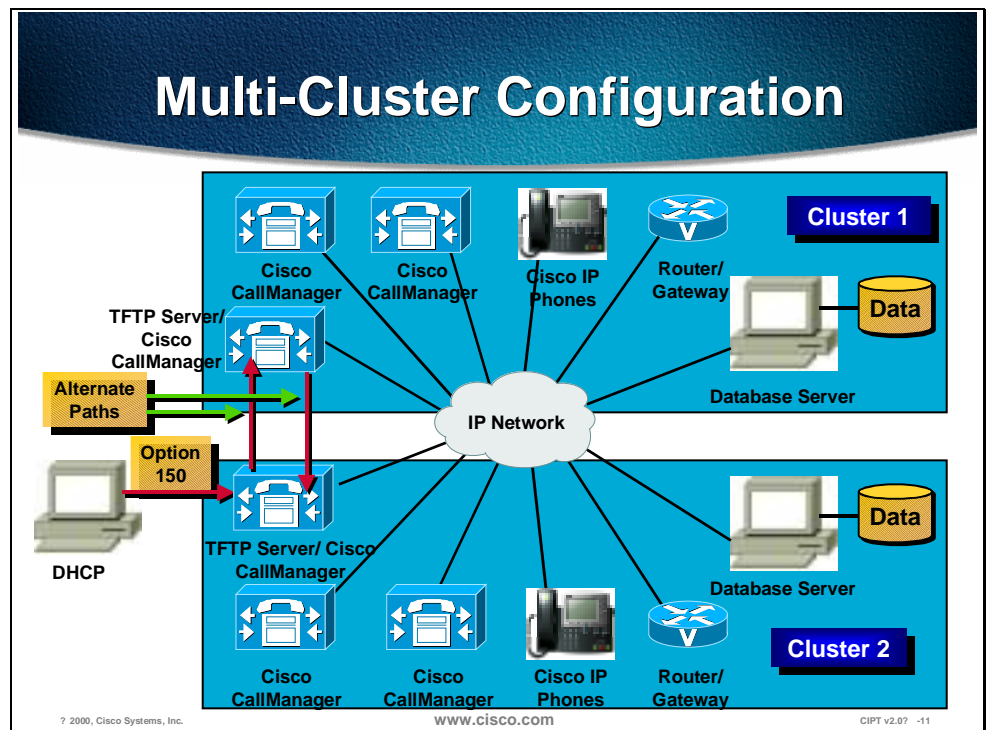

Every Cisco CallManager could have its own Cisco CallManager group and that Cisco CallManager will be the primary Cisco CallManager. Then assign devices to the appropriate Cisco CallManager group using device pools based on network topology.

Specify alternate paths if multiple clusters are trying to share configuration files. Disable file deletion if multiple cluster's TFTP servers are sharing a single network drive. A single Cisco TFTP server in a cluster builds all the device configuration files, and a DHCP server can only point to one TFTP server for a scope. Within seven minutes, 10,000 telephones should transfer. Server installation and device pool configuration will be covered in detail later in this course.

Monitoring and Troubleshooting

Monitoring and Troubleshooting

- Phones will not boot if Cisco TFTP is down
- Devices will persistently store their configuration and executable so they will operate even if TFTP is down
- Version of the Cisco TFTP server found by right clicking on the *ctftp.exe* file in the bin directory

© 2000, Cisco Systems, Inc.

www.cisco.com

CIPT v2.07 -13

It is a common misconception that if Cisco TFTP is down, the phones will not boot. Devices will persistently store their configuration and executable so they will operate even if TFTP is down. The version of the Cisco TFTP can be helpful when monitoring and troubleshooting Cisco TFTP. The version of the Cisco TFTP server can be found by right clicking on the *ctftp.exe* file in the bin directory.

What Are Your Tools?

- **PerfMon**
- **EventLog**
- **CiscoWorks 2000**
- **Local log files**
- **Trace File**

© 2000, Cisco Systems, Inc.

www.cisco.com

CIPT v2.0—6-13

The tools for monitoring and troubleshooting Cisco TFTP are listed below in order of the priority line of defense:

- **Performance Monitoring (PerfMon)**
 - First line of defense and to open go to Start>Programs>Administrative Tools>Performance.
 - If all counters are zero, the service is stopped.
- **EventLog**
 - Second line of defense and to open go to Start>Programs>Administrative Tools>Event Viewer>Application Log.
 - Even if a service (including TFTP) cannot read the database (where it gets trace configuration), it will add errors to the event log. This is the only place this kind of error will appear.
- **CiscoWorks**
 - Great for getting an enterprise wide view.
 - Receives events similar to event log with some differences.
- **Local log files**
 - Provide the greatest level of detail.
 - Often times the files will only be understood by development engineers.
- **Trace File** is enabled through Cisco CallManager Administration and user masks are turned on and the trace is written to a file at the path of; My Computer>Program Files>Cisco>Trace>CCM.

PerfMon Keys

1. **HeartBeat**
2. **TotalTftpRequests**
3. **TotalTftpRequestsLocal**
4. **Non-zero TotalTftpRequestsNotFound**
5. **Non-zero TotalTftpRequestsAborted**
6. **TotalTftpRequestsOverflow**
7. **TotalTftpRequestsLocal**
8. **TotalSegmentsSent and TotalSegmentsAcknowledgeds**

© 1999, Cisco Systems, Inc.

www.cisco.com

CIPT—Chapter 8-14

PerfMon is the first line of defense for monitoring and troubleshooting the PerfMon Keys are defined below:

1. **HeartBeat** should increase once a second.
2. **TotalTftpRequests** increment twice per 7960 boot (.cnf and ring list) and if the phone is requesting a custom ring the increment will be three per 7960 boot.
3. **TotalTftpRequestsLocal** increment twice per 7960 boot (.cnf and ring list).
4. **Non-zero TotalTftpRequestsNotFound** represents a problem (if not auto registering).
5. **Non-zero TotalTftpRequestsAborted** represents a problem.
6. **TotalTftpRequestsOverflow** implies the maximum simultaneous requests was exceeded. That is not necessarily a problem.
7. If only **TotalTftpRequestsOverflow** is going up and **TotalTftpRequestsLocal** is not going up for more than a minute, there is a problem.
8. Lots of **TotalSegmentsSent** without **TotalSegmentsAcknowledgeds** may imply the device has not got back to us.

EventLog

- **Clutter can make it more difficult to use**
- **Source is Cisco TFTP**
- **Configure the event level for 幩 otice or higher**
- **Cisco TFTP may put entries in the EventLog on boot until the database is up and running**

© 2000, Cisco Systems, Inc.

www.cisco.com

CIPT v2.0? -15

The EventLog is the second line of defense for monitoring and troubleshooting Cisco TFTP. The source of the EventLog is Cisco TFTP. Because of clutter in the output from EventLog, it can be more difficult to use. If this is making testing difficult, configure the event level for “Notice” or higher. Cisco TFTP may put entries in the EventLog on boot until the database is up and running.

Cisco Works 2000

- **Great for getting an enterprise wide view**
- **Receives events similar to EventLog with three differences**
 - **If Cisco TFTP cannot talk to the database, it cannot send trace to Cisco Works**
 - **If your are having trouble with the network, the log messages must travel across the network**
 - **CiscoWorks2000 is an optional component**

© 2000, Cisco Systems, Inc.

www.cisco.com

CIPT v2.07 -16

CiscoWorks 2000 is a great way to get an enterprise wide view of a Cisco IP telephony network. The CiscoWorks 2000 receives similar EventLog events with the following three differences:

- If the Cisco TFTP cannot talk to the database, it cannot send a trace to CiscoWorks2000.
- If you are having trouble with the network, the log messages must travel across the network.
- CiscoWorks2000 is an optional component.

Common Management Framework

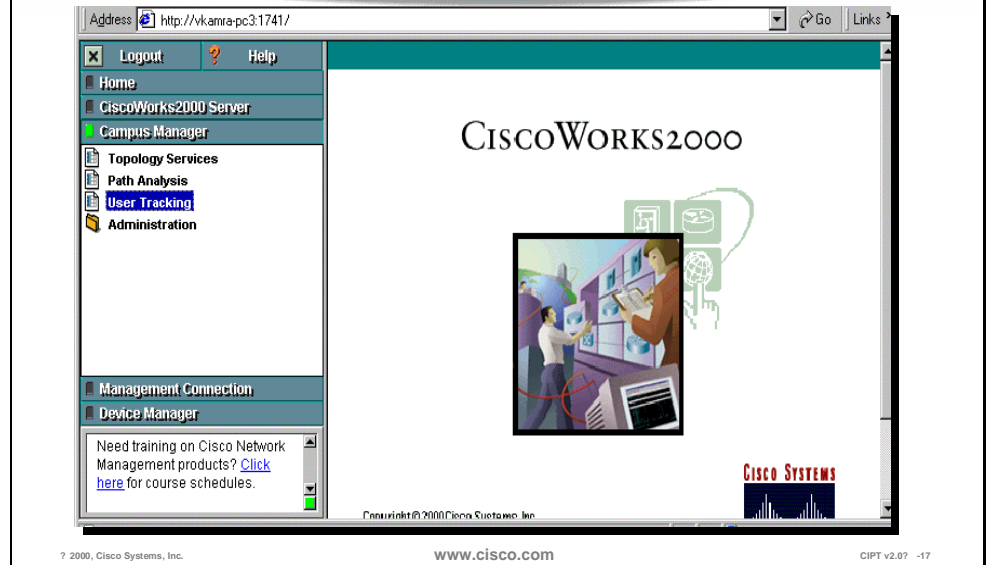

The CiscoWorks2000 family provides solutions targeted at the wide-area and local-area operations of enterprise networks. Cisco now offers two major solutions; the first, the CiscoWorks2000 LAN Management Solution, manages the local-area network (LAN) and features new, web-based applications for advanced management of the award-winning Catalyst® multilayer product line. The second, the Routed WAN Management Solution, provides wide-area network (WAN) monitoring, traffic management, and access control, as well as applications to administer the routed infrastructure of a wide range of multiservice networks built on a Cisco device foundation. CiscoWorks2000 solutions allow you the flexibility to deploy end-to-end network management when and where it is needed. The CiscoWorks2000 Management Connection, an integration tool, allows Cisco, third party, or user-developed Web-based tools to be integrated into a web desktop. This web-based management intranet simplifies accessibility and deployment of CiscoWorks2000 solutions. In addition, Cisco offers the User Registration Tool (URT) and CiscoWorks2000 Voice Manager as advanced applications which complement the CiscoWorks2000 solution bundles. The CiscoWorks2000 family includes the following:

- Routed WAN Management solution that includes:
 - Access Control List Manager
 - Internetwork Performance Monitor
 - CiscoView
 - TrafficDirector
 - Resource Manager Essentials

- LAN Management solution that includes:
 - Resource Manager Essentials
 - CiscoView
 - TrafficDirector
- User Registration Tool
- CiscoWorks2000 Voice Manager
- Cisco QoS Policy Manager
- CiscoWorks for Windows
- CiscoView
- Campus Bundle for AIX/HP-UX

Local Log Files

- **IP address or device name can be used to find the occurrence of the request or the disposition of that request**
- **Device name can be tracked**
- **Device pool and model can be tracked**
- **C++ class and routine name are included with most trace lines**

© 2000, Cisco Systems, Inc.

www.cisco.com

CIPT v2.0? -18

The local log files provide the greatest level of detail and often times the files will only be understood by the development engineer.

The IP address or the device name can be used to find the occurrence of the request or the disposition of that request. That device name can be tracked back to the building of the file, which shows the device pool and model. The device pool and model can be tracked back to the building of the configuration file prototype, which will list the network address of the CallManagers and the TCP connection port.

C++ class and routine name are included with most trace lines. Most routines associated with the serving of a particular request, include the *thread id* in a standard format.

Cisco Messaging Interface

This section describes the Cisco messaging interface.

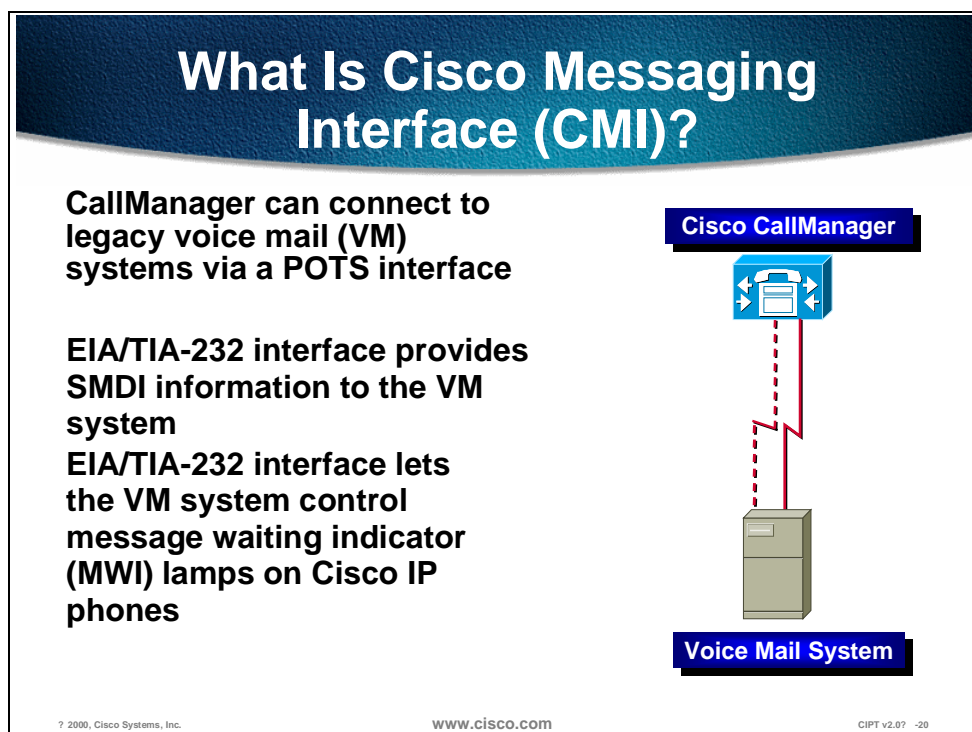

Third party voice mail machines traditionally link to PBXs via ordinary POTS lines. Cisco CallManager supports this mode of operation. Normally this involves two types of calls to the VM system:

1. Direct calls from users wanting to check their messages.
2. Calls that were forwarded from stations that were busy or did not answer.

With just a POTS connection, the voice mail system won't know anything about the source or destination of an incoming call. In this unintelligent mode, callers have to use their DTMF keypads to tell the VM system who they are attempting to reach or what mailbox they would like to access. *This is bad.*

Fortunately, the Nobel Prize winning team of researchers at Bellcore were able to come up with a solution to this problem. Bellcore Technical Reference TR-NWT-000283 released in 1991 details a specification called the Simplified Message Desk Interface (SMDI).

SMDI defines a way for a PBX or other phone system to give VM systems all the information they need to intelligently process incoming calls. Every time the PBX routes a call over the POTS interface, it sends an EIA/TIA-232 message to the VM system that tells it: the POTS line it is using, the type of call it is forwarding, and information about the source and destination of the call.

In addition, the VM system can supply the PBX with messages used to turn message waiting indicators on and off. Each of these EIA/TIA-232 messages are

sent over the same interface. CallManager responds by turning the given lamp on or off.

Routed to Voice Mail (VM) System

Message Waiting Indicator (MWI)
Or
Messages Button (Cisco IP 7960)

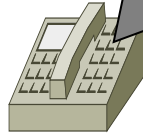

© 2000, Cisco Systems, Inc.

www.cisco.com

CIPT v2.0? -21

Pressing the MWI button on a Cisco IP phone (12 SP+ or 30 VIP), or the Messages button on a Cisco IP phone 7960 results in a call being routed to the voice mail system. While this operation is part of the big picture surrounding CMI, it actually has nothing to do with CMI. It is simply a feature of CallManager that is assigned in the keypad and with directory numbers of the voice mail system.

Installing and Configuring



The actual installation process for CMI is simply a matter of selecting the check box in the master installation program. This takes care of copying the CMI executable to the server in question, installing it as a Windows 2000 NT service and registering its performance monitor counters.

Windows 2000 NT Service Manager

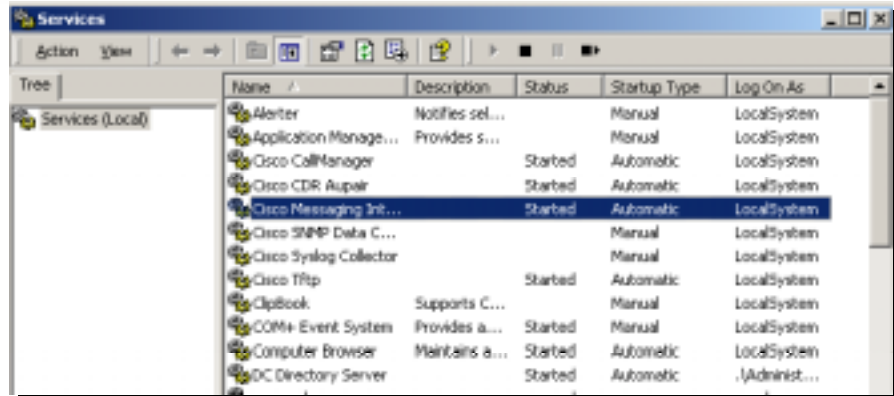

© 2000, Cisco Systems, Inc.

www.cisco.com

CIPT v2.07 -23

After Installation of CMI, you can verify that it is up and running after the server has restarted. To do this:

- Invoke the Windows 2000 Services Manager, and look for the service. It should be *Started*.
- To open Services go to **Start>Programs>Administrative Tools>Services**.
- If the Cisco Messaging Interface is not showing “Started”, right click on Cisco Messaging Interface (as shown above).
- Select **start**.
- To change Startup Type, **right click on the Cisco Messaging Interface**
- Select properties and select the **Startup Type** of Automatic, Manual or Disable.

Configuring Hardware

Configuring the Hardware

Route a group of POTS ports to the VM system. This can be done with an AS-X or VG-200. At this time H.323 interfaces are *NOT* supported.

The diagram illustrates the connection between Cisco CallManager and a Voice Mail System. On the left is the Cisco CallManager icon, a blue box with a white telephone handset and arrows. On the right is the Voice Mail System icon, a grey rectangular box. A dashed red line with a zigzag break in the middle connects the two boxes, representing a network connection.

© 2000, Cisco Systems, Inc. www.cisco.com CIPT v2.07 -24

Connecting to the voice mail system can be done with any sort of POTS port(s). In order to work properly with CMI, control of the POTS ports needs to be accomplished with either the skinny protocol or MGCP. (H.323 devices don't identify the specific line being used from a group of ports, which means CMI can't tell the VM system which port is being used for an incoming call.)

Configuring the Hardware

Configure the group of ports as a Route Group, **NOT** as individual DNs.

Add a New Part	
Part 1	Add DN
Part 2	Add DN
Part 3	Add DN
Part 4	Add DN
Part 5	Add DN
Part 6	Add DN
Part 7	Add DN
Part 8	Add DN

Cisco AS-B Gateway: SAACBA987654321

Status: Update completed. Reset the gateway to have the changes take effect.

MAC Address*: CBA387654321

Description: SAACBA987654321

Device Pool*: Default

© 2000, Cisco Systems, Inc.

www.cisco.com

CIPT v2.0? -25

Due to internal characteristics of Cisco CallManager's call handling, a group of ports being used with CMI must be configured as a route group. After defining the gateway (analog), add ports, but don't define DNs for any of the ports.

A common assumption at this point would be to create a range of DNs for Call Forward and Busy through the group. This will **NOT** work!

Configuring the Hardware

Configure the group of ports as a Route Group, **NOT** as individual DNs.

The screenshot shows the 'Route Group Configuration' window. On the left, a tree view shows 'VMGroup' expanded to show 'SAACBASE7E54321' with a sub-entry 'on all ports'. The main area displays 'Route Group Name : VMGroup' and 'Status: Insert completed'. Below this are buttons for 'New', 'Update', 'Delete', and 'Cancel'. A text field contains 'VMGroup'. Below that are 'Add Device' and 'Remove Device' buttons. At the bottom, a table titled 'Devices for VMGroup' has columns for 'Device', 'Port', and 'Order'. The table contains one entry: SAACBASE7E54321, All, and a dropdown arrow.

Device	Port	Order
<input type="checkbox"/> SAACBASE7E54321	All	1

© 2000, Cisco Systems, Inc.

WWW.CISCO.COM

CIPT v2.07 -26

Once the ports are defined, create a route group that uses all the ports, then a route list that contains the group. The final step is to create a route pattern that creates a DN that is routed to that list.

By selecting the device from the left column and entering the route group name and updating, the device has been assigned to the route group.

That route pattern number is then the DN for your voice mail system.

Connect the EIA/TIA-232 Ports

Check VM Specs for choice of normal or null modem cable.

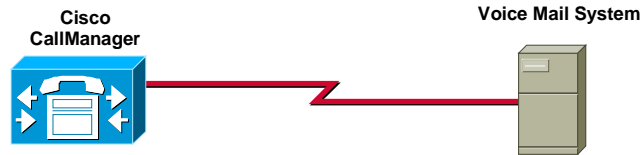

© 2000, Cisco Systems, Inc.

www.cisco.com

CIPT v2.0? -27

When connecting serial ports between two different PCs, normally a null modem cable is needed. If the VM machine runs on a PC platform, that is what should be used. If the VM system is running on proprietary hardware, consult the manufacturer's documentation for details on what sort of cable to use.

When using a good breakout box, verify cabling setup by ensuring that valid EIA/TIA-232 levels are present on pins 2 and 3 of either a 9-pin or 25-pin connector.

Configuring Software

Configuring the Software MI

Use the Cisco CallManagerAdmin web page to create the service parameters on the appropriate server

Param

Type

Value

Configured Service Parameters ServiceWide

BackupCallManagerName

BaudRate

CallManagerName

© 2000, Cisco Systems, Inc.www.cisco.comCIPT v2.07 -28

On the Admin web page, pull down the Services menu item and select *Cisco Messaging Interface*. (Create a new service if necessary at this point.) This brings up the service parameters page. These service parameters contain all the information used to actually configure the CMI service. Understanding the values used for these parameters is all that is needed to get CMI working properly.

The Voice Mail Number

- **CallManagerName**
- **BackupCallManagerName**
- **VoiceMailDN**
- **VoiceMailPartition**
- **RouteFilter**
- **DialingPlan**

© 2000, Cisco Systems, Inc.

www.cisco.com

CIPT v2.0? -29

In order to work properly, CMI has to intercept all calls that are routed to the VM system. Doing this requires the assistance of a Cisco CallManager, as well as a description of the VM directory number.

CMI actually has the names of two Cisco CallManagers: a primary and a backup. If the primary goes down for any reason, CMI will use the backup to intercept calls to the VM box.

Intercepting calls to the VM requires the DN of the route pattern for the voice mail ports, as well as the partition, router filter, and dialing plan for the route filter.

All of these parameters found in the drop down menu Param need to be entered manually—none of them are done automatically. When the Service Parameter is configured it will show up in the Configured Service Parameters drop down menu.

The Serial Port

- **SerialPort (COM1)**
- **BaudRate (9600)**
- **Parity (Even)**
- **DataBits (7)**
- **StopBits (1)**

© 2000, Cisco Systems, Inc.

www.cisco.com

CIPT v2.07 -30

These parameters are used to configure the serial port that CMI uses to communicate with the voice mailbox. Each of them has a default value, which is shown above. The COM port being used will be determined by the server hardware. The communication parameters will probably be determined by the VM system hardware. The default values match those given in the SMDI specification, but many systems will elect to user higher baud rates.

Note These settings are the most commonly used, but be sure the check all settings.

Number Formatting

- **OutputDnFormat (%010s)**
- **OutputExternalFormat (%010s)**
- **prefix%ns 澹 xample: 972%4s**

© 2000, Cisco Systems, Inc.

www.cisco.com

CIPT v2.0? -31

These parameters are used to format the directory numbers sent to the voice mail machine. These formats are used to convert our Directory Numbers (DNs) to mailbox numbers.

The formatting string is passed to a C function called *sprintf()*. This function has a huge variety of things it can do with a directory number in order to convert it to a mailbox number, but we generally will only use it to do two things: determine the width of the output string; and pre-pend a prefix to the mailbox number.

Based on the North American Numbering Plan (NANP), the formatting string by default is “%10s,” which tells CMI to format the DN into a field 10 characters wide, padded with spaces. Change the “10” to any other numeric value will change the width of the field to the designated value. The width applied here doesn’t include the characters in the prefix.

If you want your VM machine to pad DN’s with ‘0’s instead of spaces, you modify the numeric value to have a leading 0, like this: “%010s.”

Finally, any characters you place ahead of the percent character will just be prepended to the string. In the example shown above, a DN of 1234 would be formatted as 9721234.

Most numbers passed to the VM are formatted using *OutputDnFormat*. However, calling party DN’s that are seven digits or longer are formatted using *OutputExternalFormat*. Why? This allows you to protect a VM against foolishness caused by outside lines. Many voice mail machines keep track of who the calling party is on a given call. This allows the owner of a mailbox to return calls or send response messages. But we have found that some VM’s get confused when Caller ID gives them an outside number that looks as if it might have come from the inside. In those cases, changing *OutputExternalFormat* to something like “0” can often be enough to fix the problem.

Number Input

InputDnSignificantDigits (10)

Example:

If InputDnSignificantDigits is set to 4

A mailbox number of 9721234 is
converted to a DN of 1234

© 2000, Cisco Systems, Inc.

www.cisco.com

CIPT v2.07 -32

This parameter is another one designed to accommodate the differences between VM mailbox numbers and DNs. If a Legacy VM machine has mailboxes that are longer than the DNs on the system, this parameter can be used to strip the most significant digits. The numeric value of this parameter indicates how many digits should be used.

Note There is no provision for stripping digits other than leading ones.

MWI Search Space

MwiSearchSpace

- Tells CMI what partitions the VM users are in
- Example:
PartitionA:Managers:PartitionB

© 2000, Cisco Systems, Inc.

www.cisco.com

CIPT v2.0? -33

VM machines can use the SMDI interface to turn MWI lamps on and off. However, the interface definition only provides the ability to pass a single numeric mailbox number as a parameter.

Under CM, stations are defined not only by their DN, but also by their partition. So turning on a lamp might require a partition as well as a station. This argument tells CMI where VM users can be found.

Cisco CallManager Parameter

VoiceMail

This parameter tells CM what DN to call when the MWI button is pressed

© 2000, Cisco Systems, Inc.

www.cisco.com

CIPT v2.07 -34

Although this CM parameter isn't actually part of CMI, it has a direct effect on VM users. Normally, when the VM turns on the MWI lamp on a phone, the user will simply press the button to call the VM and begin listening to messages.

When the user presses the MWI button, CM looks at its service parameter called VoiceMail to determine where to route the call. This parameter needs to be set up in each CM that is supporting VM users.

Monitoring and Troubleshooting

Normal Operations

- Verify that CMI is running using the Windows 2000 NT Service Manager
- Monitor with Performance Monitor



© 2000, Cisco Systems, Inc.

www.cisco.com

CIPT v2.07 -35

Regardless of whether anything is happening, it is always possible to verify that CMI is at least functional by looking at the Heartbeat. This performance monitor counter should be incrementing once a second as long as CMI is running.

The inbound and outbound message counts are a way to track the number of messages that have been sent and received between the CM and VM since the service was started. Perhaps a better way to track the activity of CMI is with the 24-hour rolling count.

To get to Performance Monitor go to Start>Programs>Administrative Tools>Performance.

View EventLog Application

Check serial port
Check VoiceMailDN
Trace 彙 normally set to ERROR
For more info, set to DETAILED
View files:
CSUMI*.TXT



© 2000, Cisco Systems, Inc.

www.cisco.com

CIPT v2.07 -36

Most serious errors in the operation of CMI will be reflected with an error message in the application event log. If the CMI is not working at all, this should be the first place to go.

The two most common problems that keep CMI from working are the failure to open the serial port, and problems intercepting the voice mail DN.

Cisco IP Voice Media Streaming Application

This section describes the Cisco IP Voice Media Streaming application.

What Is the Media Application?

- **Combines the MTP and conference bridge functionality into one Windows 2000 NT service and device driver**
- **Adds conference bridge support to a CallManager**
- **Adds media termination point support to a CallManager**

? 2000, Cisco Systems, Inc. www.cisco.com CIPT v2.07 -39

The Cisco IP Voice Media Streaming Application runs as an NT service (*ipvmsapp.exe*). The service is responsible for forwarding the Cisco CallManager messages to the driver and for device recovery.

The device driver runs as a non-plug and play kernel mode driver (*ipvms.sys*) and does all of the RTP streaming.

The Cisco IP Voice Media Streaming application adds software conference bridge and media termination support for Cisco CallManager.

Only G.711 μ -law and a-law streams are supported.

Software Architecture

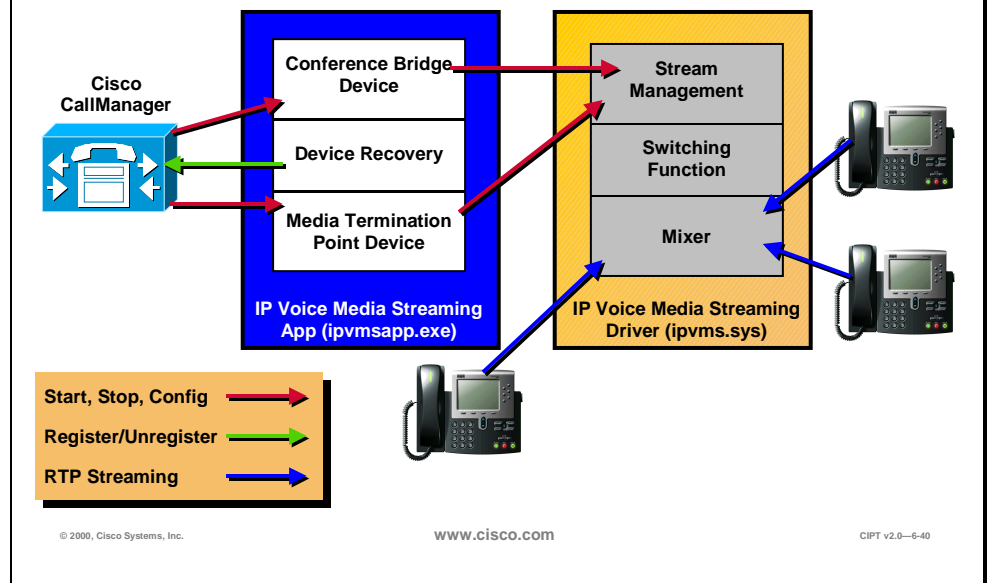

Support DLLs are used and defined below:

- IpVMChangeNotify.dll is used to receive database change notifications.
- MediaAppPerfMon.dll is used to interface with the performance monitor counters. *Mtl70mt.dll* a support DLL is also needed.

The device recovery supports up to three Cisco CallManagers. This list is read from the device pool assigned to the device.

The physical filenames are the following:

- *Ipvmsapp.exe*—service
- *Ipvms.sys*—device driver
- *IpVMChangeNotify.dll*—handles change notification (database changes)
- *MediaAppPerfMon.dll*—performance monitor manager
- *Mtl70mt.dll*—support DLL

Installation and Configuration

Installation

- **To Install Media Application use the install CD making sure the Cisco IP Voice Media Streaming application is selected**
- **The MTP and conference devices will automatically be added into the database**
- **To manually install the service/driver use the following command *ipvmsapp* 慢 *ervice***
- **This will install the Media application, but there will be no perfmon support**

© 2000, Cisco Systems, Inc.www.cisco.comCIPT v2.07 -41

Installation of the Cisco IP Voice Media Stream application can be done automatically or manually. To install automatically use the install CD and be sure to select the Cisco IP Voice Media Streaming application that is under Optional Components. When the install CD is used the MTP and conference devices are automatically added into the database.

To manually install the service/driver use the following command **ipvmsapp - Service**. This command will install the Media application. The MTP and conference bridge devices must be added using the Cisco CallManager Administration tool.

The normal place that the *ipvmsapp.exe* is located is in the *\program files\cisco\bin* directory. The commands must be run from a DOS box and in the directory where the program is located.

Adding a MTP Device

The screenshot shows the Cisco CallManager Administration interface. At the top, there is a navigation menu with options: System, Route Plan, Service, Feature, Device, User, Application, and Help. Below the menu is the Cisco CallManager Administration logo and the Cisco Systems logo. The main heading is "Media Termination Point Configuration".

On the left side, there is a box labeled "No Media Termination Point Devices". On the right side, there is a form for configuring a new device. The form includes the following fields:

- Current Device: New (Status: Ready)
- Insert (button) Cancel (button)
- Device Name*: MTP1
- Device Description: Media Termination Point
- Device Pool*: Default
- Server Name*: DLS2-CM117-CM2
- Full Duplex Streaming Endpoint Count*: 48
- Orphan Stream Time Out(sec)*: 300
- Run Flag*: True

A note at the bottom of the form states: "* indicates required item".

At the bottom of the page, there is a footer with the text: "© 2000, Cisco Systems, Inc. www.cisco.com CIPT v2.0? -42".

The installation program will automatically add this device, add only if installing the Media application manually.

The following are the required inputs:

- Device Name—used for documentation and identity
- Device Pool—logical grouping
- Server Name—name of the Cisco CallManger or server MTP is running on
- Endpoint count—divided by two by the CallManager because there are always at least two end points per MTP call
- Orphan Stream Timeout—the number of seconds that the active calls continue streaming after a connection is lost with a CallManager
- Run Flag—allows the MTP functionality to be disabled without removing the device

After adding the device it will then show up in the left box.

Adding a Conference Bridge Device

The screenshot shows the Cisco CallManager Administration interface. At the top, there is a navigation menu with links: System, Route Plan, Service, Feature, Device, User, Application, and Help. Below the menu is the Cisco CallManager Administration logo and the Cisco Systems logo. The main heading is "Conference Bridge Configuration". To the right of the heading are two links: "Conference Bridge Parameters" and "Meet Me Number/Pattern Configuration".

On the left side, there is a box labeled "No Conference Bridge Devices". In the center, there is a section titled "Current Device: New" with a status of "Ready". Below this are two buttons: "Insert" and "Cancel".

The configuration fields are as follows:

Model Type*	Software
Device Name*	CFB1
Device Description	Conference Bridge
Device Pool*	Default
Server Name*	DLS2-CM117-CM2
Full Duplex Streaming Endpoint Count*	48
Orphan Stream Time Out(sec)*	300
Run Flag*	True

* indicates required item

At the bottom of the page, there is a footer with the text: "© 2000, Cisco Systems, Inc. www.cisco.com CIPT v2.07 -43"

The installation program will automatically add this device. Only add it by installing the Media application manually.

The Cisco CallManager divides the endpoint count by three because there are always at least three end points per conference bridge call.

Orphan Stream Timeout is the number of seconds that the active calls continue streaming after a connection is lost with a Cisco CallManager.

Run Flag allows the conference bridge functionality to be disabled without removing the device. Be aware of the conference bridge parameters selection.

Setting Ad Hoc/Meet Me Parameters

The screenshot displays the Cisco CallManager Administration web interface. At the top, there is a navigation menu with options: System, Route Plan, Service, Feature, Device, User, Application, and Help. Below the menu is the Cisco CallManager Administration logo and the Cisco Systems logo. The main heading is "Conference Bridge Parameters" with a sub-heading "Conference Bridge Configuration" and a link "Meet Me Number/Pattern Configuration". The current device pool is "Default" with a status of "Ready". There is an "Update" button. Below this is a section titled "Cisco CallManagers in Device Pool" with a dropdown menu for "Device Pool" set to "Default". A table lists the CallManagers in the pool, with "CMT1" selected. To the right of the table are two input fields: "Max. # of users in one Ad Hoc Conference" with a value of "4" and "Max. # of users in one Meet Me Conference using Unicast" with a value of "10". At the bottom of the page, there is a copyright notice "© 2000, Cisco Systems, Inc.", the website "WWW.CISCO.COM", and a document ID "C1PT v2.02 -44".

To get to this screen select the Conference Bridge Parameters option from the Conference Bridge Configuration screen.

On this screen, select the device pool, then for each Cisco CallManager that is defined in the device pool, set the Ad Hoc and Meet Me parameters.

Voice summing occurs in software on the server and only three voices can be heard simultaneously.

Monitoring and Troubleshooting

Monitoring and Troubleshooting Tools

- **Performance Monitor**
- **Event log**
- **Windows 2000 Service Manager**
- **Cisco CallManager trace**

If a hardware transcoding application or conference bridge is registered with the same Cisco CallManager as the Media application then the Media application device is disabled. If the hardware resource un-registers or is shut down the Media application resources will be unavailable until the devices are reset.

© 2000, Cisco Systems, Inc.www.cisco.comCIPT v2.07 -45

The monitoring and trouble shooting tools for the Cisco IP Voice Media Streaming application are from the Windows 2000 server and Cisco CallManager. The following are the tools used to monitor and troubleshoot:

- Performance monitor—used to see if the Cisco CallManager has the Cisco IP Voice Media Application resources available for use.
- Event log—used to see any Cisco IP Voice Media Streaming application entries.
- Windows 2000 Service Manager—used to verify that the Cisco IP Voice Media Streaming application service and device driver are running.
- Cisco CallManager Trace—is used to see what the Cisco CallManager thinks is happening.

If hardware transcoding application or conference bridge is registered with the same Cisco CallManager as the Cisco IP Voice Media Streaming application, then the Media application is disabled. If the hardware resource un-registers or is shut down the Media application resources will be unavailable until the devices are reset.

Viewing Performance Monitor Counters

Counter Name	Value
CallManagerHeartBeat	0.000
CallActive	0.000
CallSetCompleted	0.000
CallSetCompleted	0.000
CallSetProgress	0.000
LicenseRevalidation	0.000
MediaTermPointsActive	0.000
MediaTermPointsAvailable	24.000
MediaTermPointsUsedResources	0.000
MultiCastConferenceActive	0.000
MultiCastConferenceCompleted	0.000
MultiCastActiveConfParticipants	0.000
MultiCastAvailableConferences	0.000
MultiCastOutOfResources	0.000
RegisteredAnalogUsers	0.000
RegisteredDigitalUsers	0.000
RegisteredPSTNGateway	0.000
RegisteredPhones	0.000
UnicastActiveConfParticipants	0.000
UnicastAvailableConferences	24.000
UnicastConferenceActive	0.000
UnicastConferenceCompleted	0.000
UnicastOutOfResources	0.000

© 2000, Cisco Systems, Inc.

www.cisco.com

CIPT v2.07 -46

This screen shows all of the Cisco CallManager performance counters. To monitor and troubleshoot for the Cisco IP Voice Media Streaming application the counters that help are:

- MediaTermPointsAvailable
- UnicastAvailableConferences

These two counters identify whether the Cisco IP Voice Media application resources (devices) are registered with the Cisco CallManager.

The other counters on this list identify MTP and conference bridge resources being used and completed.

Viewing Event Log Entries

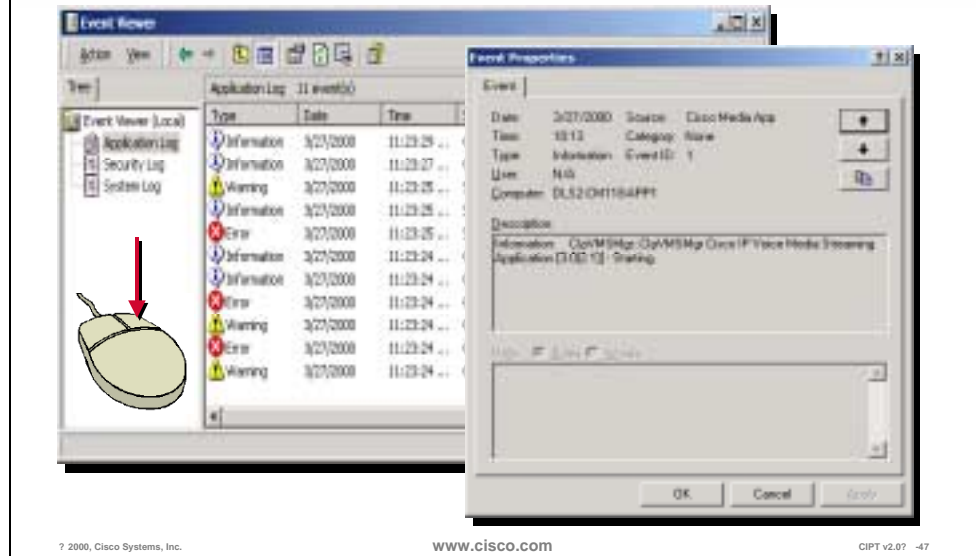

Event log is a monitoring and troubleshooting tool of the Windows 2000 server and can provide details about events related to the Cisco IP Voice Media Streaming application.

To open it go to Start>Programs>Administrative Tools>Event Viewer>Application Log. Right click on an event and select properties to get an expanded view of the event.

Verify Service Is Running

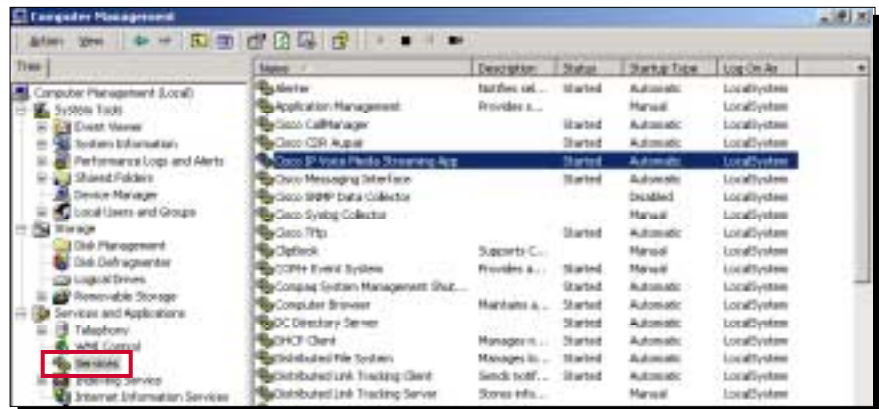

© 2000, Cisco Systems, Inc.

www.cisco.com

CIPT v2.07 -48

The Windows 2000 Service Manager is used to verify that the Cisco IP Media Streaming application service and driver are running.

To open it go to Start>Programs>Administrative Tools>Computer Management>Services.

Check if Device Driver Is Running

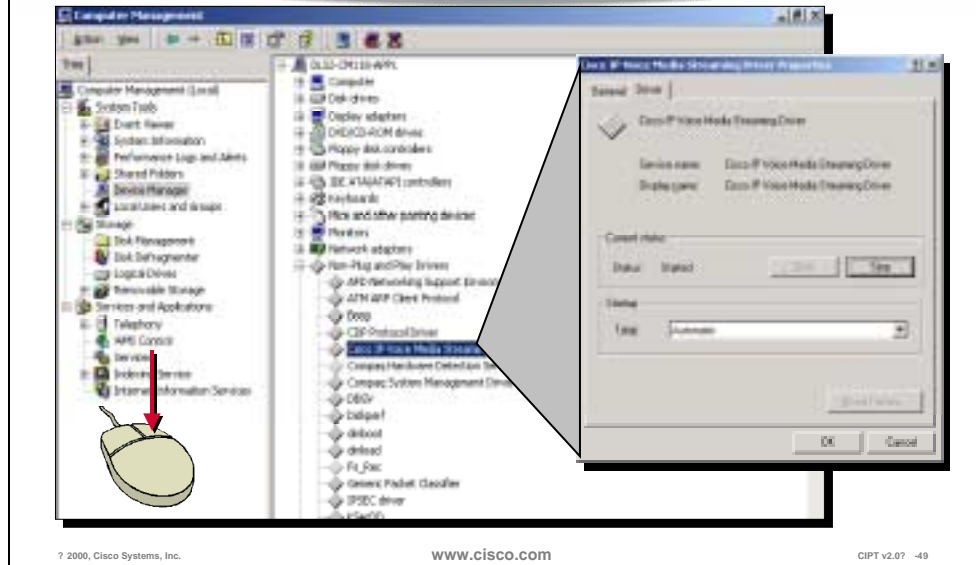

To open it go to Start>Programs>Administrative Tools>Computer Management> Device Manager>Non-Plug and Play Drivers. Right-click on the Cisco IP Voice Media Streaming application for a detailed view of the properties.

Cisco IP Voice Media Application Trace

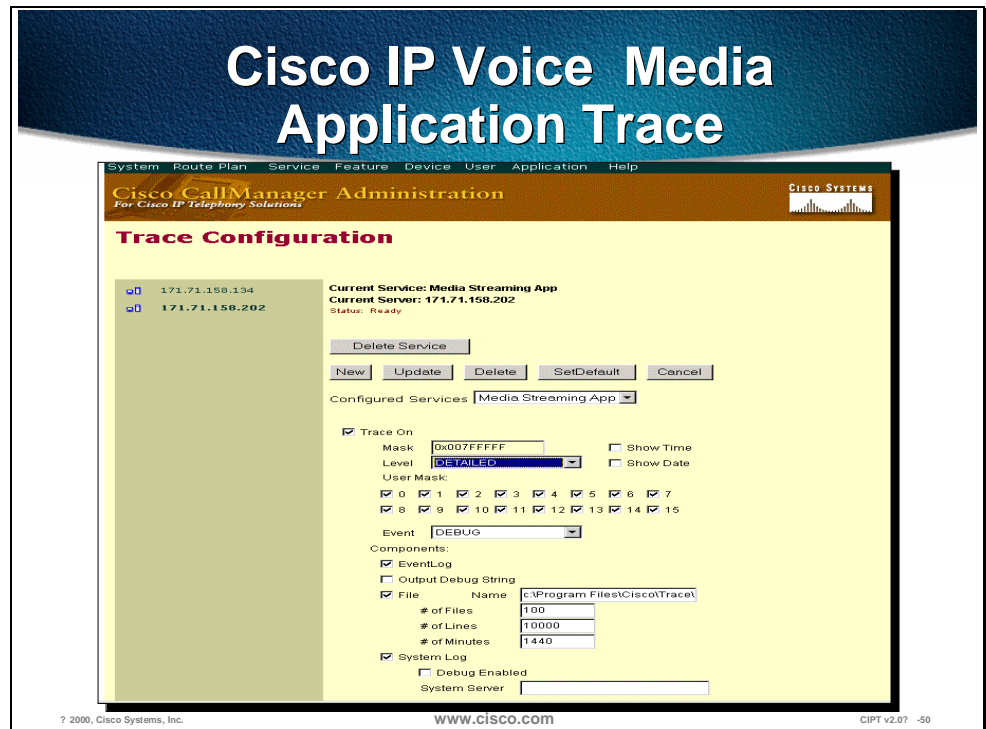

The detailed trace log tends to be a bit cluttered, but by reading it carefully it will usually highlight the source of any difficulties. In Cisco CallManager Administration go to the Service in the tool bar and select Trace from the drop down menu. Set the level to detailed with all mask bits turned on and make sure the EventLog check box is selected for entries to be placed into the event log. Select the file option and that a valid filename/path is entered. After making any changes the Update button must be selected for the changes to take affect.

The following page includes samples of trace log files.

Media App Startup and Database Configuration

Sample of Media App Startup

```
Cisco Media App| ClpVMSMgr::ClpVMSMgr Cisco IP Voice Media Streaming Application [ 3.0(2.1)] -  
Starting  
Cisco Media App| --> ClpVMSMgr::IsDriverPresent  
Cisco Media App| ClpVMSMgr::IsDriverPresent Driver is Present, IP Addr = 1122442412  
Cisco Media App| <--ClpVMSMgr::IsDriverPresent
```

Sample of database configuration parameters

```
Cisco Media App| --> ClpVMSMgr::ReadConfiguration  
Cisco Media App| ClpVMSMgr::ReadConfiguration MTP DeviceName = MTP_dls2-cm118-  
Cisco Media App| ClpVMSMgr::ReadConfiguration MTP ServerName[ 0] = dls2-cm118-app1, Port = 2000  
Cisco Media App| ClpVMSMgr::ReadConfiguration MTP Number of Calls = 48  
Cisco Media App| ClpVMSMgr::ReadConfiguration MTP Orphaned Stream Timeout (sec) = 300  
Cisco Media App| ClpVMSMgr::ReadConfiguration MTP Run Flag = 1  
Cisco Media App| ClpVMSMgr::ReadConfiguration CFB DeviceName = CFB_dls2-cm118-  
Cisco Media App| ClpVMSMgr::ReadConfiguration CFB ServerName[ 0] = dls2-cm118-app1, Port = 2000  
Cisco Media App| ClpVMSMgr::ReadConfiguration CFB Number of Parties = 48  
Cisco Media App| ClpVMSMgr::ReadConfiguration CFB Orphaned Stream Timeout (sec) = 300  
Cisco Media App| ClpVMSMgr::ReadConfiguration CFB Run Flag = 1  
Cisco Media App| <--ClpVMSMgr::ReadConfiguration
```

© 2000, Cisco Systems, Inc.

www.cisco.com

CIPT v2.07 -51

The above samples of the trace of Media App Startup and database configuration parameters are small snapshots of the entire trace and highlight the parts of the trace we are most concerned with when troubleshooting or gathering information for troubleshooting.

Unregistered/Registered Devices

Sample of Unregistered Devices

```
Cisco Media App| --> ClpVMSMgr::TimerCheck
Cisco Media App| ClpVMSMgr::TimerCheck One Second Check
Cisco Media App| ClpVMSMgr::TimerCheck Mtp CMgr[ 0] = ST_IDLE
Cisco Media App| ClpVMSMgr::TimerCheck Cfb CMgr[ 0] = ST_IDLE
Cisco Media App| <--ClpVMSMgr::TimerCheck
```

Sample of Registered Devices

```
Cisco Media App| --> ClpVMSMgr::TimerCheck
Cisco Media App| ClpVMSMgr::TimerCheck One Second Check
Cisco Media App| ClpVMSMgr::TimerCheck Mtp CMgr[ 0] = ST_REGISTERED
Cisco Media App| ClpVMSMgr::TimerCheck Cfb CMgr[ 0] = ST_REGISTERED
Cisco Media App| <--ClpVMSMgr::TimerCheck
```

The above samples of the trace of Unregistered Devices and Registered Devices are small snapshots of the entire trace and highlight the parts of the trace we are most concerned with when troubleshooting or gathering information for troubleshooting.

Summary

This section summarizes the concepts you learned in this chapter.

Summary

- **Cisco TFTP allows the devices to get information from the database without having to access it directly and allows the executables to be updated automatically.**
- **Cisco Messaging Interface allows Cisco CallManager to connect to third-party voice mail systems.**
- **Cisco IP Voice Media Streaming application supplies MTP/conference bridge resources to a CallManager.**

? 2000, Cisco Systems, Inc. www.cisco.com CIPT v2.07 -53

The Cisco Trivial File Transfer Protocol (Cisco TFTP) is a Windows NT 2000 service. The Cisco TFTP service builds configuration files from information found in the database. Cisco TFTP serves configuration, executable, and ringer files consistent with ITU RFC 1350. Cisco TFTP allows executables to be updated automatically.

The Cisco Messaging Interface allows Cisco CallManager to connect to third-party voice mail systems using the POTS interface with SMDI.

The Cisco IP Voice Media Streaming application supplies software MTP and conference bridge resources for a Cisco IP telephony solution. This can be used if there are no hardware MTP (transcoding)/conference resources in a CIPT solution.

Review Questions

Answer the following questions.

Review Questions

- 1. Why would I want more than one TFTP server in a cluster?**
- 2. Should the group of ports used for voice messaging be configured as directory numbers or a route group?**
- 3. If software and hardware MTP/conferencing are being used, which does Cisco CallManager prefer?**

© 2000, Cisco Systems, Inc. www.cisco.com CIPT v2.0? -54

- Q1) If the DHCP can only point to one Cisco TFTP Server, why would there be a need for more than one Cisco TFTP?
- Q2) When using Cisco Messaging Interface to connect to a third party voice mail and hardware is involved, should the group of ports used for voice messaging be configured as individual directory numbers or a route group?
- Q3) If a Cisco CallManager has the Cisco Voice Media Streaming application running for software MTP/conferencing and hardware transcoding/conferencing resources configured, which does the Cisco CallManager use, hardware or software?

Dial Plan Architecture

Overview

A dial plan is essentially the “front end” that allows users to dial one another. The goal of a successful dial plan is to provide diverse call routing and provide for ease of dialing for users. Often customers require abbreviated dialing as well as supporting redundant paths that are transparent to the calling party. The dial plan in Call Manager 3.0 is enhanced to allow for greater scalability, flexibility and ease of use. Tighter integration of Call Manger and IOS Gateways will allow for larger AVVID deployments.

This chapter includes the following topics:

- Objectives
- Dial Plan Architecture
- Special Dial String Considerations
- Configuring Dial Plan Groups and Calling Restrictions
- Campus and Dial Plan Guidelines and Considerations
- Summary
- Review Questions

Objectives

This section lists the chapter objectives.

Objectives

Upon completion of this chapter, you will be able to perform the following tasks:

- **Identify and describe the dial plan architecture**
- **Identify and follow design guidelines for dial plan architecture**
- **Identify special dial string considerations**
- **Configure dial plan groups and calling restrictions**

? 2000, Cisco Systems, Inc. www.cisco.com CIPT v2.0? -3

Upon completion of this chapter, you will be able to complete the following tasks:

- Given a list of components of the dial plan architecture, identify and describe the functional components of the dial plan architecture.
- Given a list of design guidelines for dial plan architecture, identify and construct a dial plan.
- Given a list of dial string considerations identify the special dial string considerations described in this chapter.
- Given a case study and calling characteristics, configure dial plan groups and calling restrictions.

Visual Objective

This section shows the visual objective of a dial plan.

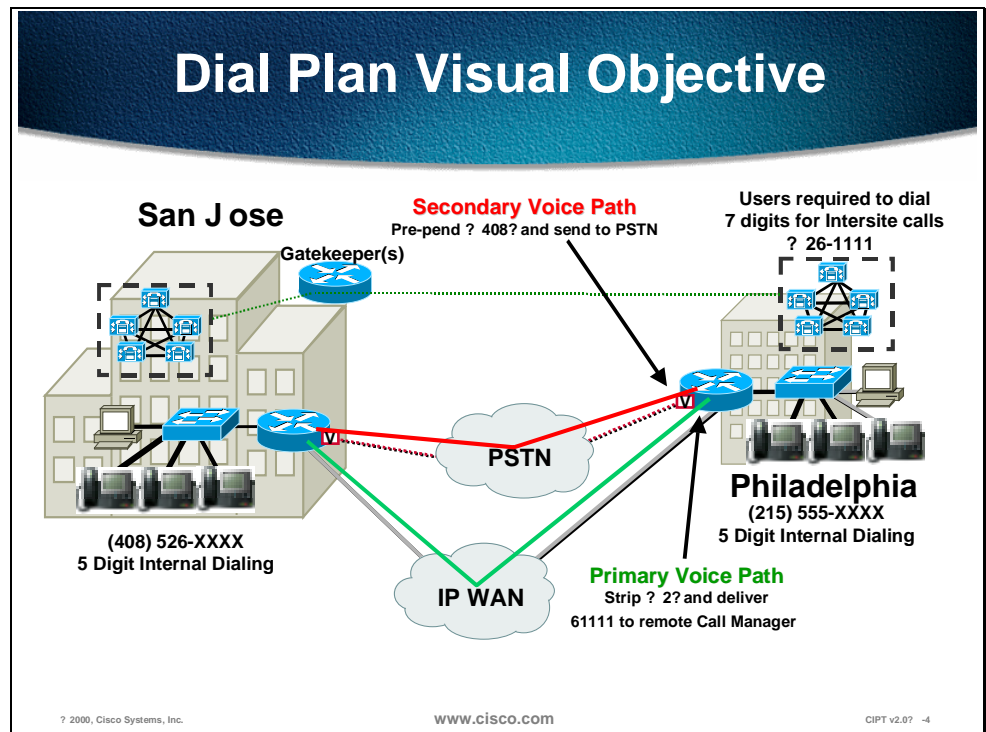

The figure above depicts the goal of a well-designed dial plan where voice calls transparently use the IP WAN as the first choice and use the PSTN transparently to the user if the IP WAN is down or unavailable.

Dial Plan Architecture

This section gives an explanation of the dial plan architecture and functional components.

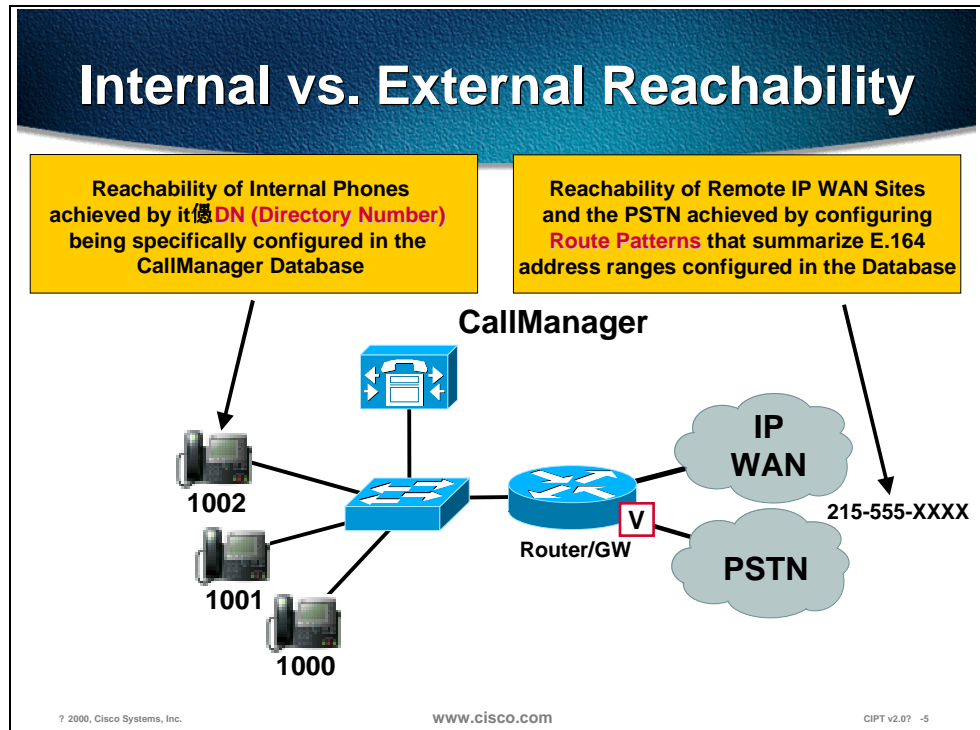

The CallManager's dial plan architecture is setup to handle generally two types of calls:

- Internal calls to IP phones registered to the CallManager cluster itself
- External calls via a PSTN gateway or to another CallManager cluster via the IP WAN

The dial plan for internal calls to IP phones registered with a CallManager cluster is fairly simple in the fact that when an IP phone is initially configured it is assigned a phone number and the IP phone maintains that number wherever it resides. Whenever the IP phone registers with the CallManager cluster it effectively updates the CallManager cluster dynamically with its new IP address while maintaining its same phone number. The internal dial length (number of digits dialed) for internal calls may be configured as desired. Note that not only IP phones may be reached in this manner. Other devices that register with CallManager and maintain a DN (Directory Number) can include soft phones, and analog phones attached to MGCP/skinny based gateways.

When configuring the CallManager to handle external calls then the use of the route pattern is required. The route pattern is in most cases used for directing calls out to a PSTN gateway or in the case of an IP WAN call to a remote CallManager. The CallManager 3.0 dial plan architecture is a three tiered decision tree that allows for multiple routes to be taken for a given dialed number as well as digit manipulation based on the customer network

requirements. Such capabilities such as *trunk groups* can be configured for gateway redundancy and a form of least cost routing. Digit manipulation is the task of adding or subtracting digits from the original dialed number to accommodate the users dial habit or gateway needs.

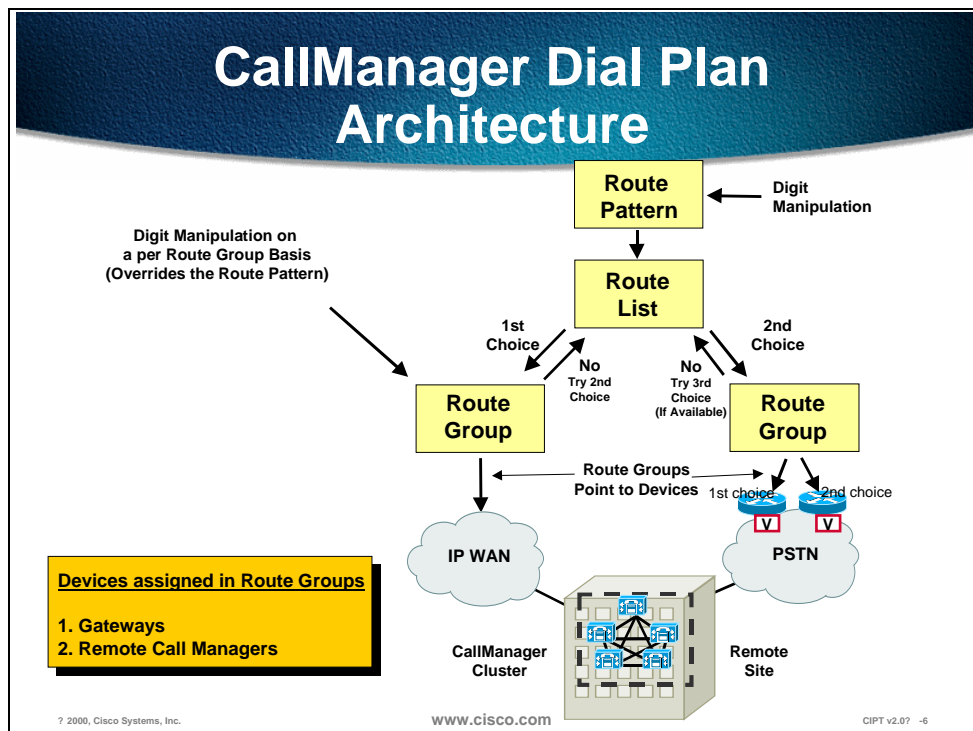

An example of alternate route selection is where the path to a given dialed number will take the IP WAN as the first choice and then the PSTN as the second choice if the IP WAN is down or has insufficient resources. The criteria for the dial plan using an alternate route could be based on insufficient trunks available on a gateway by the call admission control mechanism indicating that the IP WAN cannot accept the call.

The following are definitions of the functions in the dial plan architecture:

- Route Patterns—*Match* of an E.164 address range or specific address points to a single Route List
- Route Lists—How to *reach* a destination via prioritized route groups
- Route Groups—Forms a prioritized *Trunk Group* by pointing to devices
- Devices—Gateways or remote CallManagers

Dial Plan Configuration Interface

The screenshot displays the Cisco CallManager 3.0 Administration web interface. At the top, a navigation menu includes 'System', 'Route Plan', 'Service', 'Feature', 'Device', 'User', 'Application', and 'Help'. The 'Route Plan' menu is expanded, showing options: 'Route Filter', 'Route Group', 'Route List', 'Route Pattern', 'Translation Pattern', 'Parkline', 'Calling Search Space', 'External Route Plan Wizard', and 'Route Plan Report'. The 'Route Group', 'Route List', and 'Route Pattern' options are highlighted with red boxes. The main content area features the 'Administration' heading, the Cisco Systems logo, and the title 'Cisco CallManager 3.0 Administration'. Below this, the Cisco Systems, Inc. address is listed: 18581 North Dallas Parkway, Suite 100, Dallas, Texas 75287. A 'Details' button is present. Copyright information at the bottom reads: Copyright © 1999, 2000 Cisco Systems, Inc. All rights reserved. The footer of the page includes '© 2000, Cisco Systems, Inc.', 'www.cisco.com', and 'CIPT v2.07 -8'.

In the Cisco CallManager interface, you will go to the Route Plan heading and select Route Group, Route List, or route pattern to configure the route pattern.

Route Pattern Configuration Order

- 1. Devices**
- 2. Route group**
- 3. Route list**
- 4. Route pattern**

© 2000, Cisco Systems, Inc.

www.cisco.com

CIPT v2.07 -7

The order you would configure your route pattern is shown in the following list:

1. Devices
2. Route group
3. Route list
4. Route pattern

Device Configuration Characteristics (For a Remote Call Manager)

The screenshot shows the Cisco CallManager Administration interface for Gateway Configuration. The page title is "Gateway Configuration" and the device is identified as "H.323 Gateway: 10.1.18.23". The device profile is "Inter-Cluster Trunk". The configuration fields are as follows:

Field	Value
Device Name*	10.1.18.23
Description	
Device Pool*	IPWA-ICTD
Calling Search Space	unrestricted
Location	< None >
Caller ID CSS	
Calling Party Selector*	Registrator
Registration Ad*	None
Gatekeeper Registration*	Remote
Gatekeeper Name	10.1.18.100
Media Termination Point Required	<input type="checkbox"/>

Annotations on the right side of the screenshot:

- Defining H.323 GW as an Inter-Cluster Trunk (Remote Call Manager)
- Remote H.323 Device (Call Manager)
- Device Pool to define CODEC used for calls to this device
- Enabling device as Gatekeeper Controlled
- Gatekeeper IP Address

Annotation on the left side of the screenshot:

- Where this device may call (Incoming Calls)

Footer: © 2000, Cisco Systems, Inc. WWW.CISCO.COM CIPT v2.0? -16

The figure above identifies the device configuration characteristics for a remote CallManager. The remote CallManager needs to be defined as an H.323 gateway in an Inter-Cluster Trunk. The device name is the remote H.323 device that is the CallManager. The device pool is used to define the codec used for calls to this device, remote CallManager. The Gatekeeper Registration has the device and remote CallManager is enabled as *Gatekeeper Controlled*. In the Gatekeeper Name area, you will enter the IP address of the gatekeeper and primary CallManager. Also in this example the Calling Search Space is defined as *unrestricted*. The Calling Search Space is used to define where this device may call.

Route Group

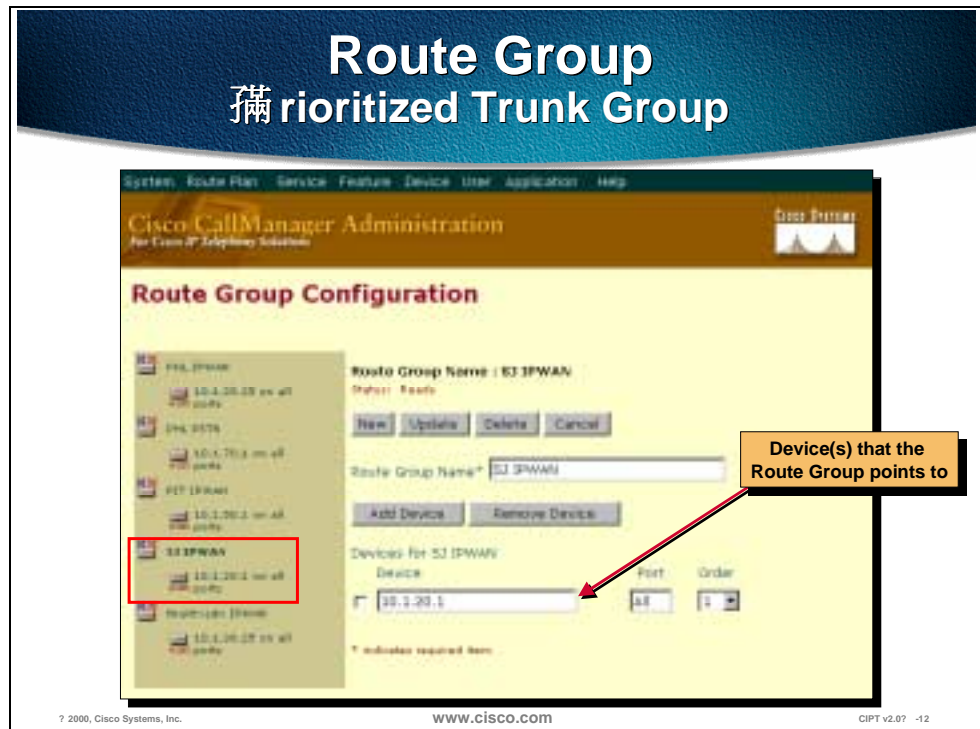

Route groups control specific devices, which are gateways. Gateways may be skinny, MGCP or H.323 based. Endpoints such as NetMeeting clients or remote Call Managers across the IP WAN are configured as H.323 gateways. The route group points to one or more devices and can select the devices for call routing based on preference. The route group can direct all calls to the primary device and then utilize the secondary devices when the primary is unavailable. This serves effectively as a trunk group. One or more route lists can point to the same route group. All devices in a given route group have the same characteristics such as path and digit manipulation. As mentioned above route groups have the ability of performing digit manipulation that will over ride what was performed in the route pattern.

廊 J IPWAN? Route Group

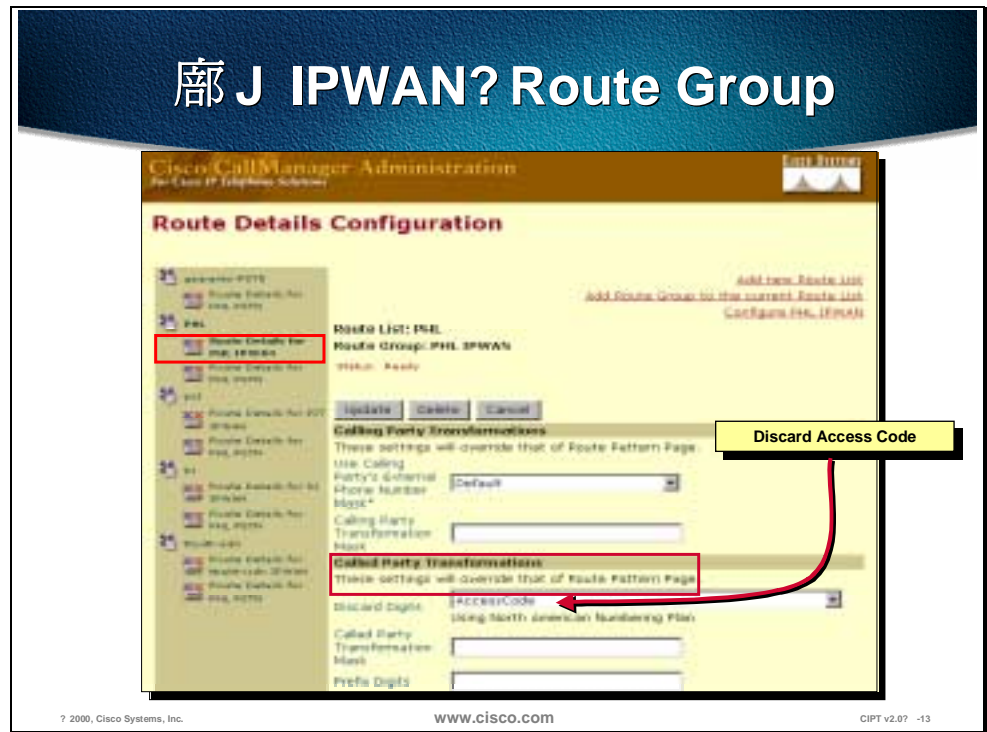

The figure above shows settings that will override the settings of the Route Pattern Page for the “SJ IPWAN” Route Group. For the example above, the Called Party Transformations will discard digits of the access code.

備 HL PSTN? Route Group

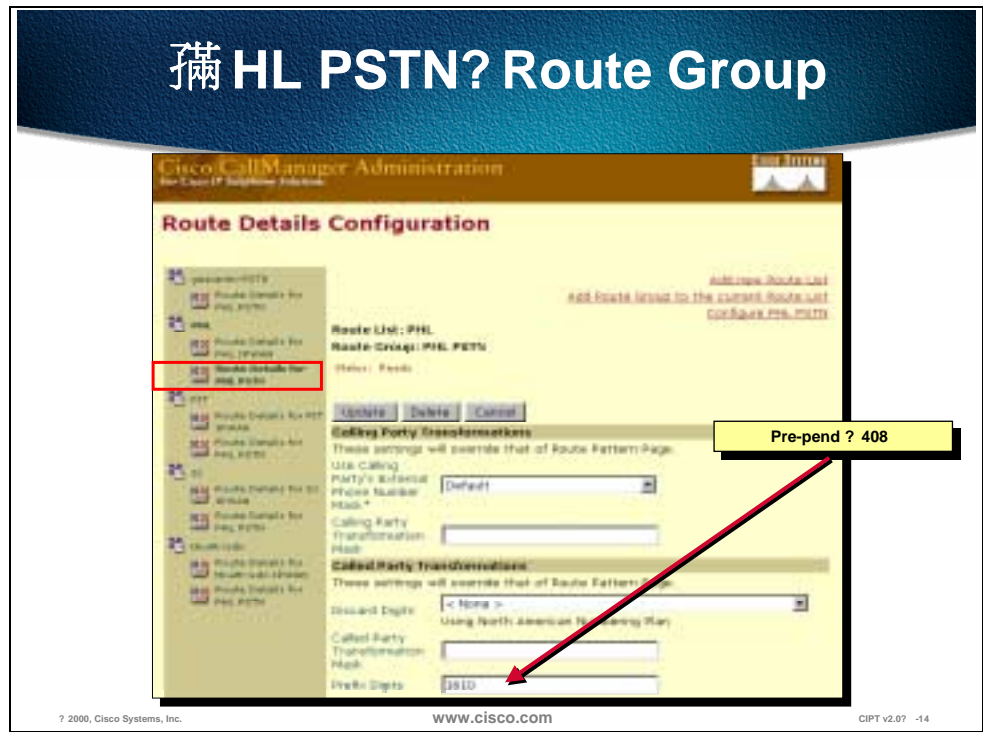

The figure above shows the digits of 1408 will be pre-pended to the number if the called party is has the prefix digits of 1601. The “PHL PSTN” Route Group is devices.

Typical Route Group Device Types

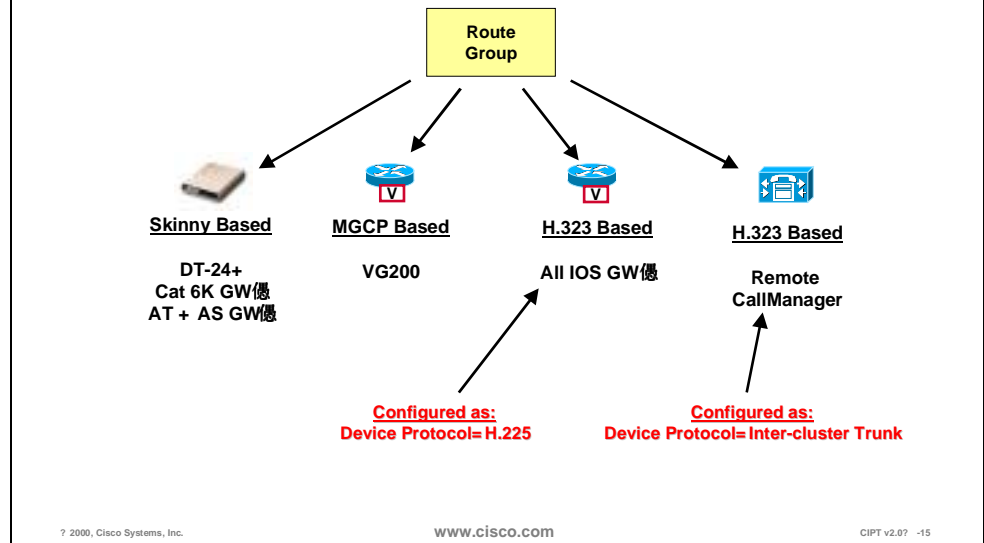

Devices are associated with gateways or remote CallManagers. Within the device configuration information on how the call is actually placed is defined. The figure above illustrates the types of devices that route groups can point to in order to intelligently deliver calls.

- An H.323 gateway may be configured to be gatekeeper controlled. This means that before a call is placed to an H.323 device it must successfully query the gatekeeper first.
- The codec used by calls to the device may be selected by placing the device in a region, which determines the codec to be used.
- Multiple clusters for inbound and outbound calls may share H.323 gateways where as MGCP and skinny based gateways are dedicated to a single CallManager cluster.

The route pattern dial structure is typically used when IP phone calls are destined to go to gateways or remote CallManagers via H.323. In these instances alternate routes may be taken in the event the primary path to a destination is not available. This is the model used in the multi-site IP WAN with the distributed call processing model where all inter-site calls will take the IP WAN as the primary path and the PSTN as the secondary path.

Calls between IP phones that reside on the same CallManager/cluster do not utilize the route pattern dial structure and therefore *cannot* utilize alternate routes if connectivity is down between them. In all likely hood if IP connectivity is down between to IP phones then there are good chances that one of the phones has lost connectivity to a CallManager and cannot even place a call. A good example of this is when using multi-site WAN deployments with centralized call processing. In this case there is no alternate routing between sites.

Route List

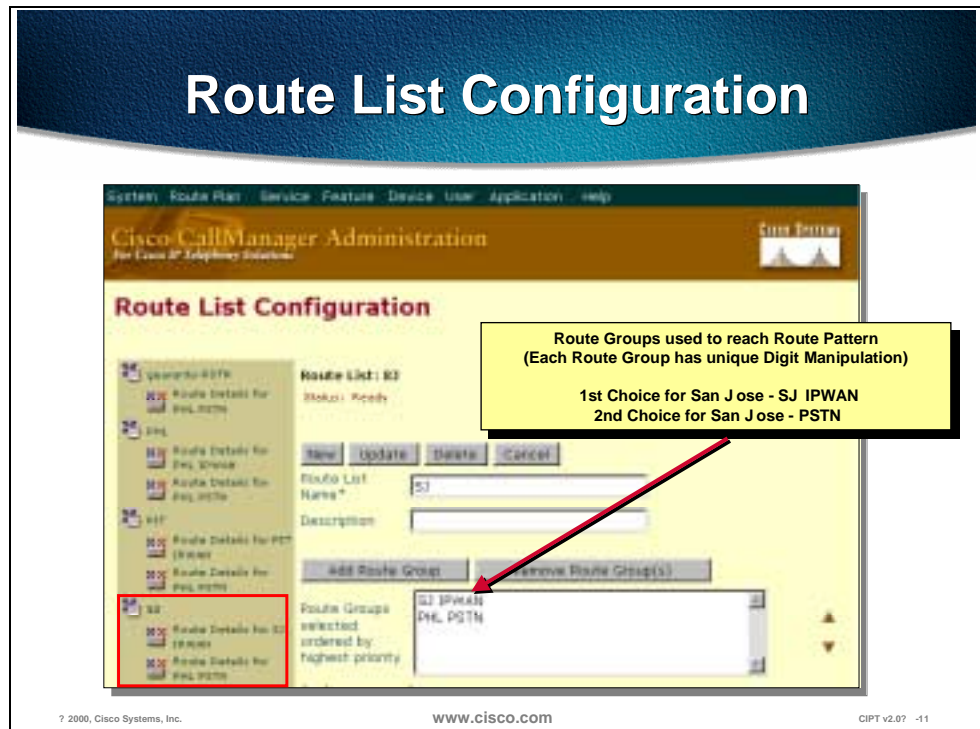

The CallManager 2.4 term *route point* has been replaced by the *route list* in CallManager 3.0 while performing much of the same role. A route list defines the way a call is routed. Route lists are configured to point to one or more route groups, which effectively serve the purpose of trunk groups. The route list sends a given call to a route group in a configured order of preference. This could be where the primary route group may offer a lower cost for calls where as the secondary route groups will only be used if the primary is unavailable due to an all trunks busy condition or insufficient IP WAN resources.

Route Pattern

A route pattern is an address. Some addresses, such as directory numbers match only one dialed digit string. Other addresses such as gateway route patterns, match a range of dialed digit strings.

The screenshot shows the Cisco CallManager Administration interface for configuring a Route Pattern. The main configuration area is titled "Route Pattern Configuration" and shows the following fields:

- Route Pattern:** 52.1XXXX
- Partition:** IPAMM
- Numbering Plan:** North American Numbering Plan
- Route List:** G3
- Discard Digits:** <None>

Annotations on the right side of the screenshot explain the fields:

- Route Pattern:** Digits left of *. * are the Access Code
- Partition:** (WHO can reach ? 2.XXXX)
- Route List:** (Defines HOW to reach ? 2.XXXX?)
- Digit manipulation:** (Defines HOW to reach ? 2.XXXX?)

The Route Pattern identifies a dialed number (E.164 address in North America) and uses the underlying Route List and Route Group configurations to determine how to route the call.

When a Route Pattern matches a dialed number, it will hand the call to the Route List associated with the Route Pattern. The Route List will then make the decision as to which downstream route groups (trunk groups) to send the call to based on the ordered priority. Prior to handing the call to the Route List, digit manipulation will occur depending if digits need to be added or removed from the matched Route Pattern.

The digit manipulation occurs in the Route Pattern for *outbound* calls only before it gets sent to the Route List + Route Groups. Note that individual downstream route groups may have unique digit manipulations for the same Route Pattern. This is extremely useful where different routes to a given dialed number may require different manipulations. An example of this would be where users were required to dial seven digits to reach a remote location that has a four digit internal dial plan length. Across the IP WAN the first three digits may have to be removed in order to deliver the last four digits to the remote Call Manager in its native internal dial string length. If the IP WAN was down or could not accept additional voice calls then the dialed seven digits would have to be prepended with the area code in order to reach the called party via the PSTN. A route pattern is associated with only one route list.

Route Pattern Notes

CallManager matches most specific pattern

Wildcards and Range Matching

- **X** **Single digit (0-9)**
- **N** **Single digit (2-9)**
- **@** **North American Numbering Plan**
- **!** **One or more digits (0-9)**
- **[x-y]** **Generic range notation**
- **[^ x-y]** **Exclusion range notation**
- **.** **Terminates access code**
- **#** **Terminates inter-digit timeout**

© 2000, Cisco Systems, Inc.

www.cisco.com

CIPT v2.0—7-16

The Cisco CallManager matches the most specific pattern from the route pattern. Wildcards are used for range matching of digits. The following are some of the wildcards that are used in the route pattern:

Wildcard	Definitions
X	Single digit (0-9)
N	Single digit (2-9)
@	North American Numbering Plan (NANP)
!	One or more digits (0-9)
[x-y]	Generic range notation
[^x-y]	Exclusion range notation
.	Terminates access code
#	Terminates inter-digit timeout

Pattern Examples

1111	Matches 1111
* 1* 1	Matches * 1* 1
12XX	Matches numbers between 1200 and 1299
13[25-8] 6	Matches 1326, 1356, 1366, 1376, 1386
13[^ 3-9] 6	Matches 1306, 1316, 1326, 13* 6, 13# 6
13! #	Matches any number that begins with 13, is followed by one or more digits, and ends with # ; 135# and 13579# are example matches

© 2000, Cisco Systems, Inc.

www.cisco.com

CIPT v2.0-7-17

The table above shows examples of route patterns and the possible matches to the pattern examples. The next few pages discuss the following examples that can occur when using a route pattern:

- Digit collection
- Closest match routing
- Inter-digit timeout

Digit Collection

User' s dial string:

1111

CallManager actions:

**No other patterns could
match; extend call**

1111	Match!
1211	Doesn' t match
1[23] XX	Doesn' t match
131	Doesn' t match
13[0-4] X	Doesn' t match
13!	Doesn' t match

The figure above is the final figure in a series of six slides that show the process in Cisco CallManager of digit collection and match of a route pattern. As the user enters each digit, all the patterns above are a possible match. Then last digit entered by the user and only one route pattern is matched.

Closest Match Routing

User' s dial string:

1211

Matches 1 digit
string
Select as closest match

Matches 200 digit
strings

1111	Doesn' t match
1211	Match!
1[23] XX	Match!
131	Doesn' t match
13[0-4] X	Doesn' t match
13!	Doesn' t match

© 2000, Cisco Systems, Inc.

www.cisco.com

CIPT v2.0-7-31

The figure above is the final figure in a series of eight slides that show a closest match to a route pattern while the Cisco CallManager collects digits. During digit collection, a number of route patterns matched, until the final digit is entered. Two possible route pattern matches are found, one route pattern with one digit string match and the other with 200 digit stings matched. The Cisco CallManager will select the route pattern with one digit string match as the closest route pattern match.

Inter-digit Timeout

User' s dial string:
1311<timeout>

1111	Doesn' t match
1211	Doesn' t match
1[23] XX	Match!
131	Doesn' t match
13[0-4] X	Match!
13!	Match!

Matches 200 digit strings
Select as closest match

Matches 500 digit strings

Matches ∞ digit strings

© 2000, Cisco Systems, Inc.

www.cisco.com

CIPT v2.0—7-40

The figure above is the final figure in a series of nine slides that show a inter-digit timeout while a user places a call while the Cisco CallManager collects digits to match a route pattern. While the Cisco CallManager collects digits, it will try to match route patterns that are in the database. Inter-digit timeout occurs when the closest matched route pattern has a number of possible digit string matches. The figure above shows that the closest match route pattern has 200 digit string matches to wait for and Cisco CallManager invokes inter-digit timeout.

Route Filters

Route filters work with route patterns in digit discarding and limiting the @ wildcard.

Route Filter Wildcards

- **. wildcard: denotes a portion of a route pattern that can be stripped when the pattern matches**
- **@wildcard: any number you can dial from your home phone (for example, 911 or 1010321 1 408 555 1212)**

© 2000, Cisco Systems, Inc. www.cisco.com CIPT v2.0-7-41

Route filters are most commonly used to manipulate dialed strings that use the following wildcards:

- . wildcard. The . wildcard denotes a portion of a route pattern that can be stripped when the pattern matches.
- @ wildcard. The @ wildcard matches any number in the North American Numbering Plan (NANP). Essentially, any number you can dial from your home phone.

The following are important points to remember about the @ wildcard and route filters:

- Closest match routing works on the individual patterns of an @ pattern, not on the pattern as a whole.
- Route filters don't block calls in and of themselves; they restrict which patterns are added.

Wildcard: Digit Discarding Instructions

- Use digit discarding instructions to strip initial digits
- Use only NoDigits or PreDot unless the pattern contains an @ wildcard

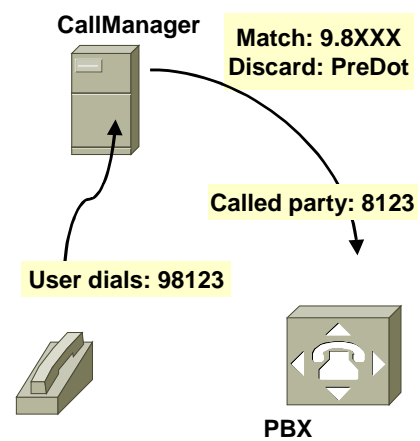

© 2000, Cisco Systems, Inc.

www.cisco.com

CIPT v2.0-7-42

Digit discarding instructions are used to strip the initial digits dialed by the user. It is recommended to use only “No Digits” or “Pre Dot” unless the pattern contains an @ wildcard. In the figure above, the “Pre Dot” digit discarding instruction is used to strip digit before the “dot” in the route pattern. The user dials “98123” the Cisco CallManager matches it to the route pattern “9.8XXX” and uses the digit discarding instruction (Pre Dot) and strips the “9” and passes only “8123” to the PBX.

@Wildcard: Digit Discarding Instructions

- Use digit discarding instructions to discard whole sections of the dialed number
- All digit discarding instructions are available

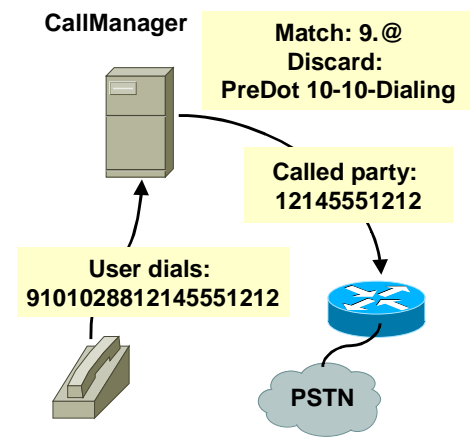

© 2000, Cisco Systems, Inc.

www.cisco.com

CIPT v2.0-7-43

The @ wildcard is a macro that causes the CallManager to add about 300 patterns. Use digit discarding instructions to control which digits are sent as the called number and use route filters to add fewer patterns and restrict outside dialing.

The example above shows digit discarding instructions related to the @ wildcard. The user dials “9101028812145551212” and the Cisco CallManager matches the dialed digits to the 9.@ route pattern. The digit discard instructions are to discard a whole section of dialed numbers and in this example the discard instructions are “pre dot” and digits “10-10-Dialing”. The dialed digits from the user are “12145551212” get passed on to the router then to the PSTN.

Digit Discarding Instructions

If the pattern is 9.8@..

Instructions	Discarded Digits	Used for
PreDot	98 1 214 555 1212	Access codes
PreAt	98 1 214 555 1212	Access codes
11D/10D→7D	98 1010321 1 214 555 1212	Toll bypass
11D→10D	98 1010321 1 214 555 1212	Toll bypass
IntlTollBypass	98 1010321 011 33 1234 #	Toll bypass
10-10-Dialing	98 1010321 1 214 555 1212	Suppressing carrier selection
Trailing-#	98 1010321 011 33 1234 #	PSTN compatibility

© 2000, Cisco Systems, Inc.

www.cisco.com

CIPT v2.0—7-44

If the route pattern is [9.8@](#) the table above describes the digit discarding instructions that can be applied to the pattern.

Limiting The @Wildcard

- **Eliminates or constrains route patterns added by the @pattern**
- **Relies on tags, named substrings of the NANP**
- **Uses three operators: Exists, Does not exist, == <value>**
- **Operators connected with AND and OR**

© 2000, Cisco Systems, Inc.

www.cisco.com

CIPT v2.0-7-45

Because the @ wildcard creates close to 300 route patterns, route filters are used to limit the @ wildcard. The route filters created to limit the @ wildcard rely on tags and named sub-strings of the NANP. Route filters use the following three operators and are connected with “and” and “or”:

- Exists
- Does not exist
- ==<value>

The following four pages show examples using the three operators in a route filter to limit the @ wildcard.

9.@Route Pattern with no Route Filters

The following individual patterns to get added...

9 [2-9] 11	311, 611, 911 SERVICES
9 [2-9] XXXXX	7-digit dialing by OFFICE CODE
9 [2-9] X[2-9] XX XXXX	10-digit local dialing by LOCAL AREA CODE
9 1 [2-9] X[2-9] XX XXXX	11-digit long distance dialing by AREA CODE
9 011 3[0-469]	International dialing by COUNTRY CODE

© 2000, Cisco Systems, Inc.

www.cisco.com

CIPT v2.0—7-46

If a route pattern of [9.@](#) is added with no filters, over three hundred dial strings are possible matches. The following pages show how to limit this route pattern using the following operators:

- Exist
- Does not exist
- == <value>

9.@with Router Filter SERVICE EXISTS

9 [2-9] 11	Added: contains SERVICE
9 [2-9] XX XXXX	Not added: no SERVICE
9 [2-9] XX [2-9] XX XXXX	Not added: no SERVICE
9 1 [2-9] XX [2-9] XX XXXX	Not added: no SERVICE
9 011 3[0-469] !	Not added: no SERVICE

© 2000, Cisco Systems, Inc.

www.cisco.com

CIPT v2.0-7-47

When the route pattern 9.@ is used with a route filter of “service exist” then only the “9[2-9]11” pattern is added.

9.@with Route Filter COUNTRY-CODE DOES-NOT-EXIST

9 [2-9] 11	Added: no COUNTRY-CODE
9 [2-9] XX XXXX	Added: no COUNTRY-CODE
9 [2-9] XX [2-9] XX XXXX	Added: no COUNTRY-CODE
9 1 [2-9] XX [2-9] XX XXXX	Added: no COUNTRY-CODE
9 011 3[0-469] !	Not added: contains COUNTRY-CODE

© 2000, Cisco Systems, Inc.

www.cisco.com

CIPT v2.0—7-48

The 9.@ pattern with the route filter of “country-code does-not-exist” results in the route pattern that contains a country code to be eliminated from the route pattern. This example would be used to filter calls that use a country code.

9.@with Route Filter AREA CODE == 900

9 [2-9] 11	Not added: no AREA-CODE
9 [2-9] XX XXXX	Not added: no AREA-CODE
9 [2-9] XX [2-9] XX XXXX	Not added: no AREA-CODE (It contains LOCAL-AREA-CODE)
9 1 900 X [2-9] XX XXXX	Added: AREA-CODE constrained to 900
9 011 3[0-469] !	Not added: no AREA-CODE

© 2000, Cisco Systems, Inc.

www.cisco.com

CIPT v2.0-7-49

The 9.@ route pattern with the route filter of “area code == 900” is used to limit the route pattern to calls that go to the area code “900”.

Tags In The NANP Dial Plan

Tag Name	Example number	Description
AREA-CODE	1 214 555 1212	The area code in an 11-digit long distance call
COUNTRY-CODE	01 1 33 123456 #	The country code in an international call
END-OF-DIALING	01 1 33 123456 #	The #, which cancels inter-digit timeout in international calls
INTERNATIONAL-ACCESS	01 1 33 123456 #	The initial 01 of an international call
INTERNATIONAL-DIRECT-DIAL	01 1 33 123456 #	The digit that denotes the direct-dial component of an international call
INTERNATIONAL-OPERATOR	01 0	The digit that denotes the operator component of an international call
LOCAL-AREA-CODE	214 555 1212	The area code in a 10-digit local call
LOCAL-DIRECT-DIAL	1 555 1212	The initial 1 required by some 7-digit calls
LOCAL-OPERATOR	0 555 1212	The initial 0 required for operator-assisted local calls
LONG-DISTANCE-DIRECT-DIAL	1 214 555 1212	The initial 1 required for long distance direct-dial calls
LONG-DISTANCE-OPERATOR	0 214 555 1212	The initial 0 required for operator-assisted long-distance calls
NATIONAL-NUMBER	01 1 33 123456 #	The national number component of an international call
OFFICE-CODE	1 214 555 1212	The office or exchange code of a North American call
SATELLITE-SERVICE	01 1 881 4 1234 #	A specific value associated with calls to the satellite country code
SERVICE	1 411	Access to local telephony provider services
SUBSCRIBER	1 214 555 1212	A particular extension served by a given exchange
TRANSIT-NETWORK	101 0321 1 214 555 1212	Long distance carrier code
TRANSIT-NETWORK-ESCAPE	101 0321 1 214 555 1212	The escape sequence used for entering a long distance carrier code

© 2000, Cisco Systems, Inc.

www.cisco.com

CIPT v2.0—7-50

The @ wildcard can be used to easily establish matches in route patterns to over 300 dial strings. The table above represents the tags use in the NANP Dial Plan that will help in creating route filters for a route pattern with an @ wildcard.

Digit Translation Tables

The capability exists within CallManager to provide for digit translation. This is the ability of “translating” a dialed number into another number or even changing the number of digits. This can be achieved for internal as well as external calls whether inbound or outbound. Translation Table may be configured such that when a user dials a zero then the call gets delivered to an attendant who may have an extension that is 1111.

Digit Translation Table

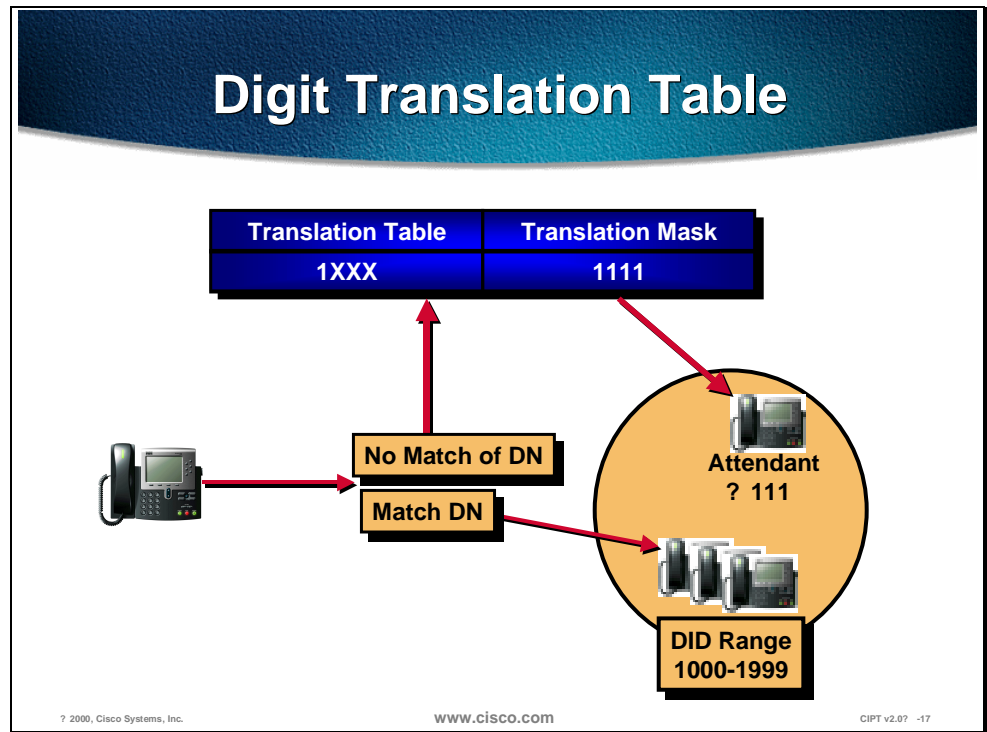

The following is an example of a common application of a translation table. Many customers desire that unassigned DID (Direct Inward Dial) numbers get sent to an attendant if those numbers are dialed.

Lets say a customer has a DID range from 1000-1999 and they want all calls to unassigned DID numbers to go to an attendant at extension 1111. In this case a Translation Table of 1XXX would be configured that pointed to a translation mask of 1111.

Wildcards are used in the above example. CallManager performs a longest match lookup up where if an IP phone exists in the 1000-1999 range, it will send the call to the IP phone. If no IP phone exists in the 1000-1999 range then the match will occur on the 1XXX translation table and the call will be sent to extension 1111.

Translation Patterns

- **Almost exactly like route pattern: uses wildcards, transformations, etc.**
- **Results of transformations are the input for another trip through digit analysis**
- **Use to handle extension mapping**

© 2000, Cisco Systems, Inc.

www.cisco.com

CIPT v2.0—7-52

Translation patterns are almost exactly like route patterns in its use of wildcards and transformations. The digit collection in a translation pattern results in another trip through digit analysis. The primary use of translation patterns is for extension mapping.

Routing Flowchart

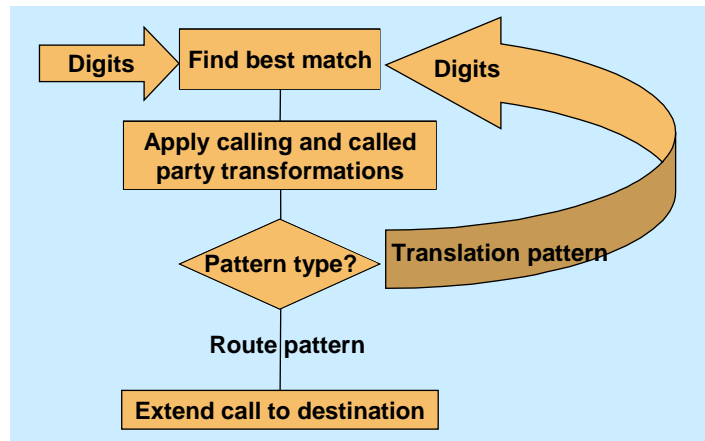

© 2000, Cisco Systems, Inc.

www.cisco.com

CIPT v2.0-7-53

The above routing flow chart shows at what point the digits go back through digit analysis when using a translation pattern. In the routing flowchart, the digit analysis determines what pattern type is being used. When a translation pattern is used, the digits go back through digit analysis. When a route pattern is used, the call is extended to the destination.

Translation Patterns

- **The calling search space parameter on translation patterns provides a mechanism to handle overlapped dial plans such as would be common in a multiple tenant situation**
- **Calling search space and partitions are covered in the next section**

© 2000, Cisco Systems, Inc.

www.cisco.com

CIPT v2.0—7-56

Translation patterns are very useful in a multi-tenant situation. The calling search space parameter (that is discussed later in this chapter) used on translation patterns provide a mechanism to handle overlapped dial plans.

Special Dial String Considerations

A goal of the dial plan is to be as simple as possible and to minimize the number of entries. The most efficient way to achieve this is to configure specific dial plans only for *On-Net* (IP WAN) locations and to use the local PSTN gateway access code (such as 9 or 0) for *Off-Net* calls that must take the PSTN as well as act as an alternate path for IP WAN calls if the IP WAN is down or has insufficient resources.

“ On-Net” Route Pattern

This assumes the multi-site IP WAN with a distributed call processing model typically where an abbreviation of the full E.164 address will be used for ease of dialing for the user in this case. Take the case of where an *On-Net* location has a number range of (408) 526-1000 through 1999. In this case there may only be a single route pattern that will have an entry of “61XXX”. This simplifies user dialing and requires only one route pattern entry where the Xs serve as Wildcards.

The CallManager route pattern can also strip/pre-pend digits to the dial number in order to present the remote CallManager with the appropriate internal dial plan length. In fact for all IP WAN calls the number of digits presented to a remote CallManager across the IP WAN *must* also match the dialed digit length that the remote site uses for internal calls. The remote CallManager will simply look at the digits and route the call. There is no digit manipulation for incoming calls.

Dial Plan ? 懈 n-Net

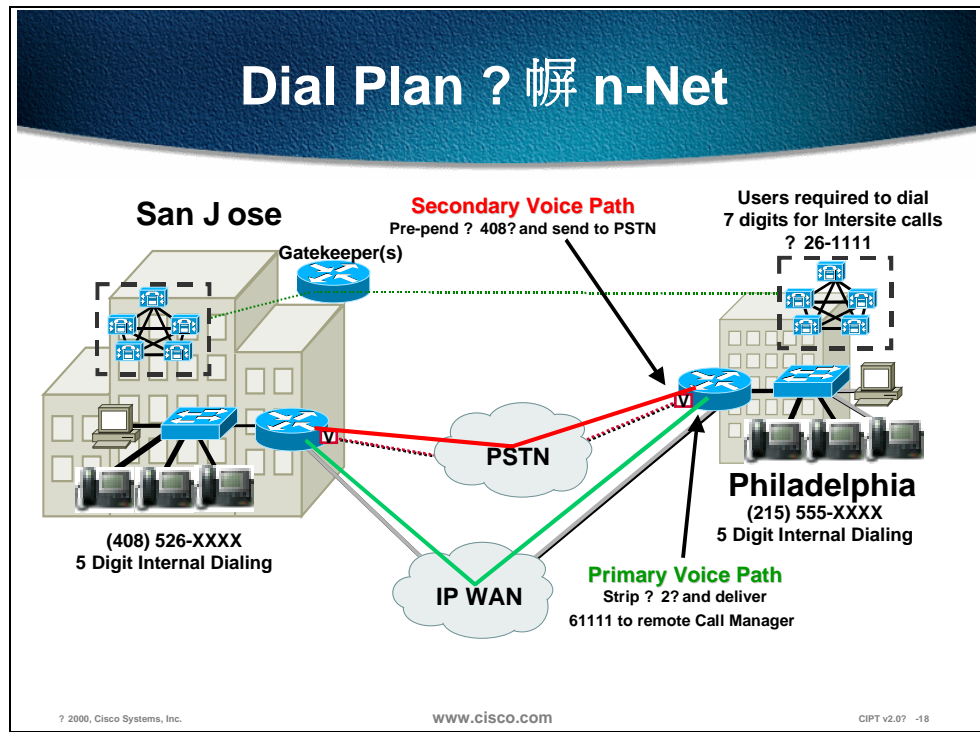

If in this environment the IP WAN resources are insufficient and the call has to be sent out the PSTN then the route group for the PSTN gateway must insert the area code and 3-digit exchange. In CallManager 2.4 for any given route pattern only one digit manipulation table could have been used and therefore IOS gateways only could be used because they *could* insert the area code and 3-digit exchange. This administrative burden has been removed with the ability of performing unique digit on a per route group basis in CallManager 3.0. This allows for a single point of dial plan administration per site and both IOS and skinny based gateways may be used. The figure above depicts OnNet calls across the IP WAN with the PSTN as a backup where the digit manipulation required is different for each path.

All Calls out of the PSTN

For all calls out of the PSTN this typically will only require a single route pattern that will be the PSTN trunk access code, which is usually a 9 or a 0. In North America the route pattern 9.@ can be configured such that all users making outside calls will dial a 9 (9 is most commonly used) and simply dial the telephone 7 or 1+ 10-digit phone number. In CallManager 3.0 Local Area Codes do not exist and therefore should be configured specifically and not require a 1. This way CallManager can differentiate between a local 7-digit numbers vs. a local area code in order to determine when the dialing is complete. Otherwise the CallManager will wait 10 seconds without detecting any digits before assuming the dialing is complete.

Calls out of the PSTN

- **Skinny based and MGCP gateways have all their dial plan information done in CallManager**
- **H.323 based IOS gateway typically only requires a minimal amount of dial peers**

© 2000, Cisco Systems, Inc. www.cisco.com CIPT v2.0? -19

As far as local PSTN the gateway dial plan configuration it is fairly simple. The skinny based and MGCP gateways have all their dial plan information done in CallManager while an H.323 based IOS gateway typically only requires a minimal amount of dial peers. These dial peers would be used by the gateway to direct all calls from CallManager to the PSTN. In the dial plan configuration section there will be an example of the IOS H.323 gateway dial peer configuration.

Outside North America

- **Multiple length dial plans presents a challenge**
- **CallManager does not know when dialing is complete, unless you have a specific route pattern**
- **CallManager by default will wait 10 seconds without receiving any digits before assuming dialing is complete**
- **Two route pattern options:**
 - **Option 1 – 0.!**
 - **Option 2 – 0.! #**

© 2000, Cisco Systems, Inc.

www.cisco.com

CIPT v2.07 -20

In areas outside North America it is common to have different countries use different length dial strings. Multiple length dial plans presents a challenge in that the CallManager does not know when dialing is complete unless you have a specific route pattern. CallManager by default will wait ten seconds without receiving any digits before assuming dialing is complete. Below are common options for configuring a route pattern for the PSTN access outside of North America. The local PSTN access code used will be “0” which is commonly used.

Option 1—Route Pattern = 0.!

“0.”—Represents the local PSTN access code.

“!”—Stands for any digit and any number of digits. This also means that the CallManager will wait ten seconds by default without receiving any digits before assuming the dialing is complete and then sending the call.

A common option here is reducing the *idle digit wait timer* in the CallManager service parameters to three seconds. This will allow for a call to be sent sooner when the user is finished dialing instead of having the user wait the annoying ten seconds before the call gets sent. The risk, however, of reducing this is that the CallManager may determine that the dialing is finished prematurely if the user simply pauses.

Option 2—Route Pattern = 0.!

“0.”—Represents the local PSTN access code.

“!”—Stands for any digit and any number of digits. This also means that the CallManager will wait ten seconds without receiving any digits before assuming the dialing is complete.

“#”—This indicates when a user hits the # key CallManager will assume dialing is complete immediately and send the call.

In this option users are instructed to dial the # (pound/hash) key to terminate the dial string and immediately place the call. This requires some user education and some changes to existing customer dialing habits, which can be met with varying degrees of resistance. However, this is similar in nature to pressing the Send button on a cell phone.

Configuring Dial Plan Groups and Calling Restrictions

New in CallManager 3.0 is the ability of providing calling restrictions on a per phone basis as well as the creation of closed dial plan groups on the same CallManager. Users can be grouped into communities of interest on the same CallManager that have the same calling restrictions as well as dial plans. Different communities of interest can operate as ships in the night from one another, share the same gateways as well as have overlapping dial plans. This ability has a particular interest in the multi-site IP WAN with centralized call processing deployment model. These new capabilities are achieved in CallManager 3.0 with the use of partitions and calling search spaces.

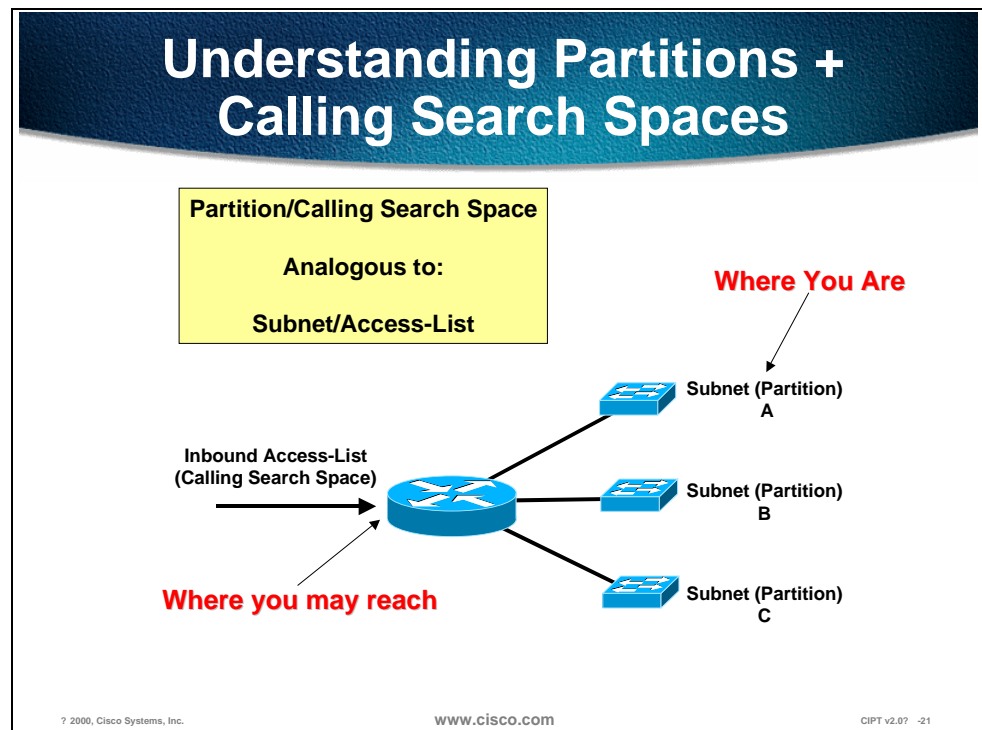

Partitions and calling search spaces draw an analogy to routers with access lists. Think of a partition as an IP subnet where you will place users. A calling search space is likened to an inbound access list that dictates “which” subnet you can reach.

Partitions And Calling Search Spaces Analogy

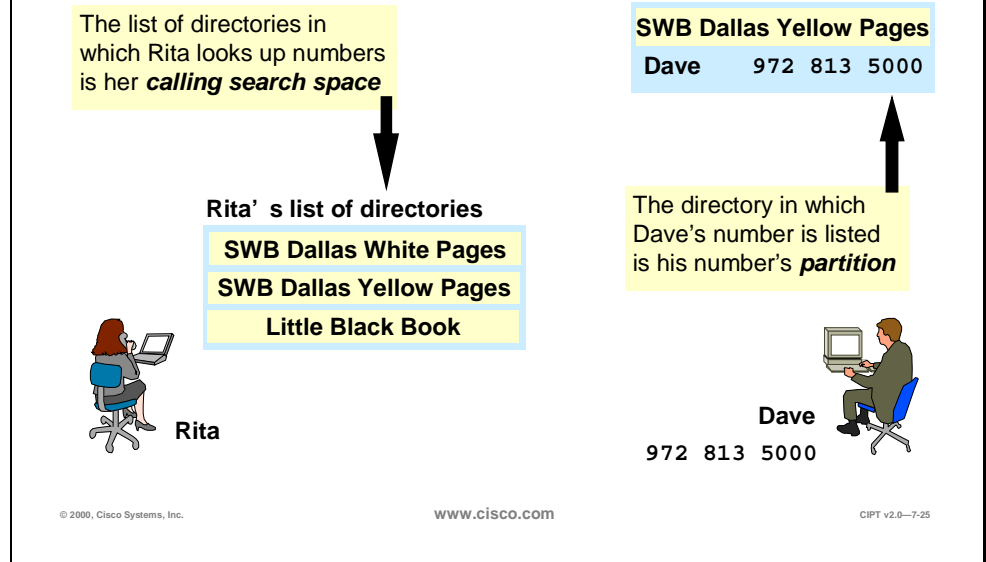

The analogy above shows the relationship between calling search space and partitions. A partition is a directory where a user lists their number and a calling search space are the directories a user is able to look in to make calls.

In the analogy, Dave lists his number in the "SWB Dallas Yellow Pages" directory. This is the partition that Dave belongs to.

Rita has a list of directories (SWB Dallas White Pages, SWB Dallas Yellow Pages and her Little Black Book) that represent her calling search space.

If Rita does not have a directory that Dave is in (SWB Dallas Yellow Pages), then she is unable to call Dave. In other words, if Rita is assigned to a Calling Search Space that does not include the partition that Dave is in, then Rita cannot call Dave.

If Rita does have a directory that Dave is in (SWB Dallas Yellow Pages), then she is able to call Dave. In other words, if Rita is assigned to a Calling search space that includes the partition that Dave is in, then Rita is able to call Dave.

Partitions And Calling Search Spaces Definition

- **Partition: A logical grouping of patterns. All patterns in a partition are equally reachable**
- **Calling search space: An ordered list of partitions. Digit analysis looks through the caller' s list of partitions when searching for the closest match for the caller' s dialed number**

© 2000, Cisco Systems, Inc.

www.cisco.com

CIPT v2.0—7-63

Partitions

Partitions are considered to be a group of devices with similar reachability characteristics. Devices that get placed in partitions are IP phones, DNs and route patterns. These are entities associated with DNs (directory numbers) that users will dial to reach. Partition names should be chosen to have some meaningful correlation to the group of users it represents. For example, for users located in Building D in San Jose you may want to create a partition called SJD.

Calling Search Space

A calling search space is an ordered list of partitions that a user may look in before being allowed to place a call. Calling search spaces are assigned to devices that may initiate calls. These include IP phones, soft phones and gateways.

The way dialing restrictions can be invoked is simple in that when a user is assigned a calling search space, the list of partitions in the calling search space only are ones that the caller is allowed to reach. DNs dialed that fall in a partition not in a caller's calling search space will be given a busy signal.

Partitions And Calling Search Spaces Rules

- **Digit analysis looks through every partition in a calling search space and looks for the best match**
- **Order of partitions listed in the calling search space is used only to break ties when there are equally good matches in two different partitions.**
- **If no partition is specified for a pattern, the pattern is listed in the null partition.**

© 2000, Cisco Systems, Inc.

www.cisco.com

CIPT v2.0-7-64

Partitions and calling search spaces follow rules when doing digit analysis. Digit analysis will look through every partition in a calling search space and looks for the best match. The order of the partitions listed in the calling search space is used only to break ties when there are equally good matches in two different partitions. If no partition is specified for a pattern, the pattern is listed in the null partition (as well as any partitions specified in their calling search space) to resolve dialed digits. The null partition is always the last partition looked through.

Example of Calling Search Space and Partition

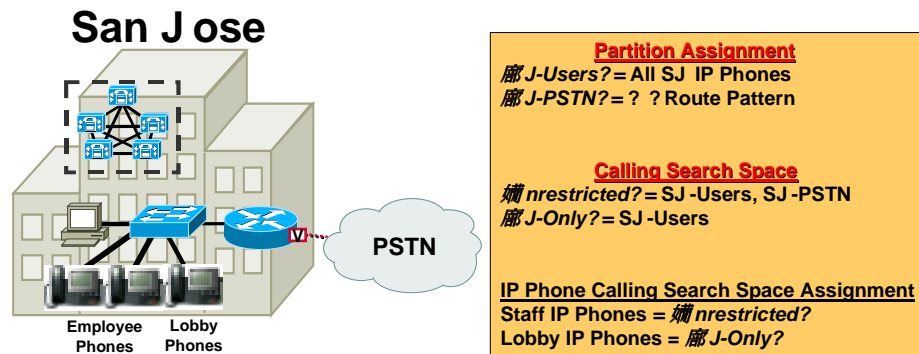

Employees 嬭 ay dial anywhere
Lobby phones 廊 nly can dial internal to SJ

© 2000, Cisco Systems, Inc.

www.cisco.com

CIPT v2.0? -22

The figure above illustrates a basic example of how partitions and calling search spaces may be used to provide dialing restrictions.

In this example staff employees have unrestricted dialing whereas the lobby phones only have the ability of dialing people within the local site. As noted in the diagram all IP phones are placed in the SJ-Users partition and the route pattern 9 associated with the PSTN is placed in the SJ-PSTN partition. Two calling search spaces are created that denote two different dialing characteristics. A calling search space called unrestricted is created that has both SJ-Users and SJ-PSTN Partitions in it. A second calling search space called SJ-Only is created with only the SJ-Users in it. San Jose staff IP phones are assigned the unrestricted calling search space denoting that they may dial anywhere. The lobby phones are assigned the SJ-Only calling search space meaning they can only dial local phones in the building.

Partition and Calling Search Space Assignments

Partition Name	Designated device's assigned to Partition
SJ-Users	All IP Phones within San Jose
SJ-External	All External Destined Route Patterns (Local PSTN)

Calling Party Search Space	Partitions	Assigned to
Unrestricted	SJ-Users SJ-External	Devices that can make Internal + external calls
SJ-Only	SJ-users	Devices that can make internal calls only

© 2000, Cisco Systems, Inc.

www.cisco.com

CIPT v2.0? -23

The figure above illustrates the prior configuration of creating two partitions that define reach-ability characteristics for a given site. One for internal local site users and one for external calls. Devices and route patterns will be placed in these partitions.

Partitions

Devices Placed in a Partition

Partitions with unique reachability Characteristics

Devices assigned to Partitions

Directory Number	Pattern Usage	Device	Port
1172	Device	SEP00503EFFF04ED	
1072	Device	SEP00503EFFF04ED	

© 2000, Cisco Systems, Inc.

www.cisco.com

CIPT v2.07 -24

The configuration of partitions starts with the assignment of devices in the Cisco CallManager Administration Partition Configuration page shown above.

Calling Search Space: 婿 here I can dial

The screenshot displays the Cisco CallManager Administration web interface. The main heading is 'Calling Search Space Configuration'. On the left, a navigation menu has 'Unrestricted' highlighted with a red box. The main content area shows configuration for a Calling Search Space named 'Unrestricted'. The 'Route Partitions' section is titled 'Route Partitions Unselected' and contains a list of selected partitions: 'S3 Users', 'S3 PSTN', 'S3Web', and 'PSTL'. An arrow points from a text box to the 'Route Partitions' list.

Devices assigned 婿 nrestricted Calling Search Space may call devices in any Partition

© 2000, Cisco Systems, Inc. www.cisco.com CIPT v2.0? -25

The Calling Search Space establishes where a user can call. Devices assigned unrestricted Calling Search Space may call devices in any partition.

Assigning Partitions and Calling Search Spaces 鐵 Global Phone Configuration Level

Only 鐵 alling Search Space? configured at main phone configuration

The screenshot shows the Cisco CallManager Administration interface for a phone configuration. The phone is identified as 005036FFD4ED (Gene Arantowicz). The 'Device Information' section includes fields for MAC address, Description, Device Pool, Location, Calling Search Space, and Button Template. The 'Calling Search Space' is currently set to 'Unrestricted'. A yellow callout box with an arrow points to this dropdown menu, containing the text: '鐵 alling Search Space can be assigned to IP phone'.

You will need to assign partitions and calling search spaces at the global Phone Configuration level. At the main Phone Configuration page, only the Calling Search Space is configured as shown in the example above.

The default setting for Calling Search Space allows a user to call anyone, but if other devices do not have a Calling Search Space of default, no one can call devices in the default group.

Assigning Partitions and Calling Search Spaces

Individual Line/DN Level

Individual Line configurations Override Main configuration

Partition Assigned at the Individual DN configuration level

Calling Search Space Can be assigned to Individual DN (Overrides Main Phone Configuration)

© 2000, Cisco Systems, Inc. www.cisco.com CIPT v2.0? -27

Assigning partitions and calling search space at the individual line or directory number (DN) level you are able to override main configuration. A DN can be assigned to a single partition and the calling search space that is selected can override the main phone configuration.

The above configuration example represents perhaps the simplest example of the required configuration for multi-site WAN local call processing. A more ambitious dial plan while outside of the scope of this document would perhaps include the following considerations:

1. Intra-site calls only
2. Intra-site and local emergency calls only
3. Intra and Inter-site calls only
4. Intra and Inter-site and local emergency calls only
5. Intra and Inter-site, local emergency, and local PSTN calls only
6. Intra and Inter-site, local emergency, and national long distance PSTN calls only
7. Fully unrestricted dialing including international numbers

Campus and Dial Plan Guidelines and Considerations

Depending on the number of paths a call could be potentially be routed the complexity of a dial plan may vary. The figure below depicts the most common uses of a dial plan scenario in campus environments.

Campus Dial Plans

In a campus environment with no multi-site IP WAN connectivity, the most common dial plan considerations that need to be made will be for providing PSTN access.

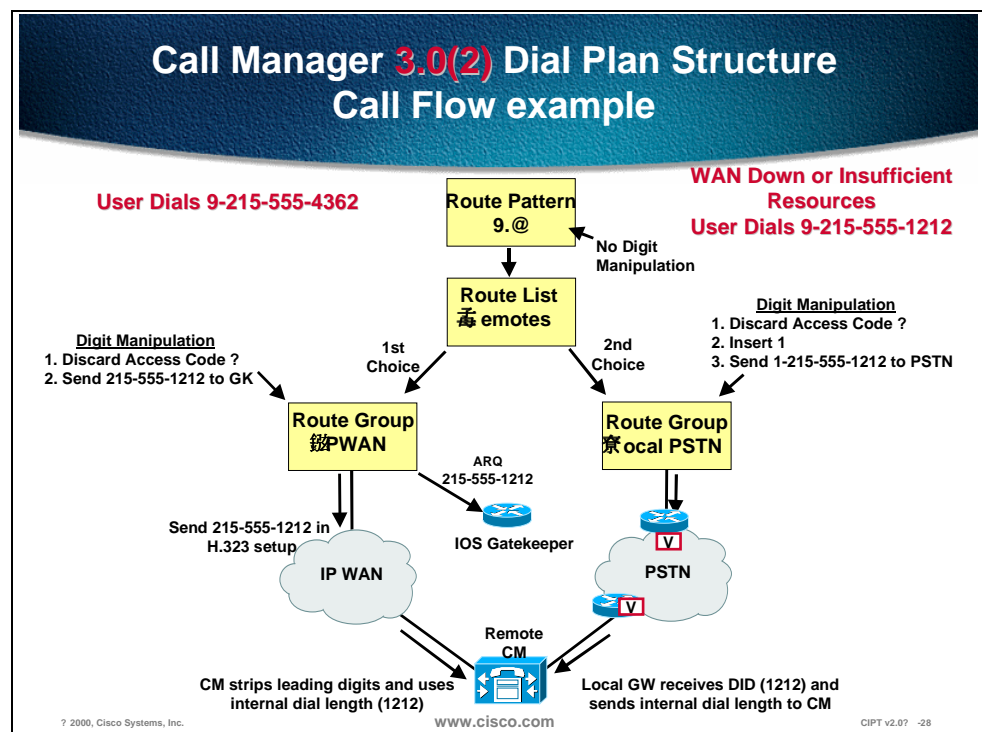

In the example, all users will have to dial five digits for internal dialing and will be required to dial the PSTN access code of 9 plus the 1—(area code)—(7 digit number) for all external long distance calls and 9 plus the (7 digit number) for local calls. Also provided will be gateway redundancy in the event a gateway or trunk failure to the PSTN. The PSTN gateways to be used will be IOS gateways using H.323.

Notice that the dial plan configuration in this model only requires a single route pattern. The 9.@ signifies that 9 is the local PSTN access code and the @ signifies the North American dialing plan in this case.

The route pattern 9.@ for North American dialing 911 services are included. Note that specified in the route group Discard Access Code is selected for digit manipulation. This will strip off the 9 so that 1—(area code)—(7 digit number) or the (7 digit number) is sent to the local PSTN gateway, which is an IOS

gateway in this case. The CallManager denotes any digits to the left of the “.” as the access code so when Discard Access Code is selected it will strip off any digits to the left of the “.”. Note that in the route group two gateways are listed in order of preference. This is how gateway redundancy will be achieved in the event of an all trunks busy condition or a gateway failure.

Local PSTN GW Configuration

For Incoming Calls
Assuming DID
(Direct Inward Dial)

For Outgoing Calls

Global Configuration
Mode

```

dial-peer voice 1 voip
  codec g711ulaw
  dtmf-relay h245-alphanumeric
  destination-pattern 6...
  session target ipv4:10.1.10.5
!
dial-peer voice 2 pots
  destination-pattern ?
  port 1/0:1
!
dial-peer voice 3 pots
  destination-pattern 1?
  prefix 1
  port 1/0:1
!
dial-peer voice 4 pots
  destination-pattern 911
  prefix 911
  port 1/0:1
  
```

Dial-Peer for all incoming calls from PSTN to Call Manager IP Address Must be G.711

Call Manager IP Address

Dial Peer for all 7 digit outgoing PSTN Numbers

Dial Peer for all 10 digit outgoing PSTN Numbers

Dial Peer for 911 Services

Note - For ON DID? Incoming Calls (Analog trunks)

1. Dedicate each incoming trunk to user with connection PLAR or
2. Send all calls to an Attendant

© 2000, Cisco Systems, Inc.

www.cisco.com

CIPT v2.07 -29

Above is the configuration required in each IOS PSTN gateway. The goal is to be able to configure the IOS H.323 gateway with a minimum amount of entries as possible. The ideal situation is that all the dial plan configuration would occur in CallManager. This is the case with skinny + MGCP based gateways. However the more prominent gateways available are H.323 based so they are used in the following example:

The above configuration would assume that 1 + 10 digit dialing would be required for long distance calls to the PSTN and where 7 digit dialing would be required for local PSTN calling.

Note that within the scope of 9.@ that emergency 911 services are included. That means a user dialing 911 will get sent out the PSTN trunks automatically however the IOS H.323 gateway still requires a dial peer for 911 as depicted. Various dial peers can be added for 411 + 611 services, which are included in the scope of the 9.@ route pattern as well.

Summary

This section summarizes the concepts you learned in this chapter.

Summary

- **The dial plan architecture is designed to handle internal and external calls.**
- **Partitions and calling search spaces are analogous to routers with access lists.**
- **Cisco CallManager provides digit translation.**

© 2000, Cisco Systems, Inc. www.cisco.com CIPT v2.0? -30

The CallManager's dial plan architecture is setup to handle generally two types of calls:

- Internal calls to IP phones registered to the CallManager cluster itself
- External calls via a PSTN gateway or to another CallManager cluster via the IP WAN

Partitions and calling search spaces draw an analogy to routers with access lists. Think of a partition as an IP subnet where you will place users. A calling search space is likened to an inbound access list that dictates which subnet you can reach.

The capability exists within CallManager to provide for digit translation. This is the ability of translating a dialed number into another number or even changing the number of digits. This can be achieved for internal as well as external calls whether inbound or outbound. Translation table may be configured such that when a user dials a 0 then call gets delivered to an attendant who may have an extension that is 1111.

Review Questions

Answer the following questions.

Review Questions

- 1. In a CIPT solution what is an example of alternate path routing?**
- 2. What is the recommended order for configuring a route pattern?**
- 3. How are partitions and calling search spaces related?**

© 2000, Cisco Systems, Inc.www.cisco.comCIPT v2.07 -31

- Q1) The Cisco IP telephony solution takes full advantage of an IP network. What is an example of alternate path call routing in a CIPT solution?
- Q2) Route groups, devices, route pattern and route list are parts that need to be configured for a route pattern. What is the recommended order for configuring a route pattern?
- Q3) Partitions and calling search spaces provide calling restrictions on a per phone basis as well as the creation of closed dial plan groups on the same CallManager. What is the relationship between partitions and calling search spaces?

Cisco Access Gateways

Overview

The Cisco AVVID telephony solution offers multiple methods of connecting an IP telephony network to the PSTN, legacy PBX, and key systems. Choosing a gateway from a list of twenty products can be daunting when first attempted. Cisco's product line ranges from specialized, entry-level stand-alone voice gateways to the high-end, feature rich Integrated Router and Catalyst gateways. However, once a list of required features is combined with the long-term needs of the product, a gateway solution can be found.

This chapter discusses the Cisco access gateways that are in the CIPT environment and includes the following topics:

- Objectives
- Gateway Requirements
- Single-Site Enterprise Deployments
- Install and Configure Commands
- Laboratory Exercise
- Summary
- Review Questions

Objectives

This section lists the chapter objectives.

Objectives

Upon completion of this chapter, you will be able to perform the following tasks:

- **Identify the criteria needed to select a gateway**
- **Identify and describe the hardware components of the Cisco access gateways**
- **Add and Configure the selected Cisco access gateway**

? 2000, Cisco Systems, Inc. www.cisco.com CIPT v2.0? -3

Upon completion of this chapter, you will be able to complete the following tasks:

- Given a case study of existing networking and telephony components, identify the criteria needed to select a gateway.
- Given a Cisco access gateway, identify and describe the hardware components of the Cisco access gateways.
- Given a Cisco access gateway and network topology, add and configure the selected Cisco access gateway to the CIPT network.

Gateway Requirements

This section describes the gateway requirements. Different gateway protocols are supported with Cisco CallManager. The tables below show which gateways support a given protocol.

Gateway Protocol Matrix			
Gateway	MGCP	H.323	Skinny Station Protocol
VG200	Yes	Phase 2	No
DT-24+ /DE-30+	No	No	Yes
Catalyst 4000 WS-X4604- GWY Gateway Module	Future	Yes, for PSTN Interfaces	Yes, for Conferencing and MTP/ Transcoding Services
Catalyst 6000 WS-X6608-x1 Gateway Module	Future	No	Yes

© 2000, Cisco Systems, Inc. www.cisco.com CIPT v2.07 -4

Cisco Router Protocol Matrix

Gateway	MGCP	H.323	Skinny Station Protocol
1750	No	Yes	No
3810 V3	Future	Yes	No
2600	Future	Yes	No
3600	Future	Yes	No
7200	No	Yes	No
7500	No	Future	No
5300	No	Yes	No

© 2000, Cisco Systems, Inc.

www.cisco.com

CIPT v2.07 -5

The skinny gateways are a series of digital gateways that include the DT-24+, the DT-30+, and Catalyst 6000 Voice Gateway module. The H.323 protocol is in the Cisco IOS integrated router gateways that use H.323 to communicate with CallManager. The new Media Gateway Control Protocol (MGCP) is used by the Cisco CallManager to control the new stand-alone gateway and the VG200 analog gateway. Each of these protocols follows a slightly different methodology to provide support for the three core gateway features. How each protocol solves these requirements is detailed below.

Note The VG200 only supports FXS and FXO interfaces in MGCP mode. A wider interface selection will be offered in the next product releases, when the VG200 supports H.323v2. While the 5300 supports MGCP, it's currently incompatible with the CallManager. Although the 3810, 2600, and 3600 products get MGCP for analog interfaces in 12.1(3)T, they will not be officially supported by the CallManager until 3.0(2), when the MGCP administrative interface is expanded to incorporate larger numbers of analog interfaces.

Core Gateway Requirements

- **DTMF relay capabilities**
- **Support for supplementary services**
- **Ability to handle clustered CallManagers**

© 2000, Cisco Systems, Inc.

www.cisco.com

CIPT v2.07 -6

The Cisco AVVID gateway selection is made by combining common or core requirements with site and implementation specific features. The three core requirements for an AVVID gateway are the following:

- DTMF relay capabilities
- Support for supplementary services
- The ability to handle clustered CallManagers

Any gateway selected for an enterprise deployment should have the ability to support these features. Additionally, every AVVID implementation will have it's own site-specific feature requirements.

Requirement gathering is a critical component of design of any network. If incorrect assumptions are made, the design could be faulty from the beginning with no chance of a successful implementation. Validation of the base requirements is critical to success.

DTMF Relay

DTMF Relay

- **Signaling method that uses specific pairs of frequencies within the voiceband for signals**
- **Signals carried without difficulty over a 64kbps PCM voice channel**
- **DTMF signal loss or distortion when using a low bite-rate codec for voice compression**
- **Provide an out-of-band signaling method for carrying DTMF tones across a Voice over IP infrastructure**

© 2000, Cisco Systems, Inc.

www.cisco.com

CIPT v2.0? -7

Dual-Tone Multifrequency (DTMF) is a signaling method that uses specific pairs of frequencies within the voiceband for signals. The signal in this case is the digits. In voice, signal means on-hook, off-hook, and so forth. The actual representation of the two frequencies is a number or digit. Over a 64kbps PCM voice channel, these signals can be carried without difficulty. However, when using a low bite-rate codec for voice compression, the potential exist for DTMF signal loss or distortion. An elegant solution for these codec induced symptoms is providing an out-of-band signaling method for carrying DTMF tones across a Voice over IP infrastructure.

Gateways Supporting DTMF

- **Skinny gateways**
 - DT-24+ /DE-30+
 - Catalyst 6000 gateways
- **H.323 gateways**
 - c1750, c2600, c3600, c7200, as5300, 3810 v3, and VG200 (T1 CAS)
- **MGCP gateways—VG200**

© 2000, Cisco Systems, Inc.

www.cisco.com

CIPT v2.07 -8

Skinny Gateways

The DT-24+/DE-30+ products and the Catalyst 6000 gateway utilize the skinny gateway protocol to carry DTMF signals out-of-band using the TCP port 2002. out-of-band DTMF is the default gateway configuration mode.

H.323 Gateway Out-of-Band DTMF Configuration

```
Router(config)#  
dial-peer voice 100 voip  
destination-pattern 555?  
session target ipv4:10.1.1.1  
codec g729ar8  
dtmf-relay h245-alphanumeric  
preference 0
```

© 2000, Cisco Systems, Inc.

www.cisco.com

CIPT v2.07 -9

H.323 Gateways

The c1750, c2600, c3600, c7200, and as5300 series products communicate with the CallManager using H.323. Both CallManager 3.0 and Cisco IOS release 12.0(7)T, include the enhanced H.245 capability for exchanging DTMF signals out-of-band. The figure above shows an example out-of-band DTMF configuration on an IOS gateway.

Only the 3810 V3 with the new High Compression Module (HCM) voice compression modules will support H.245 DTMF relay due to memory limitations on the TI542 DSP used on previous 3810 versions.

MGCP DTMF Relay Configuration

```
Router(config)#  
mgcp dtmf-relay codec all mode out-of-band
```

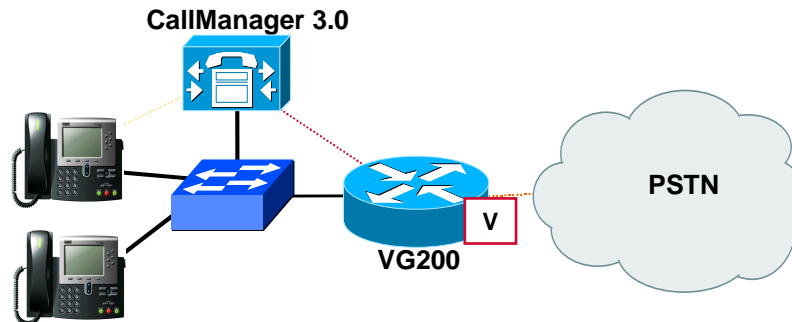

MGCP Gateway

The VG200 uses MGCP for CallManager communication. Within the MGCP protocol is the concept of *packages*. The VG200 loads the DTMF package upon start-up. Once the out-of-band DTMF capabilities are configured in the CallManager MGCP gateway GUI, the VG200 will send *symbols* over the UDP control channel to represent any DTMF tones it receives. CallManager will interpret these signals and pass on the DTMF signals, out-of-band, to the signaling endpoint. The figure above shows the global configuration command for DTMF relay VG200.

Additional configuration parameters must be entered in the Cisco CallManager Administration MGCP gateway configuration interface.

Supplementary Services

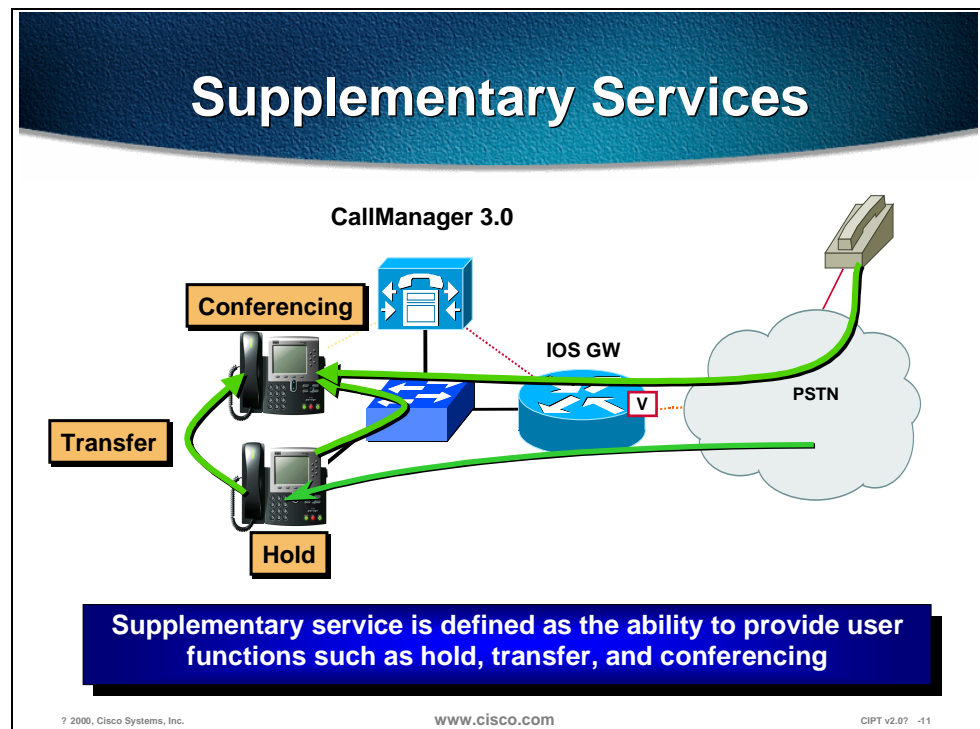

Supplementary service is defined as the ability to provide user functions such as hold, transfer, and conferencing. These are considered fundamental requirements of any voice installation. Each gateway evaluated for use in a CIPT network should provide support for supplementary services natively.

Skinny Gateways

The DT-24+/DE-30+ and Catalyst 6000 series gateways provide full supplementary service support. The skinny gateways utilize the gateway-to-CallManager signaling channel and skinny gateway protocol to exchange call control parameters.

H.323 Gateways

Only H.323v1 was supported prior to the release of CallManager 3.0. The inability to modify the destination of an RTP stream after H.323v1 call setup eliminated supplementary services like hold, forward and transfer. Because H.323v1 provides no capability to move an RTP stream from one destination to another after original call setup, the software Media Termination Point (MTP) tool was used to provide supplementary service support on the IOS gateways. MTP, which runs as a software process on either the CallManager or a separate NT 4.0 server, terminated the RTP stream from the IOS gateway and the RTP stream from an IP phone. This workaround enabled an IP phone to use supplementary services when using an IOS VoIP gateway because the RTP stream from the MTP to the IOS gateway is never modified until call completion. All RTP streams changes are made on the skinny station side of the MTP connection.

H.323v2 Open/Close LogicalChannel for Supplementary Services

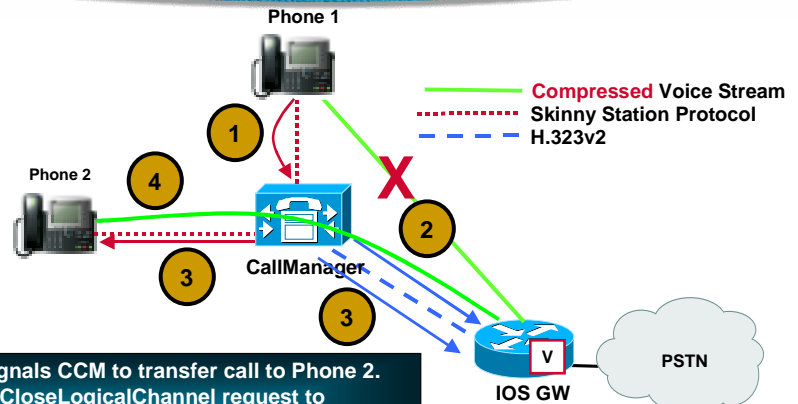

1. Phone 1 signals CCM to transfer call to Phone 2.
2. CCM send CloseLogicalChannel request to IOS GW; IOS GW acknowledges.
3. CCM sends Skinny setup msg to Phone 2; sends IOS GW an OpenLogicalChannel request with new DestinationID for the existing SessionID.
4. Bearer path setup.

© 2000, Cisco Systems, Inc.

www.cisco.com

CIPT v2.0-8-12

With the use of H.323v2 in IOS release 12.0(7)T, specifically the Open/Close LogicalChannel and the emptyCapabilitySet, by IOS Gateways and CallManager 3.0, the requirement for software MTP to provide supplementary services is eliminated. MTP is no longer needed to terminate the G.711.

RTP streams from both the IP phones and the IOS gateway and compressed voice calls, specifically G.723.1 and G.729a, are now supported between IOS gateways and CallManager endpoints. Once an H.323v2 call is set up between an IOS GW and an IP phone, using the CCM as an H.323 proxy, the IP phone can request to modify the bearer connection. Because the RTP stream is directly connected to the IP phone from the IOS GW, a supported voice codec can be negotiated. If IP phone 1 wishes to transfer the call from the IOS gateway to IP phone 2, it will issue a “transfer request” to the CallManager via the skinny station protocol. The CCM will translate this request into an H.323v2 CloseLogicalChannel request to the IOS gateway for the appropriate SessionID. The IOS Gateway will close the RTP channel to IP phone 1. The CCM will then issue a request to IP phone 2, using skinny station, to set up an RTP connection to the IOS gateway. At the same time, the CallManager will issue an OpenLogicalChannel request to the IOS gateway with the new destination parameters, but using the same SessionID. After the IOS gateway acknowledges the request, an RTP voice bearer channel is set between IP phone 2 and the IOS gateway.

VG200: MGCP and Supplementary Services

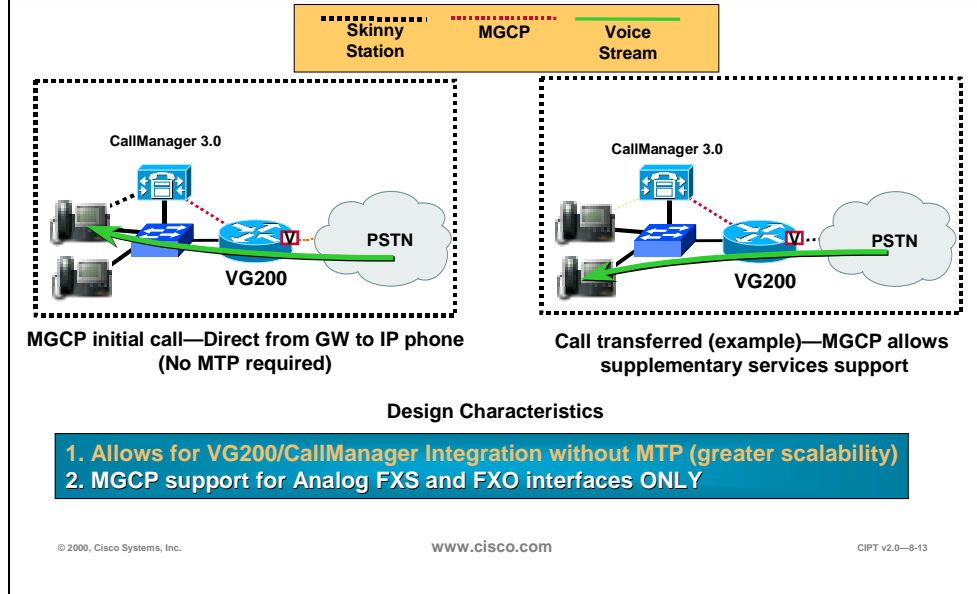

MGCP Gateway

The VG200 provides full support for the hold, transfer, and conference features through the MGCP protocol. Because MGCP is fundamentally a master/slave protocol with the CallManager controlling all session intelligence, it can easily manipulate VG200 voice connections. If a CIPT end-point needed to modify the session (that is, transfer the call to another CIPT end-point), the end-point would notify the CallManager via the skinny station protocol. The CallManager will then inform the VG200, using the MGCP UDP control connection, to terminate the current RTP stream associated with the SessionID and start a new media session with the new end-point information.

CallManager Redundancy

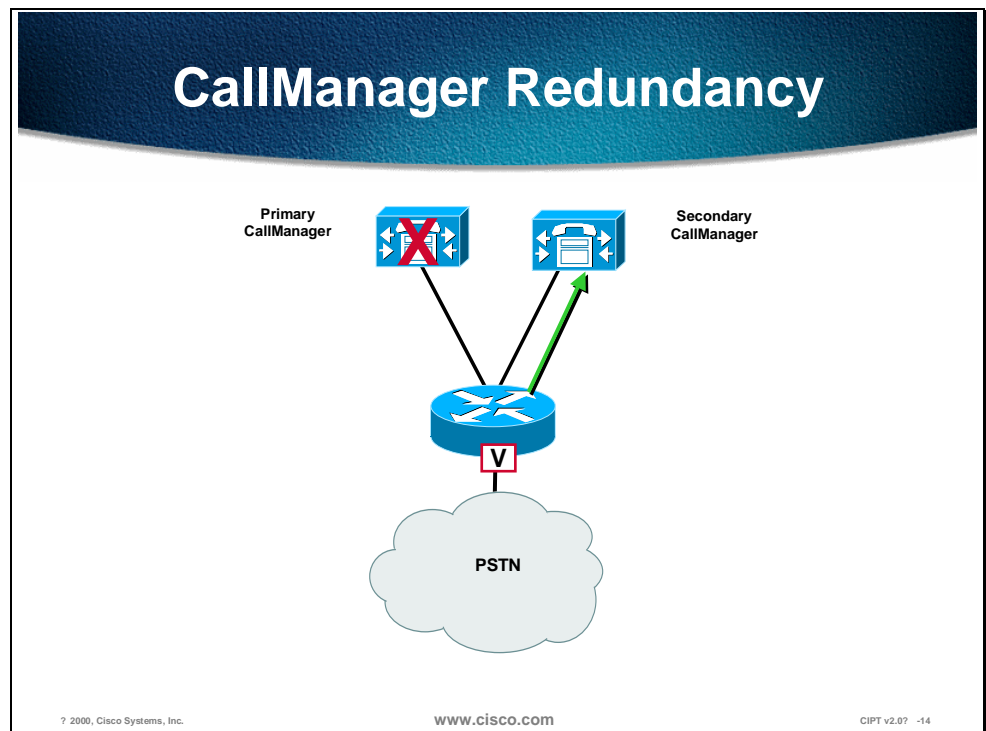

An integral piece of the CIPT architecture is the provision of low-cost, distributed PC-based systems to replace expensive and proprietary legacy PBX systems. This “distributed” design lends itself to the robust fault tolerant architecture of clustered CallManagers. Even in its most simplistic form (that is, only a two-system cluster), a secondary CallManager should be able to pick-up control of all gateways initially managed by the primary Cisco CallManager.

Skinny Gateways

The DT-24+/DE-30+ and Catalyst 6000 digital skinny gateways are provisioned with CallManager location information upon boot-up. When these gateways initialize, a list of CallManagers is downloaded to the gateways. This list is prioritized into a primary Cisco CallManager and secondary Cisco CallManager. In the event that the primary CallManager becomes unreachable, the gateway will register with the secondary CallManager.

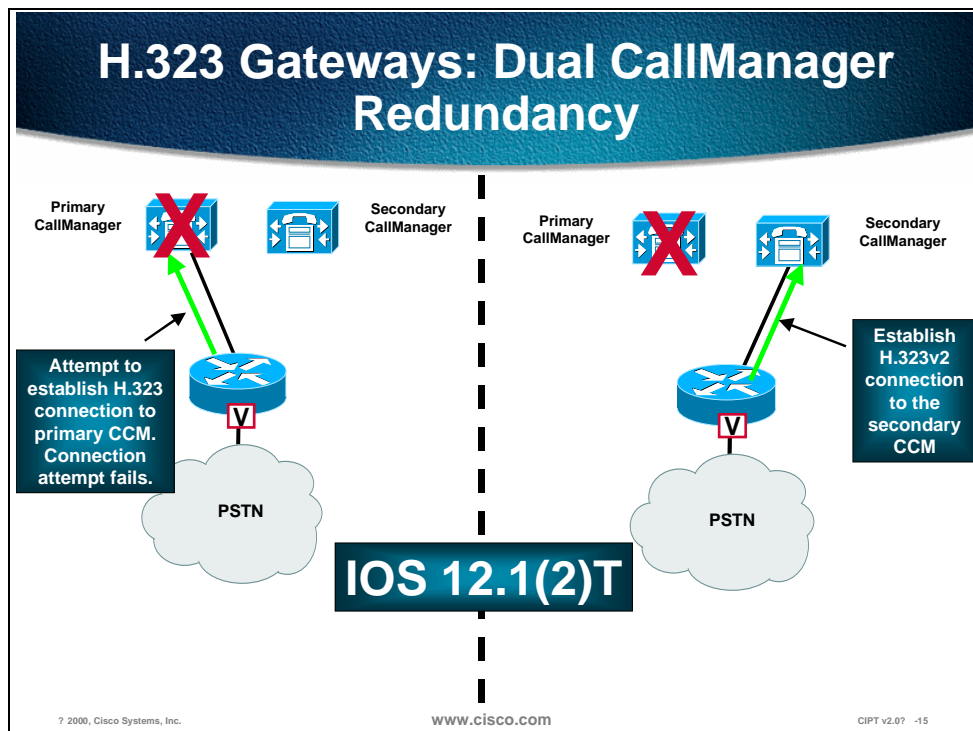

H.323 Gateways

Using several enhancements to the *dial-peer* and *voice class* command sets in IOS release 12.1(2)T, IOS gateways can now support redundant CallManagers, as well. A new command **H.225 tcp timeout <seconds>** has been added. This tracks the time it takes for the IOS gateway to establish an H.225 control connection for H.323 call setup. If the IOS gateway can't establish an H.225 connection to the primary CallManager, it will try a second CallManager defined in another *dial-peer* statement. The IOS gateway will shift to the *dial-peer* statement with next highest *preference* setting. The following page shows the CLI commands needed to configure H.323 gateway failover.

H.323 Gateway CallManager Redundancy

```
Router(config)#
dial-peer voice 101 voip
  destination-pattern 1111
  session target ipv4:10.1.1.101
  preference 0
  voice class h323 1
Router(config)#
dial-peer voice 102 voip
  destination-pattern 1111
  session target ipv4:10.1.1.102
  preference 1
  voice class h323 1
Router(config)#
voice class h323 1
  h225 tcp timeout <1-30 sec>
```

© 2000, Cisco Systems, Inc.

www.cisco.com

CIPT v2.0? -16

The figure above is an example of CLI IOS gateway CallManager redundancy. For the H.225 TCP timeout there is a value range that can be entered.

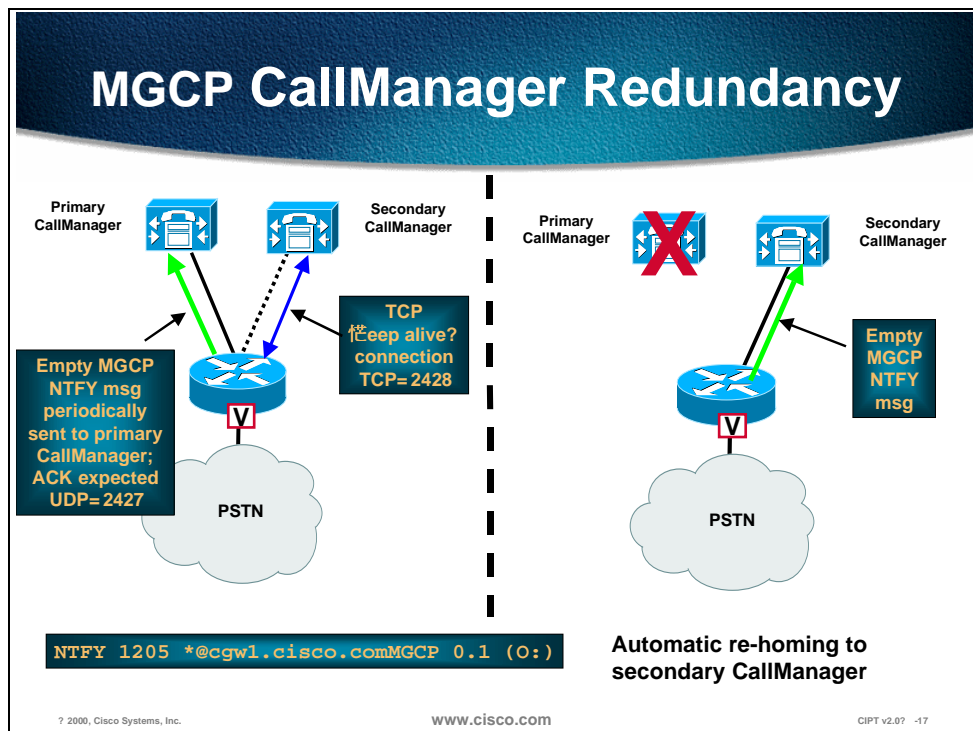

MGCP Gateway

Adding MGCP to the VG200 and the Cisco CallManager provides this stand-alone gateway with the ability to failover to a secondary CallManager in the event communication loss with the primary CallManager. Within the VG200 configuration file, the primary Cisco CallManager will be identified using the **call-agent <hostname>** command and a list of secondary CallManager will be added using the **ccm-manager redundant-host** command. Keep alives with the actively associated Cisco CallManager will be through the MGCP application-level keep alive mechanism, whereby the GW will send an empty MGCP NTFY message to the Cisco CallManager and wait for an acknowledgement. Keep alive with the backup Cisco CallManager(s) will be through the TCP (RTP/UDP will be utilized in a later version) keep-alive mechanism.

Switchback to Primary CCM

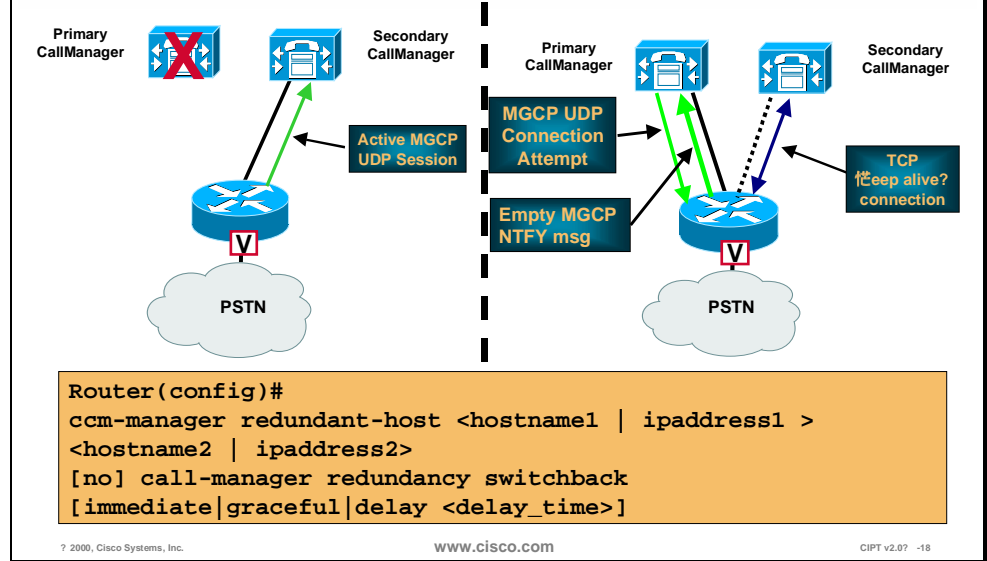

If the primary CallManager becomes available at a later time, the VG200 can re-home back to the original CCM. This fallback can either occur immediately, after a configurable amount of time or only when all connected sessions have been released. This is enabled through the following VG200 global configuration command:

MGCP CCM failover commands are the following:

```
cmm-manager redundant-host <hostname1 | ipaddress1 >  
<hostname2 | ipaddress2>
```

```
[no] cmm-manager switchback  
[immediate|graceful|delay <delay_time>|schedule-time]
```

The settings for the Cisco CallManager redundancy switchback are defined as follows:

- Immediate—The moment the primary Cisco CallManager is running all devices (on a call or not) will immediately switchback from the secondary.
- Graceful—When the primary Cisco CallManager is back running, devices will wait until they are not on a call to switchback from the secondary.
- Delay—A time (seconds) can be set when devices will switchback from the secondary after the primary is running.
- Schedule-Time—Allows you to schedule a time for switchback.

Site-Specific Gateway Requirements

Each AVVID implementation will have its own gateway requirements. Below is a sample list of questions that should be asked prior to any AVVID gateway selection.

Requirements Gathering

- **Is an analog or digital gateway required?**
- **What is the required capacity of the gateway?**
- **What type of connection is the gateway going to use? FXO-Ground-Start? Network-side or user-side PRI?**
- **What types of supplementary services are wanted?**
- **Is voice compression a part of the design? If so, which types?**
- **Is Direct-Inward-Dial (DID) required?**
- **Is Calling Line ID (CLID) needed?**
- **Is FAX-relay needed?**
- **What type of network management interface is preferred?**
- **To which country will the hardware be shipped?**
- **Is rack space available for all needed gateways, routers, and switches?**

© 2000, Cisco Systems, Inc. www.cisco.com CIPT v2.07 -19

The above questions should be asked prior to installation for the purpose of defining gateway functions. The purpose is to find out if the proposed design will encompass growth and future needs. Along with growth and future needs, there also needs to be questions answered about migration from one version to another.

Direct-Inward-Dial (DID) is a private branch exchange (PBX) or Centrex feature that permits outside calls to be placed directly to a station line without the use of an operator.

Calling Line Identification (CLI/CLID/ANI) is a service available on digital phone networks that tells the person being called which number is calling them. The central office equipment identifies the phone number of the caller, enabling information about the caller to be sent along the call itself. CLID is synonymous with ANI (Automatic Number Identification).

Of course, the feature list might be much longer than this example. However, this list is a good start to help narrow down the possible choices. Once the features have been defined, a gateway selection can be made for each of the pertinent configurations; single-site enterprise deployments of various sizes and complexities and multi-site enterprise deployments. Both of these categories are defined in more depth in the following sections.

Cisco Gateway PSTN Signaling? Analog

Gateway	FXS	FXO	E&M	Analog DID/CLID
VG200	Yes	Yes	Yes	Future
DT-X+	No	No	No	N/A
1750	Yes	Yes	Yes	Future
3810 V3	Yes	Yes	Yes	12.1(4)T/12.1(2)Xx
2600	Yes	Yes	Yes	12.1(4)T/12.1(2)Xx
3600	Yes	Yes	Yes	12.1(4)T/12.1(2)Xx
7200	No	No	No	N/A
7500	No	No	No	N/A
5300	No	No	No	N/A
Catalyst 4000 WS-X4604-GWY	Yes	Yes	Yes	12.1(4)T/12.1(2)Xx
Catalyst 6000 WS-X6608-x1	Yes	No	No	No/Yes

© 2000, Cisco Systems, Inc.

www.cisco.com

CIPT v2.0? -20

To help focus on a gateway, the site-specific feature list can be compared to tables in the figures above and below, which correlate analog and digital gateways respectively, with supported telephony features.

Cisco Gateway PSTN Signaling 燃 Digital

Gateway	T1 CAS	E1/R2	E1 CAS	User Side PRI	Network Side PRI	User Side BRI	Network Side BRI	Digital DID/CLID
VG200	Yes	No	No	No	No	No	No	N/A
DT-X+	No	No	No	Yes	Yes	No	No	Yes
1750	No	No	No	No	No	Future	Future	N/A
3810 V3	Yes	No	Yes	No	No	Yes	No	Yes
2600	Yes	12.1(2)Xx	12.1(2)Xx	12.1(2)Xx	12.1(2)Xx*	Yes	Future	Yes/Yes**
3600	Yes	12.1(2)Xx	12.1(2)Xx	12.1(2)Xx	12.1(2)Xx*	Yes	Future	Yes/Yes**
7200	Yes	Future	Future	12.1(3)T	12.1(3)T*	No	No	Yes/Yes**
7500	Future	Future	Future	Future	Future	No	No	Yes/Yes**
5300	Yes	Yes	Yes	Yes	12.0.7T*	No	No	Yes/Yes
Catalyst 4000 WS-X4604-GWY	Yes	Yes	Yes	Yes	Yes	Future	Future	Yes/Yes**
Catalyst 6000 WS-X6608-x1	No	No	No	Yes	Yes	No	No	Yes/Yes

© 2000, Cisco Systems, Inc.

www.cisco.com

CIPT v2.0? -21

Stand-Alone Gateways

Stand-Alone Gateways

- ~~AS-2, 4 and 8 - Skinny~~
- ~~AT-2, 4 and 8 - Skinny~~
- ~~DT-24/DE-30 - Skinny~~
- AS5300 鑽 .323v2
- DT-24+ /DE-30+ 珣 skinny
- VG200 蕨 GCP/H.323v2

© 2000, Cisco Systems, Inc. www.cisco.com CIPT v2.07 -22

Stand alone gateways and which protocols they use include the following:

- AS-2, 4 and 8—skinny protocol
- AT-2, 4, and 8—skinny protocol
- DT-24/DE-30—skinny protocol
- AS5300—H.323v2
- DT-24+/DE-30+—skinny protocol
- VG200—MGCP/H.323v2

The AS, AT, and DT-24/DE-30 are still supported and will end of sale very shortly.

The DT-24 and DE-30 are replaced by the DT-24+/DE30+ and the analog station and analog trunks are being replaced by the VG200.

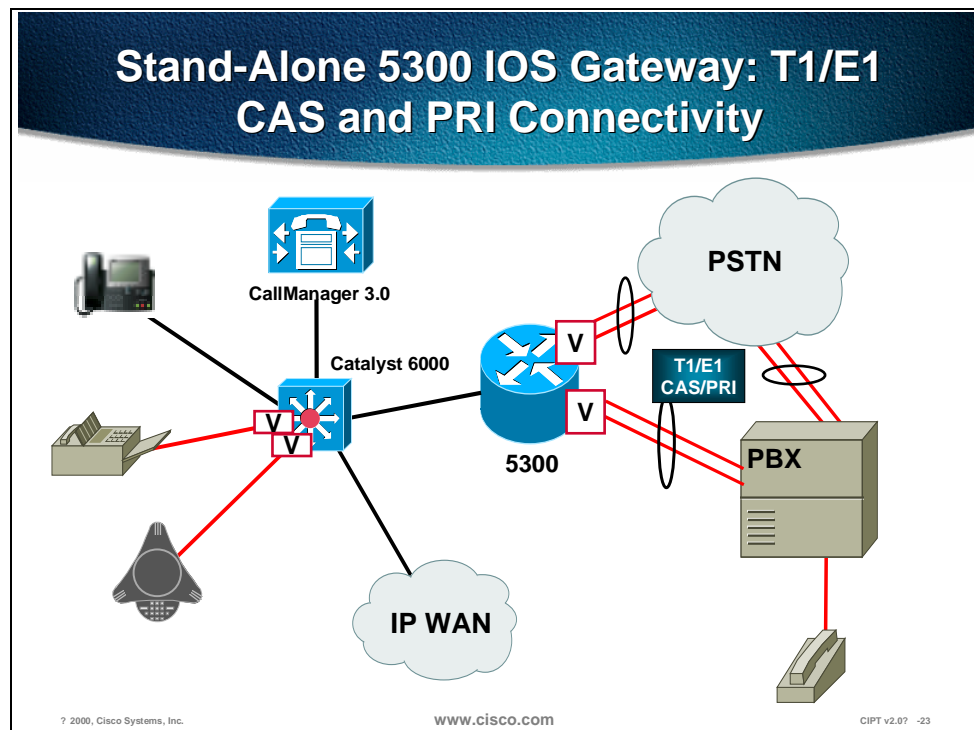

The Cisco IOS Gateway AS5300 is capable of providing T1/E1 CAS and PRI connectivity, as shown in the figure above, to the PSTN or PBX.

DT-24+ /DT-30+ Stand-Alone Gateways

- **T1/E1 PRI**
- **User/network side ISDN**
- **Skinny gateway**
 - Supplementary services
 - Out-of-band DTMF
 - CCM failover
- **G.711/G.723.1**

© 2000, Cisco Systems, Inc.

www.cisco.com

CIPT v2.07 -24

The DT-24+/DE-30+, that replaced the DT-24 and DE 30 respectively, are capable of T1/E1 PRI, user/network side ISDN and G.711/G.732.1. The DT-24+/DE-30+ are skinny gateways the provide the following services:

- Supplementary services (hold, transfer, and so forth)
- Out-of-band DTMF
- Cisco CallManager failover

VG200 Stand-Alone Gateway

VG200 在 MGCP 模式

- 2xFXS/2xFXO
- Analog only
- **NO** FAX-relay 支持 .711 FAX support only

VG200 在 H.323v2 模式

- T1/E1 CAS, FXS, FXO, and E&M

7 2000, Cisco Systems, Inc. www.cisco.com CIPT v2.0? -25

The Voice Gateway 200 (VG200) replaces the analog stations and analog trunks. In the MGCP mode, the VG200 is capable of providing the following:

- 2xFXS/2xFXO
- Analog only
- G.711 FAX support only—no FAX-relay

When the VG200 is using H.323v2 mode, it is capable of T1/E1 CAS, FXS, FXO, and E&M.

High Level Concepts

- **Media Gateway (MG)** contains simple endpoints
- Services provided by intelligent **Media Gateway Controller (MGC)** or **Call Agent (CA)**
- Endpoint provides user interactions and interfaces; MGC provides centralized call intelligence
- Master/slave relationship between MGC and MG
- Simple endpoint executes small set of simple transactions as instructed by MGC
- New services introduced by MGC
- Inexpensive endpoint can be mass-produced

© 2000, Cisco Systems, Inc.

www.cisco.com

CIPT v2.07 -26

What is MGCP? Media Gateway (MG) contains simple endpoints Services provided by an intelligent Media Gateway Controller (MGC) or Call Agent(CA). The endpoints provide users interactions and interfaces and the MGC provides centralized call intelligence. Between MGC and MG there is master/slave relationship. This simple endpoint executes a small set of simple transactions as instructed by MGC.

New services will be introduced to MGC and it is an inexpensive endpoint that can be mass produced.

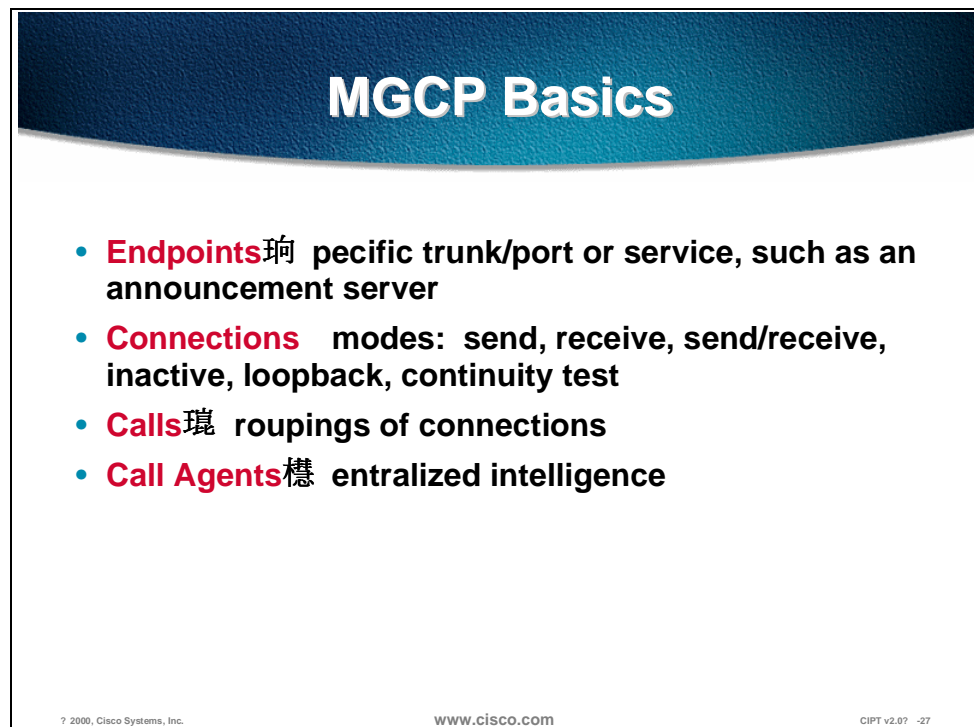

The slide features a dark blue header with the title "MGCP Basics" in white. Below the header, there is a bulleted list of four items. At the bottom of the slide, there is a footer with three small pieces of text: a copyright notice, a website URL, and a version number.

- **Endpoints**—specific trunk/port or service, such as an announcement server
- **Connections**—modes: send, receive, send/receive, inactive, loopback, continuity test
- **Calls**—groupings of connections
- **Call Agents**—centralized intelligence

© 2000, Cisco Systems, Inc. www.cisco.com CIPT v2.0? -27

The following are the basic concepts and terms used with MGCP:

- Endpoints—specific trunk/port or service, such as an announcement server
- Connections—modes: send, receive, send/receive, inactive, loopback, continuity test
- Calls—groupings or connections
- Call Agents—centralized intelligence

MGCP Primitives

- **NotificationRequest (RQNT)** 鑄 nstructs the gateway to watch for specific events
- **Notify (NTFY)** 鑄 nform MGC when requested events occur
- **CreateConnection (CRCX)** 緝 reate a connection to an 培 ndpoint? inside the gateway
- **ModifyConnection (MDCX)** 緝 hange the parameters associated with an established connection
- **DeleteConnection** 燻 elete an existing connection 娉 ck returns call statistics
- **AuditEndpoint (AUEP)** 娉 duit an existing endpoint
- **AuditConnection (AUCX)** 娉 duit an existing connection
- **RestartInProgress (RSIP)** 鑄 ateway notification to the MGC that a MG or endpoint is restarting or stopping

? 2000, Cisco Systems, Inc. www.cisco.com CIPT v2.07 -28

The MGCP primitives are the components that allow CIPT to discontinue its dependence on software MTP. The emerging standard has been proposed by Cisco as a means to counter some limitations of the H.323 protocol suite.

The following are MGCP primitive terms and definitions:

- NotificationRequest (RQNT)—Instructs the gateway to watch for specific events
- Notify (NTFY)—Inform MGC when requested events occur
- CreateConnection (MDCX)—Change the parameters associated with an established connection
- DeleteConnection—Delete an existing connection—Ack returns call statistics
- AuditEndpoint (AUEP)—Audit an existing endpoint
- AuditConnection (AUCX)—Audit an existing connection
- RestartInProgress (RSIP)—Gateway notification to the MGC that a MG or endpoint is restarting or stopping

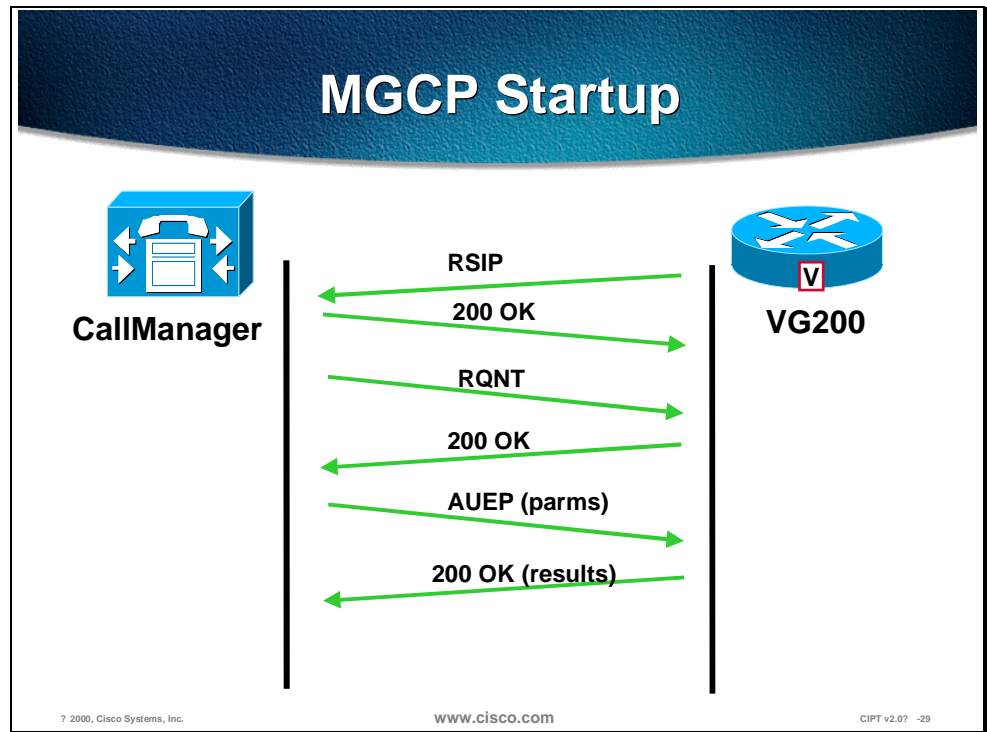

The figure above shows the communication between the Cisco CallManager and VG200 using MGCP on startup. The process is as follows:

1. RestartInProgress (RSIP) is sent from the VG200 to the Cisco CallManager telling the Cisco CallManager an endpoint is restarting or starting up.
2. The Cisco CallManager acknowledges with a 200 OK.
3. The Cisco CallManager sends a NotificationRequest (RQNT) to the VG 200 instructing the gateway to watch for specific events.
4. The VG200 acknowledges with a 200 OK.
5. Cisco CallManager sends an AuditEndpoint (AUEP) in order to audit the existing endpoint (VG200).
6. The VG200 acknowledges with a 200 OK with the results of the audit.

MGCP FXS Call

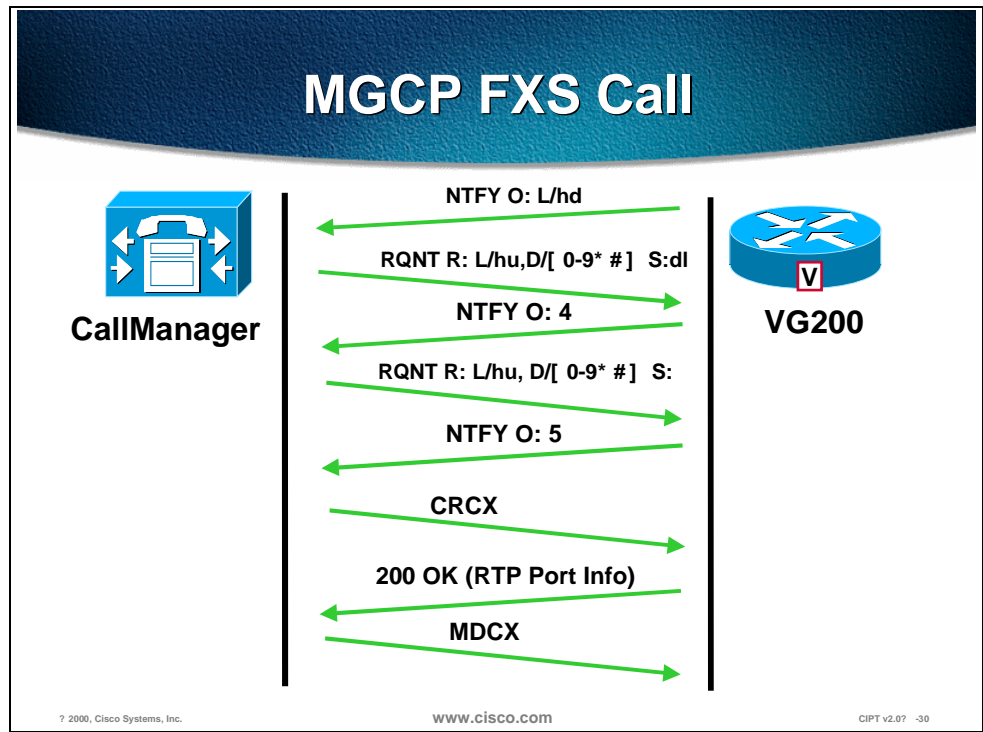

The figure above shows the procedure when a MGCP makes an FXS Call. The procedure is as follows:

1. The FXS phone goes offhook, GW sends notify (NTFY) for offhook event.
2. Cisco CallManager sends request notify (RQNT) with digit map and signal to turn on dial tone. CallManager requests each digit is sent individually (not accumulated).
3. User presses first digit.
4. NTFY sent to Cisco CallManager, Cisco CallManager sends RQNT to turn off dial tone.
5. User sends digit.
6. Cisco CallManager sends create connection (CRCX) to create a call leg. GW sends response with RTP SDP parameters (IP address and port for audio stream). Cisco CallManager sets up connection with remote RTP endpoint and starts ringing tone to caller.
7. Cisco CallManager sends modify connection (MDCX) to caller, setting IP address and port of other RTP endpoint. (MDCX can also set local send/receive state.)

Adding an MGCP Gateway



To use the Cisco VG200 with MGCP, you must use the FXO or FXS analog ports.

Before using Cisco CallManager, you must configure the Cisco VG200 gateway using the Cisco IOS command line interface (CLI). The procedures and commands required to perform this configuration are described in the Software Configuration Guide for the VG200 Gateway. More of the installation and configuration of the VG200 will be done during the lab time.

The procedure is as follows:

1. Open Cisco CallManager.
2. Select **Device > Add a New Device**. The Add Device screen appears.
3. Select **Device Type > MGCP Gateway**.
4. Click **Next**.
5. Enter the appropriate settings, as described in the MGCP Configuration Settings table (slot 0 is not used on the VG200.)

MGCP Configuration Settings

Field	Description	Usage Notes
MGCP Domain Name	Uniquely identifies the VG 200 gateway.	Use the Domain Name Service (DNS) host name if it is configured to resolve correctly. Otherwise use the IP address. You must use the same value here that is used to configure the VG200 at the IOS command line.
Description	Clarifies purpose of device.	
VIC in Slot 1/Sub-Unit 0	The type of Voice Interface Card installed in the right side of the VG200 voice network module, which resides in Slot 1.	If there is an FXS or an FXO VIC installed in Slot 1/Sub0Unit 0, then select the installed VIC Type. Slot 0 is not used on the VG200.
VIC in Slot 1 / Sub-Unit 1	The type of Voice Interface Card installed in the left side of the VG200 voice network module, which resides in Slot 1.	If there is an FXS or an FXO VIC installed in Slot 1/Sub0Unit 1, then select the installed VIC Type. Slot 0 is not used on the VG200.

6. Click **Insert**.

VG200: DTMF Signaling Interaction

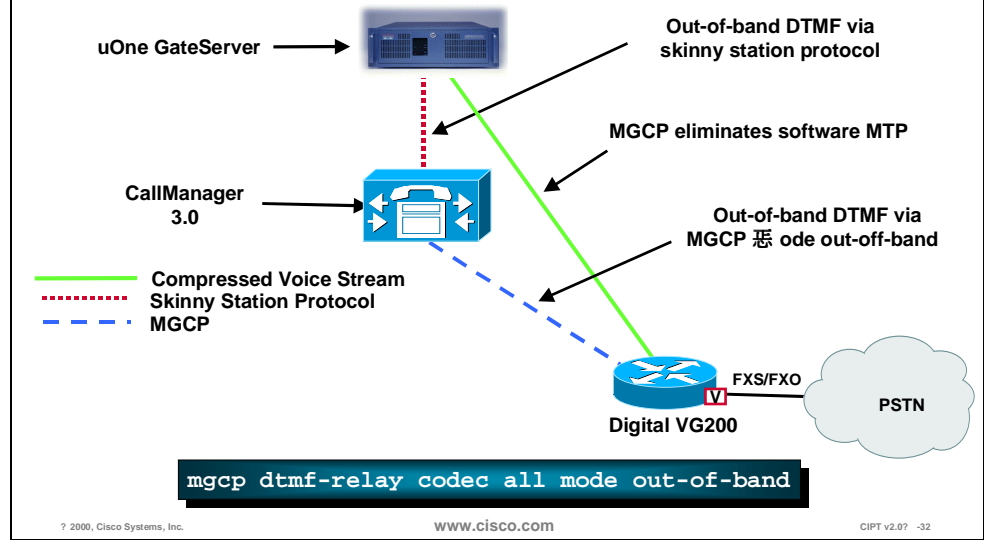

The figure above shows the VG200 and DTMF signaling interaction. Between the Cisco CallManager and the VG200 there is an out-of-band DTMF signal via the MGCP “mode out-off-band.” The Cisco CallManager and Cisco uOne GateServer use skinny station protocol to use out-of-band DTMF. The MGCP eliminates the software MTP by compressing the voice stream between the VG200 and the Cisco uOne GateServer.

Out-of-Band DTMF

MGCP Member Configuration [Back to MGCP Configuration](#)
[Back to FindList Gateways](#)

Slot 1 / Sub-Unit 0 MGCP - AALN1515.000@vg200-5
1515 1515
Slot 1 / Sub-Unit 1
1515 1515

MGCP Member Information

Description: AALN1515.000@vg200-5
Device Pool: Default
Calling Search Space: <None>

Port Information

Prefix DN:
Max Digits:
Expected Digits:

DTMF Capabilities for this member

Send In-band DTMF Receive In-band DTMF
 Send Out-of-band DTMF Receive Out-of-band DTMF

© 2000, Cisco Systems, Inc. www.cisco.com CIPT v2.07 -33

This screen is the MGCP Member Configuration page from the Cisco CallManager administration pages. The MGCP member information defines the MGCP with a description, Device Pool, and Calling Search Space. Port Information is defined through the Prefix Directory Number (DN), the Number of Digits, and Expected number of digits to be received. The DTMF capabilities for this member is where you would determine the out-of-band send/receive capabilities for the VG200.

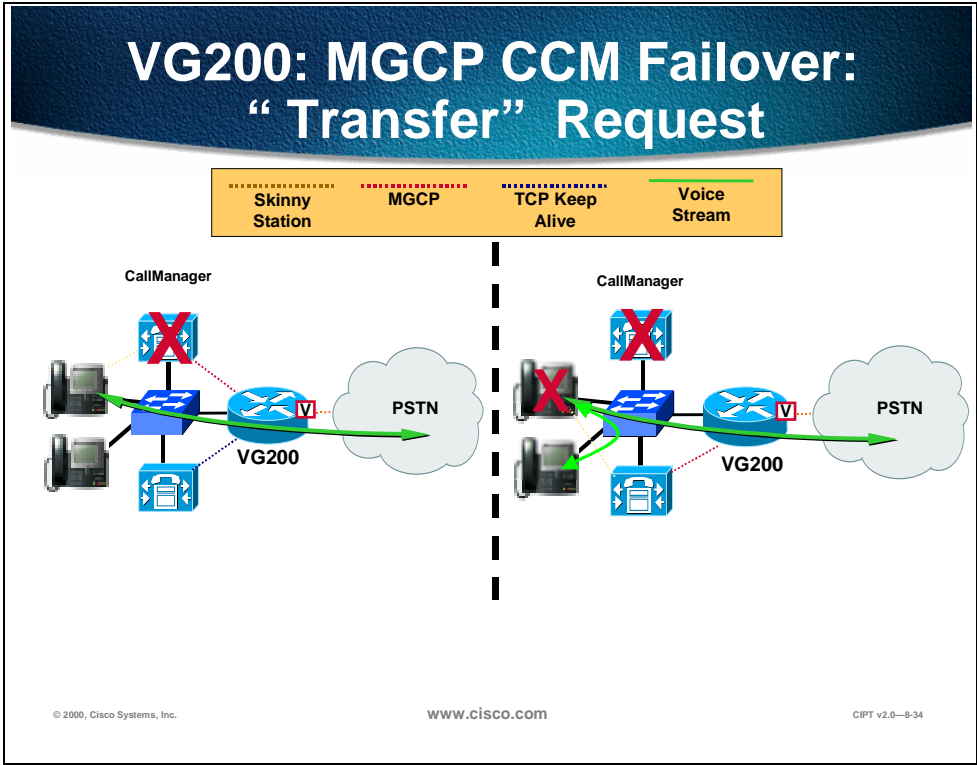

The VG200 uses MGCP to allow supplementary services. MGCP allows for VG200 and CallManager integration without the use of software MTP that allows for greater scalability.

The MGCP support is for analog FXS and FXO interfaces only.

The figure above left shows a MGCP initial call going direct from the gateway to the IP phone with no MTP required.

The figure above right shows the call being transferred, which is allowed using MGCP.

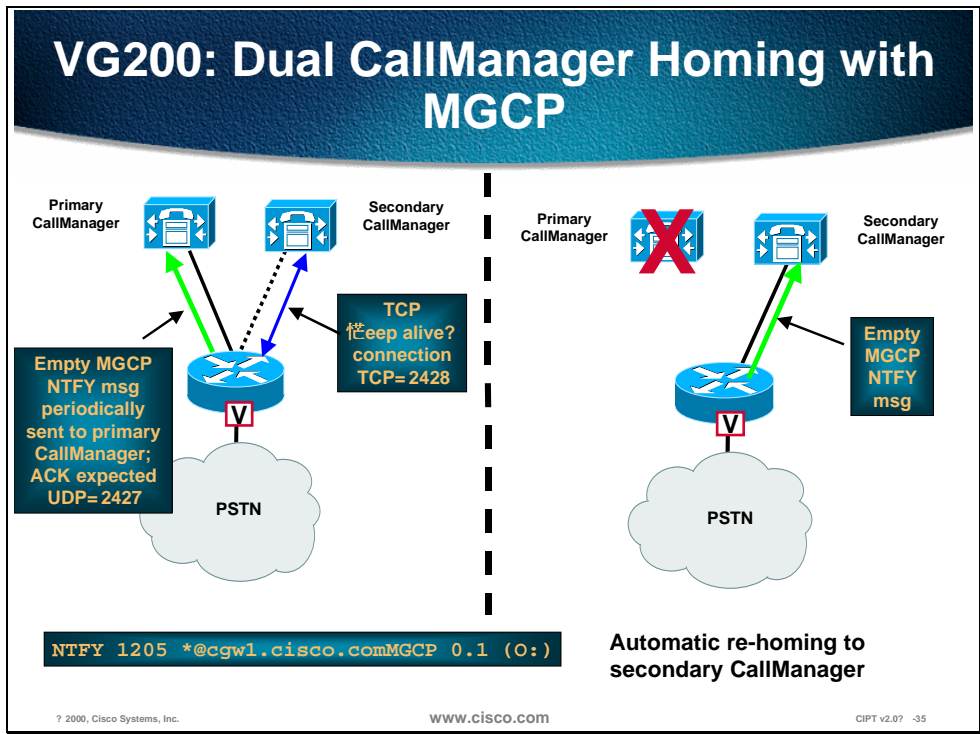

This figure shows the homing process the VG200 uses with MGCP in a dual Cisco CallManager environment.

The VG200 sends an empty MGCP NTFY message periodically to the primary CallManager. An ACK of UDP=2427 is expected (not required). Between the VG200 and the secondary CallManager is a TCP “keep alive” connection (TCP=2428).

When the primary CallManager goes down, the VG200 sends an empty MGCP NTFY message to the secondary CallManager to re-home.

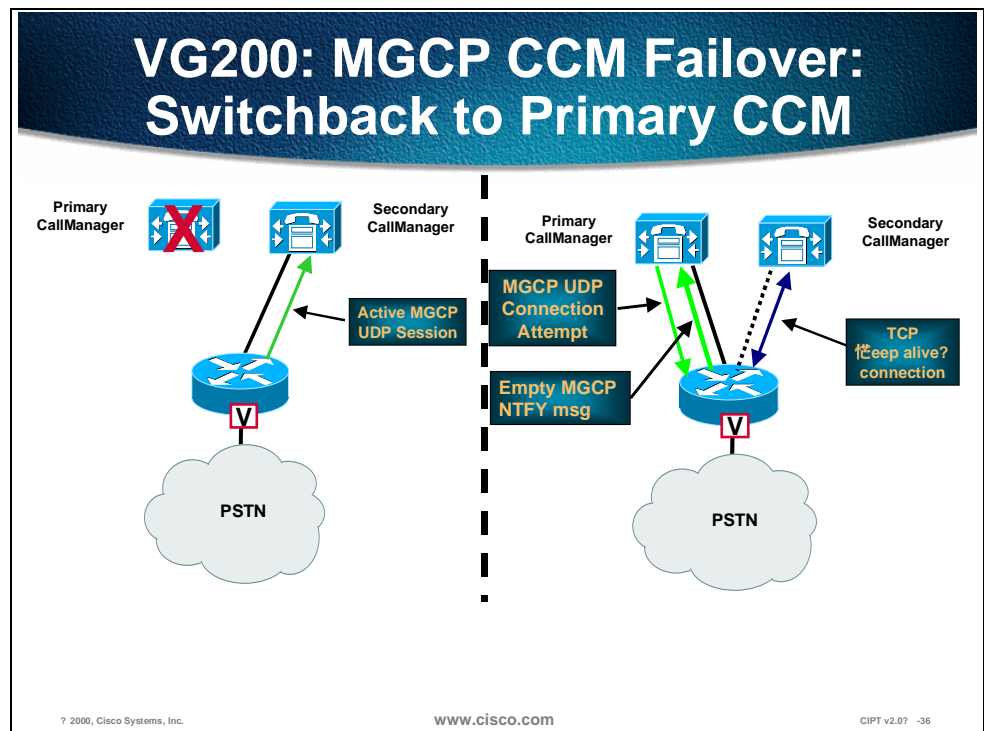

The figure above shows the process of a MGCP Cisco CallManager failover: transfer request. The following are the steps used in this process:

1. Normal call progression with an active primary Cisco CallManager and a secondary failover Cisco CallManager.
2. Upon primary Cisco CallManager failure, GW switches to secondary Cisco CallManager. Call stay is alive.
3. IP phone attempts to transfer; feature request fails due to unknown call progression after failover.

When the primary CallManager fails over to the secondary, an MGCP UDP session is between the VG200 and the secondary Cisco CallManager is active. When the primary CallManager comes back the primary CallManager sends a MGCP UDP connection attempt. The VG200 sends an empty MGCP NTFY message to the primary CallManager and the VG200 sends a TCP keep alive connection. The MGCP parameters with the VG200 allow the GW to switchback to the primary CCM upon MGCP UDP detection. The CLI defines the level of gracefulness for the switchback.

The following is the command for the VG200 for the CallManager redundancy switchback:

[no] ccm-manager switchback

[immediate|gracefully|delay<delay_time>|schedule-time]

VG200-MGCP: Legacy Voice Mail Integration

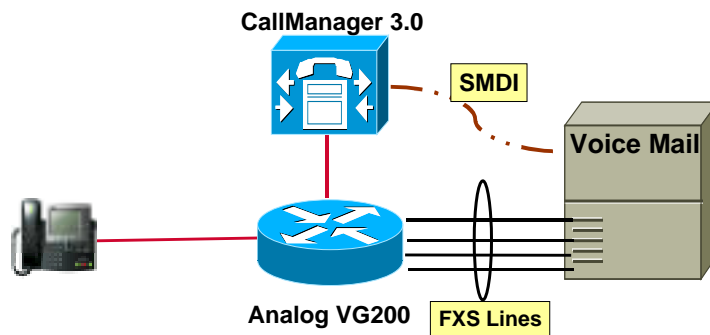

© 2000, Cisco Systems, Inc.

www.cisco.com

CIPT v2.07 -37

The VG200-MGCP integration with legacy voice mail allows the Cisco CallManager to associate a port with a voice messaging mailbox and connection and is widely homologated.

VG200 CLI: *show run*

```
ip route 0.0.0.0 0.0.0.0 FastEthernet 0/0
!
mgcp
mgcp call-agent 172.20.71.30
mgcp dtmf-relay codec all mode out-of-band
mgcp sdp simple
!
ccm-manager switchback immediate
ccm-manager redundant-host 172.20.71.26 172.20.71.47
ccm-manager mgcp
!
voice-port 1/0/0
!
voice-port 1/1/1
!
dial-peer voice 1 pots
destination-pattern 30301
port 1/0/0
!
dial-peer voice 4 pots
application MGCPAPP
port 1/1/1
```

© 2000, Cisco Systems, Inc.

www.cisco.com

CIPT v2.0? -38

The figure above shows the command line interface (CLI) of the VG200 after a **show run** command.

The MGCP has been a DTMF-relay for all modes out-of-band. You can also identify what type of switchback occurs when going from the secondary CallManager to the primary CallManager (immediate). On dial-peer voice 4 pots, the application used is MGCPAPP on port 1/1/1 (The command MGCPAPP is case sensitive).

MGCP Port Configuration

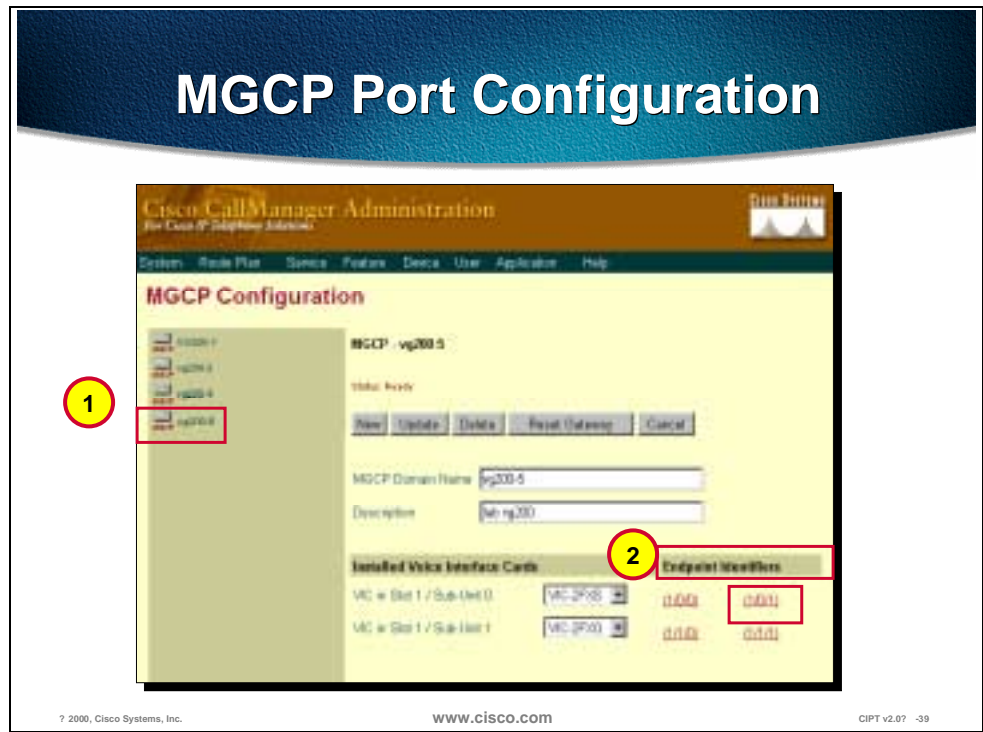

MGCP port configuration is done through the MGCP configuration within the Cisco CallManager administration. Prior to configuring MGCP ports on the VG200, you have to add a MGCP gateway in the Cisco CallManager administration. Select which MGCP gateway to configure from the left side bar as shown in the figure above. Next, select the endpoint identifier you would like to configure.

Assigning a Directory Number

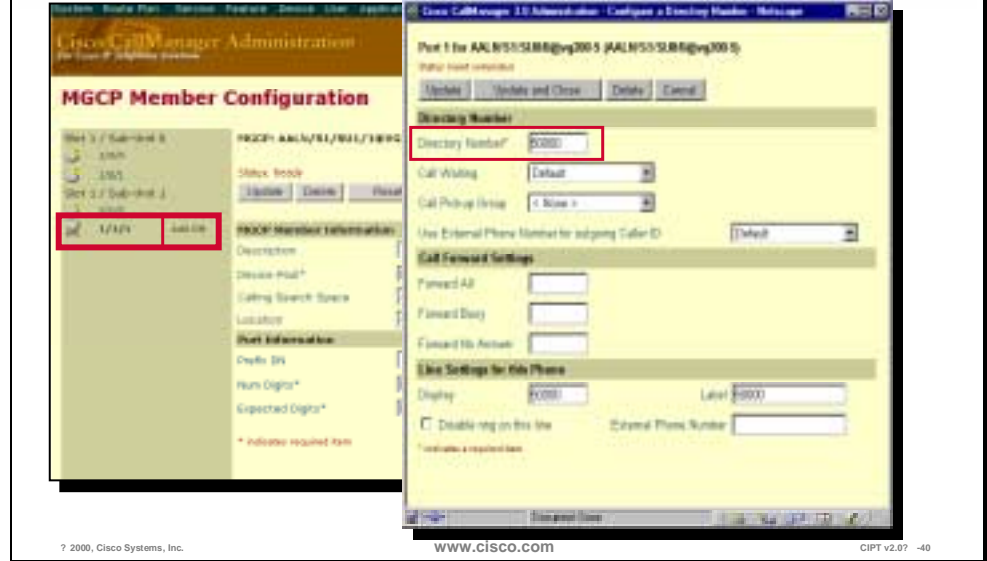

After you have selected your endpoint identifier, select **Add DN** from the left column. A new window will appear that you will be able to assign a directory number for the port you selected.

Assign a Port Type



In MGCP Member Configuration select the endpoint identifier of the FXS port and then select the port type [Ground Start|Loop Start].

Member Configuration

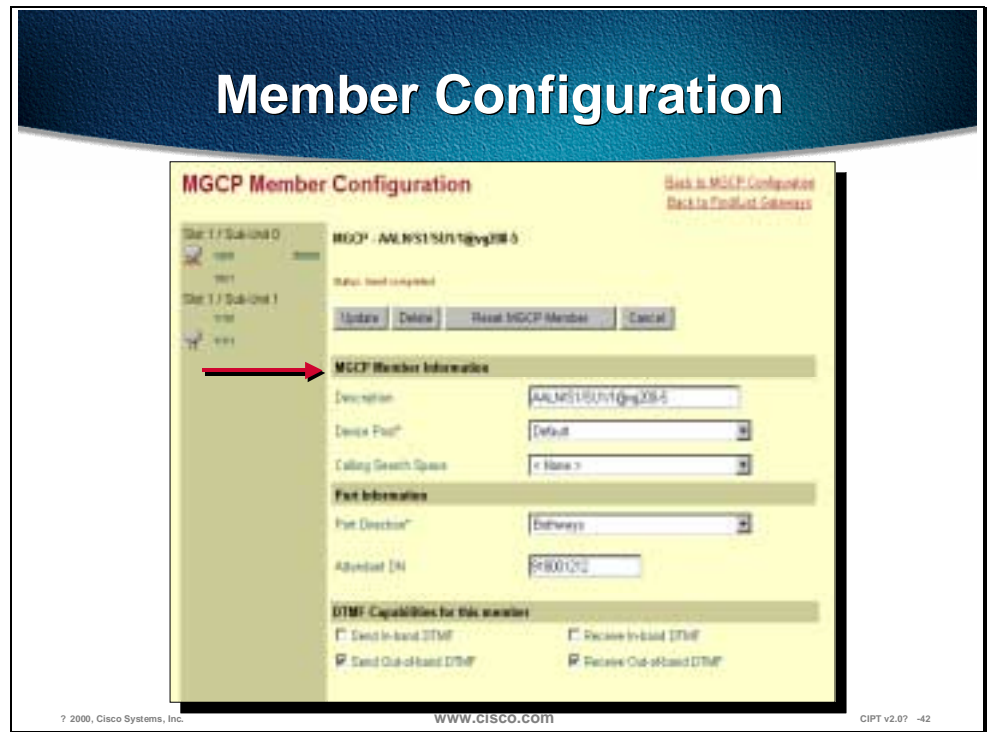

The MGCP Member Configuration page in CallManager administration summarizes entries made to the VG200 and the endpoint identifiers. In the MGC Member Information area add a Description, Device Pool (great for helping manage the network) and Calling Search space.

The Port Information includes the Port Direction and attendant Directory Number.

DTMF capabilities for this member summarizes the type of send/receive DTMF used with this MGCP.

Integrated Router Gateways

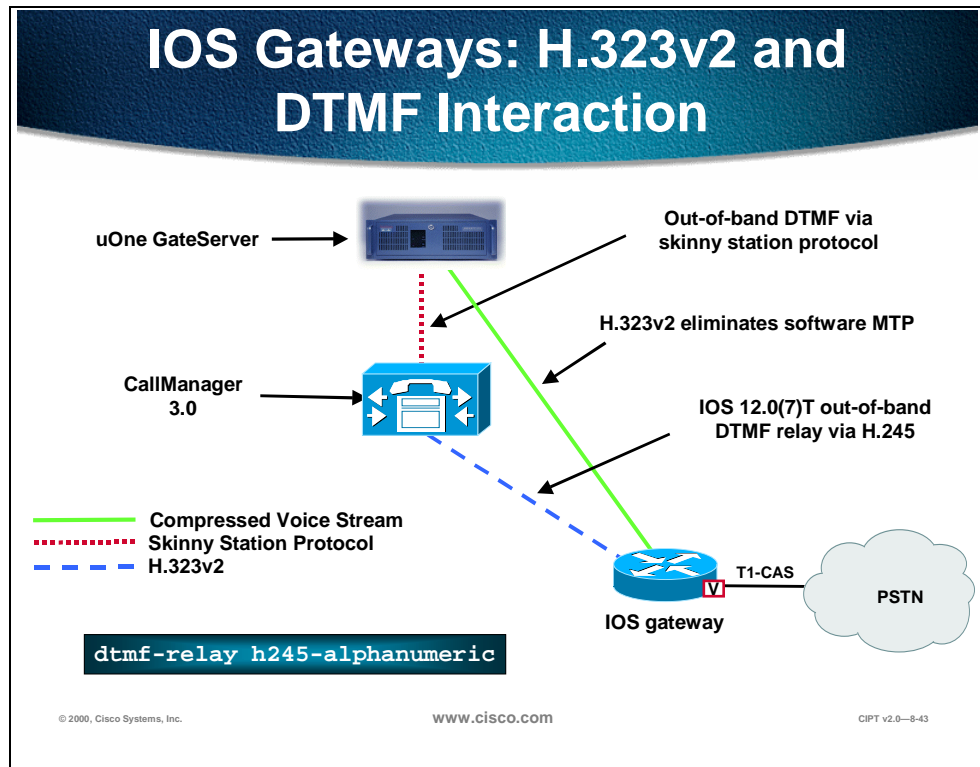

The IOS router gateways use the IOS 12.0(7)T out-of-band DTMF relay via H.245 to communicate with the CallManager. The IOS router gateways use H.323v2, which eliminates the need for software MTP.

IOS Gateways: H.323v2 and Supplementary Services

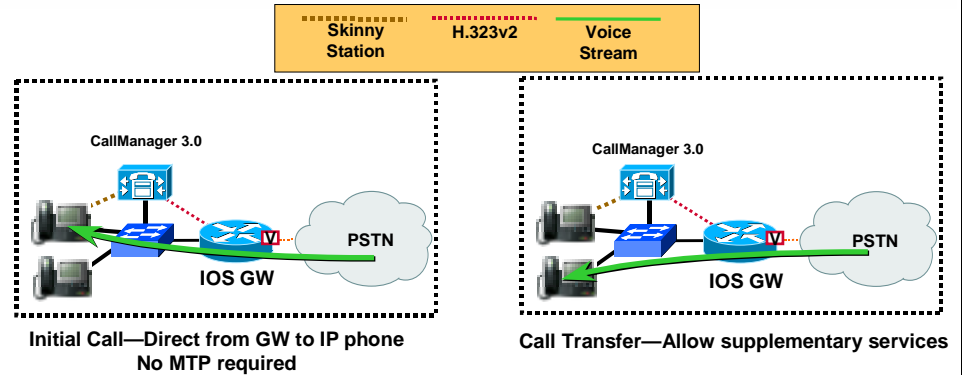

Design Characteristics

1. Allows for IOS GW/Call Manager Integration without MTP (greater scalability)
2. H.323v2 and H.245 DTMF Relay require a minimum of 12.0(7)T and CCM 3.0

© 2000, Cisco Systems, Inc.

www.cisco.com

CIPT v2.0—8-44

IOS router gateways use the H.323v2 that allows for gateway to CallManager integration without MTP and provides for greater scalability. In order to use H.323v2 and H.245 DTMF relay you must have a minimum of Cisco IOS 12.0(7)T and Cisco CallManager 3.0.

H.323v2 CallManager Redundancy CLI Commands

```
Router(config)#
dial-peer voice 101 voip
 destination-pattern 1111
 session target ipv4:10.1.1.101
 preference 0
 voice class h323 1
 dtmf-relay h245-alphanumeric
Router(config)#
dial-peer voice 102 voip
 destination-pattern 1111
 session target ipv4:10.1.1.102
 preference 1
 voice class h323 1
 dtmf-relay h245-alphanumeric
Router(config)#
voice class h323 1
 h225 tcp timeout <1-30 sec>
```

© 2000, Cisco Systems, Inc.

www.cisco.com

CIPT v2.07 -45

The figure above shows the H.323v2 Cisco CallManager redundancy CLI commands.

3810 VoIP 12.0(7)XK? 2.1(2)T

- **Use the 3810-V3**
 - **Only the HCM card can support DTMF-relay**
- **G.711, G.723.1, G.729**
- **FXS, FXO, E&M, T1/E1 CAS, T1/E1 QSIG**

© 2000, Cisco Systems, Inc.

www.cisco.com

CIPT v2.0? -46

The Cisco 3810 router is one of the IOS gateways that can be used in the Cisco IP Telephony Network. Use the 3810 version 3 and only the High Compression Module (HCM) card can support DTMF-relay. The Cisco 3810 supports G.711, G.723.1, and G.729 codec. The Cisco 3810 can accommodate FXS, FXO, E & M, T1/E1 CAS, and T1/E1 QSIG.

2600/3600 MGCP Update

- **H.323v2**
- **Analog MGCP 12.1(3)T 継止 CM support in 3.0(1)**
- **FXO battery reversal detection on disconnect**
- **T1/E1 QSIG 12.0(7)XK**
- **T1/E1 PRI 12.1(2)T**

© 2000, Cisco Systems, Inc.

www.cisco.com

CIPT v2.07 -47

The Cisco Routers 2600/3600 can support the following features that work in the Cisco IP Telephony Network:

- H.323v2
- Analog MGCP 12.1(3)T—Cisco CallManager support in 3.0(1)
- FXO battery reversal detection on disconnect
- T1/E1 QSIG 12.0(7)XK
- T1E1 PRI 12.1(2)T

The following tables are quick reference guides to the Cisco H.323 gateways for the following topics:

- PSTN interfaces
- QoS and PPP
- QoS and frame relay

The table represents the H.323 gateway PSTN Interfaces:

H.323 Gateway PSTN Interfaces

Gateway	Data Interfaces	Analog PSTN Interfaces	Digital PSTN Interfaces in DS0s	Voice Compression *
1750	Ethernet, T1/E1 Serial	4	0	G.711, G.729
2600	Ethernet, FastEthernet, Token Ring, T1/E1 Serial and T1-OC3 ATM	4	48/60	G.711, G.729, G.729a, G.723.1
3620	Ethernet, FastEthernet, Token Ring, T1/E1 Serial and T1-OC3 ATM	4	48/60	G.711, G.729, G.729a, G.723.1
3640	Ethernet, FastEthernet, Token Ring, T1/E1 Serial and T1-OC3 ATM	12	136/180	G.711, G.729, G.729a, G.723.1
3660	10/100 Ethernet, Token Ring, T1/E1 Serial and T1-OC3 ATM, HSSI	24	288/360	G.711, G.729, G.729a, G.723.1
7200	10/100 Ethernet, Token Ring, DS1-DS3 Serial and T1-OC3 ATM	0	288/360	G.711, G.729, G.729a, G.723.1
7500	Future			

© 2000, Cisco Systems, Inc.
www.cisco.com
CIPT v2.0? -48

The following table represents the Cisco H.323 gateway's QoS that has VoIP over PPP:

H.323 Gateway QoS: PPP

VoIP over PPP Quality of Service Matrix						
Gateway	LFI/MLPPP	LLQ (PQ-CB-WFQ)	IP RTP Priority	CRTP - Fast/CEF switched	GTS	RSVP
1750	12.0(5)XQ1	12.1(2)T	12.1(1)T	12.1(1)T	12.0(5)XQ1	Yes
3810 V3	12.0(7)XK	12.0(7)XK	12.0(7)XK	12.0(7)XK	12.0(7)XK	12.0(7)XK
2600	Yes	Yes	Yes	Yes*	Yes	Yes
3620-40	Yes	Yes	Yes	Yes*	Yes	Yes
3660	Yes	Yes	Yes	Yes*	Yes	Yes
7200	Yes	Yes	Yes	Yes*	Yes	Yes
7500 Distributed	Future	Future	Future	dCEF in 12.1(4)T	12.1(3)T	RSVP runs on RSP

* Limited support in 12.0(7)XK, more support in 12.1(1)T

© 2000, Cisco Systems, Inc.
www.cisco.com
CIPT v2.07 -49

The following table shows the H.323 gateways QoS use with frame relay:

H.323 Gateway QoS: Frame Relay							
VoIP over Frame-Relay Quality of Service							
Gateway	FRF.12	LLQ (PQ-CB-WFQ) per VC	CRTP - Fast/CEFswitched	FRTS	GTS	RSVP	IP RTP Priority
1750	12.0(5)XQ1	12.1(2)T	12.1(1)T	12.0(5)XQ1	12.0(5)XQ1	Yes	12.1(1)T
3810 V3	Yes	12.1(2)T	12.0(7)XK	Yes	Yes	Yes	12.0(7)XK
2600	Yes	12.1(2)T	12.0(7)T	Yes	Yes	Yes	Yes
3620-40	Yes	12.1(2)T	12.0(7)T	Yes	Yes	Yes	Yes
3660	Yes	12.1(2)T	12.0(7)T	Yes	Yes	Yes	Yes
7200	Yes	12.1(2)T	12.0(7)T	Yes	Yes	Yes	Yes
7500 Distributed	12.1(3)T	12.1(3)T	dCEF in 12.1(4)T	12.1(3)T	12.1(3)T	RSVP runs on RSP	12.1(3)T
* Limited support in 12.0(7)XK, more support in 12.1(1)T							
<small>© 2000, Cisco Systems, Inc. www.cisco.com CIPT v2.0? -50</small>							

Note Catalyst gateways and DSP resources will be discussed later in this course.

Single-Site Enterprise Deployments

Choosing gateways for single-site enterprise deployments can be one of the more daunting tasks facing AVVID designers. A primary reason for this is balancing the density and feature requirements of the current environment with the future complexities of a growing business and rapidly evolving applications. This section will examine the requirements and detail the implementation specifics for several single-site enterprises: 100-500 users, 2,500 users, and 10,000 users. In all designs, G.711, or uncompressed, voice is used to provide the highest voice quality while enabling ease of configuration.

Single-Site Enterprise Characteristics

- **G.711 voice on all gateways to eliminate configuration complexity and maximize voice quality in a high bandwidth environment**
- **Because G.711 is used, there is no requirement for FAX-relay**
- **DTMF-relay is a design requirement for application interaction**
- **Support for supplementary services such as hold, transfer and conference**
- **Support for CallManager failover in a clustered environment**
- **As the size of the enterprise installation grows, hardware based conferencing**

© 2000, Cisco Systems, Inc. www.cisco.com CIPT v2.07 -51

Single-Site/Campus Design Characteristics

The following characteristics are part of a single site enterprise in regards to gateways:

- G.711 voice on all gateways to eliminate configuration complexity and maximize voice quality in a high bandwidth environment
- Because G.711 is used, there is no requirement for FAX-relay
- DTMF-relay is a design requirement for application interaction
- Support for supplementary services such as hold, transfer and conference
- Support for CallManager failover in a clustered environment
- As the size of the enterprise installation grows, hardware based conferencing

Three Types of Single Site Deployments

- **Small enterprise (< 500 users)**

- Analog and/or digital trunks
- No Legacy voice mail

Medium enterprise (500-2,500 users)

- Legacy voice mail **VG200/WS-X6624-FXS**
- Digital trunks (CAS or PRI)

Large enterprise (2,500-10,000 users)

- Legacy voice mail **VG200/WS-X6624-FXS**
- PRI
- Central site for WAN deployments **QoS**

© 2000, Cisco Systems, Inc.

www.cisco.com

CIPT v2.0? -52

The following are the three types of single site deployments:

- Small enterprise (<500 users)
 - Analog and/or digital trunks
 - No Legacy voice mail
- Medium enterprise (500-2500 users)
 - Legacy voice mail—VG200/WS-X6624-FXS
 - Digital Trunks (CAS or PRI)
- Large enterprise (2,500—10,000 users)
 - Legacy voice mail—VG200/WS-X6624-FXS
 - PRI
 - Central site for WAN deployments—QoS

100-500 Users, Single-Site Enterprise

Analog PSTN Connectivity

The single-site, small enterprise of 100 users or less is one of the most common AVVID implementations in the commercial sector. These sites will typically be Greenfield installations where an end-to-end Cisco solution can be easily provided.

Analog Connection Considerations

- **Use analog connection to PSTN when there is no other choice**
- **Use VIC-2FXO-M1 (-M2 for CE countries) if using FXO interfaces to connect to the CO**
- **4 port BRI VIC, the 2BRI-S/T-TE is another option to provide DID support**

© 2000, Cisco Systems, Inc. www.cisco.com CIPT v2.07 -53

The following are considerations is connecting analog to the PSTN:

- Only use an analog connection to the PSTN when there is no other choice. When possible, connect to the PSTN using digital interfaces, preferably PRI.
- If using FXO interfaces to connect to the PBX, use the VIC-2FXO-M1 (-M2 for CE countries), which provides the feature of battery reversal detection on far-end disconnect to help eliminate the disconnect problems common with some FXO interfaces.
- Another option to provide DID support is the 4 ports BRI VIC, the 2BRI-S/T-TE. With 12.1(2)Xx, the 2600 and 3600 lines of IOS gateways provide calling-line ID on all telephony interfaces.

Analog PSTN connectivity, fax support and voice mail, are among the common requirements in this type of small enterprise design. The example below depicts a 2600 IOS gateway containing four FXO voice interface cards (VICs) is used for PSTN connectivity. This will allow for a total of four analog lines from the central office switch for PSTN connectivity. If additional PSTN interfaces are needed or the enterprise wants to add fax support, either an IOS router/gateway with additional slots or a stand-alone AVVID gateway, the VG200, can be added to this design.

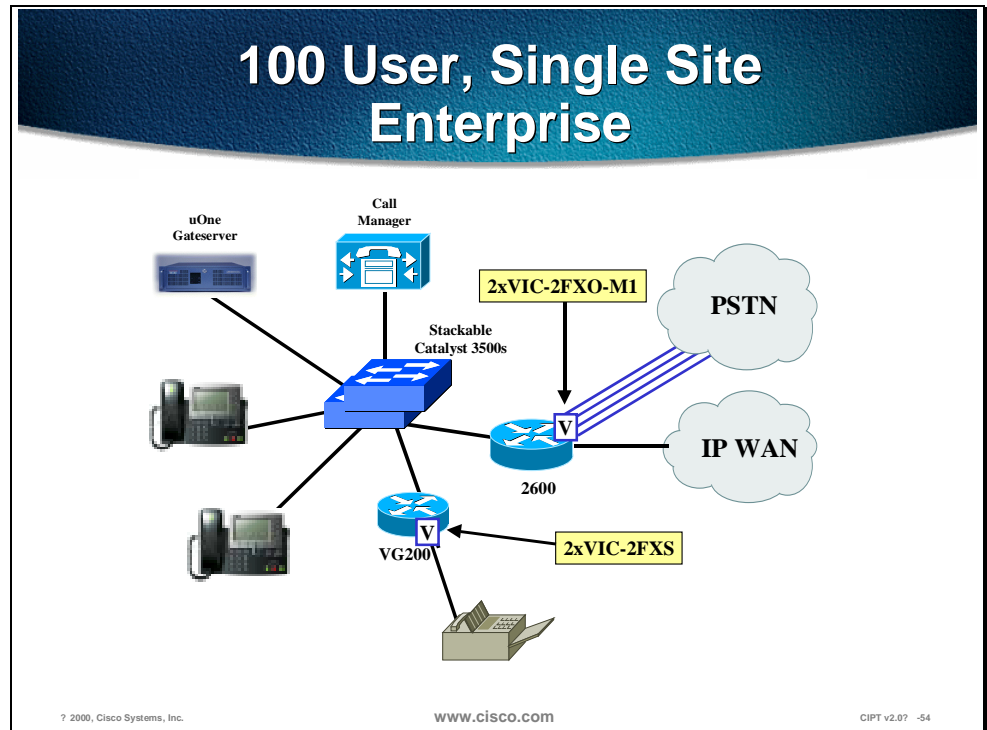

The above figure shows a 100 user, single-site enterprise.

Fitting the requirements of a small enterprise infrastructure is the Catalyst 4000 Ethernet switch. Shortly following the release of Cisco CallManager 3.0, the Catalyst 4000 will add support for providing line power to Cisco IP phones, Legacy telephony interfaces, IP-to-IP packet transcoding and conferencing services. Both transcoding and conferencing services will be addressed in later chapters. The Legacy telephony interfaces, however, are a vital piece in deploying the enterprise AVVID network. A Catalyst 4000 with the gateway module, the WS-X4604-GWY, can act as a PSTN gateway using analog or digital VIC interfaces or can be configured to provide six analog ports for GIII FAX machines or Polycom conferencing stations.

Digital PSTN Connectivity Considerations

- Use PRI when possible using the DT-X+ or Catalyst 6000 at CCM 3.0 FCS
- The 2600 and 3600 will have PRI in 12.1(2)Xx
- The Catalyst 4000 will have both PRI and CAS at FCS

© 2000, Cisco Systems, Inc.

www.cisco.com

CIPT v2.07 -55

Consider the following when you have a digital connection to the PSTN:

- Use PRI when possible using the DT-24+/DE-30+ or Catalyst 6000 with the Cisco CallManager 3.0 or higher.
- The Cisco 2600 and 3600 will have PRI in 12.1(2)xx.
- The Catalyst 4000 will have both PRI and CAS.

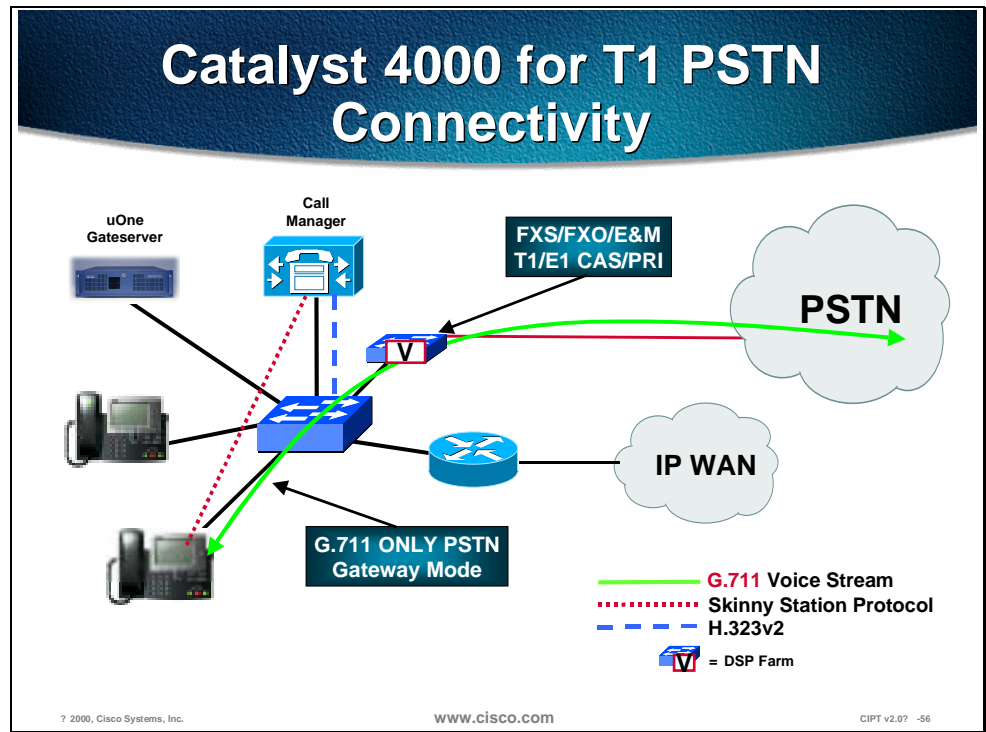

The figure above shows a 500 user single-site enterprise design using the Catalyst 4000 for T1 PSTN connectivity.

Whenever possible, connect to the PSTN using PRI interfaces. PRI can provide DID and CLID natively. The DT-24+/DE-30+ and Catalyst 6000 Voice Gateway module offer PRI PSTN connectivity at FCS. Also coinciding with the release of CCM 3.0 and the voice modules for the Catalyst 4000, the Catalyst 6000 will add support for Legacy telephony interfaces, IP-to-IP packet transcoding services, conferencing services, and in-line power to Cisco IP telephones through new voice modules. Conferencing, MTP/transcoding, and powered Ethernet services will be addressed in later sections. The voice gateway module for the Catalyst 6000 is very pertinent to deploying AVVID networks. The Catalyst 6000 Voice Gateway module provides eight ports of T1/E1 PRI connectivity to the PSTN and Legacy PBX systems. The PRI ports can be configured as either user-side or network-side ISDN, increasing the flexibility of the design.

For large numbers of analog interfaces, a new card, the WS-X6624-FXS, can be added to the Catalyst 6000 installed in the network core. The WS-X6624-FXS module, a 24 port analog module for the Catalyst 6000 and 6500 line of switches, is ideal for connecting Polycom conferencing phones, GIII fax machines and modems throughout the building. The figure above is an example of a central 6509 supporting all analog devices, a 3640 connecting to the PSTN with a T1 interface, and Catalyst 3500s in the wiring closets providing Ethernet connectivity for IP phones and desktop computers.

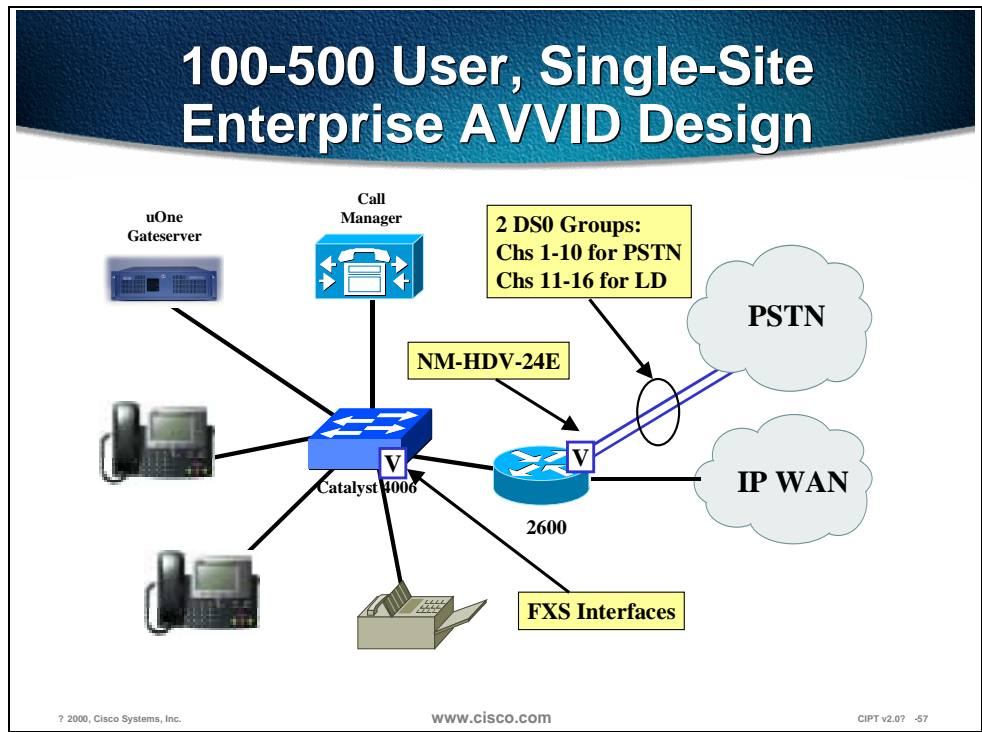

The figure above shows a 100-500 user, single-site enterprise AVVID design.

When DID capable DS0s are required, and PRI is not available, a common design is to connect to the central office switch using a CAS T1. Typically, a customer will designate some of the timeslots for local PSTN access and other timeslots for connecting to their long distance carrier. The figure above shows a diagram of the single-site, small enterprise deployment using an IOS gateway configured with ds0-groups for DID local PSTN access and long distance access with the Catalyst 4000 providing FXS connections for GIII FAX.

Sample Configuration for ds0_億

```
controller T1 1/0
 framing esf
 linecoding b8zs
 ds0-group 1 timeslots 1-10 type ground-start
 ds0-group 2 timeslots 11-16 type ground-start
 dial-peer voice 1 pots
 destination-pattern 9? ?
 Port 1/0:1
 dial-peer voice 2 pots
 destination-pattern 8? ? .
 port 1/0:2
```

The figure above is a sample configuration for assigning ds0-groups in global configuration mode.

Small Enterprise Gateway Matrix

Gateway	Data Interfaces	Analog PSTN Interfaces	Digital PSTN Interfaces in DS0s	Voice Compression*
VG200	Ethernet	4	0	G.711, G.729, G.729a, G.723.1
2600	Ethernet, FastEthernet, Token Ring, T1/E1 Serial and T1-OC3 ATM	4	48/60	G.711, G.729, G.729a, G.723.1
3620	Ethernet, FastEthernet, Token Ring, T1/E1 Serial and T1-OC3 ATM	4	48/60	G.711, G.729, G.729a, G.723.1
3640	Ethernet, FastEthernet, Token Ring, T1/E1 Serial and T1-OC3 ATM	12	136/180	G.711, G.729, G.729a, G.723.1
Catalyst 4000	Ethernet, FastEthernet, GigabitEthernet, T1/E1 Serial	6	48/60	G.711***
Catalyst 6000	Ethernet, FastEthernet, GigabitEthernet, OC12, Selected 7200 PAs**	120 192	960/1200 1536/1920	G.711***

© 2000, Cisco Systems, Inc.

www.cisco.com

CIPT v2.07 -59

A 100-500 user, small enterprise gateway matrix is detailed in the table above. The new VG200 stand-alone gateway, Catalyst 4000 WS-X4606-GWY, and Catalyst 6000 WS-X6608 are listed as well as the traditional IOS gateway. Note that the Voice Compression column only lists the codecs that are pertinent in AVVID architectures. The IOS gateways support many more compression algorithms, however, Cisco CallManager devices only support G.711, G.729, G.723.1, or G.729/729a.

* Voice compressions listed as pertinent to AVVID networks only.

** With the WS-6182-2PA

*** Using the MTP transcoding feature, G.729a and G.723.1 can also be supported.

2,500 User, Single-Site Enterprise

The 2,500 user, single-site enterprise installations follow similar design principals of the small enterprise implementation. However, in this larger enterprise, DID and CLID are a fundamental requirement. Both of these are can be implemented on T1/E1 PRI connections from the carrier. Because these enterprises will usually have a Cisco infrastructure in production, the easiest way to install AVVID components on site is through the addition of voice specific modules into the existing Cisco 3660 and the Catalyst 6000 core.

2,500 User, Single-Site Enterprise Gateway Matrix				
Gateway	Data Interfaces	Analog PSTN Interfaces	Digital PSTN Interfaces in DS0s	Voice Compression*
3640	Ethernet, FastEthernet, Token Ring, T1/E1 Serial and T1-OC3 ATM	12	136/180	G.711, G.729, G.729a, G.723.1
3660	10/100 Ethernet, Token Ring, T1/E1 Serial and T1-OC3 ATM, HSSI	24	288/360	G.711, G.729, G.729a, G.723.1
Catalyst 6000 WS-X6608-x1	Ethernet, FastEthernet, GigabitEthernet, OC12, Selected 7200 PAs**	120 192	960/1200 1536/1920	G.711***

© 2000, Cisco Systems, Inc. www.cisco.com CIPT v2.0? -60

A 2,500-user enterprise gateway matrix is detailed in the figure above. Note that the Voice Compression column only lists the codecs that are pertinent in AVVID architectures. The IOS gateways support many more compression algorithms, however, Cisco CallManager devices only support G.711, G.729a, or G.723.1.

* Voice compressions listed as pertinent to AVVID networks only.

** With the WS-6182-2PA

*** Using the MTP transcoding feature, G.729a and G.723.1 can also be supported.

10,000 User, Single-Site Enterprise

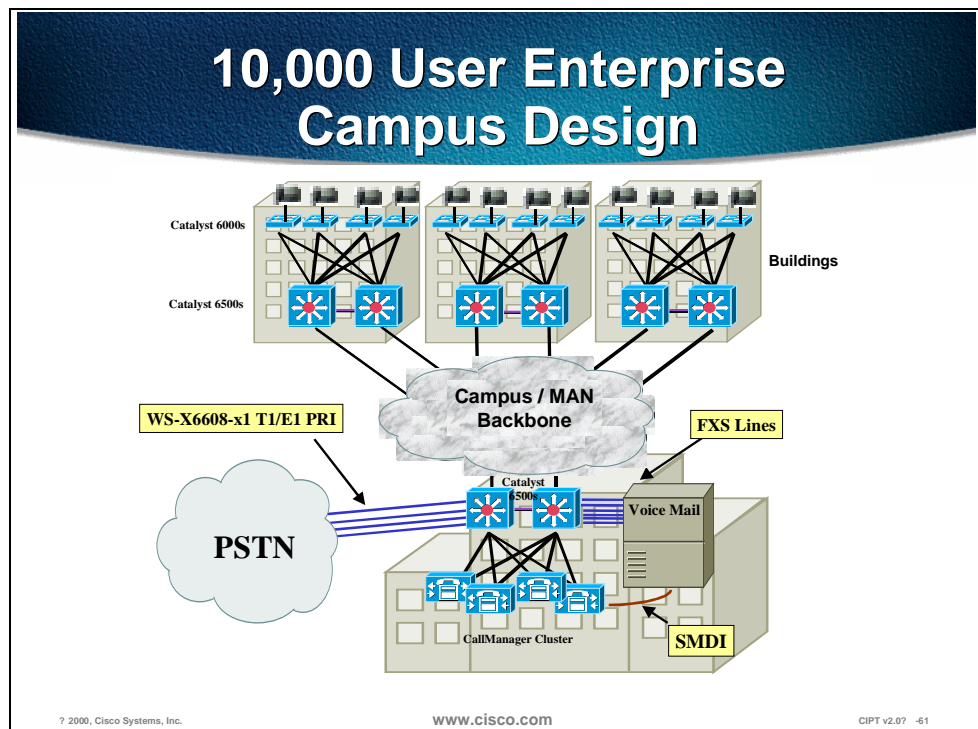

Large enterprises place much higher demands upon an AVVID design, particularly the gateways. These customers require multiple digital PSTN connections that can provide DID support. Additionally, AVVID installations in these large environments will be phased, requiring an extended time of interoperability with both Legacy PBX systems and voice mail servers. In many instances, these customers are relying on 7200 and 7500 IOS router platforms for their production networks. The large enterprise customer can leverage these existing 7200 and 7500 chassis in the AVVID design by adding Voice over IP port adapters (PAs), the PA-VXC-2TE1, for T1/E1 CAS PSTN and PBX connectivity. These VoIP PAs support 2 T1/E1 CAS each and can provide significant density. The 7200 supports both T1 and E1 CAS in 12.0(5)XE3. On the 7500, T1 and E1 CAS will be supported in 12.1(1)T. Both the 7200 and the 7500 will provide PRI support in 12.1(3)T. E1 R2 support will be added to the digital voice interfaces at the same time.

When both DID and CLID are required features, in either T1/E1 CAS or PRI implementations, another alternative is to add the Cisco 5300 as a stand-alone VoIP gateway. This solution provides the larger enterprises, with extremely tight downtime tolerances, the ability to add an AVVID architecture without any modifications to the existing IP infrastructure. The 5300 supports either T1/E1 CAS or PRI.

Note Cisco IOS 12.0(7)T is required to enable network-side ISDN. The VoIP enabled Cisco AS5300 is homologated for use most countries.

For a detailed compliance list, please use the compliance search tool located at: http://www.cisco.com/cgi-bin/compliance/app_report.pl?formtype=initial_search

If a higher number of digital connections are needed, an addition of the WS-X6608-x1 module to an existing Catalyst 6000 in the network will provide support for both DID and CLID over PRI connections. This module, which is an 8-port PRI module, uses the same interface as the DT-24+/30+ Stand-Alone AVVID Gateway. All ISDN signaling is back-hauled to the CallManager, which controls the card using the skinny gateway protocol. Both user-side and network-side ISDN signaling is supported through simple software configuration. The WS-X6608-E1 is homologated for use in the following countries: Austria, Belgium, Denmark, Finland, France, Germany, Greece, Iceland, Ireland, Italy, Luxembourg, The Netherlands, Norway, Portugal, Spain, Sweden, and the United Kingdom.

10,000 User, Campus Gateway Matrix				
Gateway	Data Interfaces	Analog PSTN Interfaces	Digital PSTN Interfaces in DS0s	Voice Compression*
3660	10/100 Ethernet Token Ring, T1/E1 Serial and T1-OC3 ATM, HSSI	24	288/360	G.711, G.729, G.729a, G.723.1
7200	10/100 Ethernet Token Ring, DS1-DS3 Serial and T1-OC3 ATM	0	288/360	G.711, G.729, G.729a, G.723.1
7500	Future			
5300	10/100 Ethernet	0	96/120	G.711, G.729, G.729a, G.723.1
Catalyst 6000	10/100/1000 Ethernet, OC12, Selected 7200 PAs**	120 192	960/1200 1536/1920	G.711***

© 2000, Cisco Systems, Inc. www.cisco.com CIPT v2.0? -62

A 10,000 user, campus gateway matrix is detailed in the figure above. Note that the Voice Compression column only lists the codecs that are pertinent in AVVID architectures. The IOS gateways support many more compression algorithms, however, Cisco CallManager devices only support G.711, G.723.1, or G.729a.

* Voice compressions listed as pertinent to AVVID networks only.

** With the WS-6182-2PA module

*** Using the MTP transcoding feature, G.729, G.729a and G.723.1 can also be supported.

Install and Configure Commands

This section lists the steps and highlights the commands used to configure the various gateways.

Adding Analog Gateways

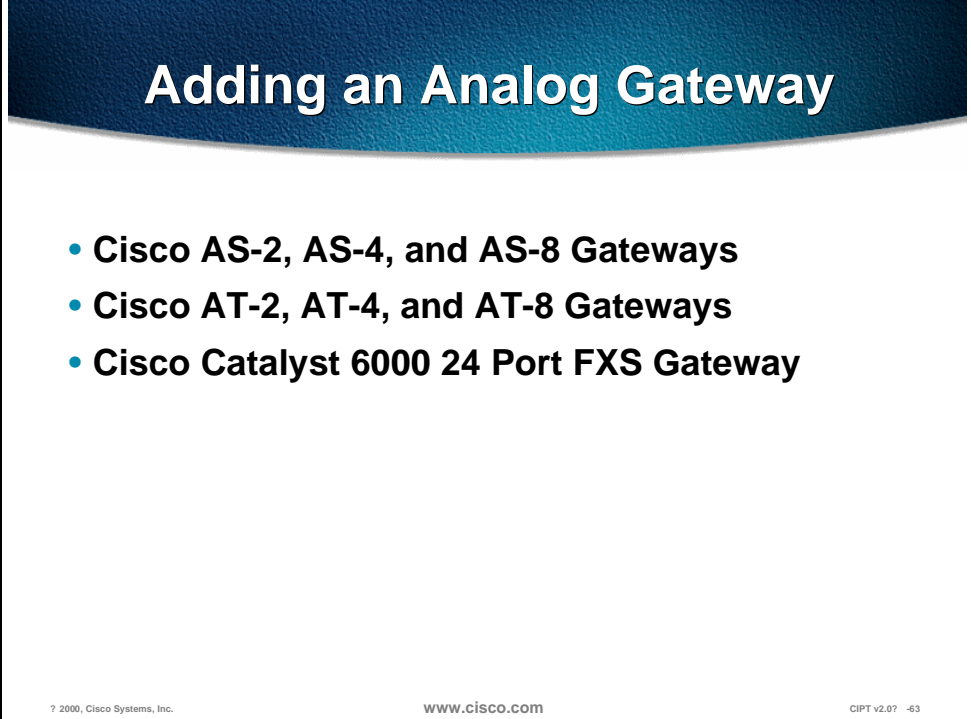

Adding an Analog Gateway

- **Cisco AS-2, AS-4, and AS-8 Gateways**
- **Cisco AT-2, AT-4, and AT-8 Gateways**
- **Cisco Catalyst 6000 24 Port FXS Gateway**

© 2000, Cisco Systems, Inc. www.cisco.com CIPT v2.07 -63

The following Cisco analog gateways can be added to CallManager:

- Cisco AS-2, AS-4, and AS-8 Gateways
- Cisco AT-2, AT-4, and AT-8 Gateways
- Cisco Catalyst 6000 24 Port FXS Gateway

Procedure

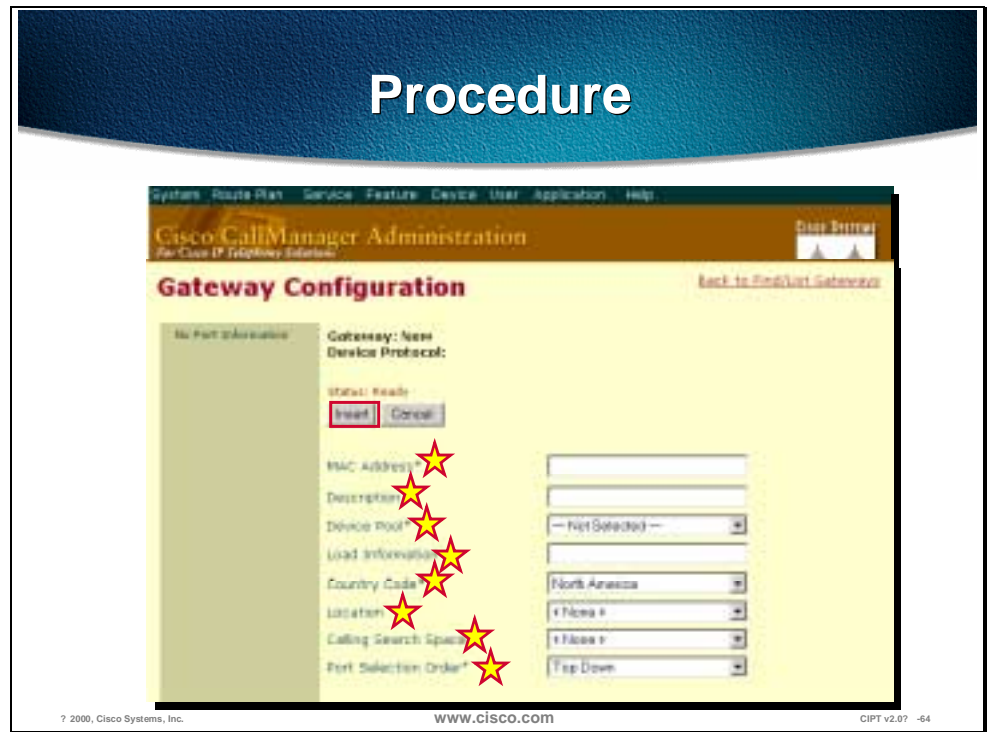

The figure above is a layered slide that demonstrates the Cisco CallManager Administration pages you will use to add a Cisco analog gateway in the CallManager database. Use the following procedure:

1. Open Cisco CallManager.
2. Select **Device > Add a New Device**. The Add Device screen appears.
3. Select **Device Type > Gateway**.
4. Select the Gateway Type. Analog gateways include the following:
 - Cisco AS-2, AS-4, and AS-8 Gateways
 - Cisco AT-2, AT-4, and AT-8 Gateways
 - Cisco Catalyst 6000 24 Port FXS Gateway
5. Select **Device Protocol > Access Analog**.
6. Click **Next**. The Gateway Configuration screen appears.

See the following page that describes the analog gateway configuration settings.

Cisco Access Analog Gateway Configuration Settings

- **MAC address**—Identifies hardware-based telephones and device name
- **Description**—Clarifies the purpose of the device
- **Device pool**—Specifies the collection of properties for this device including CallManager group, date and time setting, region, and calling search space for auto-registration of devices
- **Load information**—Specifies the custom software for gateway
- **Country code**—The country in which the gateway is located
- **Location**—Specifies the remote location accessed using restricted bandwidth connections
- **Calling search space**—Specifies the collection of route partitions searched to determine how a dialed number should be routed
- **Port selection order**—Specifies the order in which ports are selected

© 2000, Cisco Systems, Inc.

www.cisco.com

CIPT v2.07 -65

7. Enter the appropriate settings, as described above and in the table on the following page, and then click **Insert**.

The following table shows Cisco access analog gateway configuration settings.

Field	Description	Usage Notes
MAC Address	Identifies hardware-based telephones and device name.	Value must be 12 hexadecimal characters.
Description	Clarifies the purpose of the device.	
Device Pool	Specifies the collection of properties for this device including CallManager Group, Date and Time Setting, Region, and Calling Search Space for auto-registration of devices.	
Load Information	Specifies the custom software for gateway.	Values entered here override the default values for this gateway.
Country Code	The country in which the gateway is located.	Select the country in which the gateway is located from the drop-down selection box.
Location	Specifies the remote location accessed using restricted bandwidth connections.	
Calling Search Space	Specifies the collection of Route Partitions searched to determine how a dialed number should be routed.	
Port Selection Order	Specifies the order in which ports are selected. TOP_DOWN selects ports in descending order, from port 1 to port 8. BOTTOM_UP selects ports in ascending order, from port 8 to port 1.	Valid entries are TOP_DOWN or BOTTOM_UP. If you're not sure which port order to use, choose TOP_DOWN.

Adding Digital Gateways

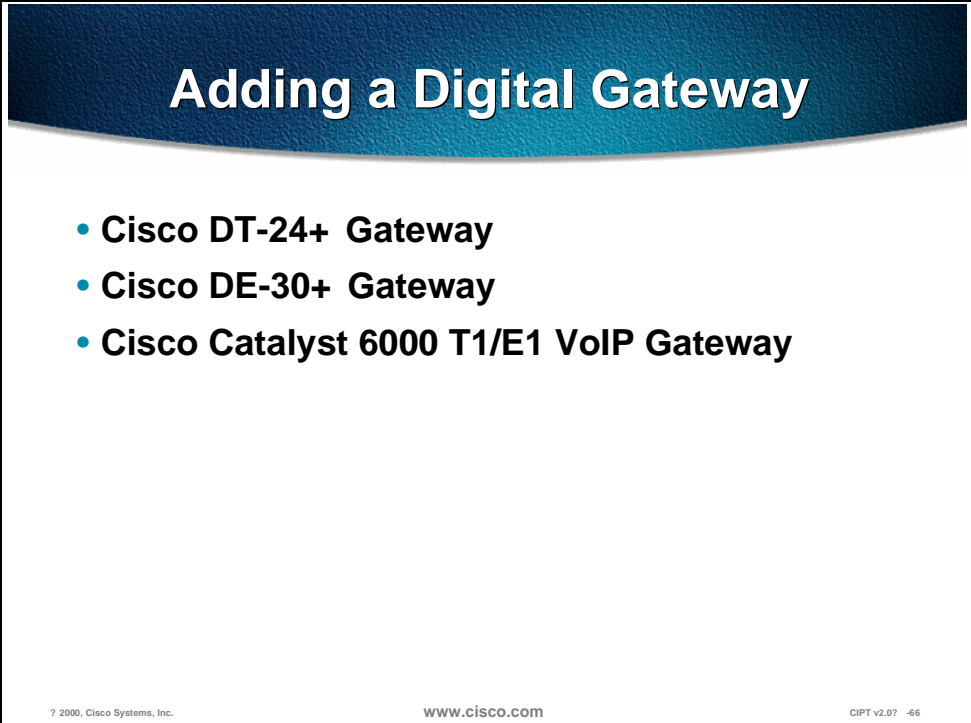

Adding a Digital Gateway

- **Cisco DT-24+ Gateway**
- **Cisco DE-30+ Gateway**
- **Cisco Catalyst 6000 T1/E1 VoIP Gateway**

© 2000, Cisco Systems, Inc. www.cisco.com CIPT v2.07 -66

The following are Cisco digital gateways you can add to CallManager:

- Cisco DT-24 + Gateway
- Cisco DE-30+ Gateway
- Cisco Catalyst 6000 T1/E1 VoIP Gateway

Procedure



© 2000, Cisco Systems, Inc.

www.cisco.com

CIPT v2.0? -67

Use the following procedure to add Cisco digital gateways to CallManager:

1. Open Cisco CallManager.
2. Select **Device > Add a New Device**. The Add Device screen appears.
3. Select **Device Type > Gateway**.
4. Select the Gateway Type. Access Digital PRI gateways include:
 - Cisco DT-24+ Gateway
 - Cisco DT-24 Gateway
 - Cisco DE-30+ Gateway
 - Cisco Catalyst 6000 E1 VoIP Gateway
5. Click **Insert**.
6. Select **Device Protocol > Access Digital PRI**.
7. Click **Next**. The Gateway Configuration screen appears.

Digital Gateway Configuration Settings

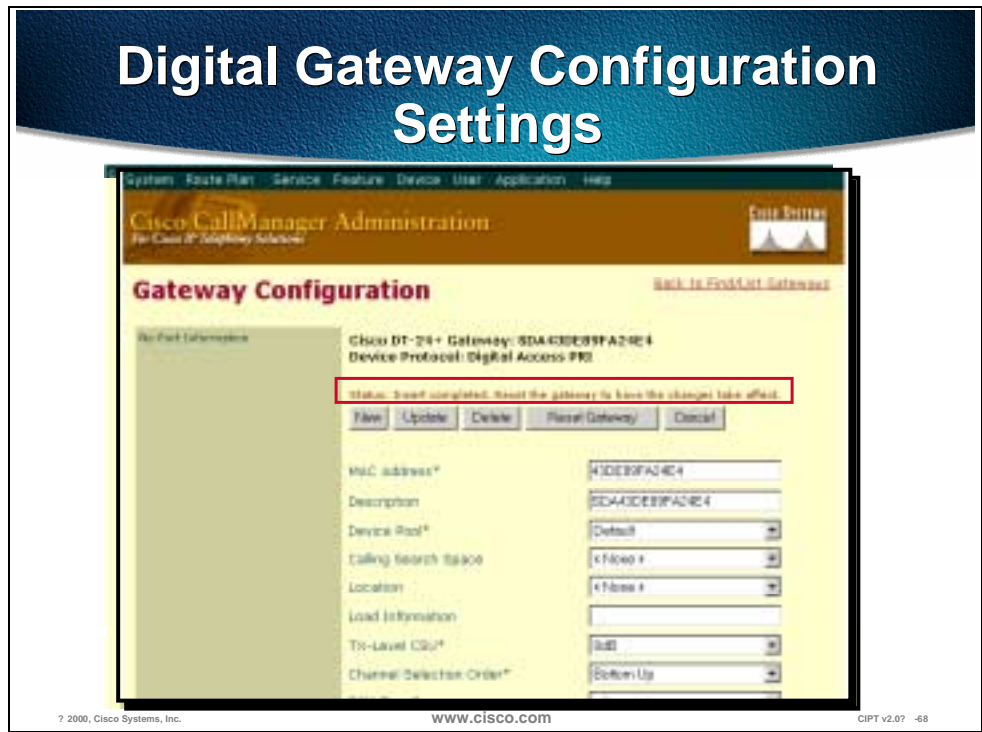

Enter the appropriate settings as described in the following table and following pages, Access Digital PR1 Gateway Configuration Setting, on the next page.

8. Click **Insert**. The Gateway Configuration screen appears.

Field	Description	Usage Notes
MAC Address	Identifies hardware-based telephones and device name.	Value must be 12 hexadecimal characters.
Description	Clarifies the purpose of the device.	
Device Pool	Specifies the collection of properties for this device including CallManager Group, Date and Time Setting, Region, and Calling Search Space for auto registration of devices.	
Calling Search Space	Specifies the collection of route partitions searched to determine how a dialed number should be routed.	
Location	Remote location accessed using restricted bandwidth connections.	
Load Information	Specifies the custom software for gateway.	Values entered here override the default values for this gateway.
TX-Level CSU	Specifies the transmit level based on the distance between the gateway and the nearest repeater. The default is full power (0dB).	Select one of the alternative settings to attenuate the line. -7.5dB -15dB -22.5dB
Channel Selection Order	Specifies the order in which ports are enabled from first (lowest number port) to last (highest number port), or from last to first.	Valid entries are TOP_DOWN (last to first) or BOTTOM_UP (first to last). If you're not sure which port order to use, choose TOP_DOWN.
PCM Type	Specifies the digital encoding format.	Choose from the following: A-law Use for Europe and the rest of the world μ-law Use for North America

Configuration Settings

Clock Reference*	Network
Protocol Side*	USER
Caller ID DN	
Calling Party Selection*	Originator
Channel IE Type*	Use Numberplan IE
Delay for first restart (1/8 sec ticks)	10
Delay between restarts (1/8 sec ticks)	4
Num Digits*	23
Sig Digits	#
Prefix DN	
Presentation BA*	Allowed
Called party IE number type unknown*	Cisco CallManager

© 2000, Cisco Systems, Inc.

www.cisco.com

CIPT v2.0—8-69

Field	Description	Usage Notes
Clock Reference	Specifies from where the clock is derived. Cisco Catalyst 6000 blades have eight ports on the same hardware card, each of which can be used as a clock reference by other ports on the same blade.	Select Internal or Network. Internal—When clocking is derived from the card and is then distributed at the span. Network—When the Cisco Access Digital Trunk Gateway receives its clocking from the network. Span 1 to Span 8—When the Cisco Access Digital Trunk Gateway receives clocking from another port on the same Cisco Catalyst 6000 blade.
Protocol Side	Setting used for Cisco Digital Access gateways depending on if gateway is connected to a Central Office/Network device or to a User device. The two ends of the PRI connection should use opposite settings. For example, if you are connected to a PBX and the PBX uses User as its protocol side, Network should be chosen for this device. Typically, this option is User for Central Office connections.	Read only. To change the Protocol Side setting, you must delete this device and add a new device with the correct information. User—used for any Cisco IP Phone, Conference Bridge, Media Termination Point, Cisco TAPI Port, Cisco TAPI Route Point, and H.225 client applications such as NetMeeting. Network—used for a Cisco Access Analog device, an H.323 gateway, another Cisco CallManager, or Robbed Bit signaling T1 gateway. Used for Cisco Access Digital if gateway is connected to a User device.
Caller ID DN	The pattern you want to use for Caller ID, from 0 to 24 digits.	For example, in North America: 555XXXX = variable Caller ID, where X is equal to an extension number. The CO appends the number with the area code if you do not specify it. 5555000 = Fixed Caller ID. Use when you want the corporate number to be sent instead of the exact extension from which the call is placed. The CO appends the number with the area code if you do not specify it.
Calling Party Selection	Determines which directory number is sent. Any outbound call on a gateway can send directory number information.	The following options specify which directory number is sent: Originator—send the directory number of the calling device. First Redirect Number—send the directory number of the redirecting device. Last Redirect Number—send the directory number of the last device to redirect the call.
Channel IE Type	Indicates whether channel selection is presented as a slot map or a channel map. Number—B-channel usage always a channel map format Slot map—B-channel usage always a slot map format	Select 0, 1, or 2. Type 2 in this field. Use Number When 1B B-channel usage is a channel map for one B-channel but is in a slot map if greater than one B-channel.
Delay for first restart (1/8 sec ticks)	Controls the rate at which the spans are brought in service when and Inhibit Restarts at PRI Initialization is disabled.	Use this option when many PRI spans are enabled on a system and Inhibit Restarts at PRI Initialization is disabled. For example, set the first five cards to 0, and set the next five cards to 16. (Wait two seconds before bringing them in service.)
Delay between restarts (1/8)	Determines the length of time between restarts if Inhibit Restarts is disabled when	

sec ticks)	a PRI restart is sent.	
Num Digits	Specifies the number of significant digits to collect, from 0 to 32. Significant digits are counted from the right (last digit) of the number called.	This field is used if you enable Sig Digits. It is used for the processing of incoming calls and indicates the number of digits starting from the last digit of the called number used to route calls coming into the PRI span. See Prefix DN and Sig Digits.
Sig Digits	Represent the number of final digits a PRI span should retain on inbound calls. A trunk with significant digits enabled truncates all but the final few digits of the address provided an inbound call.	Enable or disable this box depending on whether you want to collect significant digits. If disabled, the Cisco CallManager does not truncate the inbound number. If enabled, you also need to choose the number of significant digits to collect
Prefix DN	Specifies the prefix digits that are pre-pended to the digits this trunk receives on incoming calls. The Cisco CallManager adds prefix digits after first truncating the number in accordance with the Significant Digits Enabled and Number of Digits to Collect settings. Prefix Digits apply only to the processing of INCOMING calls.	For an example of how these capabilities work together, assume you have a trunk to the central office that is configured as DID (Direct Inward Dial). To people in the public network, the trunk is accessed by dialing 555-3000 through 555-3999. Because the trunk is configured as DID, however, the central office provides only the last four digits on inbound calls—the incoming trunk sees calls arriving for addresses within the range of 3000-3999. Assume that your internal directory numbers are configured within the range 8000-8999. That your local exchange carrier gave you a block of numbers in the 3000-3999 ranges is an annoyance, and you do not want to have to configure all your users with one directory number for inside calls and one for outside calls. By specifying a prefix digit of 8 and a significant digit count of 3 on the DID trunk, you tell the Cisco CallManager to discard all but the last three digits of any inbound number and then append the digit 8 in front of what remains. This configuration allows you to map the inbound numbers to your internal numbering plan.
Presentation Bit	Determines whether the central office transmits or blocks caller ID.	Allowed Select if you want the Central Office to send caller ID. Restricted Select if you do not want the Central Office to send caller ID.
Called party IE number type unknown	The format for the 'Type of Number' in called party directory numbers. Cisco CallManager sets called DN 'Type of Number'. We recommend you do not change the default value unless you have advanced experience with dialing plans, such as NANP or the European dialing plan. You may need to change the default in Europe because Cisco CallManager does not recognize European national dialing patterns. You can also change this setting when connecting to PBXs using routing as a non-national type number.	Use the following definition for each of the variables: CallManager—The Cisco CallManager sets the directory number type. International—Use when you are dialing outside the dialing plan of your country. National—Use when you are dialing within the dialing plan of your country. Unknown—The dialing plan is unknown.

Configuration Settings

Called Numbering Plan*	Disco CallManager
Calling Numbering Plan*	Disco CallManager
PRQ Protocol Type*	PRQML
PRQ restarts at PRQ initialization	<input checked="" type="checkbox"/>
Enable status poll	<input type="checkbox"/>
Number of digits to strip*	1
Zero Suppresson*	BRZ
Framing*	ESF
FCC Channel*	AT&T 54018
Yellow Alarm*	Bd
Trunk Level*	BT
Audio Signal Adjustment into IP Network*	NoOfPadding
Audio Signal Adjustment from IP Network*	NoOfPadding

* indicates required item

Field	Description	Usage Notes
Calling party IE number type unknown	The format for the 'Numbering Plan' in called party directory numbers. Cisco CallManager sets called DN 'Numbering Plan'. We recommend you do not change the default value unless you have advanced experience with dialing plans, such as NANP or the European dialing plan. You may need to change the default in Europe because Cisco CallManager does not recognize European national dialing patterns. You can also change this setting when connecting to PBXs using routing as a non-national type number.	Use the following definition for each of the variables: CallManager—The Cisco CallManager sets the directory number type. International—Use when you are dialing outside the dialing plan of your country. National—Use when you are dialing within the dialing plan of your country. Unknown—The dialing plan is unknown.
Called Numbering Plan	The format for the 'Numbering Plan' in called party directory numbers. Cisco CallManager sets called DN 'Numbering Plan'. We recommend you do not change the default value unless you have advanced experience with dialing plans, such as NANP or the European dialing plan. You may need to change the default in Europe because Cisco CallManager does not recognize European national dialing patterns. You can also change this setting when connecting to PBXs using routing as a non-national type number.	Use the following definition for each of the variables: CallManager—The Cisco CallManager sets the Numbering Plan in the directory number. ISDN—Use when you are dialing outside the dialing plan of your country. National Standard—Use when you are dialing within the dialing plan of your country. Private—Use when you are dialing within a 'private' network. Unknown—The dialing plan is unknown.
Calling Numbering Plan	The format for the 'Numbering Plan' in calling party directory numbers. Cisco CallManager sets calling DN 'Numbering Plan'. We recommend you do not change the default value unless you have advanced experience with dialing plans, such as NANP or the European dialing plan. You may need to change the default in Europe because Cisco CallManager does not recognize European national dialing patterns. You can also change this setting when connecting to PBXs using routing as a non-national type number.	Use the following definition for each of the variables: CallManager—The Cisco CallManager sets the Numbering Plan in the directory number. ISDN—Use when you are dialing outside the dialing plan of your country. National Standard—Use when you are dialing within the dialing plan of your country. Private—Use when you are dialing within a 'private' network. Unknown—The dialing plan is unknown.
PRI Protocol Type	The communications protocol for the span: 4E—AT&T InterExchange carrier 5E8 Custom—Cisco IP Phone (does not conform to national ISDN standards) 5E9 and NI2—AT&T family local exchange switch or carrier Australian—European ISDN DMS—MCI family local exchange switch or carrier ETSI SC—European local exchange carrier Euro—European ISDN	Determine the switch to which you are connecting and the preferred protocol, as follows: Nortel Meridian—5E8 Custom Lucent Definity—4ESS or 5E8 Madge (Teleos) box—5E8 Teleos Intecom PBX—5E8 Intecom Alternatively, select the protocol based on the carrier: MCI—DMS-250 Sprint—DMS-250 or DMS-100 AT&T—4ESS
Inhibit restarts	A restart is a message that confirms the	Enable or disable. When the D-Channel

at PRI initialization	status of the ports on a PRI span. If restarts are not sent, they are assumed to be in service.	successfully connects with another PRI's D-Channel it sends restarts when this option is disabled.
Enable status poll	Enable to view the B-channel status in the debug window.	
Number of digits to strip	The number of digits to strip on outbound calls, from 0 to 32.	For example, 8889725551234 are dialed, and the number of digits to strip is 3. In this example, 888 are stripped from the outbound number.
Zero Suppression	Determines how the T1 or E1 span electrically codes binary 1's and 0's on the wire (line coding selection).	For a T1, this could be AMI (Alternate Mark Inversion) or B8ZS (Bipolar 8-Zeros Substitution). For an E1, this could be AMI or HDB3.
Framing	Determines the multiframe format of the span.	The choices are (for T1). SF—superframe consisting of 12 frames. ESF—extended superframe consisting of 24 frames. E1 is always ESF (Extended Superframe, consisting of 16 frames).
FDL Channel	Determines what kind, if any, facility data link is supported by the span. The FDL is a maintenance channel that allows remote troubleshooting of link-layer problems, and remote monitoring of performance statistics of the link.	Only relevant on T1 spans. Choices are: ANSI T.401 AT&T PUB 54016
Yellow Alarm	Determines how a remote alarm indication is coded on a T1 span. A yellow alarm indicates that the other end of the link has lost frame synchronization on the signal being transmitted by this end.	Choices include F-bit (out of band signaling; allows 64kbps clear channel bearer capability per B-channel), or bit-2 (in band signaling; robs bit 2 of every channel).
Trunk Level	Adjusts the gain of audio entering or leaving the span.	
Adjustment to Received Audio Signal	Specifies the gain or loss applied to the received audio signal relative to the port application type.	Select the gain or loss you want applied to the received audio signal relative to the following port application types: AnalogCOTrunk—Minus3db DigitalToAnalogCO—NoDbPadding AnalogTieTrunk—NoDbPadding DigitalToDigitalCO—NoDbPadding ISDNStation—NoDbPadding ISDN_DigitalTieTrunk—NoDbPadding ISDNTrunk—NoDbPadding OnPremisePOTSLine—Plus3db OffPremisePOTSLine—NoDbPadding SatelliteAnalogTieTrunk—NoDbPadding SatelliteDigitalTieTrunk—NoDbPadding AnalogTollTrunk—Plus3db
Adjustment to Transmitted Audio Signal	Specifies the gain or loss applied to the transmitted audio signal relative to the port application type.	Select the gain or loss you want applied to the transmitted audio signal relative to the following port application types: AnalogCOTrunk—Minus6db

		<p>DigitalToAnalogCO—Minus3db</p> <p>AnalogTieTrunk—NoDbPadding</p> <p>DigitalToDigitalCO—NoDbPadding</p> <p>ISDNStation—NoDbPadding</p> <p>ISDN_DigitalTieTrunk—NoDbPadding</p> <p>ISDNTrunk—NoDbPadding</p> <p>OnPremisePOTSLine—Plus3db</p> <p>OffPremisePOTSLine—Minus3db</p> <p>SatelliteAnalogTieTrunk—Minus3db</p> <p>SatelliteDigitalTieTrunk—Minus3db</p> <p>AnalogTollTrunk—NoDbPadding</p>
D Channel Enable	<p>If enabled for an E1 or T1 PRI, then one of the span B-channels will be appropriated and used to establish a D-channel across the span for Common Channel Signaling (CCS) of calls.</p> <p>If disabled, then all B-channels on the span will be available for audio calls.</p>	
Card Locations	<p>When you set this option, the Device Wizard--Slot Position screen appears. Follow the diagram in the Device Wizard.</p>	<p>Only appears on a DT-24 Gateway.</p> <p>A slot position refers to the peripheral component interconnect (PCI) card slot into which the digital signal processor (DSP) card is plugged. When adding a new card to the digital access, always add cards from right to left when viewing the gateway from the back. The first (oldest) card should be in the right-most slot (labeled 1 in the Device Wizard), and each subsequent card should be installed in the next available slot position, moving from right to left. If you have existing cards that were not installed in the right-most positions, move the original cards to the right-most slots before adding the new card.</p>

Adding an H.323 Gateway

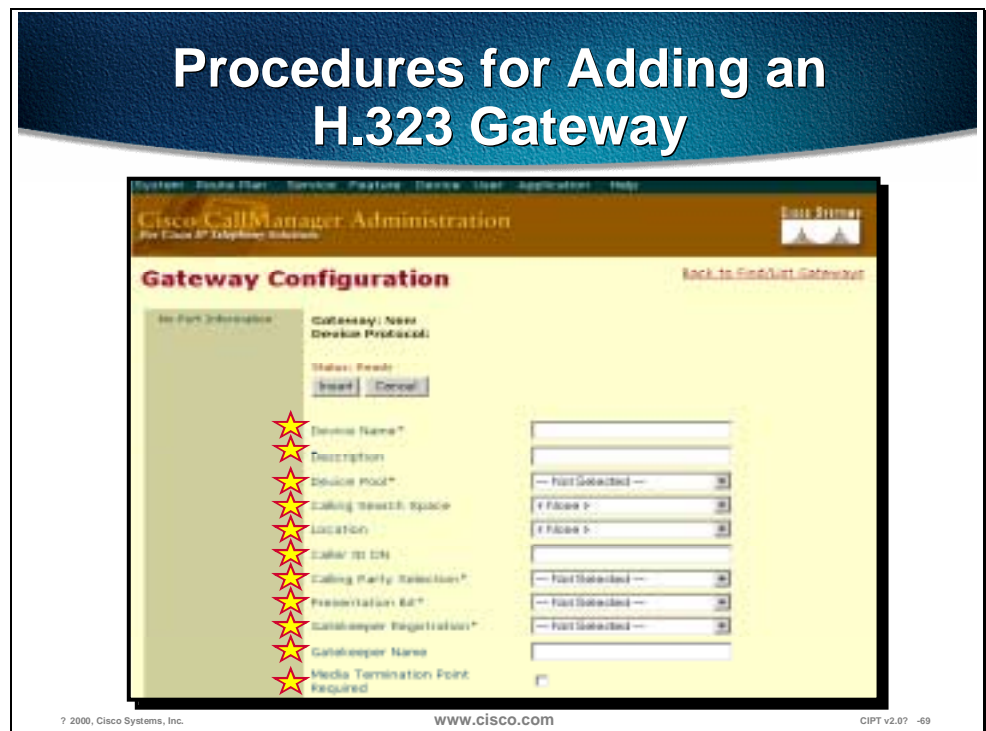

To add the an H.323 gateway, use the following procedure:

1. Open Cisco CallManager.
2. Select **Device > Add a New Device**. The Add Device screen appears.
3. Select **Device Type > Gateway**.
4. Select **Gateway Type > H.323**.
5. Select the Device Protocol. The following device protocols are available:
 - H.225
 - Inter-cluster Trunk
6. Click **Next**. Enter the appropriate settings as described in the table, H.323 Gateway Configuration Settings, on the following page.

Field	Description	Usage Notes
Device Name	Specifies unique name used by CallManager to identify the device.	
Description	Clarifies purpose of device.	
Device Pool	Specifies the collection of properties for this device including CallManager Group, Date and Time Setting, Region, and Calling Search Space for auto-registration of devices.	
Calling Search Space	Specifies the collection of Route Partitions searched to determine how a dialed number should be routed.	
Caller ID DN	The pattern you want to use for Caller ID, from 0 to 24 digits.	For example, in North America: 555XXXX = variable Caller ID, where X is equal to an extension number. The CO appends the number with the area code if you do not specify it. 5555000 = Fixed Caller ID. Use when you want the Corporate number to be sent instead of the exact extension from which the call is placed. The CO appends the number with the area code if you do not specify it.
Calling Party Selection	Any outbound call on a gateway can send directory number information. This field determines which directory number is sent.	The following options specify which directory number is sent: Originator—send the directory number of the calling device. First Redirect Number—send the directory number of the redirecting device. Last Redirect Number—send the directory number of the last device to redirect the call.
Presentation Bit	Determines whether the central office transmits or blocks caller ID.	Allowed Select if you want the Central Office to send caller ID. Restricted Select if you do not want the Central Office to send caller ID.
Gatekeeper registration	A Gatekeeper is an H.323 entity on the LAN that provides address translation and controls access to the LAN for connections between H.323-compliant devices such as terminals and gateways. Use only for H.323-compliant gateways. All other devices do not use this box.	If your device is not gatekeeper controlled, select None. If your device is registered with the Cisco CallManager gatekeeper, select Local. If your device is registered with a specific remote gatekeeper, select Remote.
Gatekeeper Name	The Domain Name Service (DNS) name or IP address of the H.323 gatekeeper.	Use only for H.323-compliant gateways. All other devices do not use this box. This is an optional box. If Remote is selected as the Gatekeeper Registration, type a Gatekeeper Name (optional).
Media Termination Point Required	Determines whether or not a Media Termination Point is used to implement features that H.323 does not support (such as hold and transfer).	Used for H.323 clients only.

7. Click **Insert**.

Laboratory Exercise: Dial Plan and Cisco Access Gateways

Summary

This section summarizes the concepts you learned in this chapter.

Summary

- **Cisco CallManager 3.0 supports three types of gateway protocols: skinny, H.323, and MGCP.**
- **Out-of-band signaling for carrying DTMF tones across VoIP provides a solution for codec induced symptoms.**
- **IOS gateways support H.323v2, which can support supplementary services and eliminates the use of software MTP.**

© 2000, Cisco Systems, Inc. www.cisco.com CIPT v2.07 -70

Cisco CallManager 3.0 supports three types of gateway protocols:

- Skinny gateway protocol—used by the digital gateways, including the Cisco Digital IP Telephony Gateway DT-24+ and DE-30+, as well as the Catalyst 6000 Voice Gateway module.
- H.323—used by the Cisco IOS integrated router gateways to communicate with Cisco CallManager.
- Media Gateway Control Protocol (MGCP)—used by Cisco CallManager to control the new VG200 standalone analog gateway.

DTMF uses specific pairs of frequencies within the voice band for signaling. Over a 64 kbps pulse code modulation (PCM) voice channel, these signals can be carried without difficulty. However, when using a low bit-rate codec for voice compression, the potential exists for DTMF signal loss or distortion. Using an out-of-band signaling method for carrying DTMF tones across a voice over IP infrastructure provides an elegant solution for these codec-induced symptoms.

The use of H.323v2 in IOS release 12.0(7)T and above (specifically the OpenLogicalChannel, CloseLogicalChannel, and emptyCapabiliySet features) by IOS gateways and CallManager 3.0 eliminates the requirement for MTP to provide supplementary services. Because MTP is no longer needed to terminate the G.711 RTP streams from both the IP phones and the IOS gateway, compressed voice calls (G.723.1 and G.729a) are now supported between IOS gateways and CallManager endpoints.

Review Questions

Answer the following questions.

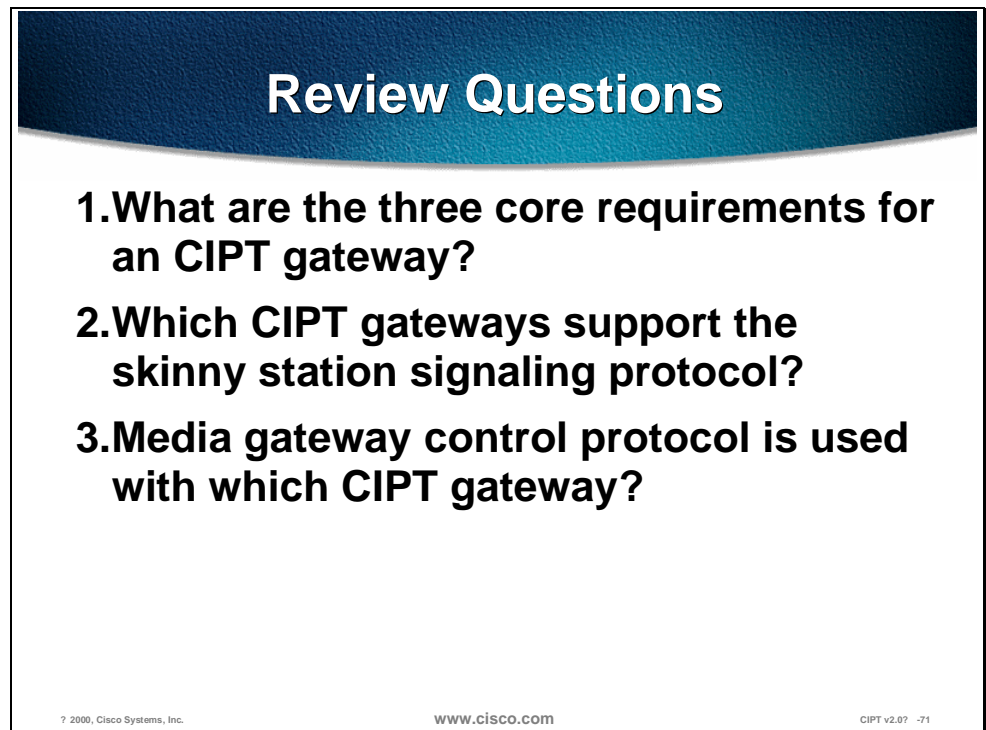

Review Questions

- 1. What are the three core requirements for an CIPT gateway?**
- 2. Which CIPT gateways support the skinny station signaling protocol?**
- 3. Media gateway control protocol is used with which CIPT gateway?**

© 2000, Cisco Systems, Inc. www.cisco.com CIPT v2.0? -71

- Q1) Every CIPT gateway selection is made by combining common or core requirements with site and implementation specific features. What are the three core requirements for a CIPT gateway?
- Q2) Of the CIPT gateways, which gateway models support skinny gateway protocol?
- Q3) The Media gateway protocol is supported by Cisco CallManager 3.0. What is the hardware that supports MGCP?

Catalyst DSP Provisioning

Overview

This chapter describes Catalyst digital signal processor (DSP) resources, with emphasis on two new Catalyst 4000 and Catalyst 6000 voice modules, and discusses how to provision these resources. These new modules are the WS-X4604-GWY for the Catalyst 4000 and the WS-X6608-T1 (WS-X6608-E1 for countries outside the USA) for the Catalyst 6000. They can perform conferencing and media termination point (MTP) transcoding services in addition to serving as a PSTN gateway.

This chapter includes the following major sections:

- Objectives
- Understanding the Catalyst DSP Resources
- Catalyst 4000 Voice Services
- Catalyst 6000 Voice Services
- Catalyst Conferencing Services
- Catalyst MTP Transcoding Services
- Installation in Cisco CallManager Administration
- Summary
- Review Questions

Objectives

This section lists the chapter objectives.

Objectives

Upon completion of this chapter, you will be able to perform the following tasks:

- **Identify and describe conferencing design details**
- **Identify and describe MTP/transcoding design details**
- **Install and configure conferencing and MTP/transcoding resources in the Cisco CallManager administration**
- **Invoke DSP resources on a phone call**

© 2000, Cisco Systems, Inc. www.cisco.com CIPT v2.0? -3

Upon completion of this chapter, you will be able to perform the following tasks:

- Given a list of Cisco IP telephony design details, identify and describe the design details related to hardware conferencing.
- Given a list of Cisco IP telephony design details, identify and describe the design details related to hardware MTP/transcoding.
- Given a Catalyst 6000 with the WS-X6608-T1 or WS-X6608-E1 installed, install and configure conferencing and MTP/transcoding resources in the Cisco CallManager administration.
- Given a Cisco IP telephony network and DSP resources installed and configured, invoke the DSP resources (conferencing or MTP/transcoding) on a phone call.

Understanding the Catalyst DSP Resources

This section describes the Catalyst DSP resources.

Media Termination Point (MTP)

A Media Termination Point (MTP) is invoked on behalf of H.323v1 endpoints (such as calls through Inter-CCM version 2.4 trunks) involved in a call to enable supplementary services to those endpoints.

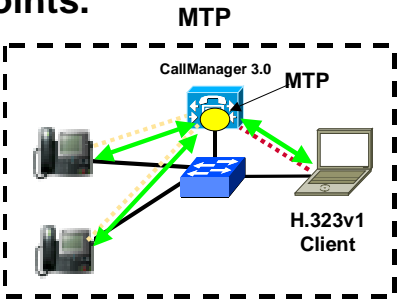

The diagram illustrates the Media Termination Point (MTP) setup. It shows a central Cisco CallManager 3.0 server (represented by a blue cube) with a yellow circle labeled 'MTP' on top. Two IP phones are connected to the CallManager 3.0 server. An H.323v1 Client (represented by a laptop) is also connected to the CallManager 3.0 server. Green arrows indicate the flow of media from the IP phones through the MTP to the H.323v1 Client. A red dashed arrow indicates the flow of signaling from the H.323v1 Client through the CallManager 3.0 server to the IP phones. The entire setup is enclosed in a dashed black box.

© 2000, Cisco Systems, Inc. www.cisco.com CIPT v2.0-9-4

A Media Termination Point (MTP) is invoked on behalf of H.323v1 endpoints (such as calls through Inter-Cisco CallManagers version 2.4 trunks) involved in a call to enable supplementary services to those endpoints. This service is used when Cisco IP Voice Media Streaming Application is installed and running on a Cisco CallManager.

Transcoding

A Transcoder is a device that takes the output stream of one CODEC and Transcodes (converts) it from one compression type to another compression type. Specifically, G.723.1 or G.729a can be converted to G.711 and vice-versa.

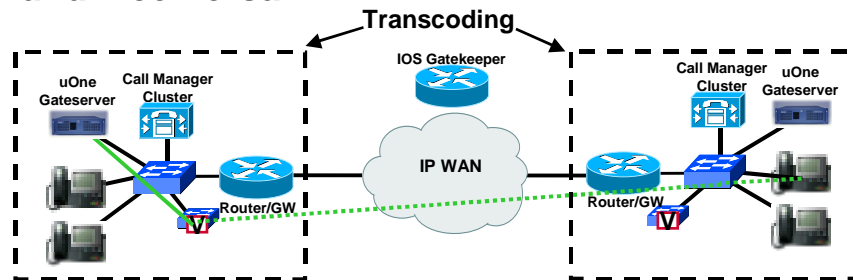

© 2000, Cisco Systems, Inc.

www.cisco.com

CIPT v2.0-9-5

A transcoder is a device that takes the output stream of one CODEC and transcodes (converts) it from one compression type to another compression type. Specifically, G.723.1 or G.729a can be converted to G.711 and vice versa. As of now this hardware resource is available on the Catalyst 6000 T1/E1 module.

Conferencing

- **Ad Hoc**
 - User presses “ conf” button; 1st caller put on Hold; gets dial-tone and dials a second user; presses “conf” again and all users are now connected on the conference bridge
- **Meet-Me**
 - Conference Controller presses “ Meet-Me” button; gets dial-tone and dials conf call number; all conf call attendees calls conf call number

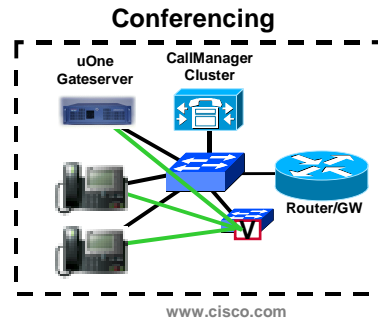

© 2000, Cisco Systems, Inc.

CIPT v2.0—9-6

Conferencing is the ability to speak with three or more persons on a phone call. There are two types of conferencing, Ad Hoc and Meet-Me. An Ad Hoc conference is when a user is on a call with another person and then wants to add someone else on to the call. A Meet-Me conference is a phone conference that individuals or groups of people use a phone device to call into one conference number for a phone conference.

DSP Resource Modules for the 4000 and 6000

Catalyst 4000

- WS-X4604-GWY

Catalyst 6000

- WS-X6608-T1/WS-X6608-E1



© 2000, Cisco Systems, Inc.

www.cisco.com

CIPT v2.07 -4

The DSP resources on the new Catalyst 4000 and 6000 gateway modules essentially provide hardware support for IP telephony features offered by the Cisco CallManager. These features are hardware-enabled voice conferencing, hardware-based MTP support for supplementary services, and MTP transcoding services.

Catalyst enabled *conferencing* supports voice conferences in hardware. DSPs convert G.711 voice sessions into TDM streams, which can then be mixed into a conference call by another DSP. The Catalyst MTP service can either act like the original software MTP resource or as a transcoding MTP resource.

An MTP service provides supplementary services such as hold, transfer, and conferencing when using gateways that do not support the H.323v2 feature of OpenLogicalChannel and CloseLogicalChannel with the EmptyCapabilitiesSet. This is available as a software feature that can run on the CallManager or on a separate NT server. When running in software on a CallManager, 24 MTP sessions are supported. When running on a separate NT server, up to 48 MTP sessions are supported. The new Catalyst gateway modules can support this same functionality, but provide the service in hardware.

MTP transcoding is in effect an IP-to-IP voice gateway service. A transcoding node can convert a G.711 voice stream into a low bit-rate (LBR) compressed voice stream, such as G.729a. This is critical for enabling applications such as integrated voice response (IVR), uOne messaging, and conference calls over slow speed IP WANs. MTP transcoding is only supported on the Catalyst voice gateways.

Catalyst DSP Resource Matrix

Catalyst DSP Resource Matrix			
Catalyst Voice Modules	PSTN Gateway Sessions	Conferencing Sessions	MTP Transcoding Sessions
Catalyst 4000 WS-X4604-GWY	104 G.711 sessions	24 G.711 conferencing sessions?maximum of 4 conferencing of 6 participants	16 MTP transcoding sessions
Catalyst 6000 WS-6608-T1 or WS-6608-E1	32 G.711 sessions per physical DS1 port; 256 per module	16 G.711 conferencing sessions per physical port, maximum conference size of 6 participants; 128 conference sessions per module	16 MTP transcoding sessions per physical port; 128 per module

© 2000, Cisco Systems, Inc. www.cisco.com CIPT v2.07 -5

The table shows the DSP resources that can be configured on the Catalyst voice services modules. Some of these numbers may change in the future. The number of users will determine the amount of resources needed. Every Cisco CallManager must have its own DSP resources.

Catalyst 4000 Voice Services

This section describes the Catalyst 4000 voice services.

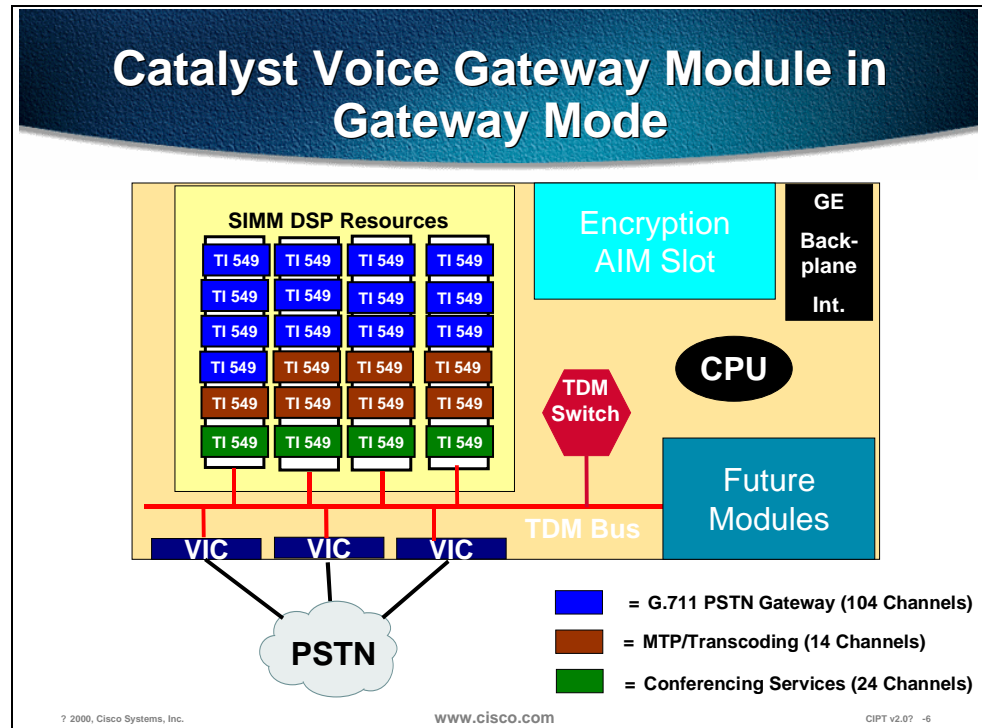

The PSTN gateway and voice services module for the Catalyst 4003 and 4006 switches, supports three analog voice interface cards (VICs) with two ports each, or one T1/E1 card with two ports and two analog VICs; the VIC interfaces can be provisioned in any combination of FXO, FXS, or E&M. Additionally, when configured as an AVVID gateway from the CLI, this module can support conferencing and transcoding services.

The Catalyst 4000 voice gateway module can be configured in either *toll bypass* mode or *AVVID gateway* mode. However, the module's conferencing and transcoding resources can only be configured in gateway mode. Once the gateway mode is enabled, the module's 24 DSPs (4 SIMMs with 6 DSPs each) are automatically provisioned as follows:

- PSTN gateway: 104 channels of G.711 voice
- Conferencing: 24 channels of G.711 conferencing
- MTP transcoding: 14 channels of LBR-G.711 transcoding

Configuration Commands

```
voicecard mtp
  mtp-address <IP>
  manager-address [<IP1>|<DNS1>]
  manager-address [<IP2>|<DNS2>]
  manager-address [<IP3>|<DNS3>]
voicecard conference
  conference-address <IP>
  manager-address [<IP1>|<DNS1>]
  manager-address [<IP2>|<DNS2>]
  manager-address [<IP3>|<DNS3>]
```

© 2000, Cisco Systems, Inc.

www.cisco.com

CIPT v2.07 -7

Gateway mode is the default configuration. The conferencing-to-transcoding ratios can be changed from the CLI, as shown by the configuration commands. By changing the number of transcoding sessions to 14, instead of 16, an additional 8-conferencing session can be enabled.

The following configuration points should be noted:

- The WS-X4604-GWY uses an IOS interface for initial device configuration. For all *PSTN gateway functions*, the Catalyst 4000 module uses H.323v2 and is configured identically to an IOS gateway. From the CallManager configuration screen, simply add the Catalyst 4000 gateway as an H.323 gateway.
- For all *voice services features*, such as hardware-based conferencing or MTP transcoding, the module relies on the Skinny Station Protocol for CallManager interaction. Therefore, once the above CLI commands are entered for defining conferencing and transcoding functions, all additional configurations for these voice features take place on the CallManager.
- Each service on the module, whether PSTN gateway, conferencing, or MTP transcoding services, requires an IP address. These can be the same IP addresses or different ones for redundancy and management.
- A prioritized set of CallManagers can be defined for both the conferencing services and MTP transcoding services.

Catalyst 6000 Voice Services

This section describes the Catalyst 6000 voice gateway module.

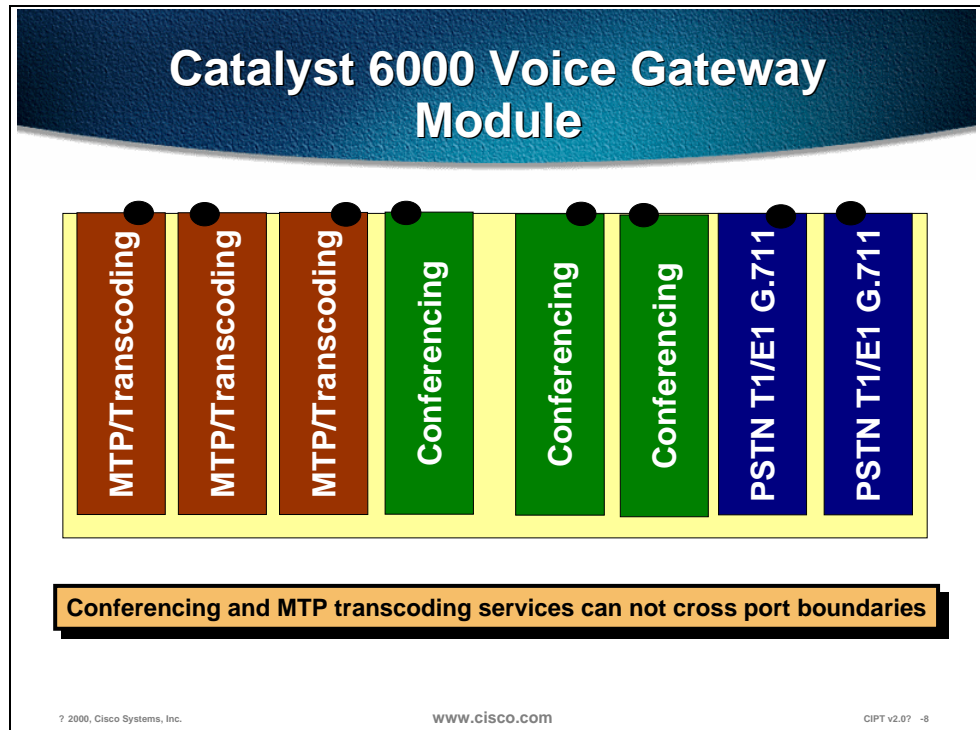

The WS-6608-T1 (or WS-6608-E1 for European countries) is the same module that provides T1 or E1 PSTN gateway support for the Catalyst 6000. This module has eight CAS or PRI interfaces, each of which has its own CPU and DSPs. Once the card has been added from the CallManager as a voice gateway, it can be configured as a conferencing or MTP transcoding node. Each port acts independently of the other ports on the module. Specifically, each port can only be configured as a PSTN gateway interface, a conferencing node, *or* an MTP transcoding node.

Whether acting as a PSTN gateway, a conferencing resource, or an MTP transcoding resource, each port on the module requires its own IP address. The port can be configured to have either static IP address or a DHCP provided IP address. If a static IP is entered, a TFTP server address must also be added, because the ports actually get all configuration information from the downloaded TFTP configuration file. Once configured through the CallManager interface, each port is capable of supporting *one* of the following configurations:

- PSTN gateway mode: 32 sessions of G.711 voice
- Conferencing mode: 16 conferencing sessions
- MTP mode: 16 MTP transcoding sessions

Catalyst Conferencing Services

This section describes hardware conferencing services.

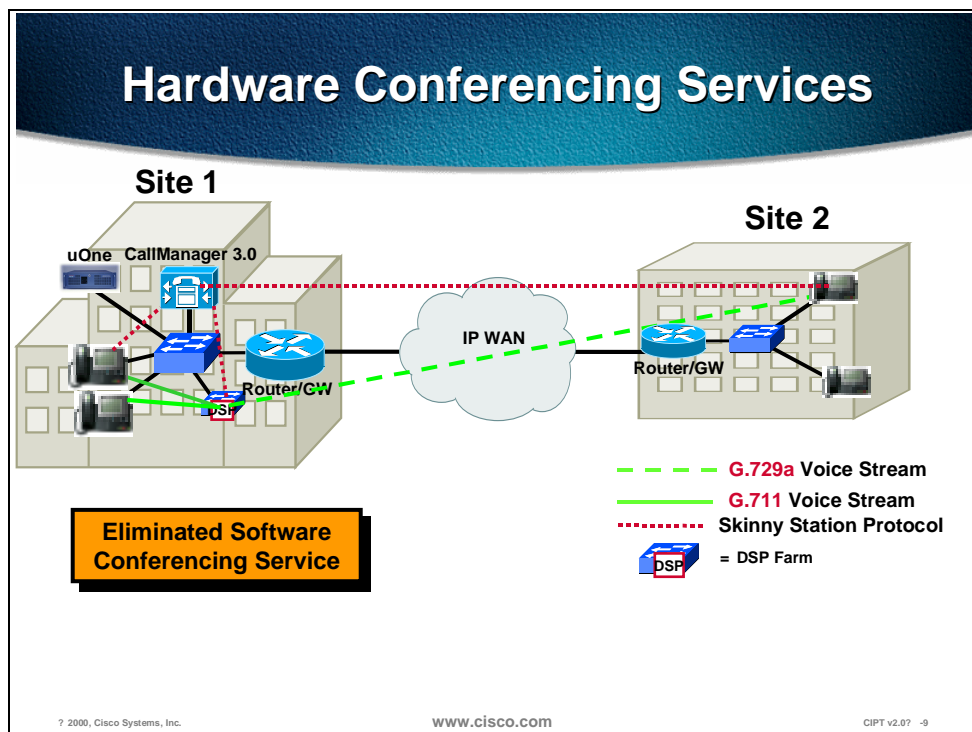

To scale CIPT deployments in large enterprise environments, hardware based conferencing must be used. The new hardware for the Catalyst 4000 and Catalyst 6000 switch families was developed with this requirement in mind. These new Catalyst voice modules can handle conferencing in hardware, eliminating the requirement of running a software conferencing service on an NT server in the AVVID network.

Both the WS-X4604-GWY and WS-X6608-T1 (or WS-X6608-E1) modules use the Skinny Station Protocol to communicate with the CallManager when providing conferencing or MTP transcoding services.

The Catalyst 4000 module, the WS-X4604-GWY, can support up to four simultaneous conferencing sessions of six callers each. The Catalyst 4000's conferencing ability is enabled as soon as it is configured as an AVVID gateway. The Catalyst 6000's T1 or E1 PSTN gateway module, the WS-X6608, also supports conferencing. After the WS-X6608 has been added as a T1 or E1 AVVID gateway, it can be configured, on a per port basis, for conferencing services. The Catalyst 6000 conferencing module supports up to 16 simultaneous conference sessions per port. This results in a maximum of 128 conference participants per module.

Conferencing Design Details

Conferencing Design Details

- **Max number of 16 participants per conference call**
- **WS-X4604-GWY supports 24 conferencing sessions per module**
- **WS-X6608-T1 or WS-X6608-E1 supports 16 conferencing sessions per physical port, 128 per module**
- **All conference calls are G.711 only**
- **MTP transcoding can be used to convert G.729a or G.723.1 to G.711 for conference calls**
- **CallManagers cannot share DSP resources**

© 2000, Cisco Systems, Inc.

www.cisco.com

CIPT v2.07 -10

The following points summarize the design capabilities and requirements of the new Catalyst voice modules:

- Maximum of 16 participants per conference call.
- WS-X4604-GWY supports 24 conferencing sessions per module.
- WS-X6608-T1 or WS-X6608-E1 supports 16 conferencing sessions per physical port, 128 per module.
- All conference calls are G.711 only.
- MTP transcoding can be used to convert G.729a or G.723.1 to G.711 for conference calls.
- Each CallManager must have its own conference and MTP transcoding resources, because the DSP resources can only register with one CallManager at a time. CallManagers cannot share DSP resources.

The following additional points should be noted:

- When provisioning an enterprise with conference ports, it is vital to know how many callers will be attempting to join the conference calls from a compressed CallManager region. Once the number of compressed callers is identified, then the MTP transcoding resources can be accurately provisioned.
- Each configured CallManager should have its own conferencing module associated with it, because conference bridges cannot register with more

than one CallManager at a time, and CallManagers cannot share DSP resources.

Conferencing Caveats

Conferencing Caveats

- **Catalyst conferencing services support G.711 connections only.**
- **On the Catalyst 6000, conferencing services cannot cross port boundaries.**
- **Each CallManager must have its own conferencing resource configured.**

© 2000, Cisco Systems, Inc. www.cisco.com CIPT v2.07 -11

The following caveats apply to Catalyst conferencing services:

- Catalyst conferencing services support G.711 connections only.
- On the Catalyst 6000, conferencing services cannot cross-port boundaries.
- Each CallManager must have its own conferencing resource configured.

The conferencing resource can support only G.711, however, a compressed (G.723 or G.729) call can join the conference because the conferencing resource will transcode that call to G.711 to participate in the conference.

Note One user requires one session or stream to connect into a conference, so if a device registers 16 sessions or streams it is saying that it can support 16 parties connected to conferences on that device.

Catalyst MTP Transcoding Services

This section describes the Catalyst MTP transcoding services.

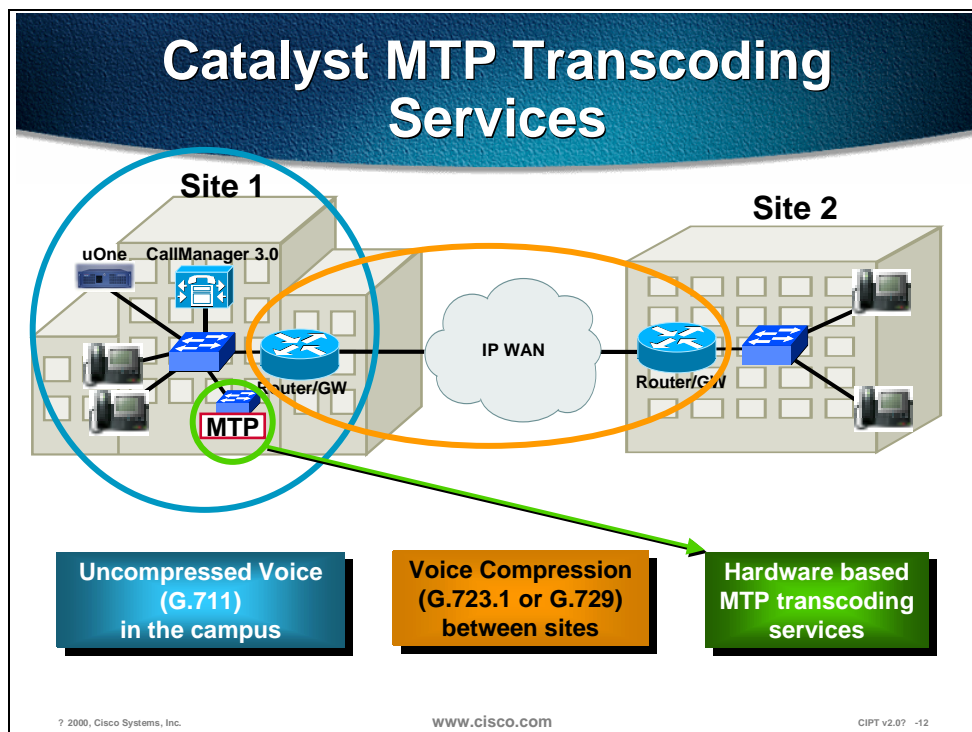

Introducing the WAN into a CIPT implementation forces the issue of voice compression. In the previous designs, all campus-oriented voice was uncompressed (G.711) to provide the highest quality while incurring the fewest complications. Once a WAN enabled CIPT network is deployed, voice compression between sites is the recommended design choice. This calls into question how WAN users use the conferencing services or IP enabled applications, such as the uOne Messaging Server, which only support G.711 voice connections. The solution is to use hardware-based MTP transcoding services to convert the compressed voice streams into G.711.

MTP Transcoding Design Details

MTP Transcoding Design Details

- **Provision MTP transcoding resources appropriately**
- **WS-X4604-GWY supports 14 transcoding mediastreams per module**
- **WS-X6608-T1/E1 supports 16 transcoding mediastreams per physical port, 128 per module**
- **Transcoding is low bit-rate to high bit-rate, or vice versa**
- **Each CallManager must have its own MTP transcoding resources**
- **Own jitter buffer of 20 to 40 ms**

© 2000, Cisco Systems, Inc.

www.cisco.com

CIPT v2.07 -13

Each Cisco CallManager should have its own transcoding resource. Transcoding resources can transcode from low bit-rate to high bit-rate and vice versa. For example a G.729 call can be transcoded to a G.711, but may not be transcoded to G.723. This is very helpful when deploying the CIPT solution across the IP WAN. A case where a caller is across the IP WAN and needs to access their voice mail (uOne Gateserver) that only allows G.711 codec. The transcoding resource can take a G.729 codec call coming in across the WAN and convert it to G.711 codec so the call can access their voice mail. In the transcoding resource it produces its own jitter buffer of 20 to 40 ms.

IP-to-IP Packet Transcoding and Voice Compression

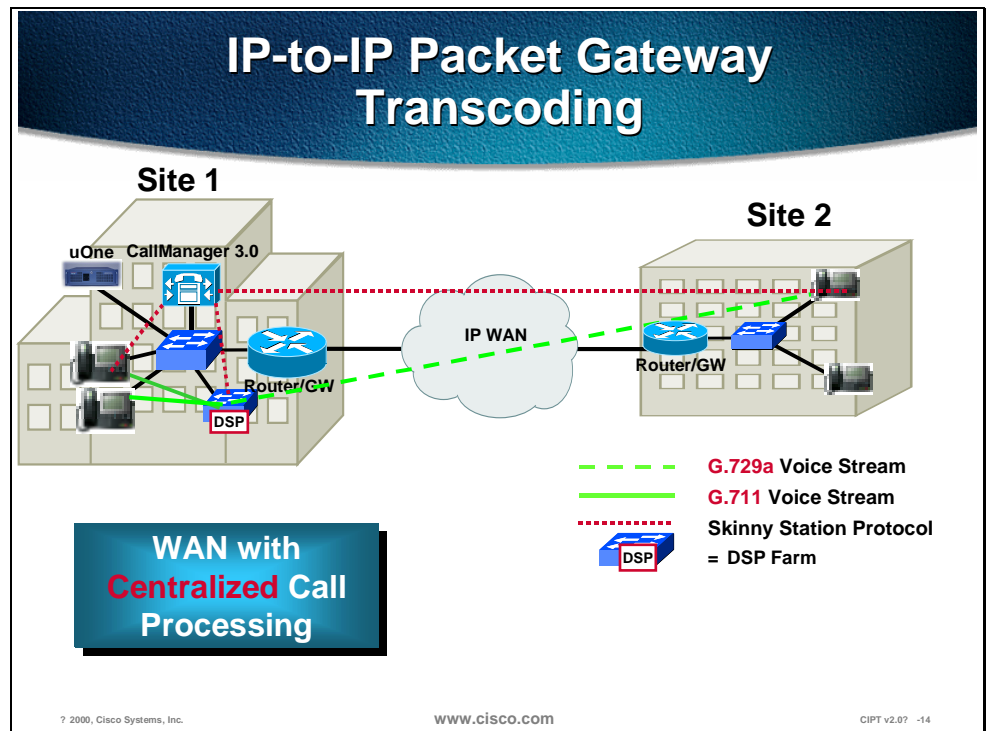

Voice compression between IP phones is easily configured through the use of regions and locations in CallManager 3.0. However, both the Catalyst conferencing services and the uOne messaging software currently only support G.711, or uncompressed, connections. For these situations, MTP transcoding or packet-to-packet gateway functionality has been added to two of the new modules for the Catalyst 4000 and Catalyst 6000.

A packet-to-packet gateway is a device with DSPs that has the job of transcoding between voice streams using different compression algorithms. That is, when a user on an IP phone at a remote location calls a user located at the central location, the CallManager instructs the remote IP phone to use compressed voice, or G.729a, only for the WAN call.

However, if the called user at the central site is unavailable, the call rolls to the uOne messaging system, which supports G.711 only. In this case, a packet-to-packet gateway transcodes the G.729a voice stream to G.711 to leave a message with the uOne Messaging Server.

Voice Compression, IP-to-IP Packet Transcoding, and Conferencing

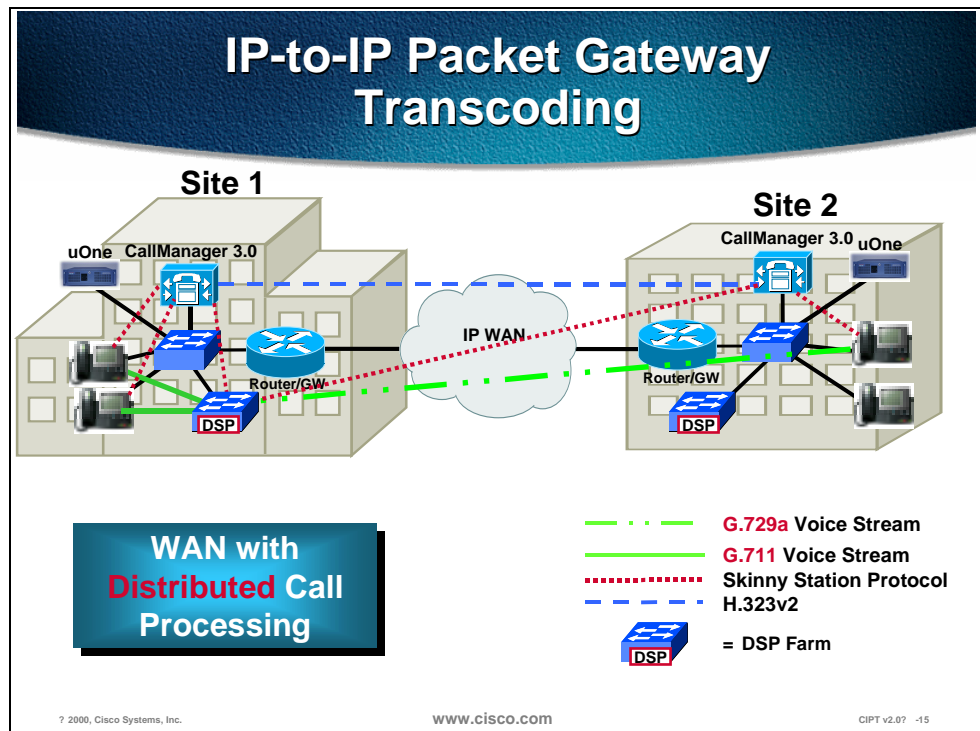

Connecting sites across an IP WAN for conference calls presents a complex scenario. The H.323v2 signaling is the inter-cluster communication between Cisco CallManagers during the call set up to notify the caller that they need a DSP resource for their call. In this scenario, the Catalyst modules must perform the conferencing service as well as the IP-to-IP transcoding service to uncompress the WAN IP voice connection. In the illustration above, a remote user joins a conference call at the three-participant conference call uses 11 DSP channels: three conferencing channels, six G.711 channels, and two transcoding channels.

The following is the breakdown:

- One DSP channel to convert the IP WAN G.729a voice call into G.711
- Three G.711 DSP channels to convert the G.711 stream into TDM for the conferencing DSP
- Three channels from the conferencing DSP to mix the three callers together
- Three G.711 channels to convert the TDM voice back into G.711
- One DSP channel to convert G.711 into G.729a for the IP WAN caller

MTP Transcoding Caveats

MTP Transcoding Caveats

- **Catalyst MTP transcoding supports low bit-rate codec-to-G.711 conversion, and vice versa service only**
- **On the Catalyst 6000, transcoding services cannot cross port boundaries**
- **Each CallManager must have its own MTP transcoding resource configured**
- **If all n MTP transcoding sessions are used, and an $n + 1$ connection is attempted, the next call will be completed without using the MTP transcoding resource**

© 2000, Cisco Systems, Inc. www.cisco.com CIPT v2.07 -16

The following summary caveats apply to Catalyst MTP transcoding:

- Catalyst MTP transcoding service only supports Low-bit-rate (LBR) codec (G.723.1 or G.729a)-to-G.711 conversion, and vice versa. There is no support for LBR-to-LBR codec conversion.
- On the Catalyst 6000, transcoding services cannot cross-port boundaries.
- Each CallManager must have its own MTP transcoding resource configured.
- If all n MTP transcoding sessions are used, and an $n + 1$ connection is attempted, the next call will be completed without using the MTP transcoding resource. If this call attempted to use the software MTP function to provide supplementary services, the call would connect, but any attempt to use supplementary services would fail and could result in call disconnection. If the call attempted to use the transcoding features, the call would connect directly but no audio would be heard.

Installation in Cisco CallManager Administration

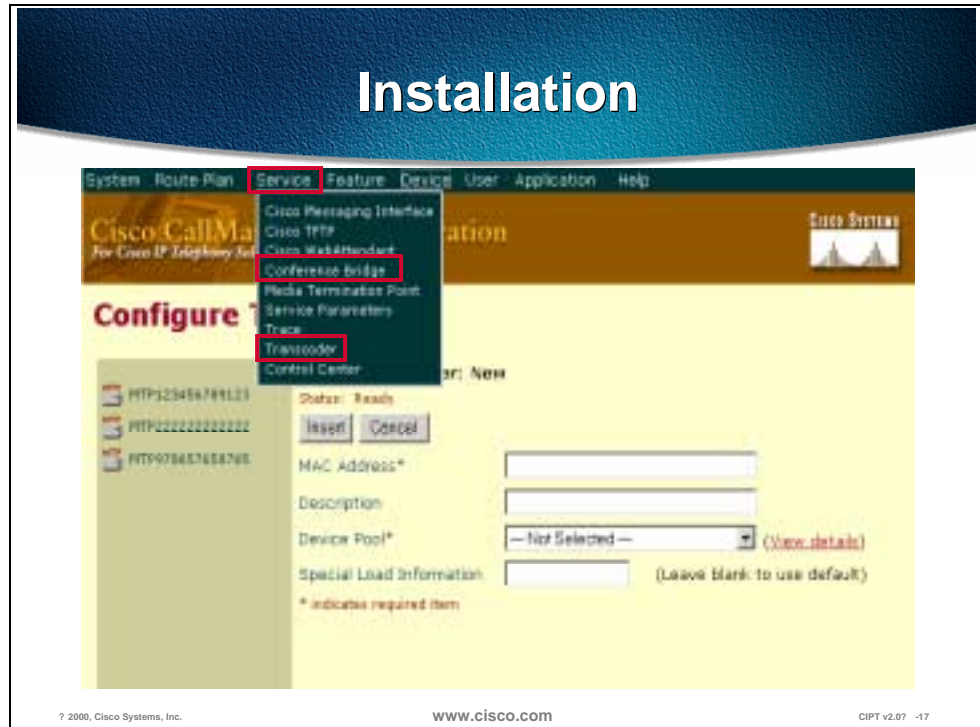

The figure above is the last figure in a series of slides that show the Cisco CallManager Administration pages used to install and configure the WS-6608-x1 in the Cisco CallManager.

After installing the WS-6608-x1 in to the Catalyst 6000 and configuring through the CLI of the Catalyst 6000, install the device in the Cisco CallManager administration. The module has eight ports, each with its own MAC and IP address, and the resources can be allocated in the Cisco CallManager administration.

Select *Service* and select either Conference Bridge or Transcoder to configure in the Cisco CallManager Administration.

The following pages describe the steps used to configure conference bridge and transcoding in the Cisco CallManager administration.

Conference Bridge



The figure above is the last slide in a series of slides to demonstrate the Cisco CallManager Administration pages used to install and configure Conference Bridge resources in the Cisco CallManager.

Servers and *device pools* must be configured before proceeding.

The procedure is as follows:

1. Open Cisco CallManager Administration.
2. Click **Service > Conference Bridge**.
3. Select **Hardware** in the Model Type field.
4. Enter a MAC address (must be at least 12 characters) in the MAC address field.
5. The Device Description field is automatically generated from the MAC address you provide.
6. Enter any special load information into the Special Load Information field, or leave blank to use default.
7. Select a device pool from the drop-down menu or choose **Default**, in the Device Pool field.
8. Click **Insert**. A message displays stating that the Conference Bridge device must be reset in order for the changes to take effect.
9. Click **OK**. The page refreshes and displays the conference device you just added. The device should appear in the list on the left side of the page.

10. Click **Reset Device** and follow the instructions in the Reset Device dialog box.

Conference Bridge Parameters

Servers, Device pools, Cisco CallManager, and Parameters must be configured before proceeding with the steps.

The procedure is as follows:

1. Open Cisco CallManager Administration.
2. Click **Service > Conference Bridge**.
3. Click **Conference Bridge Parameters** from either the top right-hand corner or the bottom right-hand corner of the page.
4. The page refreshes and the Conference Bridge Parameters page appears.
5. Select a device pool from the drop-down menu or choose **Default**. The Cisco CallManagers in this device pool appear in the box to the left of the page.
6. Highlight the Cisco CallManager on which you want to update the conference parameters. The maximum number of users configured for both an Ad-Hoc conference and a Meet-Me conference using Unicast appear in the fields to the right of the page.
7. Change the maximum number of users accordingly and click **Update**.

Note You must reset each conference bridge device after making updates for the changes to take affect. To do this, click **Conference Bridge Configuration** and select the Conference Bridge device you want to reset. Next, click **Reset Device** and follow the instructions in the Reset Device dialog box. Changes will only take place when there are no active calls. When you click **Restart**, the changes are made immediately.

Meet Me Number / Pattern Configuration

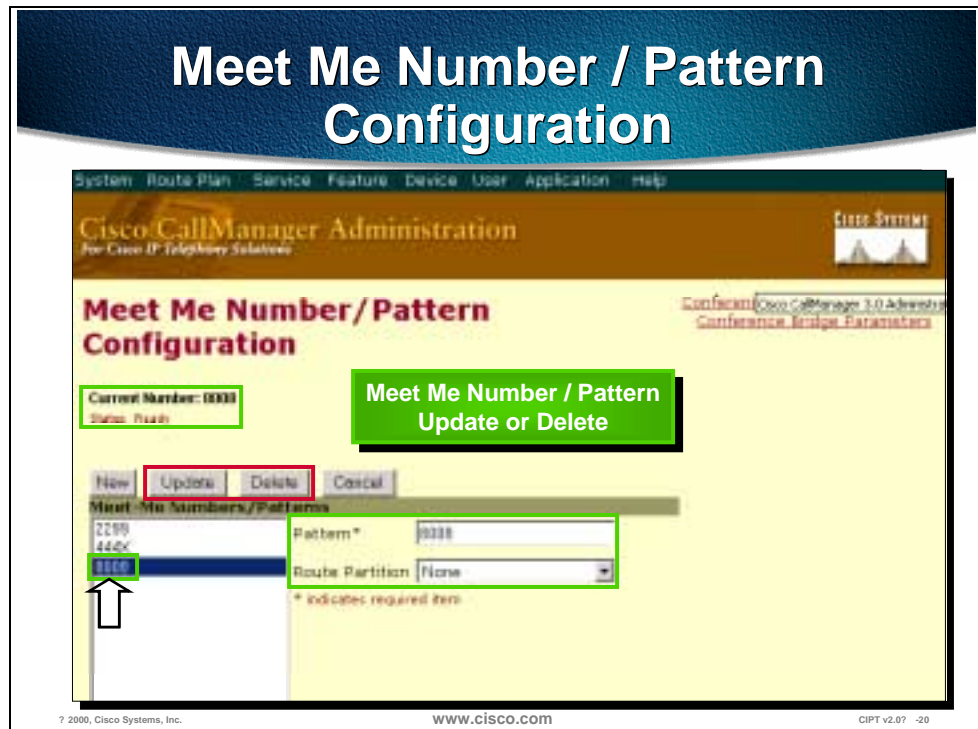

The figure above is the final slide in a series of slides used to demonstrate the Cisco CallManager Administration pages used to install and configure Meet-Me Number and Pattern Configuration.

The following prerequisites must be met before proceeding with the steps:

- Servers must be configured
- Device pools must be configured

The procedure is as follows:

1. Open Cisco CallManager Administration.
2. Click **Service > Conference Bridge**.
3. Click **Meet-Me Number/Pattern Configuration**, from either the top right-hand corner or the bottom right-hand corner of the page. The page refreshes and the Meet-Me Number/Pattern Configuration page appears.
4. Enter a Meet-Me Numbers/pattern in the Pattern field.
5. Select a partition from the scroll menu in the Route Partition field.
6. Click **Insert**. The page refreshes and the new Meet-Me Numbers pattern appears in the list on the left side of the page.

Update or Delete

1. From the Meet Me Number/Pattern Configuration page, select the Meet Me Number/Pattern to Update or Delete. The page refreshes and the Meet Me Number/Pattern Configuration page reflects the information related to the Meet Me Number/Pattern selected.
2. Select either Update or Delete and confirm dialog box defaults.

Transcoding

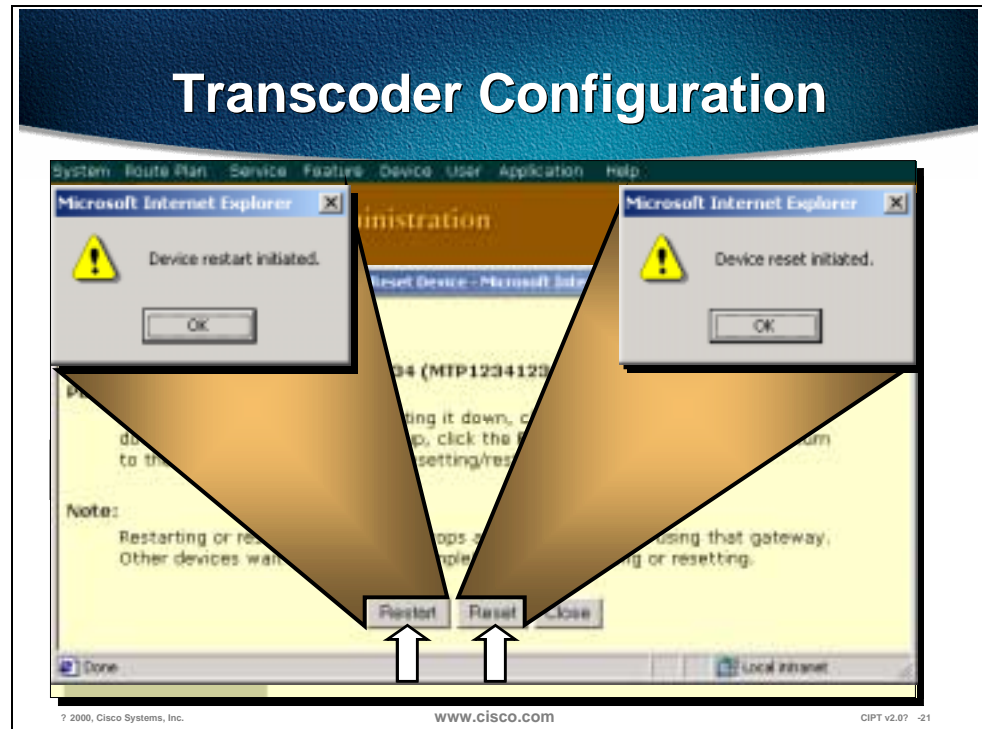

The figure above is the final slide in a series of slides used to demonstrate the Cisco CallManager Administration pages used to install and configure a Transcoding resource in Cisco CallManager.

To configure the transcoder:

1. Open Cisco CallManager Administration.
2. Click **Service > Transcoder**.
3. Enter a MAC address (must be at least 12 characters) in the MAC Address field. Description field is automatically generated from the MAC address.
4. Enter any special load information into the Special Load Information field, or leave blank to use default.
5. Select a device pool from the drop-down menu or choose **Default** in the Device Pool field.
6. Click **Insert**. The page refreshes showing specific information, including the status, for the transcoder you just configured. The transcoder should now be in the list on the left side of the page.

Update, Delete or Reset

After selecting a transcoder resource from the left of the Configure Transcoder page, select one of the following:

- Update to update the transcoder information in the Cisco CallManager.
- Delete to delete the transcoder resource from the Cisco CallManager.
- Reset to restart or reset the transcoder resource.

Summary

This section summarizes the concepts you learned in this chapter.

Summary

- **The WS-X6608-T1/E1 module can have its ports configured as conferencing or transcoding resources.**
- **Only low bit-rate to high bit-rate transcoding (and vice versa) is supported.**
- **The conferencing resource will transcode low bit-rate calls to high bit-rate.**

© 2000, Cisco Systems, Inc. www.cisco.com CIPT v2.07 -22

The WS-X6608-T1/E1 module can be configured as a DSP resource. Each port on the module can be configured as different resources. For example, Port 1-2 could be left as T1/E1 resources and ports 3-5 could be transcoding resources and ports 6-8 could be conferencing resources. Each port has its own MAC address and has to be configured from the Catalyst CLI and in the Cisco CallManager.

The transcoding resource can only transcode low bit-rate (G.723 or G.729) to high bit-rate (G.711) and vice versa.

When a call comes in from the IP WAN using low bit-rate (G.723 or G.729) to be in a conference, the conferencing resource transcodes that call because the conferencing resource only supports G.711 codec for conferencing.

Review Questions

Answer the following questions.

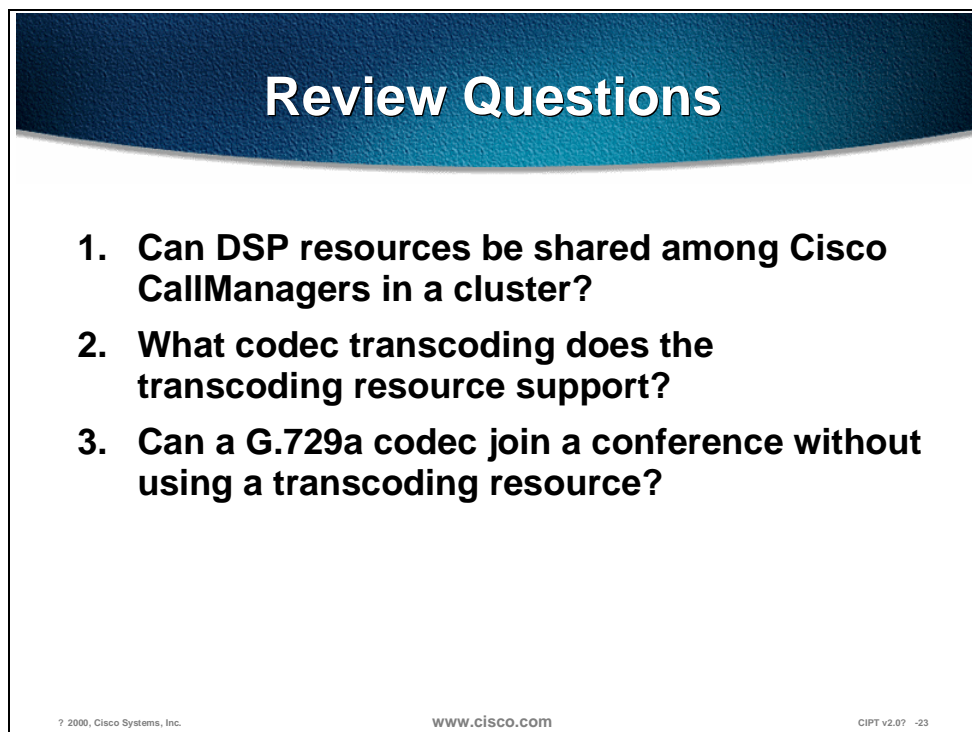
A slide titled "Review Questions" with a blue gradient header. It contains three numbered questions in bold black text. At the bottom, there is small text: "? 2000, Cisco Systems, Inc.", "www.cisco.com", and "CIPT v2.0? -23".

Review Questions

- 1. Can DSP resources be shared among Cisco CallManagers in a cluster?**
- 2. What codec transcoding does the transcoding resource support?**
- 3. Can a G.729a codec join a conference without using a transcoding resource?**

? 2000, Cisco Systems, Inc. www.cisco.com CIPT v2.0? -23

- Q1) Digital Signaling Processor (DSP) resources provide transcoding and conferencing resources. Can DSP resources be shared among Cisco CallManagers in the same cluster?
- Q2) The transcoding resource supports G.711, G.729 and G.723. What codecs can the transcoding resource transcode to and from?
- Q3) When a caller across the IP WAN uses G.729 across the IP WAN to join a conference, can that caller join the conference without a transcoding resource?

Cisco IP Phones

Overview

Cisco IP phones are full-featured telephones that can be plugged directly into your IP network. In this section, the following topics are discussed:

- Objectives
- Understanding Cisco IP Phones
- Configuring Cisco IP Phones and Features
- Trace Basic Call Processing
- Summary
- Review Questions

Objectives

This section lists the chapter objectives.

Objectives

Upon completion of this chapter, you will be able to perform the following tasks:

- **Identify and describe the hardware components of the Cisco IP Phones**
- **Identify and trace the call processing between the phone and the CallManager**
- **Add and configure a phone and change new user with and with out auto-registration**
- **Describe and Identify error codes and status messages**

© 2000, Cisco Systems, Inc. www.cisco.com CIPT v2.0—10-3

Upon completion of this chapter, you will be able to complete the following tasks:

- Given a Cisco IP phone, identify and describe the hardware components of the Cisco IP phones.
- Given a Cisco IP phone on a IP telephony network, identify and trace the call processing between the phone and the CallManager.
- Given a Cisco IP phone, add and configure a phone and change to a new user with and with out auto-registration.
- Given a Cisco IP phone on a IP telephony network, describe and identify error codes and status messages.

Understanding Cisco IP Phones

The Cisco IP phones enable communications using voice over a data network. To do this, the Cisco IP phones depend upon and interact with several other key IP telephony components, including Cisco CallManager and telephony gateways and routers. Detailed description of the feature, functions, and operation of the Cisco IP phones are provided. The Cisco IP phones (12 SP+, 30 VIP, Cisco IP Phone 7960 and Cisco IP Phone 7910) use some basic signaling and other functions. The Cisco IP Phones 7960 and 7910 also bring some exciting new features with them.



This section describes and identifies the hardware components of the following Cisco IP phones:

- 12 SP+
- 30 VIP
- 7960
- 7910—Available at Cisco CallManager 3.0(2) release

Cisco IP Phone Model 12 SP+

- **Two-way speaker for on-hook dialing**
- **12 user-programmable feature buttons**
- **40-character display**
- **Mute button**



© 2000, Cisco Systems, Inc.

www.cisco.com

CIPT v2.0--10-6

The Cisco IP Phone model 12 SP+ is an IP phone targeting the office user. This phone supports 12 programmable line and feature buttons, and internal high-quality two-way speakerphone, and microphone mute. The 12 SP+ also features a 2-line LCD display of 20 characters per line for call status and identification. An LED associated with each of the 12 features and line buttons indicates feature and line status.

Model 12 SP+ Features



- **Speakerphone with automatic acoustic echo cancellation**
- **Adjustable ringer volume**
- **Hearing-aid compatible**
- **Speaker on/off and mute button**

© 2000, Cisco Systems, Inc.

www.cisco.com

CIPT v2.0-10-7

Features of this phone include:

- Twelve programmable feature buttons for accessing any combination of lines/features. You can use the default 12-series template for any 12-series phone (12 S, 12 SP, or 12 SP+). Refer to the table on the following page for a description of the default Cisco IP Phone 12 SP+ template.
- A speakerphone with automatic acoustic echo cancellation
- A 40-character LCD display, on two lines with 20 characters per line
- Speaker on/off and microphone mute buttons
- Adjustable speaker volume control
- Adjustable ringer volume control
- An integrated two-port Ethernet hub that allows the telephone and computer to share a single Ethernet jack
- Direct connection to a 10BaseT Ethernet (RJ-45) network
- A hearing-aid compatible handset
- An integrated, user-adjustable handset amplifier
- Adjustable ring tone
- G.711/G.723.1 audio compression
- H.323 and NetMeeting compatibility
- An IP address assignment (DHCP client or statically configured)
- Voice activity detection (VAD) programming
- Out-of-band dual tone multifrequency (DTMF) signaling to conserve LAN/WAN bandwidth

The following table shows the default 12 series template.

Button	Feature	Index	Label
1	Line	1	Line 1
2	Line	2	Line 2
3	Redial	1	Redial
4	Speed Dial	1	Speed Dial 1
5	Speed Dial	2	Speed Dial 2
6	Speed Dial	3	Speed Dial 3
7	Hold	1	Hold
8	Transfer	1	Transfer
9	Forward All	1	Forward All
10	Call Park	1	Park
11	Message Waiting	1	Msg Waiting
12	Conference	1	Conf

Cisco IP Phone Model 30 VIP

- **Two-way speaker for on-hook dialing**
- **30 feature buttons**
- **26 user-programmable feature buttons**
- **40-character display**
- **Mute button**



© 2000, Cisco Systems, Inc.

www.cisco.com

CIPT v2.0-10-8

The Cisco IP Phone model 30 VIP is a full-featured IP phone targeting executives and corporate managers. This phone supports 26 programmable line and feature buttons, an internal high-quality two-way speakerphone, microphone mute, and a transfer button. The 30 VIP also features a LCD display of 40 characters for call status and identification. An LED associated with each of the 30 features and line buttons indicates feature and line status.

Model 30 VIP Features



- **30 feature buttons**
- **Redial, transfer, hold, and display**
- **Voice activity detection**
- **Headset compatible**

© 2000, Cisco Systems, Inc.

www.cisco.com

CIPT v2.0-10-9

Features of this phone include:

- 30 feature buttons:
 - Four fixed-feature buttons for transfer, display, hold, and redial
 - 26 feature buttons programmable as any combination of access lines/features
 - The default 30 VIP template uses buttons 1 through 4 for lines, button 5 for Call Park, button 6 for redial, buttons 8 through 13 and 22 through 25 for speed dial, button 14 for message waiting indicator, button 15 for call forward, and button 16 for conference. Refer to the table on the following page for a description of the default Cisco IP Phone 30 VIP template.
- An integrated two-port Ethernet hub that allows the telephone and computer to share a single Ethernet jack
- Direct connection to a 10BaseT Ethernet (RJ-45) network
- A speakerphone with automatic acoustic echo cancellation
- A 40-character LCD display, on two lines with 20 characters per line
- Speaker on/off and microphone mute buttons
- Adjustable speaker, ringer, and headset volume controls
- A hearing-aid compatible handset
- An integrated, user-adjustable handset amplifier
- Adjustable ring tone
- G.711/G.723.1 audio compression
- H.323 and NetMeeting compatibility

- An IP address assignment (DHCP client or statically configured)
- Voice Auto Detection (VAD) programming
- Out-of-band DTMF signaling to conserve LAN/WAN bandwidth
- Automatic redial

The following table shows the default 30 VIP template.

Button	Feature	Index	Label
1	Line	1	Line 1
2	Line	2	Line 2
3	Line	3	Line 3
4	Line	4	Line 4
5	Call Park	1	Call Park
6	Redial	1	Redial
7	None	1	None
8	Speed Dial	1	Speed Dial 1
9	Speed Dial	2	Speed Dial 2
10	Speed Dial	3	Speed Dial 3
11	Speed Dial	4	Speed Dial 4
12	Speed Dial	5	Speed Dial 5
13	Speed Dial	6	Speed Dial 6
14	Message Waiting	1	Msg Waiting
15	Forward All	1	Forward All
16	Conference	1	Conf
17	None	1	None
18	None	1	None
19	None	1	None
20	None	1	None
21	Speed Dial	7	Speed Dial 7
22	Speed Dial	8	Speed Dial 8
23	Speed Dial	9	Speed Dial 9
24	Speed Dial	10	Speed Dial 10
25	Speed Dial	11	Speed Dial 11
26	Speed Dial	12	Speed Dial 12

Model 12 SP+ and 30 VIP Specifications

- **Two standard 10BaseT RJ-45 interfaces (IEEE 802.3), allowing two connections:**
 - 10BaseT network to phone connection
 - “Hub port” for phone to PC/other device
- **48 VDC required power supply:**
 - For NA, 120 VAC, 60 Hz
- **Other power configurations are also available**

© 2000, Cisco Systems, Inc.

www.cisco.com

CIPT v2.0—10-10

Two standard 10BaseT RJ-45 interfaces are included on each phone:

- One connection is for the 10BaseT network to phone connection
- One hub port that is for connecting the phone to a PC or other network device

A 48 VDC power supply is required. This is supplied locally at the desktop using the included AC to DC power supply for North American models.

The power supply included for North American configurations requires 120 VAC, 60 Hz.

Optional power configurations include:

- 230 VAC, 50 Hz
- 100 VAC, 50 Hz
- 100 VAC, 60 Hz

Cisco IP Phone 7910



- **Common Areas—hallway, break room, reception or office cubicle**
- **Medium telephone traffic**
- **Single line**
- **Display area: 2 x 24 character based**
- **10BaseT**
- **Message waiting**
- **Basic features**

© 2000, Cisco Systems, Inc.

www.cisco.com

CIPT v2.0—10-11

The Cisco IP Phone 7910 has a single line appearance. The display area on the Cisco IP Phone 7910 is 2 x 24 and is character based. The Cisco IP Phone 7910 has a message waiting indicator light on the handset and comes with other basic features.

The basic feature member of the second-generation Cisco IP phone portfolio is the 7910, primarily designed for common-use areas such as lobbies, break rooms, and hallways that require basic features. This single-line phone also provides four dedicated feature buttons, located prominently under the display for Line, Hold, and Transfer. A system administrator can program an additional group of feature access keys. The standard configuration for these keys includes, speed dial, redial, messages, and conference.

The 7910 also provides a large character-based 2x24 character LCD display. The display provides features such as date and time, calling party name, calling party number, and digits dialed.

Additional buttons for call monitor speaker (used for on-hook dialing) and handset volume control, and a ringer and mute button for the handset microphone are arranged at the bottom of the set.

The Cisco IP Phone 7910 plugs into a standard RJ-45 Ethernet with one 10 BaseT interface. The 7910+SW model also supports 10/100 BaseT and has 2 RJ-45 connections.

The foot stand of the 7910 is adjustable from flat to 60 degrees to provide optimum viewing of the display and comfortable use of all buttons and keys.

Cisco IP Phone 7910 Specifications

- **Hearing-aid-compatible (HAC) handset with ADA-compliant volume**
- **G.711 and G.729a audio compression**
- **H.323 and Microsoft NetMeeting compatibility**
- **DHCP and BootP are supported**
- **DHCP automatically assigns IP addressee**
- **Comfort noise generation and voice activity detection (VAD) programming on a system basis**
- **Designed to grow with system capabilities**

© 2000, Cisco Systems, Inc.

www.cisco.com

CIPT v2.0—10-12

The Cisco 7910 offers some basic specifications:

- Hearing-aid-compatible (HAC) handset with ADA-compliant volume
- G.711 and G.729a audio compression
- H.323 and Microsoft NetMeeting compatibility
- DHCP and BootP are supported
- DHCP automatically assigns IP addressee to devices when you plug in the phone
- Comfort noise generation and voice activity detection (VAD) programming on a system basis
- Designed to grow with system capabilities; features will be able to keep pace with new changes via software updates from the system

Cisco IP Phone 7960



- Professional, Manager—**
- High or busy telephone traffic**
- Six lines—mix directory numbers or features**
- Display area: calling information, feature access via soft keys, additional display area for value-added services and applications**
- Full duplex handsfree**
- Comfort noise**
- Built-in headset connection**
- 10/100 BaseT, 3 Port switch**

© 2000, Cisco Systems, Inc.

www.cisco.com

CIPT v2.0—10-13

The Cisco IP Phone 7960 includes an information button (button 1 is registered as a line button) five programmable line or speed dial buttons, four on-screen mode buttons for accessing voice mail messages and adjusting phone settings, services, and directories, and four soft keys providing access to additional call detail and functionality. The Cisco IP Phone 7960 includes an LCD display, which is used to display call detail and soft key functions.

The default Cisco IP Phone 7960 template uses button 1 for line, and buttons 2 through 6 can be assigned as additional lines or speed dial. Other phone features, such as call park, call forward, redial, voice mail, conferencing, and so on are accessed using soft keys or on-screen program buttons on the Cisco IP Phone 7960. These buttons are not configurable, and therefore are not included in the default template. The table below is a description of the default template for the Cisco IP Phone 7960.

Button	Feature	Index	Label
1	Line	1	Line 1
2	Line or Speed Dial	2	Line 2 or Speed Dial 1
3	Line or Speed Dial	1	Line 3 or Speed Dial 2
4	Line or Speed Dial	2	Line 4 or Speed Dial 3
5	Line or Speed Dial	3	Line 5 or Speed Dial 4
6	Line or Speed Dial	4	Line 6 or Speed Dial 5

Because of the complexity of these new features, Cisco CallManager does not control all phone features. Many features, such as the information button, soft

keys, and the on-screen mode buttons cannot be configured, but you can access them locally from the phone.

Use Cisco CallManager to add a Cisco IP Phone 7960 to the database, assign default and custom keypad templates, and configure directory lines.

The asynchronous response mode (ARM) core will implement the following major features:

- Graphical, soft key centric user interface (UI).
- Call control using an enhanced version of the skinny station protocol.
- Connectivity will be through standard TCP/IP for both call control and RTP VoIP streaming over 10/100 Mbps Ethernet.
- Switch configuration will be through a proprietary IPCP protocol exchange with the up stream switch. The IP address configuration will be through DHCP. CallManager selection will be through a configuration file. The configuration file will contain a prioritized list of CallManagers and will be downloaded through TFTP. The ARM code will be field upgradeable through download of an application image using TFTP. The ARM code will also support a DNS stub resolver to allow the resolution of host names.

The digital signaling processor (DSP) firmware implements the following major audio features:

- G.711 / G.729 / per-call selectable encode/decode
- Codec overlays allows per call overlays of larger low-bit-rate code segments from the ARM main memory space via dual port memory.
- Voice activity detection is an adaptive SNR-based for improved performance under varying noise conditions.
- Comfort noise generation per-codec selectable comfort noise generation⁶⁵. Gain/frequency response shaping blocks allows per-call and per-transducer tailoring of gain and frequency response characteristics.
- Echo control will implement handset, headset and hands free acoustic echo control as required. Characteristics of this control will be per-transducer based.
- Tone/WAV generation are single/dual sine generation facilities as well as WAV prompt play outs.
- Selectable audio frame-size is a per-call encode/decode of any speech frames in a 10 ms multiple.

Supported Networking Protocols

Cisco IP Phone 7960



- Internet (IP)
- Voice over IP (VoIP)
- Bootstrap (BootP)
- Trivial File Transfer (TFTP)
- Dynamic Host Control (DHCP)
- Cisco Discovery (CDP)
- Real-Time (RTP)
- User Datagram (UDP)

© 2000, Cisco Systems, Inc.

www.cisco.com

CIPT v2.0-10-14

The Cisco IP Phone 7960 supports industry standard and Cisco networking protocols required for voice communication. The following are the supported networking protocols on the Cisco IP Phone 7960:

- Internet Protocol (IP) is a messaging protocol that addresses and sends packets across the network.
- Voice over IP Protocol (VoIP) enables transfer of voice communications over a data network using the internet protocol.
- Bootstrap Protocol (BootP) enables a network device, such as the Cisco IP Phone 7960 to discover certain startup information, such as its IP address.
- Trivial File Transfer Protocol (TFTP) allows transfer of files over the network and enables configuration files specific to the phone type to be obtained.
- Dynamic Host Control Protocol (DHCP) dynamically allocates and assigns an IP address to network devices. DHCP also enables connection of the IP phone into the network and become operational without manually assigning an IP address and configuring additional required network parameters.
- Cisco Discovery Protocol (CDP) is a device-discovery protocol that runs on all Cisco-manufactured equipment. Using CDP, a device can advertise its existence to neighboring devices and receive information about neighboring devices in the network. The Cisco IP Phone 7960 uses CDP to communicate information such as auxiliary VLAN ID, per port power management detail, and QoS configuration information with the Cisco Catalyst switch.
- Real-Time Transport protocol (RTP) enables an audio media stream to be established between two Voice over IP devices.
- User Datagram Protocol (UDP) is used by the RTP audio media stream and uses UDP ports 16,384 through 32,767.

Cisco IP Phone Operation

Cisco IP Phone Operation

- **Phone and CallManager use a lightweight active skinny station protocol over TCP/IP**
- **Skinny station protocol is an open stimulus response architecture:**
 - **All events at the phone are reported to the CallManager**
 - **All actions at the phone are directed by the CallManager**

© 2000, Cisco Systems, Inc.

www.cisco.com

CIPT v2.0-10-15

The skinny station protocol is an active stimulus/response protocol that has been published. It is lighter than the corresponding H.323 terminal requirements in both function and required message volume. A fully compliant H.323 device would require implementation of H.225 and H.245.

The phone, in conjunction with the proxy services provided by the CallManager service, is H.323 compliant. Voice with G.711 coding and combined with H.225 call setup and H.245 media control are done together.

The ITU-T has created recommendation H.323, which provides mechanisms for establishing, controlling, and clearing information flows, including audio information, between two H.323-compliant terminals. To implement a full H.323-compliant terminal requires a high expenditure for computer power and memory size. An H.323 proxy can be implemented in a relatively high-powered server and can communicate to a simplified, skinny station efficiently using the skinny station messaging system. Within the context of H.323, by implementing the station telephone set as a skinny station over IP and using a proxy for H.225 and H.245 signaling, a relatively inexpensive IP phone (such as an 10Base-T phone) is constructed.

Cisco's IP phone solution has created a generalized messaging set that uses skinny stations (Cisco IP phones) to coexist in an H.323 environment. Because of the savings in memory size, processor power, and complexity, the IP phone provides a user station that is user friendly and cost effective. When coupled with an H.323 proxy, the skinny station can interoperate with H.323-compliant terminals to establish, control, and clear audio calls.

H.323-Compliant Voice Terminals

- CallManager terminates H.225/H.245 over TCP/IP as an H.323 proxy for the phones, redirecting the media stream to the phone
- Phone terminates the voice media stream over RTP/UDP/IP

© 2000, Cisco Systems, Inc.

www.cisco.com

CIPT v2.0—10-16

H.323 devices are communications devices that comply with the H.323 communications standard. In the CIPT system, NetMeeting and H.323-compliant third-party gateways are considered H.323 devices.

Cisco CallManager differentiates between NetMeeting and third-party gateways by the protocol side assigned (can be configured in *devices* in Cisco CallManager administration).

You can use the optional media termination point to enable features such as hold and transfer on calls using H.323 gateways or clients and to provide A-law to μ -law conversion.

Phone's Actions on Startup

1 Get IP address, mask, DNS, and so forth

- Static or DHCP

2 Get TFTP server address

- Use any one
- Static address
 - Option 150 (single IP address)
 - Option 66 (first IP address or DNS name)
 - Look up CiscoCM1.your.domain

3 Get configuration from CallManager TFTP*

- List of up to three CallManagers
- Region info and keyboard template
- Version of code to run

4 Get new code (one time only)

5 Register with CallManager

* Use configuration in Flash after timeout

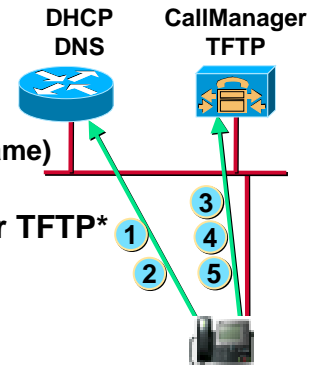

© 2000, Cisco Systems, Inc.

www.cisco.com

CIPT v2.0-10-17

The Phone's Actions on Startup

1. When a telephone is plugged into an Ethernet jack, assuming the prerequisite infrastructure and a CallManager, the first thing that will happen is the telephone will request an IP address from a Dynamic Host Configuration Protocol (DHCP) server. In general, this is the recommended mode of operation. Static addressing can be supplied to the telephone, and you can enter the IP address manually, but this would prevent mobility.
2. As part of that DHCP request, when an IP address is supplied to the telephone, it is also possible to supply the address of the TFTP server, or the CallManager from which the telephone will get its configuration. Once again, the TFTP server address could be specified manually but this would limit adds, moves, and changes and remove some of the benefits. This TFTP server address can be given in several forms: either Option 150 or Option 66 or the Bootstrap Protocol (BOOTP).
3. Once that address has been given, the phone will register itself with the CallManager and download its configuration, which can contain a list of up to five CallManagers that the telephone can use for call control. This creates an extremely resilient system. The phone gets its region information and also the features or functionality that each of the keys will produce.
4. The phone receives any new code it is to run. If, for example, the firmware or the code that each telephone runs is changed, this can be added to the CallManager. Once restarted, each telephone will automatically reload that code. The telephones can be configured to auto register.
5. An administrator rolling out the phones would plug each one in and then assign a number. New phone entries will appear by Media Access Control (MAC) address, which is how the CallManager ties the actual instrument to a telephone number. An alternate, not the normal operation, would occur when you plug in the telephone; CallManager would automatically give that

telephone a line number. However, this would make things like directories very difficult to set up.

* Use configuration in Flash after timeout.

Making a Call IP Telephone to IP Telephone

- 1 Off-hook and digit stimulus
- 2 Play tone commands
- 3 Ring command
- 4 Off-hook stimulus
- 5 Setup media stream command
- 6 Audio stream established

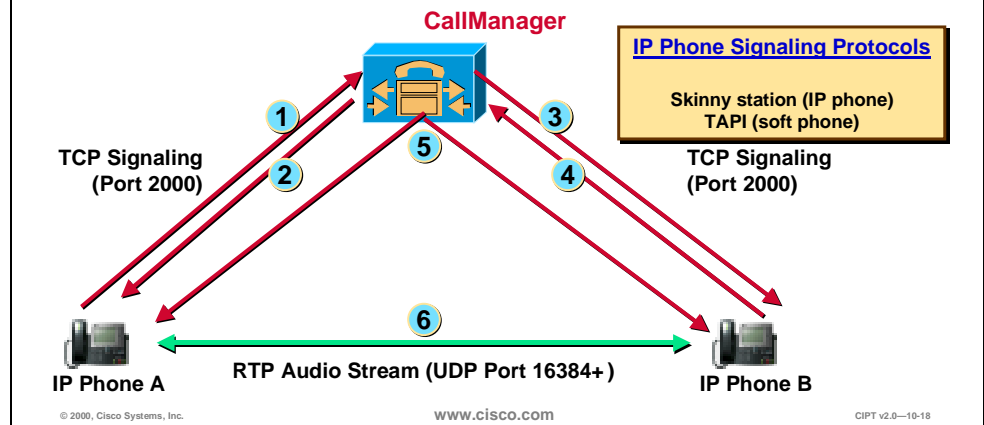

When a telephone call is made from an IP telephone to an IP telephone, it is a client/server model. The CallManager handles the call control pieces. The procedure is:

1. Lift the handset, press the speaker button or press the “new call” soft key, on the IP Telephone, it goes off-hook.
2. CallManager tells the phone to play a dial tone. The .wav file is in the phone.
3. Dialed digits are entered, dialing the phone across the street. CallManager performs digit analysis and dials that extension and the phone rings.
4. When the called party answers, the called phone generates an off-hook stimulus to CallManager.
5. CallManager informs the two telephones to set up the media stream between the two phones.
6. Once the audio stream is established, using the Real-Time Transport Protocol (RTP), the CallManager is effectively out of the picture and the two telephones can communicate directly.

As of CallManager 2.3, the RTP audio stream uses User Datagram Protocol (UDP) ports 16,384 through 32,767.

This is an important point as these UDP port ranges are synergistic with those used on the Cisco IOS™ gateways. Consequently, IP/RTP priority can now be used to prioritize traffic for both Cisco IOS gateways and the IP telephones.

Making a Call IP Phone to H.323 Gateway

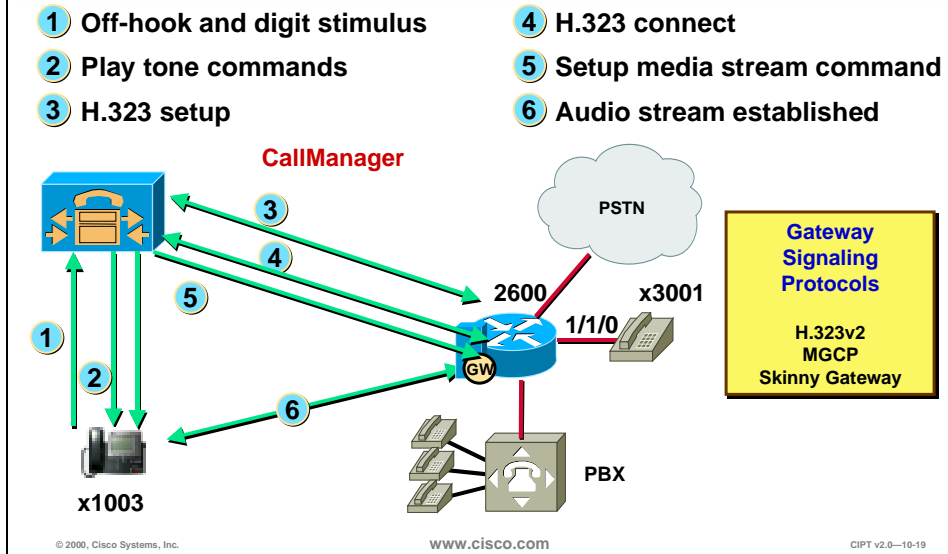

In this example, the CallManager is the H.323 proxy for the phone.

Making a call from an IP telephone to an H.323 device, such as a Cisco IOS gateway that is connected to a PBX, directly to an extension, or to the PSTN, uses a slightly different setup method. The IP telephone talks the skinny client protocol, and the Cisco IOS gateway talks H.323.

The procedure is:

1. The telephone goes off-hook.
2. It plays the tones and you dial the digits you need to dial.
3. CallManager acts as a proxy.
4. CallManager sets up the call to the Cisco IOS gateway.
5. Once the Cisco IOS gateway is reached it answers the telephone.
6. An RTP stream is directly between the two devices and Cisco CallManager is no longer involved in the process until call tear down occurs.

IP Telephone Configuration

- **Load ID, should not be modified**
- **Keypad template, if customized**
- **Device pool assignment, if defined:**
 - Region, time zone, CallManager redundancy group**
- **Display (name instead of directory number)**
- **Phone number, if customization required**

Note: Above parameters all have defaults and need not be configured

© 2000, Cisco Systems, Inc.

www.cisco.com

CIPT v2.0—10-20

Load ID identifies the executable code image version for the phones. If left blank, it specifies the default version. This is the case unless instructed by Cisco consultants. The load images are downloaded to the phone the first time the phone registers with CallManager. Any subsequent initialization (resetting) will cause the phone to check the load ID with the CallManager; if it is the same, no downloading is done. Load files (*.bin) are stored in the \TFTPPath directory on the CallManager server at installation time.

A customized keypad template may be defined and assigned to a group of phones.

There are default templates included with the CallManager:

- Default 12 SP+
- Default 30 VIP
- Default 7960
- Default 7910—Available with Cisco CallManager 3.0(2)

A different template can be configured for a phone before or after initial registration. If done before, reset the phone so the template can take effect.

Device Parameter Maintenance

- **Use CallManager Administration to configure default settings for each type of Cisco IP phone and Cisco access gateway**
- **Defaults are configured by device type:**
 - **Load ID**
 - **Keypad template**
 - **Device pool**

© 2000, Cisco Systems, Inc.

www.cisco.com

CIPT v2.0—10-21

Device types are defined for both current and legacy equipment. Defaults are used at the first registration of the phone with the CallManager to set the device.

Load ID

- **Identifies the executable for the device**
- **Program load is verified during device registration**
- **Load files (*.bin) are stored in the \ Cisco\ TFTPPath directory on the CallManager server at CIPT installation**
- **Updated for the device type when files for the device type are updated or patched**

© 2000, Cisco Systems, Inc.

www.cisco.com

CIPT v2.0—10-22

There are two types of loads: phone loads and gateway loads. *Loads* are files that contain updated application software. During installation or upgrade, the latest loads are automatically provided. However, the phone can also receive a load between releases that may contain patches or other information important to the devices that use loads, such as phones or gateways. Users can enter the current phone load ID for the Cisco CallManager version they are running, or leave this field blank to use the system default.

The load ID is verified at every registration (reset) of the phone with the CallManager. Any change will cause the phone to load new code.

There are load IDs for both current and legacy (no longer sold) instruments.

Device Pool

Each device type is assigned a default device pool:

- **Region**
- **Date/time group**
- **CallManager group**

© 2000, Cisco Systems, Inc.

www.cisco.com

CIPT v2.0—10-23

Device pools reduce administration time by allowing an administrator to specify region, data/time group, and CallManager group criteria that will be common among many devices. When a new device is added, administrators will select the device pool that contains the parameters they want to use for that device. Device pools allow the assignment of the three parameters using a single value.

Device pool assignment causes the phone to obtain the following characteristics defined for the device pool:

- Region
- Date/time group
- Cisco CallManager group

There may be as many device pools as there are unique combinations of these three parameters in a given installation.

Auto Registration

- **Automatically assigns a directory number to the first line appearance of a Cisco IP Phone**
- **Done at first registration with CallManager**
- **Off by default**
- **Enabled by configuring a range of directory numbers using Cisco CallManager administration**

© 2000, Cisco Systems, Inc.

www.cisco.com

CIPT v2.0—10-24

Auto registration allows the system to automatically register IP phones when they are plugged into the system. This feature is turned on and off in CallManager administration.

If auto registration is turned on prior to installing the phones, the phones will automatically register with Cisco CallManager once they are plugged in. If auto registration is not turned on, the phones must be added to the system database manually using *Add a New Device* in Cisco CallManager administration.

Auto Registration Directory Numbers

- **New phones are automatically assigned the next available directory number by CallManager**
- **A phone moved to a new location keeps the same directory number**

© 2000, Cisco Systems, Inc.

www.cisco.com



CIPT v2.0—10-25

A directory number is the telephone number or internal extension assigned to a Cisco IP phone, for example, 1001. The directory number is assigned to the phone itself, not a location or a user. If the phone is moved, it retains the same directory number. If desired, the directory number can easily be changed using Cisco CallManager administration.

Auto registration is a Cisco CallManager feature that automatically assigns directory numbers to phones as the phones are connected to the network. If administrators want to use auto registration, they must first set a range of directory numbers for auto registration. To save directory numbers, unplug unused IP phones when auto-registration is turned on.

Power

Three Ways to Power IP Phones

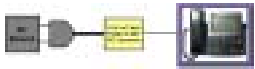
- **Inline power**
 - Needs powered linecards for Catalyst switches
 - Uses Pins 1, 2, 3, and 6 (same as Ethernet) for delivering -48V
- **External power**
 - Needs external power patch panel
 - Patch panel delivers -48V over Pins 4, 5, 7, and 8
- **Wall power**
 - Needs DC converter for connecting IP phone to wall outlet

Combination of ways can be used for redundancy

© 2000, Cisco Systems, Inc. WWW.CISCO.COM CIPT v2.0-10-26

The Cisco IP Phones 7960 and 7910 are capable of using the following three options for power. (Cisco IP Phones 12 SP+ and 30 VIP can only use option 3, wall power):

- **Inline power**
 - Needs powered linecards for the Catalyst switches.
 - The Catalyst will use Pins 1, 2, 3, and 6 (same as Ethernet) for delivering negative 48 volts (-48V)
- **External power**
 - Needs external power patch panel
 - The Patch Panel delivers negative 48 volts (-48 V) over Pins 4, 5, 7, and 8
- **Wall power**—needs DC converter for connecting IP phones to a wall outlet.

Note A combination of ways to power the Cisco IP phones can be used for redundancy.

Catalyst Switch and Phone Interaction

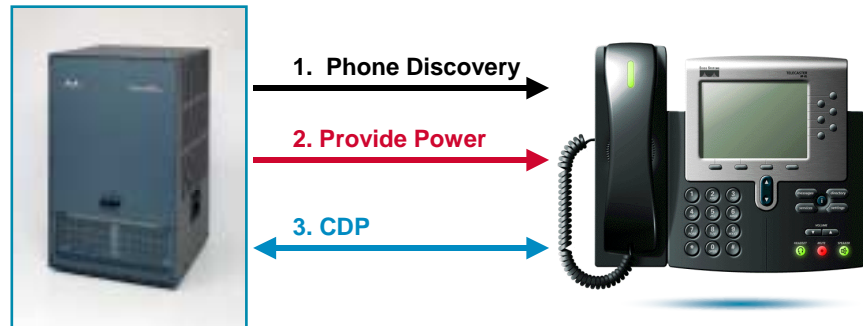

© 2000, Cisco Systems, Inc.

www.cisco.com

CIPT v2.0—10-27

The following is the process used by the Cisco IP Phones (7960 and 7910) to get inline power from the Catalyst switch.

- Unpowered phone plugs into powered linecard port, with admin mode on the switch set to **auto** or **on**.
- Port senses the device using phone discovery mechanism and reports it to the supervisor.
- Supervisor checks power budget, allocates default amount and informs port to apply -48V.
- Port turns on power to the phone and reports link up to supervisor, once the PHY on the phone is enabled.
- If phone was powered by external patch panel or wall power, switch port will report link up to supervisor.
- Phone begins CDP exchange with the switch and gets its VLAN ID (VVID) as well as reports actual power needed for operation.
- Phone will now send a DHCP request on that VLAN for an IP address.

Configuring Cisco IP Phones and Features

Configure Cisco IP Phones and Features

The following topics are discussed in this section:

- IP address plan
- Adding
- Finding
- Deleting
- Resetting and updating
- Assigning a user
- Assigning a phone button template
- Configure hook flash duration
- Display current configuration

© 2000, Cisco Systems, Inc.

www.cisco.com

CIPT v2.0—10-28

Adding and configuring a Cisco IP phone is done using the Cisco CallManager administration. The following concepts are covered in this section:

- IP address plan
- Adding
- Finding
- Deleting
- Resetting and updating
- Assigning a user
- Assigning a phone button template
- Configure hook flash duration
- Display current configuration

IP Address Plan

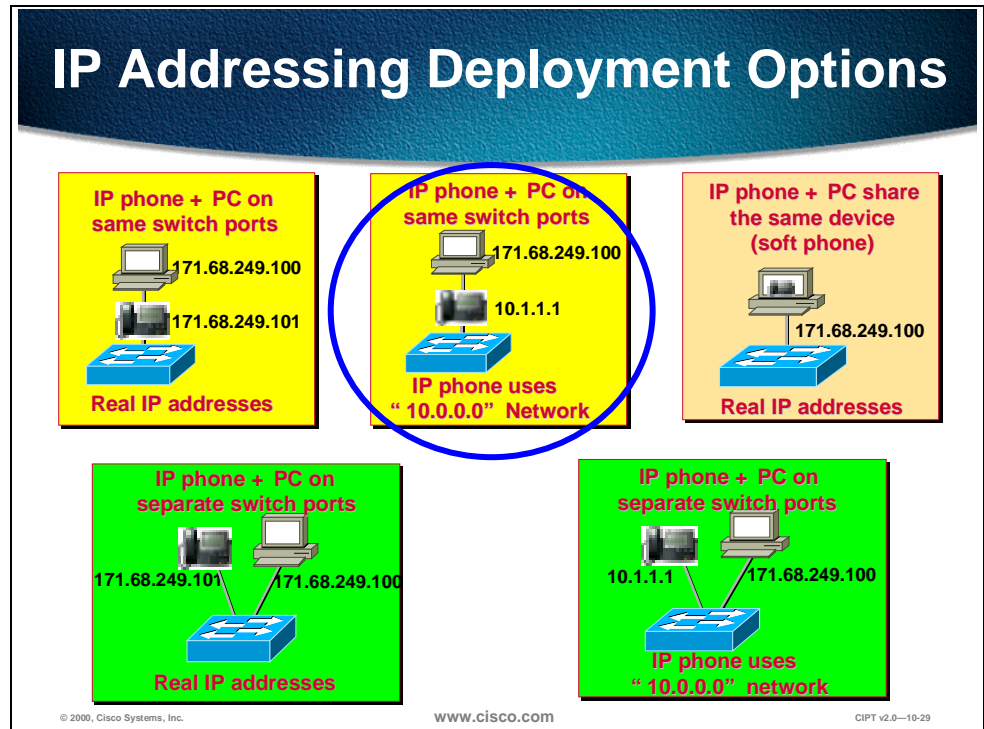

Cisco IP phones need IP addresses and the following recommendations are made for IP addressing deployment. Is there enough address space to support "X" number of phones? If not, use the following recommendations:

- Continue to use existing addressing for data devices (PCs, workstations, and so forth)
- Add IP phones with DHCP as the mechanism for getting addresses.
- If subnets are available in existing address space then use them for IP phones.
- If not, then use private addressing (network 10 or network 172.16 – 172.20).
- LAN and private IP WAN will carry these routes and route between both the address space.
- WAN gateway to Internet should block private addresses, just like today with data devices.

Note Phones don't work across NAT/PAT/ firewall boundaries today.

Adding a New Phone



Before a Cisco IP phone can be used, the phone must be added to Cisco CallManager.

Before you begin, the phone must reset after making changes to apply the new settings. These settings are not available for all phone types. Only the settings appropriate to the model selected appear on screen.

Follow these steps to add a Cisco IP phone to Cisco CallManager.

1. Open Cisco CallManager Administration.
2. Select **Devices > Add a Device**. The Add Device page is displayed.
3. Select **Device Type > Phone**.
4. Select the appropriate model from the Model drop-down list.
5. Enter the appropriate settings as described in table on the following page.
6. Add a directory number to this phone.

Note These settings are **not** available for all phone types. Only the settings appropriate to the model selected appear on screen.

The following table shows IP phone configuration settings.

Field	Description	Usage Notes
Model	Identifies the type of Cisco IP phone.	Once you select the model, you cannot modify it.
MAC Address	Identifies hardware-based telephones and device name.	Value must be 12 hexadecimal characters.
Device Name	Identifies software-based telephones.	Value can include 1-128 characters, including alphanumeric, dot, dash, or underscores. Only available for software-based phones.
Description	Clarifies the purpose of the device.	Can be user's name or phones location.
Load Information	Specifies custom software for a Cisco IP phone.	Values entered here override the default values for the current model.
Device Pool	The region, date/time groups, and Cisco CallManager group combination.	
Location	Specifies the remote location accessed using restricted bandwidth connections.	
Calling Search Space	Specifies the collection of route partitions searched to determine how a dialed number should be routed.	
Button Template	Determines the configuration of buttons on a phone and identifies which feature (line, speed dial, and so on) is used for each button.	Not available for software-only phones.
Directory Services URL	Specifies the primary and secondary servers from which the phone obtains directory information.	Used for Cisco IP Phone 7960 only.
Voice Mail URL	Specifies the primary and secondary servers from which the phone obtains directory information.	Used for Cisco IP Phone 7960 only.
Outgoing Caller ID Pattern	Specifies the number to send as caller ID for outgoing calls.	Used for H.323 clients only.
Calling Party Selection	Determines what to display if a call to this device is forwarded or transferred.	Used for H.323 clients only.
Caller ID Presentation		Used for H.323 clients only.
Media Termination Point Required	Determines whether or not a media termination point is used to implement features that H.323 does not support (such as hold and transfer).	Used for H.323 clients only.

Adding a Directory Number

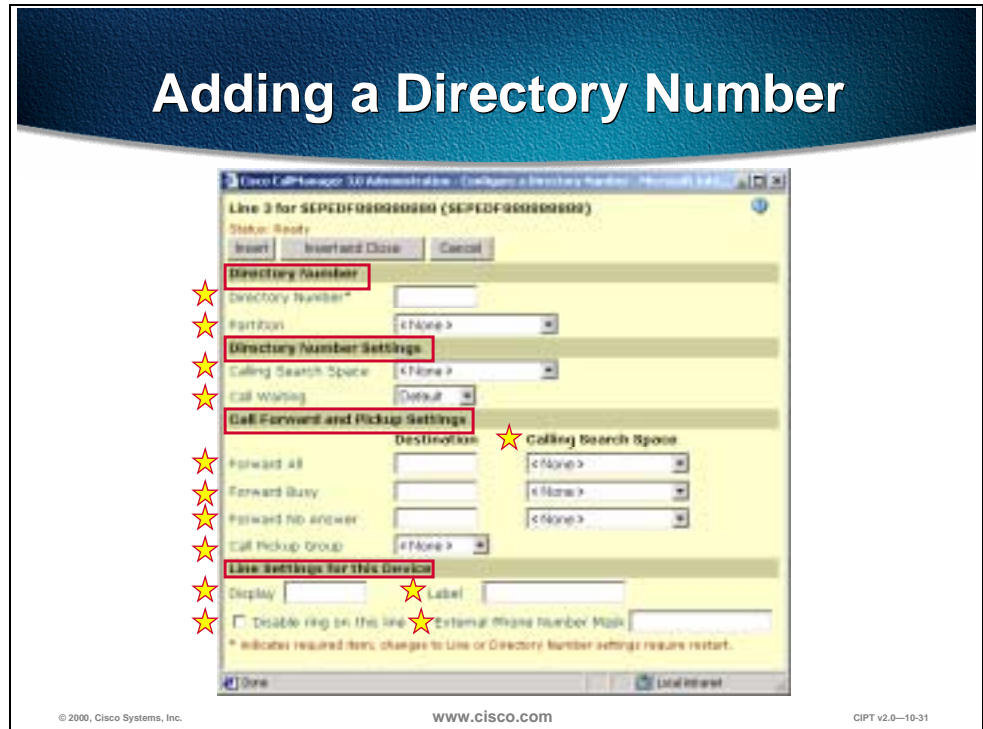

Follow these instructions to add a directory line to a specific phone.

Before you begin, the Cisco IP phone must be added to Cisco CallManager before adding a directory line.

Follow these steps to add a directory number:

1. Open Cisco CallManager Administration.
2. Select **Devices > Phone**. The Phone Search page displays.
3. Enter search criteria to locate a specific phone. A list of discovered devices appears.
4. Click **Device Name**. The Phone Configuration page displays, with the lines listed on the left side.
5. Click an unassigned line (Line 1, Line 2, and so on). The Directory Number Configuration page displays.
6. Enter the appropriate settings as described in the table on the following page.
7. Click **Insert and Close**.

The following table shows the directory line configuration settings.

Field	Description	Usage Notes
Directory Number		
Directory Number	Indicates a dialable phone number.	Values must be 1-32 numeric characters, *, or #. Unique in combination with partition.
Partition	Indicates the route partition to which the directory number belongs.	Can appear in more than one partition. Unique in combination with the directory number. Appears only if configured in the system.
Directory Number Settings		
Calling Search Space	Collection of partitions that are searched for numbers called from this directory number.	Changes cause update of the numbers listed in the Call Pickup Group field. Applies to all devices using this directory number.
Call Waiting	Specifies whether this directory number uses call waiting when a line is busy (On), responds with a busy signal (Off), or uses the system-wide default setting (default).	Applies to all devices using this directory number.
Call Forward and Pickup Settings		
Call Pickup Group	Indicates a number that can be dialed to answer calls to this directory number (in the specified partition).	
Forward All	Indicates the directory number to which all calls are forwarded.	Any dialable phone number, including an outside destination. Applies to all devices using this directory number.
Calling Search Space	Indicates the calling search space to use when forwarding to the specified destination.	Applies to all devices using this directory number.
Forward Busy	Indicates the directory number that a call is forwarded to when the line is in use.	Any dialable phone number, including an outside destination. Applies to all devices using this directory number.
Calling Search Space	Indicates the calling search space to use when forwarding to the specified destination.	Applies to all devices using this directory number.

Forward No Answer	Indicates the directory number that a call is forwarded to when no one answers after 4 rings.	Any dialable phone number, including an outside destination. Applies to all devices using this directory number.
Calling Search Space	Indicates the calling search space to use when forwarding to the specified destination.	Applies to all devices using this directory number. Appears only if configured in the system.
Line Settings for this Phone		
Display	Indicates text that appears on the called party's phone when a call is placed from this line.	Maximum of 30 alphanumeric characters. Typically use the user's name or the directory number. Applies only to the current device.
Label	Indicates the text for the line button on this phone. Cisco IP Phone 7960—displayed on the LCD. Other Cisco IP phones—not displayed but could be used when printing button templates.	Applies only to the current device.
Disable ring on this line	Stops the phone from ringing to indicate incoming calls.	Applies only to the current device.
External Phone Number Mask	Indicates phone number (or mask) used to send caller ID information when placing a call from this line.	Maximum of 30 number and "X" characters. The X characters must appear at the end of the pattern.

Finding a Phone

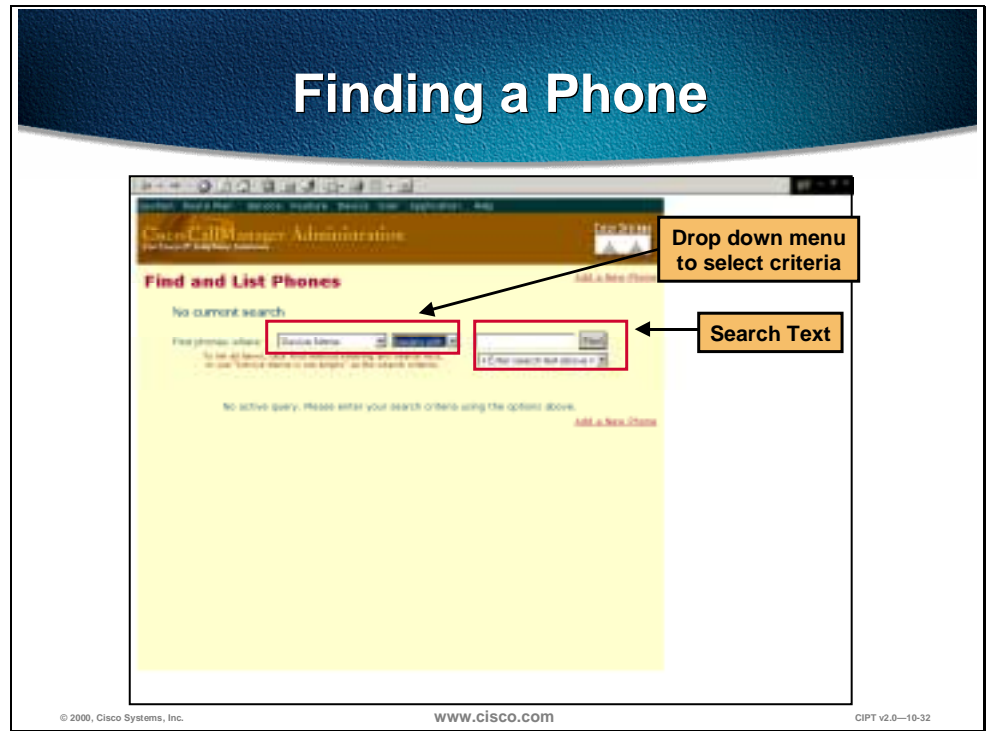

Follow these steps to search for a specific phone in the Cisco CallManager database:

1. Open Cisco CallManager Administration.
2. Select **Devices > Phone**. The Find and List Phones page displays.
3. Select one of the following options from the **Device Name** menu:
 - Device Name
 - Description
 - Directory Number
 - Calling Search Space
 - Device Pool
4. Select one of the following options from the **begins with** menu:
 - begins with
 - contains
 - ends with

- is exactly
 - exists
 - is empty
5. Enter the item to search for in the **Find** field.
 6. Click **Find**. A list of the first 20 discovered devices appears displaying the following:
 - Device icon
 - Device Name
 - Description
 - Device Pool
 - Copy
 - Delete
 - Reset

The total number of devices and pages are also listed on this page.

7. To view the next set of discovered devices, click **Next**.

Finding a Phone

Use searching by Calling Search Space or Device Pool. If calling search space or device pool is selected, the options available in the database display. Select one of these options from the drop-down list box below the Find button:

- Device Name
- Description
- Directory Number
- Calling Search Space
- Device Pool
- Begins with
- Contains
- Ends with
- Is exactly
- Is not empty
- Is empty

Finding All Phones in the Database

To find all phones registered in the database, select these search criteria:

Device Name is not empty

Deleting a Phone

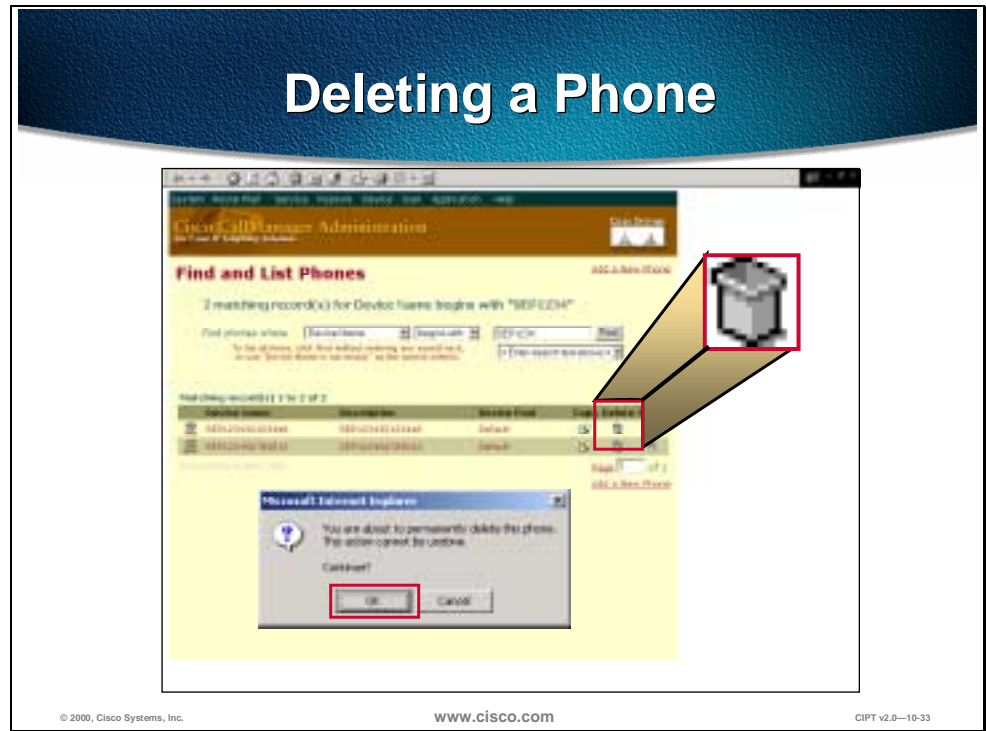

Perform the following procedure to delete a Cisco IP phone from Cisco CallManager:

1. Open Cisco CallManager Administration.
2. Select **Devices > Phone**. The Phone Search page displays.
3. Enter search criteria to locate a specific phone. A list of discovered devices appears.
4. Click the **Delete** icon next to the phone you want to delete. A message appears verifying that you want to delete the phone.
5. Click **OK**.

Resetting a Phone

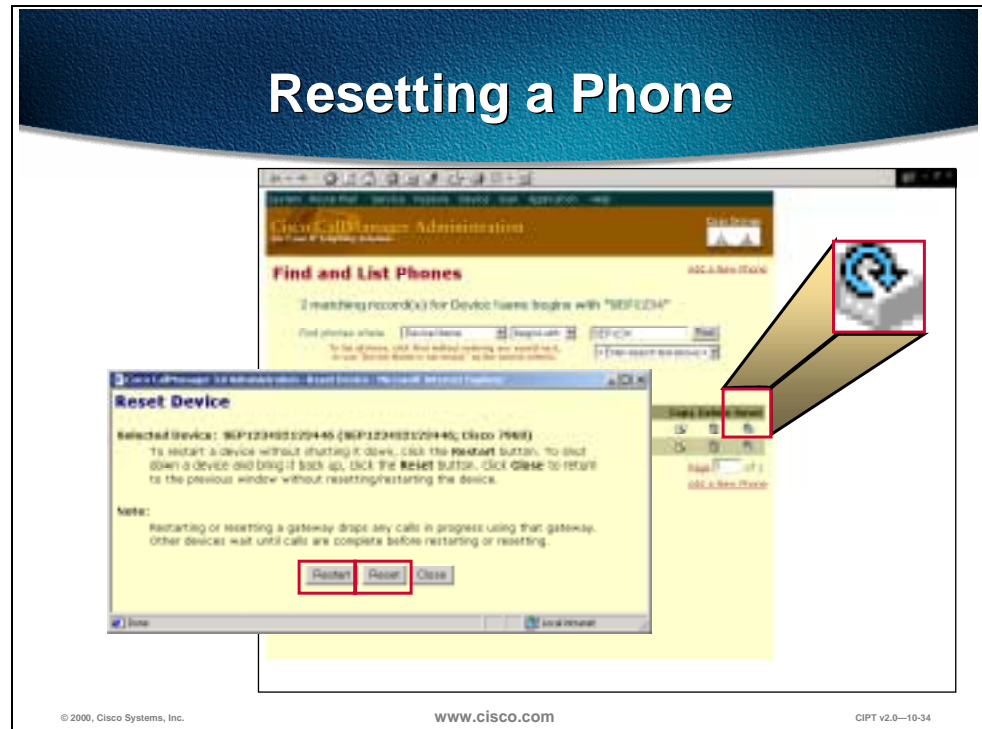

Perform the following procedure to reset a Cisco IP phone using Cisco CallManager.

Before you begin, if a call is in progress, the phone does not reset until the call is finished.

Procedure

1. Open Cisco CallManager Administration.
2. Select **Devices > Phone**. The Phone Search page displays.
3. Enter search criteria to locate a specific phone. A list of discovered devices appears.
4. Click the **Reset** button next to the phone you want to reset. The Reset Device page displays.
5. Click one of the following:
 - **Restart Device**—restarts a device without shutting it down.
 - **Reset Device**—shuts down a device and bring it back up.

Note You can reset the phone by pressing * * # * *

Updating a Phone

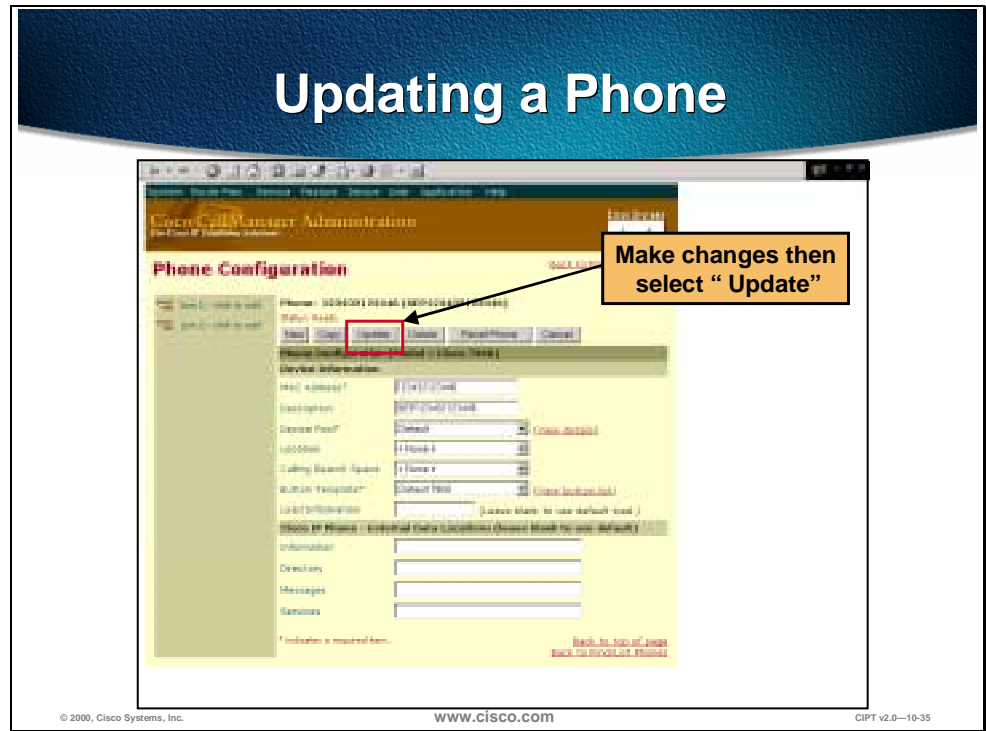

Perform the following procedure to update a Cisco IP phone from Cisco CallManager:

1. Open Cisco CallManager Administration.
2. Select **Devices > Phone**. The Phone Search page displays.
3. Enter search criteria to locate a specific phone. A list of discovered devices appears.
4. Click **Device Name**. The Phone Configuration page displays.
5. Enter desired changes.
6. Click **Update**.

Copying an Existing Phone

The image shows two screenshots of the Cisco CallManager Administration interface. The top screenshot shows the 'Phone Configuration' page for a specific phone. A red box highlights the 'Copy' button, with an arrow pointing to it from a text box that says 'Make desired changes to selected phone, then select "Copy"'. The bottom screenshot shows the 'Phone Configuration' page for a new phone, 'New (Copy of 129431229444)'. A red box highlights the 'MAC address' field, with an arrow pointing to it from a text box that says 'Must change MAC address before selecting insert'. The interface includes various fields for phone configuration, such as 'MAC address', 'Description', 'Device Pool', and 'Location'. The bottom of the image contains the text: '© 2000, Cisco Systems, Inc. www.cisco.com CIPT v2.0-10-36'.

When manually adding several similar phones to the Cisco CallManager database, add one and then copy its basic settings to apply to another phone. The MAC address must change before inserting the new phone into the database.

Perform the following procedure to copy a phone's settings:

1. Open Cisco CallManager Administration.
2. Select **Devices > Phone**. The Phone Search page displays.
3. Enter search criteria to locate a specific phone. A list of discovered devices appears.
4. Click **Device Name**. The Phone Configuration page displays.
5. Enter desired changes.
6. Click **Copy**.
7. Enter the MAC address of the new phone.
8. Click **Insert**.

Creating Phone Button Templates

Creating Custom Phone Button Templates

- **Ensure that features that are described on the quick reference card includes the following:**
 - **12 SP+—Line (one or more), hold, call park, and forward all**
 - **30 VIP—Line (one or more), call park, and forward all**
 - **7910—Line, hold and transfer**
 - **7960—Line (one or more)**
- **Consider the nature of each feature in order to determine how to configure button templates**
- **Each feature selected must include the number of times this feature is to appear on the button template (the feature index)**

© 2000, Cisco Systems, Inc.

www.cisco.com

CIPT v2.0—10-37

Use the following guidelines when creating custom button templates:

- End users receive a quick reference card and/or getting started guide that describes the most basic features. If custom template is created to be used by employees in a company, ensure it includes the following features that are described on the quick reference card:
 - 12 SP+—Line (one or more), hold, Call Park, and forward all.
 - 30 VIP—Line (one or more), Call Park, and forward all.
 - 7960—Line (one or more)
- Consider the nature of each feature to determine how to configure button template. Multiple buttons can be assigned to speed dial and line. However, usually only one is required of the other features described in the table below.
- For each feature selected, select the number of times this feature to appears on the button template (the feature index).

The following table shows phone feature descriptions.

Feature	Description
Answer/release	Used in conjunction with a headset apparatus so the user can press a button on the headset apparatus to answer and release (disconnect) calls.
Auto answer	If this feature is programmed on the template, activating this button causes the phone to go off-hook (speakerphone) automatically when an incoming call is received.
Call park	Used in conjunction with a call park number or range so that when the user presses this button, the call is parked at a directory number for later retrieval. You must have a call park number or range configured in the system for this button to work, and you should provide that number or range to your users so they can dial into the number(s) to retrieve calls.
Conference	When users press this button, they are initiating an Ad Hoc conference and they expect to call other participants to conference them in one at a time. Only the person initiating an Ad Hoc conference needs a Conference button. You must have configured an Ad Hoc conference device in Cisco CallManager Administration for this button to work.
Forward all	Users press this button to forward all calls to the designated directory number. Users can designate the forward all in the User Web pages, or you can designate a forward all number for each user in Cisco CallManager Administration.
Hold	Users press this button to place an active call on hold. To retrieve a call on hold, user presses the flashing line button or lifts the handset and presses the flashing line button for the call on hold. The caller on hold hears a tone every 10 seconds to indicate the hold status. No configuration is necessary for this feature to work.
Line	Users press this button to dial a number or to answer an incoming call. You must have added line numbers on the user phone for this button to work. Line 1 is required on all phones
Meet-Me conference	When users press this button, they are initiating a meet-me conference and they expect other invited users to dial into the conference. Only the person initiating a meet-me conference needs a meet-me button. You must have configured a meet-me conference device in Cisco CallManager Administration for this button to work.
Message waiting	Users press this button to connect to the voice messaging system. For instructions on connecting the message waiting directory number with a third-party voice mail system.
None	Use none to leave a button unassigned to any feature.
Redial	Users press this button to redial the last number dialed on the Cisco IP phone. No configuration is necessary for this feature to work.
Speed-dial	Users press this button to speed dial a specified number. User can designate speed-dial numbers in the User Web pages, or you can designate a speed-dial number for each user in Cisco CallManager Administration.
Transfer	Users press this button to transfer an active call to another directory number. No configuration is necessary for this feature to work.

Adding a Phone Button Template

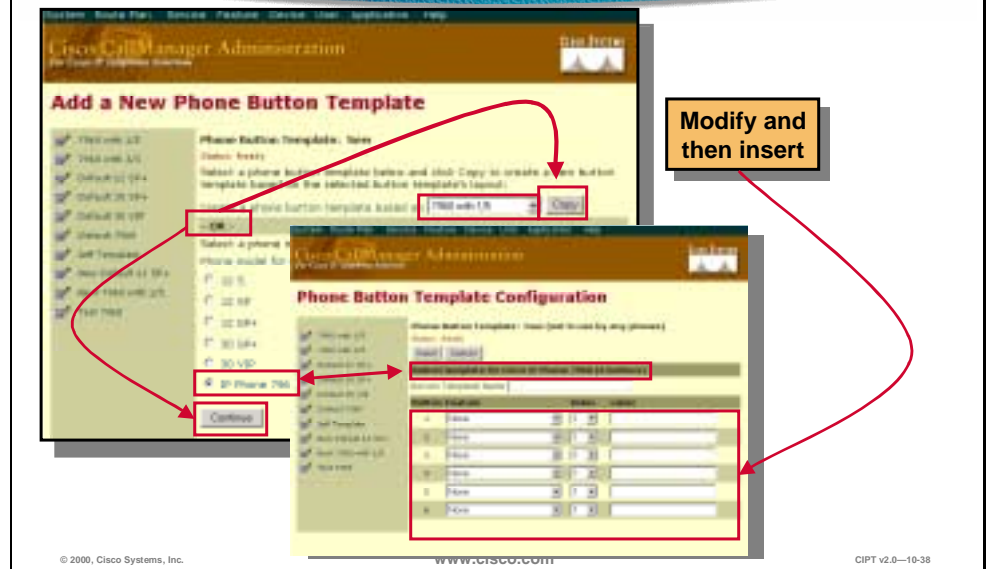

Creating and using templates is a fast way to assign a common button configuration to a large number of phones. For example, if users in a company do not use the conference feature, create a template that reassigns this button to a different feature, such as speed dial. Four default templates are included with the Cisco CallManager: Default 12 SP+ (for all 12-series phones), Default 30 SP+, Default 30 VIP, and Default 7960. When adding phones, assign one of these templates to the phone, or create one.

Before you begin, if you are creating a custom button template, be sure to review the guidelines for creating custom templates.

Follow these steps to create a new button template:

1. Open Cisco CallManager Administration.
2. Select **Devices > Phone Button Template**.

You must decide which method to use to create this template.

Based on existing template, the new template exactly duplicates the existing template. You must update this new template if you want it to be different than the original.

A new design for a specific phone must have each button set up individually, as follows:

1. Choose the method to create this template.
2. Select a template and click **Copy** to create a new template based on the selected template. The new template exactly duplicates the existing template and automatically assigns it a new name. Update this new template if you want it to be different than the original.
3. Select a phone and click **Continue** to create a new template and assign each button individually.

4. Make desired changes to the fields described in the phone button configuration settings table below:

Field	Description	Usage Notes
Template Name	Unique name used by CallManager to identify the template.	<ul style="list-style-type: none"> ■ Use any 1-50 characters. ■ Each template must have a unique name.
Feature	Specifies the function of the phone button when the template is used.	
Index	Specifies the instance of a feature so that templates can have multiple instances of the same feature.	For the Cisco IP phone 7960, first button is always Line 1.
Label	Text that appears when the template is displayed in the administration interface or printed on some Cisco IP phones.	Name or number for speed dials.

5. Click **Insert** to add the new template.
6. Click **View Button Layout** to verify the button layout.

Modifying a Phone Button Template

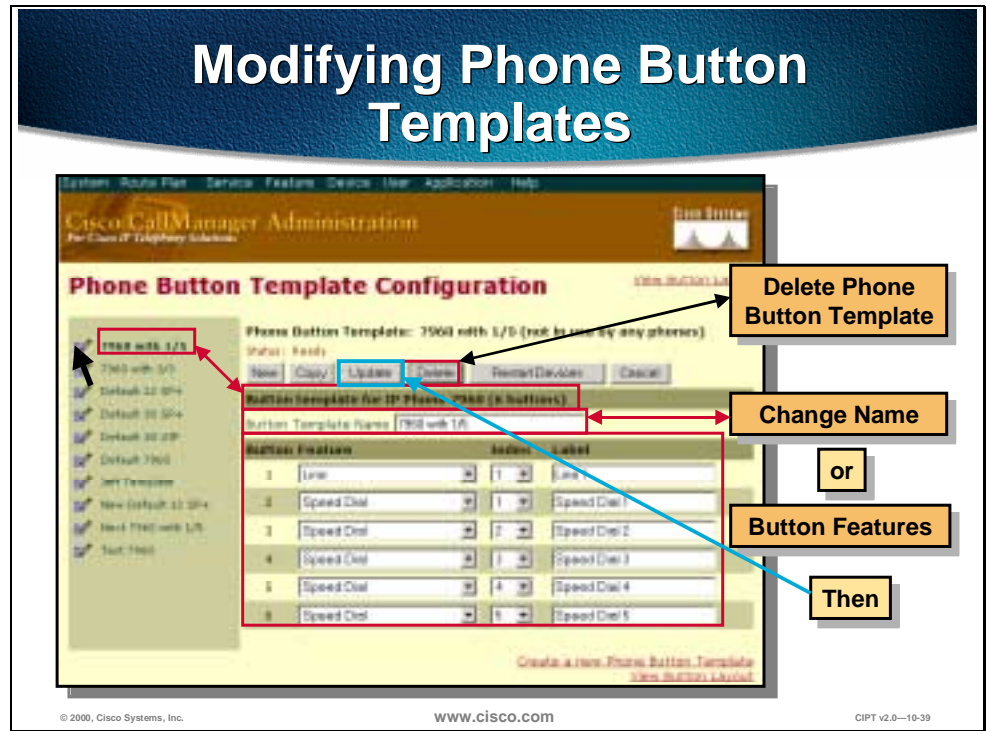

You can make changes to the default template templates included with Cisco CallManager or customer templates you created.

Deleting a Button Template

A template that is assigned to one or more devices cannot be deleted. All Cisco IP phones using the template to be deleted must be reassigned to a different button template before you can delete the template.

Follow these steps to delete a button template:

1. Open Cisco CallManager Administration.
2. Select **Devices > Phone Button Template**. A listing of current button templates appears on the left side of the screen.
3. Click the button template you want to delete. The phone button template configuration page displays.
4. Click **Delete**. A message displays verifying that you want to delete the template.
5. Click **OK** to delete the template. A message appears verifying that the template was deleted.
6. Click **OK** to continue.

Renaming a Button Template

Renaming a template does not affect the phones that use the template. All Cisco IP phones that use this template continue to use this template once it is renamed.

Follow these steps to rename a button template:

1. Open Cisco CallManager
2. Select **Devices > Phone Button Template**. A listing of current button templates appears on the left side of the screen.
3. Click the button template you want to rename. The phone button template configuration page displays.
4. Enter the new name in the Template Name field.
5. Click **Update**. The template re-displays with the new name.

Updating a Button Template

Before you begin, remember that when you update a template, the change affects all phones that use the template.

Follow these steps to update an existing button template:

1. Open Cisco CallManager Administration.
2. Select **Devices > Phone Button Template**. A listing of current button templates appears on the left side of the screen.
3. Click the button template you want to rename. The phone button template configuration page displays.
4. Enter the desired changes.
5. Click **Update**.
 - The template reappears with the changes assigned to it.
 - You must restart devices using the template after updating it.
6. Click **Restart devices** to apply the updated button template.

Phone Features

You can configure Call Park and Call Pickup for phones.

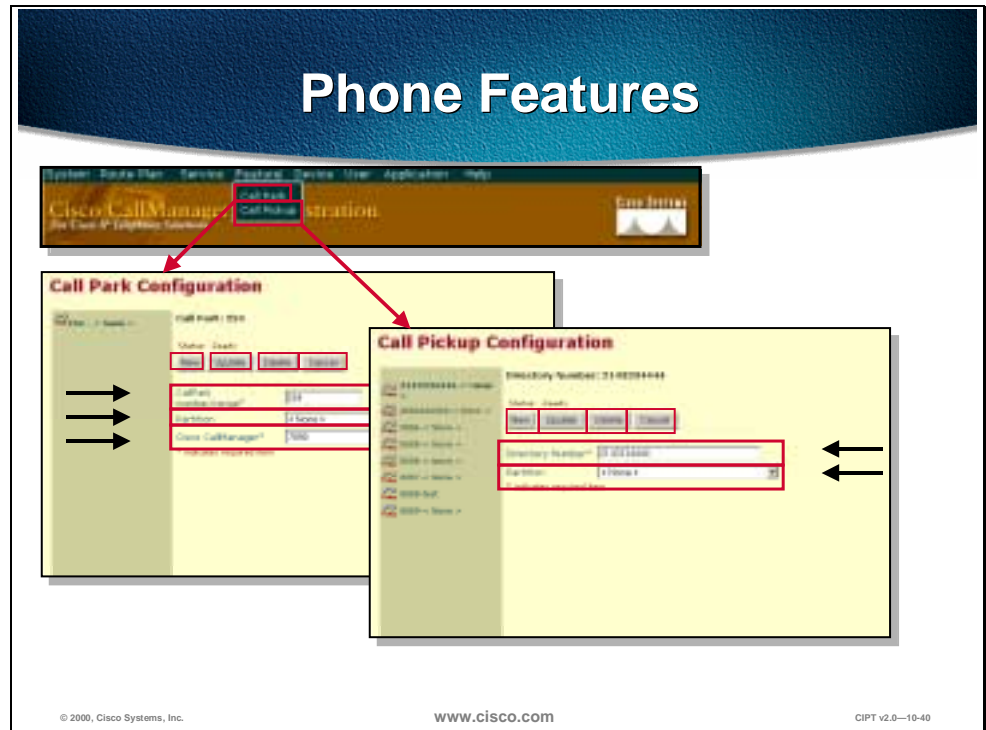

Configuring Call Park

Call Park allows you to place a call on hold so that anyone connected to the Cisco CallManager system can retrieve it. One, or a range of Call Park numbers, must be configured in the Cisco CallManager administration for this feature to be used.

For example, if an active call at extension 1000, park the call to a call park extension such as 1234. Anyone connected to the system can then dial 1234 to retrieve the call.

To use Call Park, add the call park extension (in this case, 1234) in Cisco CallManager administration. Add the call park extension when configuring phone features in Cisco CallManager.

Configuring Call Pickup

Call pickup allows you to use your phone to answer another ringing phone in your designated call pickup group.

For example, if a user is assigned to a call pickup group, they are able to pick up calls to their group that are sitting in a group queue.

On the Cisco IP Phone 7960 there is a Group Pickup. This feature allows the users to pick up a call in another call pickup group queue when the user has no calls in their own group's queue.

Configure call pickup when configuring phone features in Cisco CallManager administration.

Error Codes and Status Messages

Details of error codes and status messages displayed on the Cisco 12 SP+ and 30 VIP Phones aid in troubleshooting.

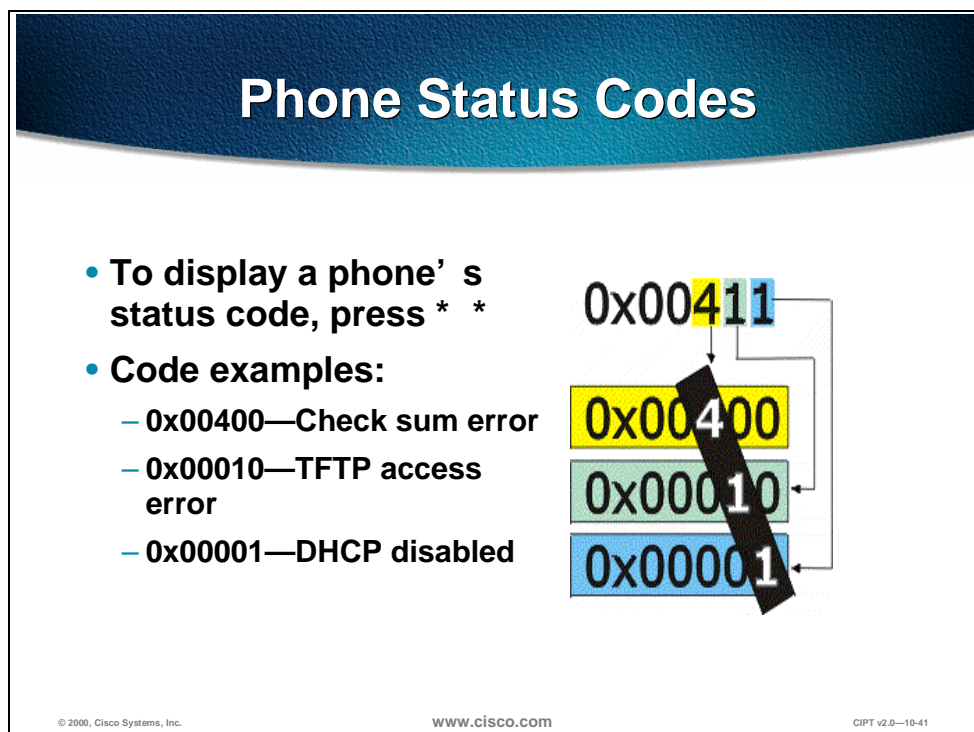

The slide is titled "Phone Status Codes" in a dark blue header. It contains a list of instructions and examples on the left, and a diagram on the right. The diagram shows a sequence of four hex codes: 0x00411, 0x00400, 0x00010, and 0x00001. A large black arrow points from the top code down to the bottom code, indicating a sequence of status changes. Arrows also point from the top code to the middle two codes.

- To display a phone's status code, press * *
- Code examples:
 - 0x00400—Check sum error
 - 0x00010—TFTP access error
 - 0x00001—DHCP disabled

© 2000, Cisco Systems, Inc. www.cisco.com CIPT v2.0—10-41

The Cisco IP Phones 12 SP+ and 30 VIP have a digital display and can display status codes. The normal status following a successful registration is 0x04800 boot patch installed, TFTP file received.

The status is a 20-bit code, presented as 5 hex digits in the documentation. Each digit is interpreted independently. These values report status, not just errors.

A detailed list of the status codes can be found in the product documentation.

The following key sequences are examples of keystrokes that can be used to access a range of information on the status of the phone, or to initiate tasks:

- * Display load
- ** Display status
- ** 9 Display call bandwidth used
- **# Displays DHCP information
- ** # ** Reset with current saved values

Phone LED Status Display

- LEDs on the phones can be used to determine network and software status:
- For example, network connection status
- LED Cause
 - 1 DHCP is disabled
 - 2 DHCP timeout
 - 3 TFTP error
 - 4 DNS error

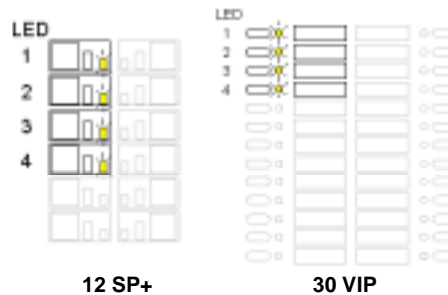

© 2000, Cisco Systems, Inc.

www.cisco.com

CIPT v2.0-10-42

In addition to the information displayed on the status display, information can also be communicated via the phones LED displays. These are the four line lights on the top left side.

Detailed information on the LED status codes can be found in the user documentation.

Phone Reset Causes

- **A phone reset can result from:**
 - **Power loss**
 - **Loss of Gateway**
 - **Ethernet connectivity failure**
 - **Keypad (local) reset “ * * # * * ”**
 - **CallManager Administration directed reset**
 - **CallManager restart**
- **Resetting a phone disconnects any call in progress**

© 2000, Cisco Systems, Inc.

www.cisco.com

CIPT v2.0—10-43

If the phone is reset, a reset cause code will be displayed. The following can result in any of the Cisco IP phones resetting:

- Power loss
- Loss of gateway—a gateway is disconnected or powers down.
- Ethernet connectivity failure—Layer 1 problem
- Keypad
 - Entering ** # ** will cause the phone to reset using the current values for the phone.
 - Entering 0.0.0.0 for an IP address will cause the phone to reset.
- CallManager administration directed reset from the device phone section
- CallManager restart using control center or server reboot.

During a power outage, if a PC is connected through the hub in the phone, the Ethernet connection to the PC is lost.

Phone Reset Codes

- **Resetting E3**—No TCP connection could be made to a CallManager
- **Resetting E4**—DHCP timed out and there is no configuration information stored in the phone's flash memory
- **Resetting E5**—Resetting in response to a StationRegisterRejectMessage request from the CallManager
- **Resetting E6**—The configuration file contained invalid information
- **Resetting E7**—DNS failed on the TFTP server name
- **Resetting E8**—Resetting in response to a StationResetID request from the CallManager
- **Resetting E9**—Resetting in response to DHCP/BOOTP server response of 255.255.255.255 for any of the following: Host, TFTP, DNS, or Default gateway (router) IP address

© 2000, Cisco Systems, Inc.

www.cisco.com

CIPT v2.0—10-44

Codes that identify the cause of a reset are displayed at the Cisco 12 SP+ and 30 VIP Phones, as the reset initiates are the following:

- Resetting E3 means that no TCP connection could be made to a CallManager.
- Resetting E4 means the DHCP has timed out and there is no configuration information stored in the phone's flash memory.
- Resetting E5 means the phone is resetting in response to a StationRegisterRejectMessage request from the CallManager was sent.
- Resetting E6 means the configuration file contained invalid information.
- Resetting E7 means the DNS failed on the TFTP server name.
- Resetting E8 means the phone is resetting in response to a StationResetID request from the CallManager.
- Resetting E9 means that the phone is resetting in response to DHCP/BOOTP server response of 255.255.255.255 for any of the following: Host, TFTP, DNS, or Default gateway (router) IP address.

Detailed information on these codes can be found in the user documentation.

Phone Reset Progress

- **Describes the automatic loading of the phone's program and attempt to connect to and communicate with the Ethernet network**
- **When the phone is powered up or reset, it goes through the boot process**
- **LEDs show the steps, or states, of the boot process**
- **When the phone reaches a point where it can make and receive calls, all of the boot status LEDs are cleared, and the date and time are displayed**

© 2000, Cisco Systems, Inc.

www.cisco.com

CIPT v2.0—10-45

For example, the Cisco 12 SP+ and 30 VIP Phones automatically retry to register after a previous registration attempt is denied because of insufficient user licenses.

When the phone reaches a point where it can make and receive calls, all of the boot status LEDs are cleared. Some occurrences during the boot process are saved as network connection status. You can view the network connection status at any time while the phone is running.

Detailed information on the status codes can be found in the user documentation.

Trace Basic Call Processing

To accomplish any type of problem determination and resolution, a baseline must be established. The following describes and lists the steps in the call processing from phone to phone.

Syslog and Trace Configuration

File Name	Value
C:\Program Files\Cisco\CallManager	100
	10000
	1440

© 2000, Cisco Systems, Inc. www.cisco.com CIPT v2.0-10-46

The syslog and trace configuration allow you to do the following:

- Determine what types of activities you want written to the log (debug, events)
- Determine the log file and how often the log files are created.
- Determine an external syslog server

Note The path to the trace page is in the Cisco CallManager Administration page, **services> trace**

Sample Trace File

```
Cisco CallManager|NodeId: 1, EventId: 1 EventClass: 3 EventInfo: Cisco Call Manager
Version=<3.0(0.11)> started
Cisco CallManager|NodeId: 1, EventId: 1543 EventClass: 2 EventInfo: Database manager started
Cisco CallManager|NodeId: 1, EventId: 1542 EventClass: 2 EventInfo: Link manager started
Cisco CallManager|NodeId: 1, EventId: 1541 EventClass: 2 EventInfo: Digit analysis started
Cisco CallManager|NodeId: 1, EventId: 1540 EventClass: 2 EventInfo: Call control started
Cisco CallManager|CallParkManager - ERROR getting_dn_DbNoMoreCallParks - No Call Park numbers
Registered.
Cisco CallManager|NodeId: 1, EventId: 1694 EventClass: 2 EventInfo: Supplementary services
started
Cisco CallManager|NodeId: 1, EventId: 1544 EventClass: 2 EventInfo: Message translation
manager started
Cisco CallManager|TitanInit - Waiting on a Connection TCP Port#=2001 IPAddress=172.28.129.22
Cisco CallManager|NodeId: 1, EventId: 1539 EventClass: 2 EventInfo: Devices started
Cisco CallManager|NodeId: 1, EventId: 103 EventClass: 3 EventInfo: Cisco Call Manager
Version=<3.0(0.11)> Online
```

© 2000, Cisco Systems, Inc.

www.cisco.com

CIPT v2.0-10-47

The figure above is an example of a sample trace file. On the far right are descriptions of the events picked up by the trace file.

Normal CDR Fields

GlobalCallIdentifier	This is the global call ID for this call.
CI	Originator leg call Identifier
CdrDateTime	Date/time of call origination
Originators Information	
SdlNodeId	The node within the CallManager cluster where the call originated
Dsl	Originator' s span or port
IpAddr	IpAddr originators IP address
IpPort	Originator' s IP port number
Partition	Originator' s partition
CdPNumDigits	Calling party number
CdrCauseElement	Cause of termination
TransportAddr	Media transport address
MediaCapabilityStructure	Capabilities

© 2000, Cisco Systems, Inc.

www.cisco.com

CIPT v2.0-10-48

The figure above lists the normal call detail record (CDR) fields and a description of the fields.

- GlobalCallIdentifier is the global call ID for this call.
- CI is the originator leg call identifier.
- CdrDateTime is the date/time of call origination.
- SdlNodeId is the node within the CallManager cluster where the call originated.
- Dsl indicates the originator's span or port.
- IpAddr is the IP address of the originator of the call.
- IpPort is the originator's IP port number.
- Partition is the originator's partition that they are assigned to.
- CdPNumDigits is the calling party number.
- CdrCauseElement is the cause for termination.
- TransportAddr is the media transport address.
- MediaCapabilityStructure is the capability for the originating caller.

Normal Destination Fields CDR Fields

Destination Information	
CI	Destination leg call identifier
SdINodeId	The node within the CallManager cluster where the call terminated
Dsl	Destination span or port
IpAddr	Destination IP address
IpPort	Destination IP port number
CdPNumDigits	Final called party number
Partition	Destination partition
CdPNumDigits	Original called party number
Partition	Partition associated with the original called party number
CdrCauseElement	Cause of termination
TransportAddr	Media transport address
MediaCapabilityStructure	Capabilities
CdrDateTime	Date/time of connect
CdrDateTime	Date/time of disconnect
CdPNumDigits	Last party to redirect this call
Partition	Partition of the last party to redirect this call

© 2000, Cisco Systems, Inc.

www.cisco.com

CIPT v2.0—10-49

The following are normal CDR fields related to the destination:

- CI is the destination leg call identifier.
- SdINodeId is the node within the CallManager cluster where the call terminated.
- Dsl is the destination span or port.
- IpAddr is the destination IP address.
- IpPort is the destination IP port number.
- CdPNumDigits is the final called party number.
- Partition is the partition associated with the original called party number.
- CdrCauseElement is the cause of termination.
- TransportAddr is the media transport address.
- CdrDateTime is the date/time of the connection.
- CdrDateTime is the date/time of the disconnection.
- CdPNumDigits is the last party to redirect this call.
- Partition is the partition of the last party to redirect this call.

Diagnostic CDR Fields

GlobalCallIdentifier	This is the global call ID for this call, and link to other CDR records
SdINodeId	The node within the CallManager cluster where this record was generated
DirNum	The directory number of the phone that generated this data
Partition	Partition of the directory number (phone) that generated this data
Id	CallIdentifier
DateTime	Daignostics date and time
pktssent	numberPacketsSent
octetssent	numberOctetsSent
pktsrecvd	numberPacketsReceived
octetsrecvd	numberOctetsReceived
packetslost	numberPacketsLost
jitter	jitter
latency	latency

© 2000, Cisco Systems, Inc.

www.cisco.com

CIPT v2.0-10-50

The following are diagnostic CDR fields:

- GlobalCallIdentifier is the global caller ID for this call and link to other CDRs.
- SdINodeId is the node within the CallManager cluster where this record was generated.
- DirNum is the directory number of the phone that generated this data.
- Partition is the partition of the directory number (phone) that generated this data.
- ID is the call identifier.
- DateTime is the diagnostics date and time.
- Pktssent is the number of packets sent.
- Octetssent is the number of octets sent.
- Pktsrecvd is the number of packets received.
- Packetslost is the number of packets lost.
- Jitter is the jitter.
- Latency is the latency.

Summary

This section summarizes the concepts you learned in this chapter.

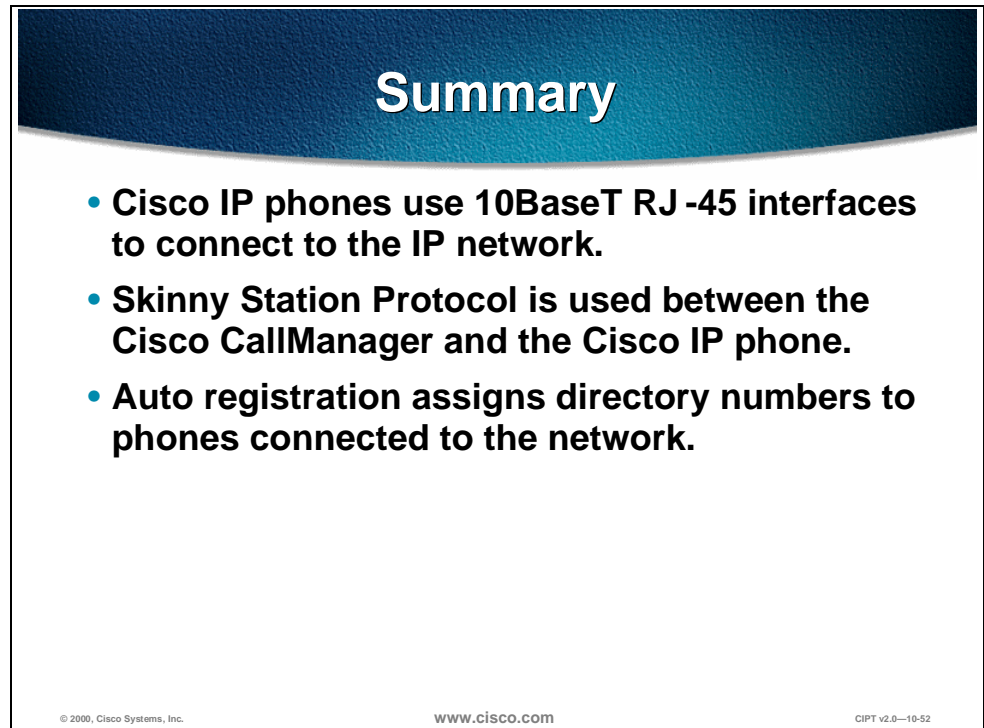

Summary

- **Cisco IP phones use 10BaseT RJ-45 interfaces to connect to the IP network.**
- **Skinnny Station Protocol is used between the Cisco CallManager and the Cisco IP phone.**
- **Auto registration assigns directory numbers to phones connected to the network.**

© 2000, Cisco Systems, Inc. www.cisco.com CIPT v2.0—10-52

Cisco IP phones are connected to an IP network by a 10BaseT RJ-45 interface. Between Cisco CallManager and the Cisco IP phones the Skinny Station Protocol is used for signaling, call setup, and teardown.

Auto registration is a feature in the Cisco CallManager administration that automatically assigns directory numbers to IP phones connected to the network. Auto registration by default is enabled (on) and can be disabled through Cisco CallManager administration.

Review Questions

Answer the following questions.

Review Questions

- 1. Is the Cisco CallManager involved with the phone call after an RTP stream is established?**
- 2. What are the networking protocols supported by the Cisco IP 7960 Phone?**
- 3. What are some events that cause the phone to reset?**

© 2000, Cisco Systems, Inc. www.cisco.com CIPT v2.0—10-53

- Q1) The Cisco CallManager handles the call control when making a call from an IP phone to an IP phone. When an RTP audio stream, using UDP port 16384+, is established between the two IP phones, does the Cisco CallManager stay involved?
- Q2) The Cisco IP Phone 7960 supports industry standard and Cisco networking protocols required for voice communication. What are the networking protocols supported by the Cisco IP Phone 7960?
- Q3) The Cisco IP phones display a code when a phone resets. What are some of the events that cause a Cisco IP phone to reset?

Cisco CallManager Architecture

Overview

Cisco CallManager Version 3.0 architecture significantly enhances the scalability, reliability, and interoperability of the enterprise IP telephony solution. Multiple Cisco CallManager servers are clustered and managed as a single entity. The capability of clustering multiple call-processing servers on an IP network is unique in the industry and highlights the industry-leading architecture of Cisco AVVID. Scalability for up to 10,000 users per cluster is provided. Triple server redundancy improves overall system reliability.

The following topics are discussed in this chapter:

- Objectives
- Scalability, Reliability, and Interoperability
- Cluster Operation and Scalability Guidelines
- Redundancy
- Campus Networking Cluster Guidelines
- Intra and Inter-Cluster Communication
- SQL Publisher/Subscriber Relationship Within a Cluster
- Station Registration
- Written Exercise
- Summary
- Review Questions

Objectives

This section lists the chapter objectives.

Objectives

Upon completion of this chapter, you will be able to perform the following tasks:

- **Define deployment architectures**
- **List the process used by devices to have redundancy in a cluster**
- **Describe the process that keeps all databases in a cluster up to date**

© 2000, Cisco Systems, Inc. www.cisco.com CIPT v 2.0—12-3

Upon completion of this chapter, you will be able to perform the following tasks:

- Given a list of recommendations for building Cisco CallManager clusters, identify the recommendations for a cluster of 5,000 users.
- Given Cisco IP telephony devices connected to a primary Cisco CallManager and the CallManager fails, list the steps in this process the devices used to ensure reliability through redundancy.
- Given a cluster of Cisco CallManagers, describe the process used that keeps all the databases in the cluster up to date.

Scalability, Reliability, and Interoperability

This section describes CallManager scalability.

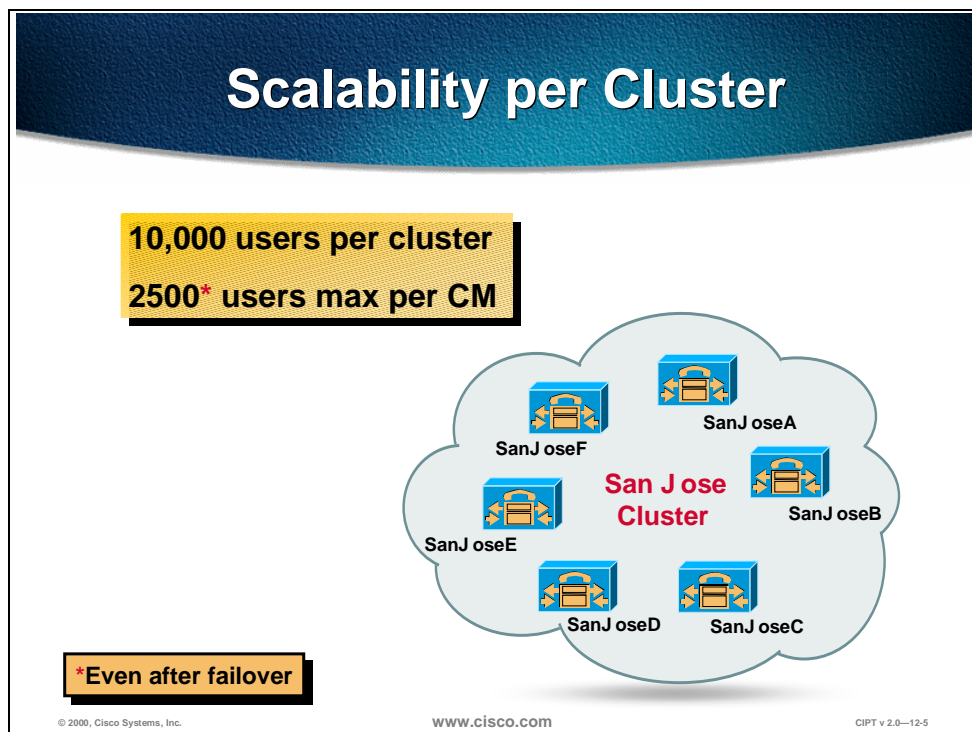

Cisco CallManager provides scalability through clustering. Each CallManger can support a maximum of 2500 users, even after a fail-over. Scaling up to 10,000 users is achieved through using six Cisco CallManagers in one cluster. By interlinking multiple clusters, system capacity can be increased to up to tens of thousands of users per multi-site system. Clustering aggregates the power of multiple, distributed Cisco CallManagers, enhancing the scalability and accessibility of the servers to phones, gateways, and applications.

Reliability

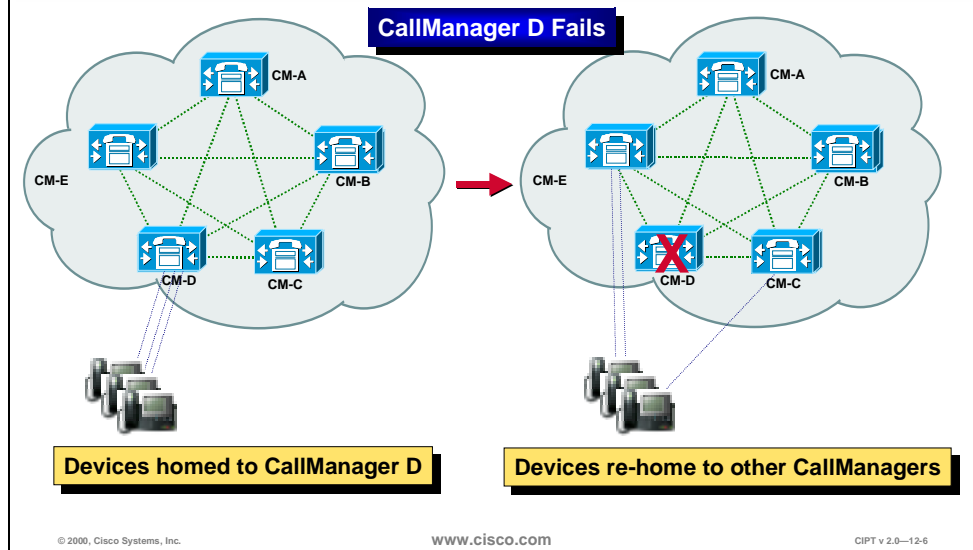

Triple redundancy for devices provides reliability. If a Cisco CallManager fails, the devices that registered to that Cisco CallManager would automatically re-home to other Cisco CallManagers. In a clustered environment devices registered to the one Cisco CallManager could have different secondary Cisco CallManagers to allow distributed re-homing to other Cisco CallManagers within the same cluster.

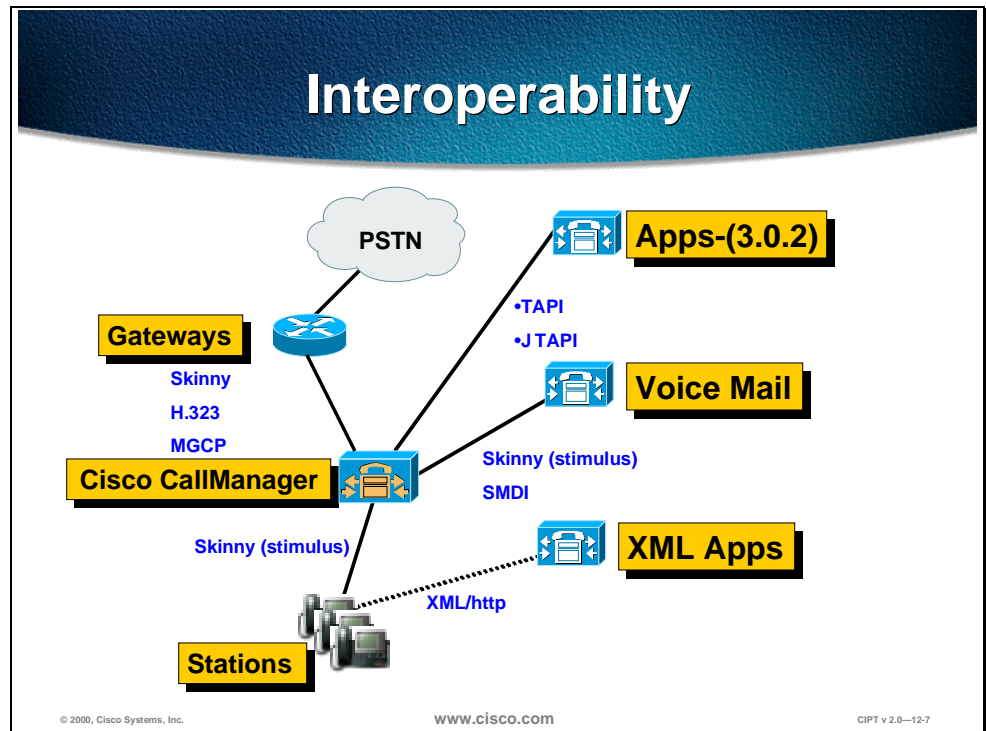

The Cisco CallManager architecture provides interoperability with other applications and devices. For example, between the Cisco CallManger and stations (IP phones) the Cisco CallManger uses skinny station (stimulus). The Cisco IP phones use eXtensible Markup Language (XML) to access XML applications.

The Cisco CallManager architecture uses skinny, H.323, and MGCP to communicate with gateways. Skinny (stimulus) is used between the Cisco CallManager and voice mail applications along with Simple Message Desktop Interface (SMDI).

In Cisco CallManager release 3.0(2), the architecture will support Telephony Application Programming Interface (TAPI) or Java TAPI.

Cluster Operation and Scalability Guidelines

This section describes how to use cluster operation and scalability.

What Is a Cisco CallManager Cluster?

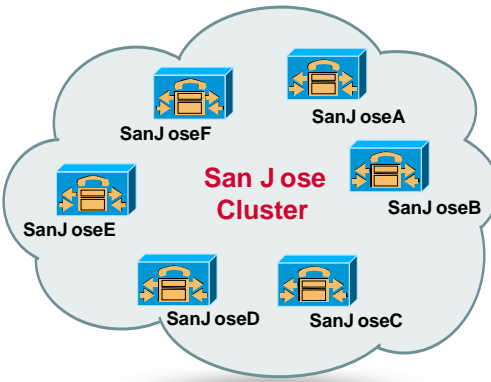

(N + 1) Scheme Provides

- Enhanced redundancy
- Scalability

CM 3.0

- Up to 6 CM(s) per cluster
- 2500 devices per CM
- 16B memory required
- 10,000 IP phones per Cluster

© 2000, Cisco Systems, Inc. www.cisco.com CIPT v 2.0—12-9

Six CallManagers can support as many as ten thousand devices in a Cisco CallManager cluster. The table below provides guidelines for the scaling of devices with CallManager clusters:

Cluster Guidelines Table

Number of Call Managers	Max Devices Per Call Manager	Max Devices Per Call Manager with N + 1 Redundancy	Max Devices Per Cluster	Max Devices Per Cluster with N + 1 Redundancy
1	2,500	N/A	2,500	N/A
2	2,500	1,250	5,000	2,500
3	2,500	1,667	7,500	5,000
4	2,500	1,875	10,000	7,500
5	2,500	2,000	10,000	10,000
6	2,500	2,500	10,000	10,000

Registered devices include IP telephones, gateways and Digital Signal Processing (DSP) devices such as transcoding and conferencing resources. The maximum number of registered devices is 2500, hence in the event of the failure of one of the CallManagers within the cluster the maximum number of registered devices under a failure scenario may not exceed 2500.

Cluster Recommendations

Cluster Recommendations Up to 2,500 Users

A cluster of two CallManagers

- **Single active CallManager**
- **Dedicated Publisher also acts as a standby**

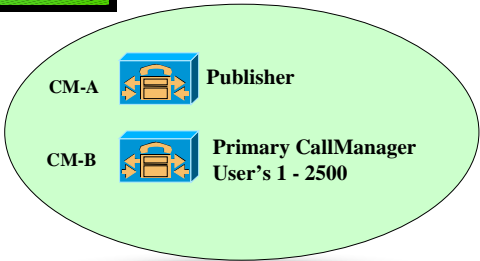

The diagram shows two CallManager nodes within a light green oval. Node CM-A is labeled 'Publisher' and has a blue icon with a white padlock. Node CM-B is labeled 'Primary CallManager' and 'User's 1 - 2500', also with a blue icon and white padlock.

© 2000, Cisco Systems, Inc. www.cisco.com CIPT v 2.0—12-10

A cluster of two Cisco CallManagers can support up to 2,500 users. Use one of the Cisco CallManagers as the active CallManager and the other as the dedicated backup.

In this example the publisher would be the backup and the subscriber would be the active “primary” CallManager.

Cluster Recommendations Up to 5,000 Users

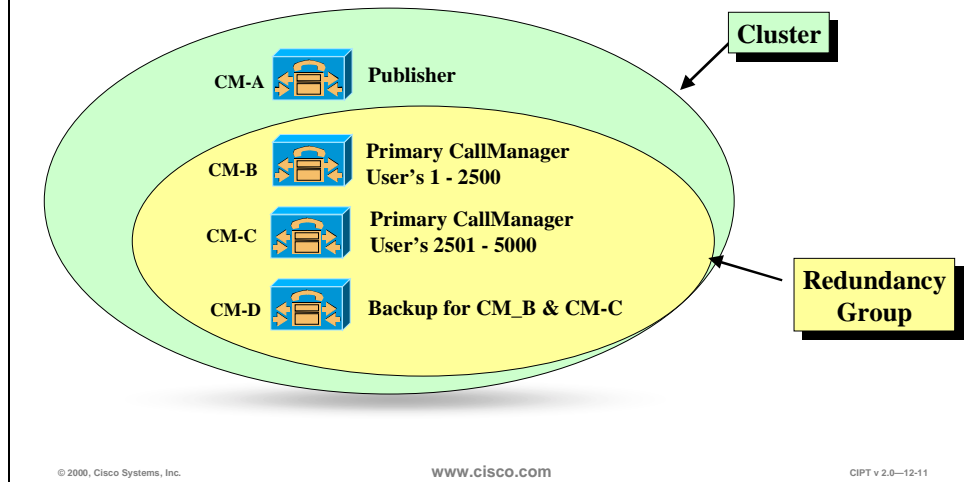

To support up to 5,000 users the recommendation is to use four Cisco CallManagers in one cluster. One Cisco CallManager is the publisher and tertiary Cisco CallManager for redundancy. Two Cisco CallManagers are the primary CallManagers for 2,500 users and both will use the fourth Cisco CallManager as the dedicated backup.

Should Glass House be on a machine by itself?

If you have three Cisco CallManagers, the Glass House should be by itself. The name of a machine should not change if SQL Server 7.0 is on it and one database should be in every island of survivability. There is no automated method for moving the Glass House to another machine.

Cluster Recommendations Up to 10,000 Users

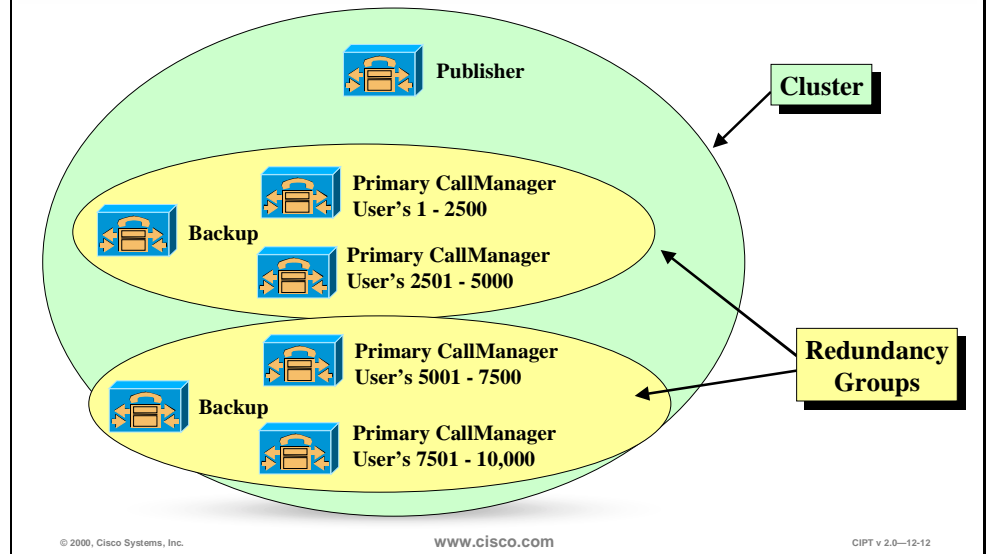

To support up to 10,000 users the recommendation is to use seven Cisco CallManagers in a cluster. One Cisco CallManager would be the publisher for database configurations. Two redundancy groups will be created each supporting up to 5,000 users. The redundancy groups have two active “primary” Cisco CallManagers and one dedicated backup. This model allows to scalability and reliability.

Guidelines

Device Type	Weight Per Session / Voice Channel	Session / DS0 Per Device	Cumulative Device Weight
IP Phone	1	1	1
Analog Gateway Ports	3	Varies	3 Per DS0
T1 Gateway	3	24	72 Per T1
E1 Gateway	3	30	90 Per E1
Transcoding Resource	3	Varies	3 Per Session
Conference Resource	3	Varies	3 Per Session
TAPI port	60	1	60
JTAPI Port	60	1	60

© 2000, Cisco Systems, Inc.

www.cisco.com

CIPT v 2.0—12-19

Many types of devices can register with a Cisco CallManager. These include IP phones, voice mail ports, TAPI devices, JTAPI devices, gateways and DSP resources such as transcoding and conferencing. Each of these resources will carry a different weight. The table above details the weight for each of the resource types. This is based upon the consumption of memory and CPU resources.

The total number of devices that can be registered or controlled by CallManager is platform dependent, and includes a maximum of 2500 IP phones. This is demonstrated in the table below. As additional platforms are added this table will be updated.

Platform Session Capabilities

Platform	
MCS 7835—PIII 750 with 1 GB memory	3000
MCS 7830—PIII 500 with 1 GB memory	3000
MCS 7822—PIII 500 with 512M memory	3000

Even if only IP phones are registered to a CallManager the limit for IP phones is a maximum of 2500. For each additional device added the total is decremented by the weight multiplied by the number of sessions or DS0 added. When this falls below 2500 for every integer below 2500, the number of IP Phones should be reduced accordingly this is shown below:

- Maximum devices per CM = 3000 (MCS 7830)
- Maximum IP phones per CM = 2500
- Actual IP phones = XXXX—installed resources with exception of IP phones: Not to exceed 2500

Redundancy

This section describes the concept of redundancy.

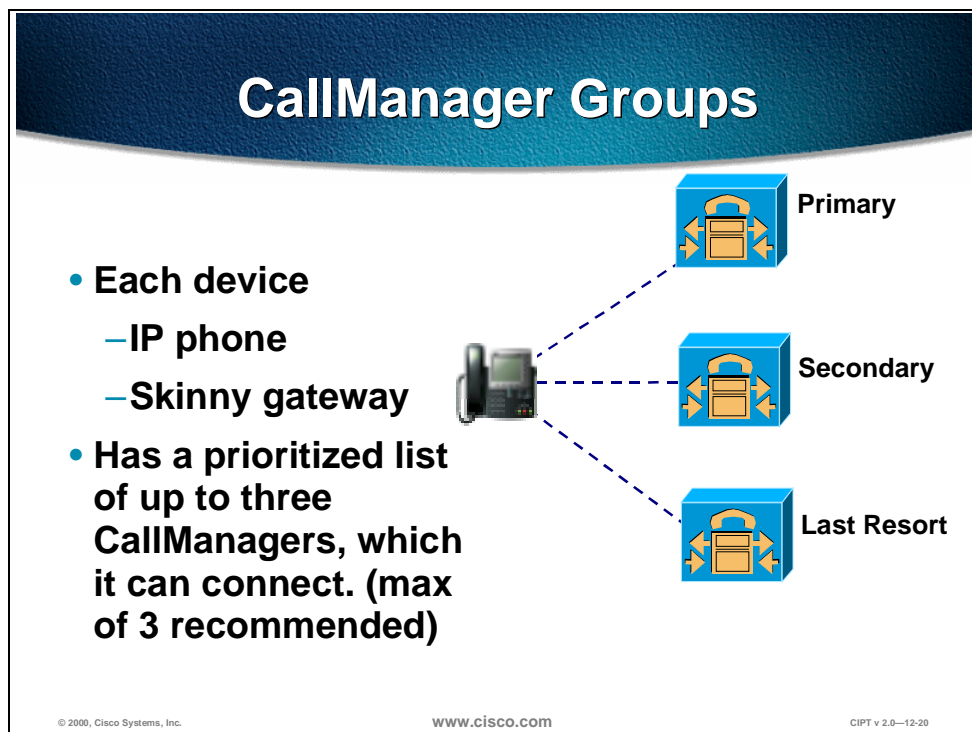

Peer-to-peer protocols such as H.323 facilitates resiliency by design. The figure above depicts this resiliency scheme for IP Phones.

Within a cluster each registered IP phone can be assigned a list of up to three CallManagers with which it can register for call processing. Shared resources such as gateways using the Skinny Gateway Protocol (SGP) are also capable of using this triple redundancy scheme. The Media Gateway Control Protocol (MGCP) also operates in a similar fashion providing spatial redundancy for call processing.

Each IP telephone maintains active TCP sessions with the primary and secondary configured CallManagers. This facilitates expedited fail-over in the event of failure of the primary CallManager. Upon restoration of the primary, the device reverts to the primary CallManager.

Redundancy is achieved by configuring CallManager groups. A CallManager group is a prioritized list of up to three CallManagers. Individual devices are then assigned to a CallManager group. A CallManager redundancy group is a subset of a cluster; all members of a redundancy group are also members of a cluster.

CallManager Redundancy Groups

In order to ensure that only a single CallManager is active at a time, all devices should be assigned to a single *CallManager redundancy group*. This CallManager redundancy group will consist of a prioritized list of up to three CallManagers. On a centralized call-processing cluster only a CallManager redundancy group is recommended this should be the default group. This is shown in the figure below. In this example a CallManager redundancy group of three exists with A as the primary, B the secondary, and C the tertiary CallManager.

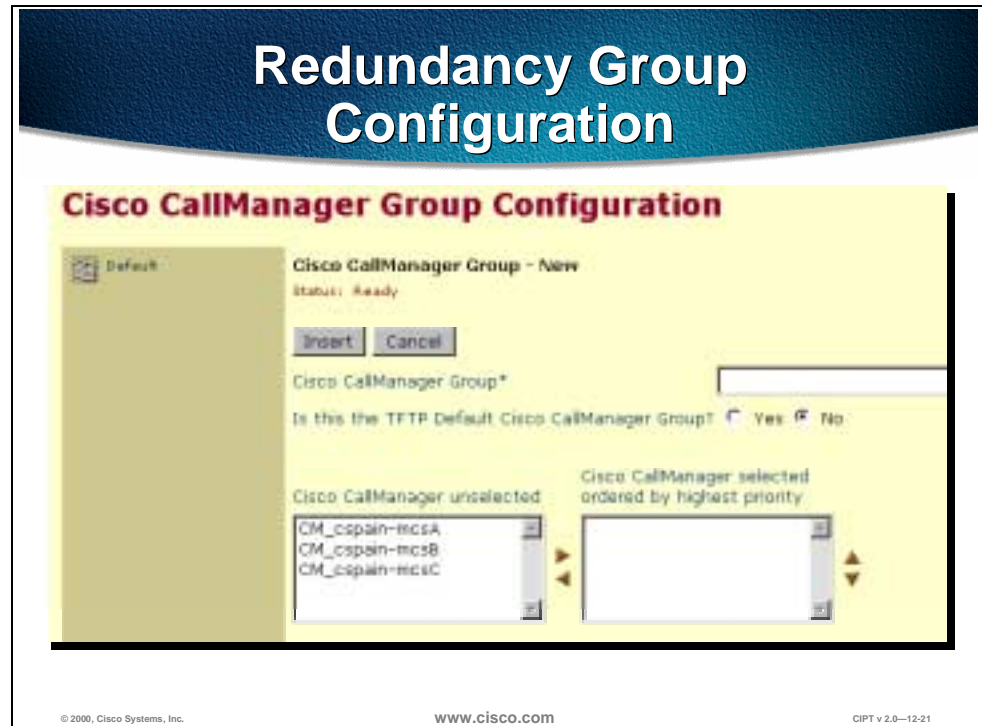

Typically, centralized call processing clusters of two CallManagers are deployed. Where an additional level of redundancy is required, a tertiary CallManager can be added. It is recommended that the publisher of the database is the secondary CallManager in the case of a two-CallManager system and the tertiary in the three-CallManager case.

N+ 1 Example

Three devices are homed to SanJoseD. All nodes in the network are connected and are relaying route and registration information to each other.

SanJoseD powered off. The devices lose their connection to CM SanJoseD.

The devices re-home to other CallManagers, which then replicate new route and registration information to each other.

Since device operation is identical, users may not notice that anything happened.

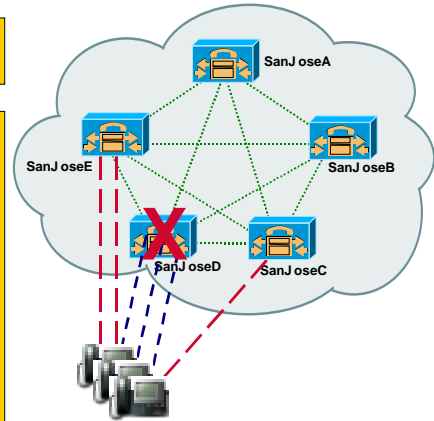

© 2000, Cisco Systems, Inc.

www.cisco.com

CIPT v 2.0—12-22

The figure above shows how N+1 redundancy works with Cisco CallManagers and attached devices. The following is the process of how N+1 redundancy works:

- Devices are homed into a Cisco CallManager (San JoseD). All nodes in the network are connected and are relaying route and registration information to each other.
- San JoseD is powered off. The devices lose their connection to Cisco CallManager San JoseD.
- The devices re-home to other Cisco CallManagers, which then replicate new route and registration information to each other.
- Since device operation is identical, users may not notice that anything happened.

Group Issues

- **CallManager groups are configured manually**
- **Devices are assigned to a CallManager group manually**
- **No easy way to identify what devices are members of what CallManager group**
- **No easy way to ensure IP phones are evenly distributed—No *reshuffle* command**

© 2000, Cisco Systems, Inc.

www.cisco.com

CIPT v 2.0—12-23

Some of the issues with Cisco CallManager groups are that all groups are configured manually and the devices are assigned to a group manually. There is no easy way to identify which devices (IP phones, gateways, and so forth) are members of which Cisco CallManager group and ensure the IP phones are evenly distributed.

There is no **reshuffle** command to have IP phones evenly registered to active Cisco CallManagers and members of Cisco CallManager groups.

The impact of these issues is that there is a limited number of allocated resources to handle these activities and job functions.

Device Pools

Device Pool Attributes

3 required fields

- **Region**
- **Time Zone**
- **CallManager redundancy group**

Calling search space is optional

© 2000, Cisco Systems, Inc. www.cisco.com CIPT v 2.0—12-27

Device pools are used to scale and simplify the distribution of CallManager redundancy groups. A device pool allows the following three primary attributes to be assigned globally to a device:

- **Region**—Regions are required only if multiple voice codecs are used within an enterprise. Regions define the voice codecs used within and between regions.
- **Date/Time Group**—Specifies date and time zone for a device.
- **CallManager redundancy group**—Specifies a list of up to three CallManagers, which can be used for call processing in a prioritized list.

In the above example, the same CallManager will be used. However, it is now possible to specify inter region communication codec requirements as follows:

- **Intra-branch communication uses G.711.**
- **Inter-branch communication uses G.729 across the wide area network (WAN).**
- **All calls to the G.711 region use G.711. This is required when accessing a uOne voice mail system, for example.**

Device Pools

Number of device pools required will depend upon deployment model used:

- **Campus (No WAN)**
 - Regions are not required—all calls G.711
 - CallManager redundancy groups are required based on cluster size
 - **Device pools = CallManager redundancy groups**
- **Centralized call processing**
 - Regions only required if multiple codecs used—Try to avoid this
 - Single CallManager redundancy group
 - **Device pools = codec * Locations**
- **Distributed call processing**
 - Regions only required if multiple codecs used—Typical
 - CallManager redundancy groups are required based on cluster size
 - **Device pools = codec * CallManager redundancy groups**

© 2000, Cisco Systems, Inc.

www.cisco.com

CIPT v 2.0—12-28

Typically, the following will be true with respect to the configuration of device pools. The exact model of clustering and device pools used will be driven by the deployment model:

- Single site cluster no WAN voice interconnectivity—Device pools will be configured only based on CallManager redundancy groups. Typically a maximum of four device pools assuming five CallManagers A, B, C, D and E with the following redundancy groups AE, BE, CE, DE. The use of regions in this scenario is not required as all calls are G.711.
- Multi-site WAN distributed call processing
 - Device pools will be configured as above but also with the additional complexity of regions for codec selection. Each cluster could potentially have a G.711 and G.729 region per CallManager redundancy group.
 - Total device pools = regions x CallManager redundancy groups.
- Multi-Site WAN centralized call processing
 - In this case only a single CallManager redundancy group exists. However, a G.711 and G.729 region will be required per location to permit intra-branch calls to be placed as G.711 and inter-branch calls to be placed as G.729, for example.
 - Total device pools = number of sites X regions.

Device Pool Configuration

Device Pool Configuration

Device Pool: Branch 1 G711 and G729 Devices
Status: Updates completed

New Copy Update Delete Restart Devices Cancel

Device Pool Name* branch 1 G711 and G729 Devices
Region* IPWAN G.729
Date/Time Group* CMLocal
Cisco CallManager Group* Default
Calling Search Space for Auto-Registration < None >
* indicates required item

© 2000, Cisco Systems, Inc.

www.cisco.com

CIPT v 2.0—12-29

In the Cisco CallManager Administration there is the Device Pool Configuration page that is used to configure device pools.

To begin device pool configuration of a device:

1. Select a **device** from the left column or select **New**.
2. Select a **Region** the device is to belong to.
3. Select a **Date/Time Group**.
4. Select the **Cisco CallManager** Group for the device
5. Select the **Calling Search Space for Auto-Registration**.

Select **Update** or **Restart Devices**.

Campus Networking Cluster Guidelines

This section describes campus networking cluster guidelines.

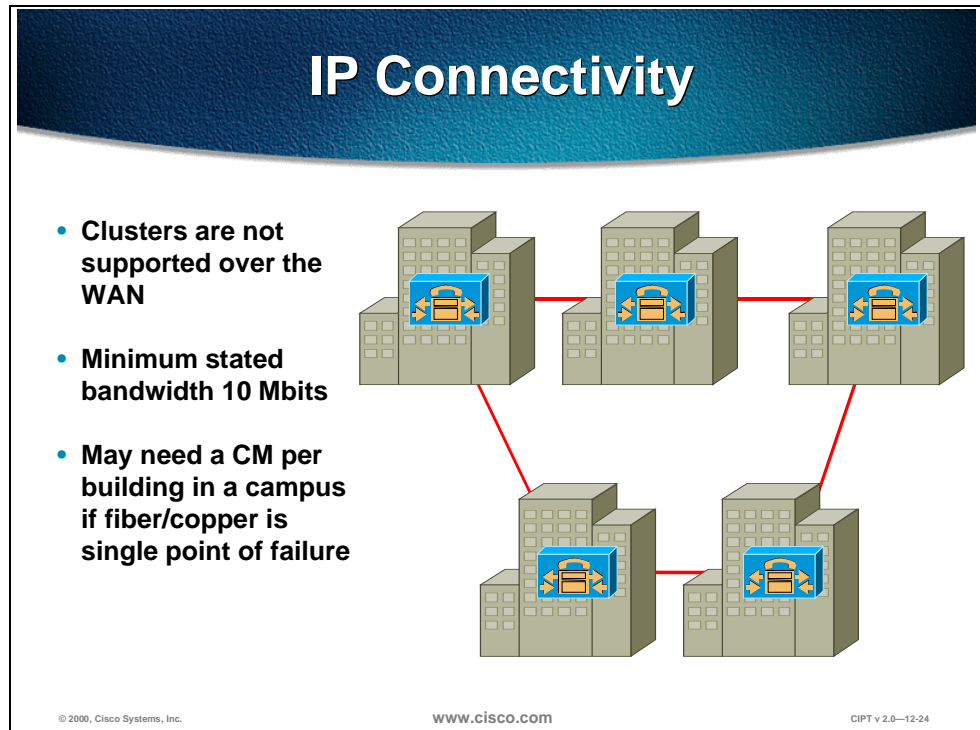

All members of a CallManager cluster are required to be inter-connected via a local area network (LAN). CallManager clusters are not supported over a wide area network (WAN) with CallManager release 3.0. The minimum bandwidth used to interconnect members of a cluster is 10Mbps. The following design constraint considerations should be followed when configuring a campus IP telephony network:

- There is a maximum of 6 CallManagers per cluster with release 3.0.
- There is a maximum of 10,000 devices registered.
- There is a maximum of 2500 devices registered devices per CallManager.
- This is inclusive of the number of devices registered under failure conditions.
- Switched infrastructure to the desktop. Shared media is not supported.

Within a switched campus infrastructure adequate bandwidth can generally be assumed. This relies upon appropriate design and capacity planning within the campus in addition to the establishment of a trust boundary and the required queuing. This was covered in the Campus Infrastructure chapter. Consequently there is no requirement for admission control within a campus cluster.

Server Placement

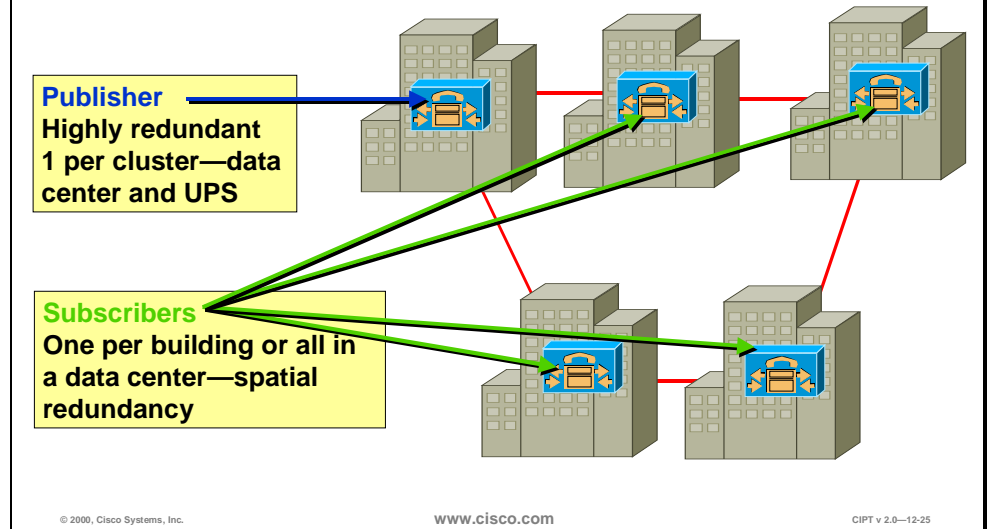

CallManager servers should be distributed within the campus to provide spatial redundancy and resiliency. Many metropolitan sites and campus buildings will potentially have only a single conduit providing IP connectivity to other members of the cluster. In this case it is imperative that should IP connectivity for any reason fail, local call processing is maintained via a local server. In a similar fashion gateway resources for PSTN access should also be strategically placed to provide the highest possible availability.

The publisher is a read-write database and the subscriber is a read-only database.

Additional Telephony Resources

**Gateways
Transcoding
application and
Conference**

**Transcoding
application and
conference are not
shared resources.**

**Hence each
CallManager will
require dedicated
MTP and transcoding
resources**

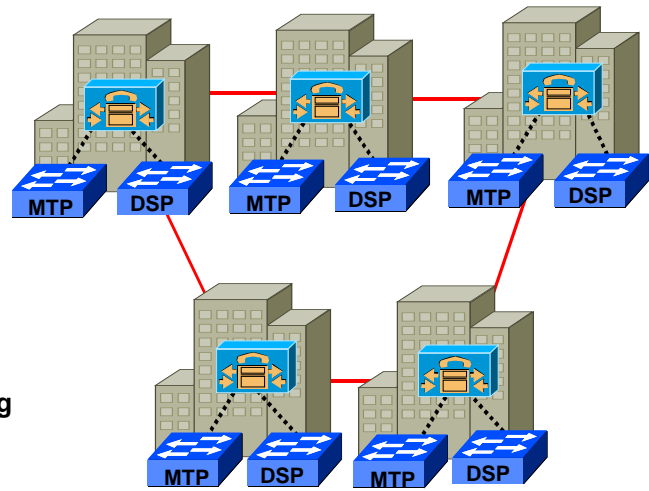

© 2000, Cisco Systems, Inc.

www.cisco.com

CIPT v 2.0—12-26

In the figure above, five buildings/sites exist and at each building/site a Cisco CallManager is placed to provide call processing. This ensures that in the event of a failure, local call processing is possible in each building/site. In cases where diverse routing of fiber facilitates negates the requirement for a local call manager all call processing could be located in a data center or centers.

Resources such as the transcoding application used for transcoding and the conferencing DSP are not shared resources and must be provisioned per Cisco CallManager. Once again, where fault tolerance is required, these resources require duplication and spatial redundancy is recommended. This can be achieved by positioning these resources in strategically placed multi-layer switches.

Intra and Inter-Cluster Communication

This section describes intra-cluster and inter-cluster communication.

The diagram is titled "Feature Transparency" in a blue header. It contains two yellow boxes with black borders. The left box is titled "Inter and intra-cluster" and lists six features: Basic call setup, G.711 and G.729 calls, Multiparty conference, Call transfer, Hold, and Calling line identity. The right box is titled "Intra-cluster only" and lists two features: Calling party name and Call park. At the bottom of the diagram, there is a copyright notice for Cisco Systems, Inc., the website www.cisco.com, and a reference to CIPT v 2.0-12-30.

The primary benefit of a Cisco CallManager cluster is the distributed architecture that provides spatial redundancy, resiliency, availability, and survivability for call processing. In addition, within a cluster all features are transparently supported across all devices within that cluster. This enables a distributed PBX to now span an entire campus or high-speed metropolitan area network with full features.

Inter-cluster communication is provided via H.323. This permits a subset of the features to be extended between clusters. Those features currently available for inter-cluster are detailed below:

- Basic call setup (signaling, digit collection and analysis, media)
- G.711 and G.729 calls (codec selection and detection)
- Multiparty conference
- Call transfer
- Hold
- Calling line identity

The features available for intra-cluster, but not inter-cluster, include the following:

- Calling party name
- Call park

Inter-Cluster Communication

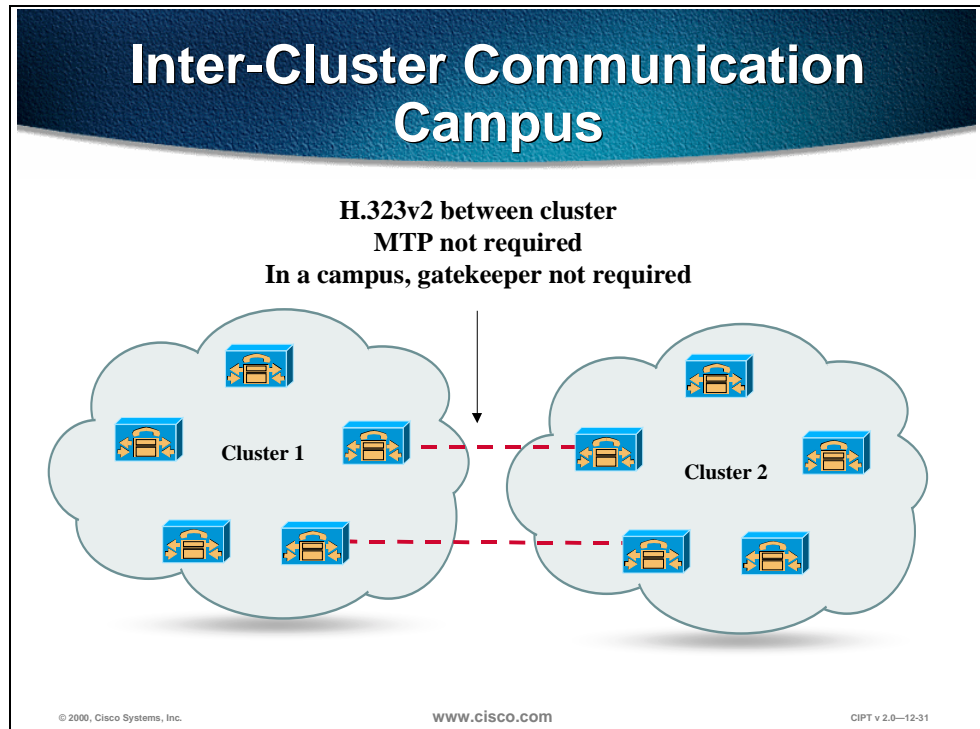

Where the requirement exists for a campus network that exceeds 10,000 users, additional clusters are required. The required number of CallManagers is greater than five additional CallManagers.

Communication between clusters is achieved using standards based H.323 signaling. With a large campus or metropolitan area network where once again bandwidth is over provisioned and under-subscribed, a method of inter-cluster call admission control is not required. The figure above demonstrates this connectivity between clusters within a local area environment.

In the above diagram the dotted lines represent the configured H.323 inter-cluster links. These are configured in pairs to provide redundancy in the event of loss of IP connectivity to any member of the cluster. The recommendation, however, is to limit inter-cluster configuration to two peers as this in the majority of deployments will provide adequate resiliency.

Unlike CallManager 2.4, the use of a media termination point to allow supplementary services for H.323 devices is not required.

CallManager 3.0 uses the empty capabilities set of H.323v2 that facilitates the opening and closing of logical channels between H.323 devices. CallManager clusters and IOS gateways running version 12.0(7)T or greater use logical channels to provide functionality for supplementary services.

Inter-Cluster Communication WAN

H.323 gatekeeper for inter-cluster call admission control
Limit = 100 registered devices
Non redundant = 10 clusters—redundant = 5 clusters

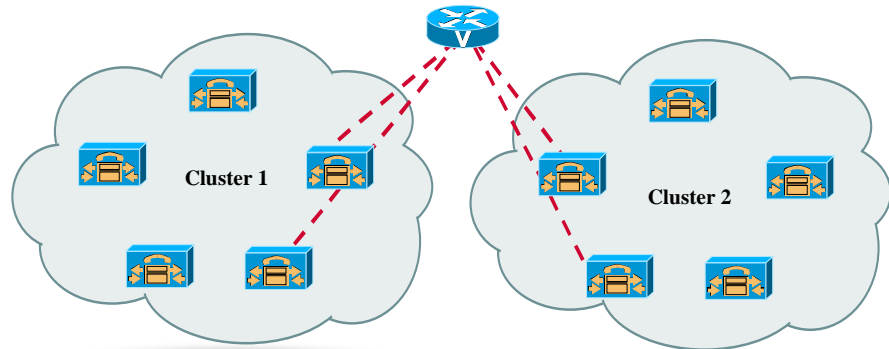

© 2000, Cisco Systems, Inc.

www.cisco.com

CIPT v 2.0—12-32

Where clusters are interconnected over a WAN there is a bottleneck for congestion between clusters, and the network should be engineered to accommodate the required volume of voice traffic. In such cases a method of providing call admission control (CAC) is required. Because clusters are interconnected using H.323, an IOS gateway can be added to facilitate this gatekeeper function. Each cluster can be designated as a zone with a maximum configured bandwidth for voice calls.

CallManager requests 128 kbps of bandwidth per inter-cluster call when using a gatekeeper, irrespective of the bandwidth used by the codec. In general, we recommend configuring a single codec for calls that traverse the WAN. In cases where multiple codecs are used, the bandwidth consumed per call should be assumed to be the greater value in all cases. This over-provisioning of bandwidth ensures that all calls are of high quality. Unused bandwidth is available for other traffic classes.

Using gatekeepers provides both inbound and outbound call admission control. A maximum of 10 CallManagers can register with a gatekeeper (five if two CallManagers from each cluster register with the gatekeeper). This method of call admission control is restricted to a single active gatekeeper per network. Redundancy can be achieved using the Hot Standby Routing Protocol (HSRP) between two gatekeepers.

Gatekeeper based call admission control is a policy based scheme; it requires static configuration of available resources and is not network topology aware. It is, therefore, necessary to restrict gatekeeper based call admission control schemes to hub and spoke topologies with the redundant gatekeeper or gatekeepers (using HSRP) located at the hub. The WAN must be provisioned accordingly, and the voice priority queue must be dimensioned to support all admitted calls.

Recommended Bandwidth Configuration

Inter-Cluster Calls Using G.729

Number of Inter-Cluster Calls	Bandwidth Required per Call		Bandwidth Required on WAN Links (LLQ/CBWFQ ¹)		Bandwidth Configured on Gatekeeper	
	Without cRTP ²	With cRTP	Without cRTP	With cRTP	Without cRTP	With cRTP
2	24 Kbps	12 Kbps	48 Kbps	24 Kbps	256 Kbps	256 Kbps
5	24 Kbps	12 Kbps	120 Kbps	60 Kbps	640 Kbps	640 Kbps
10	24 Kbps	12 Kbps	240 Kbps	120 Kbps	1.280 Mbps	1.280 Mbps

1. Low latency queuing/class based weighted fair queuing
2. Compressed Real-time Transport Protocol

© 2000, Cisco Systems, Inc.

www.cisco.com

CIPT v 2.0—12-33

Recommended Bandwidth Configuration

Inter-Cluster Calls Using G.711

Number of Inter-Cluster Calls	Bandwidth Required per Call	Bandwidth Required on WAN Links (LLQ/CBWFQ)	Bandwidth Configured on Gatekeeper
2	80 Kbps	160 Kbps	256 Kbps
5	80 Kbps	400 Kbps	640 Kbps
10	80 Kbps	800 Kbps	1.280 Mbps

© 2000, Cisco Systems, Inc.

www.cisco.com

CIPT v 2.0—12-34

The tables above provide recommendations for bandwidth configuration for inter-cluster calls.

Use these tables to ensure enough bandwidth between clusters to ensure quality voice.

Concerns About the WAN

CallManager 2.4 introduced the concept of locations to limit bandwidth to a remote site that had no CallManager.

Does this work in CM 3.0? Well, not exactly.

CallManager(s)

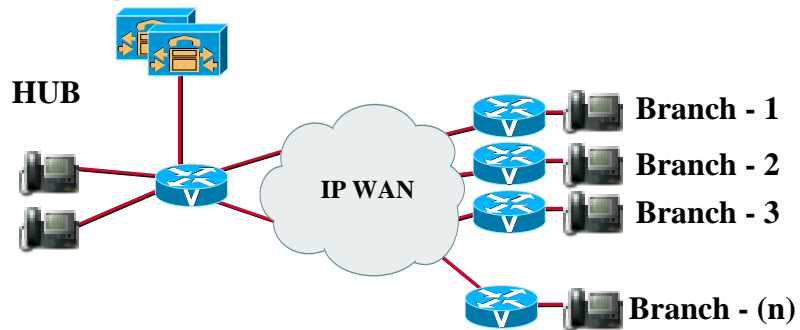

© 2000, Cisco Systems, Inc.

www.cisco.com

CIPT v 2.0—12-35

As stated earlier, CallManagers within a cluster must be interconnected over a local area link and cannot be interconnected over links of less than 10 Mbps. In CallManager 2.4, the concept of locations-based call admission control enabled provisioning of small branch and telecommuter solutions where remote call processing was acceptable.

In the figure, call processing is maintained only at the central site; the devices at the branch are configured as belonging to a location. For example, branch 1 might have 12 IP phones, each configured to be in the location Branch 1. CallManager is then able to track the used and unused bandwidth per location and admit or deny WAN calls accordingly.

Locations and Clustering

**For locations to work, all devices must register to a single CM.
Locations only works with a cluster of two (primary and backup).**

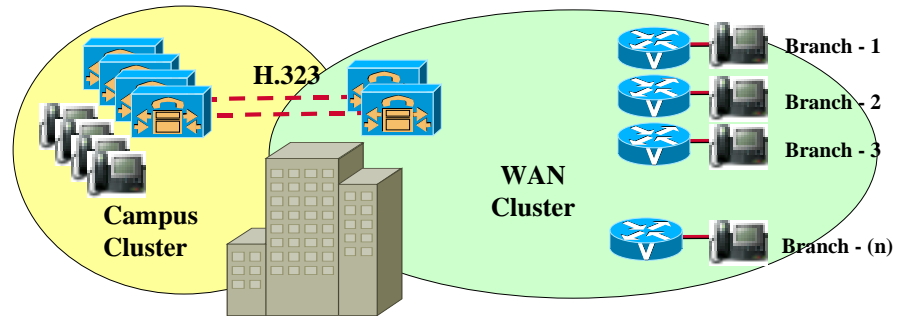

© 2000, Cisco Systems, Inc.

www.cisco.com

CIPT v 2.0—12-36

With CallManager 3.0, a dedicated CallManager cluster is required with a single active CallManager to maintain call state and call admission control.

The maximum number of users per CallManager is 2500.

To ensure that all only a single CallManager is active at a time, all devices should be assigned to a single CallManager redundancy group. This CallManager redundancy group consists of a prioritized list of up to three CallManagers. On a centralized call processing cluster, only a single CallManager redundancy group is recommended; this should be the default group.

SQL Publisher/Subscriber Relationship Within a Cluster

This section describes the SQL publisher and subscriber relationship within a cluster.

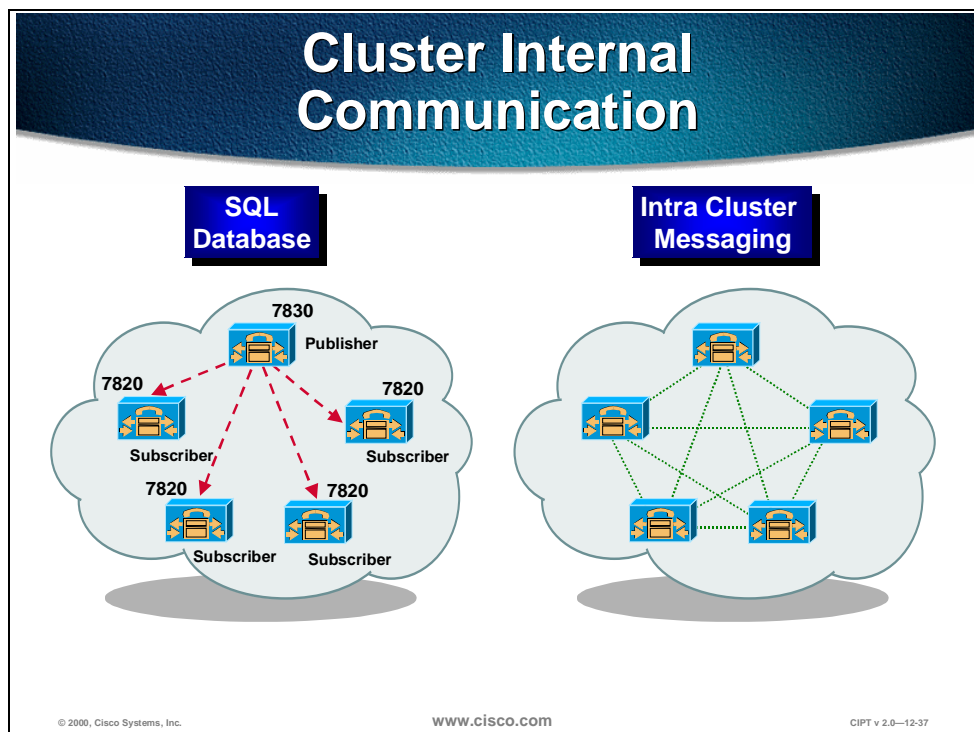

There are two primary intra-cluster communications. The first of these is the database component packets that contain all of the device configuration information. The Database used is SQL 7.0; configuration is stored and modified on the Glasshouse database and replicated to all other members of the cluster. The Glasshouse database is the publisher upon which all changes are made, and those changes are replicated to the subscriber databases. This ensures that the configuration is consistent across the members of the cluster as well as facilitating spatial redundancy of the database.

The second intra-cluster communication is the propagation and replication of run-time data such as IP phone registration and the registration of gateways and DSP resources. This information is shared across all members of a cluster and assures the optimum routing of calls between members of the cluster and associated gateways.

This distributed communication between processes is unique to a distributed system with a converged IP infrastructure.

Internal Communication

- **Database used is SQL 7.0 Standard Edition + SP 2**
 - 1 publisher per cluster
 - Remaining CMs are subscribers
 - (N -1) TCP connections
 - All configuration changes made on publisher
- **CallManager (real time data)**
 - Fully meshed.
 - (N * (N - 1)) TCP connections
 - 6 CM' s = (6 x 5) = 30 connections
 - 25 CM' s = (25 x 24) = 600 connections
 - Real time data—phone and gateway registrations, and so forth

© 2000, Cisco Systems, Inc.

www.cisco.com

CIPT v 2.0—12-38

The Structured Query Language (SQL) 7.0 Standard Edition plus Service Pack 2 is used to communicate internally in the Cisco CallManager cluster. There can only be one publisher per cluster, which makes the remaining Cisco CallManagers subscribers. All the configuration changes are made on the publisher. The following is a formula to calculate the amount of TCP connections within a cluster: (N -1) TCP connections (25CMs = 24 connections).

The Cisco CallManager cluster is fully meshed and communicates using real time data. In a fully meshed environment the real time data is used to communicate during phone/gateway registrations. The following is a formula to calculate the amount of TCP connections within a fully meshed cluster: (N * (N - 1)) TCP connections (6 CMs = (6 x 5) = 30 connections; 25 CMs = (25 x 24) = 600 connections).

Replication of Database

- Transactional process
- Immediately unless the link is down
- Transaction log replicates when possible

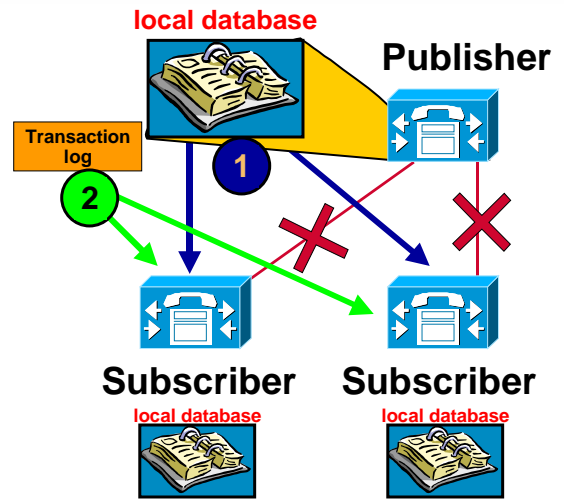

© 2000, Cisco Systems, Inc.

www.cisco.com

CIPT v 2.0—12-39

The replication of the database within a Cisco CallManager cluster happens in the following way:

- Changes made to the publisher's database are replicated out via transactional process.
- Changes happen immediately unless the link is down .
- If the link is down, SQL keeps a transaction log and replicates the data when possible.
- The subscriber database is "read-only."

The Relationship

- The publishing (primary) reads its own database
- The subscribing servers look to the primary's database for their information
- In the event of a failure, the subscribing servers read local copy of database

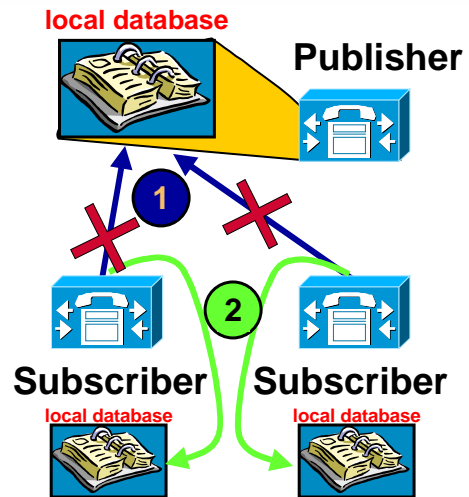

© 2000, Cisco Systems, Inc.

www.cisco.com

CIPT v 2.0—12-00

The relationship between Cisco CallManager publisher and subscriber databases within a cluster happens in the following way:

- The publishing (primary) database reads its own local database for information.
- The subscribing (or attached CMs in the same cluster) servers look to the primary database for their information

In the event of a failure, they will read their local copy of the database.

Station Registration

This section describes station registration.

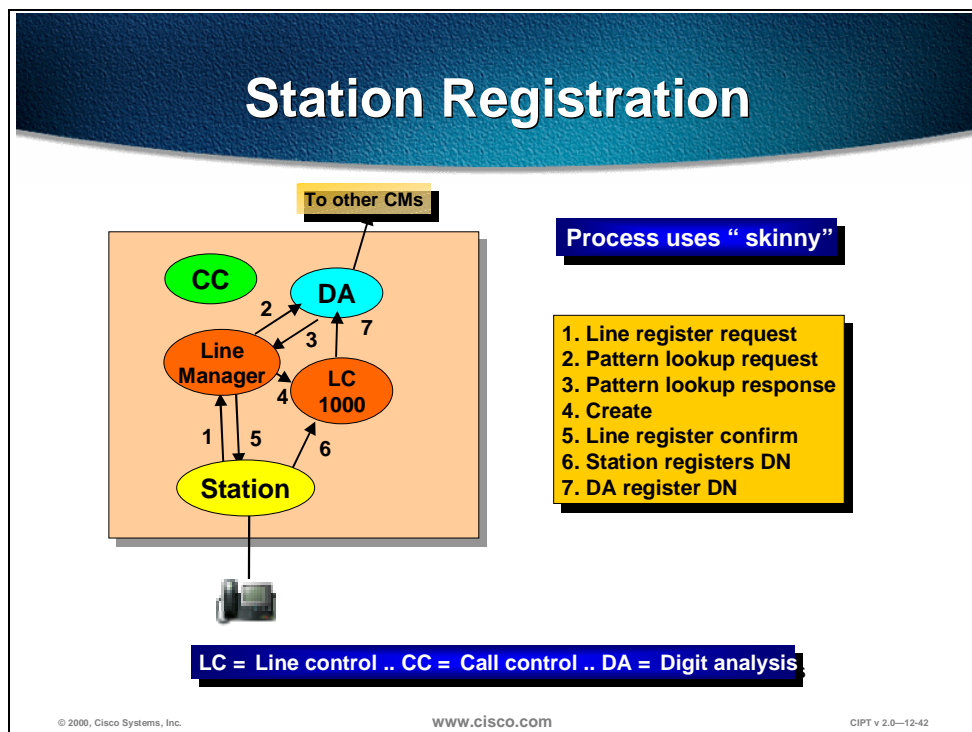

The figure above illustrates the internal process used by a Cisco CallManager when a station (IP phone or gateway) registers. The station is plugged into the network and a line register request is sent to the line manager:

- The line manager does a pattern lookup request in digit analysis (DA) to see which directory numbers are available and then receives a pattern lookup response from the digit analysis.
- The line manager then creates a directory number (DN) in the line control (LC) and then sends a line register confirmation to the station.
- The station then registers the directory number with line control and then line control registers the directory number with digit analysis.

Station Registration Multiline Operation

- **Shared line appearances operate through forwarded registrations**
- **When a station registers with the CallManager, the CallManager determines if any other CallManagers are managing one of its lines (DNs)**
- **If so, the CallManager maintains the station registration but forwards call processing messages to the other node**

© 2000, Cisco Systems, Inc.

www.cisco.com

CIPT v 2.0—12-43

If stations share line appearances, those shared line appearances will operate through forwarded registration.

If a station registers with the a Cisco CallManager (A) and the Cisco CallManager (A) determines that other Cisco CallManagers (X) are managing one of its directory numbers, the Cisco CallManager (A) will maintain the station registration and forward call processing messages to the other Cisco CallManager (X) managing the directory number.

The next figure illustrates how the above description of multi-line operation occurs internally on the Cisco CallManagers.

Remote Station Registration

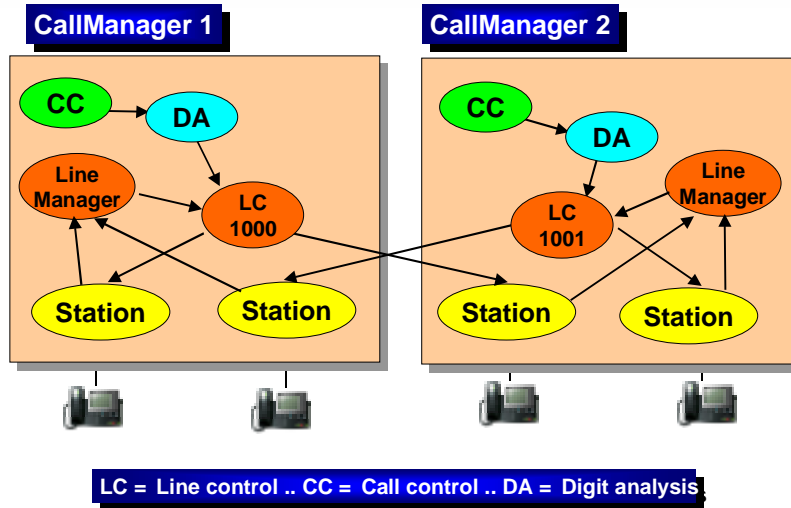

© 2000, Cisco Systems, Inc.

www.cisco.com

CIPT v 2.0—12-44

The figure above illustrates the communication when remote registration is processing signaling between two or more Cisco CallManagers. Internally within the Cisco CallManager the station communicates with the line manager and the line control communicates with the station.

With remote station registration the station registers to its own line manager, and the line control comes in remotely. The station's call control and digit analysis come from the Cisco CallManager that the station is registered with through the line manager, but the line control comes remotely from another Cisco CallManager with the station's directory number.

Station Registration Sequence

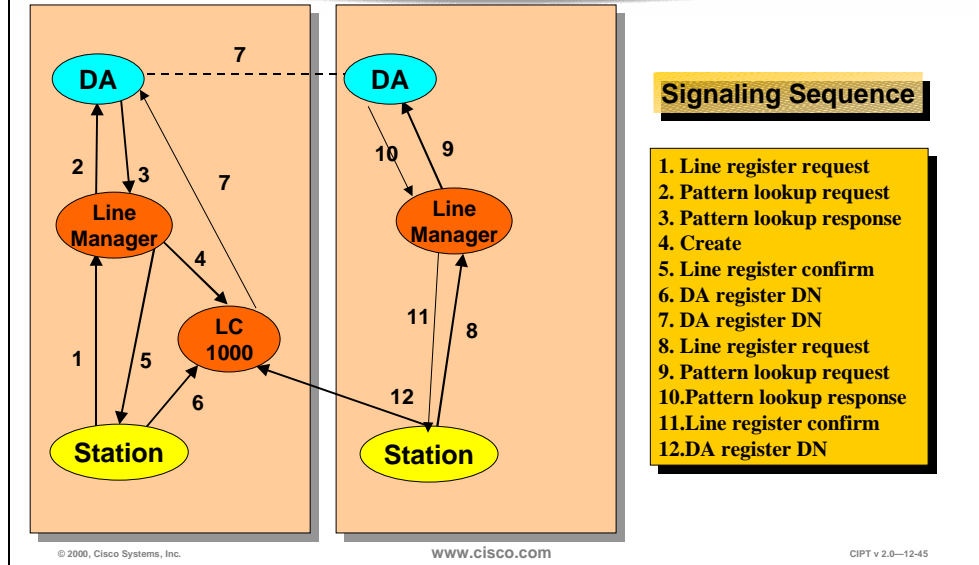

When a station registers within a clustered environment the signaling sequence is expanded to check with the other Cisco CallManagers in the cluster for duplication of directory numbers.

The figure represents all of the components of a Cisco CallManager and has a local station and remote station registering with the same directory number provided by line control. The remote station will go to the local Cisco CallManager for call control and will go to the remote Cisco CallManager for directory number and line control.

Gateway Registration

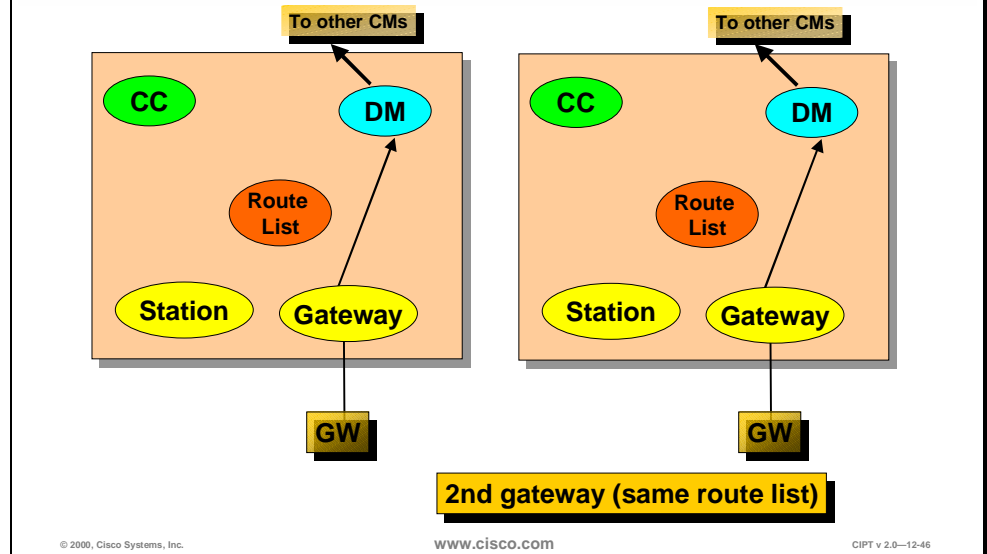

Gateway devices register with the CallManager internally. The Cisco CallManager goes through the following process:

- The gateway device registers with the device manager (DM).
- The route list information is propagated to all Cisco CallManagers in the Cluster.
- The gateway devices are high traffic devices hence *each Cisco CallManager* maintains control of calls that are originated locally.

There can be a second gateway that registers with a different Cisco CallManager with the same route list.

Gateway Call

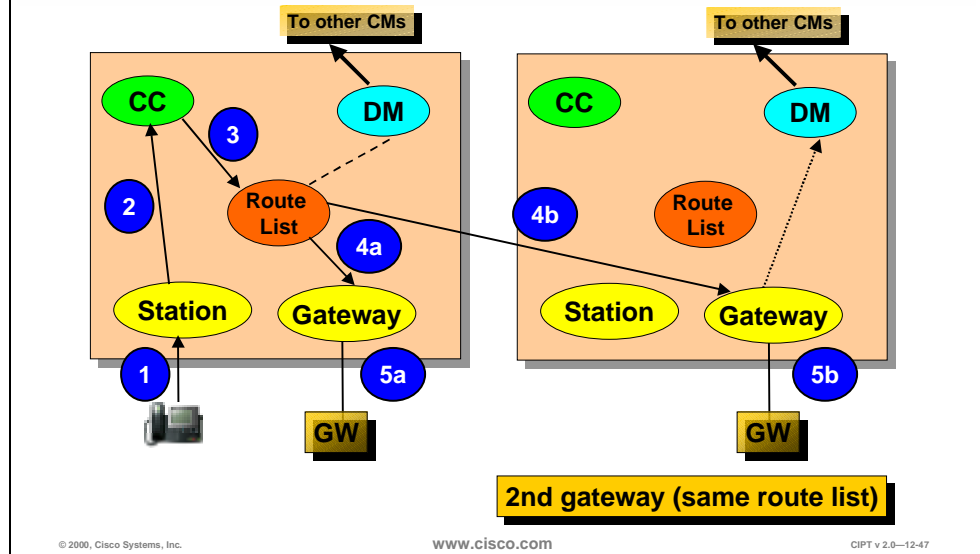

Through intra-cluster communication, a call that uses a gateway can use either gateway with the same route list. Call control is done in the Cisco CallManager that the station is registered to. The gateway selection is controlled by the Cisco CallManager providing the call control.

The following is the process used in the figure above:

1. Digits from the are dialed and go the station.
2. The station sends those digits to Call Control.
3. Call control matches those digits to the route list.
4. The route list uses either gateway assigned to the same route list.
5. Digits are passed to the gateway and completes the call.

Device Recovery

The device recovery process is demonstrated in the next three figures.

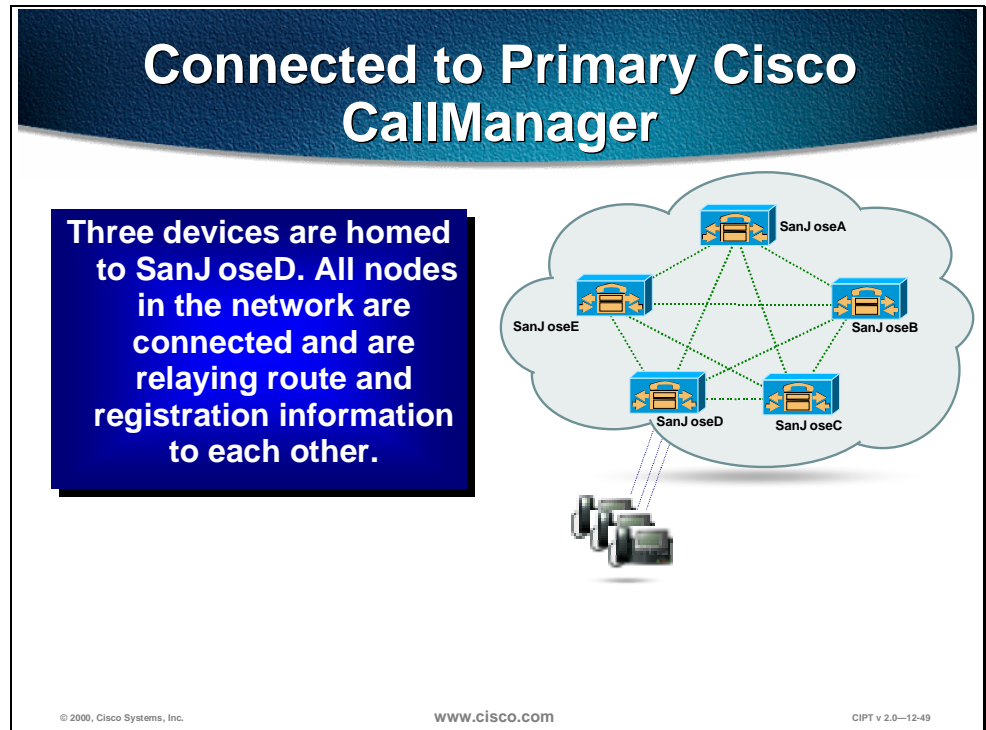

Each Cisco IP telephony device has a primary Cisco CallManager. In the figure above, three devices are homed (registered) to SanJoseD. All the nodes in the network are connected and are relaying route and registration information to each other using TCP or skinny.

Primary Cisco CallManager Shutdown

The devices lose their connection to CM SanJoseD.

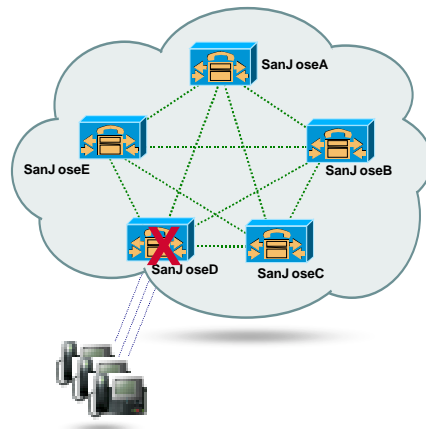

© 2000, Cisco Systems, Inc.

www.cisco.com

CIPT v 2.0—12-50

If the primary Cisco CallManager (SanJoseD) shuts down the devices homed (registered) to that Cisco CallManager lose their connection. The devices realize their primary Cisco CallManager is no longer there when they send their TCP keep alive message and get no TCP acknowledgement.

Re-home to Secondary Cisco CallManagers

Then replicate new route and registration information to each other.

The devices experience only a brief outage during rehoming

- Calls in progress are maintained if between two phones on failed CM.
- Gateway calls are dropped (currently)

Since device operation is identical, users may not notice that anything happened.

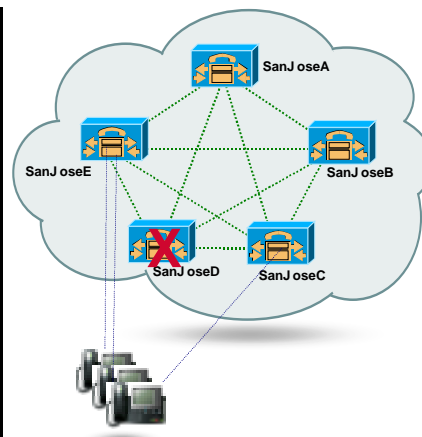

© 2000, Cisco Systems, Inc.

www.cisco.com

CIPT v 2.0—12-51

While the devices were still registered to the primary Cisco CallManager, TCP messages were still being sent to the secondary. The devices now home to the secondary Cisco CallManagers. Each device can have separate secondary Cisco CallManagers.

The devices experience a brief outage during re-homing. If a call between two phones on the same Cisco CallManager is in progress when this happens, the call will be maintained. When the calls are terminated and the phones are *on-hook*, the phones will then TCP to the primary, get no acknowledgement, and then re-home to the secondary Cisco CallManager.

However, if the call is across multiple Cisco CallManagers or gateways, the calls will be dropped.

Written Exercise 1: Cisco CallManager Clusters

Complete the following exercise to practice what you learned in this chapter.

Objective

In this exercise, you will complete the following tasks; identify the characteristics of a cluster and define the servers and groups in a cluster.

Tasks: Identify the characteristics of a Cisco CallManager Cluster

Given what you know about Cisco CallManager Clusters, identify and define the characteristics of the cluster in the figure below with the correct information. Use a dotted or dashed circle to identify the cluster. Use a solid circle to identify the Redundancy Groups and fill in the boxes with the correct information.

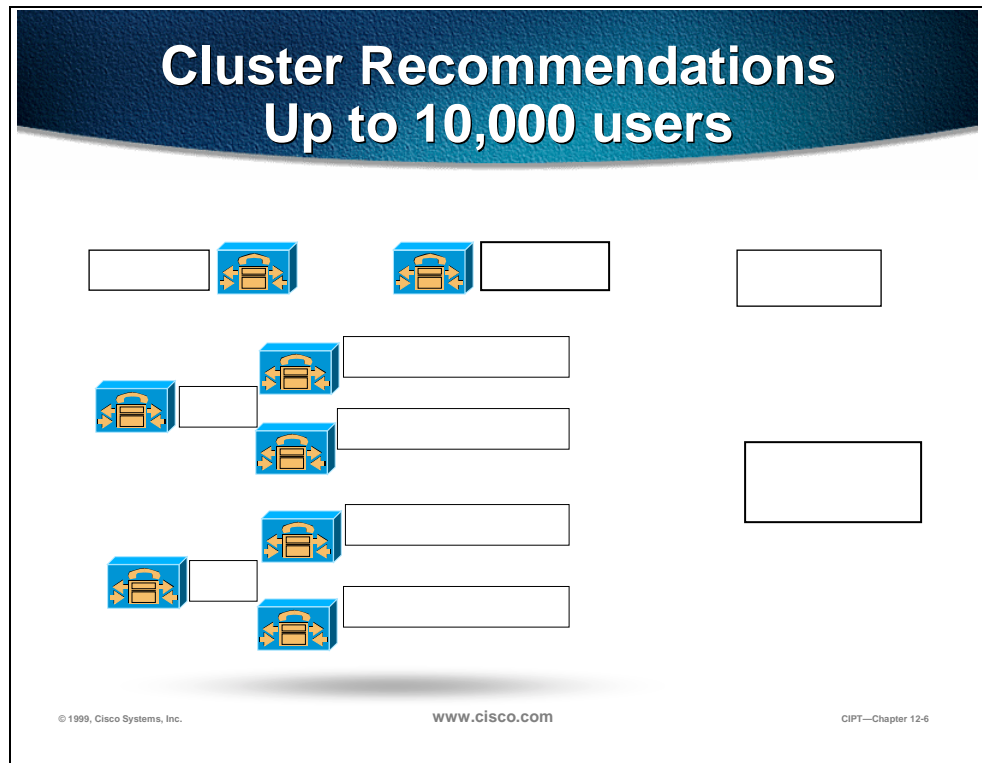

1. TFTP
2. Publisher
3. Cluster
4. CallManager Redundancy Group
5. Backup
6. Primary Cisco CallManager 1—2,500 users
7. Primary Cisco CallManager 2,501—5,000 Users

8. Primary Cisco CallManager 5,001—7,500 Users
9. Primary Cisco CallManager 7,501—10,000 Users

Completion Criteria

You have completed the exercise when you have circled the cluster and redundancy group and identified the clustered components.

Summary

This section summarizes the concepts you learned in this chapter.

Summary

- **Clustering offers many scalable options that can handle a maximum of 10,000 users per cluster.**
- **All changes to the database need to be made in the publisher. The subscribers will check with the publisher to get updates if there are any.**
- **N + 1 redundancy for Cisco IP telephony devices are configured and each device can have a primary, secondary, and tertiary Cisco CallManager**

© 2000, Cisco Systems, Inc. www.cisco.com CIPT v 2.0—12-52

Cisco CallManager clustering offers a variety of scalable solutions. Each cluster can handle a maximum of 10,000 users that is done with a maximum of 2,500 users per CallManager and six CallManagers per cluster.

In a Cisco CallManager cluster the database relationship is a SQL publisher/subscriber relationship. All changes to the database need to be made in the publisher and the subscribers will check with the publisher to get updates if there are any.

N + 1 redundancy for Cisco IP telephony devices are configured and each device can have a primary, secondary, and tertiary Cisco CallManager.

Review Questions

Answer the following questions.

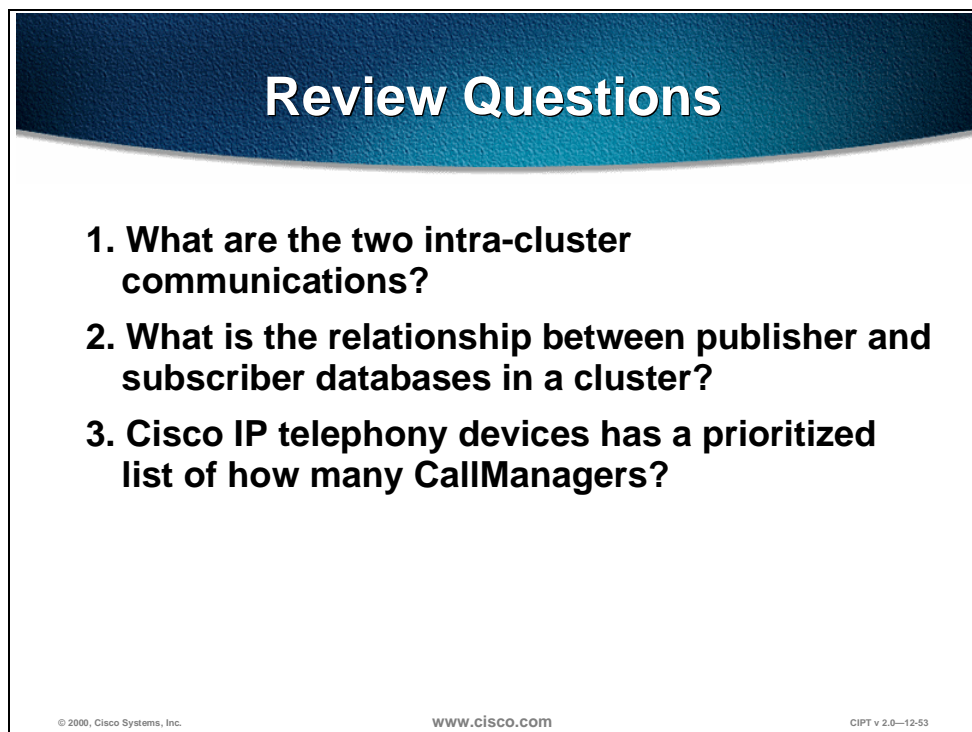
A slide graphic with a dark blue header containing the text "Review Questions" in white. Below the header, three numbered questions are listed in bold black text. At the bottom of the slide, there is small text: "© 2000, Cisco Systems, Inc.", "www.cisco.com", and "CIPT v 2.0—12-53".

Review Questions

- 1. What are the two intra-cluster communications?**
- 2. What is the relationship between publisher and subscriber databases in a cluster?**
- 3. Cisco IP telephony devices has a prioritized list of how many CallManagers?**

© 2000, Cisco Systems, Inc. www.cisco.com CIPT v 2.0—12-53

- Q1) Cisco CallManager clusters provide scalability and redundancy. What are the two primary intra-cluster communications?
- Q2) Cisco CallManager uses SQL database with Service Pack 2. What is the relationship between the publisher and subscriber database when looking up information?
- Q3) Cisco IP telephony devices need redundancy in a Cisco CallManager cluster. How many Cisco CallManagers can a device have in its prioritized list?

Campus Infrastructure

Overview

As with any architecture, Cisco AVVID relies upon a strong and stable foundation. This foundation is built upon the Cisco multiprotocol routers and Catalyst Multilayer LAN switches that are used as building blocks for enterprise networks.

This section discusses how to prepare your current LAN infrastructure for a successful AVVID deployment. The concepts and implementation techniques discussed apply equally to a campus of any size; be it a HQ environment with tens of thousands of users to a small branch with less than a hundred users. What will differ are the actual components/platforms selected and the level of detail in terms of scalability, network availability, and functionality.

The following key areas are discussed in this section.

- Objectives
- Visual Objectives
- Network Infrastructure
- High Availability
- IP Addressing
- Quality of Service (QoS)
- Power to IP Phones
- Power Protection Strategies
- Written Exercises
- Summary
- Review Questions
- Laboratory Exercise

Objective

This section lists the chapter objectives.

Objectives

Upon completion of this chapter, you will be able to perform the following tasks:

- **Identify well built network infrastructures**
- **Identify and describe IP addressing options**
- **Select the correct commands from a list of five that allow for VLAN ID**
- **Identify the QoS issues and a way to ensure voice is a priority over data**

? 2000, Cisco Systems, Inc. www.cisco.com CIPT v2.07 3-3

Upon completion of this chapter, you will be able to perform the following tasks:

- Given a set of network topologies, you will be able to identify and select a well-built network infrastructure.
- Given a case scenario for IP addressing, you will be able to identify and select the best option for IP addressing within the case scenario's network.
- Given a list of Catalyst switch commands, you will be able to identify the correct command that enables VLAN ID.
- Given a converged voice/data network, you will be able to list the QoS issues and commands to ensure voice is a priority over data.

Visual Objective

This section shows the visual objective of a successful AVVID deployment.

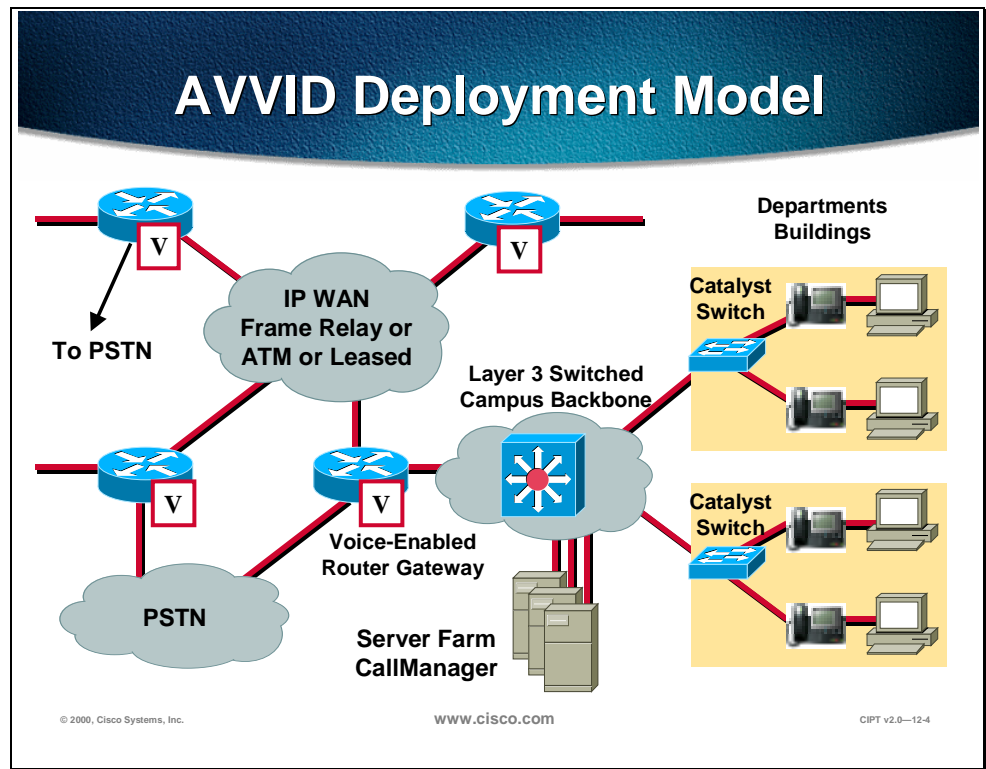

The following sections in this chapter provide a brief description of the concepts and techniques used to prepare for AVVID deployment.

Network Infrastructure

This section describes the network infrastructure you need to build an IP telephony system.

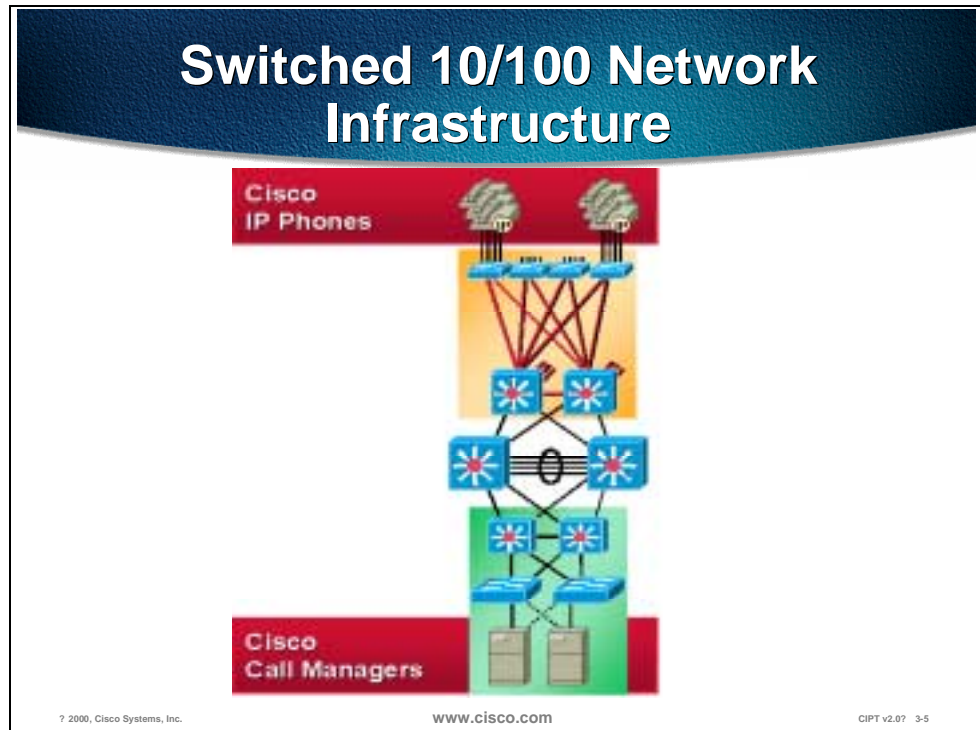

To build an IP telephony system end to end requires an IP Infrastructure based on layer 2/3 switches and routers. Switched connection to the desktop is a must for IP telephony. Ensure that the end-points are connected using switched 10/100 ports.

Note Plugging in shared hubs to the switch for device connectivity via these hubs is not recommended and may interfere with the correct operation.

IP phones available from Cisco provide a model of connectivity whereby PCs can be plugged into the phones which in turn are connected to the switch port. The phone has the necessary electronics to preserve the switched connectivity model for the PC. It has a three port switch inside that ensures quality of service for both the IP phone and downstream PC.

When using the Cisco IP 7960 Phone, separate VLANs can be configured for the phone and PC connected to the phone.

Cisco IP Phone Internals

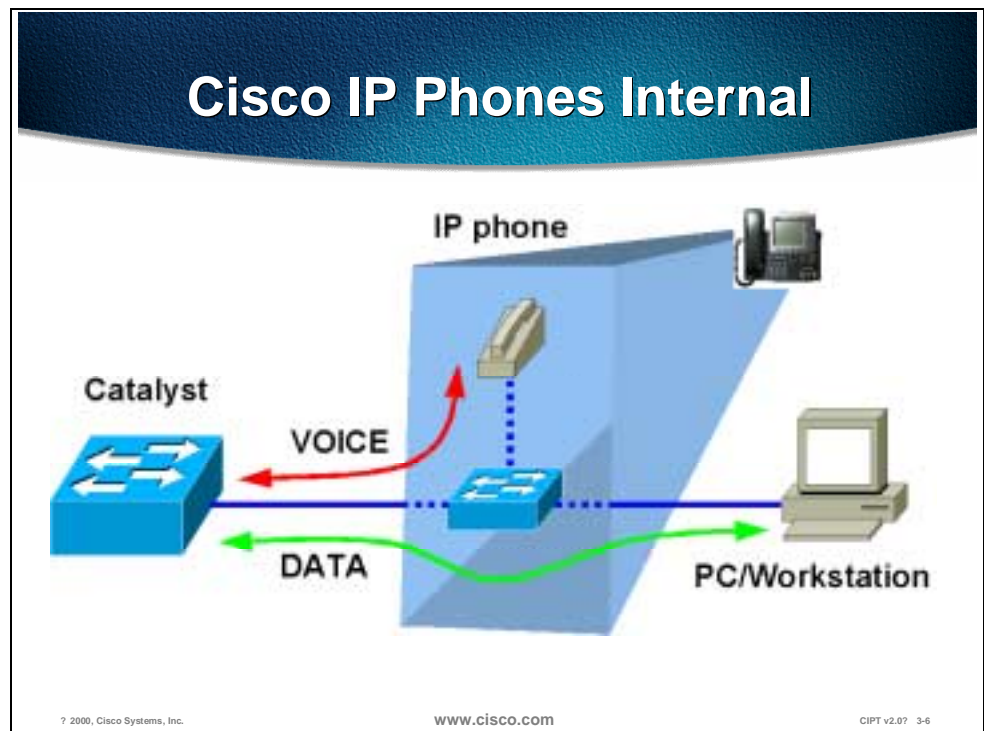

The figure above is a high-level overview of the Cisco IP phone functionality. It has two basic parts; phone circuitry and the electronics that includes a switched connectivity model to a downstream PC. Cisco IP phones have two switched connections that are available as RJ-45 on the back of the unit. One goes to the switch in the wiring closet (using a straight through cable) and the other is used to connect a PC or workstation. There are two more connectors that are used for attaching a headset and debugging purposes. Power to the phone and PC is discussed later in this chapter.

Note The switched connection shown going to a PC/Workstation can be used like any standard 10/100M interface. For example, this connection can be used to connect the Cisco IP phone to another switch for providing redundancy to the phone in mission-critical environments. This will be explored a little more in later sections.

The ports on the back of the phone from left to right are the following:

1. RS-232—not used at this time
2. 10/100 SW is used to connect to the wall jack
3. 10/100 PC is used to connect to a downstream PC

High Availability

This section describes the prerequisite for voice networking, which is high availability. Cisco AVVID is a distributed architecture that is inherently available and scalable. The ability to seamlessly provision additional capacity for infrastructure, services, and applications is a unique benefit of the architecture.

In contrast to the PBX model, the world of converged networking depicts a scenario where availability is designed into a distributed system rather than a box. Redundancy is available in the individual hardware components for services such as power and supervisor modules. Network redundancy is, however, achieved with a combination of hardware, software, and intelligent network design practices.

Typical Enterprise Network

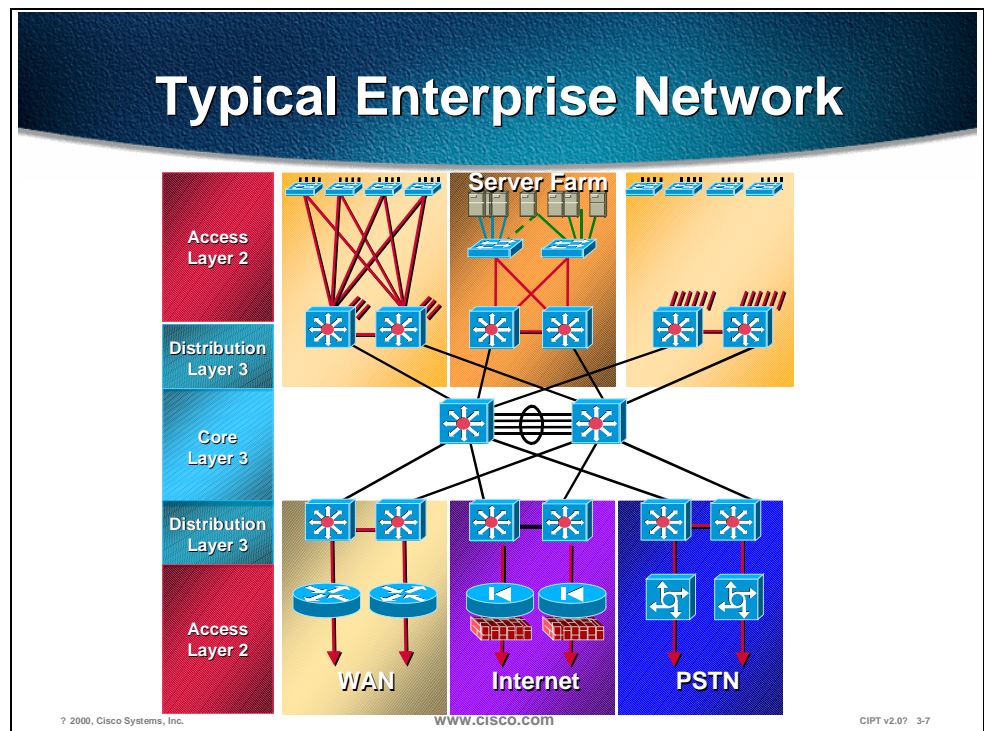

In the above diagram, network redundancy is achieved at many levels. Physical connections exist from the edge devices where IP telephones and PCs are attached to two spatially diverse aggregation devices. Should an aggregation device fail, or connectivity is lost for any reason (such as fiber cut or power outage), cut over of traffic to the other device is possible. Clusters of Cisco CallManagers can be provisioned to provide resilient call control; should any device within the cluster fail, the other servers pick up the load.

Advanced Layer 3 protocols such as Hot Standby Routing Protocol (HSRP) or fast converging routing protocols such as Open Shortest Path First (OSPF) and Enhanced Interior Gateway Routing Protocol (EIGRP) can be used to provide optimum network layer convergence around failures.

Multicast routing can be used to optimize traffic that is required at many locations. The availability of advanced multicast routing protocols such as Protocol Independent Multicast (PIM) ensure these services can be deployed efficiently.

Moving down the protocol stack, advanced tools are also available for the MAC layer, Layer 2. Tunable spanning-tree parameters and the ability to supply a spanning tree per virtual LAN (VLAN) allow fast convergence. Value-added features such as uplink-fast and backbone-fast allow intelligently designed networks to further optimize network convergence.

A big part in ensuring successful deployment comes from the fact that the underlying network is highly available. This translates to redundancy, resiliency, and fast convergence.

For a more detailed discussion on this subject, please refer to the design guide(s) at:

http://www.cisco.com/warp/partner/synchronicd/cc/sol/mkt/ent/ndsgn/highd_wp.htm

http://wwwin.cisco.com/cmc/cc/sol/mkt/ent/cmpps/gcnd_wp.htm

In addition, please take a look at the results of an independent study done by Ziff-Davis, exploring the redundancy/resiliency analysis in a network using Cisco switches and routers at:

<http://www.zdnet.com/zdtag/whitepaper/campuslan.pdf>

Physical Topologies and Connectivity Options

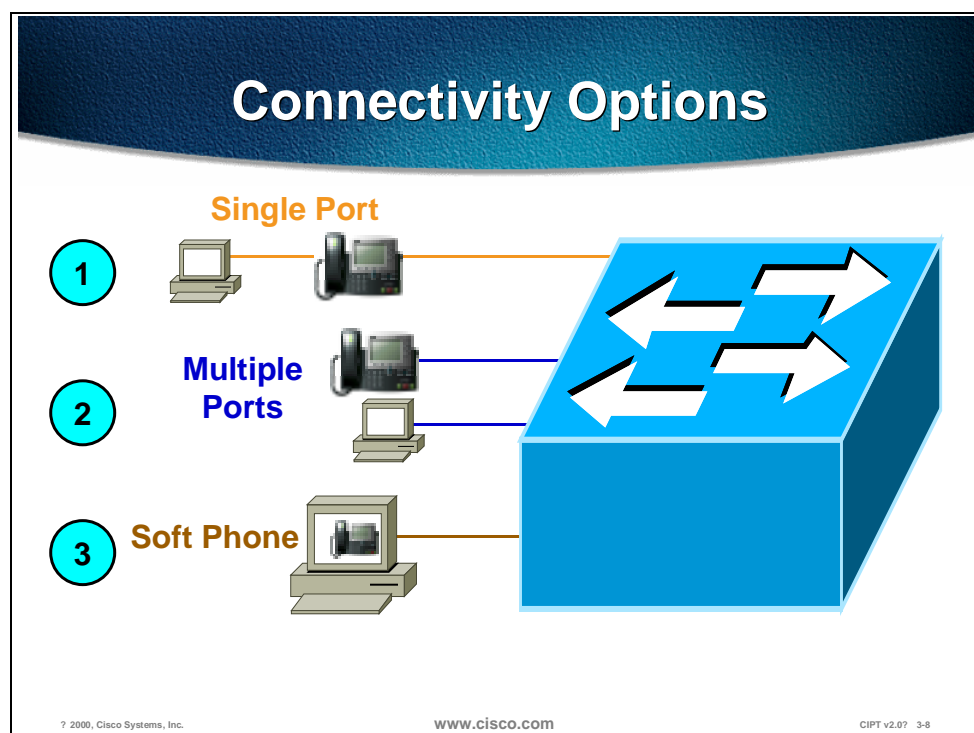

Cisco IP phones and PC/workstations can be connected to the network in three different ways.

Cisco IP phones can be connected to the switch with data device (PC or workstation) connected to the switched Ethernet port available in the back of Cisco IP phone. This is reflected as option 1 in the figure above. This is the most common connectivity option that will be used. The advantage of this option is that it uses a single port on the switch and provides switched connectivity to both the devices. Also no changes to the cabling plant are required if the phone is line powered. The drawback is that if the IP phone goes down, then the PC also goes down. This arrangement aids in rapid deployment with minimal modifications to the existing environment.

The second method shown above shows the phone and PC connected to different switch ports. Although this option doubles the switch port count for every user, it provides a level of redundancy for the user. If the phone goes down, the PC does not get affected and vice-versa. Also if the phone and PC are connected to ports on different modules then another layer of redundancy is achieved, which protects one of the devices if a module goes down.

The third option shown above is a little unique in that the phone is not a hardware device but a JTAPI application running on the user's PC. It is called a soft phone. This option may appeal to some specific environments where the need for a separate handset is minimal.

IP Addressing

This section describes the options used to extend IP addressing to accommodate IP phones.

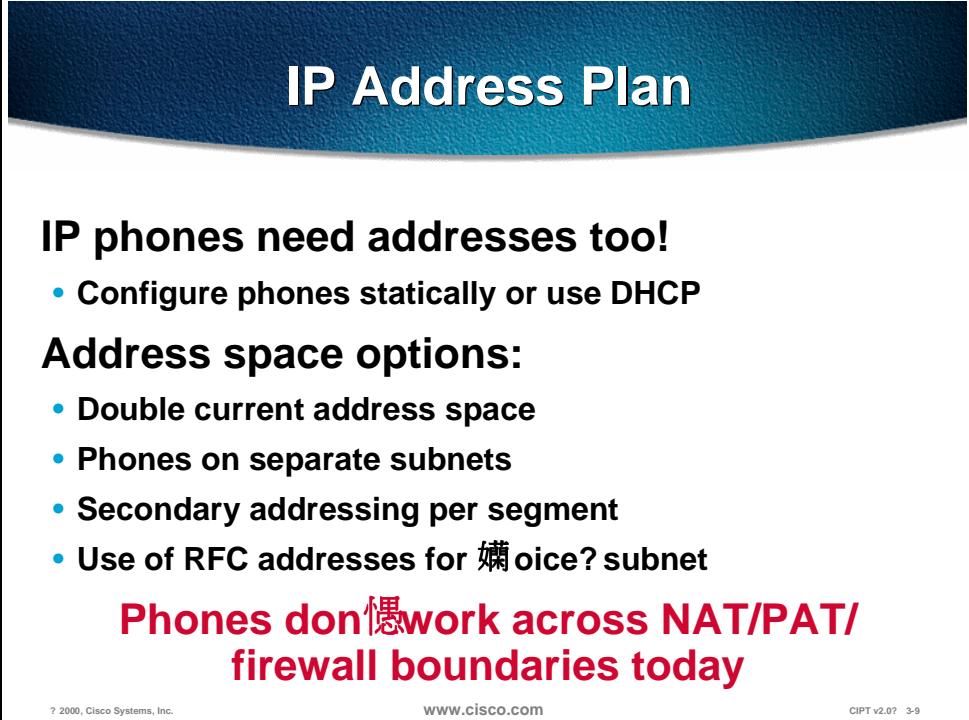
A presentation slide titled "IP Address Plan" with a blue gradient header. The main content is on a white background with a black border. It lists options for IP phone addressing and includes a warning about NAT/PAT and firewalls.

IP Address Plan

IP phones need addresses too!

- Configure phones statically or use DHCP

Address space options:

- Double current address space
- Phones on separate subnets
- Secondary addressing per segment
- Use of RFC addresses for voice? subnet

**Phones don't work across NAT/PAT/
firewall boundaries today**

© 2000, Cisco Systems, Inc. www.cisco.com CIPT v2.07 3-9

Each IP phone needs an IP address and associated information like subnet mask, default gateway, and so forth. This information can be provided by statically configuring it on the phone or it can be provided via DHCP. In this section we will discuss various options available for extending the IP addressing plan to accommodate IP phones.

To meet this requirement, there are a few options:

1. Provide an IP address in the same subnet as the existing data device
2. Redo the entire IP addressing plan for the organization
3. Create a new subnet and use it for IP phones

All of the above mentioned options could be implemented using DHCP or static configuration.

Since every phone needs an IP address in addition to the data device (PC or workstation), it means that an organization's requirements for IP addresses has doubled. Although this concept is very straightforward, a significant number of customers have IP subnets with more than 50% of their subnet addresses already in use/allocated/assigned. This would mean that option 1 mentioned previously couldn't be implemented. If new addresses have to be assigned for IP phones out of the existing subnets, then customers would have to renumber their IP addressing plan. This is option 2 as mentioned previously and may not always be feasible. One solution is to put the IP phones on a separate IP subnet. This solution maps to option 3, soft phone.

The new subnet could be in a registered address space or in private address space like Network 10.0.0.0. Now, the PC/workstation could be on a regular *data subnet* and the phone would be on the *voice subnet*. In order to minimize the configuration required on the phone, it is better for the phone to learn as much information dynamically as possible. This includes the separate *voice subnet* for the phone. So when the phone powers up, it should get its *voice subnet* automatically and then the phone can send a DHCP request on that subnet for getting an IP address.

In order to understand the automated mechanism of getting this *voice subnet* to the phone from the switch at power up, we need to understand the enhancements done in Cisco Discovery Protocol (CDP).

Phones cannot work across Network Address Translation (NAT) or firewall boundaries today.

CDP Enhancements

CDP is a device discovery protocol that runs on all Cisco equipment. Each device sends periodic messages to a multicast address and listens to the periodic messages sent by others. This is done to learn about neighboring devices and determine whether their interfaces are up or down and other relevant information like layer 2/3 protocols used, protocol addresses, native VLAN of the interconnected ports, duplex, and so forth. CDP is also used to send some layer 2/3 protocol specific messages.

There is a level of interaction between the Cisco IP phone and the Catalyst switch to make it plug and play. Cisco IP phones support CDP. This makes it possible for the switch to know that an IP phone is connected to it and vice versa.

New CDP Fields

- **Voice VLAN ID (VVID)—Communicating Voice VLAN ID (Voice subnet) to the phone**
- **Trigger Field—Soliciting response from the connected device**
- **Power Field—Required for getting exact power requirement from the phone**

© 2000, Cisco Systems, Inc. www.cisco.com CIPT v2.0—12-10

Three new fields have been added to CDP. They are:

- Voice VLAN ID (VVID) field for communicating the voice VLAN ID (voice subnet) to the IP phone.
- Trigger field for soliciting a response from the connected device—used to force a response from the connected device. Under normal circumstances, a device sends CDP messages at one minute (configurable) intervals. But if an IP phone comes up within this interval, it cannot receive its VVID. In this case the IP phone will issue a trigger in the CDP message it sends to the switch. This will force the switch to respond with a VVID.
- Power—required field for getting the exact power requirement from the phone.

A VLAN at Layer 2 maps to a subnet at Layer 3 in terms of a broadcast domain, such that a VLAN equals a subnet. The desired functionality is that when an IP phone is plugged into the switch, it should automatically get its specific VLAN ID (voice VLAN or voice subnet) from the switch if one is configured. If not, the IP phone will reside in the native VLAN (data subnet) of the switch.

A new concept called Voice VLAN ID (VVID) is introduced in CatOS starting with release 5.5. This is the VLAN (subnet) that will be given to the IP phone by the switch inside the CDP message. The prerequisite is an IP phone-specific VLAN configured on the switch. Switch configuration details will be shown, with an example, later on in the section.

When an IP phone is powered by inline power, it is automatically provided 10W of electricity. Since the switch doesn't know exactly how much power the IP phone requires, the IP phone can send a CDP message, using the *Power Consumption* field set to its own specific requirements. The switch then adjusts the resource accordingly.

Voice VLAN ID (VVID) and Port VLAN ID (PVID)

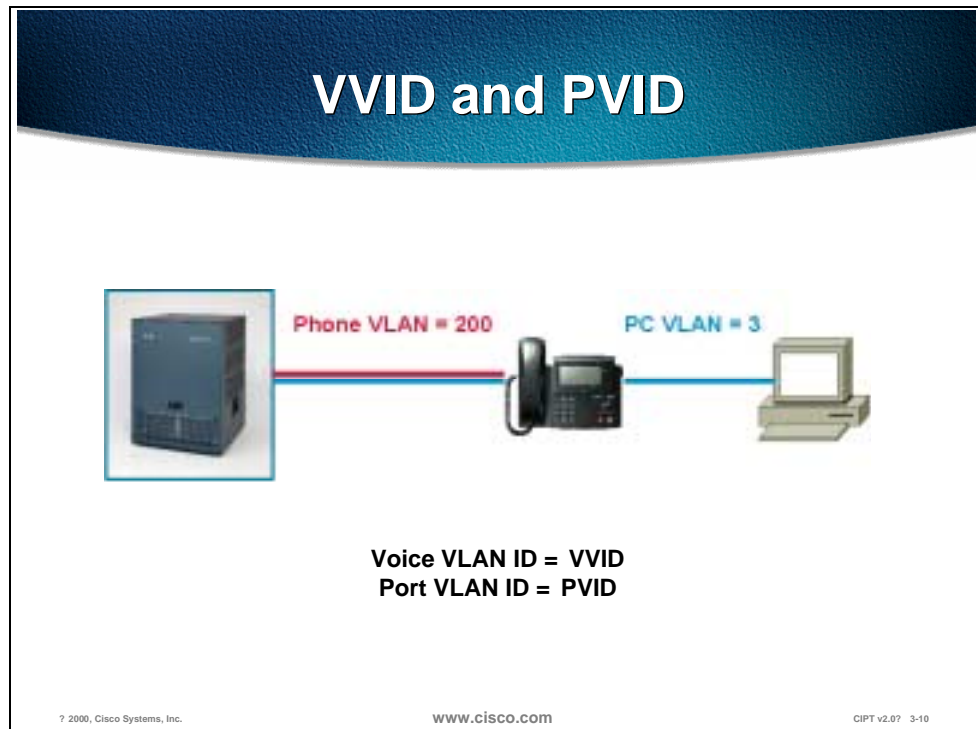

The new voice VLAN is referred to as *Auxiliary VLAN* in the CatOS CLI for configuration purposes. Traditionally in the switched world, we understand data VLANs. This is typically where all the data devices reside. The new auxiliary VLAN is used to collectively represent other types of devices. Today that device is an IP phone and, hence, this could be thought of as a voice VLAN. In the future if there are other types of non-data devices, they will fall in the auxiliary VLAN.

The idea is that these non-data devices (IP phone) will reside in a separate VLAN (auxiliary VLAN), which will make it easier for customers to automate the process of deploying the phones. Just like data devices come up and reside in the native VLAN (also referred to as default VLAN) of the switch, phones will come up in the auxiliary VLAN if the switch has been configured as such. When the phone powers up, it communicates with the switch via CDP. The switch will provide the phone with the appropriate VLAN ID that was configured. This is known as the Voice VLAN ID or VVID. This is very analogous to the data VLAN ID that is known as Port VLAN ID or PVID.

To summarize, data devices reside in the native VLAN (or default VLAN) of the switch and phones will reside in the auxiliary VLAN on the switch. Data device VLAN (data subnet) is referred to as PVID and Phone VLAN (voice subnet) is referred to as VVID.

This concept has quite a few merits. Besides making it very plug and play, it also aids in applying advanced QoS concepts on a per VLAN (subnet) basis. The data subnet may have different QoS settings and voice subnet may have more different QoS settings.

VVID Configuration

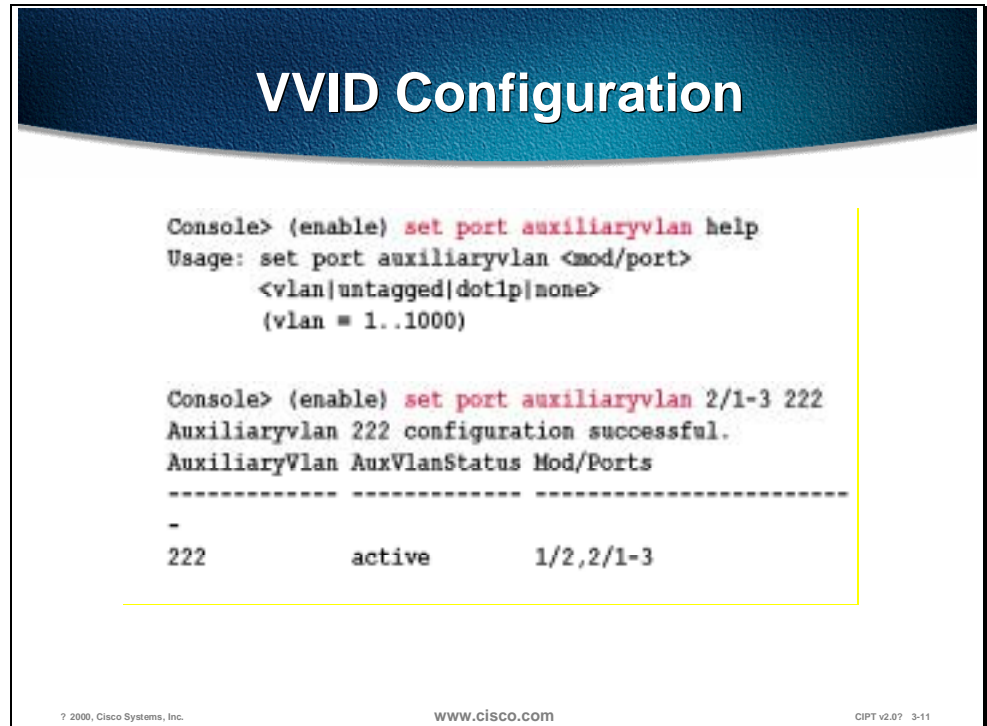

The screenshot shows a terminal window with a dark blue header containing the text "VVID Configuration". Below the header, the terminal output shows the following commands and their results:

```
Console> (enable) set port auxiliaryvlan help
Usage: set port auxiliaryvlan <mod/port>
       <vlan|untagged|dot1p|none>
       (vlan = 1..1000)

Console> (enable) set port auxiliaryvlan 2/1-3 222
Auxiliaryvlan 222 configuration successful.
AuxiliaryVlan AuxVlanStatus Mod/Ports
-----
-
222          active          1/2,2/1-3
```

At the bottom of the terminal window, there are three small text elements: "7 2000, Cisco Systems, Inc.", "www.cisco.com", and "CIPT v2.0? 3-11".

The VVID is configured in the CatOS version 5.5 using the syntax **set port auxiliaryvlan <mod/port>**.

In this example, the voice VLAN (VVID) has been set to the value 222 for ports 2/1 through 2/3. When the phone powers up, the switch will instruct it to be in VLAN 222. This command can be used to set the VVID on a per port basis, range of ports, or for an entire module.

VVID Status

```

VVID Status

Console> show port auxiliaryvlan 222
AuxiliaryVlan AuxVlanStatus Mod/Ports
-----
222           active          1/2,2/1-3
Console> (enable)

Console> show port 2/1
...
Port  AuxiliaryVlan AuxVlan-Status
-----
 2/1  222           active
...
Console> (enable)

? 2000, Cisco Systems, Inc.
www.cisco.com
CIPT v2.0? 3-12
```

Once the phone gets its voice subnet, it will issue a DHCP request on that subnet.

Listed below are some important steps in the process when an IP phone is plugged into the network to preparing to make phone calls. Assuming that the IP phone is already powered up:

1. IP phone will begin a CDP exchange with the switch. It will issue a trigger CDP to force a response from the switch that will contain its Voice VLAN ID (VVID) or voice subnet.
2. By default, IP phone is configured for DHCP. It will issue a DHCP request on the voice subnet it got in step 1 above. In general, this is the recommended mode of operation. Static addressing can be supplied to the telephone, and you can enter the IP address manually, but this would prevent mobility and increase requirements of technical personnel.
3. IP phone will get a response from the DHCP server in the network. As part of that DHCP response, an IP address is supplied to the telephone. It is also possible to supply the address of the TFTP server, from which the telephone will get its configuration. Once again, the TFTP server address could be specified manually but this would limit adds, moves, and changes and remove some of the benefits. This TFTP server address can be given as part of the DHCP response. This can be done several ways by configuring option 066 or custom option 150 on the DHCP server and specifying the address of the TFTP server. The Cisco DHCP server supports this feature.

4. The IP phone will contact the TFTP server and will receive the address of the CallManager. Up to three CallManagers can be specified in the list that the IP phone will get. This allows for redundancy in case the first CallManager in the list is not available. The phone will now contact the CallManager and register itself.
5. After the IP phone receives its configuration file, the IP phone will attempt to register with the Cisco CallManager. If the firmware version in the IP phone is correct, the registration will complete. If the firmware version in the phone is not correct the IP phone will TFTP for a new firmware version, then attempt to register with the Cisco CallManager. IP phone will receive a number (referred to as DN number) from the CallManager per configuration. This is the number that will be used for calling the particular IP phone.
6. Now the IP phone is ready to make calls.

Note This process when an IP phone is plugged into the network preparing to make phone calls takes about 90 seconds. To speed it up, turn on portfast and turn off port channeling as well as trunking. This reduces the time taken to about 30 seconds.

Sample IP Addressing Plan

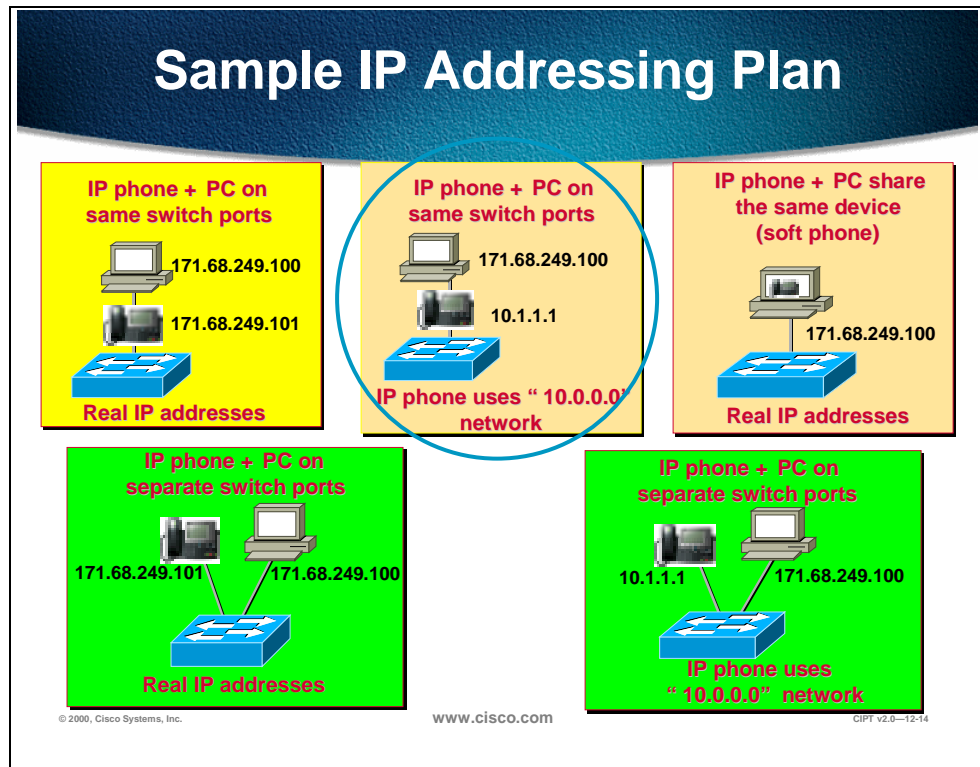

To summarize, the recommendations for IP addressing are:

- Continue to use existing addressing for data devices (PC's, workstations, and so forth)
- Add IP phones with DHCP as the mechanism for getting addresses
- If subnets are available in existing address space then use them for IP phones
- If not, then use private addressing (Network 10 or Network 172.16 – 172.20)

Quality of Service (QoS)

This section describes the need for campus QoS.

In a converged environment, all traffic types travel over a single transport infrastructure. In addition, all traffic types are not same. Voice is bursty, slightly loss tolerant, and latency sensitive. Data on the other hand is well behaved (fixed bandwidth), has a little tolerance to loss, but is latency insensitive. The challenge is in providing the required level of service for these individual traffic types.

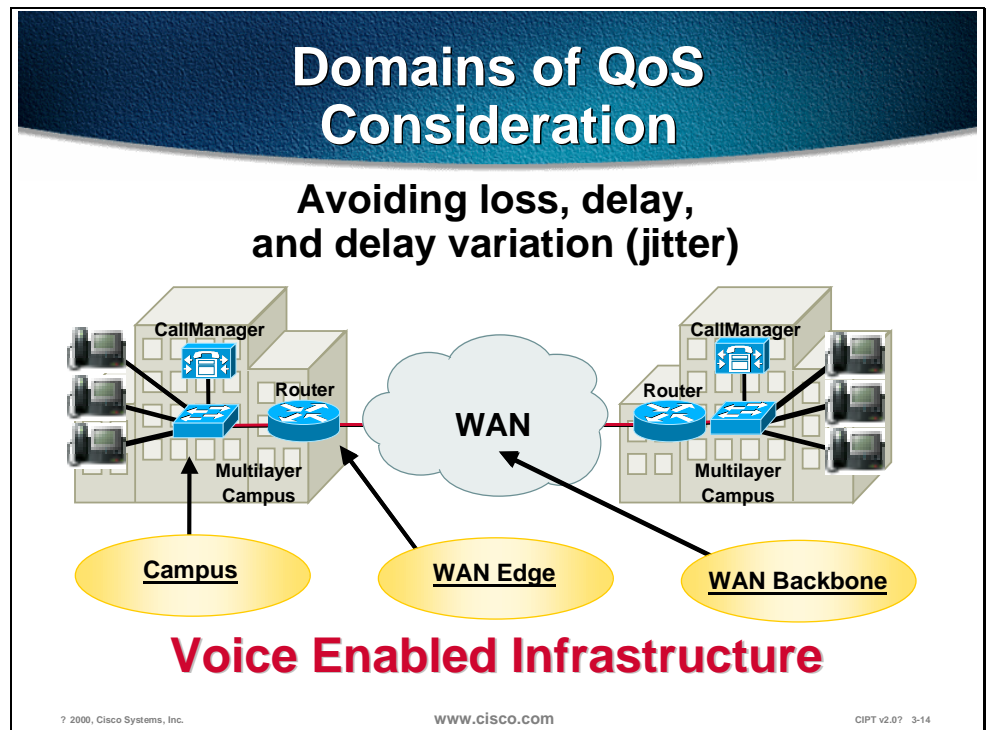

If you are running both voice and data on a common network then you need to employ proper tools to ensure that the delay and loss parameters of voice traffic are satisfied. The tools that allow you to ensure the required quality of service are available as features in phones, switches, and routers.

Need for Campus QoS

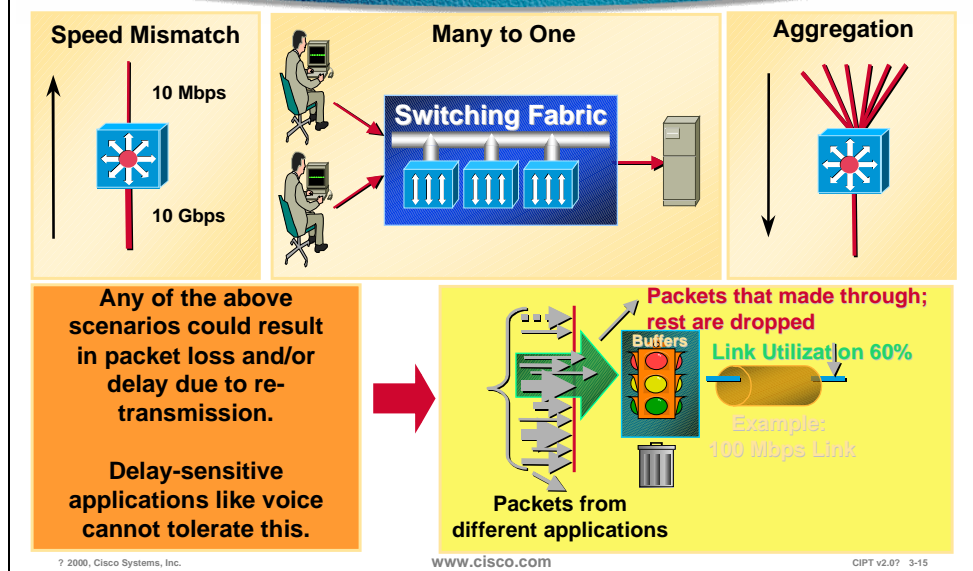

The basic premise is that we need to protect voice traffic from being run over by data traffic. This is done by classifying voice traffic as high priority and then allowing it to travel in the network before low priority traffic. Classification can be done at Layer 2 using the 3 bits in the 802.1p field (referred to as CoS) within the 802.1Q tag or at Layer 3 using the 3 bits of IP Precedence in the TOS byte of IP header. Classification is the first step towards achieving quality of service. Ideally, this step should be done as close to the source as possible.

Once the end devices set CoS and/or ToS values, the switch can either trust them or not trust them. This concept of trust is very important and is integral to deploying QoS. If the switch trusts the value(s) it need not do any re-classification and if does not trust the value(s) then it will have to perform re-classification for appropriate quality of service levels. This notion of trusting or not trusting forms the basis for *trust boundary*.

As mentioned before, ideally classification should be done as close to the source as possible. If the end-device is capable of performing this function then the trust boundary for the network is at the access layer in the wiring closet. If the device is not capable of performing this function or the wiring closet switch does not trust the classification done by the end device, then the trust boundary may shift. The shift will happen depending on the capabilities of the switch in the wiring closet. If the switch can re-classify the packets then trust boundary remains in the wiring closet. If the switch cannot perform this function then the onus falls on other devices in the network going towards the backbone. In this case, the rule of thumb is to perform re-classification at the distribution layer. It is more than likely that there is a high-end switch in the distribution layer with features to support this function. If possible, performing this function in the core of the network should be avoided.

Frame Tagged with PVID and VVID

An access port able to handle 2 VLANs
Native VLAN (PVID) & Auxiliary VLAN (VVID)
Hardware set to *dot1q trunk*

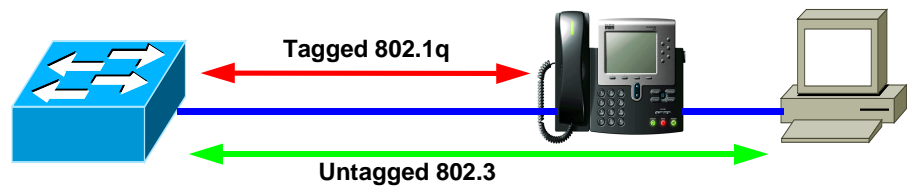

© 2000, Cisco Systems, Inc.

www.cisco.com

CIPT v2.0? 3-17

Cisco IP phones have the ability to mark voice packets as high priority using CoS as well as ToS. By default, the phone will send 802.1Q tagged packets with the CoS and ToS set to a value of 5.

Packets from the phone are sent as tagged frames with the .1p fields set to 5. Frames from the PC are sent untagged as shown in the figure above.

PC is Not Trusted Normal Mode

For example, set port qos 2/1 trust-ext untrusted

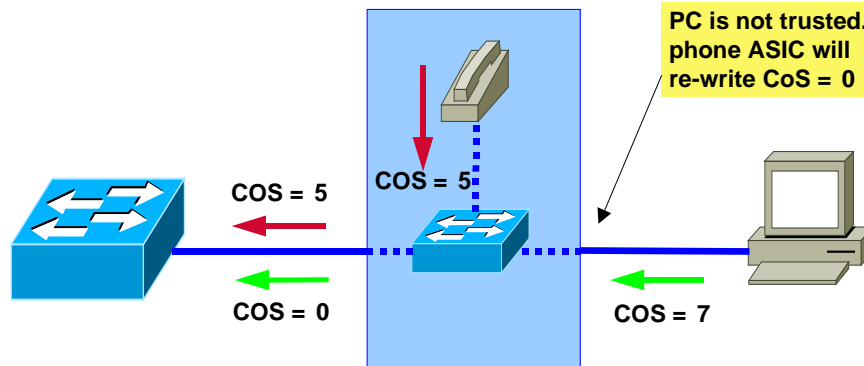

© 2000, Cisco Systems, Inc.

www.cisco.com

CIPT v2.0? 3-18

Most PCs on the desktop do not have an 802.1Q capable NIC card and as such send the packets untagged. This means that the frames do not have an 802.1p field. Also, unless the applications running on a PC send packets with a specific ToS value, this field will also be zero. A special case could be where the TCP/IP stack in the PC has been tweaked to send all packets with a ToS value other than zero. Typically this does not happen and the ToS value is zero.

Even if the PC is sending tagged frames with a specific CoS value, Cisco IP phones have the ability to zero out this value before it sends the frame to the switch as shown in the figure above. This is the default behavior. Hence frames coming from the phone will have a CoS of 5 and frames coming from the PC will have a CoS of 0. When the switch receives these frames it can take into account these values for further processing based on its capabilities.

Once frames come to the switch, it will use its queues (available on a per port basis) to buffer them before sending it to the switching engine. An important point to remember is that input queuing comes into play only when there is congestion. The switch will use the CoS value(s) to put the frames in appropriate queues. CoS 5 frames go into the priority queue, which is serviced before other queues. The switch can also employ mechanisms like WRED to make intelligent drops within a queue (also known as congestion avoidance) and WRR to provide more bandwidth to some queues over others; also known as congestion management.

Lets apply this scenario to a Catalyst 6000 family Switch. Each port on this switch has 1 receive queues and 2 transmit queues. In addition there is a priority queue for receive as well as transmit. On the receive side, CoS 5 packets will go in the priority queue and will be serviced first before the regular queue. All other packets go in the regular queue. Tail drop is used on this regular queue for congestion avoidance. As mentioned before, tail drop will come into play only if there is congestion on the receive side. This is unlikely in most cases because typically frames are coming in from a 10/100 or GE port trying to go to a 32Gbps bus and will not experience congestion. On the transmit side, as before

CoS 5 frames will go in the priority queue and will be serviced first. Remaining frames will go in regular queues. CoS values 0,1,2, and 3 will go in Lo regular queue and CoS values 4,6, and 7 will go in Hi regular queue. In addition, within each queue we can use WRED to make intelligent drops based on the CoS value and what percentages of buffers are full. Finally, the Hi regular queue and Lo regular queue will be serviced based on the WRR configuration. One can configure it to say they will be serviced in 25 to 75 ratios. This is done after the priority queue has been emptied out.

All the values for WRED, WRR, and queue sizes are configurable.

Catalyst 6000 family switches also support the notion of trusted and not trusted. The switch can be configured to do this on a per port basis. From the CLI use the following command:

```
set port qos <mod/ports.> trust <untrusted|trust-cos|trust-ipprec|trust-dscp>
```

This command allows you to configure the trust state as well as to specify to trust CoS or ToS (trust-ipprec) or DSCP (DS Codepoint) which is an emerging Layer 3 standard under IETF's Differentiated Services working group.

So far we have talked about the voice traffic that comes in as CoS 5 and PC traffic is zeroed out if there is any tag.

PC is Trusted

e.g. set port qos 2/1 trust-ext trust-cos

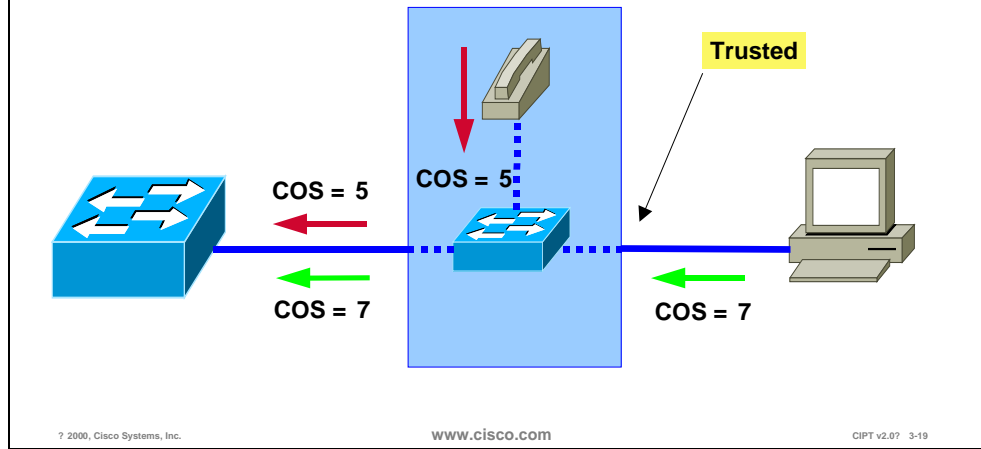

There may be times when we may want to trust the PC CoS (if sending tagged packets) or give it a value other than zero. This can be achieved on Catalyst switches as well.

This is achieved by extending the trust out to the PC. Use the following command to extend trust out to the PC:

Set port qos 2/1 trust-ext trust-cos

PC is Not Trusted

For example, set port qos 2/1 cos-ext 2

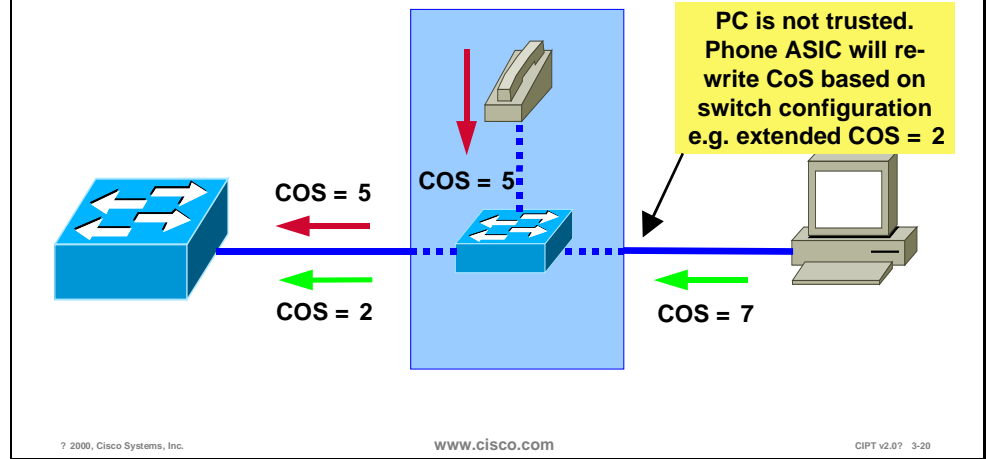

When a PC is not trusted extend a specific CoS value to the PC traffic. The command used to extend a specific CoS value to the PC traffic is:

Set port qos 2/1 cos-ext 2

All of the above configurations shown along with the individual figures can be done for any of the Catalyst switches that use CatOS.

So far we have discussed the Quality of Service Implementation model at Layer 2 using the 802.1p bits within the 802.1Q tag. This technique provides the desired results at Layer 2. When traffic has to cross a Layer 3 boundary, then it becomes imperative to implement these mechanisms using Layer 3 parameters like the 3 IP precedence bits (commonly referred to as ToS) or the new emerging DSCP parameter that uses the six most significant bits within the ToS byte of the IP header. Traffic crosses Layer 3 boundaries when packets need to cross subnets. Layer 3 switches or routers facilitate this. Traffic also crosses Layer 3 boundaries when packets need to go out of the campus network onto the WAN via edge routers. When this happens, a Layer 2 classification does not help. We need Layer 3 classification for achieving the desired level of QoS.

All of the QoS techniques employed by the routers (including the very important WAN QoS) rely on Layer 3 classification. This can be achieved by using the appropriate platforms in the campus. Beginning with the IP phones, we already have packets presented to the switch with CoS=ToS=5. This Layer 3 classification is preserved even if the packets travel all the way through to the WAN edge router where the Layer 2 header is removed. So, if the trust boundary is at the source (IP phone) then voice traffic will have the ToS bits set to 5 and will be presented to the network devices for appropriate treatment. WAN routers can use this classification to employ any of the queuing techniques. If the trust boundary is not at the source and packets need to be re-classified, then the device performing this function should be capable of doing it at Layer 3 before it can cross a Layer 3 boundary.

Catalyst 6000 family switches equipped with the Policy feature Card (PFC) perform this function by default when the port is trusted. So if a packet comes in a trusted port with CoS equals 5, then the switch will take this value and re-write the ToS bits to make it equal to 5 as well. No additional configuration is needed. If the port is un-trusted, then the packet gets a default CoS at the input port. Now we can configure a QoS access-list on the switch and re-write the ToS to a desired value based on some matching criteria; for example:

```
set qos acl ip TEST dscp 40 10.1.1.0 0.0.0.255 any
```

This command will set a ToS of 5 for all packets coming from subnet 10.1.1.0 and going anywhere.

In addition QoS access-lists can include L4 information as well to classify individual applications. Catalyst 6000 switches are also capable of policing traffic based on L3 addresses and L4 port numbers. For example, you can police individual http flow to 1M and aggregate all http flows to 25M.

All of these QoS features on Catalyst 6000 switches provide a high degree of flexibility.

Summary of QoS Issues

- **Classify and/or re-classify packets as close to the edge as possible**
- **Make the access layer the trust boundary**
- **If wiring closet switch does not have appropriate QoS hooks, shrink trust boundary to distribution layer, no further**
- **Use WRED for making intelligent packet drops**
- **Use priority classification to expedite delay-sensitive traffic**
- **Use WRR (if switch has multiple queues) in conjunction (or otherwise) for servicing Hi queue more often**
- **For very small offices with low user count and no QoS capable switch, WAN edge can be the trust boundary**

© 2000, Cisco Systems, Inc.

www.cisco.com

CIPT v2.0? 3-16

To summarize, try to maintain the trust boundary in the wiring closet. If need be, shrink it down to the distribution layer on a case by case basis and avoid shrinking it down to the core of the network. This is in line with the guidance provided earlier to keep the trust boundary as close to the source as possible.

Note The discussion above takes into consideration a 3-tier network model, which has proved to be a scalable architecture. If the network is small and the logical functions of distribution layer and core layer happen to be in the same device then, the trust boundary may reside in the core layer if it has to move from the wiring closet.

The following figure illustrates some important points to note regarding Catalyst 6000 QoS functionality.

Notes about Catalyst 6000 QoS Functionality

- **By default, QoS is not enabled.**
- **By default, ports are not trusted.**
- **QoS configurations can be applied on a per port basis or on a per VLAN basis.**
- **Catalyst 6000 can map CoS to ToS in any situation. Either by default, when the port is trusted, or by using the QoS access list.**

© 2000, Cisco Systems, Inc. www.cisco.com CIPT v2.0? 3-21

By default, QoS is not enabled. Use **set qos enable** to turn on QoS.

By default, ports are not trusted. Use **set port qos mod_num/port_num trust {untrusted | trust-cos | trust-ipprec | trust-dscp}** to trust a port.

QoS configurations can be applied on a per port basis or on a per VLAN basis. This works very well for IP telephony deployments where phones are on a separate VLAN/subnet as discussed before in the IP addressing section.

The Catalyst 6000 can map CoS to ToS in any situation. Either by default, when the port is trusted, or by using the QoS access list.

If the trust boundary happens to be on a switch in the wiring closet that is not capable of re-classifying at Layer 3, then shrink the trust boundary to the distribution layer where it is more likely that a Layer 3 capable device will be present.

Capabilities within the Catalyst Family of Switches

Capabilities within the Catalyst Family of Switches				
Capabilities	Catalyst 6000	Catalyst 5000	Catalyst 4000	Catalyst 3500
Ability to Trust	Yes	No	No	Yes
Re-Classify CoS	Yes	Yes	Yes	Yes
Re-Classify ToS	Yes	Yes (with additional configuration)	No	No
Congestion Avoidance (WRED)	Yes	Yes	No	No
Priority Queue	Yes	No	No	No
Multiple Queues	Yes	No	No	Yes
Congestion Management (WRR)	Yes	No	No	No (Round Robin)
Policing	Yes	No	No	No

© 2000, Cisco Systems, Inc. www.cisco.com CIPT v2.0? 3-22

The following are deployment recommendations:

- Create a trust boundary at the network edge in the wiring closet. Make ports trusted on the wiring closet switch where phones are attached.
- If devices cannot be trusted then re-classify ToS at the edge.
- If re-classification is not possible at the edge, shrink trust boundary to the distribution layer and re-classify ToS.
- Use the priority queue, if possible, to delay sensitive traffic.
- Use the QoS access list for more granular classification of packets using L4 information.
- Use policing, if necessary, to limit traffic for individual flows as well as aggregate flows.
- Traffic going to the WAN edge should have Layer 3 classification that the router can use for advanced WAN queuing mechanisms.
- For very small remote site networks where a Layer 3 capable switch is not available, the WAN edge router can be used as the classifier.

Power to IP Phones

The new Cisco IP phones support a variety of power options. This section explains how each of the available powering schemes work.

3 Ways to Power IP Phones

- **Inline Power**

 - ✓ Needs powered linecards for Catalyst switches
 - ✓ Uses pins 1, 2, 3, and 6 (same as Ethernet) for delivering ? 8V

- **External Power**

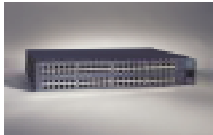
 - ✓ Needs external power patch panel
 - ✓ Patch panel delivers ? 8V over pins 4, 5, 7, 8

- **Wall Power**

 - ✓ Needs DC converter for connecting IP phone to wall outlet

Combination of ways can be used for redundancy

© 2000, Cisco Systems, Inc.www.cisco.comCIPT v2.07 3-23

The Cisco IP phone is connected to an Ethernet switch using up to 100m of UTP Category 5 cable. It has a standard 10/100 Base T Ethernet port for connection to the switch, and another for local connection to a PC/workstation.

There are three methods of powering the IP phones:

- Inline Power
- External Power Patch Panel
- Wall Power

Solution 1: Inline Power

This method uses pins 1,2,3, and 6 of the 4 pairs in a category 5 cable to transmit power (-48V DC) supplied by the switch. It is referred to as inline or sometimes as phantom power because the power signals travel over the same two pairs used to transmit Ethernet signals. This is done in such a way that the power signals are completely transparent to the Ethernet signals and do not interfere with its operation. This method needs the new power enabled line cards for the switch. Currently such a line card is available for the Catalyst 6000 family switches with plans to extend the functionality to other catalyst switches over time.

Catalyst 600 Inline Power Linecard



© 2000, Cisco Systems, Inc.

www.cisco.com

CIPT v2.07 3-24

The new powered 10/100-line card (Product Number: WS-X6648A-PWR) for the Catalyst 6000 switches is exactly identical to the existing line card in terms of functionality with the addition of delivering -48V DC to the connected IP phone.

Using power-enabled cards for the Catalyst switch, power can be provided to the Cisco IP phone over the signal-carrying Ethernet pairs. The Catalyst first tests for the phone's presence, then applies power. By first testing for unique characteristics of the Cisco IP phone, then applying power using a low current-limit and for a limited time, the Catalyst avoids damage to other types of 10/100 terminating devices.

The switch performs phone discovery by sending a specific tone down the wire towards the IP phone. In its un-powered state this tone is looped back by the phone (using normally closed relay contacts) and sent back to the switch. When the switch receives this tone it knows that the device connected is a Cisco IP phone and it is safe to deliver -48V DC to the device. This behavior is exhibited only by Cisco IP phone. Other device(s) connected to the switch port do not loop the tone back and as such are safe from -48V DC being delivered to them. This hardware polling is done by the system at fixed intervals on a port by port basis until a link signal is seen or the system has been configured not to apply inline power to that port.

When the switch finds a phone using phone discovery, it will apply power to the device. The Cisco IP phone powers up, energizing the relay and removing the loopback (normally closed relay becomes open) between transmit and receive pairs. It also sends a link signal to the switch. From this point it functions as a normal 10/100 Ethernet device.

If the link signal is received within five seconds, the Catalyst concludes that the attached device is a Cisco IP phone, and maintains the power feed. Otherwise power is removed and the discovery process is restarted.

Once the Cisco IP phone is powered and responding, the phone discovery mechanism enters a steady state. Should the phone be removed, or the link interrupted, the discovery mechanism will start again. The port is checked every five seconds for a link packet, and in its absence, the test tone is generated.

The advantage of this mechanism is that power is supplied to the phone by the switch just like today's telephony environment. It is entirely possible that only two pairs have been terminated out of the four available for the data run between wiring closet and the desktop location. The inline power method allows customers to use the existing cable plant without any modification for deploying IP telephony.

The inline power method requires CatOS 5.5 (or higher) running on the Catalyst Switch. This release of the software has all of the enhancements required for proper operation. In particular, it has all of the necessary commands to control the operation of the switch as far as delivering power is concerned. The switch has an option of either providing power through the power-enabled line card or not to do so even if it has the ability.

Each port on the switch can be configured via the CLI (or SNMP or a config file) to be in either *Auto*, or *Off* modes as defined in the following way:

- **Auto:** Switch supervisor will tell the port to supply 48V to the phone only if it discovered the phone using the phone discovery mechanism that is, the Cisco IP phone discovered by the switch via the test tone in un-powered state. This is also the default behavior.
- **Off:** Switch supervisor will instruct the port not to apply power even if it can and knows

Verifying Inline Power Status

Command: `show port inlinepower <mod>|<mod/port>`

Output:

Default Inline Power allocation per port: 12.500 Watts (0.29 Amps @42V)
Total inline power drawn by module 7: 37.80 Watts (0.90 Amps @42V)

Port	InlinePowered			PowerAllocated	
	Admin	Oper	Detected	mWatt	mA @42V
7/1	auto	off	no	0	0
7/2	auto	on	yes	12600	300
7/3	auto	faulty	yes	12600	300
7/4	auto	deny	yes	0	0
7/5	on	deny	yes	0	0
7/6	on	off	no	0	0
7/7	off	off	no	0	0

© 2000, Cisco Systems, Inc.

www.cisco.com

CIPT v2.07 3-26

The figure above shows the CLI output that provides detail on the actual power consumed.

This leads to an important area with respect to available system power. Current Cisco IP phone model 7960 consumes 5W. The switch system should be equipped with appropriate power supplies to accommodate the required number of phones.

Note The new 2500W Power Supply for Catalyst 6000 family switches need 220V. It will work with 110V but will deliver 1300W. In addition it needs 20A regardless of whether it is plugged into 110V or 220V. This means that wiring closets must have 220V available in our example case.

Switch Configuration Example for Inline Power Mechanism

Configuring inline power:

- **Command:** `set port inlinepower <mod/port> <on/off/auto>`
- **Successful output:** `Inline power for port 7/1 set to auto.`
- **Failure output:** `Failed to set the inline power for port 7/1`

Configuring default allocation:

- **Command:** `set inlinepower defaultallocation <value>`
- **Successful output:** `Default Inline Power allocation per port: 10.0 Watts (0.24 Amps @42V)`
- **Failure output:** `Default port inline power should be in the range of 2000..12500 (mW)`

© 2000, Cisco Systems, Inc.

www.cisco.com

CIPT v2.0? 3-25

The figure above shows the CLI for configuring inline power parameters in CatOS. Along with the powering options, CatOS also provides option for setting the default power allocation that is, how much power (watts) will be applied on a per port basis. The default value is approximately 10W and is good for any Cisco IP phone model phone available and planned. The phone has the intelligence to report back how much power it actually needs (via CDP) and the switch will adjust the delivered power accordingly.

Inline Power Syslog Messages

Not enough power available:

%SYS-3-PORT_NOPOWERAVAL:Device on port 5/12 will remain unpowered

Link did not come up after powering on the port:

%SYS-3-PORT_DEVICENOLINK:Device on port 5/26 powered but no link up

Faulty port power:

%SYS-6-PORT_INLINEPWRFLTY:Port 5/7 reporting inline power as faulty

© 2000, Cisco Systems, Inc.

www.cisco.com

CIPT v2.0? 3-27

CatOS has the ability to send syslog messages to the console (or any other place if so configured) indicating any deviations from the normal as shown in the figure above.

In addition the system also maintains power status on a per port basis. This can be checked using **show port status**.

The CatOS has three different values:

- On: Power is being supplied by the port.
- Off: Power is not being supplied by the port.
- Power-Deny: System does not have enough power so the port does not supply power.

When the system is using dual supervisors, power management per port and phone status is synchronized between the active and standby supervisor. This is done on an on-going basis and is triggered with any change to the power allocation or phone status. All the high availability features designed in CatOS 5.5 and higher are useful in this scenario. The HA features are not affected in any way.

One last point on this subject is power protection schemes. This will be discussed in detail later on. Conceptually though, it is recommended that UPS (es) should be used for a higher degree of redundancy and availability.

Solution 2: Cisco Patch Panel



If the switch does not have a power enabled 10/100-line card (Product Number: WS-PWR-PANEL) or one is not available for the switch, then a Cisco patch panel can be inserted in the wiring closet between the Ethernet switch and the Cisco IP phone. This device is also known as Cisco Power Patch Panel.

The patch panel has a 250W power supply and draws its power from an 110V AC source. It can accommodate 48 ports and is capable of supplying -48V to each of the 48 ports. At 5W per Cisco IP phone model 7960, it has enough power for all the 48 ports. A UPS is recommended for back up in the event of a power failure. The patch panel uses CDP as a discovery mechanism and sends power using Pins 4, 5, 7, and 8 to the phone.

External Power through Patch Panel

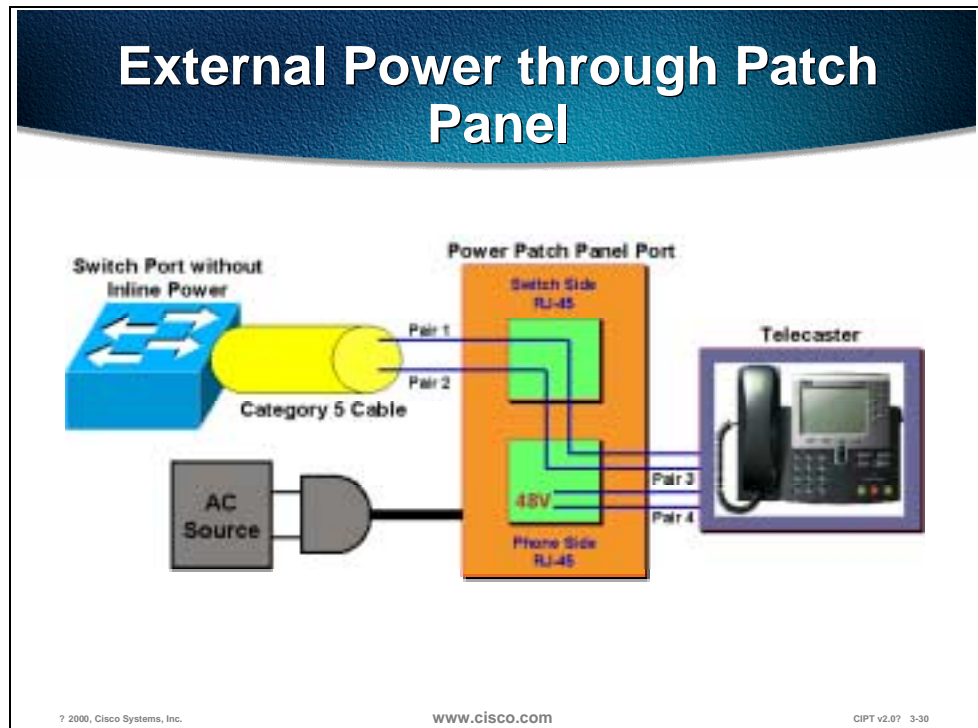

As seen in the figure above, Pins 1, 2, 3, and 6 from the switch are patched straight through to Pins 1, 2, 3, and 6 coming from the phone. Pins 4, 5, 7, and 8 from the phone terminate at the patch panel (Ethernet has no use for Pins 4, 5, 7, and 8) and -48V is applied across them to power the phone. The actual conductors used are pin 5 (pair 3) and pin 7 (pair 4) for -48V and ground return. This means that all four pairs in the Category 5 cable need to be terminated at the user's desk and in the wiring closet.

This power patch panel can operate in two different modes.

1. Discovery mode
2. Blast mode

In discovery mode, the patch panel will try to verify if the device connected to it is a Cisco IP phone or not. It does this by using the phone discovery mechanism outlined above in the inline power method. The only difference being, it will generate the test tone as opposed to the switch.

To summarize, if there is no link signal detected on the port, patch panel will send down a test tone and if it sees the tone come back within a specified period of time it knows that the device is a Cisco IP phone. If the tone does not come back in the specified time then it knows the device is not a Cisco IP phone. Once it has determined that the device is a Cisco IP phone, it will apply power (-48V) to the port and from that point on it will keep -48V applied as long as there is link signal.

In blast mode, the patch panel does not perform phone discovery. It will start applying power immediately.

Solution 3: Wall Powered

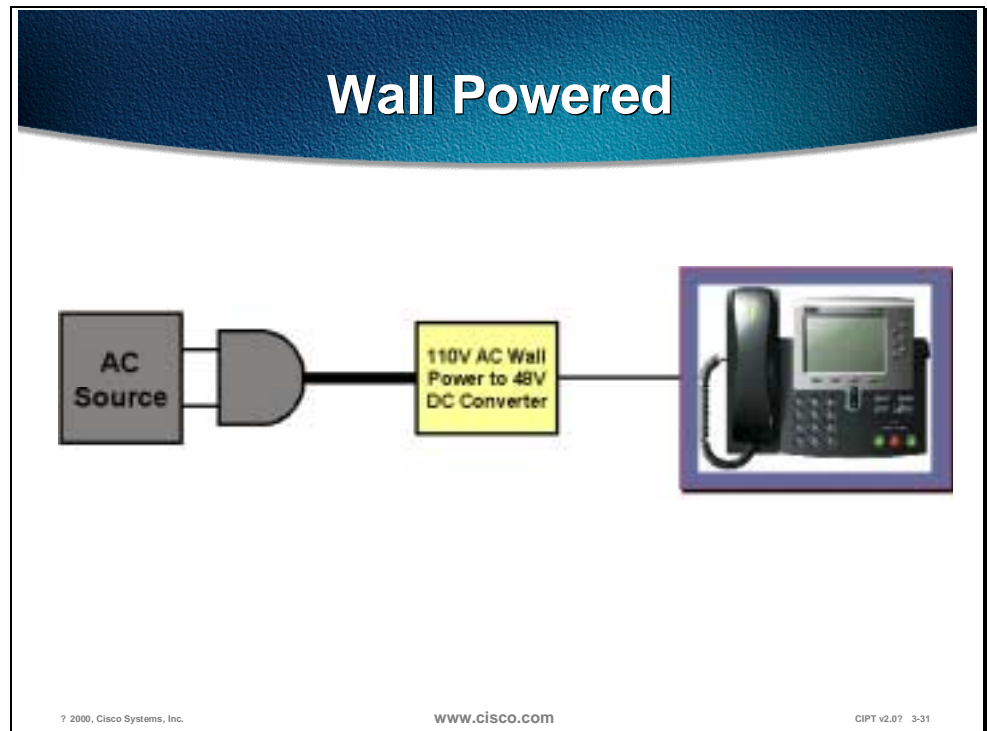

The figure above shows that the Cisco IP phone can be powered from a local transformer module plugged into a nearby (maximum 3 meters) electrical outlet.

A combination of these power options can be used to provide redundant power to the Cisco IP phone. Internally these three sources are combined through protection diodes, so that whatever combination is used, the phone will share the power. This provides redundancy; if one power source fails, the other(s) will continue to power the Cisco IP phone.

Power Protection Strategies

This section describes ways to protect power that supports IP telephony.

Power Protection Strategies

- **Back-up the wiring closet switches and downstream data center using UPS**
- **Back-up the whole building using UPS**
- **Provide a separate generator for power (besides the feed from utility company) and use it as back up**

© 2000, Cisco Systems, Inc. www.cisco.com CIPT v2.07 3-32

Reliable power is vital to support IP telephony. In order to build a reliable and highly available infrastructure, equipment can be protected from power failures using UPS. Each UPS has some amount of battery that will keep the equipment running for a certain period of time. UPS can be configured with the appropriate amount of battery for desired results.

Some common strategies are:

- **Back-up the wiring closet switches and downstream data center using UPS.** This will keep the phones up. Wall powered devices like PCs may still go down.
- **Back-up the whole building using UPS.** This will protect all devices and equipment from power failures. Protecting PCs in this fashion is useful because of the new breed of highly available data applications.
- **Provide a separate generator for power (besides the feed from the utility company) and use it as back up.** UPS may still be needed in this case because it usually takes a few minutes for the generator to ramp up. The upside is there is less battery time needed for each UPS.

In addition, UPS can be configured with options like SNMP Management, Remote Monitoring, Alarm Reporting, and so forth.

For more information please visit:

www.apcc.com

Written Exercise 1: Enterprise Network Infrastructure

Complete the following exercise to practice what you learned in this chapter.

Objective

In this exercise you will complete the following task: identify the three layers in a typical enterprise network.

Task: Identify the three layers of a typical enterprise network.

Given what you know about an enterprise network, identify the three layers of a typical enterprise network in the figure below.

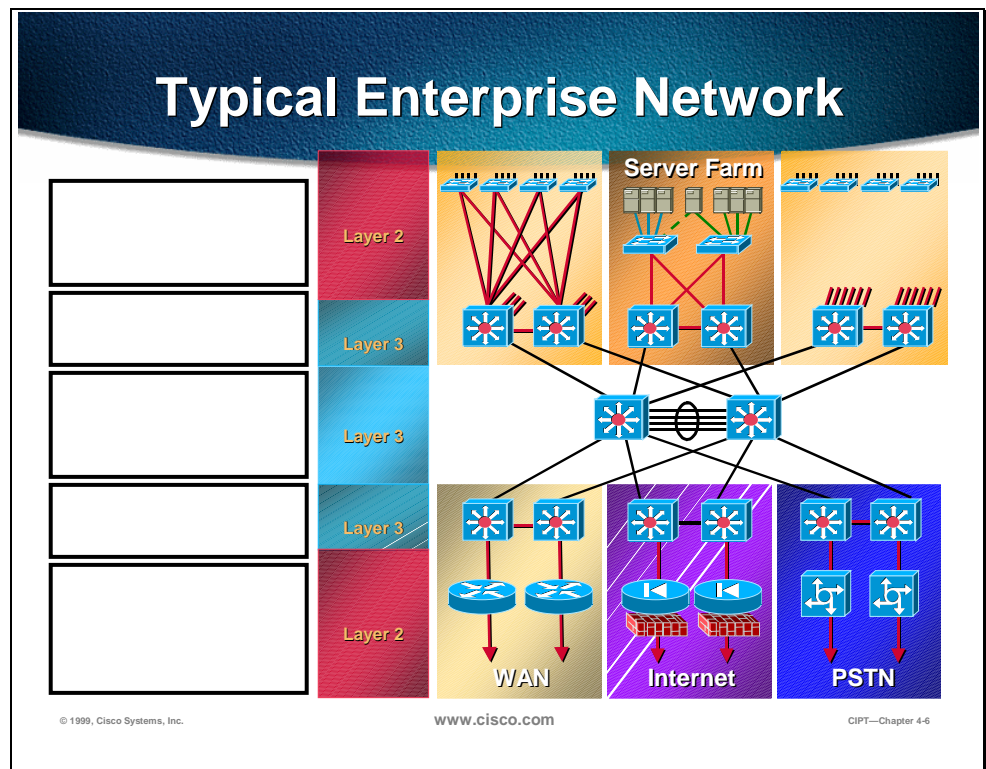

Completion Criteria

You have completed this exercise when you have filled in all the blank boxes in the figure above.

Written Exercise 2: Catalyst Family of Switches

Complete the following exercise to practice what you learned in this chapter.

Objective

In this exercise you will complete the following tasks: Identify the capabilities of the following catalyst switches:

- Catalyst 6000
- Catalyst 5000
- Catalyst 4000
- Catalyst 3500

Task: Identify the capabilities of the Catalyst Family of Switches

Given what you know about the capabilities of the Catalyst Family of Switches, identify with a “Y” for yes and “N” for No the capabilities of the following switches:

- Catalyst 6000
- Catalyst 5000
- Catalyst 4000
- Catalyst 3500

Capabilities within the Catalyst Family of Switches

Capabilities	Catalyst 6000	Catalyst 5000	Catalyst 4000	Catalyst 3500
Ability to Trust				
Re-Classify CoS				
Re-Classify ToS				
Congestion Avoidance (WRED)				
Priority Queue				
Multiple Queues				
Congestion Management (WRR)				
Policing				

© 1999, Cisco Systems, Inc.

www.cisco.com

CIPT—Chapter 4-8

Completion Criteria

You have completed this exercise when you have filled in the blank spaces in the table.

Summary

This section summarizes the concepts you learned in this chapter.

Summary

- **Cisco IP telephony requires an IP infrastructure based on layer 2/3 switches and routers.**
- **There are three connectivity options to the desktop.**
- **IP phones need IP addresses.**
- **QoS protects voice from other traffic on the network.**
- **There are ways to power Cisco IP phones.**

? 2000, Cisco Systems, Inc. www.cisco.com CIPT v2.0? 3-33

The network infrastructure needs to be based on Layer 2/3 switches and routers to build a Cisco IP telephony solution. To ensure that the Cisco IP phones are connected using switched 10/100 ports, a switched connection to the desktop is required. The three connectivity options to the desktop are the following:

- Single cable—Connect the IP phone to the wall and the PC to the IP phone.
- Multiple cables—Each endpoint device (phone and PC) connect to the wall.
- Soft phone—Soon to come, one connection with a phone application on the PC.

Cisco IP phones are IP devices that need IP addresses. The IP address information can be done using one of the following options:

- Provide an IP address in the same subnet as the existing data device
- Redo the entire IP addressing plan for the organization
- Create a new subnet and use that for IP phones

In a converged environment, all traffic types travel over a single transport infrastructure. You need to employ proper tools to ensure that the delay and loss parameters of voice traffic are satisfied. The tools allow you to ensure that the required quality of service is available as features in phones, switches, and routers.

The Cisco IP phones can use one or more of the following three methods of getting power; inline power, external power, and wall power.

Review Questions

Answer the following questions.

Review Questions

- 1. What are the three network layers of a typical enterprise network?**
- 2. What are the IP addressing options to accommodate Cisco IP phones?**
- 3. Inline power to the phones uses which pairs?**
- 4. When QoS tools are used, where should the trust boundary be established?**

© 2000, Cisco Systems, Inc. www.cisco.com CIPT v2.0? 3-34

- Q1) The typical enterprise network layer consists of three network layers. What are the three network layers?
- Q2) Cisco IP phones need IP addresses. What are the IP addressing options that can be used to accommodate the Cisco IP phones?
- Q3) Inline power is an option to power the Cisco IP phones. Which pairs are used to provide inline power to the Cisco IP phones?

- Q4) QoS tools are used to protect voice traffic from all other types of traffic. Where should the trust boundary be established?

Laboratory Exercise

Distributed Call Processing

Overview

In this deployment scenario, Cisco CallManagers, voice messaging, and digital signal processor (DSP) resources are located at each site. This deployment model can initially support up to 10 sites networked across the IP WAN. Voice calls between sites use the IP WAN as the primary path and the PSTN as the secondary path in the event the IP WAN is down or has insufficient resources to handle additional calls. Whether calls use the IP WAN or use the PSTN is transparent to both the calling party and the called party. This chapter emphasizes issues specific to the distributed call processing model, with reference to relevant material in other sections of this guide.

The following topics are in this chapter:

- Objectives
- Call Admission Control
- Dial Plan Considerations
- CallManager Cluster Considerations
- DSP Resource Provisioning for Transcoding and Conferencing
- Summary
- Review Questions

Objectives

This section lists the chapter objectives.

Objectives

Upon completion of this chapter, you will be able to perform the following tasks:

- **Identify design characteristics in building a CIPT WAN deployment using Distributed Call Processing**
- **Configure the IOS gatekeeper and dial plans to use the IP WAN link without oversubscribing**
- **Configure the each site to have a redundant path using an ISDN or PSTN path.**

© 2000, Cisco Systems, Inc. www.cisco.com CIPT v2.0—14-3

Upon completion of this chapter, you will be able to perform the following tasks:

- Given a list of Cisco IP telephony characteristics identify the design characteristics for building a CIPT WAN deployment using distributed call processing.
- Given two isolated campus CIPT solutions, configure a IOS gatekeeper and dial plans to use the IP WAN link without oversubscribing the link.
- Given a CIPT WAN deployment solution, configure each site to have a redundant path using an ISDN or PSTN path.

Visual Objective

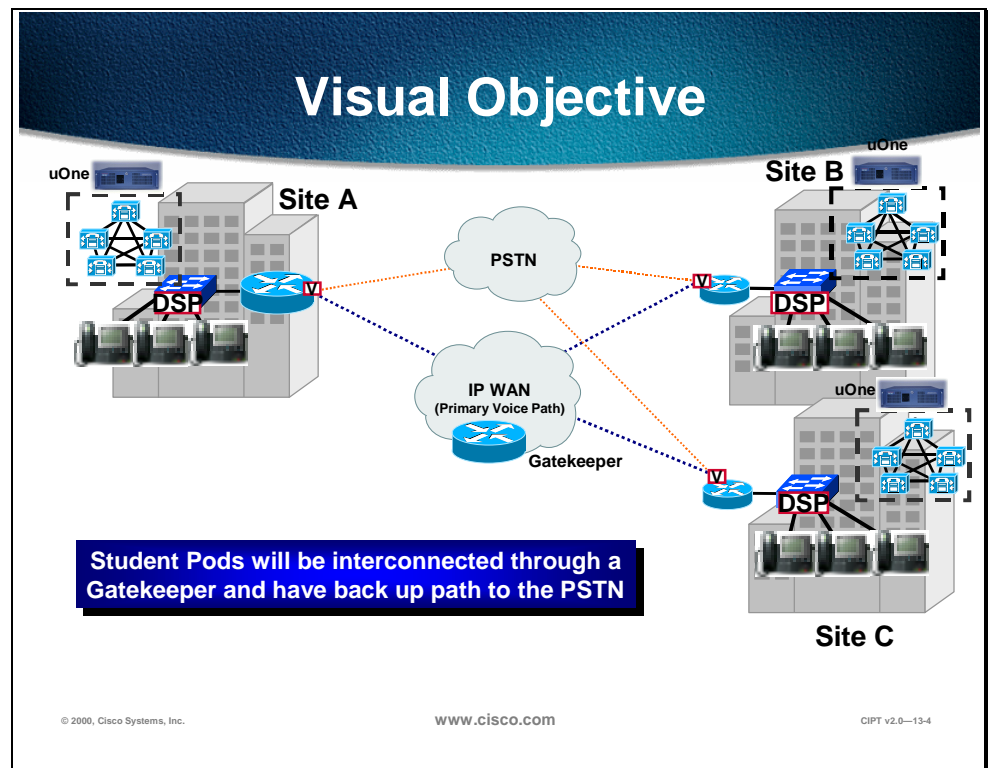

Using the isolated campus deployments, you will interconnect and configure gateways, gatekeeper, and dial plan architecture to place phone calls over the IP WAN. Configure a back-up path to the PSTN if the IP WAN is congested or oversubscribed.

Call Admission Control

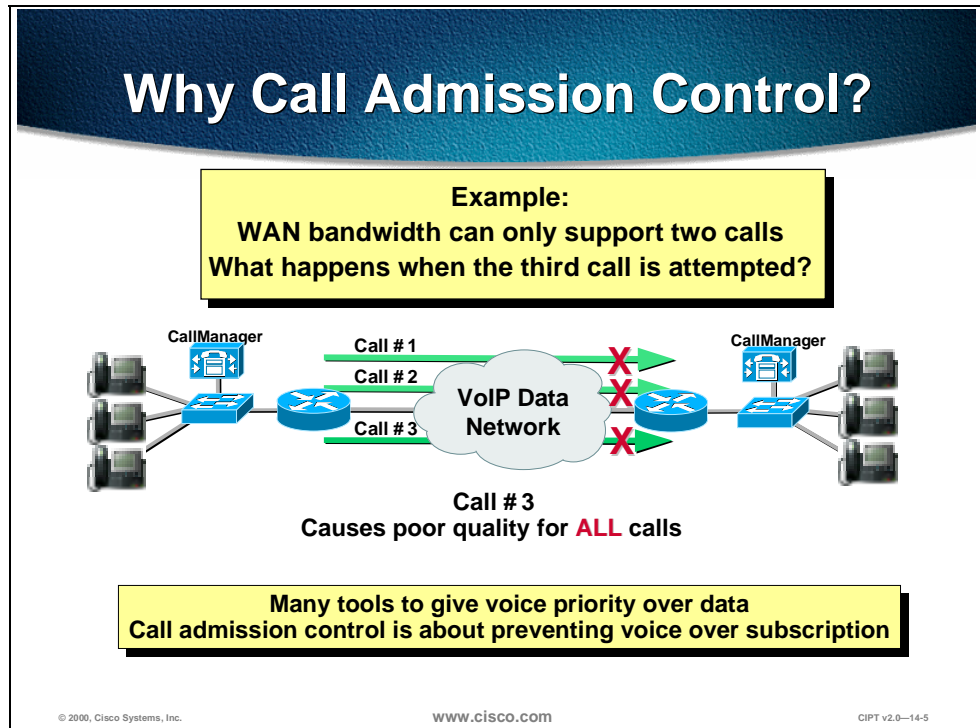

QoS tools ensure voice quality in two ways: by giving voice priority over data and by preventing voice from oversubscribing a given WAN link. The second task is accomplished by call admission control (CAC) mechanisms. The need for CAC in AVVID networks is amplified greatly by the fact that all IP phones have an open IP path to the WAN whereas toll bypass networks, in contrast, could limit the number of physical trunks eligible to initiate calls across the WAN.

Gatekeeper Based Admission Control

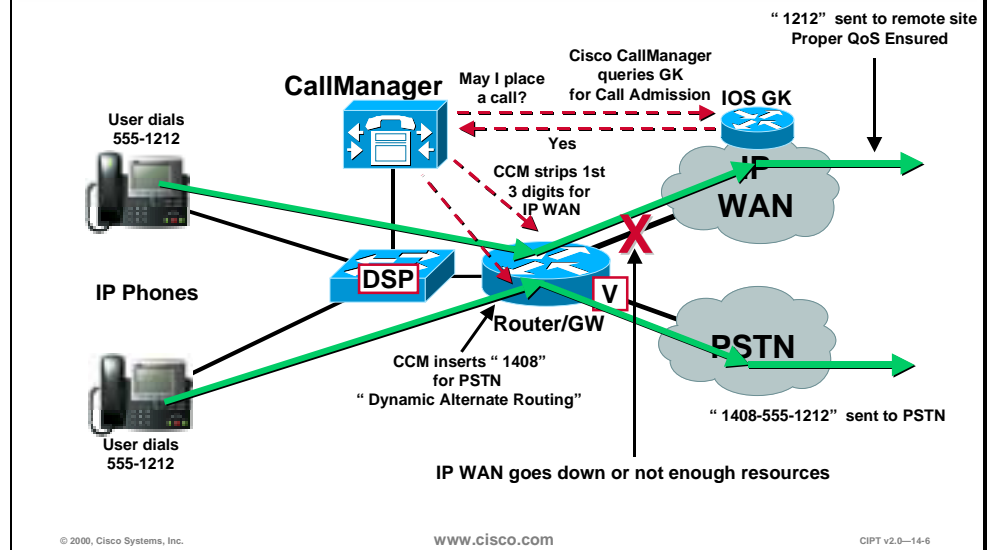

For deployments of the distributed call processing model, use the H.323 gatekeeper controlled method to provide CAC. In this design, the CallManager registers with the Cisco IOS gatekeeper, also known as Multimedia Conference Manager (MCM), as a VoIP gateway and queries it each time it wants to make an IP WAN call. The Cisco IOS gatekeeper associates each CallManager with a *zone* that has specific bandwidth limitations. Thus the maximum amount of bandwidth consumed by IP WAN voice calls in or out of a zone can be limited by the Cisco IOS gatekeeper.

In brief, when the CallManager wants to place an IP WAN call it first requests permission of the gatekeeper. If the gatekeeper grants the call it is placed across the IP WAN. If the gatekeeper denies the request the CallManager places the call across the secondary path, the PSTN.

This is effectively a call accounting method of providing admission control in which the gatekeeper simply keeps track of the bandwidth the IP WAN calls consume. The maximum bandwidth setting for a zone should take into account the limitation that the WAN link not be filled with more than 75% voice.

Note In this scheme, IP phones are not mobile between sites. Should an IP phone register across the WAN, admission control would not operate as designed.

In this model it is important that the dial plan be tightly coupled with the gatekeeper CAC mechanism because it is the dial plan that ultimately decides when to place a call across the IP WAN and what to do if the gatekeeper rejects it.

CallManager and Gatekeeper Interaction

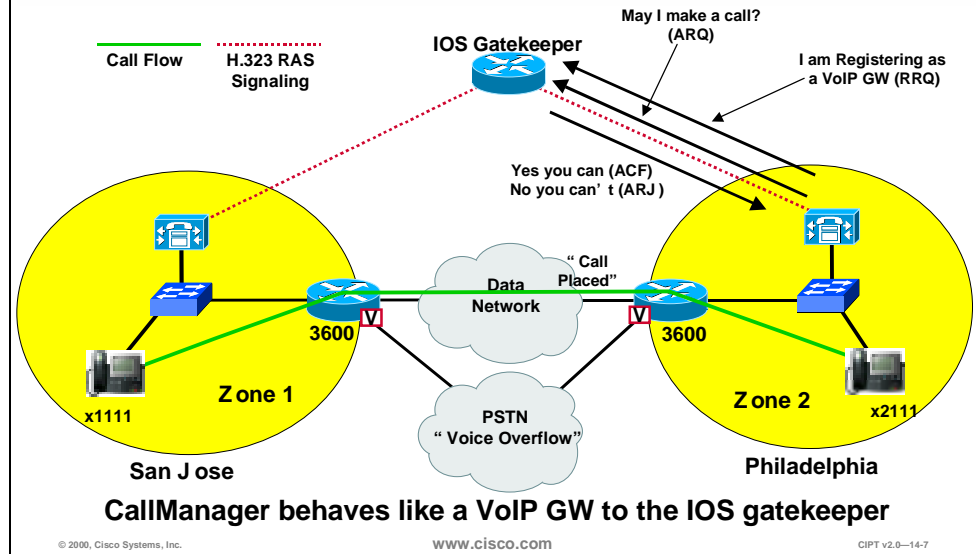

Communication between sites that have a CallManagers or CallManager cluster requires the use of H.323v2. This means that a remote CallManager or CallManager cluster must be configured as an inter-cluster H.323 device. Within the CallManager configuration for an H.323 device you can configure the device to be gatekeeper controlled and specify the gatekeeper to be queried. This means that before the CallManager sets up a call with a remote CallManager it must first send an admission request (ARQ) with the requested bandwidth to the gatekeeper.

This remote CallManager is then placed in a route group, which can be associated with various route patterns for IP WAN calls. This route group would be configured as the first choice route group in a route pattern or route list; the route group associated with the PSTN would be configured as the second choice if the gatekeeper rejected the call. In this way the call can be transparently routed across the PSTN if the IP WAN is unavailable.

- For each and every remote gatekeeper controlled H.323 device entered, the CallManager registers a *separate* VoIP gateway with the gatekeeper. This means that if a CallManager can call 10 remote sites using the H.323 gatekeeper, then it registers 10 separate VoIP gateways with the gatekeeper. For each H.323 CallManager, the CallManager registers the sending and destination addresses in hexadecimal with the gatekeeper. These characteristics are attributable to the 10 site limit for the distributed call processing in CallManager 3.0(1). This is targeted to be enhanced in CallManager 3.0(2).
- The actual IP WAN bandwidth allocated for a call is defined by putting the remote H.323 CallManager in a region with which bandwidth can be associated when IP WAN calls must be made to it. Valid codec selections for this are G.711 (80 kbps), G.729 (24 kbps), and G.723 (20 kbps).

Note With CallManager Release 3.0(1) 128 kbps is *a/ways* requested in the ARQ, regardless of the IP WAN codec to be used. This requires the use of a single WAN codec for all IP WAN calls, as well as using a fudge factor to determine the maximum amount of bandwidth entered in the IOS gatekeeper. In effect, every 128 kbps entered in the gatekeeper equates to one call at 80 kbps or 24 kbps, depending on the WAN codec selection. This is further explained later in this section.

CallManager Registration Characteristics

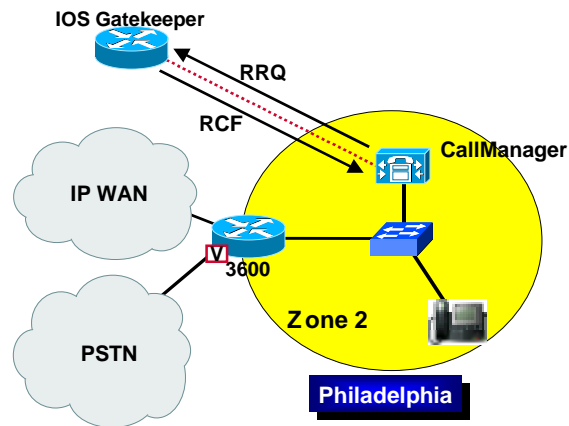

© 2000, Cisco Systems, Inc.

www.cisco.com

CIPT v2.0-14-8

The IOS Gatekeeper (GK) uses a zone subnet filter to place CallManager with a Zone. Each remote Cisco CallManager must configure across the IP WAN as a “GK Controlled” H.323 Inter-cluster trunk. Every GK Controlled remote Cisco CallManager as a *separate* VoIP Gateway (GW) with the gatekeeper. For example; for 9 remotes, a Cisco CallManager will register as 9 VoIP GWs. The Cisco CallManager registers IP SA/DA (in hexadecimal) of remote Cisco CallManager as fully qualified name, however the Cisco CallManager cannot yet register E.164 address or E.164 address range.

The Cisco CallManager sends Full Registration Repeat Request (RRQ) every minute (default). This timer is configurable and Cisco CallManager does not use H.323v2 lightweight registration. The Gatekeeper will then respond with a Registration Confirmation (RCF).

Remote CallManager Cluster across IP WAN Configuration

The screenshot shows the Cisco CallManager Administration interface for Gateway Configuration. The page title is "Gateway Configuration" and the device is identified as "H.323 Gateway: 10.1.30.20". The device profile is set to "Inter-Cluster Trunk". The configuration fields include:

- Device Name: 10.1.30.20
- Device Pool: IPWAN-GT33
- Calling Search Space: (Restricted)
- Caller ID EN: (None)
- Calling Party Codec: (G.711)
- Registration SIP: (None)
- Gatekeeper Registration: (Remote)
- Gatekeeper Name: 10.1.30.20
- Media Termination Point: (None)

Four callout boxes with red arrows point to specific fields:

- Defining H.323 GW as an "Inter-Cluster Trunk" (Remote Call Manager)**: Points to the "Device Profile" dropdown.
- Remote H.323 Device (Call Manager IP Address) Device Pool to define CODEC used for calls to this device**: Points to the "Device Pool" dropdown.
- Where this device may call (Incoming Calls)**: Points to the "Calling Search Space" dropdown.
- Enabling device as Gatekeeper Controlled (Will register IP SA/DA with Gatekeeper) Gatekeeper IP Address**: Points to the "Gatekeeper Name" field.

© 2000, Cisco Systems, Inc. www.cisco.com CIPT v2.0-14.9

Each remote Cisco CallManager must configure across the IP WAN as a GK Controlled H.323 Inter-cluster trunk. The Gateway Configuration page in the Cisco CallManager Administration is where an administrator would define H.323 as an Inter-Cluster Trunk.

The device name is the IP address of the remote Cisco CallManager. The device pool that this is placed in will define the codec used for calls and the Gatekeeper registration needs to be set to remote. The gatekeeper IP address is used to be the name of the Gatekeeper Name.

Calling Search Space is used on this page to define where this device (remote Cisco CallManager) may call.

CallManager ARQ Characteristics

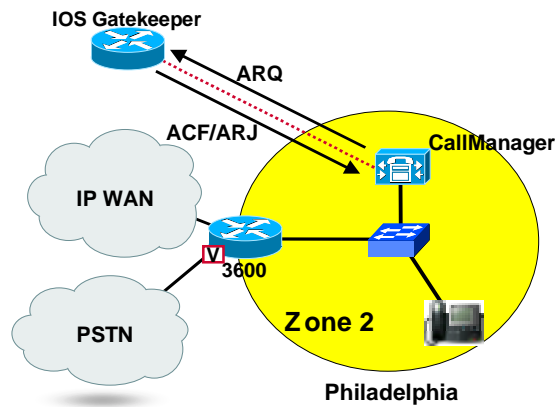

© 2000, Cisco Systems, Inc.

www.cisco.com

CIPT v2.0-14-10

Cisco CallManager does not use E.164 in Automatic Repeat Request (ARQ) and the ARQ the Cisco CallManager uses SA/DA in hexadecimal of the target H.225 device. Cisco CallManager cannot use returned IP address in the advanced communications function to be used for H.225 target address. This means a H.323 device for every remote Cisco CallManager.

The bandwidth always issued in the ARQ regardless of codec type is 128kbps. This requires use of single WAN CODEC with a fudge factor for maximum bandwidth entered in IOS gatekeeper:

- G.711 (80kbps) = 128kbps in GK
- G.729 (24kbps) = 128kbps in GK

Incoming Call from IP WAN Characteristics

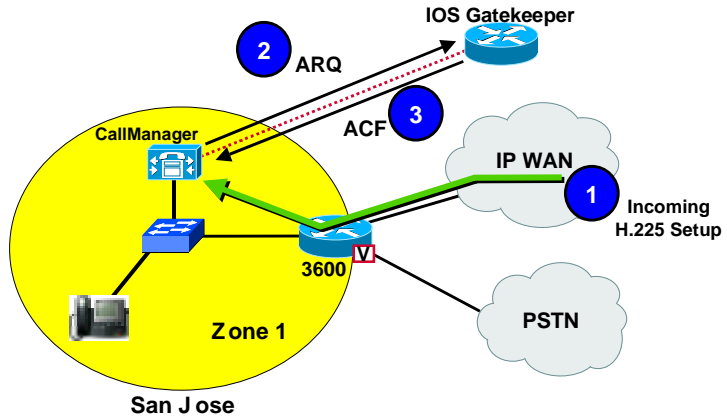

© 2000, Cisco Systems, Inc.

www.cisco.com

CIPT v2.0-14-11

When an IP WAN is incoming the terminating Cisco CallManager identifies incoming CallManager SA/DA combination in H.225 setup by using SA/DA in ARQ. In the ARQ, 128kbps are used and upon ACF the call is allowed to proceed.

Detail of Successful Call Flow Call from 1111 to 2222

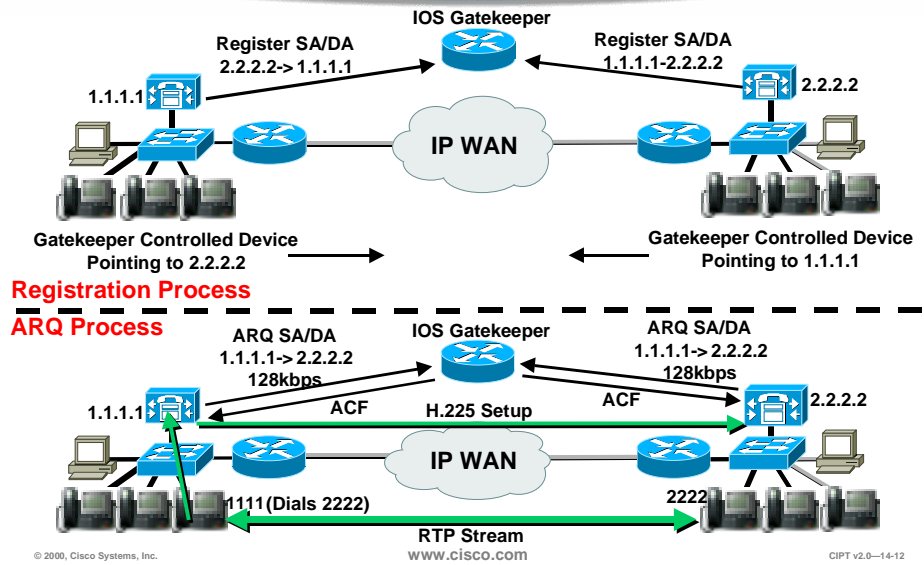

© 2000, Cisco Systems, Inc.

www.cisco.com

CIPT v2.0-14-12

Gatekeeper Configuration

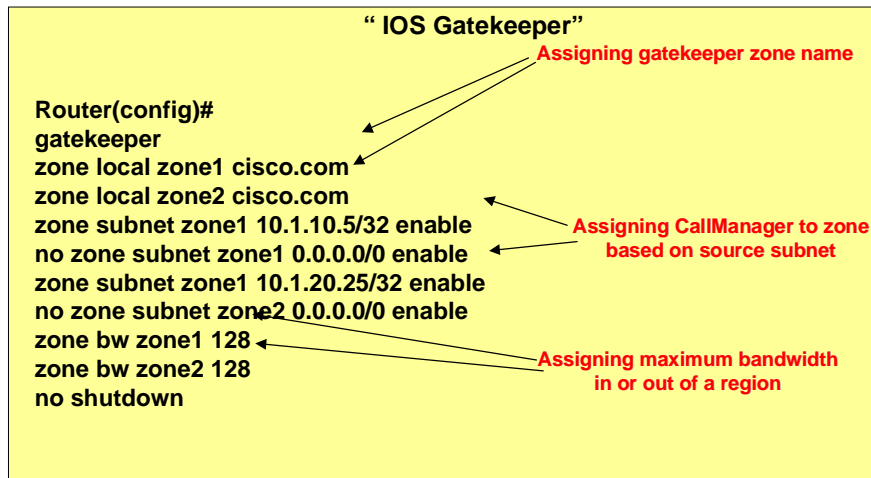

© 2000, Cisco Systems, Inc.

www.cisco.com

CIPT v2.0-14-13

The gatekeeper should use a configuration similar to the above example. Assigning Gatekeeper Zone name is done using the command **zone local zone1 cisco.com**. Assigning Cisco CallManager to zone is based on the source subnet such as, **zone subnet zone1 10.1.10.5/32 enable**. The maximum bandwidth either in or out of a region is assigned using the command, **zone bw zone1 128**. The bandwidth example would be that there is 128 kbps between the CallManager and the gatekeeper.

Deployment Considerations for Call Admission Control

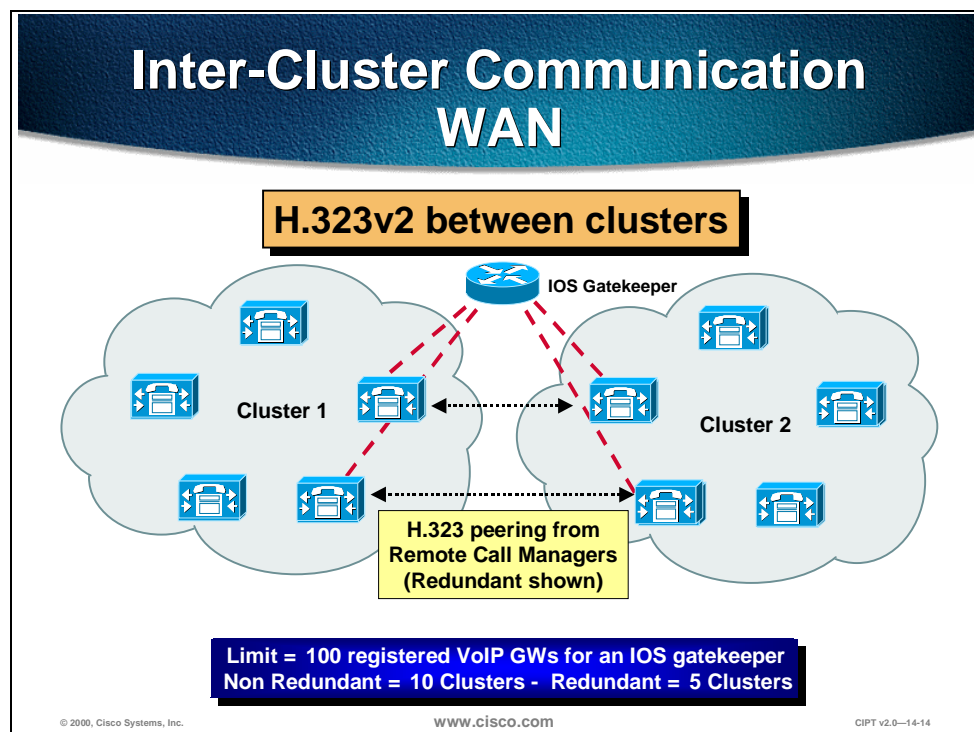

When multi-site WAN deployments involve CallManager clusters, only one CallManager in the cluster can register with the gatekeeper. This is configurable in the CallManager group configuration. All remote sites that need to call a remote CallManager cluster must have the H.323 device point to the CallManager in the remote cluster that registers with the gatekeeper. Redundant H.323 devices between campus clusters are supported as long the gatekeeper is not being used for communications between them.

For example, Cluster 1 needs to have H.323 device(s) pointing to Call Manager(s) in Cluster 2 that are *registered with the IOS GK* (and vice versa). The Cisco CallManager group used to determine which Cisco CallManager in a cluster registers with the gatekeeper. When using two gatekeepers in a redundant fashion and the primary one fails, the second gatekeeper becomes the primary with no knowledge of existing calls. This poses the possibility that poor quality could result from the new primary gatekeeper allowing too many calls in addition to existing calls of which it is unaware. This is a short-term situation that resolves when existing calls are terminated.

Mobility of devices between sites is not possible unless a new number is assigned to the device to ensure that a device uses the local CallManager for call processing.

The gatekeeper must be the IOS MCM. Recommended platforms are the Cisco 2600 or Cisco 3600 with IOS Cisco Release 12.0(7)T or greater.

Multi-site WAN Topologies

Hub and Spoke Topologies

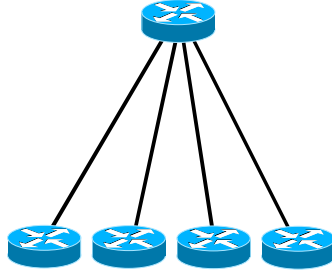

Admission Control + Capacity Planning

Ensure voice traffic at every site does not exceed configured WAN bandwidth

Minimum requirements for voice, video and data should not exceed 75% of link or VC bandwidth

(Remaining 25% for routing protocol updates and link layer header BW consumption and so forth)

Required Link Capacity =

$$(\text{Min BW for Voice} + \text{Min BW for Video} + \text{Min BW for Data}) / 0.75$$

© 2000, Cisco Systems, Inc.

www.cisco.com

CIPT v2.0-14-15

A maximum of 10 sites can be networked across the IP WAN in multi-site WAN deployments with distributed call processing. Only hub and spoke topologies are supported. Only one active IOS gatekeeper can be used with CallManager 3.0(1) with no more than 10 CallManagers registered with the gatekeeper. An HSRP backup gatekeeper can be used. CallManager 3.0(2) is targeted at using multiple gatekeepers in a hierarchical approach.

Networking Across IP WAN

Requires full mesh of H.323 devices and route patterns

H.323 device + route pattern for remote locations

IOS Gatekeeper

10 Sites

Total of 90 H.323 devices and route patterns

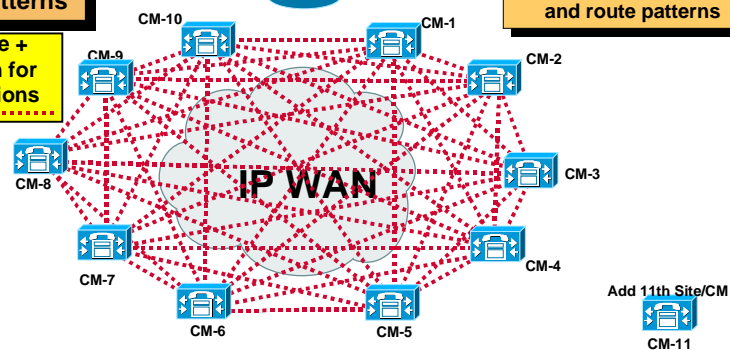

Add 11th Site

1. For 11th site must add H.323 device + route pattern for every other site
2. For other 10 sites must add H.323 device and route pattern for 11th site

© 2000, Cisco Systems, Inc.

www.cisco.com

CIPT v2.0-14-16

Dial Plan Considerations

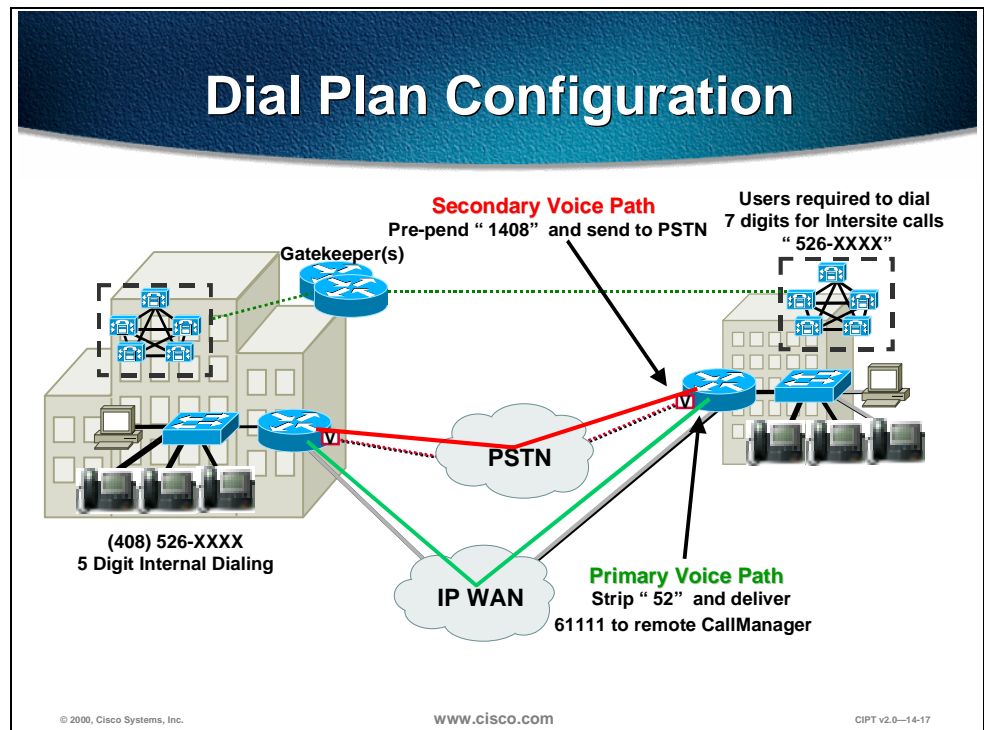

In the example depicted in the figure above, users dial five digits for internal calls and seven digits for inter-site calls across the IP WAN. If the IP WAN is down or has insufficient resources, the PSTN is used transparently for inter-site calls. For long distance calls that will be directed to the PSTN, users dial the access code 9 followed by 1 + area code and 7-digit number. Users dialing local PSTN calls dial 9 plus the 7-digit number. This model also provides gateway redundancy in the event of a gateway or trunk failure to the PSTN. The PSTN gateways are IOS gateways using H.323.

The goal of this dial plan is to be able to dial the San Jose location using only seven digits where calls take the IP WAN as the first choice and the PSTN as the second choice. Thus, users in Philadelphia should be able to dial San Jose users at (408) 526-XXXX by simply dialing 526XXXX.

Typical Route Pattern Configuration(Philadelphia)

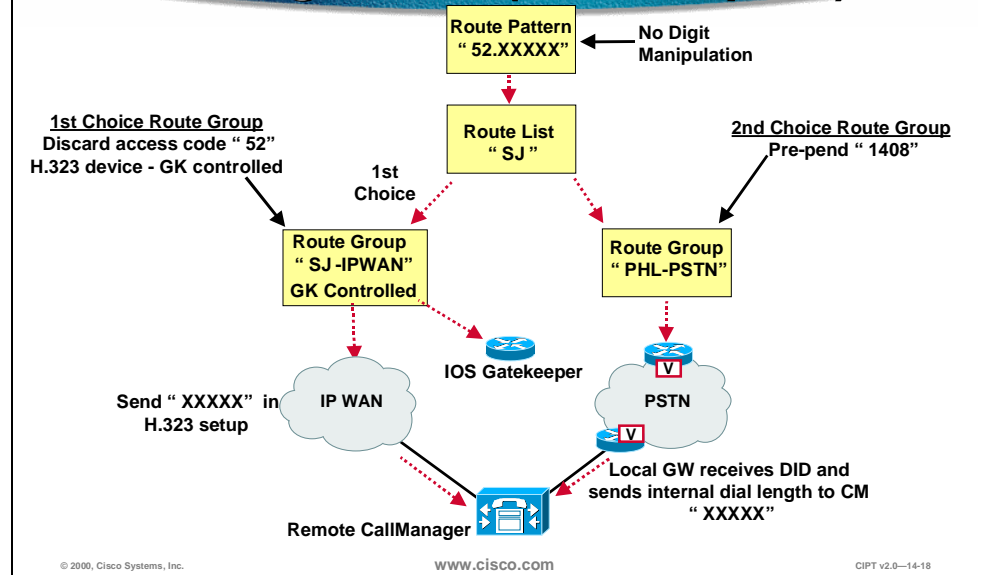

This configuration begins at the route pattern. A route pattern is entered as 52.6XXXX with an assigned route list as SJ. The location of the dot (.) signifies that all digits to the left comprise the access code for this route pattern. Also, no digit manipulation is selected or required, because each route group needs to invoke its own unique manipulation.

The route list contains two route groups, SJ-IPWAN and PHL-PSTN, listed in order of priority. The SJ-IPWAN route group is listed first and points to the San Jose CallManager. The digit manipulation specified in route pattern SJ-IPWAN discards the access code (52). This ensures that when the call is sent across the IP WAN, five digits are delivered to the remote CallManager; this is required because of its internal dial length. The H.323 device associated with the remote CallManager must be configured to be gatekeeper controlled to ensure that the gatekeeper is consulted before attempting the call across the IP WAN.

If the gatekeeper rejects the call, the route list uses the next route group, PHL-PSTN. This route group is configured to pre-pend 1408 to the dialed number to ensure that the call transparently reaches the other end.

Bandwidth Consumption of Dialed Number

Recommended Bandwidth Configuration

Inter-Cluster Calls Using G.729

Number of Inter-Cluster Calls	Bandwidth Required per Call		Bandwidth Required on WAN Links (LLQ/CBWFQ ¹)		Bandwidth Configured on Gatekeeper	
	Without cRTP ²	With cRTP	Without cRTP	With cRTP	Without cRTP	With cRTP
2	24 Kbps	12 Kbps	48 Kbps	24 Kbps	256 Kbps	256 Kbps
5	24 Kbps	12 Kbps	120 Kbps	60 Kbps	640 Kbps	640 Kbps
10	24 Kbps	12 Kbps	240 Kbps	120 Kbps	1.280 Mbps	1.280 Mbps

1. Low latency queuing/class based weighted fair queuing
2. Compressed Real-time Transport Protocol

© 2000, Cisco Systems, Inc. www.cisco.com CIPT v 2.0—12-33

Recommended Bandwidth Configuration

Inter-Cluster Calls Using G.711

Number of Inter-Cluster Calls	Bandwidth Required per Call	Bandwidth Required on WAN Links (LLQ/CBWFQ)	Bandwidth Configured on Gatekeeper
2	80 Kbps	160 Kbps	256 Kbps
5	80 Kbps	400 Kbps	640 Kbps
10	80 Kbps	800 Kbps	1.280 Mbps

© 2000, Cisco Systems, Inc. www.cisco.com CIPT v 2.0—12-34

The tables above provide recommendations for bandwidth configuration for inter-cluster calls. Use these tables to ensure enough bandwidth between clusters to ensure quality voice.

Codec Selection Based on Regions

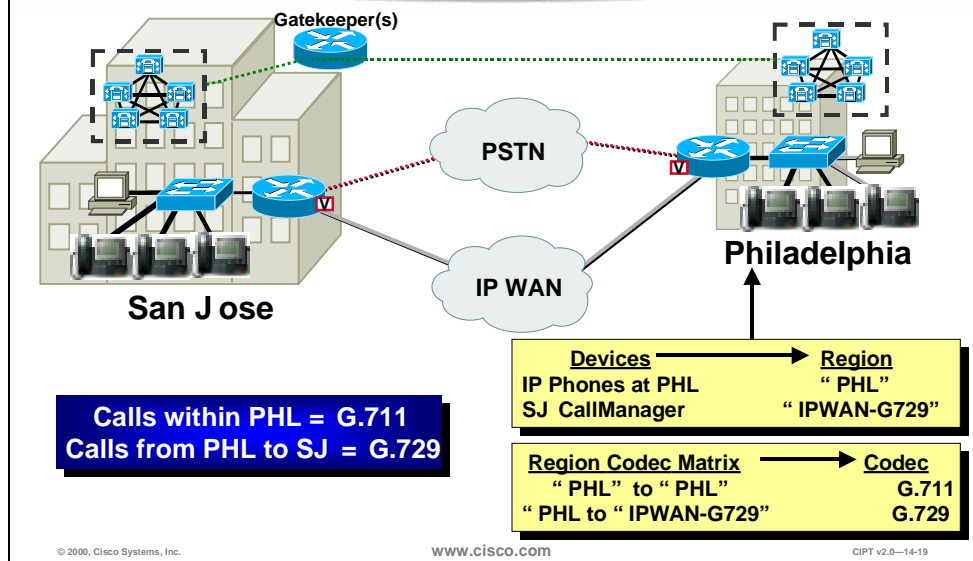

Bandwidth consumed by calls between devices, such as IP phones and gateways, can be controlled by dictating codec usage when setting up regions. Devices are placed in regions that have a codec specified for all intra-region calls; a particular code can likewise be specified for inter-region calls. Regions are assigned to devices using a device pool. The supported codecs defined in regions are G.711, G.729, and G.723 (G.723 is only supported on the Model 12 SP+ and the Model 30 VIP IP phones). The figure above illustrates the use of regions for distributed call processing environments where often only two regions need be assigned.

Just one WAN region is associated with *all* H.323 devices across the IP WAN because of the single codec restriction. In the future, multiple WAN regions will be supported.

CallManager Cluster Considerations

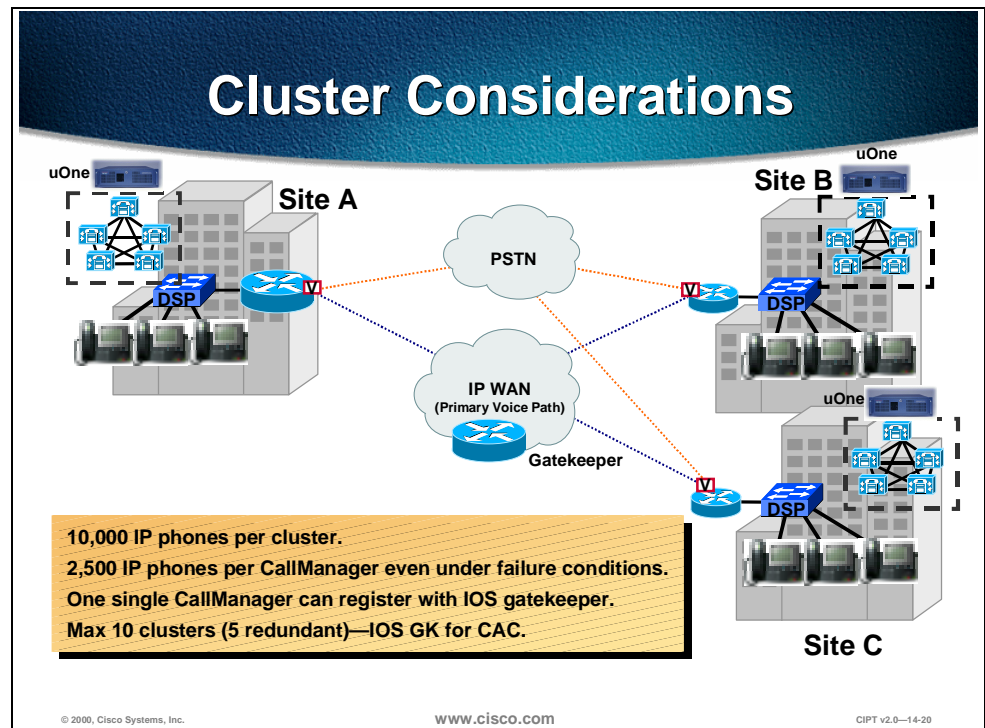

The following design considerations apply for CallManager clusters in a distributed call-processing environment using CallManager 3.0(1):

- Each CallManager cluster can support 10,000 users.
- No more than 2500 users can be registered on any given CallManager, even under failure conditions.
- Only a single CallManager within a cluster can register with the IOS gatekeeper.
- We recommend that only a single CallManager within a cluster be allowed to register with the gatekeeper. If a second is configured for redundancy, then only five sites can be deployed in this manner.

The major design consideration regarding CallManager clusters in this type of deployment is how the H.323 peering is achieved between clusters. Based on the way that CallManager 3.0(1) registers with the gatekeeper, we recommend that no redundant peering occur between clusters. This is targeted to change in the CallManager 3.0(2) time frame.

DSP Resource Provisioning for Transcoding and Conferencing

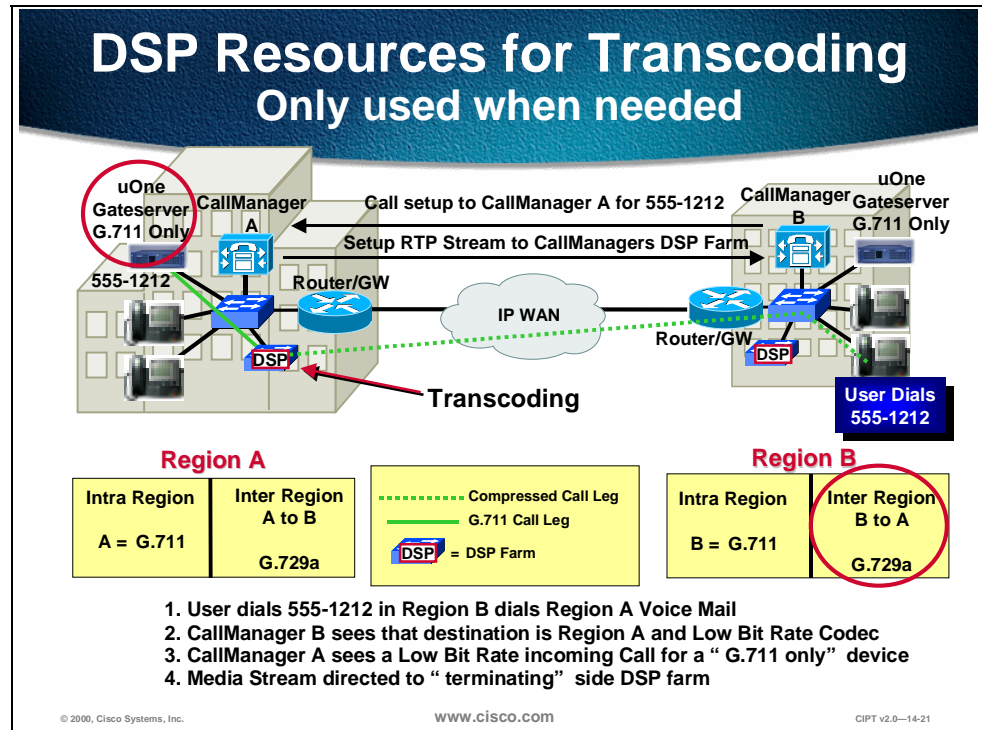

This section briefly considers DSP resources in distributed call processing environments. In multi-site WAN deployment with distributed call processing, each site is required to have DSP resources for conferencing and for transcoding across the IP WAN. Conferencing and transcoding services are enabled by the Media Termination Point (MTP) application.

The main purpose of transcoding DSP resources is to perform conversion between different codec types in an RTP stream in the event of a codec mismatch. For example, a compressed G.729 media RTP stream across the IP WAN might need to terminate on a device that only supported G.711. The transcoding DSP resource would terminate the G.729 media stream and convert it to G.711. This allows the media stream to remain compressed across the WAN. The figure above depicts the function of DSP resources across the IP WAN in the following steps:

- Step 1** Caller 555-1212 in region B dials region A voice mail.
- Step 2** CallManager B sees that the destination is region A, LBR codec.
- Step 3** CallManager A sees an LBR incoming call for a G.711-only device.
- Step 4** The media stream is directed to the terminating side DSP farm.

The number of resources allocated is based upon the requirements for transcoding to voice mail as well as transcoding to G.711 for other applications such as conferencing. These numbers are calculated based upon the ratio of users to voice mail ports and the volume of conference calls placed.

Summary

This section summarizes the concepts you learned in this chapter.

Summary

- **QoS tools ensure voice quality in two ways.**
- **Maximum bandwidth WAN link may not be filled with more than 75 percent voice.**
- **Remote Cisco CallManagers must configure across the IP WAN as “ GK Controlled” H.323 inter-cluster trunks.**

© 2000, Cisco Systems, Inc. www.cisco.com CIPT v2.0—14-23

Interconnecting two or more isolated Campus LAN CIPT deployments should consider the following:

- QoS tools ensure voice quality in two ways: by giving voice priority over data and by preventing voice from oversubscribing a given WAN link.
- The maximum bandwidth setting for a zone should take into account the limitation that the WAN link may not be filled with more than 75 percent voice.
- Each remote Cisco CallManager must configure across the IP WAN as a “GK Controlled” H.323 inter-cluster trunk.

Review Questions

Answer the following questions.

Review Questions

- 1. Can devices at a LAN site be moved to another LAN site that is interconnected across the WAN?**
- 2. What is the recommended number of CallManagers in one cluster used to register as an H.323v2 device with the IOS Gatekeeper?**
- 3. A call uses G.729 across the IP WAN and needs to speak with a device that uses G.711 only. What resource is needed to make this happen?**

© 2000, Cisco Systems, Inc. www.cisco.com CIPT v2.0-14-24

- Q1) In a WAN CIPT deployment that uses distributed call processing, are the devices at one LAN site able to be moved to another LAN site that is across the WAN?
- Q2) Between sites an IOS Gatekeeper is used to control the bandwidth across the WAN. What is the recommended number of CallManagers in the same cluster that is used to register with the IOS Gatekeeper as an H.323v2 device?
- Q3) To conserve bandwidth across the WAN, compressed CODEC (G.723 and G.729) are used. If a call that goes across the WAN uses G.729 and the device that it needs to speak with only uses G.711, what resource is needed to make this conversation happen?

Centralized Call Processing

Overview

In a multi-site WAN deployment that uses centralized call processing the Cisco CallManagers are centrally located at the hub or aggregation site with no local call processing at the branch location.

This chapter emphasizes issues specific to the centralized call processing model in the following topics:

- Objectives
- Call Admission Control
- Dial Plan Considerations
- CallManager Cluster Considerations
- DSP Resource Provisioning for Transcoding and Conferencing
- Summary
- Review Questions

Objectives

This section lists the chapter objectives.

Objectives

Upon completion of this chapter, you will be able to perform the following tasks:

- **Identify design characteristics when building a remote branch that uses centralized call processing.**
- **Configure the remote branch office to get the call processing from the centralized site.**
- **Configure the remote branch office to have a redundant path using an ISDN or PSTN path.**

© 2000, Cisco Systems, Inc. www.cisco.com CIPT V2.0—15-3

Upon completion of this chapter, you will be able to perform the following tasks:

- Given a list of design characteristics, identify the design considerations when building a remote branch office that uses centralized call processing.
- Given a CIPT isolated deployment, extend the call processing services to the remote branch office.
- Given a CIPT isolated deployment with remote branch offices using centralized call processing, configure a redundant path for the IP WAN that uses ISDN or the PSTN.

Visual Objective

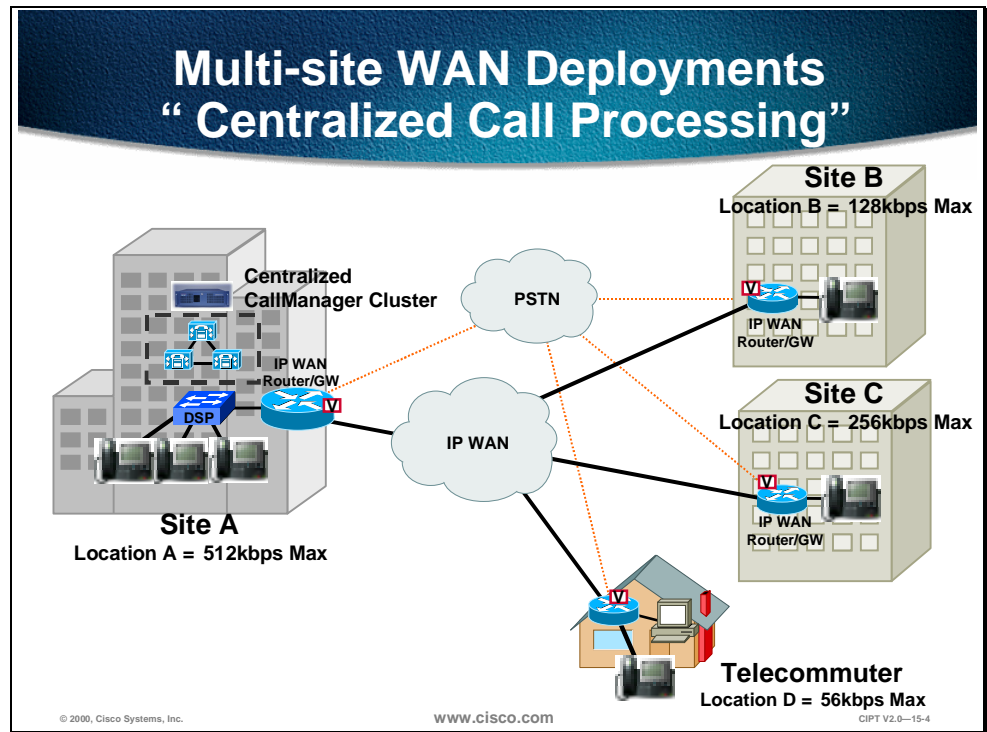

The central site will include a Cisco CallManager, voice msg + DSP resource at and the remote site can support up to 2500 users total. There will be one active Cisco CallManager that the IP phones will register to. Call admission control imposes a limit on the number of calls per site (location). Unless there is a dial backup configured in the dial plan, if the IP WAN link goes down there is no service. Now that the Cisco IOS gateways support H.323 v2 the remote branch offices do not need to use software MTP to gain access to supplementary services.

G.711 or G.729 per call (Cat 6K/4k DSP Farm required for G.729) and use partitions to allow sites to use same PSTN access code.

Centralized Call Processing Considerations

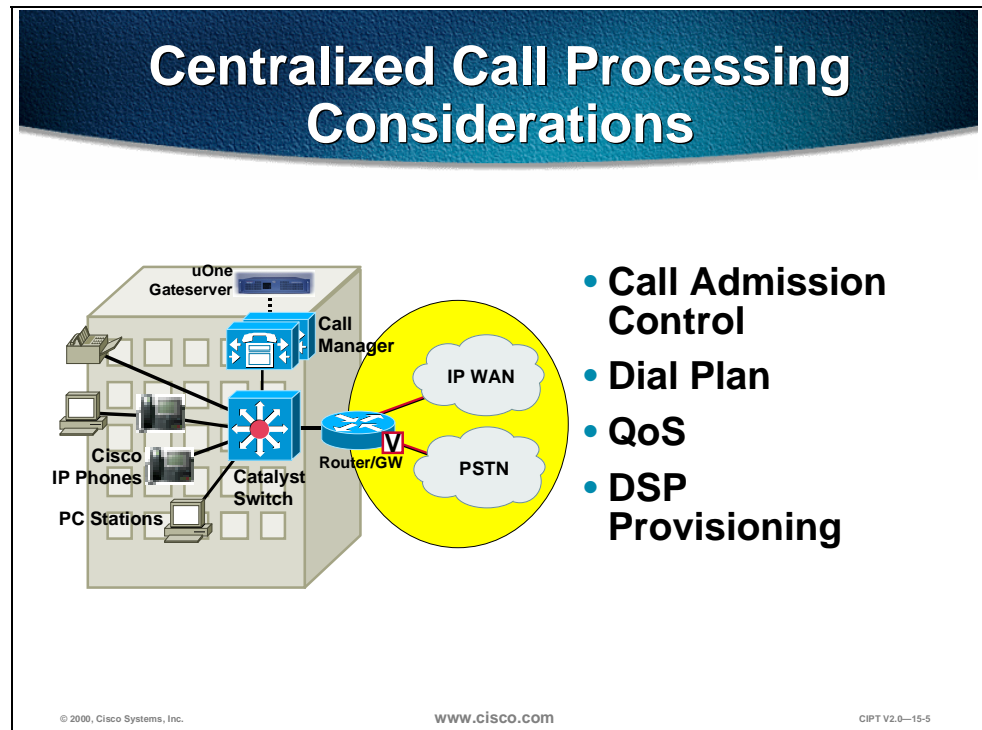

In deploying a multi-site WAN deployment using centralized call processing the following should be considered:

- Call admission control—Should it be used and how should it be used? Is there enough bandwidth over the IP WAN to use call admission control?
- Dial plan—Does each remote site need their own dial plan? How are partitions and calling search spaces used to ease configuration of dial plans?
- QoS—Will QoS be able to prioritize voice over data and even voice over voice?
- DSP provisioning—Can the DSP resources support the remote locations for accessing voice mail and conferencing?

This chapter will provide more detail to the considerations of the centralized call processing WAN deployments.

Call Admission Control

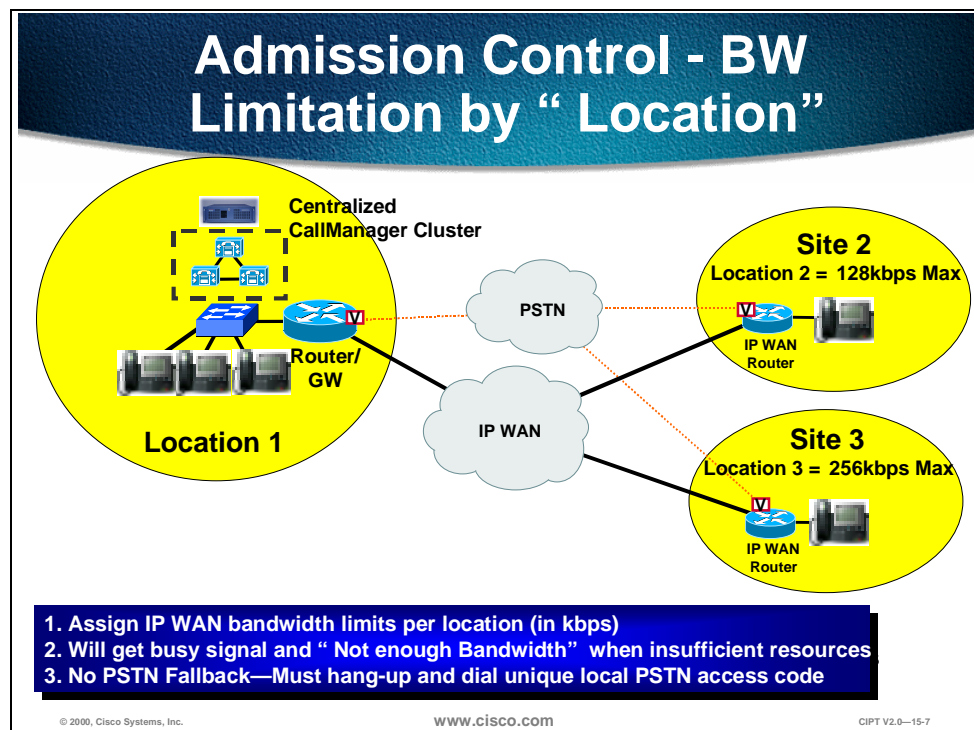

Where centralized call processing is used, call admission control (CAC) is provided using the *locations* construct. Under this scheme locations are created with a geographical correspondence, such as a branch office. For example a location could be designated as Branch 1, Mountain View Office; a postal code could also be used. The location should correlate to a geographical location that is serviced by a wide area link. A maximum bandwidth to be used by inter-location voice calls is then specified for the location. Devices within that location are then designated as belonging to that location.

The centralized CallManager keeps track of the current amount of bandwidth consumed by inter-location voice calls from a given location. If a new call attempted across the IP WAN exceeded the configured setting, a busy signal would be issued to the caller as well as a configurable visual display, such as "All Trunks Busy," on devices with this capability. If the caller gets a busy signal, the caller must hang up the phone and dial the access code for the location's PSTN gateway to facilitate an outgoing call.

Location Based Admission Control Operation with Clusters

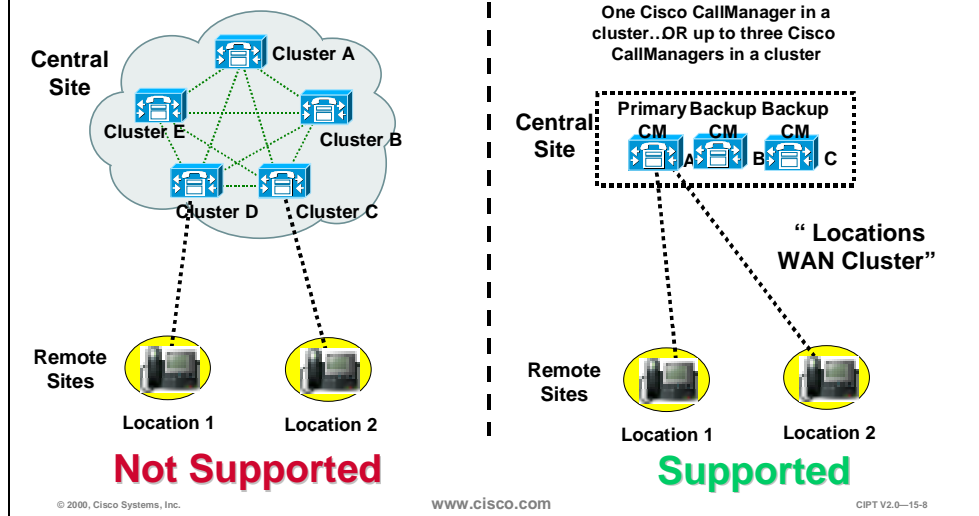

To use locations based admission control in a centralized call processing WAN deployment, the remote branch offices (locations) can only be registered to one Cisco CallManager in one cluster at the central site. Locations *cannot* be used between clusters at the central site connected to separate remote sites (locations).

Three Cisco CallManagers in one cluster can be used providing all phones are registered with the same Cisco CallManager that is achieved by keeping all phones with the same Cisco CallManager Group list. To use three Cisco CallManagers for location based admission control, a locations cluster of two or three must be created. Finally a possible location status synchronization during Cisco CallManager failover is set up to be self-healing.

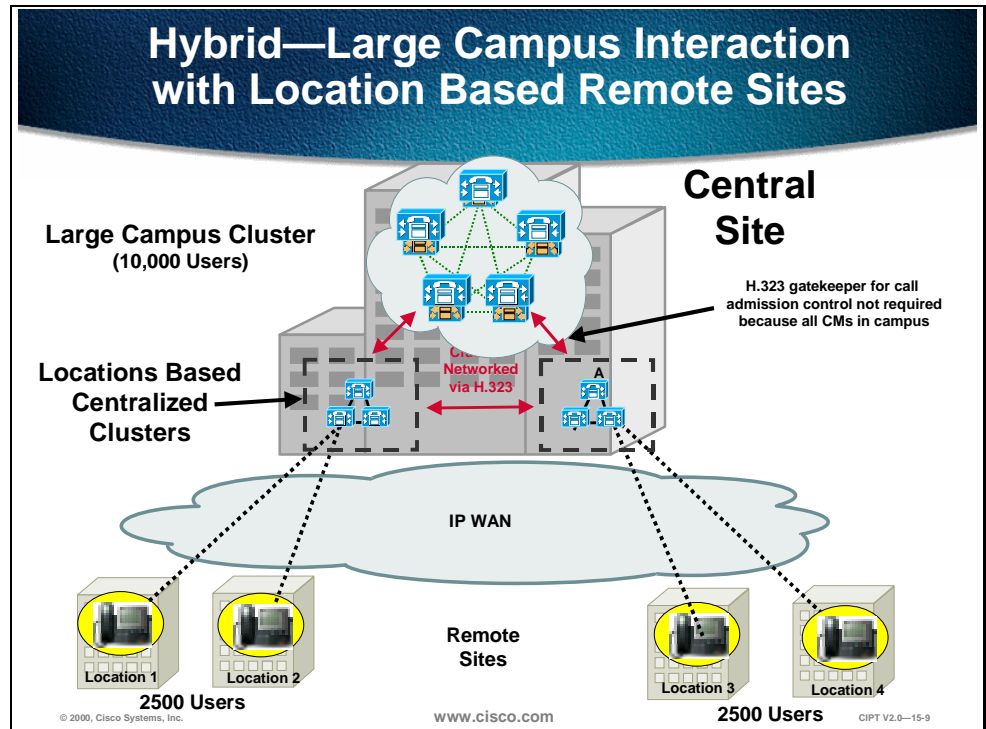

The figure above describes how a hybrid site of a large campus with location based remote sites can be designed. The large campus cluster and the locations based centralized clusters are networked via H.323 and the remote sites are registered to one Cisco CallManager within a locations based cluster.

The following page describes the caveats when using location based call admission.

Caveats for Location Based Call Admission

Caveats for Location Based Call Admission

- **Mobility of devices between locations is not possible**
- **Calls are admitted based upon the availability of 24 kbps of bandwidth**
- **The amount of bandwidth specified can be oversubscribed**
- **CallManager 3.0 deployments of centralized call processing are limited to hub and spoke topologies**
- **Bandwidth should be dimensioned according to the dedicated resources allocated on the smaller link**
- **The IOS gatekeeper can only provide admission control for calls between CallManagers in release 3.0(1)**
- **If more than 20 users at remote site, install a Cisco CallManager at that remote site**

© 2000, Cisco Systems, Inc.www.cisco.comCIPT V2.0—15-10

The following caveats should be considered when deploying locations-based call admission control:

- Mobility of devices between locations is not possible, as the CallManager decrements the specified location, not the physical location, of the device.
- Calls are admitted based upon the availability of 24 kbps of bandwidth. G.729 calls consume 24 kbps and G.711 calls consume 80 kbps. Thus, if mixed codecs are used over the WAN, all calls should be assumed to consume 80 kbps and the bandwidth allocated accordingly. Where possible, a single codec should be configured for the WAN. In this case, the bandwidth allocated should be done so in $n \times 24$ kbps increments for G.729 or $n \times 80$ kbps increments for G.711.
- When a call is placed on hold, the bandwidth is released to the pool and can be used by another call. When the original call is taken off hold, the amount of bandwidth specified can be oversubscribed. In this case the call is allowed to continue, but the low latency queue on the wide area link could be oversubscribed and voice quality might be compromised. To negate this risk, the configured size of the low latency queue should exceed the specified bandwidth on CallManager by a minimum of one call capacity for the codec specified.
- CallManager 3.0 deployments of centralized call processing are limited to hub and spoke topologies.

- Where more than one circuit or virtual circuit exists to a spoke location, the bandwidth should be dimensioned according to the dedicated resources allocated on the smaller link.
- The IOS gatekeeper can only provide admission control for calls between CallManagers in release 3.0(1). The gatekeeper cannot provide admission control between a CallManager and a remote IOS gateway. An example would be if a CallManager at one site wanted to call another site where there is an IOS gateway connected to a PBX. The CallManager does not use E.164 addresses in the ARQ when it queries the gatekeeper for admission.
- If the remote site has more than 20 users, install a Cisco CallManager at that remote site.

Dial Plan Considerations

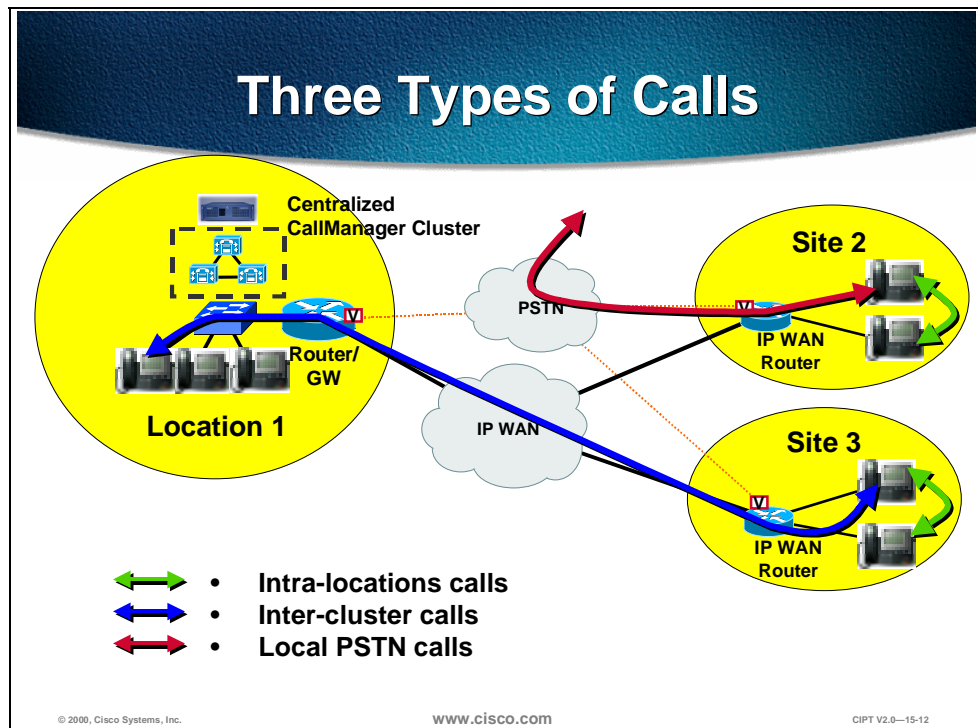

Intra-location calls are generally made between IP phones and other devices such as fax machines and analog phones connected to gateway devices based on MGCP or the skinny gateway protocol. As within a cluster, all devices register with a single CallManager so that the availability of all devices is known. When a call is attempted, the outcome is one of the following:

- The call succeeds.
- A busy tone is issued due to the remote device being active.
- A busy tone is issued due to insufficient WAN resources; a message might also be displayed on the device.

No configuration of a dial plan is required for intra-cluster calls in the majority of cases.

Inter-cluster calls are made using H.323 and, with CallManager 3.0, inter-cluster calls can use alternative routing, including PSTN fallback. Between clusters connected over a WAN, a gatekeeper is required for call admission control.

Each site can dial a single number to access the local PSTN. The same code can be used for PSTN access and, based upon the partition and calling search space, a local gateway is selected.

Design Example

Required Partitions	
Intra-Cluster and Local Gateway Access	
Partition Name	Designated Devices Assigned to Partition
Cluster-X Users	All IP phones with-in the cluster
Cluster-X Hub PSTN Access	PSTN gateway (s) at hub location
Cluster-X Branch 1 PSTN Access	PSTN gateway at Branch 1
Cluster-X Branch 2 PSTN Access	PSTN gateway at Branch 2
Cluster-X Branch 3 PSTN Access	PSTN gateway at Branch 3

© 2000, Cisco Systems, Inc. WWW.CISCO.COM CIPT V2.0—15-13

Using the network diagram from the previous page, the partitions detailed in above table would be configured to allow users to have access to either all intra-cluster locations or all intra-cluster locations and a local gateway.

The next thing that has to be defined is the calling search space. A table on the next page defines the calling search spaces for the above defined partitions.

Calling Party Search Space and Partition Assignments

Calling Party Search Space	Partitions	Assigned to
Cluster-X Internal Only	Cluster-X Users	Devices that can only make internal calls
Cluster-X Hub Unrestricted	Cluster-X Users Cluster-X Hub PSTN Access	Internal calls and PSTN calls through hub location gateways
Cluster-X Branch 1 Unrestricted	Cluster-X Users Cluster-X Branch 1 PSTN Access	Internal calls and PSTN calls through Branch 1 location gateways
Cluster-X Branch 2 Unrestricted	Cluster-X Users Cluster-X Branch 2 PSTN Access	Internal calls and PSTN calls through Branch 2 location gateways
Cluster-X Branch 2 Unrestricted	Cluster-X Users Cluster-X Branch 3 PSTN Access	Internal calls and PSTN calls through Branch 3 location gateways

© 2000, Cisco Systems, Inc.

www.cisco.com

CIPT V2.0—15-14

This represents perhaps the simplest example of the required configuration for multi-site WAN local call processing. The dial plan would consist essentially of a single pattern for PSTN calls, typically a 9. The gateway traversed would depend entirely upon the calling devices partition and selected calling search space as detailed above.

Additional considerations would require a more ambitious dial plan. For a more detailed dial plan refer to Chapter 11, “Dial Plan Architecture”.

CallManager Cluster Considerations

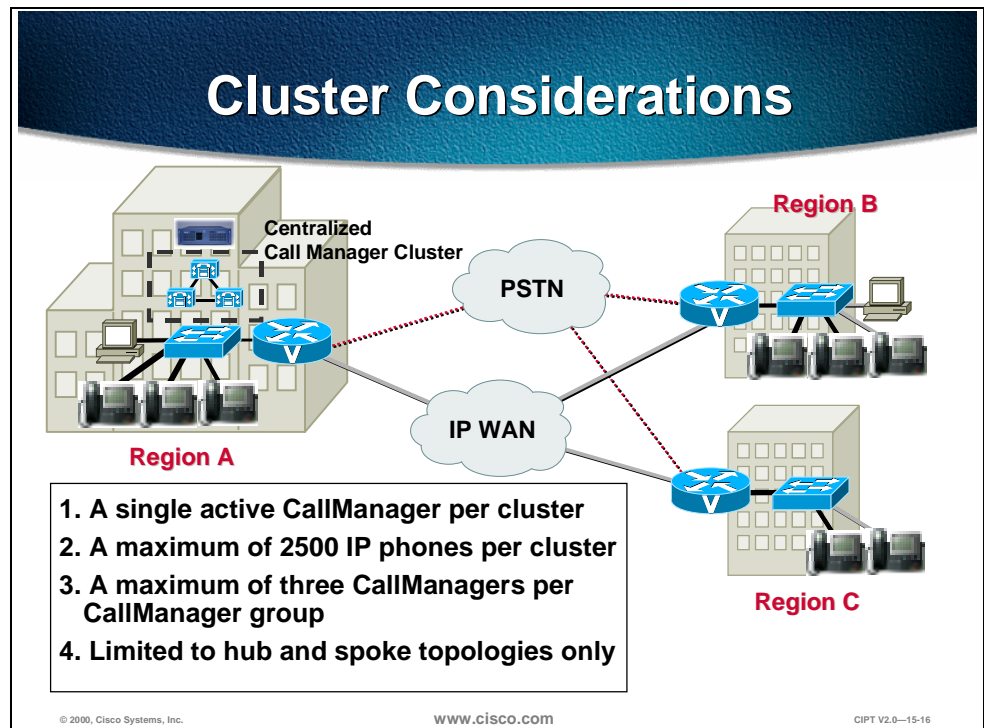

With WAN CallManager clusters, all active devices are required to be registered to a single CallManager. This allows the CallManager to maintain call state for all calls and thereby ensure that the specified bandwidth to a location is not exceeded.

A maximum of 2500 IP phones is per cluster not for the remote sites. If there are IP phones at the central site and are registered to the Cisco CallManager that the remote sites are registered to, then the phones at the central site count towards the 2500 IP phone maximum. Where more than 2500 remote devices are required, multiple WAN clusters can be configured and interconnected using H.323.

A centralized call processing WAN deployment is limited to a hub and spoke topology to incorporate the use of call admission control so that the IP WAN does not get over-subscribed.

In this deployment model a single CallManager redundancy group should be configured. This would be the default CallManager redundancy group. All devices would then be assigned to this group to ensure that all registered devices are registered to the same CallManager.

DSP Resource Provisioning for Transcoding and Conferencing

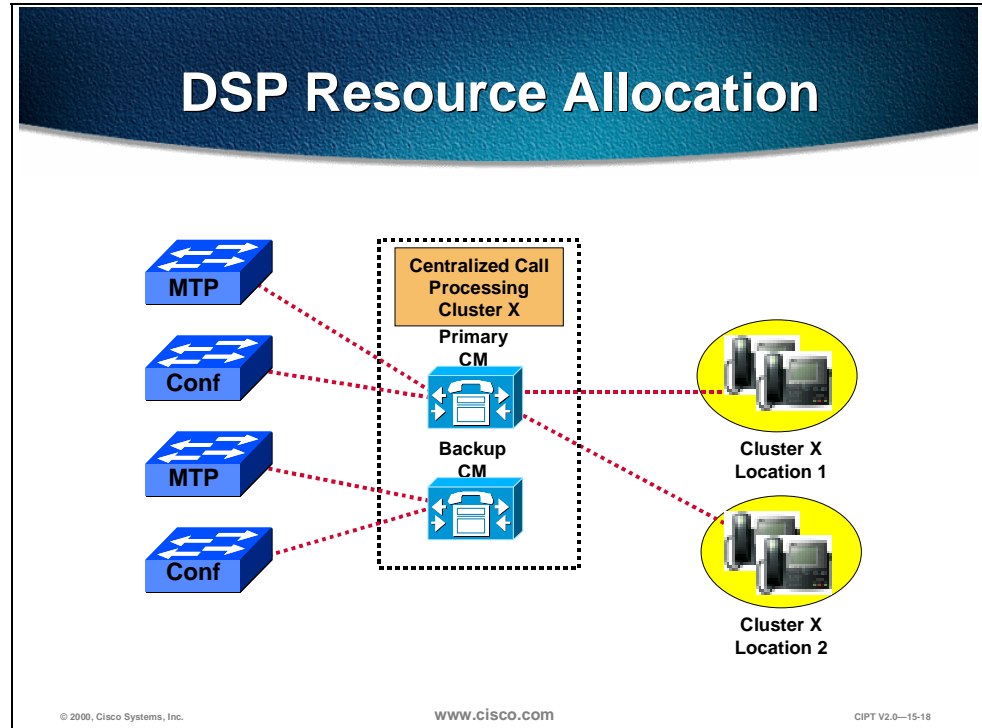

Centralized call processing is typically done in environments where the provisioning of dedicated call processing at each site is not cost effective or is administratively unacceptable. The benefits of such a deployment model are its central administration and low cost when spread across many sites. Digital signal processing (DSP) resources are required for transcoding and conferencing of calls. These resources are dedicated on a per CallManager basis and must be located at the aggregation site.

The number of resources allocated is based upon the requirements for transcoding to voice mail and transcoding to G.711 for other applications such as conferencing. These numbers are calculated based upon the ratio of users to voice mail ports and the volume of conference calls placed. In cases where the placement of resources per CallManager is deemed cost prohibitive, the resources could be statically moved in the event of failure of the primary CallManager within the WAN cluster.

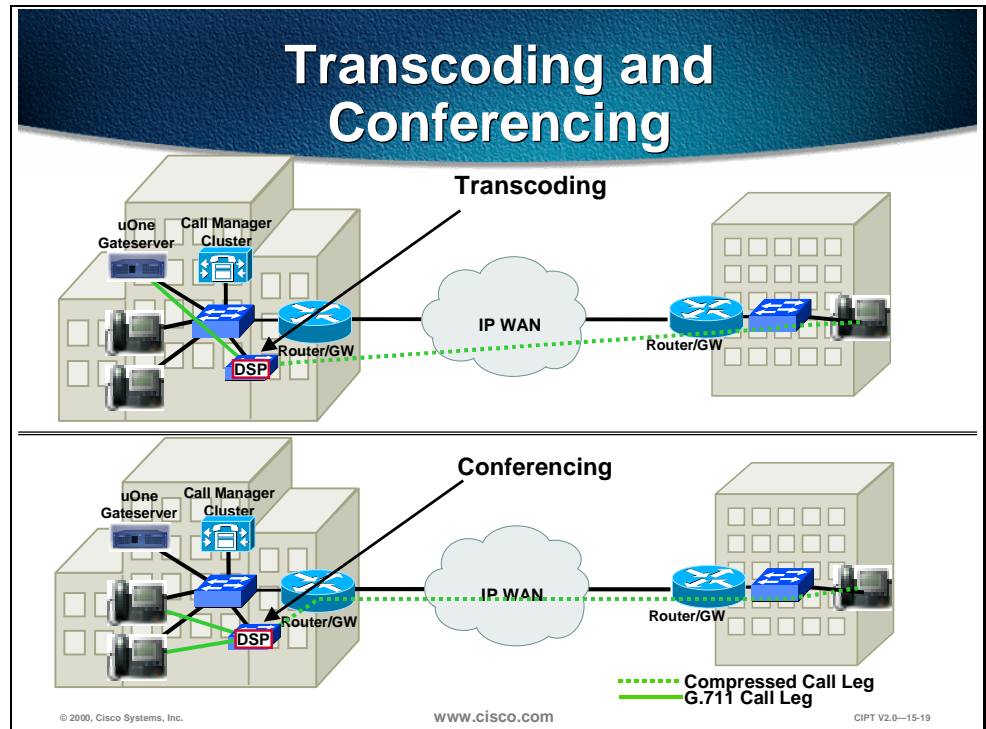

The top part of the figure above shows a centralized transcoding resource providing conversion between G.729a or G.723.1 and G.711 when a call that was initially placed at G.729a or G.723.1 rolls to voice mail, which is a G.711 only application.

Conferencing poses another example of a G.711 only application. Consequently, if a party who can only traverse the WAN using a low bit rate codec wants to make a conference call, the call will be transcoded to G.711 in the conferencing resource of the DSP.

Summary

This section summarizes the concepts you learned in this chapter.

Summary

- **Locations construct is used for WAN deployments that use centralized call processing.**
- **CallManager 3.0 deployments of centralized call processing are limited to hub and spoke topologies.**
- **A maximum of 2500 IP phones is per cluster, and not for the remote sites.**

© 2000, Cisco Systems, Inc. www.cisco.com CIPT V2.0—15-20

Locations construct is used for WAN deployments that use centralized call processing and is limited to a hub and spoke topology.

A maximum of 2500 IP phones is per cluster and not for the remote sites. If there are IP phones at the central site and they are registered to the Cisco CallManager that the remote sites are registered to, then the phones at the central site count toward the 2500 IP phone maximum. Where more than 2500 remote devices are required, multiple WAN clusters can be configured and interconnected using H.323.

Review Questions

Answer the following questions.

Review Questions

- 1. In a centralized call processing WAN deployment, how many Cisco CallManagers can the remote offices be registered to?**
- 2. What keeps track of the current amount of bandwidth consumed by inter-location voice calls?**
- 3. DSP resources provide transcoding and conferencing services for the remote sites. Where are those resources located?**

© 2000, Cisco Systems, Inc.www.cisco.comCIPT V2.0-15-21

- Q1) There can be up to five Cisco CallManagers in a cluster. In a centralized call processing WAN deployment, how many Cisco CallManagers can the remote offices be registered to?
- Q2) IP WAN bandwidth needs to be controlled. What keeps track of the current amount of bandwidth consumed by inter-location voice calls?
- Q3) DSP resources provide transcoding and conferencing services for the remote sites. Where is the physical location of these resources?

Troubleshooting a CIPT Solution

Overview

This chapter explains in detail the tools and utilities to troubleshoot a Cisco IP Telephony solution. The case study will discuss in detail a unique call flow. Understanding the information provided in this chapter will help users find a resolution quicker, as well as to isolate most of their issues. This chapter might not resolve all your problems but it will at least give the user a very good understanding of the troubleshooting IP telephony issues using the Cisco CallManager 3.0 and IOS gateways and gatekeeper.

The following topics are included in this chapter:

- Objectives
- Tools and Utility for Troubleshooting
- Case Study—Intra Cluster IP Phone to IP Phone Calls
- Laboratory Exercise
- Summary
- Review Question

Objectives

This section lists the chapter objectives.

Objectives

Upon completion of this chapter, you will be able to perform the following tasks:

- **Identify and describe the tools available to troubleshoot potential Cisco IP telephony problems**
- **Identify and describe the different call flows and series of events through the call traces and debug outputs.**

© 2000, Cisco Systems, Inc. www.cisco.com CIPT v2.0—16-3

Upon completion of this chapter, you will be able to complete the following tasks:

- Given a CIPT solution, identify and describe from a list of troubleshooting tools the tools available to troubleshoot potential Cisco IP telephony problems.
- Given a case study, identify and describe the call flow and series of events through the call traces and debug outputs.

Tools and Utilities for Troubleshooting

Tools and Utilities

- **Cisco CallManager Administration**
- **Performance Monitor**
- **Event log**
- **Local log files**
- **SDL trace**
- **Trace utility**

© 2000, Cisco Systems, Inc. www.cisco.com CIPT v2.0-16-4

The tools and utilities listed below will aid in troubleshooting a Cisco IP telephony solution:

- Cisco CallManager administration—The Cisco CallManager Administration Window is the first location to obtain useful troubleshooting information.
- Performance monitor—Windows NT server application that allows monitoring of a variety of system variables in real time.
- Event log—Displays system, security and application events for the Windows NT Server.
- Local log files—Displays IP address, TCP handle, device name or the time stamp that can be used to monitor the occurrence of request or the disposition of the request.
- SDL trace—Informs the developer engineer that the code is working properly or to find a cause of an error.
- Trace utility—Interface in the Cisco CallManager administration that is used to set all the preferences to get the specific information that is required by the user.

Cisco CallManager Administration

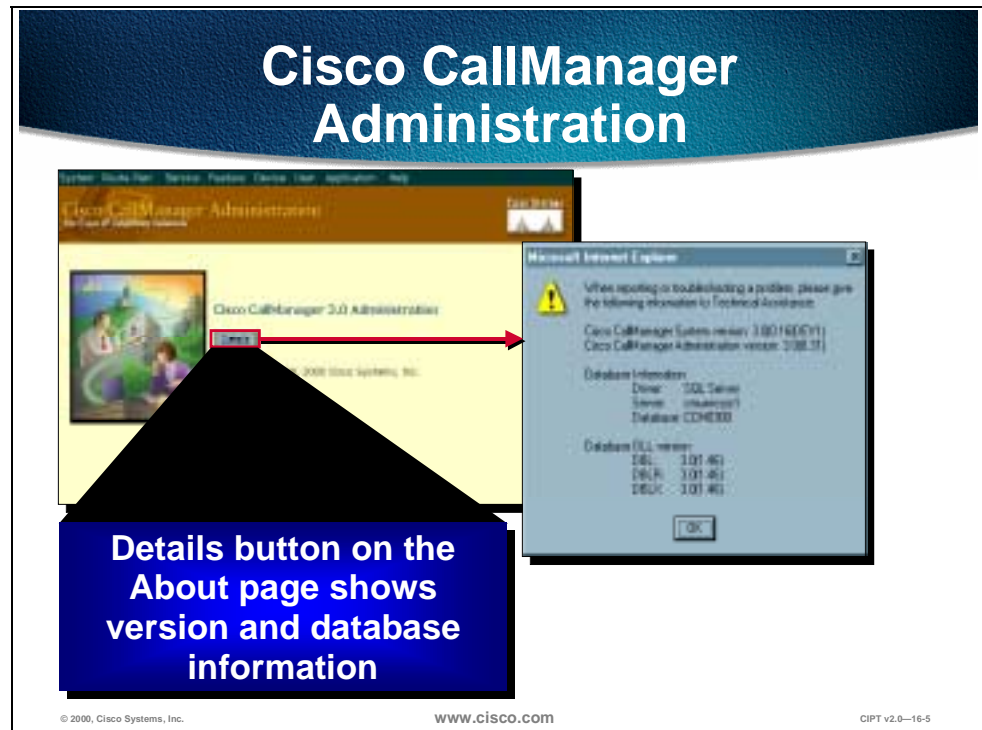

The Cisco CallManager administration has eight categories, each having a simplified pull down menu. These pull down menus have all the configurable features for Cisco CallManager.

The Cisco CallManager Administration window is the first location for a user to obtain useful troubleshooting information. If the *Details* button is pushed, information such as the Cisco CallManager system version, administration version and database information will be displayed. This is the first piece of information that should be obtained when troubleshooting any issues with Cisco CallManager. A more detailed explanation of CCM 3.0 administration is available at the following location:

http://lbj.cisco.com/push_targets1/ucdit/cc/td/doc/product/voice/call_mgr/3_0/admin_gd/index.htm

Performance Monitor

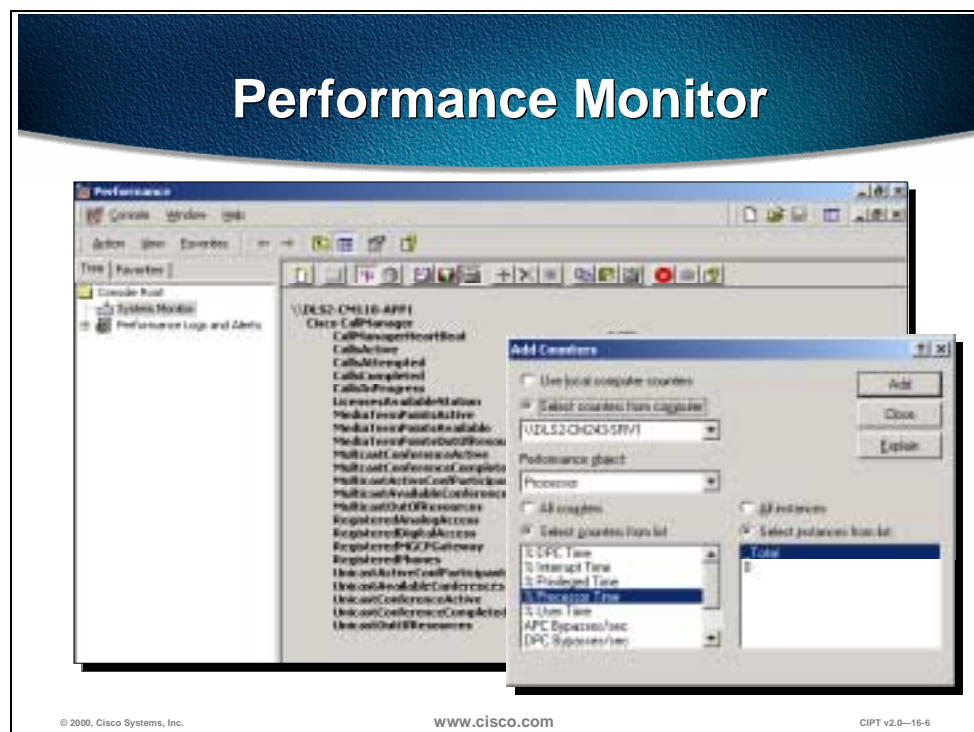

Performance Monitor is the first step for troubleshooting CIPT solution issues. Performance Monitor is a Windows NT server application that lets you monitor a variety of system variables in real time. For example, you can monitor the number of calls in progress at any time, or the number of calls currently passing through a specific gateway.

Performance Monitor shows both general and CCM 3.0 specific status information in real time.

Do the following to view the Performance Monitor window:

1. Click the **Start** button on the Task bar.
2. Choose **Program**.
3. Choose **Administrative Tools** (Common).
4. Choose **Performance Monitor**.

The Performance Monitor must be customized to view the Cisco CallManager related parameters that need to be monitored. Choose the object, counter, and instance you want to include. Open the **View** menu and click **Report** to open the Performance Monitor window. Click the **Add** button to add a new category ("Object") to the report. The Add to Report dialog box is displayed.

Event Log

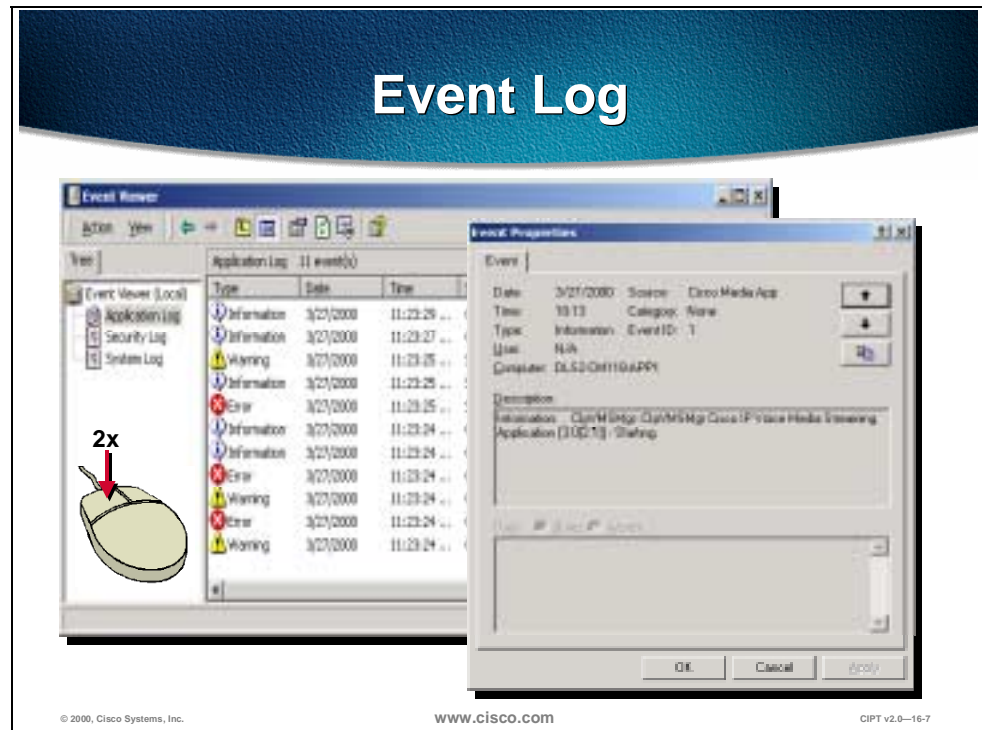

The Event log is a second line of defense for troubleshooting. Cisco CallManager events are logged in the Windows NT Event Log. The Event log then displays system, security, and application events for the Windows NT server. If a service (including TFTP) cannot read the database (where it gets the trace configuration), it will add errors to the Event log. The Event log is the only place where these type of errors will appear. The example above shows the application log and which logs applications are running on a Windows NT server.

You can find out more information about an event by double-clicking it. The Event Detail dialog box will appear displaying additional information.

Do the following to view the Event Log window:

5. Click **Start** button on the Task bar.
6. Choose **Program**.
7. Choose **Administrative Tools** (Common).
8. Choose **Event Viewer**.

The Event viewer has logs in the following three categories such as system, security, and application. The Cisco CallManager errors are always logged under the application logs.

Local Log Files

Local Log Files

- **IP address or device name can be used to find the occurrence of the request or the disposition of that request**
- **Device name can be tracked**
- **Device pool and model can be tracked**
- **C++ class and routine name are included with most trace lines**

© 2000, Cisco Systems, Inc. www.cisco.com CIPT v2.0-16-8

Local log files provide the greatest level of detailed information. When reviewing the local log files, IP address, TCP handle, device name or the time stamp can be used to monitor the occurrence of request or the disposition of the request. This device name could be tracked back to the building of the file, which shows the device pool and model. The device pool and model can be tracked back to the building of the configuration file prototype, which will list the network address of the call managers and the TCP connection port.

When observing the traces, notice that C++ class and routine names are included with most trace lines. Most routines associated with the serving of a particular request, include the thread id in a standard format.

These traces will be explained in detail in Case Study #1.

SDL Trace

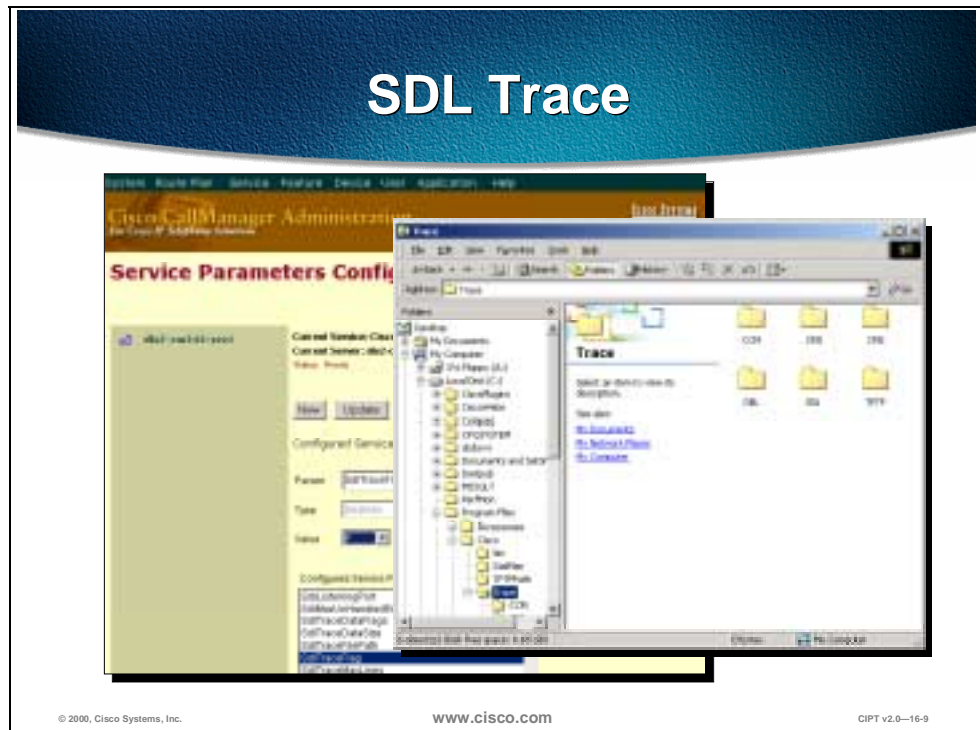

This trace informs the developer engineer (DE) that the code is working properly or to find a cause of an error. Most of this information would only make sense to a DE. While working with TAC and a DE, if the TAC engineer requests a SDL trace, it is your responsibility to enable the SDL trace and provide it to the TAC engineer. SDL traces can be directed to local files, NT event log, and Cisco Works.

SDL trace provides a C interface to trace and alarms. Alarms are used to inform the administrator for unexpected events, such as being unable to access a file, database, Winsock or being unable to allocate other operating system resources. SDL traces could be turned on through the service parameter configuration. The figure above is the snap shot of the service parameter window when the SDL traces are being turned on. Always keep in mind that these traces are only turned on when requested by the TAC engineer. Also observe the different values chosen to turn on the SDL trace in the snap shot below.

Once the SDL traces are turned on, the next step is to collect and see these traces. If the traces are being sent to the local files, then the following snapshot would tell you where to find these traces. The path is Program Files>Cisco>Services and can be observed in the snap shot above. The snapshot of these traces will be explained in the case studies in upcoming sections.

Trace Utility

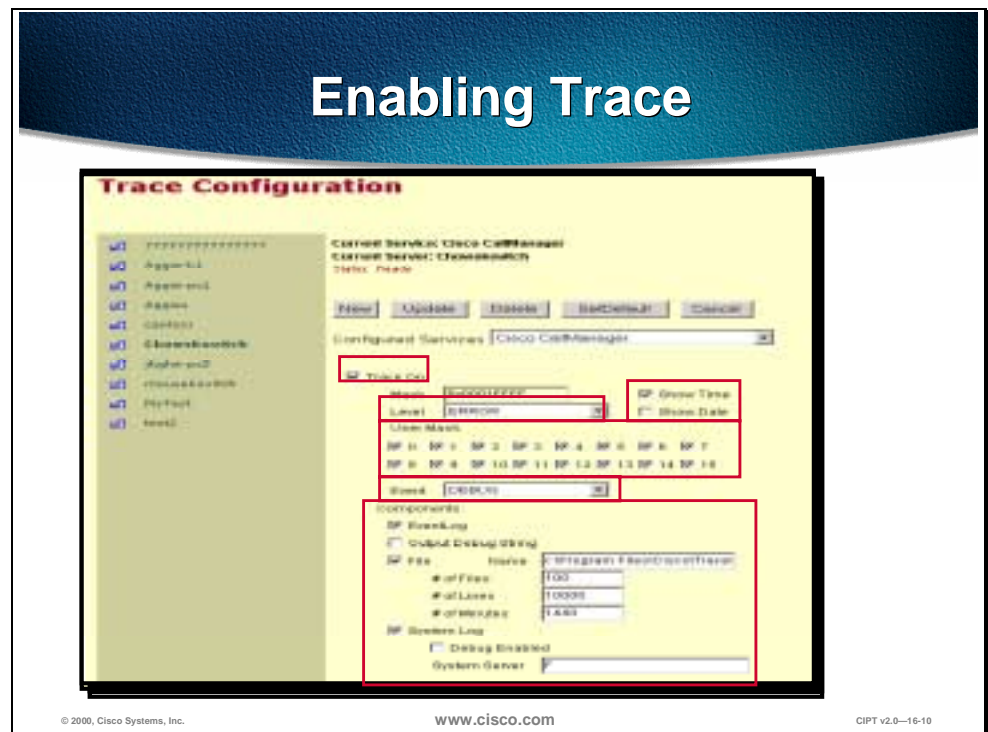

To enable a trace, perform the following steps:

9. Open Cisco CallManager Administration.
10. Select **Service > Trace**.
11. From the list of IP addresses at the left of the screen, select the IP address of the Cisco CallManager server whose trace parameters you want to configure.
12. Click **New** to create a trace configuration for a new service.
13. From the Service Type drop-down list box, select the service for which you want to add a trace configuration, and then click **Insert**.
14. Click **Trace On** to enable trace.
15. Select the desired trace level.
16. If desired, enable the Show Time and Show Date options.
17. Set the appropriate user mask bits for the service.
18. Select the desired event type.
19. Set the desired trace log components.
20. If you want to reset all trace parameters to their previous value, click **Cancel**. If you want to reset all trace parameters to their initial default value, click **SetDefault**.
21. When you are finished setting the trace parameters, click **Update** to save the changes in the database.

Trace Levels

- **Error**
- **Special**
- **State Transition**
- **Significant**
- **Entry/Exit**
- **Arbitrary**
- **Detailed**

© 2000, Cisco Systems, Inc.

www.cisco.com

CIPT v2.0-16-11

The table below lists the available trace levels. The error level provides the least amount of trace information, and the detailed level provides the most. The levels are cumulative, which means that a more detailed level includes all same information as the level below it plus some additional information.

Trace Levels

Level	Description
Error	Traces alarm conditions and events.
Special	Traces all Error conditions plus process and device initialization messages.
State Transition	Traces all Special conditions plus subsystem state transitions that occur during normal operation.
Significant	Traces all State Transition conditions plus media events that occur during normal operation.
Entry/Exit	This trace level is not currently used.
Arbitrary	Traces all Significant conditions plus low-level debugging information. Do not use this trace level during normal operation.
Detailed	Traces all Arbitrary conditions plus detailed debugging information. Do not use this trace level during normal operation.

You can enable the Show Date and Show Time options to record the date and time of each trace event.

User Mask Flag Definitions

User Mask Bits	
Mask Bits	Type of Trace Enabled by This Bit
0	Protocol layer 1 information.
1	Protocol layer 2 information.
2	Digital gateway information.
3	Analog gateway information.
4	Primary Rate Interface (PRI) information.
5	Skinnny Station protocol information.
6	Message translation information for ISDN messages.
7	Media Termination Point (MTP) information.
8	H.225 and Gatekeeper information.
9	Gateway traces (used in conjunction with bits 2, 3, and 4)
10	Database signaling information.
11	Subsystem information not covered by one of the other user mask bits.
12	Conference bridge information.
13	MGCP gateway information.
14-15	Not used.

© 2000, Cisco Systems, Inc.

WWW.CISCO.COM

CIPT v2.0—16-12

The user mask is a series of flags, or bits, that enable and disable specific types of trace information. As you turn the bits on and off, the value in the Mask field changes. The name and definition of each user mask flag is on the following page.

The following table shows the user mask bits, their name, and definition.

Mask Bits	Name	Definition
0	SUBSYS_LAYER1	Enables all layer one traces.
1	SUBSYS_LAYER2	Enables all layer two traces.
2	SUBSYS_TITAN	Enables Titan traces.
3	SUBSYS_VEGA	Enables Vega traces.
4	SUBSYS_PRI	Enables Pri traces.
5	SUBSYS_STATION	Enables all station traces.
6	SUBSYS_MSGTRANS	Used by MsgTrans Lib. Enables ISDN message traces.
7	SUBSYS_MTP	Enables MTP traces.
8	SUBSYS_H225	Enables H225 and Gatekeeper traces.
9	SUBSYS_GATEWAY	Enables gateway traces (Used in conjunction with Pri, Vega and Titan).
10	SUBSYS_MISC	Enables all traces.
11	SUBSYS_SYSTEM	Thread trace information, CDR traces, stats errors, TCP errors, InvProcessDatabase etc. This subsystem mask is used to enable traces for anything that is system related, and this is used by more than one subsystem.
12	SUBSYS_CONFBRIDGE	Used by unicast and multicast conference bridges.
13	SUBSYS_MGCP	Enables MGCP traces.
14-15	Not used.	

Trace Log

- EventLog
- Output Debug String
- File
- System Log

Creating a large number of trace files, or letting a single trace file grow too large, can severely degrade the performance of your system.

© 2000, Cisco Systems, Inc.

www.cisco.com

CIPT v2.0—16-13

The following table shows the components of the Trace log.

Component	Description
EventLog	Enable this option to send trace information to the Windows 2000 EventLog.
Output Debug String	This option is for Cisco development use only. Do not enable this option unless instructed to do so by Cisco Technical Assistance Center (TAC).
File	<p>Enable this option to store trace information in a file. You can also set the following file parameters:</p> <ul style="list-style-type: none"> ■ Name is the fully qualified path name of the trace file. Each service requires a unique trace file name. Cisco recommends that you leave the file names set to their default values. ■ # of Files specifies the total number of trace files for a given service. A sequence number is automatically appended to the file name to indicate which file it is. When the last file in the sequence is full, the trace data begins writing over the first again. ■ # of Lines specifies the maximum number of lines of data stored in each trace file. ■ # of Minutes specifies the maximum number of minutes worth of data stored in each trace file. <p>When the trace data exceeds either the maximum number of lines or the maximum number of minutes for one file, that file is closed and the remaining trace data is written to the next file in the sequence. For example, you can set up trace files to store a full week of data, with one day of data in each file. To do this, you can set the number of files to 7, the number of minutes to 1440 (one day), and number of lines to a large value such as 10000.</p>
System Log	<p>Enable this option to send trace information to the Cisco Syslog Collector. The system log parameters are:</p> <p>Debug enabled causes all trace data to be sent to the Cisco syslog collector. If you do not enable this option, only alarm (Error) traces are sent to the Cisco syslog collector.</p> <p>System server is the name of the Cisco syslog collector. Do not change this field unless instructed to do so by Cisco Technical Assistance Center (TAC).</p>

Minimum Alarm Tracing

- Enable **Trace On**
- Set the trace level to **Error**
- Enable the appropriate user mask bits for each service, as described in User Mask Bits Table
- Set the event type to **Error**
- Enable **EventLog**

© 2000, Cisco Systems, Inc.

www.cisco.com

CIPT v2.0-16-14

In general, it is best to start with a small amount of tracing so that system resources are not overloaded by the trace data. If the initial traces are not sufficient for your purposes, you can gradually increase the level of tracing until you get the desired data. If system performance begins to degrade during tracing, decrease the trace level until the performance returns to normal.

During normal system operation, it is customary to trace alarm conditions and to respond to them as quickly as possible. Alarm tracing is considered to be the minimum level of tracing for a fully operational system. To configure this minimum level of alarm tracing, set the trace parameters as follows for each service on each Cisco CallManager in the cluster:

- Enable **Trace On**.
- Set the trace level to **Error**.
- Enable the appropriate user mask bits for each service, as described in the User Mask Bits Table.
- Set the event type to **Error**.
- Enable **EventLog**.

Case Study—Intra Cluster IP Phone to IP Phone Calls

This section discusses a case study of an Intra Cluster IP Phone to IP Phone calls.

IP Phone to IP Phone (Intra Cluster)

- **IP phone initialization process**
- **Skinnny station registration messages**
- **IP phone to IP phone call flow within a cluster**
- **IP phone to IP phone call flow skinny messages**
- **IP phone registration and call flow messages through the Cisco CallManager traces**

© 1999, Cisco Systems, Inc.

www.cisco.com

CIPT—Chapter 16-18

This case study would discuss in detail the call flow between two IP phones within a cluster, called an intra cluster call. This case study will also focus on Cisco CallManager and IP phone initialization, registration and keep alive processes followed by a detailed explanation of a intra cluster call flow. We will explain all these processes by using trace utility and tools discussed in previous section.

Case Study Topology

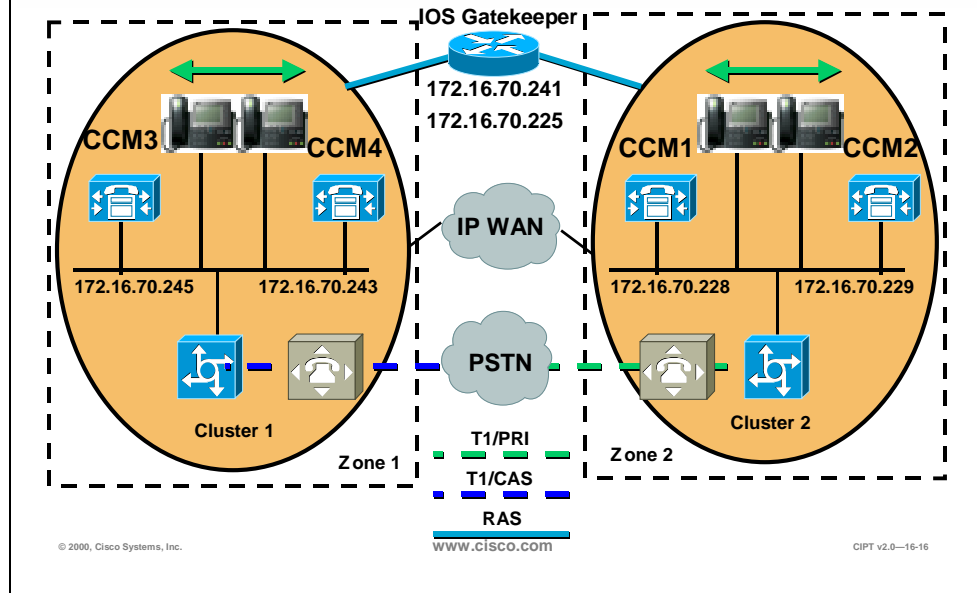

The diagram above describes the sample topology for this case study. In the diagram we have two clusters named cluster 1 and cluster 2. The two Cisco CallManagers in cluster 1 are called CCM3 and CCM4, whereas in cluster 2 the two Cisco CallManagers are named CCM1 and CCM2. All the traces collected for this case study are from CCM1 that is located in Cluster 2. The call flow is based on the two IP Phones in cluster 2. The IP addresses of these two IP phones are 172.16.70.230 (directory number 1000) and 172.16.70.231 (directory number 1001) respectively.

IP Phone Initialization Process

1 Get IP address, mask, DNS, etc.

- Static or DHCP

2 Get TFTP server address

- Use any one
- Static address
 - Option 150 (single IP address)
 - Option 66 (first IP address or DNS name)
 - Look up CiscoCM1.your.domain

3 Get configuration from CallManager TFTP*

- List of up to three CallManagers
- Region info and keyboard template
- Version of code to run

4 Get new code (one time only)

5 Register with CallManager

* Use configuration in Flash after timeout

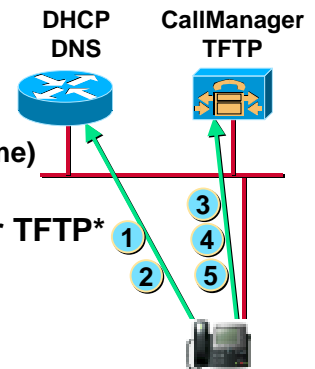

© 1999, Cisco Systems, Inc.

www.cisco.com

CIPT—Chapter 16-19

IP Phone Initialization Process

1. When a telephone is plugged into an Ethernet jack, assuming the prerequisite infrastructure and a CallManager, the first thing that will happen is the telephone will request an IP address from a Dynamic Host Configuration Protocol (DHCP) server. In general, this is the recommended mode of operation. Static addressing can be supplied to the telephone, and you can enter the IP address manually, but this would prevent mobility.
2. As part of that DHCP request, when an IP address is supplied to the telephone, it is also possible to supply the address of the TFTP server, or the CallManager from which the telephone will get its configuration. Once again, the TFTP server address could be specified manually but this would limit adds, moves, and changes and remove some of the benefits. This TFTP server address can be given in several forms: either Option 150 or Option 66 or the Bootstrap Protocol (BOOTP).
3. Once that address has been given, the phone will register itself with the CallManager and download its configuration, which can contain a list of up to five CallManagers that the telephone can use for call control. This creates an extremely resilient system. The Phone gets its region information and also the features or functionality that each of the keys will produce.
4. The phone receives any new code it is to run. If, for example, the firmware or the code that each telephone runs is changed, this can be added to the CallManager. Once restarted, each telephone will automatically reload that code. The telephones can be configured to auto register.
5. An administrator rolling out the phones would plug each one in and then assign a number. New phone entries will appear by Media Access Control (MAC) address, which is how the CallManager ties the actual instrument to a telephone number. An alternate, not the normal operation, would occur when

you plug in the telephone; CallManager would automatically give that telephone a line number. However, this would make things like directories very difficult to set up.

* Use configuration in Flash after timeout.

IP Phone Initialization Process Trace

No.	Status	Source Address	Dest Address	Summary	Len
4		[0 0 0]	[255.255.255.255]	DHCP: Request. Message type: DHCP Request	347
5		[172.17.244.50]	[255.255.255.255]	DHCP: Reply. Message type: DHCP Ack	347
6		[172.17.244.223]	[172.17.244.58]	TFTP: Read request File=SEP0010E8001D69.cfg	78
7		[172.17.244.50]	[172.17.244.223]	TFTP: Option acknowledgement (File not found)	61
8		[172.17.244.223]	[172.17.244.58]	TFTP: Read request File=SEPDefault.cfg	65
9		[172.17.244.50]	[172.17.244.223]	TFTP: Data packet NS=1 (Last)	61
10		[172.17.244.223]	[172.17.244.58]	TFTP: Ack NP=1	69
11		[172.17.244.223]	[172.17.244.58]	TCP: D=2008 S=52227 SYN SEQ=221184 LEN=8 WIN=100	68
12		[172.17.244.50]	[172.17.244.223]	TCP: D=52227 S=2880 SYN ACK=221185 SEQ=75335447	68
13		[172.17.244.223]	[172.17.244.58]	TCP: D=2008 S=52227 ACK=75335448 WIN=1800	68
14		[172.17.244.223]	[172.17.244.58]	TCP: D=2008 S=52227 ACK=75335448 SEQ=221185	158
15		[172.17.244.223]	[172.17.244.58]	TCP: D=2008 S=52227 ACK=75335448 SEQ=221289	118
16		[172.17.244.50]	[172.17.244.223]	TCP: D=52227 S=2880 ACK=221353 WIN=8632	68
17		[172.17.244.50]	[172.17.244.223]	TCP: D=52227 S=2880 ACK=221353 SEQ=75335648	78
18		[172.17.244.223]	[172.17.244.58]	TCP: D=2008 S=52227 ACK=75335672 SEQ=221353	66
19		[172.17.244.50]	[172.17.244.223]	TCP: D=52227 S=2880 ACK=221345 SEQ=75335672	66
20		[172.17.244.223]	[172.17.244.58]	TCP: D=2008 S=52227 ACK=75335684 SEQ=221345	118
21		[172.17.244.50]	[172.17.244.223]	TCP: D=52227 S=2880 ACK=221429 SEQ=75335684	82
22		[172.17.244.223]	[172.17.244.58]	TCP: D=2008 S=52227 ACK=75335712 SEQ=221429	66
23		[172.17.244.50]	[172.17.244.223]	TCP: D=52227 S=2880 ACK=221441 SEQ=75335712	162
24		[172.17.244.223]	[172.17.244.58]	TCP: D=2008 S=52227 ACK=75335820 SEQ=221441	66
25		[172.17.244.50]	[172.17.244.223]	TCP: D=52227 S=2880 ACK=221453 SEQ=75335820	182
26		[172.17.244.223]	[172.17.244.58]	TCP: D=2008 S=52227 ACK=75335868 WIN=1800	68

© 1999, Cisco Systems, Inc.

www.cisco.com

CIPT—Chapter 16-20

The following snapshot of Sniffer trace summarizes the phone initialization process: Please keep in mind that this trace is not taken for this Sample topology, but does give you a good idea of the series of events that occur during the IP phone boot up process.

Skinny Station Registration Process

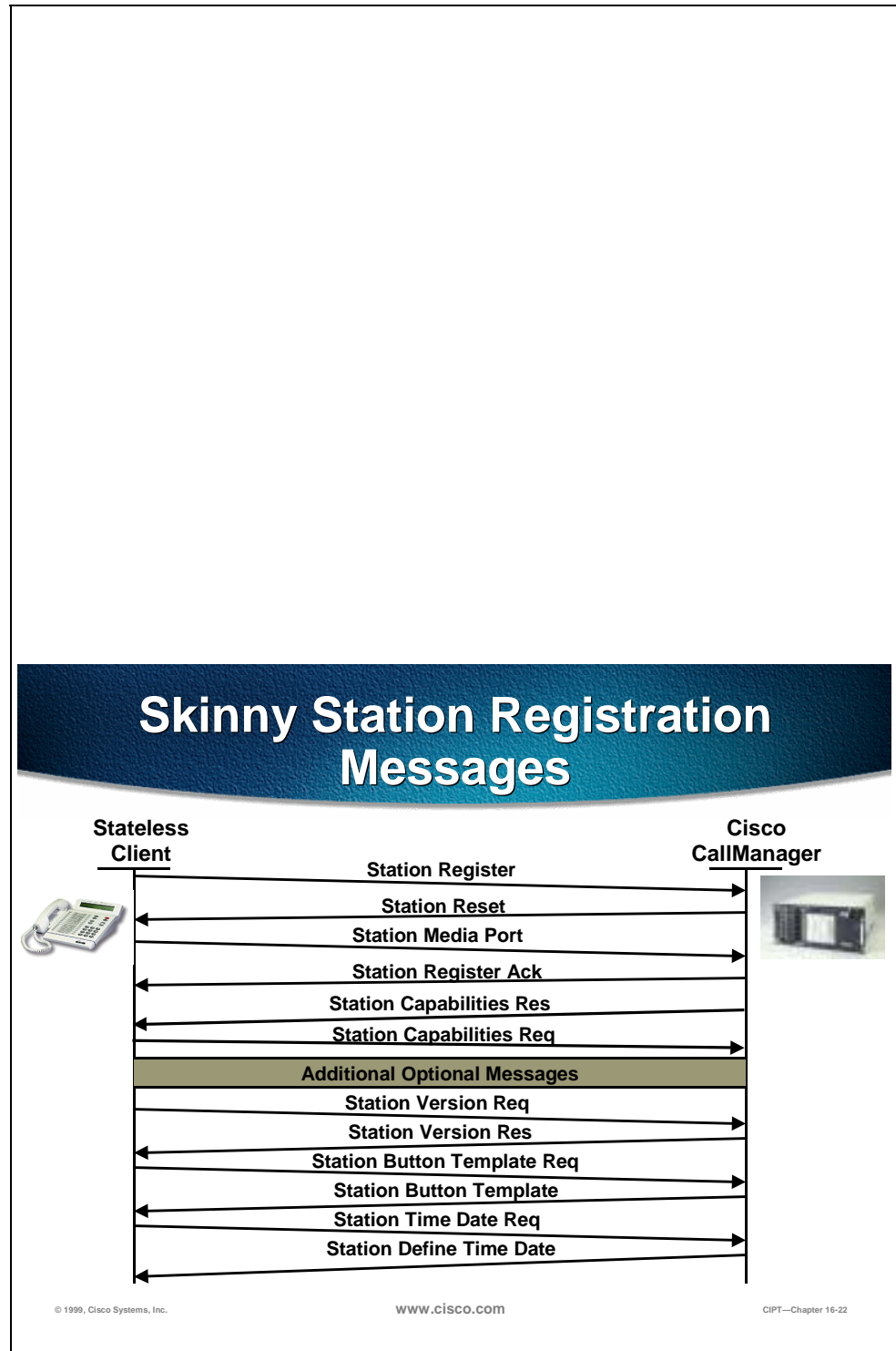

The registration process allows skinny station (IP Phone) to inform Cisco CallManager of its existence and to make calling possible. The following figure shows the different messages that are exchanged between the IP phone and the Cisco CallManager.

The primary messages in the skinny station registration process are described below.

- **Station Register:** This message is used by the station to announce its existence to the controlling Cisco CallManager.
- **Station Reset:** This message is used by the CCM to command the client to reset its processes.
- **Station IP Port:** The Station IP Port message is used by the station to provide to the CALLMANAGER, the UDP port to be used with the RPT stream.
- **Station Register Acknowledge:** This message is used by the CALL MANAGER to acknowledge the registration of a client.

OR

- **Station Register Reject:** This message is used by the CALL MANAGER to reject a registration attempt from the indicated phone.

char text[StationMaxDisplayTextSize];

};

Where:

text is a character string, of a maximum length of 33 bytes, containing a textual description of the reason that registration is rejected.

- **Station Capabilities Request:** This message is used by the CALL MANAGER to request the current capabilities of the client. These capabilities includes compression standard and other H323 capabilities.
- **Station Version Request:** This message is used by the station to request the version number of the software load for the station.
- **Station Version Response:** This message is used to inform the client of the version number for the software it should be using.
- **Station Capabilities Response:** This message is used to respond to a Station Capabilities Request message from the CALLMANAGER. These capabilities are cached in the CALLMANAGER and used to negotiate terminal capabilities with an H.323 compliant Terminal.
- **Station Button Template Request:** This message is used by the station to request the button template definition for that specific terminal or Phone.
- **Station Button Template Response:** This message is used to update the button template information contained in the client.
- **Station Time Date Request:** This message is used by the station to request the current date and time for internal usage and for displaying as a text string.
- **Station Define Time and Date:** This message is used to provide the date and time information to the client. It provides for time synchronization for the clients.

IP Phone to IP Phone Call Flow Within a Cluster

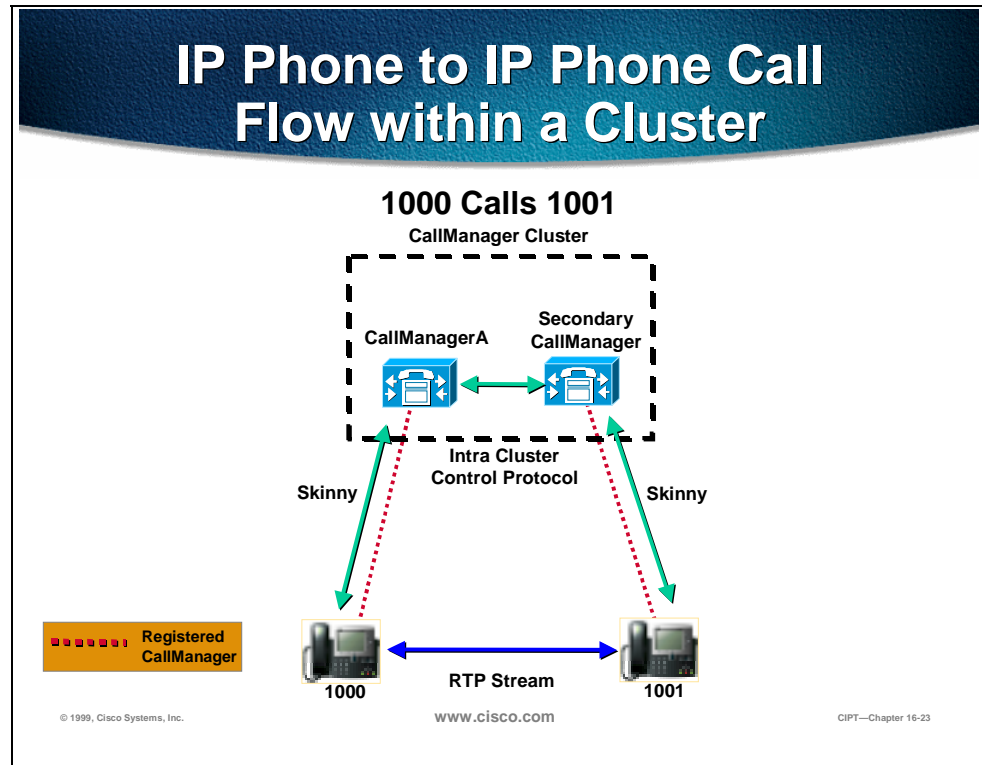

This section describes an IP phone (1000) calling another IP phone (1001) within the same cluster. The cluster is a group of Call Managers having one common Publisher SQL database and many Subscriber SQL databases.

In our sample topology, CCM1 is publisher and CCM2 is subscriber. The two IP Phones (1000 and 1001) are registered respectively to CCM1 and CCM2. The call flow is shown in the diagram above. The two CallManagers within a cluster communicate with each other using intra cluster control protocol (ICCP). When IP phone goes off-hook, it opens a control skinny session (tcp is underlying protocol) with the CCM. After call control signaling is established between two IP phones and their respective call managers, the RTP stream start flowing directly between the two phones as shown in the diagram below. The skinny call flow messages for this intra-cluster call are explained in next section.

IP Phone to IP Phone Call Skinny Messages

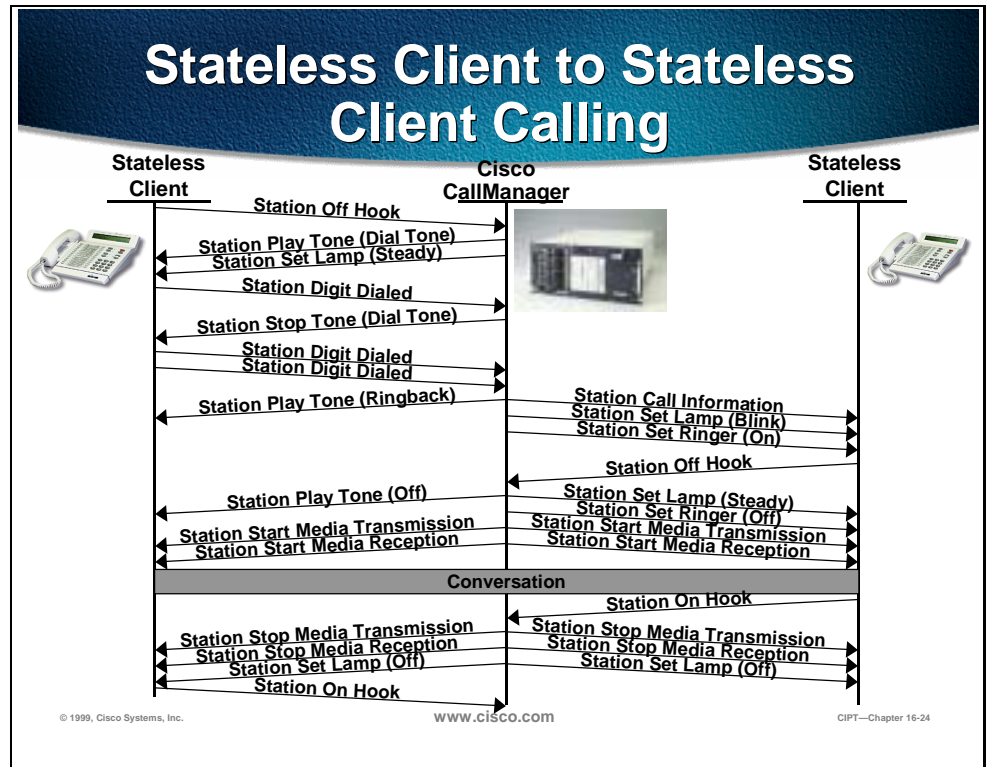

The figure above shows a sample exchange of messages between two Skinny Clients. The SC (Skinny Client or IP Phone) will initiate connection to CCM and then CCM will perform the DA (digit Analysis) before opening a control session with the destination skinny station or IP Phone. As the following diagram indicates, the skinny messages are pretty self-explanatory and use simple English. Therefore we will not explain these messages in this section. We will, however, explain these call flow skinny messages in more detail when we go over the traces in later sections.

Cisco CallManager Trace through the Trace Utility

Troubleshooting different events using Cisco CallManager Trace through the Trace Utility.

CCM Trace Through the Trace Utility

- Initialization Process Trace
- Registration Process Trace
- Keepalive Process Trace
- Intra Cluster Call Flow Trace

© 1999, Cisco Systems, Inc. www.cisco.com CIPT—Chapter 16-25

Trace utility is a very effective troubleshooting tool. Trace can be done to help trouble shoot during different processes and call flows in a CIPT solution. The path to the trace files is; My Computer>Program files>Cisco>Trace.

Initialization Process Trace

In this section the initialization process of CCM will be explained with the help of traces that are captured from CCM1 (172.16.70.228). We will try to understand different events when CCM initializes itself. This will help us in troubleshooting different processes within CCM, and we'll be able to see the effect of these processes on different services such as conferencing, call forwarding, etc.

Initialization Process Trace

```
16:02:47.765 CCM| CMProcMon - Call Manager State Changed - Initialization Started.
16:02:47.796 CCM| Nodell: 0, EventId: 107 EventClass: 3 EventInfo: Cisco CM Database
Defaults Read
16:02:49.937 CCM| SDL Info - Nodell: [ 1] Listen IP/Hostname: [ 172.16.70.228] Listen Port:
[ 8002]
16:02:49.984 CCM| dBProcs - Adding SdlLink to Nodell: [ 2] P/Hostname: [ 172.16.70.229]
16:02:51.031 CCM| Nodell: 1, EventId: 1 EventClass: 3 EventInfo: Cisco Call Manager
Version=< 3.0(0.20)> started
16:02:51.031 CCM| MulticastPointManager - Started
16:02:51.031 CCM| UnicastBridgeManager - Started
16:02:51.031 CCM| MediaTerminationPointManager - Started
16:02:51.125 CCM| MediaCoordinator(1) - started
16:02:51.125 CCM| Nodell: 1, EventId: 1543 EventClass: 2 EventInfo: Database manager
started
16:02:51.234 CCM| Nodell: 1, EventId: 1542 EventClass: 2 EventInfo: Link manager started
16:02:51.390 CCM| Nodell: 1, EventId: 1541 EventClass: 2 EventInfo: Digit analysis started
```

© 1999, Cisco Systems, Inc. www.cisco.com CIPT—Chapter 16-26

The messages above from the CallManager trace utility are showing the initialization of the CCM process on one of the CallManager CCM1. As you can see, the first message tells us that the CCM initialization process is getting started. This message is followed by another message in which CCM reads the default database values, which in this case is the primary or publisher database. Afterwards, CCM begins listening to different messages on TCP port 8002. After listening to these messages, CCM added a second CCM to its list: CCM2 (172.16.70.229). This message is followed by another message that tells us that CCM has started and is running CCM version 3.0.20.

Once CCM is up and running, it starts several other processes within itself. Some of these processes are shown above, and include MulticastPoint Manager, UnicastBridge Manager, digit analysis and CCM start loading route list. These messages above can be very useful when troubleshooting a problem related to different features in the CCM.

For example, let's say that our route lists are not functioning and are unusable. At this point we could monitor these traces and see if the CCM has started RoutePlanManger and if it is trying to load the RouteLists. You can see the usefulness of understanding these messages.

Initialization Process Trace

```
16:02:51.406 CCM| RoutePlanManager - Started, loading RouteLists
16:02:51.562 CCM| RoutePlanManager - finished loading RouteLists
16:02:51.671 CCM| RoutePlanManager - finished loading RouteGroups
16:02:51.671 CCM| RoutePlanManager - Displaying Resulting RoutePlan
16:02:51.671 CCM| RoutePlanServer - RouteList Info, by RouteList and RouteGroup
Selection Order
16:02:51.671 CCM| RouteList - RouteListName=' ' ipwan' '
16:02:51.671 CCM| RouteList - RouteGroupName=' ' ipwan' '
16:02:51.671 CCM| RoutePlanServer - RouteGroup Info, by RouteGroup and Device
Selection Order
16:02:51.671 CCM| RouteGroup - RouteGroupName=' ' ipwan' '
16:02:51.671 CCM| RouteGroup - DeviceName=' ' 172.16.70.245' '
16:02:51.671 CCM| RouteGroup -AllPorts
16:02:51.671 CCM| Nodeld: 1, EventId: 1540 EventClass: 2 EventInfo: Call control
started
16:02:51.843 CCM| ProcessDb - Dn = 2XXX, Line = 0, Display = ,
RouteThisPattern, NetworkLocation = OffNet, DigitDiscardingInstruction = 1,
WhereClause =
```

© 1999, Cisco Systems, Inc.

www.cisco.com

CIPT—Chapter 16-27

The trace above shows the RouteGroup adding the device 172.16.70.245, which is a H.323 device. Basically, it is the CCM3 that is located in Cluster 1. The RouteGroup is created in this case to route calls to the other CCM3 via IOS Gatekeeper. If there is a problem routing the call to an IP Phone located in Cluster 1, then the following messages would help us to find the cause of the problem.

Initialization Process Trace

```
16:02:51.859 CCM| Digit analysis: Add local pattern 2XXX , PID: 1,80,1
16:02:51.859 CCM| ForwardManager - Started
16:02:51.984 CCM| CallParkManager - Started
16:02:52.046 CCM| ConferenceManager - Started
16:02:52.046 CCM| MeetMeConferenceManager - Started
16:02:52.078 CCM| MessageWaitingManager - Started
16:02:52.078 CCM| MessageWaitingManager - Registered with Call Control
16:02:52.078 CCM| Nodell: 1, EventId: 1694 EventClass: 2 EventInfo: Supplementary
services started
16:02:52.078 CCM| Nodell: 1, EventId: 1544 EventClass: 2 EventInfo: Message
translation manager started
16:02:52.250 CCM| DeviceManager: Statically Initializing Device;
DeviceName=172.16.70.226
16:02:52.250 CCM| DeviceManager: Statically Initializing Device;
DeviceName=172.16.70.245
16:02:52.265 CCM| CMProcMon - Call Manager State Changed - Initialization Completed.
```

© 1999, Cisco Systems, Inc.

www.cisco.com

CIPT—Chapter 16-28

Part of this initialization process shows us CCM adding Dns (directory numbers). Thus, it is possible to tell if the directory number has been read from the database by CCM.

In the traces above the Device Manager in CCM is statically initializing the two devices. Actually the device 172.17.70.226 is a Gatekeeper and 172.17.70.245 is another Call Manager in different cluster registered as a H323 Gateway with this CCM.

Registration Process Traces Through Cisco CallManager Trace Utility

This section discusses the registration process traces through the Cisco CallManager Trace Utility.

Registration Process Trace

```
16:02:52.312 CCM| StationInit - New connection accepted. DeviceName=,
TCPHandle=0x4fa7dc0, Socket=0x568, IPAddr= 172.16.70.229, Port= 1556, StationD= [ 0,0,0]
16:02:52.312 CCM| StationInit - New connection accepted. DeviceName=,
TCPHandle=0x4bf8a70, Socket=0x57c, IPAddr= 172.16.70.229, Port= 1557, StationD= [ 0,0,0]
16:02:52.328 CCM| StationInit - Processing StationReg. regCount: 1 DeviceName=MTP_nsa-
cm2, TCPHandle=0x4fa7dc0, Socket=0x568, IPAddr= 172.16.70.229, Port= 1556,
StationD= [ 1,45,1]
16:02:52.328 CCM| StationInit - Processing StationReg. regCount: 1 DeviceName=CFB_nsa-
cm2, TCPHandle=0x4bf8a70, Socket=0x57c, IPAddr= 172.16.70.229, Port= 1557,
StationD= [ 1,96,1]
16:02:52.750 CCM| StationInit - New connection accepted. DeviceName=,
TCPHandle=0x4fbaa00, Socket=0x594, IPAddr= 172.16.70.228, Port= 3279, StationD= [ 0,0,0]
16:02:52.750 CCM| StationInit - New connection accepted. DeviceName=,
TCPHandle=0x4fe05e8, Socket=0x59c, IPAddr= 172.16.70.228, Port= 3280, StationD= [ 0,0,0]
16:02:52.781 CCM| StationInit - Processing StationReg. regCount: 1 DeviceName=MTP_nsa-
cm1, TCPHandle=0x4fbaa00, Socket=0x594, IPAddr= 172.16.70.228, Port= 3279,
StationD= [ 1,45,2]
16:02:52.781 CCM| StationInit - Processing StationReg. regCount: 1 DeviceName=CFB_nsa-
cm1, TCPHandle=0x4fe05e8, Socket=0x59c, IPAddr= 172.16.70.228, Port= 3280,
StationD= [ 1,96,2]
```

© 1999, Cisco Systems, Inc. www.cisco.com CIPT—Chapter 16-29

Another important part of the trace file is the registration process. When a device comes online in an AVVID network it tries to register with Call Manager. These devices could be H323 Gateways, H323Gatekeepers, MGCP Gateways, and Skinny Gateways or Clients or IP Phones. It is therefore important to be able to find out if devices have registered successfully or not. This will help a great deal when troubleshooting such devices in an AVVID network.

In the trace above shows that the CallManager has received new connections for registration. These devices are MTP_nsa-cm1 (MTP services on CCM1) and CFB_nsa-cm1 (Conference Bridge service on CCM1). Remember that these are software services running on CallManager but are treated internally as different external services and therefore assigned a TCPHandle, socket number and port number as well as a device name.

Registration Process Trace

```
16:02:57.000 CCM| StationInit - New connection accepted. DeviceName=,
TCPHandle=0x4fbbc30, Socket=0x5a4, IPAddr= 172.16.70.231, Port= 52095, StationD=[ 0,0,0]
16:02:57.046 CCM| NodeId: 1, EventId: 1703 EventClass: 2 EventInfo: Station Alarm, TCP
Handle: 4fbbc30, Text: Name= SEP003094C26105 Load= AJ.30 Parm= Status/IPAddr
LastTime= A P1: 2304(900) P2: -414838612(e74610ac)
16:02:57.046 CCM| StationInit - * * * * * InboundStim - AlarmMessageID tcpHandle=0x4fbbc30
Message= " Name= SEP003094C26105 Load= AJ.30 Parm= Status/IPAddr LastTime= A"
Parm1= 2304 (900) Parm2= -414838612 (e74610ac)
16:02:57.093 CCM| StationInit - Processing StationReg. regCount: 1
DeviceName= SEP003094C26105, TCPHandle= 0x4fbbc30, Socket= 0x5a4,
IPAddr= 172.16.70.231, Port= 52095, StationD= [ 1,85,1]
16:02:57.093 CCM| StationInit - InboundStim - IpPortMessageID: 32715(0x7fcb)
tcpHandle= 0x4fbbc30
16:02:57.187 CCM| StationInit - New connection accepted. DeviceName=,
TCPHandle=0x4fbb150, Socket=0x600, IPAddr= 172.16.70.230, Port= 49211, StationD=[ 0,0,0]
16:02:57.296 CCM| NodeId: 1, EventId: 1703 EventClass: 2 EventInfo: Station Alarm, TCP
Handle: 4fbb150, Text: Name= SEP0010EB001720 Load= J 0.30 Parm= Status/IPAddr
LastTime= A P1: 16676(4124) P2: -431615828(e64610ac)
16:02:57.296 CCM| StationInit - * * * * * InboundStim - AlarmMessageID tcpHandle=0x4fbb150
Message= " Name= SEP0010EB001720 Load= J 0.30 Parm= Status/IPAddr LastTime= A"
Parm1= 16676 (4124) Parm2= -431615828 (e64610ac)
```

© 1999, Cisco Systems, Inc.

www.cisco.com

CIPT—Chapter 16-30

The following set of skinny messages between IP Phone and CCM. Basically, the IP Phone (172.16.70.231) is getting registered with CCM. Recall from the Skinny station registration section where we have outlined all the skinny messages occurring between Skinny client and CallManager.

Here we can see that as soon as CCM received the registration request from a IP Telephone it assign TCPHandle number to this device. This number remains the same until device or CCM is restarted. Therefore within a trace one can follow all the events related to a particular device by searching or keeping track of TCPHandle number. This is hex number. Also notice that CCM provide load id to IP Phone. Based on this load id IP Phone runs the executable file (acquired from the tftp server) that corresponds to the device.

Keep Alive Process Trace Through Cisco CallManager Trace Utility

This section discusses the keep alive process trace through the Cisco CallManager Trace utility.

Keepalive Process Trace

```
16:03:02.328 CCM| StationInit - InboundStim - KeepAliveMessage - Forward
KeepAlive to StationD. DeviceName=MTP_nsa-cm2, TCPHandle=0x4fa7dc0,
Socket=0x568, IPAddr=172.16.70.229, Port=1556, StationD=[ 1,45,1]
16:03:02.328 CCM| StationInit - InboundStim - KeepAliveMessage - Forward
KeepAlive to StationD. DeviceName=CFB_nsa-cm2, TCPHandle=0x4bf8a70,
Socket=0x57c, IPAddr=172.16.70.229, Port=1557, StationD=[ 1,96,1]
16:03:02.328 CCM| MediaTerminationPointControl - stationOutputKeepAliveAck
tcpHandle=4fa7dc0
16:03:02.328 CCM| UnicastBridgeControl - stationOutputKeepAliveAck
tcpHandle=4bf8a70
16:03:02.734 CCM| StationInit - InboundStim - KeepAliveMessage - Forward
KeepAlive to StationD. DeviceName=MTP_nsa-cm1, TCPHandle=0x4fbaa00,
Socket=0x594, IPAddr=172.16.70.228, Port=3279, StationD=[ 1,45,2]
16:03:02.734 CCM| MediaTerminationPointControl - stationOutputKeepAliveAck
tcpHandle=4fbaa00
16:03:02.734 CCM| StationInit - InboundStim - KeepAliveMessage - Forward
KeepAlive to StationD. DeviceName=CFB_nsa-cm1, TCPHandle=0x4fe05e8,
Socket=0x59c, IPAddr=172.16.70.228, Port=3280, StationD=[ 1,96,2]
```

© 1999, Cisco Systems, Inc. www.cisco.com CIPT—Chapter 16-31

The messages above are used by both the station, device or service and the CCM to maintain a knowledge of the communications channel between them. This message is used to begin the Keep-Alive sequence to assure that the communications link between the CCM and the client is active. The messages above can be originated by either Cisco CallManager or the client.

Keepalive Process Trace

```
16:03:02.734 CCM| UnicastBridgeControl - stationOutputKeepAliveAck
tcpHandle= 4fe05e8
16:03:06.640 CCM| StationInit - InboundStim - KeepAliveMessage - Forward
KeepAlive to StationD. DeviceName= SEP0010EB001720, TCPHandle= 0x4fbb150,
Socket= 0x600, IPAddr= 172.16.70.230, Port= 49211, StationD= [ 1,85,2]
16:03:06.640 CCM| StationD - stationOutputKeepAliveAck tcpHandle= 0x4fbb150
16:03:06.656 CCM| StationInit - InboundStim - IpPortMessageID: 15296(0x3bc0)
tcpHandle= 0x4fbb150
16:03:06.703 CCM| StationInit - InboundStim - KeepAliveMessage - Forward
KeepAlive to StationD. DeviceName= SEP003094C26105, TCPHandle= 0x4fbbc30,
Socket= 0x5a4, IPAddr= 172.16.70.231, Port= 52095, StationD= [ 1,85,1]
16:03:06.703 CCM| StationInit - InboundStim - IpPortMessageID: 32715(0x7fcb)
tcpHandle= 0x4fbbc30
16:03:06.703 CCM| StationD - stationOutputKeepAliveAck tcpHandle= 0x4fbbc30
```

© 1999, Cisco Systems, Inc.

www.cisco.com

CIPT—Chapter 16-32

The messages above are used to terminate the Keep-alive sequence to assure that the communications link between the CCM and the client is active. Again, these messages can be originated by either the CCM or the client.

Intra Cluster Call Flow Traces Through Cisco CallManager Trace Utility

This section discusses the Intra Cluster call flow traces through a Cisco CallManager Trace utility.

Intra Cluster Call Flow Trace

```
16:05:41.625 CCM| StationInit - InboundStim - OffHookMessageID tcpHandle=0x4fbbc30
16:05:41.625 CCM| StationD - stationOutputDisplayText tcpHandle=0x4fbbc30, Display=
1001
16:05:41.625 CCM| StationD - stationOutputSetLamp stim: 9= Line instance= 1
lampMode= LampOn tcpHandle=0x4fbbc30
16:05:41.625 CCM| StationD - stationOutputCallState tcpHandle=0x4fbbc30
16:05:41.625 CCM| StationD - stationOutputDisplayPromptStatus tcpHandle=0x4fbbc30
16:05:41.625 CCM| StationD - stationOutputSelectSoftKeys tcpHandle=0x4fbbc30
16:05:41.625 CCM| StationD - stationOutputActivateCallPlane tcpHandle=0x4fbbc30
16:05:41.625 CCM| Digit analysis: match(fqcn= " ", cn= " 1001" , pss= " " , dd= " " )
16:05:41.625 CCM| Digit analysis: potentialMatches= PotentialMatchesExist
16:05:41.625 CCM| StationD - stationOutputStartTone: 33= InsideDialTone
tcpHandle=0x4fbbc30
16:05:42.890 CCM| StationInit - InboundStim - KeypadButtonMessageID kpButton: 1
tcpHandle=0x4fbbc30
16:05:42.890 CCM| StationD - stationOutputStopTone tcpHandle=0x4fbbc30
16:05:42.890 CCM| StationD - stationOutputSelectSoftKeys tcpHandle=0x4fbbc30
16:05:42.890 CCM| Digit analysis: match(fqcn= " ", cn= " 1001" , pss= " " , dd= " 1" )
```

© 1999, Cisco Systems, Inc. www.cisco.com CIPT—Chapter 16-33

In this call flow, an IP phone (dn=1001, tcpHandle= 0x4fbbc30, IP address=172.16.70.231) which is located in the cluster 2 is calling another IP Phone (dn=1000, tcpHandle= 0x4fbb150, IP address= 172.16.70.230) located within the same cluster.

Always remember that you can follow a trace for any device by looking at the TCP handle value, time stamp or name of the device. Also, remember that a unique TCP handle value get assigned to a device when it gets rebooted or it comes on-line the first time. This TCP handle values stays the same for this particular device until it gets rebooted again and goes off line.

The traces above show that the IP phone (1001) has gone off hook. Observe the unique messages, TCP handle value and the called number, which are displayed on the IP phone. There is no calling number at this point, as the user has not tried to dial any digits.

Again, remember all of these are skinny messages between IP phones and CCM.

The trace above shows skinny messages going from CCM to IP phone. The first message is turning the on the lamp on the calling party IP phone.

The stationOutputCallState message is used by CCM to notify the station of certain call related information.

The stationOutputDisplayPromptStatus message is used by CCM to cause a call related prompt message to be displayed on the station display.

The stationOutputSelectSoftKey message is used by the CCM to cause the skinny station to select a specific set of soft keys.

This message is used by CCM to instruct the skinny station as to the correct line context for the display.

In the message above the digit analysis process is ready to identify incoming digit and match them for potential matches which exist for routing in the database. The cn=1001 is the calling party number and dd="" is the dialed digit, which would show the called part number.

The debug above shows that the CCM is providing the inside dial tone to the calling party IP phone.

Intra Cluster Call Flow Trace

```
16:05:42.890 CCM| Digit analysis: potentialMatches= PotentialMatchesExist
16:05:43.203 CCM| StationInit - InboundStim - KeypadButtonMessageID kpButton: 0
tcpHandle=0x4fbbc30
16:05:43.203 CCM| Digit analysis: match(fqcn= " ", cn= " 1001" , pss= " " , dd= " 10" )
16:05:43.203 CCM| Digit analysis: potentialMatches= PotentialMatchesExist
16:05:43.406 CCM| StationInit - InboundStim - KeypadButtonMessageID kpButton: 0
tcpHandle=0x4fbbc30
16:05:43.406 CCM| Digit analysis: match(fqcn= " ", cn= " 1001" , pss= " " , dd= " 100" )
16:05:43.406 CCM| Digit analysis: potentialMatches= PotentialMatchesExist
16:05:43.562 CCM| StationInit - InboundStim - KeypadButtonMessageID kpButton: 0
tcpHandle=0x4fbbc30
16:05:43.562 CCM| Digit analysis: match(fqcn= " ", cn= " 1001" , pss= " " , dd= " 1000" )
16:05:43.562 CCM| Digit analysis: analysis results
16:05:43.562 CCM| | PretransformCallingPartyNumber= 1001
| CallingPartyNumber= 1001
| DialingPattern= 1000
| DialingRoutePatternRegularExpression=(1000)
```

© 1999, Cisco Systems, Inc.

www.cisco.com

CIPT—Chapter 16-33

Once CCM detects an incoming message and recognizes that the keypad button 1 is pressed on the IP phone, it immediately stops the output tone. The messages identifying incoming keypad press sequences, i.e. digits 1000. Other messages indicate the CCM is running the digit analysis process to match these digits.

Intra Cluster Call Flow Trace

```
| DialingRoutePatternRegularExpression=(1000)
| DialingSdIPProcessId=(1,38,2)
| PretransformDigitString= 1000
| PretransformPositionalMatchList= 1000
| CollectedDigits= 1000
| PositionalMatchList= 1000
| RouteBlockFlag= RouteThisPattern
16:05:43.562 CCM| Locations:Orig=0 BW=-1 Dest=0 BW=- (-1 implies infinite bw
available)
16:05:43.578 CCM| StationD - stationOutputCallState tcpHandle= 0x4fbb150
16:05:43.578 CCM| StationD - stationOutputCallInfo CallingPartyName= 1001,
CallingParty= 1001, CalledPartyName= 1000, CalledParty= 1000, tcpHandle= 0x4fbb150
16:05:43.578 CCM| StationD - stationOutputSetLamp stim: 9= Line instance= 1
lampMode= LampBlink tcpHandle= 0x4fbb150
16:05:43.578 CCM| StationD - stationOutputSetRinger: 2= InsideRing
tcpHandle= 0x4fbb150
16:05:43.578 CCM| StationD - stationOutputDisplayNotify tcpHandle= 0x4fbb150
16:05:43.578 CCM| StationD - stationOutputDisplayPromptStatus tcpHandle= 0x4fbb150
16:05:43.578 CCM| StationD - stationOutputSelectSoftKeys tcpHandle= 0x4fbb150
```

© 1999, Cisco Systems, Inc.

www.cisco.com

CIPT—Chapter 16-34

Once the CCM has received enough digits to match, it will provide the digit analysis results in a table format. Any extra digits typed on the phone at this point will be ignored by the CCM, as a match has already been found.

The above traces show that the CCM is now sending out this information to a called party phone, which is evident from tcpHandle number.

The above traces shows us that now the CCM commands the called party IP phone's lamp to blink for incoming call indication.

The CCM provides ringer, display notification, and other call related information to called party IP phone. Again, keep this information by following tcpHandle number.

The figure above represents the CCM begins providing an alerting or ringing tone to the calling party's IP phone, notifying that the connection has been established.

Intra Cluster Call Flow Trace

```
16:05:43.578 CCM| StationD - stationOutputCallState tcpHandle= 0x4fbbc30
16:05:43.578 CCM| StationD - stationOutputCallInfo CallingPartyName= 1001,
CallingParty= 1001, CalledPartyName=, CalledParty= 1000, tcpHandle= 0x4fbbc30
16:05:43.578 CCM| StationD - stationOutputCallInfo CallingPartyName= 1001,
CalledPartyName= 1000, CalledParty= 1000, tcpHandle= 0x4fbbc30
16:05:43.578 CCM| StationD - stationOutputStartTone: 36= AlertingTone
tcpHandle= 0x4fbbc30
16:05:43.578 CCM| StationD - stationOutputCallState tcpHandle= 0x4fbbc30
16:05:43.578 CCM| StationD - stationOutputSelectSoftKeys tcpHandle= 0x4fbbc30
16:05:43.578 CCM| StationD - stationOutputDisplayPromptStatus tcpHandle= 0x4fbbc30
16:05:45.140 CCM| StationD - stationOutputStopTone tcpHandle= 0x4fbbc30
16:05:45.140 CCM| StationD - stationOutputOpenReceiveChannel tcpHandle= 0x4fbbc30
myIP: e74610ac (172.16.70.231)
16:05:45.140 CCM| StationD - ConferenceID: 0 msecPacketSize: 20
compressionType:(4)Media_Payload_G711Ulaw64k
16:05:45.140 CCM| StationD - stationOutputStopTone tcpHandle= 0x4fbb150
16:05:45.140 CCM| StationD - stationOutputOpenReceiveChannel tcpHandle= 0x4fbb150
myIP: e64610ac (172.16.70.230)
```

© 2000, Cisco Systems, Inc.

www.cisco.com

CIPT v2.0—16-33

At this point, the called party's IP phone goes off hook. Therefore, CCM stops generating the ringer tone to calling party. The message above is used by the CCM to cause the Skinny Client to begin receiving a unicast RTP stream. This can be observed in the following traces that CCM provides the IP address of called party as well as codec information, and packet size in msec (millisecondsPacketSize is an integer containing the sampling time in milliseconds used to create the RTP packets. NOTE: normally this value is set to 30msec.) In our case it is set to 20msec, which is obvious from the red highlighted trace message.

Intra Cluster Call Flow Trace

```
16:05:45.140 CCM| StationD - ConferenceID: 0 msecPacketSize: 20
compressionType:(4)Media_Payload_G711Ulaw64k
16:05:45.156 CCM| StationD - stationOutputStopTone tcpHandle= 0x4fbb150
16:05:45.156 CCM| StationD - stationOutputCallState tcpHandle= 0x4fbb150
16:05:45.156 CCM| StationD - stationOutputCallInfo CallingPartyName= 1001,
CallingParty= 1001, CalledPartyName= 1000, CalledParty= 1000, tcpHandle= 0x4fbb150
16:05:45.156 CCM| StationD - stationOutputSelectSoftKeys tcpHandle= 0x4fbb150
16:05:45.156 CCM| StationD - stationOutputDisplayPromptStatus tcpHandle= 0x4fbb150
16:05:45.156 CCM| StationD - stationOutputStopTone tcpHandle= 0x4fbbc30
16:05:45.156 CCM| StationD - stationOutputCallState tcpHandle= 0x4fbbc30
16:05:45.156 CCM| StationD - stationOutputCallInfo CallingPartyName= 1001,
CallingParty= 1001, CalledPartyName= 1000, CalledParty= 1000, tcpHandle= 0x4fbbc30
16:05:45.156 CCM| StationD - stationOutputSelectSoftKeys tcpHandle= 0x4fbbc30
16:05:45.156 CCM| StationD - stationOutputDisplayPromptStatus tcpHandle= 0x4fbbc30
16:05:45.265 CCM| StationInit - InboundStim - StationOpenReceiveChannelAckID
tcpHandle= 0x4fbb150, Status= 0, IpAddr= 0xe64610ac, Port= 17054, PartyID= 2
16:05:45.265 CCM| StationD - stationOutputStartMediaTransmission tcpHandle= 0x4fbbc30
myIP: e74610ac (172.16.70.231)
```

© 2000, Cisco Systems, Inc.

www.cisco.com

CIPT v2.0—16-34

Similarly, the CCM provides information to called party (1000).

Intra Cluster Call Flow Trace

```
16:05:45.265 CCM| StationD - RemoteIpAddr: e64610ac (172.16.70.230)
RemoteRtpPortNumber: 17054 msecPacketSize: 20
compressionType:(4)Media_Payload_G711Ulaw64k
16:05:45.312 CCM| StationInit - InboundStim - StationOpenReceiveChannelAckID
tcpHandle=0x4fbbc30, Status=0, IpAddr=0xe74610ac, Port=18448, PartyID=1
16:05:45.312 CCM| MediaManager - wait_AuConnectInfo
16:05:45.312 CCM| MediaManager - wait_AuConnectInfo - recieved response,
forwarding
16:05:45.312 CCM| MediaCoordinator - wait_AuConnectInfoInd
16:05:45.312 CCM| StationD - stationOutputStartMediaTransmission
tcpHandle=0x4fbb150 myIP: e64610ac (172.16.70.230)
16:05:45.328 CCM| StationD - RemoteIpAddr: e74610ac (172.16.70.231)
RemoteRtpPortNumber: 18448 msecPacketSize: 20
compressionType:(4)Media_Payload_G711Ulaw64k
16:05:45.328 CCM| Locations:Orig=0 BW=-1 Dest=0 BW=-1 (-1 implies infinite
bw available)
16:05:46.203 CCM| StationInit - InboundStim - OnHookMessageID
tcpHandle=0x4fbbc30
```

© 2000, Cisco Systems, Inc.

www.cisco.com

CIPT v2.0-16-35

CCM has received the acknowledgment message from called party for establishing the open channel for RTP stream, as well as the ip address of the called party. This message is to inform the CCM of two pieces of information about the Skinny Client. First, it contains the status of the open action. Secondly, it contains the receive port address and number for transmission to the remote end, ipAddr is the IP address of the transmitter (calling part) of the RTP stream, PortNumber is the IP port number of the RTP stream transmitter (calling party).

The messages above are used by the CCM to command the client to begin transmitting the audio stream to the indicated remote IP phone's IP address and port number.

In the traces above, the previously explained messages are sent to the called party. These messages are followed by the messages that the RTP media stream has been started between the called and calling party.

The calling party's IP phone finally goes on hook, which terminate all the control messages between skinny station and CCM as well as the RTP stream between skinny clients.

These call flow messages are very useful in troubleshooting call flow related issues between IP phones. This section demonstrated the call flow for the intra cluster calls. This would help engineers to understand the call flow as well as troubleshoot call flow related problems.

Summary

Summary

- **The tools available to troubleshoot potential problems are on the Cisco CallManager Server.**
- **Understanding the call flow and debug traces will make it easier to isolate a problem and determine which component is causing the problem**

© 1999, Cisco Systems, Inc.

www.cisco.com

CIPT—Chapter 16-23

The main goal of this troubleshooting chapter is to explain the tools available to troubleshoot potential problems and to understand the call flows and series of events through the call traces and debug outputs. The tools and utilities that are available are the following:

- Cisco CallManager Administration
- Performance Monitor
- Event Log
- Local Log Files
- SDL Trace
- Trace Utility

Once you understand the call flow and debug traces, it will be easier to isolate a problem and determine which component is causing the problem. Understanding the information provided in this chapter will help to find a resolution quicker, as well as to isolate most of their issues.

Review Questions

Review Questions

- **Which tool provides the system version, administration version and database information about the Cisco CallManager?**
- **In order to monitor a variety of system variables in real time, which tool would need to be used?**
- **What are the three categories Event viewer has?**

© 1999, Cisco Systems, Inc. www.cisco.com CIPT—Chapter 15-24

- Q1) Of the tools on the Cisco CallManager server, which tool will provide the system version number, administration version number and database information about the Cisco CallManager server?
- Q2) Monitoring a variety of system variables in real time can be useful, which tool is able to provide such monitoring capabilities?
- Q3) The Event viewer creates Event Logs, what are the three categories the Event viewer can log?

Laboratory Exercises

