

# B-47

# STRATOJET in action



  
squadron/signal publications

**AIRCRAFT NO. 28**

**\$3.95**

*Lou Drundel*  
1976

# **B-47**

## **STRATOJET**

### **in action**



**by Lou Drendel  
& Tom Y'Blood**



squadron/signal publications



[Cover] B-47E-130-BW of the 380th Bomb Wing, dubbed; "City of Plattsburg II" lifting off with ATO.

COPYRIGHT © 1976 by SQUADRON/SIGNAL PUBLICATIONS, INC.  
3461 E. TEN MILE ROAD, WARREN, MICHIGAN 48091

All rights reserved. No part of this publication may be reproduced, stored in a retrieval system, or transmitted in any form by any means electrical, mechanical or otherwise, without first seeking the written permission of the publisher.

#### Photo Credits

USAF  
Boeing  
Canadair  
OCAMA  
Donald Bishop  
John Bowdler  
Norm Crocker  
Jerry Geer  
Gerdes  
Mike Habermehl  
R.L. Lawson  
Roy Lock  
Robert Loffredo  
Paul McDaniel  
Dave Menard  
R.D. Neal  
Bruce Orriss  
Paul Stevens  
Bob Stymes  
A. Swanberg  
Norman E. Taylor  
Richard L. Ward  
Nick Williams  
Tom Y'Blood  
Kay Yingling

*Distributed in Great Britain By  
by Almark Publishing Co. Ltd.,*

# Introduction

The B-47 was the backbone of SAC's bomber fleet in the 'fifties, yet only 2,042 Stratojets were built for the "Cold War" period. Compare this with the over 12,700 B-17s built for use during World War Two. Although only a relatively small number of B-47s were built, those were quite capable of doing the job in the early to middle years of the jet age.

Design on what was to become the B-47 began in 1943. It was not until 1945, however, that its definitive form began to take shape. In competition with the XB-45, XB-46, XB-48 and XB-49, only the last could offer any design advancement that could compare with the XB-47.

With six jet engines, a 35-degree swept wing and a surprisingly small crew of three, the Stratojet was a daring leap forward in aircraft design. The Air Force was very pleased with Boeing's design and two prototypes (46-065 and 46-066) were ordered. 46-065 was rolled out of its Seattle hanger on 12 September 1947. Powered by 3,750-lb. thrust General Electric J35s, it flew on 17 December 1947. Later the entire B-47 fleet was powered by a series of progressively uprated J47 engines.

Production of Stratojet was authorized by the USAF in September 1948. The first aircraft produced were ten B-47As (49-1900/1909), the first A flying on 25 June 1950. Considered non-combat-ready test vehicles, the As were used for airframe development and crew trainers. The As retained the clear bombardier's nose and long bomb bay of the prototypes.

The first true production model was the B-47B. On 26 April 1951, 49-2642 became the first B to fly. On the Bs, the clear plexiglas nose was eliminated, the shape of the vertical fin tip was changed, droppable wing tanks were added, air refueling equipment was installed, a short bomb bay replaced the long one, and .50-cal. tail guns were carried as the sole defensive armament. The later Bs carried uprated J47-GE-23 engines. A total of 399 B-47Bs were built, including ten by Douglas and nine by Lockheed. Serial numbers were: 49-2642/2646, 50-001/082, and 51-2045/2356.

SAC's first Stratojet was received by the 306th BW, at MacDill AFB, Florida, on 23 October 1951. Ultimately, 36 SAC wings, one MAC wing and a number of miscellaneous units would have B-47s assigned.

The next Stratojet model in line should have been the B-47C. A four-jet version of the basic B-47 it unfortunately perhaps, never materialized. The C was known by several designations, including B-47C, RB-47C, YB-47C and (for a short period) B-56. Power for the C was to be supplied by four engines in the 9,000/11,000-lb. thrust range. Vacillating USAF requirements and engineering problems finally led to the cancellation of the project.

The definitive version of the Stratojet was the B-47E. The first E (51-2357) flew on 30 January 1953. Eventually, most B-47Bs were brought up to E standards and, except for serial numbers, could not be distinguished from the Es. Before modification the first Es kept the nose windows and internal ATO of the B-47Bs. Later Es, and all modified aircraft, had a revised nose section with ejection seats. (Surprisingly, although the prototypes and B-47As had the seats, the Bs didn't.) The internal ATO system was replaced with an external jettisonable system. The B-47Es were upgunned to 20mm weapons. This still wasn't much armament, but it was all the Stratojet was ever to get. The engines were again uprated to J47-GE-25s or -25As. They were now capable of 7,200 pounds of wet thrust. (Water alcohol injection was now used for extra takeoff



46-065, the first prototype, at Andrews AFB on 8 February 1949, following its record-breaking 3 hour and 46 minute flight from Moses Lake to Andrews. The number 3 engine "bullet" was lost during the landing approach. The XB-47 was at Andrews for the Congressional Air Show. Note the whitewalls! [USAF]

The first B-47A, 49-1900, is rolled out at Wichita on 1 March 1950. Worthy of note are the vintage aircraft in the background. [PT-13D and YL-15] [USAF]



## B-47A

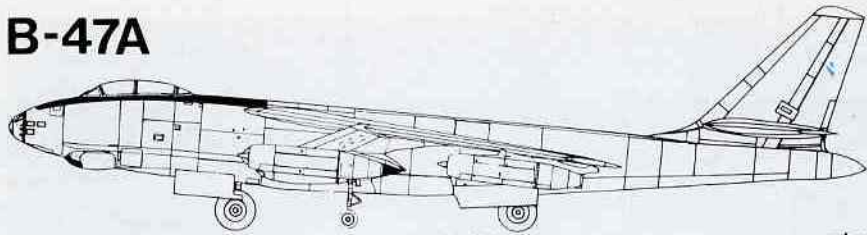

## B-47B

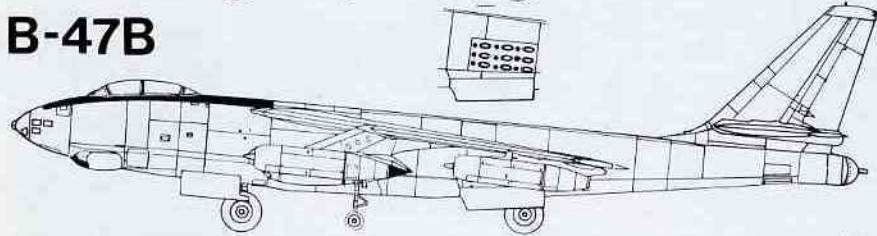

## B-47E

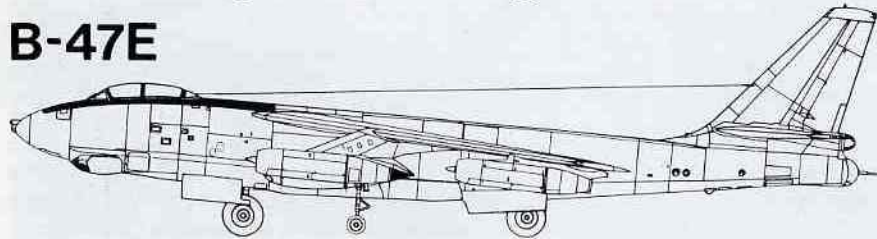

## RB-47E

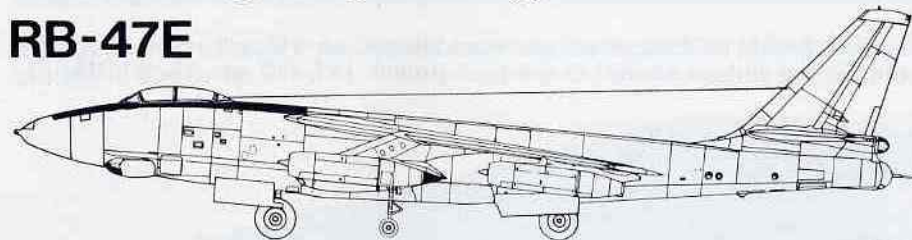

## QB-47E

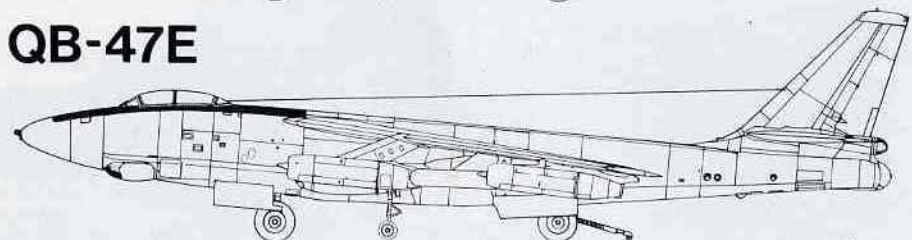

## RB-47H

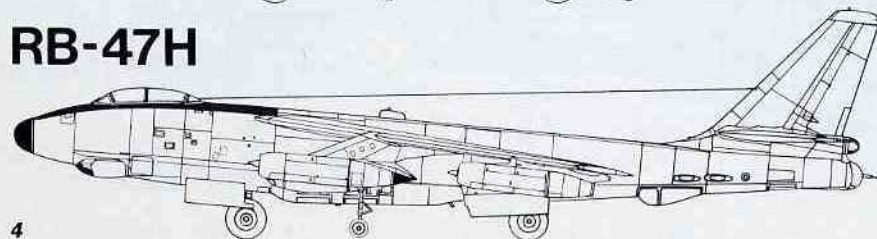

thrust.) But, aircraft weight had also climbed—from the XB-47s design gross weight of 125,000 pounds (162,500 pounds overload) to the B-47Es maximum inflight weight of 221,000 pounds. Serial numbers for the B-47E were: 51-2357/2445, 51-5214/5257, 51-7019/7083, 51-15804/15812, 51-17368/17386, 52-019/120, 52-146/620, 52-1406/1417, 52-3343/3373, 53-1819/1972, 53-2028/2040, 53-2090/2170, 53-2261/2417, 53-4207/4244, 53-6193/6244. A total of 1,341 B-47Es were built with Boeing turning out 691 aircraft, Lockheed 386 and Douglas 264.

Stratojets were modified for a variety of roles, sometimes in considerable numbers. While many of these B-47s never received any kind of designation change, many did. Stratojets that did get a new designation included: the XB-47D and CL-52, both of which were used for engine development; the TB-47Bs, used for training; several director aircraft models—DB-47B, YDB-47E and DB-47E; the exotic QB-47E drones; two types of ECM aircraft (one with a two-man capsule and one with a removable bomb bay ECM unit), the EB-47Es; the YB-47F and KB-47G, used as receiver and tanker, respectively, in probe-and-drogue air refueling tests; the YB-47J, used to service test the MA-2 radar bomb-nav system; the EB-47Ls, used for a short while as airborne communications relay stations; MAC's WB-47Es; and a large series of aircraft modified for all types of reconnaissance—the YRB-47Bs, RB-47Es (of which 240 were built), RB-47Hs, RB-47Ks, and EB-47E (TT)s.

The Stratojet soldiered on throughout the 'fifties and 'sixties. SAC's last stratojet, an RB-47H of the 55th SRW, was mustered out on 29 December 1967, while the last MAC WB-47E left in late 1969.

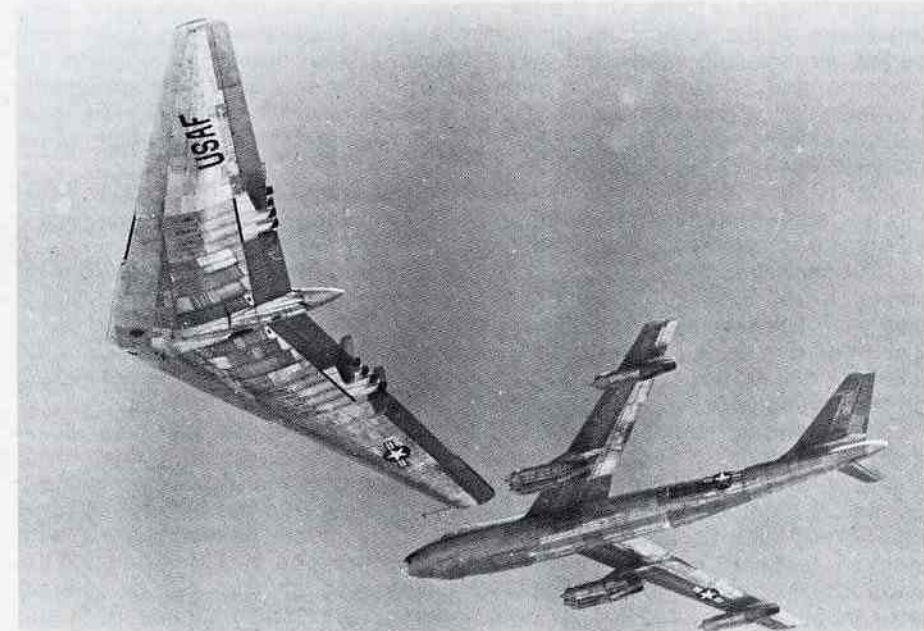

Two new shapes in the sky.....the XB-47 and the XB-49. [USAF]

CHENARD

Noticeable differences between production Stratojets and the B-47A were the plexiglass nose and the fin tip shape. [Boeing]

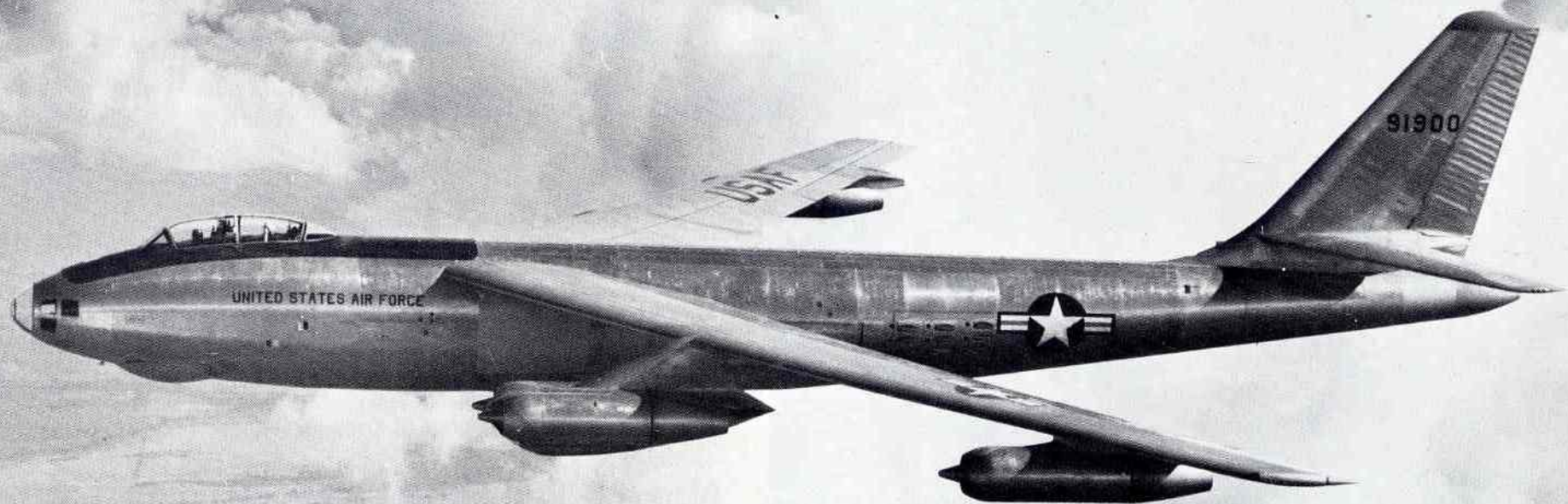

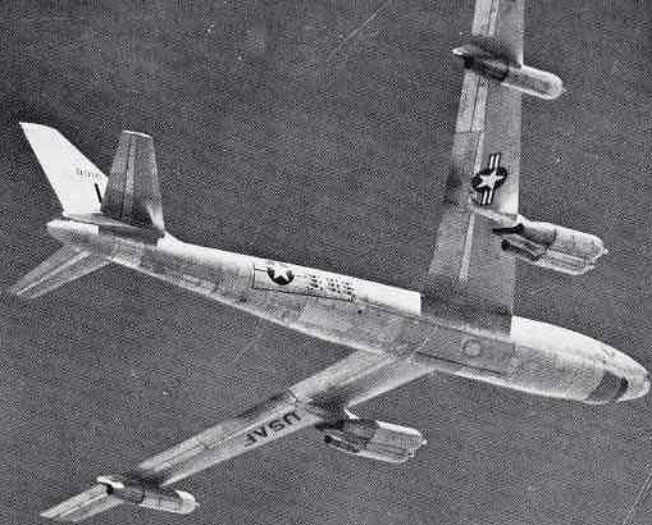

50-014, a B-47B-10-BW, refuels from a KB-29P during Phase IV Heavyweight Air Refueling Tests at Edwards in 1952. [USAF via Donald Bishop]

[Left] Stratojets were flown in formation quite a bit in early use, as demonstrated by three TB-47B's from the 3520th Combat Crew Training Wing. [USAF]

Three B-47s are still flying today although their days appear to be numbered. Two ex-376th BW EB-47Es, 52-410 and 52-412, were taken over by the Navy for ECM testing in 1965. Another B-47, 53-2104, was used by the Navy as a testbed for the General Electric TF34 engine that is now used in the S-3A Viking. 53-2104 now resides in the "Boneyard" at Davis-Monthan AFB. The third B-47 still flying was SAC's last Stratojet, 53-4296. Now sporting a needle nose, the aircraft works out of the Rockwell International facility at Los Angeles. For a time it was involved in tests of the F-111 radar system. Unconfirmed reports indicate that these last three B-47s may be finished with their careers by the end of 1976.

So the Stratojet is rapidly fading from view. But, the drama of a B-47 taking off, leaving its trail of dense black smoke behind, will be a stirring scene forever fixed in the memories of many people.

## Nose & Tail Development

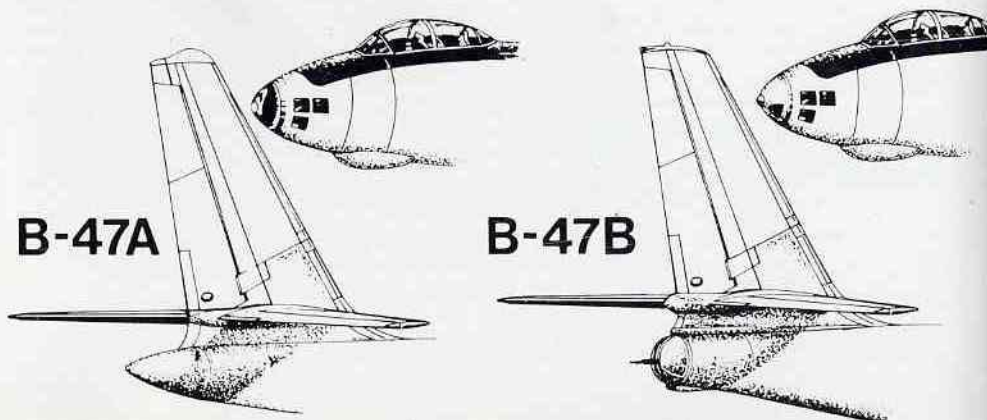

**B-47A**

**B-47B**



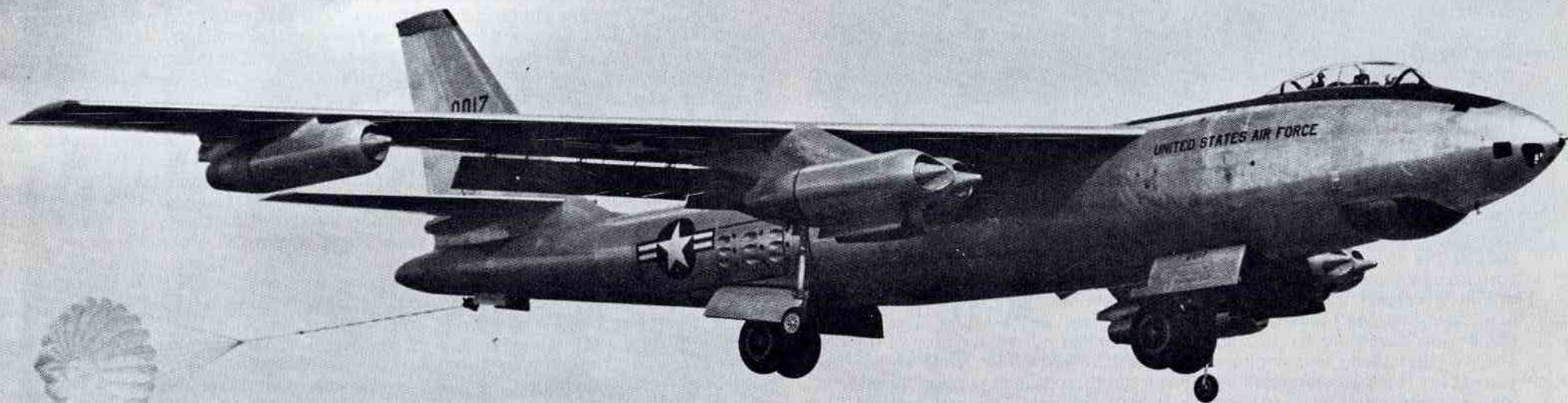

TB-47B crosses the fence with its approach chute streaming. [Boeing]

## Flying the B-47 Stratojet

The Stratojet was not a universally liked aircraft by its crew, especially in the latter stages of its service life. While some swore by the B-47, others swore at it. Using one of the early jet engines, the B-47 became somewhat underpowered as more and more weight was added to its airframe. This isn't to say that it couldn't perform its mission because of a lack of engine thrust—it could do the job. But, its performance envelope was reduced and the loss of an engine on takeoff, especially an outboard, could turn out to be very interesting.

I now fly 727-200s with three JT8D-9A engines of 14,500 pounds thrust each (43,500 pounds total thrust). The maximum takeoff weight is 172,000 pounds. The "three-holer" is not a performance leader up at that end of the scale. The

B-47E had six J47s of 7,200 pounds wet thrust each (43,200 pounds total) and a maximum takeoff weight of 221,000 pounds! Any pilot can tell you, a little extra power (especially in the case of the B-47) at high gross weights and temperatures can sure give one a more comfortable feeling. Unfortunately, the Stratojet never got that little "extra". However, I flew three different versions of the B-47 for over 1,000 hours and had only one engine failure and a hydraulic failure during that time. The actual number of B-47s lost in accidents is unavailable, but records tend to indicate that much less than 200 of them were destroyed. For an aircraft that was used heavily for over an 18 year period (1951-1969), a less than ten per cent accident rate is not too shabby.

The most critical time to lose an engine is during the takeoff. And the most critical engines for the B-47 were numbers one and six, the outboards. It has been stated that a pilot only had about 1.7 seconds to recognize an outboard engine loss on takeoff before it was too late to do anything about it. A heavy



aircraft would, of course, be much more sensitive to an outboard loss than a light aircraft. I don't know if that 1.7 second figure is really that accurate. I do know that B-47 accident summaries are full of reports of an outboard engine loss on takeoff, followed by a big ball of fire as the aircraft crashed.

The 301st BW lost an EB-47E at Lockbourne on 8 November 1960, following a double engine failure. During the takeoff both number four and six engines were lost (four partially and six completely). The takeoff roll was, naturally, much longer than normal and the Stratojet was only able to stagger about 50 feet into the air before it began a rapid roll to the right. The aircraft rolled 160 degrees before it hit the ground just off the end of the runway. There were no survivors.

In another accident, the 306th BW lost a B-47E on 26 September 1962. This was a rather unusual accident in the way it developed. Prior to takeoff on a normal training mission the crew had some trouble with an inboard engine. After getting it fixed, the crew began their takeoff. During the takeoff roll a fire developed in an inboard engine on the opposite wing from the J47 that had caused the trouble earlier. By now they were committed to takeoff. The co-pilot saw the fire but mistakenly called it out as being in the engine that had originally caused trouble. First error. The aircraft commander immediately shut down the two inboard engines on that side! Second error. The co-pilot had by now caught his mistake and correctly called out the location of the fire. The AC shut these two engines down, also. Third error. Three strikes and you're out! The B-47 staggered into the air but there wasn't enough thrust from the two outboard engines to keep the aircraft airborne. The crew ejected. The pilots survived but the navigator was killed. His low altitude zero-second lanyard had not been hooked to his parachute.

The AC met a Flying Evaluation Board and SAC concluded that he was not up to their standards. As the 306th was now being phased out, the AC sat around MacDill awaiting some sort of assignment. It wasn't long in coming. I saw the AC again a few months later at Lockbourne. Eighth Air Force had urgently needed a B-47 pilot for the 376th BW. This AC had come up and was getting ready to fly Stratojets again when SAC heard about it. In their wisdom SAC decided that this AC was not going to fly one of their "advanced" aircraft so they sent him out of SAC, back to MacDill to fly a lesser aircraft—the F-4! Perhaps it was this incident that led some wags to comment that the only way one could get out of SAC was to screw up or get carried out feet first.

ATO takeoffs were always tremendously exciting. Thirty 1,000-pound thrust rockets literally gave the crew a boot. The bottles were fired about ten seconds prior to unstick and once fired there was no way of aborting or shutting down the rockets prior to their burning out. On rare occasions a rocket would break its mount and direct its blast into the fuselage. This wasn't too good because of the fuel tank located in the immediate area. Also, until the aft main fuel tank vent ports were relocated, it was possible for the rockets to ignite fuel vapors, causing an uncontrollable fuselage fire. But, generally, ATO takeoffs were remarkable safe.

Once in the air the B-47 was enjoyable to fly. It could be rolled (up to 30 degrees per second at 280 KIAS) and looped very easily. In 1957-58 SAC began using the B-47 in the low altitude role. At first this called for using the aircraft with the LABS maneuver. Doing an Immelmann in the Stratojet must have been impressive, both from a pilot's or onlooker's viewpoint. However, following a

series of accidents resulting from structural fatigue, B-47s were restricted from the LABS maneuver. Project MILK BOTTLE, in 1958, involved beefing-up the B-47's structure and increased the aircraft's lifespan. The Stratojet then continued in a modified low altitude bombing role.

Air refueling, in any aircraft, is a stirring sight. It takes skill and patience to do it right. The B-47 was good in formation flying which, basically, is what air refueling is all about. Of course, having a boom attached between tanker and receiver makes a big difference. Refueling with a KC-97 or KC-135 differed in that the B-47 was usually faster than the '97 and refueling was often done in a descending flight path and with the '135 the B-47 was sometimes power limited and the tanker often had to slow down. Once one got the hang of air refueling it became just another part of flying. But, you could never let your guard down or grow complacent. If you did, something could reach out and bite you. The B-47 was very much a weight-and-balance aircraft because all the fuel (except for wing tanks) was located in a long stretch of fuselage. Too much fuel at one end or the other could cause some severe CG problems. In air refueling, care had to be taken that the fuel was going into the right tanks. Even alertness didn't help sometimes during the refueling. In one bizarre incident, a student AC was killed when the tanker's boom was accidentally thrust through the B-47's canopy.

In flight the AC, naturally, was in charge of the aircraft, the navigator bombed and told us where to go, and the co-pilot was a jack-of-all-trades—handling the guns, radios, refueling panel and taking the sextant "shots". To shoot the sextant the co-pilot usually had to unfasten his seat belt and often also his parachute for, invariably, the navigator would need a star fix that required the most ungodly contortions to shoot.

It wasn't uncommon for a copilot to fall asleep during those early morning flights while using the sextant. On one of these wee small hours flights the AC and navigator of one crew were startled by a loud crash behind them. Upon investigating they found the copilot (who had unstrapped for the celestial work) had fallen asleep while using the sextant and toppled the approximately five feet from his seat to the aisleway floor. He stayed awake the rest of the flight.

In any multi-crew type aircraft it is always good to get along with the rest of the crew and especially so when you're thrown together in the alert-type situation that was started in SAC in 1958. I had one AC that I couldn't get along with but, at least, we didn't have the problems a couple of crews had.

A pair of Whiteman AFB instructor pilots (IPs) were flying together one day. The IP flying the rear seat was smoking one of the foulest smelling cigars ever imaginable. The IP in the front seat was a non-smoker and he asked his fellow pilot to please put out the cigar. No answer. Three more times he asked and still no reply. As they were above 30,000 feet and feeling actions speak louder than words, the front seat IP pulled the pressurization dump valve. The cigar went out along with the cabin pressure. The rest of the flight was flown with a smoke-free cockpit.

In another case of not getting along together, a very small, "Chip on the shoulder" AC was constantly finding fault with whatever his copilot might be doing. His copilot, a huge and extremely strong person, did have one bad habit—one that was, apparently, never noticed by his AC. He very seldom trimmed the aircraft but tended to rely on his own brute strength to hold attitude.

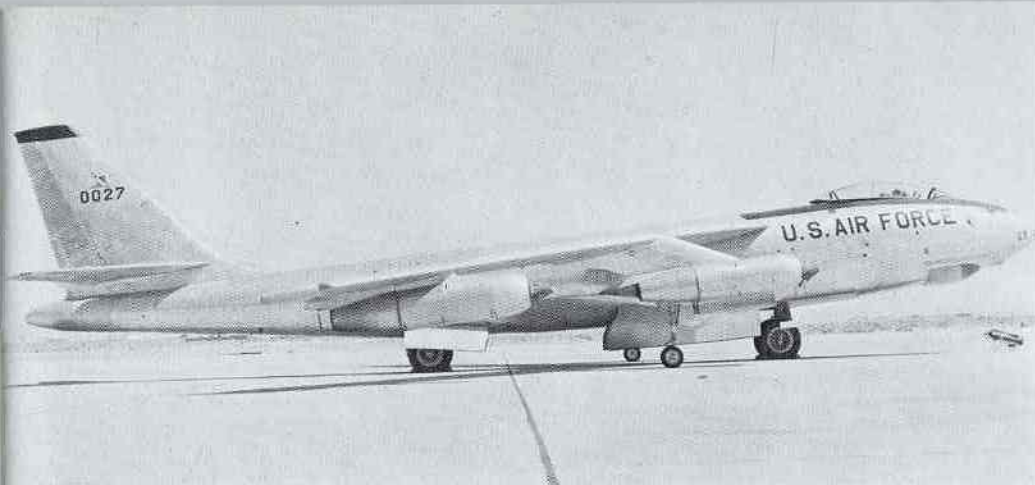

Original long bomb bay and rounded vertical fin is evident in this view of 49-1909. [Dave Menard]

[Above Left] TB-47B-15-BW of APGC.



[Center Left] TB-47B sporting the insignia of the Air Training Command. It belonged to the 3520th FTW at McConnell AFB. Note the nacelle close-off doors that were used on early B-47's to reduce rotor drag in case of dead engine, and to prevent FOD. [Foreign Object Damage] [Dave Menard]

[Below Left] Wright Air Development Center had ETB-47B assigned temporarily. [Dave Menard]

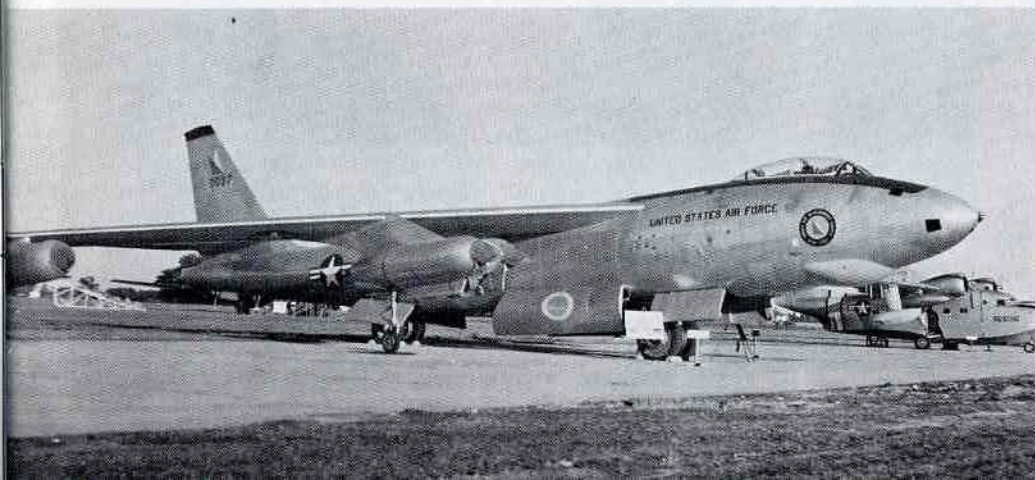

On this particular flight the copilot was flying and had let the aircraft get very nose heavy. Of course, he was holding it level on sheer muscle. The AC (who must not have been paying attention) decided the copilot wasn't flying right and he would show him how it was done. The copilot must have known what was going to happen. As the AC grabbed the control wheel, the copilot let it go. The B-47 pitched over wildly; the AC shot forward, knocking himself silly on the control wheel; and down they plummeted. Several thousand feet later the copilot pulled them out of their dive. A couple of days later these two pilots parted ways.

The Stratojet was, surprisingly, not a hard aircraft to land. Granted, the view from the rear seat was not the greatest but good landings could be made consistently from that seat. The early B-47s were somewhat squirrely to land and a 16-foot approach chute was soon added to help stabilize an approach. This chute also helped create drag so that the engines had to be kept "spooled up" in case of a go-around. (The J47s were very slow to accelerate from idle thrust.) The approach chute worked fine but, every now and then, some pilot would pull the wrong handle and deploy the 32-foot brake chute instead. This, usually, caused a dramatic decrease in airspeed and altitude.

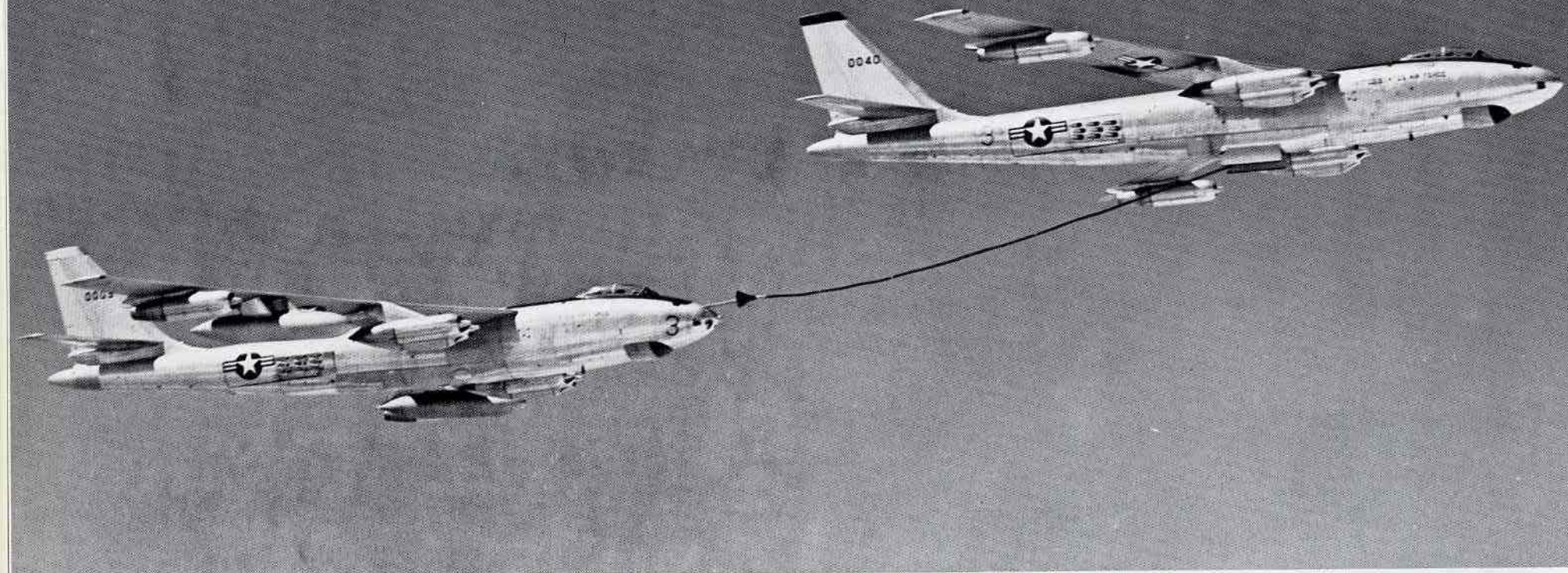

**In 1951-52 Boeing ran tests of the probe and drogue method of aerial refueling. 50-009 was redesignated YB-47F and 50-040 was redesignated KB-47G. The Boeing developed flying boom system eventually was adopted as the standard and the two aircraft were reconverted to normal configurations. [Boeing]**

The B-47 was built to taxi, takeoff and land in the same attitude. Therefore, close airspeed control was the key in takeoff and landing. If the Dash One charts showed a certain landing speed for a certain weight, the pilot had better be close to it at touchdown. The bicycle gear threw many people for awhile, but after you got used to it, landings were no harder than in a normally-geared aircraft. Ideally, both gear were to touch simultaneously. In practice this didn't happen that often. Generally, if touchdown was within five-ten knots of the computed speed and on both gear or the aft gear first, there was no problem. If the landing was "hot" and the forward gear hit first, things could get exciting. Landing forward gear first sometimes resulted in a bounce or series of bounces. This was called "porpoising". If the pilot didn't get back into the pro-

per landing attitude or began chasing the bounce, the porpoising could increase in intensity until the B-47 was uncontrollable. Result—one big prang!

I really enjoyed flying the B-47 and the aircraft very seldom let me down. I don't believe it was the "killer" that many people made it out to be. And, from a pilot's standpoint, all my landings were "super-smooth". But I'll leave it to a 307th BW navigator for the final word. He was a member of the crew of a B-47 that crashed at Des Moines on 20 July 1962. They were low on fuel and attempted a landing at the local airport. Unfortunately, they landed in a construction area and the B-47 was demolished. The crew survived. When discussing the accident with the investigating team, the navigator told them that he thought it had been a good landing—until his radarscope fell in his lap!



Two B-47Bs were modified as XB-47Ds to test the Wright YT-49-W-1 turboprop in 1955. 51-2130 was the first to fly. Each turboprop engine was capable of 9710 ESHP. Max speed for the XB-47D was 597 mph at 13,500 feet. The XB-47D's were used strictly for engine and propeller development. [Boeing]

## Ejection Seats

Pilot/Copilot-Republic

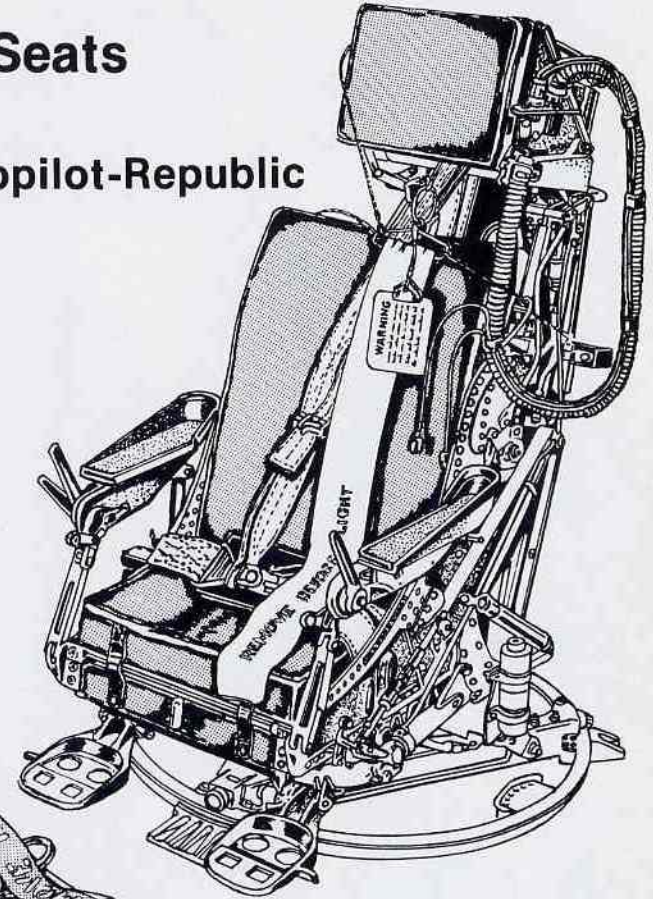

Pilot/Copilot-Weber

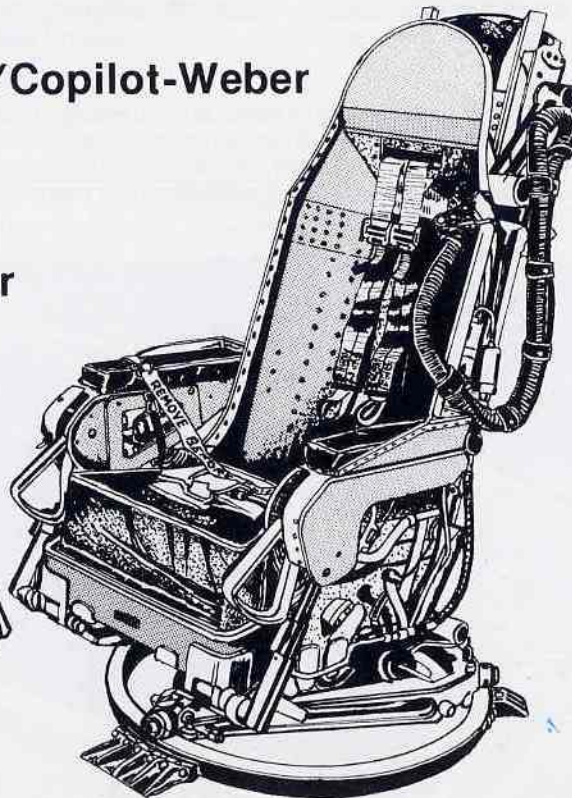

Navigator

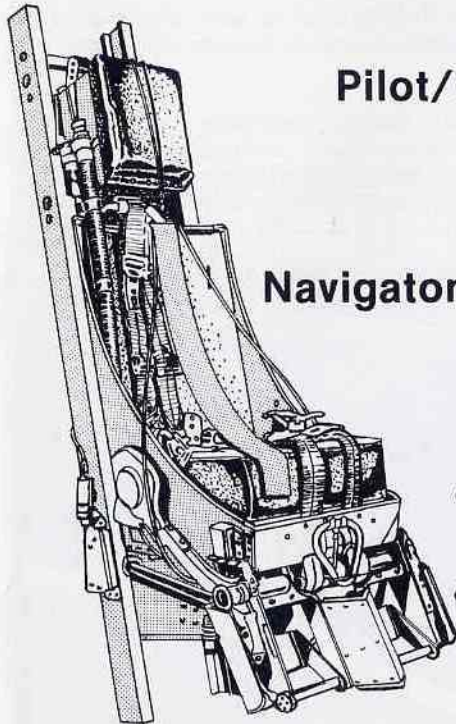

EW Crew Member

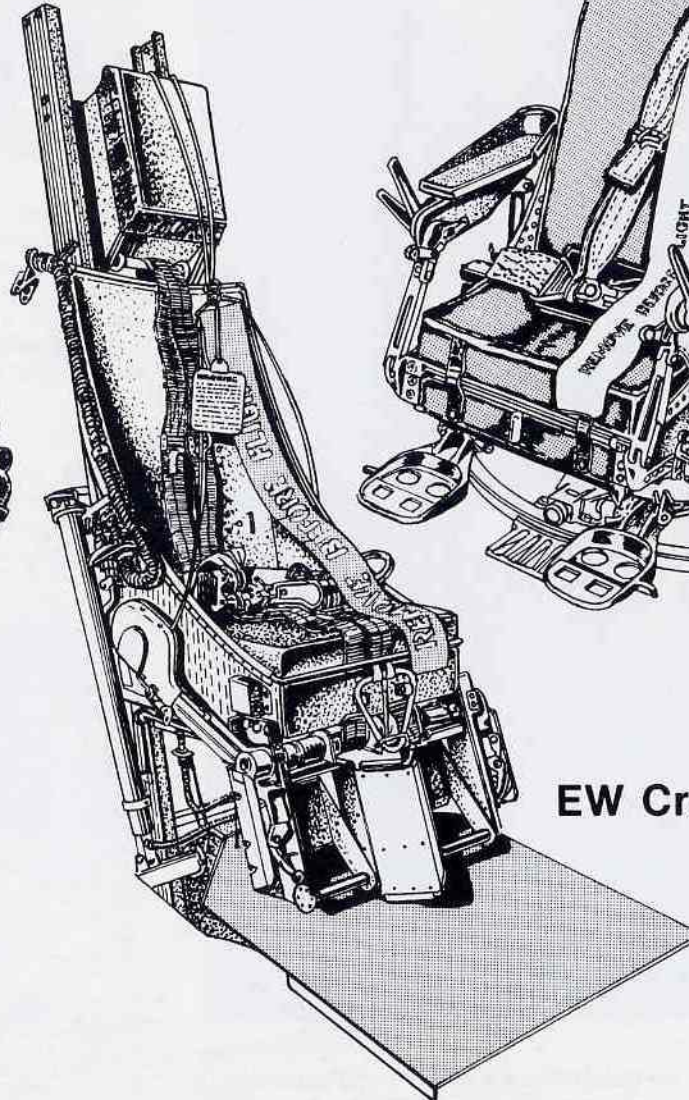

# B-47E Stratojet

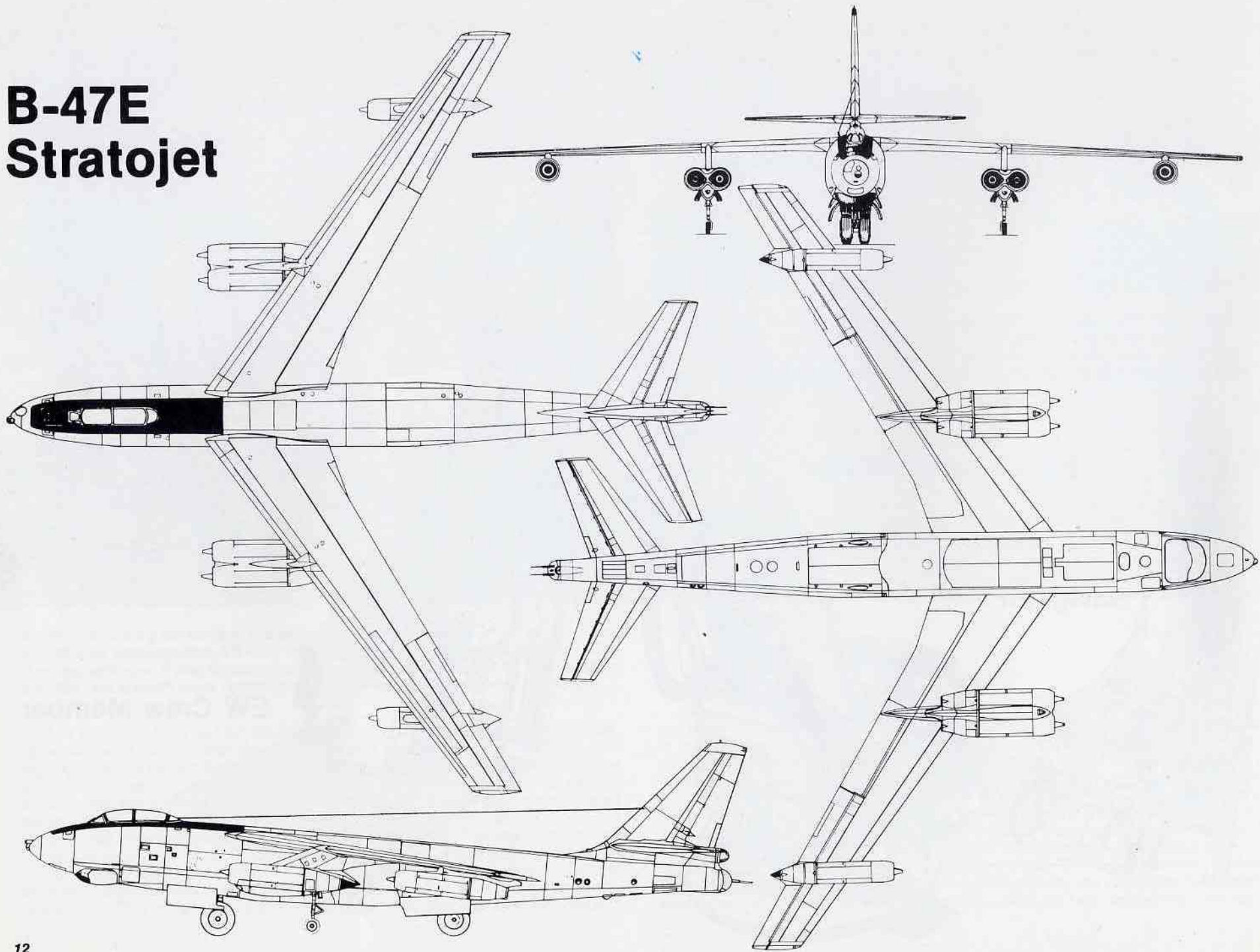



Co-pilot's view of forming B-47. The sun/anti-flash curtain is stowed directly overhead. [Boeing]



Looking aft down the spine of an early B-47. The canopy is the sliding type. The four cords in the canopy above the co-pilot comprise the radio compass sensing antenna. Radio compass loop antenna is just behind the pilot. [Boeing]

Late-style clamshell canopy. Just above the co-pilot's sun curtain is the hole for the periscopic sextant. Co-pilot had the "fun" job of taking the sextant shots for the navigator. Canopy actuator [which raised, lowered, and jettisoned the canopy] is between the two pilots. Tubular affair in front of the co-pilot was his protection from canopy that had to be jettisoned. [Boeing]

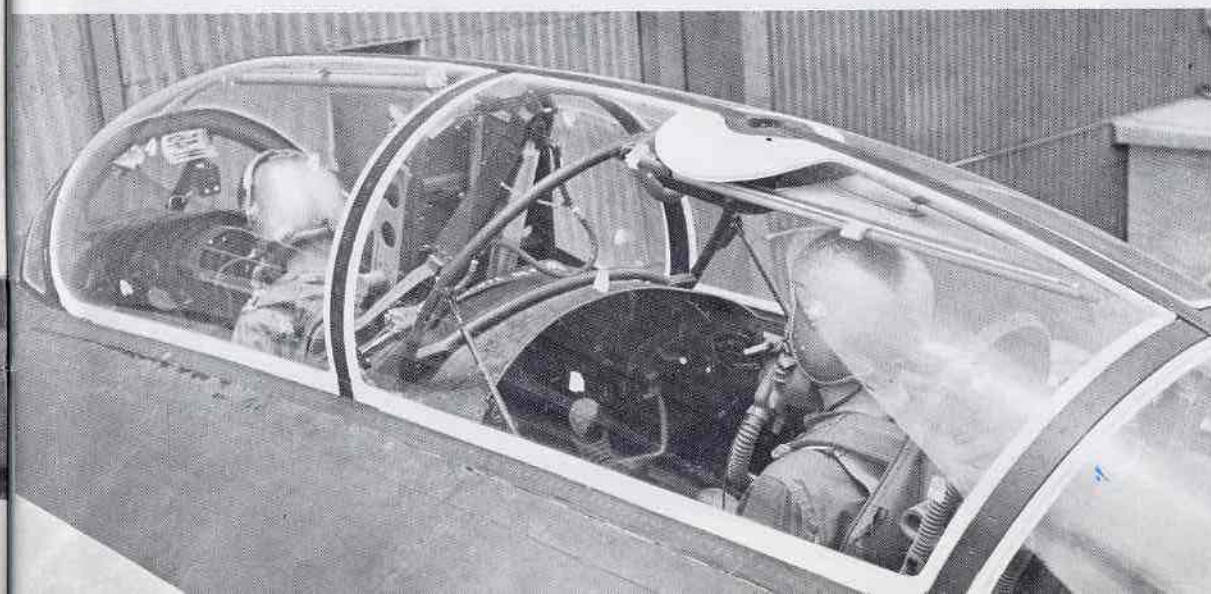

Looking aft from the navigator's position. Co-pilot is tuning his UHF command radio set. [Boeing]

# Ditching/Crash Landing Stations

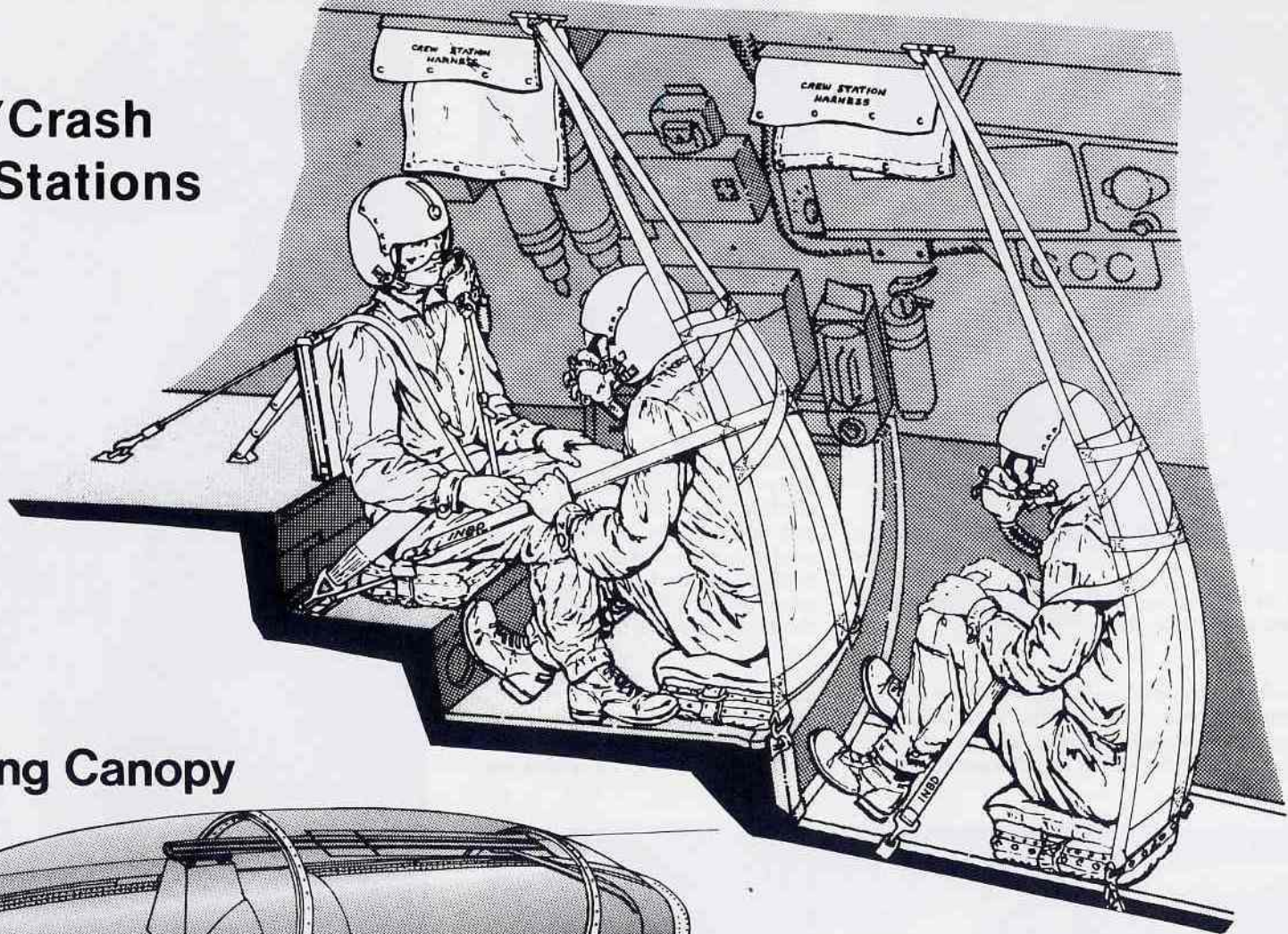

## Early Sliding Canopy

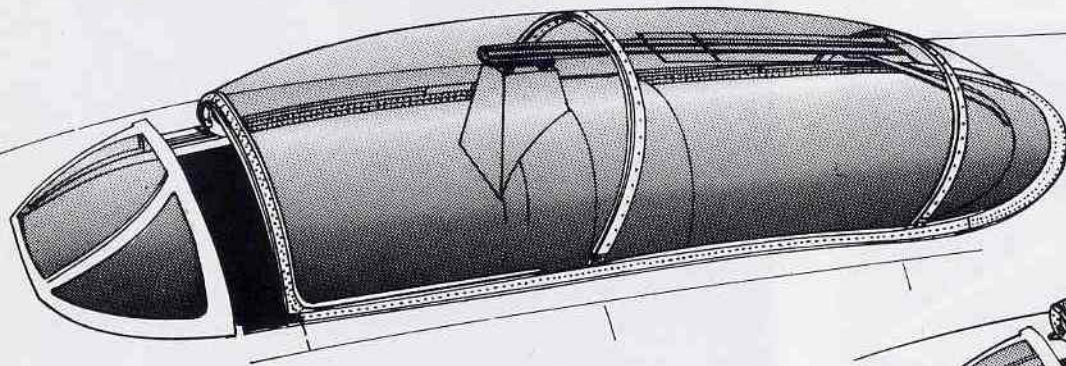

## Clamshell Canopy

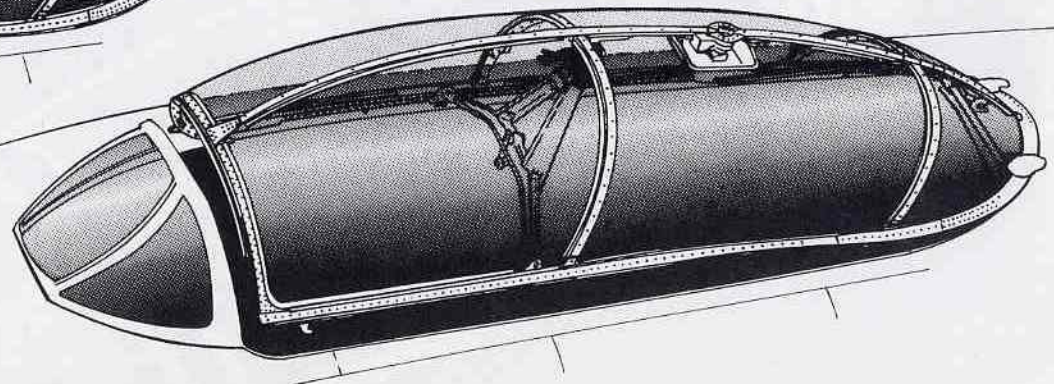

## Pilot's Station-Right Side

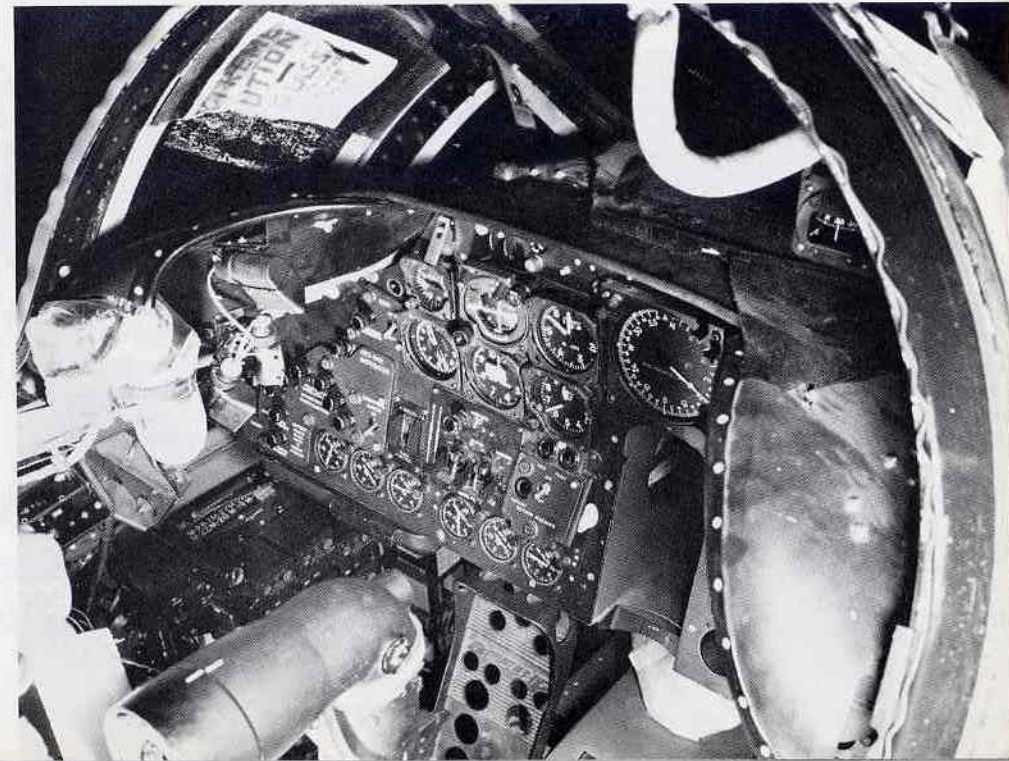
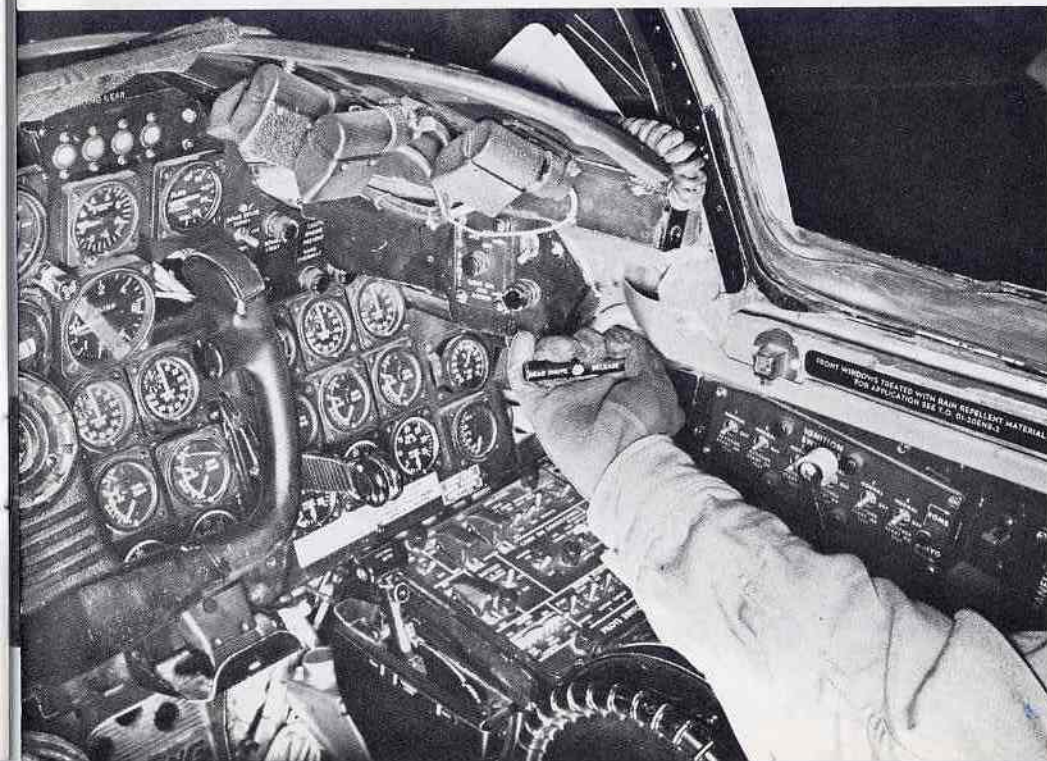
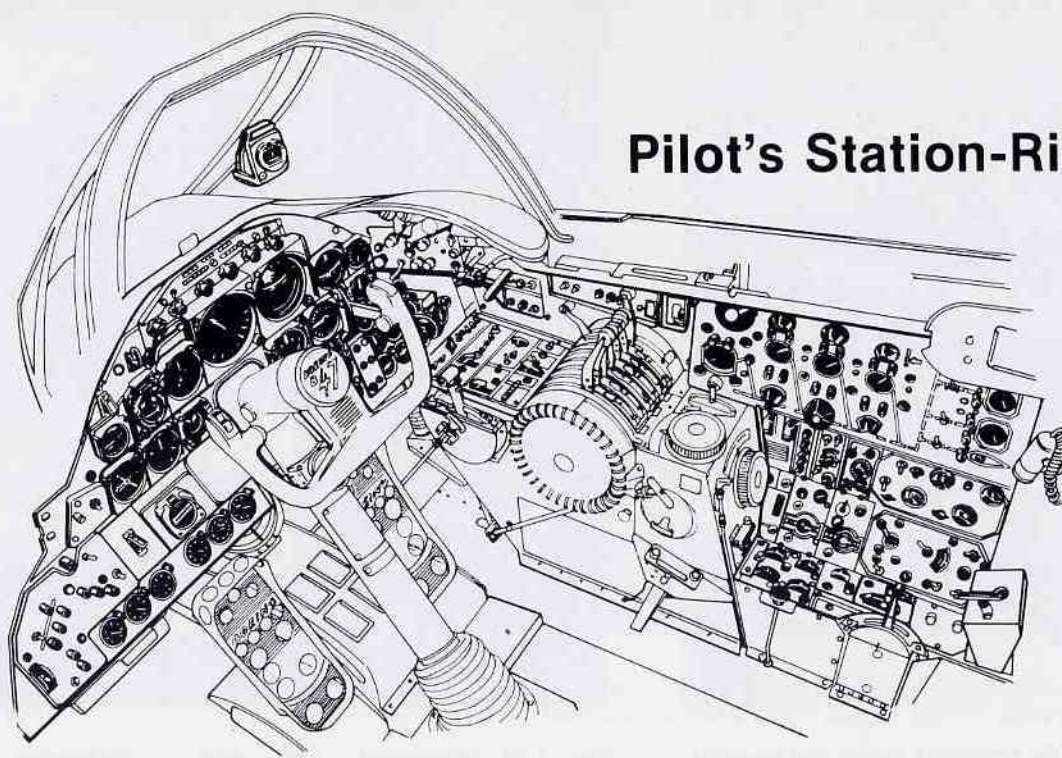



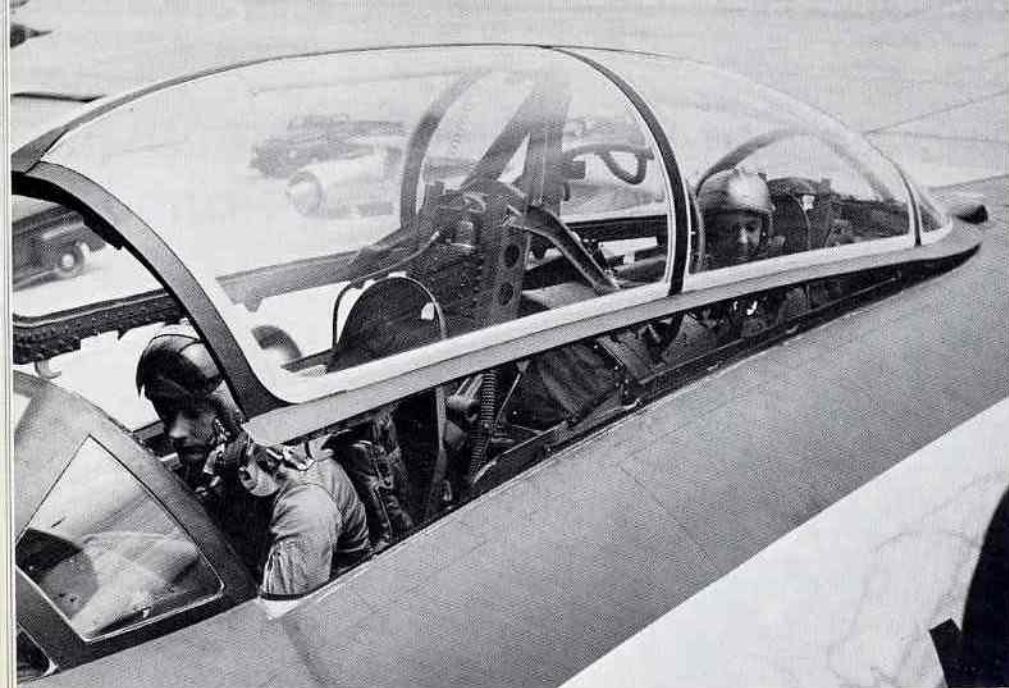

Late model clamshell canopy. Note the visibility problems facing the co-pilot.  
[Boeing]

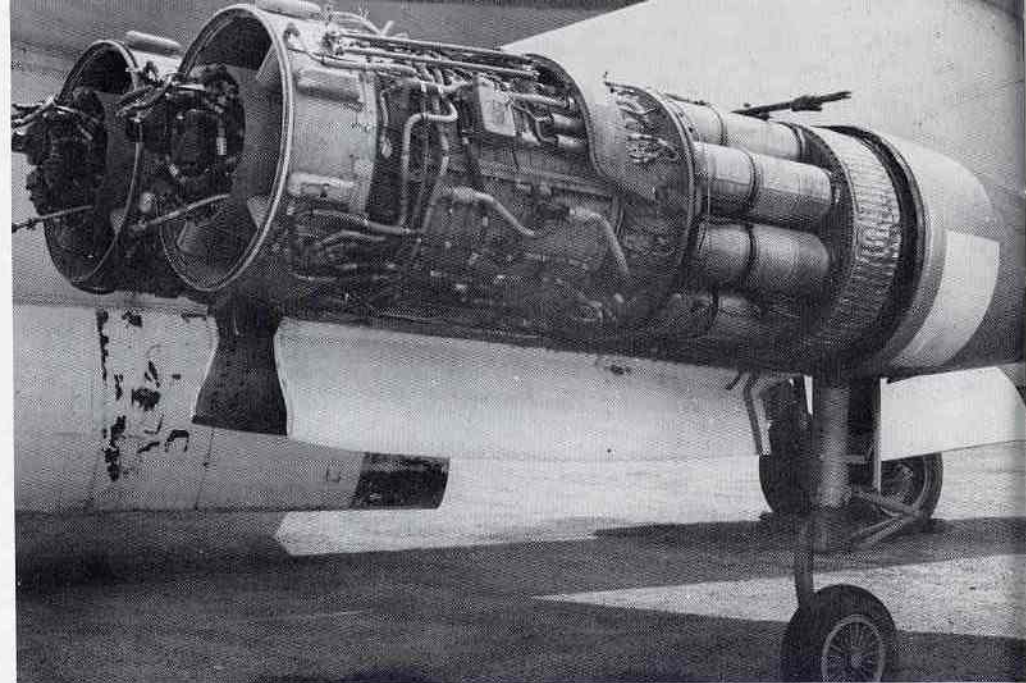

The J-47 undressed. Also note outrigger landing gear and gear doors. [USAF]

Defensive armament of the B-47 was a pair of tail-mounted M24A-1 20mm cannons. Note that the roller assembly cover is missing on gun at right. [Robert Loffredo]

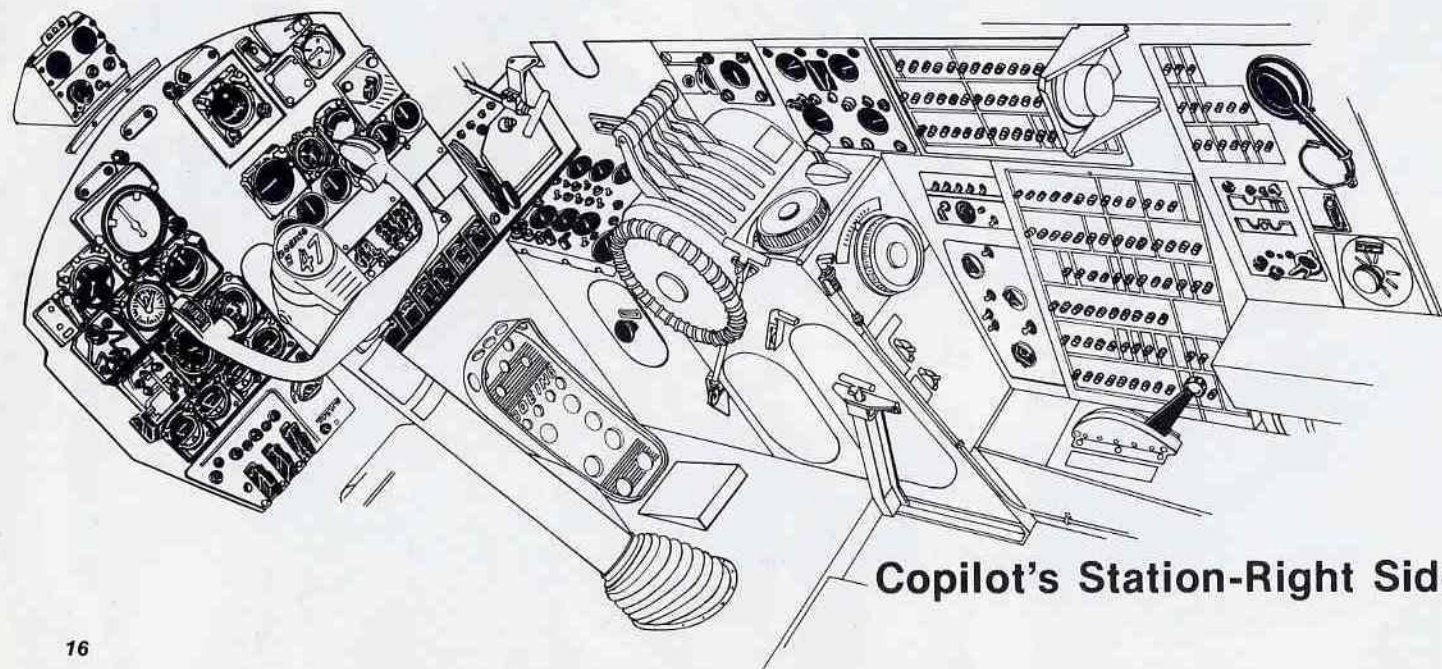

Copilot's Station-Right Side

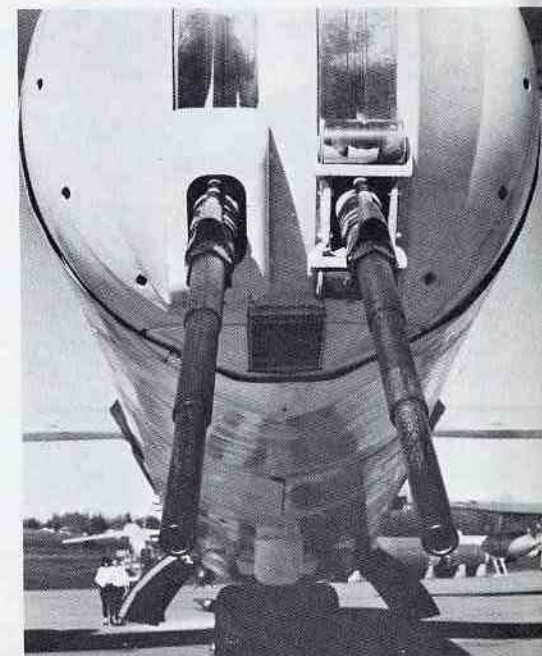

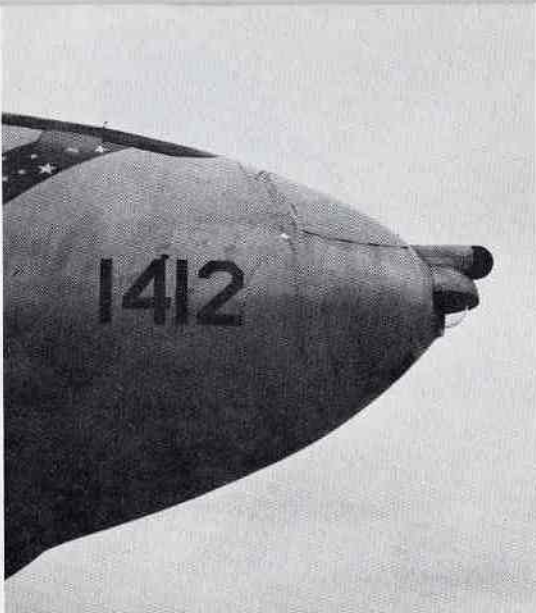

Nose of the B-47E sports the optical dome for the MA-4 horizontal periscopic bombsight. [Robert Loffredo]

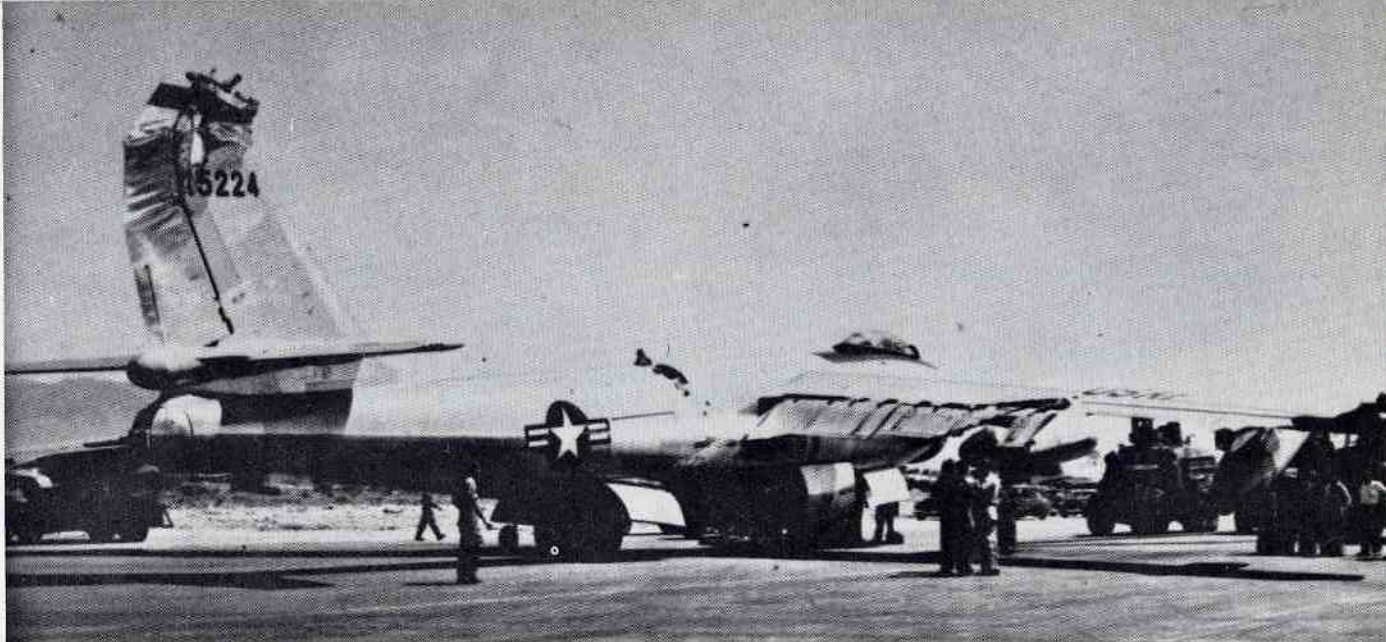

After mid-air collision with a KC-97F, the 303rd BW's 51-5224 returned safely to Davis Monthan AFB ..... much the worse for wear. The KC-97 also returned safely. Action occurred 9 September 1953 [USAF]

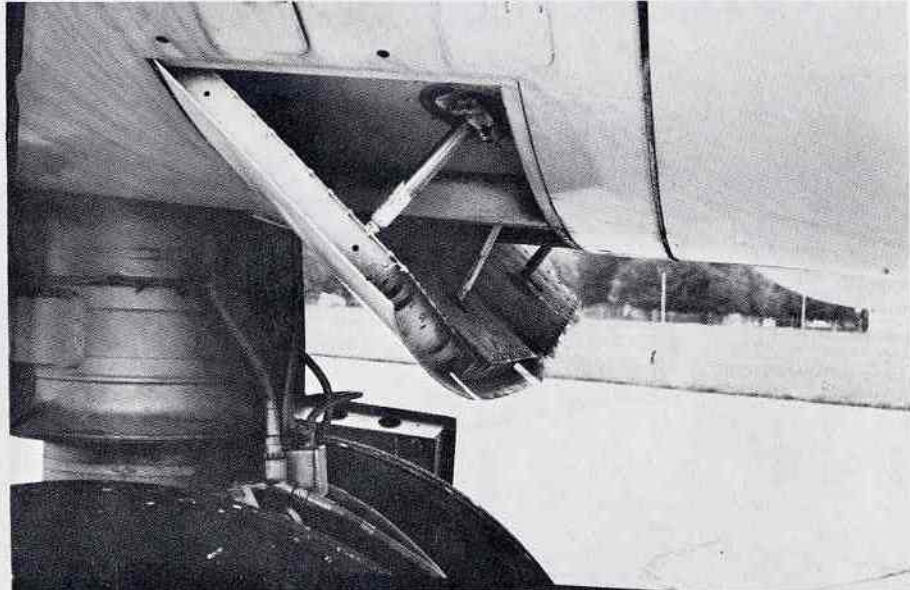

Three spoiler doors in front of the bomb bay were to prevent buffeting in that area. [Robert Loffredo]



TB-47B-20-BW of the 3520th Flying Training Wing [formerly the 3520th Combat Crew Training Wing] at Wichita with drag chute deployed. [USAF]



Before 52-412 went to the Navy as a test vehicle, it was an EB-47E with the 376th BW. It is shown here landing at Barksdale AFB in 1954. The 376th moved from Barksdale to Lockbourne [now Rickenbacker] AFB in 1957. [USAF]



51-2323, a B-47B-50-BW of the 305th BW, lands at Limestone AFB in September, 1953, during the wing's rotation to Brize Norton, England. Note early .50 caliber tail armament. [USAF]



51-7080, a B-47E-75-BW of the 44th BW, takes off from Barksdale AFB on 23 February 1954. The aft gear doors are closing sooner than the forward doors. Obvious differences in the later E's from the B's and early E's are the solid nose and external ATO. [USAF]

Tail markings similar to those of WW II and Korean War B-29's were uncommon on B-47's. Only the 305th and 306th Wings are known to have carried them. 51-2212, a B-47B-40-BW, sports the P in a square of the 306th. The 305th had a G in a square. [USAF]



## Nose & Tail Development

### B-47B

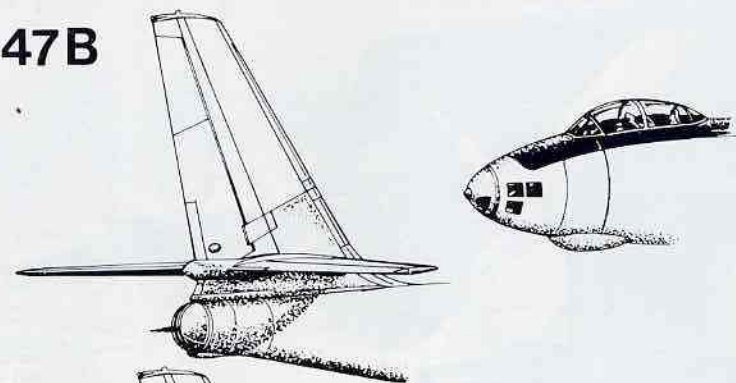

### B-47E

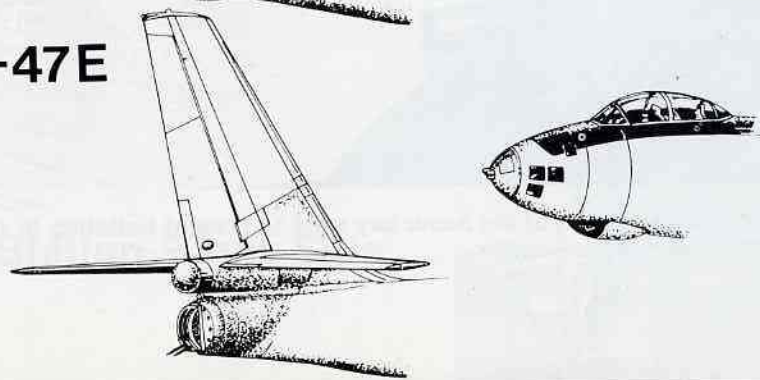

B-47B-25-BW, serial number 51-2071.

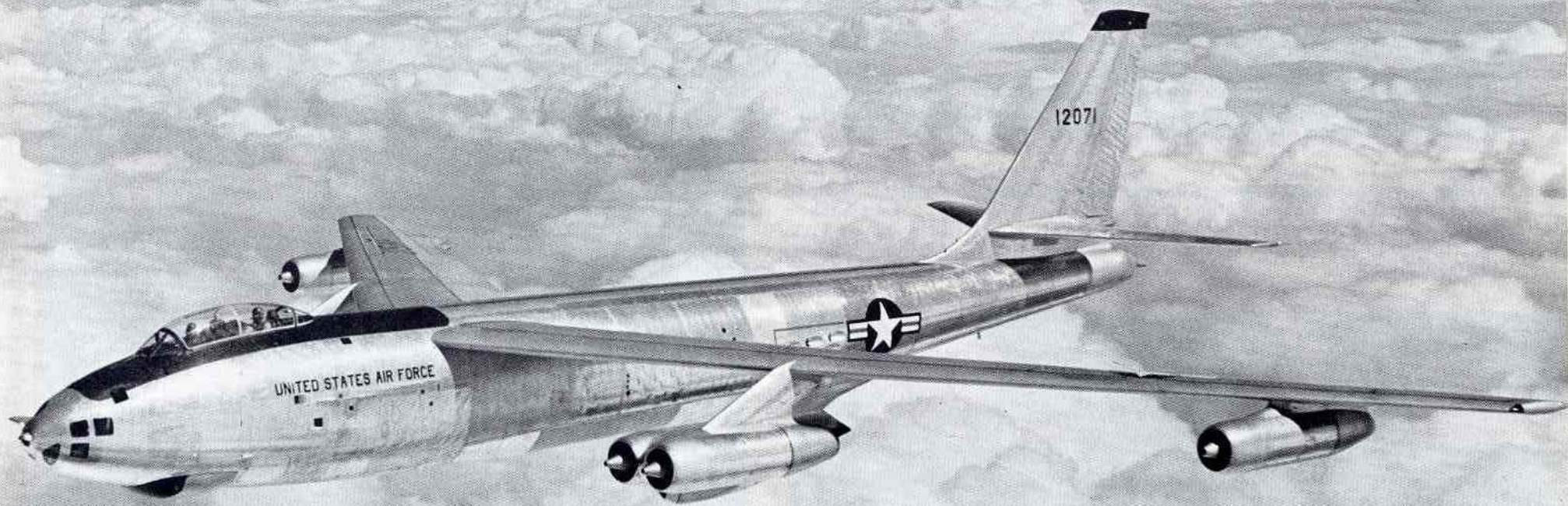



B-47's await the beginning of the 6th annual bombing and navigation competition at Rosewell AFB, 26 August 1954. Two Stratojets on left belong to the 22nd BW, while two on right are the 320th's. [USAF]

[Right] B-47E getting it off. Note Fowler flaps in extended position.

Early B-47E taking on fuel. Note that optical bombsight was not centered in the nose. [Boeing]





51-2359 taxis in with chutes billowing. The brake chute compartment is underneath the fuselage and the approach chute compartment is on the left side. The forward radar warning antenna has not yet been added above the periscopic bombsight. [Boeing]



[Left] Standard PR shot of the B-47E featured the smoke-belching ATO take-off. [Boeing]

A group of B-47's going through the Milk Bottle structural modification at Tinker AFB.





52-308, a B-47E-35-LM of the 306th BW at the National Air Show in Philadelphia, September, 1955. [USAF]



Armed Forces Day display at Burtonwood, England, in May 1956. 51-7045 is a B-47E-66-BW. Its unit is unknown but is thought to be the 97th BW, which was TDY at Lakenheath at this time. [via Richard L. Ward]

51-5244, a B-47E-65-BW, taxis in at Ezeiza Airport, Buenos Aires, during the USAF Goodwill Tour "Long Legs", 10-17 November 1957. Crowd control is non-existent. [USAF]

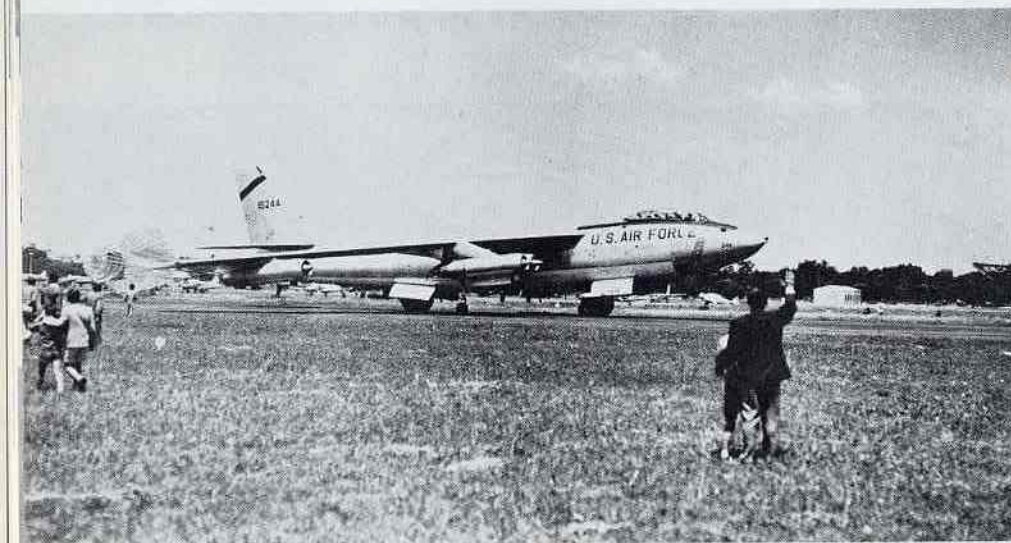

Six 100th BW Stratojets fly over the U.S.S. Constitution in a salute to King Saud of Saudi Arabia, 28 January 1957. [USAF]

TB-47B shown during visit to Lambert Field, Mo. 3 November 1956. [Paul Stevens]

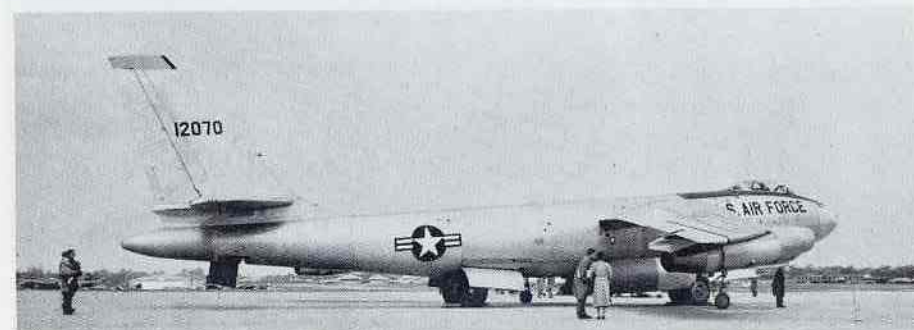

After 17 hours in the air with a malfunctioning forward main gear, Captain Robert W. Dupras brought 52-220 in for this reasonably smooth landing at Little Rock AFB. Accident was caused by a broken lockpin. The Stratojet was put back into shape by 384th BW ground crews and was flying shortly after this 5 September 1957 prang. [USAF]

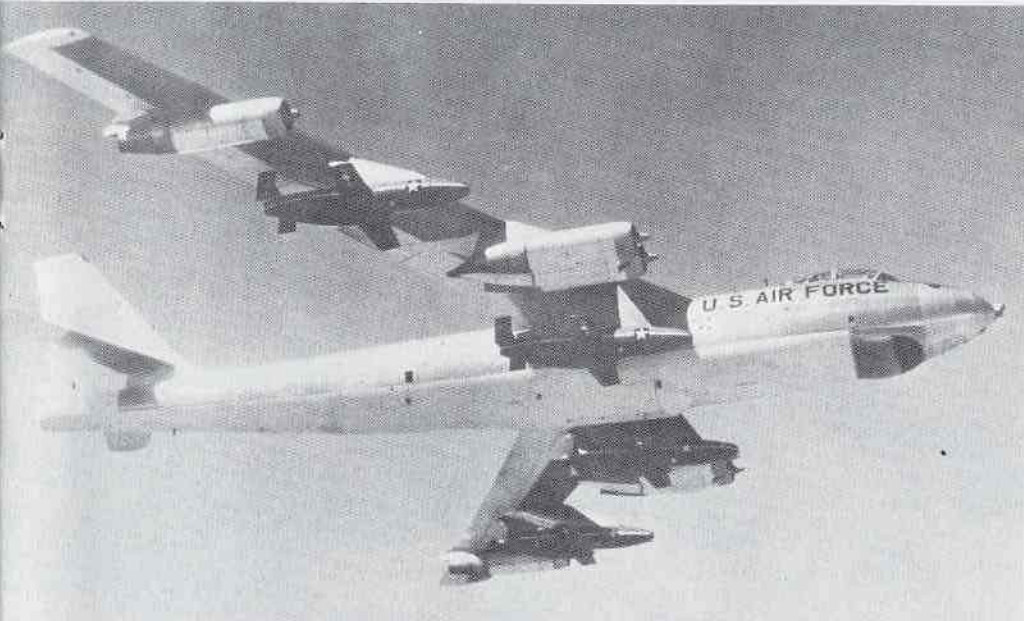

An unusual experiment was carried out with 51-2350, a B-47B-II-50-BW, carrying four GAM-67 Crossbows. This aircraft has manned capsule in the bomb bay area. [Boeing]

The CL-52, formerly a B-47B, was used to test the Orenda Iroquois engine. [Canadair via Mike Habermehl]

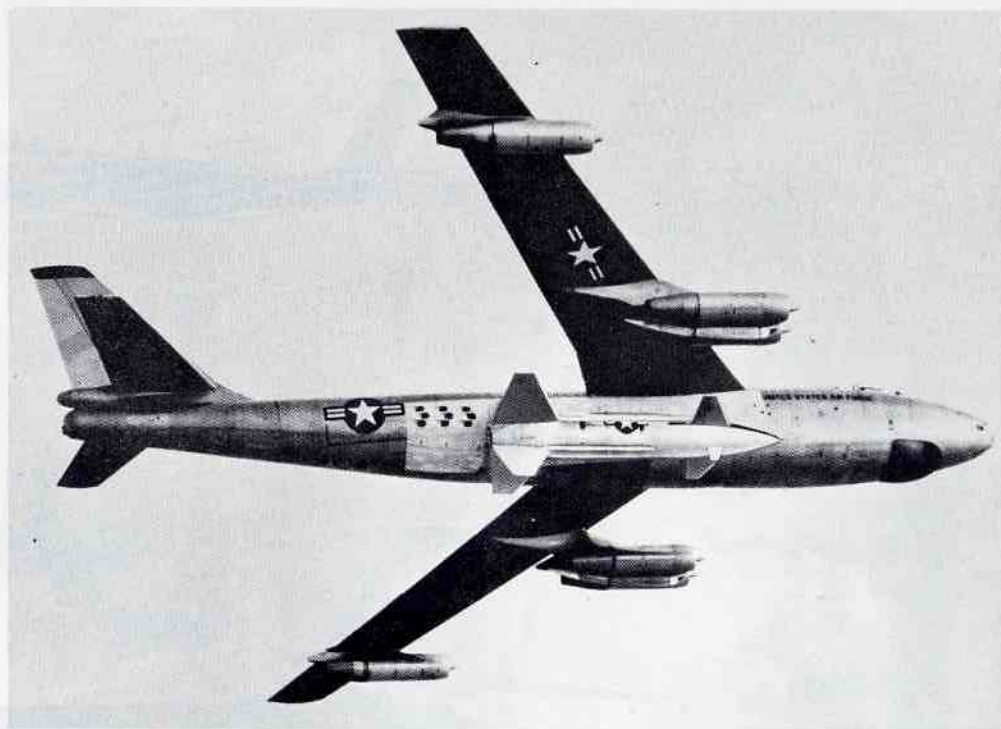

51-5219, a YDB-47E director aircraft, during tests with the GAM-63 Rascal. [Boeing]

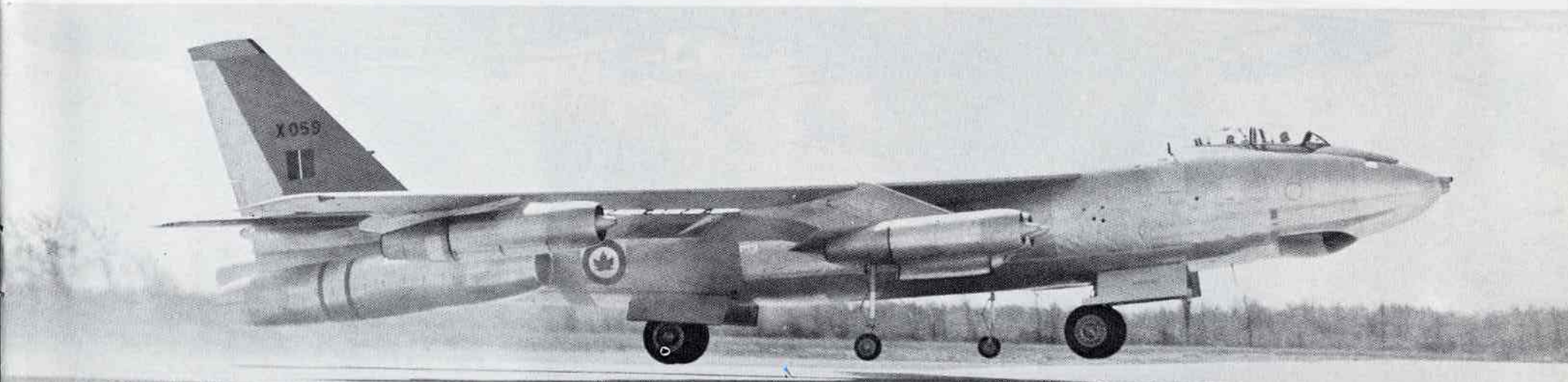



Different profiles of the B-47E [rear], and the RB-47E are evident in this familiar photo. [Boeing]



WB-47B-30-BW of the 9th Weather  
Reconnaissance Wing, 55th WRS.

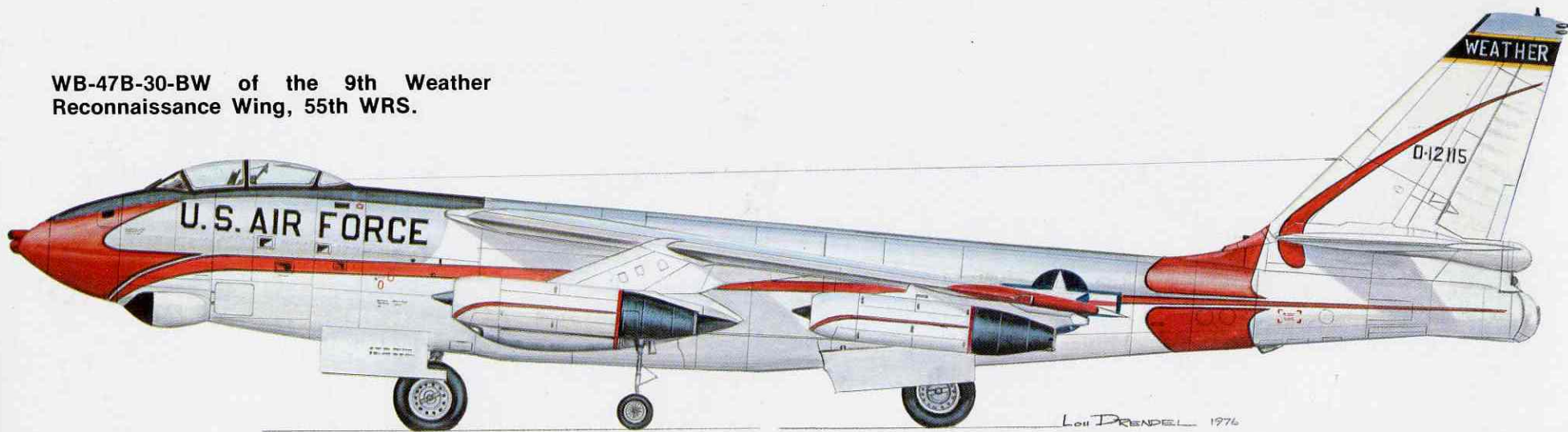

JQB-47E-45-BO of the 3214th OMS, Eglin  
AFB, Florida.

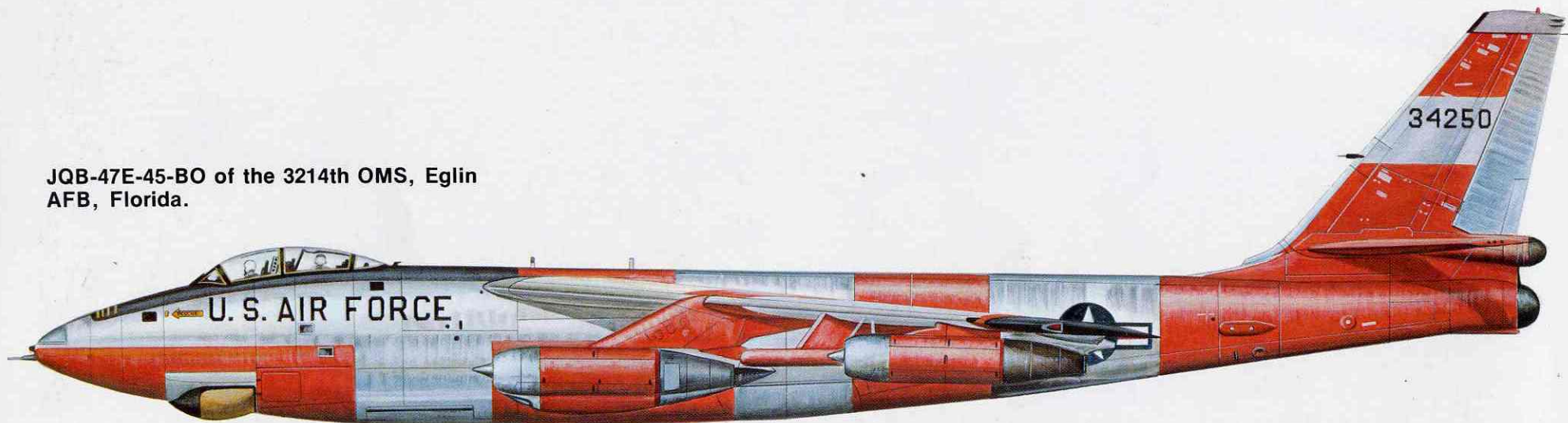

RB-47H of the 55th SRW, Offutt AFB, was the last B-47 in SAC.

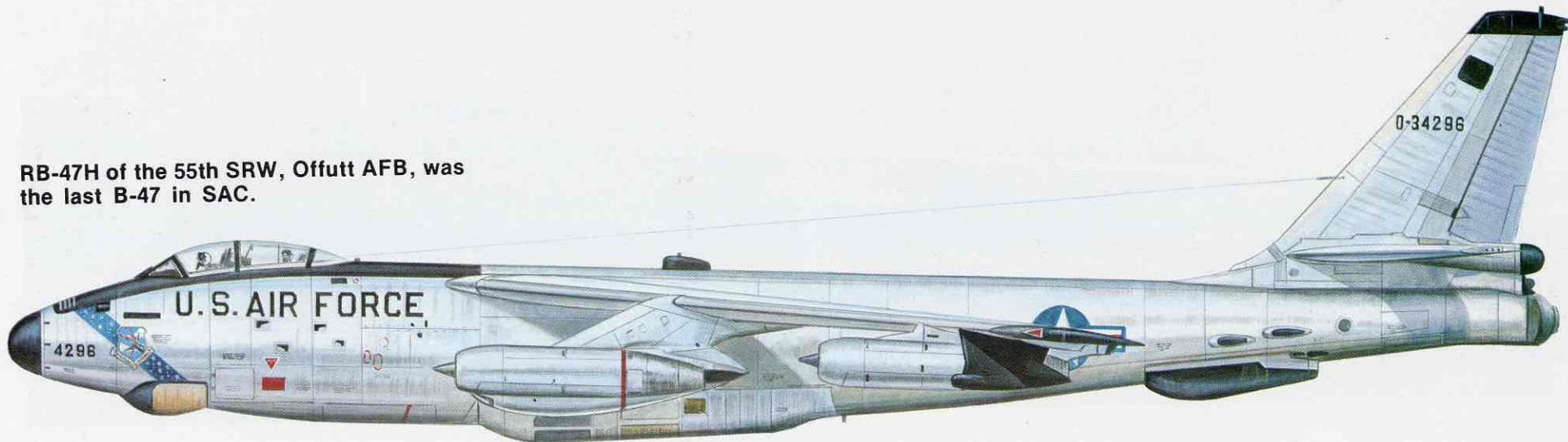

RB-47E-45-BW of the Aerospace Research And Development Center as photographed at Harlingen, Texas in 1972. [N.E. Taylor]



RB-47H was used as test bed for F-111A radar. It was fitted with the 111 nose. [N.E. Taylor]



[Above] A "whatzit"...nominally an RB-47E, shows some interesting modifications. Notable is the deep bathtub-shaped radome, the nose probe, the antenna on the fuselage top, and the long cylinders on the fuselage side. What the aircraft was testing remains a mystery to the authors. [R.D. Neal]

[Below] In its normal configuration, 53-4262, and RB-47E-45-BW, refuels from a KC-97F. [Boeing]



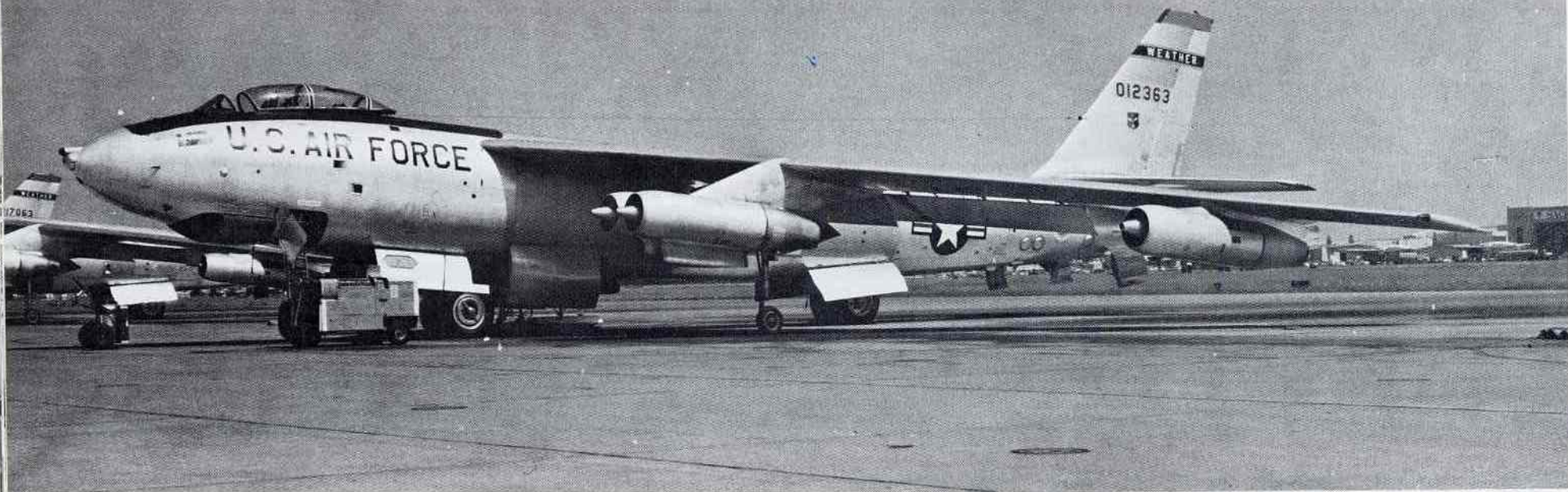

9th WRW WB-47E at McClellan AFB 4 August 1967. At the time it was flying with the 55th WRS. [A. Swanberg via N.E. Taylor]

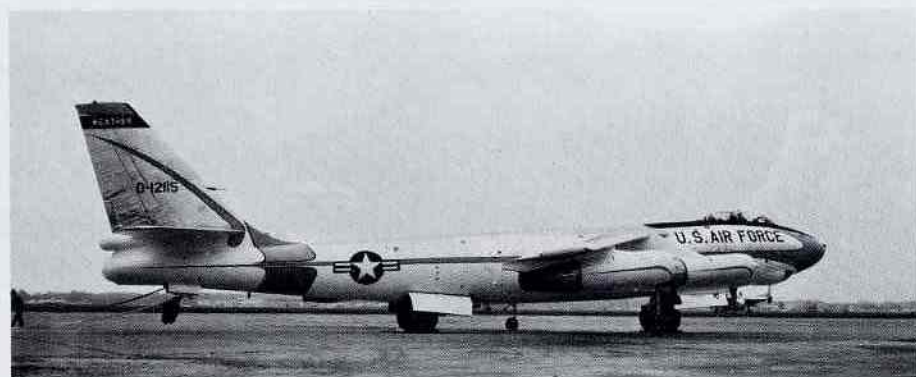
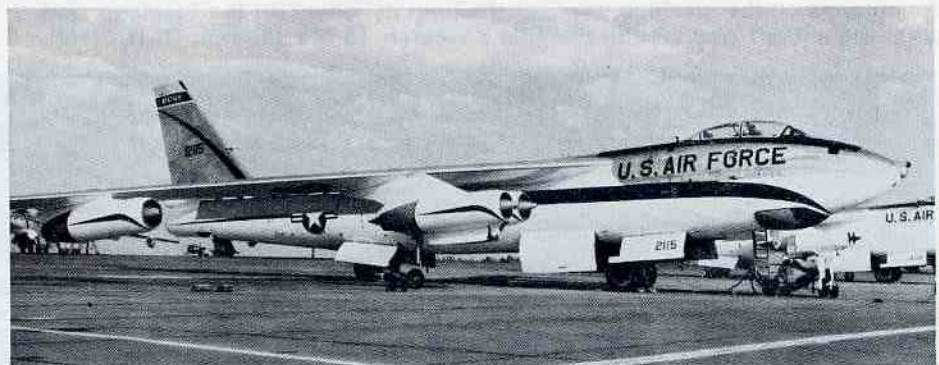

Probably the most exotically painted Stratojet was 51-2115, a WB-47B [II] 30-BW. It was the 9th Weather Recon Group's first WB airplane. It flew with the 9th from November, 1957 to November, 1963. At Scott AFB, 20 May 1961. [See color side view for further clarification of colors] [Paul Stevens]



[Center Right] Earlier paint scheme for 51-2115 featured red striping with black trim. [Boeing via N.E. Taylor]

WB-47E-55-BW taking off from Hickam AFB, Hawaii. [Nick Williams]

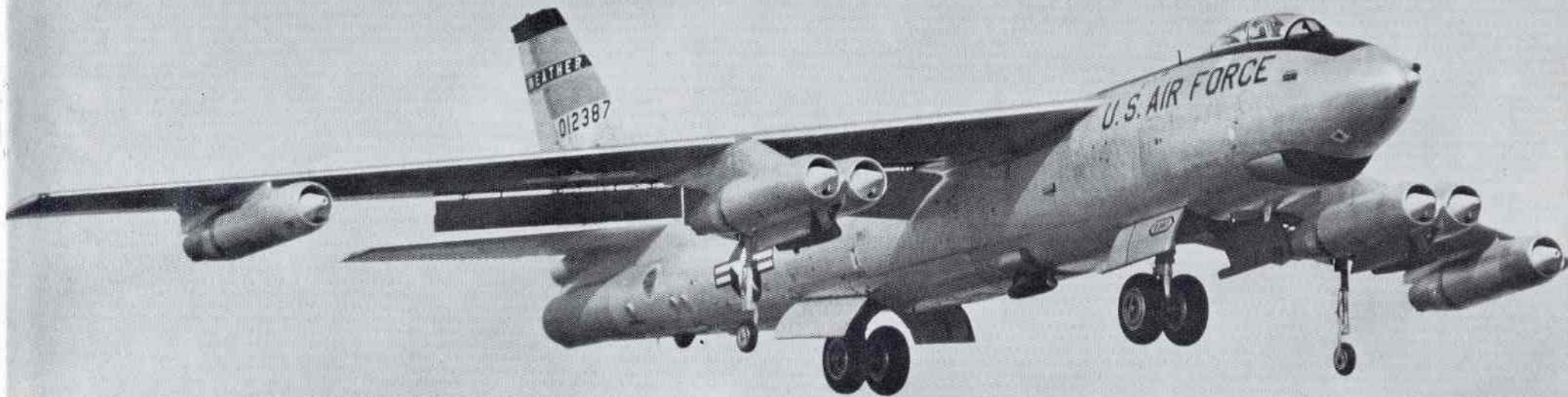

WB-47E of the 57th WRS in landing approach to Hickam AFB. The pod located aft of the forward gear was used for air sampling. [Nick Williams]

[Below] WB-47E-60-BW of the 53rd WRS, at Prestwick Scotland, in 1964. [Jerry Geer]



51-2120 of AACS.

51-2120 was the second B-47 that the 1800th AACS Group [later Wing] used for high altitude testing of navigation aids. At Scott AFB, 21 May 1960. [Paul Stevens]

CHENARD





Taxi crew readies QB-47E for an unmanned [Nullo] flight. Ground controllers on top of MRW-5A vehicle handled the aircraft during takeoff and landing. [Boeing]

[Above Right] QB-47Es had to use an arresting gear to help stop them during unmanned flights. [Norm Crocker]

Two wing pods on the QB-47Es each carried six 16mm movie cameras for scoring purposes. [Norm Crocker]

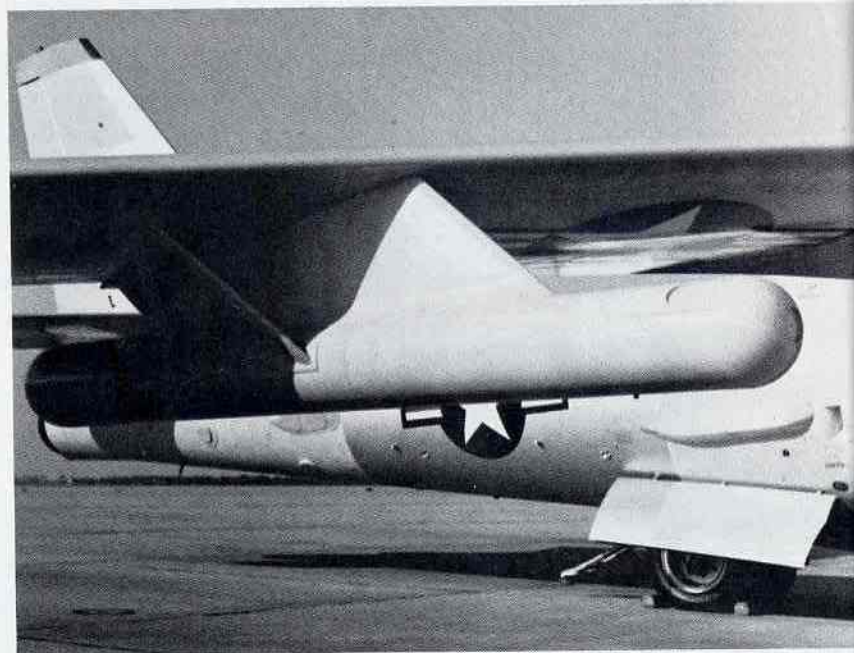



B-47E-95-BW of the 22nd BW.

## Nose Development

**B-47E**

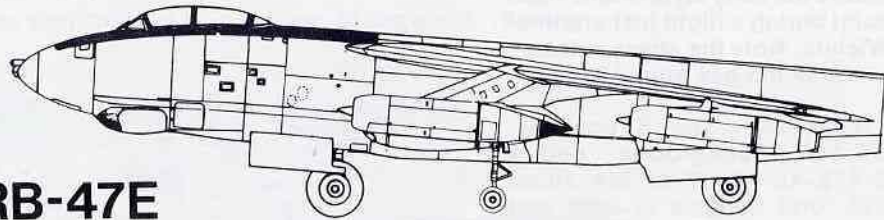

**RB-47E**

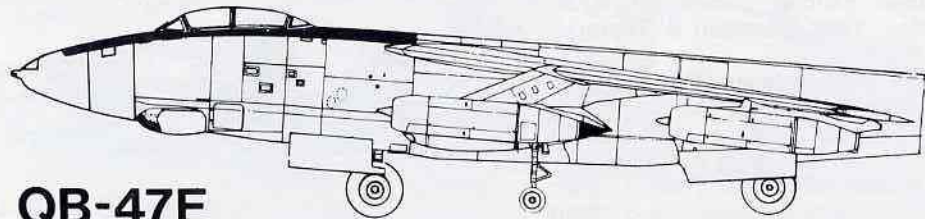

**QB-47E**

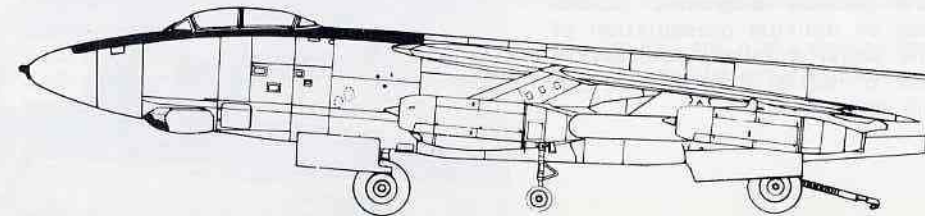

In September, 1959 51-2339 was assigned to the 4347th CCTW at McConnell AFB. Nose and stripe on rear fuselage were day-glo.

52-609 was the 1000th Wichita-built B-47 and was rolled out on 14 October 1954. The aircraft was delivered to the 40th BW on 17 December 1954. 52-811, an RB-47E, was the 1001st B-47 and went to the 70th SRW. [Boeing]

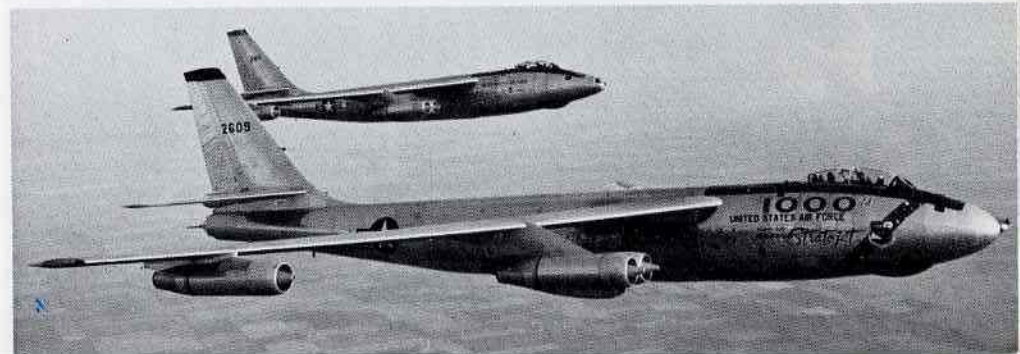





[Left] 53-2311, a B-47E-115-BW, shows the early style of anti-flash paint during a flight just south of Wichita. Note the stress wrinkles in the bomb bay area. [Boeing]

Predecessor and Successor. RB-50F [background] and a B-47E-46-BW-IV of the 303rd BW. Unit insignia is blue and deep yellow. Elmendorf AFB, May, 1960. [Norman E. Taylor]

Tail markings on these B-47's being modified at SMAMA, McClellan AFB in 1958, show that they are from the 22nd BW [arrow], 43rd BW [band], 96th BW [single diagonal], and 320th BW [double diagonal]. 52-568 has an unusual presentation of the serial number, possibly in red, on top of the nose. [USAF via Habermehl]





The first RB-47H is rolled out of the plant. [Boeing]



Four RB-47H's on the ramp at Forbes AFB...1964-65. The RB-47H's carried the SAC emblem and the star-spangled band but did not carry the wing emblem on the right side of the aircraft. [USAF]

## Final Development

B-47E

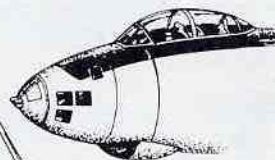

RB-47H

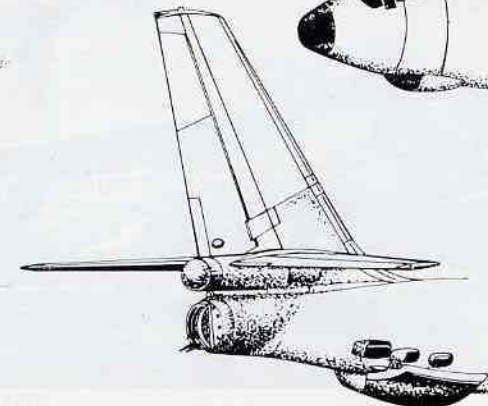
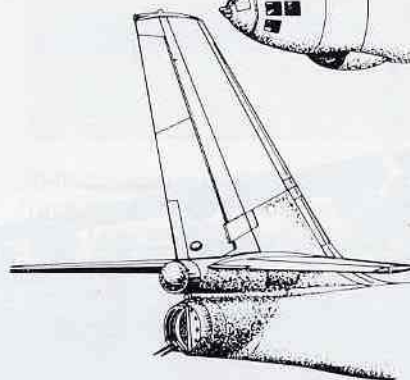
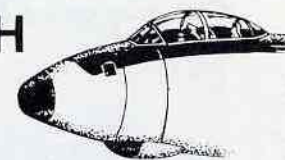



## Bomb Racks

1000 lb loading

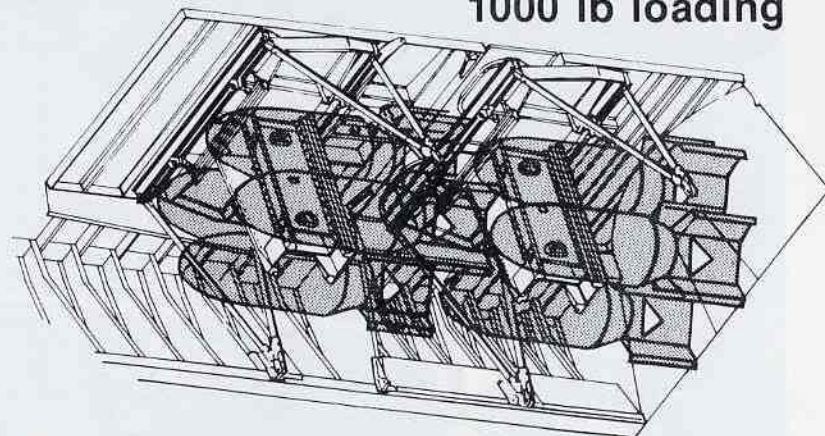

2000 lb loading

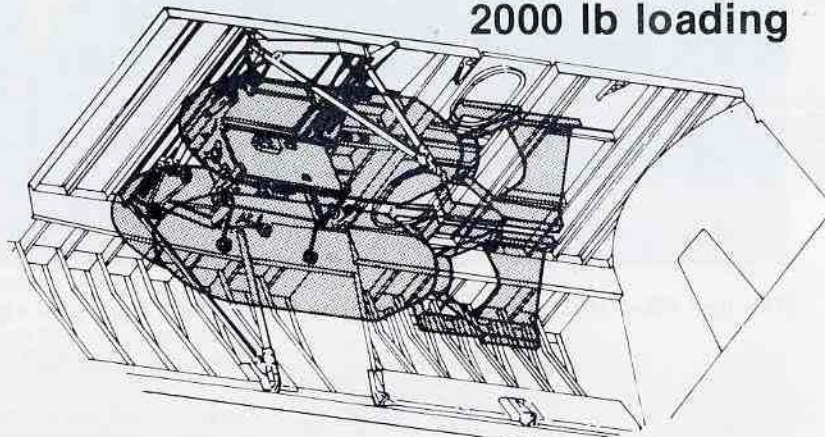

4000 lb loading

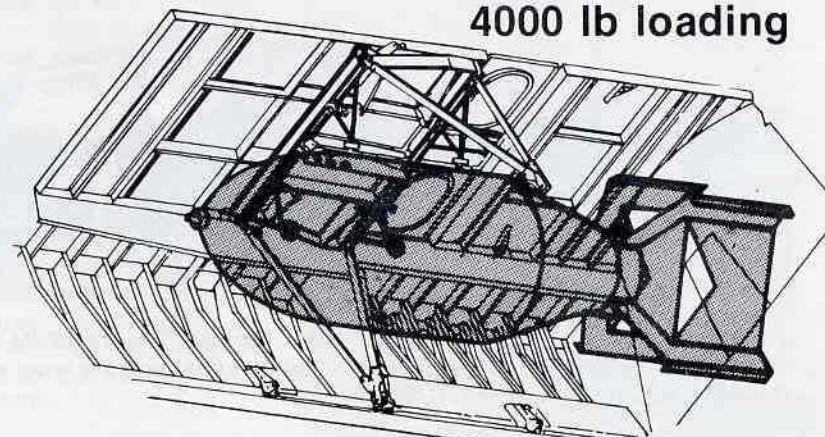

RB-47K, 53-4278. This view emphasizes the sleekness of the Stratojet. The refueling door on the RB-47E's and K's was on the centerline just behind the yellow stripes and was rectangular in shape. The double row of vortex generators can be seen on each wing in the area of the outboard engines. [Boeing]

52-377, a B-47E-45-LM of the 303rd BW, at Elmendorf AFB in May 1960. The pod attached to the side contains ECM gear. One hundred B-47's were modified by Douglas to carry these pods during TEE TOWN. [USAF via N.E. Taylor]



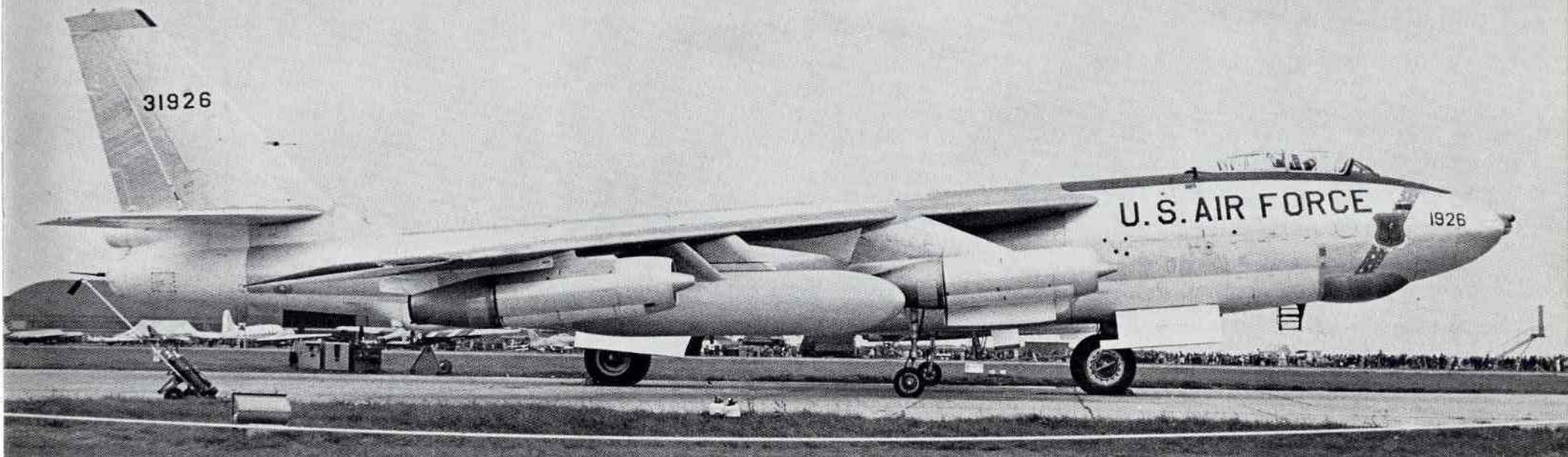

53-1926, a B-47E-70-LM of the 305th BW, on display at RAF Gaydon 17 September 1960. The outer surfaces of the wing tanks are painted day-glo. [via Richard L. Ward]

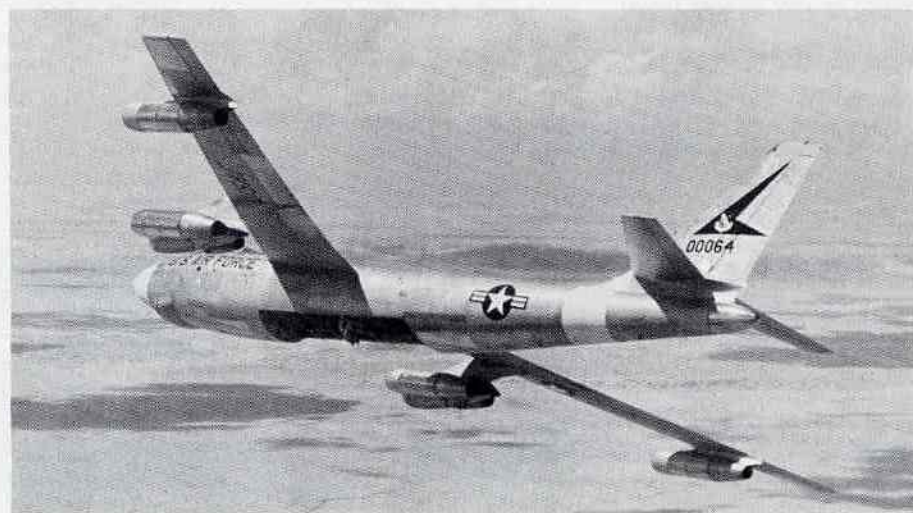
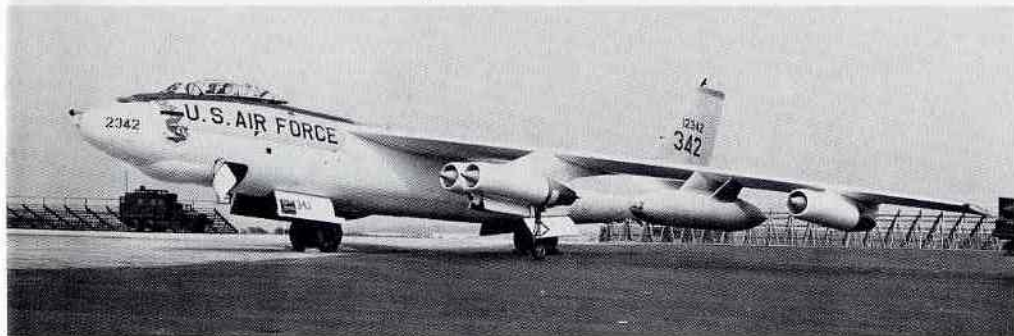

50-064, formerly a TB-47B, over the El Centro Test Range on 4 August 1961. Unusual configuration was used for B-58 escape capsule system drop tests. [R.L. Lawson]

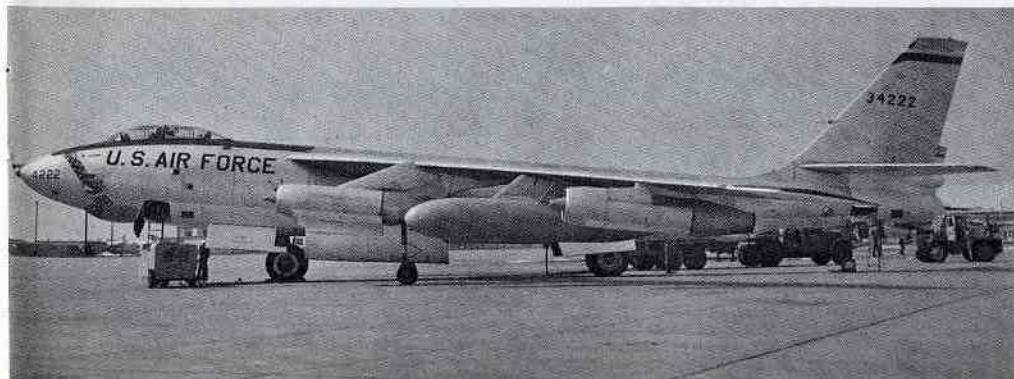

[Above Left] Former 19th BW airplane, 51-2342, at Andrews AFB, 13 May 1960. [Paul Stevens]

53-4222, a B-47E-130-BW of the 307th BW, at O'Hare Airport, Chicago 19 April 1961. Tail band is green. [Paul Stevens]



Stratojet of the 307th BW, at O'Hare 20 May 1961. [Paul Stevens]

The 306th's 51-17376 visited New Hanover County Airport, North Carolina in December, 1960. Ground steering was accomplished through the steerable forward main gear. [Paul McDaniel]

53-2410, an EB-47E-130-BW of the 301st BW. Aircraft had a manned capsule, which carried two "Ravens" [EWOs]. Extra ECM capability was provided by pod just aft of ATO unit. Tail band is red. [Jerry Geer]

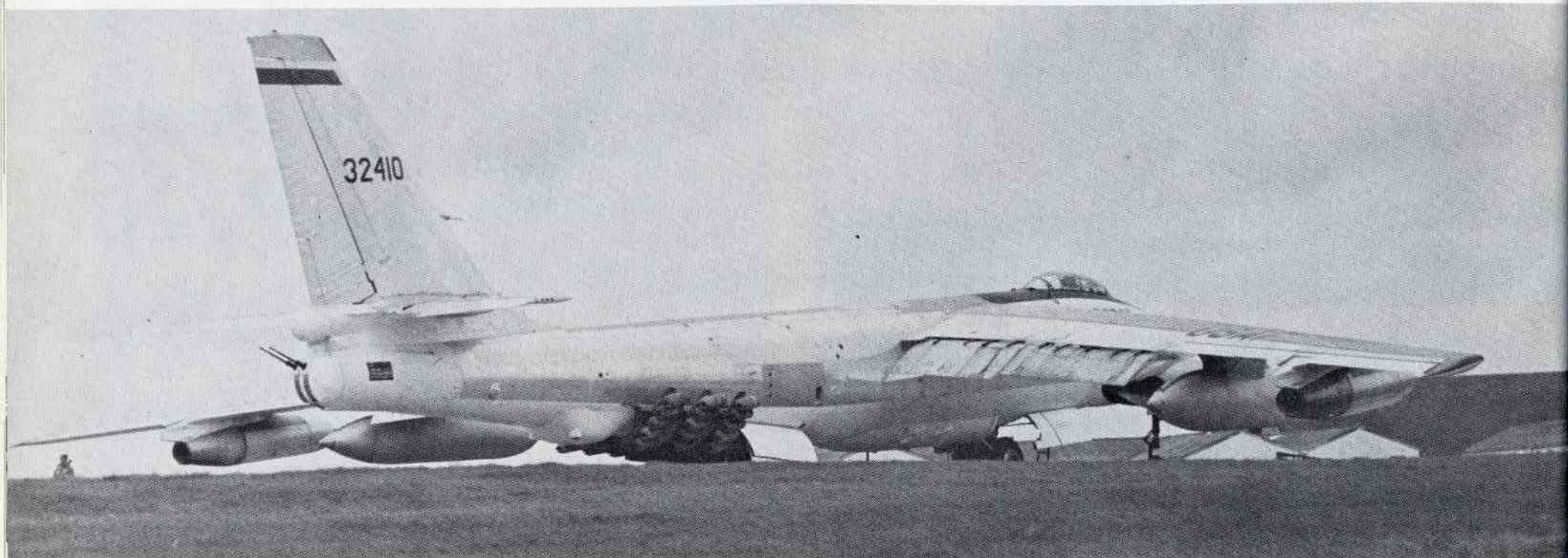
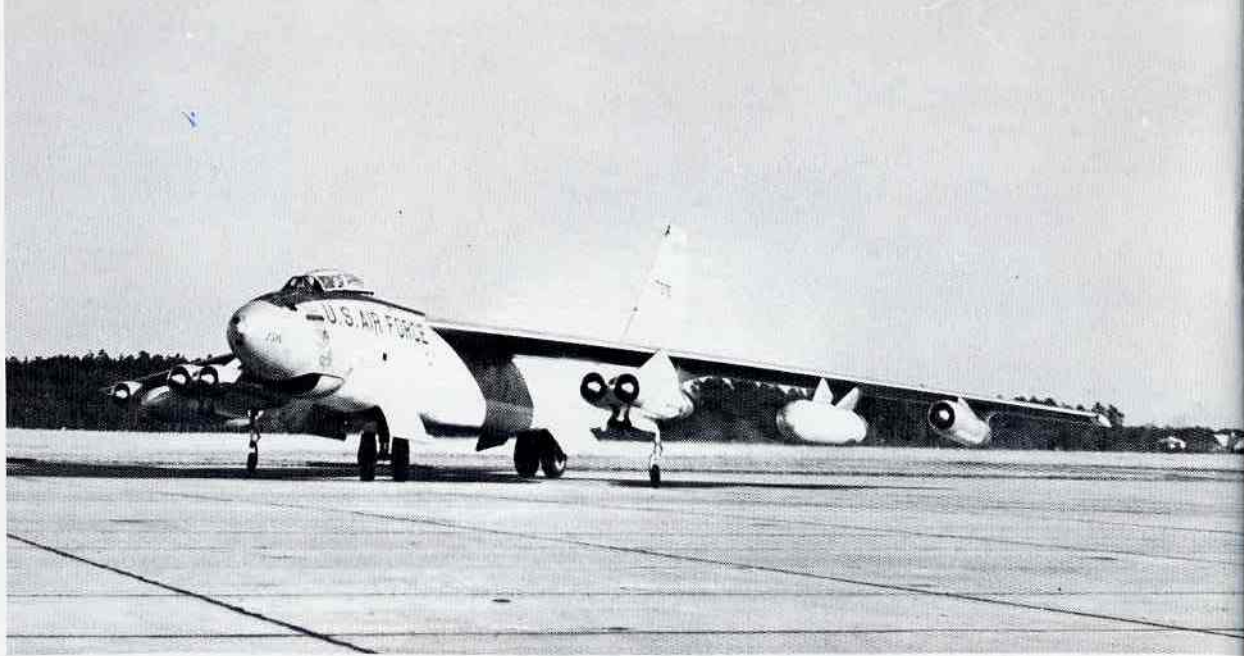



Minus about 15 feet of wing and the number 6 engine, 51-2315, a B-47B-II-50-BW of the 305th BW, taxis in at Bunker Hill AFB after the engine blew up during an air refueling on 20 March 1961. [USAF]

The pilot of 52-615, a B-47E-105-BW of the 22nd BW, tried to pull the aircraft off the ground. The results are all too obvious. All three crewmen were killed in this 5 January 1962 accident.

Whiteman AFB firemen watch as 53-6230 burns on the ramp, 15 May 1962. The 340th BW aircraft was being preflighted by its crew when the fire was discovered. The crew evacuated the B-47 and the fire department was called. After apparently controlling the fire, a number of firemen gathered in the bomb bay area. Suddenly, a tremendous explosion and fire engulfed them. Five people were killed or died later and 17 were injured. The aircraft was totally destroyed. [USAF]





Stratojet Aircraft Commander smiles for his picture as he brings his airplane in for a hookup with 305th Air Refueling Squadron KC-97. The B-47's slipway door is open and ready to receive the probe. Immediately behind the upper window on the nose are five small rods, which were to be used by the pilot to estimate drift when forced to do a last resort visual bomb run. Immediately behind the circular indentation is what appears to be a scratch on the photo, but in reality is the ultimate in sophisticated modern jet bomber instrumentation.....a yawstring! [Kay Yingling]



B-47E of the 3920th Support Wing. [Jerry Geer]



53-4210, A Phase V Capsule EB-47-E of the 301st BW, sits cocked and ready to go on the Brize Norton alert pad, 9 July 1963. [via N.E. Taylor]

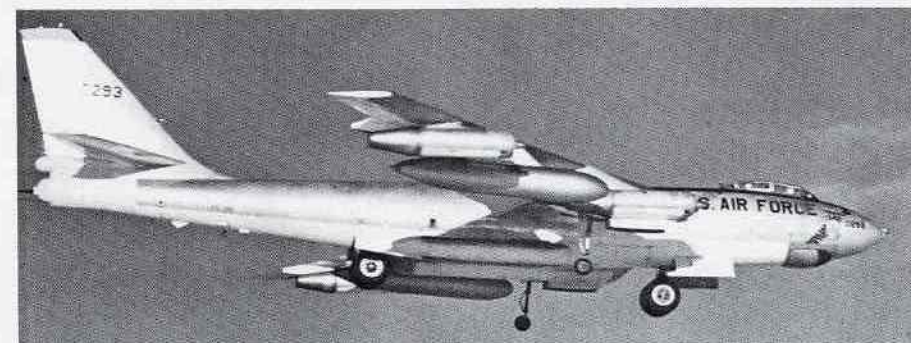

52-293, of the 303rd BW, comes in for a landing at Elmendorf AFB in June, 1962. The aircraft is carrying two TEE TOWN pods. To illustrate the vagaries of block number lists, 293 was originally a B-47E-35-LM. An inspection of the aircraft at Davis Monthan showed that it ended its operational career as a B-47E-8-LM-IV! [Taylor]

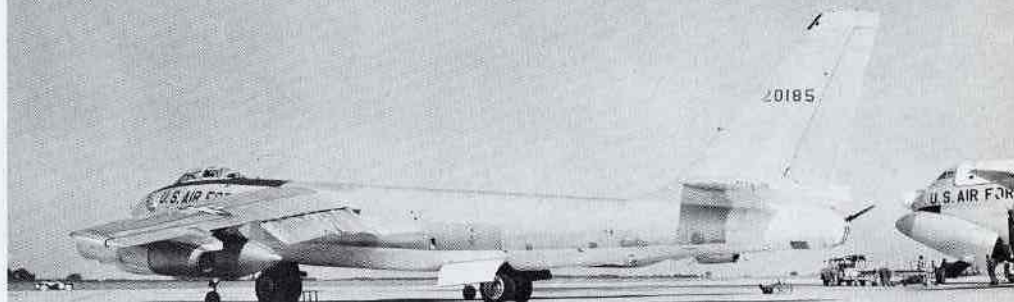

52-185, a B-47E-30-DT of the 98th BW, at Richards Gebaur AFB on 3 August 1963. [Paul Stevens]

[Above Left] 51-7066 flew with the 321st and 70th Wings before being modified to a WB-47E. The aircraft is now on display at Boeing Field in Seattle. [Paul Stevens]



## B-47 Variants

**B-47B-II** Redesignation of B-47Bs brought up to B-47E standard: number not known.

**DB-47B** Unarmed director for QB-47E and other remote-controlled target aircraft: four converted from B-47B.

**YDB-47E** For service trials with Rascal missile: two converted from B-47E.

**DB-47E** As YDB-47E: two converted from B-47E.

**ETB-47E** Special duty (electronics) trainer, converted from B-47E: number not known.

**YB-47J** Test aircraft for MA-2 radar bombing and navigation system: one converted from B-47E.

**EB-47L** Electronic communications relay aircraft: 35 converted from B-47E in 1963.

With approach chute trailing, 52-378, a B-47E-45-LM of the 303rd BW lands at Elmendorf AFB on 30 August 1963. [Norman E. Taylor]





53-1822, a 9th SAW B-47E-55-LM, was flown on Project Australia between 15 November and 4 December, 1963. Three B-47's were used as demonstrators in a proposal to lease two squadrons of B-47's to Australia pending delivery of their F-111's. The Aussies have adorned 1822 with two kangaroos [one beneath the cockpit and one above the approach chute door.] Note the highly polished nose.

The 9th, 98th, and 100th Wings flew a demonstration of conventional weapons delivery on 30 June 1964 at Eglin. This B-47 is from the 100th. [USAF]



Visitors stream through the IRAN facility at Kelly AFB during an Open House in May, 1960. Most of the B-47's in the picture formerly belonged to the 43rd BW, which had phased out its aircraft in March, 1960. [USAF via Taylor]





A very rare bird. 53-2316 is an EB-47E [TT] of the 55th SRW. Carrying two "Ravens" in a bomb bay capsule, the three Tel Twos that were modified flew recon missions primarily out of Incirlik, Turkey. [USAF/ Y'Blood]

On alert at Brize Norton is 53-6231, from the 380th BW. This aircraft has the wingtip antennas that were added to a number of late model B-47Es.

The 380th BW sent B-47E-120-BW to Quonset Point, R.I. for display on Armed Forces Day, 1965.

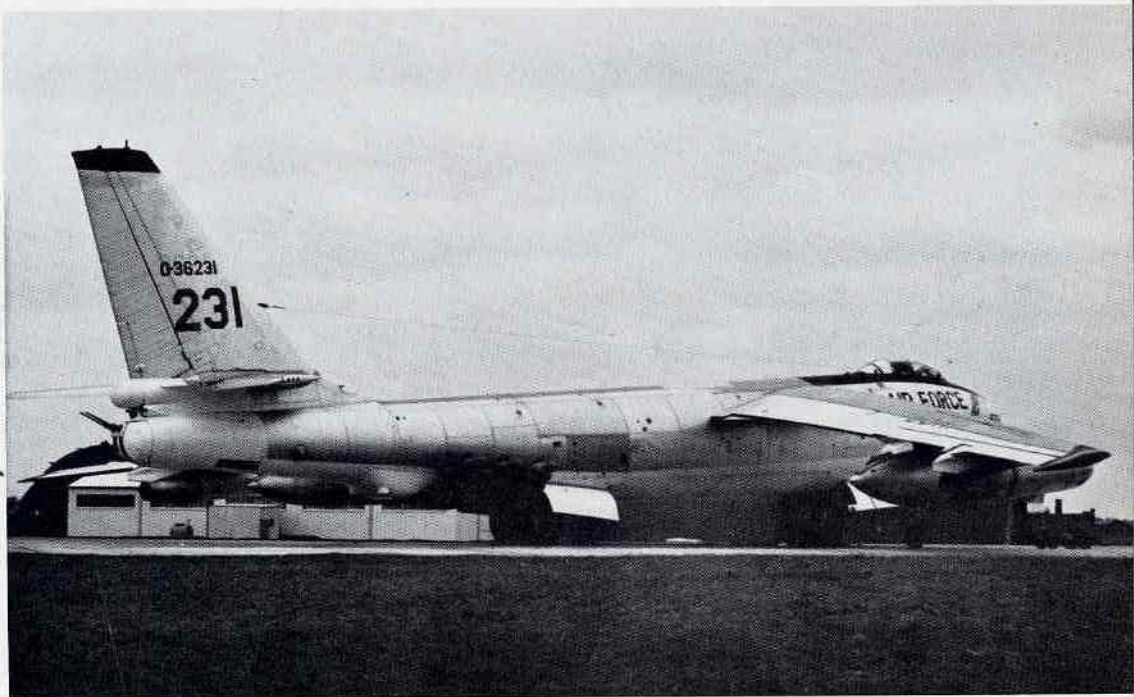



[Above] JB-47E of the Air Force Systems Command on display at Wright-Patterson AFB in May, 1967. What appears to be an unusual probe on the nose of this Stratojet is actually the tail antenna of a KC-135 parked down the line. [Gerdes via Taylor]

[Below] Changing of the guard. On 19 February 1968, 53-2276 prepares for its last flight from the Air Force Special Weapons Center at Kirtland AFB. Its replacement sits in the background. [USAF]

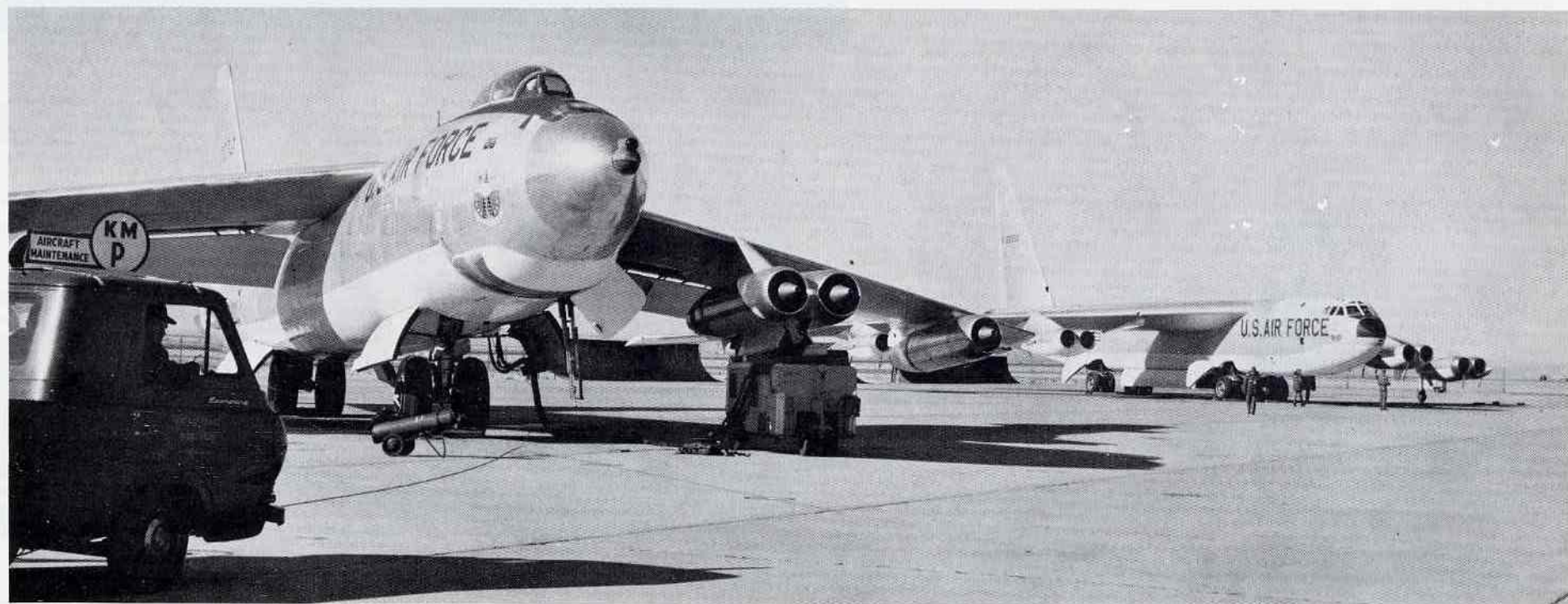

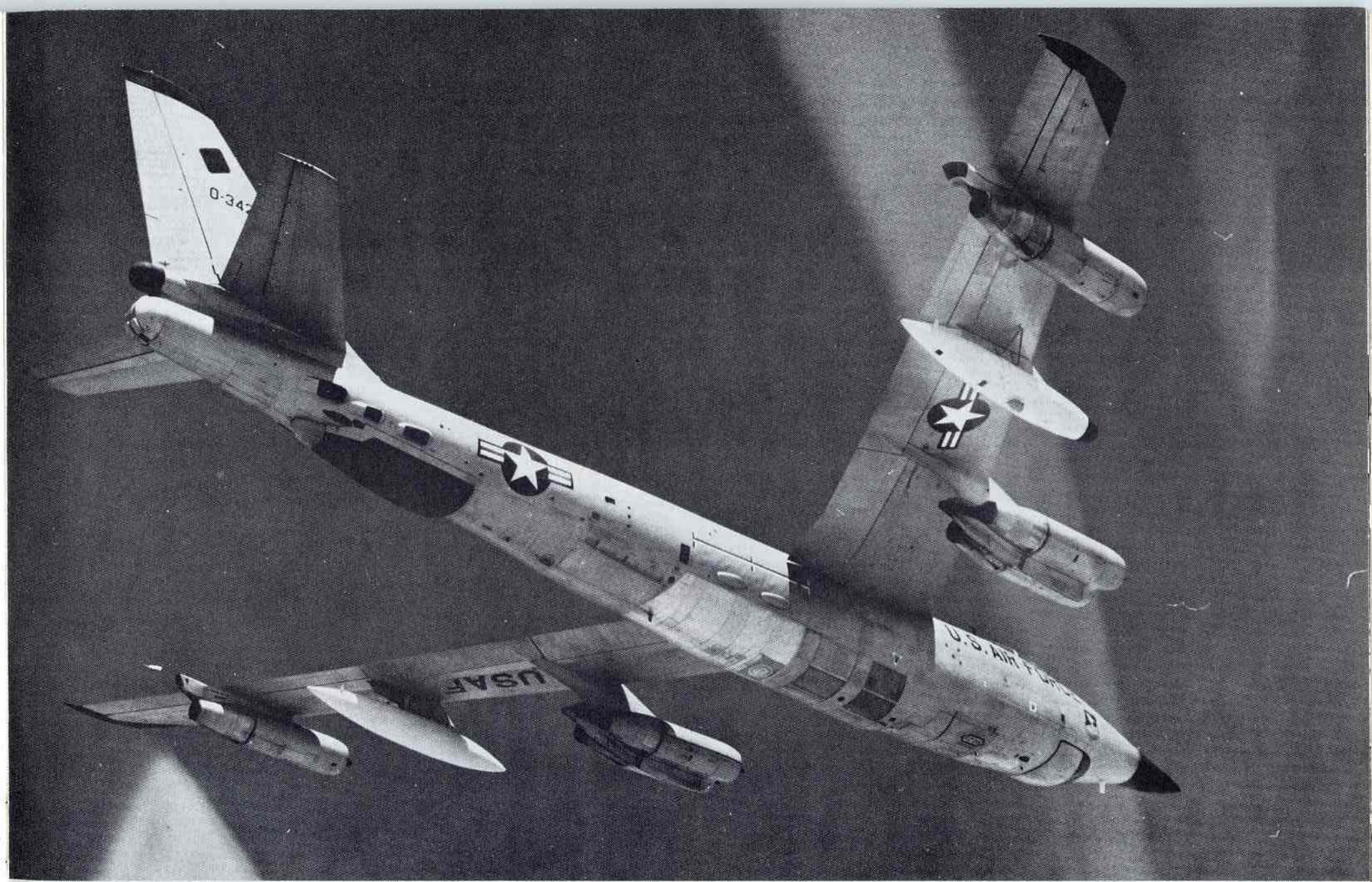

53-4296 received a new lease on life and is now one of only three B-47's still flying. Involved for a time with F-111 radar tests, it received quite a nose job! [North American via Bruce Orriss]

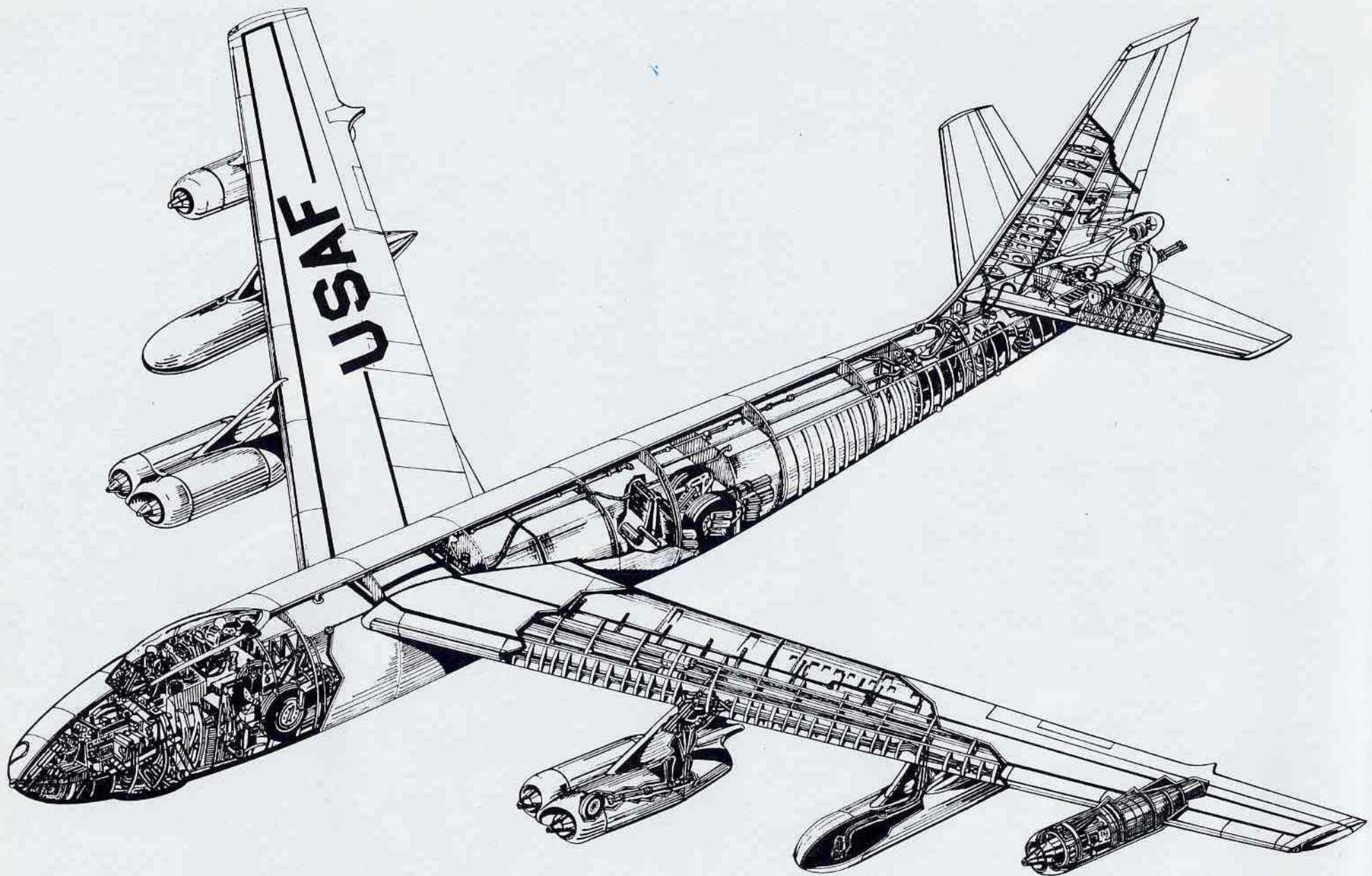

**B-47 Cutaway View**

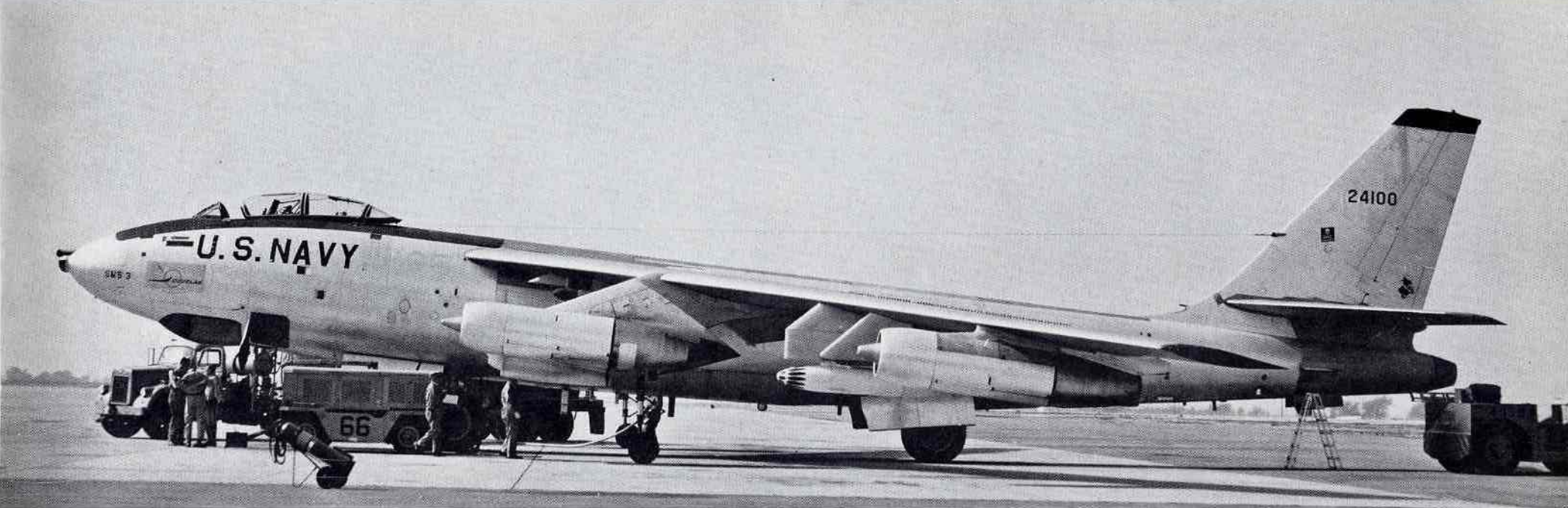

A simple serial number addition converted the 376th BW's 52-410 to the Navy's 524100. This EB-47E had red wingtips and tailcone and the pod inboard of the number one engine was white with red ovals on it's nose. A smaller pod can be seen inboard of the paired engines. Skull and Crossbones flag on the tail. Point Mugu, 2 November 1970. [Roy Lock via Norman E. Taylor]

A seven engined B-47 with a strange identification! B-47E-45-DT is shown at Edwards AFB during tests of the GE TF-34 engine. The Navy used the aircraft during 1971 to evaluate the engine for their S-3A Viking. [via Nick Williams and R.L. Lawson]

Former 376th BW EB-47E's are now used by the Navy for ECM testing. [Robert Lawson]



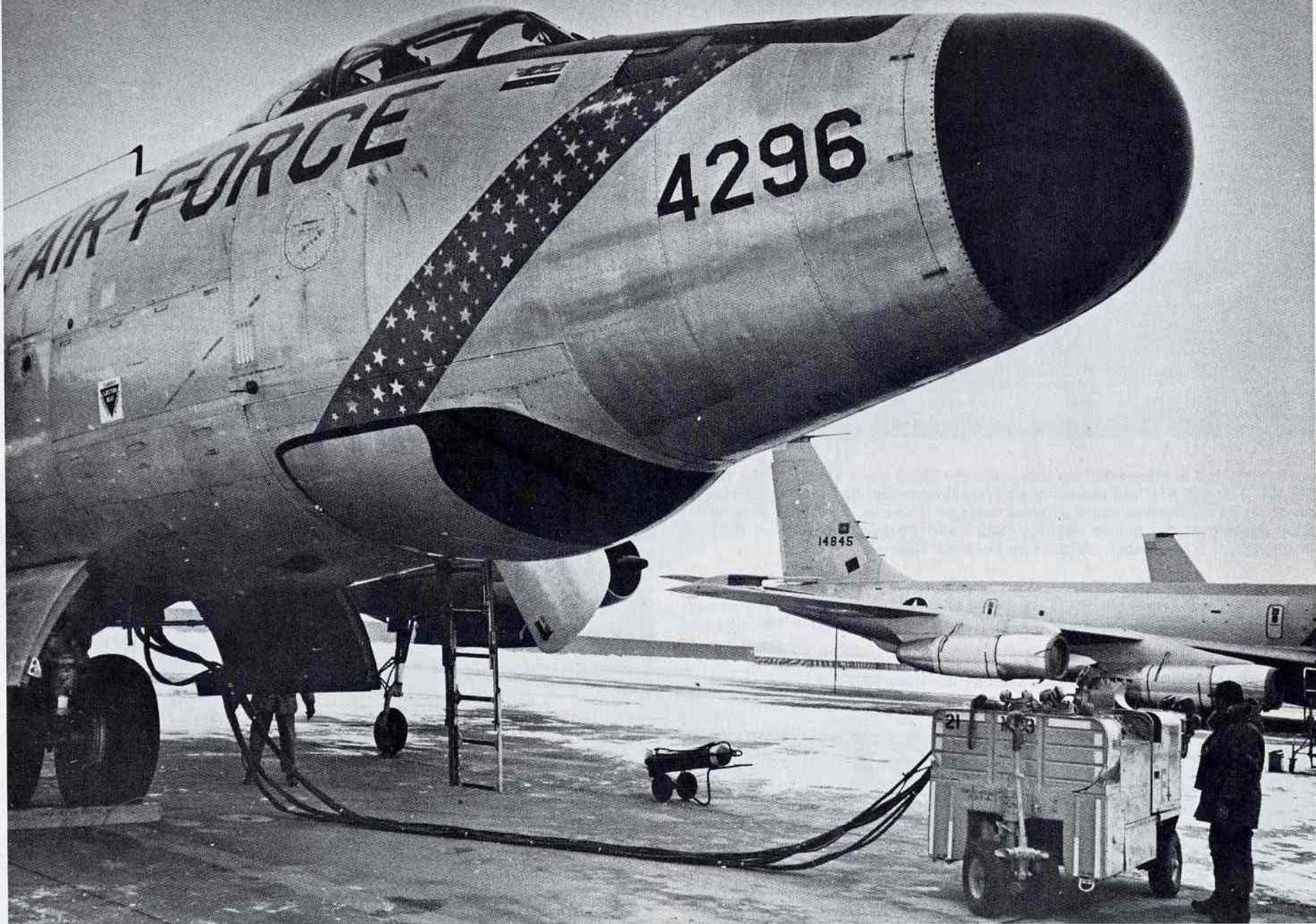

The last B-47 in SAC, 53-4296, an RB-47H-1-BW, prepares to leave Offutt AFB for the final time on 29 December 1967. [USAF]



4296 taxis away from the ramp at Offutt. The aircraft carries a variety of antenna. Some that can be seen include extended wingtip, an underwing type outboard of engines number one and six, antenna located in the aft fairings of the number one and six engine mounts and a cluster of antennas on the aft fuselage. The guns have been removed from the aircraft. [USAF]

The end of the line. Rows of B-47's sit in the "Boneyard" at Davis-Monthan AFB. [USAF]

The 55th SRW's 53-4280 is shown on display at Upper Heyford on 13 May 1967. The large pod [which was carried only on the right side] carried additional reconnaissance gear and could be removed or attached as the situation required. The emblem on the nose was carried on both sides. [Bob Stynes via John Bowdler]







53-2154, from the 98th SAW [formerly BW], sits on the Davis-Monthan ramp on 2 November 1965, awaiting it's final trip to the storage area. The aircraft had arrived four days earlier as the 98th began it's phaseout. [N.E. Taylor]

A once proud fleet sits in the sun awaiting it's final fate. Over 440 B-47's are visible in this shot of Davis-Monthan, 1965. [USAF via Taylor]



Unusual mission symbols decorate the nose of 53-4256, a JQB-47E-45-BW. This photo was taken after the aircraft had been mothballed at Davis-Monthan AFB. One symbol indicates a Bomarc, while the three large silhouettes appear to resemble the SR-71. The QB-47's were among the most colorful of the Stratojets. [Norman E. Taylor]

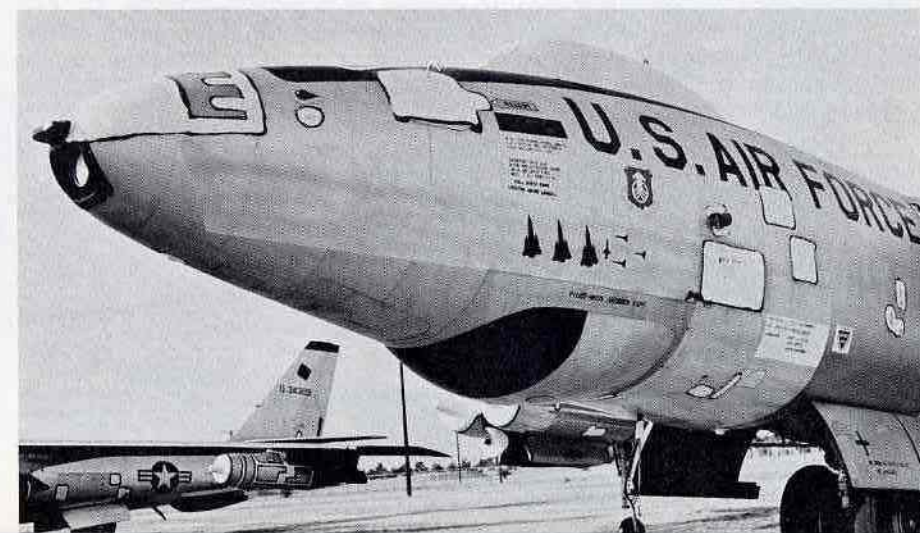



[Above] Carrying the TEE TOWN ECM pod, the 509th's 52-527 arrives at Davis-Monthan for storage on 2 November 1965. [Norman E. Taylor]

[Below] JQB-47E awaits the wrecker's torches at Davis-Monthan, January, 1969. [Norman E. Taylor]

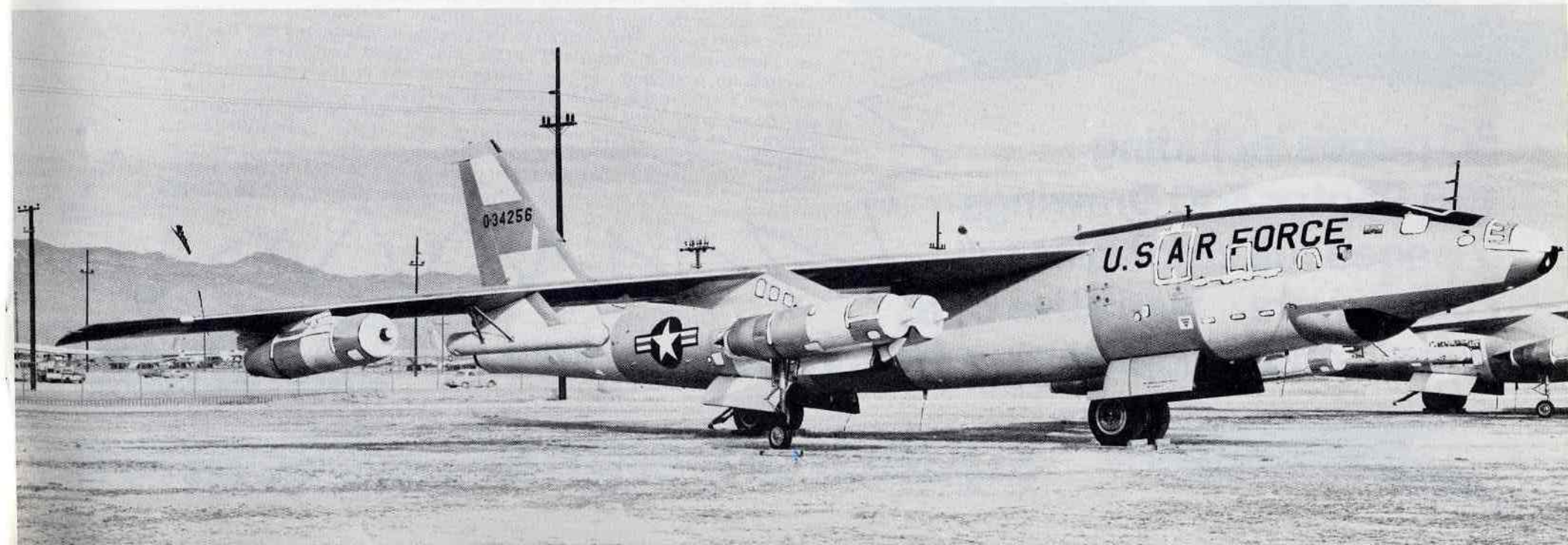

B-47E with early anti-flash paint job.

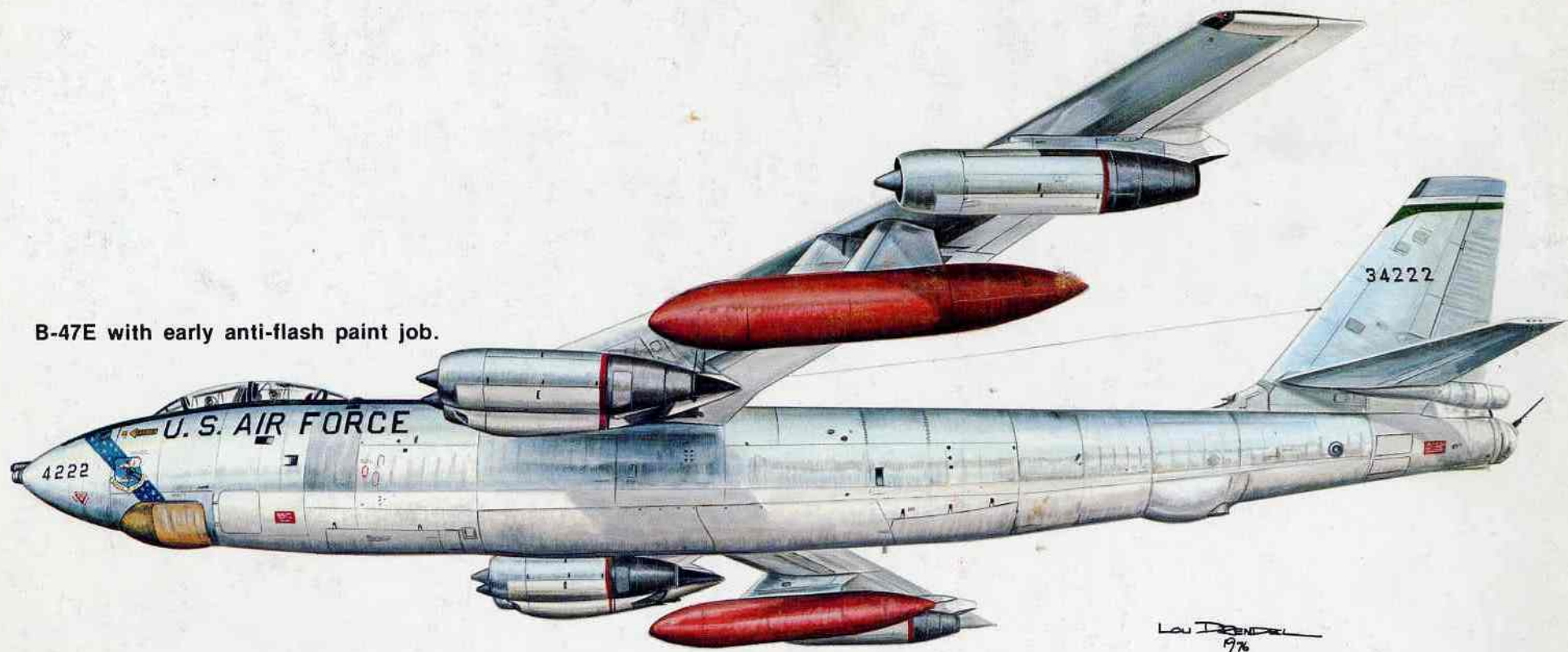

TB-47B-17-BW of the 3520th FTW at  
McCormick AFB.

