

SBD DAUNTLESS

in action



Aircraft Number 64
squadron/signal publications

DON GREER '84

SBD DAUNTLESS

in action

by Rob Stern

illustrated by Don Greer

line drawings by Kevin Wornkey

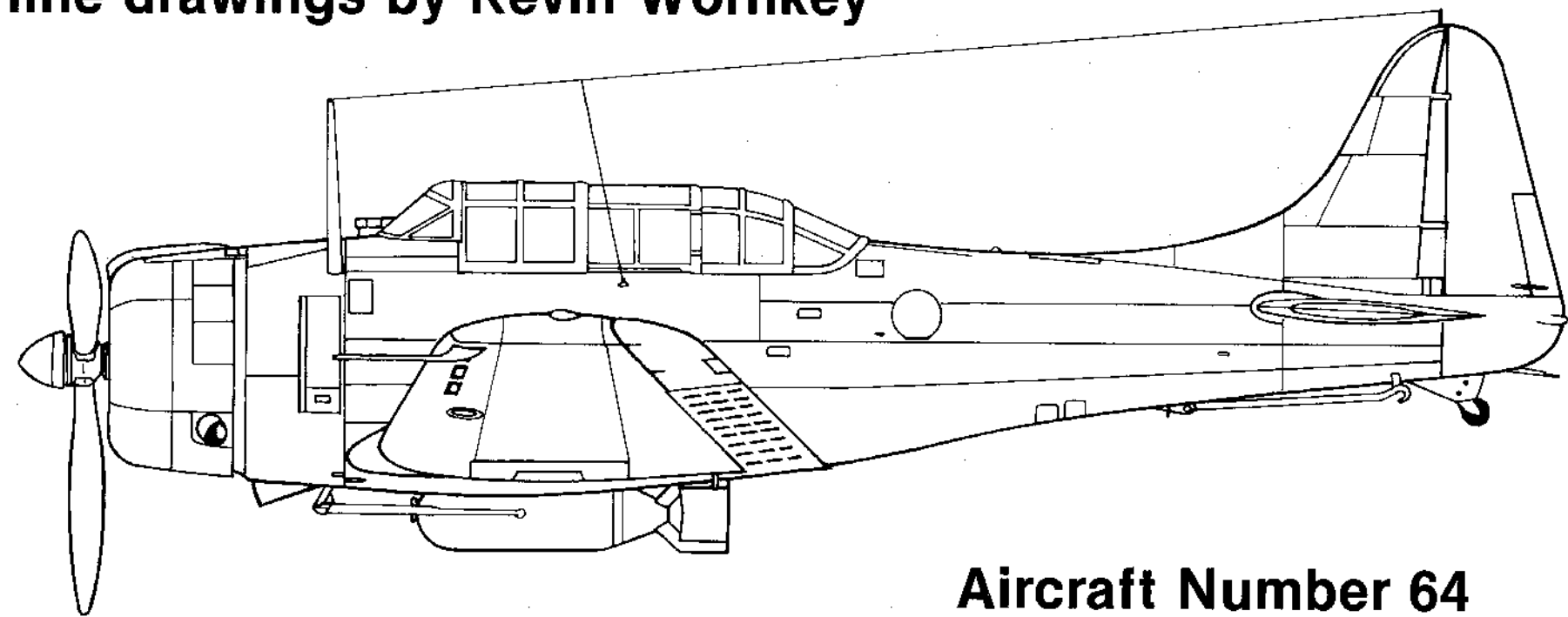

Aircraft Number 64
squadron/signal publications

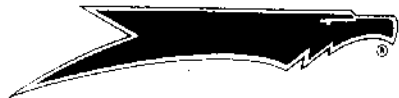



SBD-3 (BuNo 03246) of VB-3 piloted by LT Syd Bottomly and his gunner AMM2c Daniel F. Johnson about to push over into its dive during the Battle of Midway, 4 June 1942. Bottomly was credited with hitting a Japanese carrier and was awarded the Navy Cross.

COPYRIGHT © 1984 SQUADRON/SIGNAL PUBLICATIONS, INC.

1115 CROWLEY DRIVE, CARROLLTON, TEXAS 75011-5010

All rights reserved. No part of this publication may be reproduced, stored in a retrieval system or transmitted in any form by any means electrical, mechanical or otherwise, without written permission of the publisher.

ISBN 0-89747-153-9

If you have any photographs of the aircraft, armor, soldiers or ships of any nation, particularly wartime snapshots, why not share them with us and help make Squadron/Signal's books all the more interesting and complete in the future. Any photograph sent to us will be copied and the original returned. The donor will be fully credited for any photos used. Please indicate if you wish us not to return the photos. Please send them to: Squadron/Signal Publications, Inc., 1115 Crowley Dr., Carrollton, TX 75011-5010.

Acknowledgements

The author would like to thank a number of people without whom this book would never have been: Chuck Haberlein of the Naval Historical Center for his seemingly infinite patience during my flying visits, Bob Lawson of the Tailhook Association for responding promptly to my photo requests, Bob Cressman and Bob Poynter for their help in tracking down accurate markings, Dana Bell of the National Air and Space Museum for all of his help and friendship, Harry Gann at Douglas Aircraft for photos and much useful information, all the kind souls at the Air Force's Magazines and Book Division, and especially H. Paul Brehm for generously sharing his marvelous photo collection and memory.

Photo Credits

National Air and Space Museum - Smithsonian Institution (NASM)
US Naval Historical Center (NHC)
National Archives and Record Service (NARS)
Historian, DCNO (Air Warfare) (AW)
Tailhook Association
US Air Force (USAF)
Douglas Aircraft Company
Paul Schmelzer
H. Paul Brehm

Wake Island burns below the distinctive profile of an SBD-5 of Yorktown's VB-5, 6 October 1943.(USN/NARS)



INTRODUCTION

The Douglas SBD Dauntless, the Slow But Deadly Dauntless, was easily the most famous US Navy bomber of World War II, and possibly the most important dive bomber flown by any combatant during World War II. However, the Dauntless had begun its combat career as a mediocre dive bomber that was already considered obsolete even before the United States entered the war. Obsolescence notwithstanding, the Dauntless was the only US aircraft to participate in all five Naval engagements that were fought exclusively between aircraft carriers, and despite having been marked for retirement even before the war began, the Dauntless sunk more enemy shipping during 1942 than all other aircraft combined; the Slow But Deadly destroyed the cream of the Japanese aircraft carrier fleet during the Battle of Midway, a blow from which the Imperial Japanese Navy never recovered. "Certainly by the time the Helldiver appeared on the scene the main decisive carrier-to-carrier air/sea battles had been fought and won, mainly by the combination of Dauntless/Avenger/Wildcat, and there was little left from 1943 onward but for the gradual mopping-up of a defeated enemy who would not admit he was beaten."

The Dauntless story begins in 1932, when the aviation genius John Northrop left Douglas Aircraft to form his own company (with Douglas backing) at El Segundo, California. During the next few years Northrop turned out some truly remarkable designs including the Alpha which was the first all metal stressed skin monoplane, the Beta fighter which was the first 300 hp aircraft to exceed 200 mph, and the Gamma Mail plane which could fly the mail coast to coast in 11 1/2 hours. In response to a 1934 Request For Proposals from the Navy Bureau of Aeronautics (BuAer) for a new purpose-built dive bomber to replace the numerous types then serving in the fleet dive bomber role, Northrop submitted a design proposal for an all-metal stressed skin low wing monoplane design. BuAer chose the Northrop design over entries from Brewster, Martin and Vought (because they were biplanes, the Curtiss and Great Lakes designs had been rejected out of hand), ordering a single prototype from Northrop under the designation XBT-1 (BuNo 9745).

The XBT-1 (BuNo 9745) on 14 April 1936. The most noticeable feature of the new dive bomber were the large underwing fairings enclosing the partially retracting landing gear. (NASM)

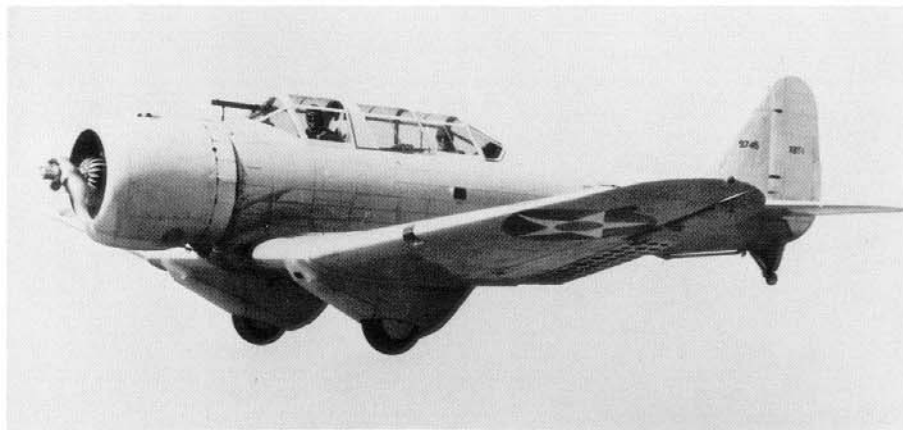

BT-1

Designed by Ed Heinemann, working directly under John Northrop, the XBT-1 prototype offered a number of features that were near state of the art in 1934. A low wing monoplane with a main landing gear that partially retracted rearward into bulged underwing fairings, which left the lower part of the tires exposed. Believing that strength was the most important factor in a dive bomber, Heinemann employed the sparless, multi-cellular wing structure that Northrop had pioneered with his Alpha mailplane, the same wing that Douglas had used so successfully in its early DC transport series. When introduced, the multi-cellular design was revolutionary, because it allowed the construction of monoplane wings without external braces or stays. However, because the multi-cellular wing design precluded the wing being folded, the XBT-1 was the only carrier aircraft with a multi-cellular wing construction ordered by the Navy. To somewhat make up for the lack of a folding wing, Heinemann made the XBT-1 as small as he could. The wing span of the prototype was just 41 feet 6 inches with the other dimensions similarly diminutive, length being 31 feet 6 inches and a height of 12 feet 6 inches. Power was provided by a 700 hp Pratt & Whitney R-1535-66 Twin Wasp Jr, giving the prototype a top speed of 184 mph. The prototype flew for the first time on 19 August 1935 providing enough promise for continued testing. In December of 1935, the XBT-1 was re-engined with an 825 hp P&W R-1535-94 Twin Wasp Jr providing a top speed of 212 mph and the ability to carry a 1000 lb bomb with a service ceiling of 22,500 ft. To solve a buffeting problem during diving, a series of holes were drilled in the dive flaps. Not only was the buffeting problem solved, but the flaps could be opened wider than ever, which further reduced diving speed, and did nothing to reduce the lift of the airfoil.

On 18 September 1936 the Navy accepted the XBT-1, ordering fifty-four production aircraft under the designation BT-1. Mainly serving with VB-5 aboard Yorktown and VB-6 aboard Enterprise, the new dive bomber was found to suffer from a catalog of vicious handling characteristics including lateral instability at low speeds, a loss of rudder and aileron effectiveness at low speeds, and a tendency to snap roll if power was applied too suddenly, which caused several fatal crashes. Needless to say, BuAer wanted no more BT-1s.

With an enlarged tail and redesigned cowling, the BT-1 entered fleet service in 1938. 6-B-1 (BuNo 0615) sports a Royal Red cowling, fuselage band and wing chevron. The True Blue tail identifies it as part of the Enterprise Air Group, and the charging ram insignia and code identifies it as a member of VB-6, 1938. (NASM)

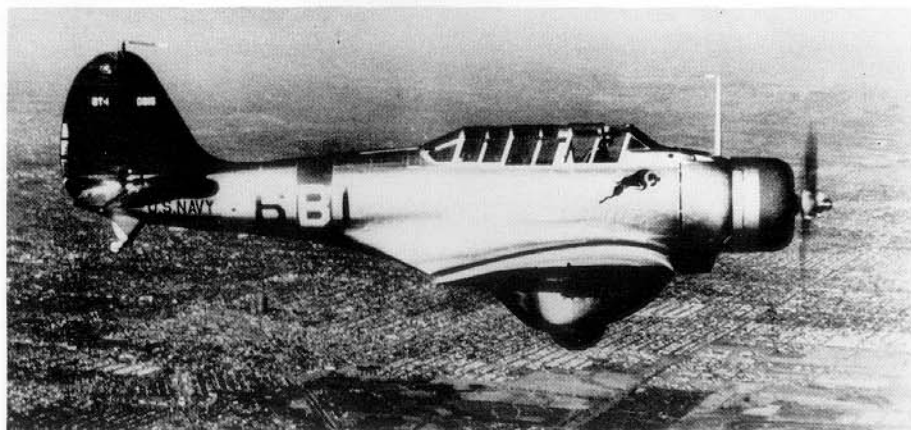

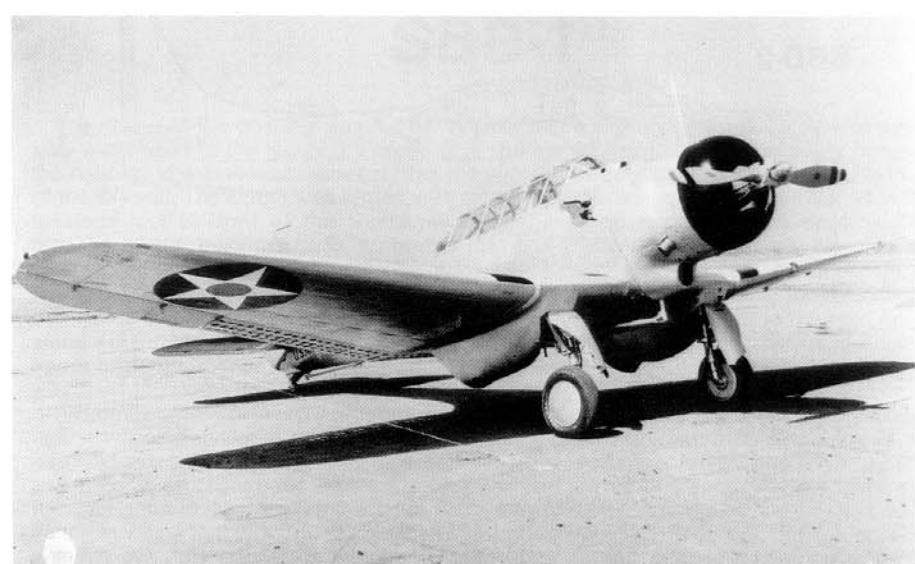

5-B-10 markings on the side of BT-1 (BuNo 0606) indicated the 10th aircraft of Yorktown's VB-5. The cowling, fuselage band and chevron were Black. The tail is Red. The perforated flap/dive brakes were carried over to the SBD. (NASM)

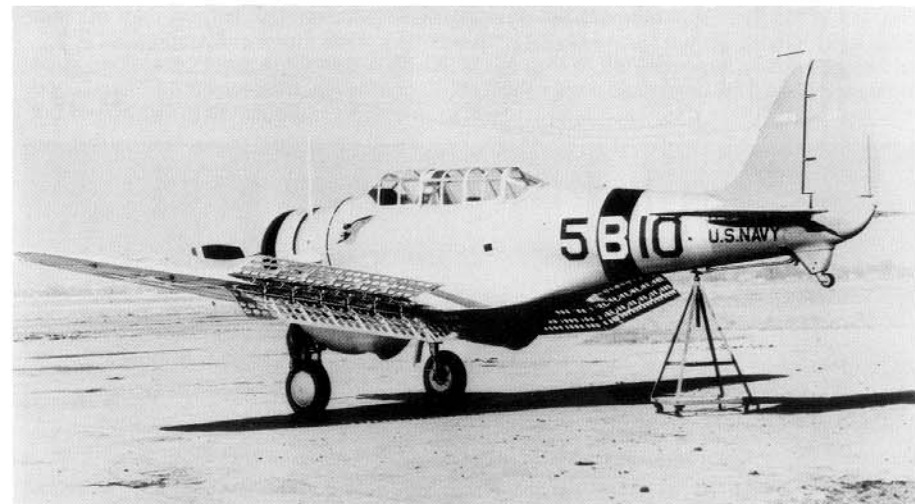

XBT-2

Fortunately for Northrop however, the original XBT-1 contract included money for a second generation prototype under the designation XBT-2. Northrop, being aware of the BT-1's deficiencies, perhaps even more so than BuAer, approached the XBT-2 with the

idea of resolving the many problems of the BT-1 and hopefully winning another production contract. Reasoning that most of the BT-1's problems stemmed from insufficient power, the first step was to change powerplants. A 1000 hp Wright XR-1820-32 Cyclone engine replaced the Twin Wasp Jr and an adjustable pitch three bladed propeller replaced the two bladed propeller of the BT-1. A completely redesigned control panel and instrumentation was added to the machine to resolve its stalling characteristics. Flight testing of the XBT-2 in this configuration began on 25 April 1938, revealing only marginal improvement over the BT-1.

Unwilling to give up the effort, Northrop flew the XBT-2 to Langley, VA, where NACA had set up the first wind tunnel large enough to test full scale aircraft. The result was a series of recommended changes by NACA including making the landing gear fully retractable, adding fixed slots to the wings to increase aileron effectiveness and increasing the size of the tail and rudder. The changes were implemented by Heinemann, followed by six months of intensive testing during which at least 21 different tail and rudder configurations and 12 different aileron profiles were tried, before a totally satisfactory combination was found. Before the completely revised XBT-2 was rolled out John Northrop resigned from Douglas (his company for a number of years had been operating as an independent aircraft manufacturer wholly owned by Douglas). The XBT-2 reverted to Douglas, being redesignated the XSBD-1. As a result of the NACA recommendations the divebomber was aerodynamically smoothed out. The most obvious being the landing gear. Gone were the huge fairings into which the rearward folding main gear had partially retracted, being replaced by a fully retractable main landing gear that folded inward into wheel wells in the lower fuselage. The cockpit greenhouse was completely redesigned. The revised prototype was accepted by BuAer in February of 1939, with 144 SBD-1s being ordered on 8 April. The change in designation from Bomber (B) to Scout Bomber (SB) was made because BuAer decided to reserve the bomber designation for multi-engine aircraft. It indicated no change in mission.

The XBT-2 (BuNo 0627) attempted to correct the many problems of the BT-1. With the larger diameter Wright Cyclone engine and fully retracting landing gear, the general shape of the Dauntless was established. After further changes, particularly to tail and rudder, it evolved into the XSBD-1. (NASM)

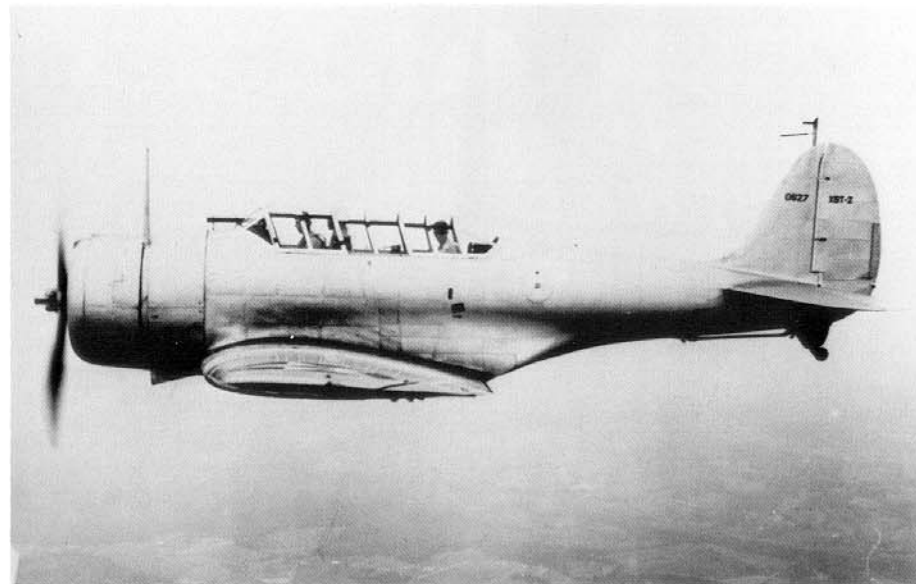

SBD Development

XBT-1

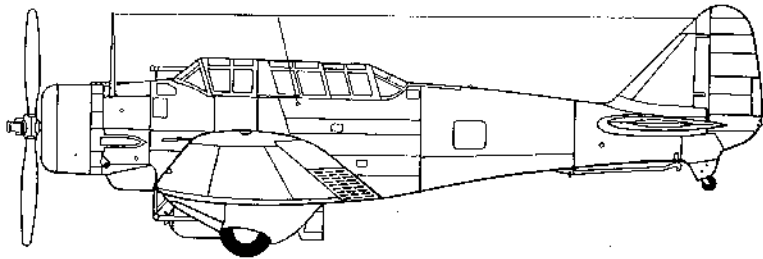

BT-1

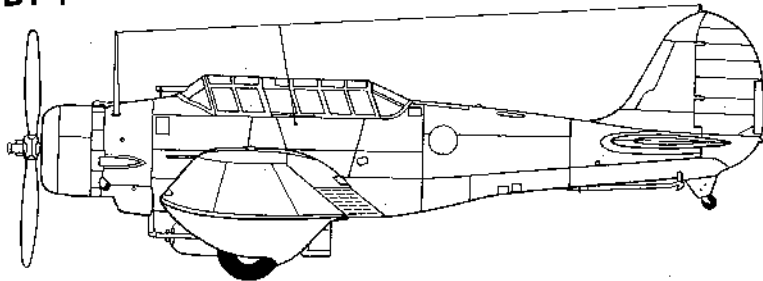

XBT-2 (Final Configuration)

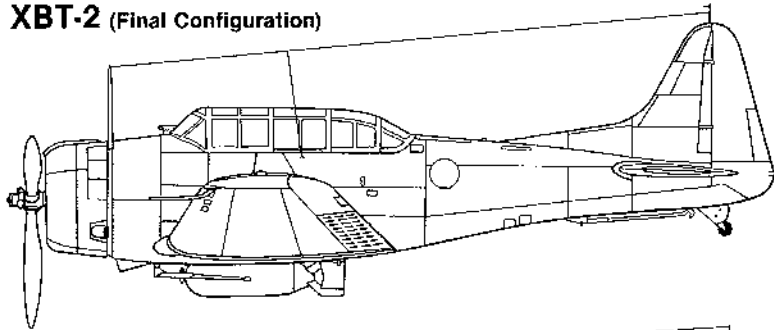

SBD-1

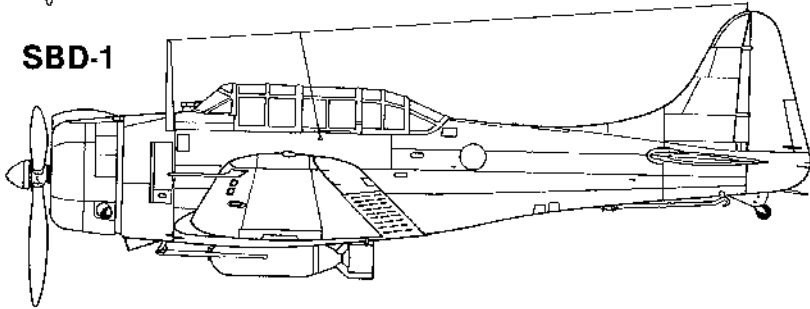

SBD-2

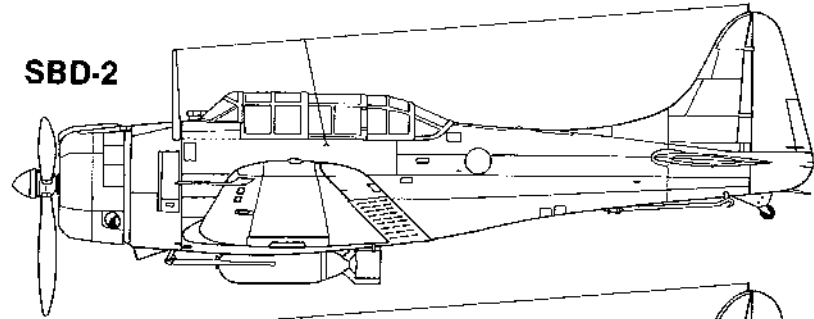

SBD-3

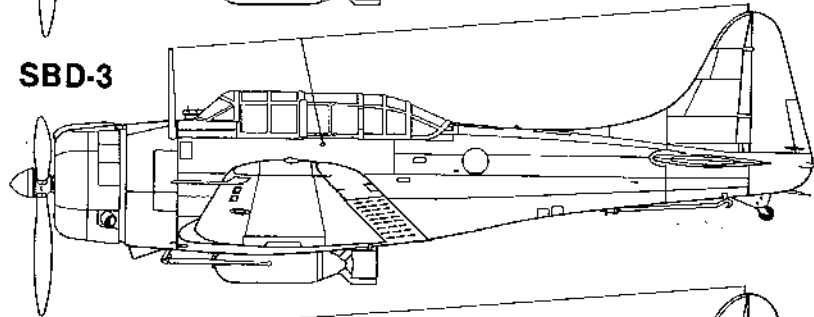

A-24

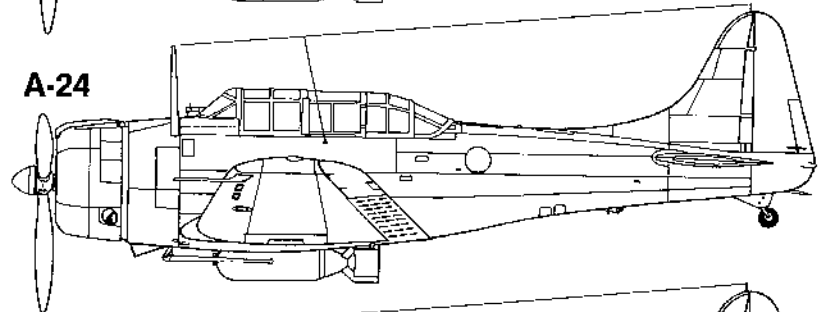

SBD-4

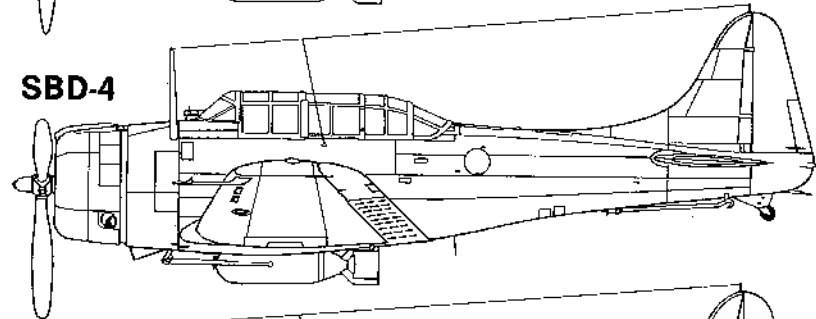

SBD-5/6

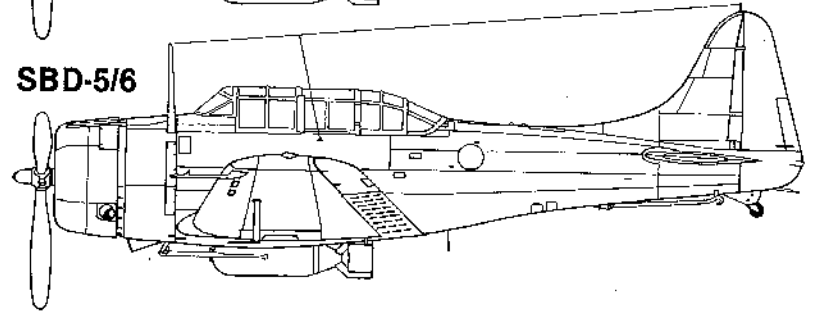

SBD-1

The shape of the cowling was further refined and a slightly bulbous carburetor air intake was added to the top of the cowling. A spinner was added to the propeller hub and the radio mast was moved rearward from the edge of the cowling to a position just in front of the firewall. The SBD-1 was armed with a pair of .50 caliber machine guns buried in the fuselage just in front of the windscreen, firing through troughs in the cowling. The breaches of the machine guns protruded into the cockpit where they could easily be cleared and cocked if jammed. The Dauntless' chief adversary, the Zero, had a similar arrangement for its fuselage mounted armament. The radio operator's position was equipped with a single .30 caliber machine gun on a flexible mount that fired to the rear. Provisions were made for a single bomb of up to 1600 lbs on the centerline and a single 100 lb bomb or depth charge under each wing. The centerline bomb was mounted to a crutch which swung down and forward ensuring that the bomb cleared the propeller arc.

Although 144 SBD-1s were ordered, only 57 (BuNo 1596 to 1631, 1735 to 1755) were actually delivered in the -1 configuration, because BuAer considered the first mark of the Dauntless to be something less than combat ready. Although armed, the SBD-1 lacked any armored protection for the crew or fuel, and had too short a range. The 210 gallons of fuel carried in four tanks in the wing center section, two 90 gallon main tanks and two 15 gallon auxiliary tanks, provided less than 900 nautical miles of range with bomb load. Considering the time necessary to form up with other aircraft prior to a mission and time spent in the landing pattern upon return, and allowing fuel for combat and an adequate reserve, the SBD-1 had an effective combat radius of less than 200 nautical miles. Douglas assured BuAer that these problems would be solved, beginning with the 58th production aircraft. Therefore, BuAer elected to accept the first 57 aircraft "as is", and dispose of them in their normal fashion...they were given to the Marines.

The SBD-1 began to equip Marine Air Group (MAG) 11 and 21 during June of 1940. SBD-1 equipped MAG 21 was stationed in Hawaii at the time of the Japanese attack on Pearl Harbor. Caught on the ground, seventeen Dauntlesses were destroyed with all of the remaining twelve being damaged.

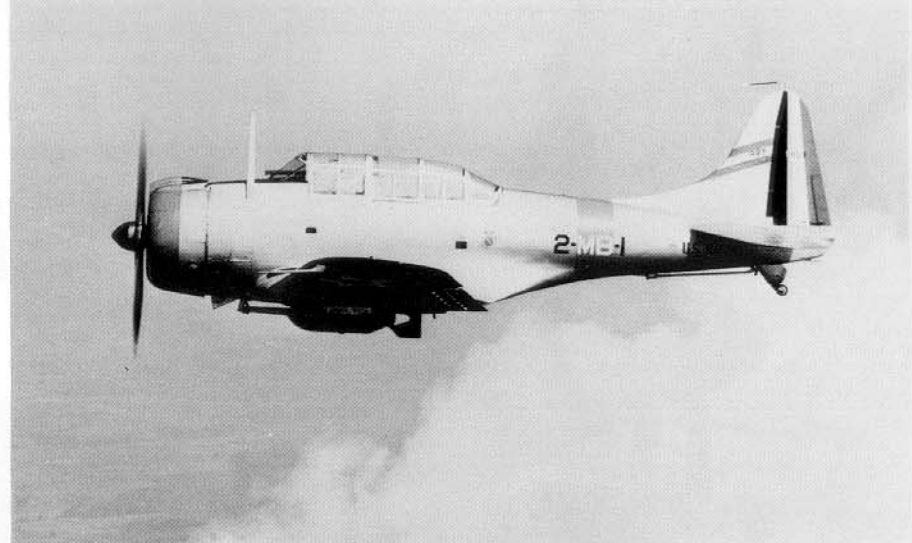

The second production SBD-1 (BuNo 1597) in the markings of the CO of Marine Bombing Squadron (VMB-2) of Air Group 11 (MAG 11), the first unit to receive the Dauntless. The markings are Navy style except for the vertical Blue-White-Red stripes on the rudder and the USMC emblem. The two Red landing assistance stripes on the tail were used for carrier landing assistance and are an unusual feature on a Marine Corps aircraft. (NASM)

A later SBD-1 (BuNo 1626) also in the markings of the CO of VMB-2, this time without the Red tail stripes. The tail wheel was solid rubber and non-retractable. (Douglas via Harry Gann)





2-MB-1 taxis while the third plane of another section (only the lower half of the cowling is painted in the section color) warms up in the background. (Douglas via Harry Gann)

A distinctive feature of the SBD-1 was the bulbous carburetor air scoop atop the cowling.

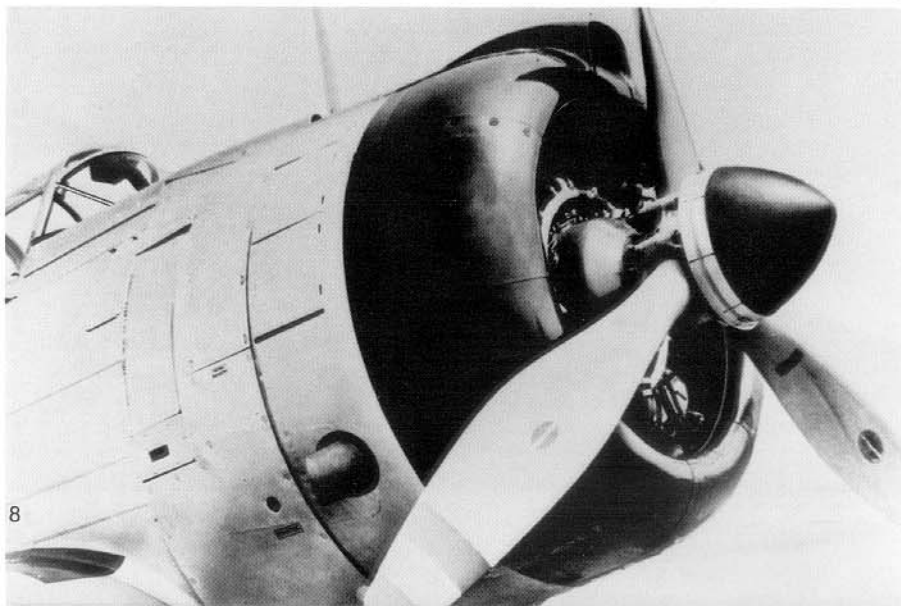

XBT-2

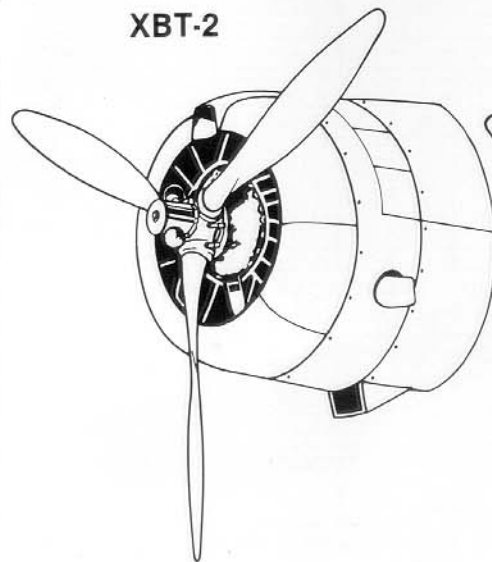

SBD-1

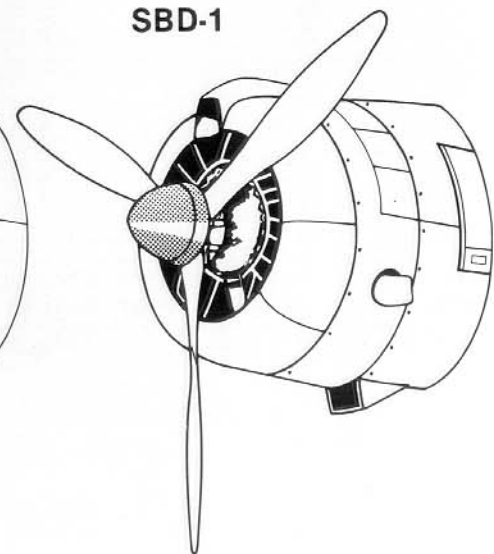

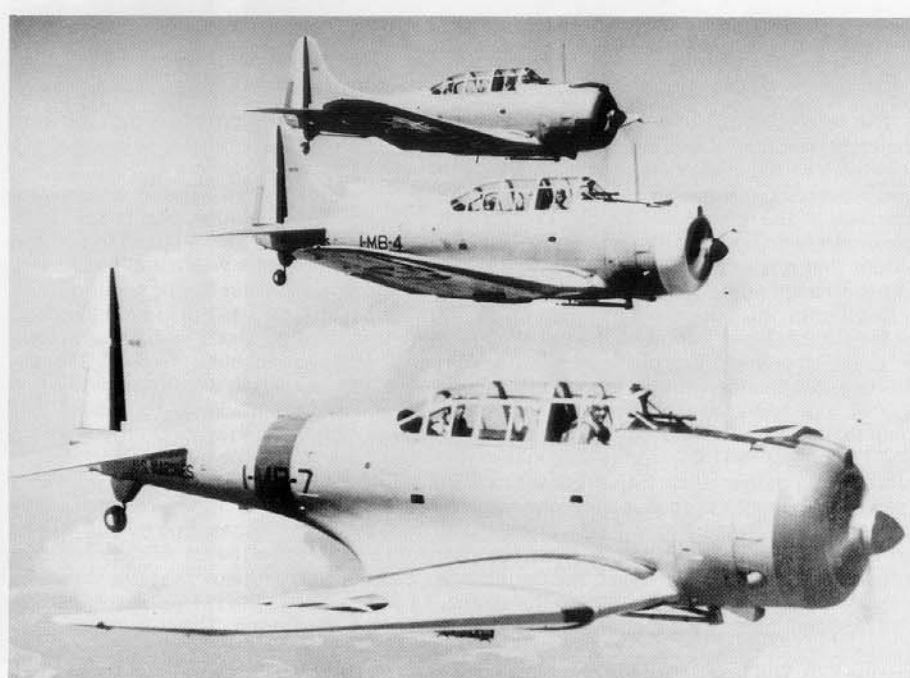
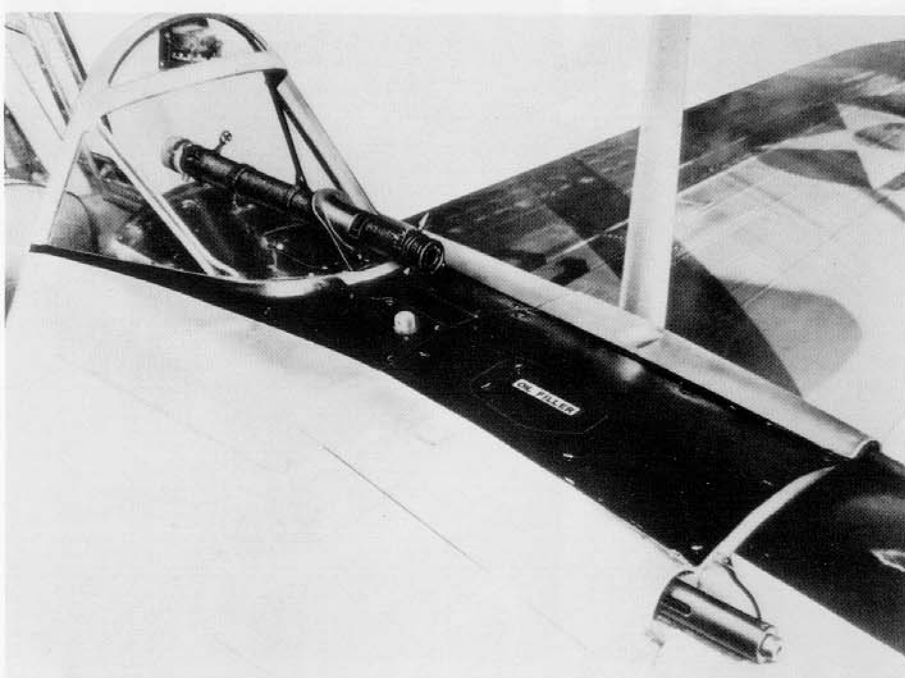

The second squadron to equip with SBD-1 Dauntless was VMB-1, also of Air Group 11 at Quantico, Va. BuNo 1616 was 1-MB-7, the third section leader (Blue stripes); 1-MB-4 was second section leader (White stripes). (USN/NARS)

(Above Left) The telescopic sight was used for both sighting the .50 caliber nose guns and dropping the bomb mounted on the centerline. It was archaic but effective.

This SBD-1 has become a trainer for a stateside VS during late 1942. The propeller spinner has been removed. The colors are a very weathered Sea Gray over Light Gray. The practice bomb is Yellow. (Douglas via Harry Gann)

XBT-2

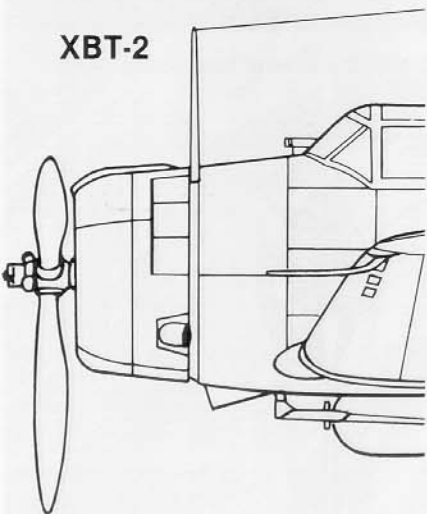

SBD-1

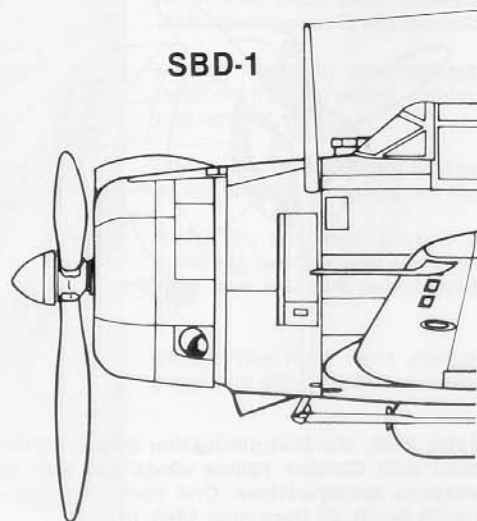

SBD-2

The remaining 87 aircraft (BuNo 2102 to 2188) of the original production order were delivered as SBD-2s, and although the changes made on the SBD-2 did not solve all of the problems of the Dauntless, it did alleviate the most serious problem — the inadequate combat radius. The two 15 gallon auxiliary tanks were eliminated and 65 gallon tanks were installed in the wing outer panels, raising fuel capacity to 310 gallons, and range to approximately 1200 nautical miles. The increased weight of fuel hurt performance to such an extent that one of the fuselage mounted .50 caliber machine guns was usually removed. The increased range led to the introduction of an autopilot to assist during the long over water flights now possible. The most noticeable external change was the reduction in size of the carburetor air scoop on the upper cowling. Despite the fact that the SBD-2 still lacked crew armor and armor protection for the fuel system, BuAer accepted the SBD-2 for aircraft carrier service with Enterprise's VS-6 and VB-6 and Lexington's VS-2 and VB-2.

VS-2 and VB-2 aboard Lexington were the first carrier squadrons to receive the Dauntless, with VS-6 and VB-6 on board the Enterprise quickly following. On the morning of 7 December 1941 Enterprise was steaming through rough waters toward Pearl Harbor after having delivered six F4F Wildcats to Wake Island. At 0630 Admiral Halsey had eighteen SBD-2 Dauntlesses launched, the scout bombers were to search the area east of the carrier before proceeding to Pearl. Shortly after 0800 the Dauntlesses, one by one, began arriving into the cauldron of the Japanese attack on Pearl Harbor. Seven SBDs were shot down or crash landed. However, the Dauntlesses claimed at least two of the twenty-seven aircraft lost by the Japanese during the attack. As soon as possible the SBDs were out to sea searching for the Japanese task force, but it was long gone. Three days later, on Wednesday 10 December, Lt C E Dickson of VS-6 destroyed the Imperial Japanese submarine I-70. The first Japanese combat vessel sunk by US forces in World War II was sunk by the Slow But Deadly Dauntless.



The SBD-2 could be distinguished from the SBD-1 by the smaller cowl scoop. (NASM)

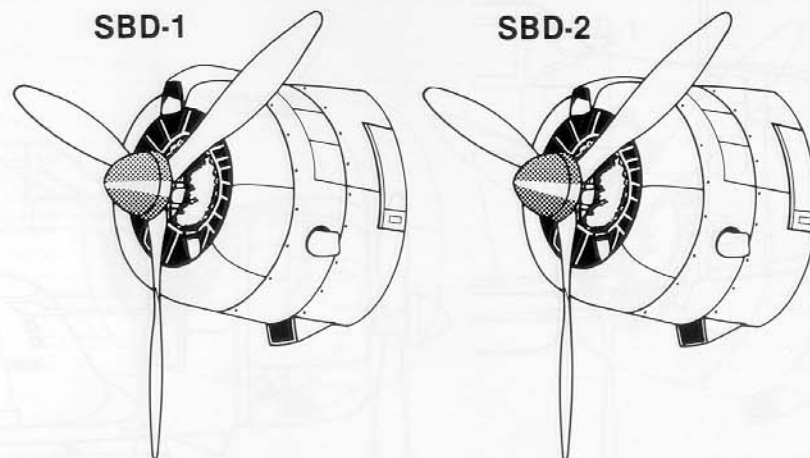

BuNo 2102, the first production SBD-2, carries the prewar colors of overall Aluminum paint with Chrome Yellow wings and was used by the Navy to service test various weapons configurations. One such trial was to test the compatibility of the standard 1000lb bomb. 30 December 1940. (NASM)

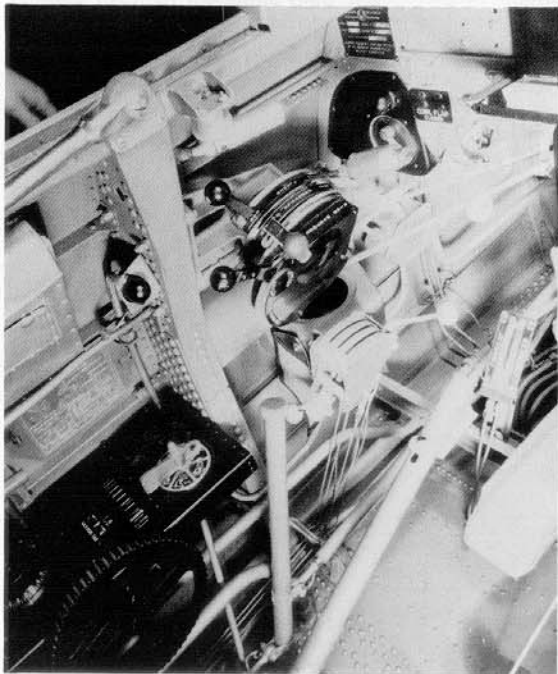
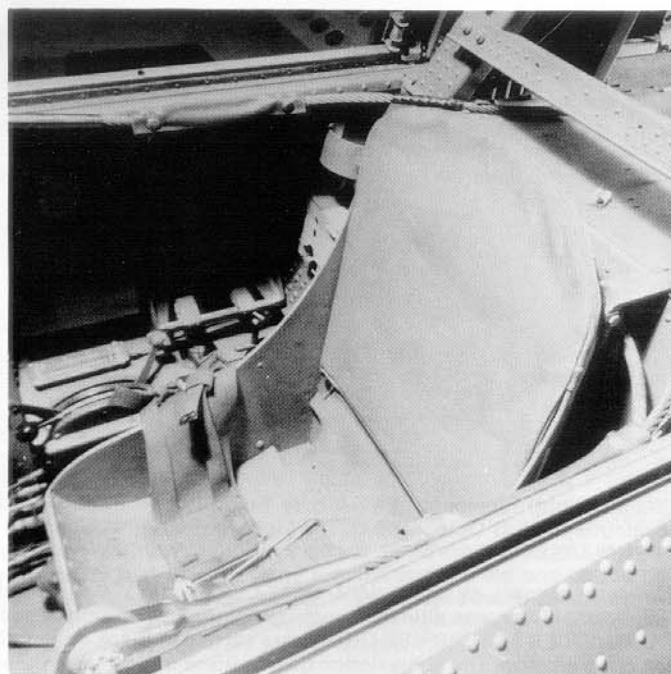
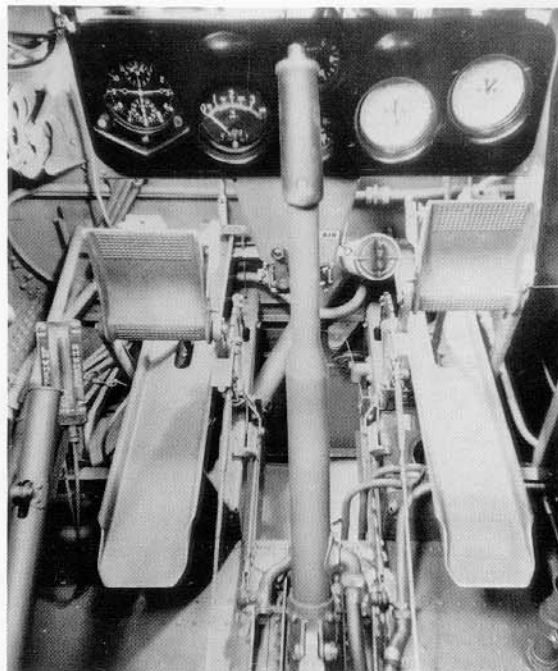

The pilot's cockpit of an SBD-2. All models were essentially similar except for instrument upgrades and additions.

(Above Left) The main instrument panel with the retractable chart table extended. The smaller lower instrument panel is hidden below the chart table.

(Above) The lower front cockpit, showing the smaller lower instrument panel, rudder pedals, foot troughs and control stick.

(Above Right) The pilot's seat and the lower right side of the cockpit including the flap control quadrant.

(Left) The left front cockpit including the throttle quadrant, landing gear and cowl flap controls are forward, and fuel tank select and trim wheel are further aft.

(Right) The right front cockpit with the electrical panel and pilot's radio controls. (USN/NARS)

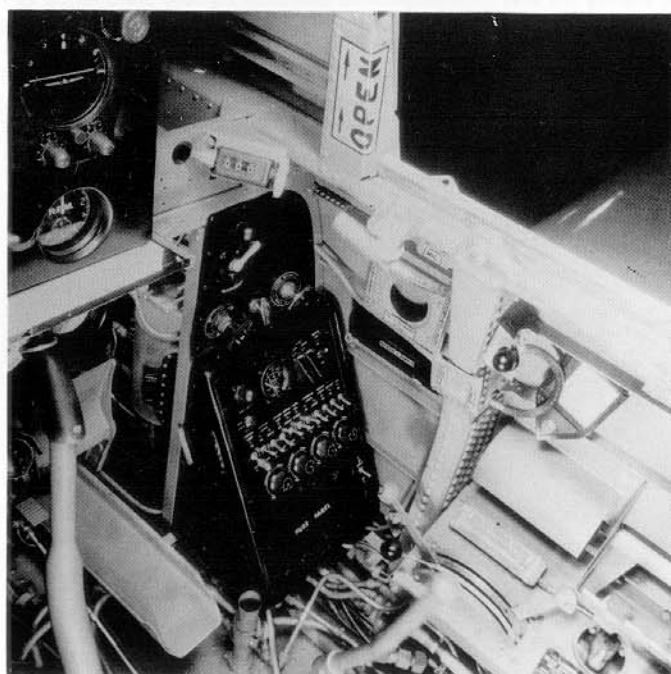

An SBD-2 belonging to the CO of the Enterprise Air Group carrying the new overall Light Gray scheme. SBD-2s were accepted for fleet service in early 1941 and immediately began replacing BT-1s, SBCs and SB2Us on Lexington and Enterprise. As war approached, the Navy changed from its bright prewar markings to camouflage. The first change was the adoption, in late 1940, of overall Light Gray as the basic paint scheme for combat aircraft. Markings were White and roundels were carried in four positions (both sides of the fuselage, and upper port and lower starboard wing surfaces). (USN/NHC)



**.30 Calibre
Flexible Gun Mount**



(Below Right) Elements of VS-6 over Enterprise in the new Sea Gray over Light Gray camouflage on 27 October 1941. The Light Gray extends along the fuselage and wing root. (USN/NARS)

The same aircraft, as above right, on 17 October 1941. Only four days previously, the official camouflage was altered to include painting all upper surfaces Sea Gray. The words **COMMANDER ENTERPRISE GROUP** are carried in Black on the SBD-2's side, barely visible in the shadow. The abbreviation **CEG** in Black can be seen on the wing just outboard of the wing walk. (USN/NARS)

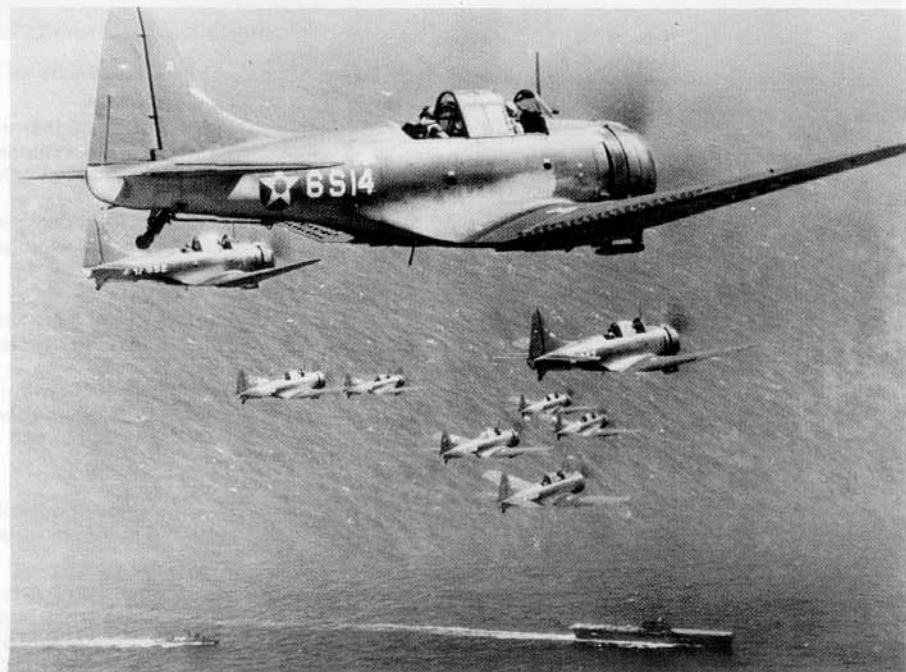
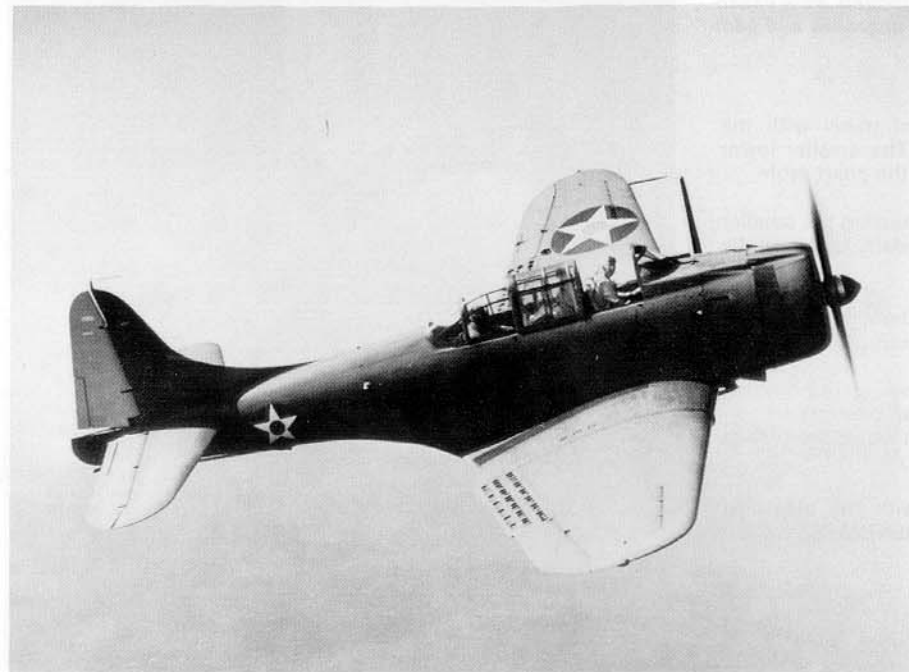

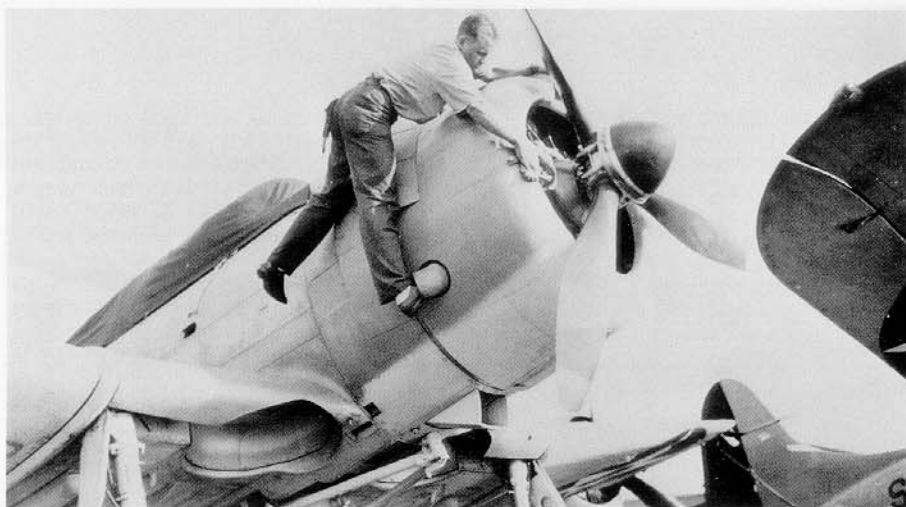

As the Navy took stock of its new situation in early 1942, it was obvious that any offensive action would have to come from the carrier force. The anger after Pearl Harbor made counterstrokes psychologically, if not militarily, important. The result was the "Revenge Raids" of early 1942. This deck crewman puts the finishing touches to S13 of VS-6 on the Enterprise during January of 1942 while enroute to the first of those raids. Complaints about "friendly" fire led to an order for the enlargement of all national insignia during January 1942. At the same time, the squadron number was ordered removed from aircraft codes. (NASM)

The first "Revenge Raid" sent Halsey's TF8 against the Kwajalein area on 1 February 1942. As Enterprise was retiring, five Bettys attacked. AMM Bruno Gaida jumped into the gunner's seat of S5 to add an additional .30 to the defense. One of the Bettys, possibly damaged, dived into the ship in probably the first kamikaze attack of the war. It grazed the Enterprise and cut the tail off of S5 not four feet from where Gaida sat firing. Gaida was unhurt. (USN/AW)

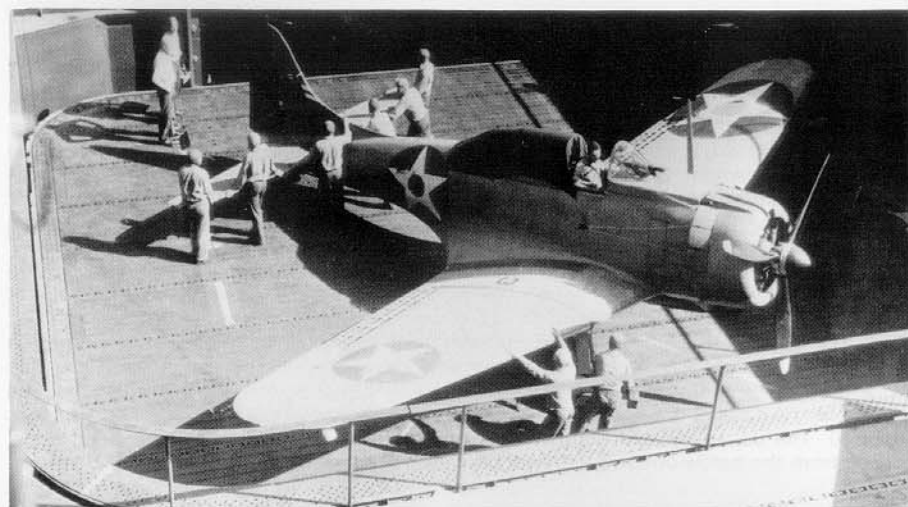

The next raid by Enterprise was the 24 February attack on Wake Island. B3 is being brought up on deck prior to the raid. The fuselage roundel and the old one on the port wing have been enlarged, but the new one on the starboard wing is much smaller. It was common practice to cover the tailstripes and canopy, and sometimes even the wing roundels, with canvas to reduce visibility from above. (USN/NARS)

The raid on Wake went as scheduled, though little was accomplished. Note the variety of national insignia size and placement. Some of VS-6's Dauntlesses, like S4 to the right, did without a fuselage roundel entirely. Obviously, the crew of the Enterprise had other things to worry about than consistency of markings. (USN/NARS)

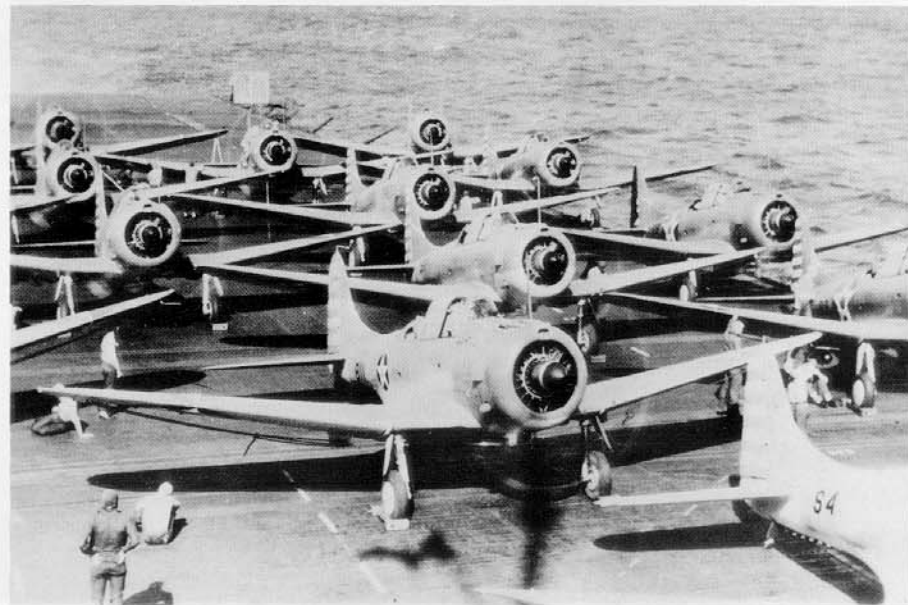

Battle of the Coral Sea

The Enterprise, Lexington and Yorktown spent the months immediately following the attack on Pearl Harbor carrying out hit and run raids on farflung Japanese positions. And while little real damage was done, it served to let the Japanese know that the US Navy was still in the Pacific and allowed the Slow But Deadly time to perfect its art. During the late spring of 1942 Allied intelligence determined that the Japanese were about to launch an attack to take Port Moresby in New Guinea; if successful, Australia would be jeopardized. During the first week in May Lexington and Enterprise moved to block the Japanese move on Port Moresby. During the ensuing engagement, which became known as the Battle of the Coral Sea, the Slow But Deadly was credited with sinking the small carrier Shoho on the 7th of May and disabling the fleet carrier Shokaku on the 8th. And although Lexington was lost, the battle was considered a tactical draw; the US lost more ships but the Japanese lost more planes and pilots. Strategically, however, the Battle of the Coral Sea could only be considered a major US victory — the Japanese advance in the Pacific was stopped. The Japanese, believing that both Yorktown and Lexington had been sunk, retired from the battle congratulating themselves on another defeat of the US Navy.

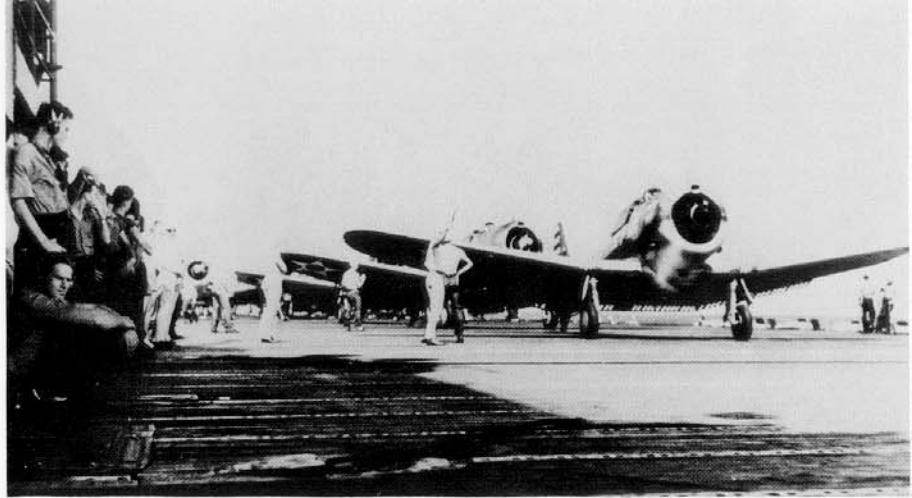

A deckload of Dauntlesses belonging to VS-6 onboard the Enterprise, just prior to the Battle of the Coral Sea. The aircraft of a carrier's scouting squadron were often kept on ready alert, with a parachute on the wing and a single 500lb bomb underneath, gassed up and ready to go. (NASM)

Yorktown took part in the early raids and then remained in the South Pacific with Lexington awaiting the next Japanese move. SBDs of VS-5 or VB-5 launch on a sweep, 18 April 1942. (NASM)



SBD-3

Reaching front line units during the late spring of 1942, the SBD-3 was originally ordered by the French who had witnessed the destructive power of the divebomber during the German invasion of Poland. In the event, all 174 machines ordered for the Aeronavale, plus an additional 410 SBD-3s were delivered to the US Navy (BuNo 4518 to 4691, 03185 to 03384, 06492 to 06701).

The SBD-3 variant finally brought the Dauntless up to combat standards. Self-sealing fuel tanks (all in the wings with a capacity of 260 gallons), crew armor, and an armored windscreen were introduced on the SBD-3. This additional equipment brought a further increase in weight and a further reduction in performance. In an attempt to prevent further performance degradation, lighter alclad replaced the dural skinning of earlier variants, and all floatation equipment was removed. The cowl mounted forward firing machine gun that was usually deleted on the SBD-2 was officially reinstated on the SBD-3; full firepower being considered more important than the weight savings. A new model of the Wright Cyclone, the R-1820-52, replaced the similarly powered R-1820-32 engine used on previous models, and the engine ventilation slot aft of the cowling was slightly enlarged with a fixed opening. The net result of these changes was an increase in empty weight, (5525 lbs to 6180 lbs) and a marginal drop in performance; "clean" top speed fell from 256 to 253 mph. During the course of SBD-3 production, a twin .30 caliber flexible machine gun replaced the single .30 caliber flexible machine gun in the radio operator's position. The new twin .30s were covered by a pair of sliding panels which replaced the earlier doors that had covered the single machine gun's stowage trough.

Engine Ventilation Slot

SBD-2

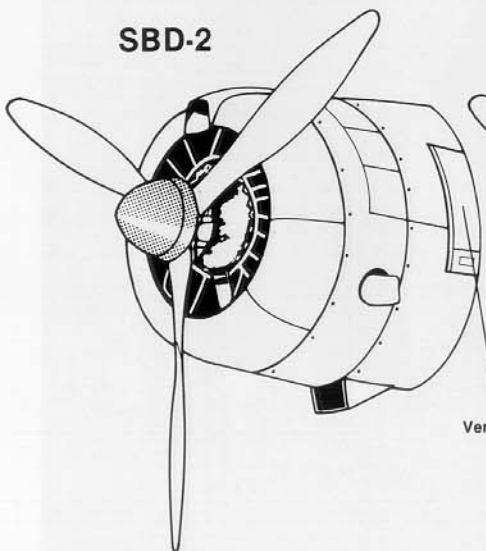

SBD-3

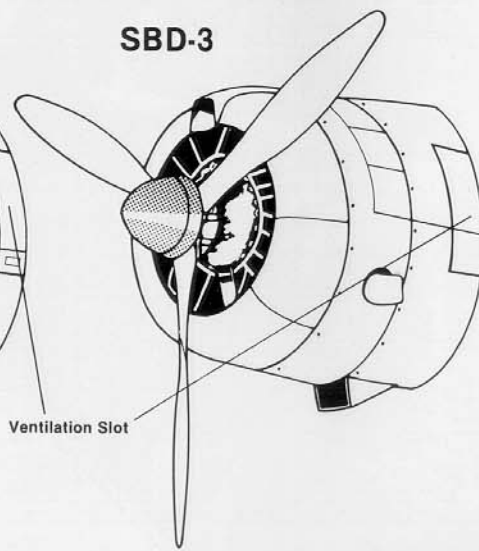

(Right Top, Right Center and Right Bottom) Three views of the first production SBD-3 (BuNo 4518) shortly after delivery, at NAS Anacosta, 28 March 1941. All changes from the SBD-2 were internal except for the enlarged ventilation slot aft of the cowling. (US/NARS & USN/AW)

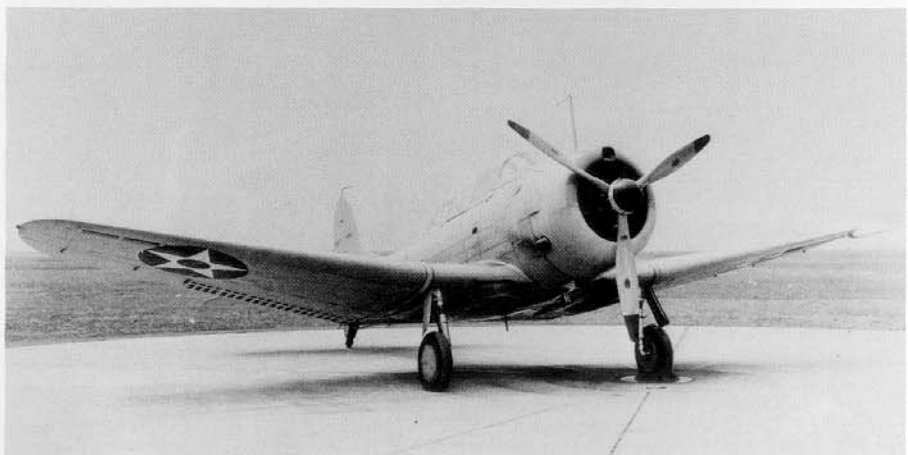
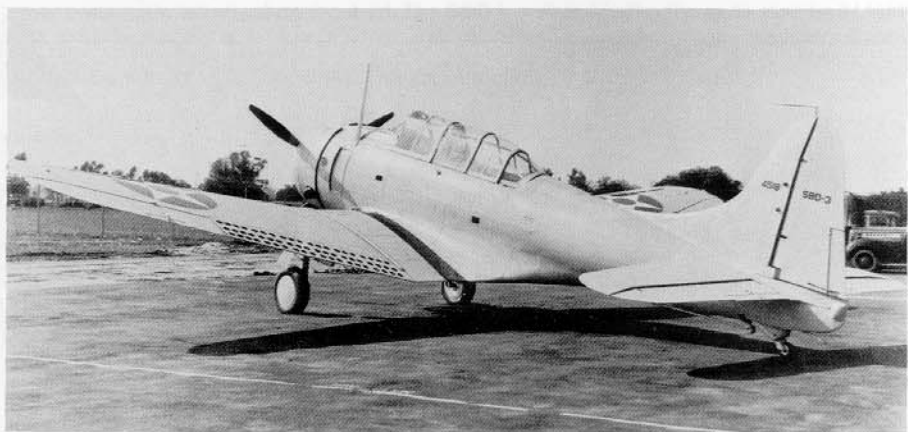
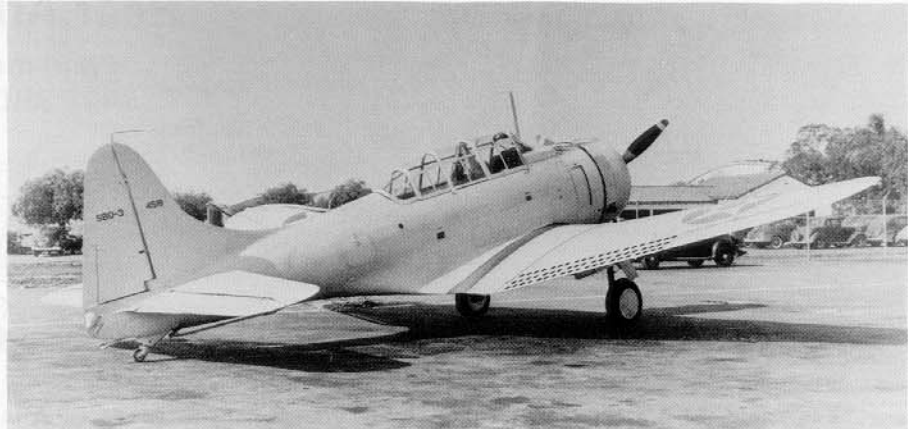

Single
.30
Calibre

SBD-2

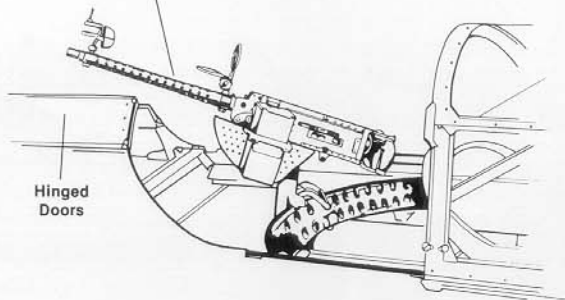

Rear Armament

Twin
.30
Calibre

**Field-modified
SBD-3**

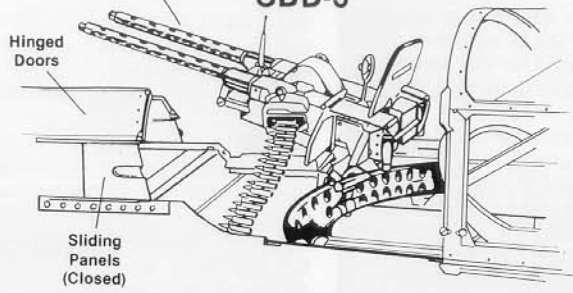

Twin
.30
Calibre

**Late
SBD-3**

Solid Panel
Replacing
Hinged Doors

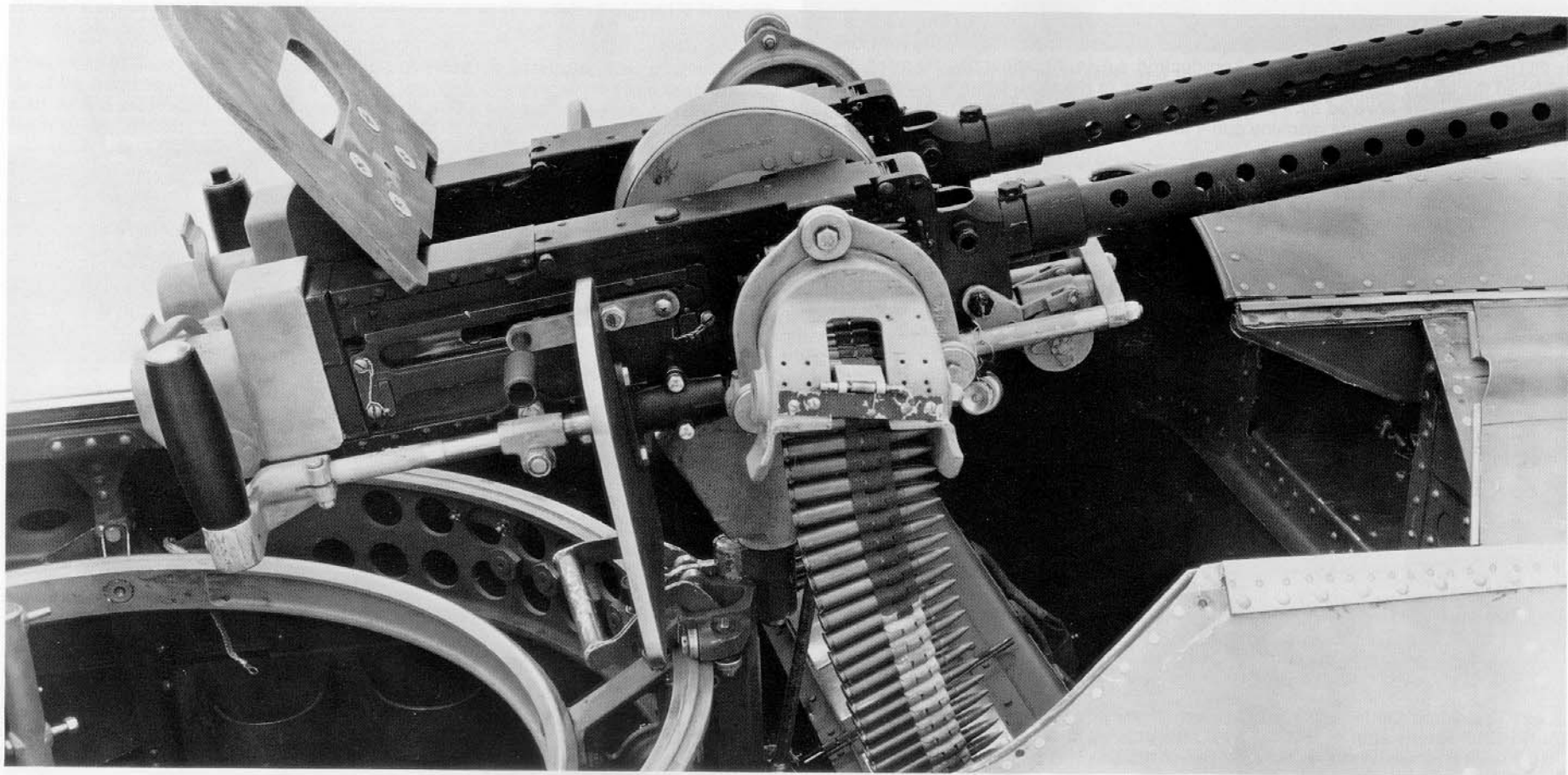
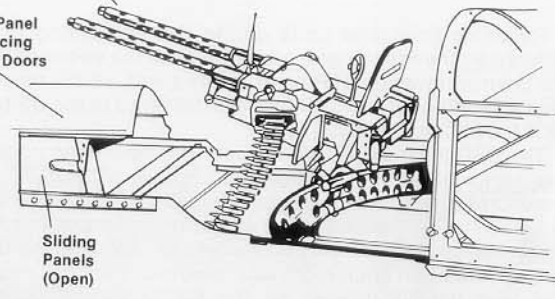

A-24 Banshee

The US Army Air Corps only belatedly took an active interest in divebombing, prompted mainly by the German success with their Stukas during the French Campaign. Lacking the time and expertise to develop their own design, the Army turned to existing Navy aircraft to fill its needs. Specifically, the Army Air Corps requested and received 168 SBD-3s from the Navy production order. Under the designation A-24-DE (sn 41-15748 to 15823 and 42-6682 to 6771), the Army version differed from the Dauntless, aside from electronics, only in minor features. The tailhook was deleted (though not the actuator fairing) and a larger pneumatic tailwheel replaced the Navy's solid rubber wheel. The A-24 was intended only as an interim divebomber, to be used mainly for training. Army Air Corps planned to use the Curtiss SB2C Helldiver (Curtiss A-25) as its main equipment.

During November of 1941 fifty-two A-24s were shipped by sea to the 27th Bombardment Group in the Philippines. However, when the Japanese attacked the Philippines, the A-24s were diverted to Australia where they were taken over by the 91st Bombardment Squadron. The 91st deployed to the Dutch East Indies where they operated the A-24 "with a spectacular lack of success". The 8th Bombardment Group, operating the A-24, from Australia, did no better. On 29 July 1942 seven A-24s on a bombing mission to Buna, were intercepted by Zeros, only one returned. The A-24 Banshee was subsequently withdrawn from frontline service.

The SBD-3 and A-24 were so similar that they alternated at the Douglas El Segundo assembly line. At the left is the tail of an Army A-24-DE (s/n 41-15762), to the right is a Navy SBD-3 (BuNo 4585). (Douglas via Harry Gann)

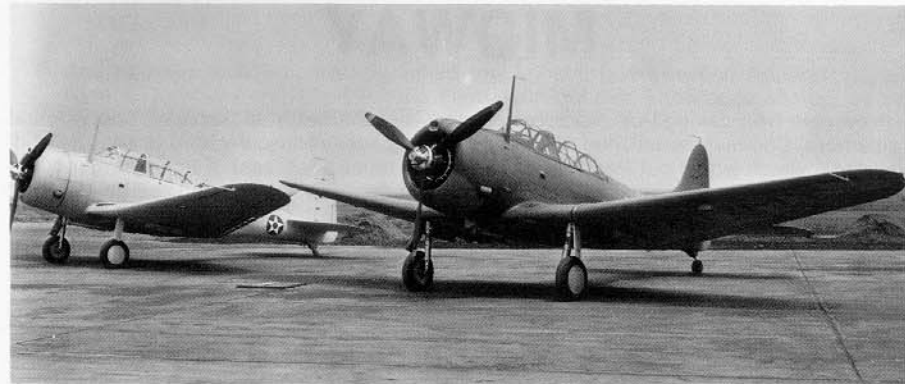

An Army A-24 Banshee and a Navy SBD-3 Dauntless side by side at El Segundo on 20 June 1941. The only noticeable differences between the two are the lack of a tailhook and the larger pneumatic tailwheel on the A-24. The SBD is painted in the the early standard Light Gray scheme while the A-24 is in Olive Drab over Neutral Gray. (Douglas via Harry Gann)

An A-24-DE (s/n 41-15780) in flight. The serial number is Yellow. (USAF)



Tail Wheel

SBD-3

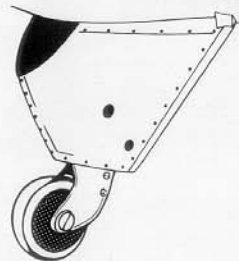

A-24

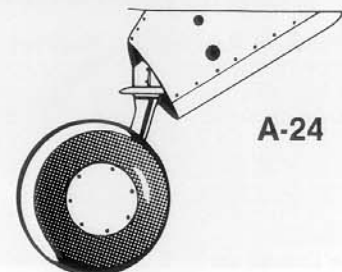

MIDWAY

Prevented from taking Port Moresby as a result of the Battle of the Coral Sea, Admiral Yamamoto, Commander-in-Chief of the Imperial Japanese Navy, decided to capture Midway Atoll, which would put Pearl Harbor only 1100 miles southeast. If Pearl Harbor could be made untenable, the US Navy would have little recourse except to pull back to the west coast of the United States. However, in making his decision to attack Midway and in formulating the battle plans, Admiral Yamamoto erroneously believed that both Lexington and Yorktown had been sunk in the Coral Sea engagement; and that both Hornet and Enterprise were too far away to oppose his forces. And his forces were formidable:

Northern (Diversionary) Force (Vice Admiral Hosogaya)

- Carrier Junyo
- Light Carrier Ryujo
- Seven Cruisers
- Twelve Destroyers

First Carrier Strike Force (Vice Admiral Nagumo)

- Carrier Akagi
- Carrier Kaga
- Carrier Soryu
- Carrier Hiryu

Midway Occupation Force (Vice Admiral Kondo)

- Light Carrier Zuiho
- Two Battleships
- Two Sea Plane Carriers
- Seven Cruisers
- Twenty-five Destroyers
- Twelve Transports (51,000 troops)

Main Force (Admiral Yamamoto)

- Light Carrier Hosho
- Seven Battleships
- Four Cruisers
- Twelve Destroyers

Advance Screening Force

- Eighteen Submarines

US forces available to counter this Japanese armada were:

Task Force 17 (Rear Admiral Fletcher)

- Carrier Yorktown
- Two Cruisers
- Five Destroyers

Task Force 16 (Rear Admiral Spruance)

- Carrier Enterprise
- Carrier Hornet
- Six Cruisers
- Nine Destroyers



When word of the Japanese move into the Coral Sea reached Nimitz, Enterprise and Hornet were rushed from Pearl Harbor. SBD-3s of Air Group 6 are being manhandled into position on the deck of the Enterprise on 3 May 1942 while enroute to the Coral Sea. (USN/NARS)

Enterprise missed the Coral Sea Fighting by one day and after unloading a Marine fighter squadron in New Caledonia, she carried out a fruitless search for the Japanese force before being ordered to EXPEDITE RETURN to Pearl Harbor. At the urging of pilots, who complained that 'friendly' gunners shot at anything Red, the rudder stripes and Red center of the national insignia have been painted out on some of the SBD-3s. (USN/NARS)

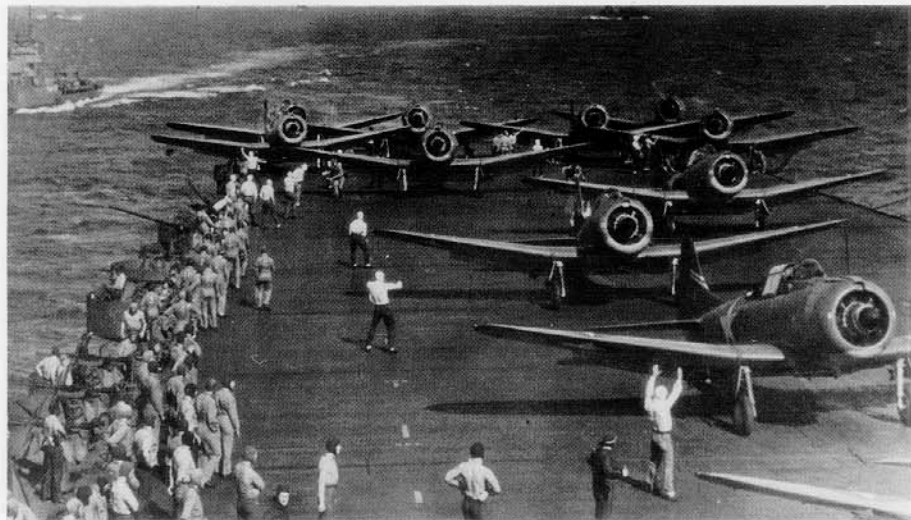

And perhaps most importantly, allied intelligence had provided Admiral Nimitz, Commander-in-chief Pacific Fleet, with detailed knowledge of the Japanese battle plans, including sailing times of ships.

Between 3 and 7 June the Japanese Northern Force carried out diversionary attacks in the Aleutians. Aware of the diversion, American forces did not respond, but continued to close on Midway.

At 0430 on the morning of 4 June, Vice Admiral Nagumo launched a strike on the Midway island defenses. Since only one land strike was anticipated, the second wave of aircraft were sitting on the carrier decks armed with torpedoes and armor piercing bombs to ward off any naval response to the air attack. However, US land based planes rose from Midway to attack both the bombers and the carrier force, and while no damage was done, it forced the strike commander to call for a second strike on Midway, thereby starting a chain of events that would lead to disaster for the Japanese. Admiral Nagumo ordered the armorers to begin the laborious hour long task of rearming the second wave aircraft with high explosive and fragmentation bombs for a second strike on Midway. Half way through the rearming, at 0728, Nagumo received word that a US force of ten ships had been sighted. No mention of an aircraft carrier. At 0758 the report came in that the US force was made up of five cruisers and five destroyers. Almost immediately Nagumo's carriers came under attack from Midway based aircraft, slowing down the final rearmament. The land based aircraft did no damage but it did force the carriers to send up all their Zeros to repel the attack.

At 0820 Nagumo received the message that there "appears to be a carrier" with the US force. A strike on the US carrier would require the Japanese armorers to begin the process all over again — removing the high explosive and fragmentation land bombs and then rearm the bombers with torpedoes and armor piercing bombs. A strike on the

An Dauntless of VS-5 (formerly VB-3), prepares to launch from Yorktown on 4 June 1942. VB-3, Saratoga's bombing squadron, in order to make good the heavy losses sustained at Coral Sea, moved to Yorktown just prior to the Battle of Midway. VB-3 a bomber squadron was designated Scouting Squadron Five (VS-5) to avoid the confusion of having two bombing squadrons onboard. (USN/NARS)



This SBD-3 of VB-6 has just trapped on board Enterprise, 15 May 1942. The painting out of the Red markings on this aircraft preceded the official order to do so, which was not ordered until 20 May. By the Battle of Midway the SBD-3 had almost completely replaced the SBD-2 on the carrier decks. (USN/NARS)

The gunner climbs out of this early SBD-3 while the pilot makes final notes on his chart before getting out. The deck crew is already clambering onto the wings to refuel the Dauntless. Note the double doors covering the trough for the gunner's single .30 caliber machine gun, Enterprise, 31 May 1942. (USN/NARS)

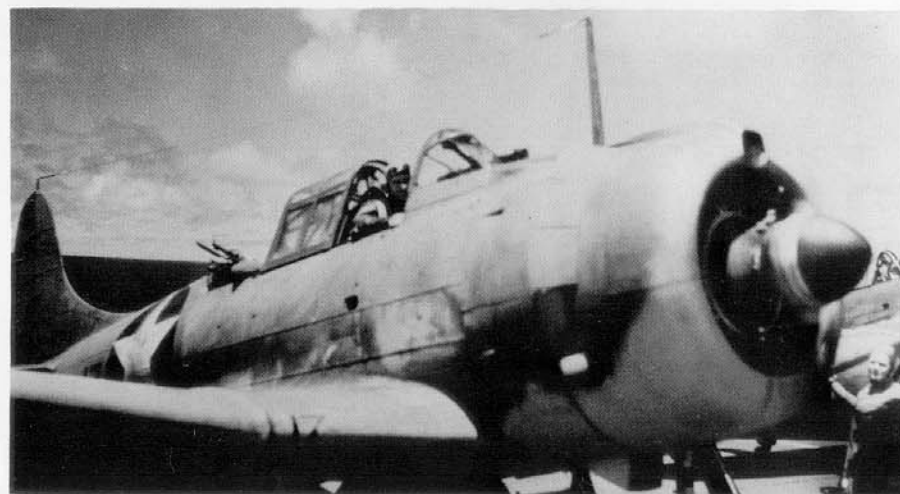
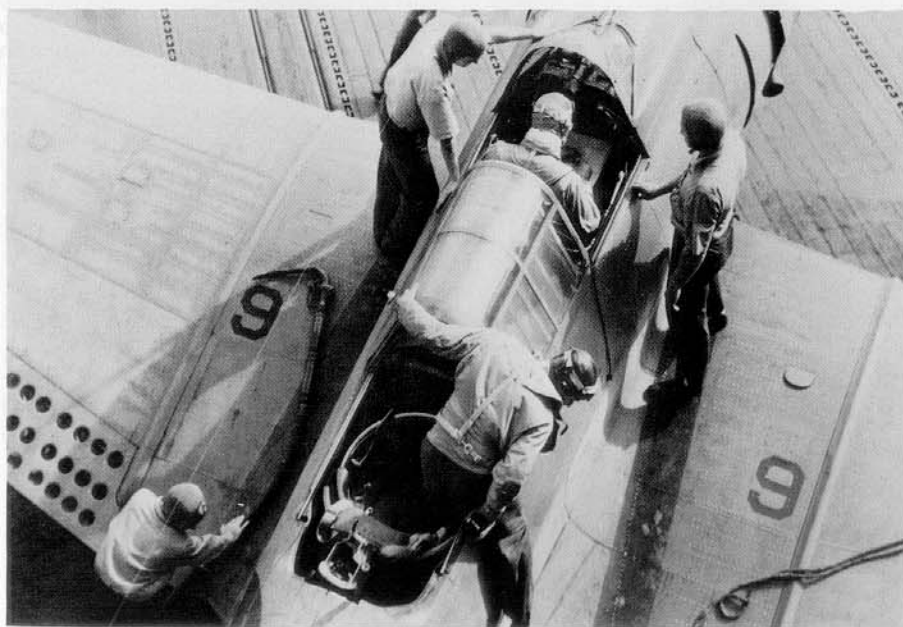

American carrier would need fighter cover, but the Zeros needed to be rearmed and refueled after having repelled the land based attack; and at 0830 the Midway strike aircraft would be returning — fuel nearly exhausted — needing immediate recovery. Nagumo decided to postpone preparing the strike aircraft until after recovery of the Midway strike force, he did take the precaution of changing course by 90 degrees.

At 0752 strikes had been launched against Nagumo's carriers from both the Enterprise and Hornet, and at 0900 the Yorktown launched its strike force at the Japanese carriers. Each strike force was made up of SBD Dauntless divebombers, TBD Devastator torpedo bombers and F4F Wildcat fighters. Because of Nagumo's change in course, the SBDs off the Hornet missed finding the Japanese carriers and had to turn back. By 0930, of the eighty-five SBDs launched, only fifty were still in the air searching for Nagumo's carriers. Between 0918 and 1010 the three Devastator torpedo squadrons found and attacked the carriers. Without fighter cover the TBDs were slaughtered by the defending fighters and flak. Of the forty-one torpedo bombers launched, only four returned. Nagumo, pleased with his defenses, continued with the rearming of his strike aircraft. This was completed at 1025.

As the Japanese carriers, their decks packed with armed and fueled aircraft ready to take off, dodged the last TBDs, fifty SBD Dauntless divebombers arrived overhead. Unopposed by fighters, that had been pulled down to water level by the torpedo bomber attacks, the lined up Dauntlesses peeled off, one after the other in near vertical dives. When the Dauntlesses pulled out of their dives, the Akagi, the Kaga, and the Soryu were burning hulks. It was 1026.

The Hiryu, cruising separately and undamaged, launched her strike as planned, hitting the Yorktown repeatedly between 1200 and 1430 hours. The Yorktown had to be abandoned at 1500. At the same time, strikes were being carried out against the Hiryu by Dauntlesses from the Enterprise, including fourteen "orphans" from the Yorktown, leaving the Japanese burning out of control at 1700. The Hiryu was scuttled the next day.

Within a few minutes the Slow But Deadly had destroyed 47 percent of the Imperial Fleet's aircraft carrier tonnage, changed the course of the Pacific war, and won what many historians have claimed was one of the ten most important battles in world history.

B15 of VB-6 returns to Enterprise after attacking the Japanese carriers, 4 June 1942. Note the flak damage.(NASM)



After Midway, Enterprise returned to the South Pacific to support the upcoming Solomons campaign. This SBD-3 of VS-5 (originally VB-3 off Saratoga) carries the unusual markings of that unit, with the S on the tail and a large individual aircraft number on the fuselage, Tonga, 24 July 1942. Practice bomb dispensers are carried under the wings. (USN/NARS)

Saratoga, repaired too late to participate in the Midway engagement, is loading her new Air Group 3, on 6 June 1942. '74' is an SBD-3 of either VB-3 (the other 'half' of the Air Group temporarily assigned to the Yorktown) or the new VS-3. The landing assistance stripe on the tail is lower than usual. (USN/NARS)

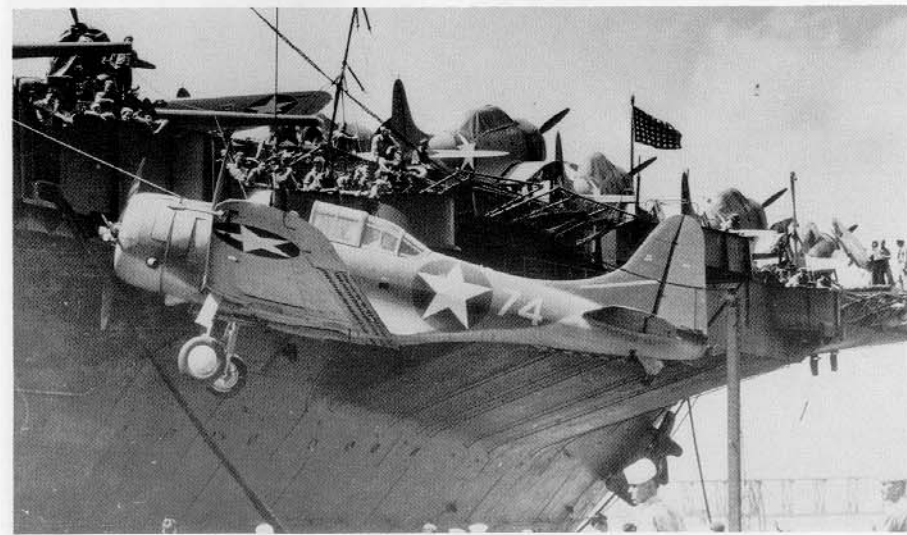

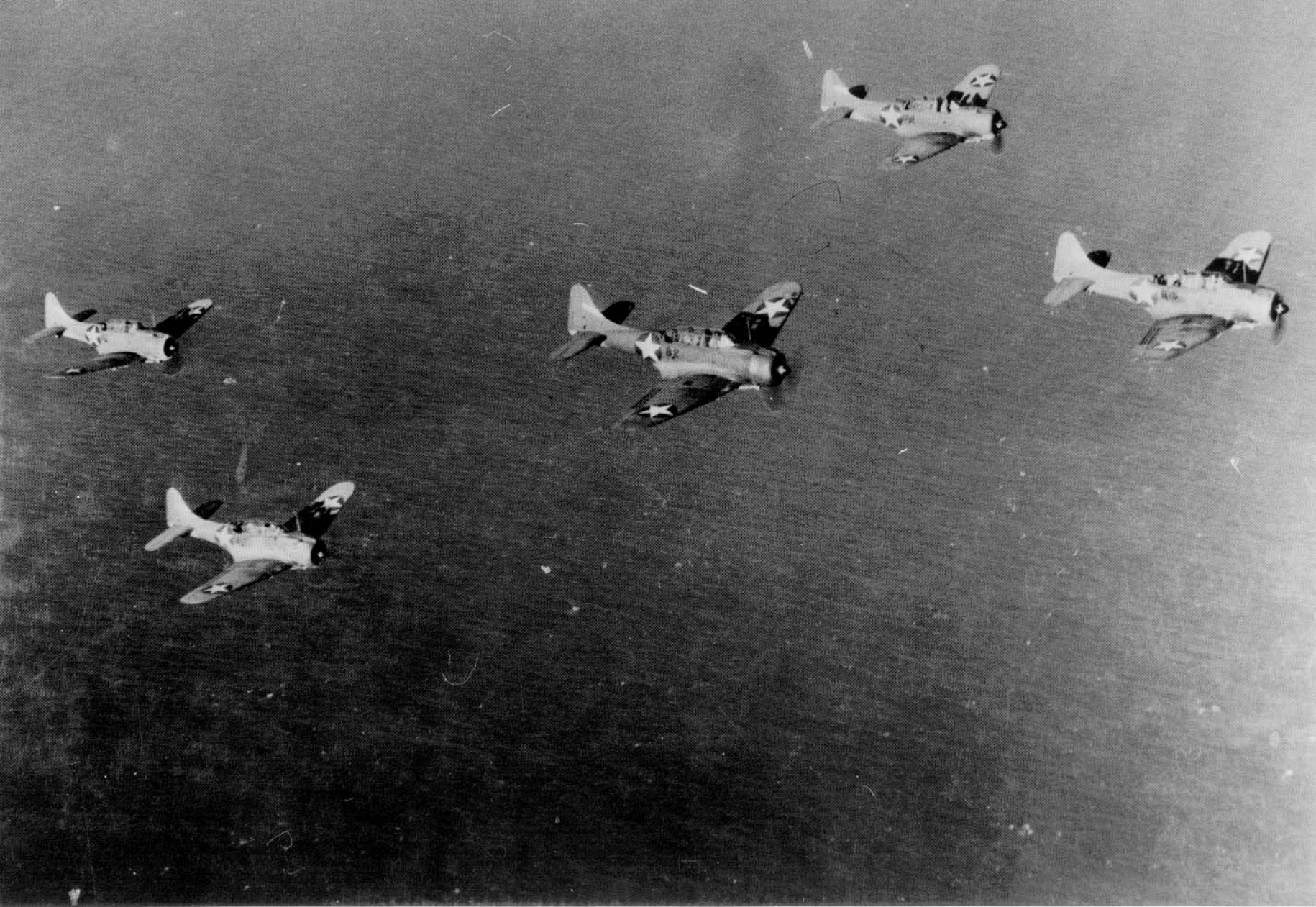

Five SBD-3s of VB-6 off Enterprise are seen near Tonga, 10 July 1942. The markings are essentially the same as those carried at Midway. (USN/NARS)



2-MB-1, an SBD-1 (BuNo 1597) flown by the Commanding Officer of VMB-2, Marine Air Group 11. Overall Silver paint with Chrome Yellow wings.



232-MB-2, a Marine Corps SBD-1 of VMSB-232 at Ewa, Hawaii, during the Japanese attack on Pearl Harbor. Scheme is overall Light Gray with White numerals.

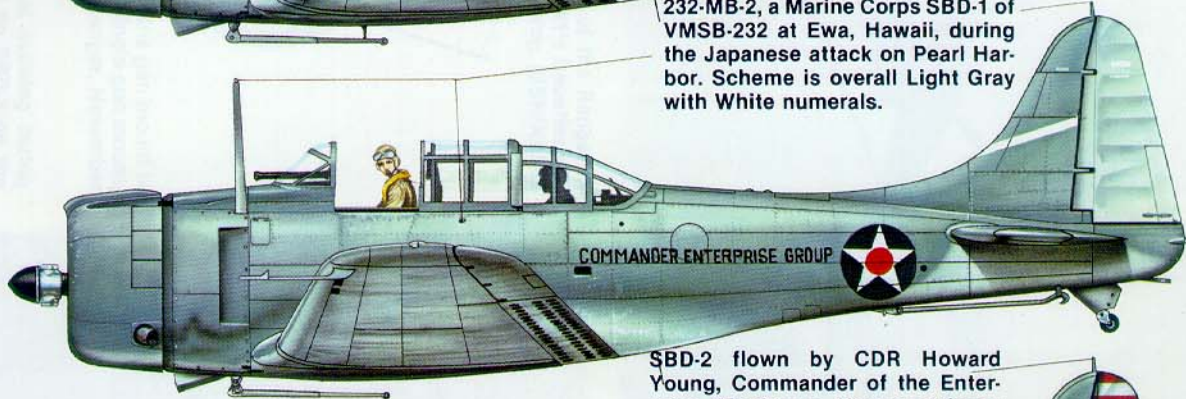

SBD-2 flown by CDR Howard Young, Commander of the Enterprise Air Group. Upper surfaces are Blue Gray over Light Gray lower surfaces. Red centered stars are carried in four locations. Pearl Harbor.



2-S-12, an SBD-3 (BuNo 4547) of VS-2 during the Spring of 1942, Battle of Coral Sea. The Red and White rudder stripes have been added and the Red centered stars are carried in all six positions.

S-9, an SBD-3 of VS-5 off the Yorktown during the Battle of Midway on June 1942. Sea Gray over Light Gray, the Red and White stripes have been removed from the rudder and the oversized stars no longer carry the Red center.

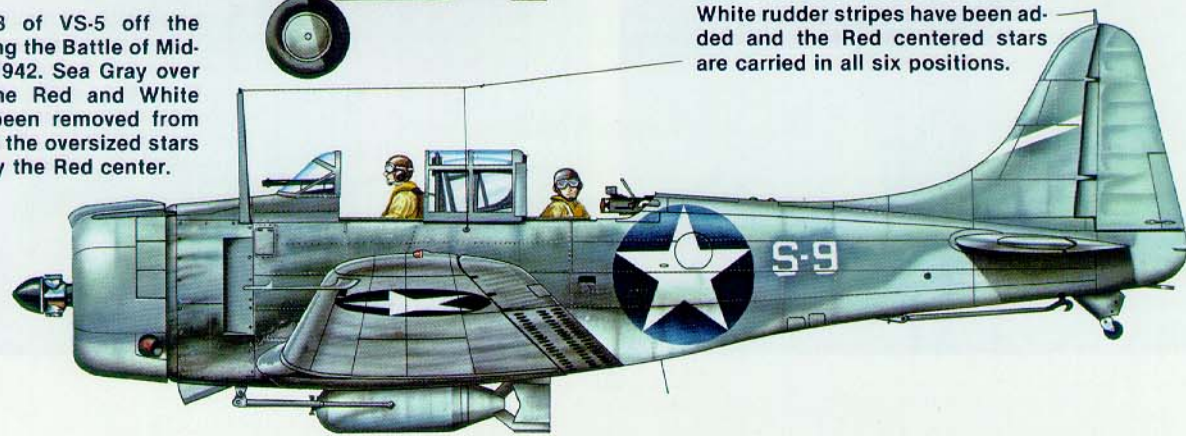



S8, an SBD-3 of VS-5 off the Enterprise (originally VB-3 off the Saratoga) at Tonga, 24 July 1942. VS-5 carried unusual markings — the S on the tail and large individual aircraft number on the fuselage.

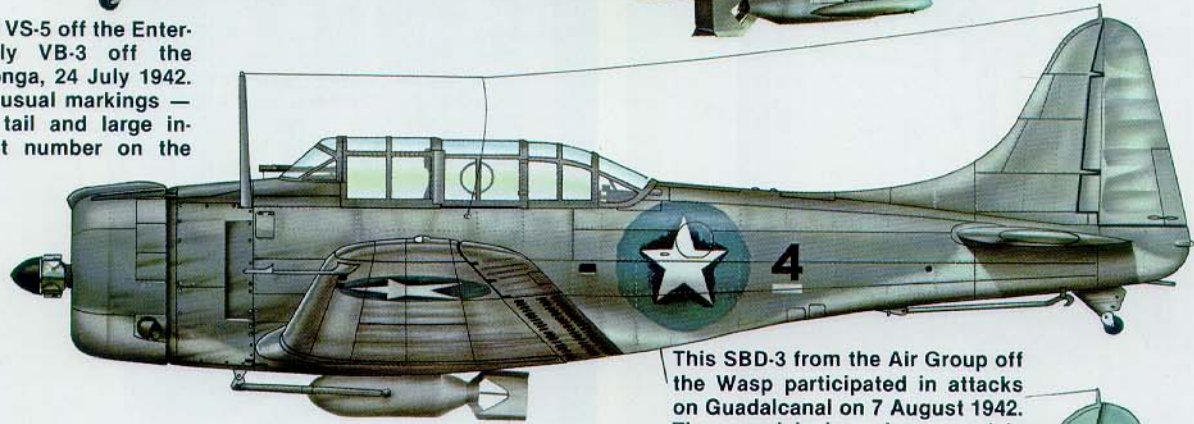

This SBD-3 from the Air Group off the Wasp participated in attacks on Guadalcanal on 7 August 1942. The roundels have been crudely enlarged by hand, while the stars have been left the original size.

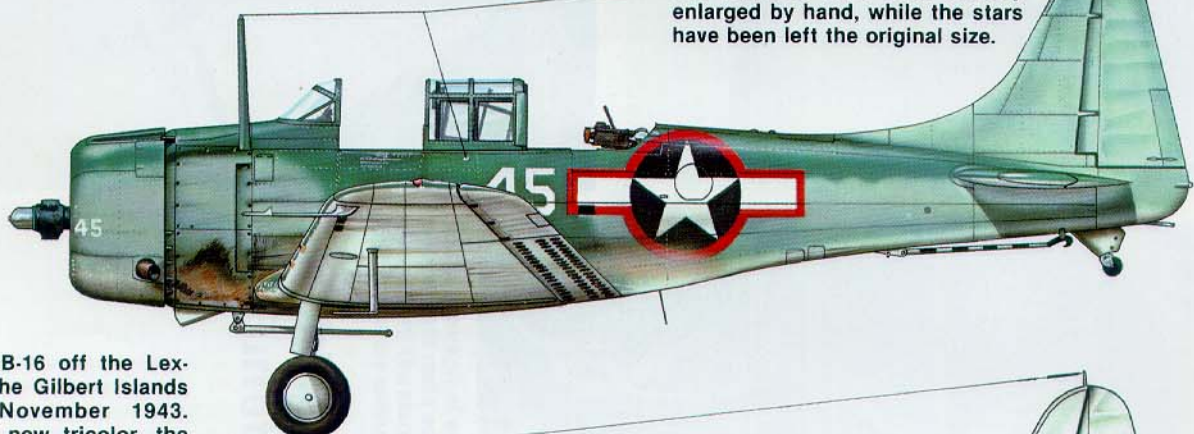

An SBD-5 of VB-16 off the Lexington during the Gilbert Islands fighting, 16 November 1943. Scheme is the new tricolor, the stars and bars carry the short lived Red surround. False gun ports have been painted on the leading edge of the wings.



S-5, an SBD-5 of VS-37 assigned to the Atlantic Fleet, February 1944, carried out anti-submarine warfare (ASW) duties. The Atlantic ASW scheme was Dark Gull Gray over Insignia White.



Number 11, an SBD-5 of VC-40 based at Piva Uncle strip, Bougainville. On 6 April 1944 this SBD, flown by Moe Johnson, participated in the raid on Talili Bay.

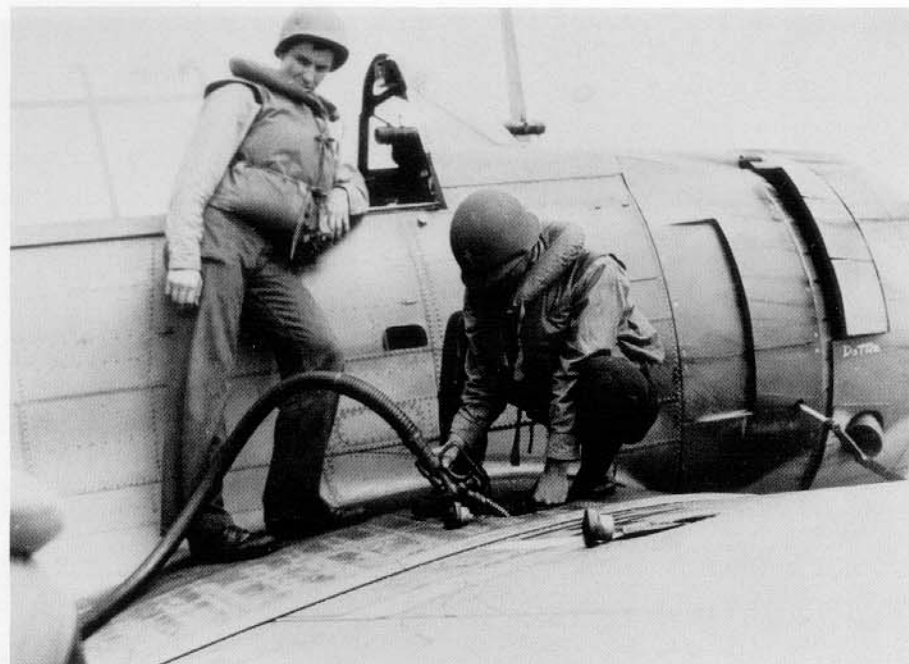
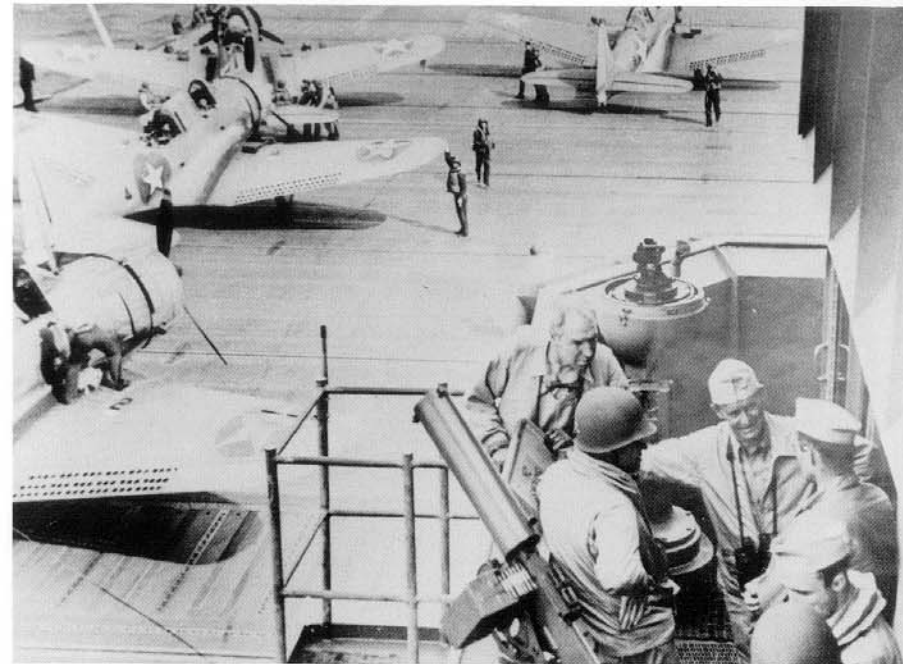

Dottie is being refueled on the Wasp prior to another strike at the Japanese positions on Guadalcanal. Note the White bar under the wing numeral and the starter crank inserted behind the cowling. (USN/NARS)



(Above Left) SBD-3s of the Wasp's VS-71 or VS-72 being prepared for a strike on the Japanese defenses on Guadalcanal during OPERATION WATCHTOWER on 7 August 1942. The fuselage roundel on 4 appears to have been rather crudely enlarged by increasing the size of the Blue circle without increasing the size of the star. A White bar is carried under the fuselage and wing numerals. (USN/NHC)

(Left) A number of Dauntless pilots claimed victories in air to air combat. The SBD was aerobatically nimble and the formidable .50 caliber forward firing machine guns could turn the tables on even a Zero when the Dauntless was in the hands of an experienced pilot. A third victory marking is being added under the windscreen of this SBD-3 aboard the Wasp, 28 August 1942. Dauntless pilots also used the same type victory marking to denote ships sunk. (USN/NARS)

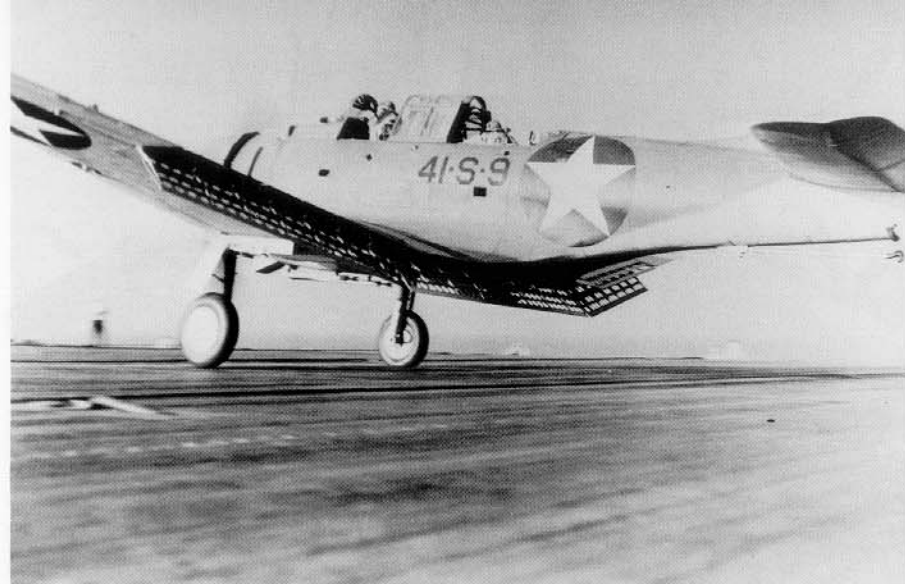
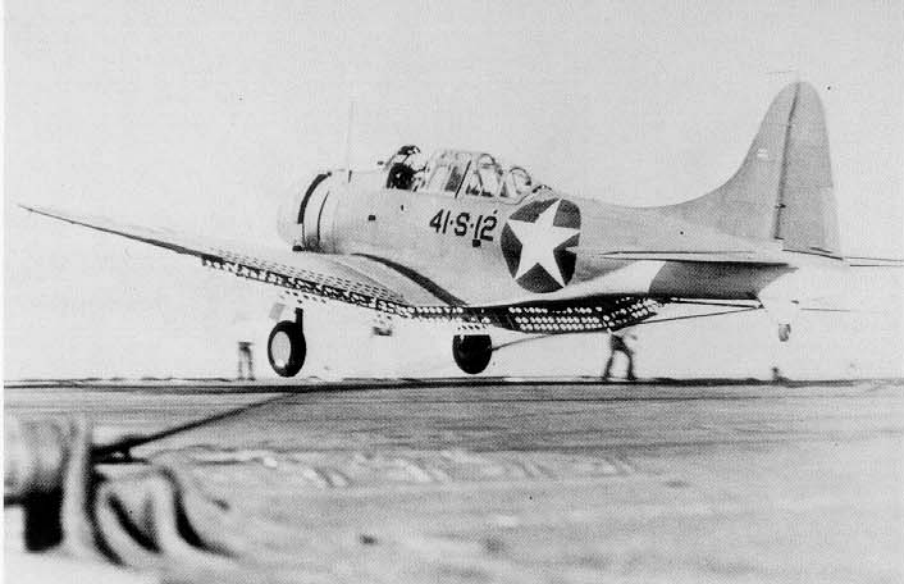

(Above Left and Above) A pair of VS-41 SBD-3s trapping on the Ranger in the Atlantic, 15 October 1942. Long after complete unit markings were banned in the Pacific, they were carried in the Atlantic theater. (USN/NARS)

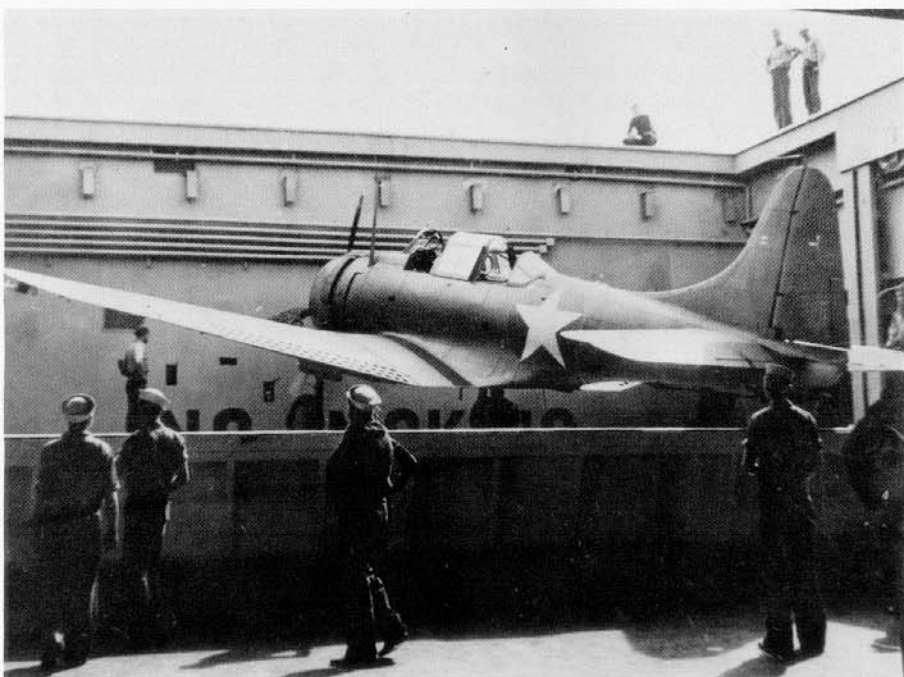

Flap-Dive Brakes

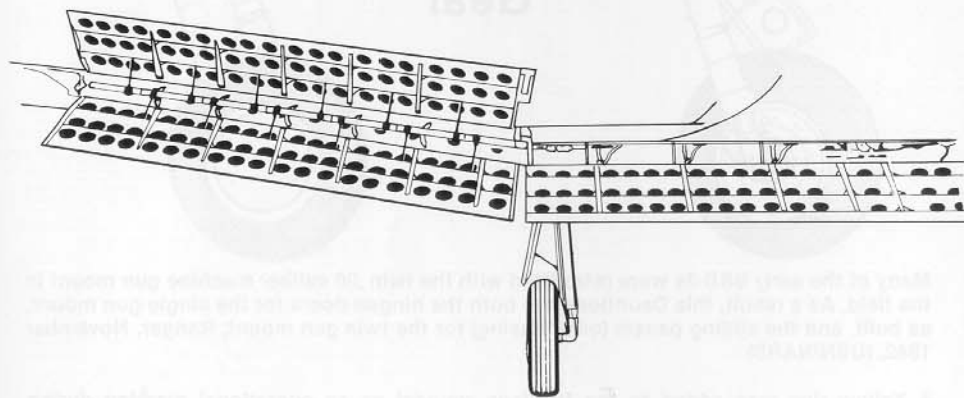

An SBD-3 on the elevator on Santee, enroute to the Torch landings in North Africa, November 1942. As the war progressed the wing span of the Dauntless became an increasing liability. (USN/NARS)

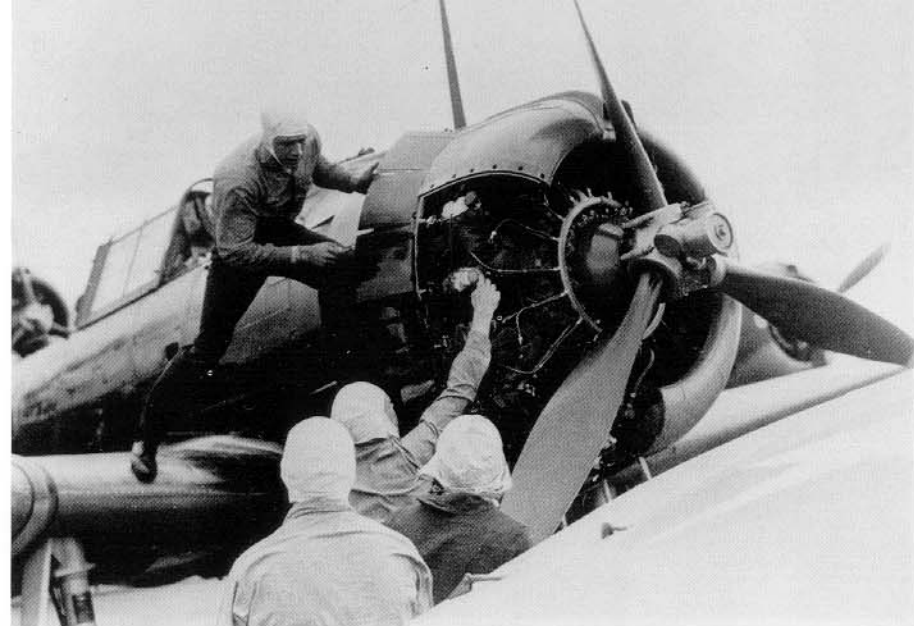

Mechanics work on the Wright R-1820-52 of this SBD-3 on the deck of the Ranger in November of 1942. The composite spinners were removed on all of VS-41's Dauntlesses, exposing the the hub and operating mechanism of the adjustable pitch prop. (USN/NARS)

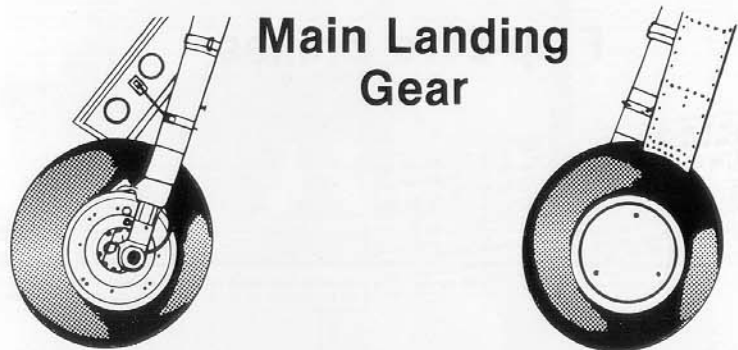

Many of the early SBD-3s were retrofitted with the twin .30 caliber machine gun mount in the field. As a result, this Dauntless has both the hinged doors for the single gun mount, as built, and the sliding panels (one missing) for the twin gun mount, Ranger, November 1942. (USN/NARS)

A Yellow ring was added to the fuselage roundel as an operational marking during OPERATION TORCH landings in North Africa. This aircraft, 41-S-16 an SBD-3 on the Ranger, originally carried its codes aft of the fuselage roundel. When the Yellow ring was added, the codes were moved forward of the roundel and the old codes were neatly painted out in Light Gray. (USN/NARS)



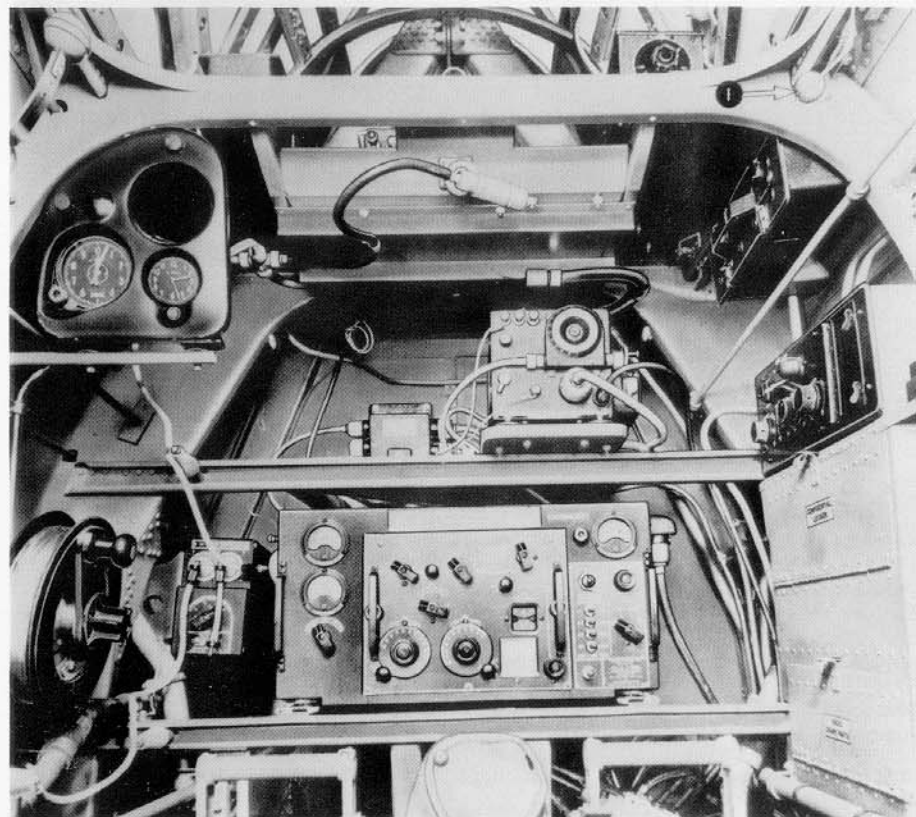
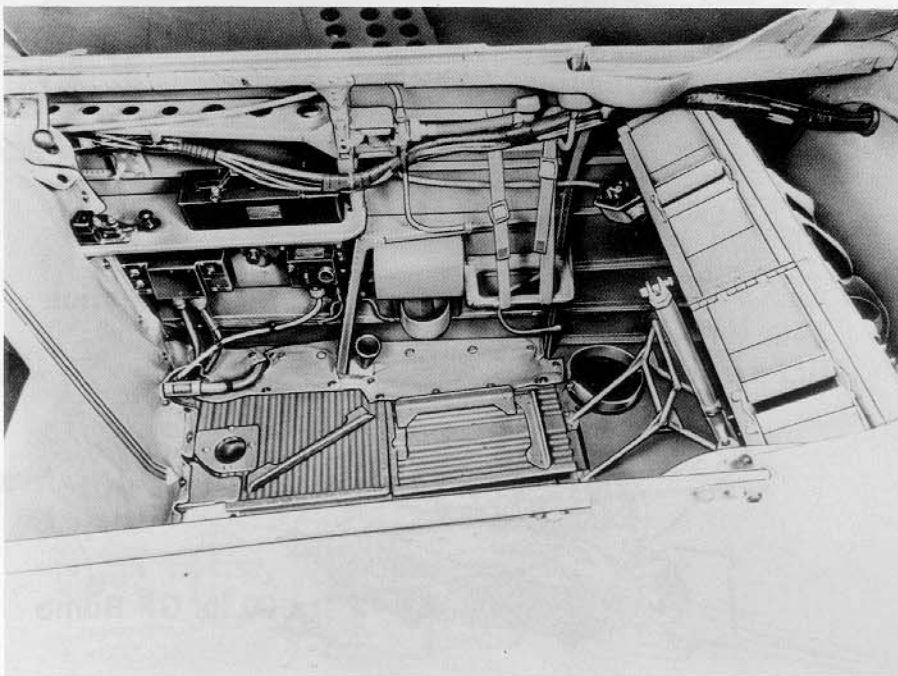
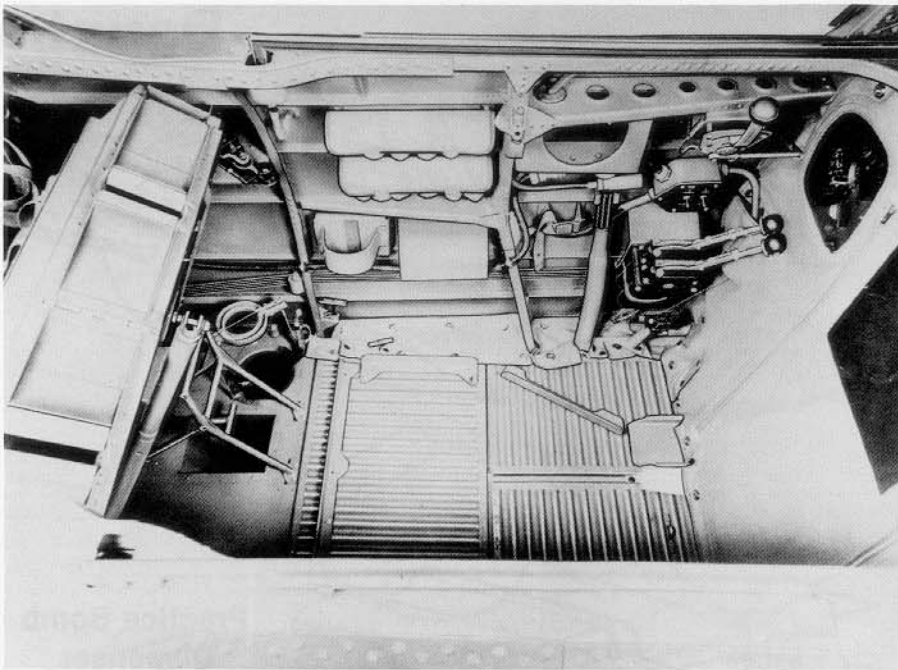

The rear cockpit of an SBD-3, minus the gun turret. (Above) Racks at the front of the rear cockpit held radio equipment. On later models the radar set was installed here as well. (Above Left) The starboard side of the rear cockpit. (Left) The port side of the rear cockpit. To the rear are ammo boxes for the twin .30 caliber gun mount. (USN/NARS)

Machinegun Turret

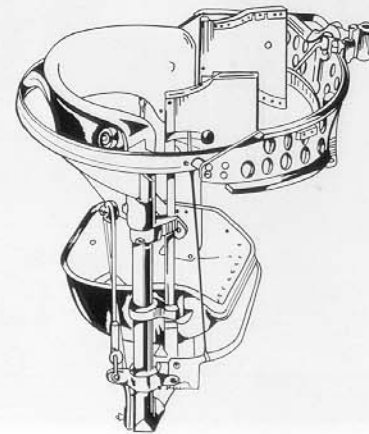

Dauntless

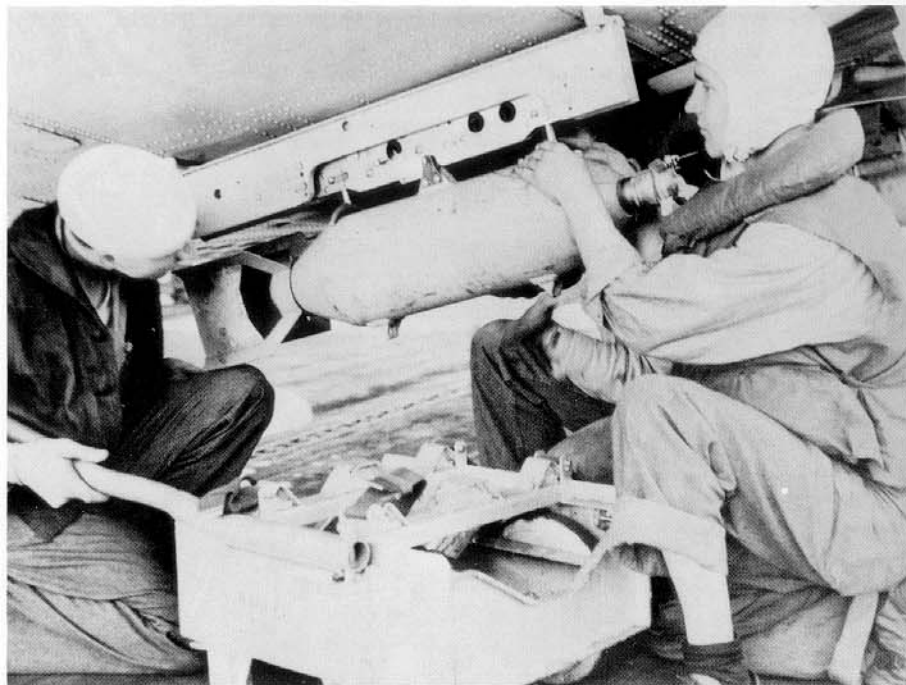

Armorer fuses a 100 lb General Purpose (GP) bomb on the underwing rack of an SBD-3, Ranger, November 1942. (USN/NARS)

A 500 lb GP bomb sits on its trolley, waiting to be loaded on the bomb crutch of an SBD-3, Ranger, November 1942. (USN/NARS)

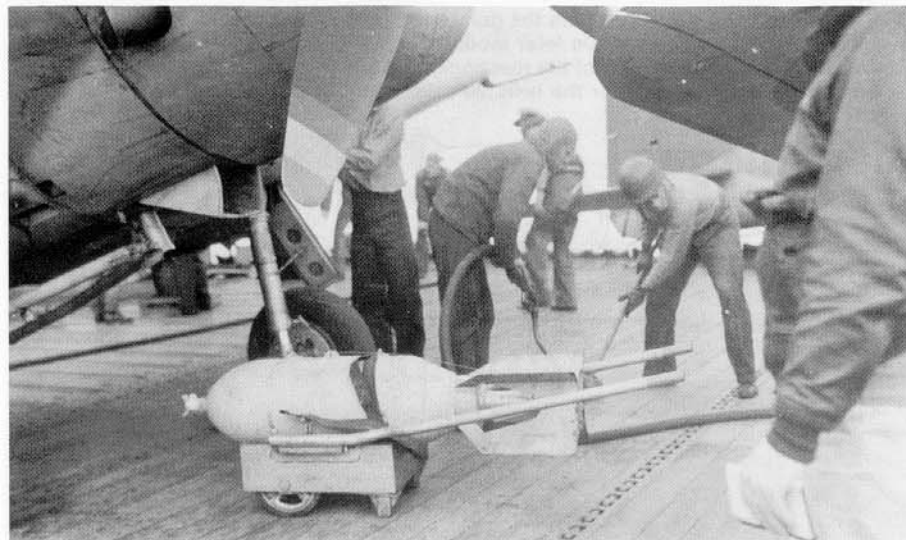

Twin .50 Calibre Pod

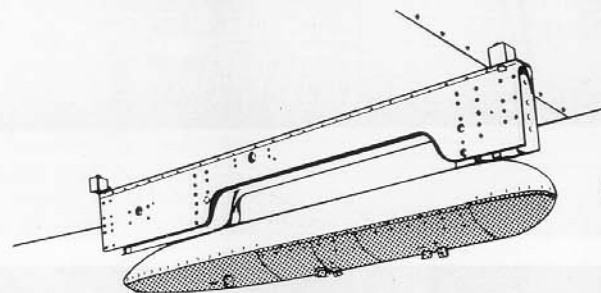
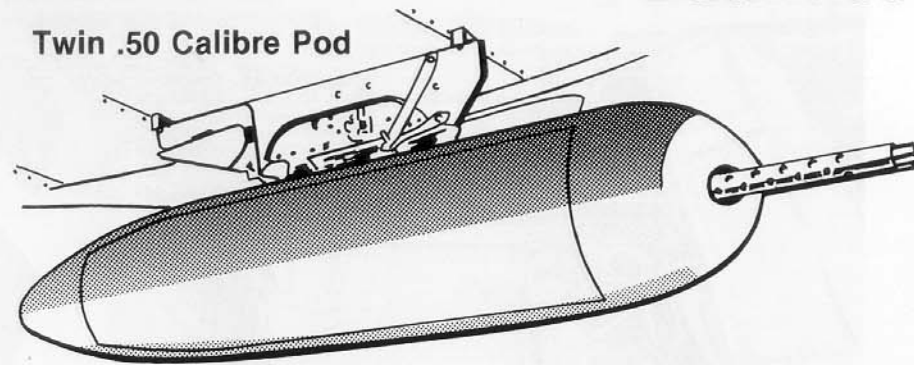

Practice Bomb
Dispenser

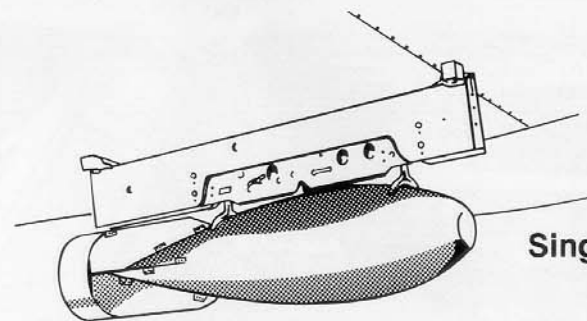

Single Practice
Bomb

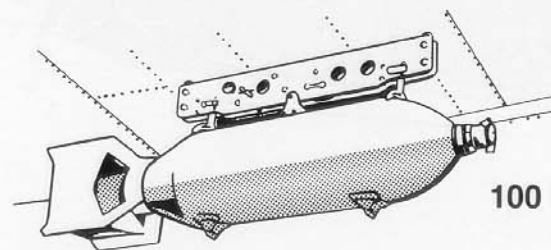

100 lb. GP Bomb

Ordnance

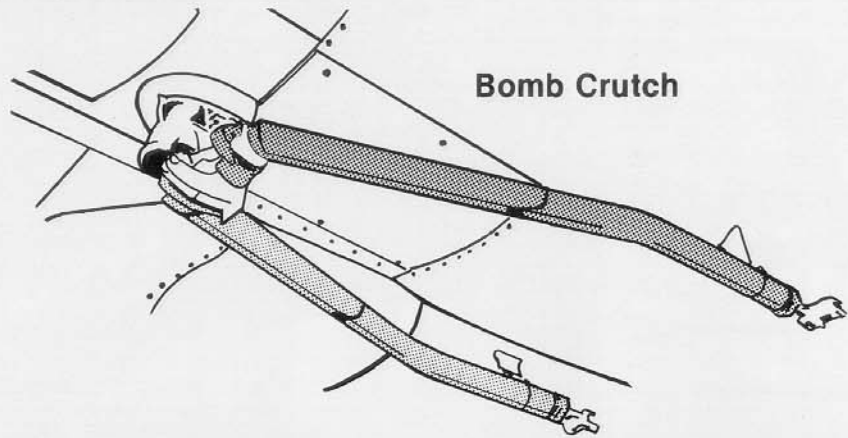

Bomb Crutch

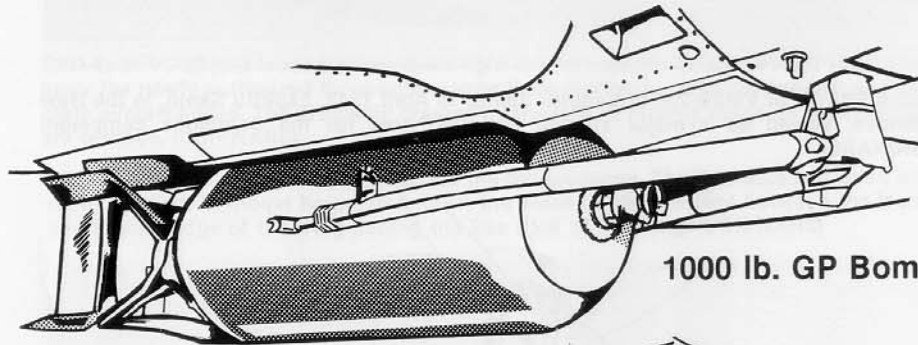

1000 lb. GP Bomb

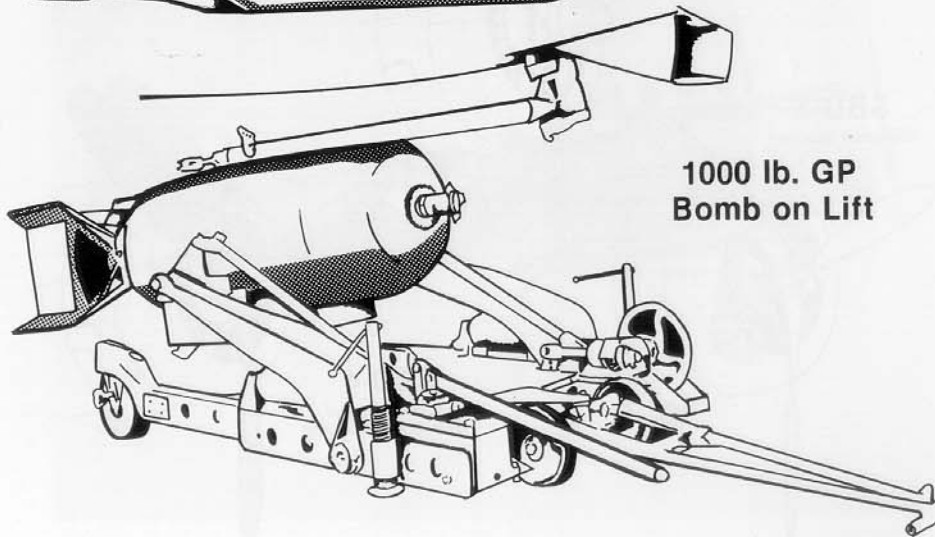

1000 lb. GP Bomb on Lift

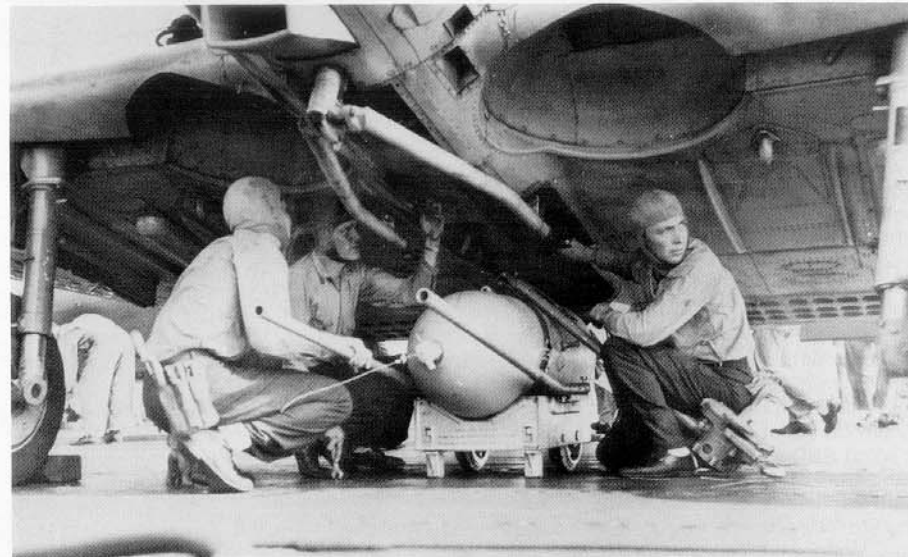

Deck crewmen on Enterprise (above) and Ranger (below) rig 1000 lb GP bombs on SBD-3s. Once the bomb is positioned, the armorers set the fuse and the bomb is hoisted with a handwinch (USN/NHC and USN/NARS)



SBD-4

The SBD-4, reaching frontline units during the closing days of 1942, differed from the SBD-3 only in minor details. The most significant change was internal, the electrical system was changed from a 12 volt system to a 24 volt system, allowing for the installation of additional radio navigation aids and airborne radar. However, due to a shortage of equipment early SBD-4s were not factory equipped with ASB. Most radar equipped SBD-4s were retrofitted at field modification centers; only toward the end of the production run were there enough radar sets available for factory installation. Dauntlesses equipped with radar carried a Yagi antenna under each wing. The earlier adjustable pitch propeller and spinner was replaced by a spinnerless Hamilton-Standard Hydromatic constant speed propeller. An electric fuel pump as well as an electric emergency fuel pump were installed. With the introduction of the SBD-4, the production tempo picked up, with 780 machines (BuNo 06702 to 06991 and 10317 to 10806) being delivered from October 1942 through April 1943. The Army received 170 modified machines (sn 42-6772 to 6831 and 42-60772) under the designation A-24A. Most were destined to be used in the training role.

Most SBD-4s were delivered to Marine or land based Navy squadrons, the non-folding wing span of the Dauntless having become an increasing liability as the new small decked light and escort carriers began to go into service. The only light carrier to accommodate the Slow But Deadly was the Independence; VB-22 flew SBD-4s off her decks, against Marcus, Wake and Tarawa during late 1943, before being replaced by folding wing TBM Avengers. SBD-4s saw extensive action in the South Pacific during the early stages of the Solomons campaign.

A VS-41 SBD-4 being serviced on the deck of the Ranger, November 1942. The only external difference from the SBD-3 was the spinnerless prop. (USN/NARS)

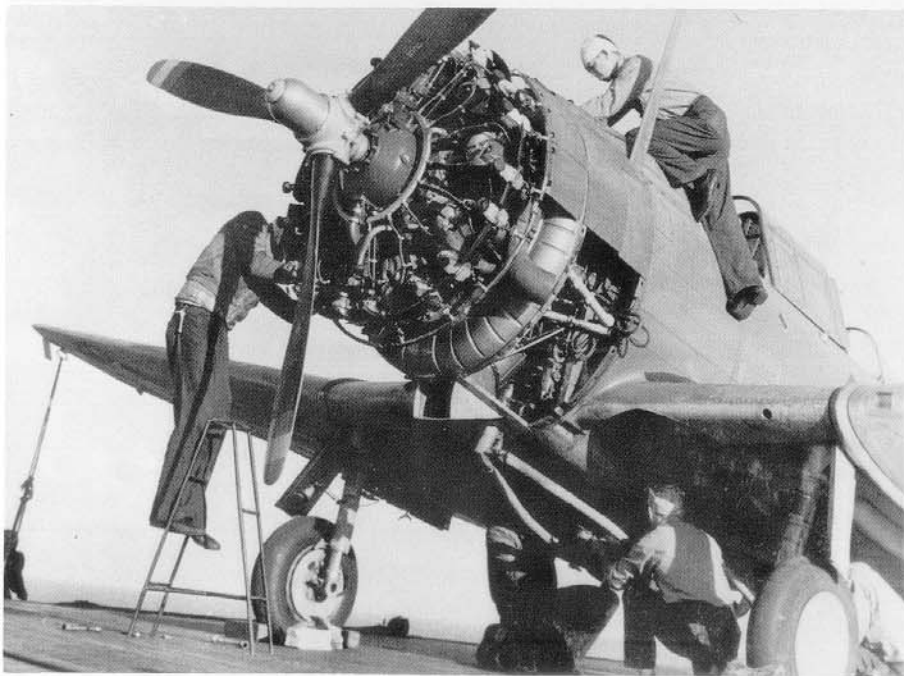

Marine SBD-4s of VMSB-234 at Espiritu Santo, 18 April 1943. Espiritu Santo, in the New Hebrides, served as a major staging and rest area for the Solomons campaign. (USN/NARS)

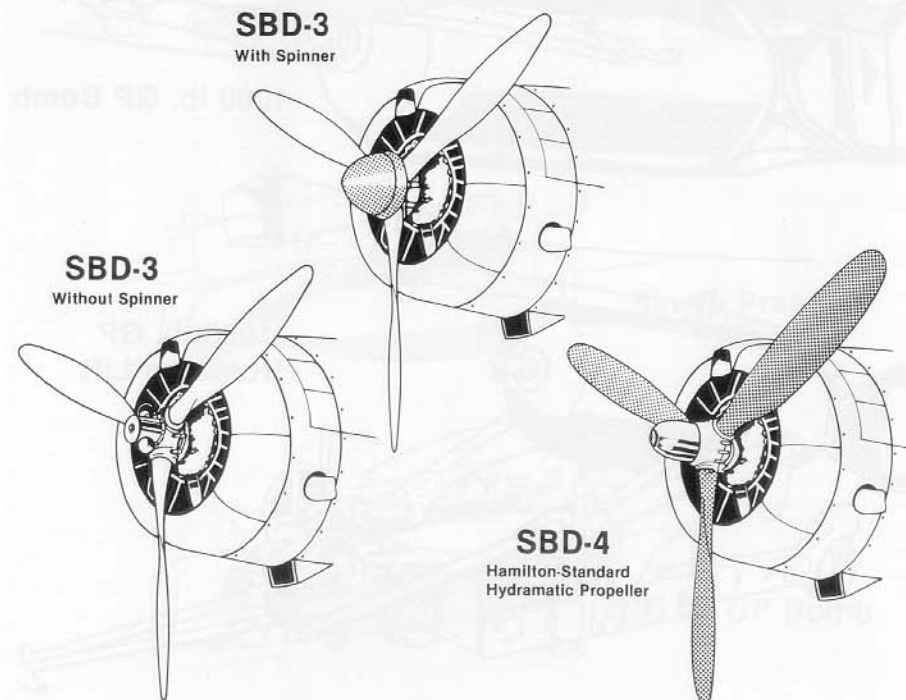

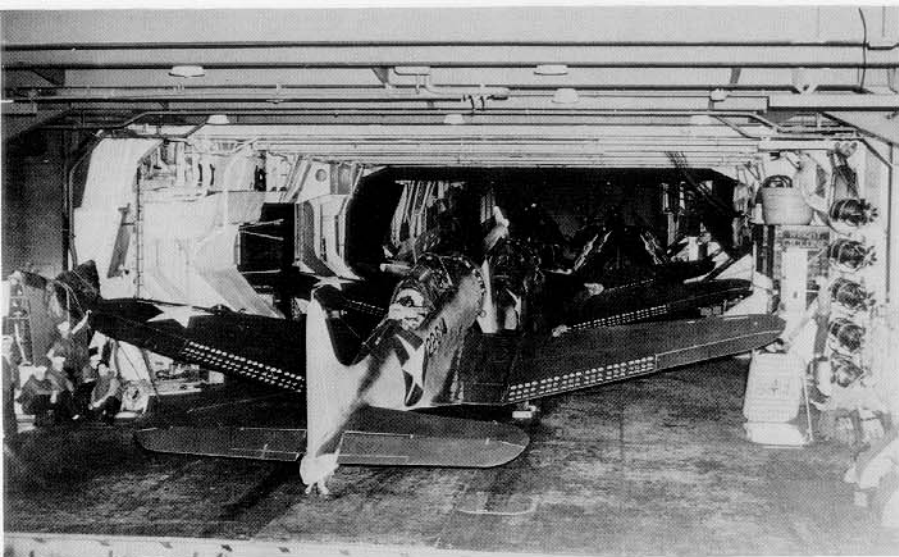

SBD-4s of VC-22 just loaded onboard the light carrier Independence, 14 April 1943. These carry the newly authorized three-color camouflage (not quite correctly applied) and complete aircraft codes. The problems created by the lack of folding wings on the Dauntless are obvious. (USN/NARS)

22-C-13 with its hook down, approaches the Independence. The Sea Blue has been incorrectly applied. It should be painted down the sides of the fuselage between the leading and trailing edge of the wing joining the Sea Blue of the wing. (USN/NARS)

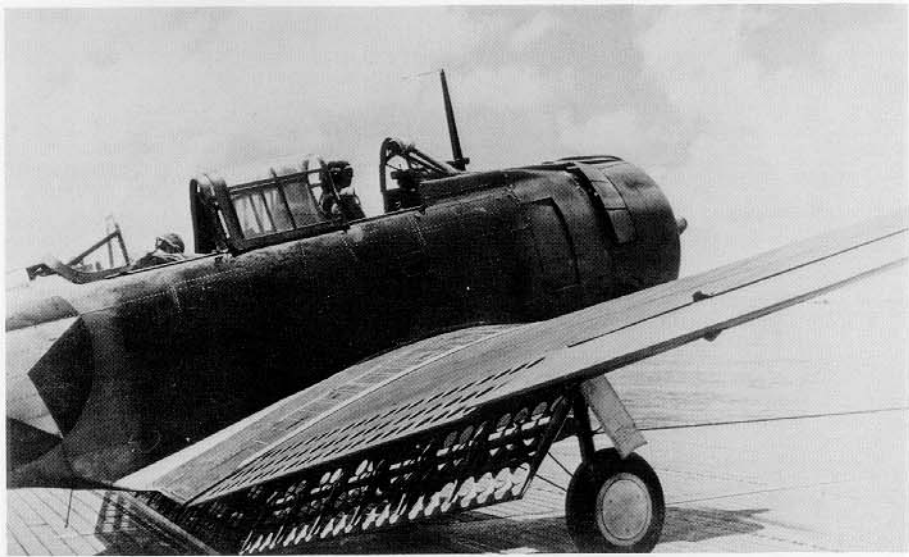

By the end of April 1943, a new patch of Sea Blue had been added to the sides of VC-22's SBD-4s to comply with regulations, which all but obscured the Black aircraft codes. (USN/NARS)

The solution was to reapply the codes in White over the Sea Blue on the fuselage sides. Since the Independence was nearly ready to sail for war, only the individual aircraft number was repainted on the aircraft, 30 April 1943. (USN/NARS)



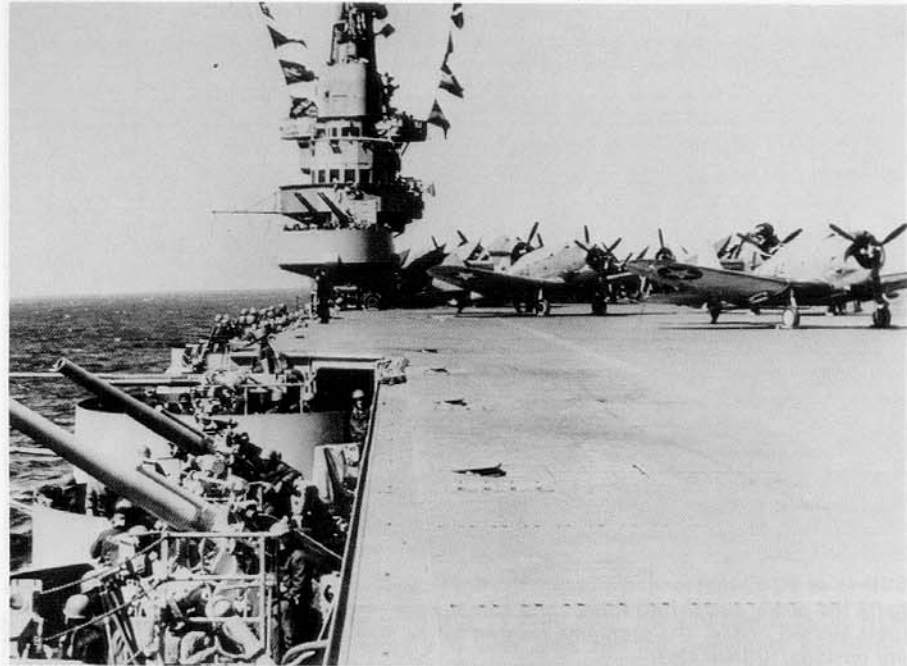
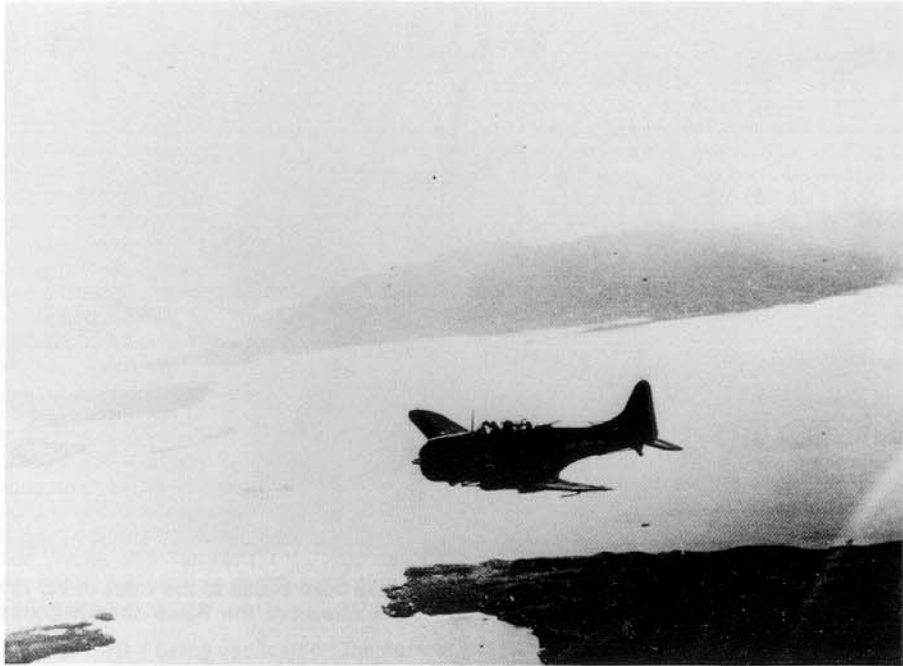

(Above) SBD-4s of VS-41 on the Ranger, 10 February 1944. The camouflage is still two-tone, since Sea Gray was considered more appropriate for Atlantic operations than Sea Blue. The fuselage roundel has had a bar added but those on the wings are still without bars. (USN/NARS)



(Above Left) The only offensive operation for the European based Ranger after the Torch landings was a raid on Norway in co-operation with the Royal Navy. For that raid only, VB-4 was embarked with additional SBD-4s. This Dauntless of VB-4 banks over Bodo harbor, 4 October 1943. Few targets were found and the raid was not repeated. (USN/NHC)

Mary Lou, an A-24A (s/n 42-6796) at Selma Field. This aircraft was originally camouflaged in Olive Drab over Neutral Gray with Medium Green splotches on the edges of the flying surfaces. The Olive Drab has faded badly and been crudely retouched on the tail. The serial number is on the cowling, a very unusual location, above a triangle of either Red or Black. (USAF)

SBD-5

The SBD-5 variant, brought the Dauntless a much needed, but hardly adequate increase in power, with the installation of a 1200 hp R-1820-60 Cyclone engine. However, due to an increase in equipment, top speed was increased by only 7 mph and cruise speed actually decreased. External changes included the deletion of the carburetor air intake scoop, reduction of cowl flaps to one on each side, and an enlargement and relocation aft of the engine ventilation slot. The archaic telescopic sight was finally replaced by a reflector sight. Wet points were provided on the wings for a pair of 58 gallon drop tanks which increased reconnaissance range to 1340 nautical miles. The SBD-5 became the main production variant with 2965 being produced (BuNo 10807 to 11066, 28059 to 29213, 35922 to 36421, 36433 to 36932, and 54050 to 54599) between February 1943 and April 1944. Douglas also produced 615 machines for the Army under the designation A-24B (sn 42-54285 to 54899). Sixty of the A-24Bs were later declared surplus by the Army; taken over by the Navy, they were eventually turned over to the Marines.

SBD-5s saw combat in large numbers, quickly replacing older models during the course of 1943. It was the SBD-5 that inventoried the fleet's attack squadrons when the fleet carriers resumed their raiding during the latter half of 1943. It had been planned that the SB2C Helldiver would be replacing the Dauntless during 1943, but delays in the Helldiver program caused the Slow But Deadly to remain at the forefront of the battle throughout 1943 and into 1944. During the course of 1944 the Curtiss SB2C Helldiver very quickly replaced the Slow But Deadly in fleet service. No longer able to operate from the decks of the carriers the Dauntless moved to land bases where it continued to give an account of itself at the expense of the enemy.

The SBD-5 prototype was an SBD-4 fitted with an uprated R-1830-60 Cyclone engine encased inside a smooth cowling with only one cowl flap and a longer, relocated aft ventilation slot. (USN/NARS)



Dauntlesses almost as far as the eye can see; SBD-5s on the assembly line at El Segundo. (NASM)

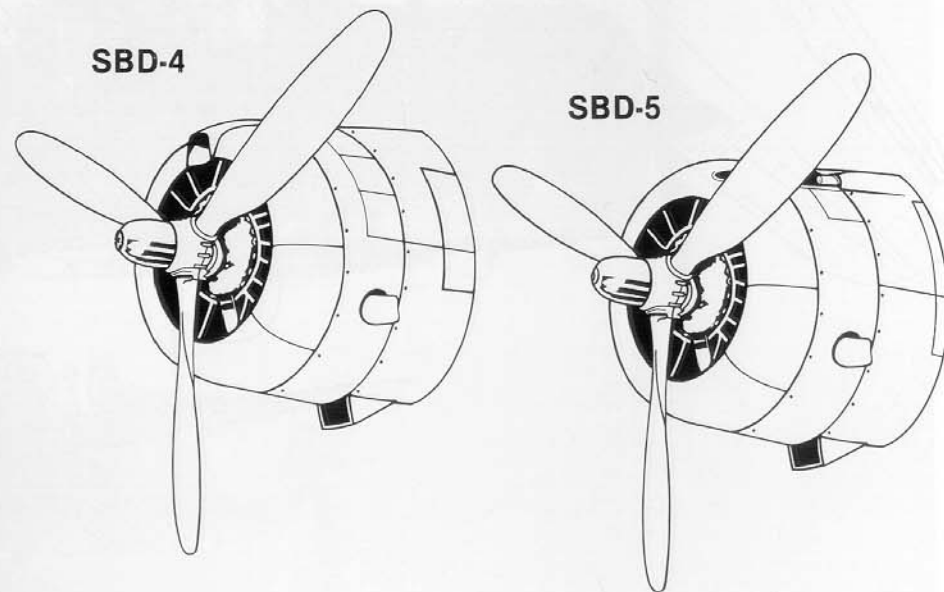

SBD-5

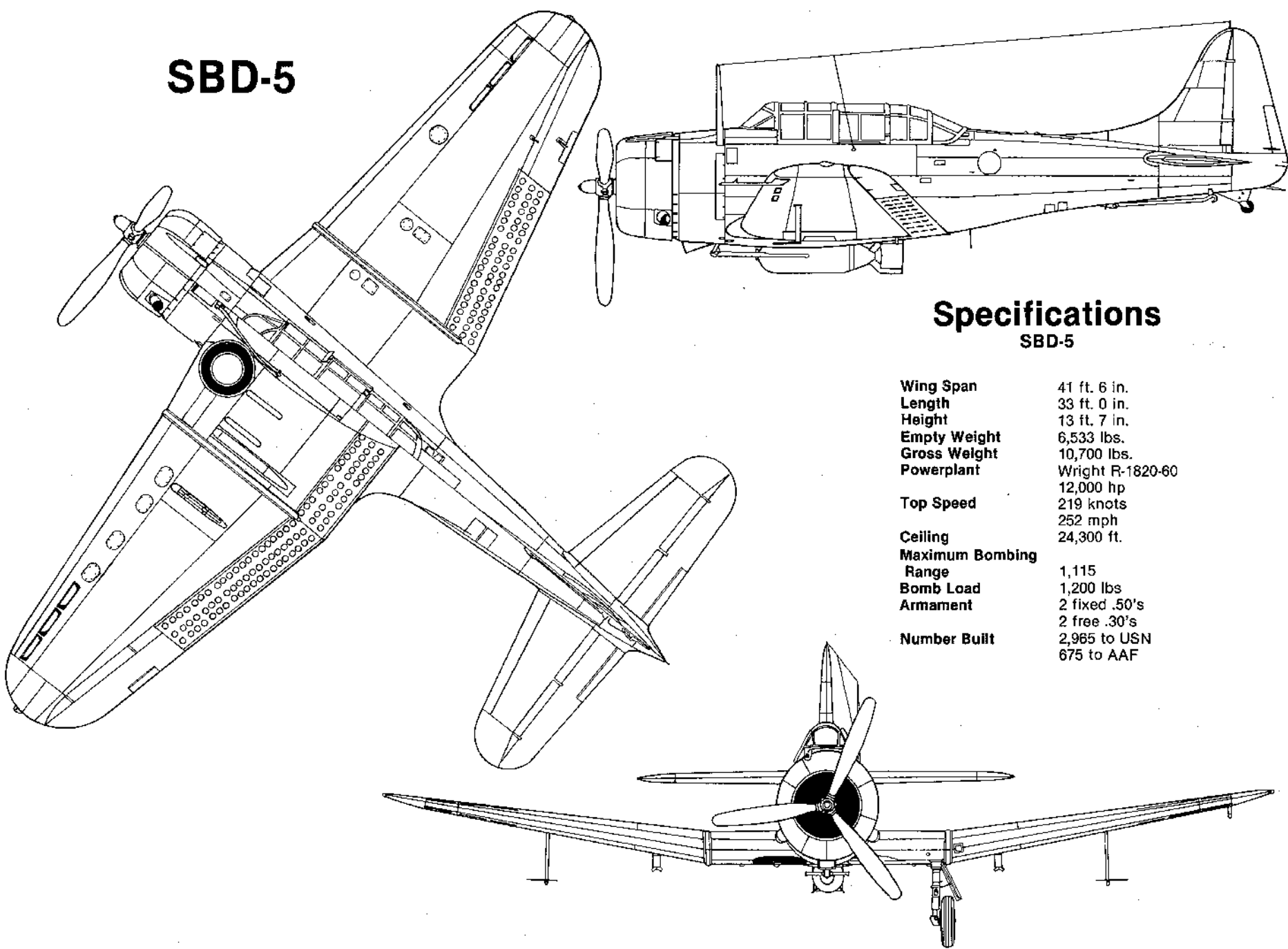

Specifications SBD-5

Wing Span	41 ft. 6 in.
Length	33 ft. 0 in.
Height	13 ft. 7 in.
Empty Weight	6,533 lbs.
Gross Weight	10,700 lbs.
Powerplant	Wright R-1820-60 12,000 hp
Top Speed	219 knots 252 mph
Ceiling	24,300 ft.
Maximum Bombing Range	1,115
Bomb Load	1,200 lbs
Armament	2 fixed .50's 2 free .30's
Number Built	2,965 to USN 675 to AAF

Gunsight

SBD-4

Telescopic
Gunsight

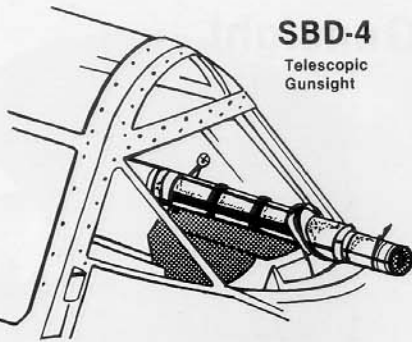

SBD-5

Reflector
Gunsight

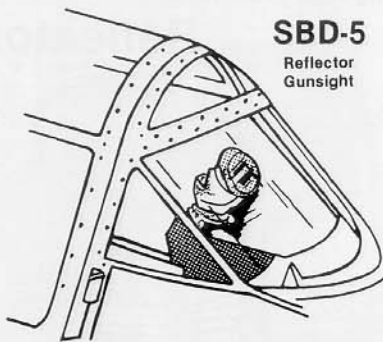

Dauntlesses of Yorktown's VB-5 led the raid on Wake during the first week in October 1943. The camouflage and markings are completely standard for the period; tricolor paint scheme, White aircraft numeral and the new bars on the roundels. 14 carries the newly introduced Yagi radar antenna while the SBD-5 in the foreground does not. (NASM and USN via Tailhook Assn.)

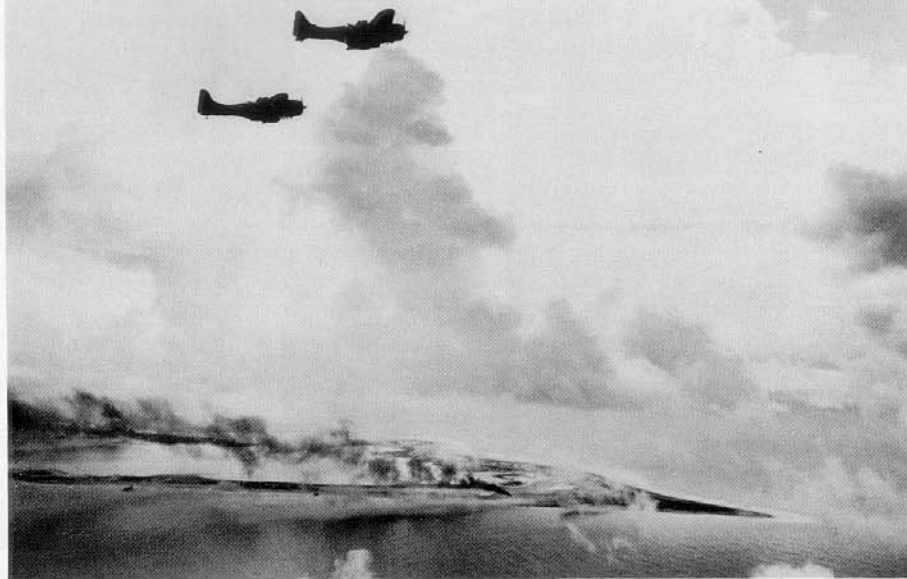

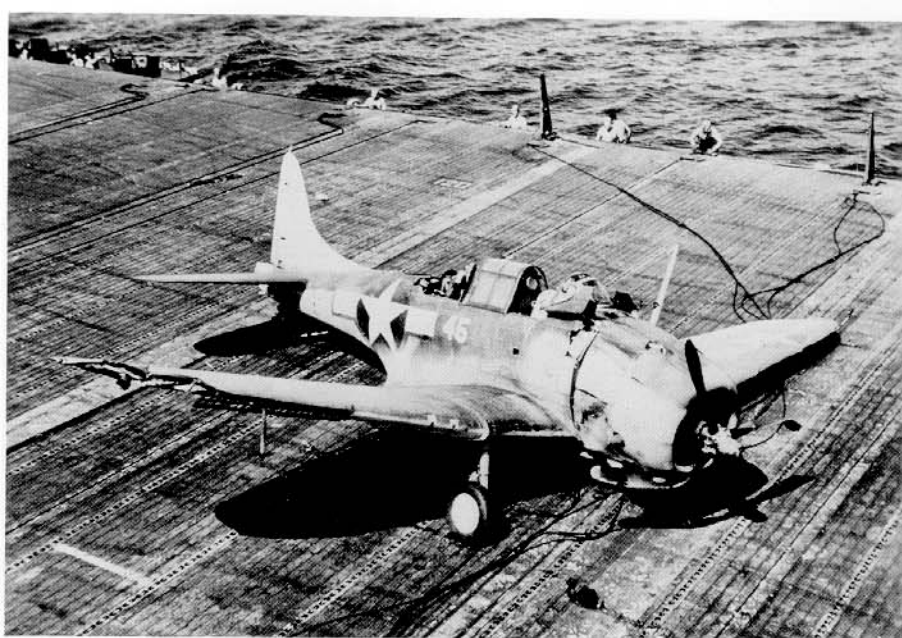

One of Lexington's own, an SBD-5 of VB-16 crash lands on the deck of the Lex on 16 November 1943. The aircraft carries the Red surround on the national insignia before it was changed to Blue after mid September. Fake gunports have been painted on the wing leading edge. (USN/NARS)

Reflector Gunsight

Pilot
Side

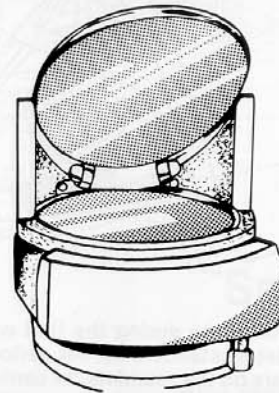

Windscreen
Side

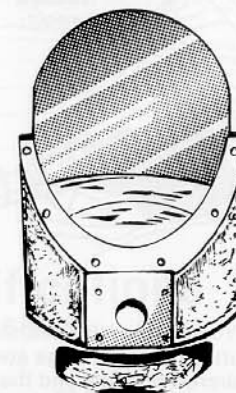

This SBD-5 bellied on the Cabot, almost running out of flight deck on 1 September 1943. This aircraft also carries the Red surround to the national insignia. SBDs never saw combat off Cabot. (USN/NARS)

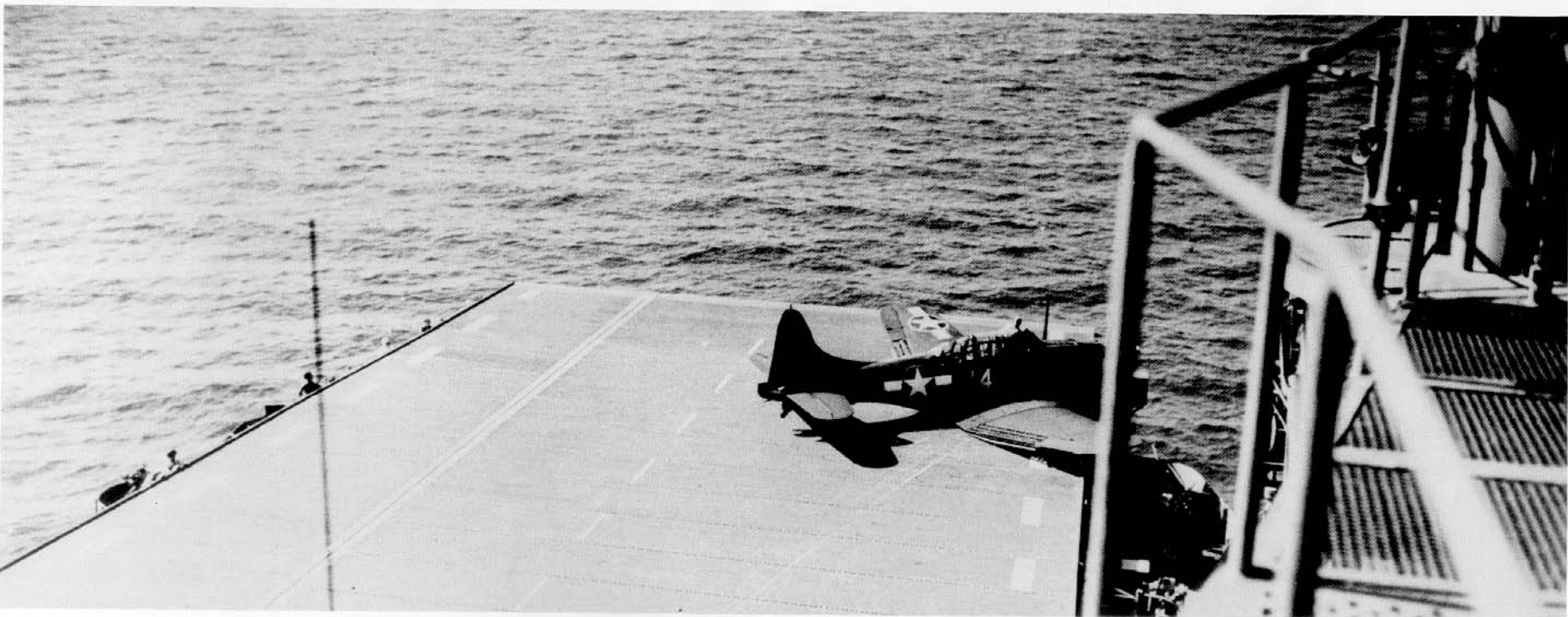

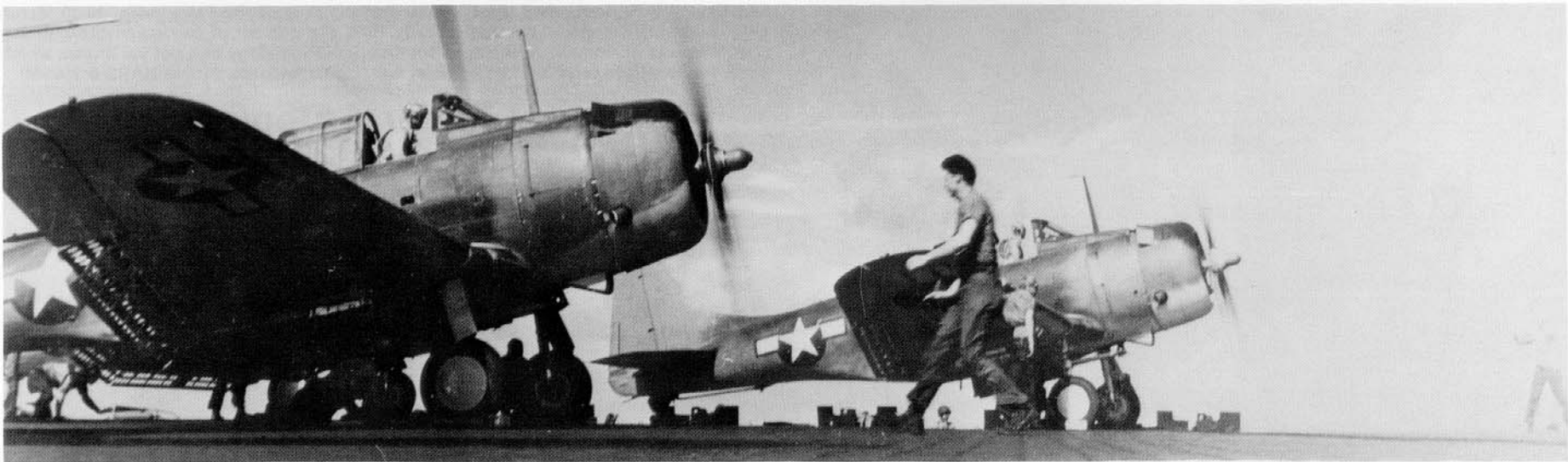

A pair of SBD-5s of VB-5 warmup on the Yorktown during operations in the Gilbert Islands on 20 November 1943. (USN/NARS)

This SBD-5 of VB-5 caught a wire before the landing gear collapsed, Yorktown, 22 February 1944. (Tailhook Assn.)

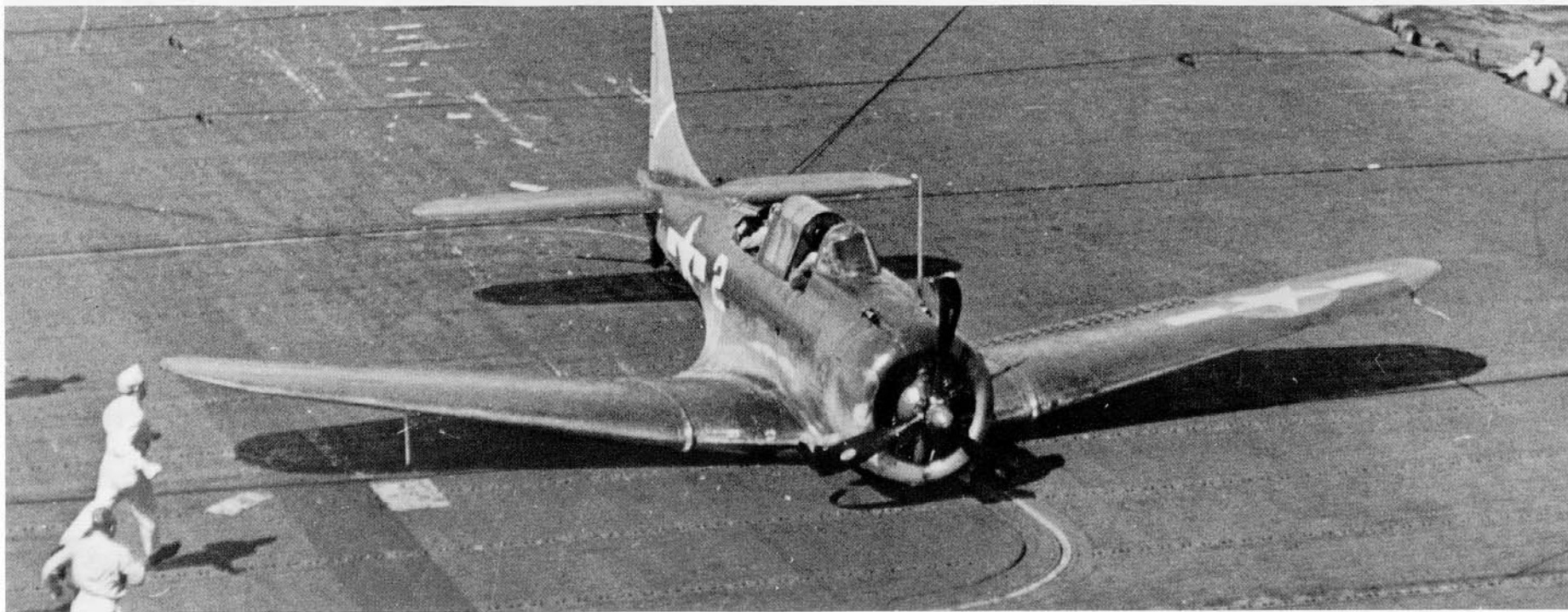

SBD-5s of VB-10 patrol over the Enterprise at the time of the Palau raids, 29-30 March 1944. During this period, late 1943 to early 1944, the number of carriers involved in any operation was still small, so the need for distinctive markings had not yet arisen, which made for very little variation from official markings standards. (USNA/NARS & NASM)

Yagi Radar Antenna

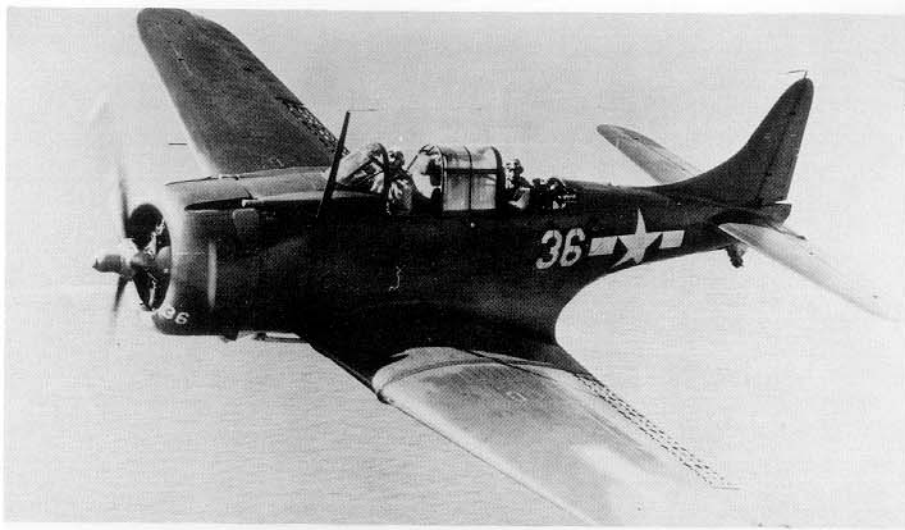



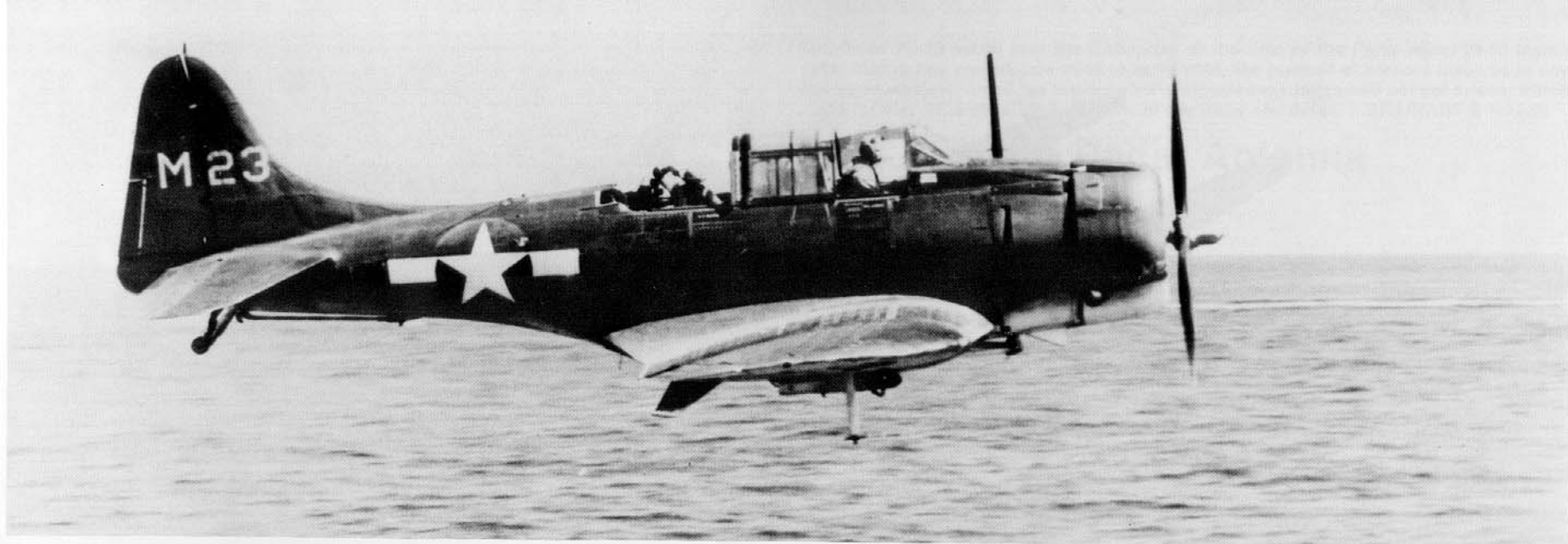

The letter and number code on the tail of this SBD-5, seen just after making a message drop on the Lexington, probably indicates the machine belongs to a land-based Marine unit, 16 April 1944. The tailwheel fairing was removed on many land-based Dauntlesses and even on some carrier-based aircraft. (USN/NARS)

A pair of SBD-5s, believed to be of VC-40, lift off from Munda bomber strip enroute to Bougainville, 28 October 1943. On this day VC-40's mission was aborted due to weather before reaching the target, a frequent occurrence in the Solomons. (USN/NARS)

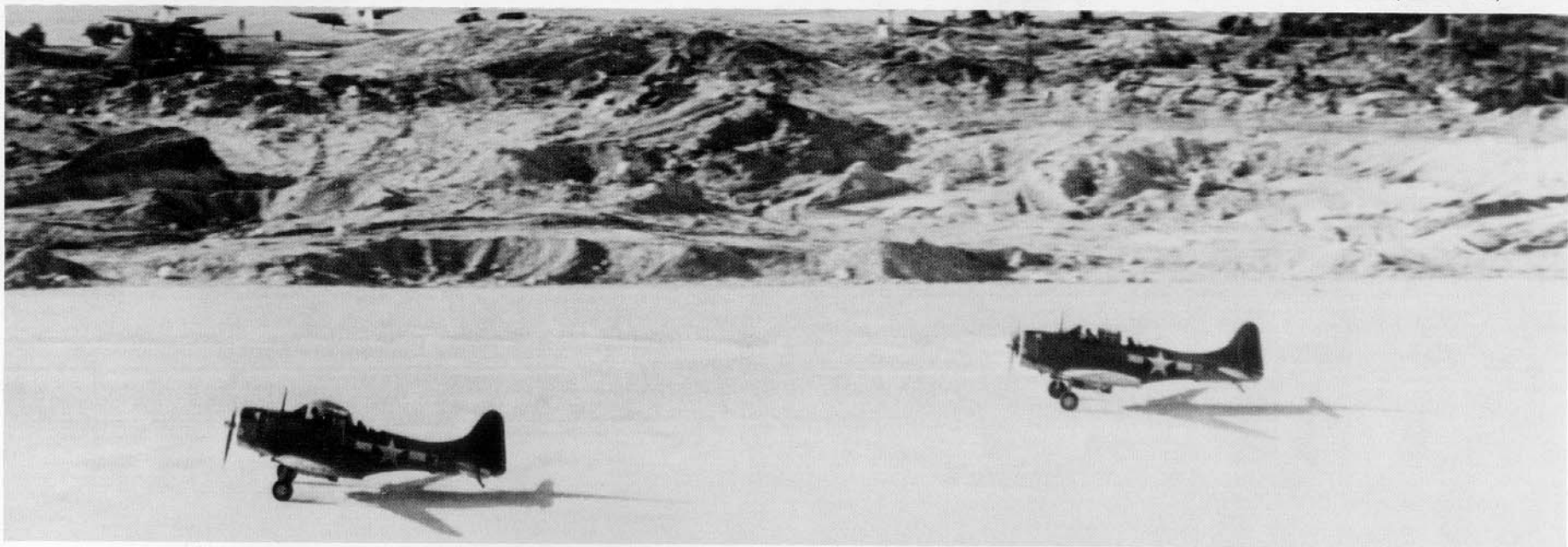

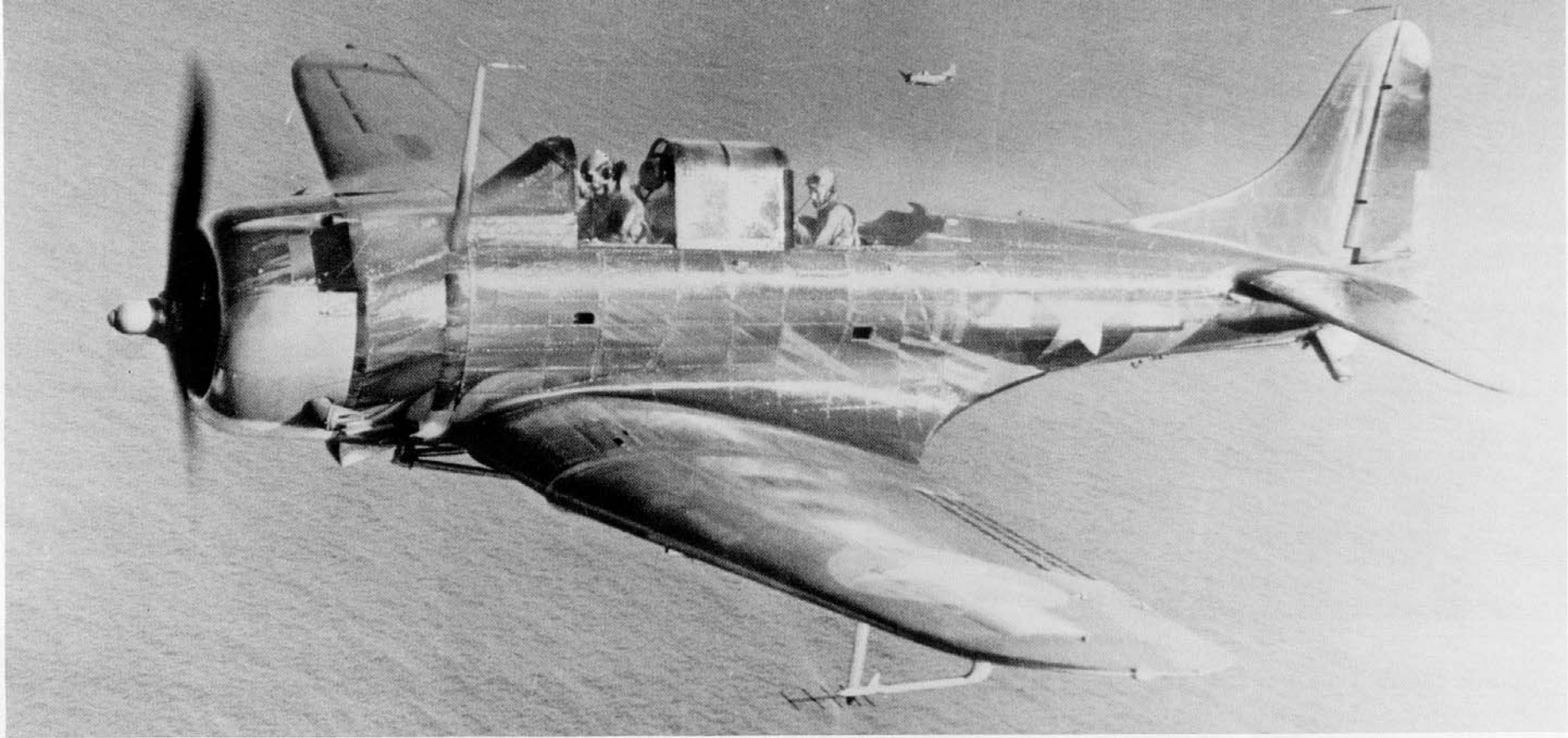

(Above) Hit by flak over Palau, this SBD-5 of VB-10 off the Enterprise developed an oil leak which has coated the windscreen. The gunner has already jettisoned his guns and is busily looking for other weight to pitch overboard. (Below) The leaking oil has coated the entire upper half of the Dauntless which continues to lose power and altitude. (Right) The struggle to stay airborne lost, the Dauntless has been successfully ditched and the pilot and gunner are abandoning ship. They were both rescued, 29 March 1944. (USN/NARS & NASM)

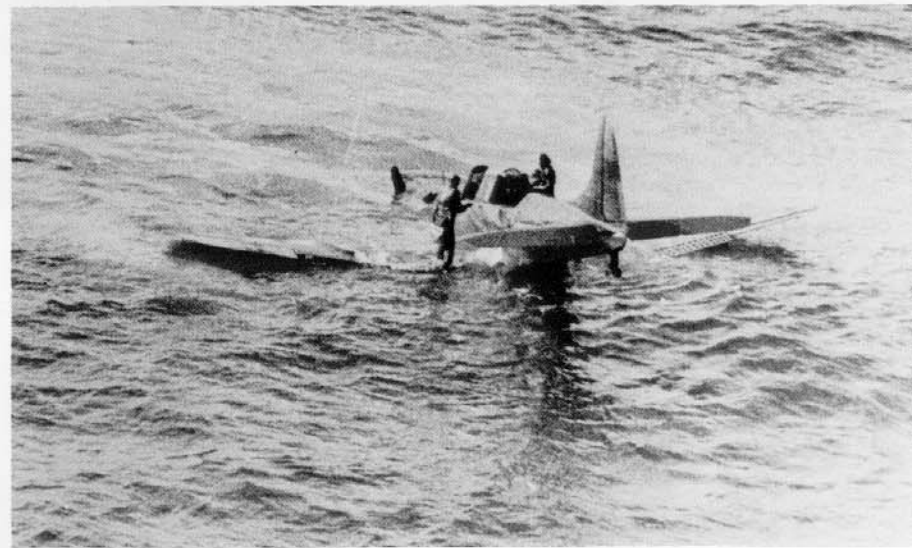
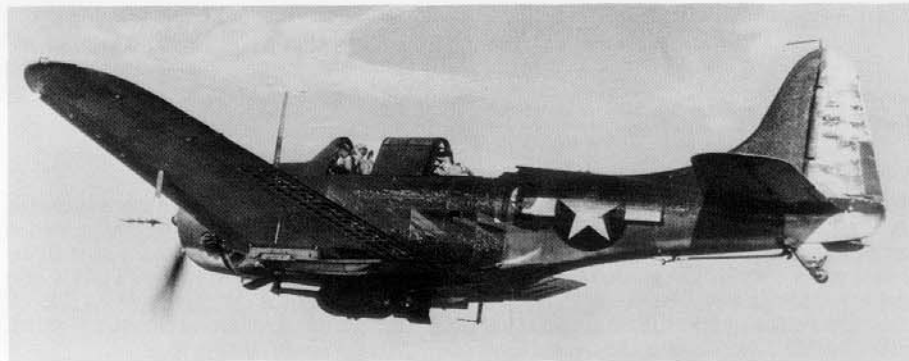

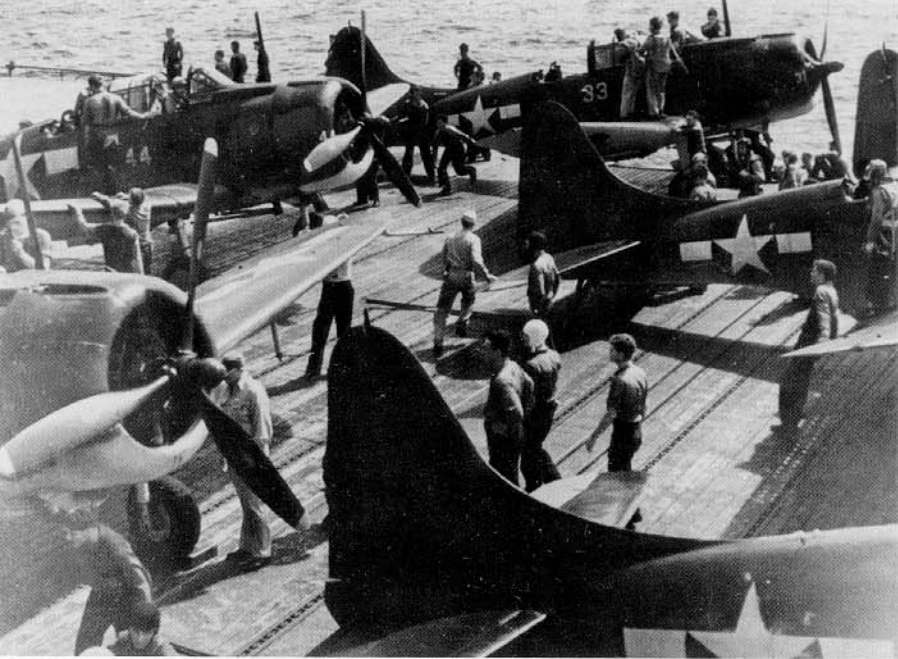

Flame Damper

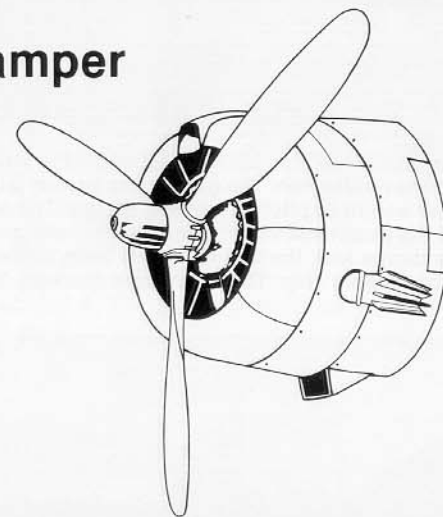

The last carrier operation for the Slow But Deadly was the invasion of the Marianas during June of 1944. SBD-5s of VB-16, on Lexington, are preparing to attack Japanese positions on Saipan, 15 June 1944. These Dauntlesses are equipped with flame dampers on their exhaust ports for night operations. The SBD had served the fleet long and well but it now gave way to the SB2C Helldiver in the fleet's VBs. VB-16 on the Lexington and VB-10 on the Enterprise were the last Dauntless carrier based squadrons in the Pacific. (USN/NARS)

An SBD-5 coded A48 over Rabaul on 22 March 1944. Under the port wing can be seen Yunakanau airfield, one of the perimeter fighter bases guarding the harbor. Above the nose of A48 is the South Daughter with St. George's Channel and Duke of York Island beyond. Blanche Bay and Simpson Harbor are hidden behind the clouds to the left. (USN/NARS)





Target



The SBD-5s of VC-40 on a typical mission. The target was Talili Bay, supply dump for Rabaul and the bomb load was a 1000 lb RDX and a pair of 100 lb GPs. The strike force was composed of 54 SBDs and 36 TBMs from both Marine and Navy squadrons. (Above) Takeoff was north-to-south from Piva Uncle strip, Torokina, Bougainville. (Below) Out over the Solomon Sea, the strike climbed steadily to attack altitude and formed up. 11 was piloted by Moe Johnson (the Black patch above the plane is a defect on the original negative). The lack of surround on the national insignia was common for land-based units in the Solomons. (Left) Three SBD-5s from another squadron, carrying F codes, form up on VC-40. (H. Paul Brehm)

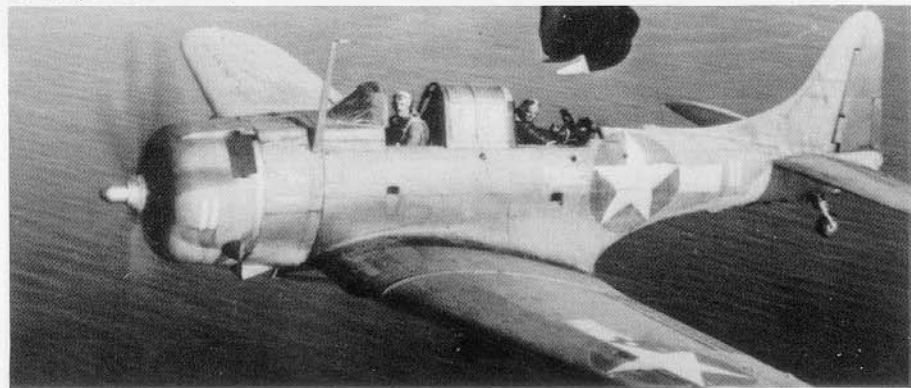



Rabaul

(Above) Attack altitude is reached and clouds are encountered. (Above Right) The cloud cover gets very heavy but the target is found and the attack pressed home. Twenty-five Dauntlesses (not counting Brehm's own) can be seen in this view. (Below) Returning low over St. George's Channel, past the South Daughter; Blanche Bay is on the other side of the volcano. (Below Right) Home again — Piva Uncle. Note the bullet holes in the wing. Defences over Rabaul was always intense. (H. Paul Brehm)





(Above) An SBD-5 of land-based VB-98 over the lush jungles of Bougainville, March 1944. (USN/NARS)

(Below) Four SBD-5s of an unidentified unit prepare to take off from Bougainville on 27 November 1944. By this date in the campaign, most Dauntlesses were in the hands of the Marines. (NASM)



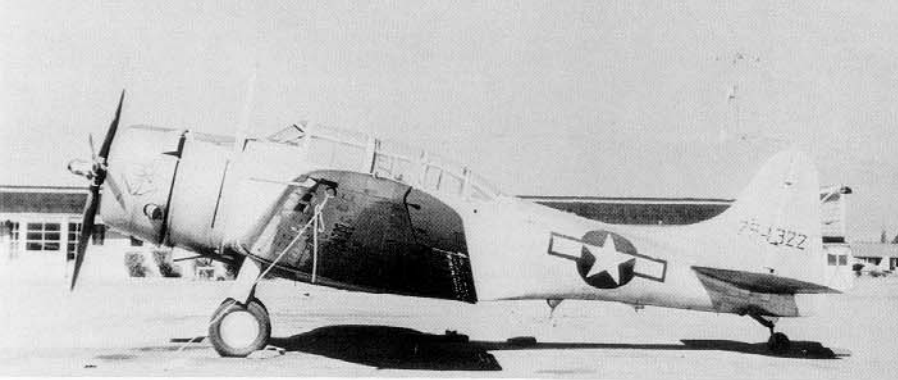

An A-24B at an unidentified Army base. The finish is natural metal. The serial number, 42-54322, is in Black on the tail and is repeated under the near wing. A large cockroach insignia is painted on the cowling. (NASM)

About as fancy as Army Dauntlesses ever got, this A-24B carries the emblem of Air Transport Command on its side. All tail markings are Yellow and the serial number is repeated in Yellow under the port wing. (USAF)

A factory-fresh A-24B-1-DO (s/n 42-54285). The color of the nose band is unknown, Orange or Yellow were often used to identify trainers, which was the use to which most Army Dauntlesses were put. Otherwise the colors are standard midwar, Olive Drab over Neutral Gray. (Douglas via Harry Gann)

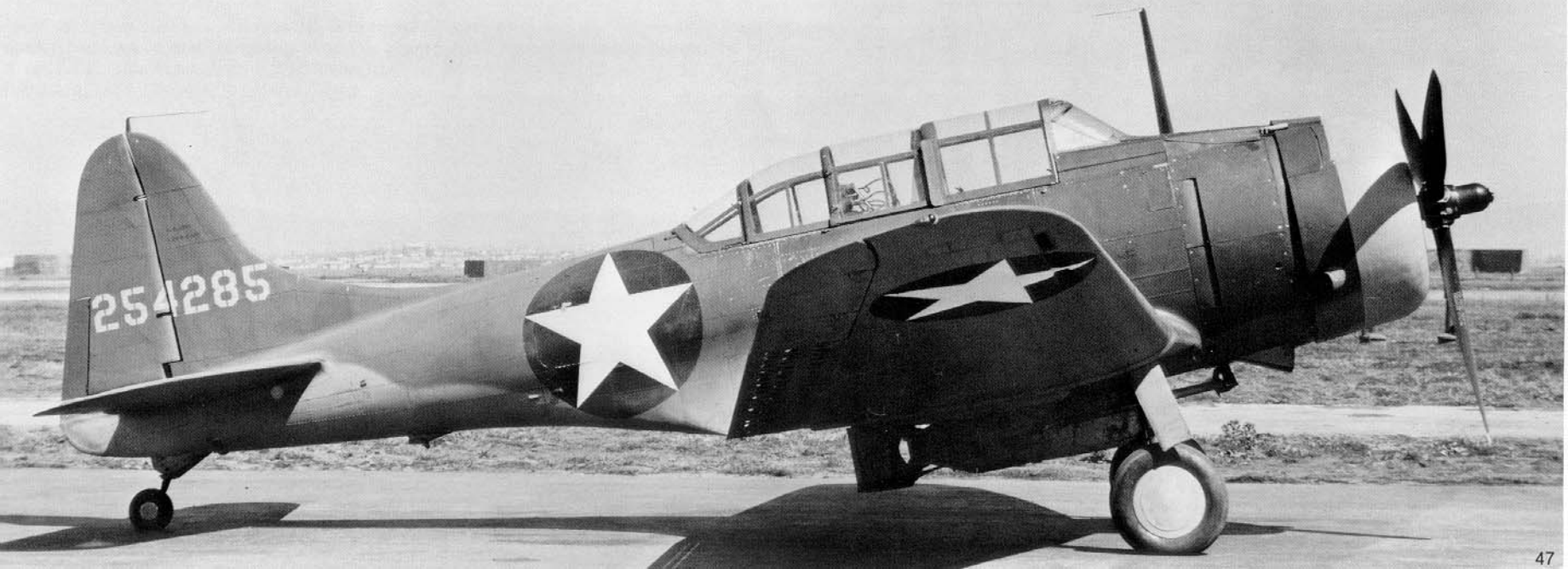

SBD-6

The last Dauntless variant, externally indistinguishable from the SBD-5, saw a further increase in power with the installation of a 1350 hp R-1820-66 cyclone engine. However, this increase in power only increased top speed to 262 mph, too small an increase and too far below the standards of 1943 to satisfy Navy requirements. The metal fuel tanks with self sealing liners were replaced by non-metallic self sealing fuel tanks. Only 450 production SBD-6s were completed (BuNo 54600 to 55049) before all remaining orders were cancelled. By the time the first production SBD-6 was delivered on 18 March 1944 it was effectively obsolete, so nearly all -6s were retained stateside for use by coastal patrol squadrons, as trainers for bomber squadrons, as target tugs, or as hacks.

The XSBD-6 (BuNo 28830) seen at NATC Patuxent River on 22 June 1944. This airframe was pulled out of the SBD-5 production sequence and upgraded with the more powerful 1200 hp R-1830-60 Cyclone engine of the SBD-6. The letters FT, which are faintly visible on the nose, indicate that this is a flight test airframe. (USN/NARS)

An SBD-6 equipped with 58 gallon drop tanks is parked on the ramp at El Segundo on 11 April 1944. These aluminum drop tanks extended the scouting range of the Dauntless to 1340 nautical miles. (USN/NARS)

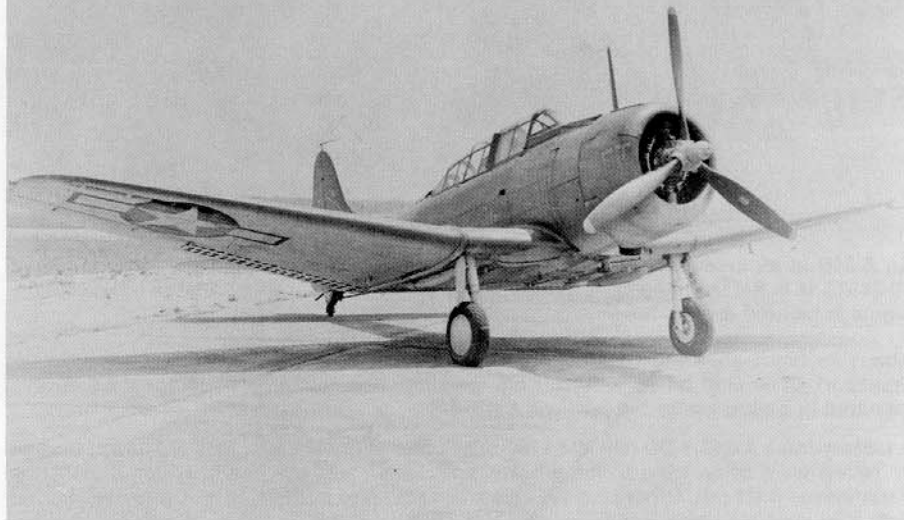



An SBD-6 on patrol in the markings of VS-51, May 1944. (NASM)

The Wright Aeronautical Company, manufacturer of the R-1820 Cyclone engine, used this SBD-6 airframe to test an experimental fan installation (probably inspired by the German Fw190), 6 April 1944. (NASM)

A number late model Dauntlesses fell into private hands after the war, where they were popular because of their forgiving handling characteristics and Aerobatic capability. In civilian hands this experimental SBD-6 was used for personal transportation by Bill Marsh of Arizona, 1954. (Douglas by Harry Gann)

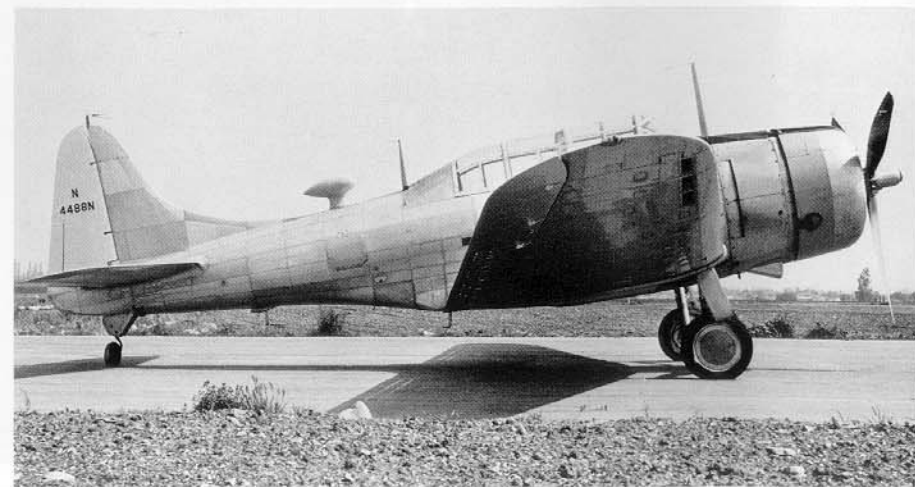

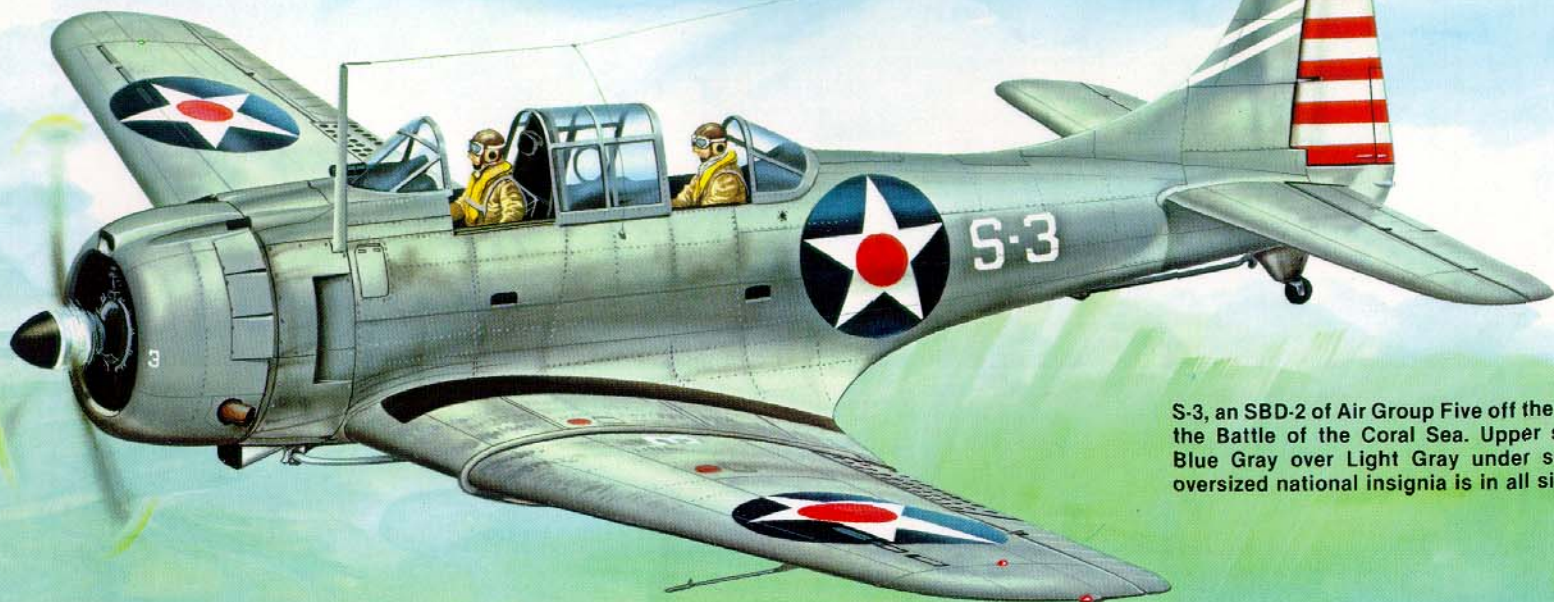

S-3, an SBD-2 of Air Group Five off the Yorktown at the Battle of the Coral Sea. Upper surfaces are Blue Gray over Light Gray under surfaces, the oversized national insignia is in all six locations.



White 14, an SBD-5 of VB-5 on the Yorktown, Wake Island, 6 October 1943. The scheme is the standard tricolor.