

P-47 Thunderbolt

in action



DON GREER '84

Aircraft Number 67

squadron/signal publications



P-47 Thunderbolt

in action

by Larry Davis

color by Don Greer

illustrated by Kevin Wornkey

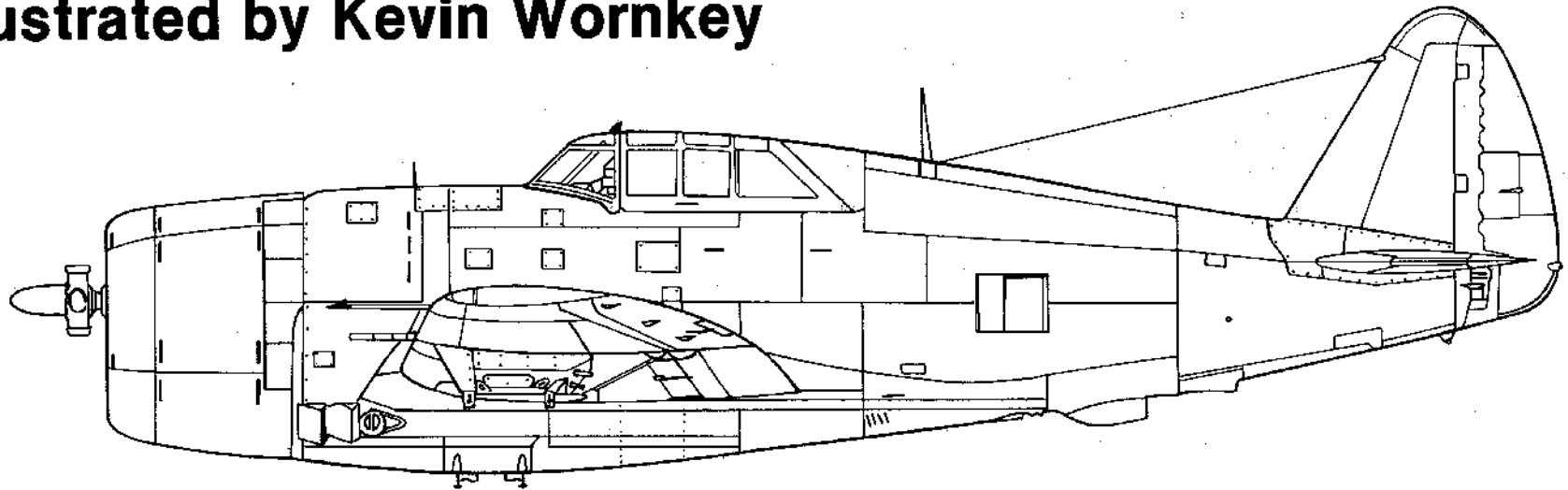

Aircraft Number 67



squadron/signal publications



Major Bill Dunham of the 348th Fighter Group and a wingman from the 35th Fighter Group, attack a formation of Japanese fighters over Luzon during the winter of 1944. Major Dunham scored sixteen victories before the war ended.

COPYRIGHT © 1984 SQUADRON/SIGNAL PUBLICATIONS, INC.

1115 CROWLEY DRIVE, CARROLLTON, TEXAS 75011-5010

All rights reserved. No part of this publication may be reproduced, stored in a retrieval system or transmitted in any form by any means electrical, mechanical or otherwise, without written permission of the publisher.

ISBN 0-89747-161-X

If you have any photographs of the aircraft, armor, soldiers or ships of any nation, particularly wartime snapshots, why not share them with us and help make Squadron/Signal's books all the more interesting and complete in the future. Any photograph sent to us will be copied and the original returned. The donor will be fully credited for any photos used. Please indicate if you wish us not to return the photos. Please send them to: Squadron/Signal Publications, Inc., 1115 Crowley Dr., Carrollton, TX 75011-5010.

Contributors

USAF

Air Force Museum
Ed Bollen
Jeff Ethell
Wayne Tabatt
Gary Fry
Gene Stafford
Bundesarchiv
Merle Olmsted
78th FGp Assn
Ben Rosen
Thomas G Ivie
Peter J Kampman
Brian Baker
Dave Menard
Dave McLaren
Tom Foote
Ron Witt
Paul Paulsen

(Opposite Page) "It was a dinosaur — but a dinosaur with good proportions!" — Alex Kartveli stated about the initial P-47 specifications. (USAF)



INTRODUCTION

The design of the P-47 Thunderbolt was a culmination of the combined efforts of two men, both ex-Russians, Alexander De Seversky and Alexander Kartveli. De Seversky was born in Tiflis, Georgia in Southern Russia in 1894. In 1910 he entered the Russian Naval Academy, graduating in 1914. He asked for, and was accepted into the Russian Military Aviation program, just in time to fly and fight against the Kaiser in World War One. Flying bombers against German positions, De Seversky lost a leg when his aircraft was shot down. Returning to duty with an artificial limb De Seversky shot down thirteen German aircraft in fifty-seven missions.

He arrived in the United States in 1918 as part of a Russian Naval Mission to study US aircraft developments. Unhappy with political developments in his native land following the Great Revolution of 1917, De Seversky defected to the United States and became an aeronautical engineer and test pilot in the fledgling US Army Air Corps. By 1921 he had become an advisor and close confidant to General William "Billy" Mitchell, and helped organize the infamous "attack" by Army aircraft on a Navy battleship, which was supposedly unsinkable from the air. The battleship was sunk easily and De Seversky's fortunes began to rise. In the mid-1920s he was consulting engineer for aviation to the US War Department, and he became a full fledged citizen of the United States in 1927.

In 1931, Alexander De Seversky, known as "Sasha" to his friends, founded the Seversky Aircraft Corporation at Farmingdale, Long Island, New York. Sasha was the founder, president, designer, and chief test pilot, virtually a one-man company. Well not quite a one-man company for it was at this time that he hired a fellow ex-Russian — Mr Alexander Kartveli, coincidentally also nicknamed "Sasha". Kartveli was an engineering genius, an aeronautical engineering genius. He already held patents on many extremely fast, industry standard-setting aircraft designs. The team of Seversky and Kartveli would ultimately be responsible for many of the engineering breakthroughs that would lead to the defeat of the Axis Powers ten years later in World War Two.

The first aircraft off the Seversky Corporation line was the SEV-3 Amphibian — but it didn't really come off a Seversky assembly line at all. At this time, the Seversky Aircraft Corporation didn't have an assembly line, they didn't even have a hangar. The SEV-3 was designed by the Kartveli/Seversky team, but was built by the Edo Aircraft Float Corporation at nearby College Point, L.I. The SEV-3 was an all-metal, low-wing monoplane amphibious aircraft, meaning that it could take off or land either on land or water. For water operation the aircraft had twin floats under the wings. And for land operations, the SEV-3 had large wheels and tires which retracted into the floats. What made the SEV-3 unusual from other amphibian type aircraft was that the floats were also moveable. They could rotate so that the aircraft could land and taxi on a conventional tailwheel setup. Powered by a 420 horsepower Wright J-6 air-cooled radial engine, the SEV-3 was a phenomenon of the era. Major Seversky set a new International Speed Record of 179.7 mph with the SEV-3 on 9 October 1933.

In 1934, the SEV-3 had its floats removed entirely and a set of fixed landing gear with spats added in their place. With a new Wright R-975 radial of 950hp, and a redesigned fuselage which included a larger, sleeker canopy, the SEV-3XAR won the first volume contract for the Seversky Aircraft Corporation — an order from Army Air Corps to build 30 of the new aircraft under the Army designation of BT-8, or Basic Trainer design 8. The BT-8 was the first modern, low-wing monoplane trainer aircraft in the Air Corps livery. Production versions differed from the SEV-3XAR in having a Pratt & Whitney R-985-11 radial engine rated at 400 hp. More powerful engines were available for the aircraft but Air Corps had a rule limiting trainer aircraft to less than 400hp. This rule proved to be the BT-8s undoing as the aircraft was greatly underpowered. Although an experienced pilot had little trouble in the BT-8, the aircraft was supposed to be a *basic trainer*, and this lack of power



(Above) The SEV-X-BT with Alexander De Seversky at the controls over Long Island. The SEV-X-BT evolved into the Seversky BT-8, the first modern trainer aircraft for the Army Air Corps. (AFM)

caused many new pilots a great deal of trouble, sometimes fatally. The BT-8 was phased out in favor of the lighter BT-9, a North American Aviation design which evolved into the T-6 Texan.

While ironing out the engineering bugs in the BT-8 design, and getting the assembly line set up and rolling, Seversky and Kartveli designed their second aircraft. Originally very similar to the SEV-3, and in fact was initially designated the SEV-3M, the new design was modified into a two-seat pursuit aircraft and redesignated SEV-2XP. This design was then further modified to meet new ideas from Air Corps, resulting in the single place SEV-1XP. This new design differed from all other Seversky designs by being a single-seat aircraft, and having fully retractable landing gear. In August 1935, Seversky entered the SEV-1XP, powered by an 850hp Wright R-1820 radial engine, in the Air Corps fighter competition at Wright Field. Air Corps awarded no contract to any manufacturer and the SEV-1XP was returned to Farmingdale where a new 850hp Pratt & Whitney R-1830 radial was fitted in place of the Wright engine. In April 1936 the SEV-1XP again entered the pursuit aircraft competition at Wright Field. When the competition was over, two aircraft were chosen for a flyoff competition — the Curtis Aircraft Company model 75 Hawk (Army designation P-36); and the Seversky SEV-1XP (Army designation P-35). On 16 June 1936, Air Corps accepted Seversky's bid and ordered 77 P-35 Pursuit planes. The P-35 was to be the Air Corps' next generation fighter design. However, one year later, Air Corps also bought 210 Curtis P-36s as the situation in Europe became ever more ominous.

In early 1939 Air Corps accepted a proposal by Seversky to build a much sleeker, higher powered version of the successful P-35 design. It was designated the XP-41 and appeared quite similar to the P-35 except for a redesigned upper rear fuselage resulting in the now-famous "Razorback" spine; and a geared supercharger was installed on the P & W R-1830 engine offering 1150 hp. And finally, the landing gear was made fully retractable and fully covered by flush fitting doors, thus smoothing the airflow under the wings considerably. All of this work was accomplished during a modification program on the final P-35 to roll off the Farmingdale assembly line. With the new aerodynamics and supercharged engine, the XP-41 attained a speed of 320 mph at 15,000 feet.

Air Corps wanted more. The exhaust driven turbosupercharger, perfected by the Boeing Aircraft Company in their B-17 program, was the development of the era, and promised much greater performance at all altitudes. Kartveli fitted one to the P & W R-1830 engine, redesigned the lower rear fuselage, resulting in a bulged underbelly, to cover the tur-

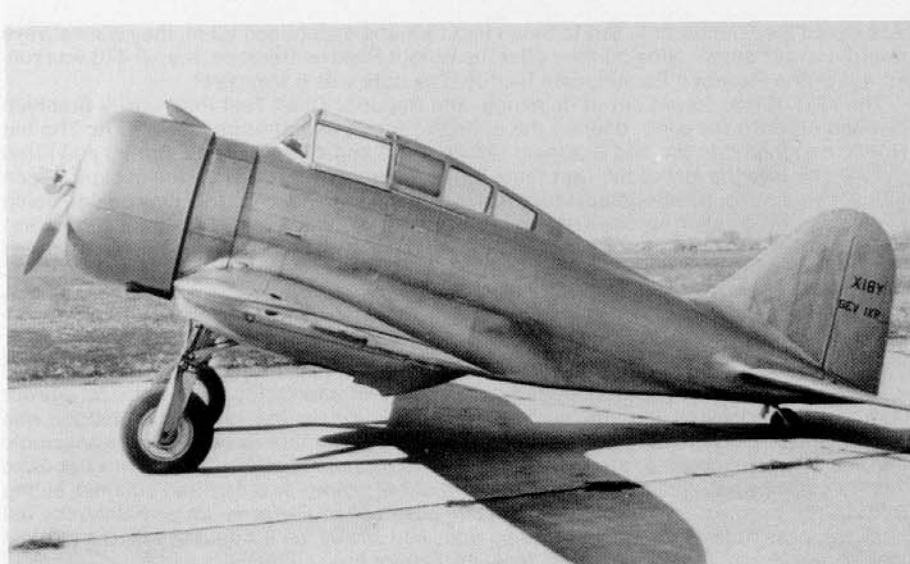

(Above) The SEV-1XP, forerunner of the P-35 design. Many of the characteristics found in the P-47 design can be seen. (AFM)

bosupercharger, and added a pair of .50 caliber machine guns in the wings to compliment the twin .30 caliber guns in the upper nose. The result was the YP-43 Lancer, an aircraft capable of 350 mph, and one that could attain the incredible altitude of 38,000 feet. The first YP-43 was delivered in September of 1940.

As promising as the P-43 design was, Kartveli had an even better design known as the XP-44. Based on the P-43 design, the XP-44 had a lower cockpit and fully streamlined frontal area, including a full spinner that mated up to a very tightly cowled P&W R-2180 radial promising 1400 hp. When this engine design fell through, Kartveli opted for the most powerful aircraft engine in the world, the Pratt & Whitney XR-2800 "Double Wasp", which developed over 2000 hp from its 18 cylinders. Air Corps officers were so impressed with the initial design that an order for eighty XP-44 Warriors was placed before a single airframe had ever been built. However, after the fall of France to Hitler's Blitzkrieg, and the ensuing Battle of Britain, even the highly promising XP-44 was considered inferior to the competition in the skies over Europe. Both the Bf-109 and Spitfire were rated superior in every way to the XP-44 design. An entirely new aircraft was needed. But Republic needed money to keep its production line going so Air Corps purchased an additional fifty-four P-43As, then cancelled the eighty XP-44s and bought a further eighty P-43As. Additionally, in June 1941, 125 P-43As were purchased for the Chinese Air Force under the Lend Lease Act, with 108 being finally delivered. The remainder were absorbed by the Army Air Force and later modified for photo reconnaissance and designated P-43B.

The entirely new model was known within the company as the AP-10, Advanced Pursuit design number 10. But unlike other Kartveli designs, and in keeping with contemporary fighter designs of the era, the AP-10, Army designation XP-47, would be powered by the

(Below) A lineup of P-35s at Selfridge Field, Michigan during the late 1930s. The P-35 won the Fighter Competition in 1936. (Bollen via Ethell)

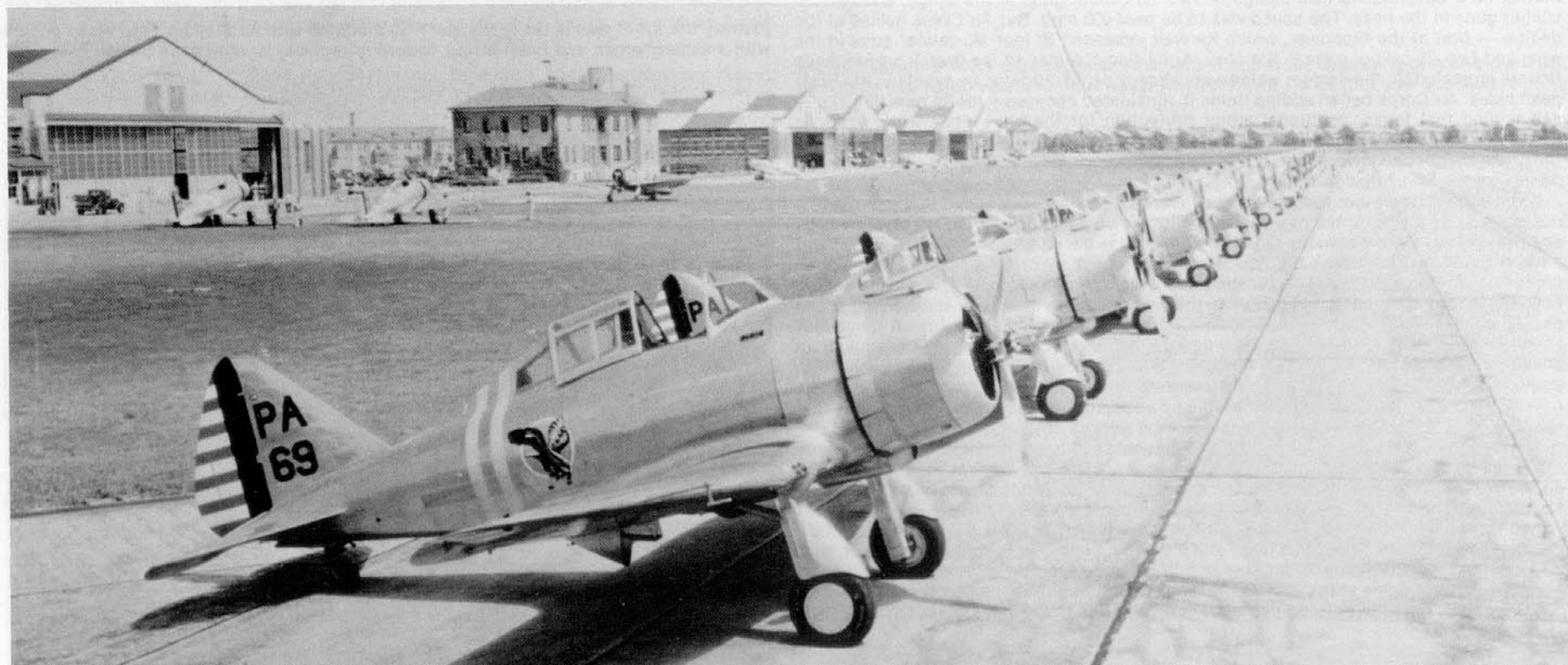

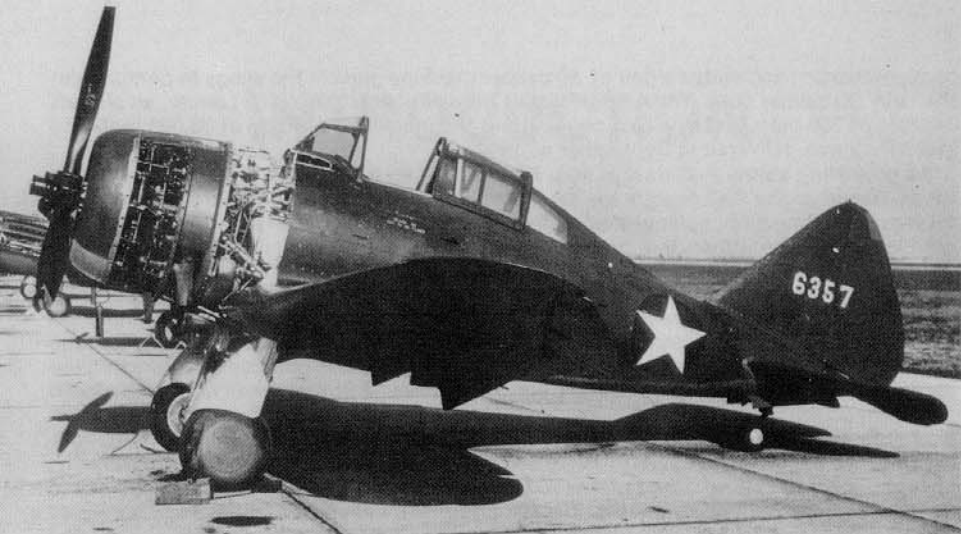

(Above) A P-35 on the ramp at Hickam Field during the summer of 1941. Several P-35s were part of the active air defenses in both Hawaii and the Philippines when the Japanese struck on 7 December 1941. (AFM)

liquid-cooled inline Allison V-1710 engine. It would be extremely sleek for a Kartveli design, have a very small airframe, and be extremely light in weight. Armament would be normal for a Seversky/Kartveli design — two .50 caliber guns in the wings, and two .30 caliber guns in the nose. Top speed was to be over 400 mph. But Air Corps balked at the design — first at the firepower, which Kartveli increased to four .30 caliber guns in the wing and two .50 caliber guns in the nose. Army also objected to the overall performance figures projected for the design, which were already being outdated by events in the European skies. Air Corps began adding items it considered necessary for its new fighters — self-sealing fuel tanks, additional armor protection for the pilot, underwing weapons pylons, and other combat equipment dictated by events in the war. Each addition raised the gross weight and lowered the projected performance for the design. By May 1940, the demise of the XP-47 design was near.

It was at the September 1940 meeting of aircraft manufacturers at Wright Field that the design specifications for the new Air Corps fighter were laid down. Kartveli reached back and brought out the old standby radial-engine designs based on the original SEV-1XP. But now modified to encompass the new Army requirements - 2000 hp engine, turbosupercharger, heavy armor protection for the pilot, over 400 mph top speed, a service ceiling near 40,000 feet, with armament equalling the best aircraft in the world, and a diving speed exceeding ALL other aircraft then known. Could a radial engine aircraft meet these new specifications? Kartveli said it could be done. But after a quick sketch on the back of an envelope he remarked "It will be a dinosaur, but a dinosaur vit good proportions." The engine part was easy — Kartveli would use the new P&W XR-2800 rated at 2000 hp. The new XR-2800 with turbosupercharger promised a speed in excess of 400 mph and a ceiling over 35,000 feet — if the aerodynamics could be worked out.

The decision was made to mount the cumbersome turbosupercharger in the underside of the rear fuselage as it had been on the P-43 series. The wings were enlarged, but retained the Seversky/Kartveli elliptical trailing edges. Within the wings would be mounted first six, then eight Browning .50 caliber machine guns making the new aircraft the heaviest armed fighter in the world. The design appeared ludicrous at first. The new aircraft, designated XP-47B by Army, was huge and did not appear streamlined at all. In fact, with its big, broad flat frontal area, and bulging under fuselage, it resembled a milk jug. So much so that the name stuck — "JUG". The British thought the nickname was short for "Juggernaut" — a term in reference to both its size and firepower. Officially, the XP-47B

was called the Thunderbolt. But to those that flew and maintained them, they were always referred to as "Jugs". Nine months after the Wright Field conference, the XP-47B was rolled out of the Republic Farmingdale facility. The date was 6 May 1941.

The XP-47B was towed out of its hangar and Republic Chief Test Pilot Lowry Brabham climbed up onto the wing, opened the cockpit "door", and strapped himself in. The big R-2800 coughed into life and Brabham taxied to the end of the runway, turned and lifted the XP-47B into the air for the first time. Disaster almost struck when the cockpit began filling with smoke. But Brabham knew that too much depended on this new design being successful to cut short its life and bail out of the smoking aircraft. He continued the first flight tests and the aircraft performed very well. There was some minor flutter in the tail assembly, and the wings vibrated at certain speeds. And of course, the aircraft was smoking badly from something. But upon landing, Brabham announced "We've got a winner here!" The problems were all ironed out including the smoke, which was traced to a small amount of oil leaking onto the very hot supercharger ducting.

Problems arose because of the extremely high service ceiling the aircraft was to operate at - near 40,000 feet. The ignition broke down and arcing occurred. The answer was to pressurize the ignition system. Oil circulation in the turbosupercharger was another major problem. And with production P-47Bs beginning to come off the assembly line, a truly major disaster struck. The number four pre-production P-47B, with Republic Test Pilot George Burrell at the controls, went out of control in a dive and crashed, killing Burrell. The problem was traced to the fabric-covered tail surfaces. Immediately, the tail surfaces were redesigned as an all-metal unit. And finally, on 8 August 1942, the original XP-47B was destroyed when the rear fuselage caught fire and the pilot had to leave the aircraft over the ocean. The sire of the P-47 series was gone. But its descendants, 15,682 of them, would carry the Thunderbolt legend to the hearts of the Axis' homelands.

(Below) The XP-41 was actually the last P-35 modified with an 1150 hp Twin Wasp engine with a supercharger, and flush-fitting, inward retractable landing gear. (AFM)

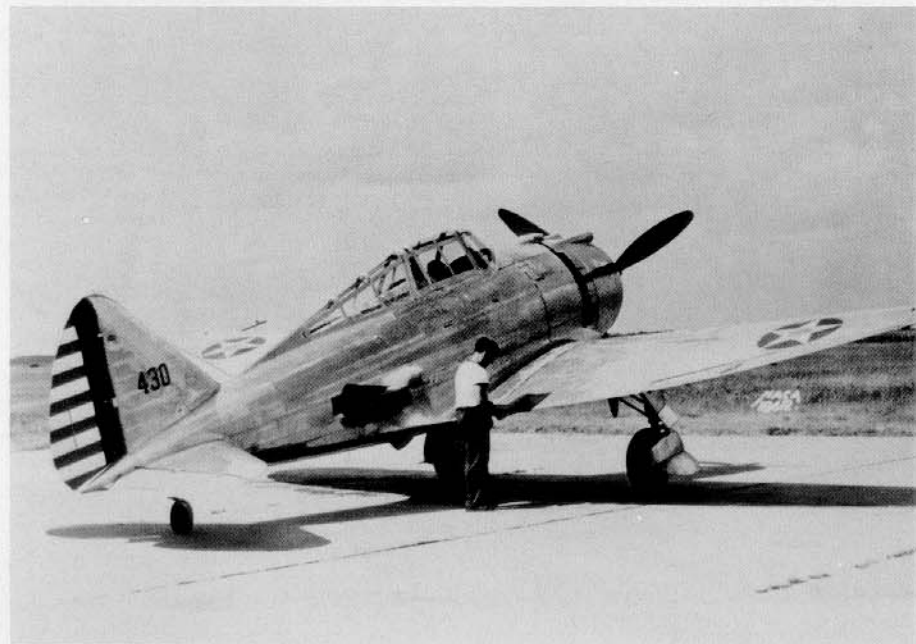

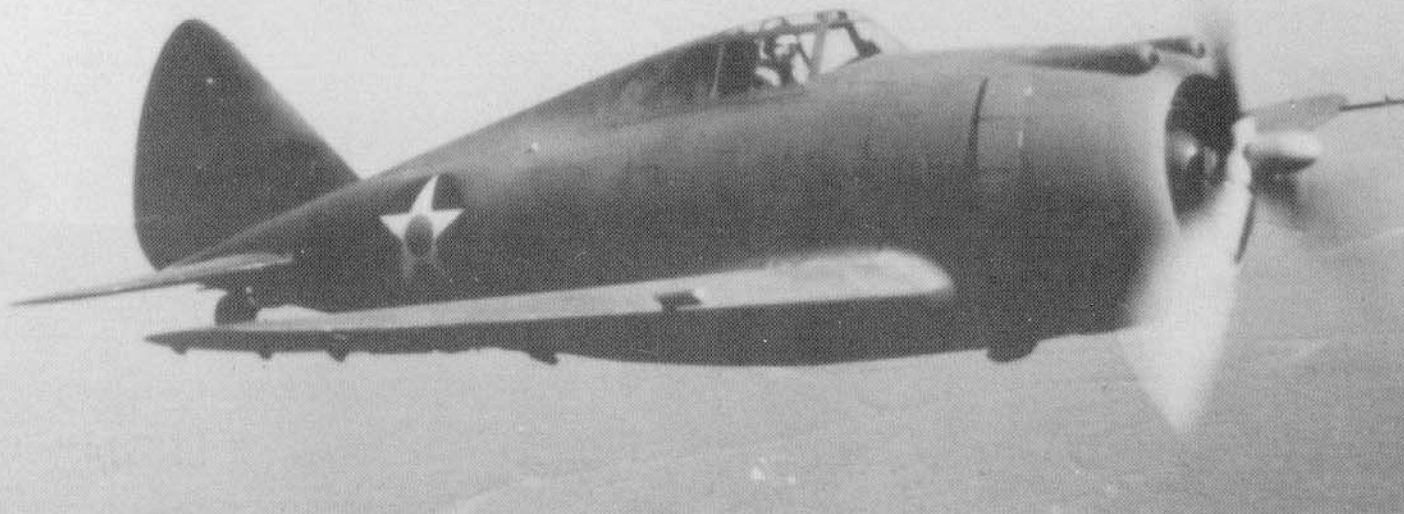

(Above) A P-43A from the Louisiana National Guard inflight over Esler Field, Louisiana during the Spring of 1942. The P-43 was the first turbosupercharged fighter aircraft mass produced for the Army Air Corps. The familiar lines of the P-47 design are already firmly established. (AFM)

(Below) A P-43A from the 122nd Reconnaissance Squadron, Louisiana National Guard, that ground looped at Winston-Salem in 1942. The turbosupercharger installation can be seen running along the belly. (AFM)

(Below) Several P-43As were supplied to other nations at the beginning of World War Two, including this recon version in the Royal Australian Air Force that was wrecked on New Guinea. (AFM)

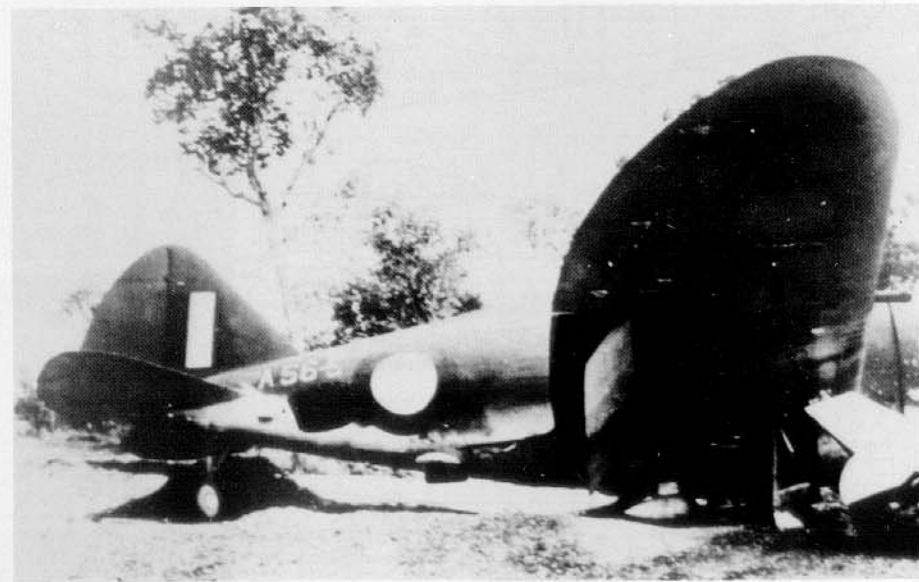

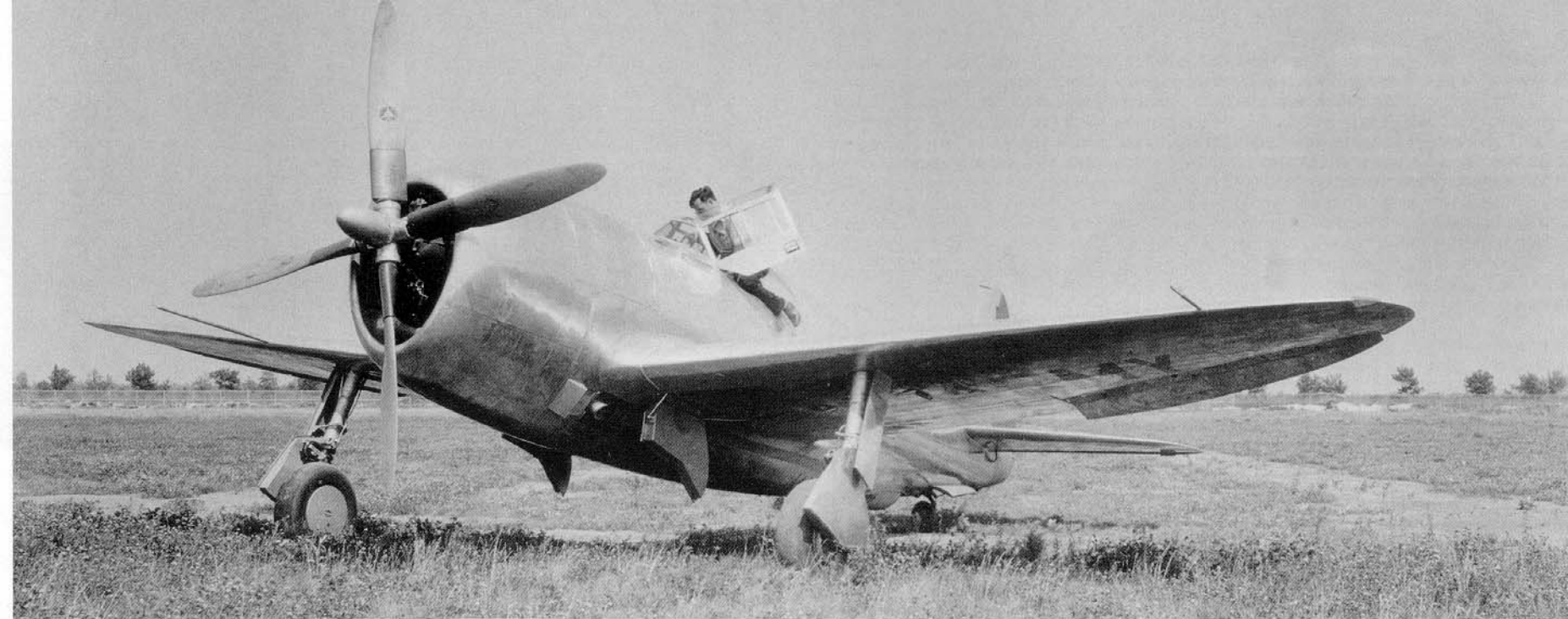

(Above) The XP-47B at Farmingdale. Note the car door style canopy entrance, which was done away with on production model P-47Bs. (AFM)



(Right) From the massive shape of the XP-47B one can easily see the milk jug resemblance that resulted in the nickname "Jug". (AFM)

P-47 Development

P-35A

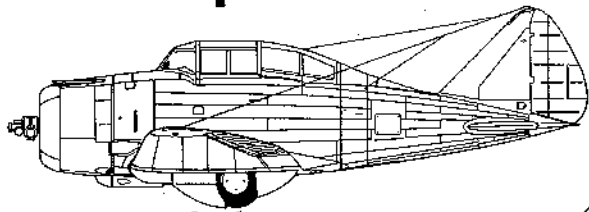

P-43

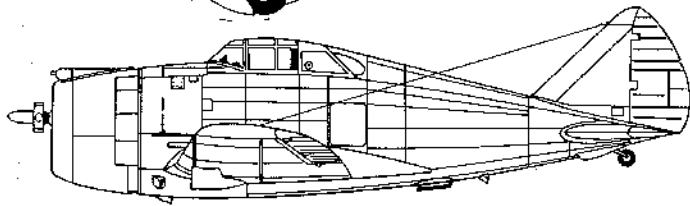

XP-47B

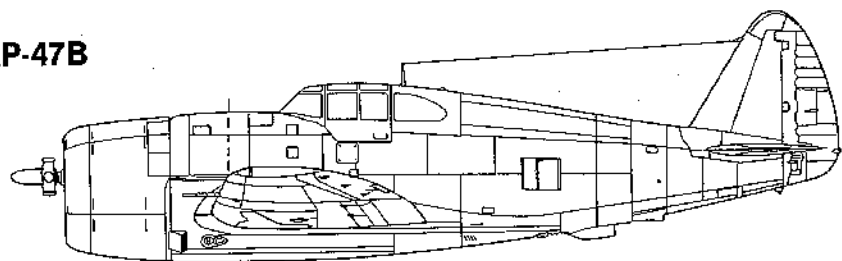

P-47B

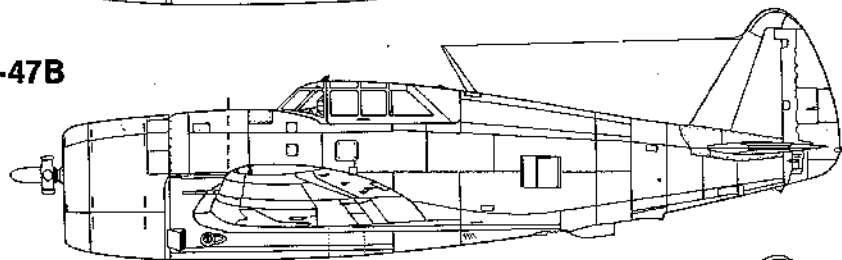

P-47C-1-RE

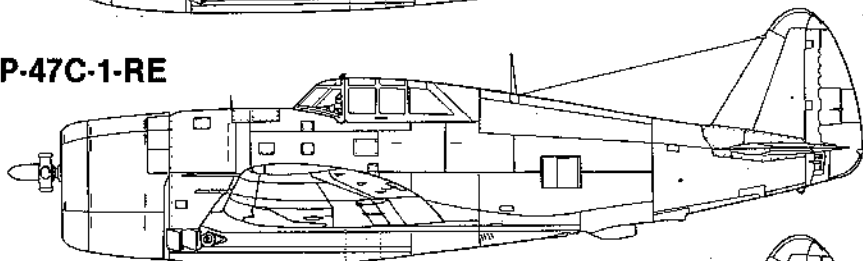

P-47D-2-RE

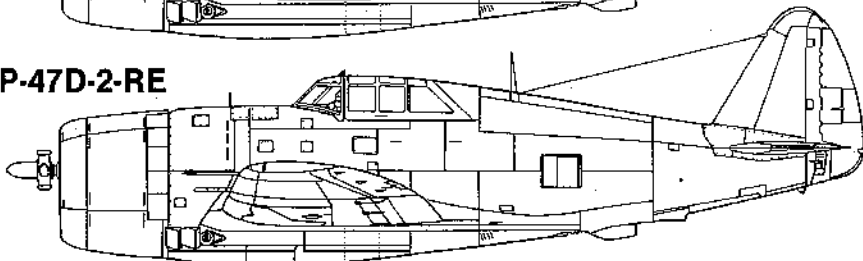

P-47D-20-RE

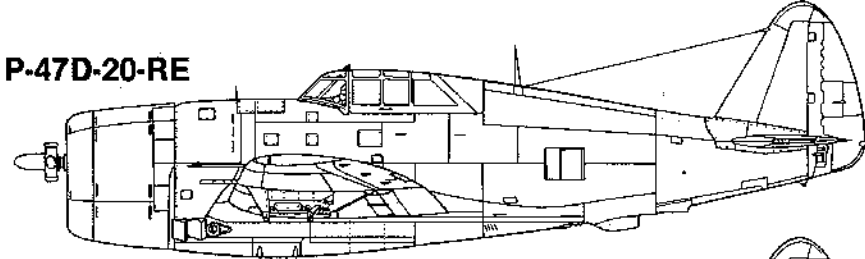

P-47D-25-RE

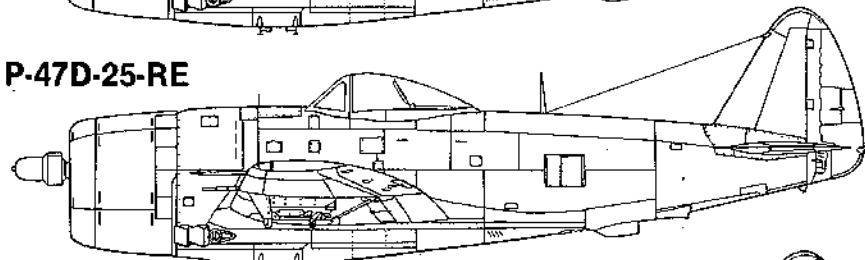

P-47G-15-CU

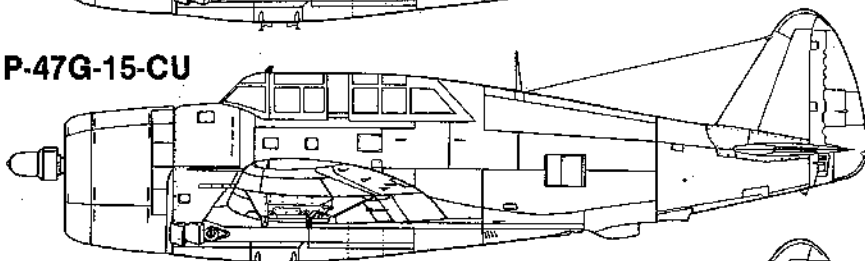

P-47D-40-RA

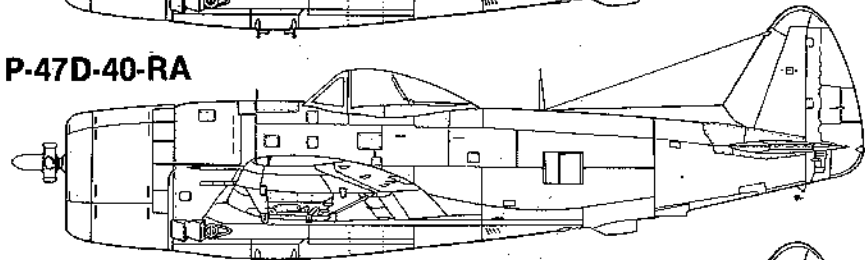

P-47N-5-RE

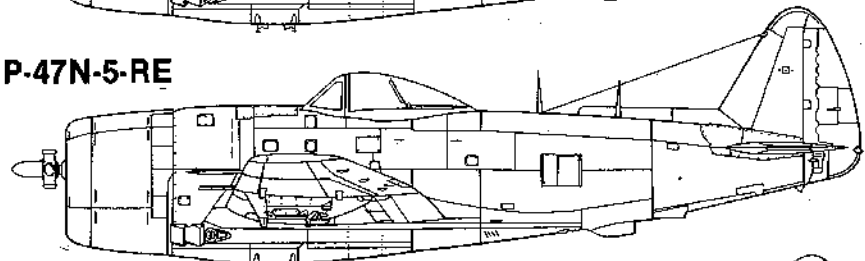

XP-72

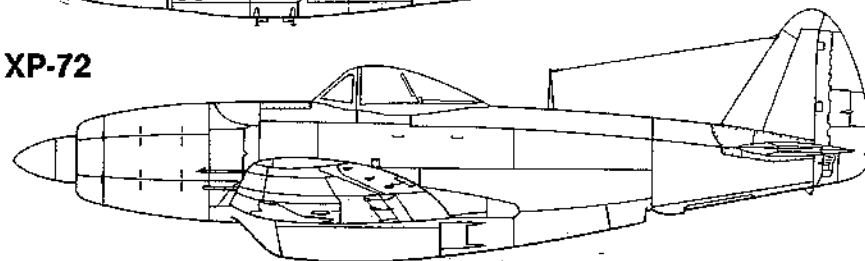

P-47B

The P-47B was the first production variant of the P-47 Thunderbolt series. The P-47B differed from the XP-47B in having a full sliding canopy in place of the "car door style" cockpit entrance, the new GE turbo-supercharger regulator was added, the radio antenna was changed from a vertical type to one that slanted toward the nose of the aircraft, and the ailerons and trim surfaces were now covered with metal instead of fabric. In addition to the new sliding canopy, the cockpit and canopy were both raised several inches for better forward visibility. Later in the model run a windshield defroster was added, and the rudder was all-metal.

The first aircraft (41-5895), completed in December 1941 and accepted by Army Air Force on 21 December 1941 was actually a special built prototype. However, it wasn't until 4 March 1942 that the first pre-production P-47B was completed. The top speed of the P-47B was 429 mph at 28,000 feet and range a scant 350 miles at 25,000 feet, or 835 miles if the pilot kept down to 10,000 feet. The first true production P-47B was accepted on 26 May 1942, with the first aircraft delivered to the 56th Fighter Group in June. The 56th FGp was the only P-47 unit in the Army Air Force, and was based at Bridgeport Municipal Airport on Long Island. However, pilots from the 56th had to train at nearby Mitchell Field since the runways at Bridgeport weren't long enough to handle the big, heavy Thunderbolt. Teething problems with the new aircraft resulted in over half of the aircraft assigned to the 56th being wrecked by July of 1942. Many problems with high speed dives, loss of control or even loss of the tail assembly, were ironed out when Republic began replacing the fabric-covered ailerons and rudder with larger, metal covered ones.

RP-47B Reconnaissance

There were actually two types of RP-47B reconnaissance Thunderbolts. The first was a short-lived reconnaissance version of the P-47B that mounted a camera in the intercooler exhaust vent on the left side of the aircraft. The RP-47B never went into production although at least one was built with a camera installed. In 1944, Army Air Force designated all P-47Bs as RP-47B-RE. Meaning that the P-47Bs were to be used for Restricted Flights only — as trainer aircraft or unit hacks.

XP-47E

The last P-47B off the assembly line, serial 41-6065, was modified by the addition of an R-2800-59 engine developing 2300hp. The XP-47E was the first P-47 to have a pressurized cockpit. Later, the XP-47E was used to test the Hamilton Standard hydramatic propeller with a 13'1 7/8" diameter.



(Above) The No 5 production P-47B with a combination canopy area -- XP-47B razorback area with side windows, but also having a sliding canopy from the P-47B. The forward rake of the radio antenna mast was another characteristic of production P-47Bs. (AFM)

Canopy Development

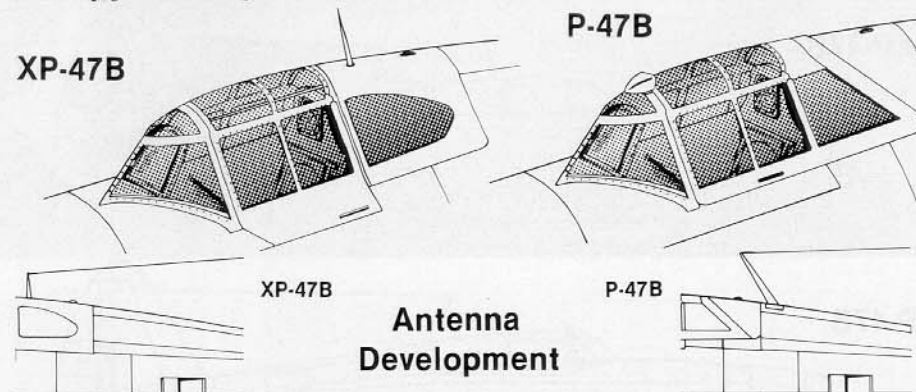

(Below) The production P-47B differed from the XP-47B in that it had a sliding canopy, the -21 engine, and all-metal ailerons and trim surfaces. The stripes on the wing are for sighting the guns. This aircraft is from the 56th Fighter Group, the first unit in the Army Air Corps to fly the Jug. (AFM)

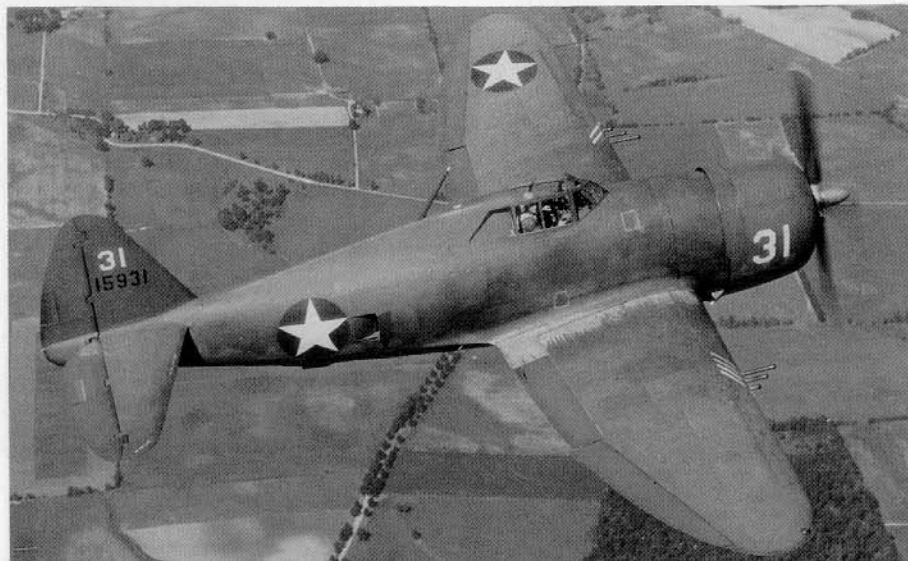

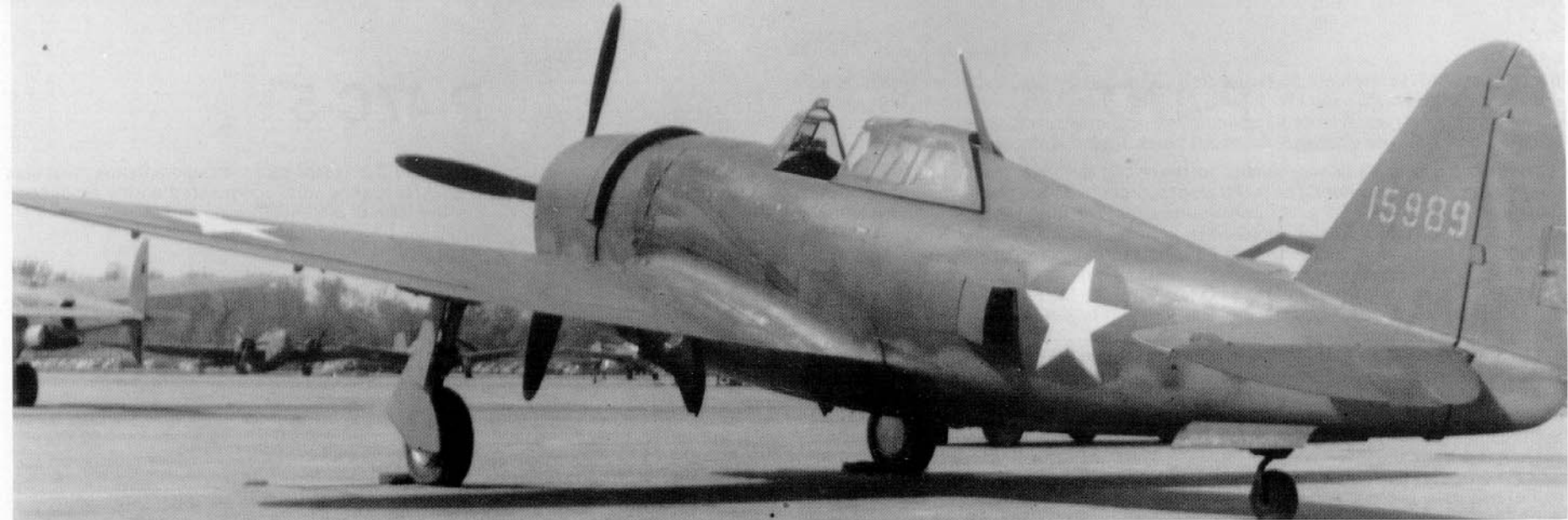

(Above) One of a handful of RP-47B photo reconnaissance Thunderbolts. Close examination of the negative revealed that the camera lens is mounted in the left open intercooler duct, immediately forward of the national insignia. The RP-47B never went to production. (AFM)

(Right) "Miss Mary Jane", a P-47B from the 61st FSq/56th FGp. The 56th FGp, although it was the only Thunderbolt-trained unit in the Army, was the last of the initial three units in 8th Fighter Command to receive P-47 aircraft for combat. (Tabatt)



XP-47B

Fabric
Covered
Tail
Surfaces

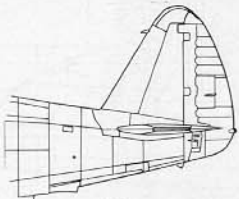

P-47B

All Metal
Tail
Surfaces

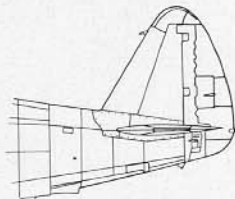

(Below) The 61st FSq, with Major Hub Zemke in the lead aircraft. Zemke was the CO of the 56th FGp and would lead the unit into combat over Europe, where the 56th would run up a most impressive score against the Luftwaffe. (USAF)

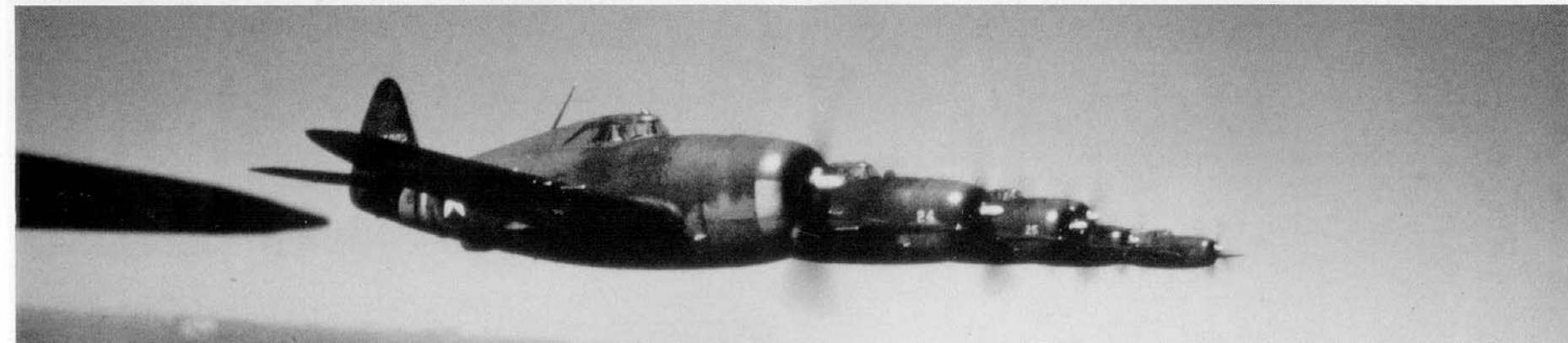

P-47C

The P-47C was initially very similar to the P-47B but with the strengthened, metal covered rudder and elevators. The P-47C also incorporated a revised oxygen system, a further development on the GE A-17 turbosupercharger regulator, the SCR-774 radio with the forward slanted antenna being replaced by a vertical mast. The first aircraft was completed on 14 September 1942. Now with America deeply involved in the European war, the P-47Cs were rushed to England, with the first aircraft arriving on 20 December 1942, where 8th Fighter Command was beginning to take shape. The 8th Fighter Command was made up of three fighter groups, the 4th, 56th, and 78th Fighter Groups — all of which would be equipped with the new P-47C.

The first group within 8th Fighter Command to receive the new Thunderbolt was the 4th FGp. The 4th was made up of the old Eagle Squadron pilots that had helped Britain win the Battle of Britain in 1940. When America entered the war, the Eagle Squadrons were consolidated under one US Army Air Force unit - the 4th FGp. Having continuously flown Spitfires the 4th was none to eager to switch the huge ungainly looking Jug. Second combat unit to receive the P-47C was the 78th FGp. The third and last unit to receive the P-47C was the only unit that actually had any training in the aircraft, the 56th FGp. It was also a pair of 56th FGp pilots that became the first Thunderbolt pilots to break the "sound barrier". The two pilots went into a steep dive and the airspeed indicator read an amazing 725 mph. Many other P-47 pilots would also lay claim to some rather astounding speed marks, some as high as 800 mph. But it was simply instrument malfunction. The design of the P-47 was such that it simply would not exceed 600 mph, no matter how far it was dropped. There were fifty-seven P-47Cs built.

The first mission flown by a P-47 unit was on 10 March 1943 when the 4th FGp tried a fighter sweep over France. The mission was a total failure due to radio malfunctions. All P-47 aircraft were subsequently modified to accept RAF radios and full P-47 operations began on 8 April. The first encounter between the P-47 and the Luftwaffe occurred on 15 April when the 4th FGp jumped some unwary Germans over France. Major Donald Blakeslee scored the first P-47 kill. The first P-47 escort mission occurred on 17 August when the 56th FGp escorted a B-17 strike along the first part of their journey to Schweinfurt.

P-47C-1

The P-47C-1 was the first to have the stretched fuselage. P-47C serial 41-6066 was used as a prototype aircraft and the fuselage was extended eight inches at the firewall. This created a better center of gravity and made the engine accessories compartment much roomier and easier to work in. The P-47C-1 also had fixed deflection plates between the oil cooler shutters and the exhaust waste gates. Detail changes were made to the electrical system, undercarriage and brakes, and a hydraulic flap equalizer was added. A total of 55 P-47C-1s were built.

P-47C-2

The P-47C-2 was identical to the C-1 with the exception of an attachment point being added to the belly of the aircraft for carrying the 200 gallon ferry tank. A total of 128 P-47C-2s were built.

P-47C-5

The P-47C-5 was identical to the C-1 and C-2 except that the radio antenna mast was replaced with a whip antenna, and cockpit heating was incorporated on the production line. 362 P-47C-5s were built, for a grand total of 602 P-47C models.

Fuselage Extension

P-47B

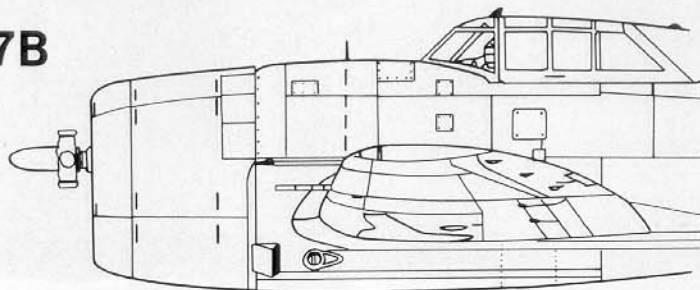

P-47C-1

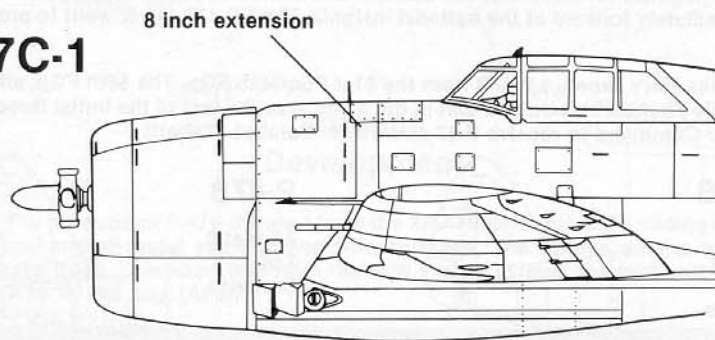

An early P-47C with a training unit in the US. The major difference between the P-47B and C was an eight inch extension of the fuselage at the firewall. "Betty" was an element leader's aircraft as denoted by the single color stripe around the rear fuselage. (AFM)

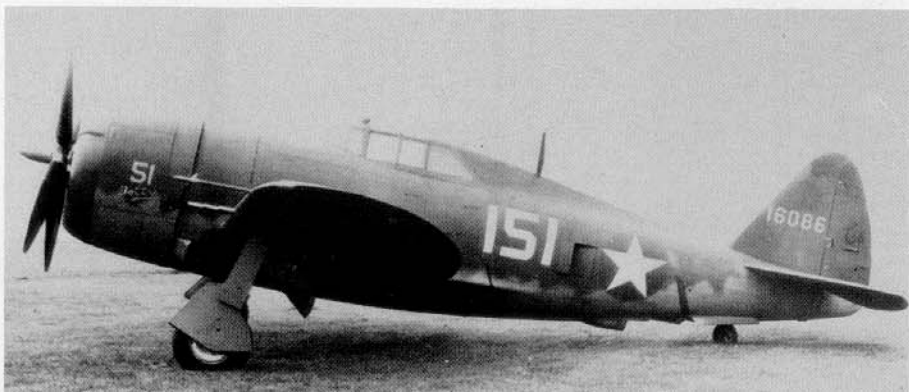

One of the first P-47Cs being readied for a combat unit on the ramp at RAF Goxhill on 4 January 1943. Goxhill was the base in England where P-47s were reassembled after shipment across the Atlantic. It was here that the British got their first real view of the massive Thunderbolt — they couldn't believe it would fly, much less carry on a dog fight with the nimble German fighters. (AFM)





(Above) A battle damaged P-47C from the 78th FGp. One of the greatest attributes of the Jug was its ability to absorb a great deal of punishment and still bring the pilot home. (Fry via Stafford)

(Above Left) A flight of P-47Cs enroute to a combat unit from Goxhill. Note the mixture of markings; two aircraft carry full theater ID bands, while the three in the rear carry OPERATION TORCH yellow-trimmed national insignia. (Ethell)

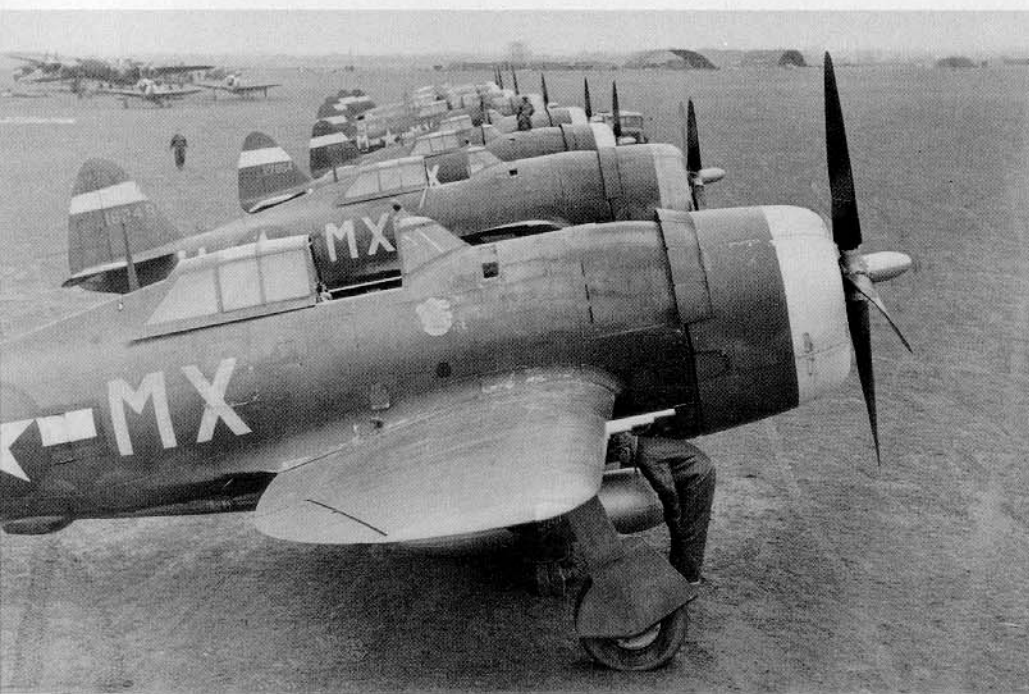

Oil Cooler Shutters

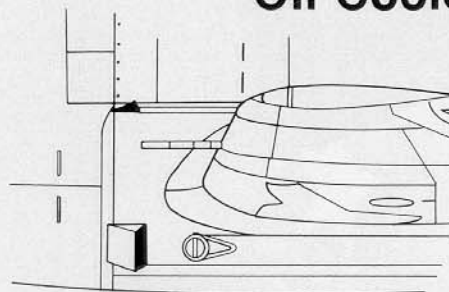

P-47B

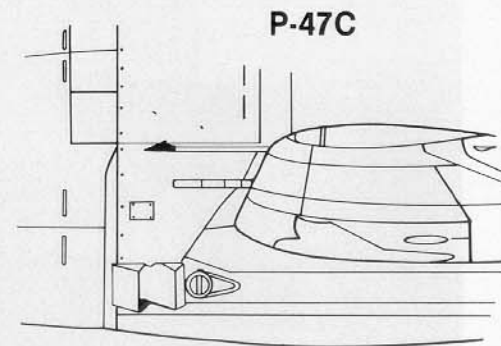

(Left) A lineup of P-47Cs from the 78th FGp at Duxford. Three Fighter Groups operated the P-47C with Eighth Fighter Command — the 4th FGp, 78th FGp, and lastly although they had been trained first, the 56th FGp. Note the long range pressed paper fuel tank, a British design, on the centerline. (Ethell)

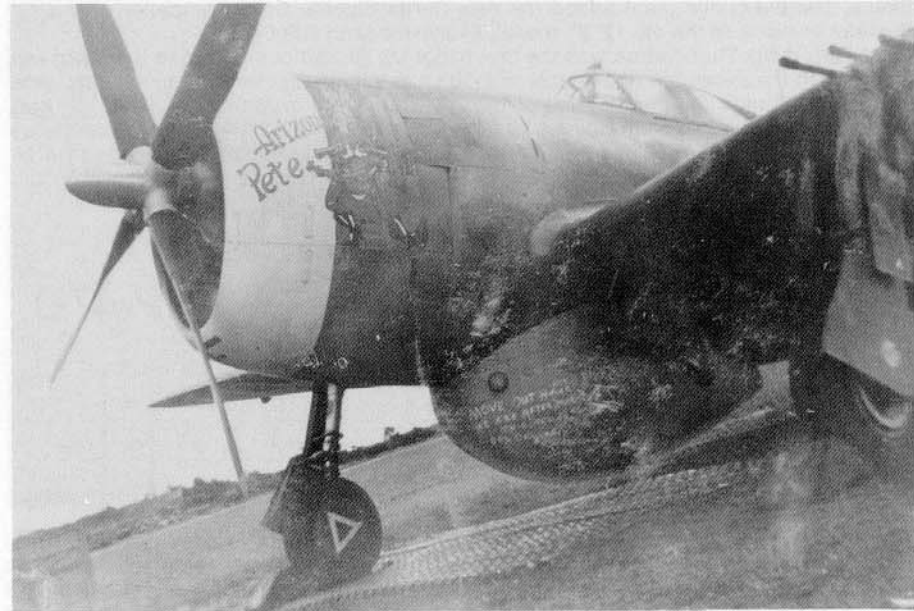

(Above) "Arizona Pete", a 4th FGp P-47C on the Debden ramp in early 1943. "Pete" carries the 200 gallon ferry tank, nicknamed "babies", that were converted for combat use. Note the streamlining of the upper edge of the tank where it meets the fuselage. (AFM)



(Above Right) A section of P-47Cs from the 62nd FSq/56th FGp at Halesworth. The 56th FGp would eventually score over 1000 kills by wars end — all flying Jugs. (AFM)

200 Gallon Ferry Tank

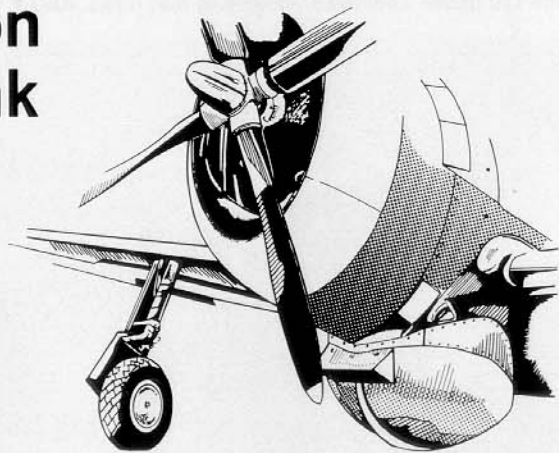

(Right) After the P-47C was phased out of active service with combat units, many were retained on active status as unit trainer aircraft or hacks used by commanders to visit other bases. "The Old Man" was used as a formation aircraft by the 446th BGP in 1944. (AFM)



P-47D Razorback

The P-47D series actually began as P-47Bs built by another factory. Republic Aviation at Farmingdale could not keep up with the orders for Thunderbolts and decided to build a second plant at Evansville, Indiana. With two plants building the Thunderbolt, the War Department needed a way to tell the aircraft apart. It was decided to designate all Evansville aircraft with the suffix of RA. Thus the first aircraft from Evansville were P-47D-RA. They were identical in every way to the Farmingdale-built P-47C-2s. The Evansville plant produced 110 P-47D-RAs.

The first Republic-Farmingdale built P-47D was the D-1. Farmingdale-built aircraft carried the suffix RE. Thus the Farmingdale aircraft were designated P-47D-1-RE. The P-47D-1-RE differed from earlier versions by having an additional pair of cooling flaps on the engine cowl. These additional flaps vastly improved the cooling of the big R-2800-21 engine, which suffered from cylinder head overheating. Other changes in the D-1 included additional pilot armor protection, further fuel and oxygen system changes, and the exhaust ducting was further modified for improved reliability and performance. There were 105 P-47D-1-REs built. The D-2 series were identical to the D-1 except for removal of the turbosupercharger shroud, with 665 D-2s being built by both factories.

The P-47D-5-RE had the GE C-21 supercharger and regulator. This along with provision for water injection greatly improved available horsepower. The D-5 was also the first production aircraft to have the B-7 two-point bomb or drop tank shackles added to the belly of the aircraft. There were 300 D-5s built. The D-3-RA was similar to the D-2 and not up to D-5 standard. The D-4-RA had the C-21 supercharger and water injection but was still not quite to D-5 standard. D-3/D-4 production was 200 aircraft. The D-6-RE was identical to the D-5 but with some minor electrical system changes. Republic built 350 D-6s.

The P-47D-10-RE incorporated the R-2800-63 engine at 2300 hp. The -63 engine had the GE C-23 supercharger with the water injection being operated by a switch on the throttle. Additionally, the hydraulic flap equalizer was deleted, and there were minor changes to the cooling, oil, and hydraulic systems. For the first time, the guns could be charged from within the cockpit by a cable. There were 250 built. The D-11 was built by both Republic factories. It was identical to the D-10 but had an electrically-driven water pump, which was automatically operated during throttle movement. The two factories built 650 D-11s.

The P-47D-15 was the first Thunderbolt built with underwing pylons and fuel system plumbing within the wings to use underwing droppable fuel tanks. The standard underwing fuel tank for US Army aircraft was the US designed 75 gallon tank. The 108 gallon tanks seen on both Thunderbolts and Mustangs, either in pressed paper or metal, was a British design. The internal fuel capacity was also increased to 375 gallons. Ordnance load was increased to 2500 lbs. And the canopy was completely jettisonable. There were 653 D-15s built by the two factories. The D-16 was built by both factories and differed from the D-15 only in minor fuel system changes. 283 were built.

The P-47D-20 was quite similar to the D-15s except that the engine had a new GE ignition system, resulting in the engine being designated R-2800-59. In addition, the D-20 had a longer tail wheel strut, redesigned underwing pylons, and had ducted heat to the gunbays instead of electrical heat. Beginning with aircraft serial 42-25274, all camouflage paint was deleted. The two Republic factories built 487 D-20s. There were 440 D-21s built which were the same as the D-20 except for a redesigned throttle button that controlled the water injection.

Beginning with the P-47D-22-RE, the two Republic factories began doing things slightly different from each other. The D-22-RE had a new Hamilton Standard Hydramatic 24E50-65 propeller with a 13' 1 7/8" diameter in place of the Curtis Electric 12' 2" model found on all earlier variants. A new GE A-23 turbosupercharger regulator was also added, along with carburetor heat being eliminated starting with the 89th aircraft. Farmingdale built 850 D-22s.

The P-47D-23 was the Evansville equivalent to the D-22 except for a change in propeller

choice. The Evansville plant added the new Curtis Electric C542S propeller with a 13' diameter in place of the old 12' 2" model. Evansville built 889 D-23s.

The Razorback Thunderbolt was the first major US aircraft committed to the European airwar. With the exception of a couple of P-38 units, all 8th Fighter Command units were P-47 equipped until the introduction of the P-51B Mustang in January of 1944. The first Thunderbolt ace was Captain Charles Landon from the 78th FGp. He achieved ace status on 30 July 1943. The first use of the Thunderbolt as a fighter-bomber occurred on 25 November 1943 when sixteen 353rd FGp P-47Ds attacked St Omer Airdrome with 500lb bombs.

Cowl Flaps

P-47C

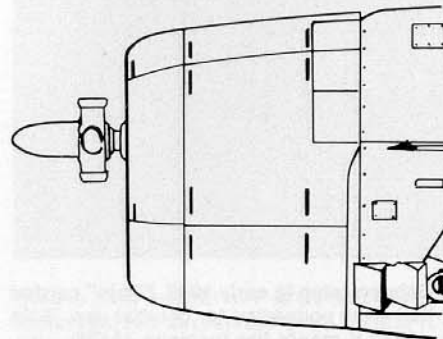

P-47D

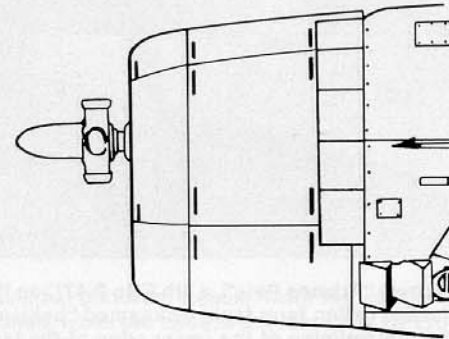

(Below) An early P-47D on the ramp at Meeks Field in Iceland, a refueling stop on the trans-Atlantic ferry route. The P-47D-1 could be distinguished by the additional cowl flaps. Note the 150 gallon Lockheed underwing fuel tanks. (USAF via Ethell)

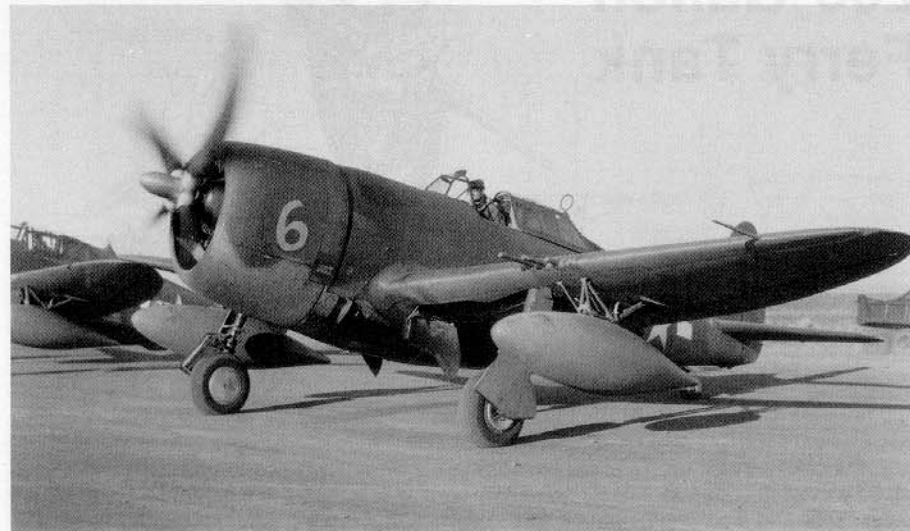



(Above) "Chief Wahoo", a P-47D-1 from the 351st FSq/353rd FGp, exhibits many mission and kill marks. Since the P-47 had a similar profile to the German Focke Wulfe FW 190A, Eighth Fighter Command had white bands applied to the nose and tail to help pilots quickly identify a friendly aircraft during a fight. (AFM)



(Above) A P-47D-2 from the 348th FGp on New Guinea. Note the white leading edges on the wing, an attempt to help pilots quickly identify friendly P-47s from the Mitsubishi Zero. Note the flat 200 gallon belly tank. (AFM)



(Above) Howard "Deacon" Hively, an ace with the 4th Fighter Group, stands beside the nose of his P-47D-1. The added cowl flaps which differentiated the P-47D from a C can be seen. (Ethell)



European Theater Operations

(ETO) Identification Bands

White on painted Aircraft
Black on natural metal Aircraft



(Above) "Beetle", a 355th FGp P-47D that was shot down in November 1943 and rebuilt by the Germans, who then used the aircraft to train German fighter crews on how to attack the Thunderbolt. (Bundesarchiv)



(Above) A brand new P-47D-4 of the 359th FGp sits on the ramp at Duxford along with 78th FGp P-47Cs. The early P-47D, even with its longer fuselage and extra cowl flaps, differed very little from the P-47C in both performance and reliability. (USAF via Ethell)

(Below) A ramp full of P-47D-5s at the Republic plant awaiting ferry pilots for the long trans-Atlantic flight to combat units in England. Note the 150 gallon long range underwing fuel tanks that were adapted from Lockheed P-38 tanks. (USAF via Ethell)



Drop Tanks

Belly Tanks

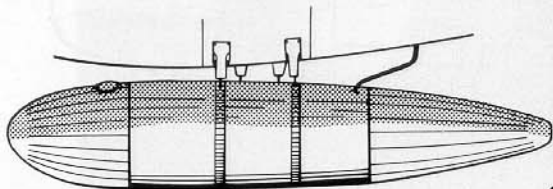

Early 200 gallon Belly Tank
Made of impregnated paper

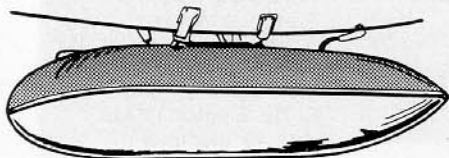

200 gallon "Flat" Belly Tank

Wing Tanks

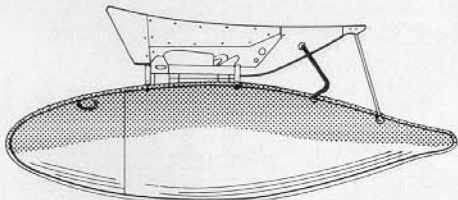

150 gallon Wing Tank

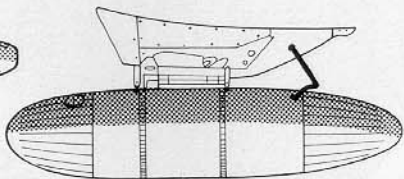

108 gallon Paper Wing Tank

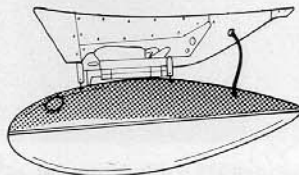

75 gallon Wing Tank

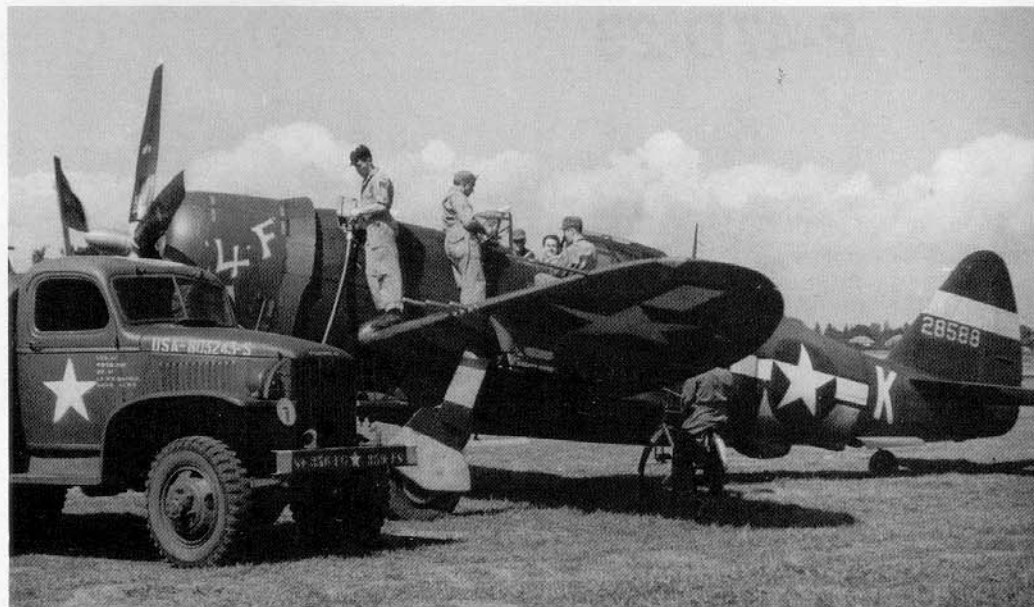

(Above) "4-F", a P-47D-5 from the 359th FGp at East Wretham during the summer of 1944. Note the "grayed-out" D-Day stripes. The cowl ring of 359th FGp aircraft was painted Kelly Green. (AFM)

(Below) "Spirit of Atlantic City, N.J.", a P-47D-5, was the personal aircraft of Walker Mahurin, who scored 21 kills with the 56th FGp, better known as Zemke's Wolfpack. (AFM)



P-47D-23

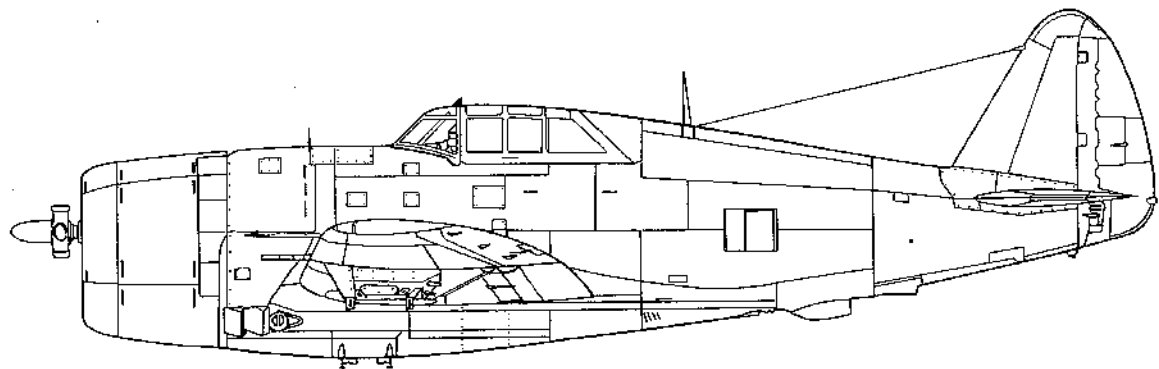

Specifications

Manufacturer:	Republic/Evansville
Engine:	Pratt & Whitney R-2800-59
Horsepower:	2000/2300 in War Emergency setting
Propeller:	Curtis Electric C542S with 13' diameter
Span:	40' 9 5/16"
Length:	36' 1 3/4"
Height:	14' 8 1/16"
Weight:	9900 lbs empty, 17,000 lbs maximum
Speed:	426 mph @ 30,000 feet
Ceiling:	40,000 feet
Range:	800 miles @ 10,000 feet
Armament:	Eight .50 calibre machine guns plus 2500 lbs ordnance

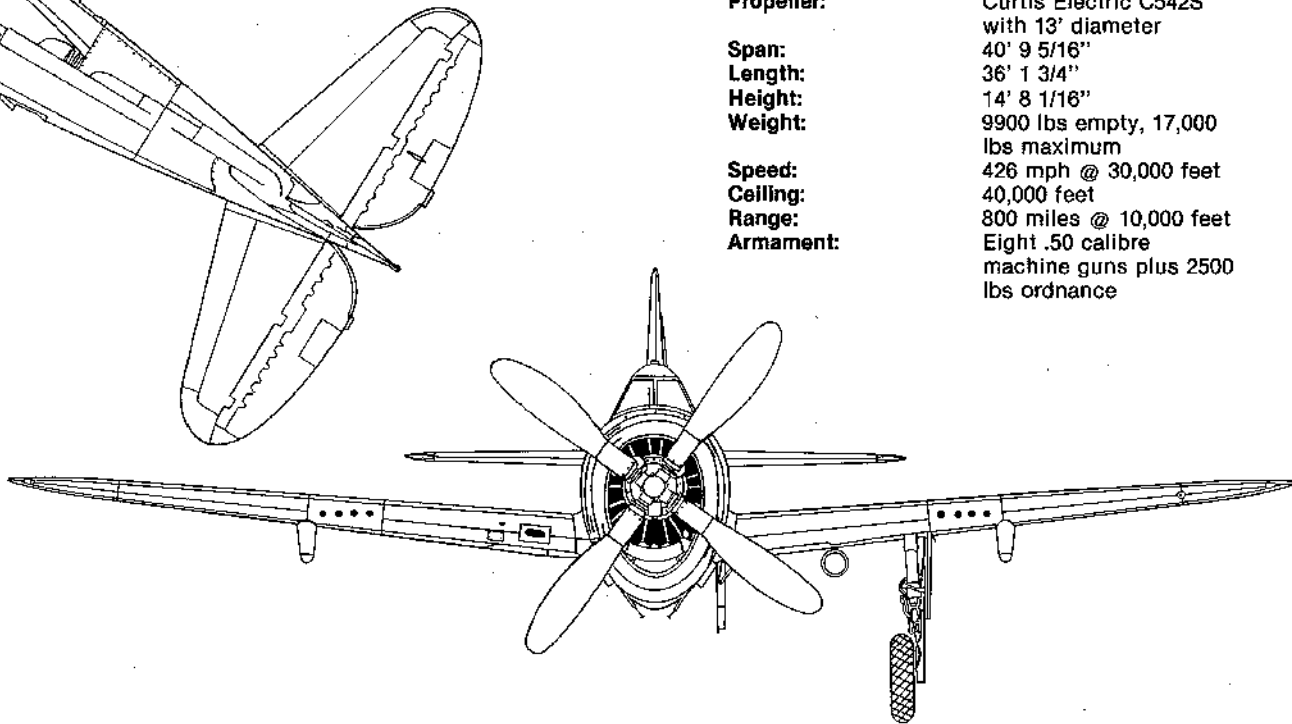



(Above) "Iron Ass", another P-47D-5 from the 56th FGp, is armed with a 250lb bomb on the centerline station and no underwing fuel tanks. Thus armed, the aircraft is probably taxiing out for a practice bombing mission since Thunderbolt pilots rarely ventured over the Continent without wing tanks. (AFM)

(Below) A P-47D-10 from the 317th FSq/325th FGp on the ramp at Foggia, Italy, during late 1943. The D-10 introduced the more powerful R-2800-59 engine rated at 2300 horsepower in War Emergency setting. Note the new Blue surround to the national insignia, covering the old Red surround, which was added in mid-1943. (Brown via Ethel)

(Below) "Speed" flew with the 354th FSq/355th FGp. Note the various whip antenna mounts on the razorback portion of the fuselage. (Mitchell via Olmsted)

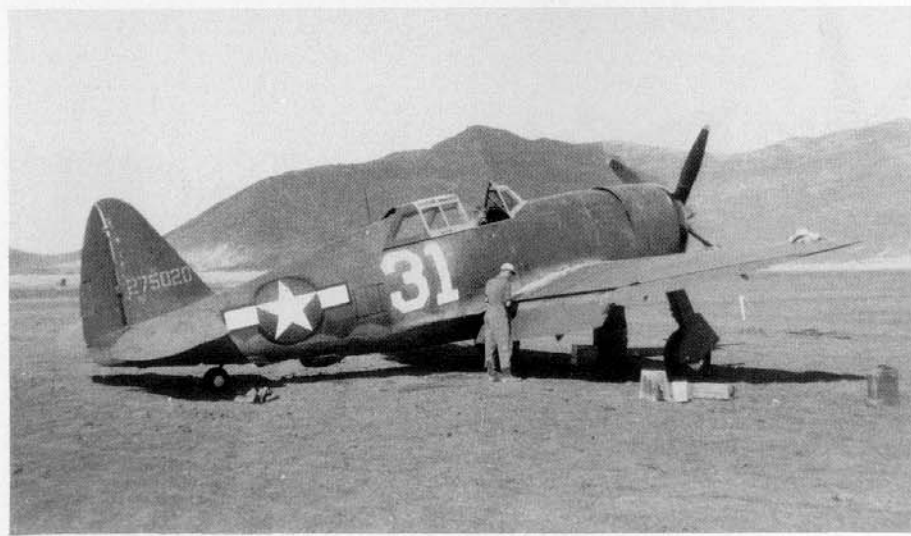
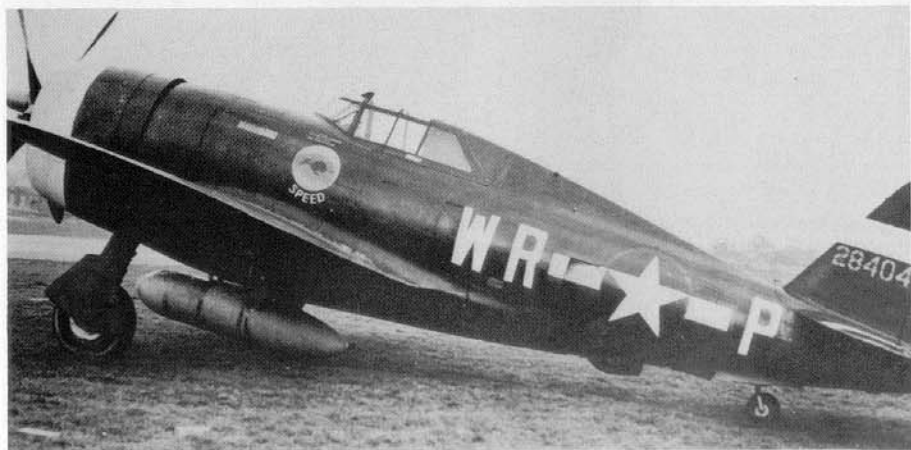

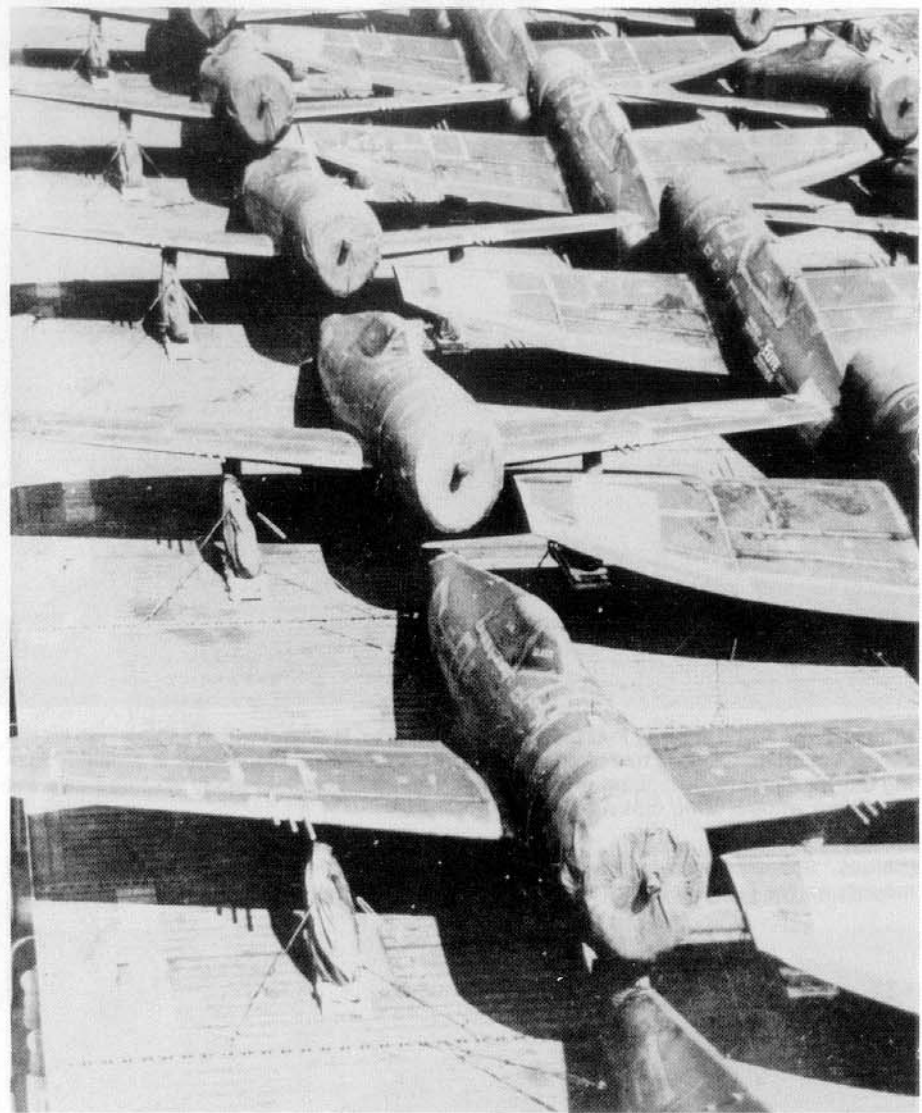

(Above) A group of P-47Ds enroute to bases in the South Pacific, aboard an aircraft carrier docked at Ford Island, Pearl Harbor, Hawaii. Hickam Field on Hawaii was the Western Pacific P-47 assembly and repair depot. (AFM)

(Above Left and Left) "Miss Mary Lou" was the personal mount of Major Henry McAfee with the 318th FG on Saipan in the South Pacific. "Mary" is armed with two of the many ordnance possibilities for the P-47s — 5 inch rocket tubes in the upper photo; and 1000lb bombs in the lower photo. The markings for the 318th FGp were a natural metal cowl and tail surfaces on an otherwise camouflaged aircraft. (USAF via Ethell)



(Above) The ramp at Isley Field on Saipan, full of P-47Ds from the 318th FGp. Note the slender, pointed shape of the Curtiss Electric propeller. (AFM)

(Below) Praeger Neyland flew "Pistol Packin' Mama" with the 56th FGp in 1944. Neyland was slightly injured and "Mama" suffered a tail wheel collapse after a 20mm hit from a Focke Wulfe. The underlined B in the fuselage code meant that "Mama" was the second aircraft in the 61st FSq to carry the code letter B. (AFM)



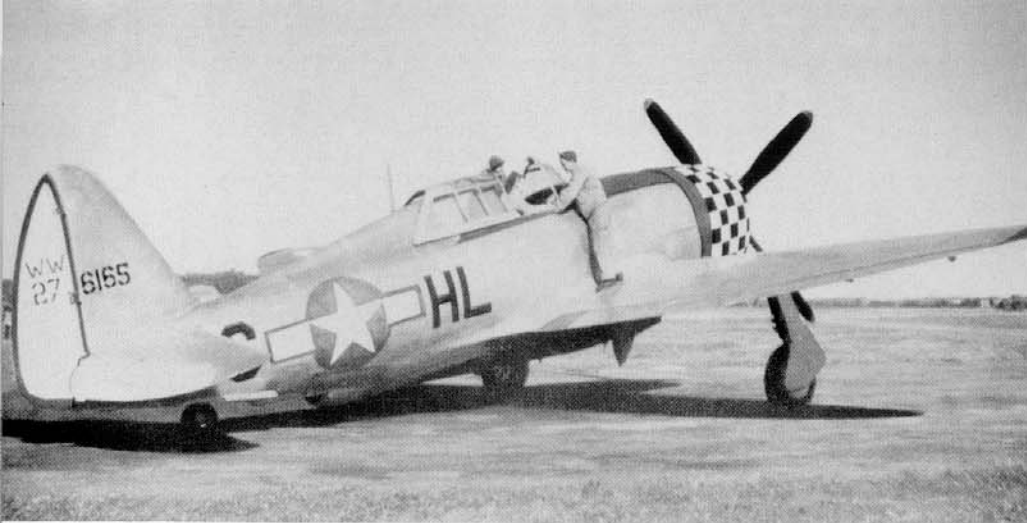

(Above) A P-47D-15 from the 78th FGp. "WW" on the tail indicates a "War Weary" aircraft, one that has many hours of combat time on the airframe. The aircraft has been relegated to the role of unit hack. (78th FGp Assn. via Olmsted)

(Below) A brand new P-47D-16 on the ramp at Solimon, Tunisia, in 1943. P-47s arrived by ship without props, wingtips, or accessories. The aircraft were assembled at Solimon and flown to their combat units, in this case the 325th FGp at Foggia. (Brown via Ethell)

Cowl Flap Modification

P-47D-1

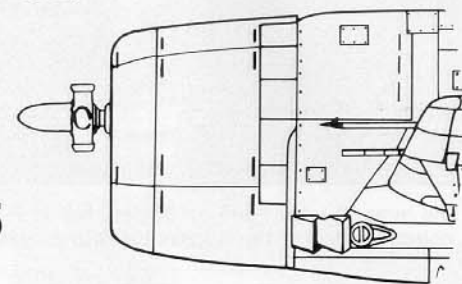
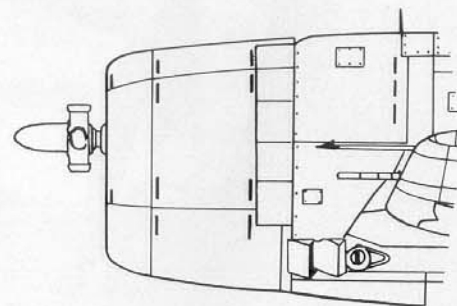

P-47D-15



P-47B (41-6002) flown by Major Hubert "Hub" Zemke, CO of the 56th Fighter Group at Mitchell Field, New York during the spring of 1943.



"Arizona Pete", a P-47C flown by Captain Kenneth "Blacksnake" Peterson with the 336th Fighter Squadron, 4th Fighter Group during 1943.

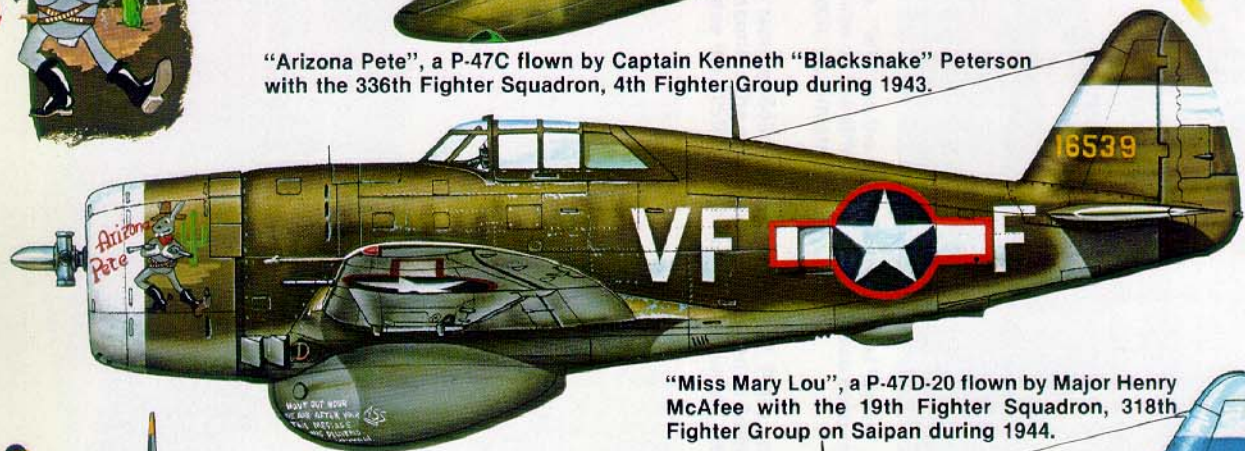

Miss Mary Lou

"Miss Mary Lou", a P-47D-20 flown by Major Henry McAfee with the 19th Fighter Squadron, 318th Fighter Group on Saipan during 1944.

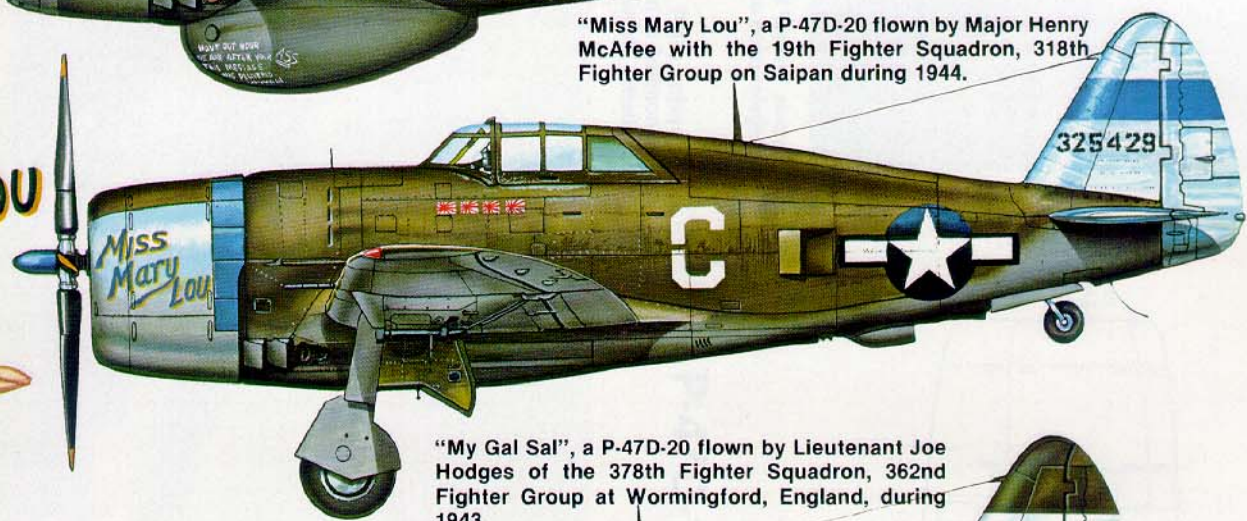

"My Gal Sal", a P-47D-20 flown by Lieutenant Joe Hodges of the 378th Fighter Squadron, 362nd Fighter Group at Wormingford, England, during 1943.

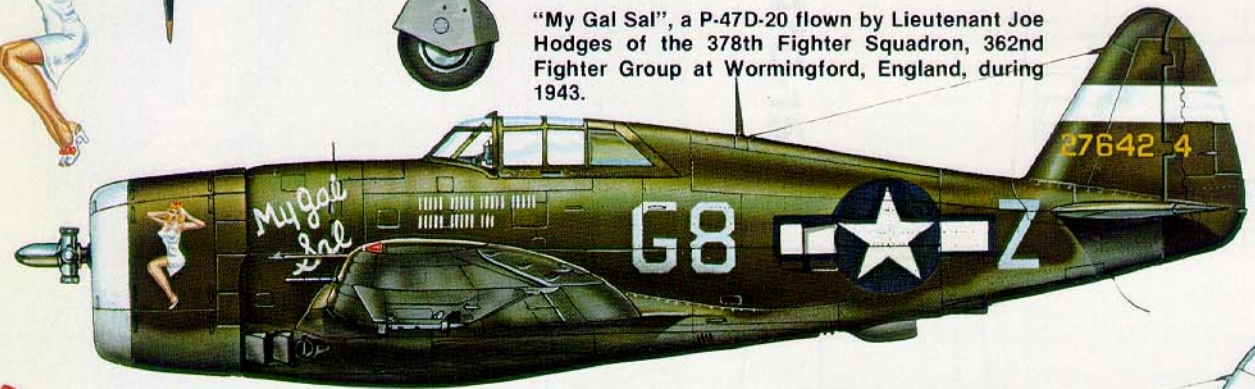

ZOMBIE

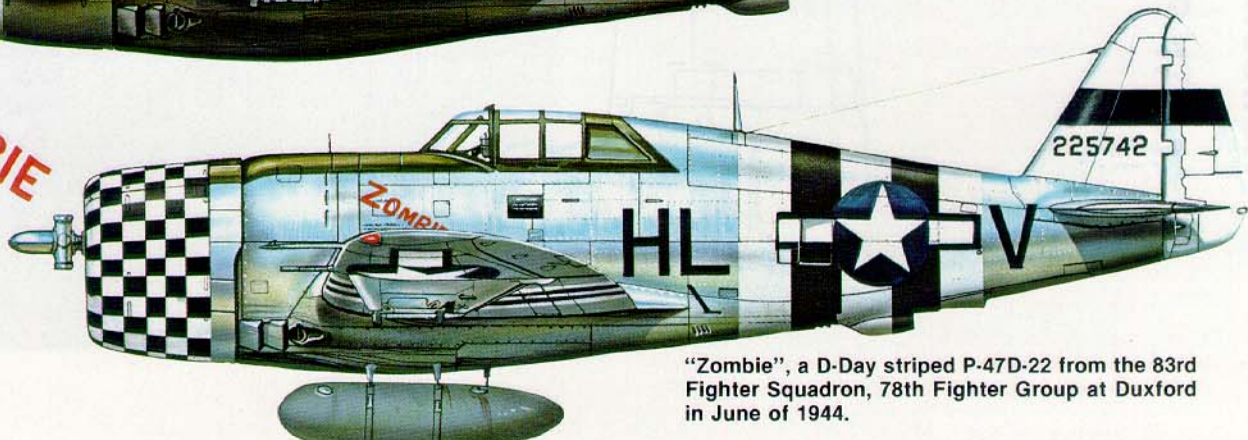

"Zombie", a D-Day striped P-47D-22 from the 83rd Fighter Squadron, 78th Fighter Group at Duxford in June of 1944.



A P-47D-25 assigned to the 1st Grupo de Caca, Forca Aerea Brasileira, and attached to the 350th Fighter Group in Italy during 1944.



"Dorothy K", a P-47D-28 flown by Lt Tallmadge Ambrose with the 410th Fighter Squadron, 373rd Fighter Group in April of 1945.

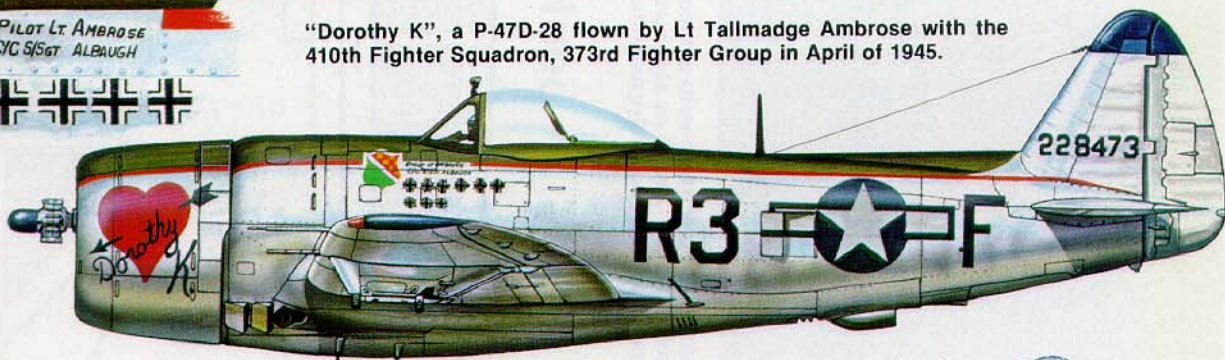

"Look - No Hands", a P-47D-30 from the 509th Fighter Squadron, 405th Fighter Group during the spring of 1945.



"BIG ASS BIRD II", a P-47D-30 from the 513th Fighter Squadron, 406th Fighter Group at Melsbroek Airfield, in Belgium during the Spring of 1945.

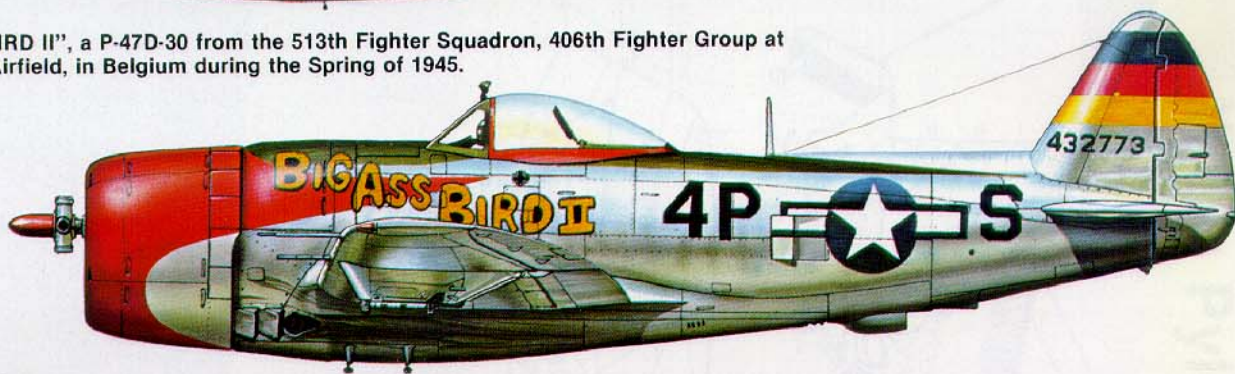

"EXPECTED GOOSE", a P-47N from the 463rd Fighter Squadron, 507th Fighter Group on Ie Shima during 1945.



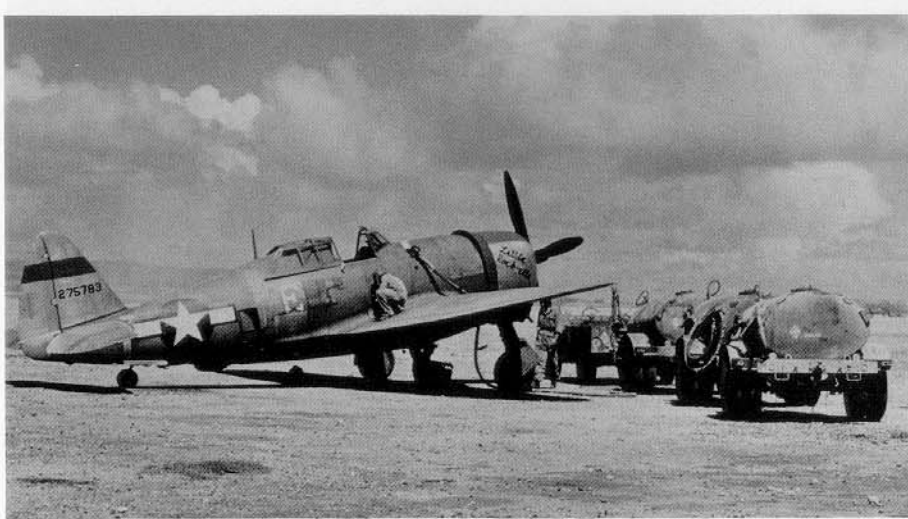

(Above) "Little Rockette", a P-47D-15 from the silver-nosed and tailed 318th FGp, being refueled for another strike against the Japanese on Saipan. The D-15 introduced the indented lower cowl flaps and underwing ordnance pylons, both of which were retrofitted to earlier model P-47Ds. (USAF via Ethell)

Wing Pylon

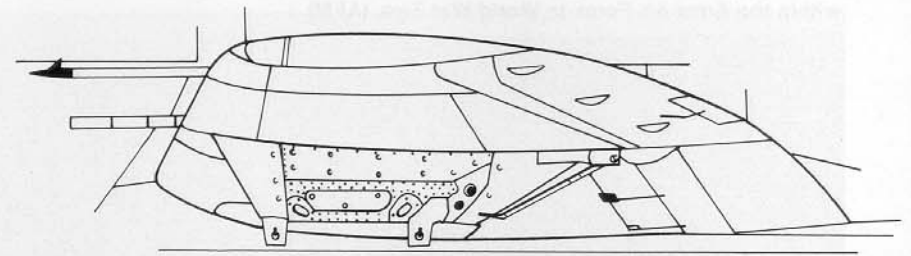
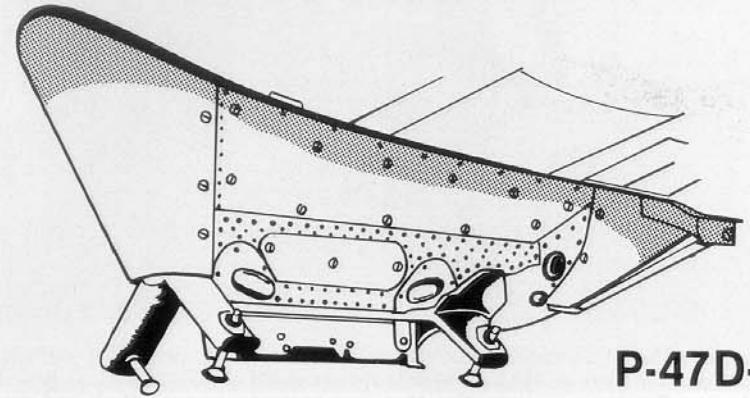

Malcolm Bubble Hood

Standard Framed Canopy

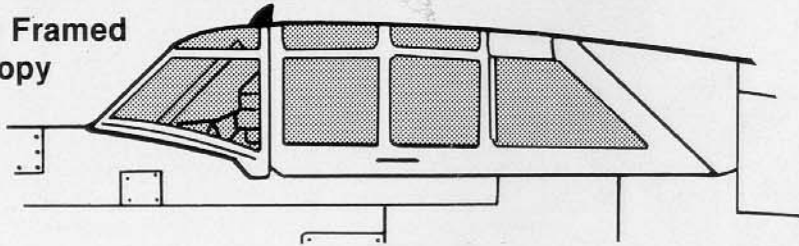

Malcolm Hood Canopy

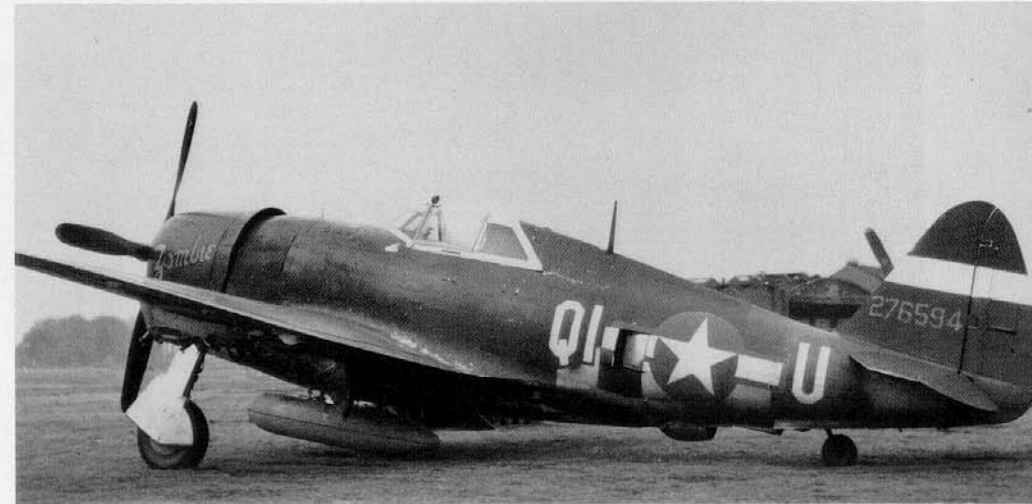
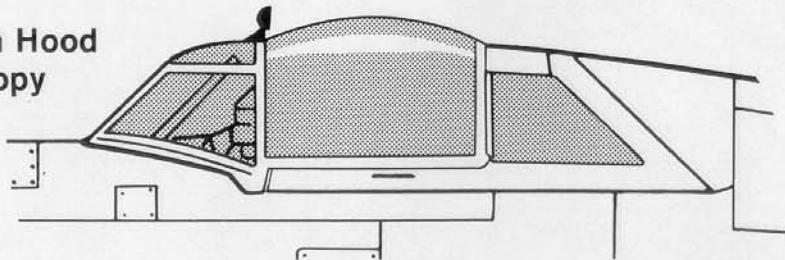

(Above) "Zombie", a P-47D-20 from the 361st FSq56th FGp on a forward airstrip in France during November 1944. Of special note is the British-designed "Malcolm hood", a bulged, unframed canopy added for better all-around vision. (USAF via Ethell)

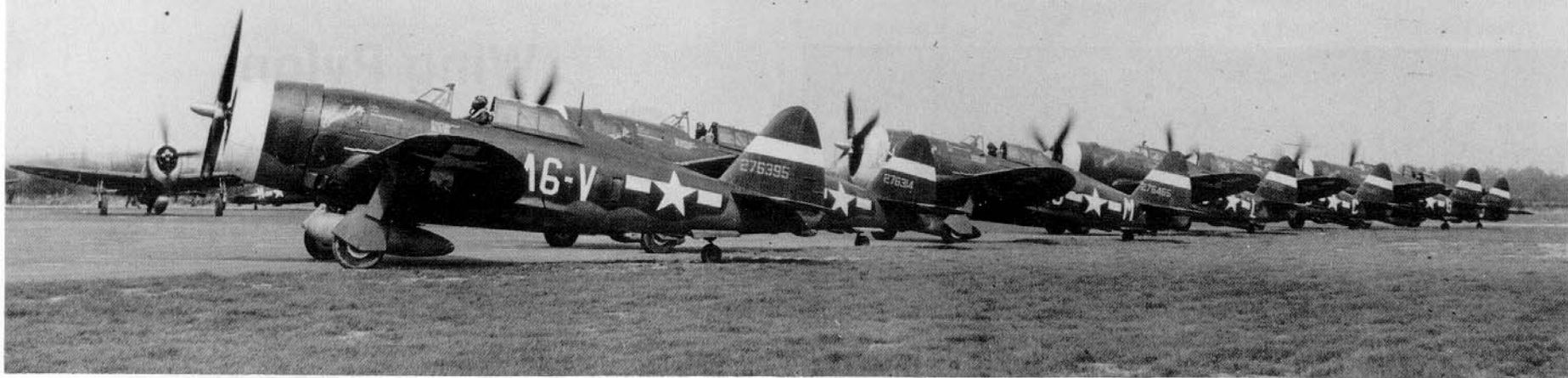

(Above) The 389th FSq await the takeoff signal prior to a strike against the rallyard at Louvain, Belgium in April of 1944. Note that almost every aircraft has some type of personal marking on the nose — a practice that was common among all air and ground crews within the Army Air Force in World War Two. (AFM)

(Below) The pilot of this 367th FSq, 358th FGp P-47D-20 brought the aircraft home with extensive damage to the port wing during one of the many D-Day strikes carried out by Thunderbolt crews. The full D-Day striping is well illustrated. (Olmsted)



(Right) "Frenchie", a P-47D-22 that was purchased with War Bonds bought by employees of the Republic Aircraft Corporation. Such aircraft were known as "presentation aircraft" and usually arrived at combat units carrying a special marking. (USAF via Ethell)



(Below) A flight of Thunderbolt Is from No 30 Squadron in Burma. The Thunderbolt I was any variant of the Razorbacked P-47D assigned to the Royal Air Force. The 240 Thunderbolt Is were delivered direct from the factory to combat units in the China/Burma/India Theater. CBI assigned Thunderbolt Is were camouflaged in RAF Dark Green and Earth, with Light Aircraft Grey undersides. (AFM)

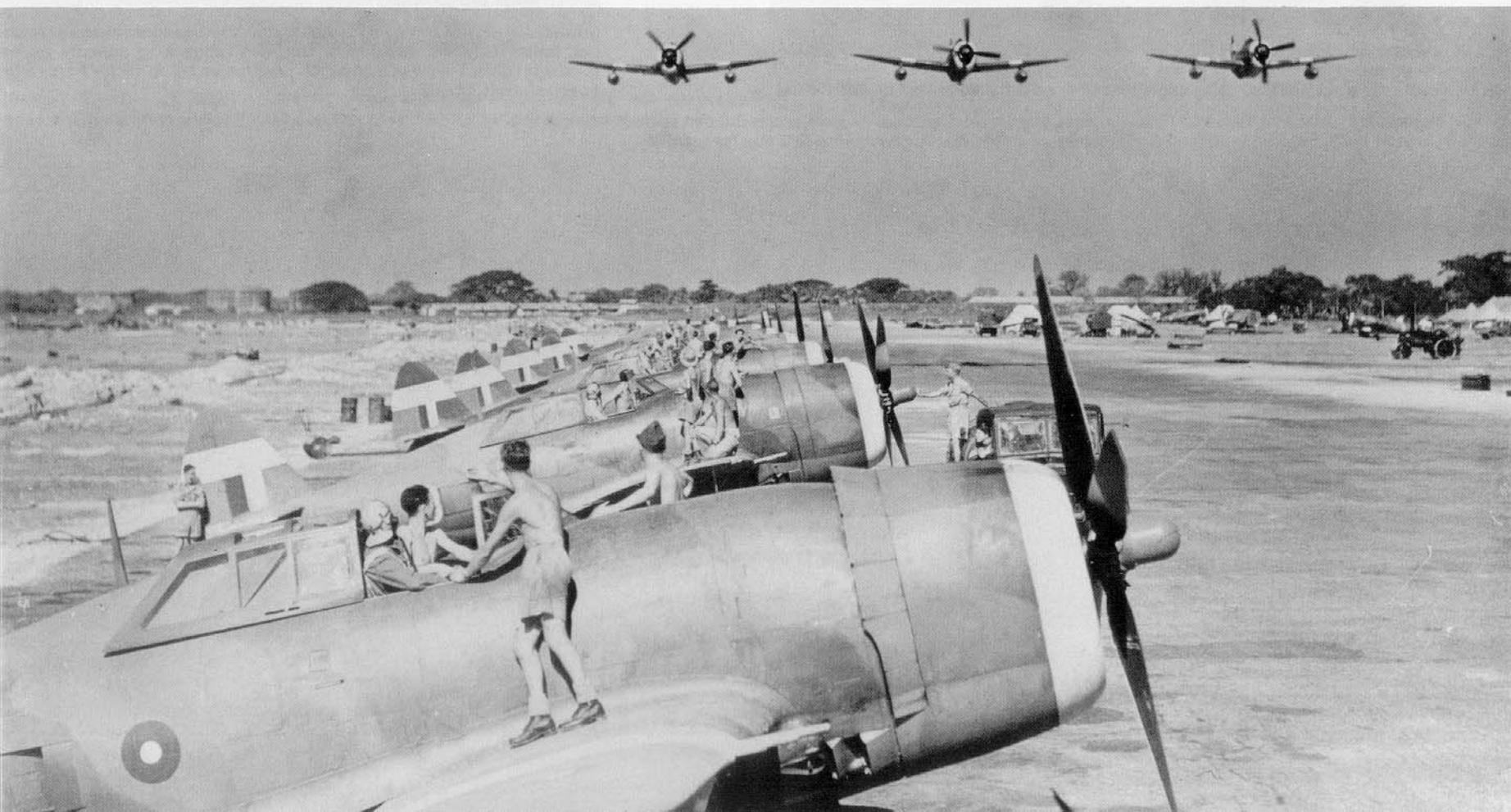
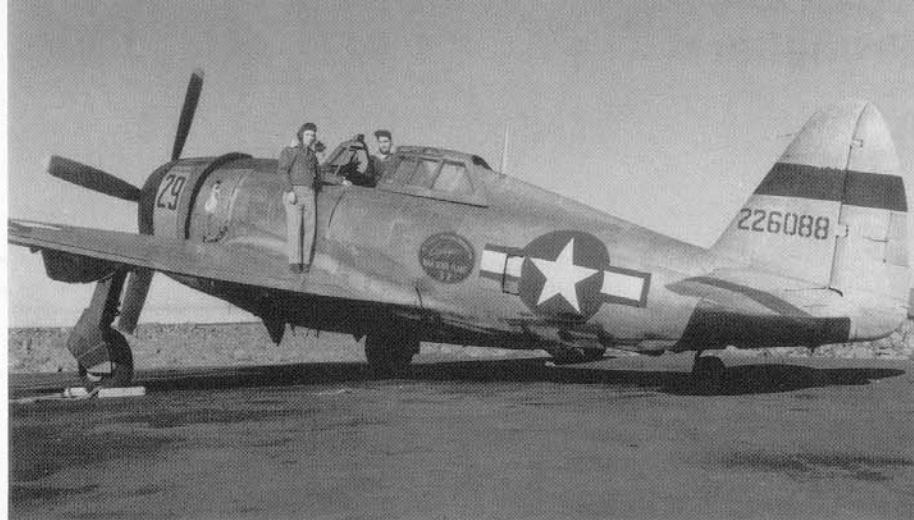

Propellers

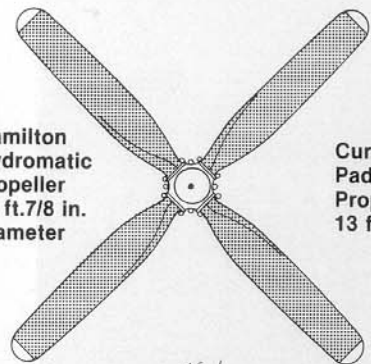

Hamilton
Hydromatic
Propeller
13 ft.7/8 in.
Diameter

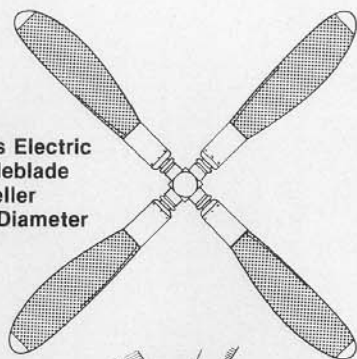

Curtis Electric
Paddleblade
Propeller
13 ft. Diameter

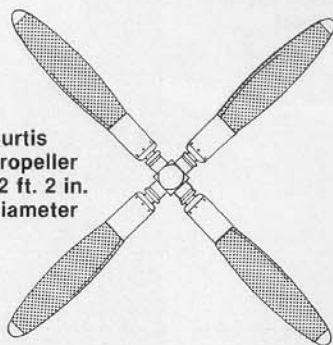

Curtis
Propeller
12 ft. 2 in.
Diameter

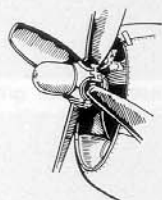

Hamilton
Propeller
Hub

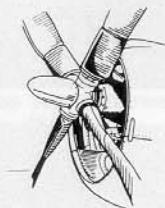

Curtis
Propeller
Hub



(Above) A P-47D-23 from the 1st Air Commando Squadron based at Asansol, India. Note the addition of the long range loop antenna to the fuselage spine. This was a common practice on US Army Air Force CBI-based aircraft. (AFM)

(Below) Major Glenn Duncan's "Dove Of Peace" comes to grief in a field near Raydon. Major Duncan scored nineteen kills in P-47s before the 353rd FGp transitioned to the North American P-51D Mustang. (AFM)



Direction Finding (DF) Loop

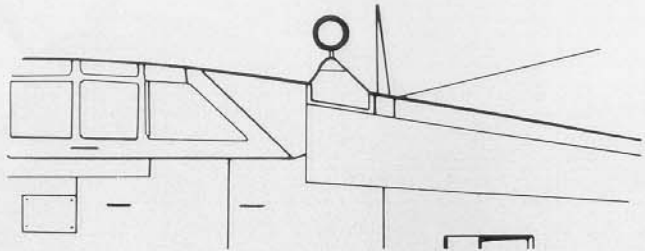

Fitted to aircraft used in The China, Burma, India (CBI) Theater, where long distance flights made additional navigation equipment essential



(Above) Another "Zombie", this time from the 78th FGp, in full D-Day stripes. Natural metal Thunderbolts began arriving during the spring 1944, but 8th Fighter Command suggested that all tactical aircraft be re-camouflaged prior to D-Day. However, this decision was left up to the individual unit commanders and many aircraft remained "clean". (AFM)

(Below) "The Blonde Angel", a P-47D-22 from the 506th FSq/404th FGp with extensive nose art, in addition to her 27 mission marks and D-Day stripes. (Rosen via ivie)



P-47G

It wasn't long before demand for the Thunderbolt exceeded the production capabilities of both the Farmingdale and Evansville Republic plants. The War Department decided to have a third factory begin production. Since Republic had no third factory, the added production would be license-built by another aircraft manufacturer. Boeing had done a similar thing with the trio of Boeing, Lockheed-Vega, and Douglas all building B-17s during the war. The Curtiss Aircraft Company had a plant in Buffalo, New York that could be used since demand for the Curtiss-designed and built P-40 series was on the wane. All the Curtiss-built P-47s would have the designation P-47G-CU.

The first Curtiss-built P-47Gs were identical in every way to the Farmingdale-built P-47C-RE. Since most of the P-47Gs would be used as trainer aircraft, the P-47G-CU had a provision for mounting a blind-flying hood inside the canopy. There were twenty P-47G-CUs built. The next variant was the G-1-CU. It was identical to the P-47C-1-RE with the eight inch fuselage extension at the firewall. Curtiss built forty of the G-1-CU. The first Curtiss-built version based on the P-47D was the G-5-CU. The G-5 was identical to the D-1-RE except for some minor changes in instrumentation and Curtiss specified brake changes. There were sixty G-5s produced. The G-10-CU was the Curtiss-built version of the D-5-RE, complete with B-7 shackles added to the fuselage belly — eighty were built.

The P-47G-15-CU was the Curtiss version of the D-10-RE. It was from the production run of 154 G-15s that Curtiss pulled two aircraft to be modified into two seat trainer aircraft, commonly referred to as DoubleBolts. A second cockpit was added in front of the original cockpit area, and took the place of the fuselage main fuel cell. The fuel cell was drastically reduced in size because of the added cockpit area. The canopy was extended forward over the second cockpit. Only two aircraft were so modified, serials 42-25266 and 42-25267, and the concept never went to the production stage. However, field modifications to a few standard P-47Ds also resulted in DoubleBolts. These aircraft were modified by the addition of a second cockpit behind the original cockpit. Full armament was carried on both the Curtiss-built and field modified DoubleBolts.

P-47G Doublebolt

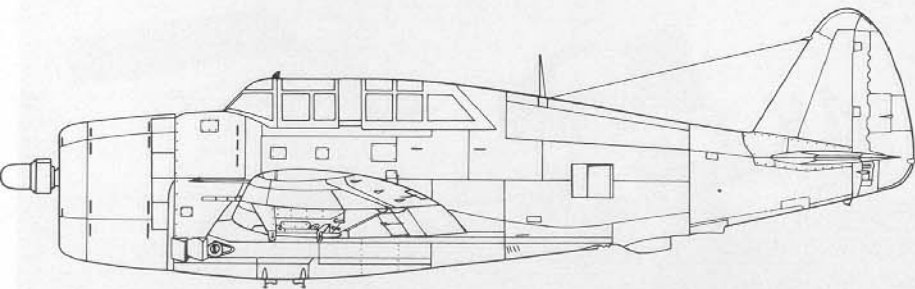

(Above) The P-47G series were various razorback Thunderbolts that were manufactured by the Curtiss Aircraft Corporation. Two P-47G-15s were factory-built as two-seat Thunderbolt trainers, the only "factory-built" two-seated Thunderbolts. (AFM)

(Below) Although only two P-47G-15s were factory-built as two-seated aircraft, many 'DoubleBolts' were built by combat units in the field. "Category E" had a second cockpit added behind the first on a War Weary P-47D-11. "Category E" was assigned to the 63rd FSq, 56th FGp. (AFM)



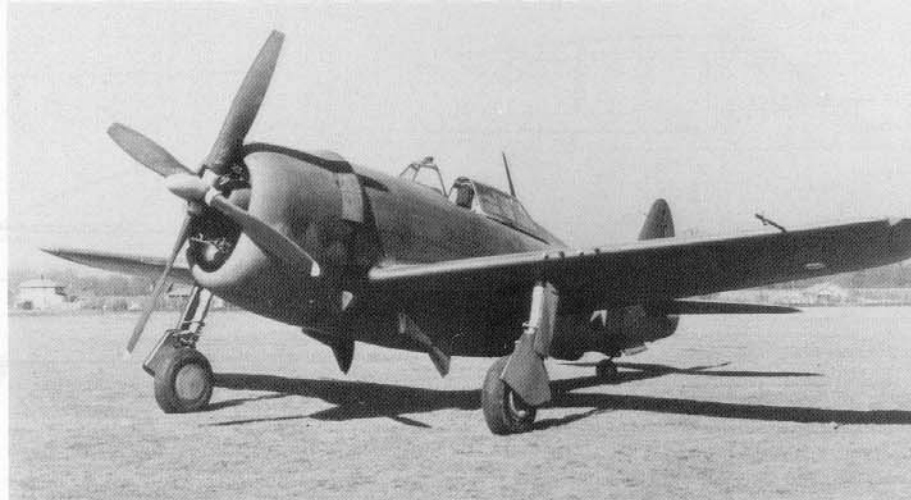

(Above) The XP-47F was a P-47B, serial 41-5938, that was fitted with a laminar flow wing similar to the P-51 Mustang. The project, which was to test the wing as a possible way to increase top speed, was canceled when the aircraft crashed. (AFM)

(Below) The XP-47J was the fastest Thunderbolt to fly. It was powered by a 2800 hp R-2800-57 in a lightened airframe and achieved 505 mph on 5 August 1944. (AFM)



(Above) The XP-47H was a modification of a standard P-47D-15 airframe to accept a 2500 hp, liquid-cooled Chrysler XI-2220 sixteen cylinder, inverted-Vee engine. Despite the added streamlining and horsepower, the XP-47H could only achieve 414 mph and did not fly until July, 1945. (AFM)



P-47D Bubbletop

One of the most numerous complaints of the combat crews flying the Razorback was the lack of rearward vision. In the summer of 1943, the last P-47D-5-RE, serial 42-8702, was taken from the assembly line and modified by cutting down the razorback spine and fitting a bubble canopy in place of the original framed version. The new canopy had full 360 degree vision and a new flat armored windscreen. The canopy was a modified Hawker Tempest unit and was electrically operated. Along with the all-new canopy design had to go an equally all-new cockpit design. The new bubbletop Thunderbolt was designated XP-47K and was completed on 3 July 1943. Additional changes included an added pair of oxygen bottles in the rear fuselage area, and the internal fuel capacity was increased to 370 gallons. The first production version of the bubbletop Thunderbolt was designated P-47D-25-RE and, as with previous Farmingdale-built aircraft, retained the Hamilton Standard prop. There were 385 D-25-REs built. The D-26-RA was the first Evansville-built bubbletop and was identical to the D-25 except that again, as with other Evansville-built aircraft, it retained the Curtiss Electric prop. Evansville built 250 D-26s. An extra 130 horsepower was added to the D-27-RE when water injection was added to the engine. Additionally, a new starter was added and the drop tank controls were improved. The D-27 was the last Thunderbolt with the Hamilton Standard prop. Republic-Farmingdale built 615 D-27s.

Beginning with the P-47D-28, the Farmingdale and Evansville Thunderbolts were identical, including the propellers. The Curtiss Electric C542S propeller was standardized over the Hamilton Standard version. Additional changes in the D-28 included minor revisions to cockpit switch locations, and a radio compass was added. The two Republic plants built a total of 1778 D-28s. The P-47D-30 was the largest production run of any type of Thunderbolt. The D-30 had a great many changes over the D-28, but most were of a minor variety. The main change of consequence was the addition of a pair of "dive flaps" on the underside of the wing at the thirty per cent chord area — between the main landing gear bays and the standard flaps. These were added for better pullout control at diving speeds. Additional improvements included blunt-nosed ailerons for better high speed control, the gun camera mount was revised and the old standby "ring and bead" gunsight was eliminated, the external stores sway braces became a permanent item and the stores were now electrically released. The D-30 also saw the movement of the rearview mirror from a standing outside position to one inside the upper windscreen. 2600 D-30s were built.

The next major step in Thunderbolt development was the P-47D-40-RA. It was significant in many ways. One complaint that combat crews had with the bubbletop versions was that of tail flutter caused by the loss of the razorback spine. In extreme cases, this tail flutter could cause loss of the entire tail assembly. Beginning with the D-40, and retrofitted to all previous variants still flying combat, a small dorsal fin fillet was added in front of the vertical empennage, thus eliminating the flutter problem. The D-40 also had provision for zero-rail rocket launch stubs on the underside of the wing in place of the old bazooka tube launchers found on earlier versions. A tail-warning radar and the new K-14 gunsight were also added to the D-40.

Since the Farmingdale plant was busy with both the P-47M and the new P-47N versions, all 665 D-40s were built by the Evansville plant. The D-40 was the final D variant to roll off the assembly line, with a grand total of 12,609 P-47Ds, including razorback versions, being built. Obviously, most of these went to service with the US Army Air Force in all theaters, but a great many were supplied to other nations including 830 to Great Britain, 427 to France, 203 to the USSR, 88 to Brazil, and 22 to the Mexican Fighter Squadron. After the end of World War Two, P-47Ds were supplied to Italy, Turkey, Iran, Portugal, Yugoslavia, Bolivia, Chili, Columbia, Dominican Republic, Ecuador, Honduras, Nicaragua, Venezuela, Peru, and Nationalist China. World War Two was not the final conflict for the Thunderbolt as RAF P-47Ds fought in Indonesia, French Thunderbolts fought in Algeria, Nationalist China used their Thunderbolts against the Red Chinese in the late 1940s, and some were used by rebelling factions of the Dominican Republican armed forces during the uprising in that island nation in 1965. Even today, they may be sitting alert in one of the "banana republics" that are in constant conflict south of our borders.

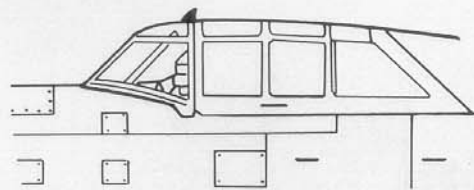

P-47D Razorback

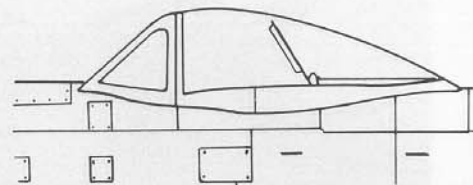

P-47D Bubbletop

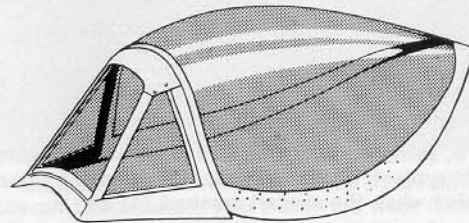

(Below) The XP-47K was the first Thunderbolt with a full bubble canopy. The XP-47K started life as the last P-47D-5, then had the razorback fuselage cut down and fitted with a modified Hawker Tempest canopy. (AFM)



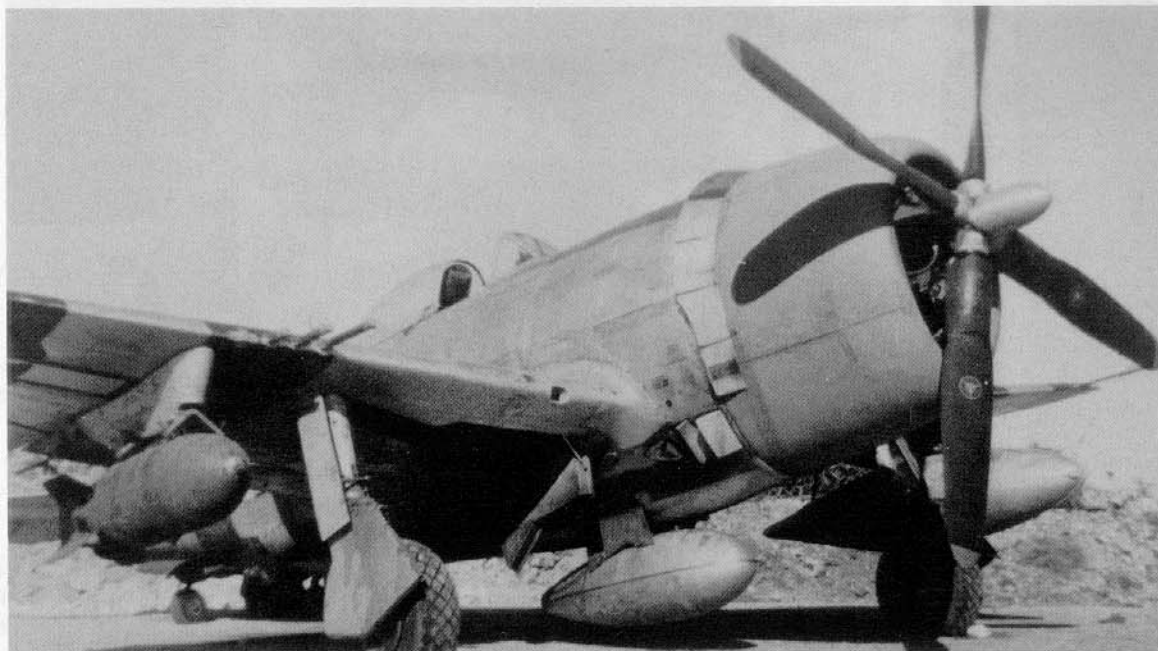

(Above) A P-47D-25 of the 310th FSq/58th FGp on Okinawa. The D-25 was the first production variant of the Bubletop Thunderbolt. Note the unusual, asymmetrical underwing load — a 300 gallon wing tank, 150 gallon fuel tank on the center station, and a 1000lb bomb. (Knight via Kampman)

(Below) A P-47D-25 from the 350th FSq/353rd FGp. The extreme bulk of the Thunderbolt is evident in this photo. The nose checks are Black and Yellow. Note the New Blue surround to the national insignia and D-Day stripes on the underside of the aircraft only. (AFM)



Cockpit

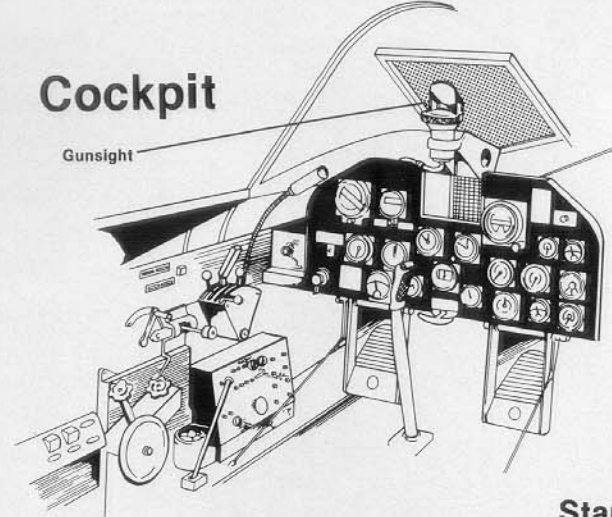

Starboard Inside of Cockpit

Seat

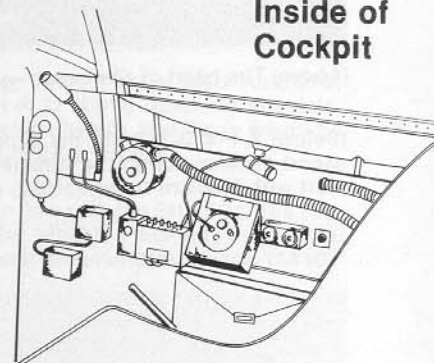
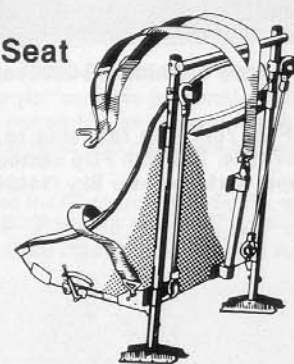

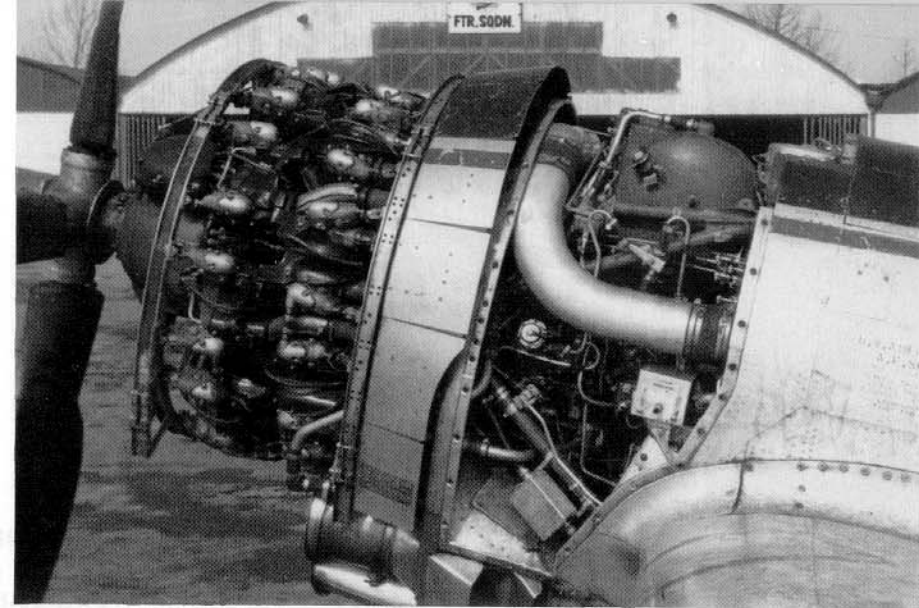

(Above) The heart of the beast — the Pratt & Whitney R-2800 radial engine. (Olmsted)

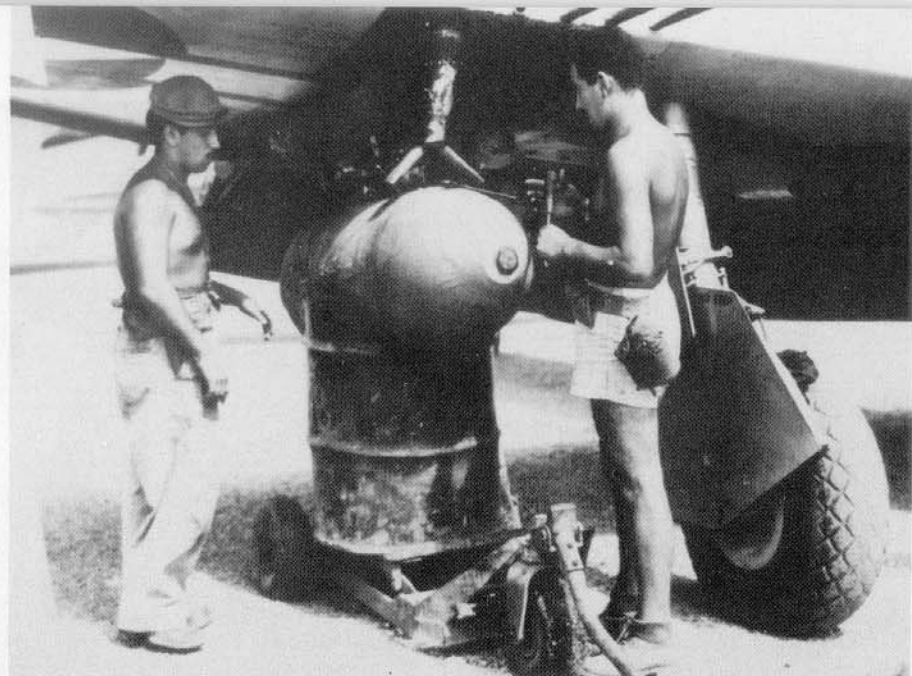

(Above) Two ground crewmen load a 1000lb bomb under the wing of a P-47D of the 201st Mexican Fighter Squadron at Poral Airstrip on Luzon. Of note is the sophisticated loading dolly. (AFM)

(Below) A P-47D-25 from the 82nd FSq, 78th FGp returning to Duxford after a bomber escort mission during the summer of 1944. The 78th FGp camouflaged some of their aircraft with Medium Green (34092) upper surfaces over Sky (34424) undersides. (AFM)



Rocket Launchers

4.5 inch Rocket Launcher

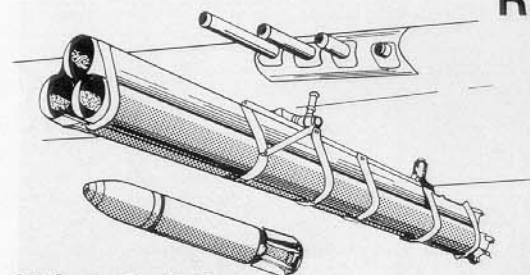

4.5 inch Rocket

P-47D-40 5 inch Rocket Launcher Stubs

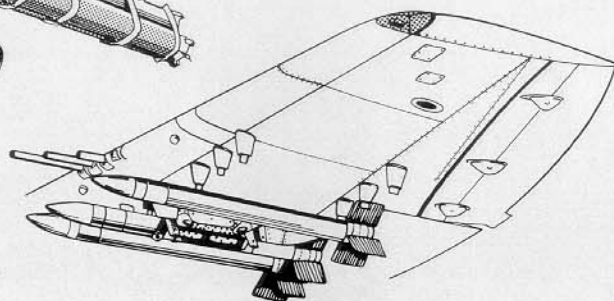

British 5 inch Rocket with Launch Rail

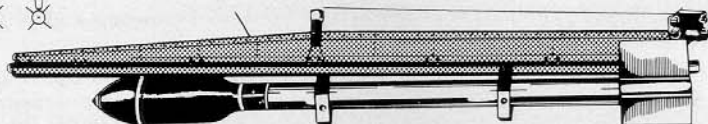

"Butch"; a 50th FGp P-47D, taxis on the PSP ramp of a hastily built forward airstrip in France during the early spring of 1945. Note the 5 inch rocket tubes, 500lb bombs, and the crew chief riding on the wing to provide forward vision while taxiing. (USAF via Ethell)

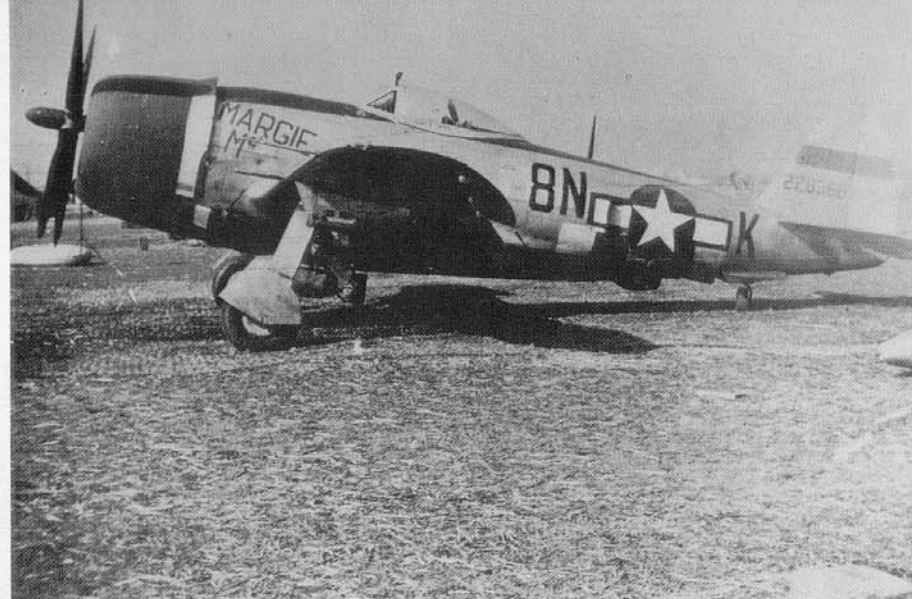
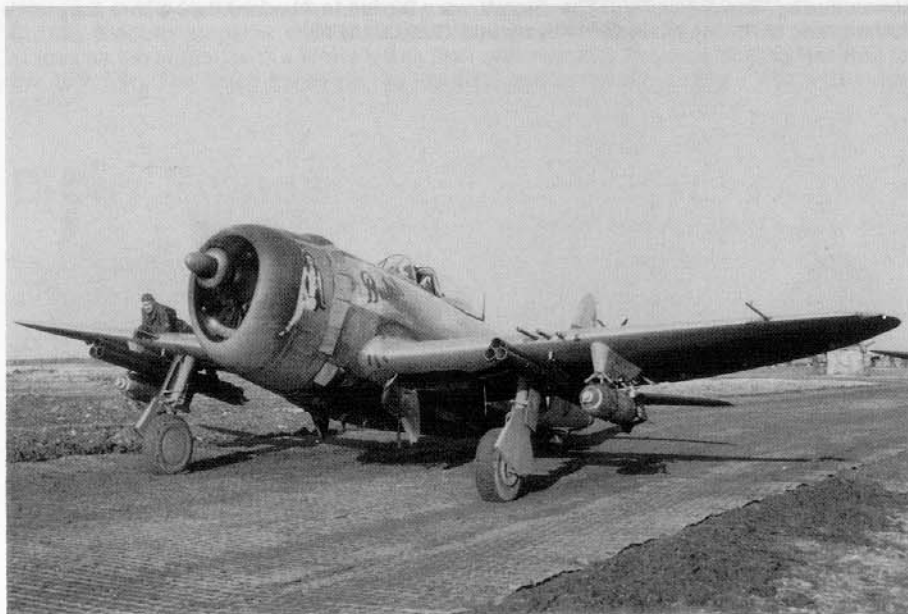

(Above) "Margie Mc...", a P-47D-26 from the 405th FSq, 371st FGp, at Metz Airdrome, France, in late 1944. "Margie" was the personal aircraft of Lt Monty Davis. By this date, the only D-Day markings remaining were the under fuselage bands, and those would be removed early in 1945. The nose and name are in Medium Blue. (Ethell)

"Ole Cock II", the personal P-47D of Donovan Smith, who flew with the 56th FGp. The 56th FGp camouflaged their P-47Ds and Ms from RAF color stocks, including Dark Green (34096) and Medium Sea Grey (36440), usually over natural metal undersurfaces. (AFM)

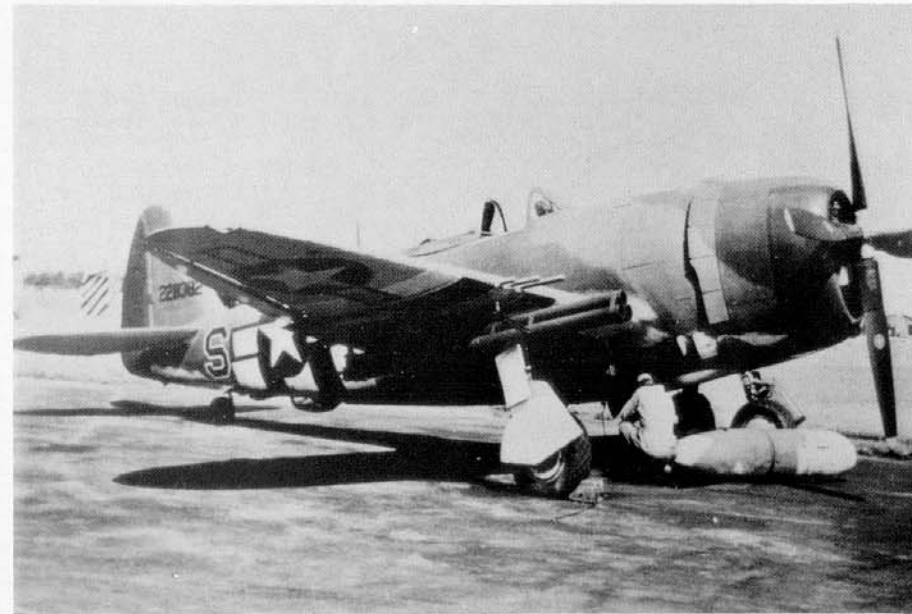

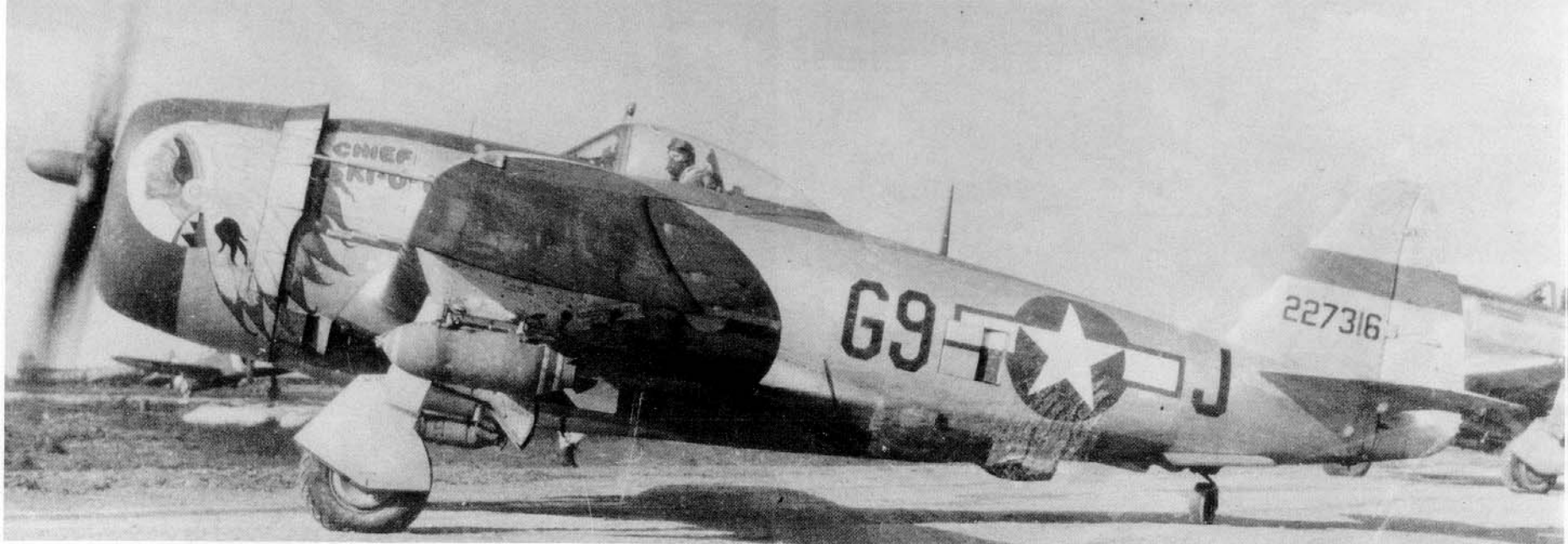

D-Day Stripes

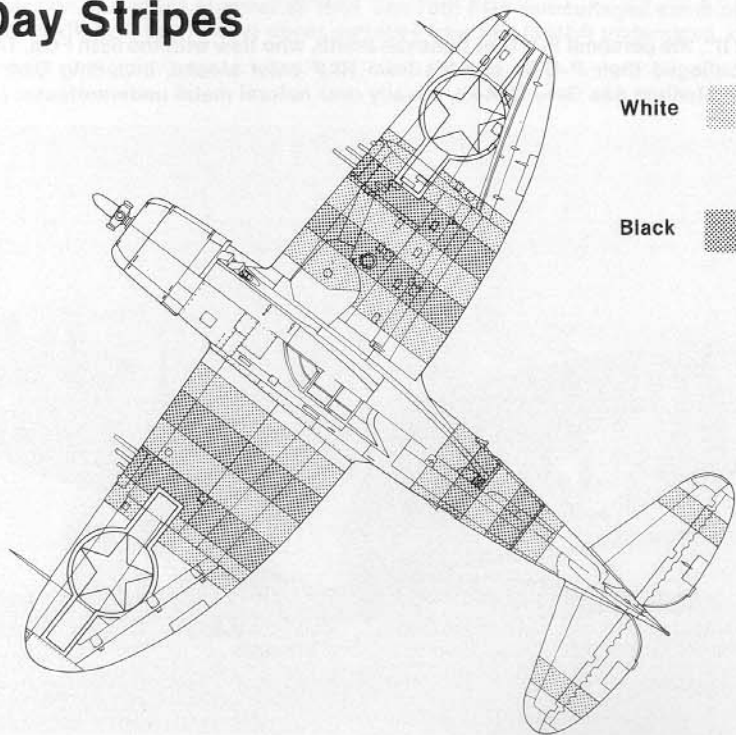

"Chief Ski-O-Watha", a P-47D-27 from the 506th FSq, 405th FGp. The 405th FGp was part of 9th Air Force and extensively used in ground attack roles — something the P-47 was born to do. "Chief" is armed with a pair of 500lb bombs under the wings, plus a 250lb bomb on the center station, probably for a strike against German troops. The cowl band, canopy rail, aft fuselage anti-glare, and tail bands are in Red. (AFM)

Little is known of the operations flown by the 203 P-47Ds that were supplied to the Soviet Union during World War Two. The aircraft were ferried to Abadan, Iran, where they were turned over to Soviet pilots for delivery into Russia. (AFM)



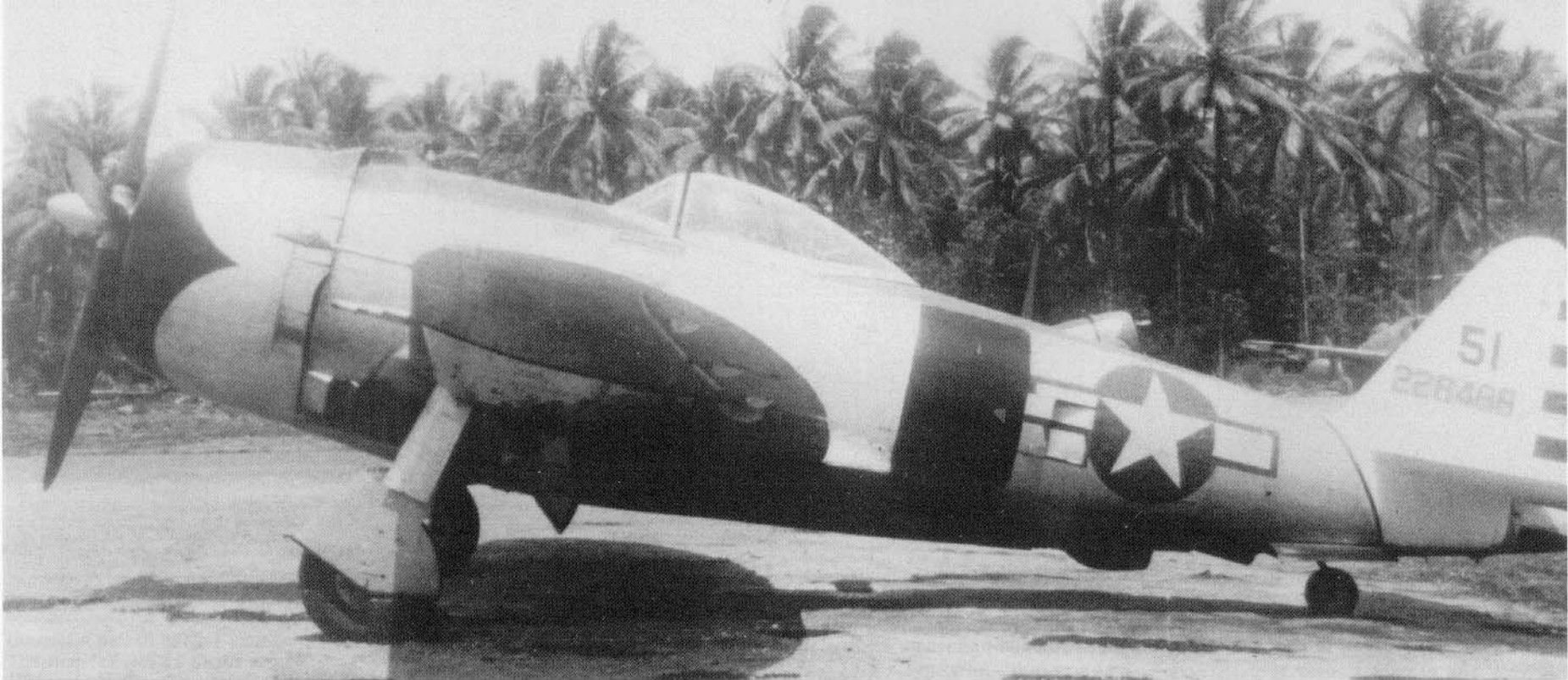

(Above) A P-47D-28-RA from the 35th FGp on Luzon in 1945. The D-28 introduced the new Curtiss Electric propeller with a 13 foot diameter. The 35th FGp carried the pre-War stripes on the rudder, with a White tail as their unit marking. The nose scallop was Red for the 40th FSq. The Black bands on the fuselage and wings are a 5th Air Force ID stripe. (AFM)

D-Day Stripes

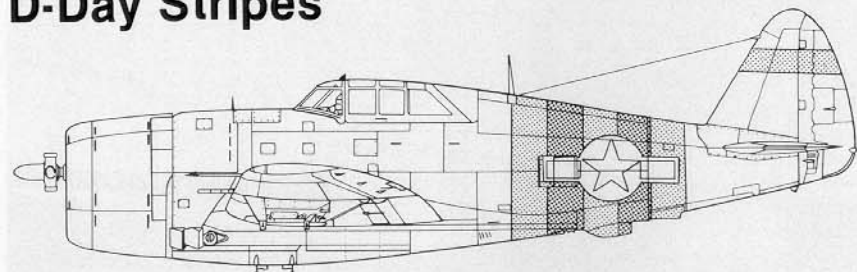

White

Black

(Right) "Maggie Tass", a P-47D-27 of the 506th FSq/404th FGp, sits amid Messerschmitt junk at a captured German airfield in 1945. "Maggie" was a presentation aircraft as denoted by the emblem between the unit code and the national insignia. (Ethell)





(Above) The 10,000th Thunderbolt built was a D-30 from Republic-Farmingdale. The D-30 was the first Thunderbolt to have the underwing dive flaps and permanent underwing pylons. (AFM)

(Below) "Sweet Music", a P-47D-30 from the 508th FSq, 404th FGp at Fritzlar Airdrome, Germany, during the summer of 1945. These D-30s have had the dorsal fins retrofitted. The dorsal fin was factory-fitted beginning with the D-40 series for added stability. (Ethell)

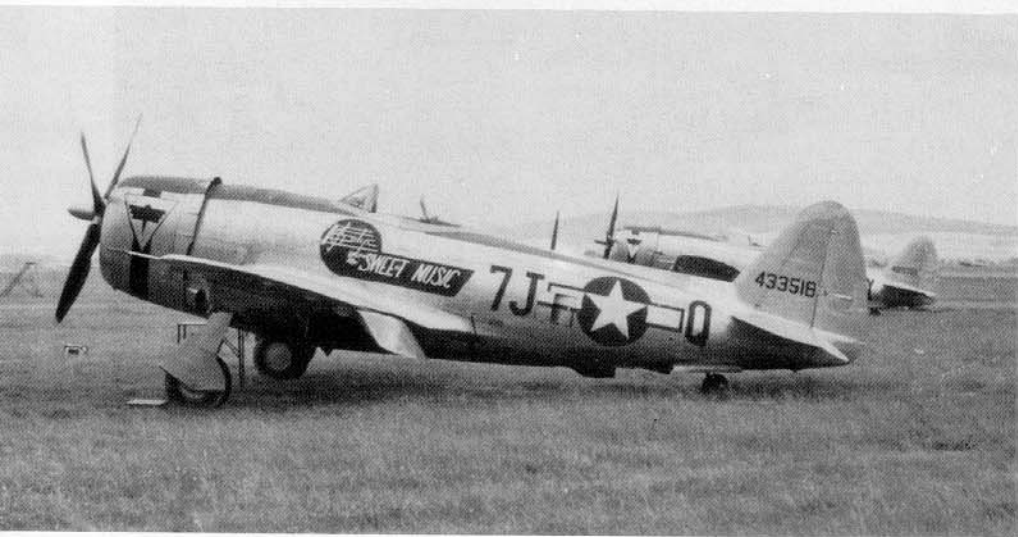

Tail Development

P-47D-25-RE

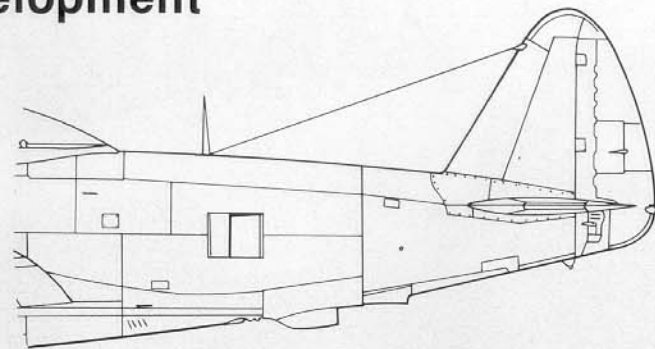

P-47D-40-RE

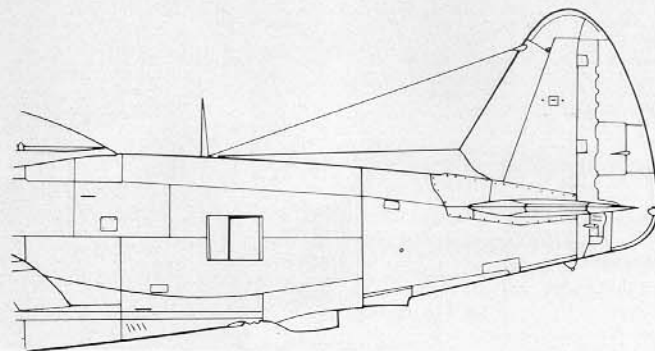

(Below) This P-47D-30 is one of 427 Thunderbolts supplied to the Free French Air Force in World War Two. Note that this D-30 has also had the dorsal fin fillet added. (AFM)

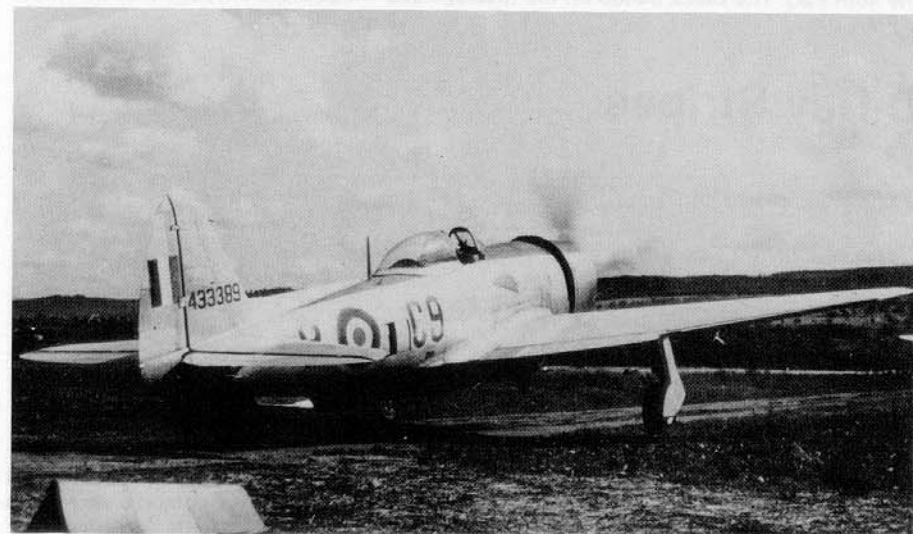



(Above) A pair of 397th FSq/368th FGp D-30s over Germany during the Summer of 1945. The Red/Yellow/Red bands around the rear fuselage were added after VE Day for identification of friendly aircraft. The tail and stabilizer tips, wingtips, and nose flash are Yellow. (Ethel)

(Below) A P-47D-30 from the 1st Air Commando Group at Asansol, India in 1945. Note the addition of the fuselage loop antenna for long range navigation. (AFM)

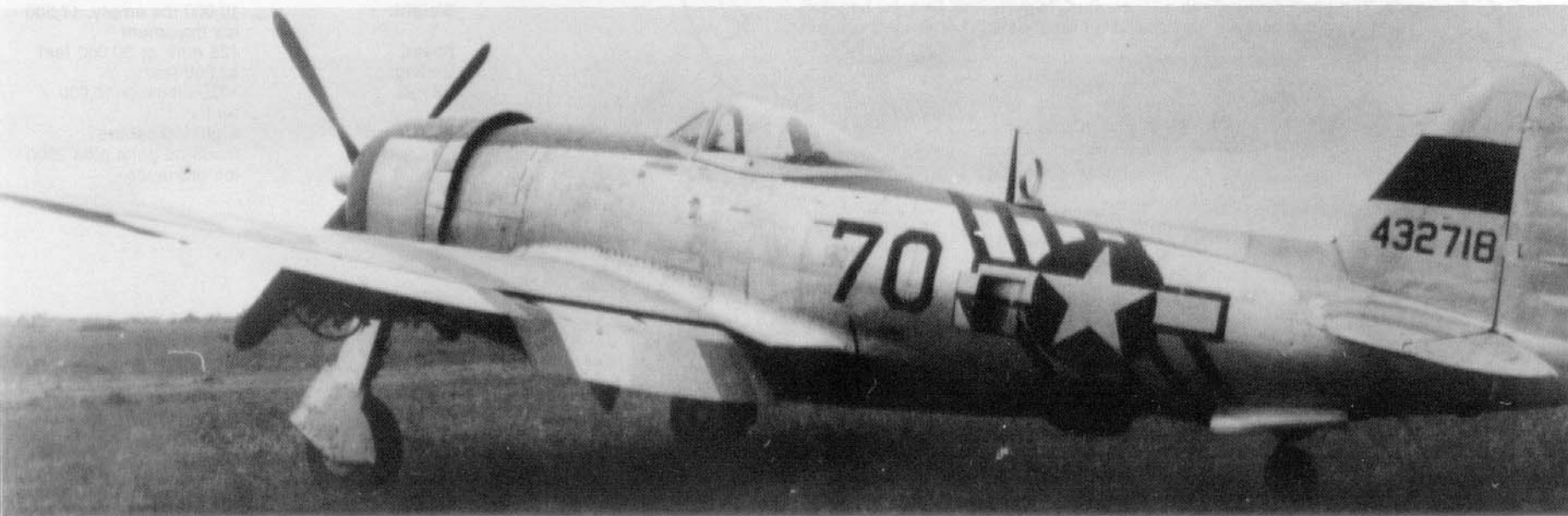

P-47D-40

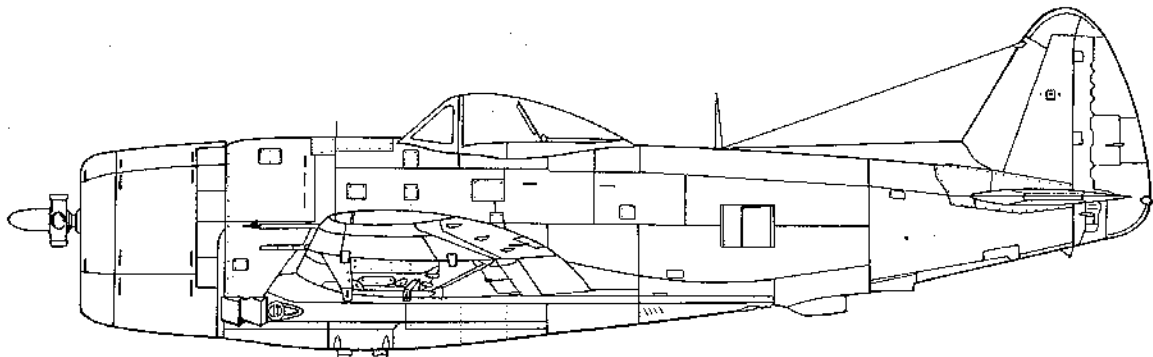
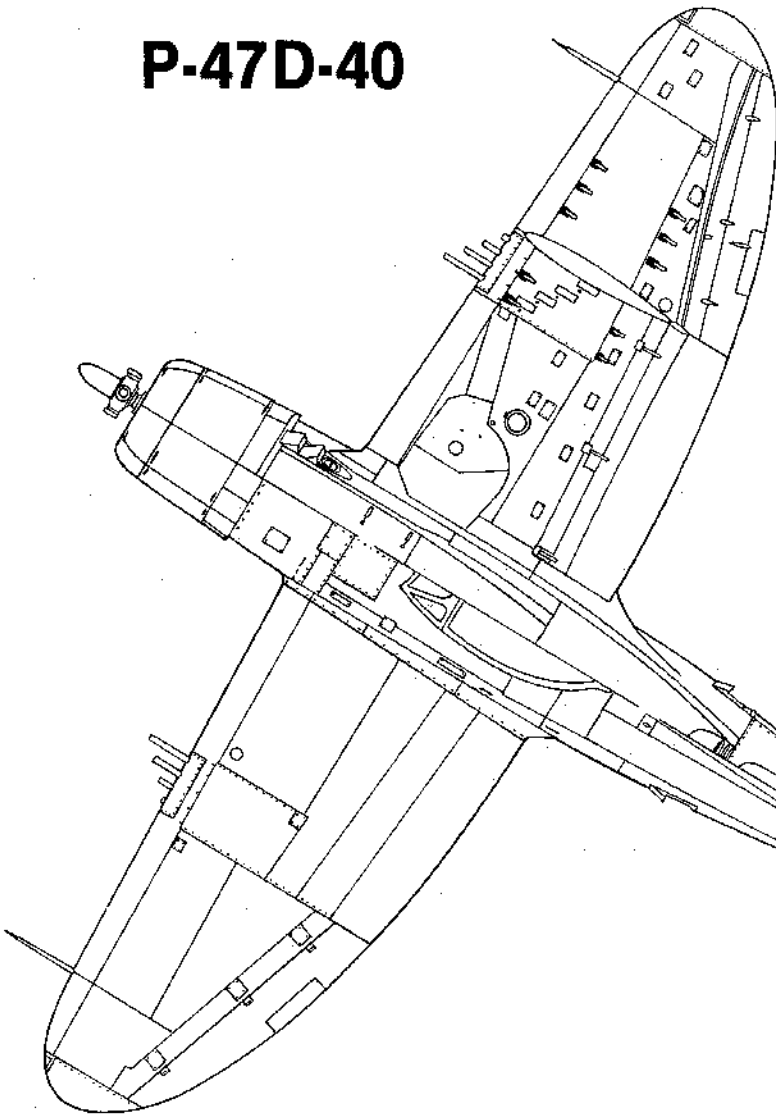

Specifications

Manufacturer:	Republic/Evansville
Engine:	Pratt & Whitney R-2800-59
Horsepower:	2000/2430 in War Emergency setting
Propeller:	Curtis Electric C542S with 13' diameter
Span:	40' 9 5/16"
Length:	36' 1 3/4"
Height:	14' 8 1/16"
Weight:	10,000 lbs empty, 17,500 lbs maximum
Speed:	426 mph @ 30,000 feet
Ceiling:	42,000 feet
Range:	1030 miles @ 10,000 feet
Armament:	Eight .50 calibre machine guns plus 2500 lbs ordnance

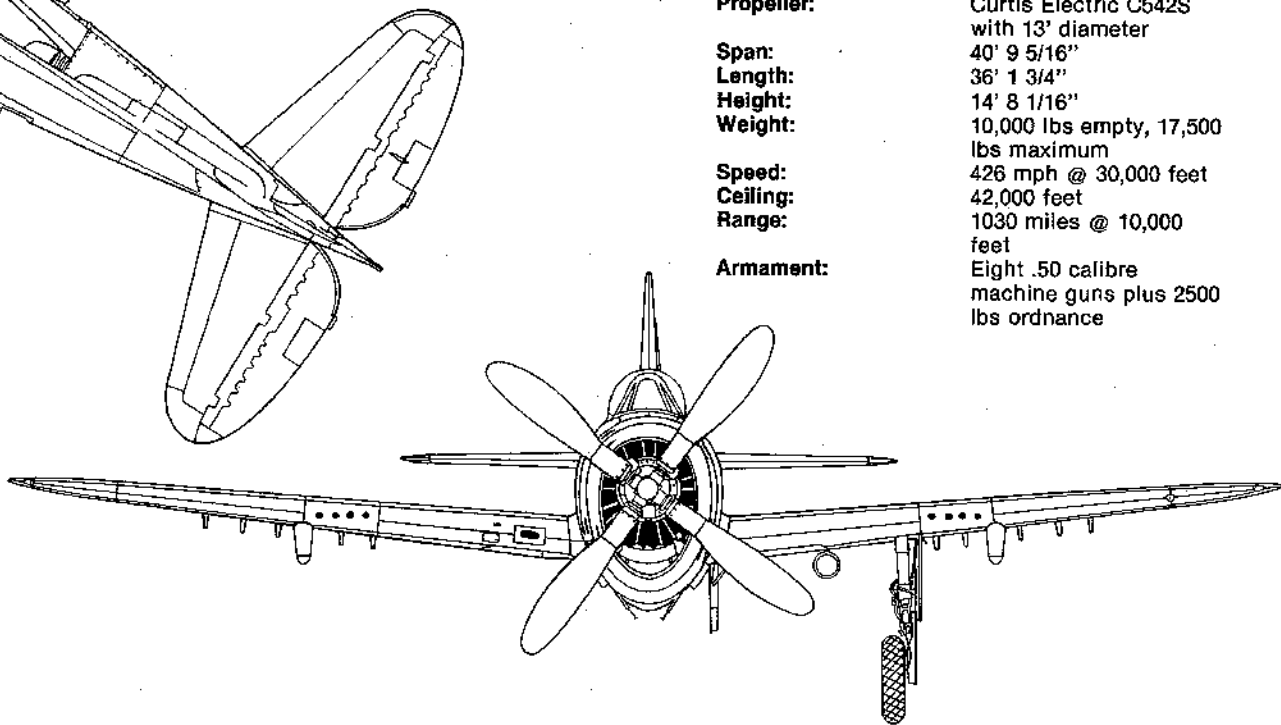

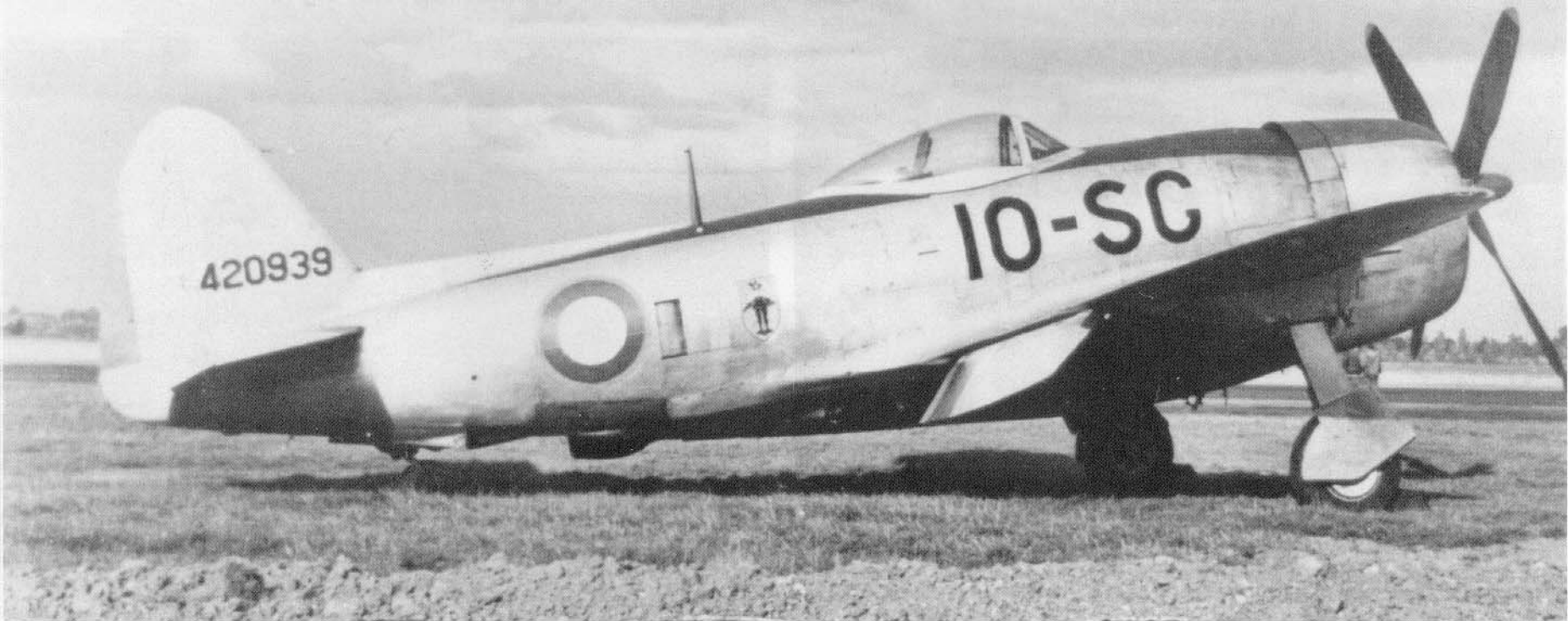

(Above) A P-47D-30 of the Free French Air Force. The D-30 was the most prolific of the Jug series with 2600 being built at the Farmingdale and Evansville Republic plants. (AFM)

(Below) A US Air Force F-47D-30 of the 47th FISq at Selfridge Field in 1953. When Congress made the Air Force a separate service branch on 26 July 1947, one of the things that changed were all aircraft designations. The designation Pursuit (P) became F for Fighter aircraft; thus all P-47Ds became F-47Ds. (Baker via Menard)

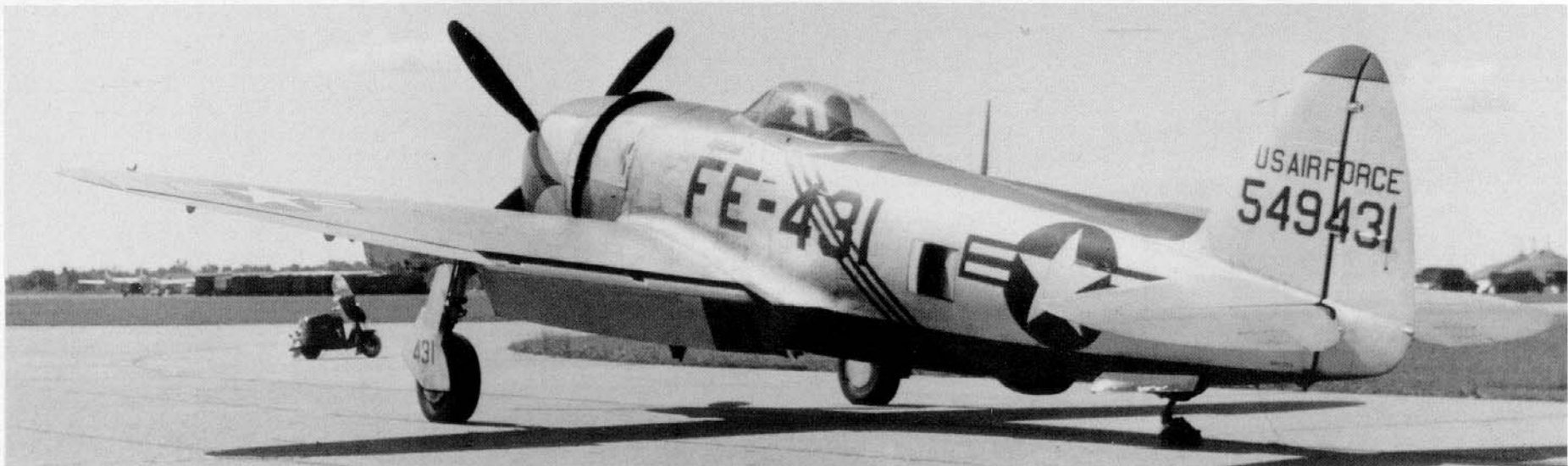



(Above) The F-47D cockpit. The cockpit colors were Interior Green floor and console walls, with Black consoles, instrument panel, and upper side walls. (Olmsted)

(Below) A F-47D-35 from the 527th FSq/86th FGp on the ramp at Munich in March 1949. The D-35 had four rocket launch stubs under each wing. The entire cowl and stripe under the antiglare panel is Red, while the rudder is White. (Olmsted)



(Above) Four F-47Ds that were supplied to the Shah of Iran's Air Force on the ramp at Tehran Airport in July of 1949. (Olmsted)





(Above) The "Pride 'O Dogpatch" is a D-30 from the 506th FSq/404th FGp at Fritzlar Air-drome, Germany. The D-30 also introduced a rear vision mirror inside the canopy, as well as electrically operated external stores releases. (Ethell)

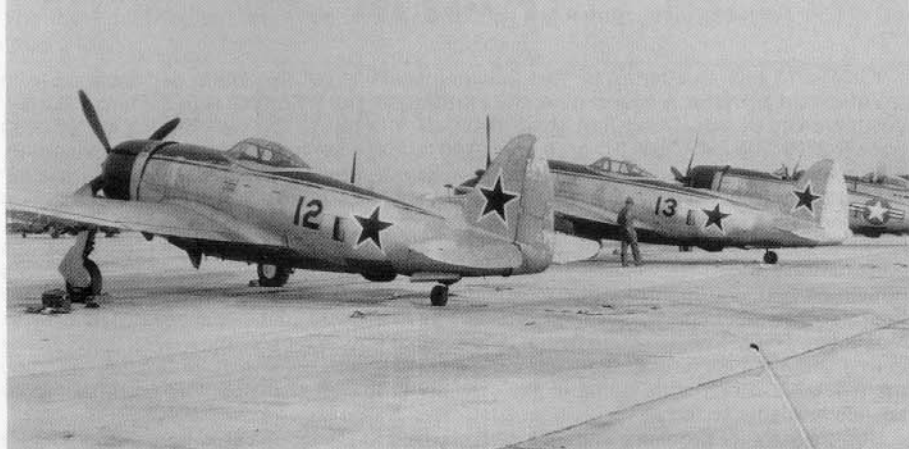

No, these are not Soviet Lend-Lease P-47Ds. These aircraft are from the 86th FGp and fought in the "reel war" as Russian Yak fighters for the movie "BERLIN AIRLIFT", made in 1949. (Olmsted)

(Below) The coming of the jet age saw the F-47s being phased into National Guard service, where they served well into the 1950s. Although the F-47D was a better ground attack aircraft, USAF opted for the F-51D Mustang for service in the Korean War. (McLaren)



P-47M

The P-47M was an attempt by Republic engineers to get maximum performance from the standard airframe. A new engine, the Pratt & Whitney R-2800'C' with the new CH-5 turbosupercharger, was fitted into three P-47D-27 airframes. The new engine, production code R-2800-14W or R-2800-57, produced 2800 horsepower in the War Emergency setting. The new engine was coupled with the new Curtis Electric C642S-B40 prop with a 13' diameter. The modified aircraft were known as YP-47Ms and were the fastest production Thunderbolts to fly. Test flights revealed a top speed of 473 mph at 32,000 feet.

The production versions of the YP-47M were all built at the Farmingdale plant under the designation P-47M-1-RE. Deliveries of the new Thunderbolts began in early 1945. The sole remaining P-47 unit in 8th Fighter Command was the vaunted 56th FGp at Boxted. They had clung tenaciously to their P-47s when all the other units had converted to P-51 Mustangs. The 56th FGp would be the only combat unit to receive the P-47M. Upon arrival in England, the new aircraft were immediately fitted with the dorsal fin fillet as found on the P-47D-40 to help cure some of the stability problems that occurred with the higher speeds available to the M.

But the stability problems were minor compared to things like abnormally low cylinder head temperatures, breakdown of the ignition systems at high altitude, and short range. The P-47M had to have underwing fuel tanks to give it a comparable range to the late model P-47Ds without tanks. Problems with the R-2800-57 engine led to all-new ignition wiring, reworked power controls, and internal baffling of the cowl flaps to raise cylinder head temperatures. Finally, upon finding extensive corrosion, all the engines in the delivered aircraft were pulled and replaced with fresh units direct from the factory. With the fresh engines and the problems ironed out, the 56th FGp went operational in P-47Ms in April 1945 — just in time to shoot down several unbelieving German ME-262 jet fighters. The war ended before the P-47M could become a viable force. Republic/Farmingdale built 130 P-47Ms.



(Above) The YP-47M was basically a D-30 airframe fitted with the R-2800 C rated at 2800 horsepower with water injection. The YP-47M was the fastest production Thunderbolt with a 473 mph top speed. (AFM)

(Below) "The Brat", a P-47M from the 63rd FSq/56th FGp, was the personal aircraft of Lt. Randall "Pat" Murphy. By 1945, the 56th FGp was the sole remaining P-47 unit in the 8th Air Force, and was totally equipped with P-47Ms by wars end. (AFM)



P-47N

In 1944, operations in the Pacific Theater began taxing the endurance of the D-model Thunderbolt to its limit. Underwing and fuselage droppable fuel tanks helped, but an increase in internal fuel capacity was needed so that the Thunderbolt could begin escort operations with bombers going to targets on the Japanese home islands. There was only one answer — internal wing fuel tanks. The XP-47K, the aircraft that had been fitted with the first bubble canopy, was again the testbed aircraft. A completely new set of wings was fitted to the XP-47K. These new wings were one foot longer each, and had “clipped” wingtips. Within the new wings, four additional 50 gallon fuel cells were fitted. The added span to the wing was accomplished at the fuselage which necessitated moving the main landing gear outboard an equal amount. This one change significantly increased the effective range of the Jug.

During the summer of 1944, P-47D-27-RE serial 42-27387 was pulled from the assembly line and was modified with the addition of the new longer wing. This aircraft would be designated XP-47N. In addition to the new wing, the XP-47N also received the new R-2800-57 powerplant that was slated for the P-47M. Other changes, most of which were either caused by the stretched wing or the added weight of the extra fuel, included relocation of the gun camera and landing light, much bigger tires and heavier landing gear struts and hydraulics. Changes with the -57 engine were the same as those found on the P-47M including a new exhaust collector ring, generator, engine mounts, automatic cowl flaps and intercooler doors, with the water injection being automatically controlled by manifold pressure. The YP-47N was completed in September 1944. With the changes, the YP-47N, although it could only draw 160 gallons from the new 200 gallon wing tanks, had an effective range of over 1500 miles, and a ferry range increasing to over 2300 miles with underwing drop tanks. One added plus to the new wing was the fact that rollrate was significantly increased with the new squared wingtips.

With testing of the new long range Thunderbolt completed in early 1945, the War Department began sending them to combat units. The first unit to receive the new long range P-47N was — no, not a Pacific-based unit that the aircraft was designed for. The first P-47Ns went to the 56th Fighter Group in England! But the war ended before the 56th could get the first Ns reassembled and into combat. Consequently, the P-47Ns were disassembled and shipped back to the Continental US for distribution to combat units in the Pacific. The 318th Fighter Group on Saipan was the first combat unit in the Pacific to receive the P-47N, beginning combat operations in Spring 1945.

In 1947, as with other Pursuit aircraft, the designation of the P-47N was changed to F-47N. F-47Ns saw active service within the US Air Force and Air National Guard until 1952, with the last active Air Force F-47N group, the 14th FGp at Dow Field, Maine, turning in their F-47Ns for new F-84B Thunderjets in 1947. However, there were at least two squadrons active in Air Defense Command through 1952 in F-47Ns. The F-47N was used by the Air National Guard until finally phased out in favor of jet aircraft in 1953.

The P-47N-1-RE was the production version of the XP-47N. Minor differences with the ignition and throttle quadrant were included. The N-1 had provision for carrying the 300 gallon underwing fuel tanks which brought combat range near 2000 miles. 550 P-47N-1-REs were built. The N-5 included some minor radio changes and the underwing zero-rail rocket launch stubs and tail warning radar as found on the P-47D-40. Republic-Farmingdale built 550 N-5s. The N-15 had the -73 engine fitted. The -73 engine had actually been fitted in several of the later N-5 aircraft. In addition to the new engine, the N-15 included the S-1 bomb release, the K-14 gunsight, and a new pilot seat. There were 200 built. The N-20 was the first P-47N to be built by both the Farmingdale and Evansville plants, with the designations again being RE for Farmingdale and RA for Evansville-built aircraft. Again, the changes involved radios and fuel systems. There were 149 N-20s built by the two factories. The P-47N-25 was the final P-47 Thunderbolt variant to be mass produced. It differed from other N models by having one of three engines - the R-2800-73, -77, or -81. The N-25 also had a redesigned cockpit floor and tail wheel linkage. The ailerons and flaps

were beefed up to withstand the rocket blast from the underwing zero-rail launch stubs. The last P-47N-25, and last Thunderbolt, rolled off the Farmingdale assembly line in October 1945.

Wing Development

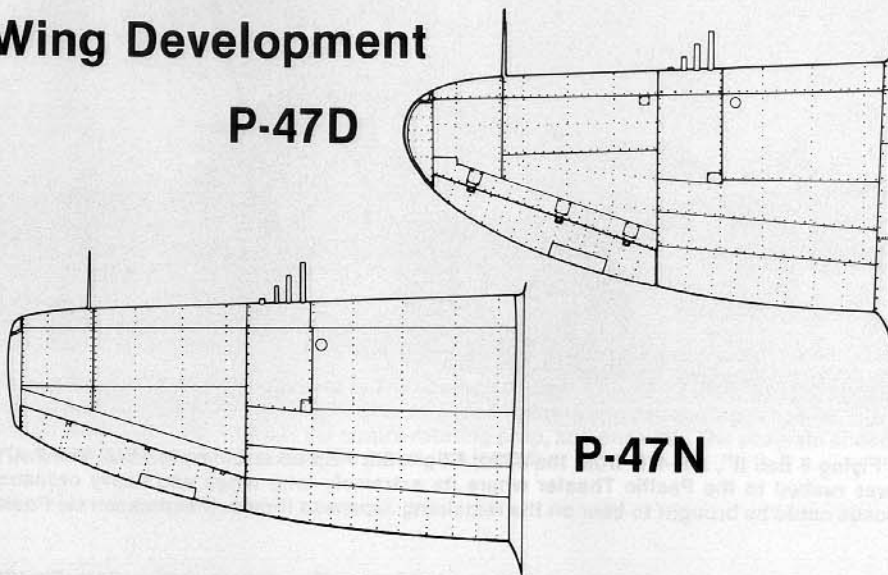

(Below) The XP-47N was the prototype of the long range Thunderbolt series for use in the Pacific Theater. The XP-47N started life as a standard P-47D-27, which was fitted with a new wing and a R-2800 C engine. (AFM)



Dorsal Fin Development

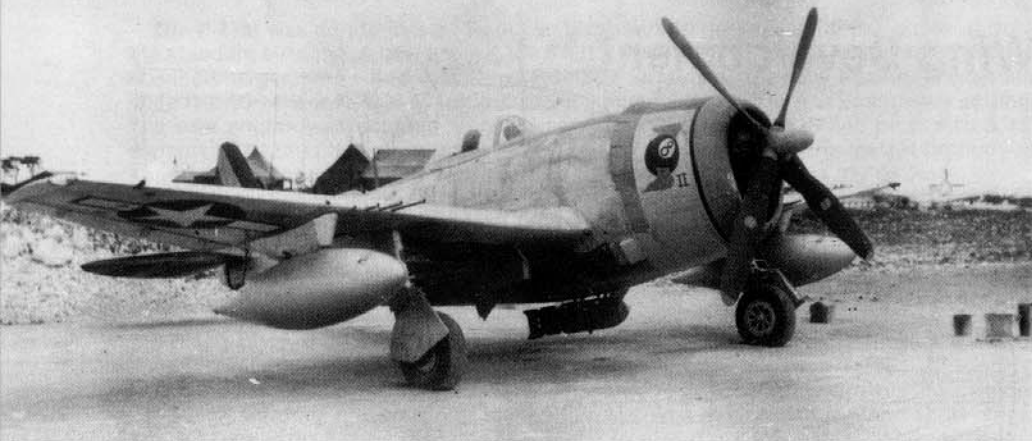

"Flying 8 Ball II", a P-47N from the 333rd FSq/318th FGp on Ie Shima in 1945. The P-47N was rushed to the Pacific Theater where its extremely long range and heavy ordnance loads could be brought to bear on the remaining Japanese forces. (Rasmussen via Foote)

A P-47N from the 456th FSq/414th FGp, taxis to the active runway on Iwo Jima. Besides the clipped tips on the extended wing, the N model had a larger fuselage fin fillet than the P-47D-40. Note the additional antennas and underwing rocket launch stubs. (Witt)

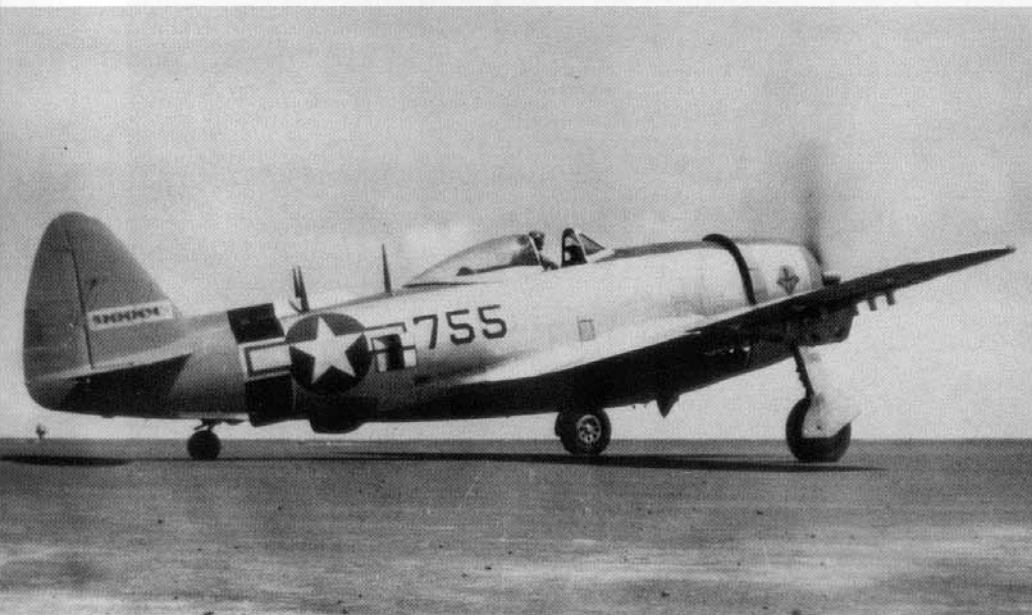

P-47D-40-RE

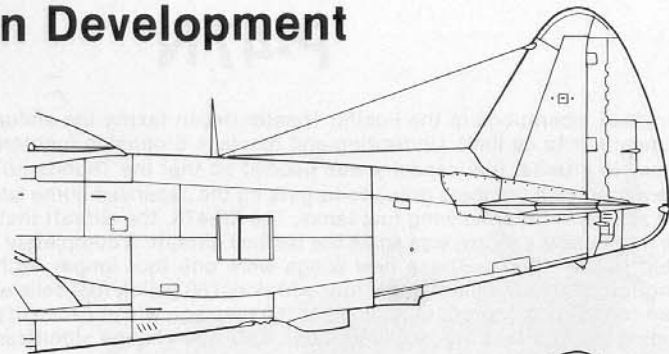

P-47N

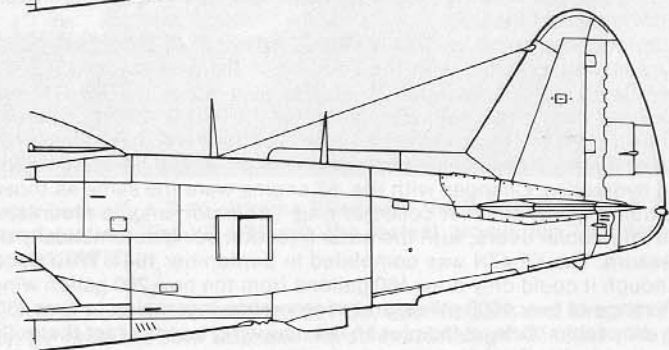

(Below) "Big Stud", the P-47N-5 of Colonel Robert Baseler, who used the aircraft to promote the Air Force at airshows throughout the nation. The N-5 series introduced the underwing rocket launch stubs, which were retrofitted to earlier versions. (AFM)

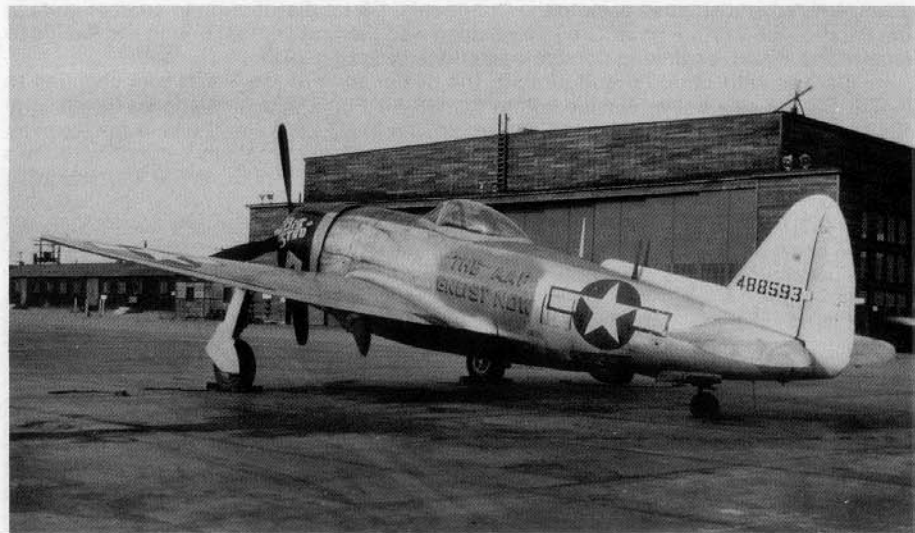

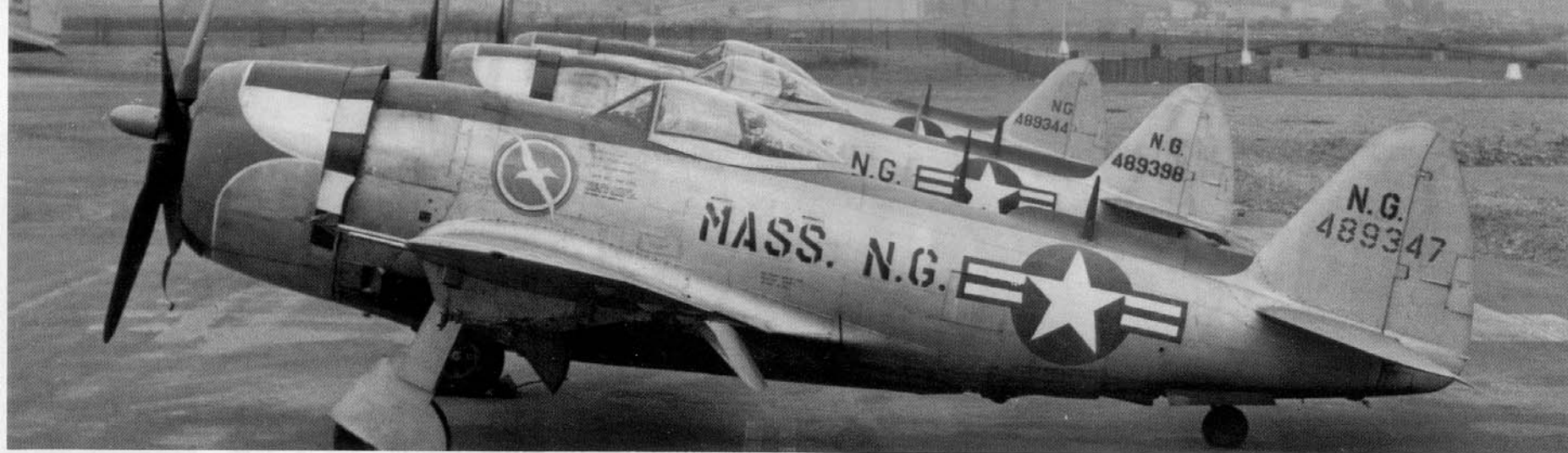

(Above) Three Massachusetts Air Guard F-47N-25s on the ramp at Logan Airport in 1949. The N-25 was the final production Thunderbolt variant, with the final aircraft rolling off the Republic/Farmingdale line in October 1945. (Paulsen via Menard)

(Below) The XP-72 was the ultimate in Thunderbolt design. The XP-72 incorporated a 3000 horsepower Pratt & Whitney R-4360 with an Aero-Products contra-rotating propeller. Two aircraft were built, one without the contra-rotating prop, and one with. The program ended in July 1944 with the advance of the jet engine. (AFM)

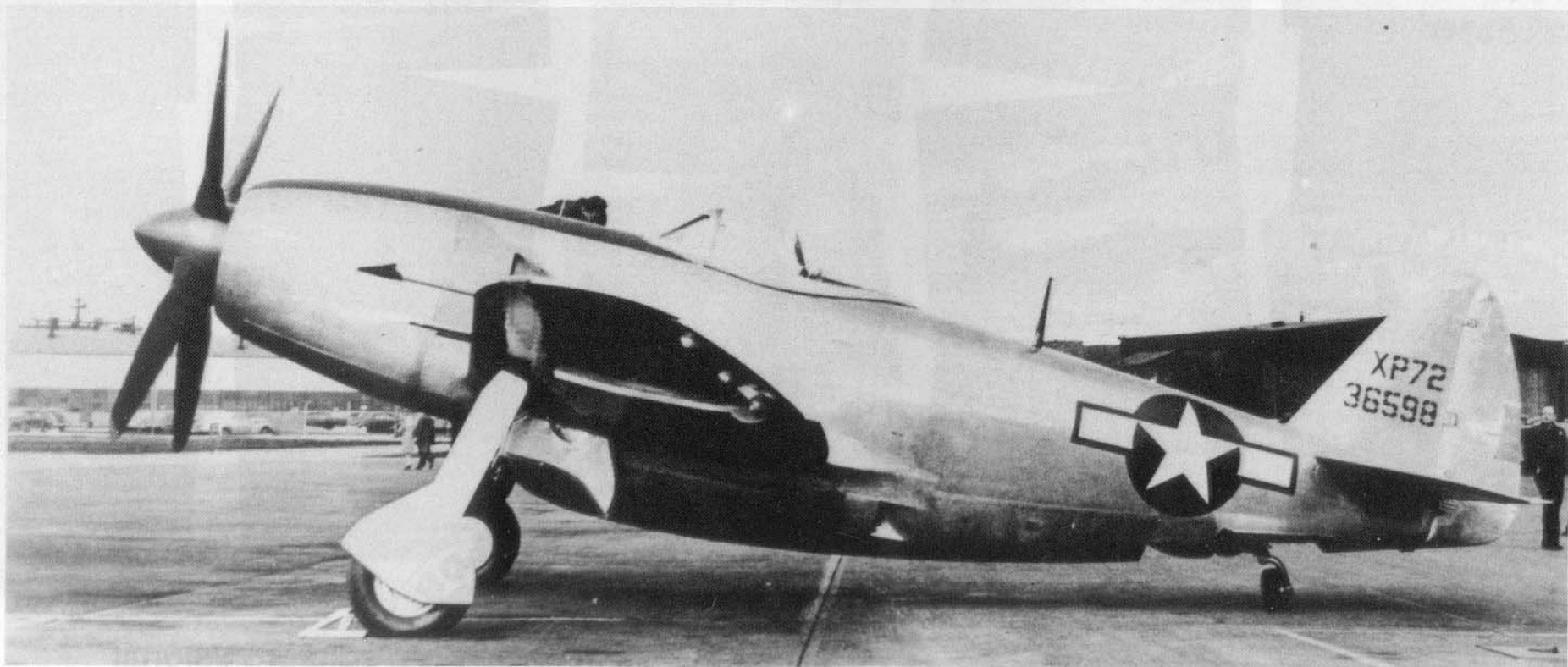

"BABY DUMPLING", a P-47N flown by Captain James Butler Jr with the 437th Fighter Squadron, 414th Fighter Group on Ie Shima in 1945.



"honeysuckle rose", a Thunderbolt Mk. II flown by W R S Campbell with No 615 Squadron at Vizagapatam, India, during 1945.



SBN 0-89747-161-X
90000>