

Henschel Hs 129

in action

Aircraft Number 176

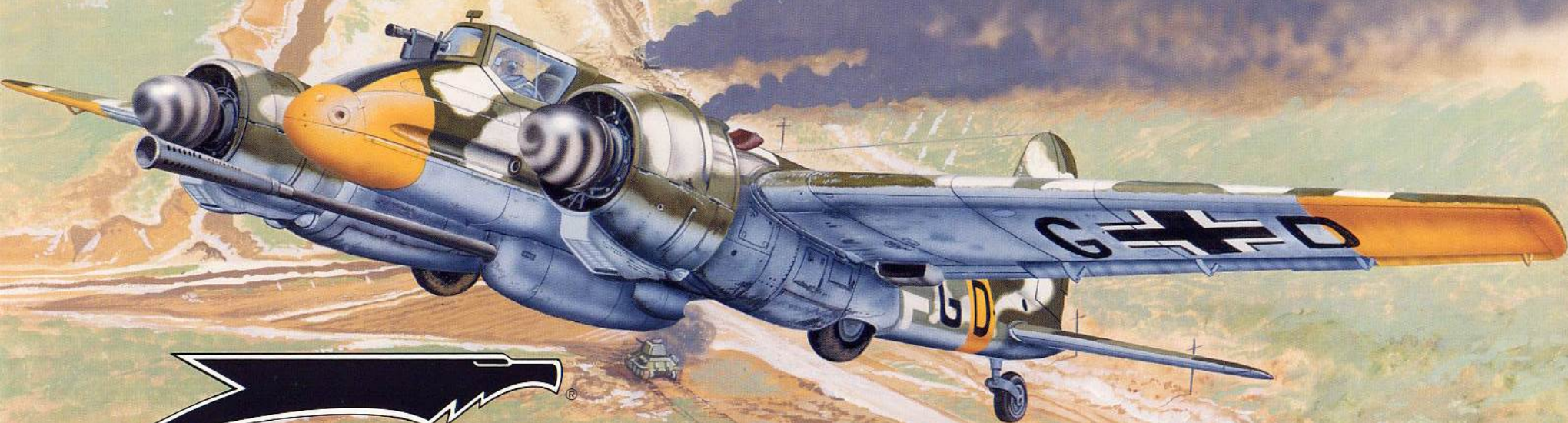

squadron/signal publications

Henschel Hs 129

in action

By Dénes Bernád

Color by Don Greer

Illustrated by Andrew Probert and Richard Hudson

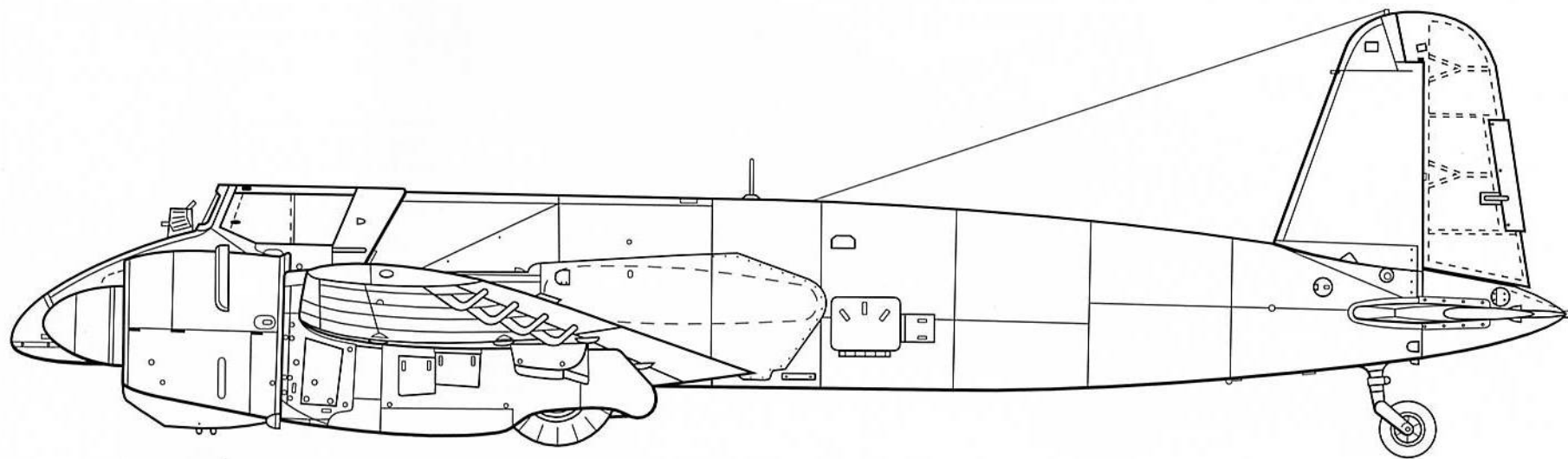

Aircraft Number 176

squadron/signal publications



A Henschel Hs 129B-3 (DT+GD, *Werknummer/Factory Number* 162035) makes a firing pass over Soviet tanks attacking German positions in central Poland in February of 1945. This variant was armed with a 75mm BK 7,5 cannon under the fuselage. W. Nr. 162035 was the third of 23 Hs 129B-3s built.

Acknowledgments:

I met Lt Lazăr Munteanu in his Cluj, Rumania apartment over ten years ago and listened to his stories of flying the Hs 129 during World War Two. He was an *asaltist* – the Rumanian name for a ground assault pilot – who daringly flew just 20 feet (6 M) over the ground in his Hs 129B during the war. I decided after listening to Lt Munteanu's stories to research and study the development and career of this little known aircraft type. The result of ten years of work is concentrated in this book.

Lt Munteanu has since passed away, along with many of his fellow ARR (*Aeronautica Regală Română/Royal Rumanian Air Force*) and Luftwaffe Hs 129 pilots. It is my hope that this book stands in tribute to the memory of these pilots and to Henschel *Flugzeug-Werke's* innovative and sound design, equally loved by its German and Rumanian pilots.

In addition to presenting the well-known story of the Luftwaffe's Hs 129-equipped *Schlacht* (Ground Attack) units, I also present the virtually unknown, yet equally exciting and dramatic saga of the Rumanian assault group and its Hs 129s. This information is largely thanks to the ground-breaking book 'Hs 129 Panzerjäger!' by Martin Pegg (Classic Publishing, 1996).

The author would like to acknowledge the invaluable assistance provided by the following individuals:

Mihai Andrei
Vlad Antipov
Dan Antoniu
Valeriu Avram
Miroslav Bílý
Răzvan Bujor
Lutz Budrass
Sven Carlsen
Carl Charles
Ernest Chefneux

James Crow
Constantin Georgescu
Carl-Fredrik Geust
Vitaly Gorbach
Manfred Griehl
Dmitry Grinyuk
Rainer Haufschild
Dmitry Karlenko
Karl Kössler
Cornel Marandiu

Robert Michulec
Mihai Moisescu
Péter Mujzer
Lazăr Munteanu
Corneliu Năstase
Günther Ott
Martin Pegg
James Perry
Peter Petrick
György Punka

COPYRIGHT 2001 SQUADRON/SIGNAL PUBLICATIONS, INC.

1115 CROWLEY DRIVE CARROLLTON, TEXAS 75011-5010

All rights reserved. No part of this publication may be reproduced, stored in a retrieval system or transmitted in any form by means electrical, mechanical or otherwise, without written permission of the publisher.

ISBN 0-89747-428-7

If you have any photographs of aircraft, armor, soldiers or ships of any nation, particularly wartime snapshots, why not share them with us and help make Squadron/Signal's books all the more interesting and complete in the future. Any photograph sent to us will be copied and the original returned. The donor will be fully credited for any photos used. Please send them to:

Squadron/Signal Publications, Inc.
1115 Crowley Drive
Carrollton, TX 75011-5010

Если у вас есть фотографии самолётов, вооружения, солдат или кораблей любой страны, особенно, снимки времён войны, поделитесь с нами и помогите сделать новые книги издательства Эскадрон/Сигнал ещё интереснее. Мы переснимем ваши фотографии и вернём оригиналы. Имена приславших снимки будут сопровождать все опубликованные фотографии. Пожалуйста, присылайте фотографии по адресу:

Squadron/Signal Publications, Inc.
1115 Crowley Drive
Carrollton, TX 75011-5010

軍用機、装甲車両、兵士、軍艦などの写真を所持しておられる方はいらっしゃいませんか？どの国のものでも結構です。作戦中に撮影されたものが特に良いのです。Squadron/Signal社の出版する刊行物において、このような写真は内容を一層充実し、興味深くすることができます。当方にお送り頂いた写真は、複写の後お返しいたします。出版物中に写真を使用した場合は、必ず提供者のお名前を明記させていただきます。お写真は下記にご送付ください。

Squadron/Signal Publications, Inc.
1115 Crowley Drive
Carrollton, TX 75011-5010

Acknowledgements, cont.

Jean-Louis Roba
Martin Rosenkranz
Matti Salonen
Gyula Sárhidai

Dragan Savic
Gerhard Stemmer
Ion Tarălungă
Vasile Tudor
Ferenc-Antal Vajda

Titus-Liviu Vancea
Thomas Willis
László Winkler
The staff at Arhiva
M.Ap.N., Bucharest

An Hs 129B-2 (Red N, W. Nr. 0373) makes a low level pass over the Eastern Front. This aircraft was assigned to 8.(Pz.) (*Panzerjägerstaffel/Tank Destroyer Squadron*)/Sch.G. (*Schlachtgeschwader/Ground Attack Wing*) 1. Soviet anti-aircraft fire downed Red N on the Eastern Front's southern sector on 27 May 1943. (Moisescu)



Introduction

The Spanish Civil War (1936-39) was an ideal testing period for Germany, Italy, and the Soviet Union to evaluate new weapons and tactics for air and land combat. This testing included the new concept of close air support for friendly troops or against enemy forces. The task of destroying fixed or slowly moving targets with pinpoint accuracy was assigned to dive bombers such as the Junkers **Ju 87 Stuka** (*Sturzkampfflugzeug*; Dive-Bombing Aircraft). The Germans supporting the Spanish Nationalists found obsolescent biplanes like the Heinkel **He 51** and Henschel **Hs 123** were unsatisfactory in attacking small, fast, and maneuverable targets. These targets included tanks, other armored vehicles, and troop concentrations. The He 51 and Hs 123 were unarmored, lightly armed, slow, and vulnerable to ground fire. The experience in Spain highlighted the Luftwaffe's clear need for a well-protected and heavily armed *Schlachtflugzeug* (Ground Attack Aircraft).

The German Legion Condor's experience in providing close air support early in the Spanish Civil War was relayed back to Germany. In April of 1937, a specification was issued by the *Technisches Amt* (Technical Bureau, LC or *C-Amt*) of the *Reichsluftfahrtministerium* (RLM; Reich Air Ministry). This specification called for a small, twin-engine aircraft armed with 20MM cannon, heavy machine guns, and bombs. The *C-Amt* suggested – but did not require – using the Argus As 410A-0 engine for this new aircraft. This 12-cylinder, air-cooled, inline powerplant was rated at 465 horsepower (HP) for takeoff and 430 HP in level flight.

The close support aircraft sought by the RLM was intended for low-level flight over battlefields where air supremacy had been achieved. This meant there would be no need for a rear gunner, which reduced aircraft weight and increased the payload. Proper armor protection from ground fire for the pilot and the engines was deemed crucial, along with protection for the pilot in the event of a forced landing. The close support aircraft was intended for operation from improvised airfields near the front line. This operating environment called for an aircraft with

simple construction and ease of maintenance and serviceability. The *C-Amt* gave the competing designers a free hand in finalizing the details of their aircraft submissions.

The tender (formal offer) for the close support aircraft was given by the *C-Amt* to four manufacturers: Focke-Wulf, Gotha, Hamburg (later Blohm und Voss), and Henschel. Gotha failed to submit a proposal by the *C-Amt's* 1 October 1937 deadline, while Hamburg and Focke-Wulf offered modified versions of their respective reconnaissance aircraft, the **Ha 141** and the **Fw 189**. Henschel offered a new design developed specifically to meet the *C-Amt's* requirements.

Hamburg's **P 40** design was a modification of its Ha 141 (later BV 141) reconnaissance aircraft, which used an asymmetrical configuration. The single-boom fuselage was offset left of the aircraft's centerline, while the two-man crew compartment was placed in a separate nacelle to starboard. The Ha 141 was powered by one 960 HP Daimler-Benz DB 600 liquid-cooled, inline engine mounted in the front fuselage. The aircraft's unusual construction resulted in excellent all-around visibility for the crew and a reduction of propeller torque effects, which affected handling on the ground.

The Focke-Wulf close support aircraft project retained the existing As 410A-0 powerplants and twin-boom fuselage of the Fw 189 reconnaissance aircraft; however, the crew compartment was reduced in size and heavily armored. The pilot and rear gunner sat back-to-back in the armored nacelle. The pilot was protected in part by the 2.95 inch (75MM) thick armored glass windshield, while the rear gunner could see out through a narrow rectangular slot in the nacelle. Proposed armament for the Fw 189 close support variant was two 20MM MG 151/20 cannon and two 7.92MM MG 17 machine guns on the fuselage sides, with one 7.92MM machine gun for the rear gunner on a flexible mount.

Henschel's original design – company designation **P 46** – was approximately 20 percent smaller in size and weight to the Fw 189. The P 46 was also powered by two 465 HP As 410A-0 engines, which gave the smaller aircraft a greater speed over its Focke-Wulf rival. The Henschel aircraft featured an unusual triangular fuselage cross section with rounded bot-

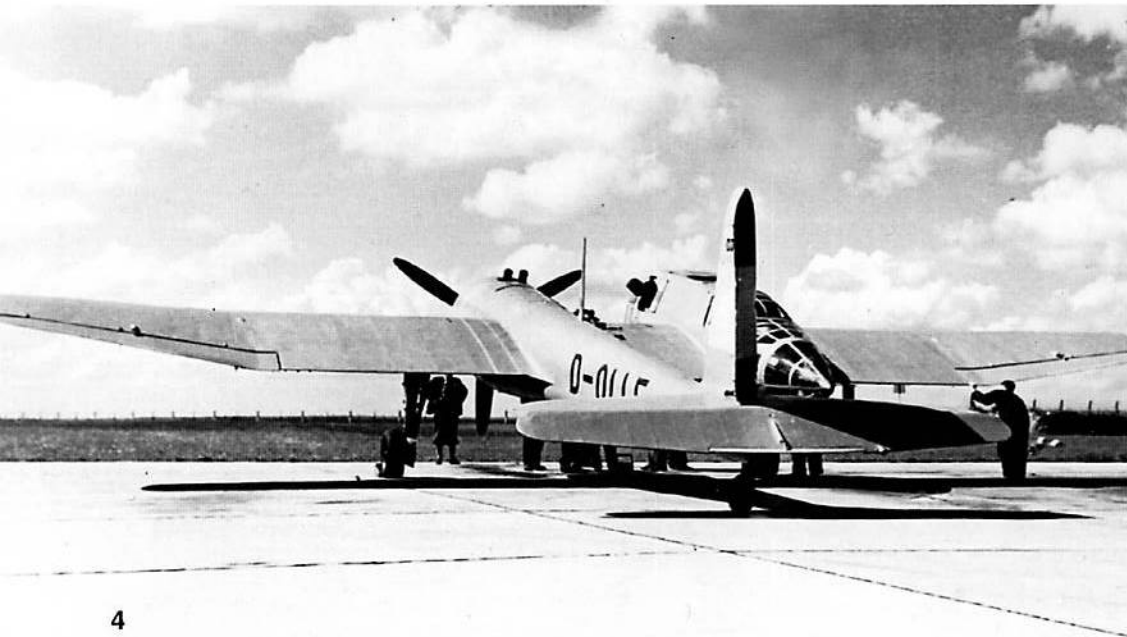

Focke-Wulf Fw 189V-1b

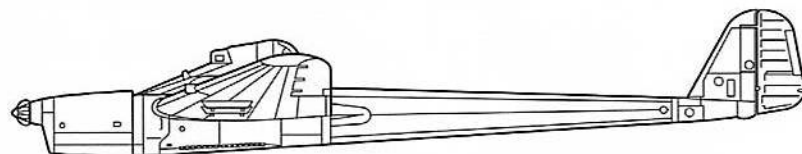

Henschel Hs 129V-1

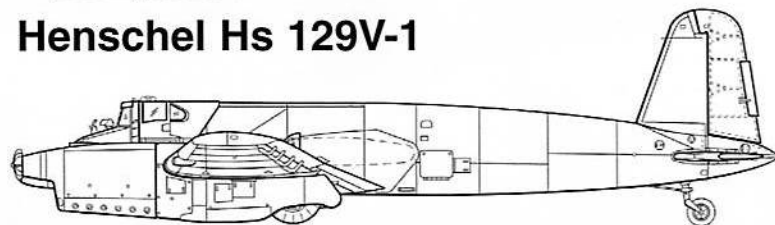

The BV 141V-4 (D-OLLE, W. Nr. 360) was Blohm und Voss' entry into the RLM's 1937 assault aircraft competition. This aircraft employed an asymmetrical design, with the cockpit offset to right of the single-boom fuselage. The RLM ruled the BV 141V-4 out of the competition early, due to the aircraft's unconventional configuration. (Bernád)

tom. The fuselage measured 11.8 inches (30 CM) wide at the top, 43.3 inches (110 CM) wide at the bottom, and 45.75 inches (116.2 CM) high. This triangular fuselage presented a smaller target and projectile deflection from the fuselage sides, but also resulted in a somewhat cramped cockpit area for the pilot. The P 46's upper fuselage width was dictated by an adult man's average shoulder width. The cockpit was well designed and met the *C-Amt's* basic requirements. A thick armored plate in the cockpit protected the pilot's back and functioned as both a back support and headrest.

The P 46's windshield was made from armored glass 2.95 inches (75MM) thick, while the small side windows were made of thinner armored glass. The aircraft's steeply slanted nose allowed excellent visibility ahead of and below the cockpit, which was key for ground attack pilots. In practice, the restricted glass surfaces on both Henschel's and Focke-Wulf's aircraft resulted in poor visibility for the pilot. The P 46 was also armed with two 20MM cannon and two 7.92MM machine guns mounted on the fuselage sides and firing forward. The lack of cockpit room meant that the Revi (*Reflexvisier*; Reflector Sight) C/12C gunsight was mounted in front of the windshield.

The *C-Amt* assessed the three designs after their submission on 1 October 1937. The Hamburg P 40 was quickly discarded due to its unorthodox concept. RLM Technical Bureau personnel examined wood mockups of both the modified Focke-Wulf Fw 189 and the Henschel P 46 and studied the estimated data submitted by the designers. No clear winner emerged from these studies, since the RLM experts found both designs barely met the minimum requirements set by the *C-Amt*. The primary culprit was the unsuitable Argus engine, which was used because no other medium-power engine was available in quantity at that time.

The RLM – despite the shortcomings found in these submissions – accepted both designs for further development and ordered three prototypes each from Focke-Wulf and Henschel in September of 1938. Focke-Wulf's design was designated Fw 189S (*Schlacht*; Assault), while Henschel's P 46 received the designation **Hs 129**. Construction for both aircraft began the fol-

lowing month at their respective plants: Focke-Wulf at Bremen and Henschel at Schönefeld, near Berlin. Focke-Wulf modified the Fw 189V-1 (D-OPVN, *Werkenummer*/Factory Number 1997) to include the revised close support crew nacelle. This aircraft was redesignated **Fw 189V-1b** and first flew in the new configuration in early 1939.

Henschel's Hs 129V-1 prototype (D-ONUD, W. Nr. 129 3001) was nearly completed by the spring of 1939; however, belated delivery of the Argus engines and propellers delayed the aircraft's first flight until 26 May 1939. Both the Fw 189V-1b and the Hs 129V-1 were criticized by test pilots for having poor forward and side vision, poor handling, and low engine power. The Fw 189V-1b's already inadequate maneuverability was further hindered by its higher overall weight than the Hs 129V-1. The Henschel's cramped cockpit was an inconvenience for its pilots, who lacked the room to easily move the control stick in flight maneuvers. Extensive trials slightly favored the Hs 129V-1, while the Fw 189V-1b program was hampered by a crash landing due to poor visibility. Focke-Wulf rebuilt the aircraft, deleting the gunner and providing greater visibility. This did not prevent the modified Fw 189V-1b from being lost in a crash after losing both rudders in flight on 8 November 1940.

After completing manufacturer's trials, the Hs 129V-1 was transferred to the Luftwaffe's *E-Stelle* (*Erprobungsstelle*; Test Center) at Rechlin on 14 December 1939. The Hs 129V-2 (W. Nr. 129 3002) was completed at Schönefeld in the meantime and first flew on 30 November 1939; however, this aircraft was destroyed on a test flight on 5 January 1940. The Hs 129V-3 (W. Nr. 129 3003) first flew on 2 April 1940 and later joined the V-1 at Rechlin. Focke-Wulf attempted to stay alive in the competition when they brought the Fw 189V-6 to Rechlin in September of 1940. This aircraft was the prototype of the Fw 189C (formerly Fw 189S) and featured a new main landing gear and twin 7.92MM rear machine guns. The RLM's mind was made up by that time, concluding that the Hs 129 – with its slightly better performance and a production cost two-thirds that of the Fw 189C – would be the Luftwaffe's new close support aircraft.

The eventual winner of the *Schlachtflugzeug* (Ground Attack Aircraft) contest was the Henschel Hs 129. This aircraft was the sole participant designed from the outset for the ground attack role. The Hs 129V-1 (D-ONUD, W. Nr. 129 3001) first flew from Henschel's Schönefeld airfield on 26 May 1939. This aircraft was finished in overall RLM63 Light Gray (FS36373). The Hs 129V-1 was later transferred to the *E-Stelle* (Test Center) at Rechlin for RLM acceptance trials. (Deutsches Museum)



Development

Hs 129A-0

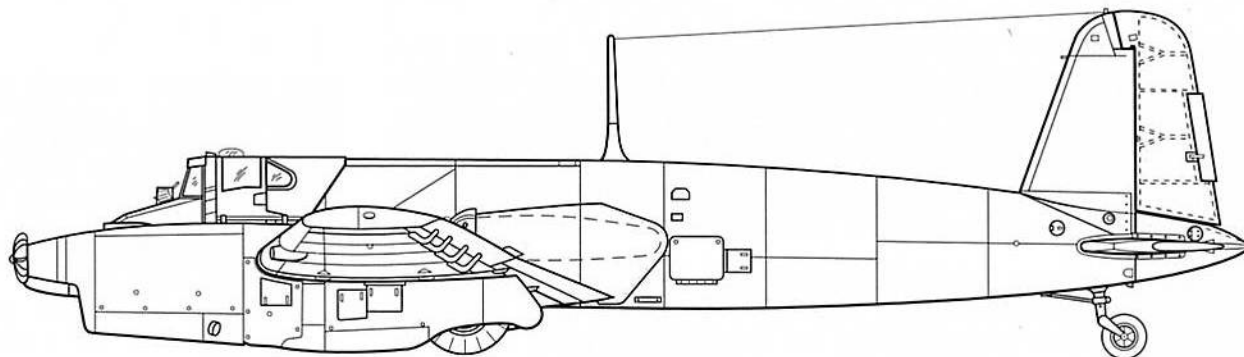

Hs 129B-0/B-1

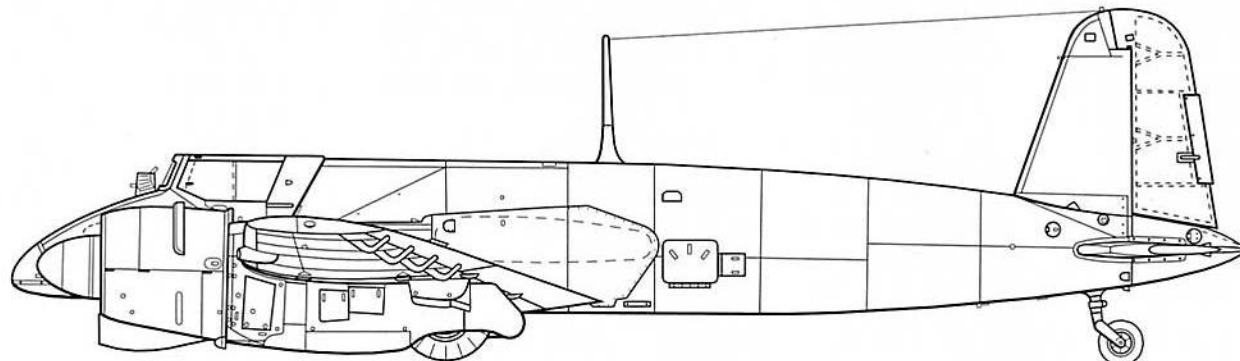

Hs 129B-2

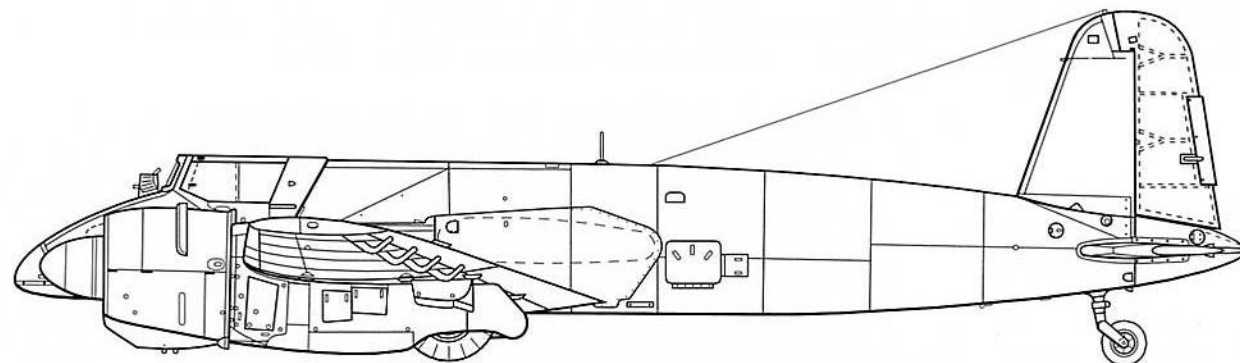

Hs 129B-3

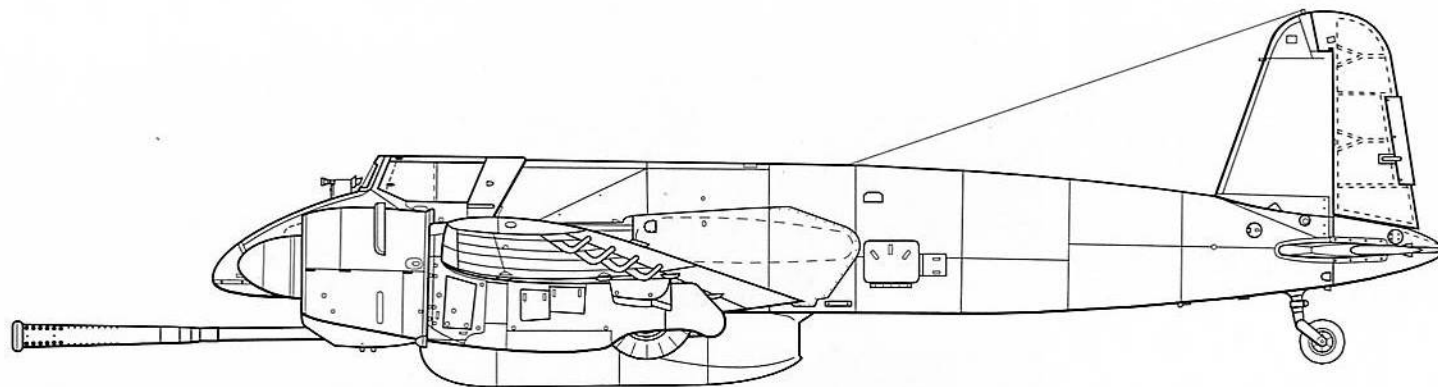

Hs 129A

In July of 1940, Henschel began constructing 23 pre-production series Hs 129s, under the designation **Hs 129A-0**. This decision was made while evaluation and operational tests were continuing at the *E-Stelle* (*Erprobungsstelle*; Test Center) at Rechlin. Henschel tentatively assigned *Werknummern* (Factory Numbers) 129 3004 to 129 3026 to these aircraft. The first Hs 129A-0 (W. Nr. 129 3004, *Stammkennzeichen* radio code GM+OA) made its maiden flight on 1 August 1940. The RLM (Reich Air Ministry) reduced the Hs 129A-0 order from 23 aircraft to 14 in late 1940.

Hs 129A-0 service trials began in the autumn of 1940, when the first aircraft were assigned to 5. (*Schlacht*) *Staffel* (5th Ground Attack Squadron), LG (*Lehrgeschwader*; Instructional Wing) 2 at Tutow. The unit – also equipped with Messerschmitt Bf 109E fighters and Hs 123 attack aircraft – received seven Hs 129A-0s by the end of 1940. The remaining seven Hs 129A-0s were completed and delivered by January of 1941. The pilots of 5. (Sch.)/LG 2 made the same complaints about the Hs 129A-0 as the test pilots: poor visibility, low engine power, and mediocre handling. One aircraft (GM+OF, W. Nr. 3009) crashed at Braunschweig on 16 December 1940, killing the pilot and a mechanic. Despite this setback the test program continued to support the Luftwaffe's urgent need for a dedicated ground support aircraft.

Two of the Hs 129A-0s were sent to Henschel at Schönefeld for engine trials work, while the remainder were reassigned to 4./SG (*Schlachtgeschwader*; Ground Attack Wing) 101 – the Hs 129 training unit – at Paris-Orly, France. This unit's Hs 129A-0s remained in service until SG 101 was disbanded in late 1944.

The Hs 129A-0 was of all-metal construction with light metal stressed skin covering. The two-spar wing center section, which carried the engine nacelles, was built integrally with the fuselage for added strength. This section was covered with 5MM armor plate. The wing's leading edge was slightly swept back outboard of the engine nacelles. The entire trailing edge was hinged, with slotted ailerons outboard and slotted flaps inboard. The two single-leg main landing gear units each had one wheel, which hydraulically retracted backwards into the lower engine nacelles. Part of the wheel slightly protruded from each nacelle to lessen damage in a wheels-up landing.

Two 54.2 gallon (205 L) fuel tanks were mounted within the wing center section, while a 52.8 gallon (200 L) fuel tank was fitted aft of the cockpit. All three tanks were self-sealing to reduce the risk of fire from combat damage. The Hs 129A-0 used 87-octane B4 fuel, which was a common fuel type for Luftwaffe combat aircraft.

The nose was built from spot welded armor plate and incorporated a cockpit 'bathtub' to protect the pilot from ground fire. This 'bathtub' ranged in thickness from 0.23 inches (6MM) on the sides to 0.47 inches (12MM) on the front and bottom. The FuG (*Funkgerät*; Radio Device) XVII radio set and the first aid kit were placed in the mid-fuselage and accessed by panels on the fuselage sides aft of the wing trailing edges. The non-retractable single wheel tail landing gear was placed on a single leg mounted on the aft fuselage.

The Hs 129A-0 had a wingspan of 46 feet 7.1 inches (14.2 M), a length of 31 feet 11.9 inches (9.75 M), and a height of 10 feet 7.9 inches (3.25 M). These dimensions would remain unchanged for all Hs 129 variants. The aircraft weighed 7188 pounds (3260 KG) empty and 9502 pounds (4310 KG) fully loaded.

Power was supplied by two 465 HP Argus As 410A-1 12-cylinder, inline, air-cooled engines driving two-bladed Argus variable pitch propellers. The Hs 129A-0 had a maximum speed of 220 MPH (354 KMH), a service ceiling of 17,716.5 feet (5400 M), and a range of 404 miles (650 KM).

This aircraft was armed with two 7.92MM Rheinmetall Borsig MG 17 machine guns with 500 rounds per gun (RPG) and two 20MM Mauser MG 151/20 cannon with 125 RPG mounted on the fuselage sides. Bulges over the wing root trailing edges covered the MG 151/20 breeches. The Hs 129A-0 could carry four 110.2 lb (50 KG) SC 50 bombs or two S125 *Nebelgeräte* (smoke generator) tanks under the fuselage.

The Luftwaffe did not accept the Argus-powered Hs 129A-1 production model, despite incorporation of most changes suggested by test pilots. In early 1941, the RLM cancelled its order for 60 Fw 189Cs and instead ordered 60 Hs 129A-1/14Ms. The 700 HP Gnome & Rhône 14M 04/05 engine was fitted to power these aircraft. This French 14-cylinder, air-cooled radial engine offered approximately 50 percent greater power than the 465 HP Argus As 410A-1s used on the Hs 129A-0. This variant was later designated **Hs 129A-1** before it was cancelled by the RLM in November of 1940. The first 16 aircraft were renamed **Hs 129B-0s**, while another ten airframes were designated **Hs 129B-1s**.

This Hs 129A-0, White 5 (W. Nr. 3005, GM+OB) was one of 14 *Antons* used by the Luftwaffe to train ground attack pilots on this new aircraft. A crocodile's head was painted on the nose of this and other Hs 129A-0s. The *Stammkennzeichen* (Radio Code) GM+OB was painted in black on the aft fuselage and wing undersurfaces. White 5 flew with the *Ergänzungszerstörergruppe* (Auxiliary Heavy Fighter Group) until it was written off in a crash landing at Deblin-Irena, Poland on 19 June 1942. (Möller)





Luftwaffe pilots pose in front of White 8, an Hs 129A-0 (W. Nr. 3008, GM+OE) assigned to the *Ergänzungszerstörergruppe* for training Hs 129 pilots. Hs 129As and early Bs had a large circular landing light mounted on the port wing. The pilot used this light to illuminate the ground below and in front of his aircraft during approach, landing, and taxiing. White 8 was destroyed in an accident in Poland on 15 July 1942. (Möller)

The early Hs 129s featured a downward slanting nose to provide the pilot with forward vision while looking down from above the battlefield. This Hs 129V-1 prototype was fitted with two continuous bomb racks under the fuselage, compared to the later four bomb shackles fitted to production aircraft. (Deutsches Museum)



The pilot of White 5 leans out of the cockpit of this Hs 129A-0 (W. Nr. 3005). The vanes placed on the propeller spinner controlled the pitch of the two-bladed Argus propeller. The large opening under the propeller spinner was the oil cooler intake, while the two smaller flanking orifices fed air to cool the Argus As 410A-1 engine. This same combination of Argus engines and propellers was used on the Focke-Wulf Fw 189 reconnaissance aircraft. (Möller)

Hs 129A-0 Nose Profile

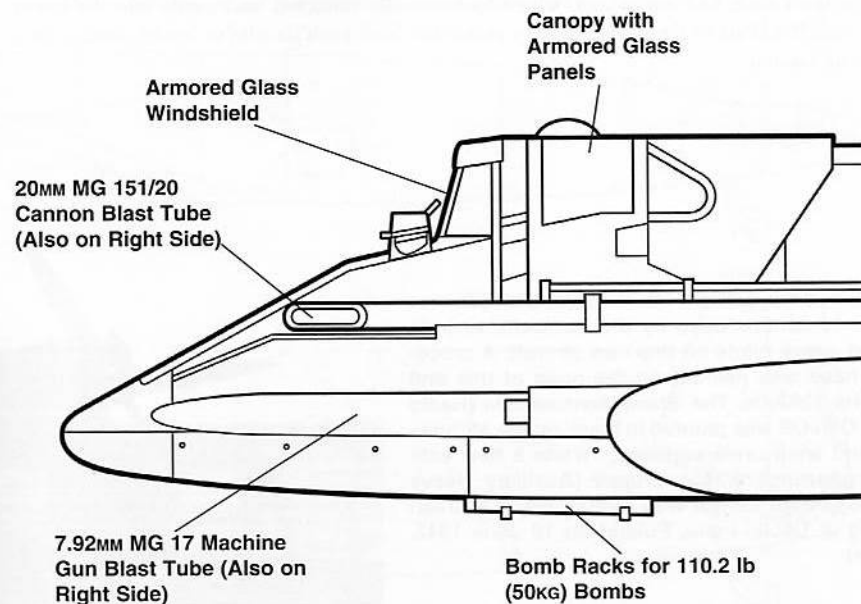

Hs 129A-0 Nose

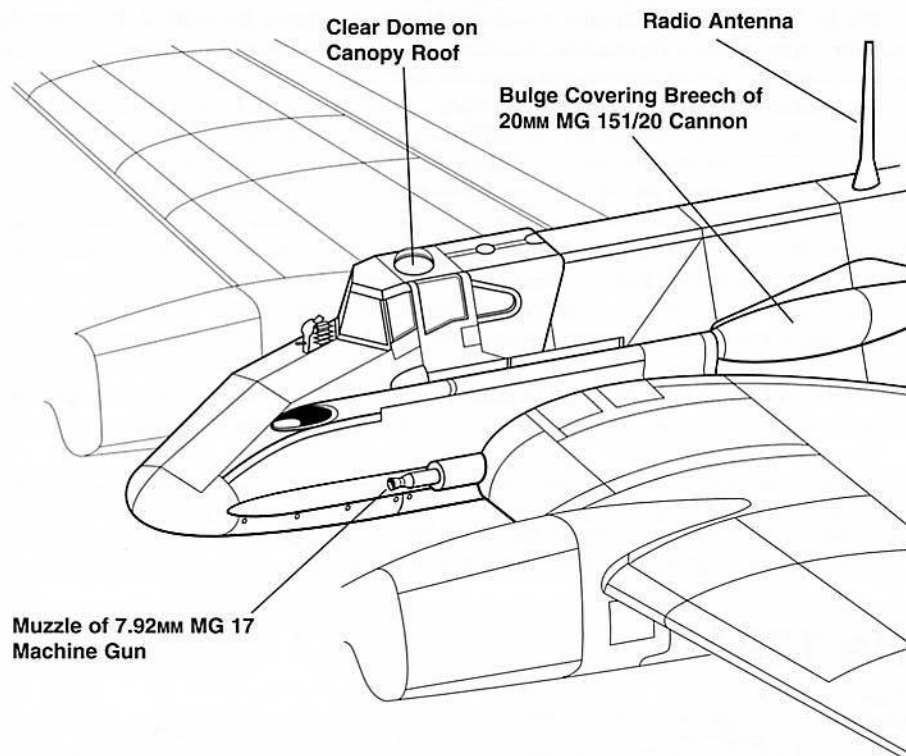

20MM MG 151/20 Cannon

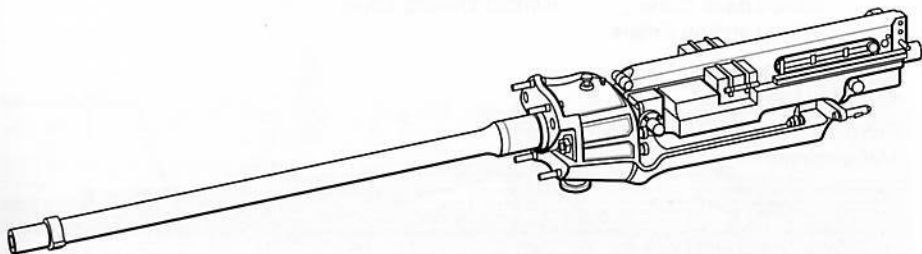

This Hs 129A-0 (GM+OG, W. Nr. 129 3010) was the tenth pre-series aircraft built for the Luftwaffe. A crocodile's head was painted on the nose of Hs 129A-0s assigned to the ground attack training unit at Paris-Orly, France. The numeral 10 on the engine nacelle was white. (Faucard)

Hs 129A Outer Wing

Swept Back Outboard Wing Leading Edge

Kinked Trailing Edge

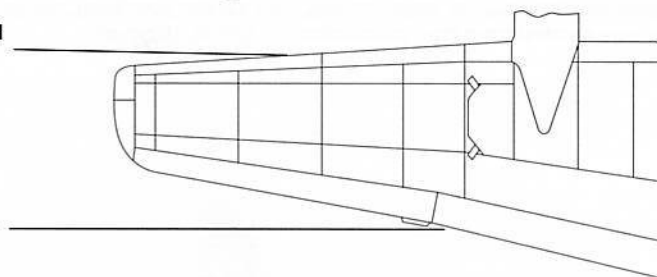

7.92mm MG 17 Machine Gun

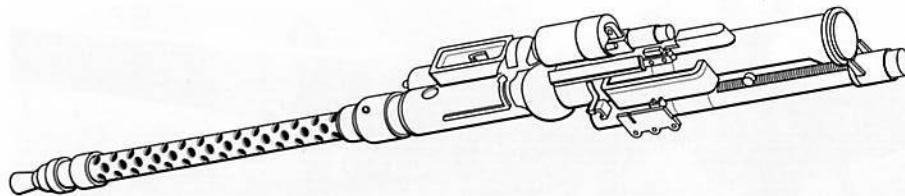

Hs 129B-0/B-1

The RLM refused to accept the Hs 129A-1 following the completion of the Hs 129A-0 operational trials in 1940, citing the aircraft's sluggish performance. Henschel chief designer *Dipl.-Ing. (Diplom-ingenieur; Certified Engineer)* Friedrich Nicolaus began a new project based on the Hs 129A-1. The P 76 retained the Hs 129A's configuration, but with slightly larger dimensions. This new design featured a wing span of 50 feet 10.2 inches (15.5 m), a length of 33 feet 2 inches (10.11 m), and a height of 11 feet 8.2 inches (3.51 m). Power would come from two 700 HP Gnome & Rhône 14M 04/05 radial engines, which drove three-bladed Ratier variable pitch metal propellers. The counter-clockwise turning 14M 04 engines were mounted to port, while the clockwise turning 14M 05 engines were placed to starboard. The Luftwaffe's pressing need for a ground attack aircraft ended the P 76 project, which would not have come to fruition for another year. Henschel was forced to adapt the Gnome & Rhône powerplant to the existing Hs 129A-1 airframe.

Henschel retrofitted the Hs 129V-3 prototype (W. Nr. 129 3003) with the French engines at Schönefeld in early 1941. The wing center section and engine bearers were modified to accept the larger and heavier powerplant. Henschel engineers relocated some internal equipment towards the aircraft's tail to compensate for the shifted center of gravity caused by the new and heavier engines. The modified aircraft, designated Hs 129V-3/U1 (*Umbausatz; Conversion Kit*), first flew on 19 March 1941. Subsequent test flights at Rechlin confirmed the improved performance of the Gnome & Rhône-engined aircraft over the Hs 129A-0 with its 465 HP Argus As 410A-1 engines. The results of these test flights led to Henschel retrofitting the 16 virtually complete Hs 129A-1s with the 14M engines. These machines were redesignated **Hs 129B-0s**. The first complete aircraft to be modified to Hs 129B-0 standards was Hs 129A-0, W. Nr. 129 3007, GM+OD.

Henschel technicians prepare a new Hs 129B-1 for an engine test at the Johannistal plant prior to delivery to the Luftwaffe. This aircraft had the early round air inlet under the engine cowling and the large landing light on the port wing leading edge. The latter feature was deleted from later production Hs 129Bs. (Bernád)

The Hs 129B-0 retained the basic construction of the previous Hs 129A-0, although several changes were made. The new variant incorporated straightened wing leading and trailing edges, which increased the wing area from 305.7 square feet (28.4 m²) to 312.2 square feet (29 m²). These changes reduced assembly time and the increased wing area improved the aircraft's handling. The nose was enlarged and slightly rounded for improved aerodynamics. The earlier two-piece, V-shaped windshield was changed to a one-piece windshield, while larger side glass panels and an upper glass panel were placed in the canopy for increased vision. Several engine instruments were moved from the cramped cockpit to the inboard engine nacelles, from where they were viewed by the pilot looking out the canopy.

The Hs 129B-1 differed in only minor details from the earlier Hs 129B-0. These details included replacement of the enclosed gun blast tubes by open troughs, redesigned engine air intakes, and repositioned radio equipment inside the fuselage.

This variant retained the fixed armament fitted to the earlier Hs 129A-0. Two 20MM MG 151/20 cannon with 125 rounds per gun (RPG) were fitted to the upper nose sides, while two 7.92MM MG 17 machine guns with 500 RPG were mounted on the lower nose sides. The first aircraft of this new batch (W. Nr. 0151) made its first flight in December of 1941.

Considerable confusion exists regarding the Hs 129's standard armament and various *Rüstsätze* (Field Conversion Sets) of external armament. A 1 January 1942 RLM document, GL/C-B2¹, mentioned the following armament variations:

Ständige Ausrüstung (Standard, or Permanently Used Equipment):

- Two forward firing 7.92MM MG 17 machine guns with 1000 rounds per gun (RPG), mounted on the fuselage side.
- Two forward firing 20MM MG 151/20 cannon with 250 RPG, mounted on the fuselage side.
- Two 110.2 lb (50 kg) SC50² or 48 4.4 lb (2 kg) SD2³ bombs under the wings.

¹ GL = *Generalluftzeugmeister*; Chief of Aircraft Procurement. C = *Technisches Amt*; Technical Bureau. B = *Fliegerische Gerät*; Aircraft Device. 2 = *Flugzeuge*; Aircraft

² SC = *Splitterbombe, Cylindrisch*; Cylindrical Fragmentation Bomb

³ SD = *Splitterbombe, Dickwand*; Thick-Walled Fragmentation Bomb



Hs 129A-0

Argus As 410A-1 engines

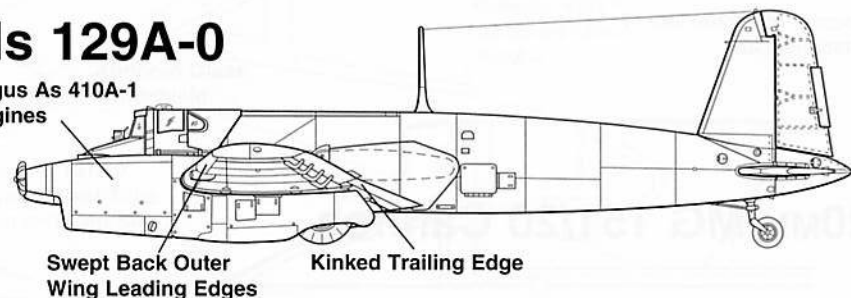

Swept Back Outer Wing Leading Edges

Kinked Trailing Edge

Hs 129B-1

Gnome & Rhône 14M engines

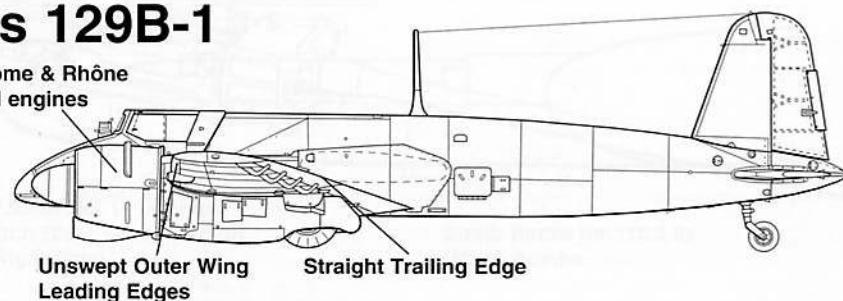

Unswept Outer Wing Leading Edges

Straight Trailing Edge

– One *Robot* automatic camera, 24MM x 24MM, with 60 frames in the fuselage.

Zusätzliche Ausrüstung (Auxiliary Equipment):

– One 30MM MK 101⁴ cannon with 30 rounds, mounted in a streamlined gondola under the fuselage

– Four 7.92MM MG 17 machine guns with 1000 total rounds (250 RPG), mounted in a streamlined fairing under the fuselage.

– Four 110.2 lb (50 KG) C50, one 551.1 lb (250 KG) C250, or 96 4.4 lb (2 KG) SD2 bombs on underfuselage racks.

– One Rb (*Reihenbildkamera*; Automatic Aerial Camera) 20/30.

There is no word given on any particular *Rüstsatz* designation number given to these Hs 129 equipment options. Official Hs 129B manuals and RLM *Lieferpläne* (Delivery Plans) also mention available armament and equipment options, but no *Rüstsatz* designations. Most existing publications – except for Martin Pegg's book 'Hs 129 Panzerjäger!' – mention particular *Rüstsätze* with Hs 129s; however, these designations are not supported by the evidence.

Henschel upgraded ten Hs 129B-0s (W. Nr. 0151-0160) under construction to B-1 standards, then produced 50 original B-1s (W. Nr. 0161-0210) according to the pending RLM order of 60 aircraft. During construction of this latter batch, Henschel shifted Hs 129 production from Schönefeld to its larger plant at Johannistal, southeast of Berlin. In December of 1941, the RLM ordered 250 tropicalized Hs 129B-1s, which would have engine sand filters installed for desert operations. This order was cancelled in April of 1942 and the last ten Hs 129B-1s (W. Nr. 0201-0210) of the previous order were upgraded to become the first ten examples of the **Hs 129B-2**.

⁴ MK = *Maschinen Kanone*; Machine Cannon

The starboard main landing gear collapsed on this early production Hs 129B-1 while landing at *E-Stelle* Rechlin sometime in early 1942. The aircraft was fitted with a tall radio antenna mast on the upper fuselage and the round air intakes under the engine cowlings. A 30MM MK 101 cannon was mounted under this Hs 129B-1's fuselage. (Griehl)



An Hs 129B-1, Yellow G, takes off on a ground attack mission over the Eastern Front during the summer of 1942. This aircraft was assigned to II./Sch.G 1 and the *Gruppe's* insignia was placed aft of the canopy. The Hs 129B-1 was armed with a 30mm MK 101 cannon under the fuselage for engaging Soviet armored vehicles. (Dabrowski)

An Hs 129B-1 banks to port while flying at low level over its base. The *Berta* (B model) had straight wing leading and trailing edges, replacing the swept leading edges of the *Anton* (A Model) wings. Axis Eastern Front identification markings included RLM27 Yellow (FS33637) noses and aft fuselage bands. (Petrick)





Gnome & Rhône 14M Engine

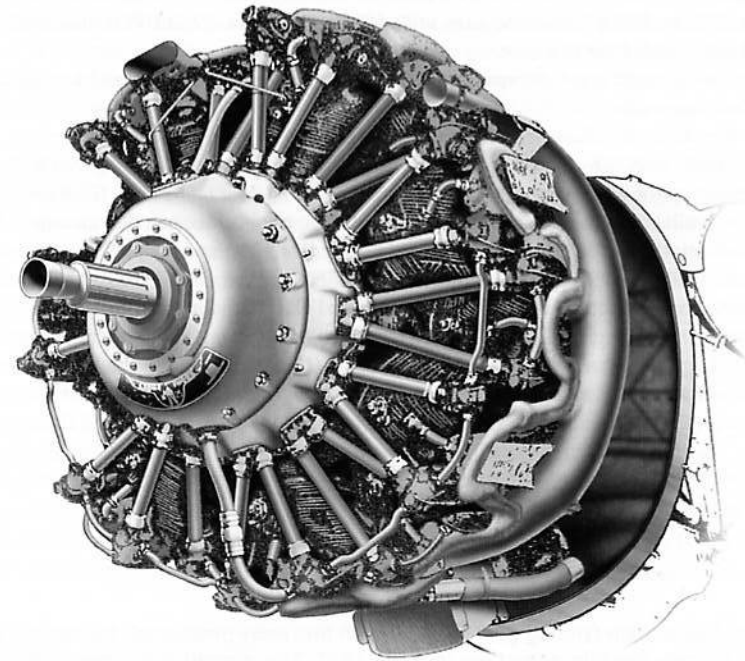

Student *Schlacht* (Ground Attack) pilots study the starboard Gnome & Rhône 14M radial engine of an Hs 129B. The engines turned their Ratier propellers towards the aircraft's centerline, which counteracted engine torque and prevented the Hs 129 from drifting to one side or another during single-engine flight. The propeller spinners had red fronts, white bands, and black aft sections, while the propellers were RLM70 Black Green (FS34050) with white Ratier logos. Lack of cockpit space caused the Hs 129's engine instruments to be placed on the inboard nacelle surfaces below the exhaust pipe, which the pilot could see from inside the cockpit. (Petrick)

Port Engine Instruments (Inboard Nacelle Surface)

RPM
(Revolutions per Minute)
Indicator

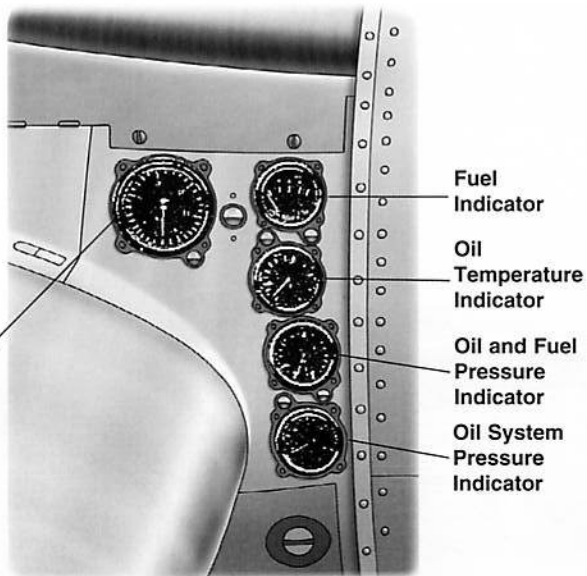

Starboard Engine Instruments (Inboard Nacelle Surface)

Fuel Indicator
Oil Temperature
Indicator
Oil and Fuel
Pressure
Indicator

RPM
Indicator

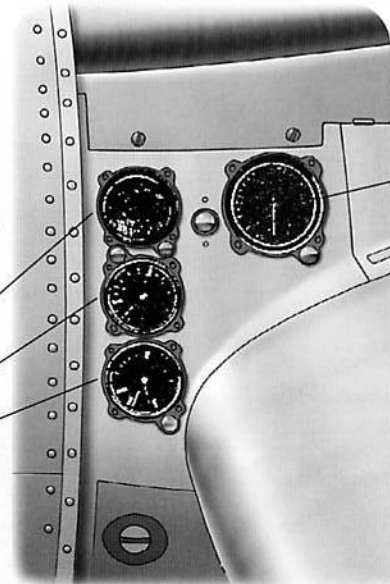

Hs 129A-0 Nose

Sharply Angled Nose

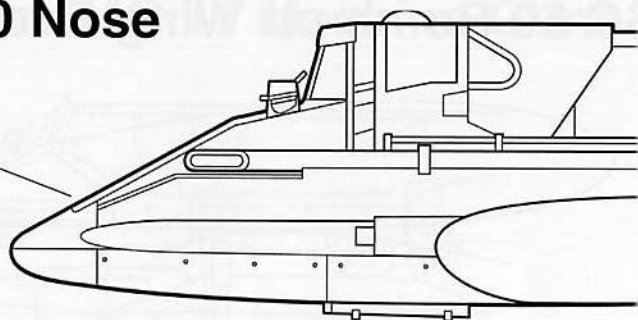

Hs 129B-0/B-1 (Early) Nose

Rounded Nose

Enclosed Blast Tubes for Guns

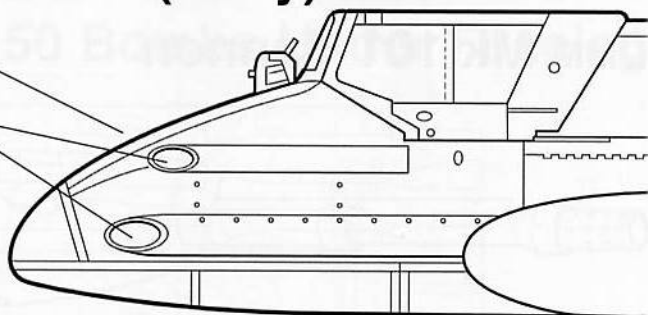

Hs 129B-1 (Late) Nose

Open Blast Tubes for Guns

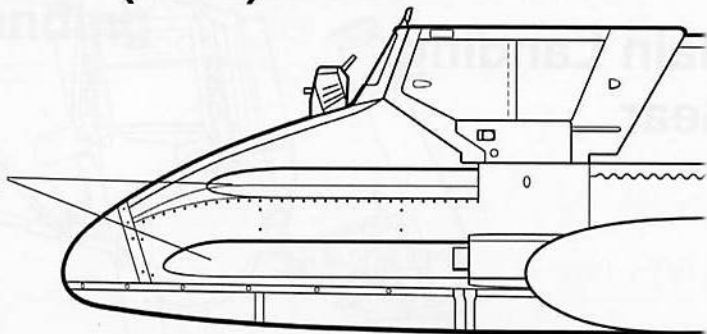

110.2 lb (50 kg) SC 50 Bomb

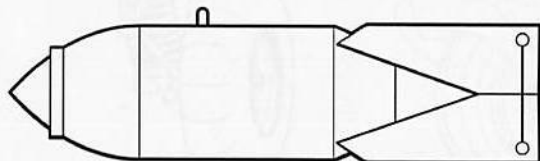

A Hs 129B rests on a snow-covered forward airfield in the German-occupied Soviet Union. The upper nose blast troughs accommodated the 20mm MG 151/20 cannon, while the 7.92mm MG 17 machine guns were fired through the lower troughs. A 30mm MK 101 cannon was mounted under the fuselage for anti-tank use; however, ground crewmen have removed the gun's streamlined fairing.

Luftwaffe mechanics work on the starboard Gnome & Rhône 14M engine of this Hs 129B – fitted with long exhaust pipes – on the Eastern Front in early 1944. The propeller spinner was removed for servicing the Ratier three-bladed propeller. A 110.2 lb (50 kg) SC 50 bomb was mounted under the Hs 129's starboard wing, while other bombs were placed on the snow-covered ground under the aircraft.



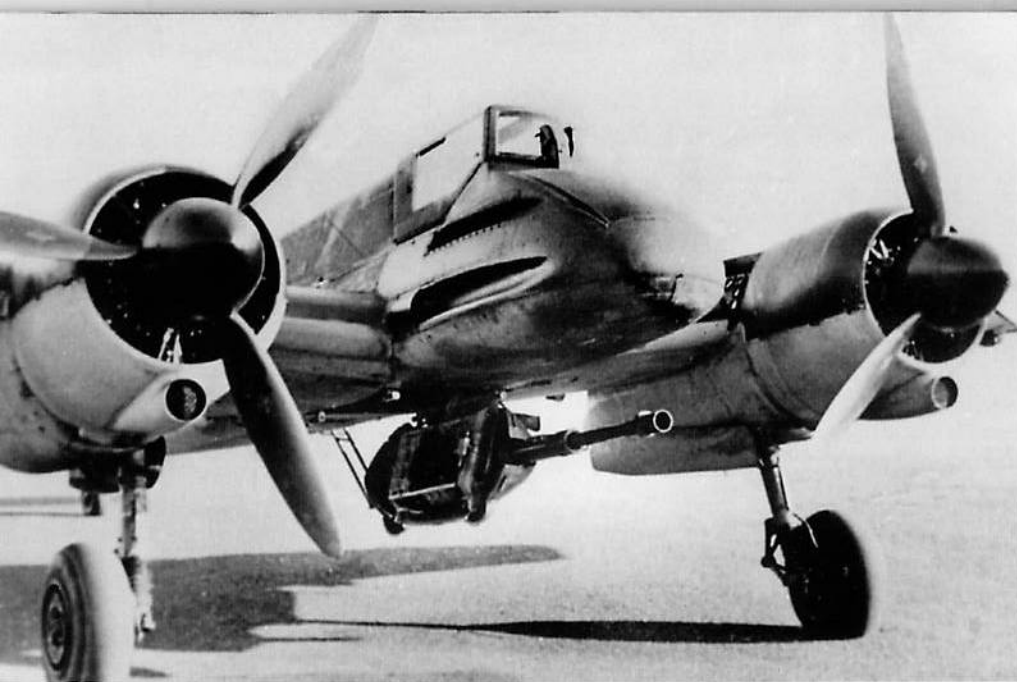

SC 50 Bomb on Wing Rack

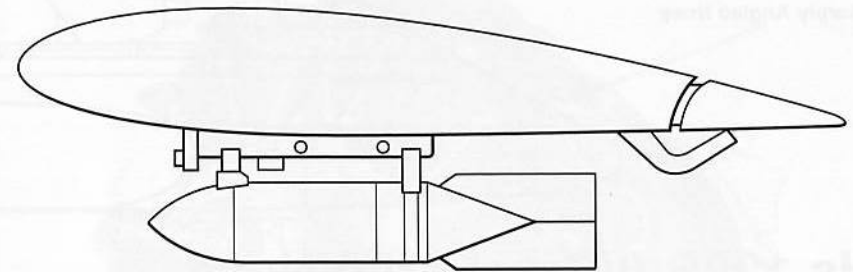

30MM Mk 101 Cannon

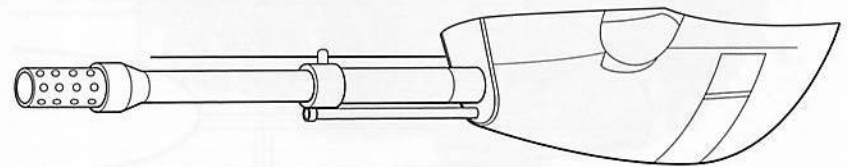

This early Hs 129B-1 was fitted with the 30MM MK 101 cannon under the fuselage. The weapon housing gondola was hinged to port to allow for servicing the weapon. Armors had not yet installed the 30-round ammunition drum to the MK 101 gun, which held armor-piercing shells for the weapon. (Radinger)

The ammunition magazine drum was installed on the aft right section of the MK 101 cannon. The sheet metal fairing was removed and the weapon hinged down along its port side to allow for maintenance. The tubular steel frame under the MK 101 held the weapon for maintenance and display purposes. (Radinger)

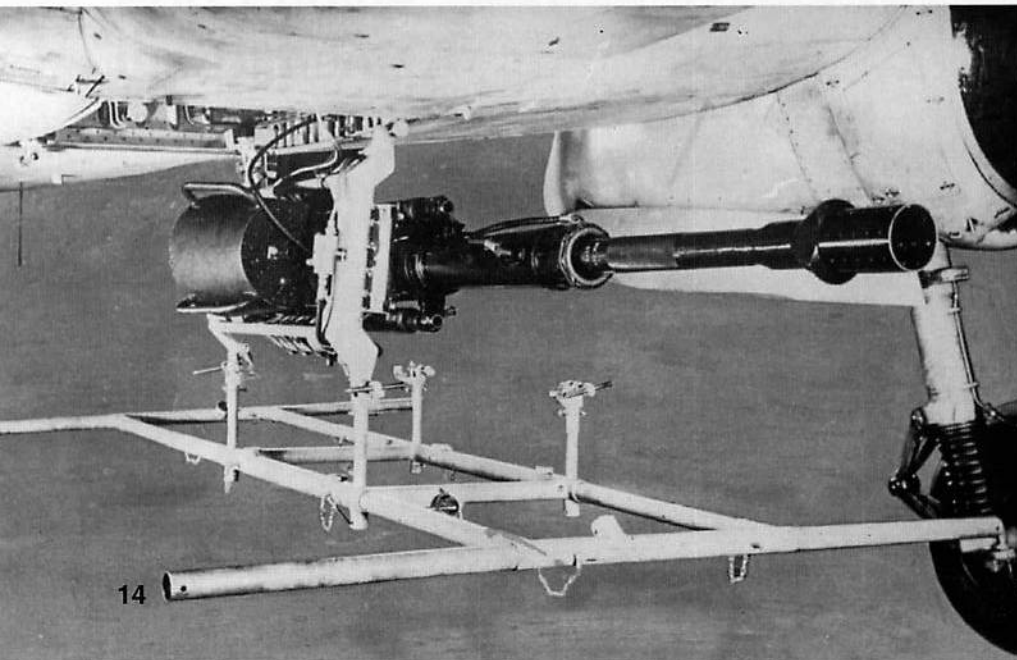

Main Landing Gear

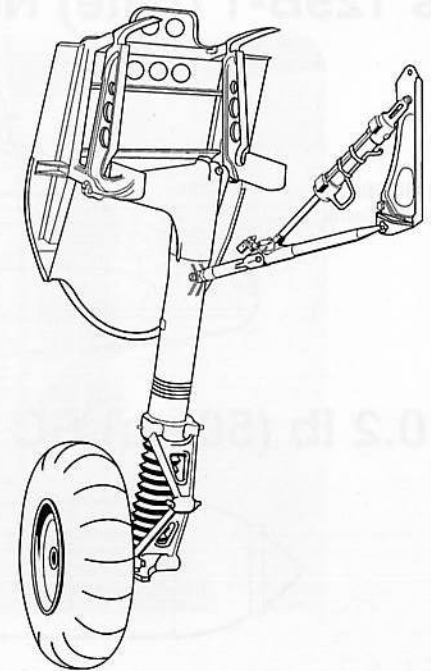

Four 7.92mm MG 17 Machine Guns

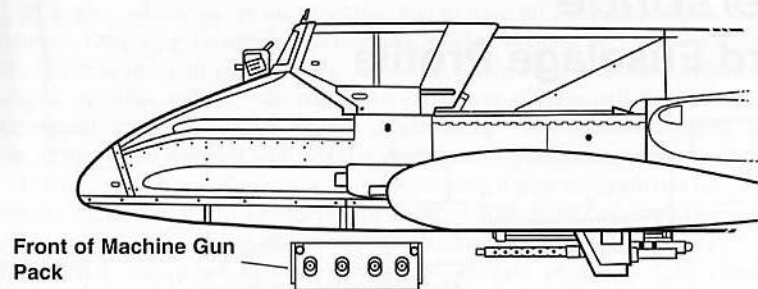

Four SC 50 Bombs Under Fuselage

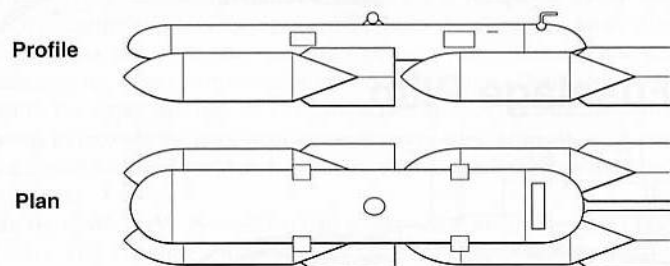

Tail Landing Gear

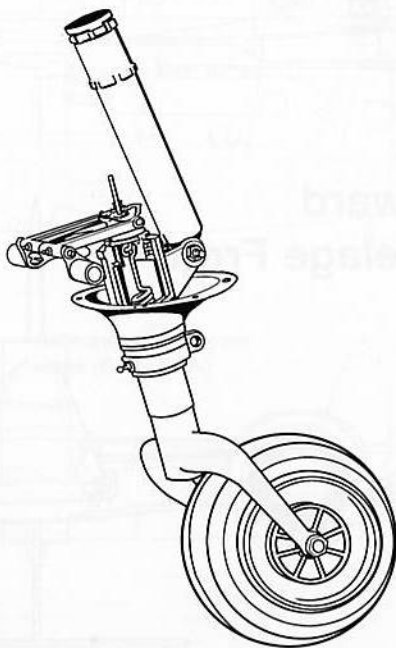

One of the Hs 129B's *Rüstsätze* (Field Conversion Sets) consisted of four 7.92mm MG 17 machine guns mounted under the fuselage. Each weapon was supplied with 250 rounds of ammunition for use against ground targets. A fairing immediately aft of the guns' barrels partially covered the breech mechanisms. (Radinger)

The R3 installation of four 7.92mm MG 17 machine guns was hinged to port for servicing. The four ammunition magazines – one placed above each weapon's breech – held 250-round ammunition belts. A cylindrical bottle beside the magazines' supplied compressed air for the gun charging and ammunition feeding systems. (Radinger)

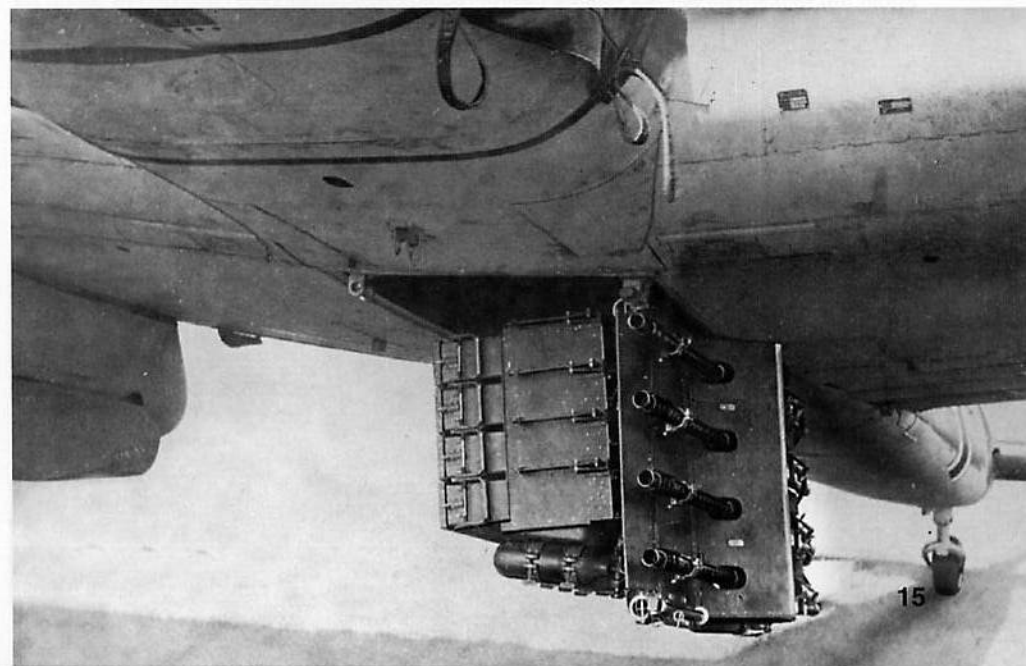



Hs 129B-0 Fitted with SG 113A *Förstersonde* Forward Fuselage Profile

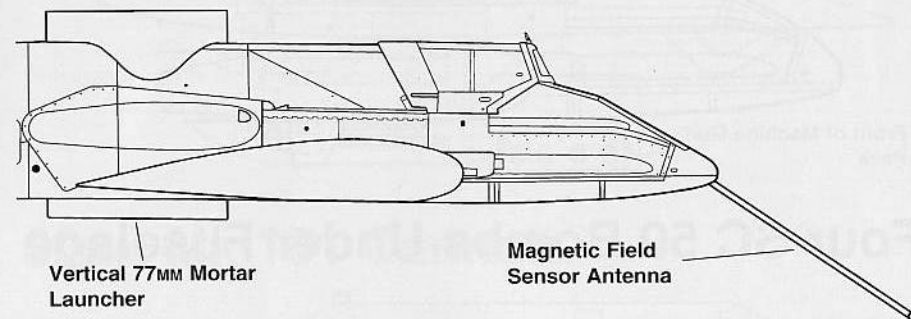

The initial Hs 129B-0 (W. Nr. 0016) was used for trials of the SG (*Sondergerät*; Special Device) 113A *Förstersonde* (Ranger Probe) recoilless anti-tank mortar. The T-shaped antenna on the aircraft's nose sensed the magnetic field of a large metal object – such as a tank – under the low-flying aircraft. This sensor triggered the six 77mm armor-piercing shells vertically mounted in the mid-fuselage. (Nowarra)

The SG 113A *Förstersonde* used six 77mm anti-tank shells placed in the mid-fuselage, which had bulges added to the top and bottom to accommodate this device. The shells were fired downward over a passing tank, while steel slugs were launched upward to counteract the recoil. The SG 113A was never used operationally because the sensor could not reliably detect the targets during testing. (Nowarra)

Forward Fuselage Plan

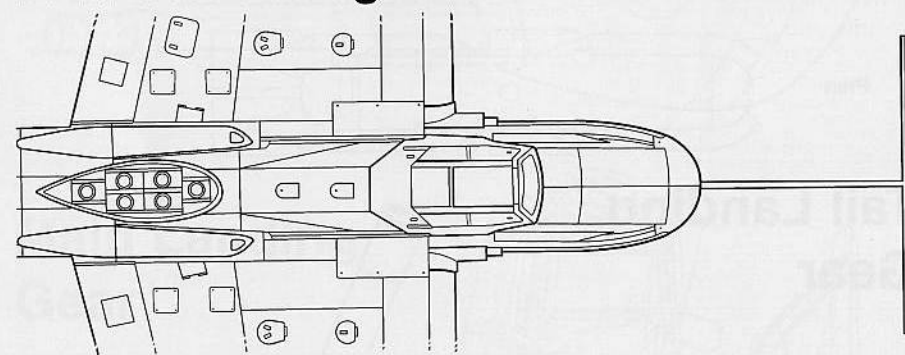

Forward Fuselage Front

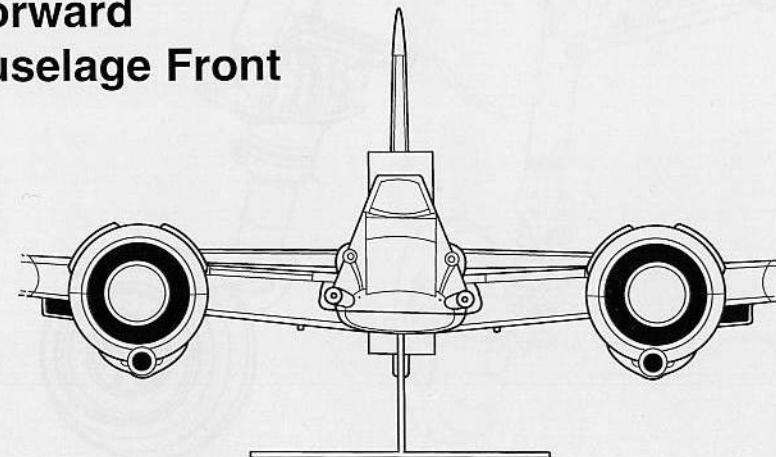

Hs 129B-2

The service introduction of the Hs 129B-1 on the Eastern Front in the spring of 1942 revealed several problems with this new variant. The most pressing concern was the Gnome & Rhône 14M engine, which was prone to seizure and to have little tolerance for dust, sand, and battle damage. *Dipl.-Eng.* Friedrich Nicolaus' design team at Henschel began work on improving the Hs 129B in order to correct these problems. These improvements included modifying the engine cowlings and later shortening the exhaust pipes. It is believed the exhaust pipes were shortened to help reduce engine overheating. The circular engine intakes of the Hs 129B-1 were replaced with angular intakes incorporating improved sand/dust filters.

The fuel system was also modified, incorporating a pressure regulator fitted near the fuel filter and engine fuel pump. Feeder pumps installed in the wing fuel tanks reduced the risk of fuel vapor lock under tropical conditions. The changes made to the Hs 129B-1 resulted in the **Hs 129B-2**, which would represent over 90 percent of all Hs 129s produced. The first Hs 129B-2 (W. Nr. 0201) – originally ordered as an Hs 129B-1 – was completed in May of 1942. This aircraft was the first of 250 Hs 129B-2s originally ordered by the RLM (Reich Air Ministry).

The Hs 129B-2 retained the basic structure and equipment of the earlier Hs 129B-1, apart from the engine and fuel system modifications. Early in B-2 production, the upper fuselage radio antenna mast was removed and replaced with a wire antenna running from the upper fuselage to the upper vertical stabilizer. A RDF (Radio Direction Finding) loop antenna was fitted to the upper fuselage of late production B-2s. This antenna homed in on ground radio beacons to provide the pilot with accurate navigation information. A rear view mirror mounted on top of the windshield and shortened engine exhaust pipes were installed on late production aircraft.

Six Hs 129B-2s (W. Nr. 0351-0356) received a *Schleppkupplung* (Towing Coupling) on the tail cone. This coupling allowed the aircraft to tow the DFS 230 assault glider; however, there is no record of the Hs 129/DFS 230 combination being used operationally.

Hs 129B-1

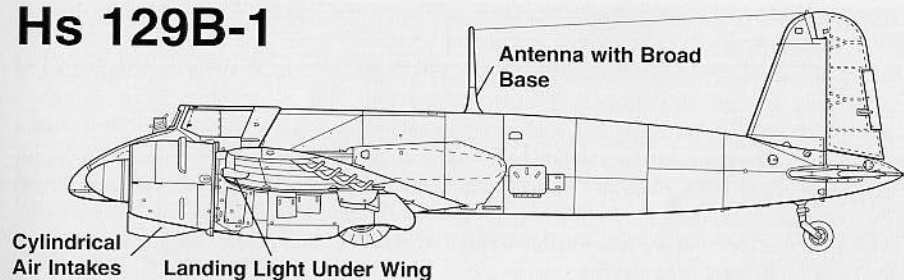

Hs 129B-2

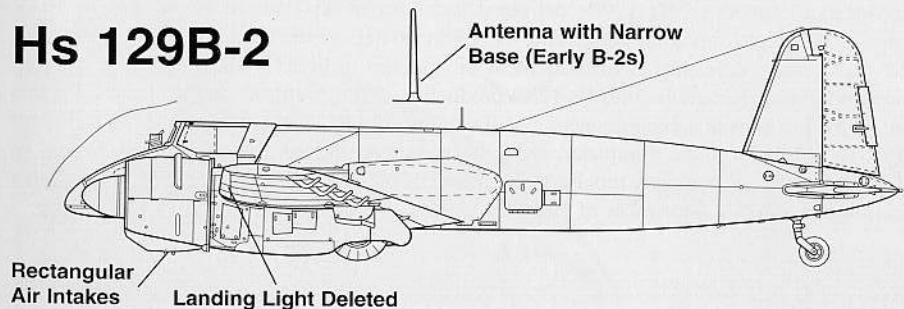

The standard armament remained two nose-mounted 20MM MG 151/20 cannon and two 7.92MM MG 17 machine guns placed on the nose. A *Rüstsatz* (Field Conversion Set) added a bomb rack under each wing for 110.2 lb (50 kg) SC 50 bombs. Hs 129B-2s were also capable of carrying four 110.2 lb SC 50 bombs or one 1102.3 lb (500 kg) bomb under the fuselage.

A fuselage mounted 30MM cannon was carried as another *Rüstsatz*, although the MK 101 used on the Hs 129B-1 was replaced by the MK 103 on later Hs 129B-2s. The MK 103 weapon featured a higher muzzle velocity and a flatter trajectory than the earlier MK 101 cannon. The MK 103 was supplied with 100 rounds of armor piercing ammunition for the anti-tank role.

Another Hs 129B-2 weapons option was a 37MM BK 3,7¹ with 12 rounds in a gondola placed under the fuselage. This same weapon – a modified Flak 18² – was also fitted under the wings of the Junkers Ju 87G-1 Stuka. The BK 3,7 installation required the removal of the two 7.92MM MG 17s and their ammunition from the Hs 129B-2's fuselage to reduce weight. Hs 129B-2 pilots used the BK 3,7 and the 30MM MK 103 guns against the side and rear armor plating of Soviet tanks, which was thinner (and easier to penetrate) than their front armor.

The emphasis on anti-tank armament was in line with the Luftwaffe's decision to employ the Hs 129B-2 away from close air support and towards countering the numerically superior Soviet tank formations on the Eastern Front. The hard-pressed German Army – pressed on several fronts by late 1942 – looked toward the Hs 129s to counter the Red Army's growing armored strength. Henschel configured many Hs 129B-2s at the factory for the *Waffenträger* (Weapon Carrier) standard, being fitted with heavy anti-tank armament on the production line rather than as a field modification. The wing bomb racks were often removed to reduce aircraft weight.

¹ BK = *Bordkanone*; Fixed Aircraft Cannon

² Flak = *Fliegerabwehrkanone*; Anti-Aircraft Gun

A late production Hs 129B-2 taxis on the runway prior to takeoff, while another aircraft turns to port prior to landing. The B-2 variant – except for initial production examples – deleted the tall radio antenna mast on the aft fuselage, used short engine exhaust stacks, and had redesigned air filters under the engine cowlings. A 30MM MK 103 gun was mounted under the taxiing Hs 129B-2's fuselage. (Petrick)





An Hs 129B-2 warms up its engines prior to take off on another mission over the Eastern Front. The large landing light on the port wing of early Hs 129s was deleted late in B-1 production and was not carried by B-2s. A pitot tube to measure air pressure for the cockpit's air speed indicator was placed on the outer starboard wing of all Hs 129 variants.

On 25 May 1943, the RLM's GL/C-B2 II issued a *Lieferplan* (Delivery Plan), which assessed the Hs 129 production situation as of 1 April 1943. This plan called for building 1635 Hs 129B/Cs with the following four *Rustsätze* categories for optional equipment. (No numeric designations were given.):

- One 30MM KM 101 [*sic* – actually MK 101] cannon. Total of 275 aircraft, with 153 built by 30 March 1943, and 122 to be built by August of 1943 at a maximum rate of 25 aircraft per month.

An Hs 129B-2 banks to port while making a low pass over its home base on the Eastern Front. The shorter exhaust stacks introduced early in the Hs 129B-2 production run helped reduce engine overheating. This variant retained the straight wing leading and trailing edges of the Hs 129B-1, which reduced production time.



The pilot of this Hs 129B-2 warms up his aircraft's engines prior to takeoff from a forward airfield on the Eastern Front. The nose was painted RLM27 Yellow (FS33637) with a black anti-glare panel in front of the windshield. An RDF (Radio Direction Finding) loop antenna was placed on the aft fuselage of some Hs 129B-2s.

- *Schleppkupplung* (Towing Coupling). Total of 595 aircraft, with 101 built by 30 March 1943 and 494 to be built by June of 1944 at a maximum rate of 40 aircraft per month.

- One 30MM MK 103 cannon. Total of 155 aircraft, with none built by 30 March 1943 and 155 to be built from September of 1943 to June of 1944 at a maximum rate of 30 aircraft per month.

- Four ETC 50 racks for 110.2 lb (50 kg) bombs or one ETC 500 rack for a 1102.3 lb (500 kg) bomb. Total of 610 aircraft, with 292 built by 30 March 1943 and 272 to be built by June of 1944 at a maximum rate of 30 aircraft per month.

Henschel had planned to produce up to 40 Hs 129B-2s per month; however, conflicting RLM demands and contradictory production orders reduced this rate to as low as 20 per month in September of 1942. The RLM had instructed Henschel to produce Junkers Ju 88 bombers under license, then requested production be switched to the Messerschmitt Me 410 heavy fighter. In December of 1943, Henschel – after having retooled for Me 410 production – was directed by the RLM to produce the Ju 388 bomber instead. These changes in production capability and the increased need to use less reliable foreign workers cut into Hs 129 production at a time when the aircraft was most needed.

The total number of Hs 129Bs delivered had reached 664 aircraft by the end of 1943. Attrition was high; during the same time, 495 of the 664 Hs 129Bs produced (75 percent) were lost to combat, accidents, or abandonment on overrun airfields. Allied bombing raids on German industry further cut into Hs 129B production, through attacks on the Henschel plants and on the factories of sub-component manufacturers. The RLM's plan in early 1942 called for 1128 Hs 129B-2s to be completed by 30 March 1945. Despite the obstacles placed in Henschel's path, the company reportedly built over 1000 Hs 129B-2s before production of this aircraft was ended in September of 1944.



Mülle was one of the rare Hs 129s nicknamed by its pilots. The name was elaborately painted on the yellow nose between the ends of the starboard gun troughs. The Revi C/12C gunsight was mounted in front of the Hs 129B-2's single-piece armored windshield due to the lack of space inside the cockpit. Some Hs 129B-2s were fitted with a rear view mirror atop the windshield.

The Hs 129B-2's nose section incorporated an armored 'bathtub' to protect the pilot from gunfire. The armor plating ranged in thickness from 6mm on the sides to 12mm on the nose and floor. The circular holes on the nose bulkhead's port side held the cockpit heater intake. This Hs 129B-2 'bathtub' came from W. Nr. 0385, which was captured by US forces in North Africa in 1943. The aircraft later was used for flight tests before being scrapped; however, the 'bathtub' is being restored in Australia by its owner, Martin Mednis. (Mednis)

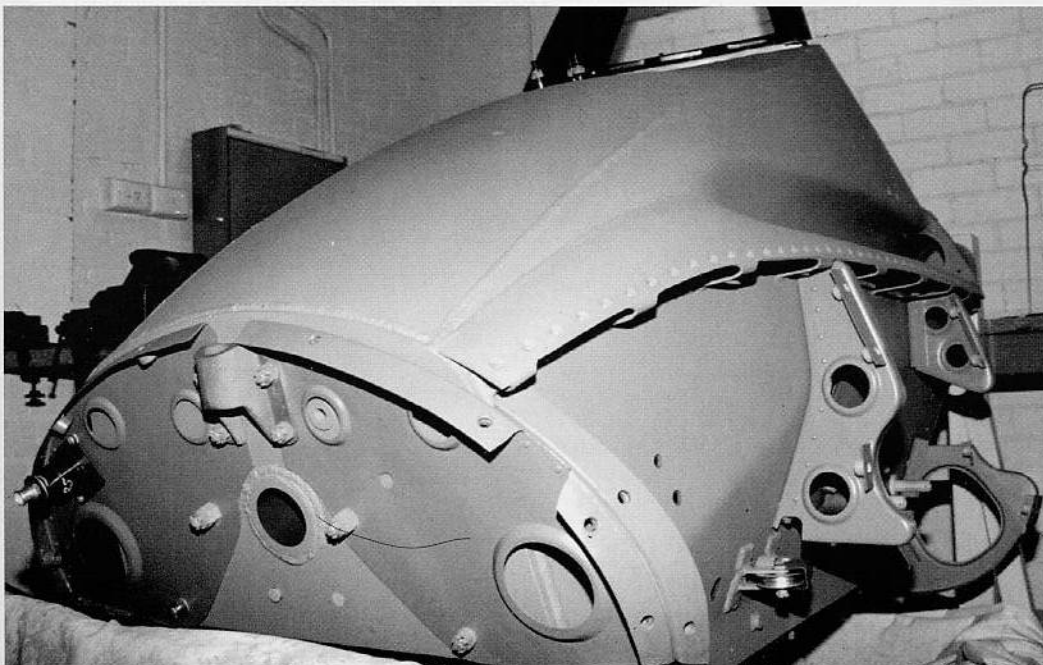

The German Army's Infantry Assault Badge was painted in white on the Hs 129B-2's nose ahead of the windshield. This insignia was popular with the *Schlacht* (Ground Attack) pilots operating in close support of ground troops. The small opening on the nose's center was for the nose-mounted movie camera, while the larger opening on the port nose was the intake for the cockpit heater. Both features were introduced on Hs 129B W. Nr. 0331. (Petrick)

Henschel Insignia



Henschel Hs 129B-2 Specifications

Wingspan:.....46 feet 7.1 inches (14.2 M)
Length:.....31 feet 11.9 inches (9.75 M)
Height:.....10 feet 7.9 inches (3.25 M)
Wing Area.....312.2 square feet (29 M²)
Empty Weight:.....8399.5 pounds (3810 KG)
Maximum Weight:....11,265.4 pounds (5110 KG)
Armament:.....Two 20MM MG 151/20 cannons with 125 rounds per gun (RPG) on upper fuselage sides and two 7.92MM MG 17 machine guns with 500 RPG on lower fuselage sides. Provision for 30MM MK 101 or MK 103 cannon with 30 rounds under the fuselage and two 110.2 lb (50 kg) bombs under the wings.
Maximum Speed:.....254.8 MPH (410 KM/H)
Service Ceiling:.....17,716.5 feet (5400 M)
Range:.....422.5 miles (680 KM)
Crew:.....One

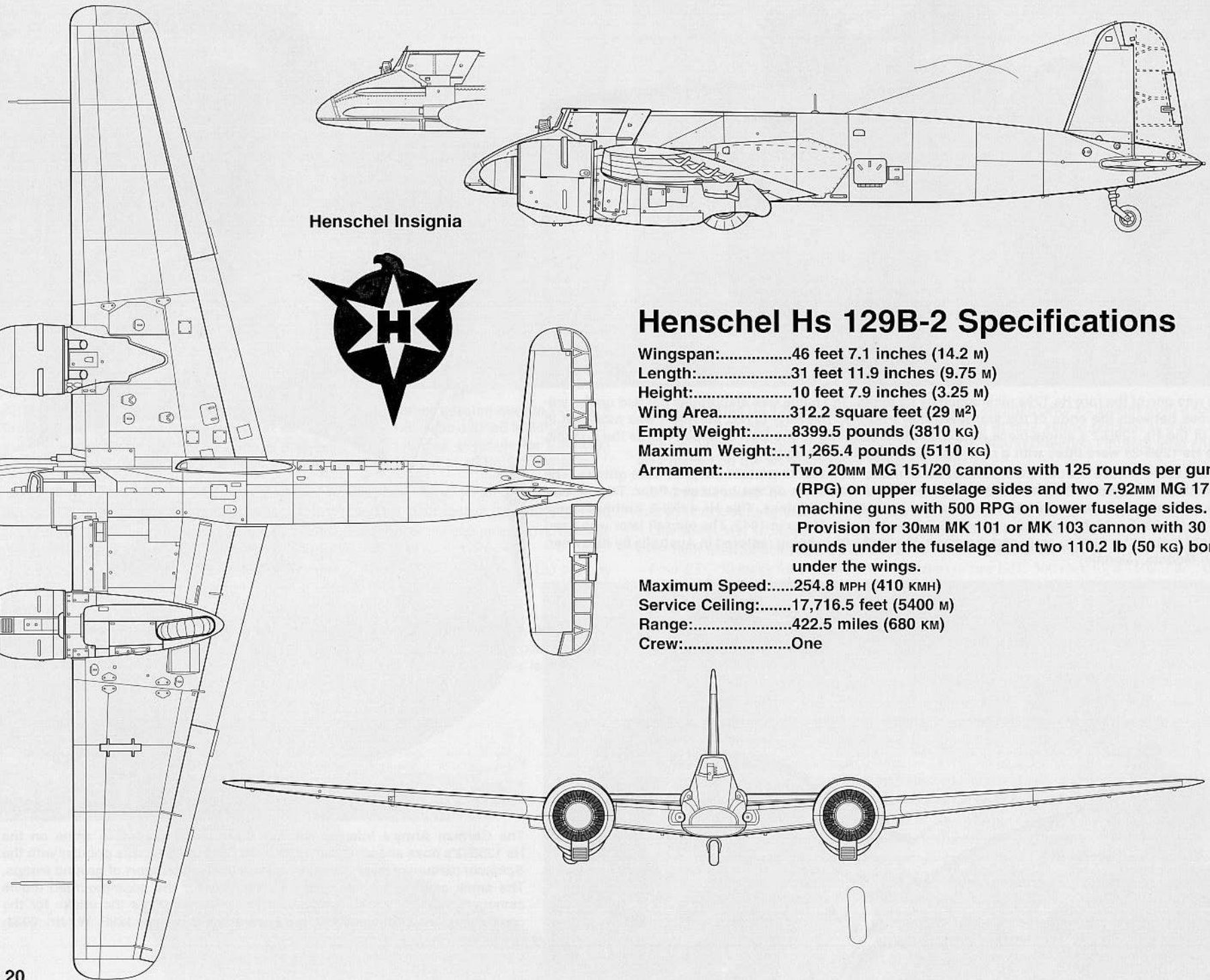

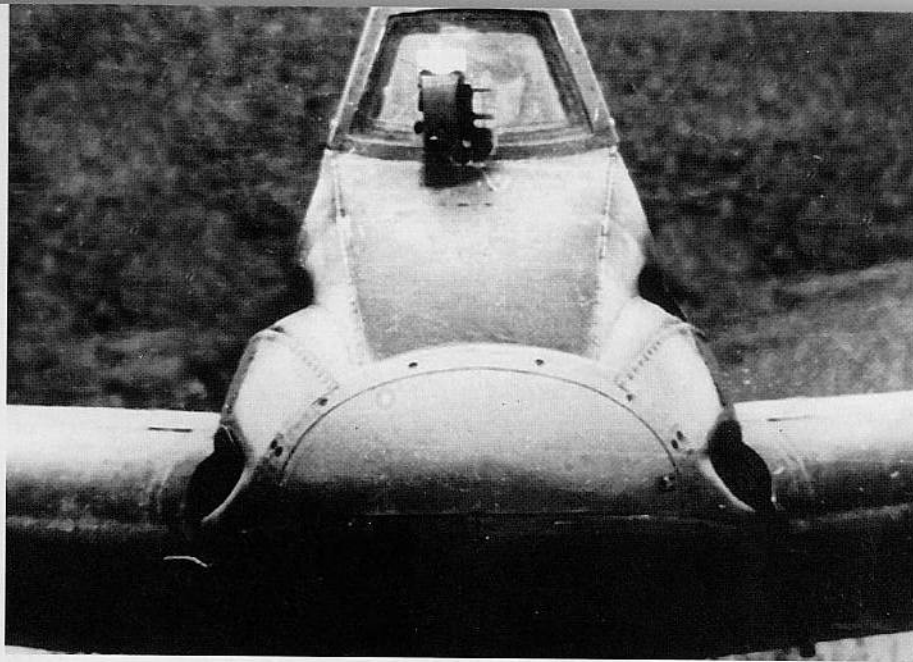

The Hs 129B-2's compact cockpit left little room for the pilot's head when he was strapped into his cockpit. The inward sloping fuselage side panels helped deflect light projectiles fired on the aircraft from other aircraft or gunners on the ground. The Hs 129's truncated triangular cross section also allowed ease of construction – an important consideration in wartime. The upper troughs on the nose were for the 20MM MG 151/20 cannons, while the 7.92MM MG 17 machine guns fired through the lower troughs. (Griehl)

The pilot of this Hs 129B-1 has closed the canopy prior to takeoff on a mission. This canopy remained unchanged through all Hs 129B aircraft. White diagonal lines painted on the port glass side panel aided the pilot in aligning with the horizon during diving attacks. These lines were calibrated for 10°, 20°, and 30° dives.



A Luftwaffe *Schlacht* pilot signals to his ground crew prior to takeoff on a close support mission. He opened the sliding panel on the forward port side of the canopy to signal with his arm. Fixed canopy panels were placed on the aft left and right sides and on the roof. A rear view mirror was often retrofitted to Hs 129B-2s to alert pilots to enemy aircraft attacking from behind. (Petrick)



Lt Leonid Sotropa, an ARR (Royal Rumanian Air Force) pilot, adjusts the shoulder harness securing him to the armored seat of this Hs 129B prior to a mission. A pair of straps connected the seat back to the aft cockpit bulkhead. Vanes placed along the Revi C/12C gunsight in front of the windshield aided the Hs 129's pilot in determining the horizon for diving attacks. (Bernád)

The late production Hs 129B-2 and B-3 cockpit differed in only slight details from the cockpit arrangements of early Hs 129s. The instrument panel included the main flight and armament indicators, while engine instruments were placed outside on the inner nacelle surfaces. The control stick was moved slightly starboard, while a cushion was placed in the pilot's armored seat. The interior was painted RLM66 Black Gray (FS36081). (via Bílý)

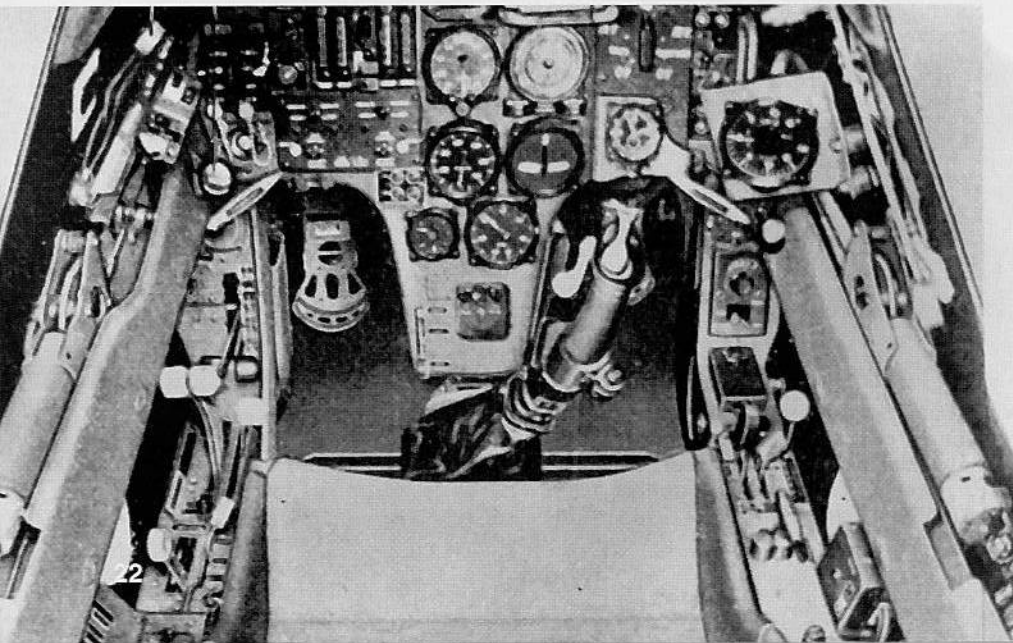

Hauptmann (Capt) Rudolf-Heinz Ruffer, one of the most successful Hs 129 pilots, is strapped into his seat and ready for engine start. The seat back extension behind the pilot's head was made from 6mm armor plate for protection against rear attack. Leather padding was placed along the windshield to cushion the pilot's head in the event of an accident. (Griehl)

Pilot's Seat

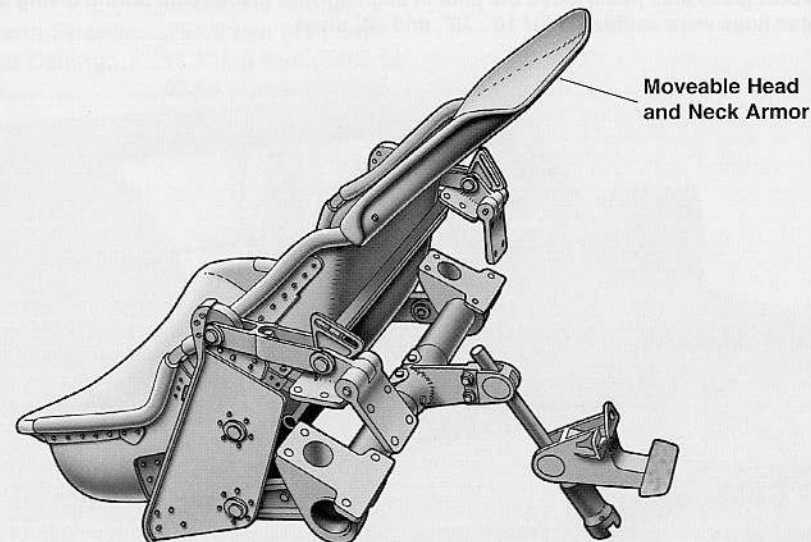



Ground crewmen feed 100-round 30mm ammunition belts into the MK 103 cannon mounted under the Hs 129B-2's fuselage. The superior MK 103 replaced the MK 101 fitted to the earlier Hs 129B-1. The weapon's rectangular muzzle brake reduced the recoil to ensure the gun's smooth operation. The MK 103 cannon could penetrate 75mm of armor plate at a distance of 328.1 yards (300 m). (Petrick)

30MM Mk 103 Cannon

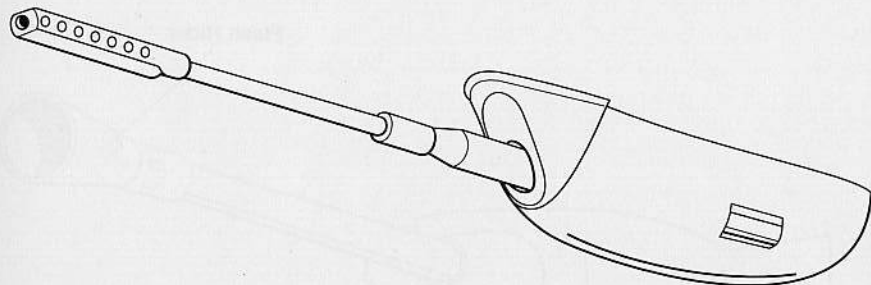

A Luftwaffe *Oberfeldwebel* (Sergeant Major) closes the collars securing the MK 103's barrel to the Hs 129B-2's fuselage. This step insured that the barrel would not flutter while the aircraft was in flight. The dark smudge near the muzzle was powder from the gun's blast. A slight depression in the nose surface above the muzzle incorporated a blast panel, which protected the aircraft's skin from the gun's muzzle blast. Henschel factory workers often installed the MK 103 on Hs 129B-2s during production, rather than providing this weapon as a field installed kit. (Griehl)



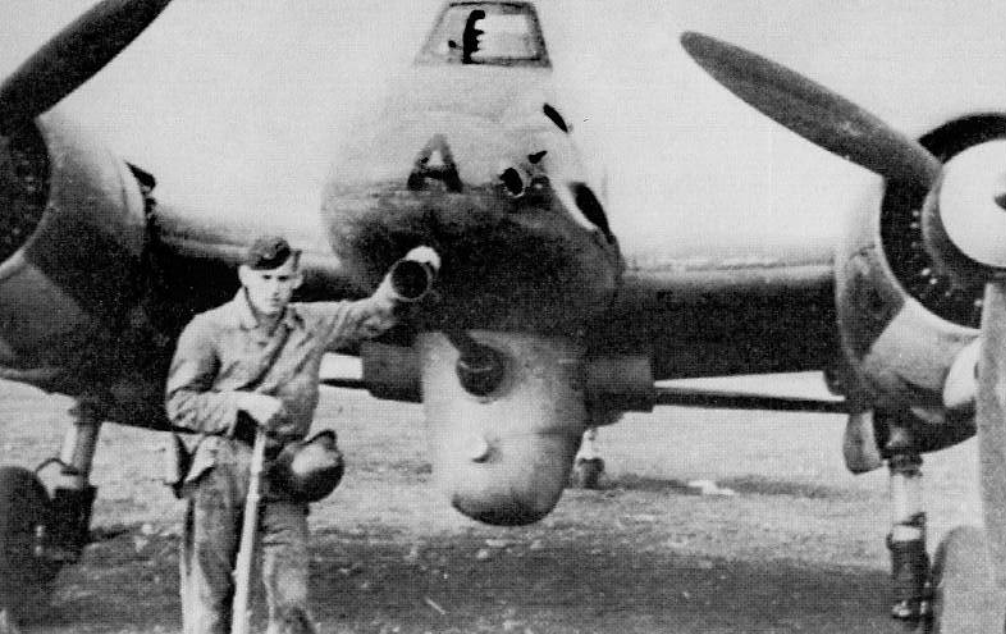

A Luftwaffe mechanic poses beside an Hs 129B-2 armed with the 37mm BK (*Bordkanone*; Fixed Aircraft Cannon) 3,7 weapon. A conical flash hider on the muzzle shielded the pilot from the bright flash produced when the weapon was fired. Hs 129B-2s armed with the BK 3,7 had the two 7.92mm MG 17 machine guns removed from the lower fuselage sides to reduce aircraft weight.

The gondola and barrel were removed to allow servicing of the BK 3,7 cannon under the Hs 129B's fuselage. This weapon was supplied with 12 rounds of armor piercing ammunition to penetrate the side and rear surfaces of Soviet tanks. The BK 3,7 was also fitted to the Ju 87G Stuka dive bomber. (Radinger)

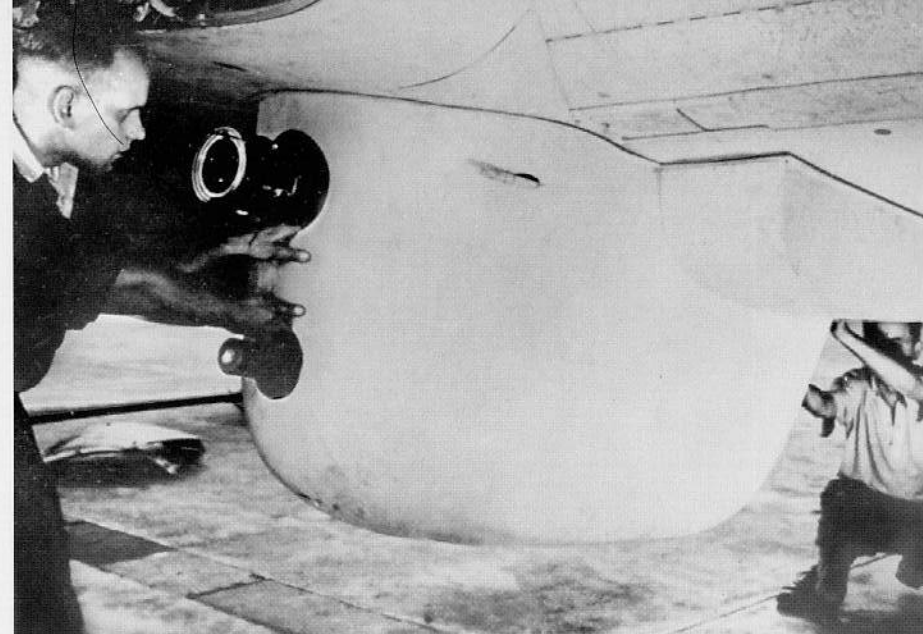
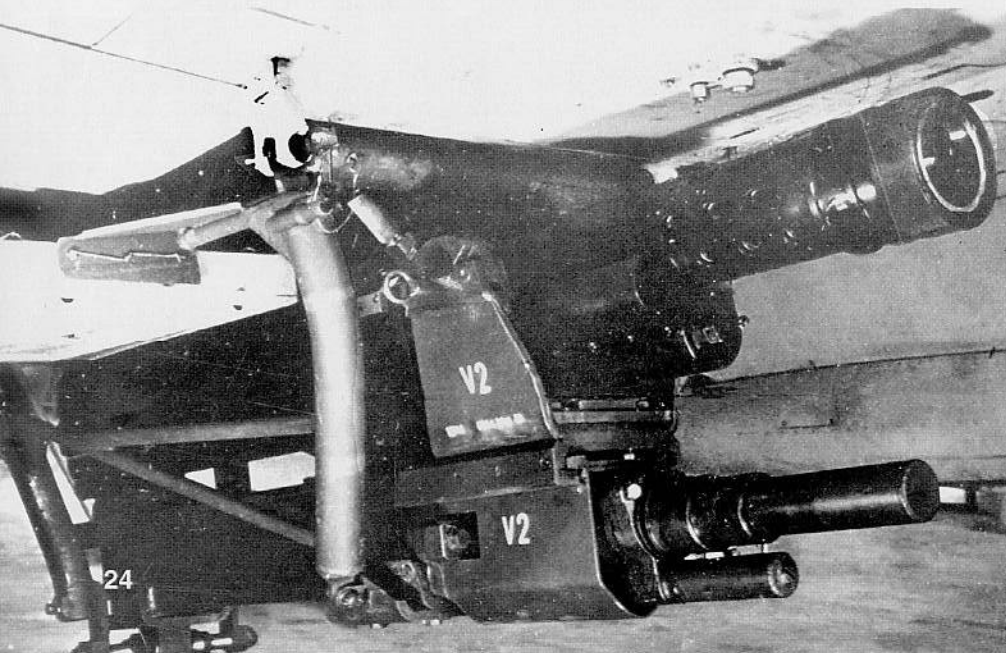

Henschel technicians adjust the gondola housing the 37mm Rheinmetall Flak 18 cannon fitted under the fuselage of an Hs 129B. The full barrel of this modified anti-aircraft gun was not yet installed on the upper front opening. This weapon passed its airborne firing trials and was redesignated BK (*Bordkanone*; Fixed Aircraft Cannon) 3,7. (Radinger)

37MM BK 3,7 Cannon

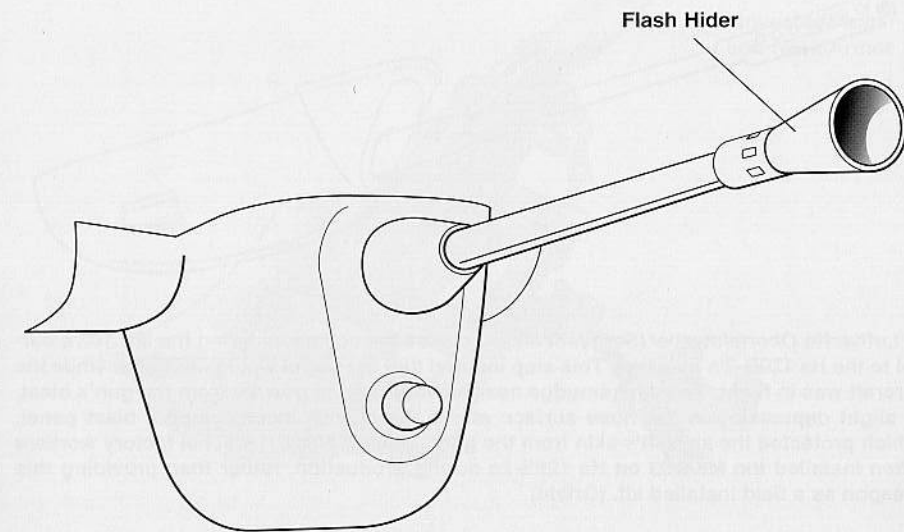

Hs 129A-0, Red 16 (GM+OM, *Werke Nummer/Factory Number* 3016) was the 15th of 16 pre-series aircraft assigned to a *Schlachtschule* (Ground Attack School) based at Paris-Orly, France in early 1943. This 'Anton' belly-landed due to engine troubles near its base in May of that year. The German Army's Infantry Assault Badge was often painted on the upper noses of Hs 129s, immediately ahead of the windshield.

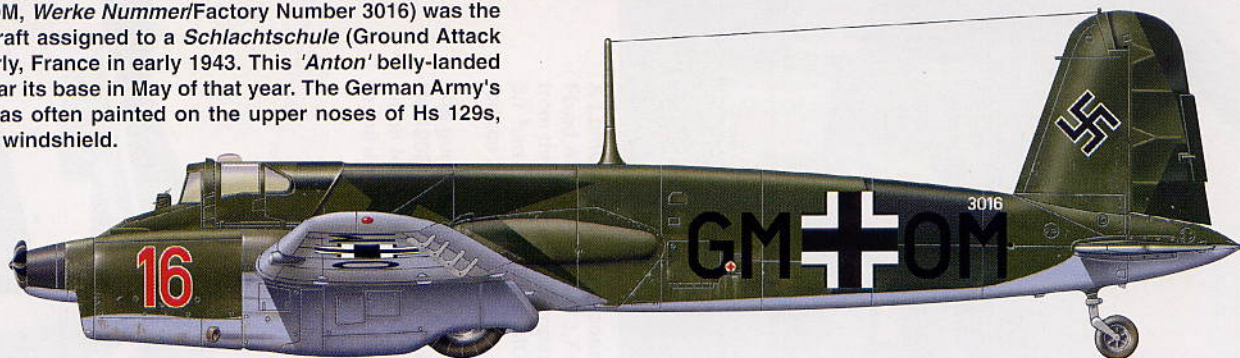

This late production Hs 129B-1, Red G (W. Nr. 0191) served with 5./Sch.G. 1 on the Eastern Front. The aircraft force-landed near Konstantinovka, Ukraine after being hit by anti-aircraft fire during a mission on 23 May 1942. This Hs 129B-1 was repaired; however, it was heavily damaged during a US bombing raid on Diepholz, Germany on 21 February 1944 and was eventually scrapped.

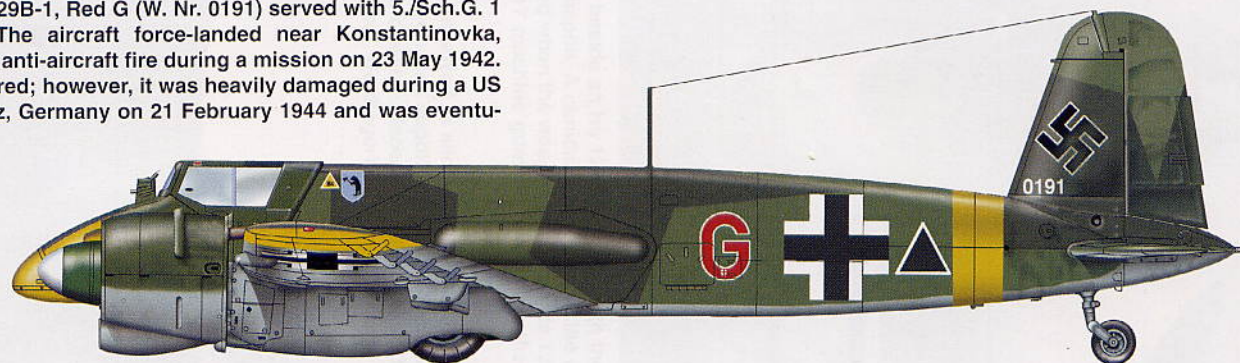

Hs 129B-2 Blue C (W. Nr. 0297) was deployed with 4./Sch.G. 2 to North Africa in early 1943. British forces captured this aircraft in unserviceable condition in Libya that spring. Hs 129s sent to North Africa were painted in a variety of desert camouflage schemes using various shades of brown and green uppersurfaces over light blue undersurfaces. The Tank Assault Badge was painted on this aircraft's upper nose surface.

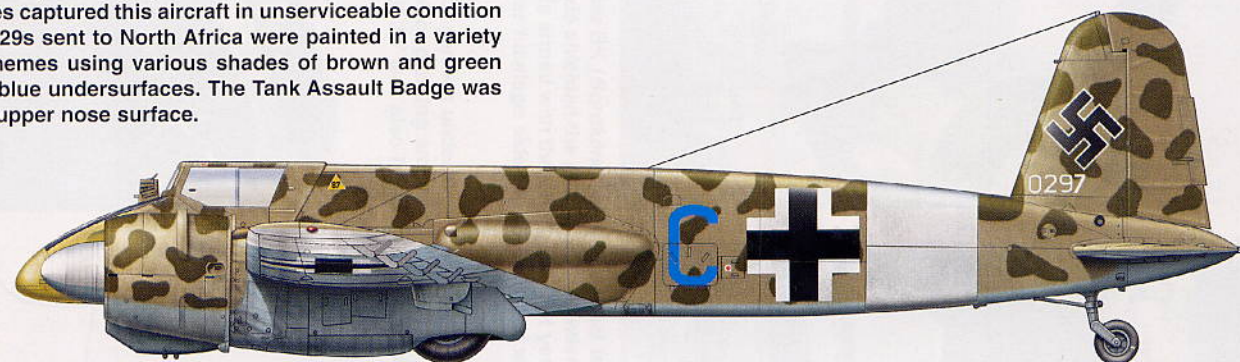

Panzerjägerstaffel (Tank Destroyer Squadron)/JG 51 was attached to *Jagdgeschwader* (Fighter Wing) 51 'Mölders' on the Eastern Front during 1943. The Hs 129B-2s of this Squadron, including Yellow 3 (W. Nr. 0350), received individual colored numbers to match JG 52's fighters. This aircraft was transferred to Rumania's 8th Assault Group in the fall of 1943, only to be recaptured by German forces on 24 August 1944 – one day after Rumania's pro-Axis regime was ousted.

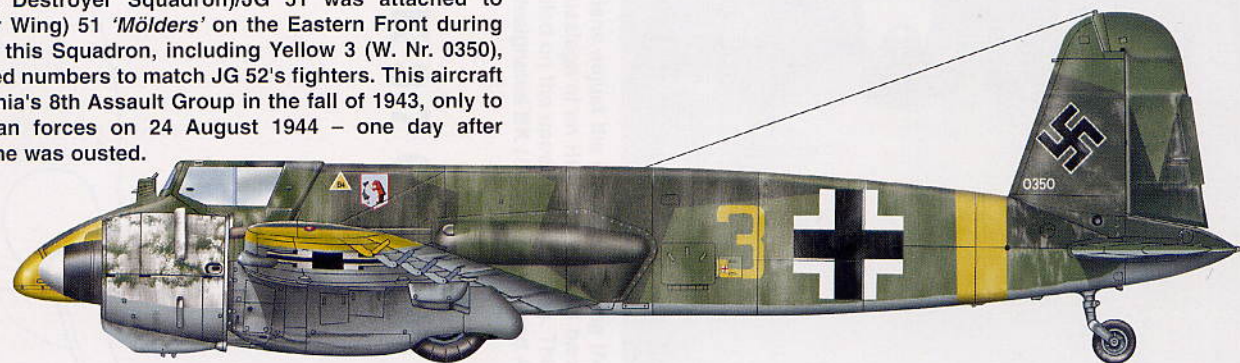

Hs 129B-2 Red L (VE+NI, W. Nr. 0360) was assigned to 2./Ergänzungsschlachtgruppe (Replacement Attack Group), an operational training unit, during the early summer of 1943. This aircraft previously served with II./Sch.G. 1 on the Eastern Front. Red L was reassigned to 6./Sch.G. 151 for training until lost in a flight accident on 1 September 1944.

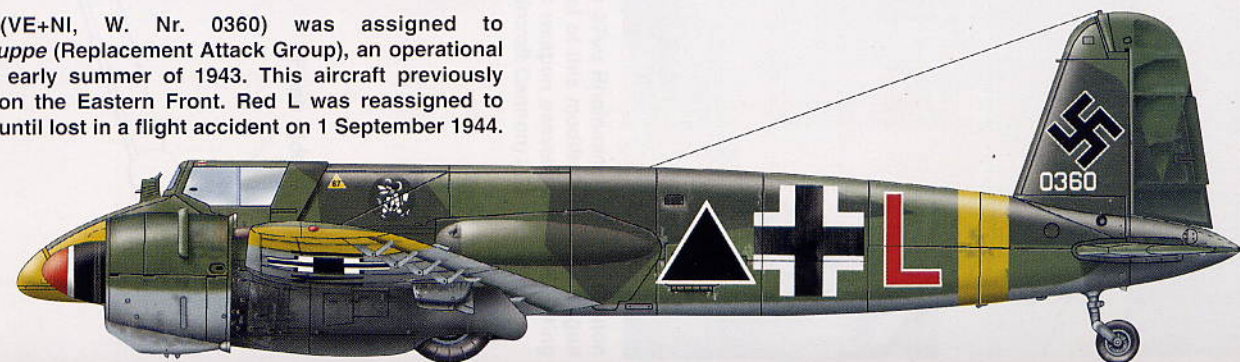

This Hs 129B-2 (W. Nr. 0249) was equipped with the SG 113A 'Föstersonde' anti-tank weapons system during early 1944. This system consisted of six 77mm mortar tubes in the aircraft's fuselage, which fired downward when overflying a tank at low level. W. Nr. 0249 was one of at least three Hs 129s modified to test the 'Föstersonde' system.

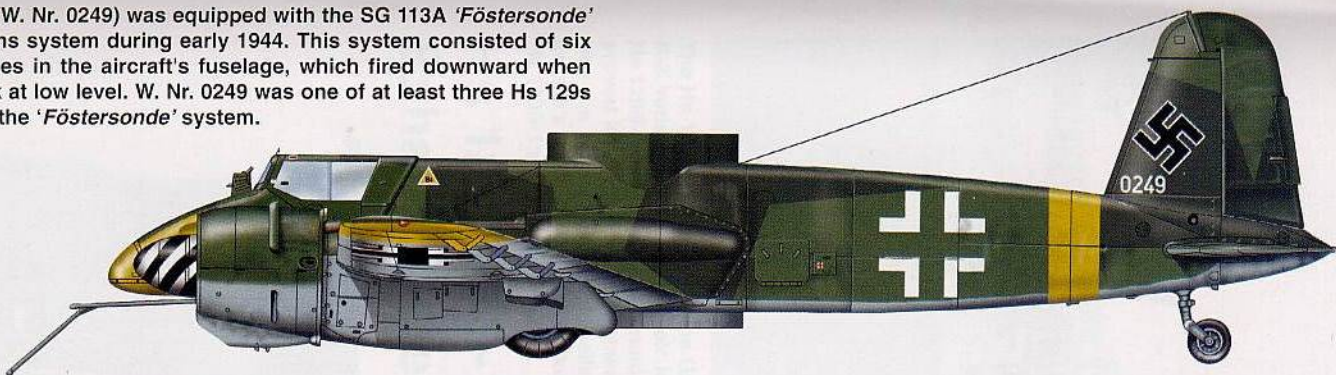

Temporary white winter camouflage paint was applied on the upper surfaces of this Hs 129B-2, White K, assigned to 10 (Pz)/SG 9 in Ukraine in March of 1944. The aircraft retained its basic camouflage of RLM70 Black Green (FS34050) and RLM71 Dark Green (FS34079) over RLM65 Light Blue (FS35352).

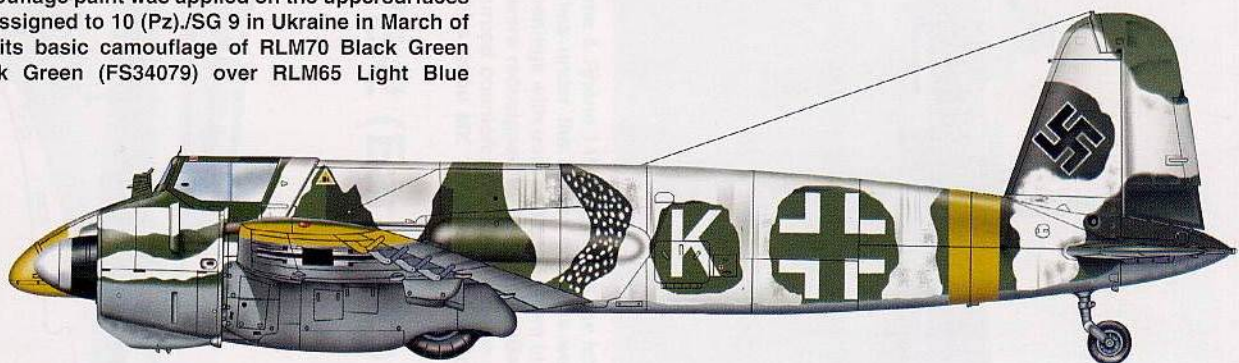

ARR (Royal Rumanian Air Force) *Adjutant aviator* (Technical Sergeant) Vasile Claru flew this Hs 129B-2 No. 213 *Lulu* (W. Nr. 140711). He was assigned to *Escadrila 42 asalt* (42nd Assault Squadron), *Grupul 8 asalt* (8th Assault Group) during mid-1944. This aircraft was written off after making an emergency landing due to engine trouble 2.5 miles (4 km) southwest of Gorlesti, Moldavia on 3 June 1944. The yellow triangle above *Lulu* indicated that B-4 87-octane fuel was specified for this aircraft.

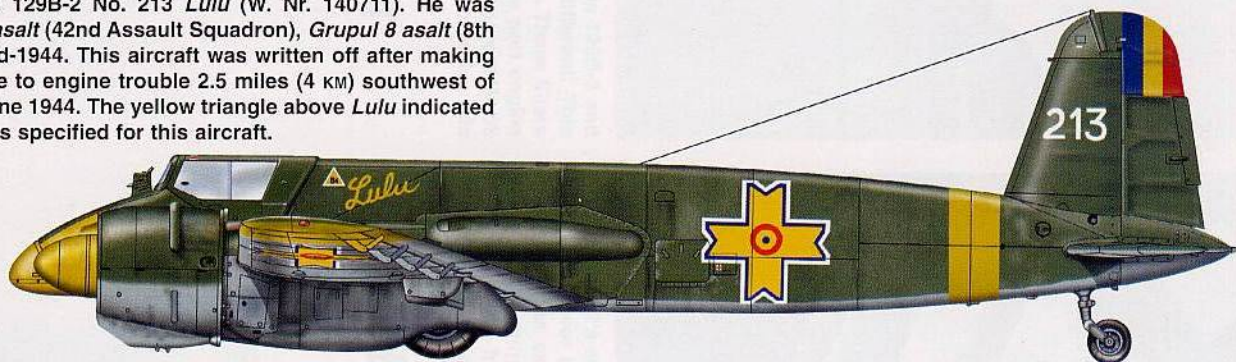

No. 324a (W. Nr. 140724) was one of some 20 Luftwaffe Hs 129B-2s captured by the ARR after Rumania's defection to the Allied camp on 23 August 1944. The aircraft served with *Grupul 8 asalt* in southern Transylvania (Rumania's Western Front) in early September of 1944. The Rumanians replaced the pro-Axis 'Michael's Cross' national marking with the pre-war roundel. This Hs 129B-2 was lost over northeastern Hungary – possibly to a German or Hungarian Bf 109G – on 19 December 1944.

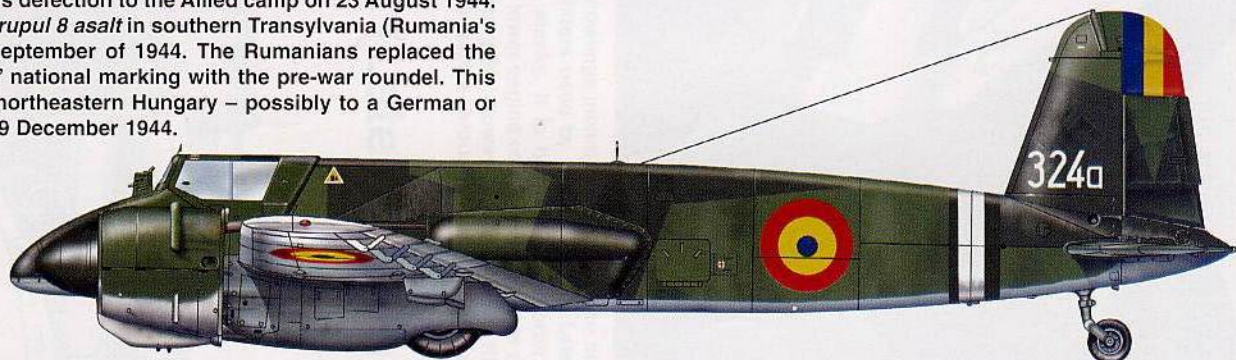

Hs 129B-3 Yellow 3 (believed to be W. Nr. 162040) of 14 (Pz)/SG 9 was lost due to engine trouble near Nagyigmánd, Hungary on 3 January 1945. This was the final variant of Henschel's tank destroyer and was armed with a 75mm cannon under the fuselage. The Hs 129B-3 was only built in small numbers and entered service too late to effectively resist the Soviet tanks invading the Third Reich during the winter of 1944-45.

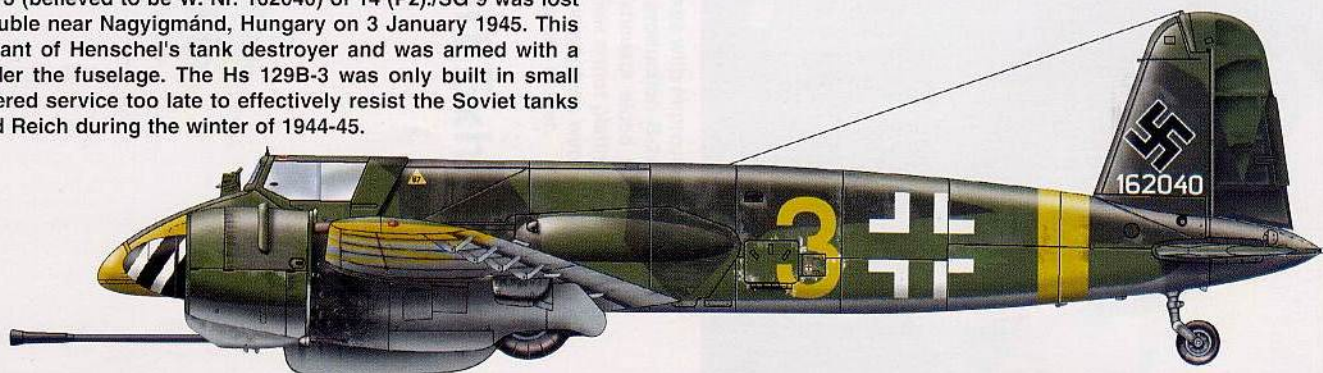



The Hs 129B-1 used the same Gnome & Rhône 14M engines as the later Hs 129B-2 and B-3 variants; however, the air intakes under the engine cowlings were different. This Hs 129B-1 had the original round openings with dust and sand filters inside. These filters proved ineffective and the intakes were redesigned for later Hs 129Bs. The port engine was the 14M 04, whose propeller turned counterclockwise, while the starboard 14M 05 engine's propeller turned clockwise. A 30mm MK 101 cannon was mounted under this Hs 129B-1's fuselage. (Crow)

Hs 129B-0/B-1/B-2 (Early) Long Exhaust Pipes

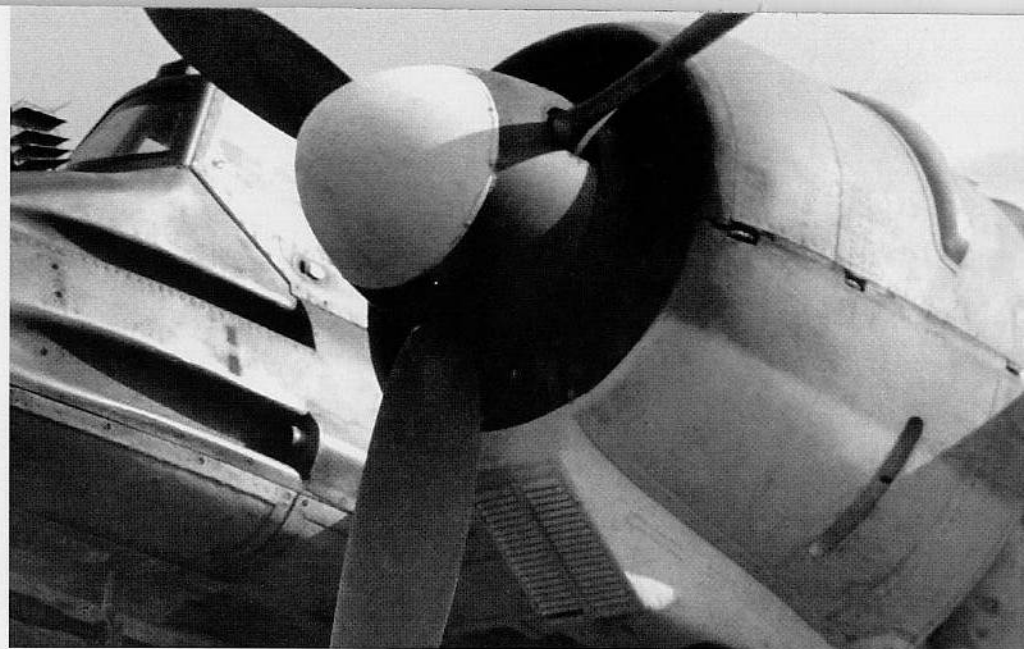
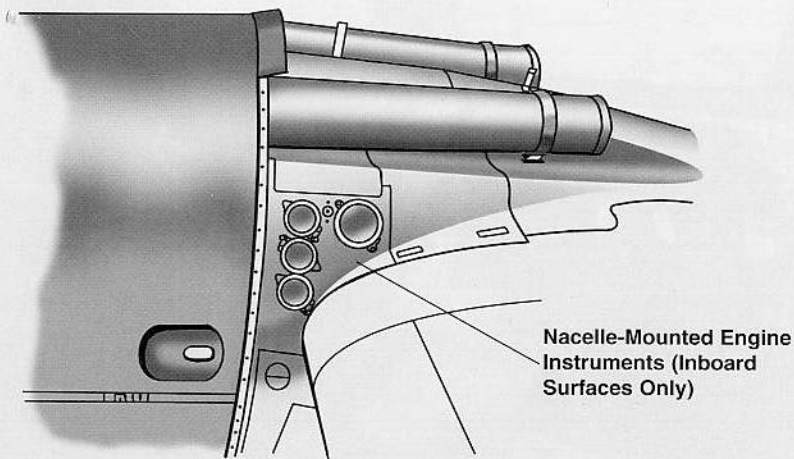

The Hs 129B-2's engine cowlings included redesigned air intakes with improved dust and sand filters over those filters used by the Hs 129B-1. Later production B-2s also used shorter engine exhaust stacks. It is believed the shorter exhausts aided in reducing engine overheating. The lower engine cowlings were made of 5mm armor plating to protect the powerplants from enemy fire; however, the Gnome & Rhône engines were continually plagued by reliability problems throughout the Hs 129B's service career.

Hs 129B-2 (Late)/B-3 Short Exhaust Pipes

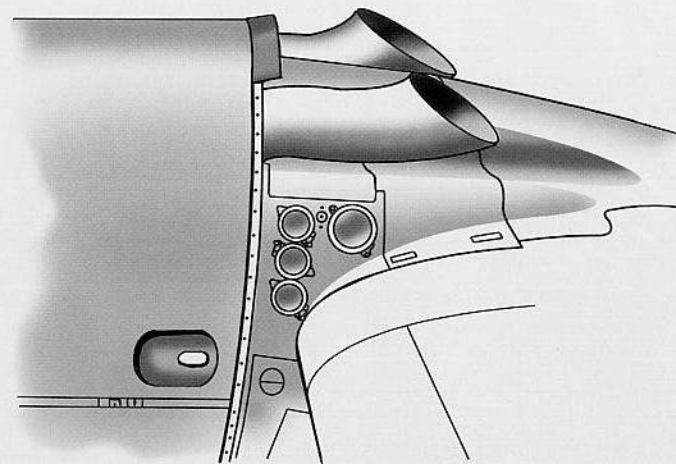



An Hs 129B-2 (Red D, W. Nr. 141859) prepares to takeoff on another 'tank busting' mission over the Eastern Front, armed with a 30mm MK 103 cannon under the fuselage. The bulge over the wing root enclosed the breech of the 20mm MG 151/20 cannon mounted on each side of the aircraft. An RDF loop antenna was placed on the upper fuselage, while a wire radio antenna ran from the upper mid-fuselage to the vertical stabilizer.

A Luftwaffe armorer feeds a 125-round ammunition belt into the starboard MG 151/20 cannon of a 10.(Pz)/SG 9 Hs 129B-2. The gun access door was hinged to open upward for servicing. German aircraft mechanics – nicknamed 'blackmen' for their uniforms – were issued with padded overalls and sheepskin-lined helmets for wear during the frigid Russian winter.



Ground crewmen service an Hs 129B-2, White K, prior to a mission over the Eastern Front in early 1944. While fuel was pumped into the starboard wing tanks, armorers fed 20mm ammunition to the MG 151/20 cannon on the fuselage sides. This aircraft was assigned to 10.(Pz)/SG 9 (10th Anti-Tank Squadron, Ground Attack Wing 9) in the Ukraine.

A ground crewman checks the FuG (*Funkgerät*; Radio Device) 16Z radio of an Hs 129B-2 on the Eastern Front in early 1944. The radio was fitted into the mid-fuselage, immediately aft of the 20mm MG 151/20 cannon. Hs 129 pilots kept in contact with ground forces in order to quickly respond to air support requests.



Hs 129B-3

The Hs 129B-2s armed with 30MM and 37MM cannons enjoyed considerable success in the anti-tank role. These aircraft could knock out Soviet tanks by attacking the vehicles from the side and rear surfaces, which had thinner armor than the front surfaces. By early 1944, the Luftwaffe was calling for heavier airborne anti-tank weapons for use against the growing number of improved Soviet tanks and assault guns. The RLM (Reich Air Ministry) requested that Henschel study the feasibility of modifying the 75MM PaK 40L¹ for installation on an Hs 129B-2.

A wooden mockup of this gun and the ventral housing was placed under the fuselage of an Hs 129B-2 (W. Nr. 141258) in early 1944. The combination was flown on aerodynamic trials at the *E-Stelle* (Test Center) at Travemünde in May of 1944. Test flights confirmed that the 75MM gun and housing did not adversely affect the Hs 129B-2's flight performance. The successful test flights with the wooden mockup were followed by the fitting of the PaK 40L onto three Hs 129B-2s (W. Nr. 140494, 141291, and 141292). These three aircraft were assigned to EKdo 26² for tests against captured Soviet tanks in August and September of 1944. The extensive test firings successfully demonstrated the 75MM gun's ability to destroy virtually all Soviet armored vehicles, including the 45.3 ton (41.1 MT) IS (*Iosif Stalin*)-2 heavy tank.

The 75MM PaK 40L gun was modified for aircraft use by adding a large muzzle brake for countering the weapon's recoil and by substituting the mechanical operation with an electro-pneumatic operation. The modified weapon was designated the BK 7,5³. The gun had a muzzle velocity of 3060 feet (932.7 M) per second and could penetrate 5.12 inches (130MM) of armor deflected from 1093.6 yards (1000 M) at a 90° angle to the target. The BK 7,5 could penetrate 3.74 inches (95MM) of armor when fired at a 30° angle. A drum magazine holding 16 rounds – each weighing 26 pounds (11.8 kg) – was fitted inside the mid-fuselage to feed ammunition to the weapon. The BK 7,5 had a cyclic rate of fire of 40 rounds per minute, which allowed a pilot to fire three or four rounds in a single pass on his target. Spent shell casings and gun gases were ejected from the ventral gun housing after the gun was fired. The pilot could jettison the gun and housing from the aircraft in an emergency.

The successful tests of the three Hs 129B-2s fitted with the BK 7,5 led to production of the Hs 129B-3. This variant received the 75MM gun as standard equipment. The two 20MM MG 151/20 cannons were removed to save aircraft weight; however, the two 7.92MM MG 17

¹ PaK = *Panzerabwehrkanone*; Anti-Tank Gun

² EKdo = *Erprobungs-Kommando*; Test Detachment

³ BK = *Bordkanone*; Fixed Aircraft Cannon

Hs 129B-2

Revi C/12C
Gunsight

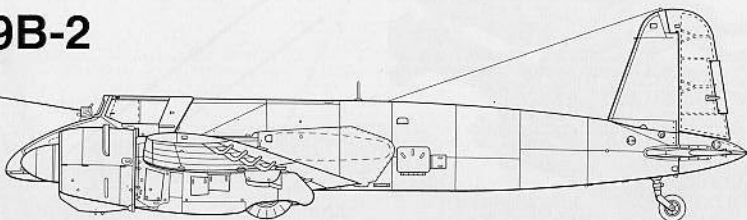

Hs 129B-3

ZFR 3B
Gunsight
75MM BK7,5
Cannon

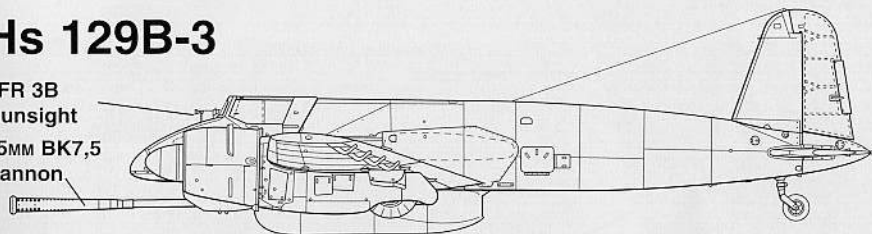

Hs 129s were abandoned due to being unserviceable or a chronic lack of fuel in the closing months of the war. This Hs 129B-3 (W. Nr. 162053) was captured by Soviet troops in the late winter of 1944-45. This is one of the only known photographs of an Hs 129B-3 with the 75MM BK 7,5 cannon in operational service. (Grinyuk)

machine guns were retained. The Hs 129B-3 replaced the Revi C/12C sight mounted on earlier Hs 129s with the ZFR (*Zielfernrohr*; Telescopic Gunsight) 3B sight mounted immediately in front of the windshield.

Hs 129B-3 production began at Henschel's Johannisthal plant in July of 1944. The 23 aircraft built (W. Nr. 162033-162055) served on the Eastern Front with SG (*Schlachtgeschwader*; Ground Attack Wing) 9 during the winter of 1944-45. The aircraft were assigned to the Wing's 10th and 14th *Panzerjägerstaffeln* (Anti-Tank Squadrons). The last two Hs 129B-3s built were delivered to SG 9 in October of 1944. The surviving aircraft saw action on the Eastern Front until these aircraft were grounded by lack of fuel in March of 1945.

The sole Hs 129C-1/V4 (W. Nr. 220001) was equipped with a 75MM BK 7,5 cannon under the fuselage. This weapon became standard equipment on the Hs 129B-3. Parallel slits immediately aft of this weapon's muzzle were part of the muzzle brake and were used to vent gun exhaust gas away from the aircraft. All four internal weapons were removed from the aircraft in a weight saving measure. The 20MM cannon muzzle openings were closed and the 7.92MM machine gun troughs were faired over. (Radinger)

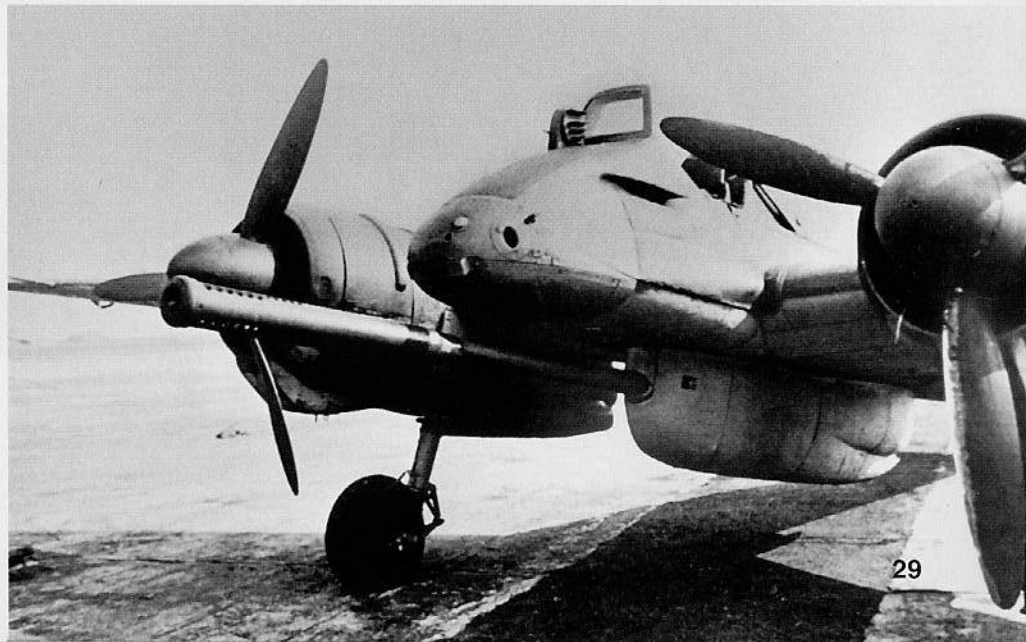

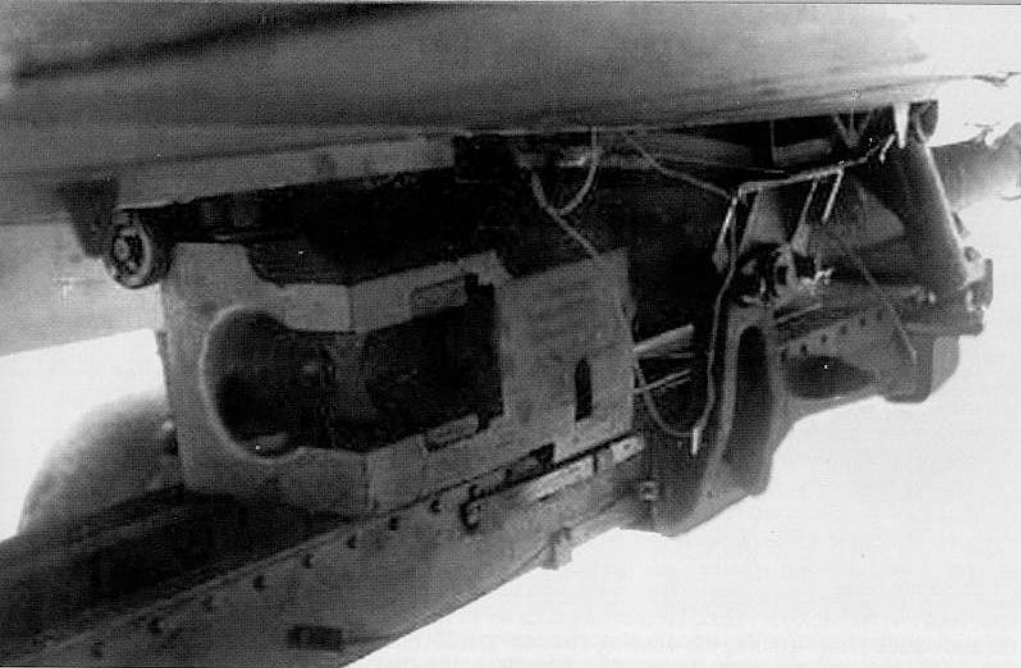

The underfuselage gondola covers were removed from the 75mm BK 7,5 cannon of an Hs 129B-3 (W. Nr. 162053). The weapon was a modified PaK 40L anti-tank gun equipped with electro-pneumatic operation for the breech mechanism. This operation gave the BK 7,5 a cyclic rate of 40 rounds per minute. The cannon was supplied with 16 rounds fed from a drum magazine inside the fuselage. This Hs 129B-3 was one of only 23 examples completed and was captured by Soviet forces in early 1945. (Grinyuk)

ZFR 3B Gunsight

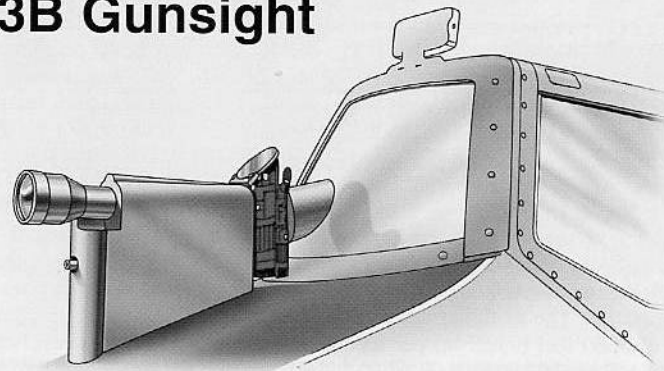

Hs 129B-3 75MM Gun Installation

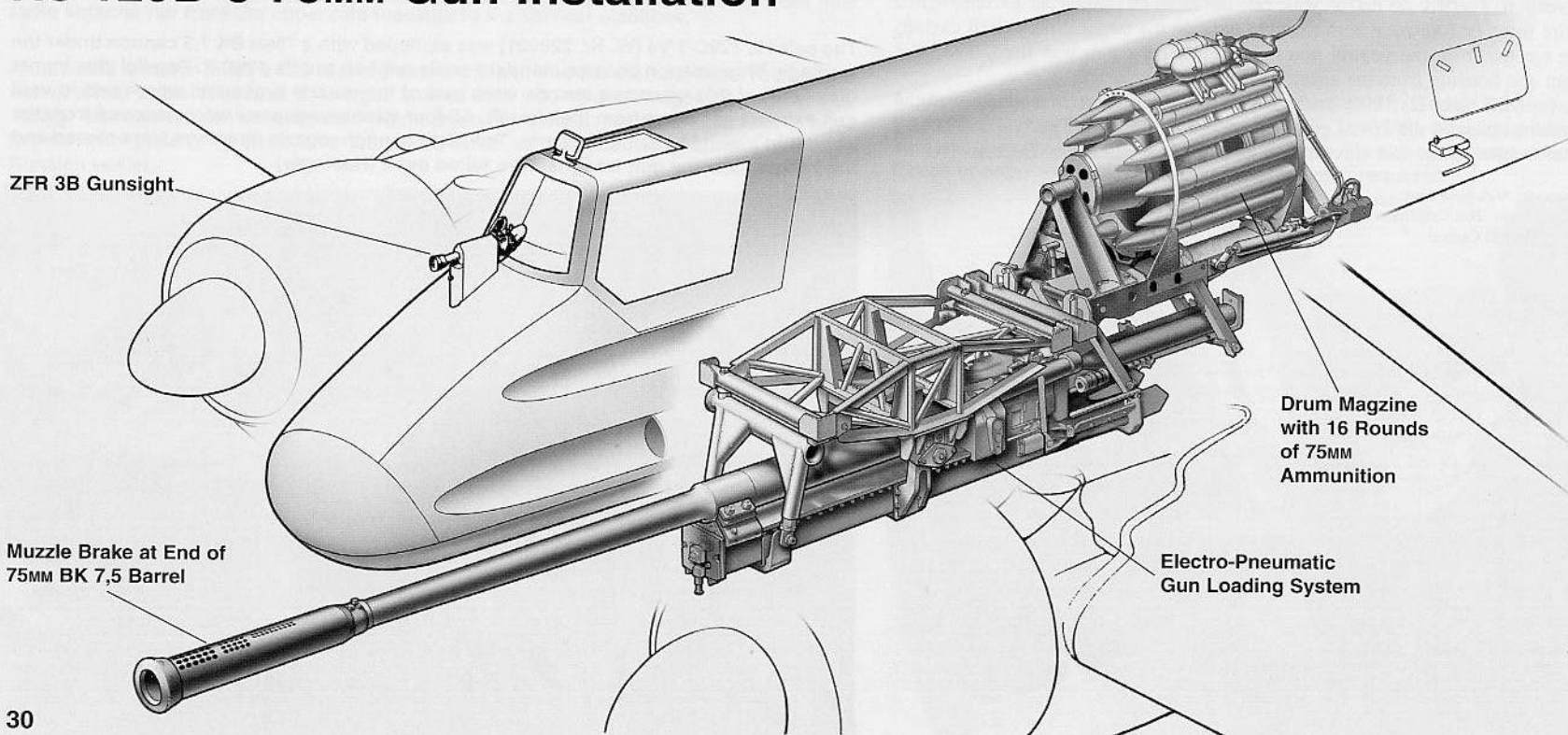

Final Developments

Henschel's design team, led by *Dipl.-Ing.* Friedrich Nicolaus, sought a more powerful and reliable powerplant than the Hs 129B-2's 700 HP Gnome & Rhône 14M engines. Nicolaus proposed using the Italian-made Isotta-Fraschini Delta RC 16/48 engine, due to the lack of a readily available German powerplant. This 1200 HP Delta RC 16/48 was a 12-cylinder, air-cooled, inline engine. Two Delta RCs would power the **Hs 129C-1**, a new variant proposed by Henschel to the RLM in 1943.

The Hs 129C-1 retained the standard fuselage-mounted armament of the earlier Hs 129B-2: two 7.92MM MG 17 machine guns and two 20MM MG 151/20 cannons. This new variant added a pair of 30MM MK 103 cannons with 60 rounds per gun mounted side-by-side under the fuselage. The pilot remotely controlled these weapons, which had limited traverse (side-by-side rotation). Two aft-firing MG 17 machine guns were mounted on the upper fuselage to provide defense against aircraft attacking the Hs 129C-1 from the rear. The pilot was provided with a special rear-view Revi 5 gunsight for aiming these guns. This sight was tested on a standard Hs 129B-2 (DE+ZR) at the *E-Stelle* Tarnowitz during 1943. Bomb shackles capable of carrying up to 2204.6 lb (1000 KG) bombs under the wings were also to be included on this variant.

The Isotta-Fraschini Delta RC 16/48 engines suffered through lengthy development problems. These problems – coupled with Italy's armistice with the Allies on 3 September 1943 – ended Henschel's consideration of this powerplant for the Hs 129C-1. The firm then chose the 820 HP Gnome & Rhône R14 M38 engine for this new Hs 129 variant. This 14-cylinder, air-cooled, radial engine offered 120 more HP than the Hs 129B-2's Gnome & Rhône 14M power-

An Hs 129B-2 (W. Nr. 0224, DE+ZR) was fitted with the Revi 5 rear view gunsight at the *E-Stelle* Tarnowitz during 1943. This gunsight was tested for the proposed Hs 129C variant, which was designed to carry two rear-firing 7.92MM MG 17 machine guns. The Hs 129C was to have been powered by 1200 HP Isotta-Fraschini Delta RC 16/48 engines; however, engine troubles led to the aircraft's cancellation in the summer of 1944. (Radinger)

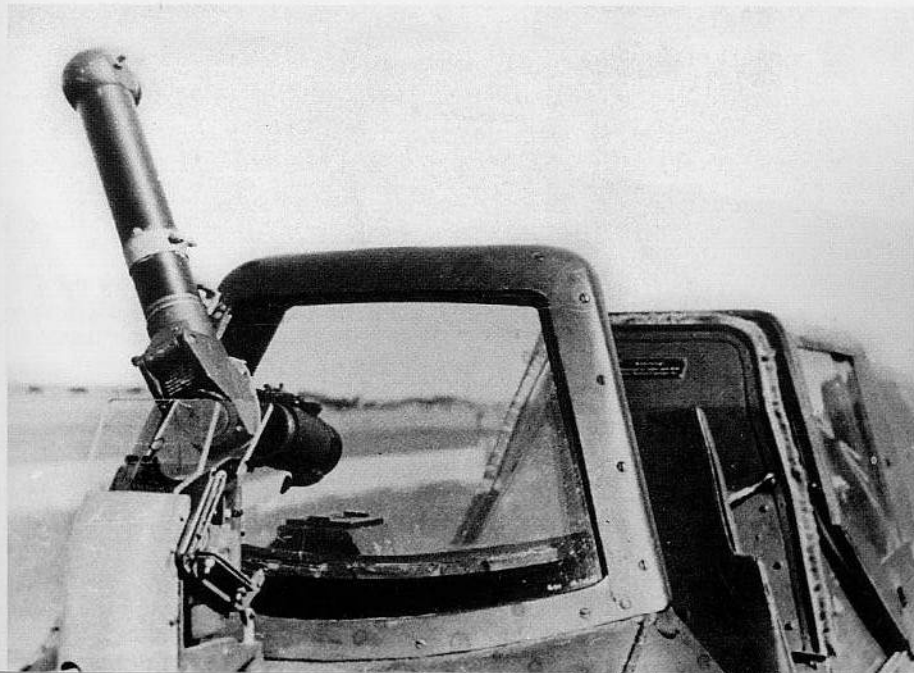

plant. Henschel installed the R14 M38 engines on an Hs 129B-2 (W. Nr. 0267), which first flew with the new powerplants in August of 1943.

The Hs 129C-1 was also designed to incorporate several aerodynamic refinements. These improvements included form-pressed armor plating, which offered a lighter airframe and reduced production costs over the outside armor plating applied to the Hs 129B-2. The new variant also included redesigned engine cowlings and oil radiators. Although satisfactory results were achieved with the Hs 129B-2 testbed, the results were not considered sufficient to warrant retooling and disruption in manufacturing. Only one Hs 129C-1 prototype, V-4 (W. Nr. 220001), was built and flew tests at *E-Stelle* Tarnowitz from April of 1943 until it was grounded on 13 July 1944. The Hs 129C-1 program was cancelled in favor of other aircraft types.

The RLM halted all ongoing work on the Hs 129 in September of 1944, ordering the existing aircraft used on weapons testing to be grounded. These weapons included the Gero flamethrower, which was mounted under the fuselage with a 79.25 gallon (300 L) fuel tank. Trials were conducted with tubes for 8.27 inch (21 cm) Wfr.Gr. 21¹ and 11 inch (28 cm) Wfr.Gr. 28 rockets mounted under the Hs 129B's wings. Tests were also conducted using the 70MM *Panzerblitz* (Tank Lightning) 1 and 55MM *Panzerblitz* 2 anti-tank rockets. None of these weapons saw operational service on Hs 129s.

Henschel produced at least 1160, but possibly as many as 1267 Hs 129s in all variants – including prototypes, pre-series, and production series aircraft – between May of 1939 and September of 1944. The firm then began production of Ju 388 medium bombers under license from Junkers.

¹ Wfr.Gr. = *Werfer-Granate*; Rocket-Propelled Shell

Allied troops found this unknown Hs 129B-2 when they overran the Aeronautical Research Institute at Braunschweig/Volkenrode, Germany during the spring of 1945. This aircraft was another test bed for the SG 113A *Förstersonde* vertical firing anti-tank mortar; however, there is no other information known about this Hs 129B-2. The canopy was removed, the radio access hatch opened, and what is believed to be a parachute was draped over the vertical stabilizer. (Crow)



Hs 129B in Luftwaffe Service

The Hs 129 had been thoroughly tested at various *E-Stellen* (Test Centers) throughout Germany by early 1942. These tests were performed under various flight parameters and with a large variety of weapons carried by the aircraft. The successful Hs 129 test program convinced the RLM (Reich Air Ministry) to commit the aircraft to combat.

The first operational Hs 129B-1s were assigned to a newly established Luftwaffe combat unit, Sch.G. 1 (*Schlachtgeschwader*; Ground Attack Wing). The Wing was formed at Lippstadt, Germany on 13 January 1942 and consisted of the I. and II. *Gruppen* (Groups). Each Group was divided into three 12-aircraft *Staffeln* (Squadrons), Nos. 1, 2, and 3, while the 4th and 8th *Staffeln* and a small *Stab* (Staff) rounded out the Wing's structure. Hs 129B-0 and B-1 aircraft were first issued only to Sch.G. 1's II. *Gruppe* (5th, 6th, and 7th *Staffeln*), while the Wing's remaining units flew older Hs 123s and Messerschmitt Bf 109E fighters. These aircraft were replaced in the 4th and 8th *Staffeln* with Hs 129Bs in April of 1942.

Hs 129Bs were painted in the Luftwaffe's standard camouflage scheme, which included upper surfaces painted in a splinter pattern of RLM70 Black Green (FS34050) and RLM71 Dark Green (FS34079). The aircraft's undersurfaces were finished in RLM65 Light Blue (FS35352). An individual letter in the Squadron's color was painted on the fuselage ahead of the *Balkenkreuz* (Beam Cross) national insignia. A black triangle with white trim was placed aft of the *Balkenkreuz* to indicate the Hs 129's assignment to a *Schlachtverband* (Ground Attack Formation). Aircraft assigned to the Eastern Front had noses, undersurface wingtips, and aft fuselage bands painted in RLM27 Yellow (FS33637). The nose panel ahead of the windshield was left in Dark Green to reduce glare for the pilot. A white stenciled Wehrmacht (Armed Forces) infantry assault badge was occasionally painted on this panel. Individual squadron insignia were usually placed behind the cockpit on the fuselage sides.

The Hs 129Bs of II./Sch.G. 1 were deployed from Germany to the southern sector of the

Eastern Front in early May of 1942. Elements of the Wing were assigned to two areas of this sector: the Crimean Peninsula (4th and 5th *Staffeln*) and the northern shore of the Azov Sea (6th and 7th *Staffeln*). Sch.G. 1 had 43 Hs 129Bs available to begin combat operations in May, starting with familiarization flights over the front soon after their arrival. The aircraft then conducted attack missions against Soviet motorized columns, artillery batteries, and fortified positions. The Hs 129Bs proved successful in these early missions, although engine reliability remained a major concern. Soviet anti-aircraft fire caused the majority of Hs 129Bs combat losses during this campaign.

In mid-May of 1942, the Hs 129Bs were redeployed from the Crimea to support German operations in the Kharkov sector in eastern Ukraine. The close support missions were most welcomed by the German troops, who faced numerically superior Soviet forces. Hs 129 pilots used the built-in 7.92MM machine guns and 20MM cannons for their early attack missions, supplemented by two 110.2 lb (50 kg) bombs mounted under the wings. The underfuselage 30MM MK 101 cannon arrived at 4./Sch.G. 1 in June of 1942. The wing bomb racks were usually removed to save weight when the cannon was fitted. Some pilots were skeptical at first about the cannon's effectiveness and preferred using bombs against Soviet tanks. The 30MM cannon soon won these pilots over, and more MK 101s were immediately sent to equip the remainder of the Wing's aircraft. This weapon became the standard anti-tank cannon fitted to most German-operated Hs 129Bs.

The Hs 129Bs of II./Sch.G. 1 followed the German Army's eastward advance into southwestern Russia during the summer of 1942. The *Gruppe* operated from the Kharkov area from late June until early August, providing close air support for German ground forces fighting the Soviet Southwestern Front around Voronezh. Detachments flew from Volchansk, Shatalovka, Orel, and Kursk to provide air support as needed. In August, the Group followed the advancing German troops and moved to Tachinskaya. The *Gruppe's* 5th *Staffel* operated from Orel, while the 8th Squadron was sent to Morozovskaya-West. That month also marked II *Gruppe's*



Curious Luftwaffe airmen study one of the first Hs 129B-1s (W. Nr. 0175) assigned to the Eastern Front. The white-bordered black triangle on the aft fuselage indicated ground attack aircraft. This Hs 129B-1 was assigned to *Stab* II. (Staff II Group)/Sch.G. (*Schlachtgeschwader*; Ground Attack Wing) 1. The propeller spinners were painted white and black on *Stab* aircraft. Prior to arriving at the front, W. Nr. 0175 developed engine trouble and force landed at its home base of Lippstadt, Germany on 23 August 1942. (Crow)

2500th combat sortie since beginning operations the previous May. Another Hs 129 unit joined the Group in August: 13.(Pz.) (*Panzerjägerstaffel*; Anti-Tank Squadron) of JG (*Jagdgeschwader*; Fighter Wing) 51 'Mölders'. This Squadron's eight Hs 129Bs saw action southeast of Kharkov in early August, before moving to Rzhev in the middle of the month.

Hs 129s supported the German advance on Stalingrad during the fall of 1942. Worsening weather during this period – including fog, low temperatures, and snow and ice on airfields – hampered air operations. Nevertheless, the Hs 129s of II./Sch.G. 1 flew attacks against the Soviet formations advancing around the German 6th Army in Stalingrad. JG 51's Hs 129-equipped *Panzerjägerstaffel* was temporarily attached to the Group during this period. Sch.G. 1 had moved from Tuzov – its base since August – to Millerovo, north of Rostov in November. The Wing was forced to move west by the Soviet drive to encircle Stalingrad, eventually reaching Voroshilovgrad, approximately 248.6 miles (400 km) west of Stalingrad. The *Gruppe* made strong efforts to support Axis forces despite having as few as ten serviceable Hs 129Bs at one time; however, they could not prevent the German defeat at Stalingrad.

Elements of II./Sch.G. 1 were pulled out of the line in late 1942 to refit. The 5th *Staffel* was withdrawn to Jesau, Germany in October. The Squadron was redesignated 8./Sch.G. 2 and sent to North Africa in support of Axis forces there. In early December, 8th *Staffel* was pulled out of Russia for rest and refit at Deblin-Irena in occupied Poland.

Hs 129B-1, Yellow L (W. Nr. 0155) was assigned to 6./Sch.G. 1 on the Eastern Front in May of 1942. The unit insignia was painted aft of the aircraft's canopy. A seldom used 79.25 gallon (300 L) external fuel tank lies on the ground near the cockpit entrance step, while 110.2 lb (50 kg) bombs under the starboard wing awaited loading onto the Hs 129's underwing racks. W. Nr. 0155 was shot down by Soviet anti-aircraft fire over Volchansk on 24 June 1942. This aircraft was fitted with a wide-base radio antenna mast on the upper fuselage, which was typical of Hs 129B-0s and B-1s. (Smith)



Ground crewmen attend to an Hs 129B-1 at Kharkov airfield in the Ukraine during the early fall of 1942. The Infantry Assault Badge painted on the aircraft's upper nose surface symbolized the close cooperation between ground attack aircraft and the infantry. Hs 129Bs of II./Sch.G. 1 operated from the eastern Ukraine to support German ground operations in this sector during the summer and fall of 1942. (Winkler)

The commander of II./Sch.G. 1, *Oberleutnant* (1/Lt) Bruno Meyer, performs a proxy wedding ceremony for one of the *Gruppe*'s pilots in front of an Hs 129B-1 in the fall of 1942. This unit was operating from southern Russia in support of the German offensive in this sector, which led to the battle of Stalingrad. (Crow)





An early production Hs 129B-2, Yellow D (W. Nr. 0226), rests at a forward airbase in southern Russia during the summer of 1942. This aircraft featured the straight antenna mast on the upper fuselage and the long engine exhaust pipes. Yellow D crash landed due to poor visibility on 4 August 1942 and sustained 35 percent damage. This Hs 129B-2 was repaired at a front *Werft* (large repair shop) and returned to service. (Griehl)

Yellow G, an Hs 129B-2 assigned to II./Sch.G. 1, takes off on a close support mission over the Eastern Front during the summer of 1942. This aircraft was armed with a 30mm MK 101 cannon under the fuselage, which was introduced into service in June of 1942. A 110.2 lb SC 50 bomb was carried under the starboard wing. The MK 101 soon became preferred by Luftwaffe Hs 129 pilots to bombs in attacking Soviet tanks. (Dabrowski)



A ground crewman secures the pilot into the seat of his Hs 129B-2 prior to a mission over the Russian steppe during the summer of 1942. Two other ground crewmen are starting the port engine using an inertia crank; this same method started the starboard engine. An ETC 50 bomb rack was mounted under the port wing. Each rack could hold one 110.2 lb (50 kg) SC 50 bomb.

This Hs 129B was assigned to 13.(Pz.)JG 51 'Mölders', an anti-tank squadron attached to the famous fighter wing. The Squadron's aircraft used colored numbers – the 4 was believed to be red – instead of the letters used by dedicated ground attack units. This Hs 129B wore temporary white camouflage while at a snow-covered base in Russia during late 1942. Tarpaulins covered the forward fuselage and engine cowlings. (Griehl)



The Hs 129 in North Africa

In the fall of 1942, Britain's victory at El Alamein, Egypt sent the German *Afrika Korps* and its Italian allies in full retreat westward. This British triumph was due in good part to their growing superiority in armor and other ground forces over the Axis forces in North Africa. In October, the Luftwaffe decided to deploy a squadron of Hs 129Bs to this theatre. The 4th *Staffel* (Squadron) of the newly-formed Sch.G. (*Schlachtgeschwader*; Ground Attack Wing) 2 was selected for deployment. This Squadron was commanded by *Hauptmann* (Capt) Bruno Meyer, a veteran ground attack pilot and Knight's Cross holder. The aircraft's Dark Green and Black Green uppersurfaces were mostly overpainted with RLM79 Sand Yellow (FS30215) with RLM80 Olive Green (FS34052) patches. Some Hs 129B-2 were also painted Sand Brown (FS33434) with reddish brown patches, and at least one aircraft had Sand Yellow uppersurfaces with Dark Green and Dark Brown mottling. It is believed that Italian paints were used on some of the German aircraft sent to North Africa. The undersurfaces were finished in RLM65 Light Blue or RLM 78 Light Blue (both FS35352). White nose bands, undersurface wingtips, and aft fuselage bands were applied to Hs 129B-2s sent to North Africa. These aircraft had individual colored numbers placed in front of the fuselage *Balkenkreuz*.

The *Staffel's* 12 Hs 129B-2/Trop. (tropicalized) aircraft were sent from Germany to El Adem, Libya, via the Balkans and Crete, in early November. On 17 November, 4./Sch.G. 2 flew its first combat mission in North Africa against a British armored column advancing towards Bir el Abd, Libya. The German attack destroyed two British armored cars and caused panic among the British troops seeing the new Luftwaffe aircraft for the first time. The 30MM MK 101 cannon proved effective against British armor; however, the desert sand proved harmful to the Gnome & Rhône engines. The sand filters installed on the Hs 129Bs in Germany proved ineffective in North Africa. The sand and heat soon took their toll on the Hs 129B's air-cooled engines, resulting in 4./Sch.G. 2 being withdrawn after only one week of operations. The Squadron was down to seven aircraft on 31 December 1942, and this total was cut to one within one month due to Allied air attacks and lack of spare parts.

The 5th *Staffel* of Sch.G. 1 – which formerly served in Russia – arrived in Tunisia on 29 November 1942 to reinforce 4./Sch.G. 2. The new Squadron's Hs 129B-2s soon saw action against Allied forces advancing from Algeria and Libya. Some Allied vehicles were destroyed or damaged by the Hs 129B-2s; however, the growing Allied air superiority resulted in several Henschels being lost to fighters and anti-aircraft fire. Spare parts, ammunition, and fuel supplies dwindled, further reducing the number of Hs 129s available to Axis commanders.

A *Rotte* (Pair) of Hs 129B-2s taxi prior to taking off for an anti-tank mission over Libya. The trail aircraft had a wider white aft fuselage band than the lead aircraft and lacked the lead aircraft's white nose band. Both Hs 129Bs displayed variations on the desert camouflage scheme applied for North African operations. This scheme consisted of RLM80 Olive Green spots over RLM79 Yellow upper surfaces and RLM65 or 78 Light Blue undersides.



An Hs 129B-2 assigned to 4./Sch.G. 2 (4th Squadron/Ground Attack Wing 2) is parked on a forward airfield in North Africa in late 1942. This aircraft received the Axis recognition markings for the Mediterranean theatre, which consisted of white nose section, undersurface wingtips, and aft fuselage band. The starboard propeller spinner was one-quarter white and three-quarters black.

The two *Schlachtstaffeln* – 4./Sch.G. 2 and 5./Sch.G. 1 (renamed 8./Sch.G. 2 on 1 January 1943) – were withdrawn from Tunisia in April of 1943. The personnel were evacuated to Sicily without most of their remaining aircraft. The Allied forces captured approximately 12 Hs 129B-2s in non-flyable condition by the end of the North African campaign on 13 May 1943.

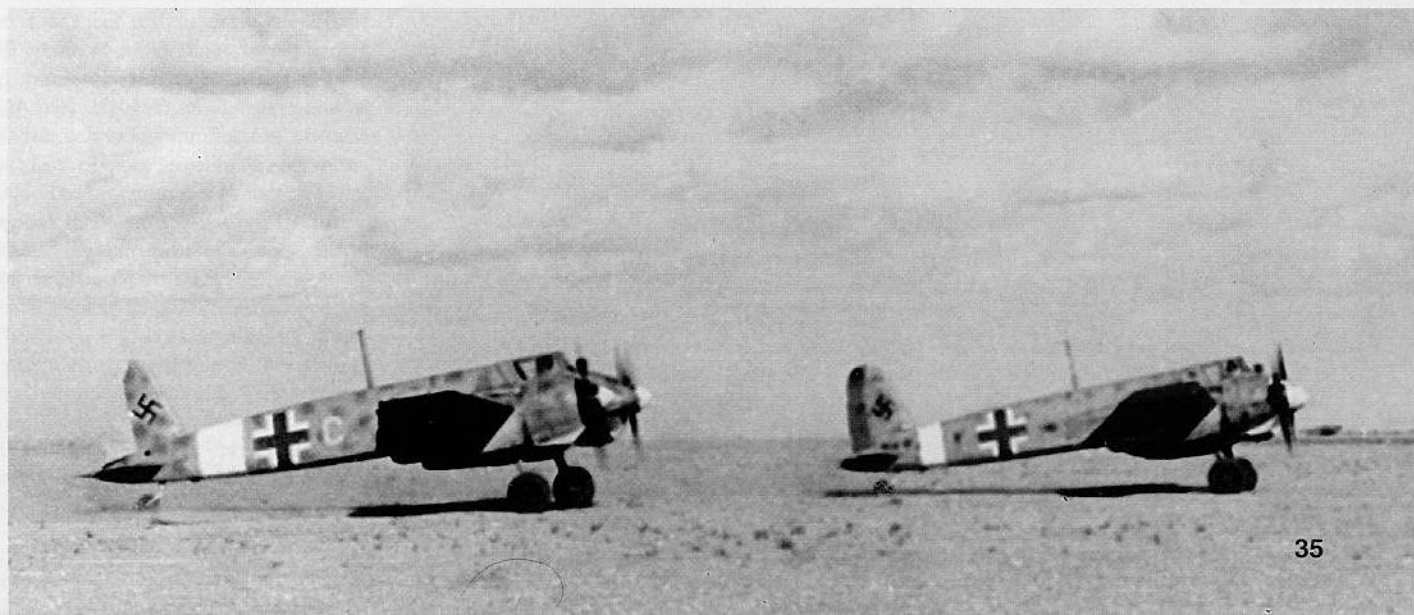

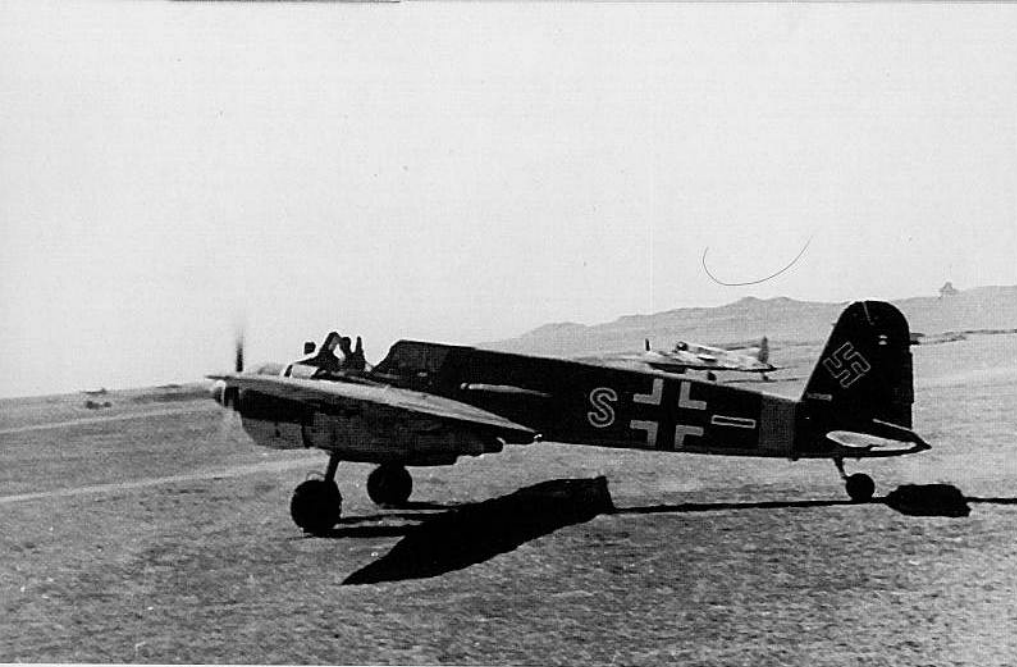

Hs 129B-2, Red S (W. Nr. 140508) assigned to 8.(Pz.)/Sch.G. 1 prepares to takeoff from an airfield in the Crimea in mid-1943. The pilot kept the canopy open for ventilation and closed it just prior to takeoff. Two white tank 'kill' marks were painted on the rudder. Soviet anti-aircraft fire brought down Red S on 16 July 1943. (Griehl)

An Hs 129B (CI+TI) passes over a German airfield while flying approximately 50 to 60 feet (15.2 to 18.3 m) over the ground. This was the usual altitude range for these aircraft on close support missions. The Hs 129s often descended to tree-top level to surprise enemy tanks and troop columns – usually with considerable success.

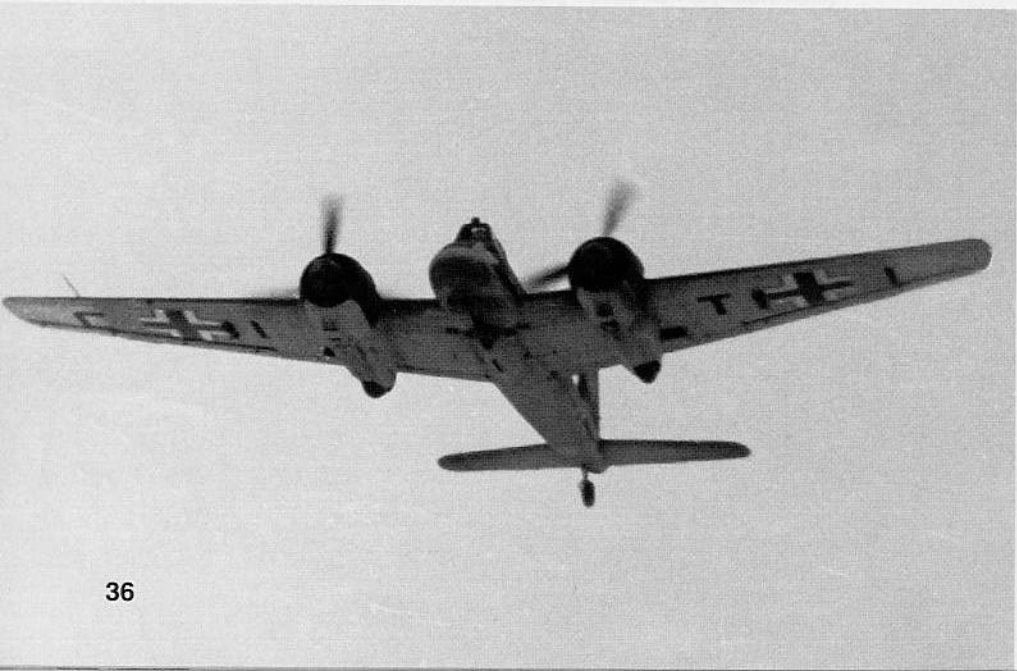

Hs 129s on the Eastern Front 1943-45

Germany's defeat at the Battle of Stalingrad in early 1943 marked the turning point on the Eastern Front of World War Two. The Soviet Red Army increased its numbers of manpower, armor, and aircraft, while the German Wehrmacht grew weaker with time. This changed situation increased the importance of the Hs 129-equipped *Schlacht* units to German commanders in the East. These units were brought under a single command in early 1943. This move allowed rapid deployment of the Hs 129 anti-tank units to where large numbers of Soviet tanks were encountered along the Eastern Front. Existing Hs 129 units in the East were reinforced with additional Squadrons, including the two units that saw action in North Africa.

Hs 129s based in the Crimean Peninsula supported German operations in the Kuban region northeast of the Black Sea in the spring of 1943. Low-level attacks successfully destroyed or damaged many Soviet armored vehicles and terrorized Soviet troops. The presence of the Hs 129s was a strong morale boost for the German troops on the ground. *Schlacht* pilots often flew from five to 12 missions a day during the Kuban campaign, responding to German calls for air support from airfields near the front lines. The sturdy construction of Henschel's attack aircraft enabled many of its pilots to absorb considerable damage from enemy fire and land safely in friendly territory.

In the spring of 1943, the German Army High Command planned an offensive to remove the large Kursk salient and regain the initiative following the defeat at Stalingrad. The attack was code named *Fall ZITADELLE* (Operation CITADEL). The Hs 129Bs would play a key role in helping neutralize the massive Soviet armored strength in the Kursk salient. Four *Schlachtstaffeln* (Ground Attack Squadrons) – 4./Sch.G. 1, 8./Sch.G. 1, 4./Sch.G. 2, and Pz.Jä.St./JG 51 – were assigned to Operation CITADEL. A four-aircraft command *Schwarm* (Flight) would lead the Hs 129B-2s into battle, while 8./Sch.G. 2 was kept in reserve.

Over 60 Hs 129Bs were available for action when the Kursk offensive began early on 5 July 1943. After two days of light combat, the Henschels saw intense action on 7 July. The Hs 129Bs and ground attack Fw 190s successfully attacked a Soviet armored column and halted the column without any losses to themselves. The Hs 129Bs claimed many Soviet vehicles during the three-week battle, but sustained heavy losses. The *Schlachtstaffeln* lost 48 of the 60 Hs 129Bs committed to the Kursk offensive, which ended in German defeat. The Soviets gained the strategic initiative on the Eastern Front for the rest of World War Two.

After the battle of Kursk, the five Luftwaffe Hs 129B squadrons moved southwest: first to Konotop, then to Poltava. The Red Army's steady advance during the summer and fall of 1943 caused German units to continuously retreat west. The Hs 129Bs saw frequent action by providing on call close air support to German troops. These efforts could not hold the Soviets back for long.

In the fall of 1943, the RLM reorganized the five ground attack squadrons on the Eastern Front into one *Panzerjägergruppe* (Anti-Tank Group), designated IV.(Pz.)/SG 9 (*Schlachtgeschwader*; Ground Attack Group). This unit consolidated the squadrons from their three previously assigned groups. The flights and squadrons were renamed:

Old	New
<i>Führer der Panzerjägerstaffeln</i>	Stab.IV(Pz.)/SG 9
4.(Pz.)/Sch.G. 1	10.(Pz.)/SG 9
8.(Pz.)/Sch.G. 1	11.(Pz.)/SG 9.
4.(Pz.)/Sch.G. 2	12.(Pz.)/SG 9
8.(Pz.)/Sch.G. 2	13.(Pz.)/SG 9
Pz.Jä.St./JG 51	14.(Pz.)/SG 9.

This consolidation of squadrons into IV.(Pz.)/SG 9 improved organization and maintenance for the Hs 129 units.

The Hs 129Bs of IV./SG 9 were hard pressed to stem the Soviet advance west in early 1944. Approximately 50 serviceable Henschels were available to German forces along the Eastern Front, joined by some 30 Hs 129Bs supplied to Rumania and operating along the Front's southern sector. The continuing Soviet drive through western Russia caused the *Gruppe's* Hs 129B squadrons to split in late March. The *Gruppenstab* (Group Staff) and 13.(Pz.)/SG 9 fell back to eastern Poland, while the 10th, 12th, and 14th squadrons headed to Rumanian-held Trans-Dnestra, Bessarabia, and Bukovina. The latter three units helped stop an unsuccessful Soviet offensive in the region that spring. Hs 129Bs of 10.(Pz.)/SG 9 helped cover the Axis evacuation of the Crimea in April.

The Hs 129-equipped IV.(Pz.)/SG 9 flew its 10,000th combat sortie on 1 May 1944 – nearly seven months after the *Gruppe* was formed. The unit's pilots claimed over 1500 Soviet tanks and armored vehicles and thousands of other vehicles (trucks, jeeps, etc.) destroyed during this period. Constant operations from forward airfields took a heavy toll on the Hs 129 squadrons. The Luftwaffe lost 56 Hs 129s to combat and 38 to accidents during the first half of 1944.

One of the most renowned Hs 129 pilots was *Hauptmann* (Capt) Rudolf-Heinz Ruffer, *Staffelkapitän* (Squadron Commander) of 10.(Pz.)/SG 9. He was awarded the Knight's Cross on 9 June 1944 after destroying 72 Soviet tanks in combat while flying the Hs 129B. Ruffer claimed eight more Soviet tanks before he was killed in action in Poland on 16 July 1944.

On 22 June 1944, the Red Army began Operation BAGRATION, the drive to clear the German Army Group Center out of Byelorussia. The two Hs 129B squadrons in eastern Poland – 10.(Pz.) and 14.(Pz.) of SG 9 – were rushed to the front to reinforce 13.(Pz.)/SG 9. The three *Schlachtstaffeln* destroyed scores of Soviet tanks and other armor; however, they could not contain the Red Army's assault through Byelorussia and into eastern Poland. The Hs 129 units in this area began the campaign with 67 aircraft: 22 of these were lost in combat and 21 additional Hs 129s were destroyed in accidents. The Luftwaffe's three Hs 129 units in Rumania were redeployed to Poland.

The Soviets launched an offensive against Rumania on 20 August 1944, which saw Rumanian Hs 129s vainly attempt to halt the Soviet advance. Rumania defected from the Axis to the Allies three days later, and German and Hungarian troops in Transylvania began to face Rumanian-flown Hs 129s. The Germans sent 14.(Pz.)/SG 9 into central Transylvania in late August to face the Rumanian threat. In late September, the Squadron was pushed back into Hungary by the Soviet and Rumanian advance. The Hs 129s of 14.(Pz.)/SG 9 operated in Hungary until the fall of Budapest on 13 February 1945, then retreated into Slovakia.

Several Hs 129B-3s – armed with a 75MM BK 7,5 cannon under the fuselage – were delivered to 13.(Pz.)/SG 9 and 14.(Pz.)/SG 9 by the fall of 1944. The low numbers of these aircraft could make little impact upon the Soviet advance through Poland and into eastern Germany. Few combat reports from the last months of World War Two mention the presence of Hs 129B-3s on the front. In September of 1944, the RLM ordered a halt to Hs 129 production in order to concentrate on fewer aircraft types. Fw 190Fs began to take over the ground attack and tank killing roles from the remaining Hs 129s. The Hs 129 force saw its flight hours severely reduced due to the acute fuel shortage affecting all German units during this period.

On 1 January 1945, only 39 Hs 129Bs remained with three operational units: *Gruppenstab* IV.(Pz.)/SG 9, and 10th and 14th Squadrons of the Wing. Other Hs 129 squadrons had converted to the Fw 190F in late 1944 and early 1945. The remaining Henschels operated in western Poland, eastern Germany, and western Hungary. Their numbers dwindled through combat



Oberleutnant (1/Lt) Rudolf-Heinz Ruffer looks at the rudder of his Hs 129B-2, Red G, while a ground crewman points to one of the white tank 'kill' marks painted on the aircraft's rudder. The Hs 129's control surfaces – rudder, elevator, and ailerons – were fabric-covered metal framing. Ruffer was later promoted to *Hauptmann* (Capt) and destroyed over 80 Soviet tanks before he was killed in action on 16 July 1944. (Pegg)



Hauptmann Ruffer poses in front of his later Hs 129B-2, White J (W. Nr. 141749), at a Rumanian airfield. The life jacket worn over his flight suit was standard for flights over the Black Sea. The *Ritterkreuz* (Knight's Cross) Ruffer wore around his neck was bestowed at Bacău, Rumania on 9 June 1944. He was killed in action over Poland on 16 July 1944. The usual RLM27 Yellow (FS33637) noseband worn by Eastern Front Hs 129s was not applied to this aircraft. (Punka)

losses and accidents, while aircraft were idled by lack of fuel and spare parts. Several Hs 129s were destroyed by their retreating crews when they could not be flown from airfields about to be overrun by Soviet forces.

The Hs 129Bs of 14.(Pz.)/SG 9 saw action in the war's last major armor battle, near western Hungary's Lake Balaton in January of 1945. The Soviet victory in this engagement forced the squadron to retreat into Slovakia, then west into Bohemia and Moravia (the present-day Czech Republic) and then into northwestern Austria by war's end.

The remaining Hs 129Bs assigned to 10.(Pz.)/SG 9 flew combat as often as their tenuous supplies allowed them. In March of 1945, the Squadron destroyed 100 Soviet tanks, 30 assault guns, hundreds of lesser vehicles, and six aircraft. In early April, 10.(Pz.)/SG 9 joined 14.(Pz.)/SG 9 in Austria and Czechoslovakia and participated in the battle for Vienna. The last Hs 129s were worn down by attrition and their flight and ground crews became foot soldiers in the last days of World War Two.

Soviet officers inspect an Hs 129B-2 (J, W. Nr. 141723) abandoned by retreating German forces on the Hungarian *puszta* (plain) during the fall of 1944. The access panel for the aircraft's radio had been removed, along with the cockpit canopy. Considerable damage had been done to the Hs 129's starboard wing. Luftwaffe records concerning this aircraft's loss did not survive the end of World War Two. (Seidl)

This Hs 129B-2 (W. Nr. 141279) was hit by Soviet anti-aircraft fire and crash landed behind Soviet lines. This aircraft was assigned to the ARR (Royal Rumanian Air Force) despite its German markings; however, Rumanian markings had not been applied before the Hs 129's loss. *Leutnant* (2/Lt) Eberhard Schmall, a Luftwaffe advisor to the ARR, survived this crash landing and was rescued by Staff Sgt Constantin Georgescu, who landed his Hs 129 next to the wreckage and picked up Schmall. Soviet troops later inspected the downed aircraft. (Karlenko)

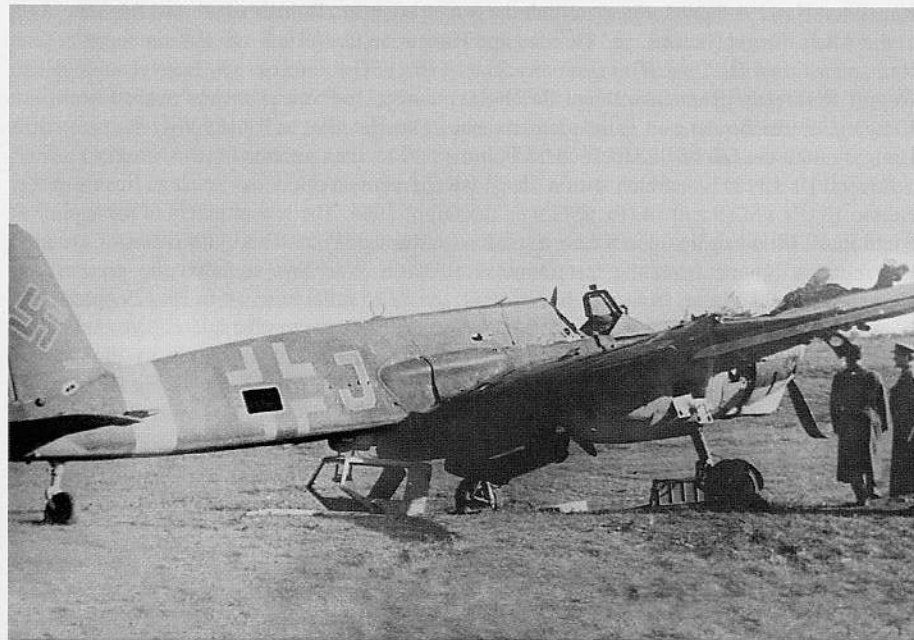



Ruffer's Hs 129B-2, Red J (W. Nr. 0364), warms up its engines prior to takeoff on a close support mission over the Eastern Front. The *Infanteriesturmabzeichen* (Infantry Assault Badge) was stenciled in white on the nose in front of the windshield and on the upper mid-fuselage. The propeller spinners had RLM23 Red (FS31140) fronts, narrow white rings, and black rear sections. (Petrick)

Schlacht pilots discuss their next mission beside the port horizontal stabilizer of Hs 129B-2, Blue M (W. Nr. 141862). *Hauptmann* (Capt) Hans-Günther Marufka, *Staffelkapitän* (Squadron Commander) of 12.(Pz.)/SG 9, flew Blue M until his death in action on 11 June 1944. (Petrick)



Two Luftwaffe ground crewmen team up to start the port engine of this Hs 129B-2 during the summer of 1943. Both Gnome & Rhône 14M engines were started using inertial cranks, which required considerable strength on the crewman's part. The Hs 129B upper and lower cowling halves were secured using three flush fasteners on each side.



Maintenance crewmen prepare an Hs 129B-2, White G (W. Nr. 0366), for a mission from a snow-covered forward airfield during late 1943. This aircraft was assigned to 4.(Pz.)/Sch.G. 1, which operated on the Eastern Front's southern sector. The white-outlined black triangle symbol for close support aircraft appeared in front of the fuselage *Balkenkreuz*, although its use had declined by this period of the war. (Rosenkranz)

Two Hs 129B-2s taxi in following the completion of a close support mission over the Eastern Front. The empty underwing bomb racks suggested that 110.2 lb (50 kg) bombs were dropped during this mission. The lead Hs 129B-2 had the Infantry Assault Badge painted on the nose and two tank 'kill' marks on the rudder, while the trail aircraft lacks the nose insignia and had at least two 'kill' marks on its rudder. (Petrick)



A captured Soviet tractor in white finish tows a 10.(Pz.)/SG 9 Hs 129B-2 across the muddy airfield at Vinnitsa, Ukraine during the Spring of 1944. Melting snow in the spring and rain during the fall greatly hampered operations from the grass runways along the Eastern Front. The Russians called this period the *rasputitsa* (time without roads). (Griehl)

A ground crewman draws fuel from an Opel tanker to fill this Hs 129B-2's starboard wing tank. Each wing tank held 54.2 gallons (205 L) of 87-octane B4 aviation gasoline, while the fuselage tank's capacity was 52.8 gallons (200 L). The Hs 129B-2 had a range of 422.5 miles (680 km). (Petrick)

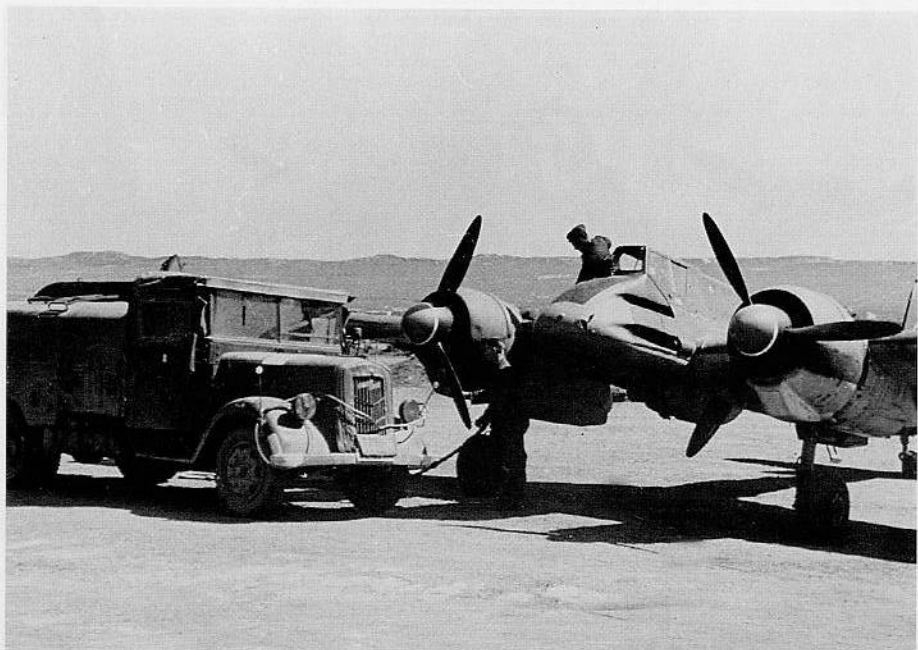

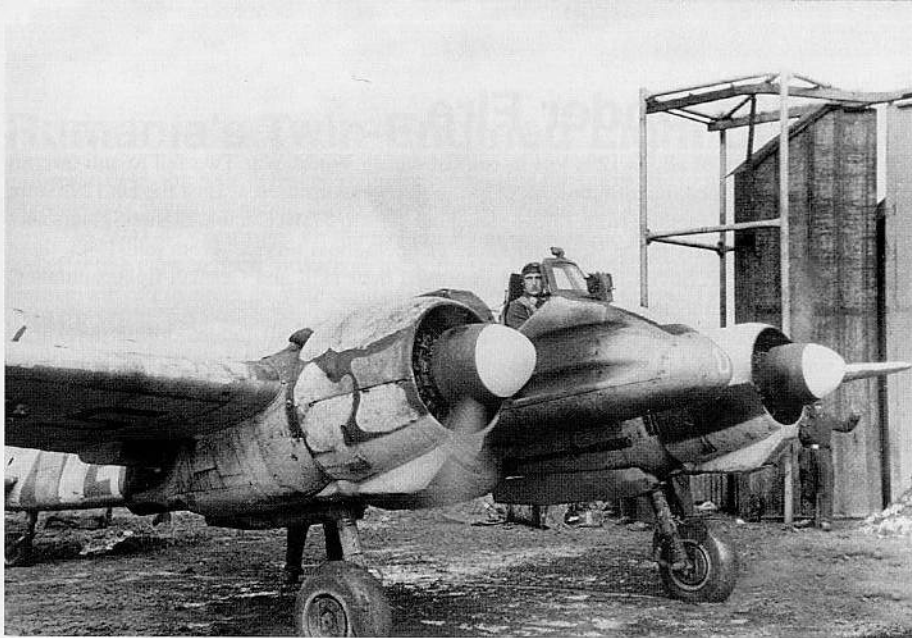

An Hs 129B-2, White O, warms up its engines prior to a mission over Rumanian-administered Bukovina in the spring of 1944. This aircraft was assigned to 10.(Pz.)/SG 9 and wore patches of temporary white winter camouflage over the dark green and black green upper-surfaces. The gun troughs were blackened from firing the 20mm and 7.92mm weapons. (Griehl)

Soviet soldiers inspect an Hs 129B sabotaged by retreating German forces to prevent its capture in Posen (Poznan), Poland in February of 1945. The RLM70 Black Green (FS34050) propeller spinners had white spirals added for recognition purposes. One of the soldiers held the barrel of the Hs 129's 30mm MK 103 cannon. (Geust)



A Soviet soldier sits in the cockpit of an Hs 129B-3 (NK+DA), which made a forced landing in Moldavia, Rumania on May of 1944. The impact broke this aircraft's fuselage in half; however, the Hs 129's forward fuselage remained intact. The canopy and engines were removed from this aircraft. (Geust)

Retreating German troops destroyed this Hs 129B-2, White 1 (W. Nr. 141862) before the aircraft could be captured by advancing US troops in 1945. A derelict Bf 109G of JG 52 rests beside the Henschel aircraft. The Hs 129B-2's rudder was believed to be painted a dark yellow in accordance with Luftwaffe markings regulations issued in March of 1945. The RLM27 Yellow aft fuselage band and II. Gruppe horizontal bar on the aft fuselage were overpainted. (Williams)





(Above) On 22 January 1945, a surprise attack by Soviet troops forced 13. (Pz.)/SG 9 to abandon nearly all of its Hs 129s at Tonndorf (Wagrowicz) airfield in Poland. The Squadron destroyed 13 of its 16 aircraft – including three Hs 129B-3s – before retreating west. Two Soviet troops inspect the wreckage of an Hs 129B-2 (W. Nr. 141537) the next day. The Germans applied bands of temporary white paint over the standard Black Green/Dark Green uppersurface camouflage. (Geust)



Hs 129s Under Fire

The vast majority of all Hs 129s lost in combat during World War Two fell to anti-aircraft (AA) fire at low to medium altitudes. Most of the AA weapons used against the Hs 129s were light automatic guns, ranging from 7.62MM machine guns to 37MM cannon. Soviet fighters shot down few Hs 129s early in the Henschel aircraft's operational service. From mid-1943, these numbers increased as Soviet fighter pilots improved their skill and German fighter numbers and pilot quality diminished.

The Hs 129 was distinct from most other ground attack aircraft fielded during the war in being a single-seat machine. Many of the other attack aircraft used during World War Two – including the Junkers Ju 87 Stuka and the Soviet Ilyushin Il-2 *Shturmovik* – had a rear gunner. Henschel designers had initially considered a second crewman for their Hs 129 design; however, this idea was rejected due to the weight the gunner and his equipment would add to the aircraft. The designers also realized that a rear gunner would not significantly increase the aircraft's survivability in combat.

The Hs 129's main defense against enemy fire proved to be both its armor protection and the pilot's ability to maneuver the aircraft. The armored cockpit 'bathtub' which enclosed the pilot ranged in thickness from 6MM on the sides to 12MM on the front and bottom. This structure also protected pilots from serious injury during crash landings. The armored glass windshield and canopy balanced protection and visibility for the pilot. Some Hs 129s had rear view mirrors installed on top of the windshield to give pilots the ability to spot enemy aircraft lurking behind. The Hs 129's survivability was increased by its triangular fuselage section, which deflected some light projectiles away from the aircraft. The concept and design of the Hs 129 was revived in the United States during the 1970s, when the Fairchild Republic A-10 Thunderbolt II was designed. This modern aircraft – like the earlier Hs 129 – has twin engines, armor protection for the pilot, and weapons designed for the close support and anti-tank roles.

The twin-engine layout gave this aircraft an advantage over single-engine attack aircraft. The Hs 129 could be flown on one engine if the other powerplant was disabled, although flying the heavy aircraft under these conditions proved tiring for the pilot. The use of air-cooled engines was a further advantage for a ground attack pilot, since they were less vulnerable to combat damage than liquid-cooled powerplants.

Over 95 percent of all Hs 129s lost to enemy fire during World War Two were over the Eastern Front – the theater where the aircraft saw the most service. The Western Allies in North Africa downed only a few Henschels. Additionally, German pilots shot down several Rumanian Hs 129Bs after Rumania's defection to the Allied camp in August of 1944.

Several Soviet aces counted Hs 129s among their victims, including *Major* Ivan N. Kozhedub. The top scoring Allied fighter pilot in the war, Kozhedub's 62 victories included three Hs 129s. This is believed to be the highest number of Hs 129s 'killed' by a single pilot.

(Left) The sabotaged Hs 129B-2 (W. Nr. 141537) lies abandoned at Tonndorf (Wagrowicz), Poland on 22 January 1945 – one day after retreating German airmen destroyed this and 12 other Hs 129s ahead of the advancing Red Army. The last two letters of this aircraft's *Stammkennzeichen* (Radio Code), TQ, straddled the port wing undersurface *Balkenkreuz* national insignia. Undersurfaces of Luftwaffe and ARR (Royal Rumanian Air Force) Hs 129s were usually painted RLM65 Light Blue (FS35352). (Geust)

Rumania's Twin-Engined Light Cavalry

In early 1943, the Axis defeat at Stalingrad convinced the Luftwaffe to modernize the ARR's (*Aeronautica Regală Română*; Royal Rumanian Air Force) obsolescent combat aircraft inventory. The 1941-43 campaigns on the Eastern Front showed the Rumanians needed a modern and effective close support aircraft. In the spring of 1943, the ARR decided to procure current German aircraft to equip its main combat element on the Front, *Corpul 1 Aerian Regal Român* (C1ARR, 1st Royal Rumanian Air Corps).

The Hs 129B-2 was selected to fulfill the close air support role and Germany agreed to supply enough aircraft to equip a three-squadron group. The ARR selected *Grupul 8 vânătoare* (8th Fighter Group) to operate the new aircraft, and this unit was redesignated *Grupul 8 asalt* (8th Assault Group) on 11 May 1943. The Group consisted of three *Escadrile* (squadrons): the 41st, 42nd, and 60th and was originally based at Târgsor, near Ploiesti, Rumania.

Grupul 8 asalt personnel converted to the Hs 129B-2 at a German-run training center in Kirovgrad, Ukraine. After conversion training on German-owned Hs 129B-2s, the Rumanians received 34 new Hs 129B-2s by August of 1943. Aircraft assigned to *Escadrila 41 asalt* (41st Assault Squadron; 41st AS), were allocated numbers beginning with 111, Henschels with the 42nd AS received numbers starting with 211, and 60th AS aircraft numbers began with 311. The Group deployed to the combat zone in early August, first to Mariupol-West and then to their new home at Kramatorskaya, Ukraine.

On 15 August, a Soviet raid on Kramatorskaya destroyed one Hs 129B-2 and slightly damaged two others. The 8th AG flew its first mission the next day, operating against Soviet troop concentrations along the Donets River in the Isyum sector of Ukraine. The Rumanians would enjoy great success with the Hs 129 throughout the remainder of World War Two.

The Group's Hs 129s were heavily involved in the fighting between the Donets and Mius rivers during the late summer of 1943. The assault pilots (named *asaltisti* by the Rumanians) flew three or four sorties per day against Soviet troop formations during this period. The Soviet breakthrough near Kiev forced the 8th AG to retreat from Kramatorskaya to Staryy Bliznetzy on 2 September. During the fall of 1943, Hs 129 pilots supported Rumanian troops along the north shore of the Black Sea and on the Crimean Peninsula. These airmen occasionally flew up to 16 missions per day from forward airfields, responding to numerous Soviet assaults on the Axis positions.

On 14 September 1943 – five days after moving its base to Dnepropetrovsk – *Grupul 8 asalt* sent its Hs 129B-2s against a large Soviet armored column. The Rumanians achieved total surprise with their low-level attack, which halted the column with large Soviet losses. The Rumanians lost two aircraft, with one pilot returning on foot to friendly territory and the other pilot taken prisoner.

The Soviet drive to clear the Ukraine kept the 8th AG's Hs 129B-2s hard pressed throughout the fall of 1943. The constant low-level close support missions took a heavy toll on the Group, with *Grupul 8 asalt* reduced to nine serviceable Hs 129B-2s by early November. Virtually all Rumanian Hs 129B-2s were downed by Soviet anti-aircraft fire, although some were destroyed on their airfields in Soviet air raids. Replacement Hs 129Bs supplied by the Germans repeated the lost aircraft's tail number, with a letter (a, b, c, etc.) at the end to indicate a replacement. (For example, 111a was the first replacement for aircraft 111.)

Hs 129s of the 8th AG flew several missions against advancing Soviet forces attacking in southern Ukraine in early 1944. The *asaltisti* sustained many losses to Soviet fighters and AA fire in an unsuccessful attempt to halt this offensive. The Soviets then attacked Rumanian-held



Oberfeldwebel (Sgt Major) Josef 'Sepp' Reitberger treads carefully over the waterlogged Ukrainian steppe behind a Rumanian Hs 129B-2 during the fall of 1943. Aircraft No. 132 (W. Nr. 141383) was assigned to the ARR's *Escadrila 41 asalt* (41st Assault Squadron), where Reitberger served as an instructor to the Rumanian pilots. No. 132 was lost in action on 30 November 1943. (Antoniuc)

A Luftwaffe Hs 129B-2, Blue Z (W. Nr. 141278) and an ARR Hs 129B-2, believed to be No. 130 (W. Nr. 141231), share a wet dispersal area in the Ukraine during the fall of 1943. The German and Rumanian Hs 129 units operating on the Eastern Front's southern sector were assigned to *Luftflotte* (Air Fleet) 4. Luftwaffe and ARR Hs 129s rarely engaged in joint missions. (Seeley)

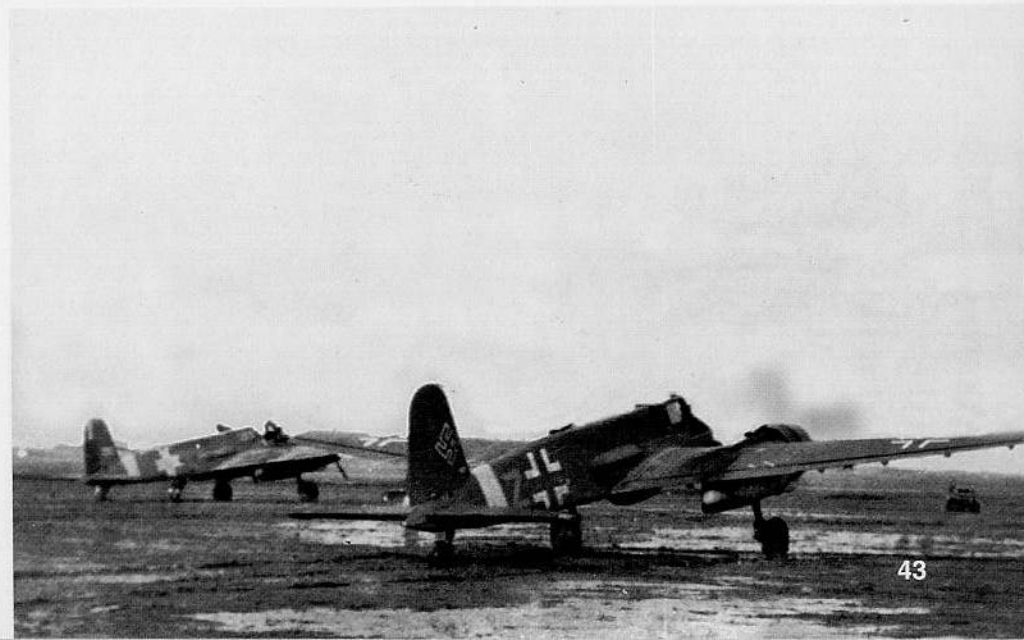



No. 228 (W. Nr. 141268), an Hs 129B-2 assigned to *Escadrila 42 asalt*, departs from a sandy Ukrainian airfield to attack Red Army forces during the late summer of 1943. Soviet anti-aircraft fire downed this aircraft on 14 September 1943, while flown by *Ofw.* Josef 'Sepp' Reitberger, a Luftwaffe instructor. He was able to make a safe forced landing in friendly territory. (Bernád)

A pilot – believed to be *Unteroffizier* (Staff Sgt) Groß, a German instructor – and a ground crewman pose on the wing of a Rumanian 60th Assault Squadron Hs 129B-2 prior to a mission. The aircraft was armed with four 110.2 lb (50 kg) SC 50 bombs under the fuselage. Groß was declared missing in action after failing to return from a mission over the Eastern Front on 21 October 1943. (Nowarra)



Bessarabia in late March, pushing the Rumanian forces further westward. *Grupul 8 asalt* – reduced to seven serviceable Hs 129Bs – returned to Rumanian soil at Tecuci, Moldavia on 3 April. The Henschels saw near continuous service as the Rumanians flew attack missions against the invading Soviet forces. Replacement aircraft arrived in late April; however, only 18 serviceable Hs 129Bs were available to the 8th AG when the fighting flared up on 28 April. The Henschels proved effective in helping check the Soviet advance into northeastern Moldavia that spring.

On 20 August, the Red Army launched a major offensive to push through the German and Rumanian defenses in northeastern Moldavia. ARR and Luftwaffe Hs 129Bs attempted to stop the offensive, but losses to Soviet AA fire and fighters mounted. The Soviets broke through the defenses and headed towards Bucharest. On the evening of 23 August, Rumania's King Michael announced that his country had ended its alliance with Germany and joined the Allies.

Grupul 8 asalt had 32 Hs 129Bs (including 19 serviceable aircraft) when the armistice was announced on 23 August 1944. The serviceable aircraft were based at Ianca, which the Germans had tried to seize. The Rumanians overpowered the Germans and retook the Hs 129Bs, as well as an additional seven Luftwaffe Hs 129Bs. The Group's 13 Henschels under repair at Matca (eight aircraft) and Foscani South (five aircraft) were destroyed by the advancing Soviet troops. Approximately 13 more Luftwaffe Hs 129Bs were impressed into ARR service in the days following Rumania's defection from the Axis. On 27 August, the 8th AG moved their aircraft to Craiova, to join with other pro-Allied ARR elements to reform CIARR.

CIARR – now subordinated under the Soviet 5th Air Army – was deployed from Craiova to southern Transylvania. The Hs 129s and other aircraft in this Corps flew in support of Rumanian and Soviet forces engaging German and Hungarian troops in Transylvania – Rumania's Western Front. *Grupul 8 asalt* consisted of *Escadrila 41* and *42 asalt* (41st and 42nd Assault Squadrons) with 32 Hs 129B-2s, including 22 serviceable machines. The intense fighting in Transylvania reduced the 8th AG to eight serviceable Hs 129Bs by 15 September. More personnel arrived five days later when *Escadrila 60 asalt* – formed from a planned, but cancelled second Hs 129 group (*Grupul 11 asalt*) – arrived in theatre. By 28 September, attrition from combat and spare parts shortages resulted in only 13 Hs 129Bs available to 8th AG.

On 11 October, the surviving Hs 129s of *Grupul 8 asalt* and the Ju 87s of *Grupul 3/6 picaj* (3rd/6th Dive Bomber Group) were consolidated into *Grupul 8 asalt/picaj*. This new unit consisted of *Escadrila 41 asalt* with the Hs 129Bs and *Escadrila 74 picaj* with the Stukas. Following this reorganization, the Hs 129Bs resumed ground support missions for Rumanian forces advancing through Transylvania. By 14 November, the Group had redeployed to Turkeve in central Hungary. Wet and overcast weather reduced flight operations, yet the Hs 129s made maximum efforts to support Allied troops when weather conditions permitted.

The ARR's Hs 129s and the rest of CIARR were transferred from the Soviet 5th Air Army to the Soviet 40th Army on 15 January 1945. This move allowed the Rumanians to provide support for the Soviet offensive in Slovakia and southern Poland. The *asaltisti* conducted bombing and strafing runs on German and Hungarian troops during the last months of World War Two. The final combat missions were flown over Moravia (located in the present Czech Republic) on 8 May 1945 – the day Germany surrendered to the Allies.

After brief occupation duty in Czechoslovakia, the ten surviving Hs 129Bs were sent back to Rumania on 30 July 1945. Spare parts shortages reduced the Hs 129B force to four serviceable aircraft by year's end. The last three Henschels in Rumanian service were withdrawn by the end of 1947 and scrapped during the following year.

It is estimated that at least 200, but possibly up to 250, Hs 129Bs were delivered to or otherwise acquired by Rumania between 1943 and 1944.



These ARR pilots reenacted the rescue of 2/Lt Lazăr Munteanu after his Hs 129B-2, No. 327 (W. Nr. 141263), was downed behind Soviet lines on 11 October 1943. Staff Sgt Dumitru Marinescu landed beside the downed aircraft and picked up Munteanu. A rescued pilot could be carried to safety in the already cramped cockpit or occasionally inside the mid-fuselage radio compartment. (Bernád)

Hs 129B-2, No. 328 (W. Nr. 141277) taxis prior to takeoff on a close support mission during 1943. The 110.2 lb (50 kg) SC 50 anti-personnel bombs under the wings have fuse extenders to insure explosion above the ground. No. 328 was assigned to *Escadrila 60 asalt*, whose aircraft were numbered in the 300 series by the ARR. This Hs 129B-2 made a wheels-up landing on 15 October 1943 and was returned to the Germans. (Nowarra)



A Soviet officer congratulates an anti-aircraft battery commander for downing Lt Munteanu's Hs 129B-2, No. 327 (W. Nr. 141263) on 11 October 1943. The phrase HAI FETI-TO (C'mon lassie) was painted ahead of the 'Michael's Cross' on the fuselage, while Munteanu's emblem – believed to be a death's head over a slanted bone – was painted on the tail under the aircraft's number, 327. (Sehnal)

ARR ground crewmen feed a 20mm ammunition belt into the port MG 151/20 cannon of an Hs 129B-2, believed to be No. 226 (W. Nr. 141244). A mouth was painted onto this aircraft's nose. The 125-round belts contained a mix of armor piercing, incendiary, and high explosive ammunition. These ammunition types were distinguished by the different projectile colors. (Bujor)

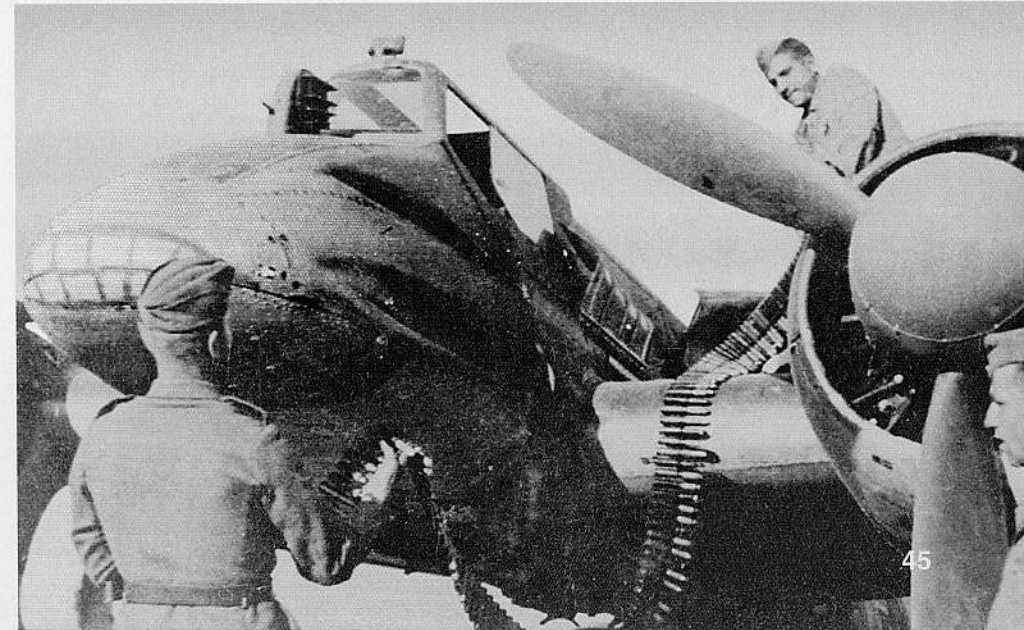



ARR ground crewmen perform airfield maintenance under snowy conditions at Nikolayev, Ukraine in early November of 1943. The two Hs 129B-2s parked behind the crewmen were No. 118a (W. Nr. 141122) and No. 226a (W. Nr. 0233). Both aircraft were replacements for the original Nos. 118 and 226 after they were lost in service. The crewmen each wore the Rumanian *căciulă* (lamb skin winter hat) with their overcoat in cold weather. (Bernád)

An *Escadrila 42 asalt* Hs 129B-2 warms up its port engine at a forward airfield on the Nogay Steppe in southern Ukraine in early 1944. One pilot watches the engine run while a colleague gestures for the photographer. The aircraft parked on this makeshift airfield wore patches of temporary white paint over the camouflaged uppersurfaces. (Avram)



A mechanic repairs the tail wheel of Hs 129B-2 No. 120a (W. Nr. 140715) at Nikolayev in November of 1943. He had only a tent sheet placed on the snow-covered ground for his work platform. German and Rumanian Hs 129 ground crewmen performed their duties under all weather conditions. (Bernád)

Hs 129B-2 Yellow 120 (W. Nr. 140809) burns after crash landing at Lepetikha airfield in the Ukraine on 21 January 1944. The crash instantly killed the aircraft's pilot, Capt Alfred Conrad, who was performing aerobatics over the airfield when he misjudged his altitude and hit the ground. Yellow 120 was damaged in two crash landings while flown by 2/Lt Lazăr Munteanu during 1943 and was repaired after each incident. (Bujor)



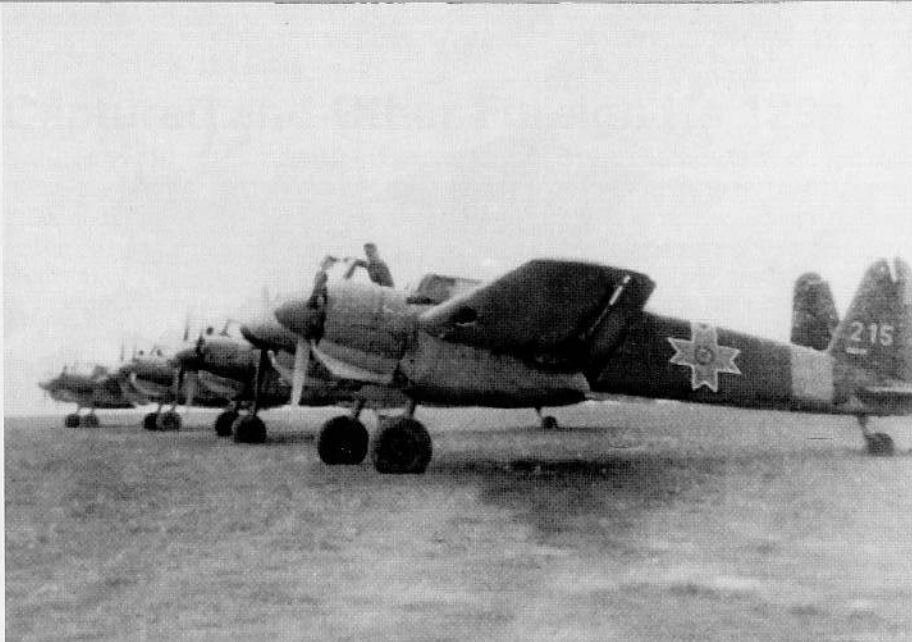

Four ARR Hs 129B-2s are lined up on an unidentified forward airfield in southern Russia in early 1944. No. 215 (W. Nr. 140719) was lost in an accident at Someseni (Szamosfalva) airfield in Transylvania on 25 October 1944. The vertical tail aft of Hs 129 No. 215 belonged to a Luftwaffe Messerschmitt Me 323 Gigant transport.

Student *asaltist* pilots pose on and in front of an Hs 129B-1 at FFS C (*Flugzeugführerschule C*; Pilot's School Class C) 20 at Krosno, Poland in early April of 1944. This German-run advanced flight school instructed Rumanian Hs 129 pilots on flying their new aircraft. Four ETC 50 bomb racks were installed under the fuselage. (Vancea)

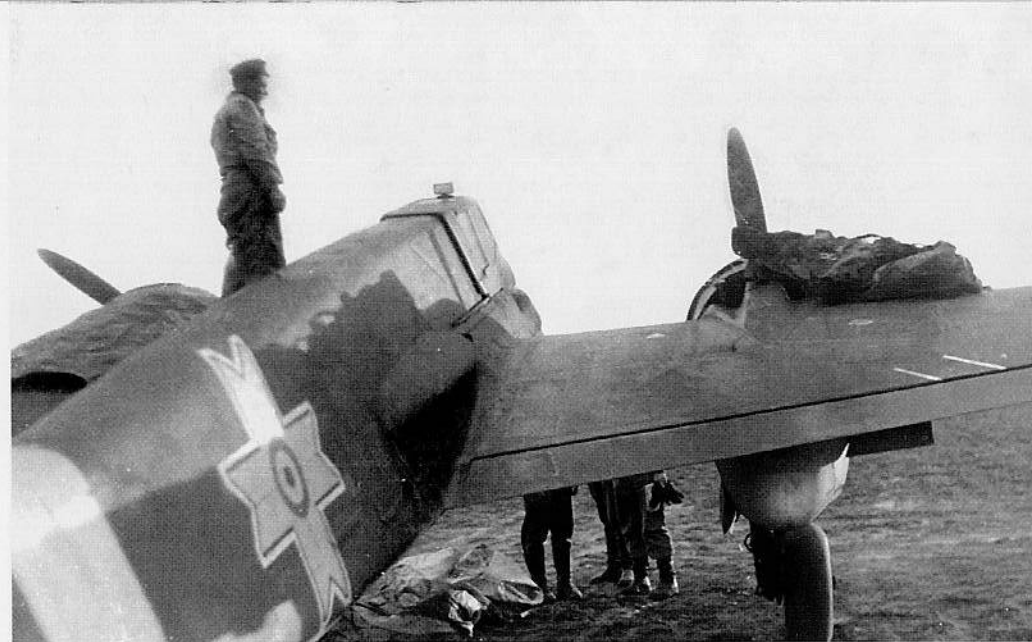

An ARR Hs 129B-2 is prepared for a day's flying at an unidentified airfield in early 1944. A tarpaulin covered the port engine, while another tarpaulin was partially removed from the starboard engine nacelle. The Rumanian 'Michael's Cross' national insignia was used from mid-May of 1941 until late August of 1944.

Tech Sgt Trifan Bulhac leans against his bomb-laden Hs 129B-2 (No. 100, W. Nr. 141879) during the fall of 1944. The Rumanians overpainted the Axis yellow nose of this captured German aircraft with dark green over light blue after Rumania's defection to the Allies in August of 1944. Four 110.2 lb SC 50 bombs were carried under the fuselage. (Avram)





An Hs 129B-2 (believed to be W. Nr. 142006) is parked at Balomir airfield in Transylvania on 7 October 1944. A row of VVS Douglas A-20 Havoc bombers are behind the Hs 129B-2, whose lack of tail number indicated a Luftwaffe aircraft captured by the Rumanians. W. Nr. 142006 was later given the tail number 238 before it was lost to Axis anti-aircraft fire on 16 October 1944. (MMN)

An Hs 129B-2, No. 113 (W. Nr. 142000) carrying bombs under the wings and fuselage forms on the port wing of another Hs 129 while on an attack mission over Hungary in early 1945. The Henschel aircraft were assigned to the 8th Assault/Dive Bomber Group, which also included Ju 87 Stukas. The white aft fuselage band and wingtips were recognition markings used by Rumanian aircraft flying under Soviet command. (Bernád)

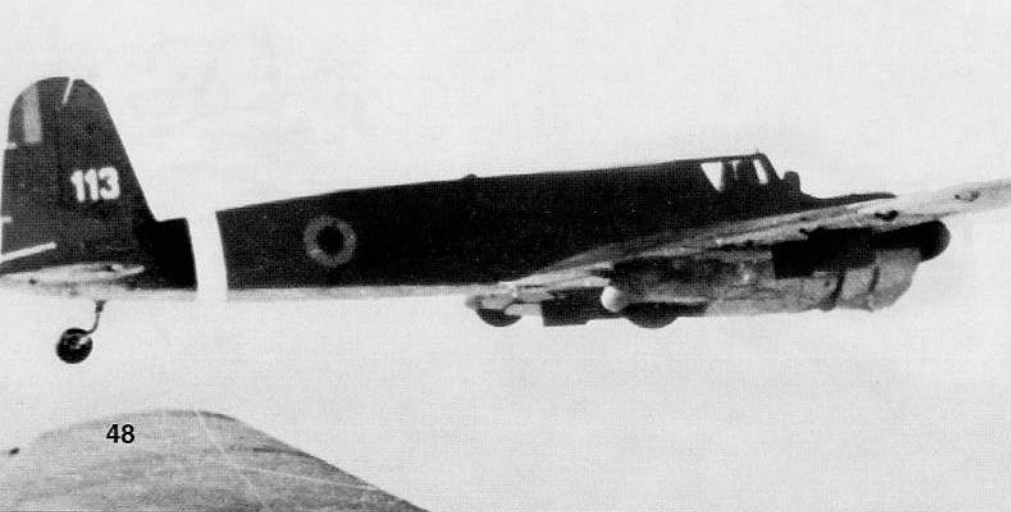

An ARR airman and a female Soviet pilot pose for a propaganda photo in front of an Hs 129B-2, No. 233, in early October of 1944. The two people sat on stacked 110.2 lb SC 50 bombs. The *Werknummer* (Factory Number) 0152 on the aircraft's tail did not fit the sequence for a late production Hs 129B-2. *Slt. av.* (2/Lt) Alexandru Nicolau flew No. 233 when he defected to the Germans on 13 January 1945. (MMN)

ARR *asaltisti* and ground crewmen standing beside Hs 129B-2 No. 222b watch their colleagues arrive at Lucenec air base in Slovakia in February of 1945. The four pilots clustered around the tail were (L-R): Ioan Logofătu, Victor Dumbravă, Vasile Pascu and Vasile Anghel. The red, yellow, and blue rudder striping on No. 222b was carried farther down the rudder than was usual for ARR Hs 129s. (Antoniu)



Captured and Other Foreign Hs 129s

A number of Hs 129s fell into Allied hands during World War Two, in both flyable and non-flyable condition. Soviet Lavochkin La-5 fighters downed an Hs 129B-1 (W. Nr. 0222) near Elshevdomo on 14 November 1942. The Hs 129 made a wheels-up landing in Soviet territory and the Soviets reportedly transported this aircraft to Moscow for evaluation. No further details about this aircraft are known. Soviet forces seized several intact Hs 129Bs – including W. Nrs. 0193 and 0228 – after overrunning a German airfield near Stalingrad in early 1943.

The British and Americans captured several Hs 129B-2s during the North African campaign in late 1942 and early 1943. These included two aircraft used for flight tests: W. Nr. 0297 by the British and W. Nr. 0385 by the Americans. Both flight test aircraft were scrapped after World War Two.

In August of 1943, Germany sent four Hs 129Bs to Hungary to begin training for a planned Hungarian ground attack squadron. One aircraft was lost in a flight accident, killing the Hungarian pilot. Low availability of Hs 129s ended further deliveries to Hungary and the three surviving aircraft were returned to Germany in the fall of 1943.

Spain expressed an interest in the Hs 129 and placed an order for three aircraft in July of 1944. The Germans cancelled this order, due to the urgent need for this aircraft by the Luftwaffe. Bulgaria also evaluated the Hs 129 for its air force, but opted for the Ju 87 Stuka instead.

US troops captured an Hs 129B-2 (W. Nr. 0385), which had been abandoned at Toubakeur, Tunisia in the spring of 1943. This aircraft was repaired and taken to Wright Field, Ohio for test flights. The Hs 129B-1 was originally serialised EB (Evaluation Branch)-105 before being renumbered FE (Foreign Evaluation)-4600. The seldom-flown Henschel was grounded after an accident on 24 July 1946 and later scrapped. The cockpit section of this aircraft is currently undergoing restoration in Australia. (Pegg)



British forces advancing in Tunisia captured an Hs 129B-2 (believed to be W. Nr. 0297) in early 1943. The aircraft was repaired and received Royal Air Force camouflage and markings, with the serial number NF756. This Hs 129B-2 was assigned to No. 1426 flight at Collyweston for test flights, which allowed the British to determine the performance, strengths, and weaknesses of the aircraft. (Pegg)

A Bulgarian test pilot sits in the cockpit of an Hs 129B-2 during a Bulgarian delegation's visit to Germany in October of 1943. Three other Bulgarian officers and a German interpreter are clustered near the cockpit. Bulgaria considered obtaining Hs 129s from the Germans to update their air force; however, the Bulgarians chose the Ju 87 Stuka. Another Hs 129B-2 (CH+SR, W. Nr. 0325) was parked nearby. (Bernád)



Henschel Hs 129 Production List

No. Built	Werknummer ¹	Variant	Production Dates	Known Stammkennzeichen ²	Notes
1	129 3001	Hs 129 V-1	Nov. 1938-May 1939	D-ONUD, TF+AM	Original Henschel Projekt P 46. Delayed due to lack of Argus engine and propeller. First flight 26 May 1939. Test flown by <i>Oblt.</i> (1/Lt) Gatzemeier at <i>E-Stelle</i> Tarnowitz on 24 April 1940. Transferred to <i>E-Stelle</i> Rechlin 14 December 1940.
1	129 3002	Hs 129 V-2	Dec. 1938-Sept. 1939	TF+AN (not used)	Delayed due to lack of Argus engine and propeller. One Argus 410 engine arrived in July 1939. The other removed from V-1. First flight 30 November 1939. Crashed 5 January 1940.
1	129 3003	Hs 129 V-3	Dec. 1938-Sept. 1939	TF+AO	Delayed due to lack of Argus engine and propeller. First flight 2 April 1940. At <i>E-Stelle</i> Rechlin 31 May 1940. October 1940 rebuilt as prototype for the B series (Gnome & Rhône radial engine) and renamed V-3/U-1. First flight with new powerplant 19 March 1941. Used as testbed at Henschel. Scrapped July 1944.
14	129 3004-129 3017	Hs 129 A-0	Nov. 1939-Jan. 1941	GM+OA to GM+ON	First flight of 129 3004 1 August 1940. Temporary (reusable) ferry code for 129 3008 HS+MB (HS for Henschel).
16	0016-0031	Hs 129B-0	Dec. 1940-Nov. 1941	KK+VI to KK+VX	Originally ordered as Hs 129A-1s. Retrofitted with G&R 14M and renamed Hs 129B-0.
10	0151-0160	Hs 129 B-1	Dec. 1940-Mar. 1941	KG+GI to KG+GR	Initially designated Hs 129A-1/14M. Retrofitted with G&R 14M and renamed B-1.
40	0161-0200	Hs 129 B-1	Mar. 1941-May 1942		Originally 60 B-1s ordered (W. Nr. 0151-0210). Last ten airframes (W. Nr. 0201-0210) upgraded to B-2 standards (see below). W. Nr. 0167 flown by <i>Feldwebel</i> (Sgt) Paul Krieg at Deblin-Irena on 20 August 1943.
(250)	(0201-0450)	Hs 129 B-1 trop	(Dec. 1941-Apr. 1942)	N/A	Tropicalized version, cancelled April 1942. Production instead as B-2.
250	0201-0450	Hs 129 B-2	May 1942-Feb. 1943	0222 was GD+ZB; DE+ZQ (0223) to DE+ZY (0235); DE+ZX was 0230; DQ+ZA (0265) to DQ+ZZ (0290); 0292 was GD+CB; CH+SE (0312) to CH+SN (0321); 0334 was GG+E?; 0360 was VE+NI; 0364 was GS+IN; 0366 was VE+NO; 0376 was PG+MM; 0406? was GD+CJ; SJ+WF (0416) to SJ+WJ (0420)	First ten airframes were the last ten B-1s, upgraded to B-2 standards. 0266 and 0267 kept at Henschel for testing. Engines of 0266 used for C-1/V-4. Henschel document: in August 1942, the 100th series production Hs 129B delivered to the front, 16 already lost by then.
40	140401-140440	Hs 129 B-2	Mar. 1943-Apr. 1943		140428, 140433 in ARR (Royal Rumanian Air Force) service.
50	140491-140540	Hs 129 B-2	Apr. 1943-July 1943	DO+XE (140492) to DO+XZ (140512)	140494 tested with BK 5 & BK 13 cannon December of 1943 & 8 July 1944.
130	140711-140840	Hs 129 B-2	1943	GL+PL (140732); NN+KF (140793) to NN+KH (140795)	March 1943: 331 Hs 129Bs delivered to the front, 212 already lost.
30	140861-140890	Hs 129 B-2	1943		
20	141111-141130	Hs 129 B-2	1943		
100	141201-141300	Hs 129 B-2	1943-1944	141258 was BH+ZS	Sept. 1943: 560 Hs 129Bs delivered to the front, 383 already lost.
1+	141335	Hs 129 B-2	N/A		141291 & 141292 tested with BK 5 cannon December 1943. Test with Flak 18 cancelled. Tests with BK 7,5 successful. Finally, 141291, 141292 & 140494 equipped with BK 7,5. 140494 & 141291 prototypes for B-3. Both transferred to <i>E-Stelle</i> Tarnowitz July of 1944. December of 1943: 664 Hs 129Bs delivered to the front, 495 already lost.
40	141371-141410	Hs 129 B-2	1944		Sustained 50% damage on 8 November 1943.
100	141491-141590	Hs 129 B-2	1944	SS+LC (141583) to SS+LF (141586)	141410 is shown as '1410' in Jupp Oehl's Flight Log as flown in combat on 21 October 1944.
80	141681-141760	Hs 129 B-2	1944	NK+DA (second letter uncertain) was 14171_ (last digit unknown).	
70	141821-141890	Hs 129 B-2	1944	RU+PA (141837) to RU+PX (141860); 141863 was SR+JC	
60	141961-142021	Hs 129 B-2	1944	N/A	142001 equipped with flamethrower, transferred to <i>E-Stelle</i> Munster-North Fassberg, 26 August 1944.
50	142041-142090	Hs 129 B-2	1944	N/A	Block also given as from 142031 to 142100, 70 aircraft.
32	162001-162032	Hs 129 B-2	June 1944-Sept. 1944	N/A	Production halted in September 1944, all extant airframes scrapped.
23	162033-162055	Hs 129 B-3	July 1944-Sept. 1944	DT+GB to 'GD, others N/A	162052 captured by the Soviets in 1945. DT+GB test flown at <i>E-Stelle</i> Tarnowitz on 11 August 1944 by <i>Oblt.</i> Gatzemeier. DT+GD ferry flight from Breslau to Udetfeld on 27 September 1944. Last 20 units (4 B-2s & 16 B-3s) manufactured September of 1944. Production halted, all extant airframes scrapped.
1	220001	Hs 129 C-1/V-4	Apr. 1943-Mar. 1944	N/A	4th and final prototype. 13 July 1944 first flight. First of 8 planned C-1s. Production cancelled 7 March 1944.
Total: 1160+					Grand total believed to be up to 1267 aircraft. (Exact production records lost at the end of World War Two.) Total of 145 Hs 129s were also repaired at Henschel Werke between June of 1942 and September of 1944.

¹ *Werknummer*; Factory Number

² *Stammkennzeichen*; literally, Cadre Mark; here, Radio Code (Displayed on Fuselage Sides and Wing Undersurfaces)

Other *Stammkennzeichen* with unidentified *Werknummern* correlation (sub-version given where known): BQ+TX (B-2), CC+IN to 'IO, CD+ZR (B-1), CG+UK to 'UR (B-2), CH+CW, CI+TI (B-2), CH+SD (B-2), CS+UL to 'UV (B-2), DE+JR, DE+ZR, DI+VG to 'VH, DL+PU to 'PX (B-2), DN+ME (B-2), GE+MN (B-2), GE+SG to 'SS (B-2), GU+OD, HI+JH (B-2), KC+QW (B-2), KF+DH to 'DX (B-2), KL+SA (B-2), NK+DA (B-2), PH+UC to 'UR (B-2), RS+OD (B-2), SS+JB to 'JR (B-2), SX+BH (B-2), VE+ZG (B-2).

Other miscellaneous information: N?+?? was 141278, PB+?? was 141985; Hs 129B, GX+??, crashed on 28 December 1943, pilot *Uffz.* (NCO) Heinz Schlütter of Fl.Ü.G. 1 *Ost*, killed. Erich Axthammer flew 4M+HD and 4M+KD on 25 November 1942 and Nos. 23 and 24 [sic] on 28 December 1942. W. Nr. 0287, DQ+ZW, 6Q+QQ, 6/SG 151, Fw. (Sgt) Giselbert von der Horst killed in accident hitting ground during low level training flights at Debrenice, on 1 April 1944. W. Nr. 0164, 6Q+OG, 6/SG 151, *Uffz.* Werner Keuneck killed in accident during aerobatics South of the village of Koschowitz, on 5 May 1944. W. Nr. 0321, CH+SN, 6/SG 151, Fw. Johannes Marcy killed in accident during practice at Sruby, 4 km south of Chotzen airfield, on 2 May 1944. W. Nr. 0360, VE+NI, 6Q+QI, 6/SG 151, *Uffz.* Hermann Sachsenhausen killed in accident during practice (lost height when turning left at 1640.4 ft [500 m] and crashed into ground), 3.1 miles (5 km) south of Sirig, near Temmerin, on 1 September 1944.

¹ Fl.Ü.G. 1 *Ost* = *Flugzeug Überführungs Geschwader*; Aircraft Ferry Wing; *Ost* = East

Oberleutnant (1/Lt) Rudolf-Heinz Ruffer – a Knight's Cross holder – takes off in Hs 129B-2, Red J (Werke Nummer/Factory Number 0364) on another mission over the Kuban sector of the Eastern Front during the spring of 1943. This aircraft was assigned to 8.(Pz.)/Sch.G. 1 and displayed eight tank 'kill' marks on the rudder. Red J was lost to Soviet ground fire on 27 May 1943.



Hs 129B-2 No. 118a (W. Nr. 141122) served with the Royal Rumanian Air Force on the Eastern Front during 1944. This aircraft force-landed at Rosnov, Moldavia after being hit by anti-aircraft fire on 29 April 1944. The Hs 129B-2 was later repaired and served in the training role at Arad airbase in Rumania. No. 118a was believed to have been destroyed during fighting between Rumanian and Hungarian forces in and around Arad in September of 1944.



ISBN 0-89747-428-7



90000 >



9 780897 474283