

RF and Microwave Radiation Safety Handbook

RF and Microwave Radiation Safety Handbook

RONALD KITCHEN



Newnes

OXFORD AUCKLAND BOSTON JOHANNESBURG MELBOURNE NEW DELHI

Newnes

An imprint of Butterworth-Heinemann

Linacre House, Jordan Hill, Oxford OX2 8DP

225 Wildwood Avenue, Woburn, MA 01801-2041

A division of Reed Educational and Professional Publishing Ltd

 A member of the Reed Elsevier group

First published 1993 by Butterworth-Heinemann as

RF Radiation Safety Handbook

Reprinted 1995, 2000

Second edition 2001

© Ronald Kitchen 1993, 2001

All rights reserved. No part of this publication may be reproduced in any material form (including photocopying or storing in any medium by electronic means and whether or not transiently or incidentally to some other use of this publication) without the written permission of the copyright holder except in accordance with the provisions of the Copyright, Designs and Patents Act 1988 or under the terms of a licence issued by the Copyright Licensing Agency Ltd, 90 Tottenham Court Road, London, England W1P 0LP. Applications for the copyright holder's written permission to reproduce any part of this publication should be addressed to the publishers

British Library Cataloguing in Publication Data

A catalogue record for this book is available from the British Library

ISBN 0 7506 43552

Composition by Genesis Typesetting, Laser Quay, Rochester, Kent
Printed and bound in Great Britain



FOR EVERY TITLE THAT WE PUBLISH, BUTTERWORTH-HEINEMANN
WILL PAY FOR BTCV TO PLANT AND CARE FOR A TREE.

Contents

<i>Preface</i>	vii
1 Introduction to RF and microwave radiation	1
2 Sources of radio frequency radiation	21
3 Effects of radio frequency radiation	47
Part 1 The exposure of human beings to RF radiation	47
Part 2 Incidents and accidents relating to RF exposure	78
4 The development of standards for human safety	86
Part 1 Basic concepts of RF safety standards and guides for human exposure	86
Part 2 Typical current safety standards for human exposure	95
Part 3 Safety calculations for structures involving flammable vapours	119
5 The calculation of RF field quantities	129
Part 1 Microwave antenna calculations and safety with moving microwave beams	129
Part 2 Other antenna system calculations	158
Part 3 Simultaneous irradiations and peak pulse power limits	168
6 Mobile communications systems	172
7 RF radiation measuring instruments and methods	293
8 X-rays and X-ray measuring instruments	244
9 Planning surveys and measurements	278

10	Conducting radiation measurements and surveys	317
	Part 1 Leakage surveys	317
	Part 2 Exposure measurements	332
11	Designing to reduce radiation hazards	366
12	Radio frequency radiation safety management and training	392
Appendix 1	Useful data and relationships	413
Appendix 2	Technical and organisation abbreviations	416
Appendix 3	Information sources including the Internet	419
	References	422
	<i>Index</i>	429

Preface

Since the previous volume on this topic was written about eight years ago many things have changed, not least the various safety standards and these interact with most aspects of the subject. I have endeavoured to implement some of the suggestions made to me for this revision without seriously increasing the book size. To some extent the updating of this sort of book is like being on an endless belt since new material appears almost daily and there is the need to draw the line at some point.

As the book is addressed to people responsible for or concerned with safety, it cannot be assumed that all those involved are radio engineers. Often people from other disciplines such as mechanical engineering, chemistry and medicine, may be involved. Consequently some attempt has been made to explain things which the radio engineer might consider everyday matters. The general introduction to the book covers some of these aspects as previously. It is followed by updated pictorial examples of the sort of RF radiation sources likely to be met in RF radiation work, including RF process machines.

Chapter 3 on RF radiation effects has been revised and a new part introduced dealing with actual RF incidents and accidents. I am indebted for part of this to Dr René de Seze and to various colleagues. The chapter on standards (Chapter 4) has been completely updated and current standards compared. The FCC limits tables have been added as have the FCC and UK tables of assessment levels applicable to radio amateurs.

A chapter on mobile radio has been added (Chapter 6) and other chapters revised appropriately. Chapters 7 and 8 dealing with measuring instruments have been re-written with the new generation of instruments in mind although there is still some coverage of analogue RF radiation instruments since many are in use around the world. Every chapter now has an explanatory heading describing the contents.

I am indebted to the various organisations for permission to publish parts of their standards and to BSI for permission to use material from their

standards. The European Union is still in the course of doing something about occupational RF radiation safety. The expectation is that the ICNIRP98 limits will be adopted for occupational purposes. The EC Machines Directive also touches the subject of radiation and is mentioned in this revision.

The best development since the last book was written is the Internet and the availability of a lot of material which can be downloaded from various sites. This means that readers of this book can easily update themselves when something new arises. I have given some Internet data in Appendix 3 and though website arrangements do change in structure from time to time, it is usually easy to use the site search facilities to unearth the desired material.

In all this I am indebted to many people for help with finding reports, pictures and other material, reading drafts, etc. They include: Robert Johnson of Narda for help with technical documents; Mike Spalding, a colleague from our Marconi days who apart from reading drafts has taken over the task of running the RF radiation safety courses; Stephen Sharples, NATS; Eric Randall, Cable and Wireless Communications; Chris Jacob, BT; John Coleman, Consultant; Steve Phillippo, Bill Hartley, NTL; Peter Condron, Crown Castle Int.; David Wood, Stuart Allen and Phillip Chadwick, NRPB, for help in finding information, and all those who provided pictures of their instruments and equipment.

I am sure that I have missed people in the above list but if so, they can rest assured that their help was appreciated. Needless to say these people and their organisations are not responsible for any use I have made of information or any opinions expressed.

Lastly, and by no means least, I am grateful for the love and support of my wife, Gene, both in reading the whole manuscript more than once despite the unfamiliar content, putting up with my long periods spent at the computer and being philosophical about the idea that I retired ten years ago.

As this book is used as the course book on the training course which I set up at TUV Fareham, the book is dedicated to the Royal Air Force and others attending the course.

*Ron Kitchen
Chelmsford
The Birthplace of Broadcasting*

1

Introduction to RF and microwave radiation

This chapter gives an outline of the essential aspects of transmission and the nature of electromagnetic waves particularly for those from other disciplines who may otherwise find the electronic content unfamiliar. It includes explanations of the terms relevant to this form of non-ionising radiation.

Radio frequency (RF) radiation

The previous book on this subject was entitled *RF Radiation Safety Handbook*, the term 'RF' covering all frequencies used for communications, radar, satellites, etc., up to the nominal ceiling of 300 GHz. However, it was suggested that some people regard 'RF' as applying only to the lower part of this spectrum. Consequently the word 'microwave' has been added in this revision, although it is redundant in the context of the book. It would be tedious to use both terms throughout the book so 'RF' is used to include 'microwaves' here as is understood by radio engineers. The term microwave is only specifically used when the topic involves something to which the term normally attaches, e.g. microwave oven, microwave antenna, etc.

The subject of RF radiation is still regarded as mysterious and something of a black art. This is no doubt due to the fact that it cannot be seen or touched. There was also an element of magic in some of the very early experimental work, particularly that of Tesla, who seems to have mixed science and showmanship.

Perhaps because RF is unseen, it has also become confused with ionising radiation in the minds of many people. It is essential to distinguish the difference between the two since, with our present state of knowledge, the consequences of exposure to them can confidently be stated as being very different.

Although we cannot see radio waves, most people will, at school or college, have done the classical experiments with magnetic fields and iron filings to demonstrate the patterns of the fields and used an electroscope to demonstrate the presence of electrostatic charge and the force which causes the gold leaf to move.

From these early and rudimentary experiments with static fields it should at least be possible to conceive that such fields are not magical and are very common in any electrical environment.

History of radio transmission

Radio transmission is, relatively speaking, a very new technology which had its beginnings in the theoretical work of Maxwell in the nineteenth century and the experimental work of Hertz, the German physicist, in the last two decades of the nineteenth century. Many others also made contributions, including the development of devices which could detect the presence of radio waves. Whilst the question of who first transmitted radio signals is not without controversy, the subsequent practical development of radio communications systems is attributed to Guglielmo Marconi who was born in Italy in 1874.

His first British patent was taken out in 1896 and covered the use of a spark transmitter. There are many accounts written of the experimental work carried out at various locations on land and on ships during the course of which the range of such equipment was very much increased. By 1921, the thermionic transmitter tube became available and made it possible to design transmitters to operate on a range of frequencies. The power output available increased with the development of electronic tubes which could, increasingly, handle higher powers with the aid of air or liquid cooling systems.

Over the years, and stimulated by the needs of the First and Second World Wars, radio transmission has become an established technology which is taken for granted and which, among other things, provides for the broadcasting to our homes of entertainment, news and information of every kind in both the radio and television spheres. The most recent development, resulting in the domestic satellite dish antenna, brings the quasi-optical nature of microwaves to the notice of the consumer.

The use of semiconductor devices (transistors) has become commonplace and as a result the mass and volume of electronic products for a given function is much less than that of their earlier counterparts which used electronic tubes. However, in the high power transmitter field electronic tubes are still the mainstay of transmitters. These use very high voltages, depending on power output. 40 kV or more is not unusual for very high power equipments. High power systems such as MF and HF

broadcasting systems need considerable provision for cooling the vacuum tubes used and in some cases the resulting heat is transferred to the station heating system!

Semiconductor devices are being used in transmitters of more modest power and also in spaced array radar equipments and do not need high voltages. Semiconductor devices do also have a considerable role in transmitter drives, audio circuits and in control systems. In the latter application, sophisticated logical control circuits are easy to achieve and occupy the smaller volumes attributable to the small size of transistors and integrated circuits.

With the vast increase of terrestrial and satellite broadcasting and communications, and the enormous number of mobile phones now in use, homes, work and recreational places are irradiated by a vast number of electromagnetic signals. Many are intended to operate receiving equipment, most of which are at very low levels because the high sensitivity of receivers does not necessitate large signals. Mobile phones do however communicate both ways and thus incorporate transmitters and receivers. As usage increases there is pressure for the use of more frequencies such that governments now sell licences to use parts of the RF spectrum.

Some radiation is unintentional, resulting from the leakage of energy from devices which have no radiation function, for example, due to inadequate shielding, unblocked apertures in metal cases, and similar shortcomings. Apart from any effects of leakage on people, it also causes interference with other equipment. It is not surprising that the presence of so much electromagnetic interference has caused people to question whether they can be harmed by it.

The word 'wireless' largely passed out of use many years ago. Radio is now the more general term in use, though strangely enough in domestic use it tends not to have the same wide use, mainly being interpreted as meaning sound broadcasting with the term 'television' or 'TV' to describe television picture and sound broadcasting. There are many words used to describe forms of radio system including satellite communications, radar, microwave links, mobile telephones, etc.

Despite the profusion of terms in use to describe the transmission of intelligence by electromagnetic waves, the nature of these waves is basically the same, the variable being the way in which the intelligence (signal) is added. It is therefore convenient to refer to these electromagnetic waves as 'radio waves' and the frequencies of the waves as 'radio frequencies'.

The nature of radio waves

Most readers will be familiar with the fact that an alternating current or voltage which is undistorted has an amplitude which varies with time and

reverses direction at each 180° , one cycle taking 360° . This pictorial representation of a current or voltage is referred to generally as a waveform and the description above is that of a sine wave. Waveforms may have other shapes such as square waves, ramps, etc., as will become apparent later.

A sinewave is illustrated in Figure 1.1 and is shown with the 'Y' axis denoted arbitrarily in amplitude (A). The term amplitude is used to refer to the magnitude of the voltage or current.

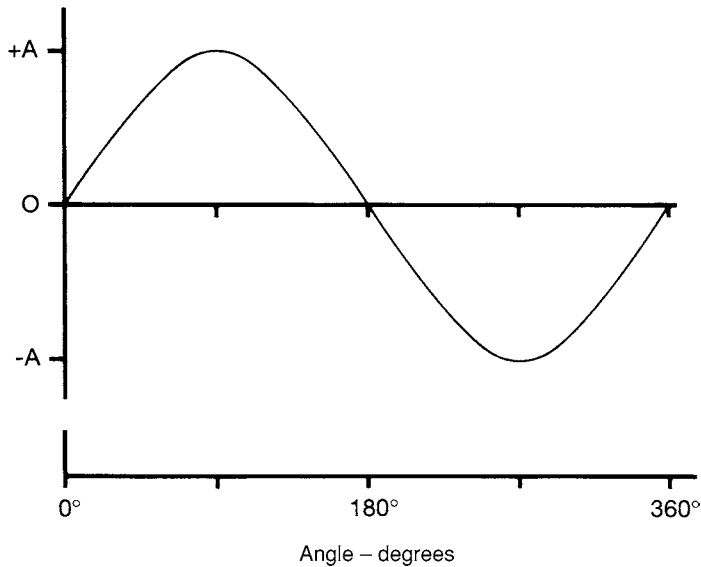

Figure 1.1 *Sine wave illustration*

The instantaneous amplitude (amplitude at a specified point in time) can be read from such a diagram and will be found to follow a sine curve, i.e. it is equal to the maximum amplitude (A) multiplied by the sine of the corresponding angle.

Hence at 0° and 180° the instantaneous amplitude is zero. Similarly at 90° and 270° the instantaneous amplitude is at the maximum A but since the sine of 270° is negative the polarity and hence the direction of current flow has reversed. This diagram is basically applicable to any simple AC waveform. One of the factors which distinguishes such waveforms is the time duration of one complete cycle (T) in Figure 1.2 and another the frequency (f).

Frequency is simply the number of cycles per unit time and the international convention is 'per second'. The unit is the hertz (Hz) named after the German physicist, one hertz corresponding to one cycle per second. It follows that the time of one cycle in seconds is given by the reciprocal of the frequency in hertz.

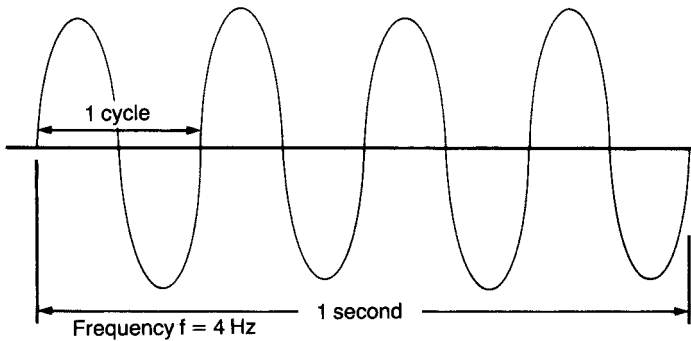

Figure 1.2 Sine wave frequency and time relationship

The AC mains supply frequency (50 or 60 Hz) is referred to as a low frequency whereas the frequencies used for radio transmission are much higher frequencies. The time T for the duration of a cycle at, for example, 50 Hz is $1/50 \text{ s} = 20 \text{ ms}$ (twenty thousandths of a second) whereas the time for higher frequencies is much shorter as shown in the examples below:

$$T \text{ (secs)} = 1/f(\text{Hz})$$

Examples:

- 1 $f = 100 \text{ kHz}$ $T = 10 \mu\text{s}$ (10^{-5} s).
- 2 $f = 1 \text{ MHz}$ $T = 1 \mu\text{s}$ (10^{-6} s).
- 3 $f = 1000 \text{ MHz}$ $T = 1 \text{ ns}$ (10^{-9} s).

For those unfamiliar with these SI prefixes (μ , n, etc.), see Table 1.1 which lists those actually used in everyday work.

Table 1.1 The most commonly used International System (SI) prefixes

Symbol	Name	Factor
k	kilo	10^3
M	mega	10^6
G	giga	10^9
T	tera	10^{12}
m	milli	10^{-3}
μ	micro	10^{-6}
n	nano	10^{-9}
p	pico	10^{-12}

If the existence of two identical waveforms as shown in Figure 1.3, is considered, it is possible for these to be displaced along the time axis so that whilst they are identical in form, the starting points of the cycles may not be identical, i.e. there is a phase difference between the two waveforms.

This may be expressed in angular terms, e.g. 90° phase difference. If two such identical waveforms are exactly in phase and are added, the amplitude of the resultant at any point will be twice that of either waveform alone.

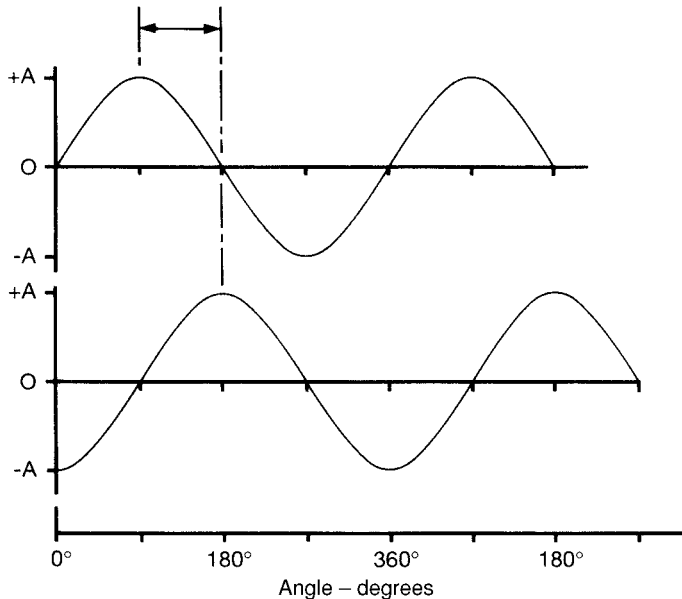

Figure 1.3 *Phase difference between two waveforms*

Conversely, if the two waveforms are 180° out of phase the sum will be zero. This becomes relevant when considering radiation surveys and it is necessary to consider the additive possibilities of radio waves reflected from the ground and from metal masses. Obviously additions increase any potential hazards whereas cancellations are less significant in this context since the safety measurement activity is essentially concerned with the highest levels present.

Readers will also be familiar with the idea that a current flowing in a conductor gives rise to a magnetic field around it. When such a current is varying, it gives rise to a similarly changing electric field. Similarly a changing electric field will give rise to a magnetic field. Unchanging fields of either kind will not result in the production of the other kind of field. With changing fields the magnetic field and electric field are thus inextricably

linked. Hence alternating currents and voltages do, by definition, involve time-varying fields.

It is easy to imagine that from any source of such fields some energy may be unintentionally released (transmitted) into free space, causing interference with receivers or other equipment, without necessarily understanding the phenomenon. This is because such 'interference' has been experienced by most people in their everyday lives. Perhaps the most common example is the motor car ignition system which can also prove to be a rudimentary example of the spark transmitter!

In the case of radio transmitters, however, the whole intention is to transmit RF energy into free space and the antenna used to do so is specifically designed to achieve this objective. If we consider the frequencies discussed above, the very low frequencies, e.g. mains power frequencies, do not give rise to any significant amount of radiation. However, as we increase the frequency then it becomes increasingly possible to radiate electromagnetic waves, given a suitable antenna to act as an efficient 'launcher'.

The electric and magnetic field quantities mentioned above perhaps need a little more elaboration. The electric (E) field at any point is defined as the force acting on a unit positive charge at that point. The magnitude of the electric field is expressed in volt per metre (Vm^{-1}).

The magnetic field at a point is also a force and is defined as the force which would act on an isolated north pole at that point. The classic demonstration of this is that the earth's magnetic field exerts a force on a compass needle, to the great blessing of navigators. The ampere is defined on the basis of the magnetic force exerted when a current flows in a conductor and magnetic field strength is measured in ampere per metre (Am^{-1}).

Being forces, both quantities are vector quantities having magnitude and direction. The normal Ohm's law equations for power when the voltage and current are in phase (plane wave conditions) can be used in an analogous way and with the same phase qualification to calculate power density.

Plane wave conditions involve the concept of 'free space impedance' which is given by the expression:

$$Z_0(\Omega) = \sqrt{(\mu_0/\epsilon_0)}$$

Where μ_0 is the permeability of free space and ϵ_0 is the permittivity of free space

Hence $Z_0 = \sqrt{(4\pi \times 10^{-7}/8.854 \ 19 \times 10^{-12})} = 376.7 \ \Omega$ (taken as being $377 \ \Omega$).

For plane wave conditions, $Z_0 = |E|/|H|$ where E and H are field values in Vm^{-1} and Am^{-1} respectively. Hence, under the same conditions, $S (\text{Wm}^{-2}) = E^2/Z_0 = H^2 \times Z_0$ where S is the power flux density in Wm^{-2} .

In the USA the most common unit used for S is mWcm^{-2} and being the larger unit, is numerically one tenth of the quantity expressed in Wm^{-2} , i.e.

$$1 \text{ mWcm}^{-2} = 10 \text{ Wm}^{-2}$$

Electromagnetic waves propagated in free space have the electric and magnetic fields perpendicular to each other and to the direction of propagation, as represented in Figure 1.4 and are known as transverse electromagnetic waves (TEM waves).

The basic nature of an electromagnetic wave can be physically illustrated by holding two pencils with their unsharpened ends touching and the two pencils being mutually at right angles to each other and held so that one is parallel to the ground and one pointing vertically to represent the planes illustrated in Figure 1.4. If now a third pencil is added, mutually at right angles to the other two, it will indicate the direction of propagation as in the figure. The vertical pencil point represents the electric field (vertically polarised wave) and the second pencil the magnetic field.

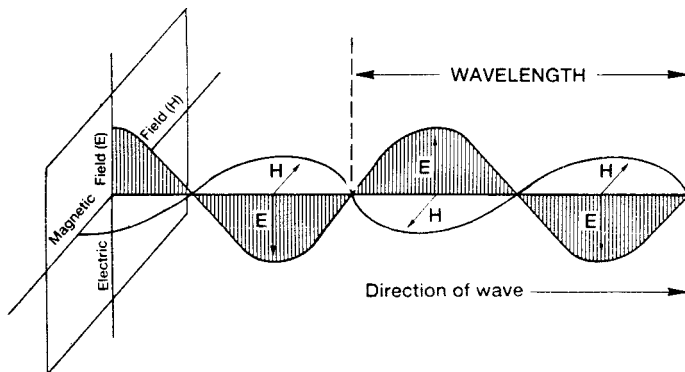

Figure 1.4 *Representation of a plane wave*

The plane of polarisation of a wave is, by convention, that of the electric field, i.e. the polarisation in Figure 1.4 is vertical. This convention has the advantage that for vertical polarisation the antenna will also be vertical (e.g. a simple rod antenna) and this convention is followed in this book. If the diagram is rotated until the electric field is horizontal then the wave polarisation is horizontal. Apart from this 'linear polarisation', other forms such as circular or elliptical polarisation are also used for specific purposes.

There is another approach to RF radiation whereby the concept of particles (photons) is used to describe the radiated signal. However, for the purposes of this work, the wave concept seems to serve the purpose best and is generally so used.

Frequency and wavelength

Two related characteristics of electromagnetic waves are used as a method of referencing the waves. They are the frequency (already discussed above) and the wavelength. The latter is denoted by the symbol lambda (λ). The relationship between these two characteristics involves consideration of the velocity of propagation of radio waves.

The velocity of propagation of all electromagnetic waves (c) is constant in a given homogenous medium and in free space has a value of $2.997\,925 \times 10^8 \text{ ms}^{-1}$ but the approximate figure of 3×10^8 metres per second is used in practical calculations. This figure is also used for air but does not apply to propagation in other media. The relationship between frequency and wavelength is:

$$c = f\lambda$$

where the wavelength (λ) is the physical length of one cycle of the propagated wave, as shown in Figure 1.4.

For electromagnetic waves in free space, where f is in hertz (Hz):

$$\lambda(\text{m}) = 3 \times 10^8 / f$$

Examples:

- 1 $f = 200 \text{ kHz}$ $\lambda = 1500 \text{ metres}$
- 2 $f = 10 \text{ MHz}$ $\lambda = 30 \text{ metres}$

When f is in MHz, the division simplifies to: $\lambda(\text{m}) = 300/f$. This lends itself to easy mental arithmetic! Wavelength is an important parameter in considering antenna systems and propagation since it is a factor in determining the physical dimensions of antennas.

Without going into antenna detail at this stage, some idea of the physical comparison of wavelengths can be obtained from the examples of the length dimension of a $\lambda/4$ (one quarter wavelength) antenna for a few frequencies shown in Table 1.2. Practical antennas will be a little shorter than the theoretical calculations of Table 1.2.

Radio waves can therefore be referred to either by the wavelength or the frequency. Domestic receivers may have the scaling in either unit but generally frequency is used, as it is in professional radio work. Wavelength does need to be used when it is involved in determining the physical dimensions of antennas and other devices.

In this book, the range of frequency considered is roughly from 10 kHz to 300 GHz. Table 1.3 illustrates the names for the various sub-divisions of the radio spectrum. The term 'microwave', mentioned earlier, does not appear in the listing although with the advent of microwave ovens it has become

Table 1.2 *Nominal quarter wave antenna length for a number of frequencies*

<i>Frequency (MHz)</i>	<i>Length – one quarter wavelength (m/cm)</i>
0.1	750 m
1	75 m
10	7.5 m
100	0.75 m (75 cm)
1 000	0.075 m (7.5 cm)
10 000	0.0075 m (0.75 cm)

widely used and misused in the public domain. There is no generally agreed definition but it is often used to apply to frequencies from several hundred MHz upwards.

It should be noted that the term ‘radio frequency’ (RF) is used here across the whole spectrum as a generic term and the term ‘microwaves’ merely refers to a portion of the RF spectrum.

The abbreviated band identifiers in Table 1.3 from VLF to UHF are in frequent use but the abbreviations SHF and EHF are less used, being now increasingly swallowed up in the loose use of the term ‘microwaves’. In addition there is a more specific classification system for bands in the upper UHF onwards.

This is given in Table 1.4 on the basis of the IEEE listings. It has to be said that different versions of these band classifications are in use across the world and in textbooks so that reference to frequency is perhaps the only safe way of avoiding ambiguities. The presentation of the different possible classifications tends to confuse rather than enlighten.

Table 1.3 *Frequency band designations*

<i>Frequency</i>	<i>Band code</i>	<i>Band description</i>
300 Hz–3 kHz	ELF	Extra Low Frequency
3 kHz–30 kHz	VLF	Very Low Frequency
30 kHz–300 kHz	LF	Low Frequency
300 kHz–3 MHz	MF	Medium Frequency
3 MHz–30 MHz	HF	High Frequency
30 MHz–300 MHz	VHF	Very High Frequency
300 MHz–3 GHz	UHF	Ultra High Frequency
3 GHz to 30 GHz	SHF	Super High Frequency
30 GHz to 300 GHz	EHF	Extra High Frequency

Table 1.4 Microwave band letters (IEEE)

Frequency – GHz	Band letter
1–2	L
2–4	S
4–8	C
8–12.5	X
12.5–18	Ku
18–26.5	K
26.5–40	Ka

Conveying intelligence by radio waves

When a wave of a given frequency is radiated continuously, i.e. a continuous series of sine waves, no intelligence is conveyed and the signal is called a ‘carrier’. This mode of transmission is known as continuous wave (CW). Nothing can be heard unless there is a local oscillator to ‘beat’ with the carrier and produce a note at the difference frequency. This is referred to as heterodyning.

If the carrier is switched on and off in accordance with some kind of code, e.g. morse code, then this intelligence can be interpreted. More generally, for broadcasting the intelligence may be speech, music, and television pictures. Other professional work includes voice and data transmission by a variety of methods, radar transmitters transmit RF signals in a series of pulses and so on.

The process of sending intelligence is referred to as the process of modulation and the technical methods of doing so are wide ranging and outside the scope of this book. It is however useful to illustrate the general nature of amplitude modulation which has some significance when carrying out radiation measurements, and also to illustrate the principle of pulse transmission.

Figure 1.5 illustrates the waveform of a carrier and of the same carrier with 50% modulation applied in the form of a simple audio frequency sine wave. It can be seen that the peak instantaneous amplitude of the 50% modulated wave is 1.5 A against A for the carrier. Clearly the total power is greater when the carrier is modulated and hence any field measurements made will need to be related to the modulation state. For amplitude modulation, Figure 1.6 shows the relationship between sine wave amplitude modulation depth versus transmitted RF power and RF current.

Figure 1.7 shows a pulse transmission where the carrier is transmitted for time t_p (the pulse duration) and with a pulse repetition rate of n Hz (pulses per second). It is of course, not possible to show this to scale since there will

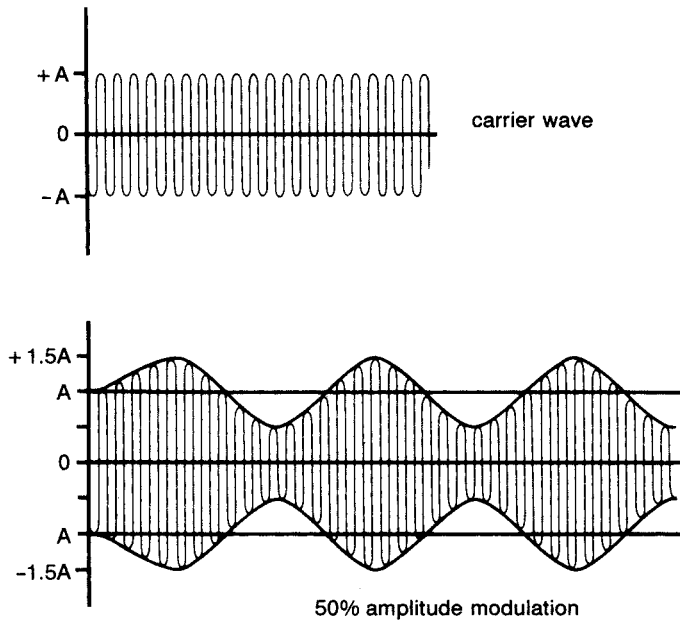

Figure 1.5 RF signal, amplitude modulated by a low frequency signal

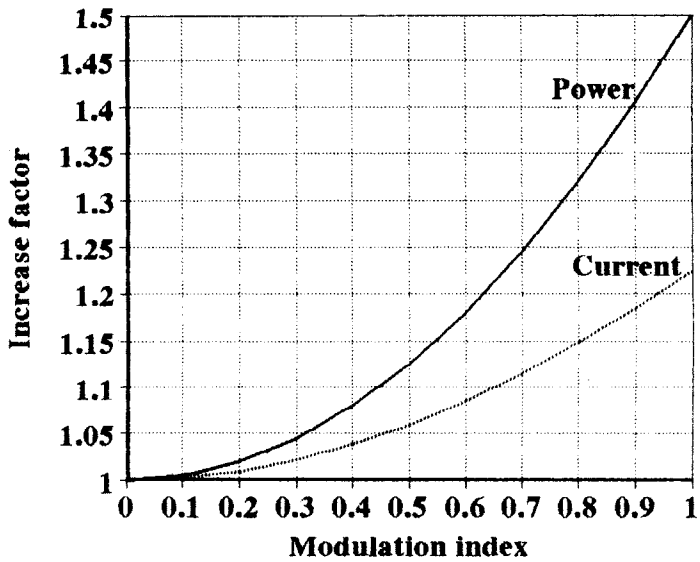

Figure 1.6 Sine wave amplitude modulation depth versus RF power and RF current

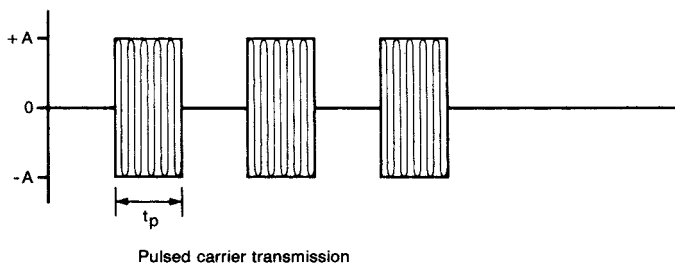

Figure 1.7 *Pulse modulation*

be too many cycles of carrier in each pulse to actually illustrate them. For example a radar working at 1 GHz and with $2\ \mu\text{s}$ pulses will have 2000 cycles of carrier in each pulse.

There are many other methods of modulation and transmission which can be applied to radio equipment and which cannot be covered here but which need to be known to those doing safety surveys.

Much power is wasted in amplitude modulation and various other forms which reduce the waste are widely in use such as single sideband (the two sidebands in AM contain identical intelligence) with a reduced carrier power, double sideband where the two sidebands carry different intelligence and again the carrier is reduced, etc.

Some of these are mentioned later in this book where they have some significance. In particular the recent development of digital radio and television will become widespread over the next few years.

Ionising and non-ionising radiations

Confusion between these two forms of radiation amongst the public has been mentioned earlier. There is also a surprising amount of misunderstanding amongst electronics and radio engineers about the distinction between these two forms of radiation even amongst newly qualified graduate engineers, so that RF radiation is sometimes considered to be the same as ionising radiation.

Ionising radiation, by definition, is radiation capable of ejecting electrons from atoms and molecules with the resultant production of harmful free radicals. There is a minimum quantum energy below which this disruption cannot take place. Since the human body is largely water, the water molecule is used to define this minimum level.

Different reference sources give varying figures for this between 12 eV and 35 eV. The actual value does not matter for the purposes of this comparison. 12 eV corresponds to a wavelength of 1.03×10^{-7} metres (103 nm) which can be seen from Figure 1.8 lies just above the ultraviolet (UVC) spectrum. The

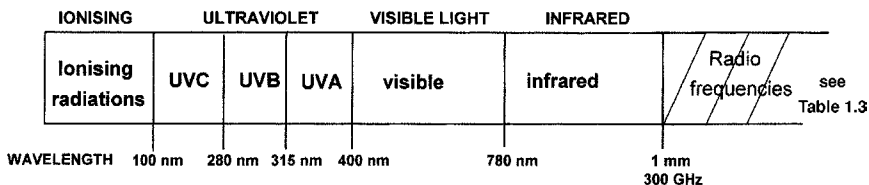

Figure 1.8 *Radiation wavelengths relative to 300 GHz (WHO)*

highest RF frequency used in standards for RF safety is 300 GHz which corresponds to a wavelength of 10^{-3} metres and lies in the EHF band of the radio frequency spectrum. If the calculation is done the other way round, 300 GHz corresponds to an energy of 0.00125 eV (see Appendix 1) which, from the foregoing, is too small by about four orders to cause ionisation.

However, in radio transmitters using very high supply voltages, ionising radiation in the form of X-rays are produced and for this reason the subject is covered in some detail in Chapter 8. It should be clear that this ionising radiation is not inherent in the RF energy but rather that both forms of radiation can co-exist inside equipment and the RF engineer or technician needs to be aware of the hazards involved. It is also the case that ionising radiation is, in most countries, subject to definitive legal provisions due to its hazardous nature.

Explanation of terms used

In this section those terms and units which are most frequently used in dealing with RF radiation are explained. The more formal definitions may be found in reference books. Other more specialised terms are introduced in the text as appropriate. Abbreviations are given in Appendix 2. Common units and conversions are given in Appendix 1.

1 Transverse electromagnetic mode wave (TEM)

An electromagnetic wave in which the electric and magnetic fields are both perpendicular to each other and to the direction of propagation (see Figure 1.4).

2 Power

The rate of doing work in joules per second. The unit is the watt (W) which corresponds to 1 Js^{-1} . Sources of RF energy are rated in watts. Both the kilowatt (kW) and the megawatt (MW) are common in radio work, the latter typically for very high power equipment such as radar equipment.

3 Mean power

The r.m.s. power supplied or generated averaged over a period of time which is long compared with the longest period of any modulation component.

4 Power flux density (power density)

Power flow per unit area through a surface normal to the direction of that flow, usually expressed in watt per square metre (Wm^{-2}). However it is also often quoted in mWcm^{-2} . The use of hybrids such as Wcm^{-2} are best avoided except where really necessary, since they can cause confusion. In this book the shorter form in common use 'power density' is used hereafter because of the frequent occurrence in text. All references to power density, electric field and magnetic field are to r.m.s. values, unless otherwise stated, in common with the practice in RF safety standards.

5 Energy density

This is, strictly, related to volume (Jm^{-3}) but is almost universally used in radiation protection work as the product of power density and time and expressed either in units of watt-hour per square metre (Whm^{-2}) or joule per square metre (Jm^{-2}). $1 \text{ J} = 1 \text{ Ws}$. It is sometimes used to express a total energy limit, for example, 'not more than 5 Whm^{-2} in a six minute period'.

In terms of the energy in a volume, e.g. Jcm^{-3} , the definition relates to the energy in a minute volume divided by that volume. With a power density of 10 Wm^{-2} the energy in a cubic centimetre of air is 0.033 picojoules.

6 Electric field strength (E) at a point

A vector quantity defined as the force acting on a unit positive charge at that point. It is expressed in volt per metre.

7 Magnetic field strength (H) at a point

A vector quantity defined as the force acting on an isolated north pole at that point. It is expressed in ampere per metre.

8 Specific absorption rate (SAR)

The rate of absorption of RF energy in a substance, normally human tissue, expressed in watt per unit mass, e.g. watt per kilogram. If the substance is not human tissue, it should be specified. Note that a SAR limit may be expressed in this standard form but be limited to a maximum mass of tissue e.g. 10 Wkg^{-1} (10 g) should be interpreted as an SAR of 10 Wkg^{-1} in any 10 gram of tissue.

9 Frequency

The number of cycles of an alternating current per unit time where the international period is one second. The unit is the hertz. 1 Hz = 1 cycle per second.

10 Pulse repetition frequency (p.r.f.)

In a system which uses recurrent pulses, the number of pulses occurring per unit time. The unit is the hertz (Hz).

11 Peak pulse power density

In pulsed systems such as radar equipment the term ‘peak pulse power’ is used when what is actually meant is the r.m.s. power in the pulse (see Figure 1.7). This should not be confused with instantaneous peak power.

12 Pulse duty factor (DF)

Where t_p is the pulse duration in seconds and n is the pulse repetition rate in Hz, then the duty factor $DF = t_p n$ and has a value less than 1.

For example, if $t_p = 2 \mu\text{s}$ and $n = 500 \text{ Hz}$, then:

$$DF = 500 \times 2 \times 10^{-6} = 0.001$$

Many people find it easier to work with the reciprocal, in this case $1/0.001 = 1000$.

The relationship between peak pulse power density (S_{pk}) and the mean power density (S_{mean}) in a pulsed system is:

$$S_{pk} = S_{mean}/DF$$

or, if using the reciprocal of DF:

$$S_{mean} \times 1/DF = S_{pk}$$

Note that although pulse transmission often seems to be uniquely linked to ‘radar’, pulse transmission is widely used and radar is just one application. Note also the high values of S_{pk} which are possible, depending on the duty factor.

13 Antenna (aerial)

The generally used term for any type of device intended to radiate or receive RF energy. These range from simple wires and rods to arrays (of which the

television antenna is an example) to large microwave parabolic, elliptical and rectangular aperture systems.

Some antennas are dedicated to reception or transmission whilst others do both. To most people the terms antenna and aerial are synonymous. The English plural is normally used for antenna.

14 Antenna, isotropic

A hypothetical, idealised, antenna which radiates (or receives) equally in all directions. The isotropic antenna is not realisable but is a valuable concept for comparison purposes.

15 Directive gain of an antenna

The ratio of the field strength at a point in the direction of maximum radiation to that which would be obtained at the same point from an isotropic antenna, both antennas radiating the same total power.

16 Antenna beamwidth

The angular width of the major lobe of the antenna radiation pattern in a specified plane. The usual criterion for beamwidth is to measure between points either side of the beam axis where the power density has fallen to half (3 dB down) of that on the axis. This is usually referred to as the '3 dB beamwidth'.

17 Equivalent radiated power (ERP)

The product of the power into the antenna and the gain referred to a dipole. It is often used to specify the power of UHF/VHF broadcast transmitters.

18 Equivalent isotropic radiated power (EIRP)

The product of the power into the antenna and the gain referred to an isotropic antenna.

19 RF machines and RF plant

RF energy is now increasingly used to undertake manufacturing operations which use heating and these terms are used here to refer to machines generally. In practice they have functional names, e.g. plastic bag sealer, plastic welder, etc. Their significance is that they use an RF generator which, in terms of safety, needs the same consideration as any other RF generator.

Use of the decibel

Whilst most people trained in electrical and electronic engineering will have covered this topic, experience in running RF radiation safety courses shows that whilst many people work regularly with decibels, a surprising number never have occasion to do so and it is often necessary to do a refresher session in this topic.

The bel and the decibel (one tenth of a bel) were originally used to compare sound intensities and are currently used in safety legislation to limit the exposure of people to intense sounds in the workplace. Some safety officers will be familiar with this method of noise control.

In radio work, the decibel is used to compare powers, voltages and currents. The decibel is a dimensionless number representing a ratio based on common logarithms. However, usage is such that the ratio is often referenced to a value of a quantity so that it can be converted to a specific value of that quantity. This is a practice of convenience which has developed, so it is best to start with the basic role of the decibel as a dimensionless number. The bel itself is not normally used in radio work.

Decibels and power

If we wish to compare two powers, P_1 and P_2 , then we can do so by dividing one by the other. The resulting ratio is P_1/P_2 and is a pure number. To express this in decibels the form is:

$$\text{Ratio (dB)} = 10 \log(P_1/P_2)$$

If $P_1 = 1600 \text{ W}$ and $P_2 = 2 \text{ W}$ then the simple ratio is:

$$800$$

The ratio in decibels is $10 \log 800 = 29.03 \text{ dB}$.

Since the decibel is based on logarithms, a number of simplifications follow. The basic rules for ratios which are pure numbers are therefore:

- 1 Multiplying numbers merely requires the addition of the decibel values.
- 2 Dividing numbers requires the subtraction of one decibel value from the other.

The basis of the first part of Chapter 5 is to use dB ratios so that only simple addition and subtraction is needed. As powers can be in kilowatts or megawatts, it can be seen that the arithmetic involved is much simpler, especially as gains can also involve inconveniently large numbers, e.g. $69 \text{ dB gain} = 7\,943\,282$.

To convert decibel values back to plain ratios we reverse the process:

For 29.03 dB in the earlier example, the ratio is given by:

$$\text{antilog}(29.03/10) = 10^{2.903} = 800 \text{ as in the first calculation}$$

Decibels and voltage

Since power can be expressed as V^2/R , then the ratio of two such expressions where, V_1 and V_2 are the two voltages and R_1 and R_2 the corresponding resistances, is:

$$(V_1^2 R_2)/V_2^2 R_1$$

If $R_1 = R_2$, then the ratio is now:

$$(V_1)^2/(V_2)^2$$

$$\text{and dB} = 10 \log (V_1)^2/(V_2)^2$$

$$= 20 \log V_1/V_2$$

Hence for voltage ratios, the formula for conversion is:

$$\text{Voltage ratio (dB)} = 20 \log \text{voltage ratio}$$

Referencing ratios

So far we have considered dimensionless quantities where the rules for handling the resultant dB values are those related to the use of logarithms generally. It is possible to reference ratios to any quantity, a common one

Table 1.5 Table of power (watts) versus decibel value relative to 1 watt

Watts	dBW
1000	+30
100	+20
10	+10
1	0
0.1	-10
0.01	-20
0.001	-30

being the milliwatt. The usual reference to this is dBm rather than the expected dBmW. In Chapter 5 some calculations are referenced to 1 watt per square metre (dBWm⁻²). Table 1.5 shows some decibel values referenced to 1 watt (dBW) for powers greater and smaller than the reference value. This is a very convenient way of handling power in calculations.

To convert back to watts power, the process is as before except that the ratio obtained is multiplied by the reference value:

$$1000 \text{ W} = 30 \text{ dBW}$$

To reverse this:

$$\begin{aligned} \text{Power (W)} &= \text{antilog } (30/10) \times \text{reference value } 1 \text{ W} \\ &= 1000 \times 1 \text{ (watts)} \end{aligned}$$

When the reference value is unity, in this case 1 watt, the last multiplication is academic.

2

Sources of radio frequency radiation

This chapter is intended to give an idea of the nature and extent of the use of RF radiation. Some illustrations of representative equipment are included in order to indicate the relative sizes and deployments of the various systems currently available.

Introduction

RF equipment is now extremely widely used in applications which would not have been conceived twenty or thirty years ago. Apart from the enormous diversity of equipment available in the established fields of communications, broadcasting, radar, navigation, production processing and medical therapy, there is an increasing use in applications such as anti-theft systems in shops, vehicle location, motorway control, telemetry to operate control systems remotely and many other novel applications. Uses are continually extending, as evidenced by the use of mobile telephones. In the amateur radio field also modern equipments are smaller and more compact, facilitating mobile use in motor vehicles.

Broadcasting

MF and HF broadcasting

Broadcast transmitters in the MF and HF bands use considerable power, 250 kW to 750 kW being common.

An article by Wood discussing international broadcasting in the Arab world[1] showed transmitter sales to this area in terms of system power and

listed nine long wave (LF) and medium wave (MF) stations with powers exceeding 1 MW, most of them being rated at 2 MW. In the HF broadcast field one station was shown as having 16×500 kW transmitters. The potential safety hazards associated with the feeders and antenna systems can be imagined. MF transmitters are usually used for national broadcasting to give wide coverage whilst HF equipment is used for long distance broadcasting, for example, as used by the BBC Overseas Service and the Voice of America broadcasting service.

By their nature and size, high power HF broadcast transmitters provide a good example of equipment which requires quite a lot of survey time because of the need to measure RF and X-ray radiation safety on a number of different frequencies. Figure 2.1 shows a 750 kW carrier rating Marconi HF broadcasting transmitter. The floor area 'footprint' is 84 m^2 so the total panel area to be surveyed, if all sides are accessible, is large. The frequency range is 3.9 to 26.1 MHz and the types of transmission include amplitude double sideband modulation and single sideband with reduced carrier. The Marconi company has now ceased to be in the broadcast transmitter business but no doubt those equipments in service will continue for many years.



Figure 2.1 *HF Broadcast transmitter (Courtesy Marconi Electronic Systems)*

Figure 2.2 shows a Telefunken transmitter in the same broadcasting field. It is rated at 500 kW. Both of these transmitters typify the large size of high power broadcast transmitters and the amount of work needed for leakage checking. In a typical broadcasting station with many transmitters, antenna exchanges will be used as well as high power dummy loads for transmitter testing, thus making the installations quite large and complex. Figure 2.3 shows the 1 MW dummy load used in connection with the Telefunken transmitter in Figure 2.2.



Figure 2.2 *Telefunken transmitter (Courtesy Telefunken Sendertechnik GmbH)*

Figure 2.4 illustrates the 50 kW MF transmitters used on the BBC Radio 5 channel. There are three Marconi 6054 transmitters on 909 kHz and at the distant end of the picture, a Nautel XL60 60 kW ‘solid state’ MF transmitter. Again it can be seen that large transmitters take up considerable space and can constitute a large survey task.

Antenna systems used for MF may be wire systems or towers fed directly so that they become the radiators. For HF broadcasting wire curtain arrays, rhombic and other types may be used. These involve a lot of masts and towers to support the arrays and hence a very large amount of land. The feeders are often $300\ \Omega$ open wire types or $50/75\ \Omega$ coaxial types. Since more than one frequency may be used over a twenty-four-hour period, additional antenna systems are required. Unused antenna systems can become ‘live’ due to parasitic energisation from working antennas.

Travelling wave antennas such as the rhombic type need resistive termination loads at the end and these could be a source of risk to those unfamiliar with them since, in the simplest single rhombic antenna, 50% of the antenna input power is dissipated in the load. The author’s experience with these in the Royal Air Force in the Middle East (long ago) was that loads built into attractive oak cases vanished overnight, leaving bare wires!

Large antenna sites make the job of ensuring the safety of riggers and maintenance personnel difficult and need to involve operation to a strict code of working practice. It is difficult to show a meaningful picture of a large HF antenna site since the antenna wires can hardly be seen. Figure 2.5 illustrates some HF wire antenna types as line drawings.



Figure 2.3 *Telefunken dummy load (Courtesy Telefunken Sendertechnik GmbH)*

Diagram 1 shows a vertical antenna supported by, but insulated from, the cross wire. It usually has a radial earth system using copper wires and is coaxially fed. The quarter wire and the ground image effectively provide a vertical dipole. Diagram 2 shows a horizontal dipole which can be fed by coaxial cable at the centre.

Diagram 3 shows a single rhombic which, as noted earlier, is a travelling wave antenna and needs to be terminated by a matching resistor and results in a loss of 50% of the input power. However, if another rhombic is used as the termination and the second rhombic terminated the power loss will only be 25%. Triple rhombics are quite common, giving a further reduction in power loss but demanding a lot of space and support poles.



Figure 2.4 High power Medium Wave transmitters at Brookmans Park transmitting station (Courtesy Crown Castle International)

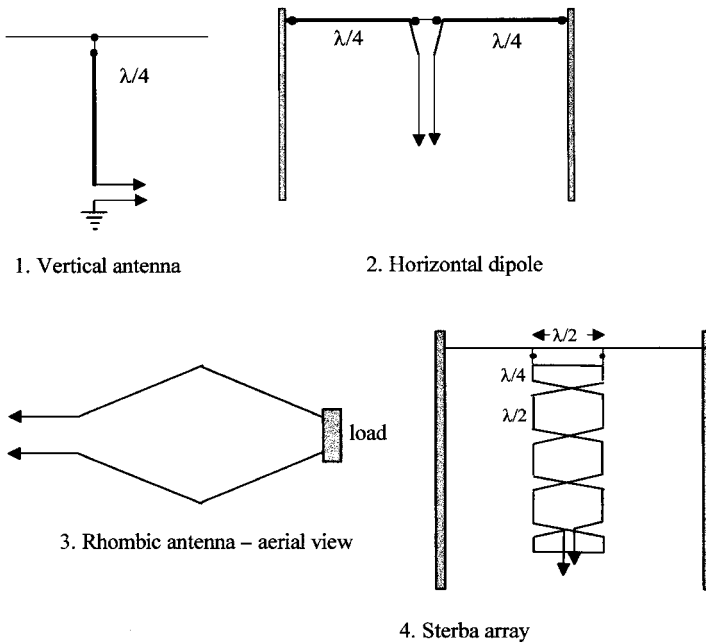

Figure 2.5 Simple HF antennas

Diagram 4 shows a Sterba array where the wire is folded in such a way that the opposite phase elements cancel each other. This type of array is usually fed by open wire feeders and stub-matched. Quite complex arrays can be used with reflector arrays incorporated depending on the performance required. One important aspect of all these antennas is the existence of live wires spread over significant areas so that in addition to radiation there is the hazard of direct contact or indirect effects due to parasitic energisation of 'unused' antennas.

Some smaller individual antenna systems such as the log aperiodic antennas which cover a wide bandwidth, may be of interest. Both vertical and horizontal types are available and are often used as a fixed antenna. Typical frequency range is 2 to 30 MHz. Figure 2.6 illustrates a horizontal log aperiodic antenna mounted on a tower. This type of arrangement can be arranged to be rotatable.



Figure 2.6 *Horizontal log aperiodic (Courtesy Jaybeam Ltd)*

UHF and VHF broadcasting

Television and VHF radio broadcasting is now taken for granted in most of the world. The number of broadcasting stations has increased considerably over the last thirty years and the need for full coverage with television and VHF radio has resulted in many lower power repeater transmitters being used to bring the services to local communities.

Figure 2.7 illustrates an analogue television transmitter installation used by National Telecommunications Ltd. (NTL) for the UK ITV channels. This type of transmitter is rated at 35 kW mean power output. Progress in this field is now rapidly leading to digital television (and radio) services.



Figure 2.7 TV transmitters – analogue (Courtesy NTL and Marconi Electronic Systems)

Figure 2.8 shows a digital television transmitter suite in use with the same organisation. The transmitters used are rated at 3 kW mean power.

High power antennas for television broadcasting are usually situated on towers. The frequencies used range from 470 MHz to 850 MHz. The antennas generally use arrays of panels, typically using a row of full wavelength slots fed by transmission lines against a conducting back shield.

Either the complete antenna is enclosed in a weatherproof cylinder or the individual panels have their own ‘radome’ coverings. Figure 2.9 illustrates the general appearance in diagrammatic form. The antenna systems are normally powered in two halves (upper and lower) which improves service reliability and allows maintenance on one half whilst the other half is run on



Figure 2.8 *TV transmitters – digital (Courtesy NTL)*

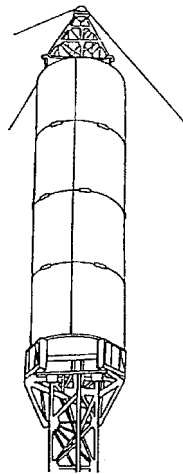

Figure 2.9 *UHF antennas typical broadcasting type with weather coverings*

reduced power or shut down. Where the individual tiers of the two halves are interleaved, as is sometimes the case, this does not apply. The equivalent radiated power (ERP) ranges from 1 MW downwards. Local television repeater stations can have very low ERPs.

High power VHF services usually use tiers of panels such as or equivalent to that shown diagrammatically in Figure 2.10, and physically arranged as for the UHF antennas. As with the UHF systems the VHF systems are often operated in two halves. Although interleaving is not used with VHF, the

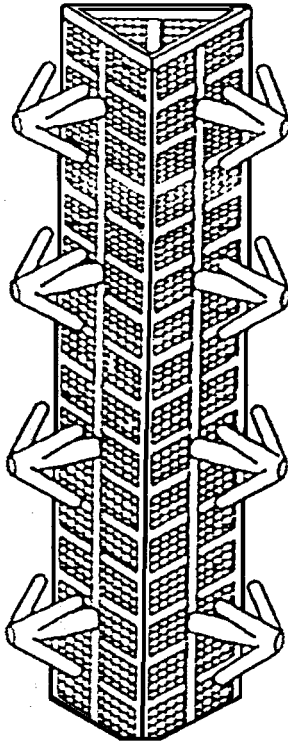

Figure 2.10 VHF antennas – typical broadcasting type

unpowered half of such an antenna may be driven parasitically causing hazardous areas near the apparently unused antenna. High power VHF antennas are often mounted on the same tower as the television UHF antennas and more than one organisation may share masts. Hence maintenance may involve climbing past one array to service a higher array.

A practical example of a section of the VHF and TV mast in the Isle of Wight (UK) is shown in Figure 2.11. This shows the covered UHF antennas with the VHF antennas in the form of dipoles just showing at the bottom of



Figure 2.11 *BBC mast Isle of Wight (Courtesy Crown Castle International)*

the picture. The close-up view highlights the problems of accessing parts of the installation. The height of the complete tower is 280 m a.o.d. It can be seen that a great deal of care is needed to ensure the safety of technicians in maintenance operations where some antennas may still be powered.

From the point of view of the public, in the United Kingdom and in other countries, the towers used to carry high power antennas are generally very high ones and located away from structures where people might become exposed.

In the UK the highest one appears to be 718m a.o.d. Radiation is generally omnidirectional and the antenna array is so arranged as to direct the far field radiation at or just below the horizon. For this reason hazards will generally be related to the tower structure around the antenna and people at ground level should not experience any significant value of power density. In places where high power UHF and VHF broadcasting antenna systems are located on buildings in residential areas, the problems may be more evident than where they are located away from buildings.

Communications

There is an infinite variety of communications equipment ranging from the familiar hand-held mobile two-way radio, which can use HF, VHF or UHF, through MF and HF systems for ground, air and ship communications to microwave systems for terrestrial and satellite communications. In the more domestic environment citizens band and amateur radio transmitters are used, as are radio telephones. There is a wide variety of antenna systems used in communications and as some of these are dealt with in other chapters, they are not covered here.

Tropospheric scatter systems

One useful example of a microwave system is the tactical tropospheric scatter system illustrated in Figure 2.12. As with many types of equipment, such a system has both civil and military applications. Tropospheric systems for land communications are trans-horizon microwave communication systems.

Long hop distances (up to several hundred kilometres) are obtained by deflecting high power microwave signals off the tropospheric layer of the atmosphere to overcome the earth's curvature between widely separated sites. Systems may have antennas varying in size from 3 metres to 27 metres, the very large antennas being used in fixed systems. The latter are often used to communicate between oil rigs and land.

The tactical system illustrated here is mobile. It comprises two antennas of 6.2 metres diameter, an equipment shelter containing all the electronic equipment and a container with dual diesel generators and fuel tank.

Figure 2.13 shows one of the two transmitters which form part of the shelter installation. The power from the klystron power amplifiers is adjustable from 5 W to 1 kW. The frequency band is 4.4 to 5 GHz on this equipment. The system is a digital one with 60 encrypted telephone channels available.



Figure 2.12 *Tactical tropospheric scatter (Courtesy Marconi Electronic Systems)*

In order to improve the path reliability, various combinations of quadruple (four path) diversity operation are available. ‘Diversity’ operation here involves the simultaneous use of different frequencies, antenna spatial positions or polarisations to receive on four independent paths, combining the outputs to minimise fading effects on reception. There is an alternative antenna option which uses only a single antenna with a dual angle feed horn giving angle/frequency four path diversity.

With 1 kW fed to the antennas, which are relatively near the ground, safety surveys are clearly important. The general approach is to have a prohibited zone in front of the antennas. There is an obvious difference between the large fixed tropospheric scatter antennas and the mobile types. The fixed type have their location and azimuth orientation fixed and safety checks will mainly be concerned with aspects applicable to fixed installations. Portable tactical systems may need to change their location and/or the azimuth orientation at any time and safety clearance must take into account the full authorised range of operation. There is an intermediate case where some ‘fixed’ systems have their antennas on a remotely controlled rotary mount, i.e. a fixed location but with a variable



Figure 2.13 Tactical tropospheric scatter transmitter (Courtesy Marconi Electronic Systems)

azimuth orientation within some defined range. In this case it needs to be treated as being liable to operate at any azimuth orientation within the authorised range.

Air traffic control (ATC) communications

Air traffic control communications systems involve highly organised networks of VHF and UHF transmitters and receivers to communicate with aircraft in the ATC control zone. Usually several transmitters are operated simultaneously to secure adequate zone coverage. Figure 2.14 shows a typical tower installation of UHF and VHF antennas on towers. The typical transmitter power output is about 50 watts.

The antennas are spaced away from the tower with horizontal booms which also reduce the exposure to those doing work on the tower. The tower aspect is discussed in Chapter 10. Note that many ATC sites also include radar systems which may irradiate parts of the towers and which may need to be taken into account.



Figure 2.14 *ATC UHF and VHF antenna installation (Courtesy NATS)*

Satellite communication systems

Satellite communication systems use microwave beams to communicate with satellites. The diameter of the dish antennas can vary from a few metres to tens of metres and may have very high gains. The narrow beams are used at suitable elevations for the appropriate satellite and give rise to very little radiation exposure at ground level away from the antenna.

Figure 2.15 shows a typical satellite ground station in use for ground–satellite communications. The antenna azimuth and elevation settings vary according to the satellite in use. Sometimes problems arise with building workers doing work in the vicinity above ground because of the fact that the antenna may seem to be pointing at them. In fact, the setting of antennas has to avoid nearby buildings due to the attenuation introduced if the beam is intercepted by buildings (‘beam blocking’). There are also strict international rules about the pointing of such antennas to avoid interfering with other satellites.

Many dish antennas used with satellites will be ‘receive only’ as in Figure 2.16 where a dish mounted close to the ground is used by Carlton TV for receiving satellite signals. It will avoid unnecessary concerns in such cases, when people may walk close to the antenna, if it is made clear that it does not radiate.



Figure 2.15 *Satellite ground station (Courtesy Cable and Wireless)*

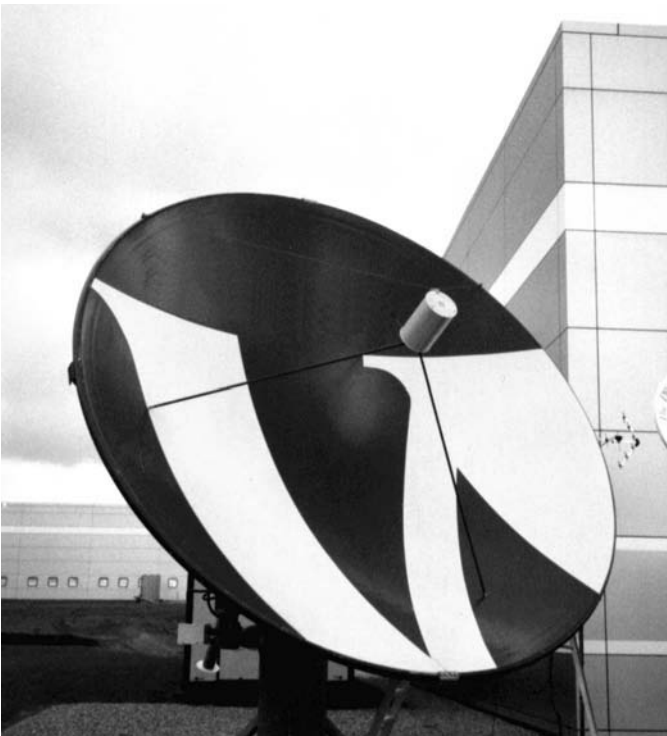

Figure 2.16 *Broadcast station satellite dish (Courtesy Carlton TV)*

Radar systems

There are many varieties of radar equipment in use around the world. Most involve movement of the antenna system, i.e. rotation or movement in azimuth, movement in elevation, etc. Leaving aside HF radar, radar systems are generally characterised by using microwave beams which are usually relatively narrow in azimuth but the characteristic in the elevation plane depends on the nature and function of the radar.

The applications include:

- 1 Defence
- 2 Air traffic control
- 3 Meteorology and the study of weather changes
- 4 Mapping the earth
- 5 Specialised applications ranging from radars for measuring the state of the sea and sea wave motion, to hand held police radar speed meters for checking motor vehicle speeds.

They may be ground based (fixed or mobile), ship borne or airborne (aircraft and satellites).

Ground-based surveillance radar systems may be deployed 'naked' or housed in weatherproof radomes (non-metallic domes transparent to radar) which can protect both the equipment and the personnel from exposure to severe weather. Figure 2.17 illustrates a typical radome used for radars on civil aviation radar sites and Figure 2.18 shows the inside of a radome with the large surveillance long range antenna on the left and the feed horn at the right. Rotation rates vary but 6 rpm is typical.

In many cases radars with or without radomes, are mounted on high towers and the height keeps the beam away from personnel below. However, this same factor makes beam surveys more difficult due to the height! Sometimes rising ground nearby makes it possible to obtain some access to the beam for survey purposes. If the higher ground is outside the premises of the radar site and if the public have access to this land, this factor needs particular consideration during a survey.

A more well-known type of surveillance radar is the approach control system for airfield control illustrated in Figure 2.19. This is a radar with a mean power of 550 W and a peak power of 650 kW. The frequency coverage is 2.7 to 2.9 GHz.

It uses a high efficiency two beam antenna system and transmitters in dual diversity. More usually these systems are tower or roof mounted but this example gives a clearer picture! Surveillance radars of this type rotate continuously (15 rpm in this case). The rectangular antenna on top of the parabolic antenna is an SSR (secondary surveillance radar) for aircraft identification and height data in normal air traffic control.



Figure 2.17 ATC surveillance radar installation (Courtesy NATS)

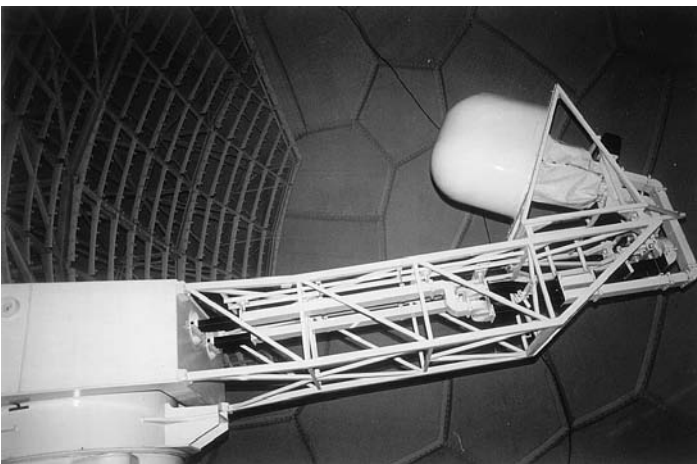

Figure 2.18 Inside ATC radome (Courtesy NATS)

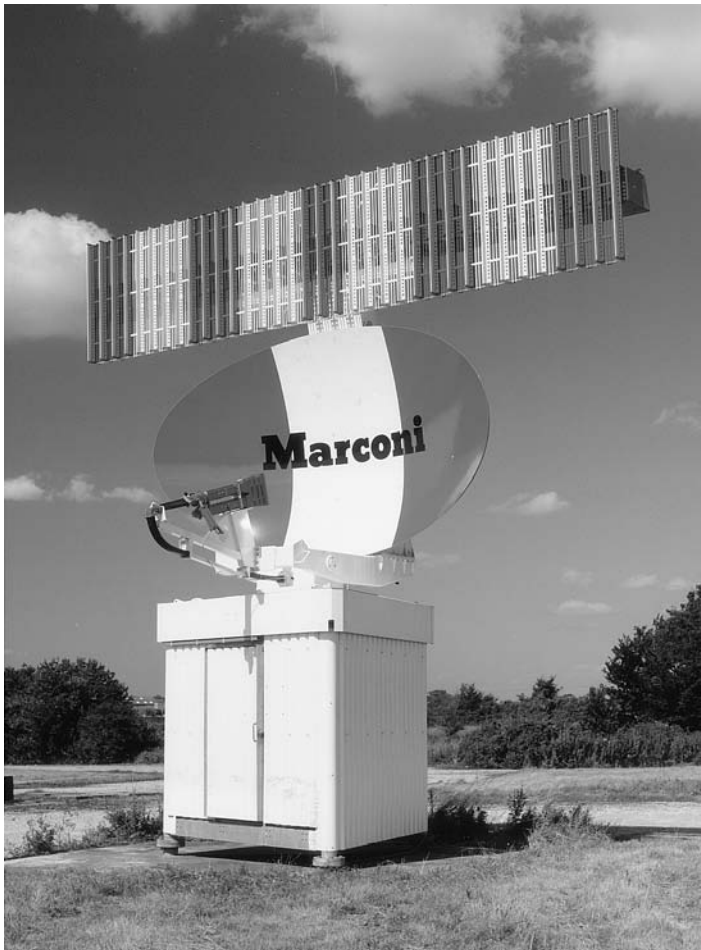

Figure 2.19 Surveillance radar with co-located Messenger SSR (Courtesy Alenia – Marconi)

For military purposes the same system (SSR) is used for target ‘identification friend or foe’ which gave rise to the abbreviation ‘IFF’. This radar uses much less power than the main radar since the aircraft equipment transmits a response instead of the normal radar dependence on reflections.

In contrast, Figure 2.20 illustrates a modern mobile radar of the planar array type. The mean power is 3.6 kW and the effective peak power 53.5 kW and operates on 23 cm wavelength (nominally 1300 GHz). The antenna rotates on the trailer mount, the speed being 6 rpm. The receive beams are electronically switched. Since both the azimuth and elevation information is provided by the processing, no separate height finder is necessary.

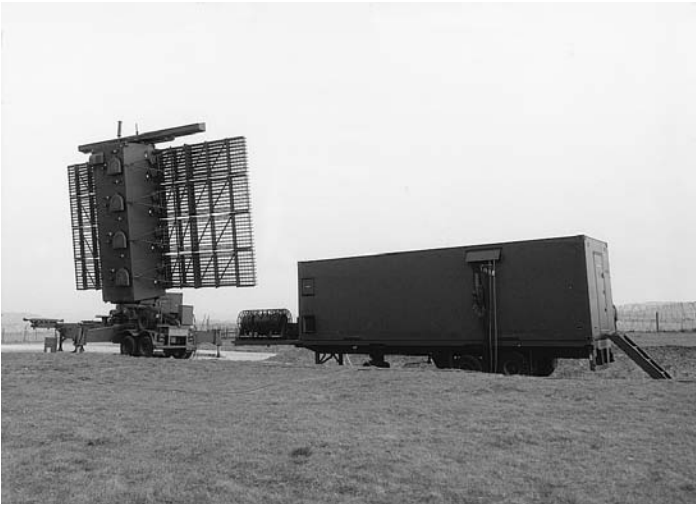

Figure 2.20 *Marconi surveillance radar Martello 743D (Courtesy Alenia – Marconi)*

An SSR antenna can be seen fitted above the main antenna, in this case one which is trough shaped and usually referred to as a ‘hog trough antenna’. From the survey point of view the system is easy to deal with and can be treated as any other conventional surveillance radar. The system is safe to walk around at ground level due to the mount height. The antenna has very low sidelobes such that in most situations they will not be of any consequence. The electronic processing equipment is fitted in cabins which can be located alongside. Some large modern military planar array radars have no mechanical movement, all the functions being done by electronic beam switching.

In naval use, surveillance radars for defence purposes may be fitted to the ship’s mast. The typical radome mounted antenna system for this purpose comprises an air search antenna mounted back to back with a sea and low air search antenna to give a compact medium- to short-range defence cover. The antenna assembly typically rotates at 30 rpm.

A further ship system for the defence field is shown in Figure 2.21 which illustrates the Seawolf radar. This tracks both the target and the missile. It is capable of controlling both guns and missiles. The tracker antenna assembly also carries duplicate command links to transmit missile position and guidance information. Trackers use a very narrow and intense beam, i.e. it has a high power density in the beam and particularly close to the antenna where people could access it.

A common feature of microwave equipments is the use of waveguides to couple RF to antennas. In the case of rotating antennas, rotating joints



Figure 2.21 *Seawolf tracker radar and gunfire control system (Courtesy Alenia – Marconi)*

are usually involved. Waveguide runs need checking for leakage as part of survey work.

Aircraft, both civil and military, carry powerful radar equipments. Problems may arise if such equipment is left running on the ground or if ground tests are not conducted under suitably controlled conditions. Similar problems can arise with aircraft communications, navigational and military jamming equipments where control is needed for ground testing and servicing.

RF machines

The use of RF generators in manufacturing processing is very widespread, covering a large range of materials and processes. Low frequency induction heating has been used for at least 50 years for metal processes.

Many of us in communications, radar and electronics research and development generally may not be very familiar with modern RF

processing machines which are now being used widely in industries which are not classified as part of the electronics industry. There are of course such machines in the electronics industry for bag sealing, packaging and similar applications as well as many specialised equipments in electronics research.

However it is probably true to say that RF machine use is growing much more rapidly in basic processing industries where flow-line operations can be used on large volumes of products. The illustrations which follow show some of these developments.

Processing machines

The invention and world-wide marketing of the microwave oven, domestic and industrial, heralded a widespread use of RF generation in the food processing industry. RF drying systems are now used as standard practice to improve the quality and colour of food products such as biscuits (cookies), bread products, crispbreads, sponge products, cereals and snack foods.

Such equipment facilitates flow-line production with the product being fed to the RF applicator via a conveyor system. Figure 2.22 shows a Strayfield 100 kW 27.12 MHz post-baking unit used on rusk-type products. The product is transported through the equipment on a conveyor system so that the operator does not have to have close access to the RF source.

It will be noted that the size of the installation is comparable with a fairly large radio transmitter. A large production organisation may have a range of such installations processing a variety of products so that the whole concept

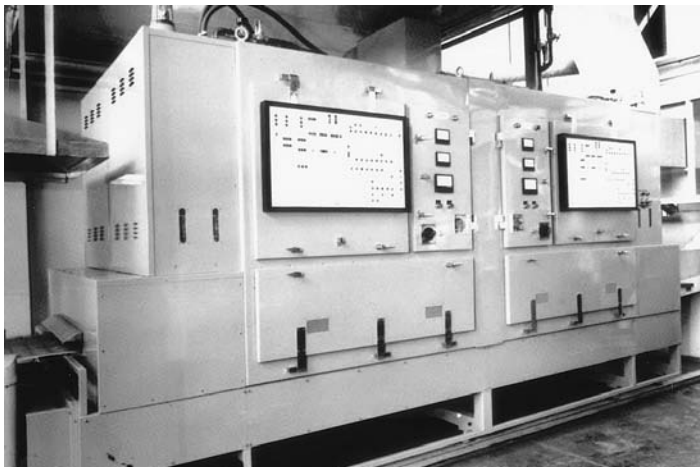

Figure 2.22 Strayfield 100 kW post-baking unit (Courtesy Strayfield International)

of a food production system is changed to one biased towards electronic equipment. Indeed the first quick glance at a photograph of such an organisation gives the impression of a large transmitting station. In the literature of this manufacturer, many well known brands of foodstuffs can be seen emerging from RF machines!

RF drying equipment is also used for drying textile materials, drying materials which have been dyed, the paper processing industry, wood-working, drying lacquer and other coatings and similar applications.

Industrial and domestic microwave ovens generally work on 2450 MHz and are in very wide use for cooking food. With the relatively shallow penetration of RF at this frequency, the cooking of meat joints and similar large objects depends on conduction of heat from the heated outer layers of the meat to the inner layers. Microwave heating has other applications in the medical field for example, the rapid thawing of sachets of frozen blood.

Other applications of RF process machines include plastics processing and welding, vulcanising, induction heating machine sealing of containers, heat sealing of packaging, crystal growing, brazing, soldering, hot forging and many others.

Figure 2.23 illustrates the Petrie 3×30 kW defroster which can defrost and temper 1 tonne of chicken per hour. It has three 30 kW RF generators and is controlled from a menu-driven graphical operator's position. It is part of a range of equipments which includes moisture profiling cigars and cooking French fries (potato chips). The latter uses a 250 kW RF generator!

Manufacturers whose products have been illustrated above indicated that they are well aware of the hazards of RF radiation and the need for adequate shielding on RF machines. There is a UK committee to which many of the RF machine manufacturers belong, the British National Committee on Electroheat (BNCE).



Figure 2.23 *Petrie defroster 3 × 30 kW (Courtesy of Petrie Technologies Ltd)*

Medical therapy equipment

Belief in the beneficial effects of magnetic fields and electrical currents applied to the human body dates back to the late nineteenth century. 'Short wave' (HF) therapy has been used in hospitals and clinics since the early twentieth century. Some of the very early claims were somewhat dubious but serious medical people have devoted their time in trying to explore the benefits and devise effective therapies.

The equipment used was usually a 27 MHz equipment since this frequency gives a significant penetration in the human tissues and this is necessary for those therapies which essentially aim to induce heating in joints. According to a challenging paper by Barker[2] too little work has been done to scientifically test the benefit of RF therapies by recognised 'double blind' test methods.

Nevertheless there are large numbers of RF therapy machines in use in hospitals and a wide variety of new designs in the suppliers' catalogues. The machines used seem to make most use of pulsed RF with various permutations of pulse width and repetition rate available to the physiotherapist.

Work done in the 1970s in the USA seems to have established a high success rate with the use of a pulsed RF field applied by coils to bone fractures, particularly those which were slow to heal.

An 80% success rate on 30 000 patients is recorded by Barker, though he does point out that it has not been scientifically demonstrated that the RF field has added to the incidental immobilisation inherent in the treatment regime.

More recently, microwave frequencies have been used though it does not seem clear what benefits are considered to result. One exception may be the use of microwave equipment to induce localised hyperthermia to destroy malignant tumours (Chapter 3). Whilst writing this chapter, a television programme from a UK Children's hospital showed an operation on a child using an RF probe in the heart. This used RF energy to reduce the thickness of a heart wall. The X-ray view of the probe in action, the subsequent fitting of a pacemaker and the subsequent view of a child restored to happiness was quite impressive and makes it important to recognise the beneficial aspects of such work. Also, RF knives have, of course, been used for many years in surgery but do not generally get any publicity.

From the point of view of safety surveys for all RF energy based equipments, we are concerned with:

- 1 Exposure of the patient – basically a medical matter
- 2 Exposure of the attending physiotherapist, which is a general health and safety matter
- 3 Any exposure of other people nearby.

Whatever the frequency and the equipment used, the safety measures will include careful control of the patient's exposure to the wanted radiation, and

keeping the patient at a reasonable distance from stray radiation from the equipment applicator leads. For the physiotherapist there is a need to minimise exposure since there can sometimes be high field levels near the equipment and its leads.

This is best arranged, wherever possible, by keeping away from the equipment except when setting it. Some equipment includes the provision of a switch for the patient so that if there is discomfort, the patient can switch it off. Third parties ought not to be exposed unless it is medically necessary, so the separation of equipment and people is important.

Figure 2.24 shows a typical modern equipment, the EMS Megapulse Senior, which can supply up to 375 watts at 27.12 MHz. Energy is applied via



Figure 2.24 *EMS Megapulse Senior (Courtesy Electro-medical Systems Int.)*

capacitor electrodes, rigid and flexible. Pulse repetition rate is adjustable and the pulse width can be set between 20 and 400 μ s. Continuous RF as well as pulsed RF can be used. Such equipments have to be tuned with the applicators applied to the patient. Some require manual tuning and others offer automatic tuning. This equipment is of the latter type. EMS have case history material which may be of interest to those working in this field.

General

A reasonable basic knowledge of equipment is needed to carry out surveys since otherwise some safety aspects may be overlooked. The nature of the RF source, in terms of the power rating, types of modulation used, pulse characteristics and duty factor, frequencies used, etc., needs to be known in order to determine the worst case situation for RF radiation. Some modulation techniques may not be familiar to the surveyor and advice may need to be sought.

The HF band is, from the survey point of view, particularly sensitive to frequency since the general characteristic of all RF safety standards is a tightening of safety limits over this band so that the permitted limit at the top of the HF band (highest frequency) is generally much lower than at the bottom end, as can be seen by referring to Chapter 4. This aspect is relevant to transmitters and to many RF process machines. Modern transmitters, particularly military systems, may have frequency hopping facilities (where the transmitted frequency changes periodically for security purposes) and there may be other peculiarities which could have implications for survey work.

There are many other sources of RF power including signal generators for testing work which can offer tens and hundreds of watts output. Often the magnitude of the output of such devices is not appreciated by the user. This is particularly the case where generators are used to power microwave waveguide benches. It is not unusual for people to disconnect live waveguides without bothering to switch off first and the author has had to investigate several such cases where the engineer concerned suddenly realised that he was taking risks.

Some such microwave equipment is used in production processing of some foodstuffs and care may be needed if the personnel concerned are not so technically knowledgeable as those in radio engineering. Indeed with RF processing machines in general, some knowledge of the effect of different processing procedures and the different types of work pieces involved may be needed for machines which process a variety of different products, since the leakage and possible operator exposure may be affected by the type of product.

Cases have been reported where operators feel a sensation of heat in the hands when loading machines and where operators sometimes find that their

footwear gets hot due to the heating of eyelets, rivets and similar parts in boots. There is therefore a good reason to discuss with machine operators any effects which they have noticed. Once the problems are understood, many of the solutions are obvious, e.g. use footwear without metal eyelets.

Shielding around the work piece may, on manually operated machines, conflict with the need for visibility and may require resort to modern transparent shielding materials. However, whilst work has been done on transparent materials for EMC purposes, when high powers are involved, the amount of loading required in the plastic tends to make it opaque.

In summary, there is a need to be aware of all equipment which may generate significant RF power and the nature of the operation of each item. The maintenance of a register of such items will be an essential provision, with some set frequency of monitoring in all appropriate cases.

3

Effects of radio frequency radiation

This chapter deals with those known effects on people that are generally accepted by researchers in the field in a way which, it is hoped, can be understood in general principle without the need for specialist knowledge.

Part 1 covers the known individual aspects of the exposure of human beings to RF radiation and also gives brief coverage of the beneficial medical uses of RF radiation.

Part 2 deals with some accidents and incidents which have occurred to people working with RF radiation with a view to learning about how to deal with such incidents and how to avoid them.

'I often say that when you can measure what you are speaking about, and express it in numbers, you know something about it; but when you cannot measure it, when you cannot express it in numbers, your knowledge is of a meagre and unsatisfactory kind: it may be the beginning of knowledge but you have scarcely, in your thoughts, advanced to the stage of science, whatever the matter may be.'

William Thompson (Lord Kelvin) 1824–1907

Part 1 The exposure of human beings to RF radiation

Introduction

Perhaps the best introduction to this topic is this reminder that real knowledge requires defining and quantifying. Standards and guides need to express safety limits in numbers which can be verified in order to safeguard

people. It is therefore essential that research is based on measurement and the progress in the development of suitable instruments has led to the possibility of measuring RF field quantities more reliably.

Safety management is concerned with safeguarding the well-being of people. The World Health Organisation (WHO) defines health as:

'The state of complete physical, mental and social well-being and not merely the absence of disease or infirmity. Humans respond to many stimuli as part of the normal process of living. A biological effect can lead to a health hazard (unfavourable effect on physical, mental and social well-being) if the change is outside the range of the body's compensation mechanisms.'

This is a fairly challenging definition and would appear to take in unfavourable effects on people due to unfounded fears of radiation as well as fears of risks which are well established.

A great deal has been written over the last thirty years or more about the actual and alleged hazards of RF radiation. The vast majority has been in the form of serious contributions and includes a large number of research papers. Lack of accurate methods of measuring fields obviously affected some of the work of the earliest workers. As technology has improved and field measurements can now be made more accurately, the experimental methods have improved. However not all research is equally well conducted with the effect that the results of some studies are treated with some scepticism. Also some research is released to the media without any form of peer review and may be given more credence than it is worth.

We see this also in the so-called food research which adds and removes the same items from our menus so rapidly that few people take the slightest bit of notice! It also does some harm to the credibility of research work.

The problems of research in the RF radiation field are fairly obvious as very few tests can be carried out on human beings. As a result, most practical work has been done on small animals such as rats, mice, rabbits, bacteria, yeast cells, fruit flies and similar subjects. There is then the problem of the extrapolation of the results to human beings when some fundamental factors, e.g. the physical sizes, and thus the resonant frequencies of the various subjects are so markedly different. Also, where thermal effects are involved, the differences in the thermo-regulatory systems of the test subjects pose a very considerable problem. Hence such extrapolation is likely to be dangerous.

An even greater problem is the fact that the radio frequency spectrum is so very wide (perhaps 10 kHz to 300 GHz) and it is well nigh impossible to extend research to the whole spectrum, to low and high levels of field, different modulation methods and so on. This is further complicated by the suggestion that some effects only occur in RF frequency 'windows' and modulation frequency or pulse rate 'windows'.

The term 'window' here implies that an effect has been claimed to occur at some RF frequencies and not at others or at low field levels and not at higher field levels of the same frequency or that the effect occurs at certain modulation rates and not at others. The variables, RF frequency, RF amplitude, modulation frequency and type, provide an almost infinite number of combinations to be studied. This illustrates the real difficulty in determining which combinations to explore. Any research results obtained from some of these combinations will always be challenged by someone on the basis that the wrong combinations have been investigated!

In more practical terms there is also the cost of equipment capable of generating all the frequencies and modulations at levels large enough for practical work. Hence work will often be done with frequencies determined only by the equipment available.

It is scarcely surprising that from time to time some particular research may be challenged, either because of something related to the experimental situation or because of the conclusions drawn. In general, the replication of research findings elsewhere is looked for but is not easy to achieve when finance is not available to pay for the work.

Some individuals express extreme views on RF radiation hazards, which are often drawn from the research of others, but which differ from those of the researchers concerned and from those of others working in the field of RF radiation. Where such views are genuinely held and the person concerned has a reasonable competence to handle the research concerned, this is no problem. It may even provide some impetus for more research, if the views are not so extreme as to be ignored.

It is an unfortunate fact of life that people are very easily frightened by the media and often do not accept reassurance from those more familiar with the subject. Indeed it has to be said that most people do not accept the pronouncements of governments and of their scientists on the subject of safety because their track records are generally not very convincing!

As a result, much time has to be given by RF safety specialists to explaining to both non-technical and technical people the current views on RF radiation. Reassuring people is not easy nor can it be totally authoritative since, if we are honest, surprisingly little is known with any real certainty on the subject of RF radiation insofar as the athermal effects, if such exist, are concerned. Usually, the most that can be said is that there is no evidence to support a particular viewpoint, to which the inevitable answer is 'you have not looked well enough'!

It appears to the writer that we human beings have an approach to risks and fears which emphasises things which are not directly attributable to ourselves. Hence the carnage on our roads is accepted on the basis that the other driver is responsible, and that apart from building more roads, little can be done. Reducing speed is usually subject to strong objections except where things are speeding through our residential area! RF radiation, for

those not working with it, is something inflicted by others and therefore suspect. When our children are affected then the strength of feeling is much increased since we are all very defensive in this respect.

This is not to say that a healthy suspicion of potentially harmful situations is undesirable since most safety provisions tend to develop from 'people pressure'. On the contrary, people need to try and understand the basis of their fears in practical terms so that they can judge and challenge statements even though they do not have professional knowledge of the subject. This in turn means that that reports intended from the media should be shorn of jargon and scientific terms and explained in a simple language which gives some idea of the relative risk and of the source and accuracy of the data on which it rests. Where research work is quoted, extracts should not be quoted without also indicating the actual conclusions of the authors since it is quite common for people to represent their own views by selective quoting when the conclusions do not suit them! We use the word 'safe' in everyday conversation and in legal provisions and it is worth examining it. In the United Kingdom in the last statistics seen by the writer, accidents in the home contributed 1000 deaths and 250 000 accidents involving referral to hospital in one year. Yet we consider home as a safe place. The most practical use of the concept is 'reasonably safe' since this is the most that we can aim for when part of the risk exists in the actions of the individual, and part in a lack of knowledge. There is a statistical risk in everything we do, whether or not we know the statistics and we can worsen these if we do not take the right precautions.

A senior medical consultant lecturing on RF radiation safety mentioned that even burnt toast is toxic – but it would involve eating about 100 slices at the same time! Our concerns about risks therefore need to be related to the probability of occurrence of some harmful effect.

Nevertheless, human psychology in the risk field seeks perfection and has to be accepted as a fact of life, now coloured on occasions by the chance to sue somebody. The author believes that there is little chance of establishing with any certainty, the more complex of the so called 'athermal risks' associated with RF radiation – if any exist – in any meaningful way, since there are too many confounding factors and equivocal results, too little money to fund really good work, and cogent reasons why the priorities for research expenditure should be towards known life-threatening illnesses. Probably the most that can be done in the long term is to refine permitted limits, where necessary, to provide more prudent assurance.

Whatever the difficulties, standards for RF radiation safety are needed and practical safety limits for everyday work have to be set by some sort of consensus amongst those experienced in the field, having regard to such research as is available. If the limits are just set arbitrarily low, the use of RF power may become a serious practical problem, without offering any assurance that the low limits actually achieve anything.

In this connection, the World Health Organisation (WHO) has in hand a very large collaborative study which may in the long term provide a standard on an international basis together with supporting documents which could assist in promoting a more systematic approach to RF radiation safety management.

Figure 3.1 is a schematic diagram of the planned activities. If this is properly funded and pursued, it will probably be more effective than sporadic under-funded and often opinionated research. If we do not get an international standard we are likely to continue to get different figures from each country as different computer models are used and there are differing

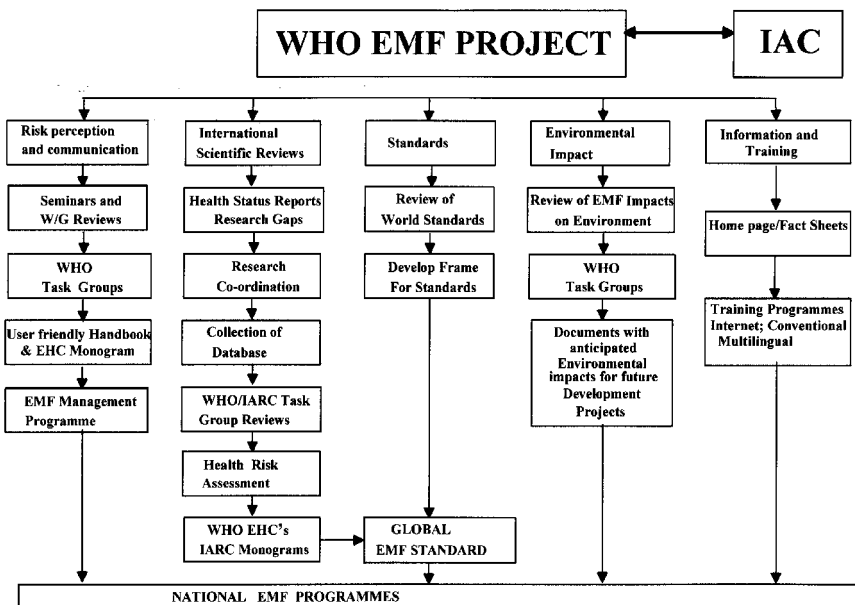

Figure 3.1 WHO RF radiation work programme (Courtesy WHO HQ)

thoughts on the addition of prudent contingencies to the calculated values. We need to get rid of the 'not invented here' approach to standards and accept a bit more give and take in agreeing a consensus approach. Exclusivity does not help in this!

It is not the purpose of this chapter to seek to resolve the differing views of the various factions interested in the debate on electromagnetic fields but rather to provide a broad outline of those known hazards of RF fields which are accepted by bodies concerned with producing safety standards, and to mention some of the areas of current investigation. For those capable of assessing the detailed medical aspects involved there are many papers

available. A useful reference is NRPB-R240[3] and also the text of the various standards mentioned in Chapter 4. In addition the other references in this chapter deal with particular aspects.

Generally speaking this chapter is concerned with RF radiation down to about 10 kHz and does not therefore address the question of power frequencies (50 and 60 Hz). There is a great interest in the safety aspects of the fields from power frequencies and reference should be made to published papers on the subject including WHO publication number 25[12] which deals with this and a number of other subjects, in addition to radio frequencies.

The nature of potential hazards

We can define the potential hazards of RF radiation in terms of:

1 Direct effects on people

- (a) Thermal effects attributable to the heating of the human body due to the absorption of RF energy. At lower frequencies this includes heating due to excessive current densities in some parts of the body.
- (b) Shocks and burns which may result from contact with conductive objects, e.g. scrap metal, vehicle bodies, etc., located in electromagnetic fields.
- (c) The so called ‘athermal’ effects, if any, where it is postulated that the fields act directly on biological tissue without any significant heating being involved.

2 Indirect effects on people

Effects on people wearing implantable devices such as heart pacemakers, insulin pumps, passive metal plates and other related hardware due to interaction with some aspect of the implantable device. Some effects in this category affect the quality of life rather than physical health, e.g. interference with hearing aids and other electronic devices.

3 Effects on things in the environment

Ignition of flammable vapours and electro-explosive devices, e.g. detonators (dealt with in Chapter 4).

Interference with equipment

Category 3 above may, of course, also involve people who may be present near the subject and may be affected by fire or explosion, people in aircraft

where critical equipment is interfered with and the aircraft may be in jeopardy. With the widespread use of mobile phones (Chapter 6) risks extend to interference with critical medical equipment in hospitals. Hence many people are likely to be affected in some way ranging from these obvious examples down to the merely irritating cases of interference with computers and domestic radio sets.

Before proceeding it is worth noting that a perceived 'effect' is not necessarily synonymous with 'harm' or 'injury'. Our environment affects our bodies daily and some effects are of value, some harmful, and some have no apparent effect.

Some aspects of these topics may be differentiated in a general way in relation to the frequencies involved. Standards do tend to differ considerably in the detail of these.

Coupling mechanisms

Low-frequency electric fields

Electric fields external to the body induce a surface charge on the body; this results in induced currents in the body, the distribution of which depends on exposure conditions, on the size and shape of the body, and on the body's position in the field.

Low-frequency magnetic fields

The physical interaction of time-varying magnetic fields with the human body results in induced electric fields and circulating electric currents. The magnitudes of the induced field and the current density are proportional to the radius of the loop, the electrical conductivity of the tissue, and the rate of change and magnitude of the magnetic flux density. For a given magnitude and frequency of magnetic field, the strongest electric fields are induced where the loop dimensions are greatest.

Absorption of energy by the human body

This can be divided into four ranges (Durney et al.)[76]:

Frequencies from about 100 kHz to less than about 20 MHz, at which absorption in the trunk decreases rapidly with decreasing frequency and significant absorption may occur in the neck and legs.

Frequencies in the range from about 20 MHz to 300 MHz, at which relatively high absorption can occur in the whole body, and to even higher values if partial body (e.g. head) resonances are considered.

Frequencies in the range from about 300 MHz to several GHz, at which significant local, non-uniform absorption occurs.

Frequencies above about 10 GHz, at which energy absorption occurs primarily at the body surface.

Note that standards differ with regard to the frequencies at which electric and magnetic fields have to be measured separately. This is usually indicated by the absence of power density limits for those frequencies in the standard concerned, or their presence for information only. It is generally accepted that plane wave relationships are not applicable below 10 MHz.

Occupational and public safety limits

There is one general issue amongst those creating standards which results in strong differences in views. This is the question of whether separate limits are needed for these two groups. The technical issues of standards are dealt with in Chapter 4 but it is useful here to look at the arguments on both sides because they touch on harmful effects.

Some people feel that since there is no accepted concept of 'dose' for RF radiation such as exists for ionising radiation, there is no scientific case for separate limits for the two groups. (As a basic concept, dose = dose rate multiplied by the exposure time.) Consequently such people see the issue as a social and political matter. On the other hand some people believe that the duration of exposure is a significant factor in determining risks. It is true that, in general, populations feel protected if they are subject to tighter limits than those whose occupation requires them to be exposed. This is probably a universal feeling to which most of us would subscribe, especially if it relates to some occupation other than our own. There could be a case on these grounds alone for lower limits for the public, though there are economic costs for such a decision. A factor often overlooked is the general acceptance by most bodies that the 'public' includes those non-technical personnel working for organisations using RF radiation. Thus there is a mixing of groups in employment and some sort of segregation is implicit.

The medical aspects raised include:

Members of the public include the chronic sick, including people with impaired functions such as the thermo-regulatory functions and who may therefore be subject to risks which might not apply to fit people.

The recent suggestion that children might in some way be more susceptible to some RF radiation both because their bodies are developing and, in relevant cases, because their body resonance, being a function of height, differs from those of adults.

The suspicion that RF radiation may have undesirable effects on people taking some types of drugs for medical conditions.

The fact that the athermal effects of RF radiation (if such exist) may eventually prove to have adverse effects on human health.

The possibility that RF radiation effects are cumulative, i.e. related in some way to 'dose'.

As it can be seen, these statements are of the precautionary type, the argument being that those who have to work with RF radiation choose to do so but the public in general have not made any such choice.

The fact that the arguments either way are not proven does not preclude the taking of a decision which is believed to err on the safe side, though the economic consequence is the likely cost involved in segregating the two groups, especially where the limitations of land ownership or occupation affect radiation levels at the interfaces with the public.

One standard, referred to in Chapter 4, tackles this problem by defining the need for RF radiation safety measures in terms of 'areas' rather than groups of people, namely 'controlled areas' and 'uncontrolled areas'. The former is an area where people who are knowledgeable about RF radiation are employed. The latter covers all other people. Extra safety factors are included for the last category. Even this approach is not without problems. This concept of control by segregated areas broadly follows the practice for ionising radiation, though it would be very undesirable for the comparison to cause any confusion between the two types of radiation.

As can be seen from the discussion in Chapter 4, some standards only have one set of limits for all people, whilst others have separate provisions for occupational work and for the 'public'. Sometimes scientific accuracy leads to a psychologically unsound concept. In the NRPB current guidance the two categories identified are 'adults' and 'children present'. The reason involves the different resonant frequencies applicable to children, but this would not be known to most people and any specific reference to children sets the alarm bells ringing!

Specific absorption rate (SAR)

This term was used earlier and needs some explanation in the context of safety assessments. It is used to quantify the absorption of energy in tissue and is expressed in watts per unit mass of tissue, usually Wkg^{-1} . It is convenient to use the concept of the 'standard man' to aid discussion of the thermal aspects of RF radiation. The generally adopted standard man has a height of 1.75 m, a weight of 70 kg and a surface area total of 1.85 m^2 .

It is easy to see that the tissue mass of the exposed person is part of the definition of SAR so, for example, if it is known that the total power deposited in the standard man is 7 W, then the average whole-body SAR is $7/70 \text{ Wkg}^{-1}$ or 0.1 Wkg^{-1} .

A 'worst-case' expression to relate specific energy absorption and temperature providing that the effect of cooling is neglected is given by the NRPB report[3] as:

$$t = J/(c \times 4180)$$

Where:

t = temperature rise (C)

J = specific energy absorption (Jkg^{-1})

c = relative heat capacity (= 0.85)

note also that $J (\text{Jkg}^{-1}) = \text{SAR} (\text{Wkg}^{-1}) \times \text{exposure (seconds)}$.

Hence an SAR of 2Wkg^{-1} for 30 minutes will give a temperature rise of 1C, neglecting cooling.

At very low frequencies (tens of kilohertz) energy absorption is relatively low. Absorption increases to a maximum at human resonance, which for adults is somewhere between 30 and 80 MHz depending on height and whether the person is effectively earthy or not. Above resonance, relative absorption declines somewhat.

There is no practical way of measuring the SAR of a human being. In order to make calculations of SAR, either computer modelling or practical experiments with dummy persons using substances which simulate the electric characteristics of human tissues are undertaken.

Practical studies which simulate the human body use either standard shapes of hollow plastic objects such as spheres or hollow plastic human models generally known as phantoms. Their construction will depend on the temperature measurement technique to be used.

The most common systems are infrared (IR) scanning and temperature recording systems or the use of implantable temperature probes connected to some form of controller and data logger.

Phantoms in which implantable probes are used may be filled with a liquid or semi-liquid media simulating human tissue. This may be a homogeneous filling or elaborate layering and scaling may be done to represent the bones and organs of the human body with their different tissue simulations. The latter is obviously more expensive in time and materials, but can provide some differentiation of tissues. A useful paper by Guy[78] on the use of phantoms in experimental work to measure SARs covers dosimetry from VLF to microwaves and is well illustrated.

In the case of phantoms to be used with IR thermography, the phantom can be bisected in the planes of interest, vertical and horizontal and flanges fitted to facilitate dismantling and assembly at the sections.

Again the simulation of tissue may be homogenous or structured. The open faces of the sections are often covered with a close woven material which will ensure electrical contact of the two halves when assembled.

The complete phantom is exposed to a known uniform RF field for a specified time. The phantom is then split at the relevant sections and their open faces subjected to IR thermography to provide a plot of temperatures.

In fact there will usually be two scans, one before the phantom is exposed and one after so that the temperature changes can be recorded.

Recently, there has been much interest in producing human head phantoms in connection with mobile phone investigations. The aim is to produce a standard test method to assess the actual SAR from mobile phones and this is mentioned in Chapter 6.

Whichever type of system and phantom is used, the object is to calculate either whole body SAR or, sometimes, a local SAR. With probe systems, it is important that the probes should not perturb (distort) the RF field. A paper by Stuchly et al.[5] illustrates the scanning probe arrangement, using a non-perturbing probe system. Phantoms do not simulate the thermo-regulatory system of the human body and the results cannot be regarded as indicative of the temperatures likely in a live healthy human body.

Computer modelling attempts to model the human body by sub-dividing it into cells and attributing the relevant characteristics to each cell by analogy with the structure of a human being. There are limitations resulting from the deficiencies of any given model relative to a human body both in respect of the static model and the modelling of the dynamic performance of the complex thermo-regulatory mechanism of the human body.

The validation of computer modelling is difficult since it is generally only possible to compare it with some experimental trial such as the phantom method described above, despite the limitations of the method. Another paper by Speigel et al.[6] illustrates both a computer simulation and the comparison of the results with a phantom model.

Although one can identify the problems these methods pose, it has to be recognised that it has not yet proved possible to devise any other effective measurement method.

Known effects of RF radiation on people

Thermal effects

General

There is general agreement that the main demonstrable effect on the human body above about 100 kHz is the thermal effect, i.e. the transfer of electromagnetic field energy to the body. A very high percentage of the human body is made up of water and water molecules which are polar molecules liable to be influenced by impinging electromagnetic fields. Hence those tissues having a significant water content are most liable to be influenced by fields. Some other tissues also have large polar molecules. The effect of RF on such body tissues is to cause polar molecules to attempt to follow the reversals of the cycles of RF energy. Due to the frequency and the inability of the polar molecules to follow these alternations, the vibrations

lag on them, resulting in a gain of energy from the field in the form of heat which causes an increase in the temperature of the tissue concerned.

With the widespread use of microwave ovens, most people have a practical awareness of the fact that microwaves can heat tissue, as represented by the animal tissues used in cooking, and should not find it too difficult to understand the nature of the thermal hazard.

The amount of heating depends on the amount of energy absorbed and the activity of the human thermo-regulatory system. In turn, the amount of energy available depends on the power of the source and the duration of the exposure, 'cooking time' in the oven context.

Human thermo-regulation

In the healthy human body, the thermo-regulatory system will cope with the absorbed heat until it reaches the point at which it cannot maintain the body temperature satisfactorily. Beyond this point, the body may become stressed.

Excessive exposure can give rise to hyperthermia, sometimes referred to as heat exhaustion, an acute, treatable condition which, if neglected could have serious results. Excessive heating can also cause irreversible damage to human tissue if the cell temperature reaches about 43C.

The writer has never come across a case of hyperthermia in connection with RF radiation even with the highest power transmitters. This is possibly attributable to the common sense of those who work with them. Nevertheless, with some equipment installations there is the potential for excessive exposure which, in the worst scenario, might have very serious consequences, so there is no room for complacency.

A rise in body core temperature of about 2.2C is often taken as the limit of endurance for clinical trials[7]. For RF radiation purposes, a limit of an increase of 1C in rectal temperature has often been postulated as a basis for determining a specific absorption rate (SAR) limit for human exposure. Most western occupational standards are based on an SAR of 4 Wkg⁻¹ divided by ten to give a further safety margin. Thus the general basis is 0.4 Wkg⁻¹.

It has already been noted that people with an impaired thermo-regulatory system or with other medical conditions which affect heat regulation may not be so tolerant to the heating permitted by standards which have been set for healthy people. Those taking some forms of medication may also be affected adversely. There are also factors other than general health which affect the ability of the human body to handle heat energy. For example, a period of strenuous physical work can elevate the rectal temperature.

Another factor is the environmental condition – ambient temperature and relative humidity can make a considerable difference in the ability of the human body to get rid of excess heat. Consequently, a given SAR may, for a constant ambient temperature and specified exposure time, give different body temperatures if the relative humidity is changed from a high figure, say

80%, to a low one, say 20%. Put the other way round, a specific increase of rectal temperature of, say, 1C will require a much higher SAR at low relative humidity than is needed at high humidity.

In 1969, Mumford[8] identified this aspect and proposed a 'comfort index' whereby the higher safety level then in use (100 Wm^{-2} for all the frequencies covered) was reduced as his temperature-humidity index increased. Current standards generally claim to accommodate environmental factors in the large contingency allowance put into the permitted limits.

A particularly interesting paper on the thermo-regulatory mechanisms of the human body is that of Adair[9]. The paper describes the regulatory mechanism in some detail. It notes experimental work done to establish the thermal equivalence of heat generated in the body during physical exercise and passive body heating such as that from HF physiotherapy equipment. It also makes reference to the radical difference between the thermal responses of man and various animals and the consequent difficulty in extrapolating animal exposure data to human beings on this account, quite apart from any resonance differences.

RF penetration in human tissues

In considering the amount of energy absorbed by the human body, it is necessary to recognise that the percentage of incident radiation which is actually absorbed depends on frequency and the orientation of the subject relative to the field.

In human tissues, RF radiation may be absorbed, reflected or may pass through the tissue. What actually happens will depend on the body structure and the tissue interfaces involved. These interfaces are the transitions from tissue to tissue or tissue-air-tissue and are clearly complex in the human body.

The depth of RF penetration of the human body is also an important factor. In the HF band, the deeper penetration is used for diathermy treatment where the deposition of heat is intended to have a beneficial effect on that part of the body considered to need treatment. The deep deposition of RF energy needs to be carefully controlled to avoid damage to tissues which might not be noticed by the subject due to lack of sensory perception of heat in the organs concerned.

The measurement of the RF characteristics of human tissue can, for the most part, only be done with chemical simulation of tissue, since there are problems with the use of excised human tissue for this purpose. The penetration depth is usually given as the depth where the incident power density has been reduced by a factor of e^{-2} , i.e. down to about 13.5% of the incident power density.

The penetration decreases as frequency increases. Figure 3.2 has been drawn using some of the data from published tables, the work of Schwan,

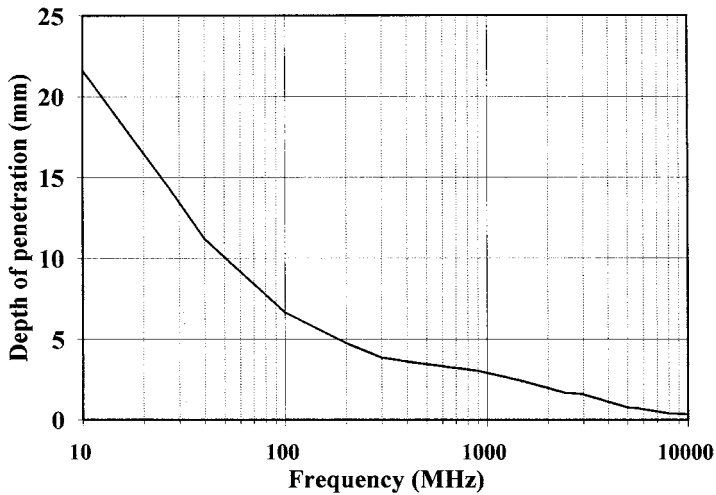

Figure 3.2 *Depth of penetration of RF energy in tissues with high water content (data from reference 10)*

Cook and Cole and other researchers. The tables are given in a paper by Johnson and Guy[10]. It illustrates laboratory calculated penetration depths versus frequency for tissues with high water content. The illustration should only be considered as giving a rough picture of the change of penetration depth with frequency as the laboratory determination of these data is subject to various factors including temperature dependency. Tissues with a low water content have significantly deeper penetration.

At the microwave end of the RF spectrum, deposition of energy is confined to the surface layers of the skin. The penetration depth at the higher microwave frequencies may only be a few millimetres[11]. Deposition of energy in the surface layers of the skin may lead to thermal injury, the risk increasing as the frequency increases.

Resonance

It has been seen how the weight of the standard man is linked to the use of the concept of specific absorption rate. The purpose of a standard height may be less obvious. To see the effect of this it is necessary to consider how the absorption of energy is affected by frequency. It is also necessary to define the attitude of the model relative to the plane wave field to which it is subjected.

Figure 3.3 shows the average SAR in a spheroidal model man subjected to a field of 10 Wm^{-2} and displayed in three curves[12]. The curves are labelled E, H and K and indicate that the model man was successively orientated

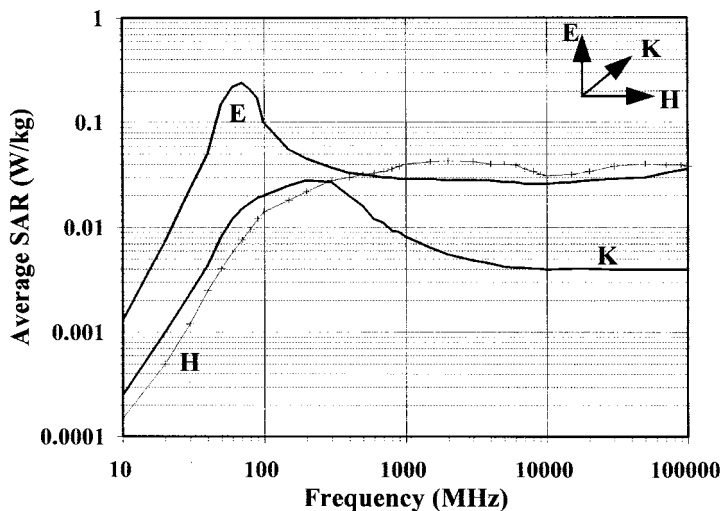

Figure 3.3 SAR versus frequency for orientations parallel to the E, H and K vectors (courtesy WHO – European Office)

parallel to the electric field (E), the magnetic field (H) and the direction of propagation (K), head to toe.

Considering the curve E, it can be seen that absorption is lowest and declining rapidly with decreasing frequency at 10 MHz. It increases rapidly with increasing frequency to peak at about 70 MHz. The peak represents ‘resonance’ of the model man.

Put simply, this means that at the resonant frequency, the absorption of RF energy is at a maximum. The reader unfamiliar with electrical resonance may be familiar with mechanical resonance where at a given frequency some object, e.g. one mounted in a motor vehicle or aircraft, which is excited with constant power over a range of audio frequencies, manifests a large amplitude of vibration at one particular frequency. The energy involved may then result in acoustic noise and possibly the eventual fatigue of materials.

Returning to the RF resonance case, the resonant frequency is related to the height of the erect person. Resonance occurs when that height corresponds to approximately 0.36 to 0.4 wavelengths.

Hence using 0.4 for the standard man, $\lambda = 1.75/0.4 = 4.37$ m and the frequency is approximately $300/4.37$ MHz = 69 MHz.

If the subject is effectively earthy due to bare feet or conductive shoe material, the resonance will occur at half the above frequency, i.e. about 34 MHz. Table 3.1 gives a few examples for subjects who are non-earthly, using the 0.4λ calculation. Small children obviously resonate at higher frequencies and tall adults at lower frequencies. Hence a frequency band can be established which covers all people, large and small. Strictly, the

Table 3.1 *Effective resonant frequency for an erect person in a vertically polarised field versus height using the relationship $h = 0.4\lambda$*

<i>Subject height (m)</i>	<i>Resonance (MHz)</i>
0.5	240
0.75	160
1	120
1.25	96
1.5	80
1.75	69

occupational frequency bandwidth for resonance is smaller since the range of heights for employed people is smaller.

Gandhi[13] states that at resonance a human being absorbs energy 4.2 times greater than that which might be expected from consideration of the physical cross-section of the body. Further, when the person is effectively earthed, the resonant frequency is reduced to approximately half of that for the non-earthed condition and the energy which is absorbed is about 8 times that expected from consideration of the physical cross-section. Another way of conceiving this is that the effective electrical cross-sectional area of the exposed person is several times that of the actual cross-sectional area at resonance.

It will be noticed in Figure 3.3 that the electric field curve (E) indicates that the electric field gives rise to more absorption than the magnetic field curve (H) up to about 700 MHz, the difference being considerable over much of that frequency range.

Hot spots

The human body is made up of a mixture of types of tissue, for example, skin, blood, bone, muscle and fat. When the human body is exposed to RF radiation, there is, as described earlier, some degree of absorption of the energy in the form of heat. However, the absorption of RF energy in the human body which is made up of such a complex mixture of tissues, can result in a non-uniform distribution of heat. Hot spots (high local SARs) may occur in the human body over the range of about 30 to 400 MHz.

These hot spots will be evident at frequencies around body resonance where absorption is greatest and at sub-resonances in parts of the body. Gandhi[14] gives the adult human head resonance range as being of the order of 350 to 400 MHz with a volume-averaged SAR of 3.3 times the

whole-body SAR at resonance and the absorption cross-section as about three times the physical cross-section. He also gives some local SAR values for knees, ankles and the neck for body resonance in the grounded man (about 34 MHz) and the ungrounded man (about 68 MHz).

The measurements were made with scaled human phantoms and showed hot spots at the knees, ankles, elbows and, in the case of the non-earthly model, the neck. These have some 5 to 10 times the average whole-body SAR.

It is difficult to tackle the problem of non-uniform heat absorption by seeking to identify the location and temperature of such hot spots. Using physical models poses the problem of carrying out measurements without affecting the distribution and magnitude of the effects due to the presence of the measuring devices and, as mentioned previously, physical models cannot simulate the human thermo-regulatory system.

Work has been done on the subject of 'hot spots' using computer modelling but this again poses the problem of validating such models as being an adequate and correct representation of the functioning human body. The reason that attention has been given to this problem is a simple one. If a safety standard defines a safe power density limit for a particular frequency on the basis of the average whole-body SAR but some small parts of that body reach significantly higher temperatures than others, there must be concern as to whether these can be harmed in some way.

Some high ratios between mean body temperatures and hot spot temperatures have been noted [3]. Ratios suggested from experiments using magnetic imaging range from 10 to 70, though this reduces to a factor of 2 to 4 when the SAR is averaged over individual organs. The theoretical end point could be where the hot spot is so hot as to cause cell damage, in which case it would be necessary to adjust the average permitted levels to reduce the hot spot temperatures. It has to be said that little is known about the real effects in a healthy individual with an efficient thermo-regulatory system as contrasted with computer or model simulation.

A paper by Gandhi and Riazi [11] looks at the power capabilities of RF sources in the frequency band 30 to 300 GHz and identifies the possibility of high energy deposition rates for the skin at frequencies in that range due to the very shallow penetration depths. It also looks at the possibility that dry clothing may act as an impedance transformer, increasing the amount of energy coupled into the body. The thickness of clothing in this frequency band is a significant fraction of the incident wavelength. This could, for a given incident power density, exacerbate the situation by further increasing the deposition in the superficial layers of the skin.

As previously mentioned, standards now recognise the problem of energy deposition in the superficial skin areas by progressively reducing the averaging time for exposures at above 10 GHz from the usual 6 minutes to a shorter period – see Chapter 4.

Susceptible organs

From the thermal transfer point of view, the two organs which are considered more susceptible to heat effects than others are the eyes and the male testes. Neither of these have a direct blood supply and hence do not have that means of dissipating the heat load.

Effects on the eyes

The production of cataracts in animal experiments using RF has been well established. It is generally considered that this effect is a thermal one. Experimental work has been limited to animals and the different physical characteristics of the eye structure in different types of animal do give rise to different results. Also, the depth of penetration of the eye tissues is dependent on the frequency of the radiation.

It is thought that for human beings the frequencies most likely to cause cataracts lie between 1 and 10 GHz. In experiments with rabbits, noted in reference 27, with exposures of two to three hours the threshold temperature for cataract induction was between 41 and 44°C and the corresponding local SAR about 100 to 140 W/kg⁻¹. Experiments with monkeys, where the eyes more closely resemble those of humans, with higher fields than that causing cataracts in rabbits, did not produce cataracts.

Whilst it is easy to do animal experiments with small localised fields, in practice, people exposed to RF fields related to antenna systems are likely to experience whole-body radiation and these sort of levels for whole-body radiation are far in excess of those permitted for microwave work.

Some reported work claims that microwave radiation at low levels, particularly with pulsed radiation, can affect susceptible parts of the eye. Gandhi and Riazi[11] referred to experiments on rabbits at 35 GHz and 107 GHz where some eye damage (albeit reversible) had been sustained with a total absorption in the eye of 15 to 50 mW. They suggested that at millimetric wavelengths, the power absorption of the human eye might be of the order of 15 to 25 mW for an incident power density of 100 W/m⁻² after 30 to 60 minute exposures.

ICNIRP[26] quotes sources suggesting that in the higher frequency range 10 to 300 GHz, ocular damage can be avoided if the power density is less than 50 W/m⁻². The Stewart report[59] looking specifically at mobile phones, tabulated seven report results with monkeys and rabbits. A disparity between the findings of two of the reports which both involved pulsed radiation is evident. It was thought possible that difference in results might be due to differences in peak SAR per pulse. This highlights the need to know the energy per pulse when using pulsed RF radiation.

It is clear that eye exposure should be treated with caution especially with high power pulsed sources. Where it is so difficult to establish safety levels for

human beings from animal experiments there is no other option but to limit exposure levels and durations. At some microwave frequencies there is also the possibility that metal framed spectacles may add to the exposure level.

In the author's view there is often unnecessary exposure to the eyes, for example by holding the head close to open RF power amplifier circuitry when aligning or diagnosing on a bench without bothering to switch off. The problem is made worse by the need to read small markings on small components. The problem can usually be avoided by better safety disciplines and by the use of modern optical aids including bench magnifiers and optical fibre inspection equipment.

There is similarly a need for caution in working with RF radiation so as to avoid the unnecessary eye exposure which can sometimes occur where waveguide flanges are removed without the source being switched off, and worse still, by the silly practice of looking down such waveguides. Although people think that the old practice of looking down the waveguide with power on to look at the vacuum tube stopped long ago, cases still occasionally arise.

Effects on the testes

Experiments with anaesthetised mice and rats showed[3] that male germ cells are depleted by exposure to SARs of about 30 Wkg^{-1} and $8\text{--}10 \text{ Wkg}^{-1}$, respectively. Conscious mice exposed to 20 Wkg^{-1} and 9 Wkg^{-1} respectively, did not show any effect. The difference is regarded as being due to the fact that the anaesthetised animals were not able to regulate their testicular temperature. Other studies with rats reported a transient decrease in fertility with an SAR of about 6 Wkg^{-1} .

The NRPB93 document[27] reports that repeated heating of the testes by 3 to 5C in animal studies, resulted in a decrease in sperm count lasting for several weeks.

There seems to be little if any published information regarding such problems with human adult males.

It seems likely that the whole-body SAR required to produce a sufficient temperature increase in the testes of an adult male would produce some basic signs of warmth and discomfort, resulting in withdrawal of the subject from the RF field. This is, of course, purely speculative since the author is not aware of any research carried out with men. However, with many years working in a large organisation manufacturing high power transmitters, no complaint of this kind has arisen.

Hearing effects

It has long been known that some people can 'hear' the pulse repetition frequency of radars and similar equipment. In this field it is not usually difficult to find human volunteers for tests so that there is no problem of

relating other animals to people. It is therefore surprising that more work has not been done in this field. The work of Frey [15] reported in 1961 involved tests with volunteers using two transmitters of frequencies 1.3 GHz and 2.9 GHz, the former being pulsed with a 6 μs pulse (244 Hz repetition rate) and the latter with a 1 μs pulse (400 Hz repetition rate).

He gave the mean power density threshold of hearing for those able to hear anything as 4 Wm^{-2} and 20 Wm^{-2} respectively. The corresponding peak pulse power densities were 2.6 kWm^{-2} and 50 kWm^{-2} .

It was stated that the human auditory system responds to frequencies at least as low as 200 MHz and at least as high as 3 GHz. In another paper [16], Frey reported that the sounds heard included buzzing, hissing, and clicking and depended, among other things, on the modulation characteristics. In these tests Frey used a frequency of 1.245 GHz. A constant repetition rate of 50 Hz was used and longer pulse widths (from 10 to 70 μs). The pulse width was changed to adjust mean power and peak power densities. The volunteers were required subjectively to assess the loudness of the sound heard relative to a reference sound which had been transmitted.

The general finding was that the perceived loudness was a function of the pulse peak power density, rather than the average power. The peak power density for perception was less than 800 Wm^{-2} .

The nature of the effect has been the subject of much investigation [17]. It seems generally agreed that the pulsed RF energy causes an expansion in the brain tissue due to the small but rapid temperature change involved. This causes a pressure wave which is transmitted through the skull to the cochlea where the receptors respond as for acoustic sound. It is not necessary to have the middle ear intact. The temperature increase which causes the pressure wave is considered to be less than 10⁻⁵C. It is perhaps worth noting that sometimes the pulse repetition frequency of high power radars can be heard from objects such as old wire fencing, and this can easily be confused with the above phenomena. Presumably the effects on old fences involves some form of rectification of the RF currents due to corroded junctions within the fence, and the consequent vibration of some fence elements at the pulse repetition rate.

Although the results of laboratory tests have been published, little, if anything, seems to have been published in recent times regarding the practical experience of those working on transmitting sites and any problems they may have noticed. With the low levels mentioned as thresholds for hearing, it might be thought that many radar personnel would experience this phenomenon (for a typical duty factor of 0.001 and the old 100 Wm^{-2} mean power density limit, the peak pulse power density would be 100 kWm^{-2}).

A survey was carried out by the author across 63 engineers working with the transmitting side of radar. Many of the participants had 30 years or more experience in that work. The survey has no scientific basis, being limited to the collection of anecdotal evidence from those concerned by means of a questionnaire.

The results were interesting in that only three people claimed to have heard the pulse repetition frequency (or sounds related to it) and for two of these, each cited only a single experience in unusual circumstances. Both occurred on a customer's premises, during the Second World War.

Both of these people considered that the circumstances led to exposure to very high fields but there was no measuring equipment available in those days and in consequence, little safety monitoring. The third case was interesting in that it seemed to imply a different mechanism, one which has occasionally been reported in the past. This person claimed that he had heard the pulse repetition frequency on a customer's premises and attributed this to a tooth filling. (The Frey work in 1961 did include the use of shielding to exclude the 'tooth filling' possibility.) It was further claimed that this ceased when the tooth was extracted.

Strangely enough, another person who gave a negative answer to the basic question did claim to hear a local radio amateur when at home, again attributing this to a tooth filling with the same claim that it ceased after the tooth was extracted!

Outside of this survey, there was one engineer in the same organisation who regularly claimed to hear the pulse repetition frequency on company premises, but was able to live with it. This applied in an environment which was maintained within the old ANSI C95.1-1982 standard. This account is again anecdotal, the experience extending over a number of years. It was the only case in which this phenomena occurred on company premises.

Assuming that none of the respondents to the questionnaire had chosen to suffer in silence, this particular company, which designs and manufactures high power civil and military radars, does not seem to have a problem with auditory effects despite the high radar peak powers usually involved and the fact that much of their high power work lies within the 0.8 to 4 GHz frequency range. Allowing that this was solely a collection of anecdotal evidence, it seems strange that, having regard to the Frey threshold data, more cases had not arisen especially since the engineers concerned had worked for many years prior to standards being produced and most had no knowledge of any aural effects.

Limb currents

Up to about 100 MHz, theoretical consideration of currents induced in the human body and especially the limbs, has given rise to some concern. As a result, research has been carried out to ascertain the magnitude of RF currents induced in the human body. It has been established that currents in the legs of an adult in an RF field may give rise to large SAR values at places where the effective conductive cross-sectional areas are small. Hence, the current density will be much larger than that implied by consideration of the actual cross-sectional area at that place. The knee and the ankle are examples

of such areas, and some attention has therefore been given to SAR values associated with them, particularly the ankle.

Gandhi et al. [18] have shown by measurements made with people that the induced currents are highest when the human body is erect and barefoot, i.e. earthy, and parallel to a vertically polarised plane wave field. The leg currents are proportional to frequency and to the square of the height of the person exposed.

An approximate formula (valid up to about 27 MHz) for the current in the leg of an erect barefoot person where the electric field is vertical is given as:

$$I \text{ (mA)} = 0.108 \times h^2 \times f \times E$$

Where:

h = subject height (m)

f = frequency (MHz)

E = electric field (Vm^{-1})

Example:

For a field $E = 60 \text{ Vm}^{-1}$; $f = 1 \text{ MHz}$; $h = 1.75 \text{ m}$:

$$\begin{aligned} I \text{ (mA)} &= (0.108 \times (1.75)^2 \times 1) \times 60 \\ &= 19.85 \text{ mA.} \end{aligned}$$

Above 27 MHz, the measured currents peaked around 40 MHz, reflecting resonance of the subject. An empirical expression for current above 27 MHz which includes an element representing the resonance frequency of the 'standard man', gives a sine wave shape for I/E versus frequency.

At field limits corresponding to the old ANSI C95.1-1982 standard electric field limits [19] for frequencies from 3 to 40 MHz, values of SAR at the ankles of 182 to 243 Wkg^{-1} have been reported from tests carried out. Ankle currents were reduced when footwear was used, depending both on the frequency and on the electrical properties of the material of which the footwear was made.

The current when wearing shoes ranged from 0.8 to 0.82 times the barefoot current. Previous work at 1 MHz showed corresponding fractions as 0.62 to 0.64. The increase with frequency is due to the fall in the impedance to ground as the frequency increases.

Another paper by Chen and Gandhi [20] illustrates the task of computer modelling the human body in order to establish the RF currents induced over the frequency range 20 to 100 MHz. The results of the calculations are presented in a series of graphs. The results are said to agree with experimental data produced by other workers. RF safety standards now include limits for the values of leg currents up to 100 MHz as well as contact current limits to prevent shocks and burns.

The general principle of measurement is shown in Figure 3.4. The subject stands in the RF field on an insulated plinth and the feet are connected to earth via a current measuring device. In the simplest case this could be an RF milliammeter which would read directly. This serves to illustrate the basic simplicity of the idea. In practice it is important not to have any unshielded connections and wires and the simple RF meter has frequency limitations and is not used. A common method is to let the current flow through a known resistor, measure the voltage across it and convert the measurement to current.

Commercial devices are illustrated in Chapter 7. The basic system is a closed device on which the subject stands. Nothing can be seen other than the current indicator. One type appears as a replica of a personal weighing machine with a current instead of weight indicator. Data can be taken out of

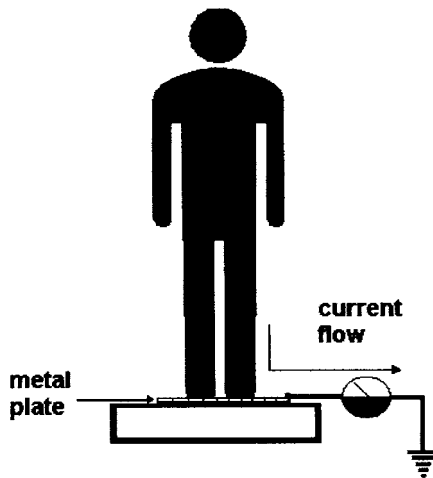

Figure 3.4 *Limb current measurement concept*

such devices via an optical fibre as any external wiring in the field would affect the integrity of the measurement.

An alternative device, also discussed in Chapter 7, is the ankle coil which clamps round the user's ankle and has a built-in current indicator.

RF shocks and burns

At low frequencies and up to about 100 MHz, contact with passive objects in RF fields may result in currents flowing through that part of the body in contact, usually the hands, causing shock and sometimes burns. These effects can result from contact with almost any conductive object such as fences, scrap metal, unused dish and similar antennas or other equipments stored in the open, vehicles, farm machinery, metal buildings, etc. Burns may result

when the current density (mAcm^{-2}) is excessive due to the contact area being relatively small. The possibility of a burn is reduced with the greater area of a full hand grasp. However, this is rather academic since contact is usually inadvertent and often involves the finger tips.

The method of measuring contact currents (current density cannot be measured) is, to use the simple illustration in Figure 3.5, to hold one terminal of an RF milliammeter and touch the other terminal on the conductive object under investigation. This is the sort of thing an engineer might do but since it involves passing the resulting current through the body of the person holding the meter, it is not acceptable.

In practice, as illustrated in Chapter 7, the instrument is an electronic one with a circuit whose impedance represents that of a human being, connected to earth. The user is insulated from the instrument and the current flows through the dummy human impedance circuit.

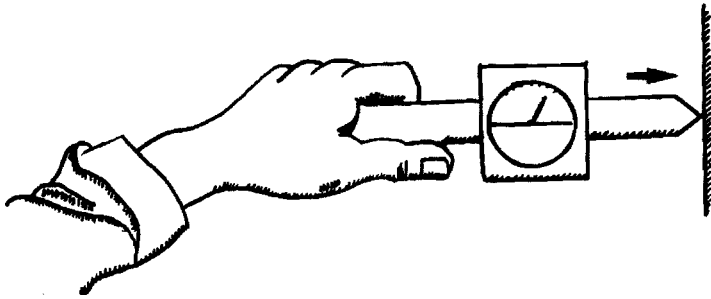

Figure 3.5 *Contact current measurement concept*

A paper by Chatterjee et al.[22] deals with the measurement of the body impedances of several hundred adult subjects, male and female, over the frequency range 10 kHz and 3 MHz. Experiments were also carried out on threshold currents for perception and for pain. It was generally found that at threshold levels up to 100 kHz the sensation experienced was that of tingling or pricking and above 100 kHz the sensation was one of warmth.

In the same paper, the calculated current for contact with the door handle of a van of effective area of 58 m^2 and 0.5 m effective height at 3 MHz is given as 879 mA when the field is 632 Vm^{-1} . This is well above threshold levels and could cause injury.

Because of the fact that burns essentially result from the current density at the point of contact and hence the effective contact area, it is quite possible to experience currents exceeding a given standard without incurring burns, purely as a result of a fortuitously large contact area. It is clearly important to measure contact currents rather than operate on the practice of assuming that if no burn occurs then there is no hazard.

It should not be overlooked that parts of the body other than the hands may incur burns. A common example is where shorts are being worn, as the bare leg may contact metal objects. Limits for occupational exposure (and public where applicable) to limb currents and to contact current over the frequency range 0.1 to 100 or 110 MHz are given in Chapter 4. Touch burns have been predicted as possible at 60 mA with a contact area of 0.2 cm^{-2} .

Table 3.2 gives the summarised effects of work carried out by UNEP/WHO/IRPA in 1993 and which is reproduced in the ICNIRP98 document [26]. Apart from the undesirability of incurring shocks or burns, there are other indirect effects which, in the author's experience, can be more worrying. Quite small shocks incurred by people working on structures can result in an involuntary movement (startle response) and a possible fall. These can be seen in terms of the 'touch perception' figures in Table 3.2. Current safety standards are not likely to prevent these small shocks.

In a number of cases where a contract to fit new antenna systems on working sites has been involved, construction staff have started assembly and noticed 'sparks' between tools and the structure. Consequently, there has been considerable alarm because of the general fear of radiation and

Table 3.2 Range of threshold currents for indirect effects, including children, women and men (Courtesy ICNIRP)

	Threshold current (mA)		
Frequencies →	50/60 Hz	1 kHz	100 kHz
Touch perception	0.2–0.4	0.4–0.8	25–40
Pain on finger contact	0.9–1.8	1.6–3.3	33–55
Painful shock/let-go threshold	8–16	12–24	112–224
Severe shock/breathing difficulty	12–23	21–41	160–320

because of the awareness of the possibility of 'startle response' accidents.

In a number of these situations, the result has been a temporary cessation of work, caused by fear. The subject therefore needs more attention than the mere observance of the provisions of a safety standard regarding contact current since the probability is that these apparently minor manifestations may occur at lower limits and have indirect physical and psychological effects.

There will often be two cases to consider as far as contact with conductive material in an RF field is concerned. The first case involves the safety of people employed on a site or on company property and in most countries there are provisions for health and safety at work. The problem lends itself to good safety management which should include the prohibition of the dumping of metal objects in such fields.

The second case is that of the public who own or have a right of access to adjacent land which may be irradiated by RF. Here those who own or lease such land have a right to use and deposit conductive objects where they wish and there is a duty on those responsible for the RF emitter to ensure that those people cannot receive shocks or burns from objects on their own property.

Perception of a sensation of heat in RF fields

As mentioned earlier in this chapter, RF energy in the higher frequencies of the RF spectrum above perhaps 3 GHz can be detected by temperature sensors in the skin since, as the frequency increases, the energy is increasingly deposited in the outer layers of the skin. The indications resulting are dependent on a number of factors including differing heat sensitivity in different parts of the body, the duration of the exposure and the area exposed. WHO[12] notes that in tests on mammals the threshold temperature for cellular injury over seconds to tens of seconds (42C) was found to be below the pain threshold (45C). For this reason, the avoidance of the skin heating sensation does not provide a reliable protection against harmful exposures.

It is postulated that it may be a better indicator at frequencies of tens of GHz and higher where the wavelength is comparable with or less than the thickness of the skin. Prudence seems to suggest that the pain threshold is completely inadequate as an indicator, until much more is known about all the variables involved.

There is a universally accepted statement about RF radiation work that people should not remain in a field which gives rise to a sensation of warmth even if the power density is within the permitted limits of a standard. It will be evident from the previous discussion that this does not guarantee that no harm has been incurred but is intended as an extra warning.

At frequencies well below those being discussed, the penetration of RF in the human body is such that much more of it will be below the skin sensors and there may not be any physical sensation of warmth. The prevention of internal damage has to be by the limitation of exposure.

Pulsed radiation

Pulsed RF radiation is very common, typically in radar and in some data transmission systems. Pulse transmission is discussed elsewhere but the two aspects relevant here are the mean power density and the peak pulse power density. A typical radar may have a factor of 1000 between these so that, say, a mean power density of 50 Wm^{-2} would imply a peak pulse power density of 50 kWm^{-2} .

In the early days of RF radiation safety regulation, the emphasis was on mean power and this left open the question of limiting the peak power density.

As a result of concern expressed by some people, research has been undertaken to examine possible effects attributable to high peak power pulses.

It is considered possible that pulsed radiation may have specific effects on the nervous system. Most standards now place a limit on peak pulse power density and pulse energy and this is discussed in Chapter 4.

Experiments with animals have indicated that the startle response to a loud noise was suppressed by a short pulse of microwave radiation. Body movements have also been induced in mice. Calculations suggest a large SAR value in these animals.

Athermal effects of RF radiation

This term is used to describe any effect which is thought to arise by mechanisms other than that involving the production of heat in the body. It has been somewhat controversial, some people disputing whether such effects existed. However, most people now probably accept the need at least to investigate observations which do not seem to be linked to the thermal deposition of energy in the human body.

With regard to tumours, there seems to be a degree of consensus amongst most bodies. This is probably best expressed in the UK NRPB press release on the report of the Advisory Group on Non-Ionising Radiation[23] which stated ‘We conclude from a review of all the evidence, including both that relating to humans in ordinary circumstances of life and that relating to animals and cells in the laboratory, that there is no good evidence that electromagnetic radiations with frequencies less than about 100 kHz are carcinogenic; this includes those produced by electrical appliances, television sets and video display units.

‘With higher frequencies there is room for more doubt, some laboratory evidence suggesting that they may act as tumour promoters, although in this case the effect may be secondary to local tissue heating.’ It goes on to recommend further research on the subject.

The ICNIRP98 document[26]

This document discusses some of the studies which seemed to suggest possible cancer implications, pointing out problems involved in the methods and citing cases where other work failed to show the same effects. With regard to a 1997 Australian study carried out by Repacholi using a genetically manipulated strain of mice prone to develop specific tumours, which produced results thought to be statistically significant, some points were made about certain aspects of the control of exposures and the desirability of replicating the study. It also raises the question of establishing whether tests with transgenic animals, such as this study, can be generalised to human beings.

The NRPB issued a press release[79] on this study which noted that the experimental design and quality assurance look to be sound. They point out that the authors of the paper indicated that the results for human health are far from clear without supporting biological evidence, the complete range of factors that may have resulted in the increased number of tumours in this sensitive strain of mice remains uncertain and it will be important for further studies to replicate the findings. The NRPB notes that this further emphasises the need for more high quality research to be carried out on the biological effects of electromagnetic fields.

Needless to say, there are people who do not subscribe to the current views and since there are so many uncertainties reflected about the role of electromagnetic fields, if any, in cancer promotion, it is not possible to do more than pursue research in this field. In this connection it can be seen how important the comments of those who conducted the above study are in providing perspective. Whilst there are these sort of unanswered questions it is not possible to be categoric one way or the other.

Nevertheless the situation will often be coloured by the fact that whilst we are all subject to the possibility of incurring cancer, some of those engaged in electrical and radio work who suffer the disease will, understandably, be inclined to attribute cancer to their occupation.

The topics encountered under the heading of ‘athermal’ effects cover almost everything to do with the human body. Reports and papers are very technical, requiring considerable practical familiarity with the subject matter. They range from the possibility of RF causing cancers as mentioned above, through the operation of all the systems and constituents of the human body, cells, tissues, organs, the immune system, reproduction, DNA, etc., to the psychological aspects claimed by some researchers.

These are not discussed further here but competent discussion of some or all of these topics can be found in references [3, 12, 23 and 59] and in the standards and other national documents of various countries.

Effects on people wearing implantable devices

There are a number of implantable devices, active and passive, which are fitted into the human body. Perhaps the most common one is the heart pacemaker on which many people depend. There are two basic types of heart pacemaker. The first could be described as a demand pacemaker which will make up for missed heart beats as needed. The second type is the fixed pacemaker which operates continually at a fixed rate with no other form of control. There may be modern developments of these devices too.

It is possible that some sources of RF radiation could interfere with the operation of pacemakers, the significance of such interference depending on the type of pacemaker fitted. The potentially more serious consequences of

interference relate to interference with the fixed rate pacemaker. However, the two descriptions above are basic. With current developments in electronic devices there is always the possibility of the use of more sophisticated devices and the possibility of new problems of vulnerability to interference.

Many of these pacemakers are subjected to interference (EMC) testing by the manufacturer but the relevant information does not normally get communicated to those responsible for safety at work, because of patient confidentiality. Consequently, those responsible for the operation of RF transmitters and similar sources who may become involved with visitors wearing a heart pacemaker have no means of carrying out their responsibilities for the individual safety of such people.

The only recommendation that can be made is that such sites should have a sign requiring visitors to notify the manager that they are wearing a pacemaker. They can then be excluded from RF fields. A similar problem can occur at exhibitions where equipment is being demonstrated and where many people may be present. There are other devices such as insulin pumps which are implanted and the views of medical authorities may need to be sought on these and any new types of implanted devices.

In the EC there is a Directive on Active Implantable Devices[66] but the current draft does not fully tackle the problem of the electrical characterisation of devices in terms of interference testing though it does mention the subject. There are also many types of passive devices fitted in the human body. These may include metal plates, rods and fixings. There is always the chance of these being resonant at the frequency in use at a particular site.

For those employed with RF radiation, it seems desirable to record any such implants fitted when personnel are first employed and thereafter, should the situation arise. It is then possible to exercise supervision over the exposures to RF of such people.

In summary, the situation on all types of implantable devices is a dynamic one in which there is constant innovation. It may be necessary to ensure that surgeons and physicians have some understanding of the implications for those involved in RF radiation, so that their patients can be given meaningful advice.

The application of exposure limits – recent developments

Although standards try to set exposure limits in such a way that they have a direct proportionality to the actual exposure effects experienced, it will be obvious from the foregoing paragraphs that the relationship between the exposure and the SAR distribution is very much affected by the frequency, field polarisation and the specific characteristics of the human bodies involved. Human bodies have complex variations in tissue properties, surfaces, internal structures and interfaces.

Also, human bodies in fields can alter the field distribution and this can be further disturbed by metal objects which they may be carrying. When very close to a source, i.e. in the near field, the nature of the coupling between the body and the source can vary according to the impedance of the source. Sources, effectively high impedance, will tend to couple predominantly with the electric field and low impedance sources with the magnetic field.

This problem has been highlighted with the use of mobile phones where the antenna and body of the instrument are not only very close to the head but also subject to the movements most of us make when using them. Similar considerations apply to other ranges of hand-held transmitter receivers with integral antennas, which usually have more power than commercial mobile phones.

This means that exposure limits do not have full validity unless they cover worst case situations. On the one hand, some sources may exceed the exposure limits but not result in much absorption whilst, on the other hand, in the close conditions discussed above, sources which meet the exposure limits may result in excess absorption in small masses of tissue. Some standards exempted low power sources under defined conditions but as a result of research into the issues raised by the public regarding mobile phones this provision had to be re-examined.

A great deal of attention is now devoted to the case of the mobile phone and this topic is covered further in Chapter 6.

The other side of the coin – beneficial effects of RF radiation

Discussion of the effects of RF radiation on people would not be balanced without a brief reference to the beneficial effects which have been and are being applied in the medical field. Some aspects of this are discussed in Chapter 2 where a typical HF radiotherapy machine is illustrated. Some current uses are, in summary, as follows:

Bony injuries

There is considerable evidence that the application of RF energy at the site of a fracture speeds up the healing of both soft tissues and bony injuries. This is now fairly well established as a technique, though the mechanism by which such healing takes place has not been established with any certainty.

Treatment of malignant tumours

If cancer cells can be heated rapidly enough to the cell thermal death point, they can be destroyed. Microwave energy lends itself to application for this

purpose. Current use is generally in association with other treatment, chemotherapy (cytotoxic drugs) or 'radiotherapy' (ionising radiation). Getting the RF energy to the tumour site can be a problem and care is needed to avoid unnecessary damage to healthy cells.

Other organs

Techniques have been described which enable the application of RF to the male prostate gland to shrink the gland. Surgery is not needed and patients can usually return home the same day.

Commercial products

There are many devices on sale to individuals which use RF or LF and which claim to treat various conditions. In general, there is little substantive evidence either way made available for many of these devices although some claiming to reduce pain have supportive users who consider them to be valuable.

Inevitably there will be some excessive claims for such devices based on the fact that for some people who have not found conventional help for their condition, they may try anything and if a device benefits them, it is understandable that they will not await some evidence of the approval of such equipment. It is unlikely that freely available items of this kind will pose any known radiation risk.

RF radiation effects - summary

The induction of RF energy in the human body in the form of heat is accepted though there is a practical problem of establishing the amount of heat energy and its distribution in the body, due to the difficulties involved in direct measurement. The susceptibilities of particular organs are known from considerations of the nature of the human body but practical experimental work is confined to animals with the consequent difficulty of extrapolating findings to human beings.

There is some data on the subject of induced body currents since it is practicable to use volunteers for such work and measuring techniques have become available. There is also some knowledge of aural effects from human experiments. Relatively little is known with any certainty about other possible effects, including those claimed as athermal effects, and much more research may be necessary to improve our knowledge in the face of the many difficulties, both technical and financial. Issues such as the questions raised by the Australian report mentioned above[26] need considerable research investment and, as noted by the NRPB, high quality research.

There is a body of knowledge, based on experimental work, for those indirect effects on people such as the inadvertent ignition of flammable

vapours and electro-explosive devices. The information in respect of flammable vapours could easily be made into an international standard.

There is an increasing knowledge of the problems of electromagnetic compatibility (EMC) and particularly the interference aspects of it as legislation now requires this to be dealt with by product designers in many countries. Although many aspects of RF interference are just a nuisance, some have life-threatening possibilities, e.g. interference with airborne aircraft control systems, interference with motor vehicle electronic control systems, firing of electrically operated detonators, etc.

Part 2 Incidents and accidents relating to RF exposure

Introduction

When health risks from electromagnetic fields are evoked, we can clearly distinguish the eventual chronic effects at levels below or around the limits established by standards and the acute effects of an overexposure. Accidental exposures without health consequences should be further considered to improve the means of prevention.

Such accidents are rare, and as the mode of interaction between electromagnetic fields and humans is quite different from other types of thermal injury (contact, ambient), it is difficult accurately to know how to explore, treat and survey the exposed personnel.

To improve our experience, there is a need:

- to review the literature and
- to register unpublished cases. A database can be useful in detecting such new cases.

The information needed and the survey protocols can be inferred from the literature review, and evaluated with a long term follow-up allowing improvement of the management of these accidents.

Difficulties arise because important information necessary for full comprehension of cases is often missing either by ignorance or because of industrial or military secrets. The author is indebted to Dr René de Seze et al. for permission to use information from their paper, including two tables[24]. The above introduction is taken from that paper since it does summarise key aspects very well.

There are a number of published papers commenting on data relating to alleged exposure accidents. Often the available data is inadequate to define the exposure either because records have not been kept, or the subject may not wish to disclose that he disregarded the local rules or even that he did not want to get involved with doctors!

The latter is very unwise and may involve a breach of regulations in many countries but does happen. There is a basic problem in that many doctors may have little experience of RF radiation. The reported treatment of one individual some years ago where he was admitted to hospital and put through tests for ionising radiation instead of RF radiation – and being duly frightened by the implication – because of either a communication failure or lack of understanding, does indicate the problems that can arise.

It is clearly important that all alleged RF exposure incidents are reported, even though there may be no obvious after-effect, if only to build a body of knowledge.

Some published data

Table 3.3 illustrates a few cases for which a medical comment was made in reference 24. For those interested in the details the full paper should be seen, especially for an explanation of the medical terms! The paper also gives a table of overexposures without resulting clinical damage (reproduced here as Table 3.4) which is interesting if only for the very large power densities quoted. Inevitably data is often missing from such tables and this may say something about the handling of incidents where they occur – incidents

Table 3.3 Summary table: overexposures to RF radiation with clinical comments

Year	Author	Source	Average power	Time of exposure	Power density Wm^{-2}	Clinical/ biological symptoms
1976	Baranski	radar 3 GHz	'high'	5 h	300 to 700	Heat, headache, vertigo
1982	Forman	radar 9–10 GHz		80 sec	600 to 900	↑ Creatine kinase
1983	Fleck H	microwave oven 2.45 GHz	600 W	5 sec		Neuropathy
1987	Nicholson	wood heater 20 kW?	20 kW?	2 sec		Burn – metallic material
1995	Marchiori	ditto		26 sec		Oedema, paresthesia
1997	Schilling	UHF TV antenna 1.75 kW	1.75 kW	1 to 2.5 min	>200	Diarrhoea, dysesthesia

Note that power densities have been changed from $mWcm^{-2}$ to Wm^{-2}

Table 3.4 Summary table: overexposures to RF radiation without clinical damage

Year	Author	Source	Average power	Frequency	Duration	Power density Wm^{-2}
1974	Graham	Troposcatter unit	1 kW	3.9–6.2 GHz	30 s	7200
1985						
1975	Graham	Radar	350 kW pk $\times 0.00025$	6–9 GHz	195 s	8500
1985						
1976	Baranski	Radar	'high power'	3 GHz	20 min	500–700
1978	Graham	Radar			>6 min	900
1985		2 people				
1978	Graham	Radar	110 W	9–10.9 GHz	4 min	4000
1985						
1980	Graham	Radar		mid UHF	15 s	5500
1985						
1981	Mitchell				15 s 4 s 3–5 s	5500 2685
1983	Graham	Radar – 6 technicians	100–150 kW		8 min	200–1450
1985						
1988	Hocking	TV bearer			90 min	50

Note that power densities have been changed from $mWcm^{-2}$ to Wm^{-2}

often not reported until much later so that data is lost, or because there is a lack of facilities with which to establish the data.

The object in studying overexposures is primarily to find out what to look for and how to treat the exposed people. In parallel with this is the need to learn from such incidents with a view to preventing them in the future and this need must take priority over any desire to hide incidents. This is one of the prime terms of reference of Dr R. de Seze's work and of this book and requires an improvement in education, supervision, guidance and particularly of safety auditing.

For those with medical knowledge, a report by the USA Brook AFB[25] gives a critique of a number of RF overexposure reports from around the world. These are quite detailed but do highlight a few general problems. Some of the medical effects reported are not recognised in Western medicine and many of the aspects queried relate to the nature of the study, the control groups used and in some cases the lack of data or statistical treatment.

The criticisms or comments do highlight the real difficulties in conducting proper studies, obtaining medical histories, exposure durations, etc. In one

case where military service trade titles are used as a basis for comparisons it highlights what has always been known by people in military organisations, namely that such titles are poor indicators of things such as RF exposure, since service duties are extremely varied and not always closely linked to the title or trade!

The report also notes that persons accidentally exposed to levels of RF radiation exceeding the permitted limits often manifest clinical symptoms such as headache, nausea, fatigue, malaise, and palpitations, which can be attributed to anxiety reactions to the situations, but it is impossible to completely rule out an organic etiology.

The causes of some incidents investigated by the author of this book highlight the mixture of factors involved, ranging from technical management, or, rather, its apparent absence, lack of knowledge on the part of the subject, some sort of ambiguity which causes misunderstanding or, rarely, to sheer stupidity. The following are a few examples.

Management

On a prototype high power radar equipment lacking a front panel, a piece of cardboard was fitted over the resulting hole and the equipment operated. Something caused one of the team to call for radiation measurements and a large beam of X-ray was found. Investigation showed that the cardboard had a real purpose as the mechanical engineer had to safeguard the cooling air supply. The senior technical engineer should have vetted the temporary arrangement but obviously did not. Looked at objectively, the mechanical engineer did a good job within the range of his knowledge. The same could not be said of anyone else.

On a transmitting station where equipment was being fitted by company A but site technical management was the responsibility of another company B, the company A engineer asked for the close-down of the transmitter to remove the output waveguide. The technical manager confirmed that it was switched off to the company A engineer who was located at the back of the transmitter ready to do the work. He removed the waveguide flange (1 kW source), felt a strange sensation and wisely leapt backwards. The transmitter was found to be switched on. This is an example of confirming something without actually checking. The reason was not established but the most likely cause was that the technical manager asked someone to switch off and there was some ambiguity in identifying which transmitter was concerned.

Lack of knowledge

Design engineer proposing to look down a live waveguide to observe something. He seemed totally unaware of modern optical aids which would obviate this silly practice. There was a history of this practice in the early

days of radar during the Second World War which was investigated, found to have caused cases of severe conjunctivitis and banned as a practice. Obviously the lesson was not well communicated, as looking into waveguides occurred occasionally for many years afterwards.

A new graduate engineer was sent to repair a height finder which was parked safely on the edge of a hilltop site facing outwards. For convenience he turned the antenna inwards onto the site and, when testing it, powered up causing fluorescent lights to come on in the huts nearby. This was found quite amusing until it was pointed out that an electrician might have been doing some re-wiring at the time. Being new, the engineer probably had no safety training.

Enthusiasm without communication

On a lighter note and, I hope, suitably disguised to avoid embarrassment, the following sequence of events took place on an installation site where the author was present. Two engineers were finishing installation of a very high power transmitter and decided to stagger their afternoon tea break so that work was continuous. The first man turned off the water supply and removed a valve. He then went to his tea break without passing his colleague, who was due back. The latter switched on the system and flooded the transmitter. Fortunately the switch-on sequence terminated so that no high voltages were switched on. Their penance took about a day with many rolls of tissue paper!

Sheer stupidity

The X-ray TLD badge of an employee was found to be 'full', i.e. it recorded the maximum dose possible. I knew that it was not possible when the badge was being worn since the only source was a small ion chamber, sealed and pumped down in operation. A test badge was put in the chamber and then sent for quick processing and gave the same result. It appeared that the badge user had put his badge in the chamber but since he denied it and normally kept his badge in an accessible place it had to be concluded that someone unknown put it in. Had it not been possible to deduce the cause it might have led to legal action and possibly some medical tests being carried out on the subject.

Whilst a 1 kW tactical troposcatter dish was lined up on a runway for detailed measurements and warning notices put at both ends of the runway, an engineer drove his car down the beam towards the dish. When stopped and asked why he had disregarded the prohibition warning, he said that he was a radar engineer and thought it did not apply to him. It was not clear whether he thought that radar engineers are, like the reputed King Canute, thought able to control the waves!

There are many more such cases and they do highlight the variables in the safety situation. Knowledge is not enough unless it is shared by all participants and communication is critical. The switch-off of equipment should always be checked personally by anyone about to do open panel work on equipment. Safety training needs to be taken seriously and, with new staff, given before they can do any harm.

Often the greatest hazard is the helpful person – helpful but lacking in knowledge. The author recalls doing measurements on a high power transmitter at a site where two new graduates were told to come and watch. They saw that I was accessing measurement on top of the transmitter from the side using a step ladder, and obviously noted that I was rather elderly! They offered to do that part of the measurements to my instructions, took the instrument and leapt onto the top of the transmitter. They failed to enquire why I had decided not to go on top of the transmitter – I was familiar with that transmitter!

One series of incidents is particularly worthy of some further examination. The first appears as the last item in Table 3.3 relating to a short report by Dr. Schilling. This concerned an incident known to the author but the following details are confined to those given by Dr Schilling in reference 39a. The importance of this incident is its very nature and the fact that it involved a double jeopardy.

Three men (referred to as A, B and C) were employed to service the main four channel UHF television array. To maintain the TV service a reserve antenna with about 1.75 kW mean power per channel was in use.

The men were working well below the powered reserve antenna when the skip in which they were standing was winched up instead of down, bringing the upper parts of the body close to the powered antenna panel. Man B's head was 3 to 6 inches from the panel. They also had a struggle stopping the skip turning over and falling to their deaths.

They felt a sensation of intense heating to the head, neck and left arm followed by head pains.

The paper gives considerable amount of medical detail which is well worth reading. They include headaches, impairment of light touch in nerves and numbness in places, diarrhoea, vomiting, lassitude, lack of stamina, etc. These varied according to the relative positions of the three people in the skip.

Two felt that it had taken a year to feel that their health was improving and the third felt much better after 18 months. It is thought that A and B who had the highest exposure may have been exposed to an RF level one order or more above the current NRPB adult limit of 50 Wm^{-2} . All three continue to have contact with Dr C. Schilling, the author of the paper.

This example shows how necessary it is to control all aspects of potentially high risk work, particularly the positioning of people working on towers when they do not have direct control of their own movement.

A further paper by Dr Schilling[39b] relates two more cases both connected with a broadcasting antenna tower and involving VHF (100 MHz) irradiation. These cases also involved a winch operated chair with a winch bond down the centre of the tower, the pilot bond being outside the tower. Six people were involved altogether, four in one incident and two in the other. The sequences of events in these cases are very detailed, and are best read together with the medical assessments, particularly by those involved in such broadcasting tower work.

The report runs to eight pages. In summary, out of the six people involved, two were appreciably affected, two less affected and two not affected. Differing work durations, positions on the tower, etc., applied to the people

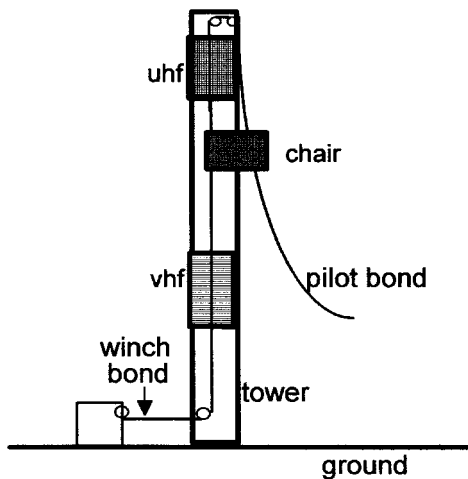

Figure 3.6 *Diagrammatic representation of chair winching on broadcast towers*

involved. The interesting fact is the long duration of effects on those assumed to have been involved in the highest fields when in close proximity of powered antennas and the winch bond. Dr Schilling raises questions about the role of the winch bond in the exposures, the relative nearness to human resonance, the appropriateness of the thermally determined NRPB limits, etc.

Figure 3.6 is a sketch illustrating the winching system referred to in these reports.

On reading these papers it seemed to the author that in very close encounters with feeders and other parts of antenna systems the predominant coupling method might be capacitive direct to the body. If this was the case, somewhat different calculations might be necessary to determine the effects.

Summary

It is clear from the cases cited in this chapter that the prevention of such accidents is very dependent on:

- The collection of full data on the radiation – power, modulation type, power densities or other field quantities
- Adequate information on the relative positions of the subject or subjects
- The sequence of activities which led to the incident
- Competent medical examination of the subjects
- A detailed review of the safety provisions in force and a judgement of their adequacy
- Consideration of the adequacy of safety training undertaken by the subjects and their supervisors
- The development of a database of such incidents. Embarrassment should not prevent such data being made available to those researching RF radiation accidents since this may help someone else avoid the situation. The source of the data can easily be disguised. There will sometimes be a case for an independent investigation to ensure objectivity.

4

The development of standards for human safety

This chapter deals with standards and guides concerned with RF radiation safety in respect of people. Part 1 is concerned with the general aspects of standards to assist the reader in understanding existing and future standards.

Part 2 examines typical standards current at the time of writing and provides and compares the basic details of those standards. It also deals with the provisions for multiple irradiations and peak pulse power.

Part 3 deals with the subject of the potential ignition of flammable substances with typical calculations from British Standard BS6656.

Part 1 Basic concepts of RF safety standards and guides for human exposure

Introduction

In order to provide guidelines for RF safety it is necessary to try and define safety limits which will reflect those findings of researchers in the field of RF safety which have been accepted by governments or standards bodies. It is inevitable that these limits will be subject to constant scrutiny and change and no book will ever be able to keep up with such changes. The aim of this part is to assist the reader in interpreting standards as they are developed.

Many countries have standards or guides on this subject and some have direct statutory laws. Those bodies which have had some recent influence include:

1 The American National Standards Institution (ANSI)

The C95.1 committee was operated directly under ANSI but now operates as a committee of the American Institution of Electrical and Electronic Engineers (IEEE).

2 International Commission on Non-Ionising Radiation Protection (ICNIRP)

ICNIRP is linked to IRPA, the International Radiation Protection Association. This body has operated for a number of years and provides recommendations for safety provisions in the radio frequency field. It also is concerned with other forms of non-ionising radiations. It has a link with the World Health Organisation (WHO). IRPA is an association of professional societies concerned with ionising and non-ionising radiation protection and states that it is non-governmental and non-political.

3 The UK National Radiological Protection Board (NRPB)

The NRPB acts as Statutory Adviser to the Health and Safety Commission on both ionising and non-ionising radiation and provides recommendations for the United Kingdom.

4 The USA Federal Communications Commission (FCC)

The FCC has responsibilities under the National Environmental Policy Act of 1969 for the assessment of RF emissions. It provides a considerable amount of technical information to the public via the Internet.

5 The Commission of the European Communities (EC)

The EC is currently drafting requirements for radiation protection involving the Directive for the Protection of Workers against the risks from exposure to Physical Agents and also the radiation content of the Machine Safety Directive. Radiation here covers all forms of ionising and non-ionising radiation.

The purpose of standards and guides in this field

- 1 Control of the exposure of people to electromagnetic fields.
- 2 The prevention of the ignition of flammable vapours and electro-explosive devices (EEDs) by RF energy.
- 3 The reduction of interference from sources of RF which may consequently cause harm to people and equipment.

It should be noted that the latter topic has wider significance in that it also embraces aspects not involving safety, such as the undisturbed use of electronic radio and television equipment. Consequently, separate provisions are made generally involving the testing of products to specified limits and this is widely referred to as electromagnetic compatibility (EMC).

Most countries will also have their own separate standards or guides to cover the potential ignition hazards of flammable vapours and civil electrically-operated explosive devices (EEDs). Military forces usually have standards and procedures to cover the risks peculiar to the military field, especially military explosive devices. These documents are not usually available in the public domain.

There is no useful relationship between the limits set in standards for the exposure of human beings and those which can cause radio interference since the latter must depend on the susceptibility of the equipment subject to the interference. Indeed a power density safety level of say 10 Wm^{-2} , as set by a particular standard for a band of frequencies, corresponds to a plane wave electric field strength of 61 Vm^{-1} , a level which is quite capable of interfering with sensitive circuits such as receiving and similar equipment.

In controlling human exposure to RF radiation there are two readily identifiable forms of safety standards reflecting whether the potential hazard relates to:

- Adventitious (unwanted) radiation in the form of leakage from RF sources. Standards dealing only with this aspect are referred to generally as 'leakage' or 'unwanted emission' standards.
- Intended radiation from an antenna, machine or applicator, the standards then being referred to as 'exposure standards'.

Leakage standards

Leakage standards generally set a maximum permitted radiation level at a defined distance from the surfaces of a source or product under specified conditions of use. Hence the microwave oven has a specification for leakage at a specific distance, usually 50 mm, but dependent on the standard concerned. Leakage limits may be defined by standards or by legal provisions. The tests are easy to define and carry out, though they can be tedious with large systems! In this sense, they are easy to use as a product standard. For box-type products such as microwave ovens, RF test sources of significant power and other similar items, leakage measurements are needed. For transmitting equipment leakage in the broadcast and television fields the relevant National Standard (occupational) is generally used. Often transmitters of all kinds are tested to in-house standards and, where applicable, to the purchaser's own specifications.

Specifications from purchasers of RF generating equipment exhibit considerable variation in requirements and measurement methods. Where there is no specific leakage test prescribed for a product, the permitted levels of the relevant national or other RF exposure standard are generally used, with RF leakage measurement mostly being undertaken at the standard distance of 50 mm.

For RF sources used on dedicated sites such as transmitting stations, equipment leakage will mostly affect the equipment user, since only those in close proximity to such equipment will be exposed to leaks which normally extend for relatively short distances.

On the other hand, the use of mobile or other equipment in the public domain is quite a different proposition since the public may be affected by leakage from the equipment, both in the safety context and also in respect of any interference problems, as well as being exposed to the antenna radiation.

In some cases the product concerned may be on domestic sale and thus used by the public generally, as is the case for some mobile radio equipment and for amateur radio transmitters. In all cases where there is intentional radiation there is, by definition, the possibility that people, including the public, at a distance from the source, may be affected by the field of the wanted radiation.

Those employed with the source of radiation may, of course, have a greater exposure owing to their closer proximity. Whilst leakage measurements take care of those who work in very close proximity to sources of RF, there is clearly a need for a standard for the control of the exposure of any person from intentional radiation whether they are in the public domain or employed with RF radiation.

Exposure standards

Exposure standards deal with the limits for human exposure to RF fields over the range of frequencies used or likely to be used. Situations in which exposure standards apply will be those where there is intended radiation which can interact with people and with the environment directly or by way of reflections of energy from structures and the ground.

Such reflection can considerably enhance the fields to which people are subjected. Of course, there will be cancellations from out-of-phase reflections as well, but the safety management aspect requires concentration on enhancements which increase exposure, where these occur. The magnitude of possible field enhancements should not be underestimated as the increase can be as much as four times or more. In power terms, this is 6 dB or more.

It will be seen from the foregoing that there is no philosophical distinction between leakage and exposure standards. The limit values used may be

identical and equipment which does not have its own leakage specification will, as previously noted, often be measured to the limits given in the relevant exposure standard.

The practical difference is the arbitrary determination of the measurement distance used for leakage standards, that is to say, the distance between the sensor of the measuring instrument and the outer surface of the source.

Another difference is the fact that leakage from equipment generally only affects people at relatively short physical distances from that equipment whereas for the exposure standard, depending on radiated power and antenna characteristics, the geographical area to be controlled may be large.

However, the difference between leakage and exposure tests, in terms of the end action is important. A leakage standard is basically a pass–fail standard so the outcome of a test failure is that work has to be done to reduce the leakage. After remedial action is completed, regular leakage check tests may be considered necessary, depending on the nature of the failure.

With intentional radiation there is clearly no desire to reduce the radiation level since the power used is that required for the operational function. Thus the task is rather to identify potential hazards and then separate people from those hazards. This means that there is usually a continuing requirement for active safety management in situations where there may be day-to-day changes in the potential hazard situation. This is a particular problem on test sites where new equipment is tested before despatch to customers, because of the regular physical movement of equipments in an ongoing activity.

As mentioned previously, there can be enhancements due to reflections from metal objects so the nature of the total environment can be very important. In particular, where RF is reflected from a resonant antenna or anything which fortuitously acts as one, there can be a concentration of the field with increases in excess of the figure mentioned above. This is particularly the case at microwave frequencies where the operation of antennas is quasi-optical. This problem is a common one on a development site where unused antennas are left in the area and are parasitically energised by a source of a frequency similar to that of the unused antenna (antenna reciprocity theorem).

In practice, there will often be more than one RF source at a given location and transmitting stations, in particular, often involve an appreciable number of transmitters. This can lead to the possible multiple irradiation of people employed outside in the proximity of antennas.

There can still be cases where power might have to be reduced when either the radiation is in the public domain and in excess of permitted levels or where personnel in an occupational situation cannot be excluded from the field because they have a task to undertake in a place where the radiation level is too high.

It may also be necessary where there is a risk to flammable substances or EEDs.

In the latter cases, the substances or devices may be on the same site as the transmitters or they might be nearby in the public domain and not owned or controlled by the transmitter operator. There may even be cases where the siting of a transmitter or transmitters cannot be contemplated at a particular place because examination of the proposed site and the neighbouring installations and facilities owned by other people, indicates that the risk is too great.

General features of standards

Basic restrictions

At the outset it should be noted that the 'safety limits' or 'safety values' which are set in standards do have a variety of names. Those names will be mentioned in Part 2 of this chapter. However, for the purposes of this chapter the general term 'safety limits' will be used, abbreviated to 'limits' where appropriate. The starting point in standards is the statement of basic restrictions on which the standard has been created. A common feature of all the standards discussed here is that a specific absorption rate (SAR) of 0.4 Wkg^{-1} is specified as the basis of occupational standards for a large part of the spectrum. They may also make provisions for higher SAR values in a very limited mass of tissue (e.g. 1 g or 10 g).

The choice of 0.4 Wkg^{-1} is based on thermal considerations and is considered to be one order below that which gives rise to observable effects. SAR is, of course, not measurable for a living person and cannot be used for practical measurement work. For theoretical purposes, measurements can be made with dummies as described earlier or modelled on a computer. Both suffer the limitation of not providing a simulation which accurately reproduces the thermo-regulatory capability of the human body.

Across the range of frequency used for RF radiation, the basis of safety standards does, increasingly, reflect the nature of the known RF interaction with the human body as new information is obtained about these interactions. For example, at the low frequency end of the RF spectrum, induced body and limb current densities and the consequent localised SARs are now the limiting factors. Limb currents can now be measured (see Chapter 7), though it may not necessarily be a requirement to do so.

In the HF/VHF region, human whole-body resonance occurs as a function of height and the SAR of a person is greatest at resonance. Hence provision has to be made in standards to limit the SAR at resonance.

At the highest end of the RF spectrum, in the higher gigahertz region, interest is centred on the deposition of energy in a small skin depth, i.e. the superficial skin layers and the possibility of the overheating of the skin. Hence the basic limits will be expressed in power density (Wm^{-2}).

In addition, most technical authorities advise people to get out of any microwave field which gives them a sensation of warmth in the skin, whether or not the measured field quantities exceed permitted values. This is a wise precaution, given our limited knowledge of such tissue interactions. It is true that in practice things such as the presence of a warm wind outdoors can give rise to a false impression of skin heating, but nevertheless the safest course is to accept it as a warning if it cannot be disproved, e.g. by turning off the radiation source.

In order to determine measurable safety limits, it is necessary to define derived limits, in terms of numeric limits for power density and the electric and magnetic field components which will ensure that the specified SAR is not exceeded. In addition, at the lower frequencies induced body and limb current density limits now have to be specified, as also do contact currents.

For situations where pulsed equipment such as radars, etc., are involved, a further limitation will be applied to the peak pulse energy.

The 'occupational' and 'public' limits issue

Some bodies concerned with standards consider that the limits for these two categories should be different, those for the public being lower than those for the occupational category. The medical and other aspects of the arguments relating to the two approaches are discussed in Chapter 3.

Ultimately, these amount on the one hand, to those who believe there is some scientific basis for provision of additional protection for the public and therefore advocate reduced levels. On the other hand, there are those who do not see any basic technical reasons and consider the matter as a social-political argument.

It will be seen later in this chapter that the trend seems to be towards providing separate limits for the public and for occupational purposes. As noted previously, it is necessary to define the two categories since many people in an organisation which uses RF sources may not be technical people. Such people are generally treated as 'the public' in the sense that they have not chosen to work with RF and are not knowledgeable on the subject.

This leads to a need to control access to areas where fields might exceed the limits for the public even though such areas lie within premises owned or controlled by the employer. Also, some transmitter sites, including those on military bases, may have children on site from time to time and children have a propensity to explore interesting objects! All standards effectively cover the public and occupational cases, but the applicable safety levels may or may not be identical. Where separate lower limits are specified for the public, they are, typically, one fifth of the occupational power density limits with corresponding division by $\sqrt{5}$ for the electric and magnetic fields although the application may not be uniform.

Contact currents

When metal masses are situated in an RF field, particularly at the lower frequencies (< 100 MHz approximately) it has always been known that it is possible to incur shocks and burns from contact with these metal masses. This is due to the parasitic induction of RF energy. Such masses may be scrap metal, stored antenna mast sections and similar objects or motor vehicles. The likely contact currents are not easily calculable for undefined masses of material, although some calculations are referenced in Chapter 3 for motor vehicles.

The consequences, in terms of possible burns, are equally difficult to forecast since the contact area of say, the hand, touching the metal mass determines whether the subject is burned or not. A large contact area such as a firm grip gives the least chance of burn compared with a point contact. However, few safety officers would be happy to suggest that anything remotely electrical should be grasped firmly! In any case, most such contacts, at least for those aware of the potential hazards, are probably accidental from stumbling or stepping back and hence likely to involve an unpredictable contact area. Contact current limits now form part of RF safety standards.

The author's experience in training people on the subject of RF radiation safety has indicated that burns in this context are sometimes confused with burns from contacting live antenna parts. It is important that the distinction is maintained as the risks from contact with, or arcing from, live parts of the antenna or transmitter circuitry can be potentially very serious at any time and any frequency and is a simple matter of energy transfer!

Often the metal object may be a vehicle body and the possible shocks involved should not be confused with the simple static charge shocks that are daily experienced in rooms and in vehicles. Some parts of a vehicle may be resonant – one task undertaken by the author with a military vehicle established that a very high field existed immediately above the cap of the petrol tank!

Limb currents

Research into currents induced in the human body when exposed to low frequency fields, has led to the recognition of such currents as being very significant below, perhaps, 100 MHz. The problem is current density (current per unit area, e.g. mA cm⁻²) which is not a measurable parameter for human beings.

Consequently, any practical limits set are usually given in terms of current rather than current density, making assumptions about the cross-sectional areas associated with the current flow. The basis of the concern about excessive current density in limbs, is that high localised SARs can result. For the purposes of defining limb currents in a way that could be measured, there is usually a formula for the maximum permitted current in the limbs.

The measurement of current flow in limbs is mentioned in Chapter 7. It has gradually become a reasonably established measurement technique at this juncture but the practice is probably mainly confined to research and engineering studies. Standards do not necessarily require measurement of limb currents, but these are now always taken into account when setting permitted limits by specifying the lower frequency field limits in such a way that the likelihood of excessive limb currents occurring is minimised.

Nevertheless it may be the case that in some situations these currents will still have to be measured because our knowledge of the relationships between field levels and limb currents is not adequately defined and most standards have a 'let out' clause warning that in some circumstances the relevant field quantity limits may not guarantee compliance with the required limb current limitations. As good current measurement practices are established and put into use, better evidence about limb currents will become available.

Time-averaging

Statements of numerical limits for field quantities are not complete without a specified averaging time. The product of power density and exposure time, for example, results in the determination of an energy density (Jm^{-2}).

Since about 1960, one-tenth hour (6 minutes) averaging has been established and many limits in standards are specified as the average power densities or other field quantities over a period of six minutes (0.1 hour). Consider, for example, a continuous limit for power density of 50 Wm^{-2} . This, over six minutes, can be expressed as an energy density in watt-hour or joule units.

In watt-hour units this is: $50 \text{ Wm}^{-2} \times 0.1 \text{ h} = 5 \text{ Whm}^{-2}$.

Hence an exposure to 100 Wm^{-2} for three minutes (0.05 of an hour), followed by zero exposure for the next three minutes would also give:

$$100 \text{ Wm}^{-2} \times 0.05 = 5 \text{ Whm}^{-2}.$$

Alternatively, the permitted limit could be expressed as:

$$50 \text{ Wm}^{-2} \times 360 \text{ seconds} = 18\,000 \text{ Jm}^{-2} \text{ (since } 1 \text{ W} = 1 \text{ Js}^{-1}\text{)}.$$

Clearly, some care must be used in the maximum power density allowed in practice, lest some instantaneous damage should occur. In fact in recent alterations to some standards, ceiling values are set for the time-averaging of some field quantities and currents.

Of course there are, for various reasons, other durations used for time-averaging as well as six minutes and these are identified in Part 2 of this chapter and in the individual standards discussed. From what has been said earlier it

will be obvious that one such case is with frequencies greater than about 10 GHz where skin damage has to be avoided by reducing averaging times.

Peak pulse energy

There has always been some concern about the possible effects of exposure to the very high 'peak pulse powers' used on modern radars and other pulsed equipment. Whilst there is no specific evidence of adverse effects on people, the very high values of power density involved inevitably cause most people to feel a little concerned. The 'aural' effect is discussed in Chapter 3 and the possibility of this happening is taken to be the factor to be considered in setting limits for this parameter.

Most standards now have some form of limit for the energy in the pulse. Limits set for peak pulse energy are usually given in Jm^{-2} or in terms of peak pulse power density (Wm^{-2}). In some cases the form of the calculation is given in the standard and needs to be followed explicitly.

Part 2 Typical current safety standards for human exposure

Introduction

Three standards have been chosen for more detailed examination and these are:

1 UK NRPB document: Documents of the NRPB – 'Board statement on restrictions on human exposure to static and time-varying electromagnetic fields and radiation', Volume 4, No. 5, 1993. Frequency range 0 to 300 GHz.[27] This should be read with NRPB Report NRPB-R301 1998[28], which materially affects the detailed interpretation of the document. Some of this material has been used below.

2 USA document: IEEE Standard for safety levels with respect to human exposure radio frequency electromagnetic fields 3 kHz to 300 GHz.

Formerly IEEE C95.1–1992 now updated to IEEE C95.1–1999.[4] The recent update mainly affected the body current provisions.

[Excerpts reprinted with permission from IEEE Std C95. 1–1999 'IEEE Standard for Safety Levels With Respect to Human Exposure to Radio Frequency Electromagnetic Fields, 3 kHz to 300 GHz', Copyright © 1999 by IEEE. The IEEE disclaims any responsibility or liability resulting from the placement and use in the described manner.]

3 ICNIRP document: Guidelines for limiting exposure to time-varying electric, magnetic and electromagnetic fields (>0 Hz to 300 GHz)[26]. The

‘greater than zero sign’ excludes static fields as these are dealt with in another document[72].

One other important document referred to here later is the USA Federal Communications Commission (FCC) table of limits used for the assessment of sites[75] as it is of interest in relation to the other three documents.

Individual countries also may have their own standards and these should not be overlooked by those working in those countries since there is a lot of variation between standards. It is worth noting that in media articles out-of-date standards are often quoted so that the identities of standards referred to should be checked carefully.

Terminology in the documents

Because of the need to repeat the above standard identities frequently, the following abbreviations are used:

NRPB93, IEEE99 and ICNIRP98, the two digits being omitted in text.

Table 4.1 shows the terminology used in these documents, and the frequency limits. For simplicity, they are all referred to as standards

Table 4.1 *Terminology and frequency coverage of selected standards*

<i>Attribute</i>	<i>NRPB93 (Doc. of NRPB Vol. 4, No. 5)</i>	<i>IEEE99 (IEEE C95.1-1999)</i>	<i>ICNIRP98 (ICNIRP 1998*)</i>
Term used for limits	Investigation levels	Maximum permitted exposure (MPE)	Reference levels
Classification of people/ environment	1. Adults 2. Children present	1. Controlled environments 2. Uncontrolled environments	1. Occupational 2. General public
Frequency coverage	0 to 300 GHz	3 kHz to 300 GHz	>0 to 300 GHz
Notes	Read the NRPB93 document in conjunction with NRPB-R301 report[28]	IEEE99 incorporates the 1999 modifications to the IEEE91 document	*This document was published in ‘Health Physics’ Vol. 74, No. 4, April 1998

Supplementary documents discussed:
FCC evaluation limits – general
FCC evaluation limits – amateur radio
NRPB evaluation limits – amateur radio

documents in this book although only the USA document is entitled 'Standard'. The NRPB document is a guide but has a relationship to the UK Health and Safety at Work legislation, in that conformity to the guidance therein will satisfy the normal safety requirements. The ICNIRP document describes itself as 'ICNIRP Guidelines'.

Again, the numerical values given in these documents are, in the generality, referred to here as 'limits'. For most practical work this will be the case, since statements that other values may be used providing the basic reference values are not exceeded, are difficult to establish, as noted in IEEE99 and the time factor for everyday work makes this provision rather academic.

In tabulating the numerical values for the three documents on a comparative basis, the lowest frequencies have been omitted as not very relevant to this book, but are available in the individual documents. Before using these standards, it is essential that a copy of the full standard document is obtained since there is a great deal of explanatory material in each of them which is specific to that document.

The limit values for the three standards are tabulated under the general headings of 'occupational' (Table 4.2) and 'public' (Table 4.3). The correct classifications are given at the top of the individual tables. It will be seen from these tables that ICNIRP use the categories 'occupational' and 'public' which appears straightforward. The IEEE standard uses 'controlled' and 'uncontrolled' areas, which in the author's opinion is the clearest approach, although not entirely free of problems. It is analogous to similar provisions in the ionising radiations field. The NRPB uses the classifications 'adults only' and 'children present'. The latter may be found difficult to understand but relates to the resonance frequencies of small people relative to that of adults. These aspects are considered further in Chapter 3.

In these tables, the power density (S), electric field strength (E) and magnetic field strength (H) are given.

The three standards also give the B field values (magnetic flux density) in tesla. These are not shown in the tables or the following graphs since they can be derived directly from the H field values (Am^{-1}). $B = \mu H$ and for a vacuum, air or non-magnetic materials, μ is $4\pi \times 10^{-7}$. Hence on this basis $1 \mu\text{T} = 0.8 \text{Am}^{-1}$ or $1 \text{Am}^{-1} = 1.257 \mu\text{T}$.

Basic restrictions

As previously noted, each standard has specified basic reference values from which the permitted values have been determined.

These are too detailed to be reproduced here but should be read in the standard relevant to the reader. The broad basis is generally 0.4Wkg^{-1} but with specific provisions for frequencies below 100 MHz in respect of body and limb currents and also at the very high microwave frequencies where the averaging

Table 4.2 'Occupational' or equivalent limits

POWER FLUX DENSITY					
<i>NRPB – Adult</i>		<i>ANSI/IEEE – Controlled</i>		<i>ICNIRP – Occupational</i>	
<i>Frequency</i>	<i>Wm⁻²</i>	<i>Frequency</i>	<i>Wm⁻²*</i>	<i>Frequency</i>	<i>Wm⁻²</i>
10–60 MHz	10	100–300 MHz	10	10–400 MHz	10
60–137 MHz	2700 f ²	300 MHz–3 GHz	f/30	400–2000 MHz	f/40
137 MHz–1.1 GHz	50	3–15 GHz	100	2–300 GHz	50
1.1–1.55 GHz	41 f ²	15–300 GHz	100		
1.55–300 GHz	100	(*original in mWcm ⁻²)			
	f = GHz		f = MHz		f = MHz

ELECTRIC FIELD STRENGTH					
<i>NRPB – Adult</i>		<i>ANSI/IEEE – Controlled</i>		<i>ICNIRP – Occupational</i>	
<i>Frequency</i>	<i>Vm⁻¹</i>	<i>Frequency</i>	<i>Vm⁻¹</i>	<i>Frequency</i>	<i>Vm⁻¹</i>
600 kHz–10 MHz	600/f (MHz)	0.1–3 MHz	614	0.065–1 MHz	610
10 MHz–60 MHz	60	3–30 MHz	1842/f	1–10 MHz	610/f
60 MHz–137 MHz	1000 f (GHz)	30–100 MHz	61.4	10–400 MHz	61
137 MHz–1.1 GHz	137	100–300 MHz	61.4	400–2000 MHz	3√f
1.1 GHz–1.55 GHz	125 f (GHz)			2–300 GHz	137
1.55–300 GHz	194				
	f shown thus ()		f = MHz		f = MHz

MAGNETIC FIELD STRENGTH					
<i>NRPB – Adult*</i>		<i>ANSI/IEEE – Controlled</i>		<i>ICNIRP – Occupational</i>	
<i>Frequency</i>	<i>Am⁻¹</i>	<i>Frequency</i>	<i>Am⁻¹</i>	<i>Frequency</i>	<i>Am⁻¹</i>
535 kHz–10.6 MHz	18/f ² (MHz)	0.1–3 MHz	16.3/f	0.065–1 MHz	1.6/f
10.6 MHz–60 MHz	0.16	3–30 MHz	16.3/f	1–10 MHz	1.6/f
60 MHz–137 MHz	2.7 f (GHz)	30–100 MHz	16.3/f	10–400 MHz	0.16
137 MHz–1.1 GHz	0.36	100–300 MHz	0.163	400–2000 MHz	0.008√f
1.1 GHz–1.55 GHz	0.33 f (GHz)			2–300 GHz	0.36
1.55 GHz–300 GHz	0.52				
	f shown thus ()		f = MHz		f = MHz

*In the original standard document no values of 'H' field are given above 10 MHz (adult) but a subsequent report[28] remedied this.

Table 4.3 'Public' or equivalent limits

POWER FLUX DENSITY					
<i>NRPB – Child present</i>		<i>ANSI/IEEE – Uncontrolled</i>		<i>ICNIRP – Public</i>	
<i>Frequency</i>	<i>Wm⁻²</i>	<i>Frequency</i>	<i>Wm^{-2*}</i>	<i>Frequency</i>	<i>Wm⁻²</i>
12–200 MHz	6.6	100–300 MHz	2	10–400 MHz	2
200–400 MHz	165 f ²	300 MHz–3 GHz	f/150	400–2000 MHz	f/200
400–800 MHz	26	3–15 GHz	f/150	2–300 GHz	10
800 MHz–1.55 GHz	41 f ²	15–300 GHz	100		
1.55–300 GHz	100	(*original in mWcm ⁻²)			
f = GHz		f = MHz		f = MHz	

ELECTRIC FIELD STRENGTH					
<i>NRPB – Child present</i>		<i>ANSI/IEEE – Uncontrolled</i>		<i>ICNIRP – Public</i>	
<i>Frequency</i>	<i>Vm⁻¹</i>	<i>Frequency</i>	<i>Vm⁻¹</i>	<i>Frequency</i>	<i>Vm⁻¹</i>
600 kHz–12 MHz	600/f (MHz)	0.1–1.34 MHz	614	0.15–1 MHz	87
12–200 MHz	50	1.34–3 MHz	823.8/f	1–10 MHz	87/√f
200–400 MHz	250 f (GHz)	3–30 MHz	823.8/f	10–400 MHz	28
400–800 MHz	100	30–100 MHz	27.5	400–2000 MHz	1.375√f
800 MHz–1.55 GHz	125 f (GHz)	100–300 MHz	27.5	2–300 GHz	61
1.55–300 GHz	194				
f shown thus ()		f = MHz		f = MHz	

MAGNETIC FIELD STRENGTH					
<i>NRPB – Child present</i>		<i>ANSI/IEEE – Uncontrolled</i>		<i>ICNIRP – Public</i>	
<i>Frequency</i>	<i>Am⁻¹</i>	<i>Frequency</i>	<i>Am⁻¹</i>	<i>Frequency</i>	<i>Am⁻¹</i>
535 kHz–12 MHz	18/f ² (MHz)	0.1–1.34 MHz	16.3/f	0.15–1 MHz	0.73/f
12–200 MHz	0.13	1.34–30 MHz	16.3/f	1–10 MHz	0.73/f
200–400 MHz	0.66 f (GHz)	30–100 MHz	158.3/f ^{1.668}	10–400 MHz	0.073
400 MHz–800 MHz	0.26	100–300 MHz	0.0729	400–2000 MHz	0.0037√f
800 MHz–1.55 GHz	0.33 f (GHz)			2–300 GHz	0.16
1.55–300 GHz	0.52				
f shown thus ()		f = MHz		f = MHz	

time reduces rapidly from, typically, the six-minute period to a very short period. Note also that some averaging times also vary at lower frequencies in some standards. Figure 4.1 gives a broad indication of the nature of the basic restrictions, the actual frequencies shown vary with the standards concerned. It should not be thought that the division lines imply exact limits of influence, but rather, that they imply the predominance of an effect.

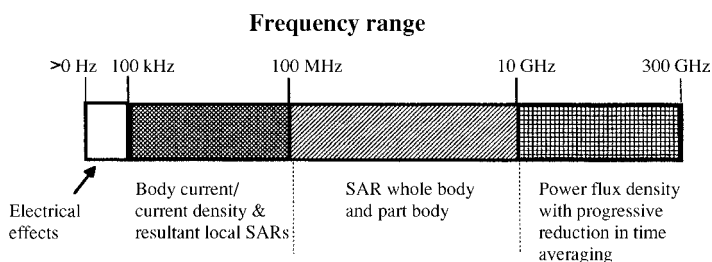

Figure 4.1 Outline of the criteria for deriving basic reference values

Field relationships

It is useful to remember the plane wave field relationships involved when looking at the detail of standards:

$$S \text{ (Wm}^{-2}\text{)} = E \text{ (Vm}^{-1}\text{)} \times H \text{ (Am}^{-1}\text{)}$$

where E and H are the electric and magnetic field strengths, respectively, and S is the power density.

Where S is divided by a number, e.g. 5, as in the ICNIRP standard public limits, E and H are each divided by $\sqrt{5}$, since for plane wave conditions

$$S/5 = E/\sqrt{5} \times H/\sqrt{5}$$

Values are all r.m.s. unless otherwise stated.

Power density (Wm^{-2})

In Table 4.2 (occupational or equivalent category) and Table 4.3 (public or equivalent category) it will be noted that power density is not a relevant parameter at the lower frequencies and the starting point for power density limits may differ from standard to standard. In this case, two start at 10 MHz and the third starts at 100 MHz. In general it is considered that below 10 MHz both fields (E and H) should be measured. Between 10 and 300 MHz this requirement may or may not prove necessary.

Figure 4.2 combines the three standards under the heading ‘occupational’, and it can be seen that there is a significant difference between the NRPB and the IEEE especially in the 10 to 1000 MHz region. Above 1 GHz the ICNIRP figures are half of those of the other two standards! Indeed they go back to the 50 Wm^{-2} applicable in some previous standards.

Comparison of Occupational limits

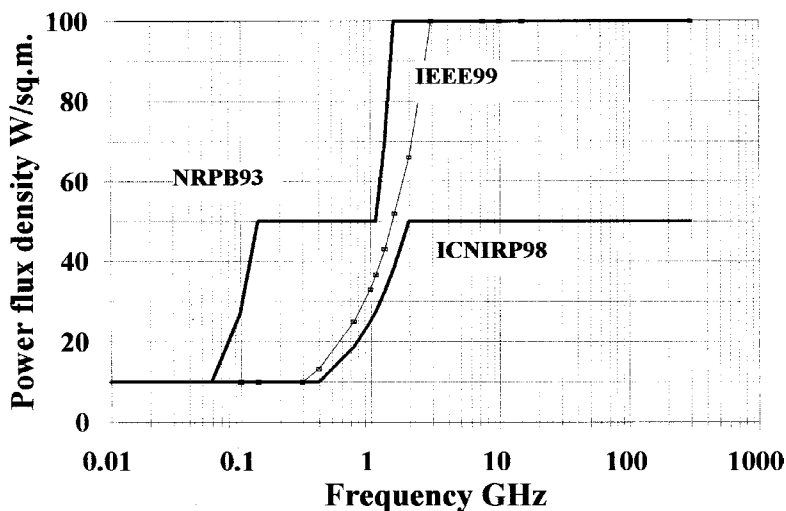

Figure 4.2 Comparison of power density limits for three standards (Occupational)

The implication for those who currently use a standard permitting 100 Wm^{-2} at the higher frequencies but intend to change over to the ICNIRP limits may be considerable in respect of repeat survey work and possible safe boundary limit changes.

Figure 4.3 shows a similar comparison for the ‘public’ category.

Figures 4.4 to 4.9 inclusive illustrate the electric and magnetic field limits for each standard. Note that the starting point on the graphs may not be that of the standard as two standards go down to 0 Hz, the third (ICNIRP) going just above 0 Hz, as shown by the note excluding DC fields. The omitted low frequency values, which are not very relevant to this book, would, if included, reduce the resolution of the graphs.

Looking first at the IEEE electric field graph Figure 4.4, it can be seen that the two curves coincide until just above 1.34 MHz where the uncontrolled

Comparison of Public limits

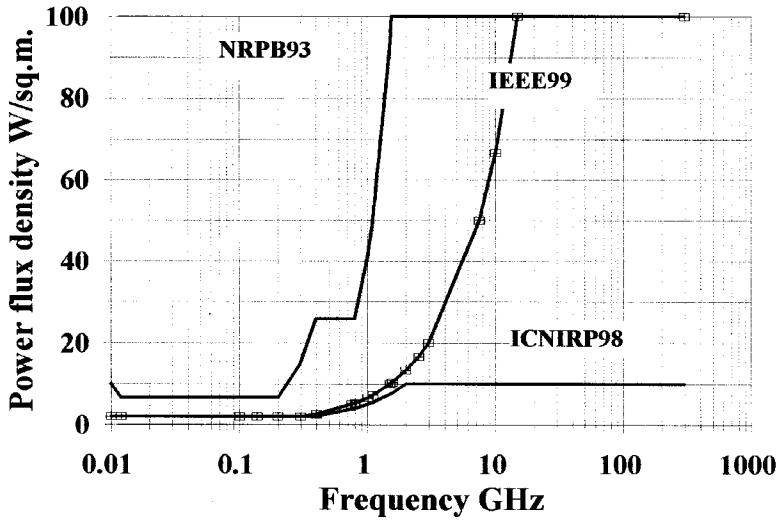

Figure 4.3 Comparison of power density limits for three standards (Public)

IEEE99 Electric field

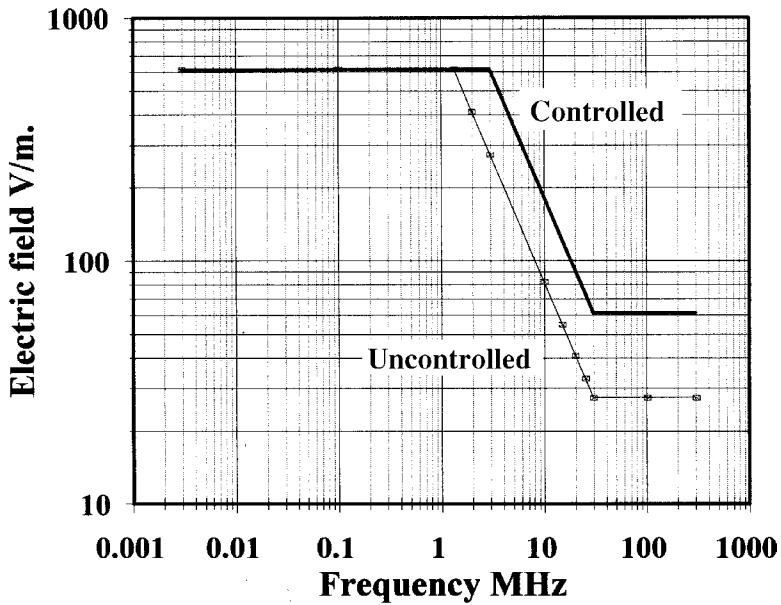

Figure 4.4 IEEE99 electric field

IEEE99 Magnetic field

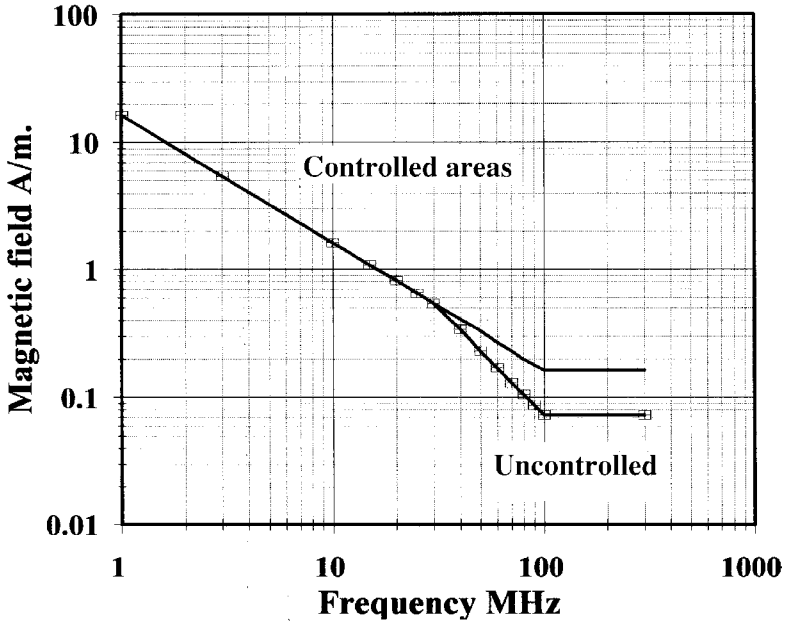

Figure 4.5 IEEE99 magnetic field

NRPB93 Electric field

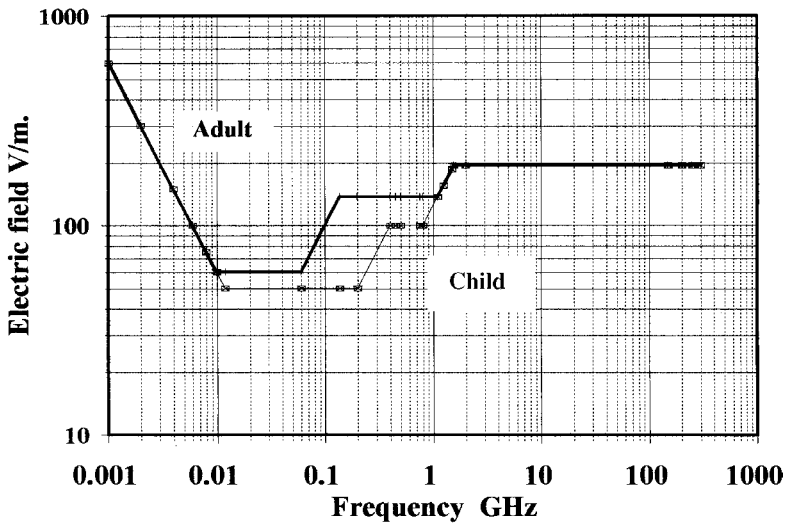

Figure 4.6 NRPB93 electric field

NRPB93 Magnetic field

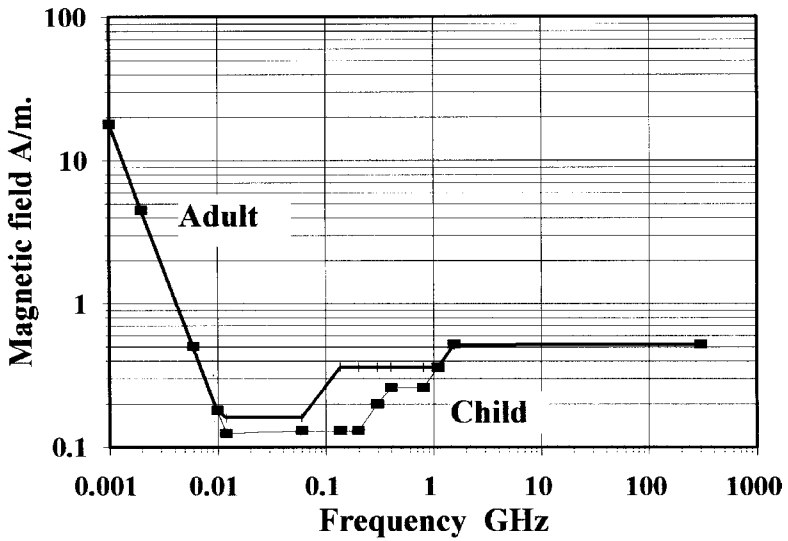

Figure 4.7 *NRPB93 magnetic field*

ICNIRP98 Electric field

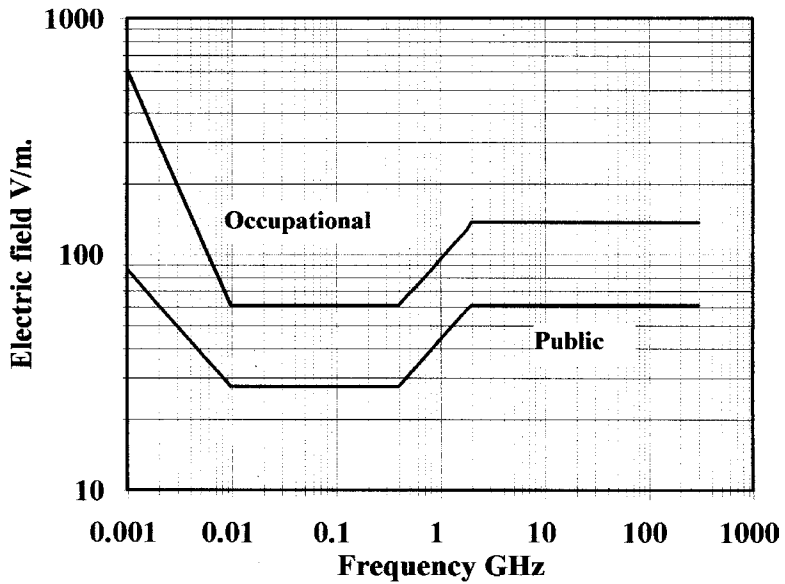

Figure 4.8 *ICNIRP98 electric field*

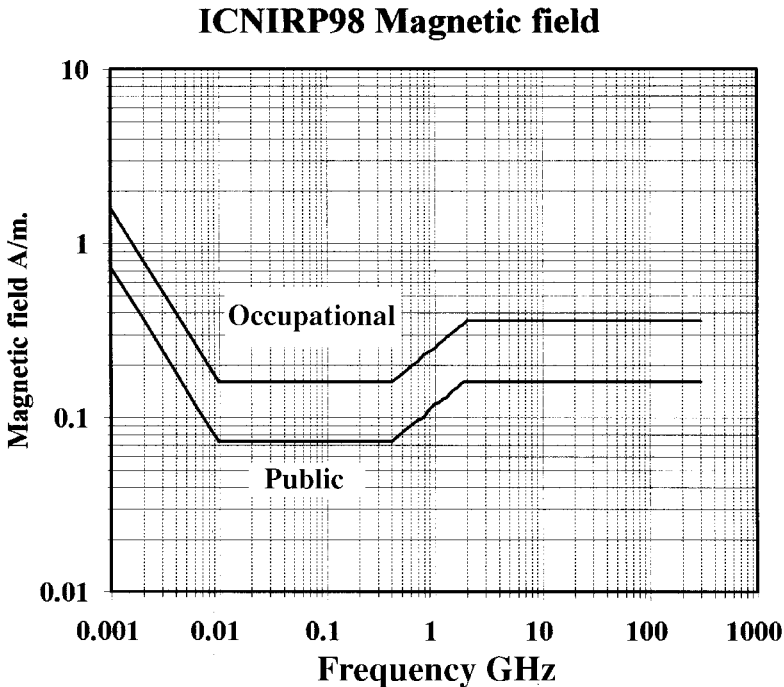

Figure 4.9 ICNIRP98 magnetic field

limits curve reflects a reduction by a division factor of $\sqrt{5}$ on the same rationale, but not with the same numbers, as the ICNIRP public curve. For the magnetic field curves in Figure 4.5 the uncontrolled limits curve starts to drop progressively below the controlled area curve after 30 MHz and eventually reducing to a value corresponding to the controlled area value divided by $\sqrt{5}$.

For the NRPB graphs (Figure 4.6, electric field and Figure 4.7, magnetic field) the patterns of the two curves are similar with the ‘child present’ curves tapering down from the adult limits and then rejoining them. The lower frequency shown is limited to 1 MHz to improve resolution. The maximum extent of the difference in both illustrations is roughly a division by $\sqrt{5}$. Note that when reading the NRPB93 document no ‘H’ field values are given for adults at frequencies above 10 MHz but the 1998 NRPB report, mentioned at the beginning of this part, remedied this and the graph utilises the new information as does Table 4.2.

With the ICNIRP electric field graph Figure 4.8, it can be seen that below 10 MHz the ‘public’ curve does not follow the $\sqrt{5}$ reduction but that the reduction is appreciably greater. From 10 MHz the reduction is by a factor

of $\sqrt{5}$. For the magnetic field in Figure 4.9 the ‘public’ curve follows the occupational curve with the numerical values reduced by $\sqrt{5}$.

Induced limb and body currents

Only the ICNIRP and IEEE specify these separately. These are shown from 10 kHz to 100 MHz (IEEE) and 10 MHz to 110 MHz (ICNIRP) in Figure 4.10.

Induced body/limb current limits

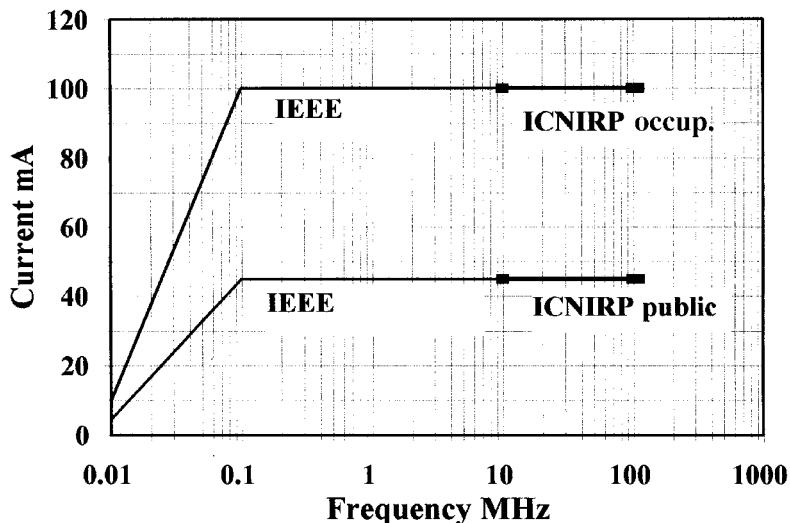

Figure 4.10 *Induced body/limb currents*

Since the latter only specify limits between 10 MHz and 110 MHz and the numerical values coincide with the IEEE standard, the ICNIRP curves are the bold horizontal lines overlapping the end of the IEEE curves. The IEEE current levels are for ‘each foot’ and the ICNIRP are specified as ‘induced in any limb’.

Note that recent changes in the IEEE document set maximum permitted values over the period of averaging specified. This is to avoid excessive currents for short periods of the averaging time still giving apparently acceptable results over the full averaging periods.

This is also true for contact currents below.

Contact currents

Figures 4.11 and 4.12 illustrate the occupational and public limits respectively. Note that the ICNIRP document extends these limits to 110 MHz rather than the usual 100 MHz. The graphs have been limited to the lower figure as the extension would hardly be discernible. Both these figures show quite a wide spread of permitted limits. The public limits can often be the key factor if the transmission equipment is in the public domain or when the equipment is on private premises but the field extends into the public domain, e.g. on MF and HF stations.

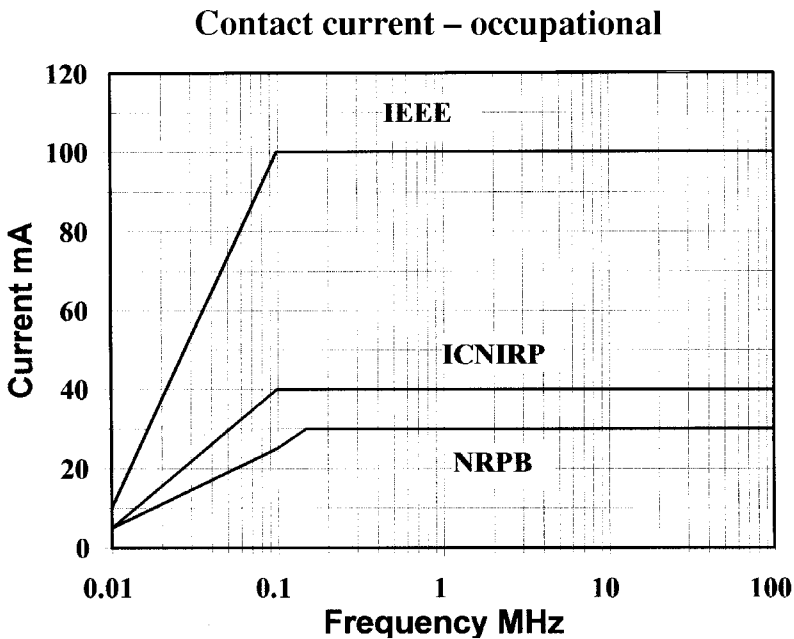

Figure 4.11 *Contact current (occupational)*

As noted earlier, the ICNIRP document generally is more restrictive than other standards. There will always be differences between bodies producing such standards in so far as the degree of conservatism needed in setting standards is concerned since this is very subjective. Perhaps the main difference between the three standards is that the IEEE and the NRPB documents involved consultations with interested parties, whereas the ICNIRP document does not seem to have involved wide outside consultation. It is likely to have considerable impact on systems operating in the public domain at frequencies where the limits are particularly tight.

Contact current – public

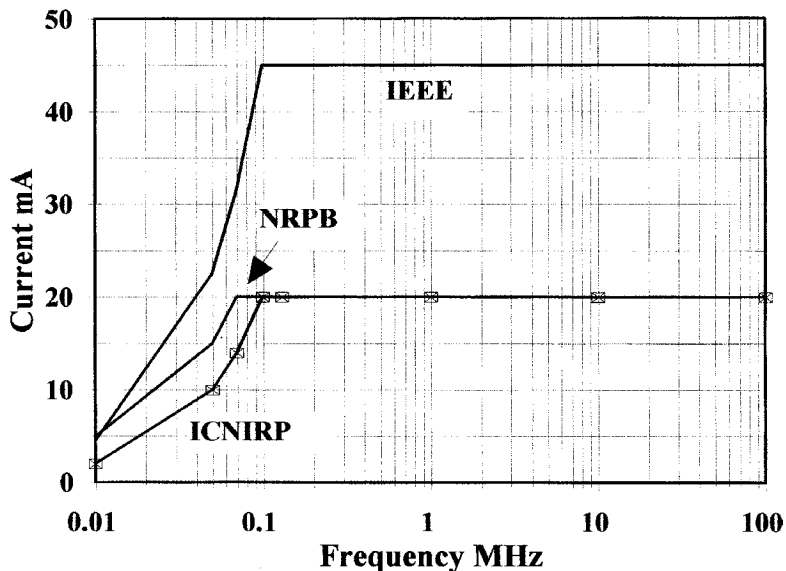

Figure 4.12 Contact current (public)

Federal Communications Commission (FCC–USA)

The FCC has produced a lot of detailed guidance in a series of documents which can be downloaded from their internet site[75] (see also Appendix 3). What is of some particular interest is that the FCC limits for general application in assessing installations, differs markedly from the IEEE99 standard. The FCC tables are reproduced here as Tables 4.4 (occupational) and 4.5 (general population). It can be seen that there are distinct differences from IEEE99.

Table 4.4 FCC limits for Occupational/Controlled exposure (MPE)

Freq. Range MHz	Electric field strength (E) Vm^{-1}	Magnetic field strength (H) Am^{-1}	Power density (S) Wm^{-2} #	Averaging time [E^2 , H^2 , or S (minutes)]
0.3–3	614	1.63	(1000)*	6
3–30	1842/f	4.89/f	(9000/f ²)*	6
30–300	61.4	0.163	10	6
300–1500	–	–	f/30	6
1500–100 000	–	–	50	6

f = frequency in MHz *Plane wave equivalent power density # $mWcm^{-2}$ changed to Wm^{-2} .

Table 4.5 FCC limits for General Population/Uncontrolled exposure (MPE)

Freq. Range MHz	Electric field strength (E) Vm^{-1}	Magnetic field strength (H) Am^{-1}	Power density (S) Wm^{-2} #	Averaging time [E^2 , H^2 , or S (minutes)]
0.3–1.34	614	1.63	(1000)*	30
1.34–30	824/f	2.19/f	(1800/f ²)*	30
30–300	27.5	0.073	2	30
300–1500	–	–	f/150	30
1500–100 000	–	–	10	30

f = frequency in MHz *Plane wave equivalent power density # $mWcm^{-2}$ changed to Wm^{-2} .

Time-averaging

When limit values are given for field quantities it is, as noted earlier, implicit that those values are the average of a specific time period.

The most universal averaging time is six minutes (0.1 h) but in specific standards there can be a number of variations. Further, a common feature of all modern standards is to recognise that special provisions are needed above about 10 GHz because most of the energy is deposited in the superficial skin layers. Note that recent clarifications relating to the new issue of IEEE99 and NRPB Report 301 also affect time-averaging both in respect to the durations used and, in some cases, the imposition of an absolute maximum value of field or other quantity allowed in the averaging process.

NRPB93

Below 100 kHz time-averaging is not appropriate. For frequencies above 100 kHz, the general recommendation is 30 minutes averaging for whole-body exposure and 6 minutes for part body exposures. Also 6 minutes should be used when the permitted levels only are used to show compliance and there is no information about localised SARs. When averaging between 100 kHz and 10 MHz, the electric and magnetic field levels should be converted to equivalent power density before applying time-averaging or the field strength should be squared, averaged over time and the square root taken to compare with the permitted level. Note that there are further detailed limitations on the averaging of the electric and magnetic fields.

At 10 GHz the averaging time should be 6 minutes in all cases and above that frequency the averaging time reduces in accordance with the expression:

$$\text{averaging time (minutes)} = 68/f^{1.05}$$

where f is in GHz up 20 GHz and is 10 seconds thereafter.

$$\text{Example: } f = 15 \text{ GHz; } 68/15^{1.05} = 3.9 \text{ minutes}$$

ICNIRP98

Above 100 kHz, power density, E^2 and H^2 are averaged over 6 minutes and above 10 GHz the expression $68/f^{1.05}$ (meanings as for NRPB above) is applied to power density, E^2 and H^2 without the limitation to 20 GHz above. If B is used then B^2 is used in these expressions. Squaring the field quantities relates the above expressions to power density.

IEEE99

For controlled environments, 6 minutes is used up to 15 GHz. Thereafter the formula: averaging time (minutes) = $616\,000/f^{1.2}$ where f is in MHz, is applied. Example:

$$100\text{ GHz (f = 100\,000 MHz) time} = 0.62\text{ minutes}$$

Induced body current and contact currents are averaged over 1 second ($0.003 < f \leq 0.1$ MHz) and six minutes for $0.1 < f < 100$ MHz.

For uncontrolled environments, the averaging times vary with frequency with 30 minutes predominating up to 3 GHz (except for H where 6 minutes predominates). Between 3 GHz and 15 GHz the expression $90\,000/f$ minutes is used, giving 6 minutes at 15 GHz. Thereafter the formula above for controlled areas applies.

Figure 4.13 shows the two expressions for averaging time in the high gigahertz region, plotted alongside each other. Apart from the NRPB limitation, there is not a great deal of difference.

Multiple irradiations

In the real world there may be situations where the subject is simultaneously irradiated from more than one source, scanning or fixed. Indeed, we are all irradiated simultaneously in our homes by all the signals we can receive on our portable radio sets! However, for most people these will be in the form of very low level signals! The most obvious concern here is for those relatively near to high power transmitters such as the engineers and technicians employed on those equipments, though it could apply to the public domain if near to the multiple sources.

To assess these exposures it will, therefore, be necessary to establish each exposure individually and sum them by the methods which follow. Note that the methods may show some differences according to the safety standard in use.

Time-averaging – above 10 GHz

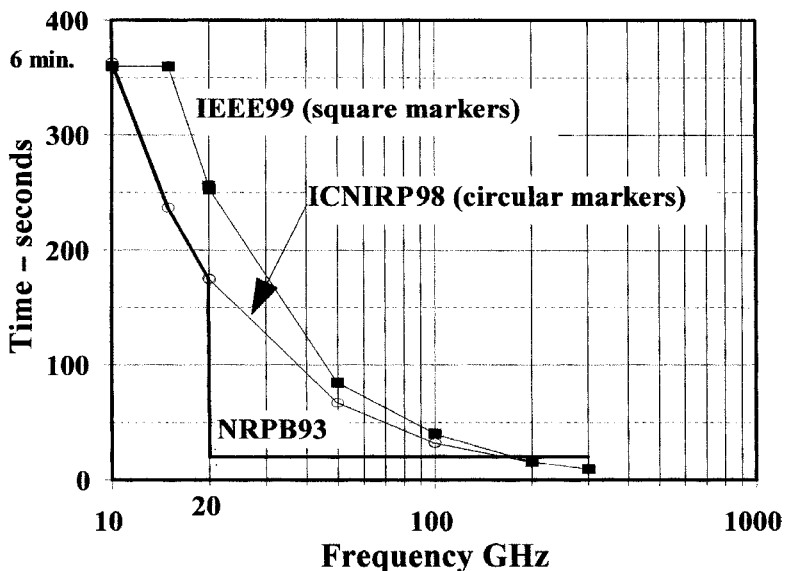

Figure 4.13 Time-averaging above 10 GHz

Simultaneous irradiation from several sources (see also Chapter 5, Part 3)

NRPB93

The NRPB uses the simple summation of the ratio ‘measured value over permitted value’ (R_f in the two expressions below) for each source of radiation, the sum not to exceed 1.

$$\sum_{0\text{Hz}}^{10\text{MHz}} R_f \leq 1 \quad \text{Use E/H field values} \quad \sum_{100\text{kHz}}^{300\text{GHz}} R_f \leq 1 \quad \text{Use power densities}$$

However the detailed application of this from NRPB report 301 amends this approach by clarifying the definition of R_f and specifying what frequencies may be combined as follows:

At frequencies below 100 kHz, exposure guidance is based on electrical stimulation effects. Above 10 MHz, exposure guidance is based on the avoidance of thermal effects. Between 100 kHz and 10 MHz both electrical stimulation and thermal effects are considered.

When simultaneous exposures at different frequencies occur, the exposures should be summed if they give rise to the same biological effect. In other words, all exposures below 10 MHz should be summed since these

may all produce induced current effects. All exposures above 100 kHz should be summed since these may all produce thermal effects.

Exposures below 100 kHz should not be added to exposures above 10 MHz because they produce entirely different biological effects. The exposures are added as fractions of the relevant investigation level. When the basis of summation is the avoidance of electrical stimulation effects, exposures should be combined as fractions of the field strength investigation level at each frequency. When the basis of summation is the avoidance of thermal effects, time-averaging of each exposure is permissible and the exposures (E and H fields) should be combined either by converting the field values to equivalent power density and summing as fractions of the permitted values or by squaring the fractions 'measured field value/the relevant permitted value', the permitted values being chosen from the appropriate tables in the standard for each frequency.

ICNIRP98

This document provides several formulae for simultaneous irradiation by more than one source, covering situations involving field quantities, limb and contact currents, induced current density and electrical stimulation effects. Only those expressions covering field quantities are dealt with below.

Thermal considerations – frequencies above 100 kHz

The following apply to field quantities:

$$\sum_{i=100\text{ kHz}}^{1\text{ MHz}} \left(\frac{E_i}{c} \right)^2 + \sum_{i>1\text{ MHz}}^{300\text{ GHz}} \left(\frac{E_i}{E_{Li}} \right)^2 \leq 1$$

$$\sum_{j=100\text{ kHz}}^{1\text{ MHz}} \left(\frac{H_j}{d} \right)^2 + \sum_{j>1\text{ MHz}}^{300\text{ GHz}} \left(\frac{H_j}{H_{Lj}} \right)^2 \leq 1$$

Where:

E_i = electric field strength;

E_{Li} = electric field reference level – both at frequency i ;

H_j = magnetic field strength;

H_{Lj} = magnetic field reference level both at frequency j ;

c = $610/f \text{ Vm}^{-1}$ (occupational) or $87/\sqrt{f} \text{ Vm}^{-1}$ (general public);

d = $1.6/f \text{ Am}^{-1}$ (occupational) or $0.73/f$ (general public).

f in MHz for c and d .

Both summations must meet the summation criterion.

The provisions for summing limb and contact currents are also given and the standard should be consulted for details. Basically, from 10 MHz to 110 MHz the limb currents are summed on the basis that the sum of the squares of the individual ratios of measured current/permited current does not exceed 1. Below 10 MHz there are other provisions. For contact currents from 1 Hz to 110 MHz the measured current/permited current ratios are summed without taking the squares, again the limit for the sum is unity.

IEEE99

Here the requirement for summing simultaneous irradiations is to sum the ratios of the time averaged squares of the measured electric field values and the corresponding squared permited limit (MPE). The same applies to the magnetic field strength and both

$$\sum_{i=1}^n \frac{E_j^2}{MPE_i^2} \leq 1 \quad \sum_{i=1}^n \frac{H_i^2}{MPE_i^2} \leq 1$$

sums must not exceed 1.

Both summations must separately meet the summation criterion. Power densities are summed without squaring the ratios, and should have the same limit of unity.

Specifying peak pulse power density limits (see also Chapter 5)

The main methods used to specify a limit for S_{pk} are generally either to give specific peak pulse power density limits directly or to specify a limit for pulse energy (Jm^{-2}).

The INIRP98 document

This provides for peak pulse power density and the corresponding field components by means of a multiplier so that the normal mean power density limits in the standard are multiplied by 1000. For plane wave conditions, this corresponds to $\sqrt{1000} = 32$ times the electric and magnetic field components.

Thus for the gigahertz region of the occupational limits, the greatest allowed pulse peak power density is $(50 \times 1000) = 50\,000 \text{ Wm}^{-2}$.

The NRPB93 document

This specifies that in any period of $30 \mu s$ the absorbed energy in the head shall not exceed 10 mJkg^{-1} – equivalent to an energy density of 0.28 Jm^{-2} .

This can be converted to peak pulse power density by dividing it by the duration of a pulse or pulses in seconds: $S_{pk} (\text{Wm}^{-2}) = 0.28 \text{ Jm}^{-2}/t_p$ where t_p is the pulse duration in seconds.

The IEEE99 standard

This provides expressions to calculate the peak MPE in terms of peak power density for a single pulse, for pulses of less than 100 ms duration and also to limit the energy density where the pulse duration exceeds 100 ms.

For the general case of a maximum of five pulses during the averaging time, with a pulse *repletion* rate of at least 100 ms and pulse duration less than 100 ms:

$$\text{Peak MPE} = (\text{MPE}^* \times \text{averaging time (secs)}) / (5 \times \text{pulsewidth (secs)})$$

MPE* is the r.m.s. value from the appropriate table. Averaging time is also from the table.

Where the number of pulses in the averaging time is >5 or the pulse durations exceed 100 ms, the following expression applies:

$$\Sigma \text{ Peak MPE} \times \text{pulsewidth (secs)} = \text{MPE}^* \times \text{averaging time (secs)} / 5$$

MPE* as before.

Reference should be made to the details in the standard. It also provides for an overriding maximum peak pulse electric field value of 100 kVm^{-1} .

General considerations – peak pulse power density limits

Because there can be a wide variation in duty factor over different equipments and operating conditions, it is necessary not only to consider whether an exposure exceeds the permitted peak pulse power limitation but also to ensure that where the peak pulse power is acceptable, the mean power density is also acceptable. This obviously means that the worst case duty factor must be used for calculations of peak pulse power and, where standards which utilise pulse widths and specified time conditions to determine permissible limits, any changes of the pulse widths possible during operational use will need to be taken into account.

The reason for the limitation of pulse peak energy generally is discussed in Chapter 3.

Whole and partial body exposure

For the main application of standards, whole body exposure is assumed. This means literally that all of the body tissue is subjected to the radiation

field. Often this will not be the case and only part of the body may be exposed. Most standards make detailed provision for higher permitted levels of fields applicable to some small mass of tissue usually 10 g of contiguous tissue, free of significant voids.

Note that the provisions for partial body exposure exclude the eyes and the testes.

Exemptions

Some standards provide for exemptions for very low power sources subject to specific conditions, but these have been subject to challenge – see Chapter 6.

There is usually considerable detail on both the partial body limits and the exemptions mentioned above which cannot be included here.

Static magnetic fields

Static magnetic fields have, on the face of it, little to do with the technical subject matter of this book. However, in the course of doing RF radiation measurements on some types of equipment, particularly in the medical field, such magnetic fields may be encountered by technical personnel who may be unaware of their presence or significance.

Most of the standards reviewed above do not specifically deal with this subject but the NRPB has produced guidance on it as a basic restriction for DC to 1 Hz. This specifies a limit of 200 mT averaged over a 24-hour period, with the general maximum of 2 T or 5 T (limbs only).

The general concerns are:

- 1 Effects on the human body and on metal implants, including heart pacemakers. In the latter case this may involve movement of the device in situ or interference with its operation. It is reported that magneto-static effects have been observed on a few pacemakers at levels between 0.5 and 1 mT and many exhibit interference effects between 1 and 20 mT.
- 2 'Flying objects' due to ferrous materials brought into the vicinity, being accelerated by the field to hazardous velocities. A flying scalpel would be a particular hazard! It is suggested that the effects on small objects in air are of little consequence below about 3 mT.
- 3 Adverse effects on instruments in use containing components susceptible to damage from the field or false readings on such instruments.

High current DC sources with high harmonic content

It is worth noting that such supplies may have significant ac magnetic field content due to harmonics and it is considered that it is not satisfactory to

determine the permitted values on the basis of the frequency of the fundamental. Spectral analysis is necessary to establish the relevant permitted value. This is discussed at some length in reference 28.

Amateur Radio stations

In the UK the NRPB have issued a leaflet summarising the Board's guidance on exposure to electromagnetic fields as applicable to those frequencies authorised for use by amateur radio stations in the UK. This is cross-referenced to the Radio Communication Agency's Amateur Radio Licence Terms, Provisions and Limitations booklet BR68.

The investigation levels for UK Amateur Radio are listed here in Table 4.6. As in the main NRPB93 guidance described earlier, it notes that these investigation levels are a set of field strengths and power density values below which the basic restrictions on exposure will not be exceeded. These investigation levels are not limits on exposure, but compliance with them will ensure compliance with the basic restrictions. Exceeding them does not necessarily mean that the basic restrictions have been exceeded. However, it does mean that the exposure situation should be investigated further to assess compliance with basic restrictions.

In the USA, the FCC have similar provisions as shown in Table 4.7 except that in this case the limits relate to peak envelope power into the antenna.

Table 4.6 *Investigation levels for UK amateur radio*

<i>Band</i>	<i>Frequency</i>	<i>Vm⁻¹</i>	<i>Am⁻¹</i>	<i>Wm⁻²</i>
LF	135–137.8 kHz	1000	64	–
160 m	1.810–2.000 MHz	316	5	–
80 m	3.500–3.800 MHz	164	1.35	–
40 m	7.000–7.100 MHz	85	0.36	–
30 m	10.100–10.150 MHz	59	0.175	–
20 m	14.000–14.350 MHz	50	0.13	6.6
17 m	18.068–18.168 MHz	50	0.13	6.6
15 m	21.000–21.450 MHz	50	0.13	6.6
12 m	24.890–24.990 MHz	50	0.13	6.6
10 m	28.000–29.700 MHz	50	0.13	6.6
6 m	50.000–52.000 MHz	50	0.13	6.6
4 m	70.000–70.50 MHz	50	0.13	6.6
2 m	144–146 MHz	50	0.13	6.6
70 cm	430–440 MHz	100	0.26	26
23 cm	1240–1325 MHz	160	0.42	67
13 cm and above	2310–2450 MHz and all higher bands	194	0.62	100

Table 4.7 FCC power thresholds for routine evaluation of amateur radio stations

<i>Wavelength band</i>	<i>Evaluation required if power PEP (W) exceeds:</i>
160, 80, 75, and 40 m	500 W
30 m	425
20 m	225
17 m	125
15 m	100
12 m	75
10 m	50
VHF all bands	50
70 cm	70
33 cm	150
23 cm	200
13 cm	250
SHF all bands	250
EHF all bands	250

There are separate figures for repeater stations, not shown in Table 4.7, which specify power in terms of the ERP – see reference 75.

Again, exceeding the limits requires a station evaluation. It also notes that people around an amateur radio station who fall into the category of ‘the public’ will generally be subject to the exposure limits for the public.

In both countries it would seem likely that the question of public safety limits could arise most particularly at displays to which the public are invited and it would be desirable to consider warning signs and antenna boundary markings where close access might be possible.

Guide to reading new standards

New standards are created much faster than any text book can keep up with them even if it was economic to do so! However there are always common features which help the reader to follow standards as they develop. This short guide is intended to help in that respect.

- Read the background material first rather than jump to the tables of values. In this way the reasons for changes become clearer.
- Determine the categorisation of those to whom the standard applies – occupational, public, etc., and their definitions!

- Look at the general scope of the standard – what does it cover in terms frequencies, field quantities, limb current limitations, contact current limits, peak pulse energy.
- Look carefully at footnotes, special conditions and limitations attaching to tables of limits, averaging times, summing of multiple irradiations and the like. The latter can be quite complex as can be seen from the NRPB and ICNIRP standards. It is amazing how many people use standards yet are unaware of key aspects. It took years for some people to discover the peak pulse energy limitations in standards!
- If the standard is to be applied to your country, compare the present and the new requirements. Some changes may not be organisationally significant but others may raise important problems, for example, tightening of limits for the public when you operate near to or in the public domain. Some sites close to roads or residential areas can be affected by the tightening of such limits if they are too close to such places and have insufficient land to move antenna systems away.

Many standards have ambiguities within them and it is not always easy to obtain clarifications. The recent update of IEEE C95.1–1992 to IEEE C95.1–1999 included some clarifications, as does the NRPB report 301[28] in respect of the NRPB93 standard. There are other standards which would benefit from clarifications! If those who produce standards actually tried out some of their calculations in practical examples, clarifications might be introduced before release of the standard or guide!

Reflections on the use of standards

Any views on the use of standards are likely to be personal views, and the following are no exception. However they do stem from long experience and may be of some value:

- 1 Do not work at levels right up to the permitted limits when there is no need to do so. Many people are inclined to set safety boundaries at such limits routinely when no one needs such a tight boundary. Similarly, do not use rotating beam rotational averaging to set limits if no one needs to work that close. Occasional access for special purposes can be dealt with by permit-to-work provisions.
- 2 Do not use partial body exposure easements as a substitute for dealing with a problem. Consider the resulting management problems which may be involved in monitoring the safe working situation.
- 3 The electric field values in standards do not necessarily guarantee that limb and contact currents will not be exceeded. Caution is needed in cases where exposures are close to the limits and measurements may be necessary.

In summary, this means relating measurements and boundaries to real requirements.

Each time a new standard is issued which tightens up limits in some way, we have people wondering why they were previously allowed to be exposed to levels of RF energy which are now forbidden. Practical experience shows that this need not always be the case if efforts are made to minimise exposure rather than to just accept the limit values given in standards. Apart from showing a conservative approach to safety it may help to avoid the currently fashionable tendency for people to sue all and sundry at the slightest provocation!

Part 3 Safety calculations for structures involving flammable vapours

Introduction

The potential hazard involved where flammable vapours are used or stored in places where significant RF fields are present is fairly well known. However, it is not always taken too seriously with the result that it can be overlooked when the weight of other problems such as the possible exposure of people to RF radiation tends secure most attention. An incident many years ago in the UK drew attention to the potential risks, when a new transmitter was about to be switched on when someone noticed that the site was adjacent to a gas terminal. This led to the work which eventually produced the standard referred to below.

The real problem is to determine what field levels are significant in a given situation. The mechanism involved is that conductors collect energy from the field. Where there is a suitable discontinuity such that a spark occurs, any flammable vapours present may be fired.

The elements required are:

- 1 A sufficiently strong RF field.
- 2 Conductive structures capable of having potentials induced in them.
- 3 A discontinuity in the conductive elements capable of providing a 'spark gap' located in a place where flammable vapours are present. It is not easy to illustrate these concepts but Figure 4.14, which is the specific case of the crane, may help in the general appreciation of these aspects.

Conductive structures are not difficult to visualise and, apart from basic structural elements, include metal pipes, tanks, metal supports, girders, wires and similar items.

Installations used for industrial processing and storage of petroleum and other substances having flammable vapours, flammable gases such as natural

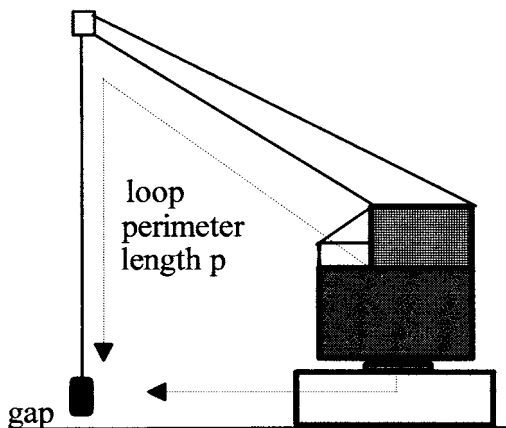

Figure 4.14 *A crane as a pick-up loop*

gas and the many forms of industrial gases used in everyday life fall into this category. The basic mechanism is that the conductive elements act as an antenna and collect RF energy, the magnitude of which will depend on the field and the effectiveness of the structure as an antenna.

British Standard BS6656 1991 [31] is the standard in the UK which covers this subject and is used here to illustrate the basic calculations involved. No International Standard on this subject is known to the author, after checking with WHO and other bodies. Many guides or similar documents on this subject tend to be military ones.

Basic approach

The basic approach of the standard is to detail a flow chart sequence of steps to ensure consideration of all the relevant aspects. This is not covered here, but the basic calculations involved are discussed in the following paragraphs. In practical use, it is obviously important to read and follow the procedural basis of the document. The standard provides formulae for calculating electric field strength (see Chapter 5, Part 2) and the modulation multipliers (m) to be used for the different types of modulation in use in those formulae are specified in the text. The latter have been listed here as Table 4.8. If calculating by other methods, the nature of the modulation should equally be taken into the calculation and a suitable contingency factor added as with the BSI calculation formulae, since unknown elements may affect the situation.

The standard covers frequencies from 15 kHz to 35 GHz. The pick-up characteristics of structures may result from parts of the structure acting as

Table 4.8 Modulation factor 'm' in calculations for field strength calculations

<i>Modulation type</i>	<i>Power used</i>	<i>Multiplier 'm'</i>
None (CW)	Carrier	1
MCW	Carrier	2
AM	Carrier	1.4
FM FSK/PSK		1
Television	Peak	1
SSB	Peak envelope	0.7
Pulsed Radar	'Peak' pulse power	Use peak pulse power

a monopole or from loops formed by the structure. At frequencies below 30 MHz, to evaluate the power which can be extracted, structures are treated in terms of the effective loop formed by the conductive members as loops are considered to be the more efficient receiving antennas at these frequencies. For example, a pipe or series of pipes may constitute a loop and the 'loop length' can be measured and used in calculations.

Probably the simplest loop to conceive, as noted earlier, is a crane with a conductive connection (chain or wire) to the lifting hook. By definition the crane has a discontinuity when the hook is not touching anything (see Figure 4.14). Because a crane is a particularly effective antenna, the standard treats this as a special case. Other conceptually simple loops include road tankers with an overhead metal discharge arm and metal walkways across the top of two or more metal storage tanks, where the loop is tank-walkway-tank.

Sometimes a loop may turn out to be resonant (about one-half wavelength) or may become resonant when alterations are done to the conductive structure. In some cases it may be possible to detune the loop with added reactance, so reducing the effective pick-up. At frequencies of 30 MHz and above, the maximum extractable power is treated on the basis of a half wave dipole with an added contingency of 10 dB to cover field enhancement, antenna gain and other effects for frequencies above 200 MHz. There are therefore two basic steps required for assessing sources other than pulsed sources such as radars:

- 1 Calculate or measure (see 'Other Aspects' below) the expected electric field at the location under examination
- 2 Calculate the extractable power for a given frequency using that electric field value. (The method is slightly different for pulsed sources such as radars.)
- 3 Compare the extractable power with the permitted level for the relevant gas group.

Calculating the maximum extractable power – below 30 MHz

$$(a) \text{ If } p/\lambda < 0.4: P_{\max} = 702 \left(\frac{E^2}{f^2} \right) \left(\frac{p}{\lambda} \right)^{3.5} \quad (1)$$

And

$$(b) p/\lambda > 0.4: P_{\max} = 28.4 \left(\frac{E^2}{f^2} \right) \quad (2)$$

Where:

E = effective field strength (Vm^{-1})

f = frequency (MHz)

λ = wavelength ($\lambda = 300/f$)

P_{\max} = max. extractable power (W)

p = internal perimeter of the loop type structure (m)

Example:

Note: For simplicity the electric field calculation step is assumed as providing the electric field value shown:

$$\text{Assume: } f = 15 \text{ MHz} \quad \lambda = 20 \text{ m} \quad E = 30 \text{ Vm}^{-1} \quad p = 5 \text{ m;}$$

hence $p/\lambda = 5/20 = 0.25$ and the first expression above, (a), is the appropriate one:

$$P_{\max} = 702 (E^2/f^2)(p/\lambda)^{3.5} = 702 \times (900/225) \times (0.25)^{3.5}$$

$$P_{\max} = 21.9 \text{ W}$$

If we keep all values as above except for p which we increase to 18 metres so that p/λ is $18/20 = 0.9$ which is greater than 0.4, then the second expression from above, (b), is appropriate and gives:

$$P_{\max} = 28.4 \times (E^2/f^2) = 28.4 \times (900/225)$$

$$\text{Hence } P_{\max} = 113.6 \text{ W.}$$

Maximum extractable power – 30 MHz and above

The expression used here is $P_{\max} = 311E^2/(f^2 + 9000)$.

The meanings of the symbols used are as before. This expression is easy to manipulate, especially when concerned with only one frequency, since it can then be rewritten as:

$$P_{\max} = kE^2, \quad \text{where } k = 311/(f^2 + 9000) \tag{3}$$

which is a constant for the frequency concerned.

Example:

If only one frequency is involved, say 50 MHz, $k = 0.02704$ and $P_{\max} = 0.02704E^2$. This could be plotted for a number of values of E if required.

$$\begin{aligned} \text{Thus when } E = 20 \text{ Vm}^{-1}, \quad P_{\max} &= 10.8 \text{ W} \\ E = 50 \text{ Vm}^{-1}, \quad P_{\max} &= 67.6 \text{ W} \end{aligned}$$

We now have a means of calculating the extractable power from a defined situation and comparing it with the permitted values. Having calculated the extractable power in the foregoing example, the next step is to see what consequences arise from this magnitude of extractable power for any particular group of flammable vapours.

To do this we need to look at the classification of those specific flammable vapours with which are involved or alternatively to the worst case possibilities.

Characteristics of flammable vapours

The standard refers to a classification system for flammable vapours which groups them according to the degree of hazard. For the purpose of providing examples, the three groups referred to are as shown in Table 4.9 which also shows a representative gas for each category.

There is a very extensive list of substances in the standard, the tabulations being obtained from BS5501 Pt. 1 1977[71] a translation of the EEC European standard EN 50014. Table 4.10 shows the RF power thresholds for gas groups I and IIa, IIb and IIc in terms of watts with an associated averaging time.

Extracted power from the previous example calculation is now compared with these limits for the relevant gas group. Note the different figures for cranes. The examples below do not include cranes.

Table 4.9 Gas groups and representative gases

Gas group	Representative gas
I and IIa	Methane
IIb	Ethylene
IIc	Hydrogen

Table 4.10 *Gas groups and threshold powers*

<i>Gas group</i>	<i>Structures other than cranes Threshold power and thermal initiation time</i>	<i>Cranes only Threshold power and thermal initiation time</i>
I and IIa	8 W averaged over any 100 μ s	6 W averaged over any 100 μ s
IIb	4 W averaged over any 100 μ s	3.5 W averaged over any 100 μ s
IIc	2 W averaged over any 20 μ s	2 W averaged over any 20 μ s
Note	Source impedance assumed = 3000 Ω	Source impedance assumed = 7500 Ω

If the maximum extracted power exceeds these limits, it is then necessary to look to a reduction of the value of E (the electric field) in the previous calculations in order to stay within the limits. If we take the last example above, where for a field of 20 Vm^{-1} , $P_{\text{max}} = 10.8 \text{ W}$; which would not be satisfactory for any of the categories in Table 4.10 and must be reduced. We can do this easily by putting the original expression equal to the limit with which we are concerned, say the group I and IIa limit of 8 W. It will be remembered that we had a simplified expression for the single frequency used in that example:

$$P_{\text{max}} = kE^2 = 0.02704E^2 \text{ (for } f = 50 \text{ MHz).}$$

So if we put $P_{\text{max}} = 8 \text{ W}$, we have $0.02704 \times E^2 = 8 \text{ W}$ and by solving for E we can meet the table limit.

$$E^2 = 8/0.02704 \text{ and } E = 17.2 \text{ Vm}^{-1}.$$

Most people would probably aim to be 20% or more below the tabulated limits to allow for the uncertainty of the field measurement and would, consequently, use perhaps 6 W rather than the 8 W above, giving about 15 Vm^{-1} .

It should be noted that it is possible to produce curves of electric field limit versus frequency for each gas group by calculating $E = \sqrt{(P_{\text{max}}/k)}$ for a number of frequencies above 30 MHz as has been done in Figure 4.15. To do the same for frequencies below 30 MHz necessitates a more complex calculation requiring the loop diameter to be determined.

However, if reference is made to Figure 4 in the BS standard there is a very useful series of plots covering the full frequency range and all gas groups. To deal with frequencies below 30 MHz, a number of curves have been drawn for arbitrary loop dimensions. This diagram is very valuable in that it indicates the trend and shows that quite small electric field strength limits apply at low frequencies, e.g. about 8 Vm^{-1} for gas group IIc at 30 MHz,

**Safe thresholds – gas group 2c
single CW transmission**

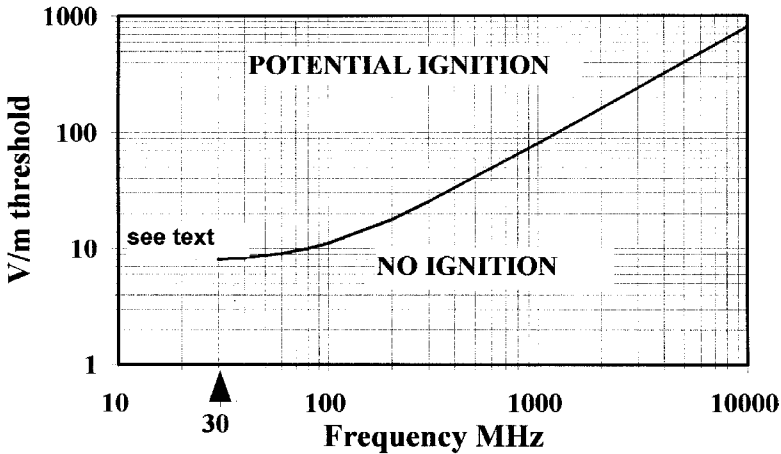

Figure 4.15 Safe thresholds gas group 2c – CW (single transmission)

rising to about 800 Vm^{-1} at 10 GHz. It is useful for a quick assessment of unmodulated transmission limits.

Pulse transmissions

Where pulse transmissions are used and the pulses are short relative to the thermal ignition times in Table 4.10 (less than half of these times) and the interval between pulses exceeds the thermal ignition time, it is recommended that the energy in a single pulse is a better criterion.

Table 4.11 lists threshold pulse energies for the same gas groups as Table 4.10. If we take the example from the previous paragraph where P_{max} was

Table 4.11 Gas groups and threshold energies

Gas groups	Radio frequency energy thresholds for all structures Threshold energy Z_{th} (μJ)
I and IIa	7000
IIb	1000
IIc	200

8 W for an electric field strength of 17.8 Vm^{-1} at 50 MHz, and suppose this to be a pulsed transmission meeting the criteria just given, the figure of 17.8 Vm^{-1} is now, of course, to be derived from the peak pulse power density and not the mean power density.

If Z_{max} (μJ) is the maximum extractable energy from one pulse and t_p is the pulse duration in microseconds, we have:

$$Z_{\text{max}} (\mu\text{J}) = P_{\text{max}} \times t_p \quad (4)$$

Assuming a value of $t_p = 3 \mu\text{s}$, $Z_{\text{max}} (\mu\text{J}) = 8 \text{ W} \times 3 \mu\text{s}$.

Hence $Z_{\text{max}} = 24 \mu\text{J}$, which would meet the requirements of Table 4.11. Of course the value of 17.8 Vm^{-1} is a very low one for the peak pulse power of a pulsed transmission, corresponding to a plane wave peak pulse power density of 0.84 Wm^{-2} . A more realistic approach is to make Z_{max} equal to one of the Table 4.11 values, say, $7000 \mu\text{J}$, and find the limiting value of P_{max} . Thus $P_{\text{max}} = Z_{\text{max}}/t_p = 7000 \mu\text{J}/3 \mu\text{s}$.

Hence $P_{\text{max}} = 2333 \text{ W}$ and the corresponding electric field value from equation (3) would be 294 Vm^{-1} , a possibly more realistic figure. The general rationale is:

- 1 Find the relevant gas group and limit threshold energy (Table 4.11). Derate further if required for risk reduction.
- 2 Compute $P_{\text{max}} = \text{chosen } Z_{\text{max}}/t_p$.
- 3 Using the relevant formula for P_{max} from previous paragraphs (1) or (2), calculate E, the maximum electric field value:

For example, using the expression for P_{max} for $f > 30 \text{ MHz}$:

$$P_{\text{max}} = 311E^2/(f^2 + 9000) \quad \text{and} \quad E^2 = P_{\text{max}}(f^2 + 9000)/311$$

Given P_{max} and f , solve for E.

Other aspects

As noted earlier, the standard also gives formulae for the calculation of field strengths from transmitters. Measurement of the field was indicated as an alternative but this is obviously only possible in respect of a situation where the risk being investigated, e.g. plant or installation, is not operational and not at risk. Where such a plant is operational it may be possible to do measurements but the transmitter source would need to use such a low power that there could not be any hazard, and the results scaled up appropriately. In the situation where measurements are made, the calculation methods may be of little interest but they might be of value when considering a potential new site for a transmitter. Table 4.12 gives a few examples from a large table of examples of the radii of vulnerable zones.

Table 4.12 Representative transmitters and vulnerable zones for specified gas groups (Courtesy of the British Standards Institute)

Type of transmission	Frequency	Power watts	Mod. type	Factor (see note 1)	Antenna gain dBi polarisation	Radii of vulnerable zones in metres		
						1/2A	2B	2C
Broadcast	198 kHz	500 kW	AM	2	4 V	4300	5500	7200
Tropospheric scatter	900 MHz	10 kW	FM	1	46 V/H	900	1200	1500
Radar (military)	1 to 3 GHz	6 MW peak pulse	P	1	45 V/H	500	1400	3000
Radar (civil)	1 to 3 GHz	2.5 MW peak pulse	P	1	39 V/H	330	860	2000
VHF/UHF base station	98 to 400 MHz	125 W	FM/AM	4	5 V	20	25	30
HF land communications (note 2)	4 to 25 MHz	30 kW	SSB	4	18 H	630	720	830
HF communications (note 2)	1.6 to 25 MHz	30 kW	SSB	4	12 FSK ¹²	8700	10900	13700
						190	230	260

Notes:

- 1 This factor is to allow for multiple sources; the transmitter power is multiplied by it.
- 2 Where two types of modulation are shown, the worst case is used. The two sets of distances relate to the ends of the frequency band.
- 3 P = pulse transmission; for the modulation terms see Table 4.8.

The table is only included here to give a general impression of the range of hazard distances typical of the systems portrayed. For practical use it is important to see the qualifications applying to the table. The standard contains a great deal of other useful tabulated data.

A companion standard (BS6657)[32] deals with the corresponding problems of the firing of commercial electro-explosive devices (EEDs), e.g. commercial detonators, by RF radiation. Most non-commercial explosives are military and are covered by specific and usually classified military documents. Detonators have leads twisted to reduce pick-up from RF fields. The characteristics of EEDs in respect of firing depend on, among other things, on the thermal time constant and the threshold energy required to

fire the device. Those with long time constants (ms) are power sensitive and those with short time constants (μs) energy sensitive. The actual values of these parameters vary considerably so that specialist advice is necessary.

Refer to the full standard document[32] for the full assessment procedure for sites.

Data in the tables above and the specific equations used are reproduced by courtesy of the British Standards Institute.

5

The calculation of RF field quantities

This chapter deals with methods used for approximate calculations for RF radiation safety work.

Part 1 gives specific methods for microwave communications and radar type equipments, with worked examples and cross references to other possible methods. It also covers the safety provisions for moving antennas and the use of time-averaging.

Part 2 deals with other antenna calculations.

Part 3 covers situations where exposure to simultaneous multiple irradiations occurs and also to peak pulse power density limitations where applicable.

Part 1 Microwave antenna calculations and safety with moving microwave beams

Antenna survey information requirements

Unless some form of calculation is available to provide an idea of the characteristics of an antenna, a safety survey becomes a journey into the unknown in which the surveyor may be put at risk and may also do a great deal of unnecessary work. Antenna radiation surveys are essentially an exploration of a volume since both the work and the public environments have a height dimension as well as the obvious area dimension.

Calculations can be undertaken to great depths using computers, with a corresponding magnitude of expenditure. Some of this may be necessary if the specification for the item demands such treatment, but this will then

apply primarily to the designer and the supplier in proving compliance with the performance specification, rather than the safety aspects. Of course, having done such calculations they may also serve for the latter purpose.

For the equipment user and those not having available the more exacting calculations done by the designer, it is possible for more limited calculations to be done quickly and cheaply with standard formulae, particularly in the microwave antenna field, if the limitations of each formula are accepted. In any case, theoretical calculations will provide information about an antenna in free space, an idealised situation.

In practical working situations the environment may appreciably affect the measured radiation levels, the flat site having most effect when the beam is set at negative elevations and ground enhancements from reflections arise. More common environments have buildings, metal structures and vehicles and the nature and location of some objects may vary from day to day due to the other activities being undertaken. Few sites are without such buildings and structures where there may be interaction with whatever objects are around and the ground may often be far from being flat.

It is clear that the calculations required for surveys only need to give an approximation of the power flux densities or other field quantities involved so that the surveyor can determine the order of things to be expected. Insofar as calculations normally reflect the hypothetical free space condition, there is no value in having such calculations done to great accuracy when a factor of 4 to 6 dB may apply to reflection enhancements from the ground or from structures. The value of calculations is firstly to ensure the safety of the surveyor by highlighting areas of potentially high exposure and secondly to help in reducing the volume to be explored by the surveyor and to confirm the order of the levels expected to be found in measurements.

Microwave calculations

General

Microwave transmission commonly uses a parabolic reflector with a rectangular, circular or elliptical aperture. It is necessary to have some method of calculating the power densities likely to be associated with such antennas at the frequencies and power levels used.

A system[30] devised by a colleague of the author, Dr D. H. Shinn, formerly of the GEC-Marconi Research Centre, provides a relatively simple method of producing calculations for most communications and radar antenna systems, other than very specialised types such as those used to communicate with satellites. It uses three normalised contour diagrams on which can be plotted a reference value. The values of the individual contours are then easily obtained from the scaling on the charts.

The horizontal axis is scaled in multiples of the Rayleigh distance and the vertical axis is scaled in terms of the relevant antenna dimensions, e.g. circular antenna reflector diameter. The system has been used by the author for many years and found very useful for the purposes discussed above. Because of the area of work in which Dr Shinn was involved, there is radar terminology used in the original paper although a communication system example is given here since the method is not specific to the radar field.

The term 'Rayleigh distance' may require some explanation. Figure 5.1 illustrates the concept involved. The Rayleigh distance has no standard definition and therefore needs to be specifically defined. The definition used here is the original Lord Rayleigh one ($D^2/2\lambda$), where, in the case of the circular aperture antenna, D is the diameter and λ the wavelength. In the figure, this corresponds to the distance PN when the distance PM is greater than PN by $\lambda/4$. It follows that the phase of the radiation reaching P from M is delayed by 90° relative to that from point N .

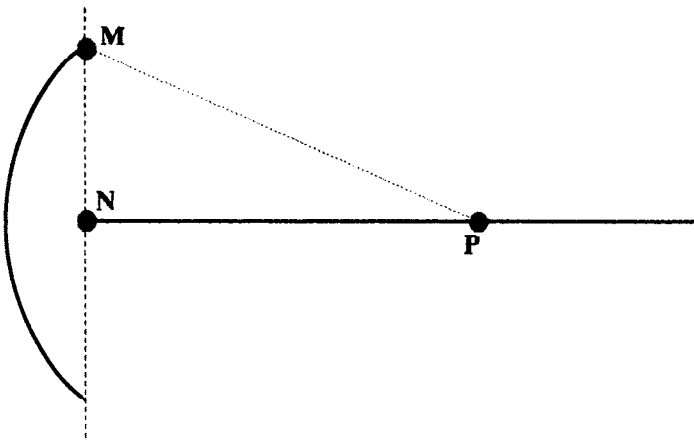

Figure 5.1 Rayleigh distance illustration

Sometimes Rayleigh distance is defined as D^2/λ (45°) or $2D^2/\lambda$ (22.5°). The value in using a definition which gives the shortest distance which can still give reasonably accurate on-axis power density estimates, is the fact that the region adjacent to the antenna and the early part of the beam is frequently the one which is most likely to be accessed by personnel and having calculations available for relatively short distances from the antenna increases confidence in doing surveys; $2D^2/\lambda$ gives a value for PN which is four times greater.

Figure 5.2 illustrates the Rayleigh distance versus frequency for three circular aperture diameters.

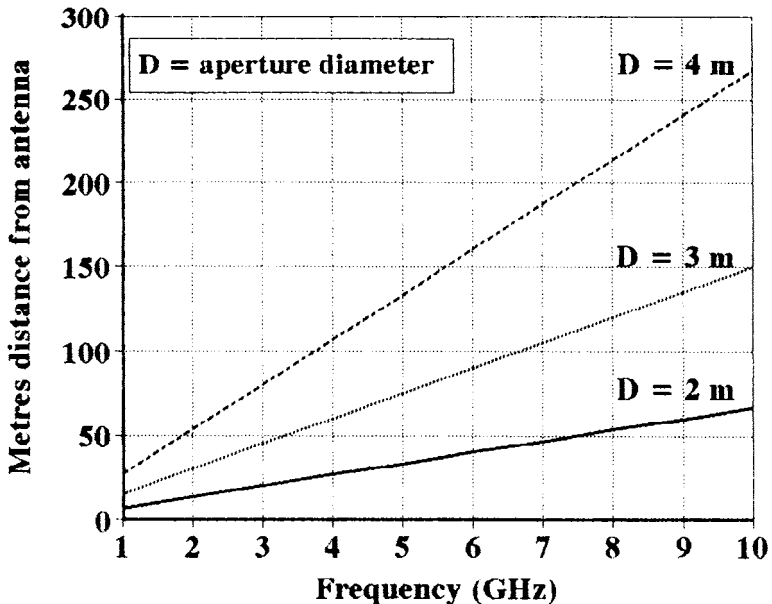

Figure 5.2 Rayleigh distance versus frequency for three circular aperture diameters

It is generally accepted that for an antenna radiating into free space, four distinct regions can be identified where the behaviour of the electromagnetic field from the antenna displays specific characteristics. These are:

- 1 The non-radiating reactive near field region (reactive field) with a very short range of a fraction of a wavelength. This region is not usually of significance in the microwave spectrum, from the point of view of safety. It can, however, be important at lower frequencies.
- 2 The radiating near field region. Here the field varies considerably with distance from the antenna. In the microwave spectrum meaningful calculations are difficult. The usual conservative approach to safety is to use the expression for the highest possible amplitude of the power density as applying to the whole of this region, and then undertaking specific measurements.
- 3 The intermediate field zone.
- 4 The far field zone.

Figure 5.3 illustrates these field zones. The intermediate and far field zones are dealt with in this chapter. The calculation methods described here involve three normalised diagrams covering:

Circular apertures: Far field calculation (Figure 5.4) (also used for the far field of elliptical and rectangular apertures).

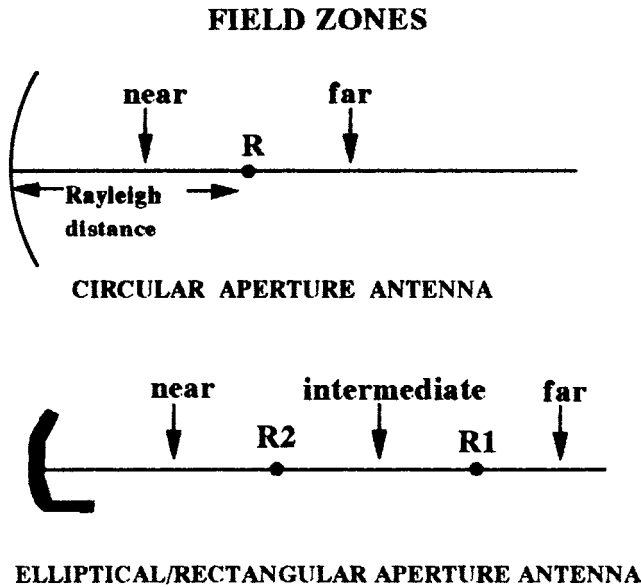

Figure 5.3 Radiation field zones of antennas

Elliptical and rectangular apertures: intermediate field, vertical section; calculation for antennas with the larger aperture dimension horizontal, e.g. a surveillance radar (Figure 5.5).

Elliptical and rectangular apertures: intermediate field, vertical section; calculations for antennas with their larger aperture dimension vertical, e.g. a height finding radar (Figure 5.6).

Most of the calculations for elliptical apertures will apply to rectangular apertures, bearing in mind that no great precision is sought in these calculations. Note that the 'X' axis on all of these diagrams does not, except by coincidence represent the ground. A horizontal line can be drawn to represent the ground on the basis of the actual height of the antenna above the ground (see the example later).

Antennas with circular apertures

This is perhaps one of the most common types of microwave antenna consisting of a reflector of paraboloidal surface and circular boundary (almost universally known as a dish) with a waveguide or dipole feed at the focus. The first diagram, Figure 5.4, is used for determining the far field of these antennas. It will be noted that the vertical axis of Figure 5.4 gives height above and below the axis of the antenna in terms of units of 'D' the antenna diameter.

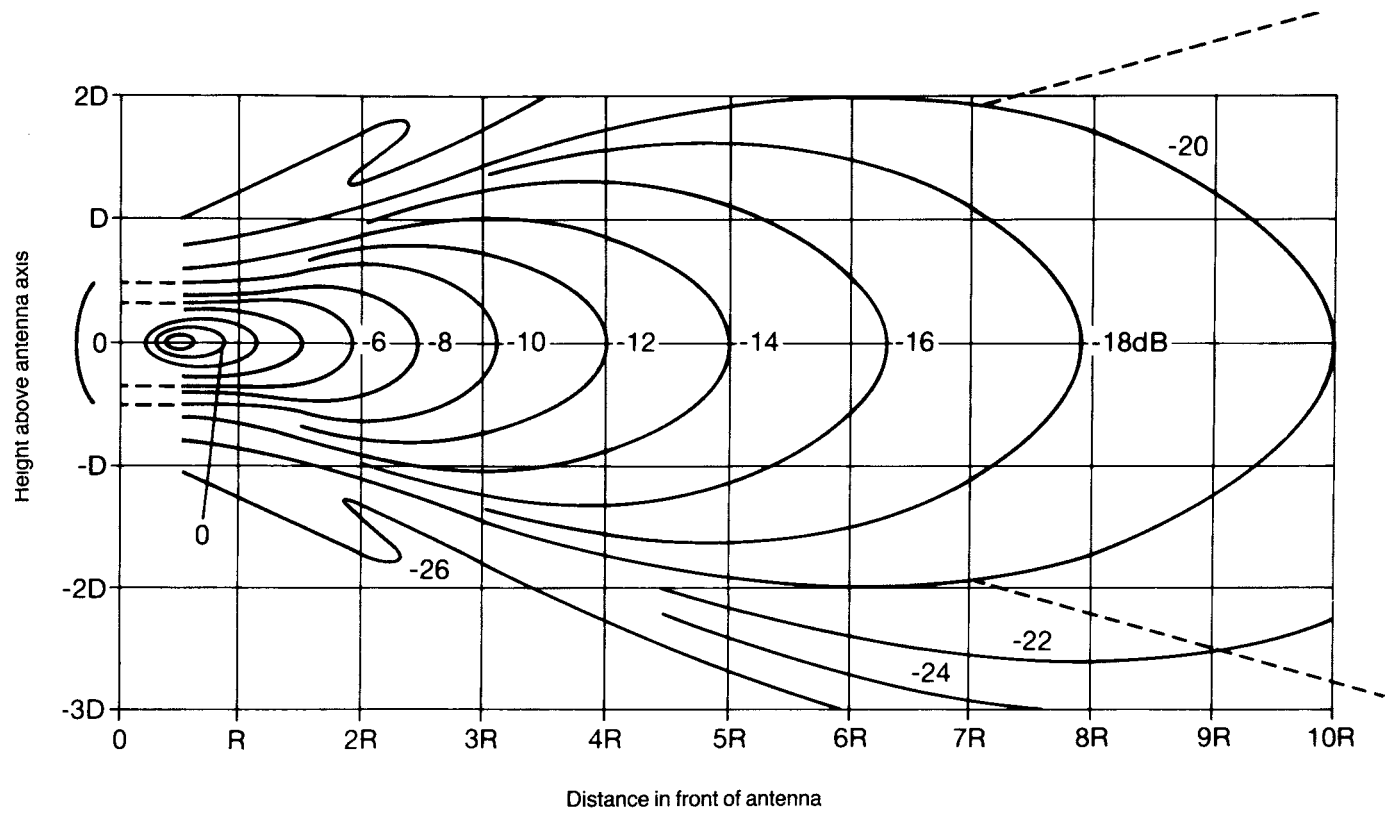

Figure 5.4 Far field of circular aperture antennas

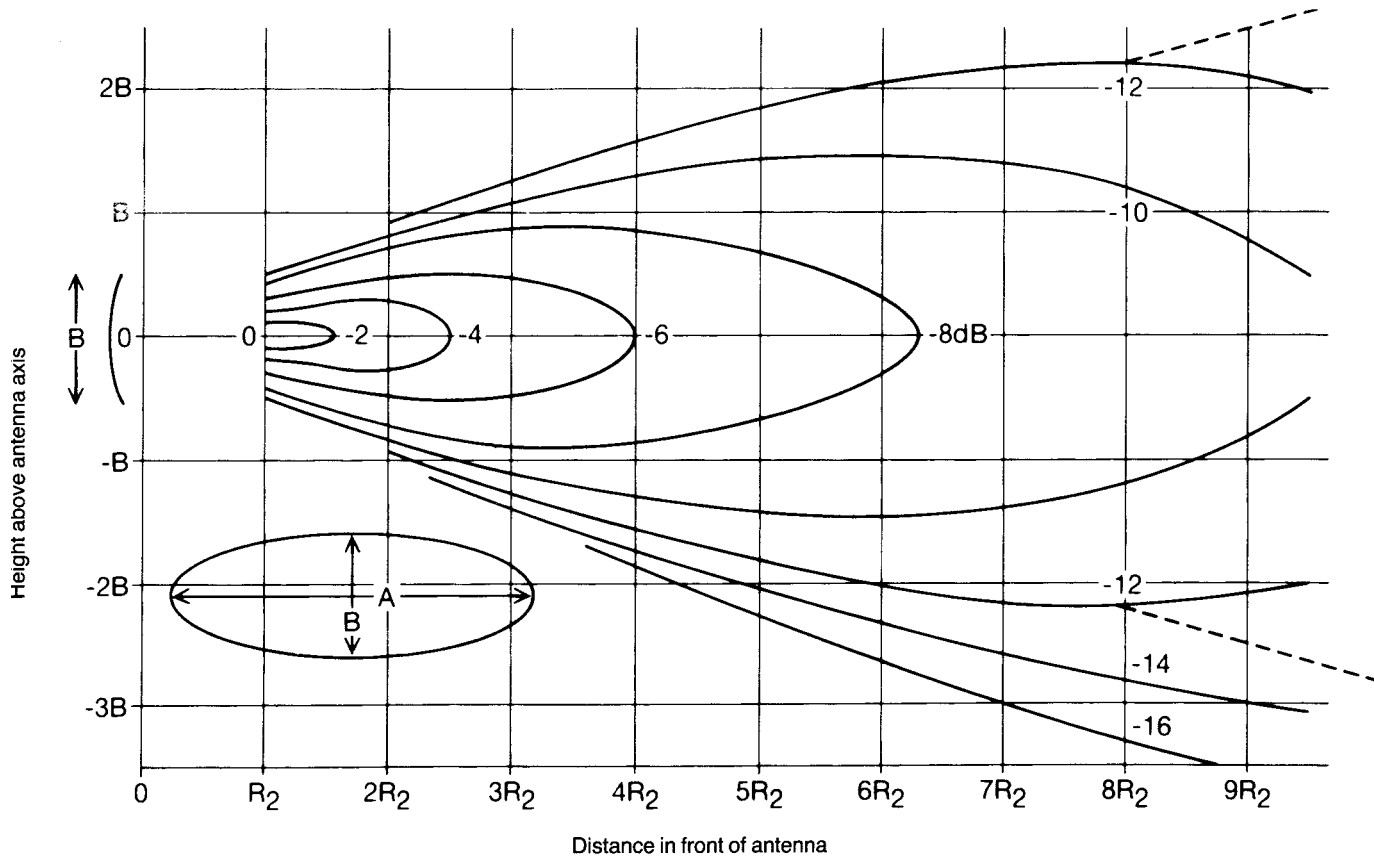

Figure 5.5 Elliptical and rectangular aperture antennas – intermediate field with larger aperture dimension horizontal

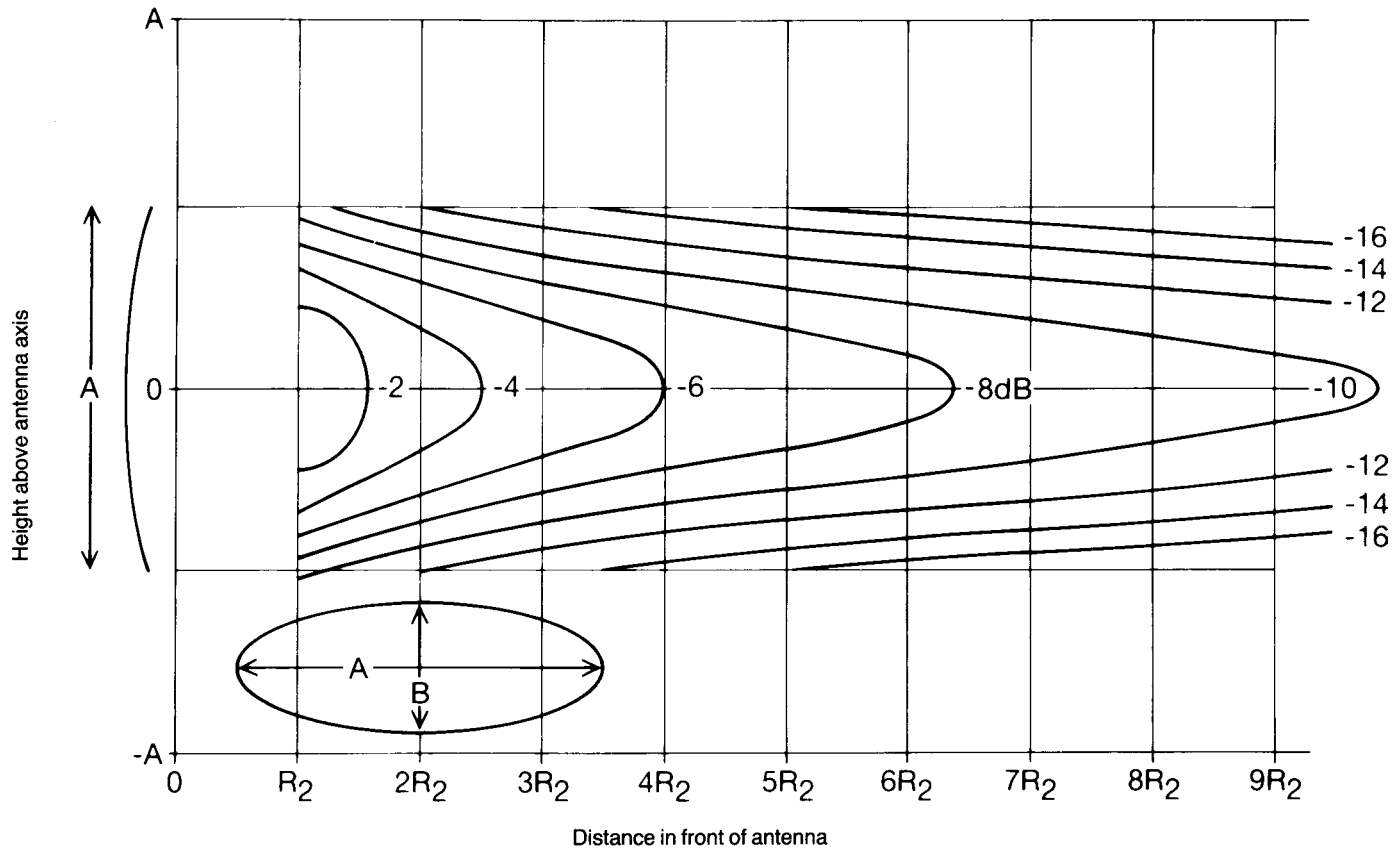

Figure 5.6 Elliptical and rectangular aperture antennas – intermediate field with larger aperture dimension vertical

The horizontal axis is marked in values of R, the Rayleigh distance, the contours going down to 0.5R, below which the pattern can be complicated but there is likely to be little power flux beyond a distance of 0.6D from the axis in that region.

The field of this type of antenna consists of two regions, the near-field region between the antenna and R where the power is nearly all contained within a cylinder of radius 0.5D. In the far-field region from greater than distance R onwards, the power spreads out and the power density on the axis is given by the far field formula:

$$S_{FF} = P - T + G - 10 \log(4\pi r^2) \text{ dBWm}^{-2} \tag{1}$$

Where:

- P = transmitter output power in dBW.
- T = loss between transmitter output and antenna input in dB.
- G = antenna gain in dBi, i.e. dB relative to an isotropic antenna.
- r = distance in metres from the antenna at distances greater than R.

Considering Figure 5.4 further, a reference value point is shown as zero on the diagram and subsequent contours are marked in two decibel steps down to -26 dB relative to the reference value. If the power density L at the reference point on the diagram is calculated in dBWm^{-2} , then the contour values are expressed by simple subtraction of their marked relative values. For example, if $L = 20 \text{ dBWm}^{-2}$, then the first three contours will be 18, 16, and 14 dBWm^{-2} respectively.

Note that the first two contours are not marked but are the -2 dB and -4 dB steps. If the reference value is converted to Wm^{-2} then the other contours will need to be determined with the dB/ratio table, Table 5.1, multiplying the reference value in Wm^{-2} by the relevant factor from the table.

Table 5.1 Conversion factors for antenna charts when plotting power densities

Contour decibels	Ref. value multiplier	Contour decibels	Ref. value multiplier
-2	0.63	-16	0.025
-4	0.4	-18	0.016
-6	0.25	-20	0.01
-8	0.16	-22	0.0063
-10	0.1	-24	0.004
-12	0.063	-26	0.0025
-14	0.04		

Multiply reference value by the multiplier for the relevant contour.

The expression for computing the reference value L is given below in equation 2. This equation is as equation 1 but with the Rayleigh distance (R) substituted for (r):

$$L = P - T + G - 10 \log(4\pi R^2) \text{ dBWm}^{-2} \quad (2)$$

The following data is required:

P = mean power of the transmitter or peak power in dBW; see the note below on mean and peak pulse powers.

G = gain of antenna in dBi, measured at the input to the antenna

T = attenuation in dB between the transmitter output and the antenna input

D = diameter of the antenna in metres

λ = wavelength in metres ($300/f$ MHz)

L = reference power flux at the point marked zero on the antenna axis of Figure 5.4. The actual power density on axis at the Rayleigh distance R is about -0.8 dB or 0.83 times the reference power flux at L .

R = Rayleigh distance (metres) defined as indicated earlier.

Where the gain data is not available, it can be estimated as follows:

$$G \text{ for } \approx 64\% \text{ antenna efficiency} = 8 + 20 \log(D/\lambda) \text{ dBi} \quad (3)$$

Where D and λ have the same meanings and dimensions as above.

Note that since calculations for pulsed transmissions will need both mean power density and peak pulse power density values, it can usually prove simpler to use mean power in such cases. The results are then plotted as Wm^{-2} and the peak pulse power density values computed by multiplying the mean power densities by the reciprocal of the duty factor. These can then be marked on the one diagram using, say, red ink to distinguish them.

Example 1

Assume CW system with the following characteristics

$$P = 1 \text{ kW (30 dBW); } T = 0 \text{ dB; } G = 40 \text{ dBi; } D = 4 \text{ m;}$$

$$f = 3000 \text{ MHz; } \quad \text{hence } \lambda = 0.1 \text{ m}$$

The calculation steps are:

Step 1

Calculate $R = D^2/2\lambda$. The horizontal axis of Figure 5.4 can then be scaled. The vertical axis is scaled without calculation from the known value of D .

The ground level can also be marked from a knowledge of the actual height from the antenna axis to ground level.

For example, if that height amounted to three times the diameter of the antenna then the horizontal axis of the diagram would correspond to ground level. Such positioning clearly depends on the size of antenna mount.

$$R = 16/(2 \times 0.1) = 80 \text{ m}$$

Step 2

Calculate the reference value $L = P - T + G - 10 \log(4\pi R^2)$

$$L = 30 - 0 + 40 - 10 \log(4 \times \pi \times 80 \times 80) = 70 - 49.05 \text{ dBWm}^{-2}$$

$$L = 20.95 \text{ dBWm}^{-2}$$

Step 3

Not many people work in dBWm^{-2} for this sort of work, but 20.95 could be entered in Figure 5.4 as the reference value and the values of the successive contours would reduce in 2 dB steps so that, for example the -6 contour value would be 14.95 dBWm^{-2} . Where the results are preferred in watts per square metre, this can be obtained with a further step.

Step 4

$$S = \text{antilog}(20.95/10) = 124 \text{ Wm}^{-2}$$

In this case the reference level is 124 Wm^{-2} and the contour values can be obtained as shown in Table 5.2 by multiplying by the factors in Table 5.1.

Table 5.2 *Converted results of example 1 for contour plotting*

<i>Contour</i>	Wm^{-2}	<i>Contour</i>	Wm^{-2}
Reference	124	-14	5
-2	78.1	-16	3.1
-4	49.6	-18	2
-6	31	-20	1.24
-8	19.8	-22	0.78
-10	12.4	-24	0.5
-12	7.8	-26	0.31

In practice, before doing any of the steps of the calculation it can be useful to evaluate $2P/D^2$, where P is in watts and D in metres. This gives a rough idea of the value of L. In this case it would give:

$$2000/16 = 125 \text{ Wm}^{-2}$$

This example is a CW communications one but if we suppose that the same data applied to the mean power of a pulsed system with a duty factor reciprocal of 1000, then the peak pulse power density can be obtained directly by multiplying the values in Table 5.2 by 1000. Such information is of value in evaluating compliance of the peak power densities against a provision in most RF standards which aims to restrict excessive peak power exposures, and also in connection with hazards to flammable vapours and electrically-fired explosive devices.

In any particular practical case for both the calculation above and for those which follow, it may be necessary to take into account the fact that the axis of the antenna is not horizontal and that the ground in front of the antenna is not horizontal. For example, if the ground is level but the antenna is pointed upwards at an angle of 0.5° , then the ground, wherever it is located, can be represented by a straight line whose origin is at the point on the 'Y' axis (extended downwards if required) corresponding to ground level and tilted down at 0.5° . In the example above this would be 7 metres down at $10R$ (800 m) from the antenna. This is illustrated in Figure 5.7 where, to reduce complexity, it is assumed that the ground level corresponds with the 'X' axis although as noted earlier this may not be the usual case. The antenna

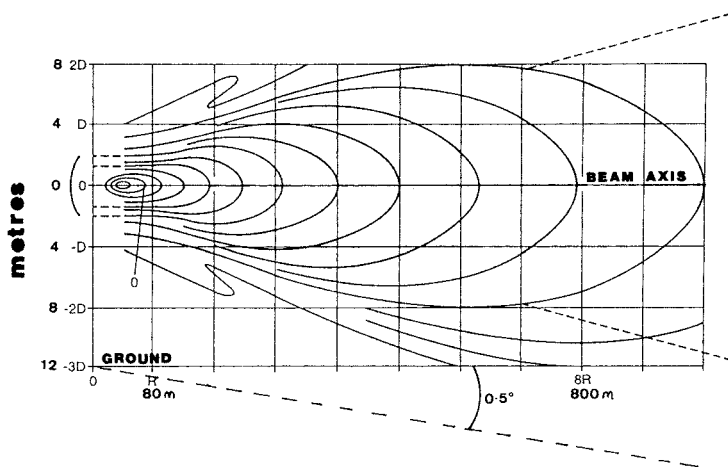

Figure 5.7 *Portraying beam elevation-ground level relationships on antenna field charts*

dimension used in the previous example (4 m) has been used in Figure 5.7, making the antenna centre 12 m above the ground.

Elliptical and rectangular apertures

The circular aperture antenna field was described in terms of a complex near field within the Rayleigh distance and a far field thereafter. In the case of elliptical and rectangular apertures one dimension is usually much larger than the other, that is to say either the height of the aperture is appreciably greater than the width, e.g. for height finding radars; or the width is considerably greater than the height as for surveillance radars. The field can be described as having three identifiable regions as shown in Figure 5.3 where R_2 and R_1 relate to the Rayleigh distances described below.

Figures 5.5 and 5.6 show the use of the letters A for the larger aperture dimension and B for the smaller aperture dimension as a reminder when using those diagrams. The field regions are:

- 1 Near field region up to the Rayleigh distance as explained earlier but with $R_2 = B^2/2\lambda$, where B is the smaller aperture dimension.
- 2 Far field region at a distance greater than $R_1 = A^2/2\lambda$ as for the circular aperture above where the power flux on axis is given by the far-field equation 1.
- 3 An intermediate field region between R_2 and R_1 where the power is spreading out in the 'B' direction but not in the 'A' direction.

In order to find the power density in the far field zone Figure 5.4 can be used, putting $R = A^2/(2\lambda)$. It is necessary to alter the vertical axis scaling of Figure 5.4 appropriately, as this is marked in terms of D the diameter of a circular antenna. This is done by putting $D = A$ for the case where the greatest dimension (A) is vertical, e.g. a height finding radar and $D = A^2/B$ where the greatest dimension (A) is horizontal, e.g. for a surveillance radar. The reference value L is:

$$L = P - T + G - 10 \log(4\pi R^2) \text{ dBWm}^{-2} \quad (4)$$

Where the gain is not known, the following equation can be used. This corresponds to an efficiency of $\approx 64\%$ for an elliptical aperture, or 50% for a rectangular aperture:

$$G = 8 + 10 \log(AB/\lambda^2) \text{ dBi} \quad (5)$$

If the vertical aperture of a surveillance radar has been used for 'beam shaping', the above expression for gain may give an overestimate of several decibels so that some other method should be used.

For the intermediate field between R_2 and R_1 it is more difficult to estimate the power flux. In this region the power density on axis varies approximately inversely with distance $1/r$ since the power is spreading out in one direction but not in the other. The exact shape of the contours are complicated but the vertical sections of Figures 5.5 and 5.6 should give values within about 2 dB. The basis of these figures is that the power flux on axis varies as $1/r$ and for Figure 5.5 that the radiation pattern in the vertical plane is fully formed. For Figure 5.6 it is assumed that the radiation pattern in the vertical plane is not formed at all.

Figure 5.5 is used where aperture dimension A is horizontal as for a surveillance radar and Figure 5.6 when the aperture dimension A is vertical as for a height finding radar. The reference power flux L_2 in dBWm^{-2} is given by:

$$L_2 = P - T + G - 10 \log(4\pi R_1 R_2) \text{ dBWm}^{-2} \quad (6)$$

where $R_1 = A^2/(2\lambda)$ and $R_2 = B^2/(2\lambda)$.

Example 2

Assume a surveillance radar (dimension A horizontal) with the following characteristics:

$$P = 2 \text{ kW} = 33 \text{ dBW}; f = 3000 \text{ MHz}; \lambda = 0.1 \text{ m}; G = 38 \text{ dB};$$

$$T = 0.48 \text{ dB}; A = 4.5 \text{ m} \quad \text{and} \quad B = 2 \text{ m}.$$

Charts Figure 5.5 and Figure 5.4 are needed.

Step 1 Intermediate field

Calculate R_1 and R_2 and thence calculate L_2 as equation 6.

$$R_1 = 101 \text{ m}; R_2 = 20 \text{ m} \quad \text{and} \quad L_2 = 26.5 \text{ dBWm}^{-2} \quad \text{or} \quad 443 \text{ Wm}^{-2}$$

Figure 5.5 should have the horizontal axis scaled in multiples of R_2 (20 m) and the vertical axis in increments of B (2 m). Note that the intermediate field as plotted is that up to the distance R_1 along the 'X' axis, i.e. 101 m.

Step 2 Far field

$$R = A^2/(2\lambda) = 101 \text{ m from step 1}.$$

Using equation 4, and $R = 101 \text{ m}$ calculate $L = 19.5 \text{ dBWm}^{-2}$ or 89 Wm^{-2} .

Scale Figure 5.4 horizontal axis with multiples of R (101 m) and the vertical axis with $D = A^2/B = 10.1 \text{ m}$ (say 10 m).

Figures 5.8 and 5.9 show the results of example 2 calculations, expressed in Wm^{-2} .

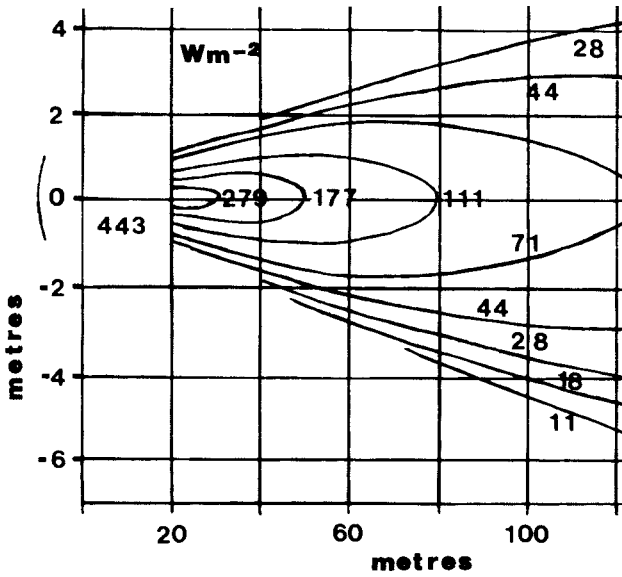

Figure 5.8 Calculated values for the intermediate field in example 2

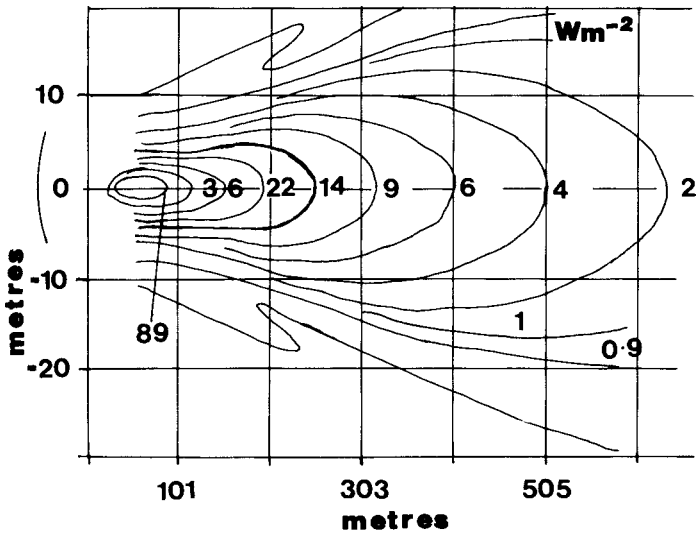

Figure 5.9 Calculated values for the far field in example 2 (values below 1 Wm^{-2} not plotted)

Use of a computer spreadsheet for calculations

The calculations used for the three normalised contour diagrams can easily be laid out in a computer spreadsheet so as to provide a quick method of producing results. By laying out parts of the relevant equations sequentially, the values of all the quantities of interest are readily available. These include the Rayleigh distance, wavelength, and the values of L in dBWm^{-2} and Wm^{-2} . Figure 5.10 was produced from a well known spreadsheet and uses the equation for the far field of a circular aperture (dish) antenna.

	A	B	C	D
1	freq MHz	3000.00	<--insert	
2	lambda(m)	0.10	----->	wavelength (m)
3	Diam	4.00	<--insert	diam (m)
4	R(metres)	80.00	----->	$R = D^2 / 2 * \text{lambda}$
5	Power dB	30.00	<--insert	power
6	T loss dB	0.00	<--insert	attenuation
7	Gain dB	40.00	<--insert	gain
8		70.00	----->	$P - T + G$ dB
9		80424.77	----->	$4\pi \times R \times R$
10		49.05	----->	$10 * \log$ of above
11		20.95	----->	= L dBW/sq m
12		2.09	----->	(antilog) L/10
13		124.34	----->	$L = \text{W/sq m}$

Figure 5.10 Computer spreadsheet layout for antenna calculations

The equation illustrated is equation 2 from earlier in this chapter:

$$L = P - T + G - 10 \log(4\pi R^2) \text{ dBWm}^{-2}$$

The diagram shows the alpha and numeric cell references. All the calculations lie in column B, all other cells containing 'labels'. The numbers relate to example 1 earlier in this chapter and are left in cells B1, B3, B5, B6 and B7. This acts as a useful check on the calculation to detect any corruption and also to avoid the 'cannot divide by zero' message!

A new calculation just requires the relevant data to be inserted in the cells mentioned above and then B4 gives the Rayleigh distance, cell B11 the value of L (the reference level) in dBWm^{-2} and cell B13 the value of L in Wm^{-2} .

The method can be used in the same way for the elliptical and rectangular aperture calculations by laying out the appropriate equations in the same way. In fact all the calculations in this chapter can be stored in spreadsheets and laid out for direct use. With the example here it is also easy to add the factors from

Table 5.3 Summary of the use of the calculation charts

Aperture type	Field region	Diagram ref.	Calculation equation	'Y' axis scaling
Circular	Far	Figure 5.4	Equation (2)	No change
Elliptical/ rectangular	Far	Figure 5.4	Equation (4) Put $R = A^2/(2\lambda)$	Put $D = A$ when A is Vertical; $D = A^2/B$ where A is Horizontal
Elliptical/ rectangular	Intermediate (‘A’ dimension Horizontal, e.g. as for surveillance radar)	Figure 5.5	Equation (6) $R_1 = A^2/2\lambda$ $R_2 = B^2/2\lambda$	No change
Elliptical/ rectangular	Intermediate (‘A’ dimension Vertical, e.g. as for height finding radar)	Figure 5.6	Equation (6) $R_1 = A^2/2\lambda$ $R_2 = B^2/2\lambda$	No change

Table 5.1 to extend the spreadsheet layout and connect it to the cell B13 content, thus calculating automatically the power density at the chart 2 dB points. It will then provide the data as illustrated in the Table 5.2 example.

A quick reference summary chart for the use of Figures 5.4 to 5.6 inclusive, is given in Table 5.3.

Useful approximations for microwave antennas

Approximations are useful in appropriate circumstances as cross-checks or in temporary circumstances until further data is obtained. They should not be a substitute for finding out the correct information, if it is available.

Where values such as L and L_2 occur below, the units applicable are as for the earlier reference in this chapter. Antenna gains given as a ratio and those given as dBi should not be confused. G_o is used to indicate ratios relative to an isotropic antenna and G for dBi. They are converted as follows:

$$G \text{ (dBi)} = 10 \log G_o; \quad G_o = \text{antilog } G/10 = 10^{G/10}$$

Examples:

$$\text{Ratio } 1000; \quad G = 10 \log 1000 = 30 \text{ dBi}; \quad G_o = 10^{30/10} = 1000$$

1 Circular apertures

(a) Gain of an ‘ideal’ antenna (excluding specialised types including satellite antennas):

D = antenna diameter (m); λ = wavelength (m) = $300/f$ (MHz)

$$G \text{ (dBi)} = 10 + 20 \log(D/\lambda) \quad (7)$$

(b) Gain of an antenna with an efficiency of $\approx 64\%$:

$$G \text{ (dBi)} = 8 + 20 \log(D/\lambda) \quad (8)$$

Figure 5.11 shows the use of equation 8 for three circular aperture antennas.

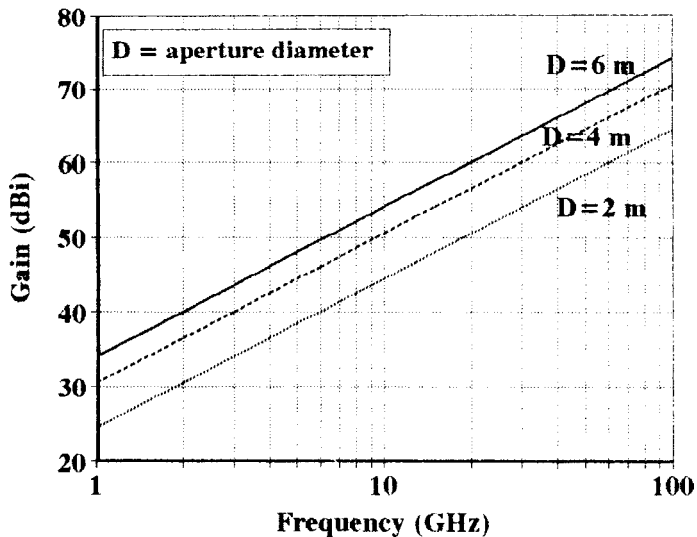

Figure 5.11 Gain of circular apertures versus frequency for three aperture diameters

(c) Maximum power anywhere on the axis where an antenna efficiency of $\approx 64\%$ is assumed:

$$S_{\max} = L + 2.5 \text{ dB}$$

or approximately 1.8 times the reference power flux L in equation 2.

Note that if the expression for gain for an antenna efficiency of $\approx 64\%$ from (b) above is used in equation 2 to compute L and $T = 0$, then:

$$L = (2 \times P)/D^2$$

which is a useful initial evaluation of L . Where the aperture area is used, the expression would be:

$$L = (1.57 \times P)/\text{Area} \quad (9)$$

and S_{\max} (Wm^{-2}) would be $1.8 \times (1.57 \times P)/\text{Area} = 2.8 P/\text{Area}$ (10)

A conservative approach used by some organisations for the maximum power density anywhere on the axis in the near field is to use the above expression modified to assume an antenna efficiency of 100% giving:

$$S_{\max} (\text{Wm}^{-2}) = 4 P/\text{Area} \tag{11}$$

(d) Beamwidth estimate

$$\text{Approximately } 64 \lambda/D \text{ degrees for the 3 dB beamwidth} \tag{12}$$

2 Rectangular and elliptical apertures

(a) Gain of an antenna for $\approx 64\%$ efficiency (elliptical) or 50% (rectangular) apertures:

$$G (\text{dBi}) = 8 + 10 \log(\text{AB}/\lambda^2) \tag{13}$$

Where A and B are the aperture dimensions, as before. Figure 5.12 illustrates gain against the product AB for a range of frequencies, using equation 13.

(b) Maximum power anywhere on the axis where an antenna efficiency of $\approx 64\%$ is assumed:

Using the expression for gain in equation 13 above in equation 6, the value of L_2 is now:

$$L_2 = P - T + 3 - 10 \log(\text{AB}) = (2 \times P)/\text{AB} \text{ (for } T = 0) \tag{14}$$

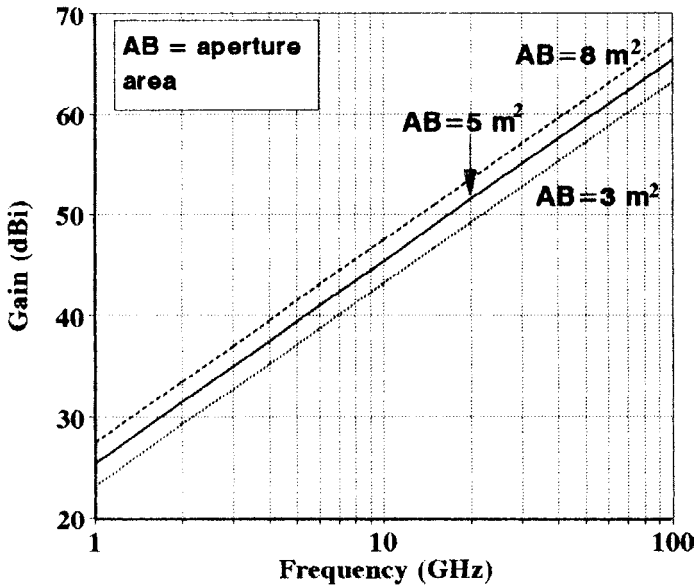

Figure 5.12 Gain of elliptical and rectangular apertures versus frequency for three values of the product $A \times B$

Hence this value $2P/AB$ can give an initial estimate of L_2 .

For the theoretical worst case (100% antenna efficiency) the maximum value anywhere on the axis is then $4P/AB$ (15)

3. *Miscellaneous*

Occasionally it is necessary to make ad hoc calculations in respect of RF radiation incidents and these may involve open waveguides, horns, etc.

- (a) Approximate gain of open rectangular waveguides, pyramidal and sectoral horns with small aperture phase error:

$$G = 32(AB)/\pi\lambda^2 \quad (16)$$

where A and B are the aperture dimensions in metres.

- (b) For circular waveguides:

$$G = 33(r/\lambda)^2 \quad (17)$$

where r is the radius dimension (m).

Inaccessible equipment, e.g. high-mounted radar and communications systems

There will always be some equipments which have inaccessible antenna systems – inaccessible in respect of the RF measurements. The initial reaction to this is ‘no access, hence no hazards’ which may well be the case. However it is possible for moving beams to irradiate places which are occupied by people. In this case it will be necessary to measure at the location involved with the beam aligned optically. This can also arise when with maintenance or building operations an elevated platform or structure is illuminated from several sources and each must be measured and summed. In these cases, a suitable contingency factor should be applied to power densities to cover additive reflections, 3–6 dB would be advised according to the situation.

Specialist aspects of microwave calculations

Where it is really necessary to be concerned with the distribution of energy across the antenna aperture and in the near field, there are many documents dealing with this aspect which can be used and these include references 36 and 70 and also the various well known engineers’ reference manuals.

Safety with moving microwave beams

The nature of moving beam systems

Microwave beams used for purposes such as radar surveillance, height finding and missile tracking may move in a constant or sporadic fashion. Conventional radar surveillance antennas normally rotate continuously at a fixed rate, typically 6 revolutions per minute, and constitute one particular case which can be examined.

Modern phased array antennas may be fixed with the beams being switched electronically or may rotate constantly as for a normal surveillance radar but have some form of electronic beam switching in elevation, either for the receive beam or for the transmit beam. If they have unpredictable transmit beam movements, they may need to be treated as other equipments with unpredictable movement patterns.

Radar height finders move round in azimuth and up and down in elevation. They usually park downwards and, if they are not arranged to switch off in this position, can produce a very hazardous area immediately around themselves. Their general movement is not predictable because of their function. Although separate height finders are being made redundant by modern radar developments there are probably plenty still in use.

Missile and other tracking radars fall into the same category of 'non-predictability'. In all such cases the problem is that the antennas could, during the course of proper operation, point at people and dwell there for an unspecified time. This can be the case with trackers on test following a receding target on a specific azimuth bearing which happens to irradiate people in the area.

There are, therefore, two basic cases which apply to both the mechanically moved and electronically moved beams and to combinations of the two:

- 1 Beams which rotate or scan an arc continuously at a constant speed, or with a defined and predictable repetitive scan pattern.
- 2 Beams which move without predictable patterns of movement.

The word predictable here means that there is a reliable repetitive pattern of movement which can be applied mathematically to the determination of the time-averaged mean power density exposure of a subject who is standing in the vicinity of the radar.

When a continuously rotating beam irradiates a person in its path, the duration of the exposure will only be a fraction of the total time taken for one revolution. Hence the mean power density will only be a fraction of that which would be measured at the location of the subject person, if the beam were stationary and aligned to irradiate that person.

In order to look at the methods used to calculate such irradiation, it is useful to consider two possible requirements. The most common one is to determine the safe boundary for people to work in the vicinity of the source.

The second requirement, which is just a variant of the first, is to determine whether people can work at a specific place or to investigate whether a person has been overexposed at a particular place, e.g. an elevated platform, the roof of a building or any other place not covered by ground-based safety boundaries.

The only difference between the two is the amount of work which might be involved as the setting of a general safety boundary around an antenna may involve measuring at a number of places whereas the second case is limited to a particular place.

Moving beams

'Moving' here includes any form of scanning in a regular and repetitive way. The most common case is the antenna which rotates through 360° in azimuth continuously and at a constant rate. There are two cases to consider:

- 1 The exposed person is located at such a distance that he is in the intermediate or far field of the antenna as Figure 5.13.
- 2 The exposed person is in the near field of the antenna as Figure 5.14.

Intermediate or far field case

If we consider Figure 5.13 where the subject is located in the far field at point X, and assume that the beam rotates continuously at 6 rpm, it is obvious that X will be irradiated once per revolution. For the greater part of the revolution, there will not be any irradiation. It follows that the average

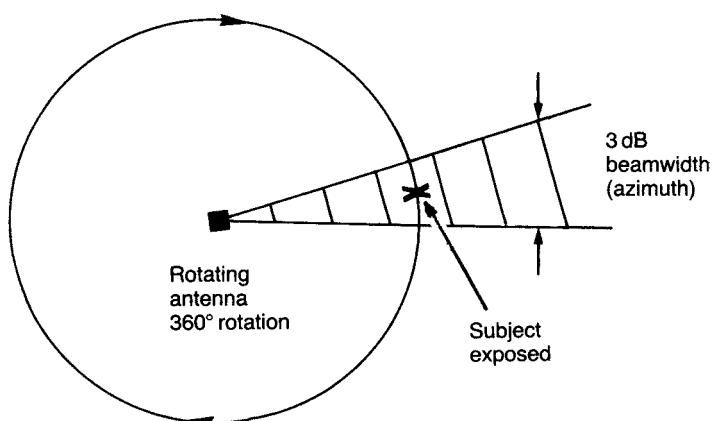

Figure 5.13 *Rotating beam power density time-averaging for a subject in the intermediate/far field*

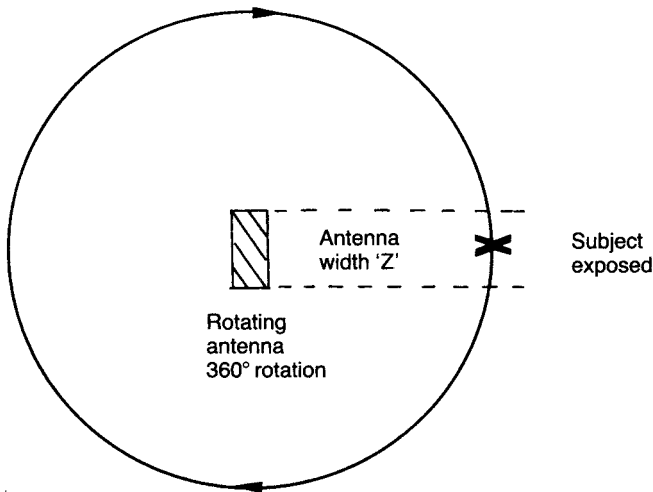

Figure 5.14 Rotating beam power density time-averaging for a subject in the near field case

power density over a single revolution seen at X is governed by a fraction which is related to beam width and the antenna rotational arc, here 360° . This factor is generally referred to as the 'rotational factor' which we can abbreviate to f_{rt} .

Since X is located in the intermediate or far field, the ratio involves the 3 dB beam width of the beam and the total angle of one revolution (360°). If the beam is now stopped and pointed directly at X, the stationary beam power density on the beam axis can be measured there. The product of f_{rt} and this measured power density is the average exposure of the subject and is usually referred to as the rotationally-averaged power density S_{rt} . An acceptable value of S_{rt} can be applied as a circular boundary round the antenna. Clearly this is the worst case.

However in practice, allowance must be made for the fact that if there are a number of work places all at the same distance from the antenna, measurements at some of these points may be very different if some places have metal masses, buildings, etc., which can cause enhancement of the power density by reflections. This may have to be taken into account by making additional measurements with the beam stationary.

Example of a calculation at one place in the intermediate or far field using angles:

Assume that the stationary measured value $S = 500 \text{ Wm}^{-2}$ at point X and that the 3 dB beam width is 3° . To find the rotationally-averaged power density the stationary value is multiplied by the rotational factor f_{rt} thus:

Rotationally-averaged power density $S_{rt}(Wm^{-2}) = f_{rt} \times 500$

$$\begin{aligned} \text{and } f_{rt} &= 3 \text{ dB beam width (degrees)/rotation arc (degrees)} \\ &= 3/360 = 0.0083 \end{aligned}$$

Hence $S_{rt} = 0.0083 \times 500 = 4.17 Wm^{-2}$ mean power density.

This must be compared with the permitted limit of the relevant standard for continuous exposure at the frequency concerned.

Time calculation method

It is possible to approach the same calculation from the time point of view.

Example of time calculation method:

Duration of one rotation at 6 rotations in 60 s = 10 s

Duration of one exposure = $(3^\circ/360^\circ) \times 10 \text{ s} = 0.083 \text{ s}$

and $f_{rt} = \text{exposure time (0.083 s)/rotation time (10 s)} = 0.0083$

Which is the same value for f_{rt} as in the previous calculation. It can be seen that the value of f_{rt} for one revolution suffices since using more than one revolution affects the numerator and denominator equally.

Note also that for a beam rotating for a full 360° or some smaller arc, the existence of sector blanking (see Chapter 9) does not affect the calculation as the ratio depends on the time duration of one sweep or rotation and not what the transmitter is doing during the sweep. The only difference in the general safety consideration is that there can, by definition, be no hazard in the blanked sector.

Note also that a beam scanning less than 360° (say 180°) repetitively can still be dealt with by the two methods above since the first method uses the scan angle and the second the scan duration. The value of f_{rt} for 180° would be twice the value obtained in the 360° case, $3/180$ instead of $3/360$.

Alternatively, a repetitive 180° scan can be conceived as a 360° scan cycle in which the subject receives two exposures, one on each pass giving an f_{rt} of $3/360 + 3/360 = 3/180$ as before.

Apart from the main beam, there will be sidelobes (if unfamiliar, see Chapter 6, Figure 6.10) which need to be taken into account. Usually these will be too low at these distances to be harmful but if they are thought or known to be significant they can be measured on a stationary basis, as for the main beam in calculating subsidiary values of S_{rt} , and summing all S_{rt} values to give the final calculation for the exposure of the subject. This is rarely necessary with high specification antenna systems.

Alternatively they could be deduced as a percentage of the main beam measured power density on the basis of the specification of the antenna. In most cases where there is only some slight significance in the presence of sidelobes, it will be much easier to provide a comfortable contingency by

doubling the 3 dB beam width in the initial consideration of f_{rt} a practice used in most cases by the author as a general contingency factor. However this has not been done in the examples in this chapter to avoid confusion.

The near field case

The previous examples dealt with exposures in the intermediate or far field of the beam. It is also necessary to consider the near field case. Figure 5.14 illustrates this case.

The beam width is now determined as the largest dimension of the antenna aperture in the plane of rotation, shown as Z in the diagram.

Now f_{rt} = aperture length in plane of rotation (Z)/ $2\pi \times$ distance from antenna to the subject.

Reference to Figure 5.14 shows that if the antenna is shown at the centre of a circle drawn such that X (the position of the exposed subject) lies on the circumference, then the distance of that person from the antenna is the radius of the circle. The denominator above is the circumference and $f_{rt} = Z/2\pi r$.

Example:

Assume that the measured power density at X in Figure 5.14 with beam stationary is 650 Wm^{-2} and that rotation is 360° . Point X is 20 m from the antenna and the aperture length (Z) is 5 m.

$$f_{rt} = 5/(2\pi \times 20) = 0.0398$$

$$\text{and } S_{rt} = 650 \times 0.0398 = 25.9 \text{ Wm}^{-2}.$$

Where the arc swept is less than 360° , the denominator should be defined proportionately on the basis of actual arc($^\circ$)/ 360° . Again, no notice should be taken of the fact that part of the arc is sector-blanked as it is the arc sweep time that is the determinant and not the nature of the activity of the transmitter.

Example:

Assume that the scan is 180° and the other data as the previous example:

$$f_{rt} = 5/(2\pi \times 20 \times 180^\circ/360^\circ) = 0.0795$$

$$\text{and } S_{rt} = 650 \times 0.0795 = 51.7 \text{ Wm}^{-2}$$

This near field method of calculation is conservative, as it should be from the safety point of view, overestimating the value of S_{rt} .

Practical examples

The more general case is likely to be to determine the stationary beam power density required to give a permissible rotational power density S_{rt} .

This would enable a hazardous area limit to be applied to the equipment, for example, in the form of a circular perimeter limiting access. It is important, as noted previously, that any metal masses swept by the beam which might provide fields higher than those calculated at the distance in question, should be investigated.

Example 1: Outside the near field

It is proposed to locate personnel outside the near field of a continuously rotating radar with a uniform rotational velocity. The rotation speed is 6 rpm and the 3 dB beamwidth is 4°. What stationary beam power density will correspond to a permitted exposure level of 32 Wm⁻²?

$S_{rt} = 32 \text{ Wm}^{-2}$; let S_o represent the required stationary beam power density.

and $S_o = S_{rt}/f_{rt}$

The beamwidth is 4° so that the rotational factor is:

$$f_{rt} = 4^\circ/360^\circ = 0.0111$$

Now $S_o = 32/0.0111$

$$S_o = 2883 \text{ Wm}^{-2}$$

It would now be necessary to measure the stationary beam at the relevant height above ground, e.g. 0 to 2.5 m for personnel clearance at ground level to establish the distance at which the power density is not greater than 2883 Wm⁻² or refer to measurements already made at various distances from the radar.

Note that as the stationary power density is 2883 Wm⁻², many times the permitted levels at microwave frequencies in any of the standards discussed in Chapter 4, it will be clear that the radar could not be allowed to radiate when stationary, e.g. if rotation failed, since it may point at people and expose them to this excessive level. It would also be a hazard to a surveyor doing a stationary measurement.

Example 2: In the near field

A task is to be undertaken at 10 m from an antenna continuously rotating in the near field. The rotation rate is 6 rpm. Assume that the permitted limit for this frequency is 40 Wm⁻². The antenna aperture length in the plane of rotation is 5 m. The measured power density at the proposed place of work with the beam stationary is 1200 Wm⁻².

- 1 Would it be permissible to work in this position?
- 2 If not, what distance would be permissible?

- 3 Alternatively, what transmitter power reduction would be required to enable the work to be done?

In the near field, the beamwidth dimension is assumed to approximate to the aperture length in the plane of the radiation.

$$f_{rt} = \frac{\text{aperture length in the plane of rotation}}{(2\pi \times \text{distance from antenna to exposed person})}$$

Consider the subject as being on the circumference of a circle whose radius is the distance from the antenna to the exposed person, the antenna being by definition at the centre of the circle. The denominator above is then the circumference of the circle ($2\pi r$).

Now

$$f_{rt} = 5/(2\pi \times 10) = 0.0796$$

$$\text{and } f_{rt} \times 1200 = 95.5 \text{ Wm}^{-2}$$

- 1 This exceeds the specified 40 Wm^{-2} and it would not be permissible to work at this place without some other method of reducing the exposure.
- 2 The value of the power density in the stationary beam at the workplace needs to be reduced. Let the new value = S_{New} .

$$f_{rt} \times S_{\text{New}} = 40; \text{ re-arranging, } S = 40/0.0796$$

Hence $S_{\text{New}} = 503 \text{ Wm}^{-2}$. The new corresponding distance would have to be established by measurement.

- 3 Since the previous measured stationary beam power density at the same place was 1200 Wm^{-2} , and the required limit from (2) above is 503 Wm^{-2} the required power reduction ratio will be: $503/1200 = 0.42 = -3.8 \text{ dB}$.

Note that the figures used in the above example are chosen to illustrate calculation methods. Caution is needed in authorising such exposures in the near field and it would be important to ensure that the field is adequately explored over the whole of the proposed workplace, not just at one point.

Special cases

Some surveillance radars use a single rotating platform with two antennas mounted back-to-back so that a person standing at a point will be irradiated twice in each revolution, once by each radar. The frequencies will usually be different and the permitted exposure limits for the two cases may also differ. It will be necessary to perform calculations for $S_{ft}(f_1)$ and $S_{ft}(f_2)$ where f_1 and f_2 identify the power densities for each of the sources considered separately.

If the permitted limits for the two frequencies happen to be the same, the two S_{rt} values can be added. The total should not exceed that permitted limit. Otherwise they are treated as indicated in Part 3 under the heading ‘multiple irradiations’ on the basis of the sum of the partial fractions.

Peak pulse power density

It is important not to forget to keep an eye on any limitations on this parameter in the standard to which you are working since in most standards both the mean power density and the peak pulse power density exposure for people are required to be controlled. See Part 3 of this chapter.

General limitations

In the foregoing text there are some important aspects to be considered and these are outlined below. Where the elevation of a rotating or scanning beam is fixed but can be changed, it is important that the setting for the measurement of stationary power density required in connection with the above calculation methods should be the worst case from the point of view of the potential exposure of people and should include consideration of the nature of the potential work, i.e. at ground level, on a mount, tower or gantry.

If clearance is only required for work at ground level then it should be endorsed as such, e.g. ‘personnel clearance to 2.5 m height from ground only’. Clearances for higher working need to be definitive and specific, e.g. ‘clearance to work on the lower platform only of gantry no. 6’.

It is worth reiterating that calculations of the type described above cannot take into account the non-uniformity of the environment around a rotating or scanning antenna such as might arise if there are potential sources of power density enhancement at particular places. These may involve metal masses, potentially resonant metal objects including discarded antennas, parts of new antenna structures being assembled and the like.

Here it may be necessary to treat each proposed workplace, even though it may be the same distance from the antenna as in a previous assessment, as a new survey task. Alternatively, a large contingency, at least 6 dB, can be added to the previous calculation to cover other locations at the same distance from the antenna, and some measurements made at the location of possible enhancements to confirm the adequacy of the contingency.

Particular care may be needed if powered plant, e.g. motorised diggers, etc., are to be used both in respect of possible large enhancements of field and also of any possible hazard to fuel in the motorised equipment. Refuelling whilst in the RF field should be prohibited.

Irregularly moving beams

There is a straightforward 'rule' which is not generally written down but which emerges from logical consideration of possible events which can occur with beams which have unpredictable modes of operation as far as the potential irradiation of people is concerned.

If any person can be subject to exposure to a power density which exceeds that specified in the relevant standard over the specified time averaging period (six minutes normally, but see the standard for other cases) then this is, by definition, unacceptable.

If this can occur by a beam dwelling in such a position as to continuously irradiate a person for the specified averaging time given in the relevant standard (six minutes is common for some frequencies) either in normal operation or due to a beam scanning failure then the situation is deemed unacceptable. Practical cases may include tracking radars, height finders and even constantly rotating antennas, if the rotation can fail without shutting the transmitter off. There are other possible cases with some types of phased array antennas, and other new radar systems.

In such cases, the logical conclusion is that such beams should be assessed on a stationary basis. It is worth noting that some organisations also apply an additional empirical restriction so that if the individual is exposed for a time exceeding 1 second as the antenna scans, the beam is assessed on a stationary basis, i.e. no reduction allowed for rotation, even though rotation is at a constant rate.

'Moving people!'

Occasionally a situation occurs where a technician needs to climb a tower or other structure which is irradiated by a stationary source of radiation, the level of which exceeds current limits somewhere on the structure. Within sensible limits, i.e. where the radiation level is not so great as to constitute an instantaneous hazard, it is possible to use a 'permit to work' with the express requirement not to stop in the exposed part of the tower, based on time-averaging. It is also something which is bound to happen sooner or later with people carrying out first surveys since, by definition, the situation is not known until first experienced. However an alert surveyor moves quite quickly when high levels are found!

Another case of 'moving people' is mentioned later in connection with ships and people being required to keep walking past deck mounted antennas. A further case is often that of people in a vehicle being allowed to pass a source of RF radiation which, at the place in question, exceeds permitted levels at a reasonable speed on a 'no stopping' basis. Care must be taken with such provisions both in respect of other problems, e.g. interfering with vehicle electronic control systems, flammable vapours risks, etc. There

is also the possibility of the reasonableness of such a permission being challenged in later subsequent legal action.

Important notes

- 1 Insofar as the foregoing aspects depend on time-averaging, it follows that they cannot be applied where a standard does not permit time-averaging in specific circumstances.
- 2 When dealing with pulsed equipments such as radars, it should be remembered that hazards related to flammable substances and electro-explosives should take into account the pulse peak power density and other field quantities, not only the mean power density values used for human safety purposes. Rotational averaging cannot be used in respect of flammable substances for the obvious reason that the ignition time will be small compared with the dwell time of normal rotating systems.

Part 2 Other antenna system calculations

There are many types of antenna in use for frequencies below those in microwave region covered in Part 1 of this chapter, i.e. SHF downwards. The need is for simple calculation methods which can give us an approximate indication of field quantities in the regions where measurements are to be undertaken. Reference books do not always give a great deal of usable information.

There are, for example, great differences in statements about the definition of the boundaries between the reactive and radiating near-fields and between the near-field and far-field. The latter boundary is of most interest and the most general definitions, apart from those sources which merely say 'a few wavelengths' were, variously, $\lambda/2\pi$, D^2/λ , $2D^2/\lambda$ and $\pi/8$ radian phase difference. The dimensions of the antenna are obviously relevant since this will determine the phase differences between radiation from different parts of the antenna.

Balanis[80] gives the outer boundary of the *reactive near-field region* as a distance $R \leq 0.62[D^3/\lambda]^{1/2}$ where D is the greatest antenna dimension. For a very short dipole or equivalent this outer boundary is given as the distance $\lambda/2\pi$ from the antenna surface. Figure 5.15 illustrates the $\lambda/2\pi$ outer boundary for the frequency range 1 to 100 MHz and Figure 5.16 the $R \leq 0.62[D^3/\lambda]^{1/2}$ outer boundary, using a half wave dipole ($D = \lambda/2$) for the same frequency range.

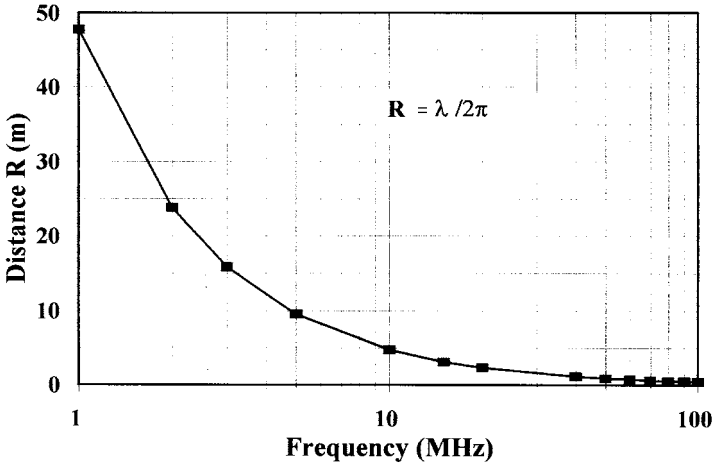

Figure 5.15 Plot of $\lambda/2\pi$ versus distance for 1 to 100 MHz

In the *radiating near field region* the outer boundary is taken as $R < 2D^2/\lambda$ where D is as before but D must be large compared with the wavelength ($D > \lambda$). It is also noted that if the antenna has a maximum overall dimension which is very small compared with the wavelength this region may not exist.

It is interesting to note that the NRPB specify as the basis for measurement that electric and magnetic fields should be measured separately in the near field defined as less than r (far field distance) $= 2D^2/\lambda$

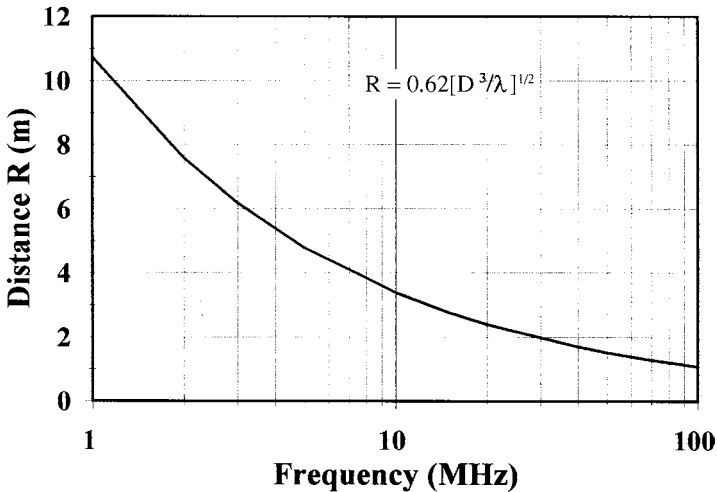

Figure 5.16 Plot of $0.62[D^3/\lambda]^{1/2}$ versus distance for 1 to 100 MHz

providing that $r > \lambda/2\pi$. An additional requirement is that all exposures below 12 MHz should be so measured.

Antenna calculations involve the use of antenna gain data and it would be useful if gain was always referenced to an isotropic antenna. This is often not the case as it may be relative to a dipole or short monopole and some specifications just give '× dB' which is meaningless. Table 5.4 gives the most common gain reference relationships both as ratios and in decibels. To convert, say from 'relative to a dipole' to 'relative to an isotropic antenna': if the data is in decibels relative to a dipole (dBd), add 2.15 to give dBi; if given as a numeric ratio multiply by 1.64. Gain is of course defined as in the direction of maximum radiation.

Table 5.4 *Linear ratio gains and decibel gains relative to an isotropic antenna*

<i>Antenna</i>	<i>Gain ratio, linear</i>	<i>Gain dBi</i>
Isotropic	1	0
Short dipole	1.5	1.76
Half wave dipole	1.64	2.15
Quarter wave monopole	3.28	5.16

Far field formula

For a true isotropic antenna, gain = 1

$$S (\text{Wm}^{-2}) = P/4\pi d^2$$

where P = power (W), d = distance from antenna (m).

Note that practical antennas described as isotropic (meaning equal all-round radiation in azimuth only) may have a gain greater than 1 because the design intentionally restricts the elevation coverage. For example, a typical collinear from the Jaybeam Ltd catalogue covering 380–470 MHz, has an elevation 3 dB beamwidth of 16°.

For dipoles, yagi antennas and similar antennas, the general far field formula used (for the direction of maximum radiation) is:

$$S (\text{Wm}^{-2}) = PG_o/4\pi d^2 \quad (18)$$

where G_o = gain (ratio) in the direction of maximum gain. Hence

$$E \text{ (Vm}^{-1}\text{)} = \sqrt{(30PG_o)/d} \text{ or } 5.48\sqrt{(PG_o)/d}$$

$$\text{and } H \text{ (Am}^{-1}\text{)} = (\sqrt{(PG_o)/68.83d}$$

Table 5.5 gives power density versus distance for the gains shown.

Table 5.5 Far field formula power density versus distance for various gains – vertical antenna; power = 500 W

Gain (dBi)	0 dBi	1 dBi	2 dBi	3 dBi	3.5 dBi
Ratio	1.00	1.26	1.58	2.00	2.24
<i>Distance metres</i>					
0.25	636.6	802.1	1005.9	1273.2	1426.0
0.5	159.2	200.5	251.5	318.3	356.5
0.75	70.7	89.1	111.8	141.5	158.4
1	39.8	50.1	62.9	79.6	89.1
1.5	17.7	22.3	27.9	35.4	39.6
2	9.9	12.5	15.7	19.9	22.3
2.5	6.4	8.0	10.1	12.7	14.3
3	4.4	5.6	7.0	8.8	9.9
3.5	3.2	4.1	5.1	6.5	7.3
4	2.5	3.1	3.9	5.0	5.6
4.5	2.0	2.5	3.1	3.9	4.4
5	1.6	2.0	2.5	3.2	3.6
6	1.1	1.4	1.7	2.2	2.5
7	0.8	1.0	1.3	1.6	1.8
8	0.6	0.8	1.0	1.2	1.4
9	0.5	0.6	0.8	1.0	1.1
10	0.4	0.5	0.6	0.8	0.9

This far field formula tends to overestimate values in the near field. Whilst this is conservative as far as safety assessments are concerned it can be limiting especially in regard to access to equipment by technicians working close to antenna systems on telephone and similar base stations.

The FCC document OET65 bulletin supplement A[75] recommends a method attributable to R. Tell whereby the field is considered on the basis of an imaginary cylinder of length h (m) – the same length as the antenna – with the antenna at the centre – see Figure 5.17.

The method is related to experience with mobile telephone base stations and similar applications using vertical collinear antennas but is also implied as applicable to sectored antennas by virtue of the example allowing consideration of azimuth gain (sector beamwidth). It is also said to be usable close to TV and FM broadcast antennas where people may need to work.

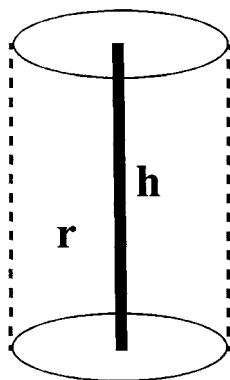

r = radius of cylinder;
h = height of antenna

Figure 5.17 *Conceptual cylinder round a vertical antenna*

For Tell's cylindrical model, spatially averaged plane-wave equivalent power densities parallel to the antenna may be estimated by dividing the net antenna input power by the surface area of an imaginary cylinder surrounding the length of the radiating antenna. While the actual power density will vary along the height of the antenna, the average value along its length closely represents that found by the formula:

$$S \text{ (Wm}^{-2}\text{)} = P_{\text{net}}/2\pi rh \text{ for an isotropic antenna} \quad (19)$$

where P_{net} is the net power input, h is the aperture height of the antenna, and d is the distance, in this case the cylinder radius. It can be seen that S is then the power density spatially averaged over the area of the cylinder of radius r (m).

For sector type antennas, e.g. on mobile phone base stations, the equation is amended to:

$$S \text{ (Wm}^{-2}\text{)} = (180/\theta_{\text{BW}}) \times (P_{\text{net}}/\pi rh) \quad (20)$$

θ_{BW} is the sector azimuth beamwidth (degrees) divided into 360 degrees. (The 180 on the left is due to cancelling 360 with 2 before π in the denominator!) This provides a nominal, rather than actual representation of gain.

The actual gain also depends on the elevation beamwidth. The use of the cylinder concept will not give such accurate values in the far field as equation (18) and the FCC document recommends using both, changing from one to the other where they converge. Note that the use of h in equation (19)

involves an indirect frequency dependency since the aperture height of the antenna will be related to frequency but with collinear dipole antennas will also depend on the number of dipole elements in the collinear. An example of the use of equations (18) and (19) is shown in Figure 5.18. The antenna length value used as the aperture height in the example is a typical figure for a commercial collinear antenna.

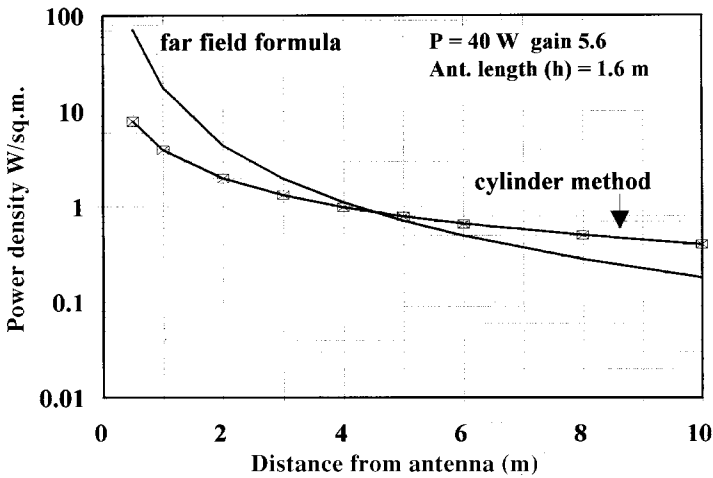

Figure 5.18 Comparison of 'cylinder' formula and the far field formula versus distance

Broadcast antennas

The USA FCC provides calculation information for site assessment purposes in freely available material which gives considerable detail. The basic outlines are reproduced here but, because of the many charts and graphs, those interested in using the information should obtain copies (see Appendix 3). The basis of the approach is equation (18). Note that for broadcasting transmitters, the numerator (PG_o) can be replaced by the equivalent isotropic radiated power EIRP and this term is much used in broadcasting. Also equivalent radiated power ERP, which is referenced to a dipole can be used by multiplying by the numeric gain of a dipole over an isotropic antenna (1.64). The relationships are therefore:

$$S \text{ (Wm}^{-2}\text{)} = \text{EIRP}/4\pi R^2 = 1.64 \text{ ERP}/4\pi R^2 = 0.41 \text{ ERP}/\pi R^2 \quad (21)$$

In order to take account of enhancements from reflection, a factor of 4 on power density (+6 dB), which most people use, would result in a multiplier

of 4 being applied to the numerators in equation (21). However the USA Environmental Protection Agency has done work on this topic and recommends a factor of 2.56 instead. The equation then becomes, with the relevant numerator–denominator cancellations:

$$S (\text{Wm}^{-2}) = 0.64 \text{ EIRP}/\pi R^2 = 1.05 \text{ ERP}/\pi R^2 \quad (22)$$

The graph in Figure 5.19 shows the FCC beam axis calculations for powers from 10 W to 10 kW ERP, with the reflection factor included.

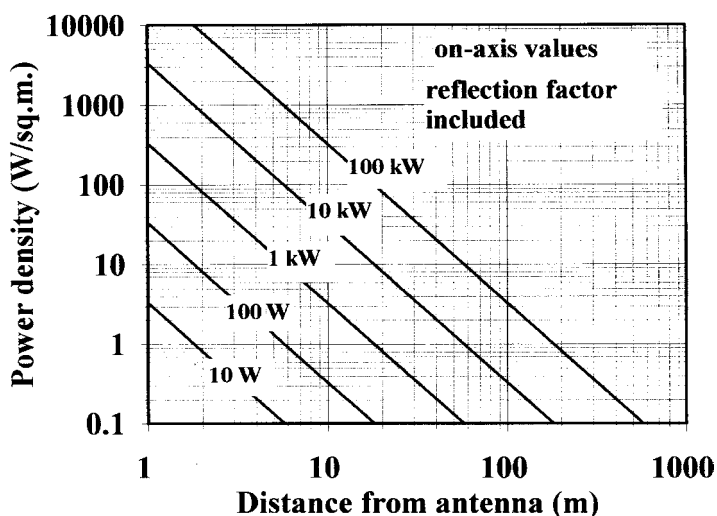

Figure 5.19 *Transmission on-axis power densities for various power values*

Broadcast stations

The FCC OET65 bulletin supplement A[75] covers AM, FM and TV Broadcast stations. It provides detailed calculation methods, tables and charts for the distances powers and antenna heights to comply with the FCC limits (see Table 4.5 of Chapter 4, Part 2). These limits largely, but not entirely, correspond with the INIRC98 public limits but the calculation methods can be used for other limits. Reference[75] also lists other supplements – see ‘references’ at the end of the book.

AM broadcast stations

Figure 5.20 shows a graph of electric field and magnetic field values vs. distance for 1 kW with an antenna tower height of 0.01λ . There are charts and tables for various tower heights.

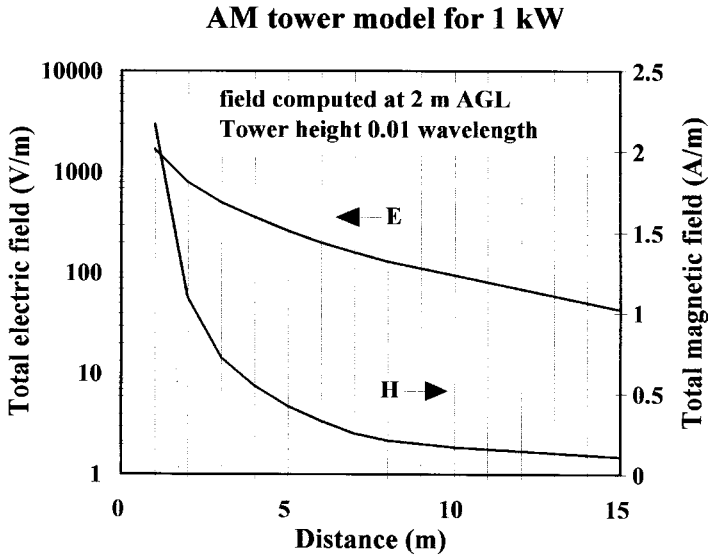

Figure 5.20 AM broadcast model for 1 kW, 0.01λ tower height

FM and TV broadcast stations

These sections provide similar charts and tables.

The USA EPA developed the following general equation to predict fields at the base of television broadcast towers.

$$S = \frac{(2.56)(1.64)(100)(F^2)[0.4 ERP_V + ERP_A]}{4\pi R^2} \tag{23}$$

Where:

- S = power density in microwatts/sq. cm. (μWcm^{-2})
- F = relative field factor in the downward direction of interest (-60° to -90° elevation)
- ERP_V = total peak visual ERP in watts (see note below)
- ERP_A = total aural ERP in watts
- R = distance from ground (or at 2 m above ground) to centre of radiation in metres

Note: The values for ERP in this equation are total ERP. Therefore, although most television antennas transmit in the horizontal polarisation, if a circularly-polarised antenna should be used the contributions from both horizontal and vertical polarisation must be included.

In Equation (23) the value of 2.56 is the ground-reflection factor. The value of 1.64 is the gain of a half-wave dipole relative to an isotropic radiator. The factor of 0.4 converts peak visual ERP to an r.m.s. value which is more

realistic with regard to practical conditions of video transmission. The factor of 100 in the equation is a conversion factor.

For convenience Equation (23) can be simplified to the following expression (same units as above):

$$S = \frac{33.4(F^2)[0.4 \text{ ERP}_V + \text{ERP}_A]}{R^2} \quad (24)$$

If the relative field factors, F (derived from the relative power gain), are known from an antenna's vertical radiation pattern, equations (23) and (24) can be used to arrive at predictions of ground-level power density that are much more accurate than would be the case by using a worst-case estimate of 1 for F . For VHF-TV antennas the value of 0.2 for F can generally be assumed. However, it should be kept in mind that this value generally represents an average and may not necessarily apply in all cases and in all directions.

Free software can be downloaded from the FCC for these calculations. The FCC material in this section and the FCC charts are reproduced with permission of the USA FCC, from public domain material.

Useful additional references relating to UHF/VHF broadcasting are:

Jokela: Theoretical and measured power density in front of VHF/UHF broadcasting antennas.[65]

Mild: Radiofrequency electromagnetic fields in Swedish radio stations and tall FM/TV towers.[63]

European Broadcasting Union (EBU) Tech. 3278-E.[49]

Calculation methods given in British Standard BS6656:1991 (flammable vapours)

Specific methods for use in assessing the risk to flammable vapours from BS6656[31] which can also be used for general calculations are reproduced here courtesy of the BSI, London.

Note that the definitions of terms including G and G_v have been left as published in the Standard (G and G_o are used elsewhere in the book). The calculation methods given vary as to which gain value is used and also in the use of metres and kilometres for distance.

Frequencies up to 30 MHz (vertical polarisation)

This requires reference to monopole curves (Figure 5 or Figure 6) given in BS6656. The effective field strength E (in Vm^{-1}) is given by the equation:

$$E(\text{Vm}^{-1}) = (F(\phi)E_{0m})\sqrt{(PG_v)} \quad (25)$$

Where:

E_0 is the field strength given in BS6656 Figure 5 for a land path or Figure 6 for a sea path or derived from the method given in BS6656 Appendix G;

m is the modulation factor, i.e.

- 1.4 for amplitude modulation by speech or music;
- 2 for MCW;
- 0.7 for SSB;

$m =$ unity for all other types of modulation and for continuous wave (CW) transmissions;

$F(\phi)$ is the horizontal radiation pattern factor, a function of the azimuth angle ϕ , $F(\phi) = 1$ on the bearing of the main lobe. If the value cannot be ascertained, it should be ascribed the value $F(\phi) = 1$.

P is the carrier power (or peak power for pulsed transmissions or peak envelope power for SSB) fed to the antenna (in kW);

G_v is the antenna gain relative to a short vertical monopole, in the direction of the main lobe, expressed as a linear power ratio. If the gain is known relative to an isotropic source as a linear power ratio, it should be divided by three to give G_v . If it is expressed in dBi, deduct 5 dB and convert to a linear power ratio.

For distances that are small compared with the wavelength, the above equation may overestimate the extractable power close to the antenna. At distances less than $(100F(\phi)\sqrt{G_v})/f$ metres where f is the frequency in MHz, the effective field strength should be calculated from the following equation:

$$E \text{ (Vm}^{-1}\text{)} = 3 f m \sqrt{P} \quad (26)$$

Frequencies up to 30 MHz (horizontal polarisation)

Horizontally-polarised waves are rapidly attenuated along the ground but elevated structures may still be illuminated. The effective field strength E (in Vm^{-1}) at a height h (in metres) above ground is given approximately by the equation:

$$E \text{ (Vm}^{-1}\text{)} = 2.7 h m F(\phi) \sqrt{(PG)/(d^2 \sin \theta \times 10^4)} \quad (27)$$

Where:

P (kW) is the carrier power (or peak power for pulsed transmissions or peak envelope power for SSB) fed to the antenna.

G is the antenna gain relative to an isotropic source in free space, in the direction of the main lobe, expressed as a linear power ratio.

m and $F(\phi)$ are as before.

d (km) is the distance between transmitting antenna and plant.

θ is the elevation angle of the main lobe.

Frequencies above 30 MHz

Transmissions may be vertically or horizontally polarised but the effect of the ground is almost independent of polarisation. In the absence of ground reflection and in the far field, the effective field strength E (in Vm^{-1}) is given by the following equation:

$$E (\text{Vm}^{-1}) = [0.173 \text{ m F}(\phi)\sqrt{\text{PG}}]/d \quad (28)$$

Where:

P is the carrier power (or peak power for pulsed transmissions or peak envelope power for SSB) fed to the antenna (in kW).

G is the antenna gain, relative to an isotropic source, in the direction of the main lobe, expressed as a linear power ratio.

M and $F(\phi)$ are as before.

d is the distance between transmitting antenna and plant (in kilometres).

‘Note: The above equation is based on far field propagation formulae. For high gain antennas such as those used for radar, equation overestimates the field strength close to the antenna. A more accurate assessment of the field strength close to the antenna can be obtained from BS6656 reference 14.’

BSI reference 14 here is to the work of Dr D. H. Shinn, i.e. the antenna calculation methods in Part 1 of Chapter 5 of this book, but not to the specific references to limits for flammable vapours since his paper[30] which included that topic, preceded the creation of BS6656.

Other useful calculation information for HF

A study looking at the prediction of field strengths near HF transmitters of 10 kW or more (Davenport et al.)[42] provides some useful plots for a horizontal curtain array, horizontal log-periodic dipole array and a rhombic antenna.

Part 3 Simultaneous irradiations and peak pulse power limits

Simultaneous irradiation from several sources

In a situation where a person is irradiated simultaneously by a number of different sources, it is obvious that the total energy impinging on the subject must be taken into account. However, since different frequencies have different permitted limits the method used for summing must be related to the fractions of permitted value, i.e. measured value/permitted value.

It will be recalled from Chapter 4 that the process has become more complicated. For example, the NRPB93 document originally used a very simple formula applicable to power density, the electric field and the magnetic field. However with the issue of the NRPB Report 301 this was completely changed and the interpretation is now largely in line with the concepts, but not the detail, of ICNIRP98.

The IEEE99 document uses the method of squaring the field ‘measured quantity/permitted level’ ratios, and provides an example in an appendix. All standards should give worked examples since their provisions are rarely as clear and unambiguous as their authors believe!

The ICNIRP98 document covers the summing of induced currents, contact currents and electric and magnetic fields. The main expressions have been given in Chapter 4 and as noted before, emphasise the summing of quantities according to the resulting possible effects, i.e. below 100 kHz electrical stimulation effects predominate. Above 10 MHz, thermal considerations apply. From 100 kHz to 1 MHz both effects may be relevant.

The ICNIRP98 document approach is flawed above about 300 MHz for many instruments since it requires measurement of the electric and magnetic fields to 300 GHz and the latter is not possible. However, one manufacturer does now claim to measure magnetic fields to 1500 MHz. The general methodology involves summing the squares of the fractions ‘measured values/permitted values’ for all the frequencies concerned.

If we take the case of frequencies above 1 MHz, the ‘100 kHz to 1 MHz’ part of the summation expression becomes zero and we then only need to perform calculations with the magnetic and electric fields of the second part of the expression. Probably most measurement takes place above 1 MHz. For example, with two sources of frequency f_1 and f_2 , both > 1 MHz, we have:

$$(E_1/E_{p1})^2 + (E_2/E_{p2})^2 \ll 1 \text{ and } (H_1/H_{p1})^2 + (H_2/H_{p2})^2 \ll 1$$

where E_1 , H_1 , etc., are the measured values and E_{p1} , H_{p1} , etc., are the permitted values from the relevant table (public or occupational). Both requirements must be met.

There is now not much difference between the standards in calculating simultaneous irradiations above 1 MHz using the squaring of the ratios ‘measured values/permitted values’ except insofar as the permitted limits differ in each standard.

It is interesting to note that the NRPB93 standard, as modified by the NRPB report 301, when dealing with the thermal effects above 10 MHz, specifies either converting the field quantities to plane-wave equivalent power densities – in which case the simple ratio ‘equivalent power density/permitted power density’ is used and squaring is inappropriate; or the measured field quantities and their relevant permitted levels are squared as

for the ICNIRP example above. The problem of measuring the higher frequency magnetic fields mentioned above is equally applicable.

Power density measuring instruments do in fact give the plane-wave equivalent power density in respect to the field actually measured – E or H field, so that measured values could be used directly for the first option.

Some care is needed when dealing with diversity systems such as some radar systems. A double diversity system which has the two pulses separated in time but where this time difference is small compared with the specified averaging time (probably always the case) both transmitters will contribute energy and will need to be summed. On the other hand the peak pulse powers, from the flammable vapours risk point of view, constitute separate transmissions at different times.

Peak power in a pulse

The need to limit human exposure to the peak pulse energy has been recognised for a long time but there has been a difficulty in establishing a mechanism for determining meaningful limits. The references to the standards below can be followed up in Chapter 4. The relationships involved in pulse transmission were discussed in Chapter 1 and, in summary, are:

Duty factor DF = pulse duration t_p (sec) multiplied by the number of pulses per second (Hz). This gives a number <1 , a typical value being 0.001. It is easier to use the reciprocal which is $1/0.001 = 1000$ in this example.

Mean power density \times duty factor reciprocal = peak pulse power density:

$$S_{\text{mean}} \times 1/\text{DF} = S_{\text{pk}}$$

Thus for a permitted mean power density of 50 Wm^{-2} and $1/\text{DF} = 1000$:

$$S_{\text{pk}} = 50\,000 \text{ Wm}^{-2} \text{ (50 kWm}^{-2}\text{)}.$$

Specifying peak pulse power density limits

The main methods used to specify a limit for S_{pk} are generally either to give specific peak pulse power density limits or to specify a limit for pulse energy (Jm^{-2}).

ICNIRP98

This provides for peak pulse power density and the corresponding field components above 10 MHz by means of a multiplier so that the normal mean power density limits in the standard are multiplied by 1000. For plane-wave conditions, this corresponds to $\sqrt{1000} = 32$ times the electric and magnetic field components. Below 10 MHz other limits apply.

Arithmetically, this is a simple method of tackling the problem for radar and similar equipments but it does set a blanket limit. For example at a frequency 2 GHz (mean power density limit 50 Wm^{-2}) the occupational limit for peak pulse power density would be $50 \times 1000 = 50\,000 \text{ Wm}^{-2}$. With only one pulse of $t_p = 20 \mu\text{s}$ the energy in each pulse would be $50\,000 \times 20 \times 10^{-6} = 1 \text{ Jm}^{-2}$, somewhat higher than would be allowed by the NRPB93 provision.

Limitation occurs by virtue of the duty factor – the multiplier of 1000 corresponds to a typical DF of 0.001. Smaller duty factors (where the DF < 0.001) will result in the peak power density in the pulse exceeding the ICNIRP98 limit at places where the mean power density is equal to the mean power density ICNIRP limit 50 Wm^{-2} used in the example above. For example, if the mean power density is the permitted 50 Wm^{-2} and the duty factor is 0.0008 (reciprocal = 1250) this would give a peak power density in the pulse exceeding $50\,000 \text{ Wm}^{-2}$. To meet the limit the permitted mean power density exposure would have to be reduced proportionally.

NRPB93

The provision in this standard as noted earlier is that in any period of $30 \mu\text{s}$ the energy density shall not exceed 0.28 Jm^{-2}

e.g. For one single pulse of $10 \mu\text{s}$ ($1 \times 10^{-5}\text{s}$) in the specified ‘window’

$$S_{pk} = 0.28 / (1 \times 10^{-5}) = 28\,000 \text{ Wm}^{-2}$$

A single $2 \mu\text{s}$ pulse in the same period would give $S_{pk} = 140\,000 \text{ Wm}^{-2}$. If more than one pulse occurred in the $30 \mu\text{s}$ period their times would need to be summed. The limit case would be $t_p = 30 \mu\text{s}$ and would give $S_{pk} = 9333 \text{ Wm}^{-2}$. It can be seen that for a single very narrow pulse in the $30 \mu\text{s}$ period the value of S_{pk} could be extremely high because of the total energy basis e.g. a single $1 \mu\text{s}$ pulse would give $S_{pk} = 280\,000 \text{ Wm}^{-2}$.

Because there can be a wide variation in duty factor over different equipments and operating conditions, it is necessary to ensure that both the peak pulse power density and the mean power density will be permissible at the relevant place for the worst case variation in operating conditions.

Other methods of specifying peak pulse power density – IEEE99

The IEEE C95.1–1999 standard, provides expressions to calculate peak power density and also to limit the energy density where the pulse duration exceeds 100 ms – see Chapter 4.

It also sets an absolute limit for the electric field value as 100 kVm^{-1} on the basis of the breakdown voltage level in air.

6

Mobile communications systems

This chapter deals with systems which are generally mobile and operate in the public domain either occasionally or regularly. Such systems generally involve non-mobile elements such as radio base stations which may use higher powers than the mobile units. Since mobile telephones have become a particular issue, much of the chapter deals in a more detailed way with the fixed and mobile elements of such systems.

General

There is a growing concern in the public mind specifically related to mobile telephone systems, resulting in a request for the subject to be included in this book. However, there are many systems in the mobile category. It therefore seems desirable to look at the whole subject first. The main factor that distinguishes mobile systems in the minds of people is that they occupy the public environment and it is hard to get away from them! Some are taken for granted and cause no real concern; for example private communications system sets used by particular operators such as police, fire and ambulance service mobile equipment, though they may produce stronger fields than say, ordinary mobile telephone handsets. Such systems are also used by public utilities and other organisations including the military services.

All terrestrial mobile communication systems need some sort of radio base station and this is generally static, though obviously in military and other similar situations these may also be vehicle-based. Satellite systems may also have fixed or mobile ground stations.

These may also be ship or aircraft mounted. Consequently, all these systems operate in the public domain in one form or another.

Amateur radio also involves transmissions in the public domain – usually in residential areas, but also when mounted in road vehicles. The power used may be somewhat higher than other mobile systems, depending on the country concerned and the frequency. Figure 6.1 illustrates a compact ($34 \times 11 \times 28.5$ cm) HF transmitter capable of 100 W output. Apart from such transmitters used for amateur radio ‘shacks’, there is a large variety of transmitter-receiver equipments used for vehicle mounting and also a range of hand-held portable systems.



Figure 6.1 Amateur radio HF transceiver (Courtesy of Waters & Stanton Ltd)

Amateur radio domestic stations have limitations on mast heights and antenna systems due to local planning regulations. The most often observed problem with amateur radio transmission probably centres on radio and television interference rather than any other aspect. Radio amateurs are usually very co-operative in reducing such problems with filters, etc.

Citizen's band radio (CB) on HF (around 27 MHz) is used in vehicles. The use of high power amplifiers (illegal in some countries) can provide some risks, particularly in respect of flammable substances, as can be seen in Chapter 4, Part 3, Figure 4.15.

A type of mobile equipment often met in the public domain is the mobile broadcasting unit. Figure 6.2 illustrates a typical BBC outside broadcast van with roof mounted microwave antennas, one of which is extendable. Such equipment is used by competent people and is unlikely to cause any concerns. Similar equipment is used in the form of portable satellite transmit/receive systems for news gathering, etc. Here again the contact with the satellite is via a relatively narrow beam and this is only directed upwards at the appropriate elevation. Any interruption to the beam would cut communications so that any risk associated with such equipment would be from deliberate misuse. However, such equipment needs to be used with care on civil and military airfields, because of possible interference effects.



Figure 6.2 *BBC outside broadcast van (Courtesy of BBC West Midlands)*

Some mobile systems like the one illustrated in Figure 6.3, where the equipment installed in the vehicle is used for investigations relating to air traffic control systems and associated equipment, are used for maintenance and fault-finding. Not all such systems radiate, many vehicle mounted systems being used for receiving purposes such as field strength measurements, the investigation of the sources of interference, etc. Hence the sight of a vehicle with antennas mounted on it should not automatically cause worries about possible radiation!

Mobile military radio systems also are used in the public domain on exercises and demonstrations. Although these, in general, may use higher powers than civil systems, they are operated by people trained in RF

radiation safety and are unlikely to be a cause for concern, except possibly from interference with radio or television.

Figure 6.4 illustrates the degree of miniaturisation that has taken place in portable equipment. It consists of a positioner and a parabolic dish. The positioner can control the azimuth and elevation of the antenna. When used with suitable transmitter and or receiving equipment it can be used for data communication and many other forms of signal acquisition including covert



Figure 6.3 National Air Traffic Service technical investigation vehicle (Courtesy of NATS UK)



Figure 6.4 *Portable antenna positioner and dish antenna (Courtesy of Qpar Ltd)*

surveillance. The positioner and antenna fit into a small suitcase and can be carried easily.

In general, there is likely to be an increase in the use of radio equipment in the public domain for novel applications in this electronic age. In some countries such equipment is used on railway systems both for communication and for checking the contents of goods trains on the move. For motorway use there is work in hand to study the application of small radar systems to motor vehicles to improve safety. Some radar systems are already fitted to high specification models. Hand-held radar systems are also in use by traffic police for speed checking.

There are also many fixed antenna masts in the countryside which have important telemetry functions such as controlling water supplies, river flow,

etc. The location of these has to be determined by the service being operated, e.g. the location of a reservoir or water storage tank and may often need to be near residential areas.

It is likely that RF interference rather than any personal health risk, will be the predominant feature as we develop further systems providing that designers and installers are trained in RF radiation safety. Some systems currently suggested such as the radio-controlled home, controlled by a mobile telephone, offer a vision of new problems such as a breed of hackers switching on cookers and washing machines for amusement!

RF interference, as part of electro-magnetic compatibility (EMC) is discussed elsewhere in this book but it should be noted that regulations which seek to reduce unnecessary radiation from equipment, do not apply to transmission on authorised frequencies. Generally interference in these cases is dealt with individually by regulatory authorities.

One specific aspect of interference from mobile phones is the fear that use in places such as hospitals, despite it being forbidden in most cases, can cause serious interference with medical equipment. Chapter 7 describes a commercial device which can automatically detect such misuse and broadcast a pre-recorded request for it to be switched off!

Mobile telephone systems in public use

The general public concern about the safety of mobile telephone systems extends both to the use of the hand-held instrument and to the base station antennas.

The concerns seem to be:

- People who have genuine, if vague, worries about safety, with the possibility of tumour production as a common element.
- In particular, those unfamiliar with RF find it very hard to understand the nature of such radiation. Some people have, from past experience, a general distrust of the pronouncement of scientists, particularly government scientists, on safety topics.
- Those who have aesthetic objections to towers and antennas near their homes and use safety to support the arguments.
- Worries about antenna systems on or near school buildings.

To take the last item first, it is the author's view that people who site such telephone system antennas on or very close to schools, ask for all the problems they get. Of course some companies have specific policies to avoid schools and they should be commended for recognising the human psychology concerned. Whilst most people working with RF radiation on such systems and most government bodies concerned with public safety do not believe that

the fields at ground level can cause any harm, the worries of parents about their children are too strong to be overcome by logic and science and are not worth the attempt when other sites can be found. There are times when science cannot overcome the defensive psychology of parenthood!

With regard to the general health worries, it is important to provide material about RF safety that is understandable to the average person. A number of government bodies have done this both via the Internet and via leaflets – see Appendix 3. The non-technical media does not help a great deal because of the sensational aspect of reporting and the limited technical background of most reporters. It is important that communicators simplify the subject rather than talking down to people. ‘Take my word for it that $\times \text{Wm}^{-2}$ is safe’ is likely to lead to a reminder that scientists told us that asbestos was safe, that thalidomide was safe, etc.! It is increasingly being recognised that worry about radiation can affect peoples’ sense of well-being and that much more care should be taken in communicating with the public in a more meaningful way.

Notwithstanding these concerns, the reported UK sales figure for mobile telephones over the pre-Christmas period 1999 was 4.1 million! In particular, in the author’s locality where parents have been worried about antennas on schools, almost every teenager seems to have a mobile phone and these are used in public for endless calls to friends. Indeed, now that Internet and other facilities on mobile phones are available, it seems likely that their use will eventually become universal and either supersede the wire network or, more likely, operate from a dual purpose line and radio instrument.

Towers

The aesthetic aspect of towers and antennas is a difficult one as many professional engineers may well share the aesthetic concerns. It would be better if the aesthetic aspect was treated alone rather than being supported by vague references to fears about radiation, where they are not really justifiable. In some cases the aesthetic objections have been overcome by camouflage. Antennas concealed in existing objects reduce the sprawl of antenna systems and do no harm to the view seen by residents. Figure 6.5 illustrates two sector antennas on a pole mount with the antenna cover removed. It is sited alongside a street lamp. When the cover is fitted it is probably aesthetically less intrusive than the lamp.

In some cases antennas have been incorporated in objects such as flagpoles and other approaches include masts disguised as trees. It was difficult not to sympathise with the UK telephone company who, having erected an antenna disguised as a tree in amongst other trees, only received a complaint in the winter because all the trees except theirs had shed their leaves leaving the plastic tree as an alleged eyesore!

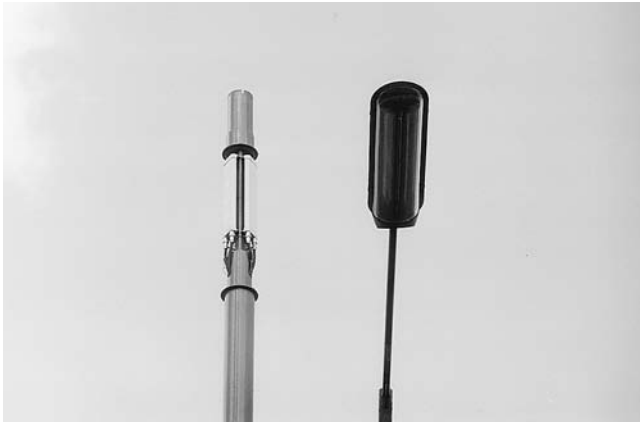

Figure 6.5 *Concealed sector antennas – weather cover removed (Courtesy of E. Randall)*

If appropriate consideration is given to the local environmental aspects it may not be necessary to argue the safety issues since these are often raised because the objector feels that aesthetic concerns have little weight. Large towers can be aesthetically objectionable to some people although most people in urban areas have to live with the large towers used for mains power distribution.

Most countries have some sort of planning rules for masts and towers. In the UK there is a readily available code of best practice for mast and tower development [82] which provides guidance to the Local Authorities responsible for planning matters and to those installing masts and towers. This document is available free to the public. There is currently pressure to improve these planning procedures to take more account of the views of local residents, since the existing procedures were intended to aid and speed the creation of telephone networks and, it is argued, these are now sufficiently well developed that procedures can be tightened. In view of the Stewart report recommendations later in this chapter under the heading 'Recent developments' this planning document is being revised. It is possible that devolution in the UK may lead to differences in planning procedures across England, Scotland and Wales.

In the USA there is a similar provision for mast installation planning control.

It seems obvious that some form of local consultation is necessary when proposals for new masts are involved, otherwise objections will mount as individuals canvas support and the debate will be protracted. It is important that local people know why the proposed site has been chosen, especially since it will probably be to serve those telephone users involved. However,

it does seem likely that, despite the ever-growing usage of mobile telephone equipment, users will continue to display the 'not in my backyard' approach to mast siting despite the fact that more distant base stations may result in a demand for more power from handsets!

Radio communications and the problems of coverage

Long before cellular telephones became available, portable radio systems were used for point to point contacts. These generally communicated directly, or sometimes via repeaters, to anyone listening on the frequency concerned. A repeater system is one that receives transmissions from individual sources on one frequency and retransmits them on a slightly different frequency with higher power. They are sited where possible on a high mounting and on high ground to serve a defined area. Amateur radio also uses repeaters to obtain a greater range of coverage.

Such individual portable radio systems are generally higher power (a few watts output) than present day mobile phones, and have a relatively short range. They are, of course, still widely used for specific purposes as indicated earlier in connection with police, fire and ambulance services as well as taxis, public utilities and other services. Repeaters usually use higher powers but will generally be mounted as high as possible on towers.

The interest in a more general system of radio communication based on the concepts of conventional telephone systems but with mobile radio systems allowing use anywhere by normal number dialling led to the development of private mobile radio (PMR) systems. The original systems used analogue transmission and many of these are still in use but are being rapidly replaced by digital systems.

The original systems used geographically located cells each with its own base station and with communication links so that a journey through a series of cells results in a seamless hand-over without interruption to communication thus enabling the use of mobile phones on the move, particularly in vehicles. Vehicle systems include both specially designed vehicle installations generally using more power than personal mobile phones and ordinary handsets used in everyday fashion or arranged in a 'hands free' configuration.

There are concerns about the driver's use of any type of telephone system in moving vehicles, a point made in the Stewart report. Whilst it is not currently illegal in the UK, prosecutions do take place on the basis of 'failing to have control of the vehicle'.

With all mobile telephone systems there are problems of geographical coverage due to the terrain and other factors that lead to the use of high towers, high ground and in built up areas, the roofs of buildings. Buildings may attenuate signals and make reception impossible or at least difficult.

They may also reflect signals causing technical problem with reception. Metal clad buildings may provide very considerable attenuation. Hence the conflict which develops when there is a need for more base stations to secure coverage. Users welcome the improved coverage resulting but, as has been mentioned earlier, may still complain of the aesthetic problems and alleged safety fears.

With the onset of digital systems, known as GSM systems (global system for mobile communications) the object was for a system that could be used in any country. The power in GSM handsets is lower than that used in analogue systems so that the analogue cell structures needed to be supplemented. The analogue systems operated on frequencies around 900 MHz and GSM operates around 900 and 1800 MHz. Frequency allocations may vary between countries but more than 400 countries now use GSM thus facilitating operation across national borders. Some handsets are now dual band types, to make 'roaming' even easier.

Apart from private mobile radio there is provision for private communication networks (PCN), global mobile satellite working and public paging systems. In the UK, the latter have bands allocated around 138, 153 and 454 MHz.

In this chapter the interest centres on:

- base stations
- mobile phone handsets (generally called mobile phones)

Base stations and antenna systems

For the purposes of this chapter the permitted exposure limits referenced are, unless otherwise noted, from the ICNIRP 1998 document (see Chapter 4) as this, at the moment, is the nearest to an international document. Figure 6.6 is a plot of frequency versus power density from 800 MHz to 2 GHz giving the ICNIRP public limits for power density. It can be seen that the lowest level (4 Wm^{-2}) is at 800 MHz and increases with frequency to 10 Wm^{-2} at 2 GHz.

The public concern – base stations

Base station antennas may be found on separate masts or on shared masts, roof tops and similar places that offer the potential area coverage by virtue of height. Omnidirectional types of antennas are used where all-round coverage is needed. The simplest type is a vertical rod. Collinear types, consisting of two or more dipoles end to end vertically and fed in series or parallel, enable a gain to be achieved whilst still radiating omnidirectionally in azimuth, by restricting the angular coverage in elevation.

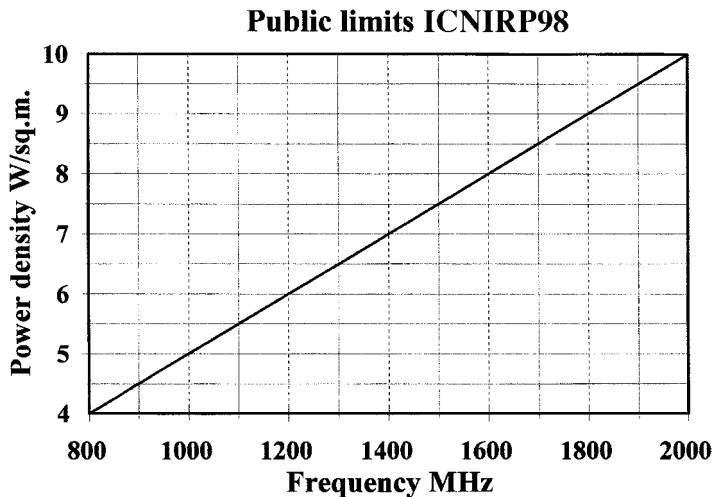
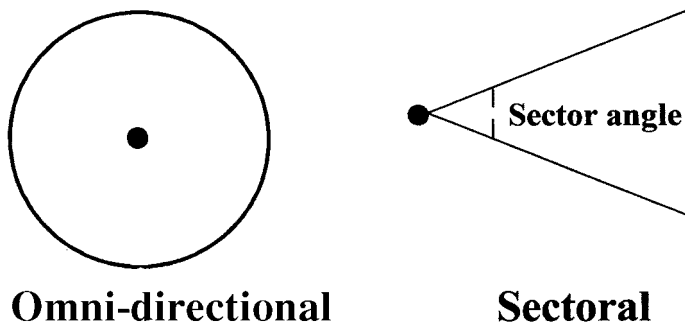

Figure 6.6 *ICNIRP public limits over mobile phone frequencies*

For the coverage of ‘sectors’ in azimuth, rectangular flat sectored antennas can be arranged to give an angular coverage of some nominal amount, e.g. 45°, 60°, 90°, 120° and other sub-divisions according to need. Figure 6.7 shows the distinction between azimuth coverage for omnidirectional and sectored antennas.

Figure 6.8 shows sketches of a sector and an omnidirectional antenna, picked at random from a catalogue, courtesy of Jaybeam Ltd. The example



Vertical antennas – azimuth pattern

Figure 6.7 *Omnidirectional and sectoral antenna azimuth coverages*

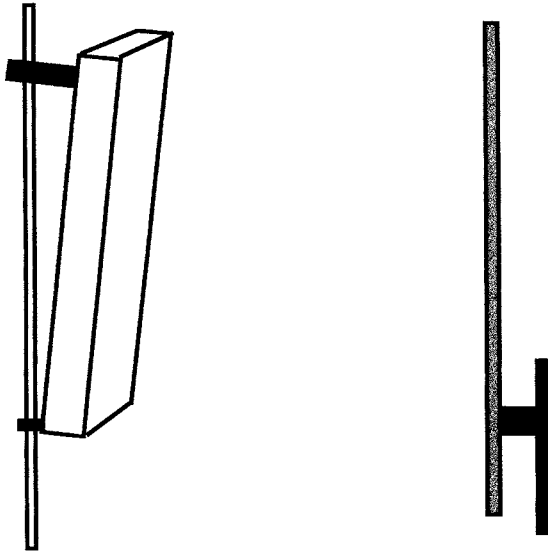

60 degree sector type

Collinear

Figure 6.8 *Examples of omni-directional and sectoral antennas*

on the left is intended for the 870–960 MHz band, with linear vertical polarisation. It is a 60° sector antenna with an azimuth beamwidth of 60° and an elevation beamwidth of 16.5° . The height is 1.15 m and the tilt of the beam can be set between plus 12° and minus 12° . The gain is 15 dBi. There are an enormous number of configurations of this type of antenna with vertical polarisation, cross polarisation, dual banding (900/18800 MHz), several antennas in one housing, etc. Fibreglass or some similar weatherproofing is used. The compact nature of these antennas ($115 \times 27 \times 10.5$ cm in this example) lend themselves to some degree of camouflage where aesthetic considerations are important.

The collinear on the right of Figure 6.8 covers 825 to 896 MHz and has, of course an omni (360°) coverage in azimuth and a beamwidth of 7.2° in elevation. The gain is 10.3 dBi and the antenna is 3.37 m long. Again this lends itself to camouflage, being very slim.

An alternative type of sector antenna system is the use of yagi antennas (similar to domestic television antennas in appearance) stacked in vertical or horizontal banks to achieve the desired coverage – see Figure 6.9. Compared with the sector antennas mentioned above, such arrays are more bulky.

Figure 6.10 shows the generalised shape of beams. It will be noted that the small sidelobes at the left of the diagram are of no value but result from the

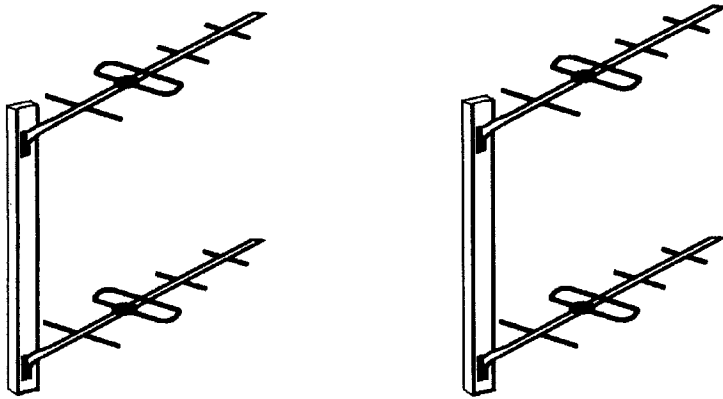

Figure 6.9 *Stacked Yagi antennas*

practicalities of beam antenna design. The term ‘beamwidth’ has no meaning unless it is defined and, as shown, the usual definition is the width in degrees of angle between the opposite points corresponding to a 3 dB reduction in power density relative to the axis, as shown in the diagram. A 3 dB reduction corresponds to the half power value, i.e. a reduction of power density by a factor of two relative to the axis and a corresponding reduction of the magnetic and electric fields by the square root of that factor, i.e. $\sqrt{2}$. Any beamwidth can, of course, be defined on the same basis by specifying the dB reduction factor, e.g. 10 dB beamwidth. However where the beamwidth is just stated as X degrees, the 3 dB definition is assumed.

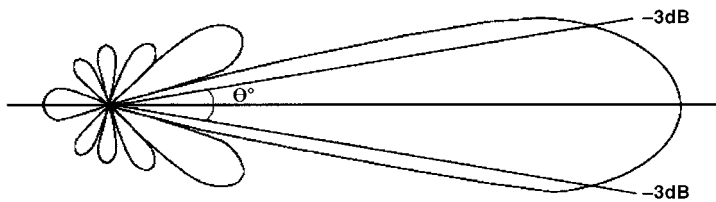

Figure 6.10 *General beam characteristics*

The practice of ‘drawing’ a beam is an engineering and educational convenience but should not be seen as confining all hazardous levels within it! If the -3 dB value exceeds permitted limits then there is clearly a potential hazard outside that boundary.

In addition to the above antenna systems, small parabolic dishes, typically 0.25–0.6 m diameter, are used for communication links and operate in the GHz region with very small input power usually less than 1 W. This type of antenna is covered in Chapter 5.

Antennas mounted on towers allow the height to be determined to suit the required coverage, subject to any national planning regulations. A simple example is shown in Figure 6.11. In practice, sharing of masts is common and the total number of antennas on a mast may be considerable, particularly on any broadcasting transmitter masts sharing with mobile phone antenna systems. Indeed, since there is a rental income from hiring space on towers (and roofs), there is a trend to maximise the use of existing facilities.

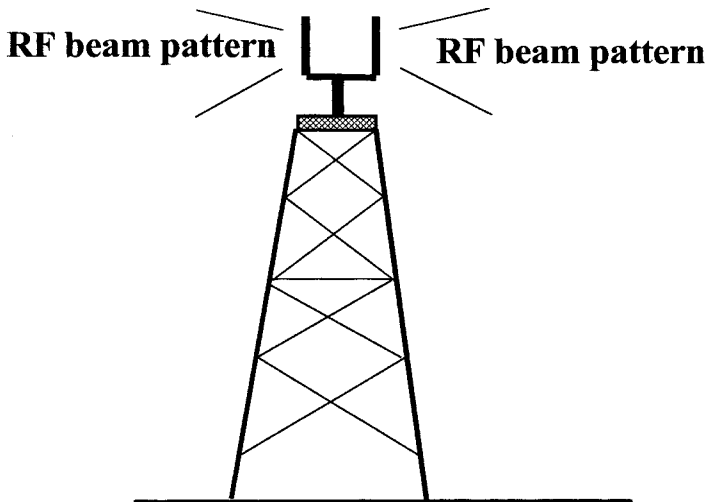

Figure 6.11 Tower diagram

Figure 6.12 shows a small mast with sectored antennas arranged around the top of the mast. Figure 6.13 similarly illustrates the use of 4 collinear antennas. In both cases, a microwave dish communication link can be seen below the top of the mast.

It does seem to be generally accepted that mobile phone system antennas on high masts do not cause harm to people on the ground at the power levels used in such systems. Figure 6.14 shows the theoretical levels at the ground for an antenna on a 15 m high building at distances up to 300 m away. The frequency is 1800 MHz. The unit used here is, as on the original drawing, mWm^{-2} ($1 \text{ mWm}^{-2} = 0.001 \text{ Wm}^{-2}$). Note that the figures shown are very small compared with the ICNIRP public limits for 1800 MHz. In fact they are several thousand times less. The data for this diagram is given as:

power into antenna = 5 W; two carriers; boresight gain = 18 dBi;
 azimuth gain at 42° = 15.5 dBi; elevation 3 dB beamwidth = $\pm 4^\circ$;

Gain at back of antenna -7 dBi and at the top and bottom of the antenna -2 dBi.

Another diagram, Figure 6.15, shows measured levels in the same way for four transmitters in the nominal 900 MHz band mounted on a mast. The results are expressed as a percentage of the then locally permitted limit of 2 Wm^{-2} . Against the current ICNIRP public limit, they should be divided by a factor of $4.5/2 = 2.25$. Hence the highest level on the diagram (0.74%) would become 0.33%.

Where antennas on the roof of a building are used, shadowing effects can occur as shown in Figure 6.16 due the edge of the roof attenuating the beam, with a resultant loss of usable signal. Raising the antenna on the



Figure 6.12 *Tower-mounted sectored antennas (Courtesy of BT)*



Figure 6.13 *Tower mounted colinear antennas (Courtesy of BT)*

roof can partly overcome shadowing though planning regulations may not permit it. Signals can also be attenuated by buildings in the path or by topographical factors.

Reflection of signals from metal or other structures can reduce or increase signals at particular places. Hence the attainment of full service coverage is complex. Within built up areas, tiny very low-powered equipment may be locally sited on suitable objects to ensure suitable coverage. In remote sparsely populated countryside reception may not be possible on economic grounds.

An interesting measurement survey in the New Zealand Wadestown suburb of Wellington where two mobile phone base stations are situated is reproduced with permission as Figure 6.17. For an idea of scale, the two

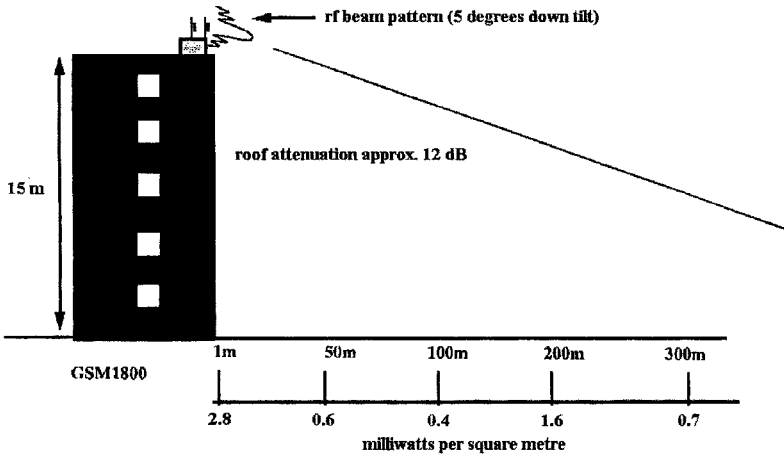

Figure 6.14 Theoretical levels for GSM(1800) exposure at ground level (Courtesy of C&W Communications)

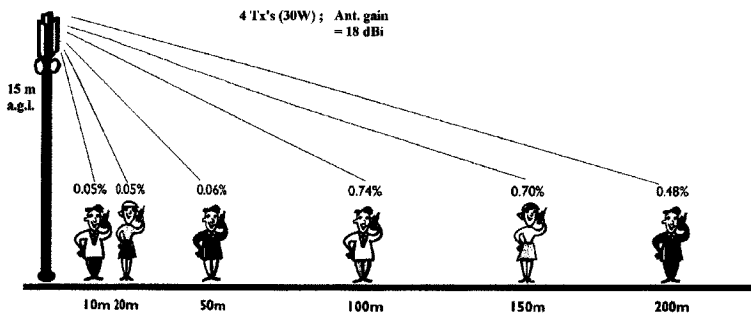

Figure 6.15 Measured levels from mast-mounted antennas as a percentage of a permitted level of 2 Wm^{-2} (Courtesy of C&W Communications)

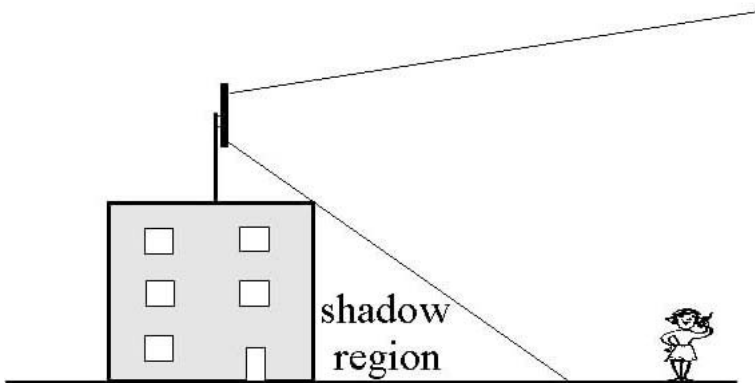

Figure 6.16 Shadowing of coverage from roof-mounted antennas

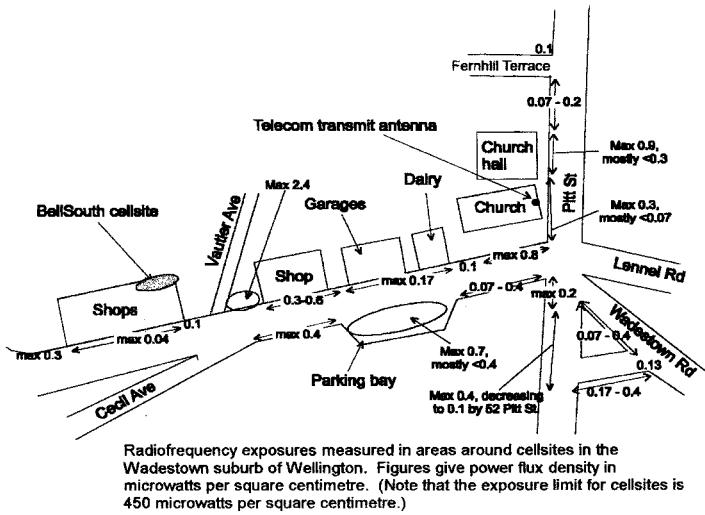

Figure 6.17 New Zealand survey measurements (Courtesy of New Zealand Dept. of Health)

transmitter sites are about 100 m apart. Note that the measured values are expressed in μWcm^{-2} which may be a little confusing: $1 \mu\text{Wcm}^{-2} = 0.001 \text{mWcm}^{-2} = 0.01 \text{Wm}^{-2}$. New Zealand is now using the ICNIRP limits and the limit for the 900 MHz band, expressed in the same units as the map, is $450 \mu\text{Wcm}^{-2}$. A qualifying note states that it was evident that in some places there was an additional contribution from the TV and radio transmitters on Mt Kaukau, a common problem for anyone doing such surveys since broadcasters do not switch off for anyone! Notwithstanding any stray contributions it can be seen that levels are very low.

The UK NRPB has recently published the result of a measurement survey of levels at 118 locations around 17 base station sites as report NRPB-R321 [55]. In summary, measurements were made at sites where people lived, worked, or had frequent access. People are rarely exposed to the main beam, because of close proximity to the mobile phone mast in question, or due to shielding by buildings. At the locations measured, up to 250 metres from the base stations, measurements of power density did not show any general trend of a decrease in exposure with increasing distance from the mast. Calculations assuming exposure to the main beam have shown that with typical maximum power levels, exposure at normally accessible locations will also be a small fraction of guidelines.

The measurements also show that exposures of people to radio waves from nearby masts are frequently comparable to exposures from more distant masts, and from TV, FM radio and other transmitters, a point made by other people also. The highest measured public exposure from all these

sources of RF signals combined was 0.2% of international guidelines, while typical average exposures were 0.002% of the guidelines.

The NRPB commented that ‘The findings of NRPB-R321 are likely to be typical but it was not an exhaustive study. A much larger study is required before we can be certain that results are applicable to the majority of mobile phone masts.’

Persons employed on work with base station equipment

Rooftop equipment

The previous section was concerned with the public interest, the definition of ‘public’ implying people who do not work with radio transmission equipment. People who do work with such equipment will from time to time be in close proximity to transmitters and their antenna systems on a building or up a tower. It is also likely that there may exist in such workplaces other transmitting equipment belonging to other organisations so the working environments may range from simple ‘one-user’ locations to complex multi-user situations. For the purposes of this chapter discussion will be limited to mobile phone-related equipment since the wider issues are dealt with in later chapters, especially with regard to towers with many users. It should however be noted that when MF and HF antennas are present, it is important that people installing or servicing telephone equipment should be briefed on the potential hazards associated with such equipment, particularly in respect of the risk of burns and shock.

Most companies in the telephone field provide safe boundary charts for their staff in the form shown in Figure 6.18. In the UK there is also an informal system, devised by safety practitioners from UK telephone and other organisations, for marking antennas cables in colour coded form in order that technicians can recognise the radiation status of antennas on site. However, it does serve to illustrate the need for some form of marking. See Figure 6.24 at the end of this chapter.

Figures 6.19 and 6.20 show typical base station installations on buildings. Both show an uncluttered layout at sufficient height to avoid worries at ground level. Figure 6.21 shows the same sort of installation on an old tower structure and again apparently free of other conflicting systems.

The main problems with roof installations seem to be:

- Where many antennas from different users are located on a roof, account may have to be taken of the summation of radiation where beams overlap so that an individual can be subject to multiple irradiations. This is less likely with a single user roof installation.

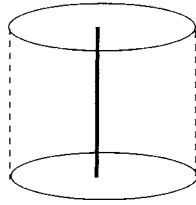

Omni Antenna

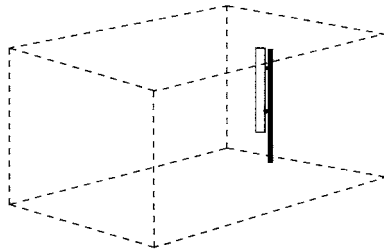

Sectoral antenna

**Delineation of safe distances
close to antennas**

Figure 6.18 *Outline safe areas for roof-mounted antennas*



Figure 6.19 *Roof mounted equipment – Brick building (Courtesy E. Randall)*



Figure 6.20 *Roof mounted equipment – glass and brick structure (Courtesy of E. Randall)*



Figure 6.21 *Roof mounted equipment – round brick tower (Courtesy of E. Randall)*

- In complex installations where not only telephone systems but also broadcast, HF and other types of radio systems are present, technicians working on an equipment need to be aware of the risks associated with all the systems present, particularly including the effect of the summation of radiations (see Chapter 5, Part 3 or your national standard) where appropriate. In particular, MF and HF antennas can increase the risk of burns due to the parasitic energisation of metal structures in the field such as safety rails, metal mounts, air conditioning equipment and the like located nearby. Also field re-radiated in such cases can be significant in contributing to human exposure.
- Actual direct contact with antennas of any frequency may give serious burns and shock depending on the transmitter power.
- There is a need for a clear understanding of the differences between RF earthing and mains supply voltage safety earthing. Supply voltage safety earthing needs to be as short as possible (to limit ohmic resistance), capable of carrying the required potential fault current and free from induced RF which can interfere with the operation of nearby equipment. (For some distribution systems such as Protective Multiple Earthing, PME, separate regulations may apply.) RF earthing is essentially part of the antenna system, thus its provision is part of the remit of the equipment designer. Ad hoc RF earthing arrangements may increase radiation and the risk of burns or shocks from the live equipment.
- The designer must also consider the possibility of increased parasitic radiation from inappropriately-earthed structures nearby which do not appear to have anything to do with the radio installation such as metal safety rails since a small shock can result in a startle response and possible fall. It follows that suitable instructions must be conveyed by the designer to the installer.
- The need to plan the access requirements on the roof for maintenance engineers responsible for the structure. In some cases such as the resurfacing of roof areas, it may be necessary to switch off or even move radio equipment. Remember that in such cases the public limits, if any, of the relevant standard will apply to people who are not employed to work with transmitting equipment.

On the roofs of many buildings there is some sort of penthouse with door access to the roof. These are often put to use for odd jobs such as photocopying or the storage of records. It is at this point that people employed in the building, but not connected with any aspect of radio work, could gain access to the roof and, being unaware of the safety provisions used by the radio company, put themselves at risk of getting closer to antennas than the technical staff are allowed. This tends to occur when people use a roof on a sunny day to sit and have lunch!

Consequently, provision has to be made for the limitation of access to the door key. If the door is also a fire exit, the local key needs to be secured, e.g. located in a glass-fronted sealed box. Similarly, safety arrangements need to be made for builders and repairmen accessing the roof to do building or air conditioning equipment repairs. Permits to work requiring the signature of a senior person should be the norm. From the author's experience the weak link is always the subcontract order, e.g. building maintenance, tower repainting, etc., usually put out by someone who knows nothing about radiation safety and often resulting in some undesirable situation. Some examples are given elsewhere in the book.

In summary:

- A safety plan should be prepared to cover these points.
- Where the radio installations present belong to more than one organisation, they should all act together to define the safety provisions.
- The occupier of the building should play his part in setting administrative provisions and access control to meet his legal safety needs.
- Where the owner of the building is not in the radio transmission business, e.g. commercial premises, office blocks, etc., and the people concerned are not technically knowledgeable on the subject of RF radiation, they may still have legal responsibilities for safety. Consequently they may need an advisor to assist in the discharge of their duties.

It is important to ensure that the reason for safety procedures, permits to work, etc., are understood by those working in the building, otherwise they are likely to be seen as bureaucratic rules and to be ignored when they are inconvenient.

Tower located equipment

The more general aspects of this are dealt with in a later chapter since the problems are not limited to mobile systems, but some aspects of rooftop safety apply, particularly the need for technicians, riggers and others climbing towers to know of any risks since they have to pass close to other equipment on the tower. They also need to be aware that if they are replacing defective antennas or fitting new ones, these may become parasitically energised from other operational antennas during the fitting process. Whilst any shocks felt or sparks seen whilst doing so may, unless there are high power systems involved, be minor, the great risk is the 'startle response' causing a fall, mentioned previously, but even more important on towers where during climbing and movement there may be less security of foothold. The author has, in past employment, dealt with five cases where people would not continue to work after being frightened by sparks from tools when up a tower.

On masts and tower installations with proper safety management, there should be no real risk to personnel, based on the current limits in the relevant safety standard in use. However, in the best run organisations accidents happen and probably no one can ever reduce the accident risk to zero. What can be done is to eliminate those accident risks which stem from bad work practices, e.g. ambiguous or outdated procedure instructions, lack of markings and identifications, failure to use the correct climbing gear, etc.



Figure 6.22 Tower with inside ladder (Courtesy of E. Randall)

Figure 6.22 illustrates a tower with an internal ladder for climbing whilst the slim tower of Figure 6.23 illustrates the need to climb externally. The latter can be more hazardous unless proper precautions are taken. Climbing accidents can be very serious and often happen due to lack of climbing equipment, incorrect footwear, sudden instinctive movement when encountering an unexpected antenna, cramp, sudden weather changes – especially hail, etc. Most large organisations have formal climbing training and this is really essential.

Mobile phone handsets

The radiation from handsets seems to be the main area of contention at the moment with the concerns being related to possible tumour production in the brain and other possible effects on memory. In addition theoretical suggestions have been made, as noted earlier, about possible effects of the low repetition frequency pulses from telephones affecting the natural rhythm repetition rates of the brain. Another suggestion, not new, is that there could be undesirable effects on tissues at the cellular level.

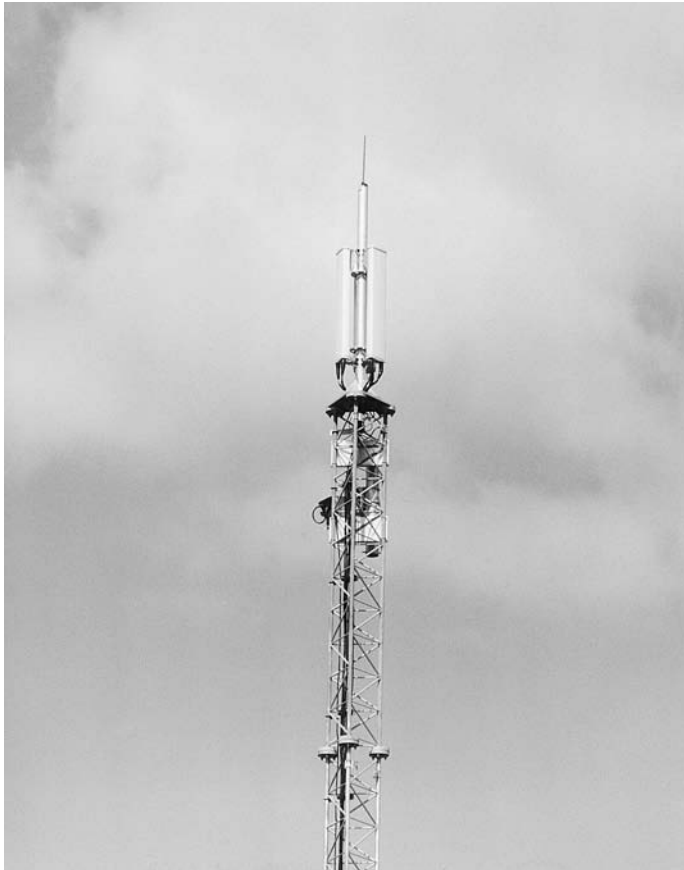

Figure 6.23 *Narrow tower without separate ladder (Courtesy of E. Randall)*

These are of course complex medical matters and attention to some of these aspects is being given by various bodies. Looked at from a non-medical point of view it is difficult to see that the very low power from handsets, especially with digital systems, can give rise to high values of SAR. With typically less than 1 watt available of which only half of that could be developed across a matched load, this seems to be a very small amount of power with only a part of that being absorbed in tissue.

Exposure limits for electric and magnetic field strengths have been derived as the result of many studies. As mentioned earlier, maximum absorption occurs under plane wave conditions when a human subject is upright and parallel to the incident electric field. Little is known of the absorption from the many other human postures possible but it is likely that the derived exposure limits considerably overestimate the true absorption in cases where the body is

not parallel to the electric field. This has been observed in the close vicinity of low power transmitters. In some older standards there were exemptions for such devices within specified limits. This has now been challenged.

There could, of course be a possibility that absorption could be higher in certain postures, particularly those applicable to hand-held devices. One argument is that the energy is deposited in a very small mass of tissue and it has to be said that with such a device held close to the face the effective coupling with the body and the movements of the user when holding the device make the situation rather complex. Also there is radiation from the body of the handset.

This is obviously a complex research subject involving considerable biological knowledge and the writer makes no claim to such expertise. A radio engineer can only try and reconcile such claims with logic and experience. It is difficult to see why radio telephones are such a special case since the same arguments ought to apply to higher power transmitters at greater distances which deliver similar levels to the human body and where all forms of modulation may be used.

One of the main lines of investigation at the moment seems to be the fact that researchers have established that it is possible to have small masses of tissue, e.g. 1 gm, where the SAR exceeds the limit given in relevant standards even though the handset power level is low and the SAR over a larger mass is within limits.

The present work on this topic seems to have three facets:

- 1 The investigation of the SAR produced in a 'dummy' head which has been made as representative of the human head as possible. There does not at present seem to be any standardisation of the dummy head so that it is unclear as to whether any differences in testing results are attributable to that factor. It is understood that work is now being done on a standard for a dummy head.
- 2 Some companies have produced shielding devices to be fitted to mobile phone handsets aimed at reducing the exposure to the head. Indeed, sales of shielding devices have boomed as a result of public concern though these may be counter-productive since any effective reduction of radiated power may result in the power being increased to maintain the call. These devices may also result in a redistribution of radiation levels around the handset.
That is not to say that someone could not come up with useful ideas and some work in this direction is going on at present. A thorough evaluation method is needed for any new devices since it is important to avoid the points made above.
- 3 Various investigations have been undertaken with the object of reducing radiation towards the user by virtue of the instrument design. A study by Amos [56] into the modelling of handset antenna interactions with the user and SAR reduction techniques found that the ear is an important parameter

in the design model used in simulations and also that removal of the ear from the model reduced the SAR due to the radiation being spread over a larger volume of tissue so the average SAR in 1 gm of tissue was less.

Also, the size of the shielding can, the feed position and the electrical parameters of tissues may all have significant effects on the resulting SAR. Increased distance between the radiating element and head can significantly reduce SAR and has implications for the design of handsets and the positioning of the handset.

One experimental antenna publicised in the media by another experimenter used a small parabolic antenna. This would have the disadvantage that the user would have to keep still to avoid turning and losing the contact. It would also run counter to the current trend to make the handset smaller.

Abad al-Hameed et al.[69] describe experimental work on antenna design with a phased array antenna which is designed to produce a minimum field at a selected point in space. The idea was demonstrated by choosing the null to lie on the head surface at the point which would otherwise have the most intense exposure.

The paper demonstrated that a simple phased array handset antenna can be designed to protect the user from radio frequency exposure whilst also providing an improvement in performance.

Another approach by G. Nicolaidis et al.[58] used a dielectric loaded bifilar loop antenna. The results show that the antenna adopts a near-perfect figure-of-eight radiation pattern. Placing the antenna so that the user's head is axially in line with the minima in the pattern, will yield a low radiation exposure.

The emphasis in these papers is to retain the effectiveness of the handset antenna for its prime purpose whilst trying to reduce the power coupling to the head. Testing involves using a model head which represents the human tissues involved as far as possible and this is difficult, thus providing an element of doubt about the faithfulness of the representation.

Amos[56] examine ways of reducing power coupling to the head and point out that some standardisation of the model used, taking into account the point made about the effect of the ear would be useful for comparisons of results.

Recently there has been a concern expressed by a few individuals in the field that pulses sent at low frequency rates could affect the various brain rhythms. It is not clear whether the proponents of this viewpoint are entirely familiar with the modulation theory involved since the discussion of the topic does seem to view the pulses as if they are pure ELF frequencies when in fact they switch very high frequency signals and require some form of demodulation to recover the basic pulses in their simple form.

One proponent gives, as an example, the potential effect on the alpha rhythm in epileptics caused by flashes of light at frequencies in the alpha rhythm range, a well-known phenomena, generally guarded against by

design specifications. However, this is a direct effect where the eye in its normal role provides the conversion of light to electrical signals.

'Hands-free' vehicle installations with the antenna externally mounted may reduce the amount of radiation near the user. However, in the UK, traffic accidents have been linked with use of both hand-held and 'hands-free' mobile phones on the move and there is pressure to stop or reduce such use. Unfortunately people seem to be very equivocal on this subject despite the fact that accidents are inevitable when trying to do two things at once. The current UK enforcement approach, resting on the claim that a driver does not have full control of the vehicle, is very subjective and in most cases difficult to prove unless some sort of incident is involved.

Very recently, some concern has been expressed in the UK about the lead to the earpiece on hands-free systems with a claim that induction in the lead transferred power to the ear. No detailed test report has been published at the time of writing. If this really is the case, which many doubt, it should not be difficult to deal with it by the usual filtration methods.

At the moment, the best advice to anyone who is genuinely concerned about these aspects in spite of all the current assurances, is to read the very extensive 'question and answer' documents which can be read and copied from the WHO, USA FCC, NRPB and other government web sites. These are, as far as possible, explained without too much technical jargon and are updated as appropriate.

The first two questions from the WHO document are reproduced here with permission from WHO, on the basis that the text is unchanged. The document was last updated on 8th December 1999.

Question 1: Are there health hazards associated with living, working, playing, or going to school near a cellular phone or PCS base station antenna?

Answer: No. The consensus of the scientific community, both in the US and Internationally, is that the power from these base station antennas is far too low to produce health hazards as long as people are kept away from direct access to the antennas (there is a reference here to two questions about limiting access to antennas).

Question 2: Is anyone seriously concerned about possible health risks from cellular phone and PCS base station antennas?

Answer: Not really. There are some reasons to be concerned about human health effects from the hand-held cellular and PCS phones themselves (although it is not certain that any risks to human health actually exist). These concerns exist because the antennas of these phones can deliver large amounts of radio frequency energy to very small areas of the user's body. Base station antennas do not create such 'hot spots', so the potential safety issues concerning the phones have no real applicability to the base station antennas.

The material included in responding to other questions includes a critical appraisal of published and unpublished papers and gives the references to

them. It is a useful source of material for those wishing to refer to some particular aspects of the subject which have arisen in the media.

Recent Developments

The Stewart report

The UK Independent Expert Group on Mobile Phones (IEGMP) chaired by Sir William Stewart, produced their report in May 2000[59], quite an achievement from their first formal meeting in September 1999.

A brief outline of the conclusions and recommendations is given below and the text dealing with the scrutiny of published work on the effects of RF radiation is discussed in Chapter 3.

Report conclusions (summarised)

- 1 The one substantial established risk to health from mobile phone technology is the increased incidence of motor vehicle accidents when drivers use mobile phones, either hand-held or hands-free.
- 2 There is good evidence that exposure to mobile phones has direct, short-term effects on the electrical activity of the human brain and the cognitive function. There is an urgent need to establish whether these direct effects on the brain have consequences for health because, if so, and if a threshold can be defined, exposure guidelines will have to be reconsidered. It is also important to determine whether these effects are caused by local elevation of temperature or, as seems possible, by some other, 'non-thermal', mechanism.
- 3 The epidemiological evidence currently available does not suggest that RF exposure causes cancer. This conclusion is compatible with the balance of biological evidence, which suggests that RF fields below guidelines do not cause mutation, or initiate or promote tumour formation. However, mobile phones have not been in use for long enough to allow comprehensive epidemiological assessment of their impact on health, and we cannot, at this stage, exclude the possibility of some association between mobile phone technology and cancer.
- 4 Experimental studies on cells and animals do not suggest that mobile phone emissions below guidelines have damaging effects on the heart, on blood, on the immune system or on reproduction and development. Moreover, even prolonged exposure does not appear to affect longevity. The limited epidemiological evidence currently available also gives no cause for concern about these questions.
- 5 The balance of evidence indicates that there is no general risk to the health of people living near to base stations where the exposures are only small fractions of guidelines.

Report recommendations

These are extensive but include:

Detailed comments on future research needs.

Advocates the precautionary use of the ICNIRP 1998 reference levels (occupational and public) instead of the present NRPB reference levels.

Tightening of planning for base station siting and erection; limitations near schools.

Defined exclusion areas round base stations to delineate where the relevant guidelines are exceeded.

Audits of base stations.

Discouraging the use of mobile phones by children except for essential calls needed for safety, etc.

Dissuading motorists from using mobile phones in vehicles when on the move.

The full details of the recommendations cover a number of pages and the whole report exceeds 125 pages. It can be downloaded from the web site (see Appendix 3).

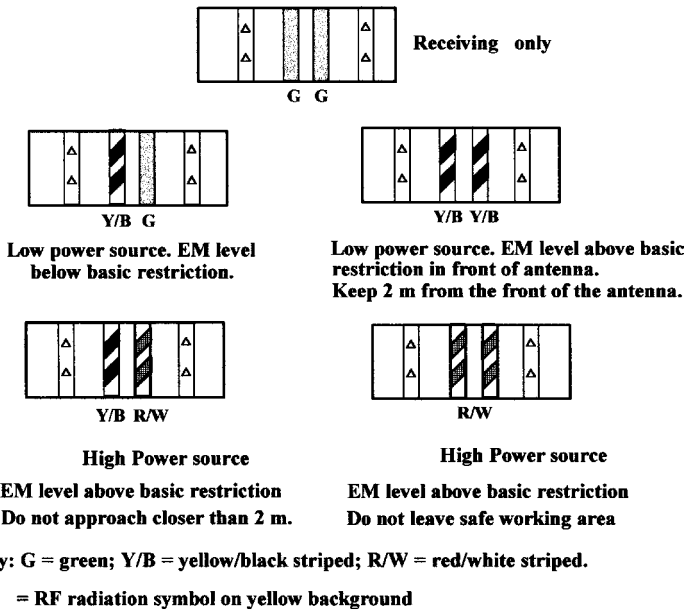

Figure 6.24 *Experimental safety markings for rooftop and similar installations*

Experimental safety marking system

It was mentioned in an earlier chapter that an informal system of marking RF radiation hazards in respect of rooftop installations such as mobile phone equipment had been proposed by a group of safety engineers. This is illustrated in Figure 6.24 but since the medium here is black and white the colours have been coded. The objective was to have markings primarily aimed at technical staff who might approach systems with which they are unfamiliar. Hence the categorisation is limited to the four categories shown in the legends. The aim was to have markings which could be made available on self adhesive tapes and put onto antenna cable, etc. The system has no official status.

7

RF radiation measuring instruments and methods

This chapter aims to describe and illustrate the range of instruments typically available for the measurement of RF field quantities. It also includes coverage of contact current and limb current measuring devices. In addition, some instruments used for the measurement of very low frequencies are described.

Introduction

Since the original book was written and published in 1993 there has been a considerable development of instruments in this field. With the event of microprocessors, the use of digital processing facilitates data collection and storage via optical fibres. Some emphasis is therefore put on the new devices. It is worth noting that the distinction between analogue and digital instruments is not a fundamental one and they have much in common to the extent that some analogue instruments had converter units to digitise the output. The main distinction is the availability of the microprocessor and the consequent ability to offer a greater range of facilities and processing without the need for extra boxes, etc. However, many people will have an investment in the previous generation of analogue instruments and are not likely to throw them away quickly! Hence some coverage is also given to these.

The instruments illustrated in this chapter are typical ones and most, but not all, of them have been used by the author. However, any reference here to an instrument is solely intended to highlight features and does not imply any recommendation. Equally, there is no adverse implication in the absence of any instrument manufacturer or instrument. The actual choice of

instruments should be made against the specific requirements of the work and the nature of the radiation to be measured. Since only brief details of instruments can be given here, it is essential that purchasers should obtain full specifications since these can change without notice. Internet contact details are given in Appendix 3 so that overseas agencies can also be identified. Each manufacturer represented here has a large range of instruments, probes and ancillary apparatus so that it should not be thought that equipment available is limited to the types shown. Catalogues are readily available from suppliers.

It should be noted that brief mention is also made of very low frequency measuring equipment which, whilst outside the frequency coverage of this book, was requested by people offering suggestions about this book revision. They are complementary insofar as some LF emissions from control equipment in large transmitters can affect RF measurements and may need to be identified separately.

It is useful to introduce the caution sign for RF radiation here as it is often met in the various catalogues of RF instruments and should not be confused with ionising radiation which has the trefoil symbol (Chapter 8). It is shown in Figure 7.1 and is in fairly general use. The UK/EU version is a black tower symbol on a yellow background with a black outer triangle. The USA sign is virtually the same.



Figure 7.1 *RF radiation safety warning sign*

Instrument purpose and classification

The primary purpose of safety measurements is to verify compliance with safety guides and standards. The type of measurements made will therefore be related to the parameters specified in such documents. Some RF test equipment purchasers have their own specifications which include safety tests specific to their own requirements. This may, on occasions, require additional measuring equipment. Groups of measuring equipment can be identified according to their application, though these groups are not mutually exclusive.

Portable measuring instruments for field use

Instruments are needed to carry out surveys indoors and outdoors, involving the measurement of power density, electric field and magnetic field quantities. Additionally, new techniques and instruments such as limb and contact current measuring meters are becoming available. The requirements for instruments will include ergonomic factors such as ease of carrying and manipulating the instrument and low weight to reduce wrist strain when using the equipment for long periods.

In many cases use may include climbing towers and structures, operating the equipment on the way up and down. Here, minimisation of the use of the hands is important and can often be achieved by a chest mounted or side slung carrying case for the instrument meter unit, so that only the probe has to be held in the hand.

There will usually be a tendency to use the same instruments for the inside and the outside work to avoid excessive investment in equipment unless there are good reasons for choosing different equipment. Surveys may include research and development measurements on new designs and the investigation of complaints about suspected irradiation.

Systems for laboratory and production use

There are also some systems which are not easily moved about in the sense mentioned above due to the weight or bulk involved and are more suitable for fixed use in a test bay or in a safety check-out system. These, typically, provide central control of a number of sensors and may, increasingly, tend to offer some degree of automation of the testing of volume products such as microwave ovens.

Personal safety monitors

These include equipment designed either to be worn as a personal monitor or fixed in a room or enclosure and intended to warn all people in the room

of fields which exceed a preset threshold. Such monitors are often used in equipment maintenance activities such as ground and aircraft transmitter servicing bays and in the comparable military ground, ship and avionics activities with radio, radar and jamming transmitters.

Some types of fixed monitors lend themselves to some degree of safety control by providing external electrical signals or a contact closure when the preset alarm level is reached. This can be linked to warning alarms, illuminated warning signs or even physical barriers such as an electrically-locked gate.

There is a considerable development activity in this field at the moment and the number of equipments falling under this heading is rapidly increasing. Since there are some dubious items sold in the domestic field, care should be taken in procurement. Reputable suppliers will supply specifications which can be verified by suitable measurements.

Induced current measurement systems

These are equipments designed to measure currents induced in the human body, for example in the limbs, during exposure to fields, and contact current instruments intended to measure the currents that can be experienced when touching metal masses located in an RF field.

Ancillary equipment

Occasionally, receivers and spectrum analysers may be needed for diagnostic work such as the identification of interfering signals giving an out-of-band response during field measurements. Equipment in this category is well-established general purpose test equipment which needs no detailed discussion here.

Other ancillary equipment includes small test sources intended to test that RF survey instruments function correctly. This should not be confused with checking calibration, for which the test sources would be inappropriate. These sources are very useful since the most likely cause of a failure with most instruments tends to be the probe cable or a discharged battery. Checking instruments before setting off on a journey can help to avoid the embarrassment of arriving at a destination with unserviceable instruments. The test sources are commercially available and may sometimes be built into the test equipment. They should not be confused with equipment which is designed for routine calibration checks, e.g. for checking personal monitors.

It is often necessary to ensure that test sources do not themselves create local electro-magnetic interference to operational systems at the place of use, especially in military establishments and on board ships. In such cases, the sources are often fabricated with a half-spherical or conical aperture into which the probe is located when using the test source.

Instruments for RF radiation measurements

Construction and operation

There are now a number of established commercial suppliers of specialised RF radiation measuring instruments for RF safety measurement work covering power density, electric field strength and magnetic field strength.

The suppliers were, for the most part, located in the USA but Germany has also come into the picture in the last few years. Most suppliers have agents in other countries and with the advent of the Internet, it is easy to identify these.

Some of the products of these companies are illustrated later in this chapter. Over the last twenty years or so there has been a steady development of the RF capabilities of such instruments and a gradual extension of the frequency range of the wideband instruments. This inevitably lags transmitter development as higher frequencies come into use, and in these cases there is a problem in carrying out safety measurements. It should be noted that some suppliers of modern wideband instruments can provide calibrations for frequencies higher than the specified upper frequency, so that it may be worth discussing the matter with them.

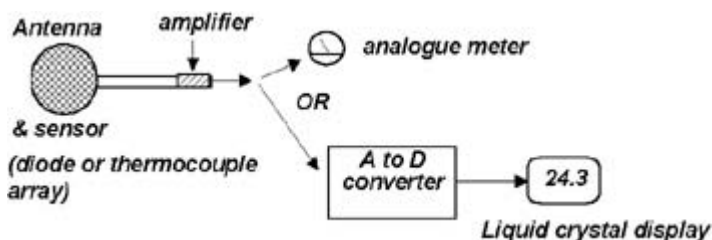

Figure 7.2 Schematic illustration of analogue and digital instrument concepts

Considering first the analogue generation of instruments, the basis of such instruments is shown in a much simplified theoretical form in Figure 7.2 and involves a receiving antenna, a square law detector to produce a true r.m.s. output, a suitable amplifier and an indicator. The antenna and detector is often referred to, in the generality, as a sensor. The analogue instrument indicator is a conventional moving coil meter. The detector used is either a thermocouple, a diode circuit, or both in wideband systems. The general physical realisation is normally that of a probe sensor connected by cable to a meter unit. The meter unit has batteries, a meter, switching facilities and circuits to process the probe signal.

A schematic diagram tends to conceal the technical problems involved in the design of the instrument portrayed. The key aspects of the design are:

- 1 Design of the antenna, the effective bandwidth covered and the choice of type of detector – diodes or thermocouples.
- 2 RF isolation of the antenna from the rest of the instrument so that, in the theoretically ideal situation, the sensor (antenna and detector) appear as totally isolated and of infinitely small effective electrical volume to ensure very loose coupling with the field. The objective is to minimise perturbation of the field and errors due to gradients across the probe in situations where there are steep spatial gradients in the field.
- 3 Protection from interference due to frequencies outside the measuring bandwidth of the instrument, i.e. ‘out of band responses’ giving rise to readings which may be thought to result from the in-band (wanted) field under test.
- 4 The field which is being measured should not be able to induce currents in the instrument other than via the sensor. In particular, it should not be able to induce currents in the lines from the sensor to the amplifier. Nor should it interfere with any circuitry in the meter unit since it is obvious that RF induced in such places can invalidate readings.

Probe antennas

The antenna is normally in probe form, that is to say that it is sited on the end of a tube, the other end of which may also constitute the handle. Some instruments use probes with flexible leads. Others use a probe rigidly fixed to a meter unit thus reducing connecting lead length but reducing flexibility in handling. Sometimes a flexible lead is included as an alternative. The antenna and detector arrangement is a very critical part of the design of any type of RF radiation meter.

The requirements are very exacting since the flatness of the frequency response over the bandwidth involved (typically 0.3 GHz to 50 GHz on the wideband types) determines, in a large part, the measurement specification for the instrument.

The antenna will be arranged to measure either the electric or the magnetic fields at lower frequencies but in the wideband instruments covering the microwave region, the electric field is used exclusively above 300 MHz by most instrument suppliers, although one supplier claims a top frequency for magnetic fields of 1.5 GHz. It is important that an electric field sensor should not be affected by the magnetic field and vice versa.

The basic antenna types for electric and magnetic field measurements are a single electric field antenna element and pick-up loop. A single element will only respond to the polarisation corresponding to that of the source, for example with electric field measurement, when the electric field element is parallel to the source electric field.

Such antennas are known as non-isotropic, that is to say they do not respond to all the energy in a field containing signals with more than one

polarisation, such as that which involves reflections from local conductive objects including the ground, or to the elliptical polarisation in the near field. As a result, they will not give an indication of the total field present.

The most frequently used systems are isotropic and consist of three orthogonal elements with the outputs joined together to give a combined output which can be shown to correspond to the average value of the sum of all the impinging RF energy components. They cannot, of course, provide phase information.

Isotropic sensor elements are illustrated in Figures 7.3 and 7.4 in the form of scaled up models in order to increase the clarity of presentation. Figure 7.3 illustrates an isotropic electric field sensor consisting of three lossy antenna elements and Figure 7.4 depicts an isotropic magnetic field sensor

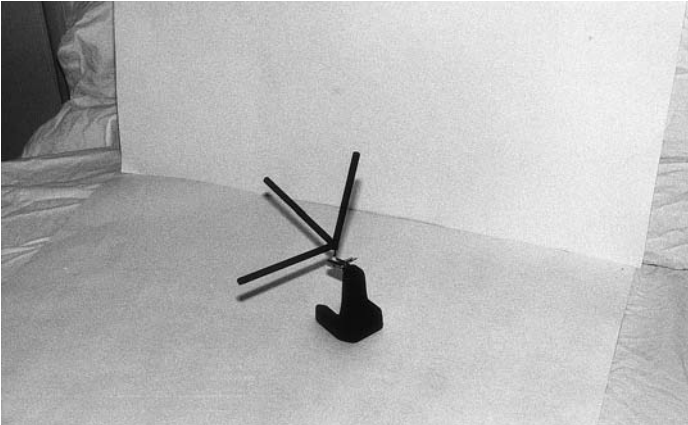

Figure 7.3 *Sensor isotropic antennas – electric field*

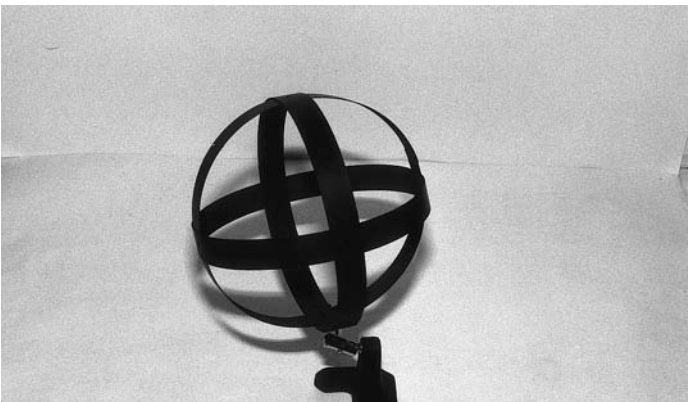

Figure 7.4 *Sensor isotropic antennas – magnetic field*

comprising three loop antennas. The method of joining together the three electric field elements may be end connection as illustrated, whereas for dipole elements they may be centre connected.

Practical instruments for magnetic field measurement sometimes use square loops. It should be noted that the loop arrangement where the three loops have a common geometric centre it is very important to avoid one loop shadowing another. This can be best understood by considering an alternative physical realisation of the loop system where the loops are mounted on three mutually adjacent faces of a cube. It can then be seen that as the probe is moved about, there can be shadowing of one loop by another, affecting the instrument indication and causing a departure from the isotropic state.

Types of probe detectors

In instruments of the thermocouple-based types, the thermocouple elements are, typically, thin film depositions, e.g. of antimony and bismuth or other thermocouple pairs, on a thin plastic substrate within the probe antenna – see Figure 7.5. Similarly, where diodes, usually Schottky diodes, are used

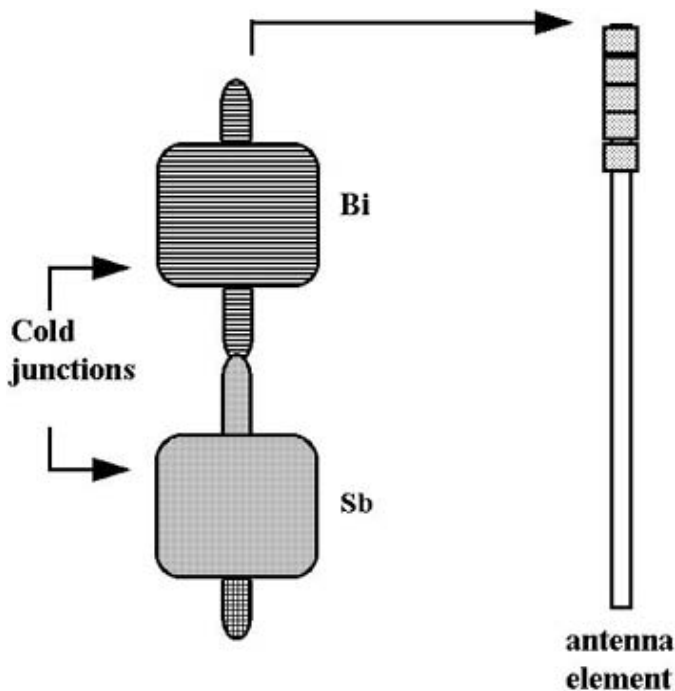

Figure 7.5 Typical thermocouple elements (Courtesy Narda Safety Test Systems)

they are fitted within the probe antenna. Some equipments may use both types of detectors to cover a wider band of frequencies.

Wideband probes are increasingly used, the frequency coverage having increased with the use of modern manufacturing techniques. Two early papers (1972) on the use of thin film techniques in wideband probes were produced by Aslan[33] and Hopfer[34], respectively. A third paper (1980) on a wideband probe with a wider frequency band was produced by Hopfer and Adler[35]. These provide interesting information on the approach to probe design.

For the higher frequencies more complicated arrangements of thermocouples are used for the electric field probes where resistive thermocouples are distributed along the three orthogonal dipoles. Up to about 12 GHz these behave as resistive dipoles. Above this frequency a travelling wave effect provides more output. This is shown in diagrammatic form in Figure 7.6 and in situ in a probe in Figure 7.7.

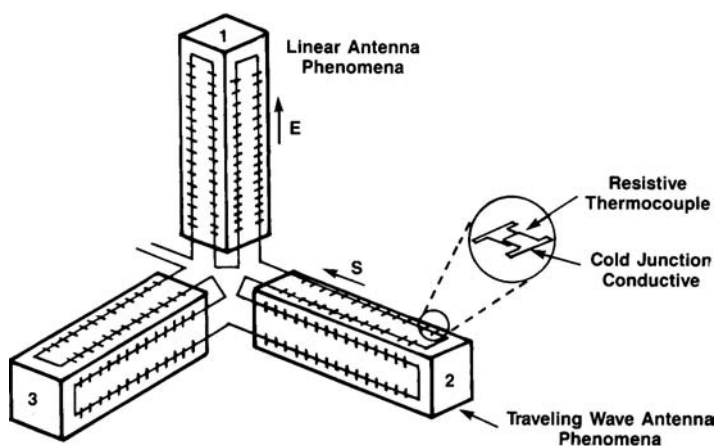

Figure 7.6 Diagrammatic illustration of a high frequency electric field sensor

For the magnetic field probe, the detectors are fitted in the individual loops. For both types of probe the amplifier is located close to the antenna, usually being fitted in the probe handle. Figure 7.8 shows this in situ in a probe.

The sensor connecting leads are high resistance to provide a degree of isolation of the sensor and a loose coupling into the field. The amplifier conditions the signals passed to the instrument unit by reducing the impedance and thus reducing effects caused by probe cable flexing. As noted earlier magnetic field probes are limited to a top frequency of 300 MHz generally or 1.5 GHz in the case of one manufacturer.



Figure 7.7 *Actual electric field antenna – sensor structure for higher frequencies (Courtesy Narda Safety Test Systems)*

Probe application

The application for which the probe is to be used has a considerable bearing on the design of the probe as far as the detector is concerned. There are two choices as noted previously – thermocouples and diodes.

Thin film thermocouples

These being based on heating effect, will give a true r.m.s. output almost up to burn-out point. However sensitivity is inadequate below around 300 MHz. Historically they have been a problem in terms of overload burn-out, although this has been very much improved over the years as can be seen from suppliers data sheets.

Diodes and compensated diodes

Diodes present a problem in that their operating characteristics have a square law region and a linear region of operation. In the square law region there is no problem but failure to maintain operation in that region can lead to

errors. Errors also arise from the presence of two or more signals, and from situations where the signals have a high harmonic content. If used for pulse work additional errors can arise if the pulses are shorter than the detection time of the diode.

A number of manufacturers have patent circuitry which is claimed to keep operation in the square law region and obviate much of this problem. Some manufacturers give clear information about this issue. A recent paper by Johnson et al.[51] examined the range of sensor capabilities, examining thermocouples, diodes and compensated diodes. The diode case is analysed in some detail. Also comparative measurements using two equal signals at varying levels were carried out using an instrument fitted with an uncompensated diode detector and an instrument with a compensated diode detector were carried out. The uncompensated diode gave errors, with five test levels used, from +72% to +22%. The compensated diode over the same



Figure 7.8 Actual magnetic field antenna – sensor structure (Courtesy Narda Safety Test Systems)

tests gave errors of +14% to 0%, two of the five test results giving zero and one giving +2%.

A further test using a source of 2 GHz pulsed at 5 μ s with a duty factor (DF) of 0.001 using the plain diode circuit gave errors of approximately 13 dB at levels near to most guidance levels. It was noted that the error would be greater with the narrower pulses common in the radar environment.

The general conclusions were:

- Field sensors employing diode detection should only be used for CW signals.
- Average power measurements on pulsed and complex modulation signals should be measured using thermocouple probes.
- Compensated diode sensors can be utilised for multiple signal environments, but are not recommended for pulse modulated emitter measurements.
- Although r.m.s. average levels are specified in most exposure situations, if peak pulse power is the desired quantity, specialised diode sensors need to be employed. None of the commercial sensors reviewed in ref. 51 could perform this task at the present time. Future military systems will undoubtedly drive the development of such peak power detectors for general use.
- Meters that operate with diode, or compensated diode, sensors need proper temperature compensation circuitry if systems are going to be operated over wide temperature ranges.

A typical example of an analogue instrument is depicted in Figure 7.9 and can be taken as typical of those supplied by other manufacturers to date and in wide use around the world. It is the Narda 8716 meter and the 8721 probe (0.3 to 40 GHz). The basic facilities are range switching, zero adjustment and moving coil meter indication but practical instruments may offer switched averaging times, maximum hold facilities, etc. Note that not all suppliers supply only digital instruments now – at least one still offers mainly analogue types. Also many of these are still in current use.

Digital RF radiation meters

With the advent of microprocessors, once the analogue signal from the sensor has been converted to a digital signal, many processing aspects become easier. The Figure 7.2 schematic showed the basic alternative arrangement for a digital instrument. The probe output is converted via an analogue to digital (A–D) converter and the digital operation controlled by a microprocessor.

Measurement units can be selected and plane-wave conversions between the field quantities can be done at the flick of a switch. Measurement data can be stored and downloaded to a computer, etc. With appropriate software, various forms of computer display of measurement data can be



Figure 7.9 Narda type 8716/8721 analogue RF radiation meter (Courtesy Narda Safety Test Systems)

produced. Mistakes can also still be made. Selecting Am^{-1} is not much help if the probe is an electric field probe – a mistake the author has observed during training courses! However, the same mistake was sometimes made on analogue equipments by calculating the wrong quantity. There is no doubt that the digital instrument is very flexible and the same technique is also gradually creeping into ionising radiation measuring instruments. In an ideal world both types of output on one instrument would be very useful but also very expensive. There are some subtle field variation effects which can be detected better with an analogue instrument, but these may be of little interest to most people.

As with the earlier generation of instruments, the probe containing the sensor antennas and detector determines the frequency coverage and type of field measurement and the instrument proper provides the signal processing, etc. There are many probes available from the various manufacturers and these can be fitted as required to the appropriate instrument. Whereas in the past calibration lists or charts had to be used and the data processed manually with a calculator, it is now possible to load calibration data directly into the instrument, often covering the data for a number of associated probes.

Frequency coverage

Frequency coverage is a common factor between both types of instrument. Individual commercial instruments are available covering power density, electric field and magnetic field measurement over portions of the spectrum up to 50 GHz. The basis is usually that of a meter unit capable of operating with two or more plug-in probes, or a probe incorporating both types of field antennas. Probes covering different frequency ranges, different full scale deflections and different measured quantities are available.

The degree of versatility and the available probe combinations varies across different suppliers and is largely a matter of the marketplace.

The utilisation of such instruments, which can involve considerable capital cost, depends on the measurement commitments of the user. For example, an organisation using only HF transmitters will not need microwave measuring equipment. A microwave oven manufacturer may only be concerned with the microwave equipment needed to cover the frequency used in the ovens (usually 2450 MHz or 915 MHz).

Firms involved in the supply of transmitters for the whole of the communication and radar fields may require equipment covering all the spectrum from LF to the current limit of such instruments, 50 GHz. Indeed, they may be well ahead of this and using frequencies of 100 GHz and more, thus having to resort to more basic methods of measurement.

For those with a wide range of requirements the wideband power density measuring equipments are attractive, typically covering 0.3 GHz to 50 GHz or, in two cases, covering 300 kHz to 50 GHz. The prime attraction is, of course, not having to change instruments over this wide range which covers amongst other things, most radar equipments.

For measurement at the lower end of the frequency spectrum, various guides and standards require the separate measurement of the electric and magnetic field components, power density not being considered to be a relevant parameter. Because separate probes are normally needed for electric and magnetic field measurement and these are designed for limited band coverage, the test equipment investment for the number of discrete probes which need to be purchased could, with the analogue generation of instruments, be quite high, although at least one manufacturer produced an instrument in the HF band and another in the VHF and UHF bands in which a single probe incorporated both electric and magnetic field sensors, the choice of measurement of these two being made at the throw of a switch.

Measurement capabilities

Power density measurement

Power density is perhaps the most commonly measured quantity in RF safety management surveys. It is a common fact of life in the radio

engineering field that we often require to measure a parameter which cannot technically or conveniently be directly measured.

Although instruments are available which have scales calibrated in power density, such instruments do not actually measure power density, instead measuring either the electric or the magnetic field component. The electric field is used for the high frequency wideband probes beyond the technical range of magnetic field measurement.

It should be noted that technically the power density reading is not valid where the measured signal is not a plane wave, for example, in the near field. Instruments are calibrated on the assumption of a free space impedance of 377 ohms, i.e. plane wave conditions.

Research to date into the possibility of designing a practical true power density measuring instrument for near field work has, so far not been successful. However, when existing types of instrument are used in the near field, then the electric field, for an instrument with a probe which measures that quantity, will be valid and can be retrieved by using the calibration equation in reverse. Similarly, where a magnetic field probe is used, the magnetic field value can be retrieved and will be valid. Here again the digital instrument can do this processing by selecting the correct field quantity.

Instrument scaling

Since digital instruments have switched scaling facilities, then many of the problems mentioned in this paragraph are not relevant, whereas analogue instrument meters can, in comparison, become complicated and prone to scale misreading. However, for both digital and analogue meter users, a knowledge of the plane wave field relationships is equally important.

The unit scaling of analogue RF radiation meters of all types is a subject of some interest as it affects the amount of calculation to be done when using them.

Power density-scaled measuring instruments are mostly scaled in mWcm^{-2} although many people prefer Wm^{-2} in line with the majority of safety standards. It will be recalled that the mWcm^{-2} is the larger of the two units, i.e. $1 \text{ mWcm}^{-2} = 10 \text{ Wm}^{-2}$, so that the conversion is easy to remember. Hybrid units such as mWm^{-2} or Wcm^{-2} can be a nuisance and can lead to safety problems due to erroneous interpretation, though there may be cases where they are justified, e.g. in specifying absolute maximum ratings for pulse measurement. Some hybrid units will be found in this book where the permission to use some material prohibited any alteration to that material. In these cases the equivalents are given in the related text.

Scales for power density are calibrated by the usual plane wave relationship. Where an electric field probe is used, the calibration equation is:

$$\text{power density } S \text{ (Wm}^{-2}\text{)} = E^2/377, \text{ where } E \text{ is in Vm}^{-1}$$

or

$$S \text{ (mWcm}^{-2}\text{)} = E^2/3770, \text{ where } E \text{ is in Vm}^{-1}$$

Where a magnetic field probe is used, the calibration equation is:

$$\text{power density } S \text{ (Wm}^{-2}\text{)} = H^2 \times 377, \text{ where } H \text{ is in Am}^{-1}$$

or

$$S \text{ (mWcm}^{-2}\text{)} = H^2 \times 37.7, \text{ where } H \text{ is in Am}^{-1}$$

Electric and magnetic field measurements

With the older generation of meters, when using electric and magnetic field probes to measure the electric and magnetic fields using one meter unit and two probes, the scale is usually in power density, leaving the user to convert according to the probe used on the basis of the examples given above.

In some cases, electric field scaling is in $(\text{Vm}^{-1})^2$ as given in an earlier ANSI C95 standard but happily, not in the IEEE C95.1-1999 standard. In this case it is necessary to take the roots of the indicated values to obtain Vm^{-1} or to divide $(\text{Vm}^{-1})^2$ by 377Ω to obtain plane wave equivalent power density in Wm^{-2} . Working in the large numbers implicit in the $(\text{Vm}^{-1})^2$ scaling was another potential source of human error.

Where the meter is scaled in mWcm^{-2} or Wm^{-2} , and an electric field probe is used, plane wave conversion to the electric field value uses the expression:

$$E \text{ (Vm}^{-1}\text{)} = \sqrt{(\text{Wm}^{-2} \times 377)}$$

e.g. 5 Wm^{-2} gives $\sqrt{1885} = 43.4 \text{ Vm}^{-1}$

or $E \text{ (Vm}^{-1}\text{)} = \sqrt{(\text{mWcm}^{-2} \times 3770)}$

e.g. 0.5 mWcm^{-2} gives $\sqrt{1885} = 43.4 \text{ Vm}^{-1}$

$$\text{since } 5 \text{ Wm}^{-2} = 0.5 \text{ mWcm}^{-2}.$$

Where the meter is scaled in mWcm^{-2} or Wm^{-2} , and a magnetic field probe is used, conversion to the electric field value uses the expression:

$$H \text{ (Am}^{-1}\text{)} = \sqrt{(\text{Wm}^{-2}/377)}$$

or $H \text{ (Am}^{-1}\text{)} = \sqrt{(\text{mWcm}^{-2}/37.7)}$

Examples:

Note that if normally working in Wm^{-2} , it is easiest to multiply mWcm^{-2} by 10 first, as follows:

1 Electric field instrument

$$\text{reading } 2 \text{ mWcm}^{-2} = 20 \text{ Wm}^{-2}$$

$$E (\text{Vm}^{-1}) = \sqrt{(20 \times 377)} = 86.83 \text{ Vm}^{-1}$$

2 Magnetic field instrument

$$\text{reading } 3 \text{ mWcm}^{-2} = 30 \text{ Wm}^{-2}$$

$$H (\text{Am}^{-1}) = \sqrt{(30/377)} = 0.28 \text{ Am}^{-1}$$

Analogue meter scale coding

One other aspect of scaling is of interest. Many instruments have a colour coding system for probes with the same colour used for the appropriate meter scale, for example, 'yellow probe: read yellow scale'. This takes into account instruments where a variety of probes can be used with one meter unit and it can be very useful in helping to reduce errors in reading analogue instruments. Several years of training engineers and technicians in RF radiation safety has shown that even with such coding, misreading of scales is extremely common when people are first introduced to RF radiation measuring instruments. The main reason for this seems to be that the eye instinctively seeks the scale with the best resolution of sub-divisions on a multi-scale marking where all scales are not equal in this respect!

It can be seen that many of the calculations and the errors resulting from analogue meter multiple scales are avoided with the switched facilities provided by digitally-based instruments, given that the user chooses the correct probes and the relevant probe correction factors, if the latter are stored in the instrument processor.

Special instruments

One type of instrument probe currently available from Narda offers scaling both in conventional power density and also in terms of the percentage compliance with the current IEEE limit values, such that exceeding a limit results in an indication of greater than 100%. This type of instrument was available in the analogue range and is now available in the current digital instrument catalogues.

Although at first glance this does not seem to be a very remarkable thing to do, it is not just a matter of scaling. It requires that the ANSI limit values, which vary with frequency, be provided for by tailoring the frequency-sensitivity response appropriately, no easy task.

It can also be used when more than one signal is present since, providing that the frequencies are within the instrument bandwidth, the signals will effectively be scaled against the relevant permitted limits and the addition of

the signals will give a valid percentage of the RF protection guide, as if this had been computed manually.

The ANSI/IEEE standard has been mentioned as an example but in principle the technique can be applied to any standard. However, availability for other standards will depend both on the amount of R&D needed and the likely sales revenue for any given standard!

Where such a standard has the numerical limits revised, the conformal probe will require appropriate changes.

Instrument features and limitations

Features

All electronic instrument design involves compromises, both technical and financial, and this information does not usually feature overtly in sales literature. However, some companies do, from time to time, issue technical papers which provide a little insight into the difficulties and achievements.

The USA IEEE/ANSI organisation produce a document giving a recommended practice for RF field measurements, which includes discussion of instrument characteristics. This is IEEE C95.3-1991 [36]. There is a generally recognised need for further work in this field.

There are a number of general features of field and other RF test instruments which have not been mentioned in detail in the earlier discussion of the basic operation of RF radiation measurement instruments:

1 Instrument zero

Some instruments have a single manual zero control or a coarse and fine-ganged potentiometer arrangement. Ganged controls can be a problem with wear so that the adjustment of one begins to disturb the other. Potentiometer knobs of any kind are easily disturbed accidentally with the hand unless they are guarded in some way.

Other instruments have a 'push to zero' button together with a screw-driver-adjustable coarse potentiometer. Some instruments claim to have fully automatic zeroing. Generally those instruments which are set to zero by a potentiometer or push button need to be taken out of the field to set zero but a few claim that zero can be set in the presence of a field. Some caution should be exercised in selecting instruments with fully automatic zero, unless it can be established from the specification that the design is such that errors do not arise with amplitude modulated fields or other factors.

2 Alarm circuit

This is a valuable facility whereby an alarm can be set to operate at a preset fraction of full scale deflection. This is not only useful in making personnel

aware of their situation but can also be helpful, if set appropriately, in avoiding damage to instruments due to overload by reminding the user to be ready to change ranges. It is often arranged that the alarm will sound continuously if the probe is burned out or otherwise becomes open-circuit with a cable break or connector disconnection.

3 Maximum hold facility

On analogue instruments, this is the facility to set the instrument to a memory mode where it stores the highest r.m.s. value of the field experienced during a survey. For example, in walking slowly through a microwave beam holding the instrument, the meter will indicate the highest value encountered and retain the reading when the user leaves the beam. Some manufacturers use the term 'peak hold' but this should be deprecated both because of the possible confusion with peak power in pulsed systems and because the instrument is not, in any event, a peak measuring device.

With digital instruments, facilities generally include some form of indication of the highest reading which has occurred since some action, e.g. since starting measurement or since resetting the facility. They can also indicate when 'max. hold' is in use – an important point since with the analogue generation of instruments it was often the case that this was forgotten, with the consequent strange results!

4 Space and time-averaging

Some instruments, including some analogue types provide facilities, either directly or by the use of an add-on unit, whereby readings can be averaged over a predetermined time limit for time-averages, or averaged spatially, that is to say, averaged over a specific volume of space such as a room. For spatial-averaging, the instrument is started and the surveyor then walks round in a pre-planned way at a steady speed slow enough to allow the instrument to register the field. At the end, the instrument is stopped and it calculates and displays the spatial-average of the field measurements. The provision of digital instruments which can store and download data can remove most of the tedium from this type of averaging as an integral function.

In the case of time-averaging, there are various applications of which the simplest is to average a time-varying field over a defined period of time at a specific place. The instrument is set up to measure the field in question and put in a fixed location. Time-averaging is initiated for six minutes or any other period available on the instrument. At the end of the time period, the instrument stops measuring and displays the time-averaged value. Again, digital instruments can simplify this task.

5 Battery charging facility

Instruments either use dry batteries or rechargeable batteries. Those able to use the latter usually have a charger inbuilt. Rechargeable batteries do eventually need replacing, a fact that is often overlooked. Also some types of battery need to experience a full discharge to give the best life. Battery literature should be consulted. Batteries are often rather neglected and usually get their own back at the most inconvenient moment!

A battery state indicator is essential. One advantage of a rechargeable battery is that recharging can be done at the place where a survey is being undertaken, during breaks in surveying.

6 Choice of probes

Some instruments provide a wider range of choice than others. Not everyone will need a wide range and probes are expensive so the choices need to be thought out. Careful thought should be given to the CW and peak overload ratings when purchasing instruments, especially those to work with pulse transmission, in order to reduce the possibility of probe burn-out.

Some makers offer a choice of sensitivities and maximum ratings. This topic is normally addressed in equipment handbooks so that seeing the handbook before purchasing an instrument should be the rule! This will also identify probes which have not been designed for pulse work. Most suppliers will loan an instrument for a short trial period and this is strongly recommended unless the purchase is a repeat purchase. Caution is needed in such trials and handbook instructions should be followed since 'blowing up' a probe on a loan instrument is not popular!

The ergonomic aspects of instruments can be very important to some people whereas those who only use them for a few minutes at a time may not be much concerned. Try carrying the equipment which you propose to purchase for 2 or 3 hours if you need an instrument to conduct extensive surveys!

Where radiation surveys are a regular task, extra equipment may be needed to cover the loss of instruments during repairs and regular calibration. For large surveys, at least a two-man team will be necessary and some degree of duplication of instruments is therefore required.

As with other electronic instruments, the advent of digital semiconductor circuits has resulted in the provision of many extra facilities in RF radiation instruments, some of which have been described above. The important thing, however, is what facilities are required rather than the number of facilities that are provided. Occasionally an instrument appears which lacks some essential facility. One from the distant past which comes to the author's mind is the lack of a battery voltage check on a particular instrument which used rechargeable batteries!

Limitations

The development of isotropic sensors has considerably improved measurement but since anything in production has imperfections or variations between items, any departures from true isotropicity give rise to a potential measurement uncertainty. Typical isotropicity uncertainties range from ± 0.5 to ± 1 dB. Variation of instrument response across the frequency band covered gives rise to a further uncertainty of measurement. This is given in specifications and obviously varies across the market but ± 2 dB is probably typical for much of the frequency range of wideband probes with maybe up to ± 3 dB for the lowest frequency end of the band.

Zero stability is also a source of possible measurement errors since if the zero setting is not stable it will be difficult to keep it correctly set. In consequence, the errors will be hidden in the measurements made. Also, if zero setting is inadvertently done with a field present, sooner or later a place will be found where that field disappears, giving rise to a mysterious negative reading. This applies to most instruments but, as mentioned earlier, there are some types where it is claimed that zero setting can be done in a field without giving rise to this problem.

Again, it is important that an electric field sensor should only respond to the electric field and not the magnetic field component and vice versa. However, in circumstances where the field being measured, say the magnetic field, is relatively small and there is a high level electric field present, then it is likely that the latter will affect the meter reading. This is largely a matter of correct instrument usage – avoid trying to do the impossible!

One trade-off involved in design is that of the length of the leads from the sensor to the amplifier or instrument unit. At very low frequencies (< 1 MHz) the leads may act as an extension of the ‘antenna’, picking up RF and giving erroneous readings. In some cases, low frequency probes may incorporate active sensors with an amplifier preceding the detector, thus reducing the significance of the pick-up from these leads.

Calibration also poses a basic limitation since the uncertainty of measurement obtainable at a calibration laboratory is a determinant in the fixing of the instrument uncertainties. The availability of suitable calibration laboratories across the world is both variable in distribution and limited in number. The major instrument manufacturers generally have good calibration facilities and supply calibration correction factors with new instruments. Some can provide the calibration data in software form for downloading to their digital instruments.

A different type of problem is that mentioned earlier of the erroneous readings which may be obtained if there is a source of strong signals outside the bandwidth of the instrument. If these produce a reading, it may be taken as being a valid reading for the field currently being measured. Realistically, it has to be recognised that as with any other type of frequency sensitive filter,

out-of-band frequencies are just attenuated and if the amplitude of any such signal is sufficiently large, it will make its presence felt as a false reading.

Where out-of-band responses are obtained with relatively low amplitude signals, this is a cause for concern and the instrument needs further investigation. It is not unknown for a particular model of instrument to have some out-of-band weaknesses over particular frequency ranges which can only be found by systematic evaluation.

At lower frequencies, below about 10 MHz, investigation has shown that differences in electric potential between the probe and the meter unit, for instruments having high resistance sensor output connections, results in erroneous readings due to the instrument responding to the potential difference. The errors in readings are said to be greatest at the low frequencies used for the AM broadcast band[37]. It may not apply to those where the antenna is integral to the meter unit. Most manufacturers will give guidance on measurement methods for such low frequency cases.

It can be seen from these examples that specific measurement results will not only be affected by instrument calibration and the stability of instrument characteristics between calibrations, but also by factors in practical use which result from the method of use of instruments, their limitations and the judgements of the user.

RF radiation meter sensors, diode or thermocouple are very vulnerable to overload and burnout of the elements. Users often forget that the sensor system is there to pick up energy and is not made safe by merely switching off the instrument. It is easy to forget this when walking about with an instrument. Hence probes should be kept in the carrying case or covered with a shield such as aluminium cooking foil or a metal can to attenuate the electric field. One company makes an electric field attenuator into which the probe is inserted.

When working with pulsed transmitters or RF machines, it is important to check the pulse duty factor against the maker's operating instruction manual, since some limitation of reading may be needed to avoid damage at low pulse duty factors (see Chapter 9).

This aspect should be addressed in the equipment handbook. It is still common to find that when no reading is obtained near a waveguide aperture, engineers will, if it is at all possible, push the probe end into the aperture and often destroy the sensor before they realise what is happening.

The replacement of probes is a very expensive matter. Whilst some manufacturers are looking at methods of reducing this cost, there is also a loss of utilisation whilst repairs are done, and this can sometimes be considerable. In the author's experience, most such instruments are very reliable but the number of times the sensor is burned out seems to be proportional to the number of people allowed to use the equipment and may perhaps owe something to a lack of personnel training. In summary, careful use by trained people can materially affect the availability and cost of ownership of the equipment.

Technical checklist for instrument specifications

The list below is not arranged in any particular order. The order of priority for the various choices will depend on the needs of the user. Some aspects may only be relevant to analogue meters since some facilities are implicit in the design of the new digital generation of instruments. Hence the checklist can be adjusted for relevance.

- 1 Frequencies to be covered and the frequency coverage of the instruments being considered.
- 2 Choice of probes: diode or thermocouple sensor detector, where there is a choice. Suitability for pulse and amplitude modulated signals (if required). For diode types, check the maker's provision to reduce the measurement errors referred to earlier.
- 3 Dynamic range.
- 4 Overload safety margin, especially for pulsed modulation.
- 5 Quantities to be measured: Wm^{-2} ; Vm^{-1} ; Am^{-1} .
- 6 Meter scaling.
- 7 Required operating temperature and humidity range.
- 8 Investigate protection against out-of-band responses carefully!
- 9 General facilities required ('needed' rather than 'nice'): maximum hold; alarm; space/time-averaging, etc.
- 10 Mass and ergonomics.
- 11 Knowledge of reliability and durability.
- 12 Options, e.g. optical fibre connection, etc.
- 13 Battery options.

Specifications

Specifications may leave something to be desired in terminology, parameter definition and indeed in the things that are not mentioned.

Terminology

Terms like 'accuracy' and 'absolute' have no place in metrology. The 'accuracy' of an instrument is not knowable except as an 'uncertainty of measurement'. Nothing is known absolutely. What we do know is that the measured value lies within a given range of uncertainty, e.g. $\pm 10\%$. This figure, which will include systematic and random components, will depend on the source to which it is referred, e.g. National or local standard and the conditions of measurement.

Digital instruments have limitations related to the least significant digit and the rounding process.

'Out-of-band' characteristics are often not mentioned, yet this can be important. Specifications should be so written that it is possible for the user

to assess the probable uncertainty of measurement over a practical everyday environment. Where the temperature has a significant effect, this should be taken into account.

Practical examples of current RF radiation instruments

Field survey instruments

As noted in the introduction, it is only possible to use a limited number of examples in this section as the main instrument producers between them have a very large number of instruments and probes in their catalogues. An attempt has been made to use specimens which illustrate some specific aspects of modern RF radiation instruments. Note that quite a number of current models are analogue and these are not overlooked.

Apart from the general equipment illustrated here, most companies also produce more specialised equipment with limited frequency ranges for dedicated purposes such as microwave oven checks and RF machine checks. In addition there is peripheral equipment such as calibration sets, optical data transmission units, etc.

Figure 7.10 shows the Narda type 8718 with the smaller and lightweight 8712 to the right. These are both digital instruments with LCD displays. The 8718 has built-in test sources, choice of any unit of measurement, subject to the use of an appropriate probe, etc. There is a large range of probes which



Figure 7.10 Narda type 8718/8712 digital RF radiation meter (Courtesy Narda Safety Test Systems)

can be plugged in directly or via a flexible cable. The nature of the probe will affect the use of the equipment and this is covered in a tabulation of probe data. Probes with a frequency range starting at 300 MHz or greater use only thermocouples. The wider band instruments use a combination of compensated diodes and thermocouples.

The instrument offers a wide range of facilities, including automatic spatial-averaging, data storage and software for use with a Windows compatible personal computer to display and analyse data. The 8712 is a simpler instrument, lightweight and, it is claimed, easy to use. Lightweight instruments can be particularly convenient when climbing structures. The 8700 probe series can be used in both instruments and can cover the electric field range of 3 kHz to 50 GHz, with a note about certain probes being able to cover up to 100 GHz. The magnetic field coverage is 300 kHz to 300 MHz. Fibre optic links, etc., are available.

Figure 7.11 shows a Holaday instrument, the type HI-4460 hand-held readout unit. This offers the sort of digital facilities offered with the previous example. Probes can be chosen from a range of types. The one shown here is the HI-4433 MSE electric field isotropic probe using diode sensors. The frequency range is 0.5 MHz to 5 GHz. There is also a range of magnetic field probes covering frequencies from 5 MHz to 300 MHz. Other electric field probes cover frequencies up to 40 GHz. As with other companies the range of instruments is such that the catalogue should be obtained.

General Microwave Raham instruments have been long established in the field. Many of their main instruments are, on the basis of the latest catalogue, analogue types. The catalogue includes a clear statement about the linearity problems of diode detectors. Figure 7.12 shows the model 495 meter unit which can be configured with a range of probes to provide three isotropic electric field models with frequency ranges varying, the largest being 0.2 MHz to 40 GHz. The facilities include time-averaging, 'maximum hold', correction factor setting dial, etc. Another model covers the magnetic field from 10 MHz to 1 GHz. The fifth model is anisotropic, covering 10 MHz to 3 GHz. There are also other models using a small meter unit.

Wandel & Goltermann also produce a range of instruments, having entered this field in the last few years. Since the writing of this chapter was started they have been taken over by Narda, so that acknowledgements are now to 'Narda Safety Test Solutions' which the writer has abbreviated to NSTS in this text with W&G added to avoid confusing any readers unaware of the details of the change.

Figure 7.13 shows a group of the NSTS (W&G) instruments covering not only the RF field but also low frequencies. The latter are covered later. EMR-200 and EMR-300 are two basic instruments for which probes need to be chosen. The EMR-300 offers extra facilities – result storage, real time clock and spatial-averaging. The probes cover various frequency ranges, for



Figure 7.11 *Holaday HI-4460 and HI-4433 probe (Courtesy Holaday Industries)*

example the electric field probe type 9 covers 3 MHz to 18 GHz and the magnetic field probe type 10 covers 27 MHz–1 GHz. The probes use diode detectors and it is suggested that the type 9 is suitable for radar work. This is a difficult problem and the manufacturer has an Application Note[74] on this topic. A copy should be obtained by anyone concerned with this type of measurement. The general subject is discussed in Chapter 10.

The general physical design of the instruments is good and they are easy to handle. They offer the selection of units, maximum value indication, averaging, and the other facilities generally found in this class of instrument. Calibration data can be loaded from a floppy disk.

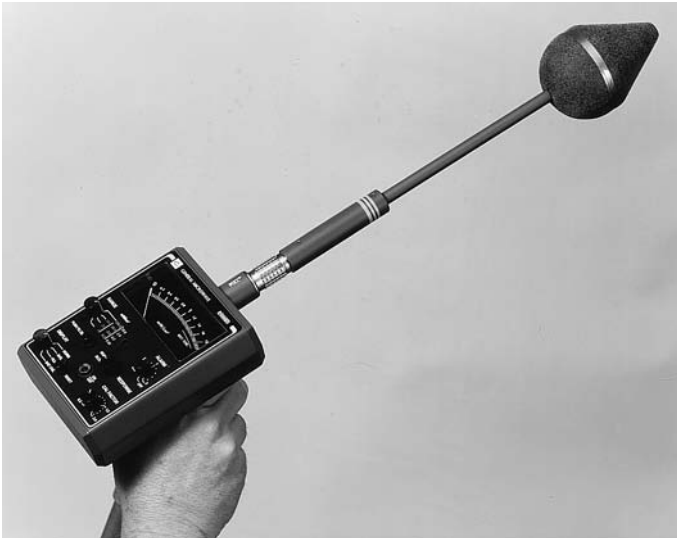

Figure 7.12 GMC Raham 495 meter unit and probe (Courtesy General Microwave Corp.)



Figure 7.13 Grouping of NSTS (W&G) instruments (Courtesy Narda Safety Test Systems)

Systems for use in particular situations including production

There are a number of equipments which are bulky and do not come into the category of portable equipment, or are portable but intended for specific tasks, e.g. microwave oven testing, RF production machine testing.

Figure 7.14 shows the Holaday automated test system for microwave ovens. It consists of arrays of probes in banks, which record leakage values simultaneously, logs data, provides on-line diagnostics, etc. It can be integrated with a conveyor belt for flow-line production.

There are many special equipments for oven testing and general compliance testing where there is a need for regular leakage testing. Some are basically like the instruments already illustrated but with the frequency coverage tailored to the requirement. Others may include a heavier bench or

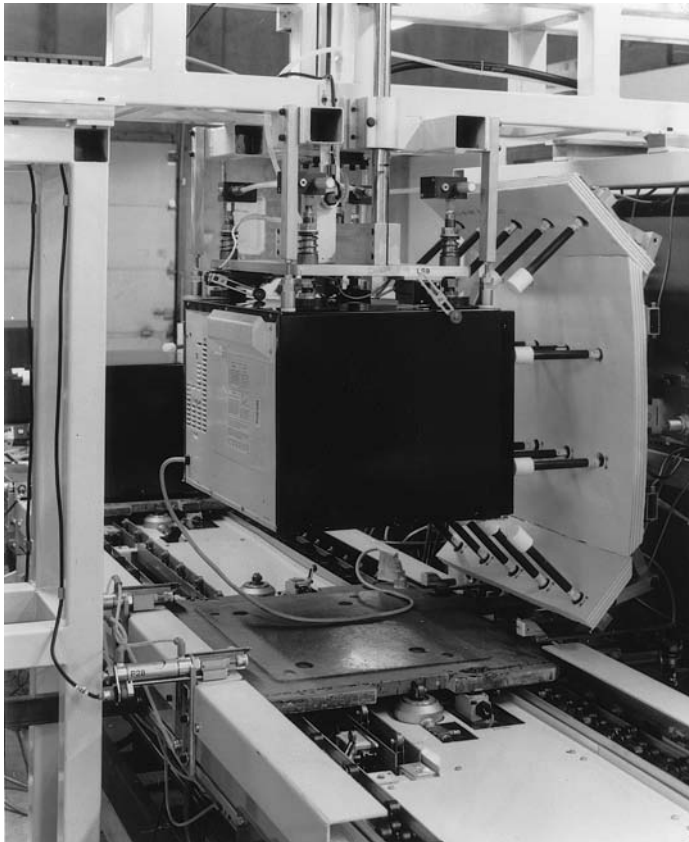

Figure 7.14 *Holaday automated microwave oven test system (Courtesy Holaday Industries)*

rack-mounted unit. Virtually all the suppliers mentioned here provide these specialised instruments.

Other aspects of compliance testing already mentioned earlier in this chapter are the conformal probes produced by Narda which are linked to a particular safety standard and have the probe response tailored accordingly. The measurement result is presented as a percentage compliance, i.e. percentage of the permitted limit for the frequency concerned. Full scale is generally something like 300–600% which enables high levels to be investigated. Narda lists five electric field conformal probes for occupational standards, FCC, Japan, IEEE, NATO, Canada and ICNIRP and one for the FCC public limits. There is also a magnetic field probe for the ACGIH limits. Of course if significant changes are made to these standards, the relevant probe needs alteration.

Personal and area monitors

These are briefly mentioned here but their use will be discussed in Chapter 10. Narda Safety Test Systems, General Microwave and Holaday produce instruments in this category. There are basically two types:

- 1 Personal monitors – usually ‘badge’ types worn by personnel and intended to give a warning of a predetermined level of RF radiation, but could include small hand-held devices.
- 2 Devices fixed in an environment, e.g. transmitter cabin, etc., and intended to alert the occupiers of the area.

Personal monitors

These should not be confused with some of the small devices offered in the domestic market and costing a few pounds or dollars. Many of these can be a hazard in themselves by giving wrong answers! The instruments referred to here are professional products of high quality, tailored to a specific function. They use the same basic sensors that are used in the portable instruments. They have a detection field which is in the form of a cone in front of the wearer so that the wearer will be alerted to RF radiation exceeding a pre-set limit and can seek assistance from the RF radiation safety officer to determine the cause and to improve the working situation. The preset limit may be below the permitted limit for the frequency concerned, thus avoiding the suggestion that the individual has been exposed to excessive radiation. The setting level can generally be specified when ordering the instrument.

Figures 7.15, 7.16 and 7.17 show, respectively, samples of the Narda, GMC and Holaday products. The NSTS (W&G) version is the instrument at the bottom right of Figure 7.13. There are so many varieties covering



Figure 7.15 *Narda personal badge monitors (Courtesy Narda Safety Test Systems)*



Figure 7.16 *GMC Raham personal badge monitor (Courtesy General Microwave Corp.)*



Figure 7.17 Holaday personal badge monitors (Courtesy Holaday Industries)

different frequency bands and facilities that only perusal of catalogues will do justice to them. Apart from the general usage mentioned above they can be very useful for people climbing towers and structures.

Figure 7.18 shows a new digital instrument from GMC Raham which uses a different approach in that the instrument is a hand-held electric field instrument and is preset in the factory at 200 Vm^{-1} , but other values can be set. It covers the electric field from 3 MHz to 1 GHz. The probe is integral with the meter unit.

Holiday make a small isotropic digital monitor HI-4417 (Figure 7.19) with the small sensor unit connected by an optical link to the readout meter

which, in turn, can be clipped on to a climbing harness. It does not have a preset limit but covers the electric field, $0\text{--}300\text{ Vm}^{-1}$ autoranging. The frequency range is 10 kHz to 1 GHz.

Area fixed or moveable monitors

The basic concept here is that a device with a preset limit is located in an area or part of an area such as the space round the output feeder or waveguide of a transmitter. If the field exceeds the limit, an alarm is sounded and a contact closure may be available to activate other warning signs, etc. Figure 7.20 illustrates the Narda ‘Smarts’ device. This is one of a number of such devices with various frequency ranges which can be chosen to meet a requirement.



Figure 7.18 GMC Raham rugged radiation monitor model 2001 (Courtesy General Microwave Corp.)



Figure 7.19 Holaday HI-4417 lightweight monitor (Courtesy Holaday Industries)

Recently the concept of warning devices has been extended to cover specific situations. The Holaday CellAlert is a small portable device which can be located in areas where the radiation risk is interference with critical apparatus such as is used in hospitals where the use of mobile phones is banned or restricted. It detects the operation of nearby mobile phones and broadcasts a verbal reminder that mobile phones are not allowed. Perhaps the next step should be one which can close down the offending telephones!

New approach to personal monitors

Narda Test solutions have indicated that they have developed a new broadband personal monitor (100 kHz to 100 GHz) which features shaped

frequency response detection and datalogs readings received. These new monitors feature a different type of sensor called a 'Surface Area Sensor'. In simple form, the surface area sensor is used to detect the radial field generated by the body, when current is flowing through the body. Since at low frequencies the major heating of the body is through the current induced into the body (rather than the incident field), whether it is from the E or H field, the sensor is said to be a more accurate alarm based on that current. It works whether or not that current is from the E or H field, or even whether the current is induced on the front or rear surface of the body. It is an interesting approach to personal monitoring.

The devices are the 8846 and 8848 series and are conformal types, i.e. they are set to alarm at 50% of a particular standard indicated by a prefix letter: A = FCC occupational, B = Canadian safety code 6, C = ICNIRP occupational and D = NRPB Adults. In each case the 8864 device covers 300 kHz to 3 GHz and the 8848 device 300 kHz to 45 GHz. They respond to all polarisations.

The setting of the alarm at 50% is to allow for the 3 dB reduction in sensitivity to radiation coming from the side of the wearer and still ensure



Figure 7.20 Narda Smarts model 8820 radiation detector (Courtesy Narda Safety Test Systems)

that the alarm will assure that the field levels will as far possible not exceed permitted limits. The wideband coverage does improve versatility for those who operate with a range of different frequencies.

Limb current and contact current measurement equipment

The technical aspects of these subjects are discussed in Chapter 3. From the commercial instrumentation point of view, in order to measure currents induced in the body at frequencies below about 100–120 MHz, various devices have been developed. Most use a flat platform device such that by standing on the device in the RF field concerned, the body current can be measured. There is usually some provision for feeding out the measurement information and recording it.

An alternative method was originally developed by the UK NRPB and uses a shielded coil device with integral LCD readout in the form of an ankle clamp. There are some commercial models based on this technique.

Figure 7.21 illustrates the Holaday Industries HI-3701 stand-on induced current meter. This appears very much like a personal weighing machine except that the indicator gives induced current. A remote readout HI-3715 is also available and shown in the picture. The measurement range is 1000 mA full scale in 5 ranges and the frequency range is 3 kHz to 100 MHz.

Figure 7.22 illustrates the Holaday Industries approach to the ankle clamp technique. It comprises the clamp and the readout device. The clamp is the HI-3702. Data logging is via the optically isolated readout



Figure 7.21 Holaday Industries HI-3701 stand-on induced current meter (Courtesy Holaday Industries)

unit type HI-4416. The measurement range is 3 to 1000 mA over the frequency range 9 kHz to 110 MHz.

Figure 7.23 shows the Narda stand-on measuring device model 8850B. The frequency range is 3 kHz to 110 MHz and the current range to 1000 mA.

Contact current meters

Figure 7.24 shows the Narda model 8870 contact current meter. The internal circuitry simulates a grasping contact for a barefoot human. The measurement range is 0 to 1000 mA and the frequency range 3 kHz to 30 MHz. It can either be operated in the flat frequency response mode or set to indicate percentage of the 1991 IEEE standard over a range of 0 to 200%.



Figure 7.22 *Holaday Industries HI-3702 clamp-on induced current meter (Courtesy Holaday Industries)*



Figure 7.23 Narda stand-on induced current meter (Courtesy Narda Safety Test Systems)

Instruments for very low frequencies

There is sometimes a need to investigate very low frequency fields including power frequencies. In very high power transmitters, power and control system fields can interfere with RF leakage tests. In such cases it can be useful to reduce or cut off the RF signal and investigate the other circuitry for possible low frequency fields. Similarly such need may arise in some RF machines and medical systems. Some people may be especially interested in power frequencies, i.e. 50/60 Hz.

A few examples of equipment offering such facilities are illustrated below. Although these examples are of those produced by the firms who also provide

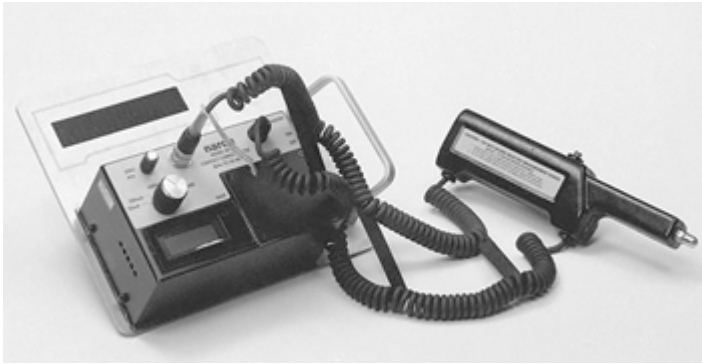

Figure 7.24 *Narda model 8870 contact current meter (Courtesy Narda Safety Test Systems)*

the RF radiation monitors, there may be many other varieties available around the world. Choices should be made in the light of individual requirements from instruments which have credible specifications.

Electric and magnetic field instruments

Figure 7.25 shows the Holaday HI-3638 electric field meter covering 5 Hz to 400 kHz and a measurement overall range of $1\text{--}40\,000\text{ Vm}^{-1}$ in four ranges. Detection is single axis with a true r.m.s. response up to a crest factor limit.



Figure 7.25 *Holaday HI-3638 electric field meter (Courtesy Holaday Industries)*



Figure 7.26 Holaday HI-3627 ELF magnetic field meter (Courtesy Holaday Industries)

The readout unit is digital (HI-4416) and optional software is available for the analysis of data. It is aimed at such tasks as field measurements on VDUs, computer monitors and mains supply fields, etc.

Figure 7.26 shows the Holaday HI-3627, which is an isotropic magnetic field meter with a frequency range of 5–2000 Hz and a dynamic range of



Figure 7.27 W&G EFA-2 magnetic field meter (Courtesy Narda Safety Test Systems)

0.2 milliGauss to 20 Gauss ($1 \mu\text{T} = 0.01 \text{ G}$). A true r.m.s. response is claimed.

Other instruments are available over a wider frequency coverage.

The Holaday HI-3604 (not illustrated here) covers 30 Hz–2000 kHz and has facilities to measure both magnetic and electric fields, single axis. The magnetic field display is available in Gauss, tesla or ampere per metre.

Figure 7.27 shows the NSTS (W&G) EFA-2 magnetic field analyser covering 5 Hz to 30 kHz. It uses a three-dimensional magnetic field probe. A miniature version of the probe is available for measurements in small spaces. True r.m.s. and peak values can be measured. Data is presented in



Figure 7.28 *W&G EFA-3 electric field meter (Courtesy Narda Safety Test Systems)*

tesla or Gauss. The EFA-1 is similar but does not offer the data storage and extra facilities of the EFA-2.

Figure 7.28 shows the electric field instrument EFA-3 covering the same frequency range as the EFA 1 and 2.

It can be seen that there is an ever increasing range of measuring equipment becoming available on the market. This is supplemented by ancillary items such as optical fibre systems for remote recording, software for the presentation of data in various forms on a PC. There is also a variety of calibration equipment available from some of the suppliers mentioned in this chapter.

8

X-rays and X-ray measuring instruments

This chapter aims to alert people to the possible presence of ionising radiations in some radio transmitters. It describes the nature of the radiation involved and the provisions for the safety of people and provides some examples of X-rays generated from high power equipment. In addition, it describes the types of instruments used for X-ray monitoring and measurements.

The nature of X-ray radiation

Most people are aware of the use of X-rays in medical diagnostic work and may, indeed, have had practical experience of it. Whilst it provides benefits of a unique kind in this application, it has a nuisance value when produced in situations where it is not wanted. Since X-ray production is associated with electrons being accelerated in a vacuum, the various types of high voltage electronic vacuum tubes used in radio equipment are potential sources. The applications include transmitters, some RF process machines, and cathode-ray tube-based equipment such as television sets, visual display units and oscilloscopes.

Some knowledge of the nature and hazards of X-rays is necessary for those working with RF radiation since the two forms of radiation may co-exist. As mentioned earlier, X-rays and gamma radiation involve electromagnetic waves similar in nature to RF radiation, but having wavelengths much shorter than those at the highest end of the radio frequency spectrum and are classified as ionising radiations. The international sign for ionising radiations is the trefoil, shown in Figure 8.1. In many countries the use of this sign is a legal requirement.

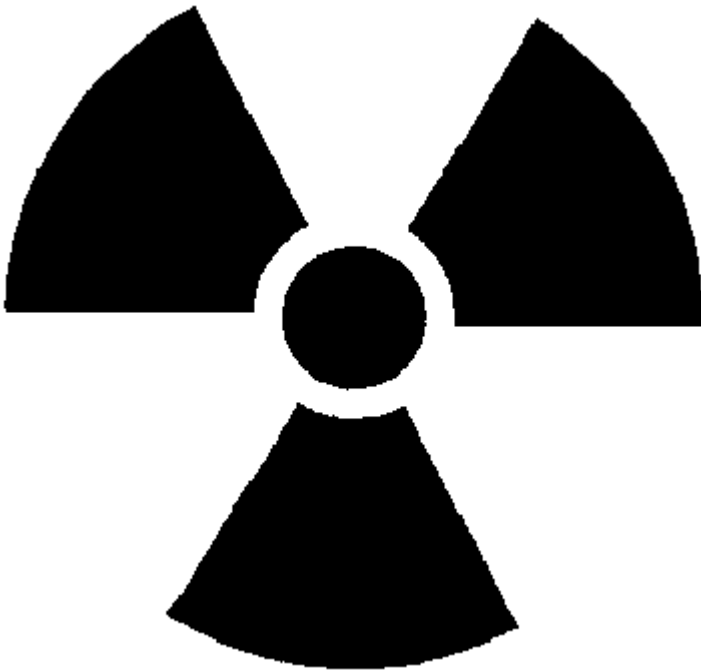

Figure 8.1 *Trefoil – international ionising radiations sign*

X-rays and gamma rays are emitted as quanta or ‘packets’ of electromagnetic radiation, generally referred to as photons. These two forms are identical in nature but have different origins. Gamma radiation is emitted as a result of changes in the nucleus of substances known as radioactive substances and has no relevance here. X-rays result from the stopping of electrons, for example, by the anode of an electronic vacuum tube, after being accelerated by high voltages. As with radio frequency radiation, X-rays can be reflected and this is often important when considering the design of equipment cabinets.

It follows that ‘solid-state’ transmitters (transmitters using semiconductor devices instead of electronic vacuum tubes) using the normal low supply voltages do not generate X-rays unless some high voltage is developed by conversion of the low voltage supply to operate devices such as cathode ray tubes.

The wavelength of X-rays is several orders smaller (‘shorter’) than the wavelengths used for radio and radar purposes, as was shown earlier in Chapter 1. The energy of the radiation is inversely proportional to the wavelength, so that short wavelengths have higher energies than the longer wavelength radiations.

The term energy has been used above and this needs some explanation. The SI unit of energy is the joule (J). A more convenient unit, the electron-volt (eV), is used in ionising radiation work. It is defined as the energy acquired by an electron when accelerated through a potential difference of one volt. Hence, to take a common example, a cathode-ray tube with an anode potential of 12 kilovolts will impart an energy of 12 keV to an electron traversing this potential difference. 1 eV is a small quantity, being equal to 1.6×10^{-19} Joule.

An idea of the wavelength for different energy levels is given in Figure 8.2. Note that in some reference books, wavelengths for X-rays are found expressed in angstrom units ($1 \text{ \AA} = 10^{-10}$ metre). Frequency is rarely used in connection with X-rays but can, of course, be calculated as for radio frequency wavelengths.

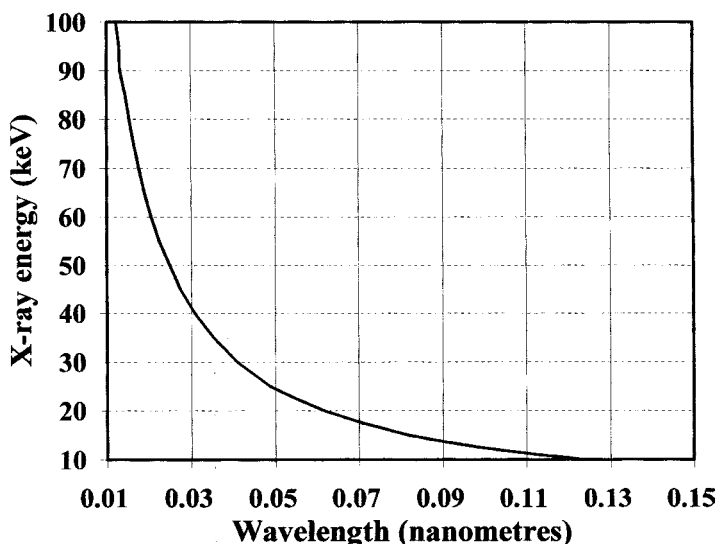

Figure 8.2 X-ray wavelength versus X-ray energy (keV)

The X-ray wavelength λ , in nanometres, can be calculated for a given photon energy as follows:

$$\lambda \text{ (nm)} = 1241/\text{photon energy (eV)}$$

Example:

10 keV gives a wavelength of 0.124 nm.

Note that in the expression above, the 'e' is often omitted, particularly in data from the medical X-ray field, and X-ray tube anode voltage is used

instead, i.e. V instead of eV, so that numerically a 10 keV and a 10 kV accelerator are the same thing. These alternatives do not make any difference to the calculations.

The most ready source of information on X-ray production in electronic tubes comes, not surprisingly, from the manufacturers of X-ray tubes for use in medical diagnostic equipment. Here the aim is to produce X-rays, whereas in radio applications the X-rays are a nuisance. Figure 8.3 gives a general idea of the X-ray energy distribution and wavelength for potentials of 100 kV and 50 kV.

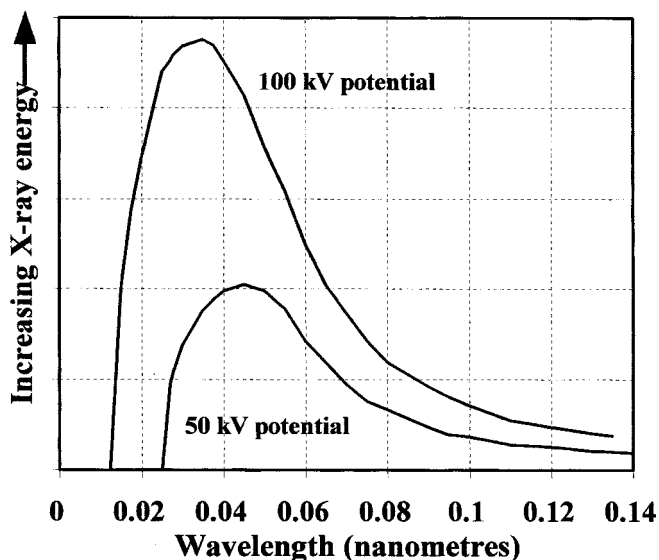

Figure 8.3 X-ray energy distribution versus tube voltage

It can be seen that each spectrum is continuous to a specific short wavelength limit which is determined by the peak voltage across the tube. The actual shape of the energy distribution will depend on the nature of the applied tube voltage, for example, constant or pulsed. The longest wavelength end of the spectrum is not sharply defined, some of the long wave energy being stopped by the glass of the tube, electrode structure and any filtration included.

The peak energy in the distribution occurs at about two or three times the shortest wavelength. Within the spectrum there will also be a narrow band or bands of energy specific to the tube anode material. This is not identified in Figure 8.3.

The effect of increasing the applied voltage is twofold. The short wave limit of the spectrum is decreased in wavelength and the energies of all the

wavelengths present are increased. If the tube current (the beam current) is increased, the energies of all the wavelengths present increase proportionately. The X-ray dose rate is generally proportional to the square of the actual voltage (V^2) on the tube concerned – some authorities say to ($V^{2.5}$). It is shown later that it can be proportional to even higher powers.

In radio transmitters and similar equipment the instantaneous peak accelerating voltage experienced by electrons in the final power amplifier tube will not correspond to the transmitter supply voltage but may be two or more times that voltage and this must be borne in mind when designing equipment. If doing measurements with panels removed from an equipment it is important to be aware of the ‘jump distances’ at which a high potential may jump across to another conductor, especially if that ‘conductor’ is a hand-held radiation instrument!

Low energy X-rays are generally referred to as ‘soft’ X-rays and higher energy X-rays as ‘hard’ X-rays. In turn these are inclined to be shortened in conversation to ‘soft’ and ‘hard’ radiation. When referring to wavelengths, high energy X-rays are also referred to as ‘short wave’ radiation and the low energy end of the spectrum as ‘long wave’ radiation. These should not in any way be confused with the radio broadcasting usage of the terms.

From the point of view of the transmitter engineer, the energy of the X-rays is an indicator of the penetrating power in materials, higher energy X-rays requiring thicker shielding for a given material than softer X-rays. This is clearly an important factor in the design of transmitter shielding. In X-ray machines for medical use, metal shields (filters) are used to attenuate selectively so as to maximise the wanted X-ray energies and minimise the unwanted energies.

For radio equipment, where we do not want any of the X-rays, there are complications in shielding high power tubes and the intrinsic electronic tube shields do not necessarily reduce the dose rates to the levels required by the user. Hence there may be a need for further shielding within the transmitter structure to achieve these ends (see Chapter 11). Both gamma rays and X-rays, being electromagnetic waves, are subject to attenuation in accordance with the inverse square law and both may extend for a considerable distance. As those who work with ionising radiation will know, X-rays generated by electronic equipment have one valuable characteristic when compared with radioactive sources, namely that the radiation ceases when the power switch is turned off! Consequently, the first line of defence when carrying out surveys and unexpectedly high X-ray levels are encountered, is either to withdraw to a safe distance or to switch off the equipment, preferably the latter since other people may be unaware of the problem.

Whilst the level of X-rays commonly encountered by users of transmitting equipment is not to be compared with those met in medical X-ray work or in the nuclear industry, it should be said that very high power electronic vacuum tubes can, if experienced unshielded, give rise to very high dose rates,

as illustrated later in this chapter. However, such tubes normally include some degree of shielding as part of their structure and further shielding is provided in the transmitter. Some specialised military equipments may be capable of generating very high doserates of X-rays and maintainers must be aware of the safety precautions.

Ionising radiation units

The SI units for ionising radiation[40] have now become well established, though they may be new to people who have not been involved in X-ray work. Appendix 1 lists the (SI) units together with conversion factors. However many measuring instruments in use have markings in the old units.

The two important aspects of basic ionising radiation measurement are:

- 1 Doserate – the amount of radiation per unit time.
- 2 Dose – the doserate multiplied by the time duration of the exposure, i.e. the total radiation experienced. It may be applied to a specific exposure or to longer units of time, e.g. year, working life, etc.

A simple, though very limited, analogy for those unfamiliar with dose and doserate is a water system where the flow rate (say, litres per hour) represents the doserate and the quantity of water so collected in a given time (litres) represents the dose. The actual calculation of the dose is simply doserate (litres per hour) times the number of hours for which the water flowed.

The importance of the dose concept stems from the fact that for ionising radiation there is no accepted safe threshold below which harmful effects do not occur. Thus the effects of ionising radiation are treated as cumulative and all doses are additive as far as potentially harmful effects are concerned (this is not the case for RF radiation). It follows that legally specified limits should be seen as ‘permitted limits’ not ‘safe limits’ since by definition, ionising radiation cannot be seen as safe. However we have to live in a natural environment where ionising radiation is present everywhere, albeit generally at low doserates, so one cannot escape the resulting dose.

The foregoing is also true of medical doses but these are considered as risks taken against the consequences of not diagnosing a medical condition, i.e. risk versus benefit. Medical doses are not generally measured and accumulated with occupational doses.

The basic dose concept has to be qualified in some way to reflect the fact that the harm caused by a given amount of radiation exposure depends on the type of radiation involved. Since we are only considering one type of radiation, it may not be clear why it is necessary to refer to other forms of radiation. The reason that this is relevant is that it necessitates two separate units and it is, therefore, important to the understanding of those units.

The first unit is the gray (Gy) and is used for the absorbed dose rate and dose. It is a measure of the exposure rate and dose actually experienced prior to considering the question of the type of radiation involved and the relative harm attributed to a given measure of it. As a dose rate the time unit is normally the hour and the unit is the gray per hour (Gyh^{-1}). As an absorbed dose, the unit is the gray (Gy).

Now dose = dose rate multiplied by the duration of exposure so that 3Gyh^{-1} experienced for 2 hours results in a dose of:

$$2 \times 3 = 6 \text{Gy}.$$

In order to determine the equivalence of different types of radiation, a further unit is used, the dose-equivalent rate and dose-equivalent. The unit is the sievert (Sv) and is obtained by multiplying the absorbed dose rate or dose by a factor called the relative biological effectiveness (RBE), commonly referred to as the quality factor (QF). Whilst the value of QF is significant for alpha and neutron radiations, the value for gamma and X-ray radiation is 1. This means that, in practice, when $\text{QF} = 1$, the numerical values in grays and sieverts are the same and only the sievert need be used. The sievert is a large unit and the usual transmitter dose rates will be in the order of microsievert per hour (μSvh^{-1}) with the accumulated annual doses in the order of millisievert (mSv).

The predecessor of the sievert was the rem and many measuring instruments still carry markings in the old units, e.g. rad and rem. These units were those used for absorbed dose (rad) and dose equivalent (rem) before units were rationalised and the new SI units introduced. Sometimes the now obsolete unit the röntgen (R) may be found on scale markings.

It has not been considered necessary to replace this latter unit in the SI system. However, existing instruments may well last for a long time. In terms of the deposition of energy in tissue, the röntgen is a little smaller than the rad but it is usual to treat the numerical value as equal to the numerical value in rad and rem (see Appendix 1).

In the present context, the millirad, millirem and milliröntgen will be the relevant order of magnitude for normal leakage levels. These can be considered numerically equal. The conversion of millirem, millirad or milliröntgen to microsievert involves a factor of 10 so that, for example, a commonly encountered specification figure is 0.75 millirem per hour and this becomes 7.5 microsievert per hour.

X-ray hazards

The hazards connected with all ionising radiations are frightening, as well as they might be, considering the possible outcomes. However the average user

of transmitters and other X-ray producing electronic equipment will not normally encounter very high doserates, assuming that safety instructions are followed. Nevertheless, the full hazards need to be known and understood. These are well documented nationally and internationally and need only a brief mention here.

Acute effects are those which result immediately from the dose encountered and stem from the cell damage caused by the power of ionising radiation to eject electrons from the atoms and molecules of human tissue. This cell damage can also result in the production of toxic substances, e.g. peroxides, in the cells.

Blood cells tend to be affected with a fall in the white cell count. The effects depend on the dose and we are often reminded of the Russian power station accident at Chernobyl. Obviously at very high doses, the effects can be fatal.

Late effects are those which may occur long after an exposure such as the production of tumours and genetic changes affecting subsequent offspring.

The obvious implication is that ionising radiation must be taken seriously and given adequate attention when designing equipment. At the same time a sense of proportion is required to avoid an excessive fear of it. It needs to be recognised that some uses of ionising radiation are very important for our well-being, medical X-rays and scans being good examples of situations where the immediate benefits are likely to be greater than the long term risks, though there is always concern about unnecessary X-rays carried out to defend doctors against lawsuits. It should be noticed that most older published material concerning the medical effects at different doses uses the rem as the unit. To relate this to the SI unit, 1 rem = 10 mSv.

X-ray permitted limits

Differing legal provisions apply across different countries and there is no easy way of dealing with this topic. Across the EC the Euratom Directive applies and is the basis of the Community safety provisions. Many of the provisions are, of course, not relevant here since they deal with radioactive substances.

In this chapter, in order to illustrate the use of limits the UK provisions in the Ionising Radiations Regulations 1999,[41] which meet the requirements of the current EC Euratom Directive, are used. As far as X-rays are concerned, the numeric limits will probably not differ much from those in use in other countries which follow the guidance provided by the International Commission on Radiological Protection (ICRP).

The basis of the applicability of the legal provisions to such things as transmitters is: 'Any practice involving the operation of any electrical equipment emitting ionising radiation and containing components operating at a potential difference of more than 5 kV which can increase the exposure of individuals to radiation from an artificial source.'

There is a further reference to radioactive substances which is not specifically relevant here but which could apply if such substances existed in the equipment.

The general principle involved is the determination of permitted dose limits for various categories of people, i.e. trainees under 18 years of age, adult employees and women of reproductive capacity. The detail is more complicated than the previous regulations in that:

- It specifies annual and five-year dose limits for the categories above
- It additionally allows some higher limits for the lens of the eye, skin, hands, forearms, feet and ankles per calendar year
- For people who are not employees or trainees and including any person under age 16 years a low annual limit is given.

To avoid complexity here only the following limits per calendar year, ignoring the five year figures and the extra provisions, are listed. Clearly anyone subject to this legislation needs to be in possession of the full document.

Adults excluding women of reproductive capacity	20 mSv
Trainee under 18 years of age	6 mSv
Persons not trainees or employees including all under 16 years of age	1 mSv

In summary, two forms of special working areas are specified:

- **Controlled areas**
Where any person is likely to receive an effective dose greater than 6 mSv a year or, for employees 18 years or over, greater than three tenths of any relevant dose limit.
- **Supervised areas**
Where any person may receive an effective dose greater than 1 mSv a year.

The use of an approved dosimetry service to monitor the dose received by people in designated areas is required. This is usually done by the use of individual monitoring badges.

The dose badges referred to above are usually thermo-luminescent dosimeters (TLDs) which record the total dose of the wearer and are periodically processed by the issuing body and dose records produced. They generally replace film badges where a piece of film was used for the same purpose. A typical dose badge is illustrated in Figure 8.13.

It should be said that many employers concerned with the manufacture of high power transmitters and other high voltage equipment use TLD badges voluntarily as a prudent monitoring measure, even when not legally required. The badges can also be used for certain equipment measurements and this is discussed later in this section.

It can be seen that the basis of the limits shown above provides for working practices with different economic and other consequences for each, for example, the cost of having controlled areas, TLD badge costs, and administrative costs relating to record keeping, medical examinations, etc.

Perhaps most important of all is the reluctance of technical personnel to incur unnecessary radiation doses which echoes the general objective of most countries to limit population doses. It is therefore important that new designs have specifically tackled the reduction of X-ray leakage, thus avoiding unnecessary doses to test and operating personnel and expensive remedial design work.

Of course, this structure of permissible X-ray leakage levels does not answer the question most asked – what is the permitted leakage from a transmitter? Rather, it merely fixes the possible everyday working conditions. Fortunately, in practice, transmitter leakage limits are effectively determined by the market place. Users, in general, want as little stray radiation as possible.

This is generally reflected in the specifications of the larger purchasers. In most cases, transmitters are likely to be in the $<1 \mu\text{Svh}^{-1}$ range. Measurement is done at 100 mm distance from the equipment surfaces, except for video display units (VDUs) and cathode-ray tubes which, for unexplained reasons, are measured at 50 mm. Limits for X-ray radiation for some items, e.g. television sets, computers, etc., where domestic usage is involved, may be subject to specific legal provisions in some countries.

The inverse square law applies to X-ray radiation and leaks giving readings of the order of $1 \mu\text{Svh}^{-1}$ measured at 100 mm from the surface of the transmitter panels will probably be unmeasurable at 200 mm. This means that in many cases to incur even a small dose would probably involve leaning on the transmitter for some considerable time! Of course, the situation could change drastically if a panel is removed and hence the need for strict safety rules and their enforcement.

The transmitter supplier can provide the safety instructions but the user must accept responsibility for their observance. Cases arise from time to time where personnel use their discretion and do something unauthorised in particular circumstances without having the necessary understanding of the risks involved. A common case is where a door interlock is overridden to work with a transmitter door open without any regard to the fact that the door also provides some X-ray shielding.

The author's past observations include:

- Personnel breaking a lead-glass window (used for X-ray shielding) and quietly repairing it with a piece of plastic.
- Temporarily replacing a missing panel with cardboard and overriding door trip switches without checking on the X-ray consequences (the cardboard avoided cooling airflow loss). A considerable beam of X-rays from the cardboard led to a rapid shut down!

- Cases where small servicing access panels were forgotten and left off when X-rays were present. One old transmitter had a 10 cm square hole in the back where the shield had been taken off and lost and an X-ray beam emerged through the aperture.
- Lack of servicing screens for 'open door' maintenance adjustments.

At least one extreme case is known where a man removed X-ray shielding and then ran the equipment. In consequence he lost the thyroid gland function which was destroyed by the radiation and it had to be removed by surgery. There was also severe ulceration of the face and mouth. It is common when fault finding to want to move obstructions to see what is happening and training is needed to modify such behaviour where X-ray radiation exists.

X-ray production

As noted previously, X-rays are produced when electrons are accelerated by high voltages within a vacuum and this definition fits the electronic vacuum tubes used in high power broadcasting, communications and radar systems. These include triodes, tetrodes, klystrons, magnetrons and travelling wave tubes. Basically, the peak energy of the X-rays will depend on the peak voltage across the tube anode-cathode and the dose rate will depend on the square of this voltage. In high power RF circuits this peak voltage will often be greater than the DC supply voltage and can be two or more times the supply voltage. In amplitude modulated systems, the X-ray dose rate can, in certain types of high power system, increase more rapidly than theory would suggest, when the modulation level is increased.

Practical information on X-ray production in X-ray tubes is not difficult to obtain but the same information for electronic vacuum tubes is not at all easy to obtain. However, Thomson Tubes Electronics publish technical information on this subject in respect of their high power pulsed klystron amplifiers. The information supplied is one of the best examples of technical support, in relation to adventitious ionising radiation, which the author has seen from an electronic vacuum tube supplier.

The first example of an RF circuit provided by Thomson Tubes Electronics uses a pulsed klystron operated at high peak power (5.6 MW peak; 5.55 kW mean) and relates to the TH 2066 klystron. Whilst this example may appear to be a very high power case, klystrons currently available can provide effective peak powers of 20 to 30 MW.

This particular test does provide a great deal of useful data. Figure 8.4 shows the result of the tests for X-ray dose rates which were carried out on the TH 2066 klystron tube. The tube collector has a shield of copper of

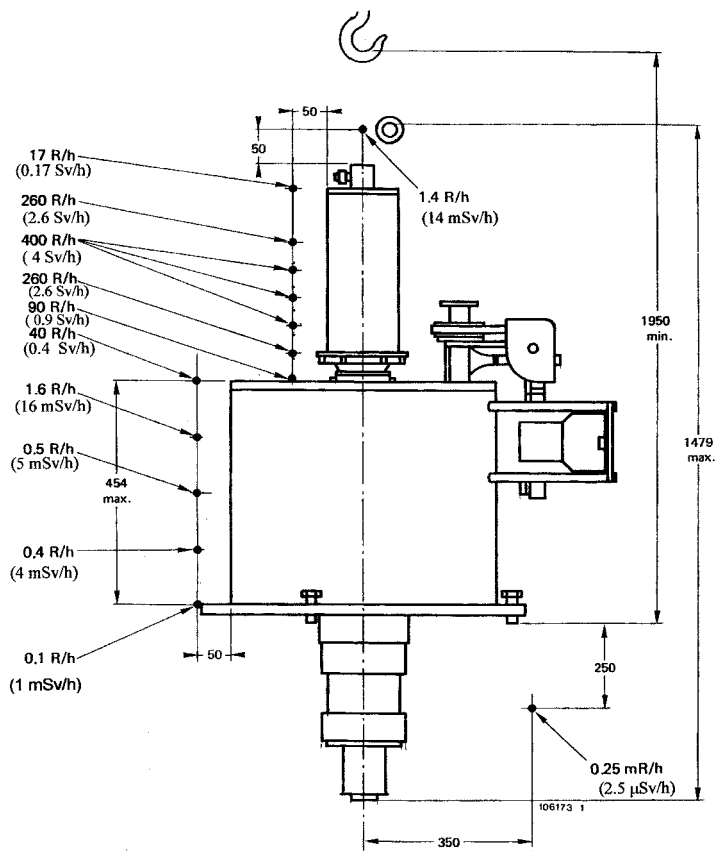

Figure 8.4 Klystron X-ray test results (Courtesy Thomson Tubes Electroniques)

effective thickness approximately 1.5 cm (upper part of the diagram). This diagram has been left as supplied with units in röntgens per hour but the sievert values have been added in parenthesis (1R = 10 mSv).

With the tube mounted in its electromagnet the highest dose rate shown is 400 Rh^{-1} (4 Sv h^{-1}) at 50 mm from the tube. Most of the radiation occurs, as shown, in a plane perpendicular to the axis of the collector in the top part of the diagram. From the shielding point of view, it can be seen that the metals in the electromagnet (centre portion of the tube outline) provide substantial attenuation of the much smaller amount of X-ray emission which arises from the body of the tube.

Further shielding will be necessary to reduce the radiation level at the external surfaces of a transmitter or other equipment using this tube under these conditions.

The method used to undertake this type of measurement is to use pre-positioned non-electronic 'pocket' dosimeters since it is far too hazardous to use personnel. Electronic instruments may be subject to the high level interference in such tests.

Another example provided by Thomson Tubes Electroniques[43] is for a type TV 2002 high power pulsed Klystron with a 240 kV peak beam voltage, a mean output power of 25 kW and a peak output power of 25 MW, considerably more power than the example in Figure 8.4.

The result of the measurements was to establish that the doserate at one metre from the tube was 400 Rh^{-1} (4 Sv h^{-1}), much higher than the previous example which gave this level at 50 mm from the tube. It would need considerable attenuation to reduce it to, say, $2.5 \mu\text{Sv h}^{-1}$. Whilst the doserate of 400 Rh^{-1} in both examples is very hazardous, it would be difficult to access this level in the first case due to the closeness to a very hot tube. It would, however, be possible to access lesser but still hazardous levels.

In the second case where the distance for the same doserate was one metre, the possibility of accessing this hazardous doserate might be quite high unless effective protection is provided.

It was calculated that a non-filtered X-ray generator with the same beam power would supply about $36\,000 \text{ Rh}^{-1}$ (360 Sv h^{-1}) at 1 metre away. This gives some idea of the attenuation of the thick-walled collector of the tube which constitutes the filter.

In this example, the applied voltage V_b is 240 kV. It is noted that in this case, as the tube power varies as $V_b^{5/2}$ then the X-ray doserate will vary as $V_b^{7/2}$. Hence, if the value of V_b is increased from 240 kV to 290 kV (an increase of approximately 21% in voltage and 46% in the squares of the voltages), the X-ray doserate, with the pulse conditions unchanged, will double.

Figure 8.5 from the same literature, shows a source of X-ray radiation from a target bombarded at 240 kV with and without the 1.5 cm copper filter (the thick-walled collector of the tube). The copper filter corresponds to that on the tube in the previous example. The Y axis is scaled in percentage spectral density and the X axis is scaled in terms of the tube voltage in kV. It can be seen that the unfiltered spectrum is broad with the peak spectral density at about 125 kV. The copper filter acts as what a radio engineer might see as a high pass filter, except that energy rather than frequency is being considered.

Since the X-ray absorption coefficient of copper increases as the wavelength increases (energy reduces) the lower energy part of the spectrum is heavily attenuated, leaving the new energy density curve as one which has a much higher energy at the peak spectral density.

Consequently this is relatively harder to attenuate; that is to say it requires a greater thickness of a given material to attenuate it.

These klystron measurements under high power operating conditions indicate how necessary it is to take X-ray radiation seriously on high power radars and similar equipment. It is clear that very specific safety instructions

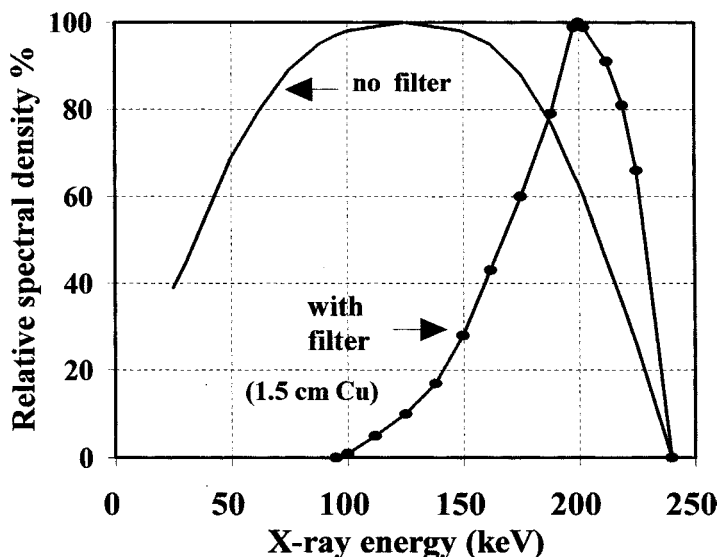

Figure 8.5 Klystron energy distribution (Courtesy Thomson Tubes Electroniques)

are needed together with sufficient training for technical personnel to ensure that the warnings are understood.

Figure 8.6 shows a Thomson type TH558 tetrode tube of the type used in high power broadcast transmitters and rated at 650 kW for the MW and LW broadcast bands and 550 kW for the HF band. Data provided in a private communication to the author gives some information on X-ray leakage for pulse duration modulation (PDM) and RF operation and this is listed in Table 8.1. The operating conditions are not given. An additional note stated that the worst dose rate outside the closed transmitter cabinet, measured at 50 mm distance was $0.1 \mu\text{Sv h}^{-1}$.

Elsewhere, experiments have shown that with high power HF broadcast transmitters equipped with the type of tube illustrated in Figure 8.6 and using pulsed power efficiency modulation systems intended to provide some economy in the amount of energy consumed, there can also be a rapid increase of X-ray radiation with increase of amplitude modulation depth at the highest depths (e.g. from, say, 80 to 90%) when carrying out measurements with a sinewave test tone.

Figure 8.7 gives an example of this on a high power transmitter. The transmitter already has a fair amount of shielding and the leakage levels were measured with all panels in place and doors shut. The Y axis is not scaled in specific values which, in this case, could be misleadingly low as it applies to a design situation where most of the leakage has already been shielded and only a few remaining locations gave any measurable leakage.



Figure 8.6 *Tetrode type TH558 (Courtesy Thomson Tubes Electroniques)*

Instead the highest value on the curves has been arranged to be scaled as 2x with x and zero, as the other marked points. By this means, the doubling of dose rate can be seen in Figure 8.7. Note that zero here indicates 'unreadable'.

The lines in the graph have no significance as they merely exist to link those test results which are related to each modulation level used. It is

Table 8.1 *Electronic vacuum tube X-ray leakage in pulse duration modulation (PDM) and RF operation – tube type TH558 (Courtesy Thomson Tubes Electroniques)*

Type of operation	CW ($\mu\text{Sv h}^{-1}$)	Modulation ($\mu\text{Sv h}^{-1}$)
Close to PDM tube	8	7
Close to RF tube	≤ 0.2	20

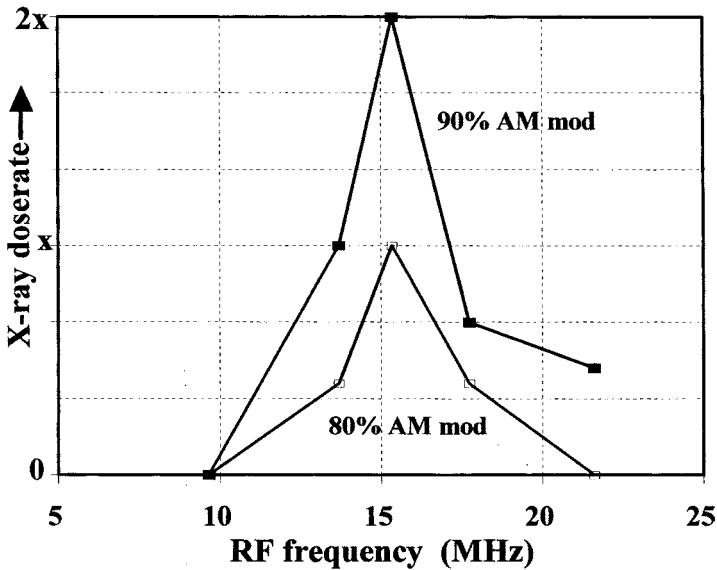

Figure 8.7 High power HF broadcast transmitter X-ray leakage investigation

important to recognise that X-ray radiation levels can be high where shielding has not already been designed into the transmitter. In such cases the magnitude of the leakage might well be in tens of μSvh^{-1} or more, depending on the structure of the transmitter. In this case the result was to fit lead shielding to the cabinet doors.

It can also be seen from the same diagram that another factor which is not accountable by normal theoretical considerations arises, namely that the absolute level of X-ray leakage, measured at the same places and under ostensibly the same conditions, shows a dependence on the RF frequency.

This appears to be due to some effect arising from the pulsed operation of the power efficiency circuit and the resulting effective peak voltage across the power tube. An experiment to replace the power output tube by one from a different manufacturer merely displaced the RF frequency at which the X-ray peaked by a small amount. A paper by Hunter[44] attempts an analysis of the effect of pulsed power efficiency systems and highlights the fact that bursts of X-rays appear to be generated on the rise and fall edges of the modulator pulses.

The implication of the foregoing is that when surveying such amplitude-modulated transmitters, especially very high power ones, the tests must include the higher modulation depths and a range of RF test frequencies such that any peaking of the X-ray will be spotted. The author did not find any effect attributable to the audio modulating signal frequency and 1 kHz is a quite usual test frequency.

Testing at the highest modulation levels on very high power transmitters can introduce problems resulting from the fact that such transmitters may have absolute time duration limits for operation at 100% modulation, since the normal average modulation level is much less. The main problem is to survey the surfaces of large cabinet structures in the allowed time limit. The need to test at a number of frequencies does not usually impose any extra burden since RF leakage tests require this and will usually be carried out in conjunction with the X-ray tests.

It should be emphasised the phenomena described above has not been noted with ordinary conventionally AM modulated HF transmitters of lower powers.

High voltage electronic vacuum tube applications

Apart from the obvious ground based radar and HF broadcasting applications illustrated earlier, there are many other applications which also make use of them. Television transmitters use high power UHF amplifiers. Figure 8.8 illustrates a high power induced output tube (IOT) rated for 30 kW + 3 kW in common amplification. This example is water cooled. With the advent of digital television, EEV IOTs for that application have ratings from 100 kW to 40 kW peak digital transmitter power rating. A useful descriptive paper on IOTs is listed as reference 77.

Travelling wave tubes (TWTs) are also widely used on land, at sea and in the air. Figure 8.9 shows a high power military coupled cavity type. Peak powers range up to 1 MW. In the EEV catalogue, cathode voltages for radar applications may range up to 100 kV whereas the types used for ground satellite stations range up to 12.5 kV. It is generally found that X-ray radiation from TWTs is liable to increase towards the end of tube life and this needs to be taken into account when dealing with radiation safety.

Industrial applications of RF energy also use high power electronic vacuum tubes for dielectric heating, pipe welding, induction heating, plastic welding, wood glueing, etc. Figure 8.10 shows a range of triodes used for industrial applications. The catalogue range covers powers up to 300 kW and maximum anode voltages ranging up to about 20 kV.

The range of equipment in which there is the possibility of X-ray radiation is vast whilst, so often, the training of engineers and technicians seems to be largely based on semiconductor technology with their relatively low and safe potentials. Hence the need to ensure that people are trained in the safe use of equipment using high potentials.

Measuring equipment

The measuring equipment used for X-ray measurement may be unfamiliar to those who have not had to involve themselves in ionising radiation. There is



Figure 8.8 *Induced output tube IOT (Courtesy Marconi Applied Technology)*

a considerable variety of types of instrument available and the basic operation of these is covered in the following paragraphs.

Ionisation chamber instruments

The basis of the measurement of X-rays in this type of instrument involves the determination of the amount of ionisation caused in a gas-filled chamber. Ionisation involves the production of ion pairs consisting of a negative ion (electron) and a positive ion. The chamber may use air or other gases, the air chambers usually being vented to the atmosphere. Dessicators may be required to reduce moisture levels in open chamber instruments.

Figure 8.11 illustrates the general principle of operation. The chamber has two conductive plates, one being connected to the high voltage positive DC supply terminal and the other to the negative supply terminal. The negative (return) connection is via a high resistance R . The chamber has a thin window, not depicted in the diagram, which minimises the attenuation of X-rays at the low energy end of the spectrum.

When the chamber is exposed to an X-ray source, ionisation takes place as indicated in the diagram. The positive voltage on the upper plate will attract the negative ions (electrons) and the positive ions will be attracted to the lower plate.



Figure 8.9 *Travelling wave tube (TWT) source (Courtesy Marconi Applied Technology)*



Figure 8.10 Power triodes used in RF heating applications (Courtesy Marconi Applied Technology)

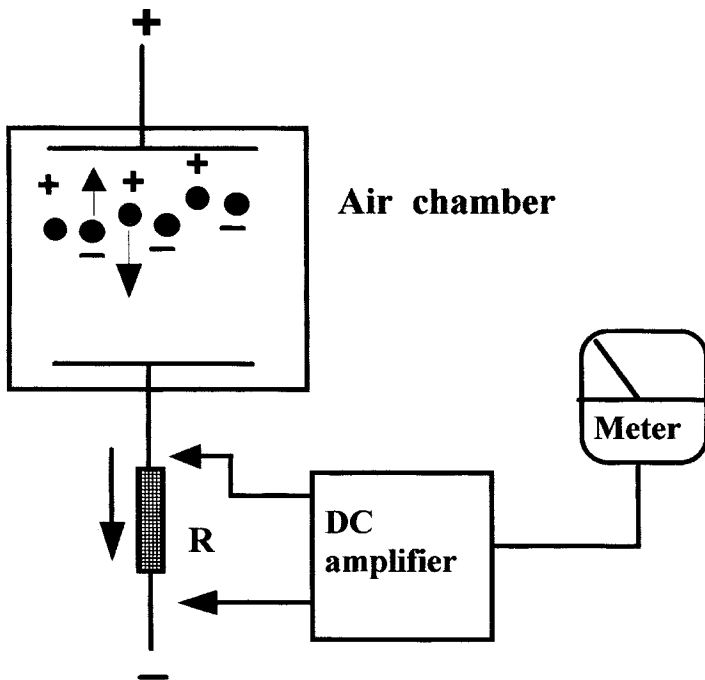

Figure 8.11 Ionisation chamber X-ray measuring instrument – basic concept

As a result a very small current which will be proportional to the number of ion pairs produced and thus the X-ray doserate, will flow through resistance R. As a result, it will develop a corresponding voltage across it. As the currents are very small, amplification is required to provide a current sufficient to operate a moving coil meter. The current flow arrow in the diagram indicates conventional current flow (positive to negative).

It is necessary to ensure that the X-rays fill the chamber window otherwise some error may result. However, in the author's experience using several instruments of differing types on a variety of transmitters, very close agreement was found on each occasion even though the instruments had different chamber aperture sizes.

The meter can be scaled in doserate. With the newer instruments, scaling in sieverts is usually available. Sometimes the chamber is made of plastic, filled with a gas and sealed. This arrangement can have a good low energy response down to about 6 to 8 keV. It can, however, suffer from the loss of the gas due to permeation through the plastic and may need periodic recharging with gas. Purchasing a spare at the same time as the instrument is purchased is not necessarily a help since this may suffer the same gas loss. If a spare is needed, it should be purchased at about half way through the 'charge life' of the original chamber.

It is generally agreed that the ionising chamber instrument should always be used for transmitter X-ray measurements. A type appropriate to the work must be chosen.

The Geiger-Muller counter

The Geiger-Muller (GM) tube is a much more sensitive device than the ionisation chamber. It is basically a gas-filled tube operating at a voltage below that which would sustain a continuous gas discharge current. Figure 8.12 shows a much simplified representation of a GM tube where the positive plate is the central conductor and the negative plate is the cylindrical cathode. The pulse voltage is developed across the resistor R and coupled to a pulse threshold detector in the instrument circuitry and then into a counter. The tube is filled with a suitable gas, argon or krypton typically being used for tubes intended for X-ray work.

An X-ray photon will cause the production of an ion-pair as before in the ion chamber but in this case the electrons so produced will produce further ion pairs due to the extra acceleration provided by the higher supply voltage, resulting in an avalanche of current. This is known as gas amplification and results in a large pulse of current.

It is important to ensure that only one pulse is counted for each initiating photon, so a small amount of another gas, usually one of the halogen family, is added. This is known as a quenching gas and prevents possible spurious discharges which can result from secondary electron production in the tube.

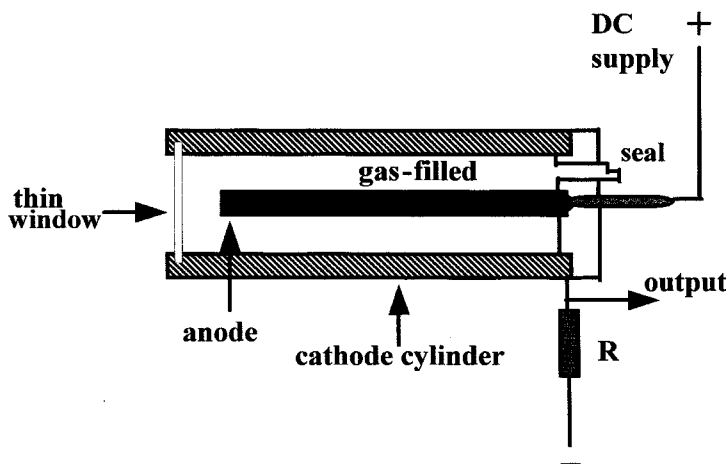

Figure 8.12 GM X-ray counter tube (Courtesy Philips Electronic tubes)

The effect is to render the tube insensitive for a short period between pulses and this is known as the 'dead time' after a pulse during which a successive pulse will not be counted. In a selection guide from Philips Electronic Tubes the magnitude of the 'dead time' ranges from 11 to 230 μs according to the type and function of the tubes. Dead time needs to be taken into account when the manufacturer calibrates the instruments.

The energy response of GM tubes is not very flat and in order to flatten it, some tubes are fitted with a filtration cylinder consisting of an arrangement of several types of metal. Specially designed tubes such as those listed by the manufacturer mentioned above, offer X-ray low energy operation down to about 2.5 keV.

When using a GM instrument on amplitude-modulated transmitters with high depths of modulation, the guidance given in the instrument handbook should be followed regarding the modulation test tone frequency to avoid the instrument registering the modulation frequency rather than the X-ray radiation.

One instrument illustrated later in this chapter uses a GM tube. GM tube instruments are generally much cheaper than chamber instruments to manufacture, but tend to have a poorer energy response at the low energies involved in many transmitters.

Scintillation counters

Another type of instrument is the scintillation counter. This typically uses a sodium iodide crystal doped with tellurium or thallium. When the crystal is subjected to X-rays it gives off flashes of light which are amplified and

detected by a photomultiplier tube. The dead time on this type of instrument can be around 4 μ s. This type of detector is very sensitive but some types lack a good low energy response. Both the GM tube counter instrument and the scintillation counter, when suitably chosen for the purpose, are particularly good for the initial part of a survey where they act as 'sniffers' (search instruments to locate leakage beams). They do not need to be calibrated for this purpose since they are only used to identify places where measurement is needed.

Other instruments and devices

The quartz fibre electrometer

Earlier in this chapter a reference was made to pocket dosimeters. The type referred to is one which has been long established, the quartz fibre electrometer. This is technically also an ionisation chamber instrument but made in a size and shape similar to a fat fountain pen. It is a cylindrical device typically about 10 cm long and about 1.3 cm diameter. It consists of an ionisation chamber with a direct reading quartz fibre electrometer on the lines of a gold-leaf electroscope. In this case, the quartz fibre is repelled by a fixed electrode. The fibre can be viewed through a lens against a scale. The device has to be charged with a voltage before use.

When subjected to ionising radiation the device will discharge, the discharge being proportional to the dose rate of the radiation received and its duration. The dose is read off the scale viewed through the lens.

The purpose of the device is to give an immediate reading of dose so that when worn by personnel, information about their exposure is quickly available. It can, as in the earlier reference in this chapter, be used in an experimental situation to record dose without having to expose personnel.

Because it has no electronics circuitry it is immune from the sort of problems which might occur with high levels of RF present if an electronic instrument was used. However, because of its nature it is susceptible to errors if roughly handled or if dropped. It is often worn by personnel as a means of getting a quick indication of radiation present, as contrasted with the thermoluminescent dosimeter (TLD), which has to be sent for processing before the information is available. It is usually backed up by a TLD.

Film and thermo-luminescent personal dosimeters

For many years a 'badge' type dosimeter using photographic film was used to record radiation doses for people working with X-ray, gamma and other forms of radiation. The badge was processed at intervals and the dose recorded. The dose information was obtained by comparing the darkening of the relevant part of the film for the radiation concerned with a sample of the film from which the badge was made. It was universally known as a 'film badge'.

In the UK and some other countries, the badge now contains a quantity of a substance which exhibits thermo-luminescence such as lithium fluoride. This means that the ionising radiation dose recorded by this substance can be converted to a light emission proportional to that dose by heating the substance in conjunction with a suitable measuring system. The system operated by the UK NRPB uses a badge which covers 0.02 to 2 MeV for photon radiation with an uncertainty of about $\pm 25\%$ and a measurement threshold of about 0.1 mSv. It also covers beta radiation, but this has no relevance in this chapter.

A typical badge dosimeter is shown in Figure 8.13. The badge is officially called a thermo-luminescent dosimeter (TLD) though, out of force of habit, people still call them film badges.



Figure 8.13 Thermo-luminescent dosimeter (TLD) (Courtesy NRPB)

An additional and important use of the badge is for equipment testing where the badge can be attached to the equipment being investigated and the equipment run for a specific time. The resulting dose reported by the dosimeter processing organisation is divided by the equipment run time, in hours, to give an average X-ray dose rate. Most badge processing services provide for rapid assessment of badges reserved for investigations and report by telephone. Personal (named) badges should not be used for investigations as the resulting dose may be accounted in their own dose records! Badges labelled test 1, test 2, etc., avoid this problem.

Example:

Dose recorded = 0.5 mSv

time equipment run = 10 hours

Hence the doserate = dose/time = 0.5 mSv/10 = 50 μ Svh⁻¹.

It is obviously important to ensure the accuracy of the run time record otherwise the calculation will result in an average doserate which is too high if the time is understated and too low if the time is overstated.

Note that the quartz fibre electrometer, mentioned earlier, can also be used for such experimental measurements, as illustrated in the Thomson klystron X-ray measurements. It has the advantage of being free of electronic circuitry and directly readable.

Practical measuring instruments

Practical instruments are very sophisticated, having a number of range and function switching facilities giving a wide range of doserate measurement. Meter zero adjustment, and battery voltage checking are also provided. Some also offer dose measurement by integrating the doserate over a specified time. Newer types of instrument may also use auto-ranging and provide digital readouts. Increasingly, data storage is possible (as it is in newer types of RF radiation instruments).

In addition to X-ray and gamma ray measurement, they generally offer some alpha and beta radiation measurement facilities. Whilst the extra measurement facilities are not directly relevant to the assessment of X-rays in transmitters, they might influence the choice of instrument if the user has other ionising radiation measurement commitments, e.g. handling radio-active sources, etc.

Most people involved in the measurement of X-ray radiation from radio transmitters recognise the value of two different types of equipment for the task. The first type, referred to earlier as a 'sniffer', is a sensitive instrument, often not calibrated, the sole function of which is to search for leaks so that they can be measured later. The main requirement is sensitivity over the appropriate energy range and portability. An audible indication proportional to doserate in addition to the meter indication is very useful since, in many large surveys, it is quicker to get a first indication aurally rather than alternately having to look at the equipment under test and the instrument meter. It should be able to detect narrow X-ray beams which might be missed by the normal measuring equipment. It will usually take the form of a Geiger-Muller counter or a scintillation counter. The second requirement is for an ionisation chamber type instrument with a suitable sensitivity with which to perform the measurement of leakages found by the sniffer instrument. There is a very wide range of choice of instruments capable of meeting these two instrument

requirements in the world market since the business of monitoring ionising radiations has been established for many years. For those unfamiliar with such instruments, careful scrutiny of suppliers' data sheets plus practical trials are recommended. Because of the nature of radio transmitters and their supply voltages, there is a need to ensure that the low energy response is adequate. Many instruments do not have an acceptable energy response down to the 8 or 15 keV likely to be needed. This is because they have been designed for much higher energies such as those experienced from radioactive substances.

Another special requirement for radio transmitter work is that the readings obtained on the X-ray doserate meter shall not be affected by RF fields. This does not mean that it has to be specially designed since some existing instruments do exhibit a considerable rejection of RF by their nature.

Some instruments specifically claim rejection of RF but, in a few cases, the energy range offered may not be adequate for the work. This can be due to a worsening of the low energy end of the energy response curve, due to the added shielding. There has recently been an improvement in the availability of 'RF proof' instruments which have retained their low energy response.

RF rejection should be judged on the basis specified by the supplier and related to the proposed use. It is unreasonable to expect the rejection of the enormous RF levels which might be found inside a high power transmitter when panels have been removed!

The instruments illustrated in this chapter are typical ones and many, but not all, of them have been used by the author. However, any reference here to an instrument is solely intended to highlight features and does not imply any recommendation. Equally, there is no adverse implication in the absence of any instrument manufacturer or instrument. The actual choice of instruments should be made against the specific requirements of the work and the nature of the radiation to be measured. Since only brief details of instruments can be given here, it is essential that purchasers should obtain full specifications since these can change without notice.

Energy responses given here together with other data, should be treated as illustrative. Where energy responses have been illustrated, the energy range covered is only part of that specified by the manufacturer (to 100 keV) since this is of most interest for transmitters. Those requiring instruments for other purposes, in addition to that covered in this chapter, should check the wider range energy response data.

The number of types of instrument per supplier illustrated here is obviously limited, but most suppliers have a range of instruments available covering two or more of the categories mentioned in this chapter and catalogues can be obtained.

SI units are used in the following descriptive material. For those working in millirem per hour, $1 \mu\text{Sv h}^{-1} = 0.1 \text{ millirem h}^{-1}$.

Search instruments

Geiger-Muller (GM) counter

Figure 8.14 shows the Mini-monitor type X, a relatively low cost instrument specifically designed as an X-ray leakage search instrument. The instrument is light and portable. It is not calibrated in dose rate but has a 'counts per second' scaling on the meter together with an audible indication of count rate. It is intended to be used as a 'sniffer' and used for comparisons, not measurement.



Figure 8.14 *Mini-monitor type X radiation meter designed for finding X-ray and gamma radiation leaks (Courtesy Mini-instruments Ltd)*

In carrying out initial surveys over large areas of equipment surface it is often impracticable to keep watching an instrument meter and it is usual to listen to the audible note. For noisy environments, a headphone socket and headphones are available as an optional extra. The instrument uses a GM tube as the basis of operation and the window area of the probe is 2.25 cm². The gamma response is given as typically 2 counts per second per $\mu\text{Sv h}^{-1}$.

Figure 8.15 illustrates the typical response versus energy for the range up to 100 keV. The published response actually goes to 1 MeV. The 'Y' axis marking is in terms of counts per $\mu\text{Sv h}^{-1}$ where it can be seen that above about 15 keV the figure of 2 counts per $\mu\text{Sv h}^{-1}$ is conservative. The operating conditions for Figure 8.15 were with the probe end-on to the radiation and the plastic cap fitted.

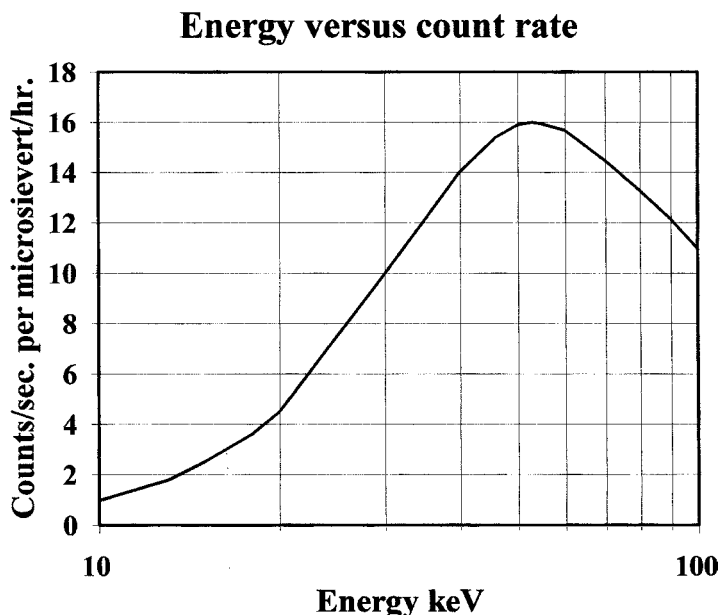

Figure 8.15 Mini-monitor type X energy–dose rate response (Courtesy Mini-instruments Ltd)

An alarm is fitted (analogous to the alarms on some RF radiation meters) which is set to full scale. It should be noted that ionising radiation instruments are often, as a general policy, made to read over full scale when overloaded as this one does and the alarm is therefore a warning against encountering an unexpected high level. Dry batteries or rechargeable cells are options. The use of mains-operated equipment is undesirable because of the likely pick-up of RF in the mains lead.

Another instrument which is suitable for use as a sniffer is the Autonnic Research Ltd, Model 100 which is scaled in sievert, the lowest range being $0-5 \mu\text{Sv h}^{-1}$. The energy response, relative to the 32 keV (barium) calibration is $\pm 30\%$ from 6 to 150 keV. This instrument also has an audio piezo electric sounder.

Scintillation counters

Scintillation counter probes are available from the Mini-Instruments company, from the Victoreen company and probably from other manufacturers. Both have versions suitable for low energy X-ray and gamma measurement.

Ionising chamber measuring instruments

Figure 8.16 illustrates the Victoreen model 440RF/D low energy RF shielded survey meter. It does, of course, cover some alpha, beta and gamma radiations as well, but the interest here is the X-ray measurement. The instrument uses an air-vented unsealed chamber with a Mylar window. It is fitted with pressure and temperature sensors, software controlled to apply standard correction factors. The chamber centre is defined.



Figure 8.16 *Victoreen 440RF/D low energy shielded survey meter (Courtesy Victoreen Inc.)*

The most sensitive doserate range is 0 to 10 μSvh^{-1} , a very useful range for transmitter work. It is also available marked in sievert, which avoids conversions for those working in SI units. The energy response claim is 'within 10% from 12.5 to 42 keV'. Auto-zeroing is provided. There is a built-in uranium check source. The claim for RF proofing is up to 200 Wm^{-2} . The instrument is portable and battery operated.

In the data sheet, the actual energy response curve is shown up to 1 MeV but only the part most relevant to radio transmitters (10 to 100 keV) is shown here in Figure 8.17. Note that the published specification actually starts at 12 keV.

A new instrument from Mini-Instruments is the SmartION ion chamber survey meter and this is shown in Figure 8.18. There are three versions of the instrument. Two of these are probably most relevant types 2100 (without the dose integrating facility) and type 2120 (with dose

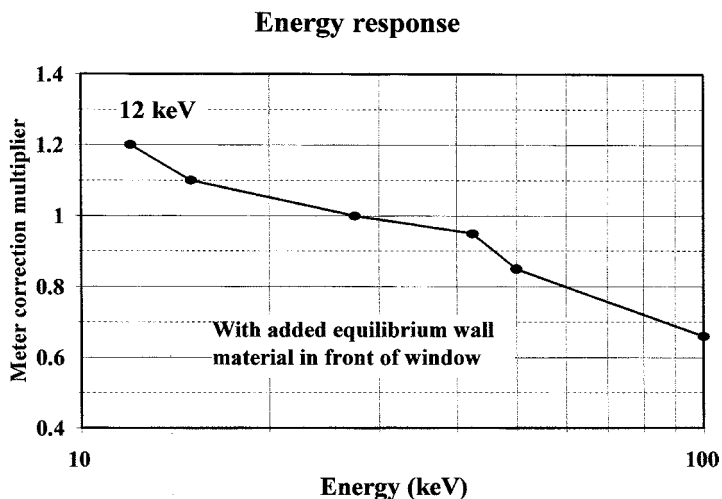

Figure 8.17 *Victoreen 440RF/D energy response (Courtesy Victoreen Inc.)*

integrating facility). Calibration options include μSvh^{-1} and the instruments cover an effective range of $1\mu\text{Svh}^{-1}$ to $500\mu\text{Svh}^{-1}$, with auto-ranging. The display is a liquid crystal type with the measured quantities displayed in digital form plus a simulated analogue scale. The energy response is shown in Figure 8.19, as with the other instruments discussed here, coverage up to 100 keV.

Dose integration is the facility to accumulate a dose reading by exposing the instrument to the X-ray source doserate for a given period of time.

Choosing instruments

For the purposes of this chapter it is assumed that the application is for transmitter or RF machine X-ray measurements only. Those having other ionising radiation responsibilities may wish to include in their choice criteria other measurement capabilities, such as beta and higher energy gamma measurements.

Checklist for ionisation chamber measurement instruments

Doserate and dose ranges available

Increasingly, due to legislation, there is need to resolve down to $0.5\mu\text{Svh}^{-1}$ so that a suitable full scale deflection is necessary. The choice of other



Figure 8.18 *SmartION ionisation chamber X-ray and gamma radiation meter (Courtesy Mini-instruments Ltd)*

doserate ranges required depends on the proposed usage. Very high doserate ranges are unlikely to be needed.

If dose measurement is also required, i.e. integrating doserate over a period of time, then this will be a choice factor. The author has rarely found this to be of great value in practice since it takes up the time of the person undertaking the survey and can be covered in other ways. However, with tighter limits this method may become more important both with very low level measurement which can be done by doserate integration and also, possibly, with specialised pulsed equipment, e.g. with infrequent pulsing.

Scaling of the instrument

Factors of interest are the units used for scaling and the readability of the meter scales. Some suppliers offer scaling in sievert on request. Such scaling is not essential but does remove a possible source of errors in converting from other units. The rad, rem and röntgen are obsolete units and best avoided if a choice is available. (The fact that some current product test specifications use old units should not inhibit the purchase of instruments with a sievert scaling, since the specification figures can be converted.)

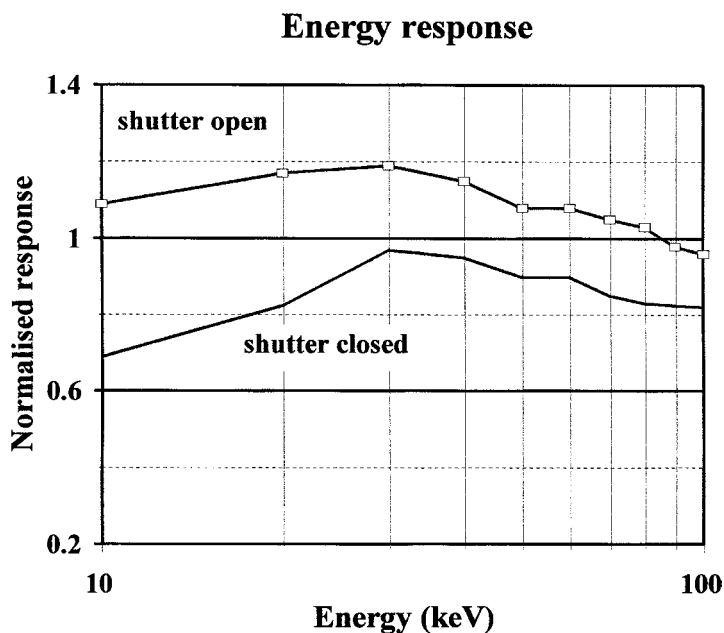

Figure 8.19 *SmartION energy response curve (Courtesy Mini-Instruments Ltd)*

Energy response

A reasonably flat energy response from 10 or 15 keV to 100 keV is desirable. The upper limit will depend on the high voltage supplies to the transmitters concerned. The need to have a good low energy response stems from the fact that 5 kV and above is usually invoked in the definition of radiation generators and that a lot of transmitters have their high voltage supplies in the 5 to 10 kV range.

Physical characteristics

X-ray surveys can take quite a time on large installations and the weight of the instrument, ease of handling and reading it and similar ergonomic factors become quite important. Note that when measuring X-ray leakage at a specified distance from a panel or other surface, the distance is measured from the centre of the chamber and not from the end of the instrument nearest to the leakage being measured. Instruments have some form of mark or other indication or definition to show the centre of the chamber. This is illustrated in Figure 8.20.

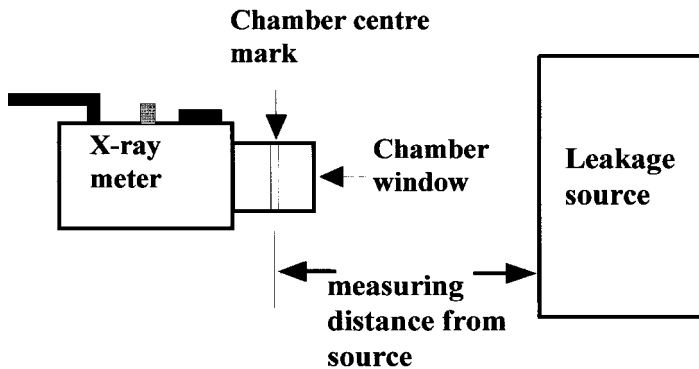

Figure 8.20 *Measurement distance measurement for ionising chamber instruments*

Reliability

This is, as with any other instrument, a very important factor but one which cannot be determined from data sheets. The cost of ownership of both RF and X-ray measuring instruments can be very high if they prove to be unreliable since each repair, except the most trivial, will generate a requirement for a re-calibration, the cost of which can be comparable with the repair cost. Indeed, if the instrument is prone to failure, the inevitable repair–recalibrate sequences may result in the equipment rarely being available and a further instrument being needed. The only practical advice on this topic is for the prospective purchaser to talk to other people known to use the instrument in question.

RF protection

It is important that the reading of the instrument should not be corrupted by the effect of any RF present. A few instruments make claims for RF rejection, although some types prove satisfactory without any claims being

made. In practice, it is normally easy to determine whether RF is affecting an instrument by judicious use of aluminium cooking foil, as described in Chapter 9, since it is usually the electric field involved.

Energy assessment

The measurement of the effective X-ray energy in a detailed sense would imply the evaluation of all the elements in the energy spectrum and is impractical and unnecessary. There are some useful basic concepts in use in this field which provide a way of evaluating the effective radiation energy. The reason for wishing to find the effective energy of the beam is that if shielding is needed it is this value which is needed to determine what thickness of metal to use.

The basic technique consists of using standard metal test plates of the thickness specified for specific energies, in the IEC standard IEC562 (later re-numbered 60562) [57] and inserting these in the X-ray beam in turn until one of them causes the X-ray doserate meter reading to fall to exactly half of the reading obtained without any plate in use. The meter is of course kept in the same place throughout and the transmitter operating conditions kept constant.

The effective energy is read by looking up the metal thickness of the relevant test plate in a table in the standard which lists energy versus metal type and thickness.

Since the subject of X-ray energy measurement and shielding is described in more detail in Chapter 10, which includes reproduction of the IEC table, the matter will not be discussed further here. However the existing contents are very useful and the key information is in the table in Chapter 10. Many people will have existing copies of this standard even if in the original IEC562 form.

9

Planning surveys and measurements

This chapter deals with the whole range of activities involved in planning surveys including instrumentation, measurement problems, data required about the site to be surveyed, etc. It also provides checklists from which readers can create their own local versions.

Introduction

Surveys can be classified into three broad headings according to their nature and purpose. These are:

- 1 RF Leakage tests for unintended radiation from transmitter cabinets, antenna exchanges, loads and other items connected to RF transmitters; leakage from RF process machines, medical apparatus, microwave ovens and other sources of RF energy. With the present interest in radiation from such things as video display units, which might not be seen by most people as RF sources, leakage tests may extend to a wider range of sources than has been the case in the past.
- 2 X-ray Leakage tests for any transmitters, RF machines, VDUs and other RF sources which use voltages higher than 5 kV to operate electronic tubes.
- 3 RF Exposure tests to establish the potential exposure of people to fields from antennas or any other systems which are intended to radiate RF energy.

Surveys may involve some or all of these activities. Microwave oven testing is an example of simple leakage testing. X-ray testing will mainly arise on high voltage transmitting equipment but can also arise with video display units, oscilloscopes and similar devices fitted in or associated with transmitting systems or RF machines.

RF exposure tests

For RF exposure surveys there are two basic approaches to exposure testing, differing only in objective and not in technique. These are:

- 1 The characterisation of an antenna and transmitter as a portable entity which can be deposited at an unknown site and so located that clearly defined safety limits can be observed. It follows that this can only be fully achieved when there is no likelihood that the equipment will be deployed amongst buildings or other structures which could invalidate the original radiation safety data. In order to do such characterisations, it is necessary to use a flat site free of any structures and buildings which might seriously affect the results, so that the survey data is as 'site independent' as possible. This approach is probably a minority case.
- 2 Measurements made at a particular place and time to determine safety provisions applicable only to that place. This type of survey takes into account the real environment – buildings, other antennas, people and their work patterns and is the most common type of exposure survey.

In order to characterise a system, the ideal test site is free space but the practical site will generally be a flat unobstructed area sufficient in size to allow operation under the worst case radiation conditions. A great deal of measurement will be necessary and suitable safety contingencies need to be added in determining the final computed safety zone.

It can be seen that this approach allows both a system producer to specify some definitive safety provisions such as a prohibited volume of space in the equipment handbook and a user to do the same in a safety management manual. This approach does not, of course, eliminate the need for specific safety measurements to confirm the safety aspects since these are required by any safety management system to meet the legal duty of care. What it can do is to diminish the total amount of safety survey work, compared with that which would be needed when starting from scratch.

The same approach can be applied to some other systems such as small communications antennas with short hazard ranges and intended for siting in relatively uninhabited areas such as roof tops. Here an adequate allowance for additive reflections can be made and the hazard area fenced off.

The second case is the much more common one from the point of view of the equipment user, where each site for antenna and transmitter systems has unique characteristics in respect of topography, buildings, structures and personnel movements. Each site needs to be treated as a unique case. The supplier's equipment handbook may only be able to convey general warnings such as details of the maximum power involved and similar basic data. Also, sites may be constantly changing equipments and structures,

erecting new buildings, etc., so that many surveys may be aimed at investigating the effect of these changes.

This chapter is arranged so that general preparation and planning aspects common to all the three headings above are dealt with first, and then those planning aspects specific to a particular type of survey are discussed. Carrying out surveys and measurements is then dealt with in the following chapter. Note that often when carrying out general exposure tests, leakage tests on the transmitters concerned are carried out at the same time since it might be negligent to overlook any existing leakage problems.

Of course if the survey is done by a contractor rather than an employee of the organisation, what is to be done should be spelled out in full in the contract.

The selection and preparation of measuring instruments

RF radiation meters and X-ray doserate meters should be chosen to be suitable for the range of work to be undertaken, as discussed in Chapters 7 and 8. As noted earlier, the choice of X-ray instruments may be affected by other measurement needs unrelated to RF transmission, e.g. radioactive sources, and other ionising radiation commitments.

In the case of RF radiation meters, this means coverage of the full frequency range needed, facilities for measuring the appropriate quantities, power density, electric field and magnetic fields in accordance with the relevant standard. It also means taking care when undertaking the measurement of pulsed transmissions that the 'peak' pulse power will not burn out the chosen instrument.

At the present time there may be a mixture of 'analogue' and 'digital' instruments in use. This chapter and the subsequent chapter should be read accordingly as some manual measurements can be done automatically on digital instruments.

Additional equipment such as spectrum analysers and wideband measuring receivers should, if required for the survey, be chosen according to application, e.g. identification of signals which interfere with the survey, determination of spectral components, etc.

Wherever possible, duplication of the radiation survey meters is recommended, particularly when away from base. Anyone who has travelled several hundred miles with a single instrument which has become unserviceable in transit will appreciate both the economic consequences and the embarrassment resulting! Very expensive infrequently used supplementary equipment may have to be accepted as a risk due to the high cost of ownership and low usage.

Dry batteries constitute one of life's regular problems. Spares often turn out to have passed their prime when suddenly called into service.

Rechargeable batteries appear to be more helpful providing that the charger or charger lead is not forgotten. However they do need to be watched for loss of capacity and replaced when they no longer hold their charge. Many types of rechargeable batteries need to be fully discharged regularly in order to maintain their efficiency.

Some sort of check source which generates a small RF field is very desirable to check functional performance and ensure that probe cables are not broken or intermittent. These devices are available commercially from the instrument suppliers or may be improvised locally. For HF and VHF frequencies a small oscillator and coil will suffice and will be a little more portable. Technology problems can be minimised by using the lowest frequency the instrument covers as the check frequency. Some instruments incorporate test sources and these may be given consideration when purchasing equipment.

X-ray ionising chamber instruments with open air filled chambers need their desiccators checked frequently as moisture can interfere with the instrument operation due to leakage currents occurring where the impedance is required to be high. It is also important to ensure that the chamber window is not damaged.

There is no easy way of providing a check source for X-ray instruments without carrying a radioactive source unless the instrument incorporates one. Purchasing ionising radiation sources is not generally popular due, usually, to a disinclination on the part of people to have them around. They are also, for the most part, subject to specific regulations regarding handling, transportation and safe custody unless the activity is low enough to secure exemption from some or all of these aspects. This clearly depends on national legal provisions. Certain radiation dose rate meters incorporate a small source for setting up, in which case no other functional check is needed.

Apart from the main instruments dealt with in Chapters 6 and 7 there are a few ancillary items – tools, materials, and similar items which can be necessary on surveys. These include:

- A modern electronic (ultrasonic) measuring ‘tape’ can be useful indoors where walls and cabinet structures can be used as reflection media when measuring equipment in order to make drawings for a survey report. Outside use is normally impractical and, in the author’s experience, electronic measuring ‘tapes’ may not survive acquaintance with a high power radar even when just carried in the pocket! Plastic-cased digital watches may suffer the same fate.

Conventional tape measures should not be metal ones!

- An optical range finder can be useful for outside work if of a robust type. A compass may also be useful on some types of survey to align moveable antennas, etc.

- A roll of aluminium cooking foil is indispensable for experimental shielding, wrapping round the RF probe when zeroing the instrument if this is proving difficult and for checking whether the RF electric field is interfering with X-ray instruments.
- Self adhesive aluminium strip/lead strip are widely available and useful for temporary shielding around waveguide flanges. The lead strip is useful for X-ray purposes.
- A roll of adhesive tape is essential to put leakage markers on equipment. The tape must be specified as a tape which will not damage paint finishes on equipment. Many commonly used domestic tapes are likely to remove the paint finishes, something which is not appreciated by the equipment owners!
- For outside work, objects are needed to act as markers at measured positions round the antenna system which is being surveyed. Plastic 'traffic cones' are particularly good for this as they stack easily for transportation. They can be marked with self-adhesive RF radiation warning labels.
- For pulsed transmission, any small medium or long wave personal portable radio can be used as a cheap and excellent detector of the pulse repetition frequency (p.r.f.). It is also probably the simplest checking device to verify that radar sector 'blanking' is properly set (blanking is described later) and to check that it is radiating. The author has found this invaluable as trying to measure fields when the transmitter has tripped out is particularly frustrating!
- Wooden or other non-conducting material rods marked at suitable distance intervals can be useful when it is required to measure at a constant height.

Practical use of RF radiation instruments

The handling and manipulation of instruments

With instruments which have a separate probe and instrument unit, the probe should normally be held well forward in front of the body and the meter unit held by the side where it can be read. The object is always to minimise perturbation of the field. Isotropic probes, which would be the normal type for most work, should be pointed at the source and rotated on their axis through 360° to peak the isotropic response and thereby reduce the effect of isotropicity error. Technically one should rotate the probe to measure the minimum and maximum and then take the average. However, in the real world when taking many measurements and faced with a lot of tedious averaging, most people use the maximum on the basis that safety is concerned with the highest values.

For instruments having a rigid probe plugging in to the meter unit so that they are effectively one unit, the probe should be pointed as above but the task of rotating the probe on its axis is more difficult as the meter will disappear from sight in the course of rotating it through 360°. This type can also give similar problems when measuring leakage in awkward access – limited situations, e.g. waveguide runs, etc. On the credit side, they do offer single-handed operation in a situation where one does not seem to have enough hands. Some instruments with probes which fix rigidly offer the option of using a flexible connector, in which case manipulation is as in the previous paragraph and operation becomes two-handed!

Regular zero setting of the instrument is required for most types and this involves taking it out of the field or using a metal shield to cover the probe. Some manufacturers supply an electric field shield. If this is done without adequate shielding, then any stray field present may be backed off so that when, later, a measurement is made at a place where that field is low or not measurable, a reverse meter reading may be experienced with analogue meters. With any type of instrument it will result in false readings and unless spotted quickly, may also necessitate repeating earlier work. There are some instruments available where the maker specifies that zero setting can be done in a field. The maker's handbook should be consulted in such cases.

Analogue instruments with a 'maximum hold' facility (now possibly most instruments) need to be used with the correct time constant selection (usually the fast setting) as instructed in the maker's handbook. The facility is very useful for a quick initial appraisal of potentially hazardous fields such as a stationary microwave beam. If the facility is left switched on when it has been finished with, it can cause considerable confusion! The facility is available in modern digital instruments which generally provide a reminder of when it is on, in the LCD window.

The build-up of electrostatic charges on instruments can have a nuisance value since it gives transient readings which disappear gradually and usually result in an unsuccessful repeat search for the illusive reading. The great danger, with RF instruments (and ionising radiation instruments for that matter, as they are also susceptible), is that it may be assumed that every sudden reading is due to static, and consequently leaks may be missed. Patience in allowing charges to discharge is what is needed.

Measurement equipment has been discussed here so far in terms of field quantities. However, instruments now exist for both limb current measurements and contact currents. Chapter 7 deals with typical instruments and Chapter 3 with the technical aspects of these subjects.

Most people may not find a need for these measurements but they can be useful for studies and planning and, as mentioned elsewhere, can assist in safety management on ships where the large number of transmitters and the presence of many metal objects which can become energised poses real problems for surveyors.

Uncertainty of measurement

The term 'error' is often used metrologically, but is inappropriate since it implies actual knowledge. The correct term is 'uncertainty of measurement'. This uncertainty will have systematic and random components. Systematic components may be known, at least in part, but random errors cannot be known and, therefore, corrected. In practice, the limited knowledge of systematic errors over the range of environmental conditions in which an instrument is used coupled with random errors results in the assessment of an 'uncertainty of measurement' to be attributed to an instrument. Some elements of the systematic components may be identified when needed for particular purposes, e.g. variation of a parameter with temperature which can be controlled to some specific tolerance by sufficient testing and appropriate design. Most commonly though, they are built into the uncertainty budget together with an estimate of the random components and linked to the environmental specification of the instrument.

It is interesting to note that some modern ionising chamber instruments have built-in temperature and pressure compensation.

In turn, when calibration checks are carried out then the result is subject to the reference source, i.e. the uncertainty of knowledge of the calibration source under the conditions of operation prevailing.

Amongst those who do practical measurements there seems to be a broad agreement that the practical uncertainty of measurement of electromagnetic fields is around $\pm 30\%$ where the variation of the calibration correction factor from unity is small or has been applied as a correction.

The use of correction factors from the instrument calibration certificate or from information marked on the probe is important when the correction is significant. Otherwise, a large uncertainty of measurement might have to be attributed. With modern digital instruments various practical features ease this task – the downloading of calibration data for a probe to the instrument and the display of that factor, the ability to perform the arithmetical correction of the relevant readings, etc.

The down side of having calibration done at a lot of frequencies is that the cost is often charged on a per frequency basis and the cost of instrument ownership is therefore increased. It is often possible to arrange calibration frequencies to suit the equipment being checked so that users at an HF station who may have a limited need for microwave frequency calibration can concentrate on their own interests.

When the measured values are near to the permitted limits it is important to allow for the uncertainty of measurement of the instrument otherwise it is possible that the permitted limit might be exceeded. This is a basic measuring concept and is not peculiar to RF field measurement.

For instruments without digital computational facilities, and where, as a consequence, measurements are manually recorded, it will usually be better

to apply all corrections after the actual meter readings have been recorded so that any arithmetic errors can be detected and corrected by reference to the recorded figures and the known calibration factors. On those instruments which have a control which can apply calibration corrections by manual application, there is the option to correct at the time or to set the correction control to unity and apply the calibration corrections later. Where duplicated instruments are used on surveys, it cannot be expected that they will give identical readings since two instruments calibrated with an uncertainty of $\pm x\%$ can, theoretically, differ by up to $2x$ after the application of any documented correction factor.

If two instruments have markedly different calibration factors it would only be reasonable to expect them to give different readings for particular measurements. This may cause concern if the calibration factor data has not been scrutinised beforehand, but when the relevant factors are applied it will usually be found that the readings begin to converge and be as close as is reasonable, taking into account the calibration uncertainties.

Sometimes the calibration is suspected when the real cause of an apparent discrepancy is something different. This can be the case in a location where there is a considerable change in field with a small change in distance and measurements with two instruments have not been made with sufficient care so that they were, effectively, taken in different places. With high frequencies the wavelength is short and readings can change considerably with a small change in physical position. When out on surveys, suspect instruments can be best checked by comparison with a known good one using a test source and taking care to position each probe identically, if possible using an improvised locating jig such as a slotted piece of wood or something similar.

A further problem can arise in the recording of measurements. It is generally appreciated that the dynamic range of RF radiation measuring instruments aligns with RF protection guides so that 'unreadable' cannot always be interpreted as meaning that there is no leakage. In fact there may be enough leakage to cause EMC problems although well below safety levels for human exposure.

It is therefore important that, unless there is no possibility of misunderstanding, it is better and more accurate to record as 'not greater than y ' where ' y ' is the lowest reading that can be resolved on the instrument rather than as zero. Where there is a general RF ambient level in the area where measurements are being made, that level will limit the lowest resolvable reading anywhere.

For example, if the general ambient is 1 Wm^{-2} then the lowest recorded value possible will be 'not greater than 1 Wm^{-2} ' even if there is, in fact, nothing being produced at the point being tested. Consequently, where the ambient background is sufficient to be an embarrassment, it will be necessary to attempt to secure a reduction by switching off unnecessary equipment and possibly by negotiating an 'out of service' maintenance time

slot for the troublesome sources. With modern transmitter installations the ambient levels inside the station will rarely be a problem, but with MF and HF stations using open wire feeders internally there may be an appreciable nuisance. In one such case abroad, the ambient field was so great that a new transmitter being installed would not work until shielded from it!

Technically, when the ambient level is significant the requirement to sum the fields as discussed earlier in the book under 'simultaneous irradiations' would apply. 'Significant' here means that the level would have a material effect on the result of that field summation relative to the appropriate permitted level. It will usually be obvious when very trivial levels cannot have any consequence for the survey result.

In a large transmitting station there may also be powerful signals at frequencies which cause out of band responses on the measuring equipment. The most important aspect of planning surveys is to ensure that the surveyor knows what he is measuring! With many organisations, particularly Air Traffic Control and Broadcasting, ten days or more notice may be required to take a system out of service because it interferes with measurement.

Sometimes there can be very low frequency fields from power control and other equipment and these can be a nuisance if they are not identified. When using an analogue instrument this can often be linked with switching 'kicks' on the meter. With a digital instrument these effects may not show up. Where low frequency fields of this sort are a problem an LF or VLF measuring instrument (Chapter 7) can be useful. It is then possible to look for such signals in the transmitter switching processes prior to putting the RF signal on.

Where there is an EMC interest, it is likely that this would need to be investigated with a measuring receiver or other sufficiently sensitive instrument, because of the limited sensitivity of RF radiation meters. For example, if, a particular instrument can only measure down to 1 Wm^{-2} (0.1 mWcm^{-2}), this is quite satisfactory for human safety measurements.

However, as a potential source of interference, 1 Wm^{-2} corresponds, on a plane wave basis, to an electric field of just over 19 Vm^{-1} which, when considering sensitive equipment, may still give rise to problems, particularly with receivers. Again, 19 Vm^{-1} , according to British Standard BS6656 (see Chapter, 5 Part 2) can, on a CW basis, be hazardous to some flammable vapours up to about 300 MHz.

Avoiding sensor burn-out in RF radiation probes

The point has been made earlier that both diode and thermocouple sensors in probes can easily be destroyed by excessive fields regardless of whether the instrument is in use or not.

Nor is switching off the equipment any help since clearly the sensor elements cannot be inhibited except by metal shielding. The specifications

for probes include maximum safe ratings for CW overload and peak power density. Where a probe is intended for pulse transmission work, the peak power density rating is very important.

An example of a probe taken at random from a manufacturer's catalogue is shown in Table 9.1. This was chosen from the thermocouple based probes and is one measuring down to $20 \mu\text{Wcm}^{-2}$. Naturally the limits on this range are tighter than other probes in the thermocouple type list where the extent of the measurement range is more limited. Some of the latter have overload values up to ten times higher than those in Table 9.1. The parameters given in this example are:

CW maximum overload rating

Peak pulse power density rating

The table also gives the measurement range of the instrument and the highest value which can be measured is 20mWcm^{-2} (200Wm^{-2}). For the purposes of this paragraph, the units used are those used in the catalogue, since they involve infrequently used units (Wcm^{-2}) and most people will find it easiest to relate these to the mWcm^{-2} unit used for instrument measurement range.

Table 9.1 RF instrument peak power limitations for a selected probe

<i>Greatest range power density fsd (mWcm^{-2})</i>	<i>CW overload power density (mWcm^{-2})</i>	<i>Peak pulse power density note unit used</i>
20	300	60Wcm^{-2} (= 60 000 mWcm^{-2})

The CW overload level is 3 times the maximum measurement value. With normal attention to measurement, this should not give any problems. The real problem arises with pulse transmission measurements.

With this example, for simplicity, assume a calibration correction factor of 1.0 at the measurement frequency. On the highest range of the instrument, the maximum measurement (fsd) is 20mWcm^{-2} .

Now for a duty factor of 0.001 an r.m.s. reading of 20mWcm^{-2} corresponds to a peak pulse power density of:

$$S_{\text{pk}} = 20/0.001 = 20\,000 \text{mWcm}^{-2} = 20 \text{Wcm}^{-2}$$

This is only one third of the manufacturer's peak pulse power limit, a factor of safety of 3.

Using the data above but changing the duty factor, to 0.0001, we get:

$$S_{\text{pk}} = 20/0.0001 = 200\,000 \text{ mWcm}^{-2} = 200 \text{ Wcm}^{-2}$$

far in excess of the limit.

It can be seen that for this duty factor the reading that would correspond to 60 Wcm^{-2} is 6 mWcm^{-2} , i.e. 30% of full range. The readings must therefore be restricted to that value or preferably a bit lower since operating at the nominal safety limit is risky. Care is needed to avoid sudden damage to the probe by allowing the reading to increase above that figure.

If we take the ratio of the peak power density rating to the greatest possible measurement of which the instrument is capable (20 mWcm^{-2} in this example) and term this the peak power density safety factor (SF) for an instrument, we get:

$$\text{SF} = \text{peak power density rating}/20 \text{ (same units for both)}$$

$$\text{and } 60 \text{ Wcm}^{-2} = 60\,000 \text{ mWcm}^{-2}$$

$$\text{Hence SF} = 60\,000/20 = 3000$$

$$\text{The corresponding duty factor is } 1/3000 = 0.000333$$

This safety factor is the reciprocal of the duty factor which just results in the 20 mWcm^{-2} maximum readable value corresponding to the specified peak pulse power rating.

It can be seen that where the duty factor reciprocal exceeds SF, some reduction in the maximum permitted reading will be required to avoid sensor burn-out as mentioned above in the earlier example.

Due allowance should be made for the instrument calibration factor if it is not unity at the frequency concerned, by applying it to the intended measured value. For example, in the discussion above the probe used as an example has a top reading of 20 mWcm^{-2} but if the calibration multiplier for a particular frequency is 1.1 then the true reading of the instrument is 22 mWcm^{-2} . If, in a particular case, it should have been kept to 20 mWcm^{-2} , then the situation could potentially involve probe damage.

In practice most of us have our own system of prudence by restricting readings defensively as necessary. The specification of limiting overload parameters cannot be done with great precision and some care will save a lot of expense.

Because these parameters may be expressed in different ways by manufacturers, the handbook should be consulted in any specific case. For example the peak overload limit is sometimes given in terms of pulse energy density, i.e. $\text{W}\mu\text{s cm}^{-2}$. In this case it is necessary to divide the limit as expressed, by the pulse width in microseconds to determine the relevant peak pulse power density.

Measurement problems

A useful paper from the Narda Company[46] highlights a number of problems which can occur when using RF radiation meters. They were written when analogue instruments were in use but are still applicable, the terms linked to moving coil meters being interpreted appropriately.

1 Magnetic field measurements in high impedance fields

When using a magnetic field probe in a field where most of the energy is in the electric field, a negative reading may occur. This is attributable to the deposition of energy in the resistive transmission lines in the probe. If there is a reasonable amount of magnetic field energy producing an upscale reading this effect would be negligible against the upscale reading.

If most of the energy was in the electric field, a small effect would not be of significance unless there was a definite downscale indication. This latter effect would suggest that the wrong field is being measured from the point of view of identifying a potentially hazardous field.

2 Transmission line antennas

At low frequencies, below about 1 MHz, the change of impedance of the sensor antennas may result in the transmission line delivering an induced signal to the sensor and thus produce an indication which is greater than it should be.

3 Diode light sensitivity

Instruments using hybrid Schottky diodes need suitable provision to prevent them responding to light and to infrared energy. This aspect is probably well taken care of in modern instruments.

4 Potential field effects

At low frequencies, usually below about 1 MHz, when measurements are made close to the radiator, a false reading may result from capacitive coupling into the field. One method of reducing this effect is to put the meter and probe in a zero potential field near the ground. Another method is to bring the probe and meter close together by clipping together, if this is possible, and isolating from the ground by using gloves, thus elevating the meter unit to the same potential as the probe.

A useful check on whether the readings are in error or not is to cover sensor area only of the probe with cooking foil, wrapping it right round and measure again. If the readings are little affected by the foil, they are likely to be erroneous. It is important that the foil does not contact earth, the meter or the rest of the probe.

5 Static field effects

This has already been mentioned in connection with leakage measurement as a source of erroneous indications, coupled with the danger of getting in the habit of disregarding indications thought to be due to static charges, which might really be due to the RF field. Some plastic materials including plastic file and report covers can generate large amounts of static, adding to the general nuisance.

6 Unattended measurements

Sometimes there may be a need to measure in situations where the surveyor's body is liable to affect readings. With the advent of digital instruments and the more readily available fibre-optical systems for data transfer, it is practicable to mount the instrument on a non-conductive stand, set it up and then remotely store the measurement information.

Some such facilities had been available with analogue instruments but these obviously involved expense in extra boxes for A to D conversion, etc. In this sense instruments with internal microprocessors and A to D converters are more attractive. Where data recording is used, a computer should be available to download and analyse the data since decisions on further measurements may be linked to the results already obtained.

RF Protective clothing

Protective clothing is an issue which frequently arises in conversations, both in respect of a surveyor doing surveys and also as a possible solution when there is a need for access to an area where the field exceeds permitted limits. A case in point is climbing towers equipped with high power antenna systems and there is a desire to avoid switching them off, e.g. broadcast systems.

Over the last twenty years or more, various organisations have looked at the problems of providing protective clothing for RF radiation workers. The obvious need is for a material which has conductive properties, uniform attenuation over the required frequency range and capable of handling the power densities involved.

In the early days some such protective suits were found to catch fire with high power densities. Other aspects included the problem of getting adequate attenuation at the window with implications for eye exposure. The former is not necessarily a problem if high power densities are not involved, e.g. when climbing towers which have a lot of antennas but no very high power density fields. However for climbing in front of high power arrays one would need to know much more about the performance of any suit worn.

Many of us who do open panel work on transmitters from time to time tend to avoid any conductive clothing for basic electrical reasons! Consequently

the author has no experience of wearing such clothing. In the climbing case, the worry about contact with high voltages would not arise although if contact could be made with a live array this may have undesirable results.

Holiday Industries have a suit comprising full-body coveralls, removable hood, glove liners and oversocks. The information summary here comes from the data sheet. The garment is constructed of Nomex® flame resistant Composition, 25% stainless steel. A graph showing SAR values for a phantom with and without suit shows a reduction on the phantom axis, with suit, of a little more than a factor of ten.

Suitable enquiries should be made with the supplier about any proposed purchase, so that the implications of any very high power systems involved can be discussed and any new evidence on uses of the suit studied. The suit in use is illustrated in Figure 9.1.

Planning surveys

Nature and purpose of surveys

The main reasons for undertaking surveys include:

- New designs.
- New installations.
- Changes to installations (power, frequency, beam characteristics, etc.).
- Structural changes on site (buildings, portable cabins, towers, etc.).
- Safety audits and routine safety reporting.
- Changes in legislation or safety limits.
- Complaints from the public.
- Alleged overexposure of people in particular incidents or situations.
- Anxieties expressed by the people employed or by visitors.

Some of the above, such as new designs, modifications and updates, are likely to involve the designer in surveys before the user becomes involved. For the others such as structural changes on site and changes in installations of a local kind, the user will have the primary responsibility to initiate further surveys.

It is essential that the safety management system defines responsibilities for surveys in the various situations mentioned above to avoid those 'I thought it was their job' situations with which most of us are familiar.

Detailed planning

It is impossible to generalise on survey planning since the amount of work varies according to the nature of the task and may range from almost none for a survey of a small item which is well known to the surveyor, to several days of work for the full survey of a complex site which has many



Figure 9.1 *Holiday Industries RF protective clothing (Courtesy Holiday Industries)*

transmitters. There may also be difficulties in getting transmitters out of service, especially in the military field, air traffic control and in broadcasting. It is not unusual for surveys to have to be done progressively in a number of time slots in between periods of operational use. This applies particularly in the HF broadcasting field.

Similarly a survey of a location which uses a variety of RF process machines or RF medical equipment may involve appreciable planning work according to the technical and organisational factors applying. For example,

it may involve detailed planning to arrange the availability of the equipment to be tested and to ensure that any interfering equipment may be switched off. In the case of process machines it may be necessary to arrange the availability of suitable work pieces so as to test machines in a representative state. It can also take time to find the necessary technical data on machines, as handbooks easily go astray.

Tables 9.2 and 9.3 provide simple checklists for leakage and exposure surveys. In practice, surveys often take in both aspects. This is particularly the case when new equipment is being commissioned. The checklist tables should be treated as a starting point since, for greatest effectiveness, checklists should be compiled locally to take in the specific features of the organisation. People are much more likely to follow procedures which they have helped to create.

Table 9.2 *Leakage surveys checklist – transmitters and RF plant*

- 1 *Requirements of survey*
Purpose of survey and use to be made of the results;
Statement of what is to be measured;
Whether X-ray and/or RF to be covered.
 - 2 *Nature of sources*
Type and power rating;
Frequencies involved;
Type of modulation/pulsed transmission;
Authorised operating conditions, prohibited conditions;
Operational or other limitations on the availability of the equipment.
 - 3 *Ancillary equipment involved in the survey*
Dummy loads, feeders, aerial exchanges, etc.
 - 4 *Availability for testing*
Times available;
Availability of ancillary equipment.
 - 5 *Previous reports*
Reference numbers of any previous reports;
Details of any changes in layout, equipment replacements, etc., since the last report.
 - 6 *Safety standards*
Standards to be used to determine report recommendations.
 - 7 *Safety management*
Relevant details of existing radiation safety management practices.
 - 8 *RF plant only – machines and process equipment*
Arrangements for work pieces and operator to be available and for interfering machines to be closed down.
 - 9 *Personnel safety*
Any special hazards to survey personnel other than those related to the RF and X-ray measurements being undertaken, e.g. hazardous substances in use.
-

Table 9.3 *Checklist for exposure surveys – transmitters and other sources*

1 *Requirements of the survey*

Purpose of the survey and use to be made of the results;
Extent and details of the measurements required.

2 *The site*

Location, map data and topography, drawings of site layout;
Relationship to highways and public footpaths;
Any sharing of the site by people not employed there, e.g. sub-letting to farmers, etc.;
Explosives and flammable substance stores;
Helicopter operations.

3 *Nature of the radiating equipment*

Types of equipment and antennas;
Dimensional and azimuth/elevation angle data for antenna systems;
Antennas to be used, if there is a choice;
Heights of towers and mounts;
Frequencies, powers, types of modulation;
Authorised operating conditions including operating restrictions and 'permit to work' arrangements;
Limitations likely at the time of survey, e.g. radio 'quiet periods', unavailability, service demands, etc.
Human activity related to the equipments, e.g. rigger access, tower climbing, etc.

4 *Off-site environment*

Nearby gas terminals, petroleum/oil installations, residential property close to site, mobile radio transmission, etc.

5 *Previous reports*

Reference numbers of any previous reports;
Details of any changes in layout, equipment replacements, etc., since the last report.

6 *Safety standards*

Standards to be used to determine report recommendations.

7 *Safety management*

Relevant details of existing radiation safety management practices.

8 *Personnel safety*

Any special hazards to survey personnel other than those related to the RF measurements being undertaken, e.g. hazardous substances in use.

Unless the survey is being carried out at a location with which the surveyor is familiar, for example in a part of the surveyor's own company or organisation, it can be desirable to obtain the necessary information in a written form as a response to a particular questionnaire, since verbal responses are often not well thought out and can mislead. It is amazing how the written answers differ from the those obtained by telephone! Also the person making the verbal response might not be the right person to answer since he may not be aware of all relevant aspects, whereas a written answer is likely to be subjected to further scrutiny and possible correction by management. This is most likely to apply to exposure surveys where

questions about the presence of flammable substances and electro-explosive devices and related aspects can be of considerable importance.

Leakage surveys will usually be easier than exposure surveys from the point of view of acquiring the necessary information, since less information is involved compared with that for antenna systems. Also the risk to the surveyor is usually less, given reasonable care, since leakage from equipment is limited as to range and potential.

Exposure surveys, dealing as they do with intended radiation, can generate many more questions extending to possible irradiation of the public in the public domain, possible hazards to aircraft, flammable substances, medically-implanted devices such as heart pacemakers and other specialised devices.

For complex surveys, it can be very helpful if the location can be visited before the survey and both the supervisor and the equipment operator contacted. If production plant is involved, then understanding the sequence of operations, the RF power duty factors for each machine and any variation with different types of workload may be very important in making any judgements necessary. Some expert assistance may be required with machines where there is a large variety of work pieces, to try and determine possible worse cases. Casual observation of the operator at work is useful since behaviour will change when being observed. The problems may include well-meaning attempts by the operator to improve output by following his own practices rather than the official work instructions.

However distance, cost or excessive workload may preclude an actual preliminary visit, in which case as much information as possible must be obtained by the use of a checklist questionnaire. One thing is almost certain – the surveyor who is not familiar with the site will find something different to the information he has been given!

Equipment and site topographical data

For any site the key information required is that related to the topography of the land, details of the surrounding area and any known special risks such as petroleum installations, gas terminals and the like.

There is also a need to know about antennas and structures, including buildings, their dimensions and spatial relationships. This is likely to include:

Microwave antennas

These may include fixed dish antennas, moving antennas such as surveillance and height finding radars, tracking radars, and satellite dishes. The data required is: the transmitter and antenna parameters: frequency, power, antenna dimensions, gain and beamwidth.

Positional information: height of antenna centre above ground, bearing of fixed antennas, beam elevation angle including range of possible adjustment of elevation positive and negative relative to the horizontal.

For antennas capable of moving, the azimuth and elevation scan angle, sector blanking angle relative to a reference, if applicable; scan duration and rotational rate for continuously rotating antennas. The height and angular information required is illustrated in Figure 9.2 in generalised form. Fixed microwave antennas capable of being repositioned in a new fixed position (azimuth or elevation) require data on the boundaries of such change, e.g. 'may be changed in azimuth by $\pm x$ degrees for operational requirements'. This allows the surveyor to assess any effects which could result and to highlight them.

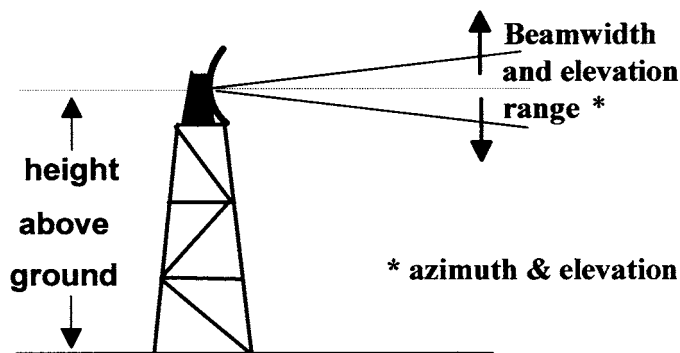

Figure 9.2 *Positional data for rotating and fixed microwave antennas*

Other antennas: type, gain and height above ground

Heights on ordnance survey maps or maps derived from them are relative to the survey datum. It is often easier to use a local datum to improve scaling resolution, for example, by making the lowest ground height on or near the site, zero on the diagram (see Figure 9.3). In the absence of map data it may be necessary to use an optical instrument to determine the relative heights.

Personnel on site

Exposure surveys on large sites or on sites having a lot of transmitters can involve a great deal of trigonometry to ascertain which antenna might pose a hazard at places where people work. Since equipment mounted on towers has to be maintained, the maintainer will, on occasions, require to climb those towers and this must be allowed for as well.

In order to take into account the exposure of people on site it is necessary to establish the pattern of personnel movement on a site. The sort of

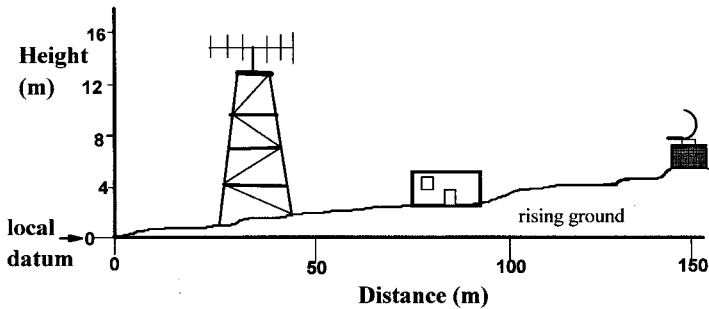

Figure 9.3 Site data and ground datum

interrogatives much loved by those who run management training courses do turn out to be useful in defining the potential human exposures:

Who has to work on the site?

Where do they have to work?

Why do they work there – maintenance, operation, administration, security, etc.?

When do they work there – day work, shift work, on demand?

What visits the site? Fuel and other flammable substance delivery vehicles, waste collection vehicles, helicopters, armaments, etc.?

In certain situations the fourth question can be very important. For example on a high power HF broadcasting station which has shift manning, it may be necessary to allow for the fact that different frequencies and antenna systems are used at night and these might need to be surveyed as well. This depends largely on whether there is any liability to outdoor exposure near antennas at night.

Generally speaking, activity in antenna fields in the dark with limited lighting can be particularly hazardous in terms of physical injuries such as tripping, contact with sources of RF shock and burns and the hazards of night climbing. It is therefore important to ensure that no unnecessary RF radiation exposures can take place in such circumstances.

Planning and documentation

In the detailed planning work, it is very useful to prepare a rough sequence chart for the activities so as not to lose track of what is needed. The aim is to plan work so that priority services which have been shut down for the survey receive highest priority in the work, to minimise their downtime. This may even mean having an inefficient plan in the sense that by doing all

the actions on the priority equipment at once, subsequent work on other equipment may take longer.

Nevertheless it is often essential to minimise the dislocation of operational installations and the survey sponsor will have to balance the operational commitment against any consequent increase in the time taken by the survey staff to do the job.

Radio communication is usually essential on large sites, both to secure operational changes and also to be told if a transmitter has tripped off. Ensuring the availability of communications equipment is thus important. With small transistorised mobile transmitter–receivers it is necessary to avoid accidentally exposing them to very high field levels as the receiver is unlikely to benefit from the experience.

When planning surveys which may have some legal significance or which may be used for planning applications and the like, it is advisable to take particular care to ensure that the sources of radiation are set up at the powers and antenna settings claimed by the equipment operator, through direct witnessing of the activities connected with the transmitters by another surveyor. Again, radio communication is useful for this activity.

The purpose is to ensure that any parties involved in planning complaint investigations and similar activities with legal or social implications can feel that the surveyor really had a full knowledge of the situation and would have spotted any failing on the part of the operator of the source.

After all, it is not surprising that a complainant who feels strongly about a situation may, when shown measurements which have been made and which confirm that a situation is not hazardous, challenge some obvious targets – the validity of the RF source data, the calibration status of the instruments and the competence of the surveyor. Where, in such investigations, the main finding is that no readings can be obtained with RF radiation instruments, it will sometimes be necessary to resort to more sensitive equipment such as a field strength measuring receiver in order to provide a more definitive answer.

This is mainly a psychological problem where non-technical people do not understand range limitations on instruments and disbelieve the survey results. This is understandable if, for example, interference such as a radar pulse train can be heard on a domestic receiver at a place where the RF radiation meter cannot measure anything! Even some radio engineers show the same disbelief about safety if their car radio is affected by such signals when entering a site!

Data gathering

It is important to collect and marshal survey data in an effective way. Whilst simple surveys of perhaps one or two sources may make limited demands in this respect, surveys of complex sites may provide so much

data that it is not easy to see what to do with it. Some sort of methodology is required. The following paragraphs attempt to illustrate possible methods of using the data to determine the measurement sequences required.

It is useful to take a surveillance radar and a height finding radar of the simplest types as examples which encompass most of the likely characteristics of moving beam antennas. For those unfamiliar with radar antennas, a brief reminder may be useful. Chapter 5 deals with the topic in more detail.

Surveillance radar is somewhat analogous to a rotating searchlight in that the beam rotates at a constant speed, typically 6 rpm. The beam can be preset in elevation above or below horizontal. Because the beam elevation, positive or negative, is preset, it is necessary to know the range of setting permitted. For example, it is important to establish whether the elevation may be set to a negative value. If so, the implications for human exposure may be significantly affected.

Because the beam rotates, it may result in RF radiation exposure over the full active scan range, compared with a fixed microwave antenna which has a limited angular range of potential exposure. Constantly rotating antennas can be subjected to six minute averaging.

A height finder antenna has the same possibility of azimuth rotation and also scans in elevation. The elevation may be positive or negative relative to horizontal. Importantly, it differs from the surveillance radar in not rotating at a constant rate. In fact it moves in azimuth and elevation quite unpredictably as far as the observer is concerned. Also, a height finder parks downward when not in use and unless it switches off automatically, there will be a very hazardous field around it. Many switch off after a delay so that the parked area is hazardous during the delay period. Hence this region will need to be controlled. Note that more modern radars dispense with the separate height finder and combine the function but older equipment is often still found in use.

Surveillance radars, or indeed any antenna moving in azimuth can be blanked over a sector of its scan so that radiation stops in that sector and no hazard is possible. Figure 9.4 illustrates this. Where sector blanking is used, then for surveying, the blanked sector data is required in terms of the limiting angles relative to North or to some other reference which is documented on the site map. North is usually grid north if a national grid mapping system exists, so that sector blanking data in suitable form can easily be related to such maps. Figure 9.2 earlier, indicated pictorially the height and angular data required for surveys for fixed and moving beam systems.

Note that the centre line from the antenna, the antenna axis, corresponds to the centre line of the antenna charts in Chapter 5 (or that of any other calculation method) and can later be annotated with the calculated power densities, if desired.

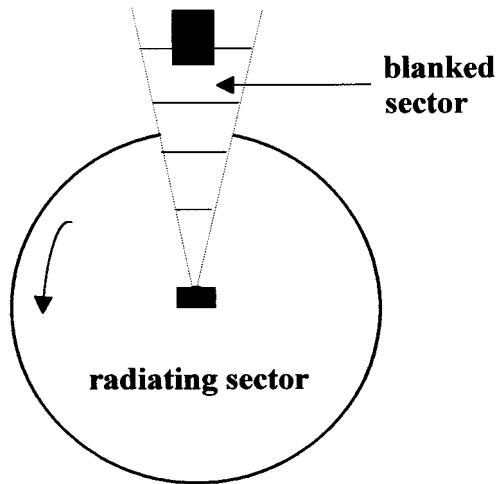

Figure 9.4 *Radiation sector blanking*

Site surveys

When surveying sites it is essential to list the purpose of the survey in terms which define the requirements for measurements. For any site these may be covered by the following general list although the general topics need to be expressed as specific tasks.

- 1 Technical. The sources of radiation and their characteristics. Functional hazards to one transmitter due to irradiation from another
- 2 Flammable and hazardous substances on site, their location, movements and transportation methods
- 3 The safety of personnel in their workplaces including working on any antennas and systems on site; climbing structures, etc.
- 4 Safety of personnel moving on the site between workplaces
- 5 The public domain
- 6 In the case of military establishments additional factors apply such as safeguarding aircraft systems, armaments and explosives, missiles and any weapon systems which could be exploded or inadvertently fired.

Simple site example

Figure 9.5 is a simple site diagram showing a site enclosed by a fence, two surveillance radars (S) and (H), a building (A), and a fuel store (F). The use of radars in the form of rotating beams in this example is solely to illustrate the amount of investigation needed as a result of the antenna movement,

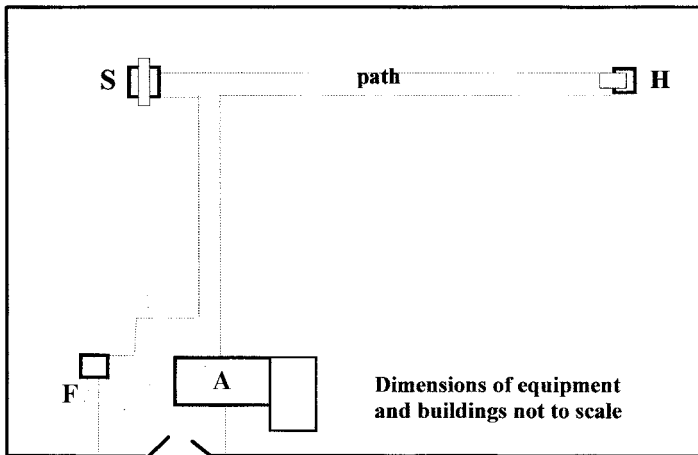

Figure 9.5 Simple site diagram

compared with fixed beam or other antennas. Again for simplicity, the antennas are assumed to be near the ground.

This diagram is the simplest case, a flat site. In a practical site, either spot height data or contours need to be shown and may significantly affect the safety issues. The basic minimum issues within this site will be:

- Safety of people inside the hut
- Safety of flammable/hazardous substances in their store
- The safety of people (technical and non-technical) moving around the site
- That one transmitter cannot damage the other including situations where one is down for maintenance and including the safety of the maintainer.

If we ignore for the moment personnel safety around the site outside buildings and anything outside the site boundary we can show the basic tests required by the lines in Figure 9.6 where line S1 indicates tests of the S signal at transmitter H, S2 tests at the fuel store, etc. The arrows indicate the stationary alignment of the relevant antenna. On this basis there are six sets of tests to establish safety at the four places on site. If one further omnidirectional transmitter was added this figure would double to twelve sets of tests, so the complexity can increase rapidly with the number of sources and the number of workplaces.

However we have not covered personnel safety around the site. Here the length of the path needs to be covered by added tests. At this point action depends on the size of the site. At one extreme the whole site can be surveyed taking considerable time and hence cost. At the other extreme the footpath and any other specific areas such as areas around the transmitter

housings, etc., can be cleared for use and the rest of the area made a prohibited area. Note that the diagram, being kept very simple, only shows the antenna locations S and H and does not show where the transmitters are. It should be assumed in practice that they have separate adjacent cabins which will become additional objects for survey.

Even now on this very simple site the question of the outside world has not been addressed. This will involve scrutiny of the area for footpaths, recreational areas, farming, etc., and tests arranged as necessary, building up a complete site test schedule and analysing to remove redundant checks, etc.

Clearance for personnel is generally taken as being a height of 2.5 m which is probably the highest the average man can reach whilst correctly operating a survey meter, without having to stand on something. It means measuring all the possible places where people are allowed to walk and establishing that the power density or other field quantity, as appropriate, does not exceed the permitted limit.

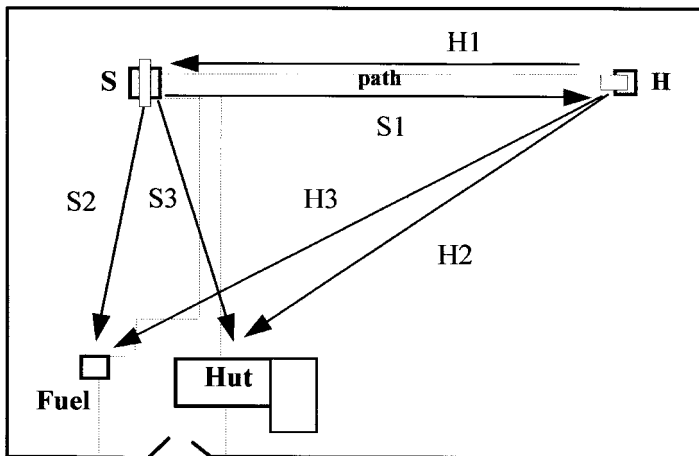

Figure 9.6 *Site test alignments*

Personnel clearance has been mentioned earlier and is particularly concerned with establishing whether people can walk up to a transmitter antenna installation when operational, e.g. to replace lamps and other minor maintenance aspects, where it would be convenient if the equipment does not have to be switched off.

When testing fields likely at the fuel store the antenna should not be aligned to point at F (unless the store has been emptied) but aligned in a representative situation, e.g. towards the bottom-left corner of the site and representative measurements made at a distance from the source which is the same as the distance between the source and F.

Even if the result shows a good safety margin below the hazard level, an allowance of say 3 to 6 dB should be made for possible local enhancements and the resulting figure regarded as the value to be assessed against the relevant standard.

However, in any particular case, some tests may prove not to be required because a beam is aligned well above anything involving people or because antenna calculations show levels to be extremely low (note that possible rotational averaging has not been involved to keep the example simple).

Again, where all radar equipments are always taken out of service for maintenance together, tests safeguarding people working on the out of service equipments may not be required. Instead, if more than one equipment is maintained and being tested at the same time separate provisions may be needed to safeguard those working on the maintenance. What is most important is to plan for all the possibilities and then eliminate what is unnecessary on logical grounds or as the result of measurements and not on calculations alone. The remaining test requirements can then be planned in an efficient sequence. Although a simple example has been used, it can be seen that by careful planning, the efficiency of the survey can be improved and the time duration reduced. Also, the nature of the planning can be varied according to the operational situation. Practical situations may involve some transmitters in a transmitter building, individual transmitters of various frequencies located in separate places, towers with many antennas, etc. The variety is almost infinite and the amount of testing highly dependent on the technical characteristics of the systems in use. Many sites do not, of course, have radar systems and the subject may seem irrelevant to those who work there. However, the merit of using them in training exercises is that moving radiators cause people to think very widely about possible exposure problems on a 'what if' basis. This will lead to the realisation that even fixed beams irradiating people climbing towers can be a hazard especially as there is no rotating beam averaging to ease the position!

A flat site is fairly rare, and it will often be necessary to draw detailed site sections to look at the height of an antenna relative to another or relative to buildings. Figure 9.7 shows an elevation view of the site as it would look when viewed at a distance, e.g. from the bottom of the site diagram, to get some feel for the height relativity.

Some distance and building size data has been invented as dimensional data was deliberately omitted from the simple site diagram. The radar beam elevation angles are drawn as zero degrees purely for illustration purposes.

Since sites are not often totally flat but vary in height in two dimensions. It is in fact necessary to draw elevation sections between each source and the 'target' being checked to establish real distances and relative heights.

It can be seen that if, for example, radar S were mounted reasonably high up, it may be the case that it will not give any problem on site unless it is set

to a negative elevation. If it is mounted on a very low mount, then it is very likely to give problems. Whether there is a problem or not will also depend on distance from the antenna to the place affected, the transmitter power and the antenna gain.

This example is also oversimplified in terms of the equipment on site, since on a real site many other equipments may be present, e.g. communications systems, other radar equipment and so on. Indeed there is an increasing tendency for towers to collect all sorts of antennas, often for outside users, so that many radiations may have to be explored. It is not unusual for towers to have 20 or 30 antennas and, depending on the powers used, this can seriously complicate surveys adjacent to such towers.

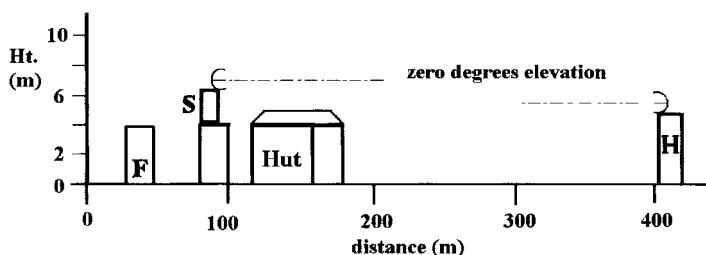

Figure 9.7 *Assessing relative heights*

Also other objects may be present such as spare antenna parts, mast sections stored on the ground, scrap metal structures and vehicles. If there are any transmitters with frequencies up to about 100 MHz, it may be necessary to check for possible shock and burns from these items. If there is anything similar in the adjacent public access areas which could cause burns, it may be necessary to do a discrete simulation on site if possible before risking causing unnecessary alarm to non-technical people by doing it outside! Farm tractors, caravans and other vehicles are often found close to site boundaries and provide significant conductive masses.

The result of the extra complication of real sites is that the schedule of tests to be done will be much more extensive and require more detailed planning and organisation. As mentioned previously, a survey may have to be adjusted in favour of operational commitments so that testing may have to be done out of the planned sequence to accommodate limited release time for a particular equipment.

Note that when beams are illustrated in diagrams such as Figure 9.2 they are shown as bounded by two lines (the half power limits) for simplicity. This tends to give the impression that all the RF is confined between the lines! However, in power density terms there is appreciable energy outside the lines, e.g. if the power density on the axis is, say, 300% of the permitted

limit, 3 dB down is still 150% of the limit! Hence care is required when surveying such beams not to get in the habit of believing that it is safe just outside those nominal limits.

A particular relatively small research site often surveyed by the author did at the peak of its activity have about twelve high power radars, three or four of which comprised two radars back to back, a microwave link and local communication systems. The site area was only three or four acres and had a number of occupied buildings. It took about two days to do the necessary site measurements and calculations and two or three more days to do the survey! Whilst on a fixed function site much of the measurement and calculation work can be done and retained for future use, a research or test site is an ever changing scene and control of safety with changes becomes very important.

Hazard avoidance and remedial action

When planning surveys, it will often be necessary to consider what action might be possible in particular circumstances where it seems likely that some safety limits cannot be met. This problem might be seen when studying layout diagrams and the antenna calculations and if it is found to be correct, some recommendation will be needed to deal with the situation.

When actually carrying out surveys, it is often the case that additional shortcomings are identified which stem from close inspection of what happens on site and these are noted and included in the recommendations. They usually involve such things as the lack of suitable safety procedures or the failure to use existing procedures.

The following list is not exhaustive but can be used to compile local lists of possible actions which can be considered in particular surveys, consulting with the relevant people to eliminate those which are incompatible with the operational or other requirements.

Transmission systems

1 Re-siting equipment/antennas

Mobile equipment may lend itself to re-siting; large fixed systems are unlikely to be re-sited except perhaps as a long term action.

2 Exclusion

Use of barriers to restrict access, including lockable climbing barriers (see later).

3 Sector blanking of rotating radars

Sector blanking (arranging the radar to radiate over less than its normal azimuth range) can be very effective but since radars have defined requirements for azimuth and elevation coverage, blanking is unlikely to be popular in the operational sector. However, it can be very useful when radars are under test, for example on the manufacturer's test sites, since most testing will not require a full azimuth coverage. Mobile radars usually have a blanked sector corresponding to the place occupied by the cabins containing processing equipment (see Figure 9.4).

4 Elevating beams to clear working areas

Again, subject to operational requirements, applying minimum elevation restrictions can be very effective in dealing with awkward problems. Equally, increasing the height above ground of the antenna can be of similar value where practicable. Both measures can solve the problem of personnel clearance to walk round an antenna system.

5 Re-siting of vulnerable 'targets'

Sometimes when the list of other possible remedial actions have been dismissed it may become necessary to move, say, a flammable liquids store to a safer place. Similarly, with the increasing use of portable cabins for technical staff, the moving of such cabins is a possibility. Design engineers, in particular, do seem to have the habit of locating such office accommodation as close to the place of work as possible without much regard for safety.

6 Limitation of human access

Confining human access to clearly defined paths and roadways which are chosen as safe routes is clearly an option. On the small site illustrated here it does not become obvious why people should be confined to footpaths. However, consider real sites such as HF stations which have many acres of antenna field. The cost and effort required to survey the whole of it, taking into account day frequencies, night frequencies, etc., could be enormous compared with the provision of clear walkways and treating the rest as 'permit to work' areas.

7 Shielding of buildings

Shielding of huts and cabins which cannot be moved. This is a rather expensive approach although this has been done successfully in a few cases, using cheap wire netting. However, the fact that an occupied hut has to be

screened implies a hazard to any personnel who walk out of the hut, unless the exit is remote from the irradiation due to being located at the rear, relative to the source.

It often lends itself to misuse where it is assumed that the wire netting shielding will do for any other frequencies. Shielding is not like that and the shielding could prove useless for other frequencies. Some people use a 'keep walking' provision on the basis that if they keep walking away from the source, they will meet the exposure limits under the six minutes averaging provision. Unfortunately, when two or more people meet they are inclined to stand and talk!

With the increase in the use of computer equipment on established sites designed before such systems existed, there may be a need for shielding for EMC purposes rather than human safety. Sometimes this leads to the clerical staff using the computer equipment worrying about any effects on themselves. This can be dispelled by explaining what, in fact, is very low level exposure by means of everyday examples such as motor vehicle ignition interference, holding a radio set near a television set, etc.

8 RF shocks and burns

The best solution if at all possible is to remove stored metal objects and scrap metal from the RF field. For objects such as masts, antenna mounts, and other items which, for operational, technical or financial reasons are not movable, these can, if in the occupational environment, be surrounded with a rope or plastic barrier and suitable signs. In the public domain, the problem is that the objects are likely to be owned by the public rather than the RF site company or organisation. Sometimes agreements can be made with the owners or occupiers of the land. Purchasing or leasing of the land involved might be another possibility, although possibly not a very attractive one. Failing this re-siting of the antenna or power reduction might be necessary.

It is a good idea to avoid the example of one organisation who, after being told that certain objects in an RF field should be fenced, erected a metal fence! It is also said that earthing would be a solution. This is a very unreliable concept since a vertical metal object on the ground which happens to be resonant as a quarter wave at the frequency concerned is quite happy to be earthy at the bottom and will have a voltage antinode at the top! Any attempt to earth the top, apart from only being relevant to the one frequency will by virtue of the earthing conductor type and length, have its 'antenna' characteristics changed.

With the general tightening of RF safety limits for public exposure, those setting up new transmitter sites which provide potential problems of high exposure levels or a shock and burns risk might well look to the possible purchase or leasing of extra land to avoid future problems outside the site boundary.

There is also what might be described as a reverse problem which can arise with large sites. This is the temptation to contract with a local farmer to allow animal grazing on site. What is often forgotten is that people attend animals so there will be a duty of care to such people in respect of RF radiation and even a possible need to check for any heart pacemakers, etc., worn by them. It will be important to ensure that they know about prohibited areas and who to contact if animals stray into such areas.

9 Transmitter power reduction

Power reduction is very unpopular both from the technical point of view and from the human one – why pay extra for a higher powered transmitter and then reduce power? Nevertheless, there are circumstances where this must be done.

For example, if the public, in the public domain, are being irradiated at levels higher than those permitted, then there may be no choice. A similar situation can arise if the transmitter is near a gas plant or a plant storing or manufacturing substances with flammable vapours and it can be shown that these might be at risk. Such a siting case existed in the UK many years ago and resulted in the work to produce the current British Standard on flammable vapours.

This emphasises the need for the planning of new sites to take into account the long term site commitments when assessing safety. So often planning permissions seek to present information based on the immediate equipment proposed and when eventually expansion is considered, it is discovered on survey that adding more transmitters may create risks.

10 Permit-to-work provisions

Often, a particular hazard can be dealt with by a ‘permit-to-work’ procedure.

Unfortunately, procedures controlled by human beings fail regularly unless they include physical controls and are audited regularly. Nevertheless, the system has to be used in circumstances where it seems most appropriate. One of the common failures with ‘permit-to-work’ systems stems from the limited communication of the restriction within an organisation so that sub-contractors are contracted to undertake maintenance, grass cutting, building work and similar tasks without any real knowledge of the hazards of RF radiation. A few examples from past experience might illustrate the problem:

- (a) The side of an aircraft hangar being fitted with new sheeting by workmen on scaffolding and generally progressing to the far corner of the hangar which was being irradiated by three high power radars on test.
- (b) A telephone call from a customer indicating that one of his maintenance staff had just been hoisted up the side of a large and working tropospheric scatter antenna (10 kW).

- (c) A technician sitting in an aircraft randomly, unaware that the radar was working.
- (d) A technician standing between a dish antenna and the feed, dismantling the antenna whilst it was operating. His back felt warm! He did not speak English, needed two authorisations from the two radio rooms listed on his otherwise well-organised permit-to-work, but only got one signature – demonstrably the wrong one.
- (e) A subcontractor cutting grass in front of a working microwave dish on a low mount, removed the access prohibition notice in order to cut the grass right up to the dish and then replaced the notice!

11 Associated safety practices

Particularly useful practices include:

- (a) ‘Key to operate’ controls using key switches. The use of good quality switches with keys which cannot be cut in the local shop and are not duplicated on site. It is amazing how the number of ordinary keys increases.
- (b) Use of start-up alarm systems to warn of impending equipment starting to move or operate. With the amount of energy available in large rotating or otherwise moving radars the potential for injury is liable to be much greater than that of the radiation, as far as a person walking past is concerned. This is not to underrate the potential hazard of RF but rather to emphasise what is often overlooked.
- (c) The use of flashing lights on radiating antennas. The use of flashing lights operating only when RF is on is particularly useful, especially on test sites where the pattern of work may change from hour to hour. With such an arrangement a radar rotating to test the bearings without the RF on would not flash until the RF was switched on.
- (d) A novel approach to safety on towers and masts which has been used in Australia was reported by Hatfield of Telecom Australia. Interlocked ‘traffic lights’ style stop and go signals were fitted to the tower and controlled remotely. Only a ‘go’ light permits access, a stop light or a light failure indicating a prohibition. The light failure point is very important since, when normal traffic lights fail, motorists expect to proceed cautiously!

RF machines and plant

- 1 Shielding for operators, particularly for the lower limbs in ‘seated at machine’ situations. Situations occur where operators have found the nails in their boots getting hot! Steel or aluminium can be quite effective for such shielding.

Where necessary, the use of transparent shielding materials of a proprietary kind can be considered where it is required to see the work piece. Some experimental work may be required but there are a number of types of conductive transparent material available which may reduce high electric fields.

- 2 Control of screening panel removal and refitting – often left off *after* maintenance. In one factory situation an RF machine had all the screening panels removed and stored in the maintenance section – presumably to save the bother of unscrewing them to service the equipment!
- 3 Operator safety training using SIMPLE explanatory methods.
- 4 Prohibition of the use of flammable vapours near RF machines, e.g. petroleum, etc. Note that in the EU, provision is being made to classify RF machines according to the leakage radiation.

Signs and barriers

Practical experience shows that whilst some of the foregoing provisions are usually implemented, the method of implementation is sometimes inadequate. The following observations result from practical problems experienced.

Adequate RF radiation signs (accompanied by additional statements where necessary) should be displayed at the access to all areas where the power density (or a field quantity) exceeds the relevant standard. On sites to which the public have access, physical barriers may also be necessary.

As far as the occupational situation is concerned, the ready availability of passive infrared detectors (PIRs) to detect the presence of people offers the possibility of sounding an alarm to warn personnel who have strayed into a field without realising it. This might help to prevent the occasional cases where people get exposed unknowingly, often due to being deep in thought about an equipment problem. An example is the prevention of maintenance people getting into aircraft radomes when the radar is operating.

Where equipment is not operational, i.e. during research and development and routine testing, it is possible to use a PIR device to switch off the radiation. They can also be used in conjunction with some of the fixed radiation monitors mentioned in Chapter 7.

No account can be taken of notices or signs where children are involved and measures taken should prevent access. In particular, the climbing of mast ladders should be prevented by lockable physical barriers. The latter is often equally applicable to adults since locked barriers are more reliable than prohibition signs alone, both for technical people and the public (who may not be familiar with signs). It is important that keys should be held by a responsible person and logged together with the relevant climbing authorisation. The making of 'own keys' should be banned on principle as it can lead to unauthorised climbing.

In most countries there is some sort of control of public rights of way and no restrictions or prohibitions can be applied to public rights of way by those operating RF transmitters. Warning notices near such paths and applying to the adjacent land should be clearly worded! Signs which are thought to imply hazards or frighten path users will cause a great deal of unnecessary trouble. The author experienced this problem when the positioning of signs was left to the maintenance staff. The result was 'danger keep out' or words to that effect, appearing to apply to the public footpath. This led to formal complaints and an order to remove them from the local authority who had been invoked by the local footpath society! What was intended, was a notice on the private paths leading off the public footpath warning people not to enter private land.

It is desirable that a suitable warning notice should be sited at the entrance to a site or establishment, asking visitors who may have a heart pacemaker or some other types of implantable devices to report the fact on entry. Because of the difficulty likely in establishing the limits of safety with these and other devices due to patient confidentiality, personnel using pacemakers should not be subjected to significant RF fields. The author dealt with a case where a security guard had a silver plate in one leg which got hot when he patrolled near some high power tropospheric-scatter antennas. Removal from the vicinity of the transmitters was the only possible solution.

Creating records and reports

General

In the author's view, it is essential to consider the nature of the survey end report well before doing the survey. Surveys have four basic steps:

- Step 1 Establish what is to be measured, details of the sources available and the environment in which they are used.
- Step 2 Carry out survey.
- Step 3 Establish findings; do any rechecks necessary.
- Step 4 Produce report.

Records involve the actual measurements made, which may not only include RF and X-ray measurements but also the associated linear distances, heights, and other related details. When planning surveys, thought needs to be given to methods of documenting the results. There are many ways of recording and documenting test results and in very simple survey tests, few problems are likely to occur. However, in large surveys, the problems of recording, converting and presenting results can lead to difficulties.

If we analyse the requirements we can identify two areas at least where some sort of organisation is needed. These are:

- 1 Recording measurements and, where necessary, converting the values to those needed for manipulation.
- 2 Presenting the results to those who initiated the requirement for the survey.
- 3 Recording results

Recording results sounds so easy that it may be difficult to see what problems can occur. However, in any survey other than the very simple types, there may be a considerable amount of data to be produced involving:

Recording the actual instrument readings and the relevant locations. Where the instrument is not direct-reading, converting these values from meter readings to the quantity actually required.

For example, unless the instrument is of the digital type, meter readings in mWcm^{-2} on a meter used for electric field measurement will involve the conversion to Vm^{-1} . People used to working in Wm^{-2} are likely to do the intermediate conversion mWcm^{-2} to Wm^{-2} and then convert to Vm^{-1} .

A simple form is the usual arrangement for such recording. The nature of the form can be determined from local considerations but it should ensure that the actual indication of the instrument is recorded before any conversion, as this permits recovery from conversion errors which can easily occur under pressure.

It is very desirable to have a standard practice for units so that people working together use the same arrangement. Preferably this should be SI units, but the most important thing is to have a clear policy. If two people work together, one used to mWcm^{-2} and the other used to mentally converting to Wm^{-2} , experience shows that there is likely to be some confusion over the recorded results.

Surveyors also need to memorise safety levels necessary for them to avoid personal hazards and as most of the main standards now use Wm^{-2} this should be easier (the exception is IEEE 1999). Similarly, since the earlier ANSI standard was the only standards body giving the magnetic and electric field quantities in terms of their squares $(H)^2$ and $(E)^2$ and has now ceased to do so, safety limits in Vm^{-1} and Am^{-1} should not give rise to any confusion.

The likelihood of mistakes in reading the indicated values with analogue equipment tends to increase when surveying in adverse weather conditions due to fatigue and reduced attention to the work. It often results from misreading analogue meter scales despite the colour coding and other good quality practices used by instrument manufacturers to prevent misreading. Most of us are more prone to errors than we care to admit!

With digital instruments with data recording facilities (not all have this) they also have facilities to display the unit chosen by the operator. This makes life much easier providing a valid unit is chosen. There is no virtue in

choosing Am^{-1} for measurements made with an electric probe. This often occurs on training courses, but that is probably the right place to do it!

Since some digital instruments have facilities for a considerable amount of data acquisition and the ability to download to a computer, it is important to remember that results still need to be viewed at the time since decisions in surveys as to whether more tests are needed may depend on them. This may necessitate the availability of a computer and the relevant software on site.

Pictorial recording of data

Identifying locations can be a problem. It was noted earlier in respect of leakage surveys that the use of marking tape on the equipment to identify leakages can be extremely useful. After all somebody has to find the leak in order to rectify the situation. There have been many examples of people 'rectifying' the wrong waveguide flange! Tape markers can be given identity numbers or letters. The report will need leakage measurements from an equipment to be related to a location for example, by annotating a sketch of the equipment or of the working area.

Preparation of such sketches beforehand can be a great help as they can then be copied and the blanks marked up during the survey. Generally a few good illustrations are better than pages of words.

Similarly, exposure measurements need to be documented in a way which can clearly be related to the real world in the form of the radiation sources, adjacent buildings, objects, paths and roads. In the case of RF process machines the nearest things may be work benches, other machines and processes, and the people associated with them.

Such machines will usually involve leakage exposures relatively close to the machine. However some modern RF production machines and the associated work flow equipment are quite large and cover an appreciable floor area, sometimes as big as a high power broadcast transmitter – see Figure 2.22 earlier in the book.

The essential thing is to present location information such as diagrams in a way that those who have to undertake some corrective action know what to do and where to do it. In the case of diagrams relating to exposures, the recipient of the report may expect enough information to make any necessary changes in the location of people or equipment or to see that such changes proposed in the report make sense.

A method of presenting numerical values of quantities and their locations for complex transmitter cabinets which has been used for many years is illustrated in Figures 9.8 and 9.9.

Figure 9.8 shows a line drawing of the cabinet layout for the transmitter of a high power HF Broadcast installation. The modulator has a similar diagram and is not shown here. The diagram only identifies key items related to possible leakage but can only show one side of a double-sided cabinet bay.

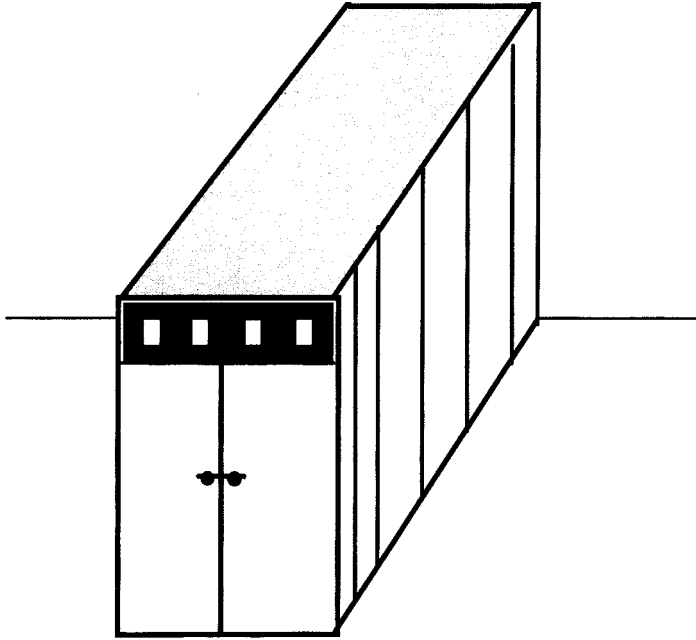

Figure 9.8 *Leakage testing – large equipment*

Figure 9.9 shows a simple modification to turn the diagram into an ‘exploded’ picture showing both sides of the cabinet.

By an entirely arbitrary convention, RF leakage data is shown in balloons and X-ray leakage data in boxes.

The leakage points have also been marked on the equipment with an adhesive tape (x in the diagram), so that it should be clear where remedial work is required.

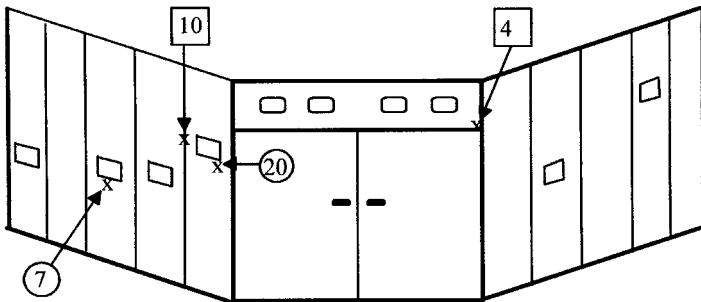

Figure 9.9 *Leakage testing – recording data for Figure 9.8*

For waveguide runs the business of drawing can be a time-consuming task unwelcome to the inartistic. Figure 9.10 shows a simple line drawing method which uses a line for each flange and arbitrary numbering of the flanges. It is then possible to go to the right flange and do remedial work. One very common problem with rectification work done after surveys is the tendency to ‘rectify’ the wrong thing due to some ambiguity in the instructions for the work!

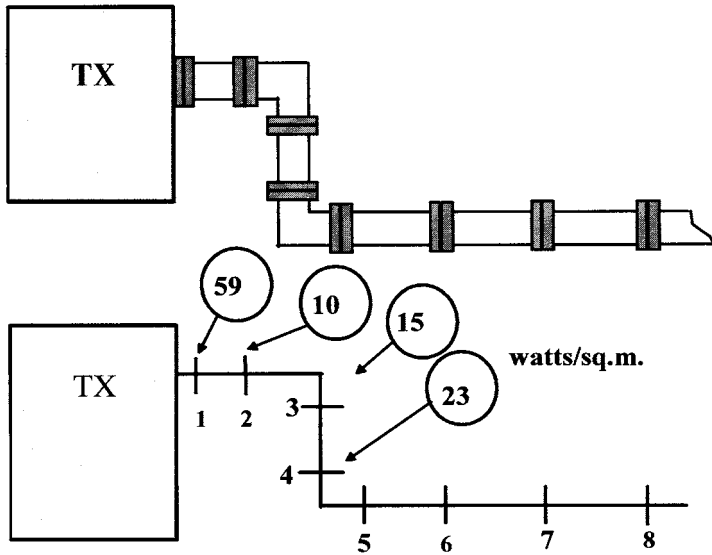

Figure 9.10 Leakage testing – waveguide runs

Controlling changes to equipment and the site

For a site on which relevant points above have been implemented, the main problem likely to be encountered is that resulting from technical or administrative changes. These pose a constant problem and include:

- Equipment changes
- Power, frequency, feeder and antenna alterations
- Adding new equipment, masts and antennas
- Administrative or organisational changes which also need pre-authorization may include:
 - Erection/demolition of buildings. This may change field distributions or change screening characteristics

- Building maintenance, with any climbing and high level work involved
- Electrical wiring work in areas of significant RF field
- Change of use of buildings, e.g. creation or re-siting of a ‘flammable materials’ store
- Rigging, mast and antenna alteration, maintenance or erection
- Use of cranes, ladders, etc., in areas of significant RF field
- Grass cutting
- Use of low flying aircraft, e.g. helicopters, in RF hazard zones. Here the danger may primarily be related to the effect of an RF field on the aircraft control equipment, rather than direct effects on personnel.

All changes to equipment should be subject to effective control. Activities involving sub-contracting of works is a common cause of safety problems, since those arranging sub-contracts are frequently unaware of the technical aspects of radiation safety. Here again the requirement for a safety signature before sub-contracts are let, will help to reduce problems. It is worth remembering the old adage well known to safety practitioners, ‘anything that can be done wrongly, probably will be done, sooner or later’.

10

Conducting radiation measurements and surveys

This chapter is divided into two parts. Part 1 deals with personal safety in surveying and then goes on to discuss the conduct of leakage measurements for both RF and X-rays. Part 2 deals with exposure measurements in considerable detail and with illustrations and explanations covering a wide range of RF transmitting equipment.

Part 1 Leakage surveys

Personal safety in surveying

It is obvious that those who undertake surveys have to be prepared for some risks, especially when dealing with working high power systems or assessing new designs of high power equipment. Such risks can be made negligible by care in the initial approach to equipment. Whilst some safety points are mentioned again in particular paragraphs because of their immediate relevance, the following warnings are generally applicable.

X-rays

Where possible wear an approved type of X-ray dosimeter badge. When both RF and X-ray surveys are requested, do the X-ray checks first. Also, even if X-ray checks have not been requested but the surveyor has some concern about the presence of X-rays, then those checks should be done first. If quoting as a sub-contractor build in the cost of X-ray checks where they might be expected! Have an RF measuring instrument available at the same time to keep an eye on RF radiation!

The initial approach to any equipment which might conceivably produce X-rays should be a cautious one where measurements should be made at as large a distance away as possible. A sensitive sniffer instrument will assist in this.

Where unexpectedly high readings are encountered, either retreat to a safe distance from the exposure to allow time to think out your next move or switch off the source. In any event such a source should not be left operating unattended.

RF radiation

Again the initial approach to any equipment which produces RF radiation should be a cautious one where measurements should be made at as large a distance away as possible. Whilst it is obviously possible to distinguish the risks between a high power transmitter and a small and trivial low power source, it is usually desirable, unless the surveyor is very experienced, to exercise caution on a general basis, thus avoiding any consequences of erroneous judgements. Particular care should be taken with prototypes of new designs. Note that as well as possible hazards to the surveyor, the RF radiation instrument may also be at risk.

Consider the possibility of RF shocks and burns at the lower frequencies. Avoid allowing technical interest to reduce your attention to other hazards present such as mechanical devices, electrical hazards, other forms of radiation, hot surfaces, etc.

Specific procedures may apply in certain antenna fields such as those at MF and HF broadcasting stations where the shock and burn hazard may be particularly acute or where climbing is subject to special controls. Surveyors should not work alone in high power antenna fields.

Common electrical safety considerations

When carrying out X-ray or RF tests with panels off and high voltages accessible, the surveyor must be familiar with:

- 1 The fact that the instantaneous PEAK potential on points can very significantly exceed the nominal high voltage supply.
- 2 The 'jump distances' for high voltages in air, i.e. the air breakdown distances whereby, if a probe or other conductive object (which includes the human body!) is brought too close to a high voltage terminal, the voltage can break down the air gap and take the object to the terminal potential. Sharp points concentrate charge.

Many people remove rings and metal watches from the hands when doing open panel work.

- 3 The possibility of an excessive amount of RF exposure being incurred whilst doing X-ray tests with panels off and the chance of incurring an RF arc from a point of appreciable RF potential.
- 4 The procedure for dealing with stored charge in capacitors when power has been switched off.
- 5 Open panel work, probably mostly confined to the investigation of X-ray radiation in new designs in the manufacturer's development laboratories and test departments, needs two people present throughout the tests and also requires, where the nature of the equipment necessitates, the use of wooden or plastic guard fences to avoid the danger of stumbling into the equipment.

In short, do not be so immersed in radiation matters that you get electrocuted.

Leakage measurement surveys

The starting point for all survey measurements whether for leakage or for exposure is the existence of a safety standard. For the purpose of illustrating survey methods, it does not matter whether this is an established national standard, a company or organisation standard or a contractual standard produced by a customer. The standard provides the criteria for all decisions during the planning of a survey and for all recommendations made as a result of the survey. Sometimes the manufacturer's own safety standards may be more severe than any of the other documents mentioned.

Where leakage refers only to the structure of a high power transmitter, it is desirable, wherever possible, to use a dummy load on the transmitter output to avoid unnecessary radiation and to ensure that one can distinguish leakage from the antenna field.

X-ray surveys

X-rays must be considered as hazardous and it is therefore important to consider the safety of those carrying out X-ray surveys. For those not experienced in dealing with X-rays, the warnings in the paragraphs above should be studied. The use of a sniffer instrument (Chapter 8) to do the initial checks will assist with personal safety as well as facilitating the detection of X-rays.

The same precautions should be observed for each equipment, however familiar the surveyor is with it. Specific protective items such as lead glass windows should not be trusted until it has been established that the correct type of glass is fitted. When satisfied that there is no sign of excessive or unusual radiation, the survey can proceed.

X-ray radiation is covered by legal provisions. Individual national regulations and codes of practice may have specific requirements which are not necessarily covered here. Note that this may also be the case when the equipment is for delivery to another country. Problems may arise in such cases if the radiation certification is not in accord with the recipient's national regulations. This may include a requirement for evidence of instrument calibration validity.

Where X-ray measurements on high power transmitters need to be done at a number of frequencies, it is quite usual to proceed in the sequence:

X-ray measurement on frequency 1; RF measurement on frequency 1
X-ray measurement on frequency 2; RF measurement on frequency 2

and so on to the last test frequency.

This method of working reduces the number of frequency changes needed and the time involved compared with doing all the X-ray work first and then starting again for the RF measurements, an important factor where the time to change frequency is significant. It is also essential when having to work on broadcast transmitters and other types of operational transmitters in time slots between periods of service, as it then means that both types of measurement for one or more frequencies are done in a given period and the results can be studied whilst waiting for the next free time slot.

Reasonable ambient levels of RF radiation in the building are not likely to affect X-ray instruments, but in case of doubt aluminium cooking foil held across the apparent X-ray beam or wrapped over the instrument window will, except at the very lowest energies, be transparent to the X-ray but stop any RF electric field present which may be the real cause of the meter reading. The author has not, in practice, found any problem with magnetic field interference, which might be harder to shield. However, it cannot be ruled out as a possibility with some high power equipment.

The equipment operating conditions should be those that give the maximum power that is permitted or scheduled for use, and, where appropriate, with modulation, i.e. worst case conditions.

The initial survey should cover all the surfaces associated with the source of radiation, front, sides, back, and top and not be limited to that part of the equipment where the source is located. This is particularly important in a large equipment where X-rays may be reflected around the cabinet and emerge at some unexpected point. All normal covers and panels should be fitted.

The initial survey should be carried out with a sensitive 'sniffer' meter and the instrument should be held as close to the surfaces of the equipment as possible to maximise the chances of detecting narrow beams. Figure 10.1 shows the use of a sniffer instrument on a high power mobile radar transmitter. Where leakage is found, the location of the leak should be physically marked with some suitable adhesive cloth tape or other material.



Figure 10.1 *X-ray leakage measurement in a radar cabin during training*

Where a Geiger-Muller tube instrument is used for initial surveys on pulsed or amplitude modulated sources, the maker's instructions should be followed with regard to pulse or modulation repetition rates, otherwise it may be found, in the limit, that the instrument is responding to the repetition rate rather than to the X-ray dose rate. To put this problem in perspective, it should be said that the author has used such an instrument over about fifteen years without ever experiencing the problem.

After the initial survey, measurements should be made with an ionising chamber instrument at those places where the leaks were found and, for

recording purposes, more systematically at those places which are the source of the X-rays such as the final output stage compartment, and high voltage modulator or other source, to confirm that there are no measurable leaks.

All measurements should be made at the nationally used distance, usually 100 mm from the chamber centre mark but with some exceptions mentioned later. Where, as should generally be the case, the 'sniffer' instrument is more sensitive than the instrument to be used for actual measurements, it follows that at some of the points which had been identified as having leaks, the ionising chamber instrument may indicate that the beam dose rate is too low to resolve.

It is desirable temporarily to leave such leaks marked, but perhaps annotate the marks to indicate that they were unreadable. The reason for this is that if, subsequently, during the survey some operating condition is found which materially increases the X-ray dose rate generally, those leakage points can readily be checked again. In particular, with amplitude modulated high power broadcasting transmitters further checks may be necessary using high modulation levels (90 to 100%) to identify any rapid increases in X-ray dose rate on the lines discussed in Chapter 8. X-ray levels with the carrier only may not be measurable in such cases.

Where permitted maintenance includes some work with panels or covers off and the equipment operating, tests should also be done in this condition to safeguard the maintainer's interests. Note that the maintenance situation must not result in an infringement of the ionising radiations regulations. If necessary a maintenance shield should be available, a standard practice with many radar equipment suppliers.

Practical points

Note that the relevance of these points may vary according to whether new equipment is being commissioned or existing equipment is being subjected to a routine survey.

- Suspect door leaks due to contact finger strips and test several times with doors being opened and closed each time. Door catches are also leak sources as they have to have a cut-out for the catch mechanism.
- Glass windows should be lead glass where X-rays are present. Ensure that it is still fitted, in case any local unofficial replacements prove to be ordinary glass! In the absence of any specific indication, it may have to be checked for leakage with power on.
- High voltage RF sources not located on solid ground floors (for example, sited on a first floor level) may need checks in the room below for X-rays (and possibly RF) depending on the nature of the floor-ceiling structure.
- X-ray radiation beams may vary in location when a new electronic tube is fitted, if the electronic tube internal structure has a different

orientation relative to the base mounting than the previous one. The problem here is generally one of being too precise and definitive about shielding, designing it perhaps on the basis of a sample of only one or two electronic tubes.

This may also apply if it is possible to fit an electronic tube with a difference in orientation, due to the whole tube being inadvertently rotated. Figure 10.2 illustrates both these problems, which are not distinguishable diagrammatically, by a plan view of a new high power tube having been

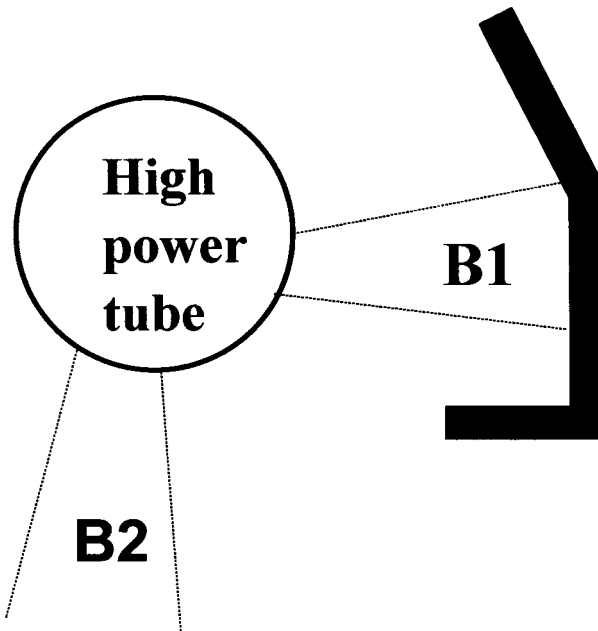

Figure 10.2 High power transmitter tube showing the possibility of X-ray beams appearing at angles outside a shield

installed with an X-ray screen covering that part of the tube where the designer expected X-ray radiation. In the diagram, B1 is the X-ray beam anticipated by the designer. A new tube may, either due to internal electrode structures or to the rotation of the tube mount, give rise to an X-ray beam B2 which is not stopped by the shield. The diagram does oversimplify the nature of the X-ray radiation from tubes to illustrate the shielding point.

When it is known that the high power tube produces significant X-ray radiation and the shielding is only partial as just discussed, there should be a leakage check whenever the tube is changed to detect beams not stopped

by the shielding. Of course an improved shield design would obviate this need, since a high leakage would, in any case, need remedial action.

Further problems are possible if more than one type or brand of electronic tube can be installed since there may be differences in the whole electrode structures of the different types of tube, from the X-ray point of view.

Very old electronic tubes may also have less inherent X-ray shielding and can be a particular problem since the equipment designer may not have had any experience of the old electronic tubes or even be aware that any user possesses them. A real case which happened a few years ago, involved a modern radar in a ship which had been fully surveyed for leakage. When a very old replacement tube was fitted, an X-ray beam was found emerging from the radar cabin door.

- Some X-ray sources produce an increase in X-ray dose rate with age. Consultation with the supplier may be needed.
- Make sure that the transmitter remains ON when surveying. On large transmitters there is often no indication when working at the sides and rear. It can prove very embarrassing to discover that you have worked for twenty minutes when the transmitter was not radiating and recorded a lot of 'no reading' statements!
- One common problem, mentioned earlier, which can occur on high voltage transmitter surveys is false readings (RF and X-rays) due to the presence of a high static field causing a build-up of charge which gives a meter reading. This will drain away if the instrument is held quite still for a few seconds. Some types of paint finishes on panels may assist the static build-up.

If the instrument has a metal part which can be touched when the instrument is held, it is sometimes a help to touch with the spare hand an earthy point on the equipment under test (e.g. panel screw head) to bleed the static charge away. This technique should NEVER be used when any panels are removed and hazardous voltages exposed since earthing one hand is potentially an aid to electrocution!

Requirements for X-ray leakage measurement in national regulations

Some national regulations identify certain types of equipment such as oscilloscopes, video display units and television receivers, items which may form part of transmitter installations.

These items may be subject to measurement at 50 mm from the surfaces of the item and in order to secure some degree of exemption from some, but not all, of the relevant regulations for 'radiation generators' the radiation dose rate limit is specified. In these cases the specific regulations should be followed.

RF leakage testing

There is a great deal of commonality between X-ray and RF leakage testing but they have been presented separately since some people may never be involved in the former. For RF testing, it is assumed that an isotropic radiation meter is used and correctly operated as discussed in Chapter 7.

When starting measurements, with the transmitter or RF machine under test not radiating, check the ambient RF field in the building, if any. Note this for later use as it may limit the lowest reading which can be resolved. If it is too high, it may be necessary to have other sources switched off. Note that X-rays, at the levels likely to be present, are not likely to affect RF radiation measuring instruments.

The initial survey should cover all the surfaces associated with the source of radiation and not be limited to the part of the equipment where the RF source is located. All normal covers and panels should be fitted. The equipment operating conditions should be those that give the maximum power that is permitted or scheduled for use, and, where appropriate, with modulation on to give a realistic worst case operating situation.* If there is a lot of leakage on an amplitude modulated transmitter it may be worth working with the carrier only and repeating with the modulation on later.

RF measurements are normally made at 50 mm from the distance from the equipment surfaces unless a standard or specification is invoked which specifies some other distance. Even if a greater distance is specified it can still be advantageous to do the initial survey at 50 mm since it is exploratory and is more likely to identify leaks.

Many RF radiation measuring instruments have a plastic ball on the sensor and this ball has a radius of 50 mm so that the required spacing implies the ball just touching the equipment surface. Other instruments have a plastic cone or a ball and cone combination which provides the same spacing. In practice, the best spacing is just NOT touching the equipment being surveyed as this tends to reduce the static charge problem mentioned earlier.

The quantities measured should be those specified in the relevant standard and will involve the separate measurement of the electric and magnetic fields up to the frequency limit specified in that standard. Above the appropriate limit, power density will be measured.

The points where leakages are found should, as in the previous case of X-rays, be marked on the equipment under test. After the initial survey, measurements should be repeated more systematically at those places where leaks are found and also where they are most likely, e.g. the final output stage compartment.

* On high power transmitters there are normally time limitations on 90 to 100% modulation and these levels would not be representative of normal transmission. Short spells on these levels would only be needed for special investigations.

Where feeders and antenna exchanges are involved, measurements should similarly be carried out. Leakage concerns on pressurised feeders includes loss of air pressure as well as RF leakage. Figure 10.3 shows training course students measuring leakage from the waveguide feed from a high power radar transmitter below the stationary operating antenna. Needless to say the personnel safety clearance in front of the antenna had been checked and the firm rule ‘feet on the ground at all times’ established. This radar was an unusual case as it was used only for training and reasonable leaks could be left on it for training purposes. Of course waveguide runs can be made up with a source generator and leaks arranged for training purposes by leaving some fixings loose!

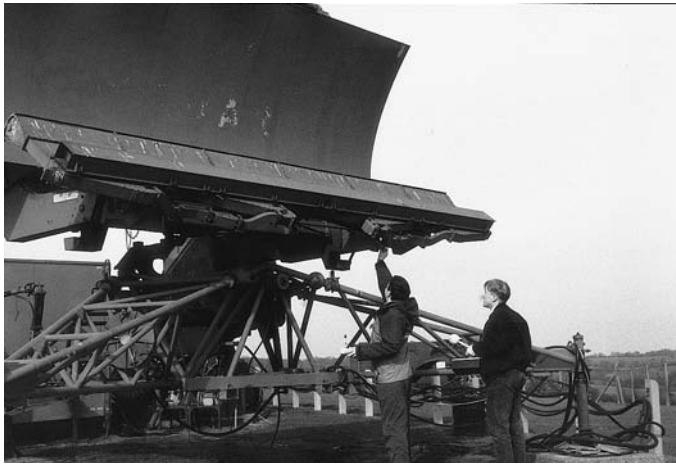

Figure 10.3 *RF leakage measurement on radar waveguides during training*

On multiple transmitter installations it is important to ensure that the correct feeders and antenna exchange parts are tested as it is easy to become confused when working on remotely sited items. Dummy loads may also have to be tested. A dummy load usually consists of some form of shielded resistive element simulating the normal transmitter load and capable of dissipating the full power output.

Dummy loads for high power broadcasting transmitters may be chemically based, the match being chemically adjusted.

For factory testing of HF transmitters, the element may be immersed in a de-mineralised water flow, power being measured from the rise in water temperature. Most dummy loads are generally reliable from the point of view of the effectiveness of the shielding but those dissipating very high powers might be very hazardous if there was a loss of shielding.

Some specialised loads for power testing use slightly different calorimetric principles to measure RF power by comparing the heat generated by the RF using circulating fluids in contact with the dissipating element, with the heat generated by a known AC mains supply.

These and other water flow systems usually rely on a connection to the transmitter control system to provide an overriding safe shut down if something untoward occurs such as a loss of fluid flow which might lead to a catastrophic failure. This is in addition to any in-built safety devices in the calorimeter system. The surveyor needs to be aware of this when testing such equipment for RF leakage and ensure that the transmitter connection is made.

Where permitted maintenance includes some work with panels or covers off and the equipment operating, tests should also be done in this condition to safeguard the maintainer's interests, as discussed earlier in connection with X-rays.

Some of the practical points listed earlier for X-rays are also applicable to RF leakage. However, in the case of windows, lead glass is not relevant. Where leakage may occur, normal glass will usually be used with a wire mesh of suitable mesh size behind it, or sandwiched between two layers of glass. Proprietary glass is now available with wire mesh incorporated. Any lead glass windows fitted should have wire mesh as well if there is RF leakage, since the attenuation property of lead glass is only effective for ionising radiation.

On very high power transmitters in the MF and HF bands, windows near the final RF output stage without wire mesh fitted can cause catastrophic damage to an instrument sensor as the surveyor scans towards the window. There may be no significant leakage until the glass is reached where the leakage field can become large.

In one particular case on a 500 kW MF installation a magnetic field probe read zero over all of the front panel. At the first approach to the window edge, the sensor was blown up so rapidly that the surveyor had no time to react. The surveyor was the author and this was the only probe he ever damaged! Consequently, in such cases, the window should be explored first, approaching from a distance with the instrument set to its highest range! All windows are important since people put their eyes close to them in order to observe electronic tubes, detect arcs, etc.

Some problems can occur round doors where contact strip earthing is fitted. On high power HF broadcast equipment arcing can sometimes occur when the strip has not been fitted and set properly or where it has been distorted. This may generate enough heat to oxidise the surface and impair the contact. Unfortunately the problem is often caused by operational staff making the door easier to open and close by interfering with the contact strip despite the fact that the effectiveness of the contact fingering depends on a firm fit.

On microwave equipment where the contact strip dimensions have not been selected correctly, resonances may occur and cause leakages, instead of stopping them. Contact fingering strips need to be designed with spacing appropriate to the frequency!

National or other test requirements

Some particular products such as microwave ovens have detailed test requirements which have to be followed. For example, a British Standard BS5175:1976[47] has a list of tests to be done including the use of a 'dummy load' of a specified volume of saline solution. There are also tests of the interlock switches, etc. In such cases the requirements of the document concerned should be followed. The USA also has specific tests for these items[48].

Other leakage test methods

Sometimes, instead of the usual leakage tests, purchasers specify requirements for transmitter user RF safety in terms of the exposure of a notional person at a specified distance from the transmitter, e.g. 1 metre. This is usually located at the place where personnel will work in front of the transmitter and possibly at the rear or even all round. This is illustrated for one face of the transmitter in Figure 10.4.

A common method of defining such exposure is to require measurements to be made at, say, three heights in the plane of a standing person at the specified distance. These are then added and divided by three to give an average exposure which is subject to a specific limit. This is known as spatial averaging.

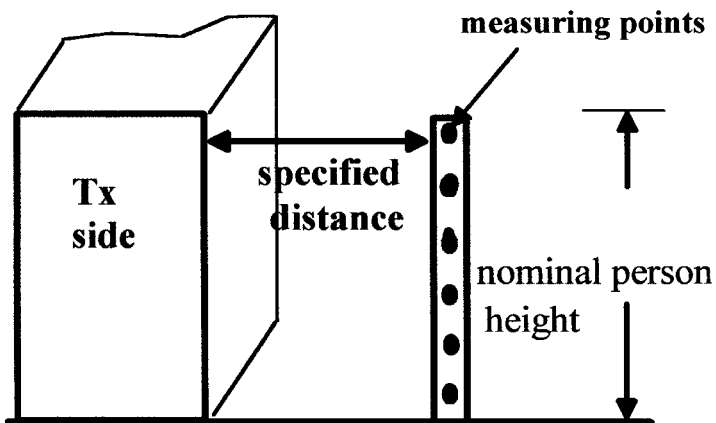

Figure 10.4 *Exposure due to leakage – another method of specification*

Since this measurement has to be repeated at as many places as needed along the length of the transmitter front, rear and sides as appropriate, it will usually be done by initially measuring along the length of the transmitter front, back and sides, at each of the specified heights in turn, in order to establish the amount and general location of any leakage. This will enable a decision as to whether any rectification action is required before taking formal measurements for the certification of the equipment. Note that with the correct choice of digital instruments, spatial averaging can be done automatically in a fraction of the time required with most older instruments.

An alternative sometimes met is again to define a distance and limit the exposure directly by requiring that the actual power density (or the appropriate field components) does not exceed a specified value at that distance at any height up to some figure such as 2 or 2.5 m. The only difference here is that there is no averaging, every measurement being required to meet the specification.

The measurement is usually done by holding the probe at the specified distance from the transmitter and measuring in the vertical plane up to the height limit required. In practice, since it is assumed that the person can be at the specified distance anywhere round the transmitter, it is necessary, as before, to survey horizontally along the required length, e.g. the front of the transmitter, etc., and at all heights up to the specified limit, perhaps using a suitable number of discrete heights to represent the vertical element of the survey. Once again the appropriate type of digital instrument can take measurements rapidly over the height required and output the data to a computer.

Whilst averaging over the specified averaging time is quite proper within the terms of the relevant standard, it is sometimes necessary to deal with transmitter station personnel who feel that averaging is a method of hiding the higher values present. The author has generally aimed at getting all cabinet RF leakage reduced to the permitted levels largely because the leaks often found were easy to remedy. Of course this will not always be the case and averaging may be needed.

RF machines and other sources

It is difficult to generalise about the measurements on RF machines since there is an enormous variety of types and the applications mentioned in Chapter 2 illustrate the wide range of uses. The testing required will be leakage testing but in manually operated machines, operator direct exposure will also be involved. To avoid duplication, both aspects are covered here.

The frequencies used are those allocated for industrial, scientific and medical uses (ISM bands) and range from HF to microwave frequencies. These ISM frequency allocations vary according to the part of the world

involved. The internationally listed centre frequencies for ISM use, subject to national authorisations, are 13.56, 27.12, 40.68, 433.97, 915 (not UK), 2450, 5800 and 24.125 MHz. A wider range of frequencies is in use on existing machines, presumably for historic reasons. In the UK 2450 MHz is used for microwave ovens.

In the medical field a considerable number of different types of RF machine are used to apply electromagnetic fields to the human body for therapeutic purposes and for surgery. Processing machines such as those used for dielectric and induction heating in food production, plastics welding, wood gluing and other fields may have leakage associated with the electronic equipment cabinets which generate the RF energy. These need leakage tests both to protect the operator and any other workers nearby. At the work piece there may be a need for exposure measurements as the hands, legs and possibly other parts of the body may be subjected to the fields around the RF applicator in the course of loading and operating the machine.

Since the duty factor for RF machine operations of the production type, that is to say the period of time in an operational cycle when the RF power is on to the total time of the cycle, is relatively small then exposure averaged over the permitted averaging time of any current standard will be appreciably reduced by this factor. A duty factor ranging between 0.1 and 0.2 may serve as an example but there can be a much wider variation than this in practice.

Reports from various countries have shown operator exposure to quite high field strengths associated with heat sealers and plastic welders.

NRPB report R144[67] gave data from the USA, Finland and Sweden on this topic. The electric field strengths recorded at various parts of the body ranged from about 100 to 900 Vm⁻¹ and the magnetic field from about 0.2 to 3.5 Am⁻¹. The figures relate to different machines and different powers but only one table, that relating to Sweden, gives the power information (3 to 6 kW). The date of the report is 1983 and the data may not be true for newly designed machines. However many machines remain in service for a very long time. The report also gives measured field levels for many radio transmitters.

A protocol for the measurement of RF radiation from RF machines was issued by the UK Health and Safety Executive in 1986 as document PM51[50]. The limits used were based on the 1981 recommendations of the American Conference of Government Industrial Hygienists (ACGIH). The document is now obsolescent but can be used in the UK, substituting the current limits in the NRPB93 standard.

The measurement plane is a vertical plane 15 cm away from the machine at the positions of nearest whole-body approach to the applicator or electrodes. The highest and lowest physical measurement heights in this plane are determined by whether machine operation is undertaken seated or standing.

This particular approach is not very useful for many types of machine where the mechanical configuration makes it seem inadequate to use the

vertical plane approach alone, as it may not have much relationship to the operator's body and hand positions when using the machine. It seems more sensible to measure at the places where parts of the operator's body come closest to the machine applicator field during use of the machine.

There is more than one opinion on this matter but the author's view is that measurements should also include measurements at the operator's body including hands, etc., in representative operation of the equipment since only then do the full body movements come to light. On machines which are not directly operator fed, for example those which use a conveyor feed, such measurements will not be necessary.

In the EC the Machines Directive 98/37/EC[81] is a directive covering all aspects of safety. The drafting of a detailed standard to cover the radiation aspects of that directive is being undertaken by a CEN committee (TC114). Their current activity is shown under reference 81 at the end of the book. The standard EN12198-1 'general principles' has been ratified. Parts 2 and 3, 'Measuring procedures' and 'Reduction of radiation by shielding' are under approval at the moment. The general approach is to define an effective reference volume for that part of the machine constituting the RF source. A 'measurement surface', defined as being a rectangle, the sides of which are parallel to the reference volume is then postulated and measurement points are located on that measurement surface.

Further measurement points are defined in relation to the working positions of the operator and other measurement points are specified where leakage may occur. When developed this may provide a somewhat more systematic method which takes in some of the points made above.

Of course methods which involve measurements in planes at a specified distance from the source can be useful in safeguarding people other than the operator since the results can be used to set boundaries for access by other people when the fields extend beyond the operator area. Whatever method is used for RF process machines, proper spacing and positioning of machines will reduce the possibility of other people being irradiated. Similarly, the avoidance of RF reflective materials near machines will reduce the possibility of field enhancements near the operator.

For machines operating at frequencies of less than 100 MHz, induced body currents are, logically, likely to become a significant factor in the control of operator exposure. The work of Gandhi et al.[18] in connection with the measurement of induced body currents from people standing in a plane wave field and from people working with an RF sealer machine suggests that currents in the bodies of such machine operators could give significant ankle SARs in those cases reported where electric field values of 300 to 2700 Vm⁻¹ and magnetic fields of 0.15 to 6.5 Am⁻¹ were present.

The currents induced by the RF sealers were, however, appreciably less than those produced in the standing human beings experimentally exposed

to plane wave fields. Summarising the survey work likely to be involved with RF machines:

- 1 Measurements at the lower frequencies should involve separate measurement of the electric and magnetic fields as stated earlier under the 'RF surveys' heading. Measurements may eventually include limb currents and contact currents.
- 2 Most, if not all machines will need leakage tests applied to the RF source container or cabinet. For flow-line processing machines, leakage testing will extend to the structure around the RF applicator and the apertures where products enter and leave the applicator zone. X-ray tests, if applicable, should also be done.
- 3 Measurements relating to the exposure of operators feeding machines will be necessary where the operator is close to the applicator, e.g. manual feeding. The worst case product, from the point of view of power applied, size, RF scattering potential, etc., should be used for measurements. Where the product is fed to the applicator automatically there may not be any exposure of the operator but access to the apertures referred to in 2 above may need to be controlled, both for the protection of the operator and anyone else who might approach the machine.
- 4 Control of flammable substances in the vicinity of the machine may need investigation. Some cleaning fluids might come into this category.

Part 2 Exposure measurements

General

It will have been noted from Chapter 9 that the practical range of RF exposure measurements can involve great variety and complexity, from the safety aspects of a single source to that of a complex site with twenty or thirty sources. It is therefore only possible to illustrate practical exposure measurements by breaking the topic down into common elements. It is assumed that some approximate calculations have been carried out before surveys are started. This may be done by the methods of Chapter 5 or by any other accepted method.

When carrying out exposure measurements, the instrument probe should not be held closer to a reflecting object, e.g. a metal structure, than 20 cm to avoid the surveyor influencing the field.

When working on stationary beams or in any situation where, for the purposes of the survey the potential hazard areas have been changed from the normal situation, adequate signs should be displayed to prohibit access. Otherwise people not familiar with the changed situation caused by surveying may, in good faith, inadvertently walk into a hazardous field.

Surveys of microwave beams

One common element of many surveys will be one or more microwave beams whether fixed as for some communications systems or moving as for radar equipment. The general technique used for moving beam systems is to stop the movement and align the beam in a direction which is convenient for the survey, but which does not cause any hazards. Fixed beams are, of course, normally surveyed in their working alignments. Tactical and other mobile systems are a possible exception as they are usually easy to move, if required.

Survey aims

Moving beams generally demand the most survey work due to their ability to irradiate people over their azimuth and elevation scans. The general objectives of such surveys include:

- 1 Assessment of the beam aligned at one or more elevations according to the nature of the site.
- 2 Assessment of the beam aligned to one or more representative elevated work platforms (where such elevated working is involved), or mast climbing paths, in order to determine the RF radiation levels present.
- 3 Making any representative measurements necessary at distances along the beam axis which correspond to the distance of flammable substances and EEDs known to exist on site, or at the proposed location of such new facilities.

Obviously the beam cannot be pointed at a flammable or explosive substances store whilst measuring unless the store is empty! It is therefore usual to point the beam in a safe direction and measure at a distance from the antenna corresponding to the distance of the store from the antenna. When extrapolating from a beam measurement on open ground to a flammable substances or explosives store, it would be wise to allow at 3 to 6 dB for field enhancements due to reflections, which might occur at the store due to the structure, metal fuel drums, especially stacks of 'empties', etc.

- 4 Assessing the safety compatibility of the operating antenna system with any other existing antenna systems – firing RF into another antenna of similar frequency could blow up receiver microwave diodes if there is any receiving equipment connected to it!

General assessment of beams

Where the antenna is near to the ground such that beam measurements can be made easily and if it is necessary to do measurements in some detail, then a simple approach to this is outlined here. Figure 10.5 shows a plan view of a stationary microwave beam with a line representing the antenna axis. The

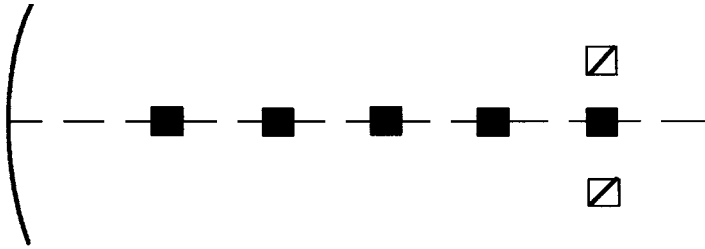

Figure 10.5 *Plan view of an antenna near the ground, aligned with markers for a survey*

beam elevation should be set to provide either the worst case or a specific elevation according to the needs of the survey. The information will usually be obtained most easily with an elevation of 0° or only a slight positive elevation. Unless the source is very low power, the whole area covered by the survey should be made a prohibited area for people not involved in the survey.

The author uses plastic traffic cones to provide markers, spacing them out as shown in the diagram, with the aid of a measuring tape. The intervals may be chosen for convenience according to the nature of the system. A spacing of 25 or 50 metres might prove satisfactory. Additional markers may be positioned where needed, for example to record measurements close in to the antenna either side of the beam axis line.

It will also be necessary to look at the beam in elevation as shown in Figure 10.6. Unless only personnel-clearance below the beam is sought then measurements on axis at different heights will be needed, the choice depending on the survey requirements. For the purpose of providing an uncluttered diagram, three heights are shown in the figure. The surveyor will need a wooden (i.e. non-metallic) step ladder to take measurements.

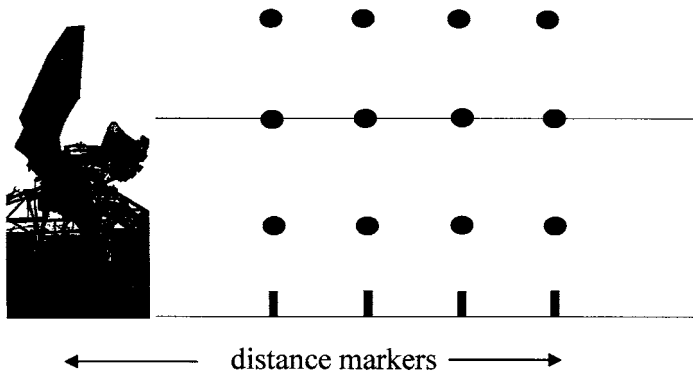

Figure 10.6 *Elevation view of the Figure 10.5 arrangement*

Checking heights above ground is usually done with a weighted non-metallic measuring tape. Heights which can be reached from the ground can be judged from a knowledge of the surveyor's own height or by using pre-marked survey poles.

There are some important preliminaries to be observed before starting measurements, since to walk into a beam without a careful check of likely radiation levels may put the surveyor and the instrument at risk. The initial steps to be taken are:

- 1 Check the calculations carefully. Ensure that the survey will not hazard flammable substances or EEDs stored on site, due to unsuitable choice of beam alignment. Also ensure that, if the equipment being surveyed is a pulsed equipment, the peak pulse power density is not likely to exceed any exposure limits stated in the standard in use.

If the limits are exceeded, the locations concerned will, by definition, be places where people must be excluded and the limits concerned will be human exposure to the r.m.s. power for the specified averaging time and human exposure to peak pulse power (where applicable). Initially multiply mean power density calculations by the reciprocal of the duty factor to assess peak power densities; repeat later using the measured values, if significantly different. The actual limits involved will be those applicable in the country concerned or specified for the organisation concerned.

- 2 Set the instrument to the highest range (greatest power density range) and ensure that the full scale power density value is adequate according to the calculated values.
- 3 If the system is a radar or other pulsed equipment, ensure that the measuring instrument is suitable for pulsed measurement and that the pulse duty factor is not such as to endanger the instrument (see Chapter 9).
- 4 If the equipment is a very high power one, check whether it can be run initially on reduced power. If the power attenuation factor is known, e.g. reduced to half power, the measured values can be scaled linearly. A cross check can be made on the attenuation factor by taking a measurement on axis at a safe place and then increasing to full power and checking the reading again, having left the instrument undisturbed in the same place.
- 5 The instrument 'maximum hold' facility should be switched on. In starting the survey at a reasonable distance from the antenna, a slow walk across the beam with the 'maximum hold' facility switched on will record in the instrument memory the highest power density met. This can be repeated at different heights and then closer to the radar until the relationship between measurements and calculations at ground level is established and the surveyor has a good idea of his own safety.

In comparing calculations and measurements, due allowance must be made for the possibility of enhancements from local causes such as metallic

objects and structures, if these cannot be avoided. After making the required measurements at points previously defined on the general lines of Figures 10.5 and 10.6, the results should be recorded. The measurements may include the assessment of general safe distances for people and for flammable substances and EEDs.

In large or critical surveys it is usually desirable to duplicate the measurements with the aid of a second surveyor thus giving increased confidence in results. It is also important to check that the transmitter power output has not changed from time to time, either directly or by means of a portable radio contact. Radars can be monitored by listening for the p.r.f. on any small personal medium or long wave receiver to ensure that they are still working.

People are sometimes puzzled by strange readings near the ground round the feet although the main beam is above the ground at that place. The levels are usually low and can involve patterns of peaks and troughs corresponding to the wavelength in use. They usually result from reinforcing rods in concrete hard standing, roads and runways and are normally of no consequence except when significant energy is impinging on the ground, e.g. with beams with negative elevations.

Measurements may also be needed around and at the rear of the antenna, positioning markers accordingly for subsequent reference. All measurements can be recorded on test record sheets, for example, with reference numbers allocated to each cone and alphabetical letters allocated to each height above ground, thus providing a logical basis for transcribing the data later on to copies of diagrams like Figures 10.5 and 10.6.

In some cases it may be preferable to put the test results in directly onto copies of drawings like those mentioned above, so as to get a visual impression of what is happening whilst actually working on the survey. This may be needed in order to determine what further survey measurements are to be made.

If it is necessary, the whole measurement sequence can be repeated at other beam elevations, taking care to watch for ground enhancements with negative elevations.

Beamwidth checks

It is often useful (but not essential) to do a rough check of the beamwidth using two cones as markers. It is probably most useful to those testing new designs since odd things can happen on prototypes!

It should be done in the intermediate or far field and should be done at a height which approximates to the beam axis. A piece of wood of suitable height or a survey pole can be useful as a measuring stick to keep the instrument probe at constant height above ground.

Starting on the beam axis, move out across the beam until the meter reading drops to a half of the value on axis, keeping the probe at the same height all the time. Mark the half power point with a cone. Move back to the beam axis, keeping the meter height as before. Move out to the opposite side of the beam to the half power point and mark with a cone. The distance between the cones will be an approximation of the 3dB bandwidth and can be checked against calculations.

In Figure 10.7, if the distance between the two cones is B (m) and the distance on the beam axis to the antenna is D (m), the half beamwidth angle in degrees is:

$$\theta/2 = \tan^{-1}(B/2D) \text{ and hence } \theta = 2 \times \tan^{-1}(B/2D)$$

This method can also be utilised for lining up cones along the beam axis. The axis should be half way between the two cones. In practice, it does become automatic since, as measurements are done at each distance, the beam must be found and the highest reading at the given height and distance taken. Cones are then pulled into line.

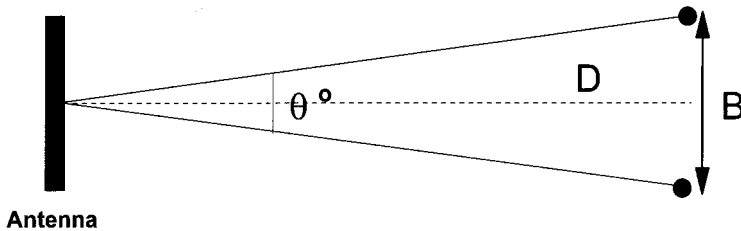

Figure 10.7 Beamwidth approximation by measurement

This does not need to be done with precision, but just accurately enough to find the beam. Surveyors have been known to miss the beam at the further distances from the antenna due to misalignment of the markers, with the consequent risk of missing significant RF levels or at least recording incorrect information. Hence it is important to find the beam at every measuring point. Once again a small radio set will help to find a beam amazingly quickly!

It should not be thought that such full assessments of beams are often necessary. Mostly users of transmitters will be concerned about a particular place and will only need to do some measurements at the place concerned. The fuller assessments are more likely to be used by those associated with the design and manufacture of transmitting systems and with antenna R&D.

Appraising the effect of beam elevation changes

When calculations have been done on charts like those in Chapter 5, the resulting beam has an elevation of zero degrees. If during a survey it is necessary to get a rough idea of what will happen at positive or negative elevations, then this is quite easy. Figure 10.8 is an actual calculation for the far field of a surveillance radar. It could, in practice, have been amended in the light of measurements already done if the calculations did not seem to be representative.

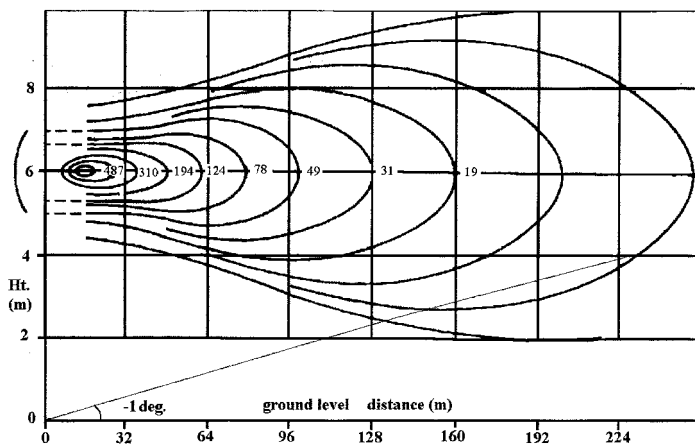

Figure 10.8 *Change of beam elevation on calculation diagrams*

The chart 'X' axis does not, except by possible coincidence, represent the ground since this depends on the antenna mount and the effective height to the antenna centre. This can be established from the scale of the 'Y' axis. In this example the height has been assumed to be 6 m and a new 'X' axis has been drawn below the existing one to represent the ground.

In order to assess the effect of the pattern being set to an elevation of -1° , a line has been drawn tilting the ground up by this amount. If personnel-clearance is being examined, another line above and parallel to this line could be drawn scaled, say, to 2.5 m. In many cases that height can be judged by inspection instead.

Examination of the diagram suggests that:

Somewhere between about 128 m distance from the antenna, the figures shown in the diagram should be considered to be increased by 6 dB due to the beam impinging on the ground with consequent enhancements – see also Figure 10.13 later.

If the subject was a fixed microwave beam rather than a rotating radar then whether the field will exceed the limits will depend on the standard in use – for example the ICNIRP occupational limit would probably be exceeded. It is likely, but not certain, that personnel-clearance for a stationary beam condition will be satisfactory up to about 90 m from the antenna.

If the subject is a rotating radar, then whether these comments would also apply will depend on whether rotational averaging is appropriate (Chapter 5). If so this will reduce the effective exposure level. Note that rotational averaging is not applicable to human peak pulse power limits nor to flammable vapours assessments because at least one pulse and usually many pulses will occur in the period when the beam irradiates the subject.

This method of quick examination of ‘what if’ situations can be very useful. Angles can be pre-marked on the diagram and a transparent ruler used to act as a line. It is important to derive the angles by trigonometry and not with a protractor, due to the disparate scales.

A point often overlooked when setting safety boundaries for microwave beams near to the ground where the elevation is zero or positive is illustrated in Figure 10.9 which shows a vertical section of a beam at zero elevation. A clearance check is often done for a limited distance from the antenna (shown by man A), it being assumed that beyond that the field will diminish with distance. However it can be seen that man B is not quite so lucky and it may, depending on frequency and the relevant permitted level, be hazardous.

Measurement of RF levels at elevated working places

Previous paragraphs have dealt with the general assessment of the radiation levels in a beam under relatively ideal conditions near to the ground. This provides general information which can be extrapolated to other situations.

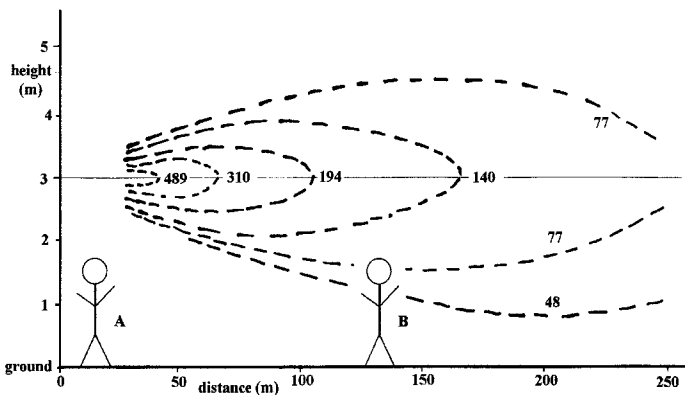

Figure 10.9 *The danger of superficial assessments of safe distances with microwave beams*

It follows that where antennas relatively near to the ground, which can be measured by the foregoing methods, still need to be considered in regard to their elevation coverage because the beam may impinge on buildings and tradesmen doing building work, towers and technicians climbing them and any other people working in elevated positions, it is necessary to align the beam, usually with the aid of an integral telescope, to the places under consideration.

Measurements are then made under representative conditions at the locations of interest. The levels to be expected will be roughly those found in the general beam assessment at the corresponding distance, if this is known, but with the possibility of up to 6 dB (power density $\times 4$) enhancement due to metal structures at the elevated positions – more if a resonant antenna is the reflection object, due to the antenna reciprocity theorem.

It will be possible to determine in advance whether it is necessary to do such measurements, from consideration of the results of the general beam assessment or existing assessment records. If it is obvious that the power density on the beam axis at the distance from the source corresponding to the location being considered is low even if increased by 6 dB, then there will be no need to do a measurement there.

Sometimes with a fixed beam it is not possible to do a direct beam assessment as described in the previous paragraphs although the antenna is relatively near to the ground, because physical access cannot be obtained due to ground obstructions. In these cases it is necessary to measure at adjacent workplaces, one by one. Where the only problem is obstructed access close to the antenna, it may still be possible to do some measurements on the beam axis further from the source, though assessments at the specific workplaces would suffice.

Measurements where the antenna is mounted high above the ground

Where the antenna is mounted high above the ground and set at zero or a positive elevation it is obvious that no systematic survey of the beam can be done as described for antennas near to the ground. On the other hand it is unlikely to provide any significant field strength at ground level where most people work if the ground is flat, but this obviously depends on the actual height and transmitter power.

It can however irradiate places as described in the previous paragraph, so that these need to be considered.

Figure 10.10 is typical of a large airport (considering only radars) and is a plan view of the locations of four surveillance radars R1 to R4 inclusive. Each of these has an SSR thus making a total of eight radars. In order to assess the possible problems it is necessary to draw the corresponding elevation view (Figure 10.11). The potential problems which come to mind are:

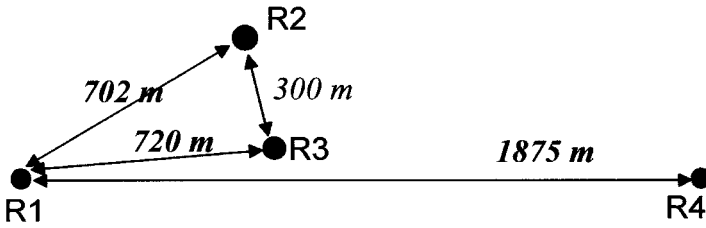

Figure 10.10 Typical airport radar layout in plan view

- 1 The effect of beams from R1 radars to climbers on R2 and R3 towers; similarly from R4 radars to R2 and R3 towers and also irradiation between R2 and R3 (R2 to R3 and vice versa).
- 2 The requirement for the summation of these beam power densities at R3 and R4 at some places up those towers.
- 3 The need to consider flammable substances in use in work on those towers and on buildings

Tabulating the possible combinations of 1, 2 and 3 above is worthwhile as they are not easy to remember. The table can then be annotated with results.

- 4 The local topography – rising ground nearby could be a problem – not so likely with an airport but possible at area transmitting sites in the countryside.
- 5 The use of cranes and ‘cherry pickers’ where the operators might become exposed, as might technicians changing airfield lights on lighting towers.

Similar considerations may apply to any high buildings nearby and any associated building and maintenance activities.

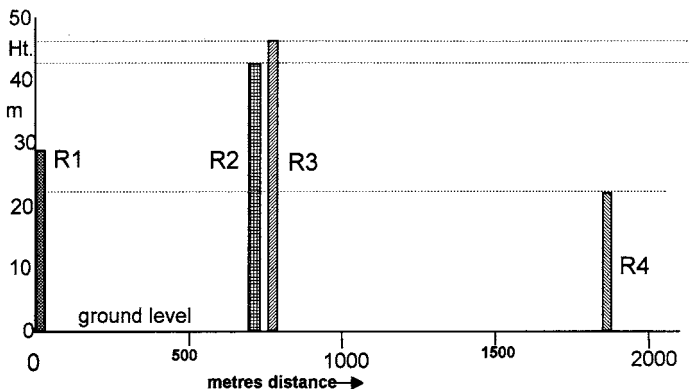

Figure 10.11 Elevation section diagram for Figure 10.10

In these type of situations, the first step will involve some careful calculations which will clarify and possibly eliminate some of these possibilities. This will include checking from calculations that levels at ground level are acceptable.

If calculations, with suitable provision for possible field enhancements from reflection, leave the matter in some doubt, it will be necessary to operate the relevant system in its fixed condition or if a moving antenna, in a worst case situation according to the objectives of the survey, e.g. lined up optically to the places where people work or have to climb past those places. When undertaking calculations with radars with transmitters in diversity arrangements, the implications of diversity must be assessed (Chapter 5, Part 3).

Use of hydraulic platforms for measurements

Sometimes there may be a special need to do measurements higher than is safe with step ladders. The use of hydraulic platforms (often referred to as 'cherry pickers') consisting of a long arm with a small cradle platform on the end such as is used for servicing street lamps, may seem to be the only practicable method. As indicated in the example which follows there are serious measurement limitations due to field perturbation from the metal arm and cradle frame. The cradle itself is usually made of fibreglass or some other non-metal. The method can only be used reliably in experimental situations which take into account or utilise these effects.

Figure 10.12 illustrates one occasion when such measurements were made on a prototype planar phased array radar. The measurements were plotted

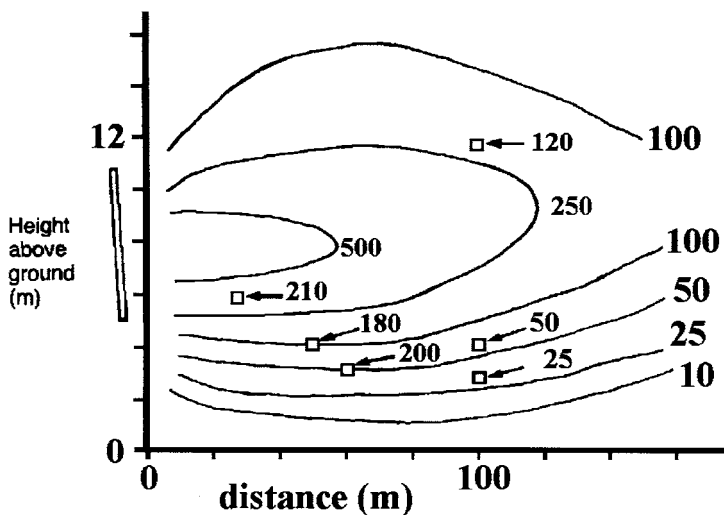

Figure 10.12 *Use of elevated platform for special measurements*

on the original power density calculations. In the figure, the numbers not associated with little boxes are the calculated contour values. All values are in Wm^{-2} . The numbers associated with the square box markers are the measured values. It can be seen that at distances greater than 100 m the measurements though few, since this was not the area of interest, are comfortably close to the calculated values.

Closer to the antenna, reaching into the near field, there were some high values. Measurement was limited to the full scale value of 200 Wm^{-2} available on the instrument. The operations are potentially hazardous and the method was only used by the author for special investigations close to the antenna in connection with the testing of a novel shielding material at high power densities. The value of the diagram is to show that the use of such things as cherry pickers or other metal lifting equipment is self-defeating if used for real measurements since the changes of field produced, e.g. the fourfold increase at 60 m distance (200 Wm^{-2}), would provide fictitious real field figures. It just happened to be the only way of evaluating the material attenuation at high field levels and the radar itself was not being surveyed, only the attenuation of the material was in question.

The shielding material proved only to be novel in that it provided its own appreciable and unpredictable field enhancements due to the fact that it was comprised of conductive particles which moved when the material was handled!

Points to watch on surveys

When dealing with conventional microwave antennas the elevation setting scale of the feed horn should not be confused with the beam elevation. The latter needs to be established from an expression which gives the relationship between these two. For surveillance radars having two separate back-to-back antennas, each needs to be surveyed separately. In assessing the rotational average power density, the results of the two calculations need to be summed.

Care should be taken to assess the effective radiated power correctly when two transmitters are used in diversity operation, e.g. in radars. The treatment of their mean and peak power densities may be different due to the practice of staggering the pulse timings.

Where a telescope is fitted to an antenna, e.g. at an aperture in a dish, this should be checked. At least one case has occurred where the telescope used in this way proved to be a waveguide at the frequency used!

Where sector blanking is in use, the limits should be checked.

Field measurements for personnel access

One of the most common survey objectives is to establish personnel-clearance, that is to say the ability to walk about at ground level in safety close to operating systems such as a radar or a fixed beam system.

Taking 2.5 m as the highest that an average person can correctly hold and manipulate an instrument and probe, then personnel-clearance requires the investigation of a volume constituted by the area in which access is sought times the 2.5 m height. In principle, this involves measuring all over the area at a number of heights up to 2.5 m.

With microwave frequencies, where the wavelength is short compared with the human body, there can be considerable differences in field across the section of a human being due to reflections from conductive objects and the ground. Hence the need to measure at a number of heights and spatially average the measurements.

The IEEE C95.1–1999 standard recommends that in such cases, measurements should be made at 20 cm vertical intervals up to 2 m and this would need to cover a width of about 2 m to represent a place where a person is to stand. For those who use 2.5 m for clearance it would seem appropriate to use 25 cm height increments in these circumstances.

This method would be very satisfactory for specific work places in small areas. Covering a large area on this basis would be an insuperable task and it would be more practicable to measure across the whole area at two or three heights and then inspect the data. It may be found by inspection that only a few places need the more thorough method since the levels elsewhere are low.

As noted earlier in connection with Figure 10.9, when doing personnel-clearance measurements it is important to remember that when beams are horizontal, i.e. zero elevation, the measurements at ground level may be low for some distance out and then increase. This obviously depends on the effective height of the antenna above ground as high mounts reduce the problem compared with low mounts. If the beam elevation is negative the increase in levels further out from the antenna may additionally be enhanced due to reflections from the ground. This can typically be 3 to 6 dB and more in those cases where reflection is from a resonant object, e.g. spare antenna stored on the ground.

Figure 10.13 shows actual measurements on a 4 m dish antenna with 1 kW CW at about 4 GHz. The antenna centre was only 4.5 m above ground and the elevation was -1.5° . In the diagram, the antenna beam axis is shown as the dotted line. At first sight the negative elevation may look much greater than 1.5° but this can be seen to result from the disparate X and Y axis scaling. This particular measurement was not done for personnel-clearance as the access to the beam area was prohibited, so that no measurements were made at 2.5 m height. The measurement was part of those used to determine the data in Figure 10.14 which occurs later in this section.

It is reproduced here to show the enhancement which can occur from the ground in a real case – in this case between 140 and 180 metres from the antenna. In the first 80 metres the levels are quite low up to 1.5 m height and inspection of the measurement data suggests that this might also be the case to 2.5 m.

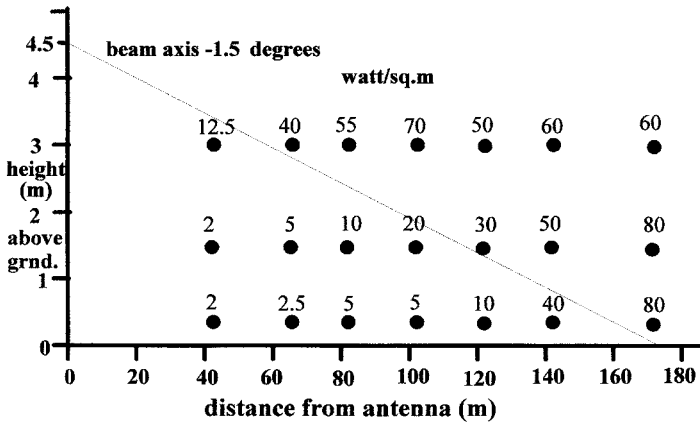

Figure 10.13 Measurement on a microwave beam tilted towards the ground

Near field measurements

Because safety management involves the control of people who may work close to antenna systems, it is often necessary to measure in the near field. The measurement of power density, as discussed in Chapter 7, is not done directly but via either electric or magnetic field sensors, the instrument calibration being done on a plane wave basis. This means that technically, the power density measurements are not accurate in the near field.

However the quantity actually measured (Vm^{-1} or Am^{-1}) is correct and can be recovered by doing the reverse calculation from power density to the appropriate field unit. The generally accepted method is thus to measure the electric and magnetic field components and compare each with the permitted limits. Up to 300 MHz, this can be done and the near field–far field boundary from 30 MHz to 300 MHz is a relatively short distance anyway so that many VHF and UHF measurements may be in the far field.

Above 300 MHz, or for one instrument supplier 1500 MHz, it is not possible to measure the magnetic field as no instruments extend beyond that frequency. Consequently it is necessary to use wideband power density meters based on electric field sensors. The general practice is to measure power density and accept that the instrument will tend to give values higher than the real power densities in the near field and is therefore, conservative. This is due to the fact that the time phase relationship between the field components will be different to the normal in-phase plane wave condition assumed by the instrument.

The electric field value can be extracted and will be correct but this is only of value if actual electric field limits are given in the relevant standard.

It is also necessary, when assessing the safety of people to use spatial averaging across an area representing the cross-sectional area of a human

body to take into account changes of power density across the exposed person in near field conditions.

Characterising beam systems

It was noted in Chapter 9 that some equipments can be generally characterised in such a way that the safety provisions can be defined with some degree of confidence and incorporated in the equipment handbook. This will usually only apply to the manufacturer but may occasionally be done by a major user.

It will mainly be the case where the nature of the equipment is such that sitting will normally be clear of all buildings and people so that there is little need to change the safety provisions on that account.

An example of this was a field-portable communication system consisting of a dish antenna on a low mobile mount driven by 1 kW RF. This is used in the field with little chance of any buildings round it because of the need for a clear signal path.

The equipment was aligned on a flat surface about 1 km long and measurements carried out as illustrated in the previous paragraph, taking in a set of measurements for every half degree of positive and negative elevation in the elevation range. The results were studied and some contingency added for the practice of fine alignment of the dish in azimuth and elevation to secure maximum signal strength.

The result was the definition of a prohibited area in the form shown in Figure 10.14. This is a rectangle having a fixed dimension with the length

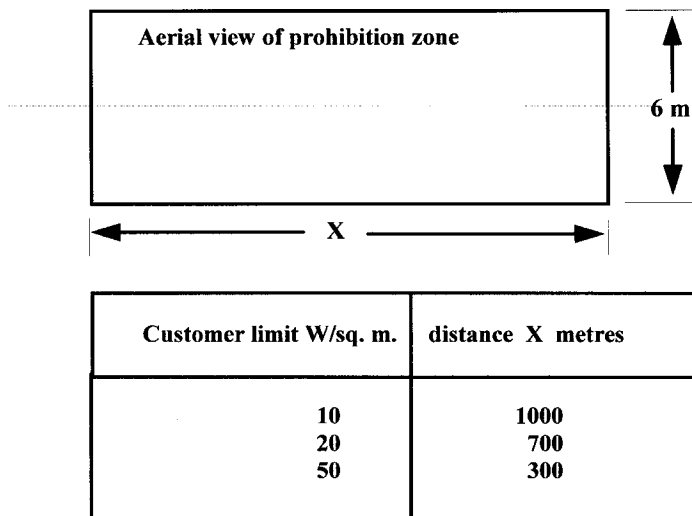

Figure 10.14 *Mobile equipment prohibited areas*

varied according to a table which reflected the safety levels used by different customers at the time. A general height prohibition was also added although this was a formality as no one was likely to use a crane or anything similar over the area.

It will also be noted from Chapter 6 that mobile telephone base antennas are treated in this way by most companies who tend to define a safe distance rectangle around the antenna as in Figure 6.18. Of course this does not preclude the need to check a specific installation, especially one in multiple use by several organisations as there may be a need to consider both summations and local enhancements.

Measurement of rotating radar systems

This is a topic which gives rise to differences in opinion and it should be said that the views expressed in this section are those of the author from experience of about 980 surveys, many of which involved radars from their design stage onwards. Whilst many colleagues would agree with these basic points and their qualifications, there are those who would differ!

The basic points are:

- 1 Where they exist, only thermocouple-type instruments should be used.
- 2 It is my view that radar measurement should be done with the radar stationary and rotational averaging calculations done afterwards. Sometimes it is said that this is not possible but I have never found a radar engineer who could not arrange it!
- 3 Some people not only measure r.m.s. power but feel the need to try and measure 'peak' pulse power (which, as explained elsewhere, is in radar work, the r.m.s. power within the pulse).

Given the relatively large uncertainty of measurement in those two measurements, against the low uncertainty of measurement of the components of the duty factor (pulse duration and pulse repetition rate) this seems both difficult and pointless, when set against the alternative of the simple multiplication of the r.m.s. power density by the duty factor reciprocal.

I have seen reports which attempted to do the peak pulse power density measurement and produced values half way between the two, without realising the fact since the surveyor had no radar background.

The first two points need some qualification since with the rapid developments in radar systems there will always be cases where current measuring methods need rethinking.

With regard to point 1 above, a method used by a colleague many years ago to try and make measurements whilst the radar rotated involved taking stationary measurements at each of the distances from the radar which were to be used for the 'when rotating' measurements. He then repeated the

measurements at exactly the same distances with the radar rotating and finally determined the correction factor for each distance. This was claimed to work well within those limits but details were never made available.

If there is no instrument of the type described in 1 above available in the market at the frequency concerned it may be necessary to use one which has a 'compensated diode' detector. In this case the matter should be discussed with the supplier who may be able to supply correction data for the more common cases. Where very narrow pulses are involved this may not be recommended.

If the radar permits adjustment of pulse duration so that for test purposes it can be set to a pulse width which is covered by such data, it may be possible to do the measurement and recalculate the results on the basis of the relationship between the normal and temporary pulse durations.

If contemplating adopting a method for radar work, the contents of references 51 and 74 should be studied.

Special cases of movable beams

Conventional moving beam antennas

As discussed in Chapter 5, beams which do not rotate or otherwise move on a cyclic basis and which may, therefore, dwell in a particular orientation, cannot be treated on a 'rotating beam' basis if the result could be to irradiate a person at levels exceeding the permitted limit. This can apply to height finder radars, tracking radars and to any irregularly moving system which may irradiate people in excess of the relevant standard by either dwelling in their direction or by making a large number of passes in their direction in a short period of time.

Obviously, if a beam is virtually stationary, tracking a target on a bearing which corresponds to that of the people being exposed, the dwell time might be long if the period of interest in the target is significant and the target track is a directly approaching or receding one. Whether this can happen will depend on the relative height and position of the people liable to exposure.

The requirement to use the stationary measured power densities implicit in the possible continuous irradiation of people is generally referred to as using 'stationary beam criteria'.

Electronically-switched beam systems

Another category of moving beam is the spaced array system where transmit beams can be electronically switched without any motion being involved. Whilst mechanical motion can easily be detected and the failure indication used to switch off the RF, it is not necessarily possible to provide such a system to determine when something has caused a beam to switch incorrectly and expose individuals.

In the case of spaced array antennas where there is no visible motion, it is usually considered necessary to use the worst possible case scenario to produce safety criteria based on the assumption that the beam has failed to that worst case situation unless there is an inbuilt failure detection system.

It is important where innovation in design is concerned, that safety should not be left until someone notices the lack of effort in that direction. It is understandable, since the struggle to produce and commission new designs produces a harvest of problems which need attention. However it is not acceptable, since safety is a design parameter, not a 'let's worry later' factor. With the current tendency for people to sue at the slightest provocation, such neglect may bring a train of retribution.

Also, for these modern systems the designer should assist in the determination of the survey methods required and their implications. Often where people and equipment can be adequately separated a simple safety boundary and hence a simple survey may be possible at only the cost of some spare land being out of bounds.

Spatial and time-averaging methods

Spatial averaging

Spatial averaging is used to average measurements over areas and volumes. An example has already been given in respect of averaging over an area, the height and width of a person in a field. Repeating this process over a ground area and averaging the sum of the averages of each set of measurements effectively averages a volume.

With many analogue instruments of varying ages still being in wide use, their use is discussed first here. Averaging measurements can be fairly tedious, though made easier by the use of an instrument averaging facility, available on most analogue instruments. In practice, when the levels being measured are well below the permitted level, e.g. when checking rooms which do not contain RF sources, the measurements might be simplified by limiting them to perhaps three vertical intervals rather than the 20 cm vertical intervals mentioned earlier.

The manual method is usually to survey the area slowly at the first height interval, recording the highest field of any reading found and then repeating at the other two intervals. Where significant readings are found, a vertical sweep from ground to the highest level specified is done to see whether there are any readings higher than the three being recorded. If the three readings are the highest ones anywhere and well below the relevant permitted limit, the three can be averaged to give a worst case spatial average.

This conservative approach obviates the need for recording many readings for each sweep and doing arithmetic averaging operations to no good purpose except to end up with a lower overall average. However, if the

readings found are close to or over the limits, it will be necessary to do formal averaging on the tedious basis mentioned at the beginning of this paragraph. It is necessary to move sufficiently slowly to allow proper readings to be indicated.

An interesting case arose when the author was conducting a training course on the premises of a client in their lecture room. On switching on a measuring instrument, zeroing it and holding it up with the meter side facing the students to explain the operation, one student asked why it was reading full scale. Investigation of the unfamiliar building led to the discovery that a microwave source was radiating on the hut roof. Yet the building was a full time dedicated lecture room!

With the ability to use the more modern facilities of some instruments, particularly some digital instruments, spatial averaging can be done at the press of a button and most of the manual data recording is unnecessary as it can be logged on the instrument as mentioned in Chapter 7 and downloaded to a computer for manipulation. Compared with the manual example above, the amount of work saved in recording readings when full averaging and digital recording is done is obviously great, particularly since manual data recording will often include the manual conversion of units, undertaken by a simple switch function on digital instruments.

However, whatever instruments are used, remember to check whether any RF sources actually exist in or about the area concerned. Then initial attention can be given to such equipment because, whatever averaging is done, if it is possible that people can remain close to a source where levels are high for a significant time, there is no point in obtaining spatial-averaging results which imply that the whole area is safe.

Time-averaging

The limits for field quantities given in most standards are, by definition, the average values over a time period which is specified. For occupational purposes the averaging time is normally one tenth of an hour (6 minutes) at least up to 15 GHz but there are variations in individual standards. There are three ways of using time-averaging:

- 1 Where the radiation field varies unpredictably with time. Averaging this by manual time-averaging is tedious and rarely, if ever, done. About the only place where it might be expected is during the development of a new transmitter and the tendency would be to use the maximum value.
- 2 The special methods of measuring rotating microwave beams earlier in this chapter which provide for rotational averaging directly and are time-averaging methods.
- 3 Where a short exposure is involved. For example, consider the case where it is occasionally necessary to walk straight through an area where the

measured power density is, say, twice the permitted limit and the time-averaging requirement for this limit is six minutes. If the person was able to walk through in less than 3 minutes, the time-averaged power density would be acceptable providing there was no exposure in the next three minutes.

Time-averaging involves recording the meter reading continuously or at frequent intervals and at the end of the time period presenting the time-averaged value. The methods which can be used are:

- (a) Recording the output of the meter from the meter recorder output terminals on a chart recorder which has an accurate time axis. This gives a picture of what is happening but does not offer averaging unless the recorder is particularly sophisticated. Sometimes the recording can be averaged by visual inspection, but otherwise it may have to be done by tedious analysis.

An alternative is to pass a data output from the measuring instrument to computer storage and perform averaging afterwards. This would usually need a fibre optics interface on analogue instruments whereas the facilities are built into digital instruments.

- (b) Using an instrument which has time-averaging facilities included. Instruments offering time-averaging facilities are able to do averaging automatically. They offer one or more pre-set averaging times which can be selected. It is then only necessary to press a start button and the instrument will stop and display the average at the end of the time period.

With an automatic measurement system it has to be accepted that large readings caused by interference, which would be noted when doing normal manual measurement, will get averaged with other readings. It may, therefore be desirable to run the time-averaging several times if such interference is known to be prevalent. This problem was found to occur in other contexts not specifically dealing with safety, e.g. an outdoor antenna test range where radar equipments were also under test, and where up to five per cent of readings had to be accepted as impossible and deleted.

Ground communications systems

There is an enormous diversity of equipment used for communications purposes from microwave to the lowest frequencies used for communications. Microwave communication equipment can be treated as detailed in the foregoing text.

Apart from microwave equipment, UHF, VHF, HF and MF equipment may be involved in communications. A wide range of modulation methods may be used from CW keying using morse code, through all the other

possible forms. The transmission of speech and digital data are two common functions of communication systems.

Large fixed tropo-scatter systems

There can be quite serious hazards associated with the very large high power systems using huge 'billboard' shaped antennas. These should not be confused with the tactical mobile systems also mentioned earlier, which use conventional dishes. For those unfamiliar with such fixed systems, illustrated in Figure 10.15, the side view is analogous to the side view of an overhead projector (the RF feed horn on a low ground mount) 'projected' onto a super large 'screen' – the billboard antenna. The 'billboard' title comes from the fact that the very large curved surface antenna resembles the very large advertising billboards often used in many countries.

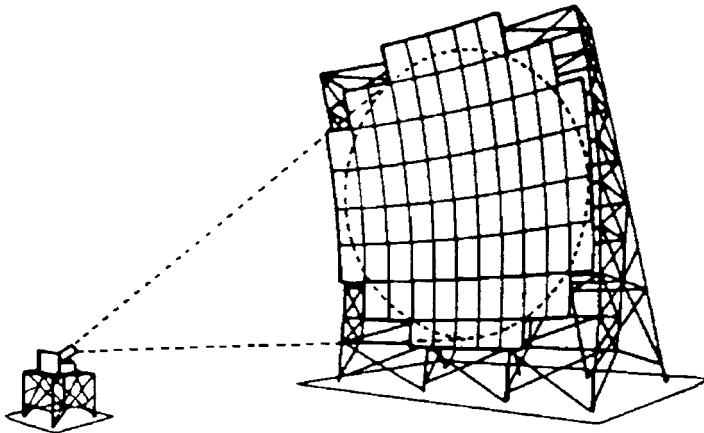

Figure 10.15 *Fixed tropospheric scatter installation*

It can be seen that the gap between the RF horn and the antenna structure is an area of considerable potential hazard unless suitably fenced or otherwise secured. Figure 10.16 shows the on-axis power density calculation produced by a colleague of the author, the equipment designer, for a 10 kW system. It can be seen that the consequence of anyone getting into this region could be very nasty and clearly these figures could not be checked by a surveyor on the grounds of personal safety and the fact that currently available instruments would not have appreciated those levels!

These calculations were in fact done in connection with an incident mentioned briefly earlier in the book where a customer reported that one of his employees had been working on the side of the antenna structure when

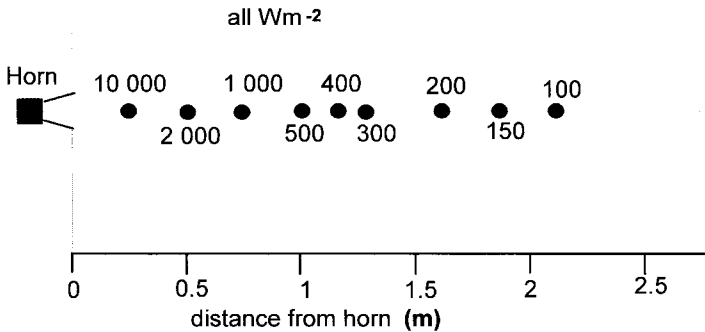

Figure 10.16 Axis power density calculation for Figure 10.15

it was realised that the equipment was operating. Judged from the information given it was considered that the man’s position in respect of the antenna had not quite reached the more hazardous region. Nothing more was heard from the customer after that.

It was also one of these equipments which was involved in another incident mentioned earlier where a security guard in a Middle East country, who had a silver plate in one leg reported that it got hot when on patrol. The advice given was obvious!

MF and HF wire and mast antenna systems

Fixed MF and HF systems may use large wire antenna systems occupying many acres of land. Lower frequency systems may use a metal tower as the radiating element. Feeders may take various forms from coaxial cable to open-wire transmission lines.

The usual practice is to determine safety boundaries for antennas and prohibit access to those areas. Since HF systems may change frequencies and antennas and during any twenty-four hour period for propagation reasons, the overall pattern for a site can be complex and surveys need to explore all the antenna combinations used.

Since only technical staff will normally be used within the antenna area of the site, control of access should be exercised via a ‘permit-to-work’ system plus the declaration of any necessary prohibited areas.

The complications that arise include:

The safety of riggers who may have to climb towers to change antennas or to maintain them. There is a possibility of burns both when climbing and when moving around the site due to the electromagnetic fields present and the field distribution changes which take place as antennas come in and out of use.

Major broadcasting organisations have specific procedures for climbing to cover both of these aspects, particularly for the routine maintenance work

such as painting masts, etc. This generally includes procedures for the use of lifting cradles used to raise people to working height. See Chapter 3, Part 2 for incidents involving this activity.

At MF and HF frequencies the magnitude of electric field strengths needed to ignite flammable vapours or fire EEDs are considerably less than for VHF and UHF. Apart from any such substances stored, it may be necessary to control the use of such materials in maintenance, since this activity can result in the substances deliberately being brought close to antennas.

To emphasise the importance of this aspect at these frequencies when carrying out surveys, Figure 10.17 is included. This was created by calculating values for 1 to 30 MHz based on threshold data from BS6656:1991 [31] for gas group 2c. Two sizes of pick-up loop size (10 m and 65 m) have been assumed. It is of course necessary to refer directly to the standard when doing specific investigations.

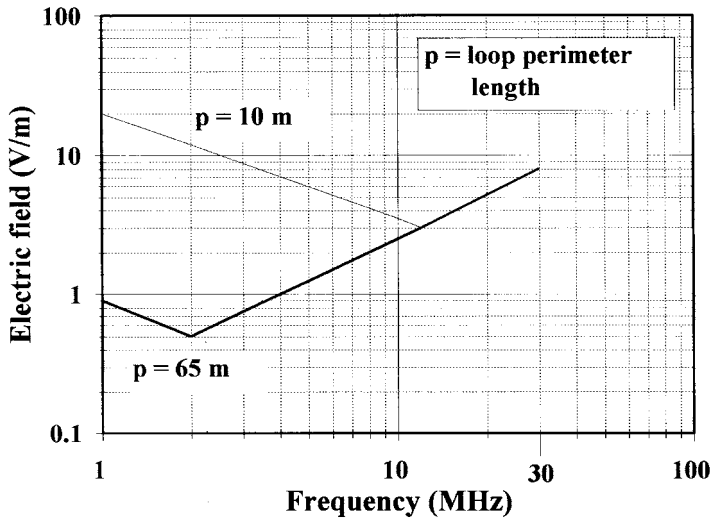

Figure 10.17 Field strength safety limits for the 1 to 30 MHz band calculated from BS6656:1991 for flammable vapours, gas group 2c

The figure shows the threshold electric field strengths for the conditions mentioned, higher values giving rise to a risk of ignition. It can be seen that the thresholds are surprisingly low at HF. Although other standards may apply to many readers, the order of the levels should be similar since they derive from practical research. The importance of this is also to illustrate that the ignition of flammable vapours can take place at levels which are well below the limits for human exposure. Some people assume that what is safe for people is safe for flammable substances.

Radiation levels are generally high very close to open wire feeders and external antenna matching units, as they are when close to arrays. Time-averaging is generally used to safeguard the surveyor by permitting short inspections of suspect feeders. This means a short exposure followed by withdrawal from the field to meet the six minute or other averaging provision. Particular care is needed on any public visits or open days since HF arrays are very interesting to look at and can tempt visitors to go up to them.

As noted earlier, frequencies below 30 MHz (or 300 MHz according to which standard is used) are not assessed in terms of power density but rather, the electric and magnetic fields are separately measured and compared with permitted limits. This obviously applies to MF and HF frequencies. At very low frequencies some of the measurement instrument problems listed in Chapter 7 should be taken into account.

The aim of a survey of a large antenna field will depend on the nature of the site, the interaction with the public and the degree of operational technical access to the antenna field required. It is therefore impossible to generalise as to method. However, the likely aims will be:

- To determine the permitted limits of access and therefore the boundaries of areas where access is to be prohibited.

Note: It is important to allow for multiple irradiations, where applicable, in all safety assessments (Chapter 5).

- To determine the safety of climbing and other technical access requirements and the procedures by which these may be controlled.
- Verifying that the public are not subject to exposure in excess of permitted levels and also that they cannot incur any burns in contacting metal objects in the public domain.
- There may also be a need look at certain EMC aspects such as the safety of motor vehicles on roads close to the antenna in respect of any vehicle electronic control systems.
- Checking hazards to flammable substances on and off site; similarly, EEDs need to be considered, if relevant.

The method of surveying will depend on which of these factors are applicable. It will generally start with a rough assessment of the antenna patterns and the magnitude of the fields at convenient points. This will then give a starting point for deciding further measurements.

From the surveying point of view, one simplification when possible, is to make as large a prohibited area round complex systems as practicable, rather than do an enormous amount of work to make it smaller. If no one needs to go into such an area, or it can be controlled for infrequent access by a 'permit-to-work', then there may be no good reason for increasing risks by arranging the smallest possible area. Surveys involving a large area of land are very tedious and expensive. The problems can be simplified to some

extent by formalising human access on site to defined pathways which are suitably marked as opposed to allowing people to choose their own routes. For administrative purposes the other areas should be deemed as 'not surveyed' and classified as prohibited areas. This can allow the survey to be concentrated on the pathways. The difference in the amount of work can be appreciated from consideration of Figure 9.5 in Chapter 9, which itself is only a small site, and an actual MF or HF site may have twenty or thirty transmitters with many antennas and many acres of land.

UHF, VHF and HF Whip and rod antennas for ground use

These may be simple rod antennas or arrays of rods. Most simple rod and whip type antennas are used on mobile installations where they form part of the vehicle installation. Arrays may be used in fixed applications or in portable systems. Portable systems, in contrast to mobile installations, may carry masts and more directive antennas for erection at the place of use.

The rough calculations for such antennas can be done by the methods given in Chapter 5 which contains a typical table. A knowledge of the power into the antenna and the antenna gain is all that is needed. Where such antennas are used in ground installations, the survey methods are quite simple and give few safety problems if the antenna is sited properly so that where necessary a small access prohibition around them can be specified.

Where such systems are badly sited by being placed amongst people or close to anything which could be hazarded then, often, moving the antenna is the answer. For HF, particular care is needed to keep unnecessary metal objects out of the field and hence prevent burns.

For most simple antenna systems which do not occupy a lot of ground area, simple prohibited access boundaries will be the best method of ensuring safety where the fields present necessitate it. In the occupational situation where only adults could access the area, often ropes or plastic barriers and suitable signs are used.

Tower mounting is often used for communication antennas. A useful example is for air traffic control (ATC). The antennas are usually VHF and UHF dipoles with a gain of a few decibels and there may be quite a large number fitted on each tower. Safety assessments on towers are difficult due to operational conditions which usually preclude switching off any systems, e.g. with air traffic control systems.

Looking at it from a practical point of view, there are two main activities involving people climbing towers, maintenance on the tower and maintenance on tower mounted equipment. Climbing central ladders will usually be safe since the antennas are normally mounted about 1.5 to 2 metres out from the tower so that the distance from the centre of the sort of tower often used for ATC will be perhaps 3.5 metres or more except at the top of the tower.

Safety checks can be done at a time when radio traffic is known to be highest. Tests of this sort with groups of antennas on the mast each fed by 40 to 50 W transmitters and operating as required by the aircraft traffic, produce quite low readings or none at all on the centre of the ladder. More powerful transmitters may give different results.

Statistically, the surveying climb may need to be done a number of times and last for long enough each time to get a representative reading over a busy traffic period. The general task of climbing towers is often complicated by other factors such as potential irradiation, by radar beams and by the increasing tendency for all sorts of antennas to be added to existing masts, including equipment for people not directly associated with the site, e.g. radio telephone equipment and other local communication equipment, microwave dishes and the like, owned by other operators. It becomes very difficult to calculate the likely exposures since the times at which individual systems transmit is seemingly random.

On a time-averaged basis there may still not be a problem with a steady climb but when work is to be done on the tower, specific arrangements may be necessary to deal with any excessive exposure from particular sources. It may be necessary to do some representative measurements at such work positions. If an antenna is to be repaired or replaced, this might also mean checking that it will not give rise to burns when handled due to being driven parasitically by one of the other antennas!

Not all communication towers are generously proportioned. Many towers are very slim and may have to be climbed on the outside thus bringing the climber much closer to antennas. Climbing and working on such towers should be controlled on the basis of survey results so that overexposure can be avoided.

Mobile vehicle-mounted systems, especially HF systems, pose particular problems. Experience in the survey of such systems has shown up a number of factors which need careful attention during surveys:

HF antennas driven with significant power and mounted on the side of vehicles can present hazards to those standing near the antenna and can be a serious worry in the public domain unless access can be restricted. The hazards include burns and exposure to fields which exceed the limits of the relevant standard. In particular, military vehicles with HF whip antennas fixed on the vehicle side may need safety covers, e.g. a perspex cover, to prevent contact with the live lower end of the antenna. This is particularly important at public displays since children are likely to touch anything which looks interesting.

Careful and systematic measurements are needed over the frequency band, both for field strengths and contact currents. This is one activity where the new contact current meters now coming onto the market could be useful in checking vehicle structures.

Whilst VHF and UHF are likely to provide less potential for burns and shock from induced RF in odd metal structures than HF, VHF sources in

particular, can still cause these hazards. They need to be checked thoroughly for odd resonance effects with structures and objects, since resonant objects may involve appreciable induced energy.

In almost any mobile system which is connected to remote communication lines, it is desirable to avoid contact with the lines at the vehicle end when operating, since they are inclined to collect RF energy directly.

Satellite ground stations

Fixed satellite ground stations with large and threatening-looking dishes do sometimes cause public concern, mostly quite unjustifiably.

The beam is very narrow and directed at a satellite, the elevation of which depends on the location of the station and the satellite concerned. Antenna systems are normally fitted with elevation limit switches which stop transmission or antenna motion when any attempt is made to drive the antenna below specified elevations. This is illustrated in Figure 10.18.

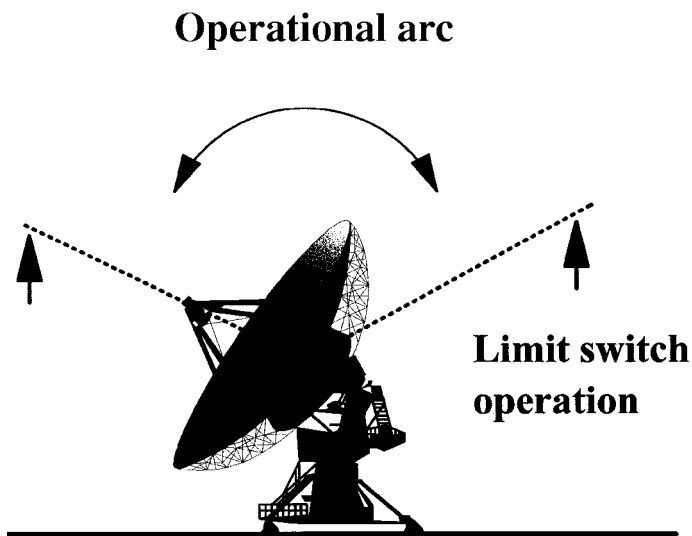

Figure 10.18 *Satellite ground stations*

Surveys will normally be concerned with local radiation applicable to station personnel, checking the correct operation of limit switches and other local control systems. Practical surveys show that, for most sites, checks outside the site will largely be for psychological purposes, since significant radiation at ground level (i.e. levels near to the limits of the relevant standard) is normally not experienced. Note that for the very large antennas, the near field can extend for a number of kilometres.

Portable satellite systems may need treating differently depending on the circumstances of location and operation and on the power and system characteristics. For example, a portable system deployed in the public domain may need to be characterised as discussed earlier to define a safety zone around it, with the provision of any necessary safety instructions to be followed by the operator. EMC effects may also be a problem if used on airfields.

Broadcasting on VHF and UHF

High power broadcasting transmitters for television and VHF radio usually have antenna systems on high towers often located in rural situations. In such circumstances the power density on the ground in the public domain is low, the hazardous fields occurring around the actual antennas. The main problem which involves survey measurements is the need to climb towers for antenna work, tower maintenance and the maintenance of aircraft warning lights on towers.

Climbing is likely to involve near field exposure and hence the previously mentioned interest in trying to find some sort of 'true power density' measuring instrument, since the conservative readings of conventional instruments are not helpful. The problem is a difficult one, especially where towers are shared by different broadcasting organisations, so that tower climbing may involve radiation from antennas belonging to the other organisation. Typical antennas are described in Chapter 2.

The VHF antenna is often located below the UHF antenna and the radiation levels for a high power system can be typically 43 to 137 Vm^{-1} in the climbing space behind the VHF tiers with 'hot spots' exceeding 275 Vm^{-1} . Where it is necessary to climb through this, it is obvious that it may be necessary to switch off or switch to lower power (both are presently used methods).

Broadcast antennas situated on the top of buildings in highly populated areas may pose other problems. Survey methods therefore need to be tailored to the situations obtaining at the time and the safety management methods will depend on many factors including station broadcasting times, whether maintenance can be done during close-down, whether power can be reduced, etc.

The European Broadcasting Union (EBU) publication Tech. 3278-E[84] is a European document dealing with the RF hazards in the Broadcasting sector and includes calculations of TV and VHF fields.

Avionics and ship systems

Avionics and ship systems have in common the fact that they move about whilst operating powerful radar, communications and other equipment.

Avionics systems

The usual requirement for avionics systems which run in the proximity of people when taxiing, taking off and landing is to determine safe distances for people and for other hazardous materials such as flammable substances and EEDs. When stationary with equipment operating, the same provisions apply plus any specific servicing safety provisions when a bay or an electronics pod is opened.

Safe distances can be established by calculations and confirmed by measurement. Contingencies need to be added to allow for enhancements from reflections.

Radiation arising from maintenance cannot be calculated and periodic monitoring is only a partial safety measure since defects may change the amount of radiation. Local in-situ monitoring is one current method using personal pocket monitors or a universal monitor which can be placed in the general area (see Chapter 7). It should be remembered that such monitors basically monitor a cone in front of the body so radiation from the rear is only covered if the wearer turns round regularly.

Surveying the inside of aircraft can be complicated due to the structure, access limitations and similar factors. However places occupied by people can by definition be checked since they are accessible. Leakage in inaccessible places may not matter from the human exposure point of view though it may be relevant to aircraft operation, potential interference, etc.

External radiation surveying is much simpler and generally involves moving the aircraft to a safe location where no harm can be done by operating systems.

One risk which may occur is that due to leaving radiating equipment, e.g. radars on after landing with possible risks to ground personnel and to flammable or explosive substances, the latter particularly in the military field. To some extent this could be tackled by taxi-track radar detectors operating warning flashers.

Ship systems

There is an increasing tendency to have more and more transmitting equipment on ships, especially warships when the size of such ships is tending to reduce. This means a corresponding increase in the number of antenna systems, some of which are well above deck but with others relatively close to walkways and personnel. The climbing of structures will need to be controlled to avoid unexpected hazards to people.

For fixed antenna systems, one method is to define safety distances after measurement by painting circles on the deck around antenna systems. The field inside radio cabins using MF and HF equipment can be high round the feeders. Whether this significantly affects the operating personnel depends

on the layout of the cabin. In some cases, open feeders, usually copper tubes, may need to be shielded. A predominant hazard is that many ship structures such as wires, walkway rails and the like may become burn hazards due to induced energy, particularly if of resonant dimensions.

The problem of safeguarding personnel can be extremely difficult in such environments. The UK MOD has done work on the use of limb current measurements as an indicator of exposure because of the limitations of field measurement methods in such environments but unfortunately the MOD information is not in the public domain.

The general topic of limb and body current measurements is dealt with in Chapter 3.

Rotating microwave beams such as radars need surveys to investigate possible exposure of people. Controls are needed to prevent hazards when docking, especially those effects which might put flammable substances and EEDs in the dock area at risk. There can also be effects on dock side machinery electronics, e.g. safety systems on cranes and other lifting gear where circuits such as travel limit controls have been affected. Similar problems can arise in respect of stores being loaded at sea.

The extent of such risks depends on the nature of the vessel and the immediate environment, i.e. dock side, other ships, etc. Some operations can be safeguarded by determining safety distances for radars and other high power microwave beam systems and observing them. Other operations, particularly loading hazardous stores, might require the system to be closed down.

Handling survey data

The amount of survey data collected varies enormously according to the nature of the task, the number of sources involved and the physical arrangement of the equipment on the site. The data collected should be related to the measurement plan for the survey.

Each planned measurement or series of measurements should have an objective and the results can be tabulated against the objectives.

For simplicity of presentation, leakage surveys and exposure surveys have been treated separately below, many surveys will involve doing both types of survey work.

Leakage surveys

For this type of survey, the situation is, in principle, quite simple. Leakages greater than the permitted limits, whether to a standard or against a contractual commitment need rectification. The important thing is to ensure that the remedial work is clearly defined. There must have been many cases where the wrong waveguide flange or other part was stripped down needlessly, because of some ambiguity in the instructions.

Whilst a lot of leakage data will have been recorded and can be included in the survey report, the reader will perhaps be best served by an easy summary table which only lists those leakages where rectification is needed. A complete table full of figures which are mainly acceptable distracts from the task in hand, which is that of dealing with the unacceptable.

Exposure surveys

It is convenient to examine human exposures and any other factors such as flammable vapours hazards separately.

Human exposures to be considered

1 Rotating or scanning microwave beams

Where it is permissible to do so, rotationally-averaged power densities can be calculated as in Chapter 5, for the places of interest.

2 Fixed antenna systems

The actual measured power densities or other field quantities will be used in these cases.

3 Multiple irradiations

The possibility of multiple irradiations will have become apparent during the survey and need to be allowed for using the expressions in any standard being used.

4 Personnel-clearance around sources of radiation (Figure 10.19)

This is usually stated as the ability to walk around an equipment at ground level and can be established from the measurements taken. It may be

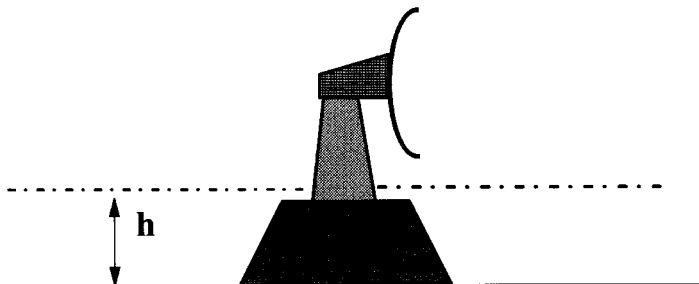

Figure 10.19 *Personnel clearance around equipment*

conditional (dependent on specified operating parameters) or unconditional. The maximum height used (usually 2 or 2.5 m), should be stated. In some cases it will not be permissible to go near equipment and this will involve the definition of a prohibited area.

When siting equipment the value of height in reducing ground level fields should not be overlooked as a prohibition area around equipment limits routine access for everyday work, e.g. changing lamps, cleaning and grass cutting, etc., and may require equipment to be switched off for access.

5 Prohibited zones round equipment

These should be determined from the measured radiation levels and the zone clearly defined. It is usually, though not necessarily, a circle.

The area should be visually inspected if this has not already been done, to see whether there are any possible sources of enhancement which might have been overlooked. If not already detected and measured, this should be done. It will be likely that the result will be to increase the size of the prohibited zone or modify the shape of it.

Whilst most provisions for such areas will apply on sites at which the people concerned are technical staff, i.e. in the 'occupational' category, if the public also have access either regularly or for displays, educational visits, etc., it may be necessary to ensure that such boundaries also meet any 'public' limits applicable in the country concerned.

6 Personnel working at elevated positions

The locations concerned should have been the subject of specific measurements and that should determine whether work exposure at each location is acceptable.

Climbing a tower to service equipment on the top and passing through a beam on the way up may be acceptable on a six minute average basis, although it may not be acceptable to stop and work at the place where the beam irradiates the tower. If this is the case, there should be appropriate markings on the tower.

Where any clearance to work is conditional, the conditions should be clearly stated. For example:

'Operation on platform X is permissible only when radar Y is operating at a positive elevation of x° or greater.'

(This consolidates what was probably a verbal agreement with the operating authority on the minimum positive elevation of the radar. This should then result in a suitable instruction being issued to operating staff.)

‘Tower Z may be climbed by authorised technicians to service equipment A at the top of the tower providing that climbing and descent is continuous through the small part of the tower which is marked with hazard warnings; for any other type of work no climbing is permitted when transmitter No. 1 is operating, except with a specific permit-to-work.’

(An example of a case where one well defined activity is authorised and all others are to be dealt with by a permit-to-work.)

7 The public (where relevant)

Consideration needs to be given to any situation where the public become involved in irradiation from transmitters. These can include farmers alongside site boundaries, pedestrians and horse riders on rights of way often found alongside sites (very common in the UK), etc. Another situation which may need examination is during public ‘open days’ held in such premises.

MF and HF antenna systems

When considering safety recommendations in situations involving wire antennas and arrays it is not only important to look at fields from antennas but also to include:

- (a) Likelihood of burns being incurred from conductive objects.
- (b) The fact that transmitter antenna arrays are also good receivers (antenna reciprocity theorem); a ‘not in use’ antenna may be energised from an ‘in use’ antenna and the terminals and structure of the array might give rise to shocks and burns.
- (c) Any burn and shock hazards likely outside the site, i.e. in the public domain.

Hazards to flammable vapours and EEDs

The key factors to remember are:

- (a) Modulation should be taken into account when assessing field levels and the risk to flammable vapours.
- (b) With pulse transmission, peak power density or peak electric field strength is the relevant parameter, not mean power density or mean electric field strength.
- (c) For EEDs, the relevant parameter will depend on the thermal time constant of the igniter and guidance can best be obtained from expert sources including any standards dealing specifically with electrically-fired explosives.

Children and RF fields

Most of the foregoing naturally addresses the safety of the personnel engaged with RF radiation equipment and the public, where applicable. However children constitute a peculiar part of the 'public' in the sense that they are not always the people outside the site boundary fence but have a tendency to be able to overcome most security provisions known to man and to climb anything in sight. It is also generally recognised that warning notices do not help much where children are concerned and indeed often constitute a positive attraction if they include any frightening images!

It follows that where children may try to get access, very substantial safety provisions are needed which may include 'fold up and lock-up' ladders at the foot of towers, PIR night detectors and similar devices. Unattended radiators in the public domain may need substantial fencing to deter the boldest climber. HF stations could be a particular problem due to the easy possible contact with HF antenna arrays. However, due to the need for a large area of land it is fortunate that many such sites are relatively remote and rural.

11

Designing to reduce radiation hazards

This chapter looks at the investigation and analysis of product radiation safety in terms of the analysis of possible risks, the possible technical methods which can be used to deal with them and the need for the documentation of safety aspects. Finally, details of some materials used for shielding are given, together with assessment and calculation data.

Introduction

When RF and X-ray surveys are carried out on sources of RF energy the survey findings will, from time to time, require some remedial action to be taken. Where such surveys are carried out on prototypes and pre-production models of new equipment designs, a body of knowledge about common design weaknesses is created and can be used by designers to guide future design work.

Experience shows that there can sometimes be a lack of knowledge on the part of the designer of the hazards of RF radiation and the methods used to reduce the hazard. This is particularly the case where a designer has just moved from very low power work where relatively little knowledge of RF radiation safety was needed, to the design of higher power equipment where the situation can be very different. A similar possibility occurs when a designer moves from low voltage equipment to high voltage equipment without much experience of X-ray radiation from the high voltages applied to high power electronic tubes.

The design process

The product design process is a complex one and is conditioned by marketing policies and objectives. Products designed for particular customers may be designed against individual requirements specifications, either written by the customer or produced in a generic form by some body or

organisation having an interest in that type of product. Products designed for a general market have to take into account the views of those purchasers known to the producer and any lack of knowledge of the market may have adverse consequences. This is true of most aspects of a product, e.g. performance, function, structure, cooling methods, and so on.

Often the wider implications such as radiation safety may be inadequately investigated so that customers find the product does not adequately meet their own requirements for the safety of their personnel. Also, the approach to radiation safety does not, in the case of most types of RF power source, lend itself to a simple 'safe product' concept. This arises from the nature of radiation since, to take the example of the RF transmitter, the aim is to radiate RF energy efficiently and as a result, it will rarely be safe to stand close to the antenna except with very low power systems.

Evidently, in the case of transmitters, process machines and similar RF power sources we can only talk about a safe installation where the concept of safety involves a mixture of safety provisions such as the control of unwanted radiation from cabinets, feeders and other items which may be accessed frequently by the operating staff and by the control of access to the point of intentional radiation.

In the case of fixed ground transmitters, this involves the exclusion of people from the proximity of an antenna, which may not be a single antenna but a choice from a number of antennas depending on the time of day and the required frequency. This may require barriers, management control and, in the worst cases, electrical interlocks.

It follows that the equipment user cannot look to the equipment designer for complete radiation safety where any hazard arising stems not from the intrinsic design but from the siting, use and management of the product. He can, however, expect guidance from the product producer about siting and use. Further, where transmitters and antenna systems are involved, the wanted radiation may impinge on adjacent people and installations outside the control of the owner of the transmitter.

Sometimes the product producer takes on a 'turnkey' project where he supplies a complete station or system and takes responsibility for all aspects of it. In these circumstances, it is essential that the site and the surrounding buildings and installations are taken into account in the station or system planning process.

Figure 11.1 identifies some of the questions which need to be considered both when advising the customer generally and when taking overall responsibility for the project.

1 Flammable vapours

Standards exist for the identification of risks involving flammable vapours which provide some guidance on the nature of the problem, outline how to

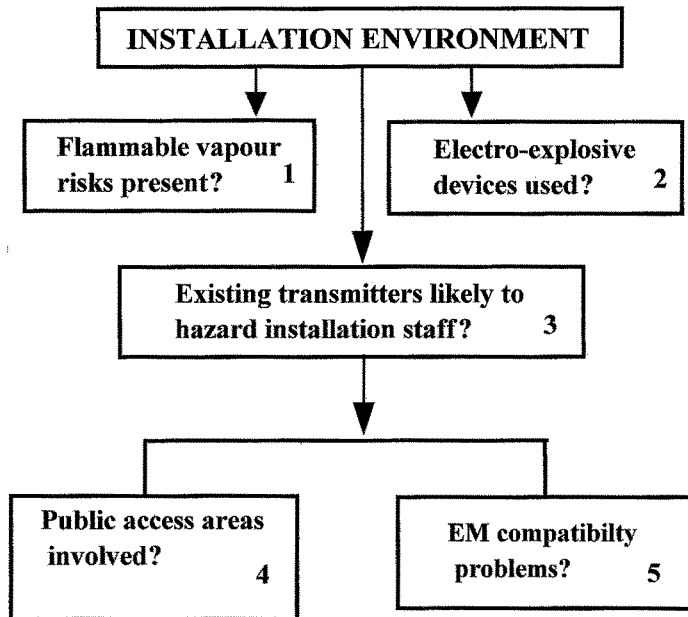

Figure 11.1 *Flow diagram – the installation environment*

approach the subject and undertake calculations to determine whether there is a hazard. A typical standard, British Standard BS6656:1991 [31] provides such information and also gives some tabulations of transmitter types and powers with the relevant safety distances, which can be used for an initial appraisal (see Chapter 5). In any specific case, the national standard concerned should be used.

Possible commercial and industrial installations which may need investigation include gas terminals and distribution systems, petroleum and similar installations for storage, processing and distribution and other processing plants involving flammable vapours.

2 Electro-explosive devices (EEDs)

This topic is conceptually similar to that above for flammable vapours but can be split into two parts – civil and military devices. Commercial detonators are covered in some standards including British Standard BS6657:1991 [32]. Commercial usage includes quarries, stores and explosives manufacturing plants.

Military explosive risks need to be evaluated in conjunction with military experts. Because of the operational handling and movement of stores containing explosives, the situation needs constant review.

3 Existing transmitters on site

When a supplier secures a contract to supply further equipment to an existing site, e.g. an additional radar, a problem which often arises at the time of delivery of the equipment is the realisation that it has to be erected and installed where there is a significant RF radiation field from existing equipment. This can lead to considerable problems with installation personnel who generally find out about the problem when they notice sparks from the tools they are using! It is clearly important to establish a procedure for safe installation as part of the contractual negotiations.

4 Public access areas

In countries where public paths and access routes are established in law and mapped on national maps, it is necessary to ensure that these are recognised and antennas sited so as to avoid radiation fields in excess of the nationally-established safety limits.

Public access is not limited to paths and also includes residential occupation and the use of land for any purpose. In all cases, an essential requirement is the avoidance of the possibility of the public incurring shocks or burns from conductive objects in their possession (vehicles, bicycles, agricultural equipment, etc.) or from objects located where the public have lawful access such as scrap metal, metal clad buildings, caravans, parked vehicles and similar potential shock and burn sources.

5 Electromagnetic compatibility (EMC)

Unwanted interaction between RF radiation sources and other equipment is not always to be seen as a safety issue. The effects may lie between safety and economics. At the one extreme, EMC problems with an aircraft may, in the worst scenario, interfere with the aircraft control system and hazard the aircraft.

In lesser cases, communication may be jammed. At the other extreme, interference experienced by an administrative computer may merely be a nuisance with an economic rather than a safety consequence, i.e. extra computer time needed to do a task.

When surveying likely sites for new transmitter installations or for the additional installation of further equipment, it is virtually impossible to quantify the potential EMC implications for the local environment and it is necessary to err on the safe side when making judgements.

For new sites, the acquisition of extra land with which to separate the RF source and the local inhabitants, roads and other potential problem areas is one of the options, though this carries a cost penalty. On existing sites the degree of freedom may be limited and more care is needed with the siting of extra equipment.

Whilst it was noted above that EMC problems may often merely be in the nuisance category, this should not be treated too lightly. In the eyes of the public there are few electromagnetic 'sins' more unforgivable than interference with radio and television reception! On occasions, a portable television set may be found to be a useful piece of test equipment. Another form of EMC nuisance which has been experienced is interference with hearing aids in the public domain. Clearly this is unacceptable and has to be rectified.

Increasing care is needed with masts and towers when planning new sites as the public have either been much influenced by the worries generated in the mobile phone field or use them to object to towers being erected. Often the objections are aesthetic but safety is the inevitable fall-back argument.

Planning design from the radiation safety viewpoint

Introduction

It is difficult to look at the radiation safety aspects of product design in isolation from the whole process of design and the object of this section is not to promote isolation but instead to identify those elements that should be included in the overall design plan. The actual solutions to specific radiation problems will not always be the obvious ones since designers have to trade-off any resulting effects on performance and cost.

Competent transmitter designers do not need telling how to do their jobs but generally do appreciate the sort of guidance on RF radiation safety which will reduce the likelihood of expensive rework to reduce excessive radiation. It is important to recognise that most transmitters have a long life so that, in a climate where safety limits in standards are constantly being tightened, design should be conservative in this respect, if later, costly, modifications are to be avoided.

Figure 11.2 is a sample flow diagram illustrating some key elements of those radiation safety considerations necessary for the design of products producing sufficient RF energy to require a safety assessment. Most of the general points will also apply to any consequential X-ray radiation produced. The diagram can be applied both to the provision of a design for a particular customer and to the design of products aimed at a general market.

The obvious difference when interpreting the notes which follow is that in some cases there is a specific customer to talk to, whereas with speculative design for general markets, the marketing and sales functions have to answer the questions implicit in headings 1 and 2 of the flowchart. The latter case may involve meeting the tightest radiation safety requirements existing in the selected market area.

Since the intention is that the steps identified in the flowchart should be integrated into the design plan for equipment which is being designed, items

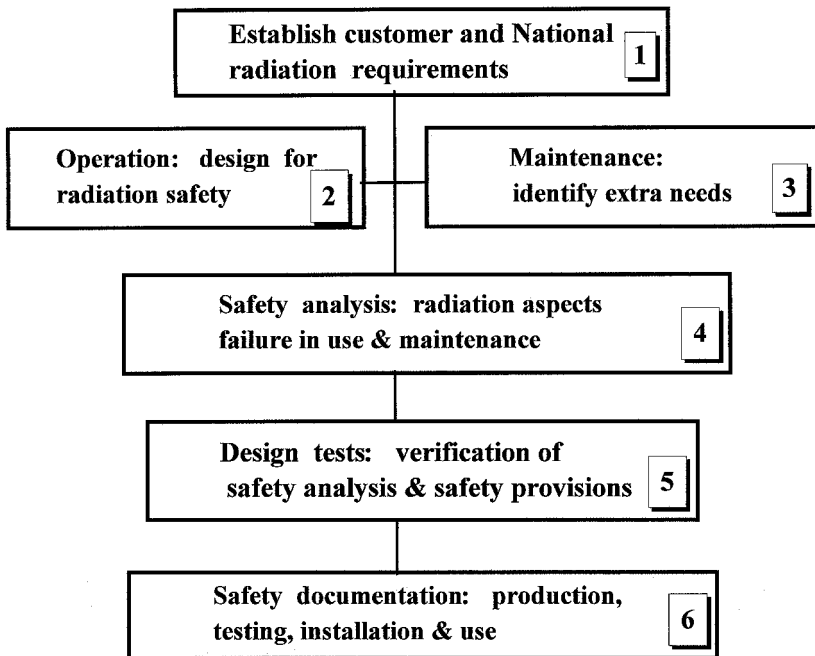

Figure 11.2 *Flow diagram – product design considerations*

such as the radiation safety analysis form just one element of the total safety analysis for the product.

The flowchart also applies to RF sources other than radio transmitters, for example RF process machines and RF sources for medical use, the degree of applicability depending on the nature of the product.

Customer and national radiation protection requirements

Some customers, particularly large ones, have corporate or local requirements and standards to be met which may be reflected in a specification or local management document. These may include the standards used for RF and ionising radiations and, importantly, a conservative organisation may have tighter requirements than the national guides and regulations.

It is clearly essential that there is no misunderstanding about this, since remedial action after delivery can be a very expensive proposition and is also a poor advertisement for the supplier. Some large customers have specific test methods to be applied to the radiation acceptance tests on the delivered equipment which may involve additional test equipment, compared with that normally used.

As far as national requirements are concerned there are variations between countries in the approach to both RF and X-ray safety. Sometimes regulations are accompanied by codes of practice which may, as in the UK, have a legal status.

If a transmitter produces X-rays it generally falls into the category of a 'radiation generator' subject to similar legal provisions to those applying to X-ray machines and other similar sources. It is clearly important to take into account all the legal requirements in those countries constituting the proposed market.

Some countries even have requirements for the calibration of measuring equipment to be performed either in that country or in one with which they have reciprocal agreements. Failing to become aware of such requirements can result in considerable expense and lost time. Most countries do require the formal calibration of ionising radiation measuring instruments.

Certain countries may also require formal 'type approval' of some types of transmitter, covering all aspects of the product design and performance, especially ship transmitters and the like.

As mentioned earlier, the European Union (EU) has a Directive on Ionising Radiation (the Euratom Directive) and is developing a Directive on Physical Agents, which includes requirements covering RF and other types of radiation. This is expected to be based on the ICNIRP98 document. There is also a further Directive on Machines which takes in RF processing machines.

The broad basis of the provisions in all the EC countries will therefore be the same. It should be noted that EC Directives are implemented in the national laws of those countries. Consequently, some of the detail of the implementation may be expressed in different ways.

Using products

Personnel who operate transmitters or other RF sources need to be protected against excessive RF radiation exposure and, where applicable, against X-ray radiation. Here 'excessive' means in excess of the relevant specification requirement, standard or legal provision. Protection should be related to the supplier's safety instructions provided with the product.

For example, if the operator has to carry out an adjustment or other manipulation with a radiation shield removed or a door opened then some provision is needed to compensate for the loss of shielding resulting from opening the door or other shield.

The aspects most relevant to the operator include:

- Leakage reduction from the transmitter cabinet, feeders, antenna matching units and all the associated items which constitute a system or installation. Both X-ray and RF should be covered where applicable.

- Adequate information on the radiation safety aspects of the equipment, including any prohibitions applying to the opening of inspection and other panels.
- The ability to identify feeders and other associated equipment by means of unique markings, so as to avoid any hazard resulting from accessing the wrong items.
- Some National product safety requirements expect designers to take into account possible minor misuse of products. This includes measures to reduce the possibility of accidental misuse due to inadequate instructions or other causes.

Product maintenance

- 1 Often during maintenance, the range of potential hazards is increased due to the diagnostic techniques involved in determining what is wrong with an equipment. It is important that maintenance instructions provided by the supplier should provide for adequate safety in respect of radiation. A typical case may be one where the safety interlocks on a door are required to be overridden in order to perform a maintenance adjustment. If opening the door to perform the adjustment reduces the protection to the maintenance technician, then a temporary servicing screen or other device should be provided so that the protection is restored.
- 2 Maintenance engineers are inclined to remove parts in order to get a better view of what is wrong. They then switch on again and observe the results. Where X-ray radiation is concerned, it is essential that adequate signs and maintenance warnings exist to prevent the maintainer taking out the X-ray shielding including any fortuitous or intended shielding provided by other metal objects and structures which are nearby. Similar RF limitations should be made clear. Marking warnings on shields is more effective than a pure reliance on maintenance handbooks since most of us, if we are honest, tend not to resort to the latter until we are in difficulties with fault finding.
- 3 Since practical installations of transmitters may involve long feeder runs, antenna exchanges, dummy loads and similar ancillary items which often need to be moved or operated in some way, as well as to be maintained, it is important to ensure that inspection plates and other access provisions on these items bear adequate warnings to prevent inadvertent access to RF energy. In very high power systems it may also be necessary to consider electrical interlocking as well.

The risk tends to become greater when working on equipment which is not close to its parent transmitter since when there are, for example, a number of feeders running together, it is easy to pick the wrong one unless they are clearly marked due to difficulty in following the runs visually.

- 4 The supplier provides maintenance instructions for the user and it is important that the range of known maintenance requirements are

considered and any design actions relating to them are documented. The writer of maintenance instructions, or better still a different person not associated with the design activity, should always try carrying out the draft maintenance instructions, following them literally. This could result in a significant improvement in maintenance instructions!

Radiation safety analysis

Having looked at the design requirements, the purpose of the safety analysis is to examine the adequacy of the proposed design against those situations which might be expected to occur in use and in the maintenance activity, including any radiation hazards which can result from an equipment failure.

Until the equipment reaches the testing stage it will not be possible to be certain of the efficacy of such things as the proposed shielding material thickness but the protection intended to be provided can be recorded against the circumstances envisaged, e.g. normal operation, maintenance adjustment, etc. It can be useful to list particular items of relevance such as doors, removable plates, windows and to identify the corresponding safety provision, e.g. interlocked, marked with a warning, lead glass window used.

Where the design is a project for a specific customer there may be more definitive safety aspects to be considered such as the contribution of the customer to the final system. This might include wiring, buildings and utilities. The effectiveness of RF earthing is often in question. There are situations where an inadequate approach to RF earthing may provide an RF burn hazard at lower frequencies.

Design tests

It is very important to ensure that design tests include thorough testing of all safety features and explore all the aspects outlined in the previous paragraphs. They should be carried out in the worst cases likely such as maximum power output, likely worst frequencies and modulation depths. For pulse transmissions the worst case pulse characteristics should be explored.

Particular care should be taken to test whether safety circuits are likely to be interfered with in an adverse way. It is not unknown for RF interference to operate fire detectors of the electronic variety and these are sometimes built into transmitters or transmitter installations.

Similarly, digital or other circuitry used to control interlocks and other safety systems should also be checked for spurious operation over a number of frequencies if the transmitter has a wide frequency range. Sometimes only one frequency or one part of the frequency band may cause interference with such circuits.

The effectiveness of any windows fitted to the transmitter should also be specifically checked. Lead glass windows need to be checked for X-ray

protection and ordinary glass windows with any associated wire mesh for RF reduction should be checked for RF leakage. General leakage testing should include checks on contact strips around doors and for leakage at door handle catches which often prove to be a leakage point.

Not all safety equipment in high power transmitters is aimed at personnel protection as some is required for the protection of the equipment. Such items include overload detectors, thermal monitors and flash-arc detectors to protect against flash-arcs in high power electronic vacuum tubes. It is equally important that these items are free from any adverse effects caused by stray RF radiation. The consequences may be economic, e.g. changing an expensive high power tube when the fault is in the flash detector and not the tube.

Design safety documentation and records

It is important, both for compliance with national health and safety requirements and for proper product quality management, to keep a good record of design safety features, any tests carried out at the original design stages and after any modification which could possibly affect radiation safety.

Because of the great importance of the product modification activity and the need for a continuation of the quality management of the product, it is usual to include some form of declaration on modification documentation so that someone suitably qualified to do so certifies whether radiation safety may be affected or not. If in doubt, a positive assumption should be made and tests carried out.

Modifications often pose considerable risks insofar as the solution to, say, a functional problem which is, understandably, the preoccupation of the design engineer, may bring with it unexpected side effects. Records of changes in safety features and the safety test results should be retained on a systematic basis so that the product safety record at any point in time provides a cumulative picture of the care taken to ensure human safety.

Technical aspects of design

Shielding

The common objective of X-ray and RF shielding is to confine the radiation to the cabinet, case or box surrounding an RF source so that the only radiation appearing externally is the wanted output to an antenna, applicator or work piece. The materials used to do this differ in their response to the two types of radiation. Basically shielding materials may absorb and reflect energy. In the case of RF energy, most is reflected back into the equipment.

RF absorber materials may also be used at higher frequencies, the object being to minimise reflection by absorbing energy. Where modern plastic-based RF absorber material is used it is important to ensure that it cannot be

thermally overloaded. Excessive temperature may lead to fire and to the production of very toxic vapours from some materials. This has been known to happen in a building where too much power was fed to this material.

The choice of materials for shielding needs to be both appropriate for the type of radiation and compatible with other metals used from the point of view of avoiding galvanic corrosion. For X-ray shielding, discussed in more detail later, the aim is to absorb the X-ray energy and material is chosen for its attenuation properties.

The objective common to both types of radiation is for a transmitter design to attempt to confine or attenuate RF and X-ray energy as close to the source as possible. There are, of course, technical problems with shielding X-rays at the source, e.g. final power amplifiers, due to the capacitance added in the circuit if metal shields are brought close to these tubes. Nevertheless the basic aim should be borne in mind since the cost of dealing with leakages occurring at a number of places in a cabinet can be considerable, especially in respect of X-rays.

Cabinet design

- 1 The design of cabinets is obviously a key factor. Inset (flush) cabinet doors will tend to be better than doors which project outside the cabinet, i.e. externally hung doors. This is because the cabinet around inset doors provides extra shielding at the door edges.
- 2 'Spare' holes in panels or gaps between panels, especially in equipment where various panel or sub-panel optional items may be purchased, should be avoided by the use of blanking plates, etc.
- 3 Small inspection flaps and covers should be firmly fixed so that tools are needed to open them and radiation warning markings put on them.
- 4 Glass windows (usually provided to observe electronic tubes, RF arcs, etc.) should be shielded with a wire mesh to reduce RF leakage. Commercial 'windows' are now available incorporating such shielding.
- 5 Lead glass or equivalent should be used for such windows when X-ray leakage is involved. Wire mesh may still be required for RF leakage as lead glass does not provide an effective RF shield.
- 6 Where lead glass windows are used, the equipment drawings and the user handbook should carry suitable information. In the case of drawings, the window should be so closely defined as a purchased item that no inadvertent substitution with ordinary glass can occur. The need to inform the user is from similar considerations.
- 7 Where the transmitter output is via waveguide and there is a significant amount of X-ray generated, a lead gasket is often used at the tube flange.
- 8 A careful choice of earthing strip for cabinet door sealing is needed to ensure proper contacting without arcing. In particular, for microwave frequencies where the wavelength may be of the same order as the

contact finger spacing of the contact strip, the contact finger design should be such as to avoid possible resonant dimensions. Under the wrong conditions 'slots' can become efficient radiators. The spacing of fixings can also have a similar effect.

- 9 In high power HF broadcast transmitters, the earth contact strip used round doors can give rise to arcing and, unless substantial enough, the heat can cause some oxidisation and surface discoloration often resulting in increased contact resistance and subsequent greater heating.

Thin film plastic-backed contact strip materials, which may be suitable for low level signals, are likely to be unsuitable where there is significant energy since arcs may melt the backing and lossy materials may be heated by the leakage field.

- 10 Occasionally a transmitter might be located above ground level, for example on the first floor. Now most high power transmitters do not have a 'bottom' in shielding terms since they are traditionally located on the ground floor with a substantial concrete base. If such a transmitter has significant X-ray energy, there is always the possibility of an X-ray beam down to the ground floor. There may also be some RF radiation reaching the ground floor. Consequently, it is desirable to identify such aspects at the earliest possible stage.
- 11 Air ventilators and air filters can be a weak spot for leakage, depending on the nature of their structure and the materials used. Consideration of this aspect before manufacturing or purchasing such items will avoid unnecessary expense. In the case of RF leakage, a suitable wire mesh across the filter may again solve such problems. Proprietary honeycomb materials are also available.

Safety interlocks and safety systems

- 1 Equipment with high voltages present will have interlock systems to prevent electrocution. Where these interlocks are intended to act also as a protection against radiation, this needs to be made clear in handbooks and the like.

In maintenance, the practice of overriding interlocks is prevalent and in such cases, as noted earlier, servicing shields may be required to restore protection. In many countries the failure to provide proper shielding and interlocks, where necessary for protection against ionising radiation, may constitute an offence.

In cases where the structure of a transmitter is such that people can physically enter it via doors which are interlocked, it is necessary to consider provisions against failure of the safety systems such that a person may become exposed if the equipment is then switched on whilst inside. Equally, discharge facilities for charged high voltage capacitors must be reliable where contact with such connections is possible, e.g. when fault finding.

If X-ray radiation is present there is usually a legal requirement for the provision of a manual alarm to be operated by the trapped person. Common sense suggests that this should always be provided since there may, in any case, be electrical and RF hazards.

- 2 As mentioned earlier, RF fields can give rise to the spurious operation of some types of safety equipment and circuitry within the transmitter or the associated system.

Often those who design such circuits may have a role which does not give them a great deal of familiarity with RF radiation. Thus the transmitter designer should communicate such requirements and also ensure that the layout of transmitters and associated systems take into account the need to ensure the integrity of all elements of the safety system. Wherever possible, safety circuits should fail safe. Where it is not possible this should be clearly stated.

- 3 Interlocks in rotating antenna systems should be so arranged that rotation can be positively inhibited, preferably by a good quality key switch. Provision for the stationary operation of moving antennas is almost always required for survey purposes and should be provided for in the design, as 'standard'. There should also be an audible warning signal sounded before movement starts when rotation is switched on again. The energy in radar moving antennas is probably a greater danger than the radiation as illustrated in a light hearted but real point in a sketch by a colleague shown as Figure 11.3 A case such as this happened on a ship about two years ago.
- 4 Similarly, where applicable, provision should be made on rotating beam systems for a sector blanking facility. Where this is done by software, some thought needs to be given to the protection of authorised settings,

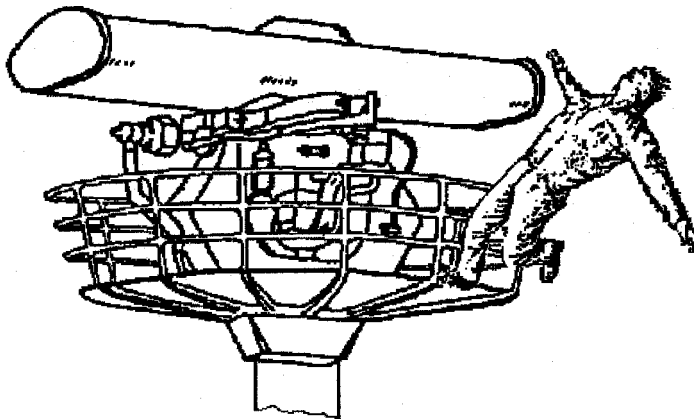

Figure 11.3 *Physical injury from moving objects (Courtesy Dr John Coleman)*

e.g. by 'password' access or some equivalent. Where the design allows, a removable key switch may be even better.

For all mechanically moving antenna systems, arrangements should be made in the design so that if movement fails, the RF radiation is switched off automatically. This prevents a failed system continuously irradiating people and is, by definition, a prerequisite for the assessment of moving beams by time-averaging, if otherwise exposure could exceed permitted limits in the 'failed rotation' situation.

Safety indicators

It has been found advantageous in many situations to associate a flashing lamp with the operation of high power transmitter systems by the provision of a circuit which is only energised when the antenna is fed with RF energy. This serves a number of purposes including distinguishing moving antennas being operated only for mechanical tests or running in bearings, from those which may have RF hazards. It also helps with surveys in indicating that the transmitter is still operating. The lamp needs to be located close to the antenna. It should be provided for by the equipment designer.

There may be a similar case for this on RF process machines though, as with X-ray machine installations, a steady red light may be more suitable as a flash may cause irritation to people because of their relative closeness.

Components

Where there is considerable X-ray radiation present in a transmitter, it should be noted that there is at least a suspicion that this can cause the failure of important components such as vacuum capacitors and some plastic dielectric capacitors. While this has not been proven, prevention is better than cure! Prevention may involve careful siting and possibly the shielding of such items. Generally speaking, a metal shield will be much cheaper than the component being protected.

The suppliers of electronic tubes will usually provide some information on the magnitude of the X-ray doses likely under particular conditions. See Chapter 8 for some examples.

Appropriate materials for high power work

High power transmitter output and modulator electronic vacuum tubes attain very high temperatures. Attempts to use modern shielding materials in the design stage, e.g. loaded plastics for X-ray shielding, have been known to result in the disintegration of the material.

Similarly, some materials which are suitable for EMC and other purposes may not be capable of taking the combination of RF and infrared heat from moderate or high power systems.

Warning signs

X-rays

The X-ray sign is international and consists of the trefoil in black in a triangle on a yellow ground. The symbol is shown at the beginning of Chapter 8.

RF radiation

In the UK a symbol for non-ionising radiation has been established for many years and is a triangular symbol consisting of a black radio tower emitting waves, on a yellow ground. It is shown at the beginning of Chapter 7. The US symbol is virtually identical.

Other signs

Other warning signs which do not expressly relate to radiation but reduce the general risks when measuring radiation include the identification of components which get very hot, signs indicating the location of hazardous substances and the general identification of individual antenna feeders and ancillary devices. Where relevant, UV and laser warnings may also be necessary.

Installations

It is important that in all cases where transmitter systems are installed, adequate safety information is passed to those undertaking the work. Designer–installer communications are often inadequate where safety is concerned. It has already been noted in Chapter 6 that RF earthing, which is often a big problem, is part of the design and therefore requires adequate definition.

Other factors, in addition to basic technical information about the products being installed, include the interactions with other equipment co-existing on the site, the possible need to sum fields to determine safe limits, safety markings and warnings needed, dealing with public safety where there is joint access, e.g. to a roof installation, and risks to flammable substances, etc.

In many cases these aspects may involve not only the designer but also those involved in arranging the choice of site and the necessary legal provisions, where facilities are being hired. It is essential that a lack of knowledge on the part of these people should not result in risks being overlooked. One case that the writer came across typifies the faulty logic which can be applied. An organisation which had an HF transmitter mounted on a tower, found a need to store fuel. Trying to find a suitable site they were attracted by the fact that the tower was mounted on a large area of hard standing and erected the tank at the foot of the tower!

Vehicle installations

- 1 Mobile equipment of the vehicle mounted type can need particular care. HF equipment using whip or extendible rod antennas can, if of sufficient power, offer a number of hazards. These include the possibility of contact burns from bare metal on the vehicle structure and from the antenna and feeder, as well as personal exposure to the field.

Sometimes the dimensions of parts of the structure are such that they are driven parasitically from the antennas on the vehicle and there can be a potential for contact burns on such parts as the corner vertical members of small van bodies. Side mounted antennas fixed vertically with the feed point at perhaps waist height for a standing adult provide the possibility of burns and of exposure in excess of permitted limits.

- 2 Where such vehicles are used in the public domain consideration needs to be given to the avoidance of such exposures and the reduction of avoidable burns, where possible, by the use of insulating shields and the like. Antenna feeder connections are obvious candidates for physical shielding (i.e. prevention of contact) and transparent materials can be useful there. The reduction of exposures to the public should generally be achieved by suitable siting when operating.
- 3 The exposure for those operating the equipment in the vehicle can be much reduced by careful arrangement of the equipment and the antenna feeder runs. Within a vehicle it is usually beneficial to run antenna feeders away from the equipment operator, e.g. behind the equipment rather than in front of it.

Feeders run in the roof of a vehicle should not be routed over the heads of the operator or other seated people, if this can be avoided as it usually provides unnecessary psychological problems in respect of small amounts of field, which can easily be avoided by suitable routing. Sometimes some shielding of cables might be needed. Also, an excess of earthing points can increase the field inside the vehicle so care is needed in the way earthing is implemented.

- 4 Where roof ladders are fitted to vehicle installations, suitable warnings may be needed when the antenna systems are roof mounted to prevent anyone climbing the ladder unaware of any roof hazards.
- 5 Remote control lines, telephone and other wires for local functions can become subject to induced RF voltages and filters may be necessary to avoid burns to personnel and also possible damage to the remote control equipment. The latter is perhaps less likely on long lines due to line capacitances.
- 6 Due attention should be paid to field levels near vehicle fuel tanks – in one case of a prototype surveyed by the author, the highest level found was over the fuel tank cap!

Ship systems

It is difficult to generalise about ships since they vary enormously in size, nature and function. A few frequently recurring points are worth noting.

Ship MF and HF installations

At the lower frequencies, the electric field associated with the feeders, which are often made of copper tube, can be very high. Some improvement can be made if the feeders are kept away from the operator. In some cases shielding of the feeders may be needed to meet the requirements of safety standards.

Care is needed with the location of the antenna system, though there is often not much choice. The main hazard apart from the antenna itself, is the creation of hot spots around the deck where shocks and burns can be incurred due to resonant metal structures being energised parasitically.

Other ship systems

Not a great deal can be done about the design of most equipments for this environment as the predominant hazards on board are:

- 1 Exposure from a variety of antenna systems when moving about on deck and when climbing.
- 2 Risks to flammable vapours and EEDs.
- 3 Shock and burns, as already noted.

Apart from the siting of antennas, none of these points can be influenced by equipment design so installation aspects are very important. What suits one location may not suit another.

X-ray shielding data

General

The most general residual problem with equipment which produces unwanted X-ray radiation is not usually a steady excess of X-ray leakage, although this can happen if shielding design has been neglected, but rather, a number of leakages from holes, and gaps, door catch fittings and similar places.

There is, world-wide, a considerable amount of published data on the X-ray attenuation characteristics of both metals and other materials such as brick, concrete and similar building materials, largely stemming from the X-ray machine field. In the UK there is a British Standard covering X-ray shielding BS4094:1971 part 2[53].

The attenuation of a given material follows an exponential law:

$$R = R_0 e^{-\mu x}$$

Where:

- R is the intensity transmitted through thickness 'x' of the material;
- R₀ is the initial intensity of the beam
- x is the thickness of material
- e is the mathematical constant e
- μ is the total linear attenuation coefficient of the material for the energy of the particular radiation involved.

The quantity 'μ' has to be found from a table of values.

The attenuation in decibels will be $10 \log 10R/R_0$.

Published tables and graphs usually plot attenuation versus material thickness for different energies or peak voltages. Some data from the X-ray machine field may have graphs for constant voltage and pulsed voltage tube supplies.

Two particular concepts are of use in shielding work. These are the half value layer and the tenth value layer of a metal for a given energy and are defined in terms of the thickness of the metal. They are defined as follows:

'Half' and 'tenth' thickness layers of shielding materials

Half-value layer thickness (of a material)

The half-value thickness of a given shielding material is that thickness which, when interposed between the source of the X-ray beam and the measuring instrument, results in the doserate being reduced to half the previous value, when measured at the same place.

Tenth-value layer thickness (of a material)

The tenth-value thickness of a given shielding material is that thickness which, when interposed between the source of the X-ray beam and the measuring instrument, results in the doserate being reduced to one tenth of the previous value, when measured at the same place.

Measuring the effective energy of X-rays from a source

In order to measure the effective energy of the X-rays from a source to provide information with which to select the required thickness of shielding material, the method used involves half value layers of appropriate metals.

The basic concept may be unfamiliar to people who have not been involved with X-rays but is straightforward. If we have a beam of X-rays

being measured by an X-ray doserate meter and set the position of the meter to give a convenient reference level, we can now insert plates of suitable metals of differing thicknesses in the beam one at a time until the meter reading falls to half the initial reading.

The plates should be large enough to ensure that all the beam goes through the plate. The plate which causes the meter to fall to half the previous value is known as the half-value layer or thickness for that energy. If reference is then made to a table of thicknesses of the metal used against the energy for which that thickness is the half layer value, then that figure is the effective energy of the beam.

The method is a well-established method of measuring effective energy and half-value layer thicknesses can be obtained from X-ray reference data tables. The method is also incorporated in IEC standard IEC562 now renumbered IEC60562[57]. In the standard there is a table of metal thicknesses and effective energies which can be made up as standard test plates (see Table 11.1). Figure 11.4 is a plot of the Table 11.1 thicknesses versus energy up to 100 keV.

Table 11.1 *Former IEC Standard IEC562
Table of metal half value layer thickness
versus energy*

<i>Effective energy (keV)</i>	<i>Material</i>	<i>Half value layer (mm)</i>
7	Aluminium	0.1
21	Aluminium	0.9
23	Aluminium	1.1
35	Aluminium	3.3
50	Aluminium	6.6
50	Copper	0.3
80	Copper	1
100	Copper	1.4
130	Copper	2.7
160	Copper	3.9
200	Copper	5

The test plates can be made of the metals specified and the thicknesses given in the table, each plate being marked with its energy value. For example, a plate of aluminium 1.1 mm thick can be marked '23 keV effective energy'. A set of plates appropriate to local needs can thus be made as standard test equipment.

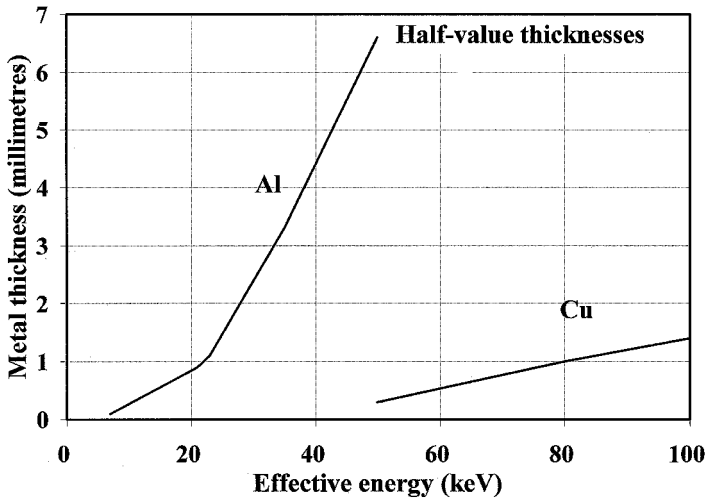

Figure 11.4 Half value layer thicknesses plotted from Table 10.1

Unfortunately, because a particular series of values of effective energy was chosen when the IEC562 standard was first created and the metal thicknesses then defined to meet the energy values listed, some of the resulting metal thicknesses are not commercially available. Interpolation can be used to suit available metal thicknesses. Apart from this problem, the method is easy to use.

Values for the tenth-value layer thicknesses have to be found in other reference data, as does the half-value layer for energies not covered by the IEC standard. Figure 11.5 gives an example of the half and one tenth values for lead, from X-ray machine data for constant potentials in British Standard BS4094 part 2[53].

Figure 11.6 gives the tenth value for aluminium, also from the British Standard. These curves are best considered as illustrative and more specific data used where possible, e.g. from other individual graphs in the standard. Standards like BS4094 usually give plots of transmission (i.e. attenuation ratio) versus material thickness for different values of energy or tube voltage. The flatter portion of such curves should be used.

When undertaking X-ray measurements it is often useful to be able to estimate the thickness of metals needed to overcome a leakage problem by experimentation. On an experimental basis it is possible by using a number of plates to make very rough estimates. Suppose that, using the data from the earlier example, several plates 1.1 mm thick are available and the X-ray effective energy has been established as 23 keV. Each plate is a half-value thickness for 23 keV so that two plates used together will give an attenuation of $0.5 \times 0.5 = 0.25$ (one quarter), and so on. If some plates are available at the

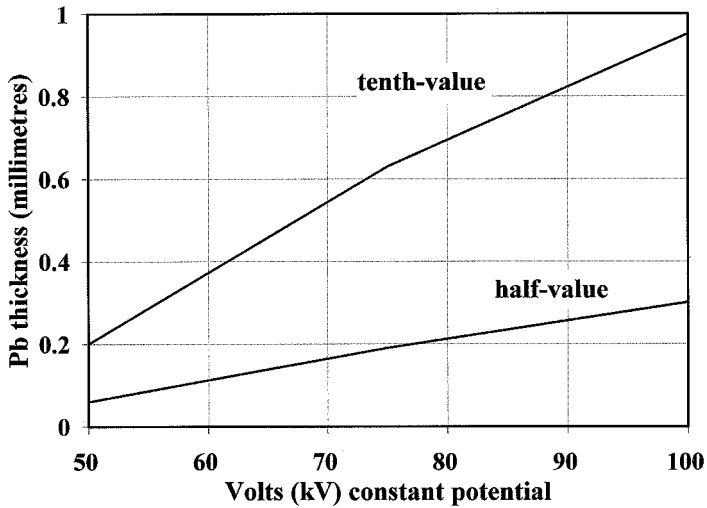

Figure 11.5 Half and one tenth value layer thickness for lead shielding (Courtesy of BSI London)

tenth-value thickness for 23 keV then we can go further and have attenuations such as $0.5 \times 0.1 = 0.05$ (one twentieth).

The reason that this was described as an approximate method is that as the metal sheets increasingly attenuate the low energy X-rays, the attenuation of the high energy part of the energy spectrum is appreciably less and the

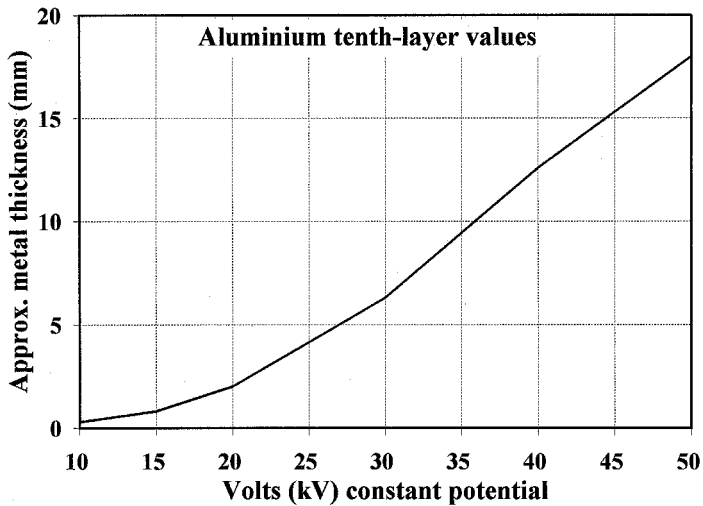

Figure 11.6 Tenth value layer thicknesses for aluminium shielding (Courtesy of BSI London)

effective energy of the residual leakage becomes higher as illustrated in Chapter 8. Hence the plates no longer correspond to the half and tenth values for this higher energy.

Consequently, it is usual to estimate material thicknesses required for either initial shielding or for remedial shielding very conservatively, perhaps by assuming a higher effective energy than that measured with a single half-value layer. It is usually cheaper to buy a thicker material than is strictly needed rather than to order a thinner material, wait for delivery and find that it is not quite good enough.

Lead glass

Lead glass is commonly used where a window is required for observation of an electronic tube or to look for arcing, and there is X-ray radiation present. It is extremely effective providing that the glass is properly mounted so that there are no gaps around the periphery. Figure 11.7 shows graphically a manufacturer's published data[54] for a proprietary lead glass. It is used here for illustration.

Similar glass is available in other countries. When contemplating using such data, the manufacturer's current data should always be obtained as there can be changes from time to time, and different manufacturers may have different data. In this example, the data on attenuation is given in terms of peak voltage versus 'lead equivalent'. It is necessary to consult a lead table or chart to establish the effective attenuation.

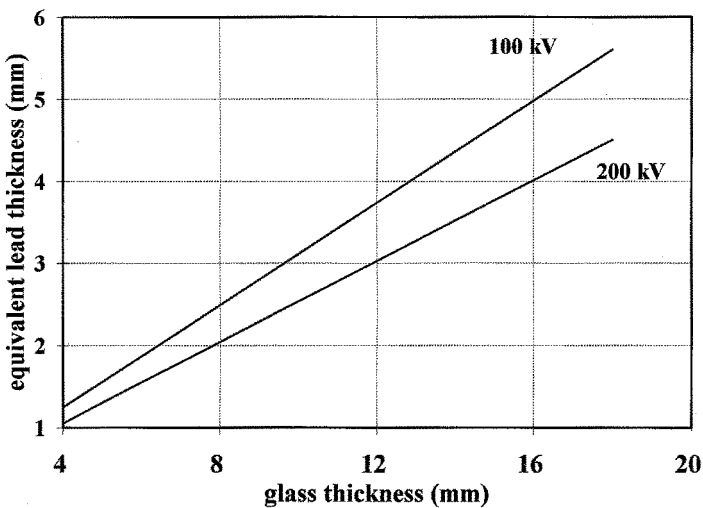

Figure 11.7 Curves for lead-glass shielding material (Courtesy of Pilkington Special Glass, Wales UK)

In choosing glass it is necessary to remember that standard lead glass is made in specific sizes and these can be marked on the 'glass thickness' axis of Figure 11.7.

RF shielding materials

It was noted earlier in connection with contact fingering strips that slots can under certain circumstances be effect radiators, i.e. slot antennas. Molyneux-Child [83] in a very useful book dealing with shielding and EMC, reminds us that slots appear in many guises, e.g. where shielding is joined by spot fixings the gaps between the fixings can constitute slots as can gaps from removable lids where the actual electrical contact points may be somewhat fortuitous. It is recommended that no slot should exceed a length of 0.01λ at the highest frequency used.

For many large transmitters the materials used will often be those of the cabinet structure, e.g. steel and aluminium. Other common materials include copper and brass. Comprehensive design data can be obtained from specialist suppliers in this field. Also references 21 and 83 give data on the electric and magnetic field shielding properties of some materials used for RF applications.

Contact strip for cabinet doors on large equipment needs to be robust. Beryllium copper is usually used. Both standard and custom-made sizes and patterns are widely available. Figure 11.8 shows part of the selection of shielding contact strips supplied by one company. These materials are widely available but a careful choice of materials, finishes and spacings is necessary to ensure appropriate shielding.

Wire mesh materials are readily available for shielding windows. These materials are all well established and characterised for electrical purposes. The performance depends on the frequency, the nature of the wire mesh and the aperture size. Reference data is available on the attenuation of such materials both from reference books and from the many manufacturers of EMC shielding materials. Proprietary ready-made window fabrications using wire mesh sandwiched between glass or acrylic plates are also available, together with performance data.

With the extensive use of plastics in electronics, there is a large range of possible approaches to shielding. Shielding by vacuum deposition or sputtering is in common use on plastics, ceramics and glass substrates. Coatings include pure aluminium, silver, nickel and copper. Multilayer coating, particularly with stainless steel and copper are said to give very good shielding. A typical range of shielded windows is available from TBA Electro Conductive Products. These do not lend themselves to illustration. Various meshes and coatings are available. The best meshes typically offer 80 dB attenuation between 100 kHz and 1 GHz. In comparison, metal oxide films offer 20 to 40 dB attenuation.

It is often important to have shielding which is transparent, especially for use with RF process machines where the operator needs to watch the process. Again, glass, polycarbonate and acrylic materials are available with shielding properties provided by the deposition of a fine layer of conductive material such as indium tin oxide.

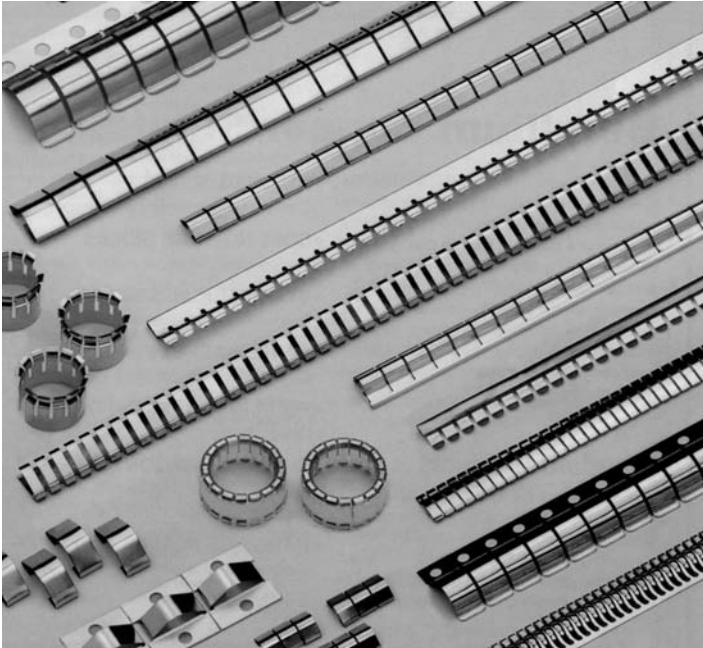

Figure 11.8 Selection of contact finger strips (Courtesy of TBA Electro Conductive Products)

This is said to have no noticeable effect on the transparency of the material in a very thin layer for electrostatic purposes but when used in thicker layers for electromagnetic shielding, transparency is reduced by between 5 to 35% for sheet resistivities in the range 8 to 20 ohms per square and the material has a yellow hue.

Other ready-made and made-to-order shielding materials include gaskets, woven meshes, air vents, etc. Of particular interest are the honeycomb air vents mentioned earlier. These are generally multiple hexagonal cells in aluminium which provide RF shielding by operating as a waveguide below cut-off. Figure 11.9 gives an impression of the structure of honeycomb structures. The length of the cell needs to be four or more times the diameter of the cells ($l/d \geq 4$). The open cells offer a low resistance to air flow. Dust filters can be used with these devices.

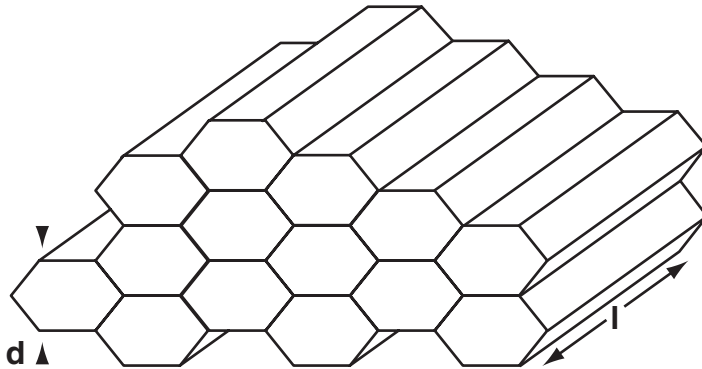

Figure 11.9 *Honeycomb vent utilising waveguides below cut-off*

Figure 11.10 illustrates a standard proprietary honeycomb shielding vent. Typical figures for attenuation vary according to the material finish. For Nickel the plane wave attenuation is given as 115 dB at 1 GHz to 95 dB at 10 GHz. For 100 kHz the H field attenuation is given as 75 dB and the E field figure at 10 MHz is 130 dB.

Structural materials and RF shielding

Table 11.2 gives a general idea of the attenuation of some common materials. There has from time to time been some promotion of proprietary conductive

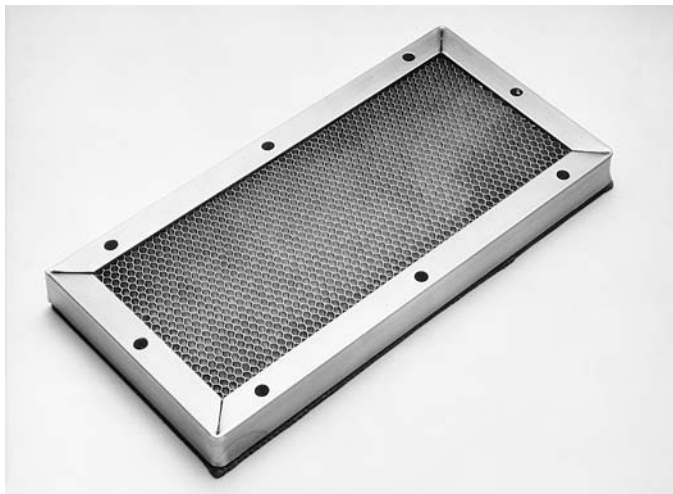

Figure 11.10 *Commercial standard honeycomb vent panel (Courtesy of TBA Electro Conductive Products)*

Table 11.2 *Some common materials which exhibit shielding properties to RF (Courtesy Dr J Coleman)*

<i>Material</i>	<i>Thickness (cm)</i>	<i>Reduction – dependent on frequency</i>
Thick brick wall	70	1/10 to 1/100
Brick wall	15	1/2 to 1/10
Wooden partition	15	1/2
Window glass	0.3	1/2
Chicken wire	1.5 cm hole	1/2 to 1/1000

concretes, one of which ‘Marconite’ was a Marconi patent, but not supplied by them. A paper of 1987[85] gave some data showing test results of 50 to 90 dB attenuation over frequencies from 1 to 10 GHz relative to ordinary concrete. It also gave some information of the use of Marconite as an addition to the earthing electrode in RF earthing. It does not give any details of the Marconite thicknesses for the tests. Other claims for such proprietary materials have occurred relatively recently but there does not seem to be anything published more recently on the use of such materials in practice.

Where shielding is required for buildings such as wooden huts, wire mesh such as chicken wire can also be used for shielding, the characteristics of the mesh being determined optimally for particular frequencies. However what is effective for a particular frequency band will not necessarily be as satisfactory for other frequencies. Sheet metal is also used for room shielding but can be expensive for large areas. It tends to be used on mobile cabins and also in connection with test rooms, particularly those involving low level signals, e.g. in EMC work, rather than with high power transmitters.

12

Radio frequency radiation safety management and training

This chapter covers the various aspects of safety management, safety procedures and audits and the keeping of safety records. It discusses RF radiation training for the various categories of personnel who might be at risk and outlines typical course content. The investigation of incidents and alleged overexposures is covered in some detail. The calibration of measurement equipment is discussed as an important aspect of overall safety management.

Introduction

Over the last twenty years or so there has been a considerable increase in the general awareness of the hazards around us, both at work and in the social and recreational environment. Traditionally, safety management has long had an important role in the more tangible aspects of life such as the machine safety and structural safety fields. Ionising radiation legislation and management has also grown to a highly regulated state with basic guidance emanating from an international body so that there is some degree of universality particularly where nations interact with each other, as in the transportation of radioactive substances.

Whilst the safety hazards connected with RF radiation have been subjected to some degree of control in most countries, it is a subject which is not always understood. Unlike the position with ionising radiation, it has not yet found a generally accepted international basis. This is mainly due to the lack of consensus in views on the subject. However this does not mean that sensible provisions cannot be made and developed if and when the subject finds greater agreement amongst the experts.

The desirable objectives of safety management in the RF radiation field are, in the generality, much the same as for any other subject. They include:

- 1 Identification of potential hazards to people in the working environment and to nearby people in the public domain. Where high voltages are used, any co-existing X-ray radiation must not be overlooked.
- 2 Providing methods to reduce such hazards at least to the limits and levels provided for by the relevant laws, codes of practice and other national provisions.
- 3 The provision of, or the use of, competent measurement services to determine and record the measured values of those quantities used for controlling safety.
- 4 The education of technical personnel and others in the safe use of RF radiation both in relation to intended and unintended radiation.
- 5 The development of the radiation safety features of product designs to reduce the potential hazard to users and facilitate verification of safety.
- 6 Investigation of alleged overexposures.
- 7 Maintenance of the records of the measurements made, safety provisions instituted, complaints received and the action taken to deal with them.
- 8 Control of access to RF fields in general including the policy to be operated in respect of personnel and visitors who have been fitted with implanted devices such as heart pacemakers.

The nature of these responsibilities and the knowledge and experience required will depend on the type of organisation concerned and these can be categorised, if somewhat loosely, as follows:

Companies designing, manufacturing and installing sources of RF radiation

Here there is a responsibility for the design and delivery of safe products and the knowledge required to tackle the safety aspects will often be considerable. For employees this means that working conditions need to be safe and any extra risks involved with the alignment and testing of parts of such equipment during manufacture, e.g. to assemblies being tested in a stripped down condition, taken into account. For the benefit of potential users of such equipment this will include the writing of safety instructions for the operation and maintenance and making it available in suitable manuals. Not all manuals are inadequate but there might be a big improvement in them if the draft was tried out by someone who had not designed the system!

Companies who manufacture other people's designs

In most countries, the legal responsibility to deliver safe products will still apply in this case and the manufacturer will need to ensure that there is

adequate expertise available to meet his legal obligations. Similarly, in many countries, importers of equipment will have full liability for product safety in use and when being maintained and will need to have a good knowledge of the way the product designer and producer have investigated the safety aspects of the product.

Equipment users

This category will include personnel on transmitting stations, those using mobile equipment by land, sea and air and those in charge of RF machines for medical, production and other applications. The safety provisions may have to take in an aggregate of equipment constituting a system and if none of the suppliers has any overall system responsibility, then the purchaser has, effectively, taken on the system safety responsibility and must have sufficient knowledge and experience to handle it.

Equipment users may include anyone who is licensed to radiate RF including non-technical users of mobile and fixed equipment. Some organisations, e.g. public services, will have technical management staff to be responsible for safety and to guide non-technical users. Others may be dependent on the adequacy of the supplier's instructions.

There is one aspect of equipment use where problems can arise and that is in organisations which are not concerned with electronics but use modern RF machines. There may not be anyone in the organisation who is knowledgeable on the subject of RF radiation safety. Often the organisation's electricians are tasked with maintenance but their training is often overlooked. Apart from the fact that responsibility has to be linked to knowledge and no one can be responsible for the safety of something he does not understand, there is also the problem of having someone who can reassure other employees about RF radiation when the regular media scares arise.

Consequently the need for training in RF radiation safety should be recognised when first investing in such equipment. In one mechanical engineering company visited by the author as a result of the worries voiced by the RF machine operators, the metal side panels were all missing and there was a lot of unnecessary radiation coming out. The panels were stored in the electricians' room, presumably because it saved time unscrewing them.

The identification of potential hazards

The earlier chapters have dealt with the technical aspects of the various hazards attributed to RF radiation and it may be useful to summarise these so that the relevant aspects can be recognised on a checklist basis. Some of these items may only rarely be experienced or not experienced at all.

1 Human exposure to RF fields

- Exposure of all or part of the human body to RF fields (referred to as whole-body or partial-body exposure).
- Exposure of the human body to peak pulse power densities.
- Limb current limitations.
- RF burns and shocks.
- Aural effects (hearing the pulse repetition frequency or noises and crackling associated with pulsed radiation). This is not regarded by itself as a hazard, but may be so regarded by those who experience it!
- Effects on implanted devices such as heart pacemakers, insulin pumps, other active devices and passive conductive materials.

2 Human hazards indirectly associated with RF radiation

- X-ray irradiation from high voltage electronic vacuum tubes.

3 Effects on materials and substances which may or may not involve people

- The ignition of flammable vapours and electro-explosive devices by RF fields.
- Damage to static sensitive devices (integrated circuits and the like) being assembled in the proximity of a strong RF field.
- Electromagnetic compatibility (EMC) problems where interference with other objects or their electronic systems ranging from aircraft to motor car electronic control systems may cause problems. The consequences may be minor or very serious.

4 The effect of static (DC) magnetic fields on the human body

- It may happen that such fields are present in some equipments which need to be checked for RF radiation, particularly in the medical field.

Where there are standards in force which specify separate and different safety limits for occupational purposes and for the public, it may be necessary to consider such of the items listed above as are relevant, under each heading, so as to ensure that both situations are satisfied.

Safety management methods

Resources

Safety management requires adequate resources to undertake the required functions, a fact not always appreciated. This is equally the case where RF

radiation is involved and where some specialist knowledge and experience is inevitably needed.

Since much of the basis of RF safety management is related to appraisal and measurement, then adequate equipment resources are necessary. Whether this is achieved locally or by the hiring of a measurement service is not, in principle, of great importance providing that the requisite knowledge is available. The relative practicability of the two will generally be determined on the basis of the required response time for the provision of services. What is always important but often overlooked when having surveys and investigations done is the proper definition of the task.

Often when contracting with outside measurement services, the degree of definition provided is such as to leave the surveyor to work out what is really required. It can be important to ensure that the proposed surveyor is familiar with the general type of equipment to be surveyed. The high power transmitter discussed in Chapter 8, Figure 8.7, was checked by an ionising radiation consultant and declared to have no measurable X-ray radiation!

Equally as important as the measurement resource, is the management provision which ensures that all the relevant equipment and systems do get surveyed when this is necessary. This is just as important in large organisations which design and manufacture RF radiation sources as it is in user organisations.

Unless there is a good system to ensure that all equipment, or a sample of production if this approach is used, is surveyed, it is possible and has been known for a new design to get into production and almost out of the factory without this having been done. Similarly it is not unknown for an RF process machine to get into use without being checked out for leakage by the purchaser.

Sometimes the first intimation of the arrival of such a device in the past has been a complaint about something interfering with the local computer! Worse than that, the author has experience of rejecting an RF machine for excessive X-ray leakage. It was discovered that the person who had tested the equipment had used an inappropriate metal shield over the instrument chamber which resulted in low readings.

As with many problems in safety management, it was likely that the person had been told to do this in some other situation where it was appropriate and had adopted it as standard practice! Although in the production of modern RF process machines one can reasonably expect that thought has been given to RF and X-ray leakage, there is clearly a need for the purchaser to meet all the requirements for ensuring the safety of his staff.

Procedures

There are many good reasons why there should be adequate documented procedures for the management of RF radiation safety. The problem with

procedures arises when managers believe that what is written will always be done! Almost every accident investigation highlights breaches of procedures.

Procedures work best where the activity is a boring one and where the reader is only too glad to follow it. For example, procedures to complete forms, for report formats and similar mechanistic activities usually work reasonably well. Detailed procedures also work well in areas of activity where strict disciplines are the normal practice and the procedure documents are always available, as in calibration laboratories, and in groups of people specialising in measurements such as RF surveys.

In such groups there is generally a heightened awareness of the importance of the quality conformance aspects coupled with an understanding of the problems which may stem from a departure from such procedures. There is also a sense of direct personal responsibility for the consequences.

Complex technical procedures for a wide general use are difficult to remember, and the written copy is often not to be found when needed. This leads to improvisation. With the ready availability of computers, safety procedures should be accessible from a keyboard and e-mail can be used to make suggestions for improvement. The latter will overcome the dislike of raising formal memoranda! It is unfortunate that the most helpful people often prove to be the greatest safety risks, since they will try anything whether or not they have the requisite knowledge. The helpful person who hastens to pick up a dropped radioactive source with his bare hands is a good example!

In the author's view, global procedures which relate to specific technical safety matters such as prohibiting access and aimed at wide general use should be regarded as high risk and wherever possible more positive methods of prevention should be used. For example, a 'fold up and lock' ladder which prevents the climbing of towers is far better than a procedure forbidding it. Even amongst the military, personal initiative is often thought to be superior to following detailed orders. Unfortunately the corresponding requirement that the person concerned should have sufficient knowledge to do this has, in the past, been given less thought. However modern legal requirements for safety management have tended to lead to better organisation of the safety system in the civil and military fields.

Of course many topics may need to be covered globally for legal reasons and because they fulfil the quality management system need for documentation. The main point made here is not that one should not bother with such procedures – they are very important, but rather that wherever possible technical methods should be used to make it rather difficult to ignore or disobey critical aspects of the instructions.

An equally important aspect is the communication of procedures to all concerned. Positive methods such as safety briefings, the inclusion of safety training modules in company training courses and the like are necessary to overcome the reluctance of people to read procedures. As with many other subjects, safety training should start at the top of the management tree, not

work its way up from the bottom since by the latter route it never reaches the top!

Those documented procedures which are certainly necessary include those covering:

- Safety policy
- Training
- Measuring equipment maintenance and calibration
- Reporting and investigating alleged overexposure
- Records and record keeping

Procedures are also likely to be needed for such things as:

- When surveys are done, who can initiate surveys, and the method of reporting on them
- Technical methods of dealing with excessive radiation, definitions of prohibited areas, 'permit to work' systems
- Anti-climbing provisions, climber training, authorisation of climbing, etc.
- Product design safety reviews (where design is undertaken)
- Control of works on site, including that of sub-contractors
- Safety vetting of capital purchase applications for items which involve RF or ionising radiations. This can avoid many embarrassing problems which can arise where those responsible for safety are unaware that something exists.

Handling survey reports

Surveys should be initiated from time to time when changes in equipment or operating conditions arise or when a periodic check is thought desirable. Survey reports provide measurement data relating to particular situations. They will sometimes highlight problems and provide some recommendations for remedial action.

The main safety management action relating to survey reports is to ensure that the necessary actions are taken to clear any deficiencies in the present situation. Since there will often be options for remedial action with different time and cost implications, technical discussions may be needed to determine the specific action.

There is also likely to be a need for temporary action if excessive exposures have been established. This may involve quickly applied measures such as the use of a temporary barrier around the area concerned and an access prohibition notice. The essential management action is to progress short- and long-term actions until completed, recording the completion in some appropriate way. The actions involved may be physical (barriers and signs) or procedural (e.g. establishing a negative elevation limit for a microwave beam).

Some surveys will be carried out with the specific objective of setting safety limits prior to the deployment of personnel. In this case the surveyor has only to define the safety limits. Problems only arise if these boundaries are found to be incompatible with the intended personnel deployment.

Survey reports and the records of any remedial action taken are vital safety records and are best retained indefinitely. In organisations where a lot of surveys are undertaken it has been found valuable to index them against equipment types so that results at different locations with the same type of transmitter system or RF machine can be cross-checked.

Safety audits

Since the use of safety procedures are so liable to fail with time or with changes of personnel or merely because management does not seem to be very interested, the carrying out of safety audits from time to time is very necessary. Whilst most readers will be familiar with the concept of an audit since it is a common quality management term, it is perhaps worth a brief explanation. An audit is simply an objective look at a given situation in relation to the rules, instructions and practices which are intended to control that situation. The outcome is a report which identifies any situations where there were breaches of procedures, instructions and practices. It may also identify situations for which no adequate control instructions appear to exist but are thought necessary by the auditor. It may also identify ambiguities in existing instructions and procedures and note suggestions from the personnel concerned. It is important that personnel involved should have a chance to contribute.

The report gives the local manager the chance to debate the issues and agree remedial action. Safety audits are usually carried out in such a way that every area of work is covered over a given period, the timing and frequency being determined in the light of the nature of the organisation. The most important feature is the requirement for a definitive response from the manager of the area concerned in a given period of time.

Safety record keeping

It is very important to keep full records of all surveys and the action taken to deal with the results. Similarly, records of permits-to-work and authorisations to climb towers and structures should be retained. Records of minute and negligible readings found and 'nil returns' are just as important as records of high readings as they establish that care was taken and that no hazard was found.

Most claims against organisations for alleged injury due to RF and other radiation are made many years later. The long term retention of all survey records is therefore crucial. A lack of records is hardly likely to help the case!

Records of safety audits and the remedial action taken are equally important since they can provide evidence of the care taken in safety management. It has to be said that when not taken very seriously they can also prove to be a record of inadequate safety management!

Records of people who have been involved in alleged overexposures of any kind of radiation together with the results of the investigation should be kept indefinitely. It is wise to do the same with external complaints from the public and the resulting investigation results. Many may document cases where the complainant was wrong and the correct explanation recorded. Typical examples include complaints about some alleged effect or interference from a transmitter which has been out of service over the period concerned, worries over antenna systems which are close to a site boundary when they are all receiver antennas, etc.

Where people are provided with thermo-luminescent dosimeters (or the film badge equivalent) for X-ray dose recording, as a prudent safety measure, i.e. not as the result of a legal provision, the resulting dose reports should also be stored long-term. Where they are worn as a legal requirement then the legal provisions should obviously be followed and these usually include specific record storage requirements. They usually require the records to follow the wearer, if he or she moves to another employer.

In the course of planning a survey, much data has to be collected on equipment and the site, including antenna sizes, mount heights, beam elevation settings, transmitter power, antenna gains and the like. This generally involves appreciable time and cost.

These data should be recorded on a card index or a similar computer record and linked to any changes made on the site so the record continues to reflect the actual status of the site. This is not only a wise safety provision but also tends to reduce the cost of preparation for surveys.

The triggering arrangement used to update the records is also a good method of automatically initiating an appraisal of the change by someone who is capable of determining whether a new survey is required and, if required, initiating it.

Training

General

Training in RF radiation safety, including the recognition of the coexistence of X-rays where relevant, may be needed for several different categories of people, for example:

- Design engineers, test engineers, operators and users who may or may not have technical backgrounds;
- Riggers and other mast and antenna structure workers;
- Maintenance and customer service engineers.

Although each group may have some unique requirements the training can be split into two basic categories:

- 1 People not required to have significant technical knowledge beyond their specific operating functions.
- 2 Technically trained people.

Category 1 is often neglected although all they often need is a simple understanding of the nature and effects of RF radiation, and information about safety provisions such as the purpose of safety shields and why they should not be removed without good reason; safety signs and prohibitions and other locally applicable arrangements for warnings and access limitation. Simple video films can be used for this sort of training, practical situations being illustrated directly. People without technical knowledge are particularly prone to media scare stories and simple training plus the knowledge that they can talk to a safety officer when they are worried can assist a great deal in improving the mental well-being aspect of the WHO definition of 'Health' (Chapter 3).

RF safety training for technical people

For Category 2 which encompasses technically trained people the basics of the training will be the same but with some particular emphasis for certain categories. For example, designers will be interested in design methods and techniques for RF safety and materials used for shielding and other purposes. Test engineers who are to undertake RF radiation safety testing and surveys will need more detail on measurement and on the instruments used together with practice in the use of those instruments and their limitations.

Experience in running training informally over many years and as formal courses over the last ten years has brought to light a few useful points on courses where there is often a wide mix of senior and junior engineers with some safety practitioners from other disciplines such as mechanical engineering, medicine, transport, etc.

RF radiation measuring equipment is unfamiliar to many people and, as might be expected, the instruments are at some risk until they become more used to them in the course practical work.

Unless courses are run specifically for a particular organisation, courses attract a range of people from widely differing fields of RF work and training may involve explaining a little about different types of transmitters and RF radiation sources in use and providing some general information about the antenna systems used.

The basis of a course lasting two and a half days or three days, run monthly is outlined below. The aspects to be emphasised are:

- 1 Some of the course content needs to be adjusted to suit the experience and occupations of the students.
- 2 Military courses often have extra time taken to cover various military organisational and medical aspects.
- 3 As much practical work as possible is put into the course, having regard to the problems of equipment availability, access to operating systems and the safety of other people at the site concerned. The practical work is geared to providing confidence in the correct use of instruments and understanding what to do in various circumstances rather than trying to provide a full experience in complete surveys. The latter is impossible in the time and in any case, it is usually very difficult to get possession of equipment for the time required without disrupting work for other people.

Whilst the author had the luxury of the use of a radar for many years, as indicated in earlier pictures it is often necessary to make use of whatever sources and antennas that are available and the use of whip and yagi antennas can suffice for basic measurement training as indicated in Figure 12.1. It was found that students like a target to aim for so that they can feel that they are doing the measurement correctly and so the measurement of a yagi antenna beamwidth was adopted. This was not because it would need to be done in practice but merely because it had a nominal value from the antenna test certificate. As the environment, large metal masses, etc., affect this in a practical layout, getting within about 25% was considered as good. It was quite interesting to see how results improved with more careful repeat measurements.



Figure 12.1 *Yagi antenna fed by 100 W source for training exercises (Courtesy TUV Fareham)*

Some students such as doctors and senior engineers do not want training to the extent of doing full surveys as they will never do such work, but like to participate in something which gives them the feel of the working environment. In many cases, further experience in doing surveys, for those who will need to do such work, may have to be gained in the student's work environment.

The course typically covers:

- 1 General introduction to RF radiation; calculations for microwave and other common antennas; calculations for the avoidance of risks to flammable vapours and electro-explosive devices.
- 2 Detailed consideration of the nature and effects of RF radiation; medical aspects; developments in the knowledge of RF radiation hazards.
- 3 RF safety standards and the background to them: ANSI/IEEE; ICNIRP EEC and national (NRPB in the UK case) standards and guides.
- 4 Theory and practical aspects of the use of RF radiation instruments; new instrument and monitor developments.
- 5 The nature of X-rays arising in RF radiation sources; legal requirements; measuring instruments and methods of measurement.
- 6 RF survey planning; typical data from surveys; methods of measurement; calculations for pulsed and non-pulsed transmissions, multiple irradiations, etc.

The practical work includes laboratory and field work. There is the chance to try various types of instruments wherever this is possible, so that students are not limited to what is held locally. One interesting aspect of past experience with courses was the enthusiasm which military medical consultants showed when allowed to get their hands on a radar! This can be the case when other senior people who do not normally get any hands-on experience are involved and it does tend to bring to life for them the important points of apparently dull procedure manuals.

Some known courses are listed in Appendix 3.

The calibration of measuring equipment

Insofar as safety depends largely on measurement, the proper maintenance of measuring equipment is an important part of safety management. The word 'calibration' is used both for the initial calibration of equipment and for subsequent calibration confidence checks. It is extremely important to have measuring equipment calibration checked at regular intervals in order to support the survey reports produced using that equipment. In some cases it will also be a legal requirement, particularly for ionising radiation measuring instruments. It may also be a condition of a quality standard to

which the organisation operates, e.g. MIL Standard 45662[61] or the ISO 9000 series[64].

There are usually national sources of calibration for RF and X-ray instruments and instrument manufacturers should also be able to offer calibration traceable to national standards. There are some mutual agreements between national bodies for the acceptance of each other's national calibration certificates, e.g. such as those between the USA, the UK and some other EU countries, which facilitate trade and can reduce the effective costs involved in calibration when exporting.

Calibration of the instruments dealt with in this work are, typically, subjected to annual calibration. It has been found useful to plot the calibration results for each instrument. By plotting a separate chart for each instrument but plotting cumulatively each time, i.e. successive calibration results for the same instrument on one chart, it is possible that trends can be identified.

For example, an instrument which seems to be drifting out of specification will show up. On the positive side, consistency within the uncertainties of measurement applicable, provides confidence.

X-ray measuring equipment

Because of the lower energies likely to be met in dealing with transmitter X-ray measurements compared with the energies met in other fields such as X-ray machines, there is a need for low energy X-ray calibration checks and this can be done down to about 6 to 8 keV using fluorescent X-rays. Many countries have national or other calibration laboratories which can do this. In the UK the NRPB provides such facilities and will calibrate to the customers' requirements. The statutory calibration interval in the UK is 14 months.

RF radiation meters

The calibration of these instruments involves a very large capital expenditure on anechoic chambers, power sources and associated equipment. Consequently, such calibrations are inclined to be expensive.

They are often charged on the basis of so much per frequency, so they usually need a compromise between a large number of test frequencies with a large cost and few tests which are cheaper but give less confidence in the instrument's performance.

A number of RF radiation meter manufacturers offer calibration services, some of which conform to MIL Standard 455662[61]. A paper by Aslan[62] outlines the facilities used by the Narda company. Some companies also sell calibration equipment.

One of the UK facilities is the National Physical Laboratory (NPL) which undertakes measurement and calibrations over a wide range of quantities.

The particular approach for RF radiation instrument calibration[60] is described in the following paragraphs.

In the frequency range 10 Hz to 2.4 GHz three Crawford type and one pyramidal Transverse Electromagnetic (TEM) cell are used to produce calculable electric and magnetic field strengths. Crawford cells are, in principle, coaxial lines expanded by input and output tapers to form a rectangular outer shielding conductor with a flattened inner conductor called the septum. They are operated in the transverse electromagnetic mode, so that both the E and H field components generated between the septum and outer conductor have the characteristics of a wave propagating in free space.

The field strength can be calculated from the dimensions of the cell, its impedance at the measurement plane and the input power. Below a certain frequency (determined by the size of the cell) the fields set up in the central region are very uniform which makes them ideal for calibrating probes. However, once the upper frequency limit is exceeded, higher order modes can propagate which give rise to large spatial variations in the fields and this limits the operating range of the cell. An uncertainty of ± 1.0 dB (12%) in the field strength is typical. Figure 12.2 shows TEM cells used for calibration in the range 3 kHz to 2.4 GHz

Between 180 MHz and 2.4 GHz an NPL tapered TEM cell is used which is equivalent to the input taper of a Crawford type cell terminated with microwave absorber. The accurately made tapered profile, including the septum whose thickness is also tapered, ensures that almost all of the input power goes into the TEM mode, so that resonances associated with higher order modes in Crawford type cells are kept to a minimum. This allows a useful test volume, even at frequencies up to 2.4 GHz where the wavelength is less than the separation between the septum and outer conductor. Figure 12.3 shows the NPL tapered TEM cell for calibration in the range 180 MHz to 2.4 GHz.

For some electric field sensors with metallic cases, operation of the tapered cell above 1 GHz results in unacceptable uncertainties and a project is underway to develop an alternative method in an anechoic chamber.

In the frequency range 2.4 GHz to 45.5 GHz measurements are carried out inside an anechoic chamber, where the calculable, uniform field is generated using a calibrated waveguide system feeding a horn antenna. Knowing the power fed into the horn and the latter's gain, one can readily calculate the power flux density and hence field strength at any distance from the horn antenna. An uncertainty of ± 0.5 dB in the power flux density is normally achieved. Figure 12.4 illustrates an anechoic chamber for calibration in the range 2.4 GHz to 45.5 GHz.

As new types of instrumentation are introduced, particularly limb current measurements and contact current measuring devices, there will be a demand for the calibration of these devices. Equally the progress along the RF frequency spectrum already results in power density measurement

requirements with the consequential calibration requirements in excess of 100 GHz. These facilities are not widely available at present. Some RF radiation safety instrument manufacturers offer calibration at frequencies higher than the nominal top gigahertz frequency of their current instruments, and enquiries should be made to instrument suppliers.

Often instrument specification limits are expressed in decibels rather than percentages and some people get confused with the conversion. Figure 12.5 provides a graph of percentage uncertainty against decibel uncertainty with one curve for positive values and one for negative values for power density measurements. For example an uncertainty of $\pm 15\%$ will give a decibel equivalence of +0.6 dB and -0.7 dB.



Figure 12.2 TEM cells used for calibration in the range 3 kHz to 2.4 GHz
(© Crown copyright 1998 reproduced by permission of the controller, HMSO)



Figure 12.3 NPL tapered TEM cell for calibration in the range 180 MHz to 2.4 GHz
(© Crown copyright 1998 reproduced by permission of the controller, HMSO)

RF radiation incident investigation

There are a few important aspects of RF exposure investigations which can be identified as generally applicable. The greatest problems stem from the loss of information. The details that are most important are:

- Exactly where the subject was situated at the time.
- The source frequency, power, duty factor, modulation type, etc., if the source is known.
- The duration of the exposure; best checked with others present if possible, as people suddenly alarmed about being exposed may not be very accurate in estimating such things.
- The identity of other persons present.
- Details of what the subject claims – symptoms and any sensations felt; the location on the body, if specific such as a hot area or a burning feeling. These should be clearly recorded as claims and the agreement of the subject obtained to the written statement. If necessary, statements should also be obtained from people who were near to the incident at the time.

If a damaged component such as a cracked waveguide is involved, ensure that if it has been removed and replaced, the defective item is secured and retained. The subject obviously needs to be medically examined promptly, in accordance with local procedures and laws. However, unless there is something specific to look at, e.g. a burn, reddening of the skin, optical damage or an acute condition such as hyperthermia, it is difficult for a doctor to relate RF exposure to changes in bodily condition. Often far too much is expected of doctors when the exposures are low and there is little to indicate anything of value about any consequences of the exposure.

At the initial examination the doctor will not have the benefit of the full report on the incident since it will not have been completed. He will need to



Figure 12.4 *Anechoic chamber for calibration in the range 2.4 to 45.5 GHz (© Crown copyright 1998 reproduced by permission of the controller, HMSO)*

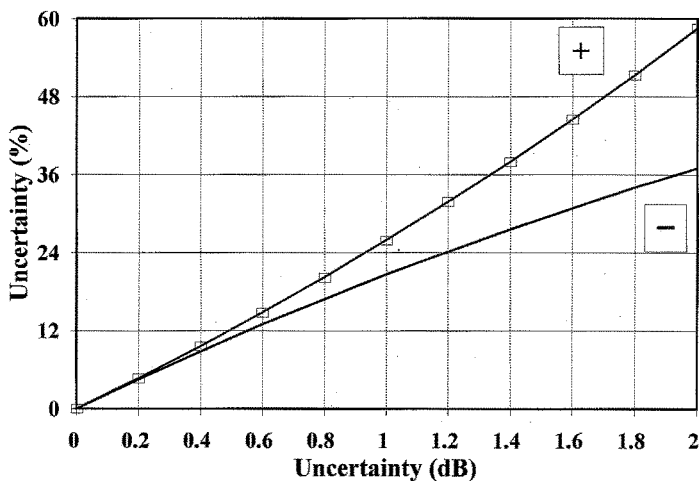

Figure 12.5 *Uncertainties of measurement expressed in decibels and percentage for power density*

see it when it is available and have it explained to him. At the initial examination it is important to ensure that the doctor understands that RF radiation is involved. Cases have been recorded of such people being rushed to hospital and given a range of pointless tests for ionising radiation exposure. This could cause more stress than the original RF exposure to anyone familiar with the significance of ionising radiations!

Gathering information

The investigation may need to cover:

- 1 The exposure of the subject in power density or field unit terms, as measured in a simulation.
- 2 The nature of the exposure – whole body, or part exposure with a statement of the part affected, e.g. arm, head, etc.
- 3 How the exposure arose – accident, breakage of a part, breach of established procedures, inadequacy of a procedure, absence of warning signs, etc.
- 4 The general awareness of safety requirements at the place where the exposure took place and the attitudes of the personnel and management concerned (effective safety management is very dependent on attitudes).
- 5 Any other form of radiation present such as ionising radiation, laser light, infrared or ultraviolet. These can easily be overlooked.

From the point of view of the investigator, the first need is to repeat the alleged incident situation with any faulty component replaced in the equipment if possible, and the same operating conditions as before.

Obviously the investigation needs to be done very cautiously. Where calculations can be done they should be completed before any operational tests are done. For leakages this is often very difficult although simple calculations are possible for loose or open waveguides. If the component is too seriously damaged to be put back into the equipment, estimates will have to be made.

Before switching on the equipment, it is important to get the subject, or someone of similar build, to stand in the position where the exposure was obtained. It is then possible to make a sketch of the relationship of the likely radiation and the subject. Photographs are very useful if they can be arranged.

Investigations have been done by the author in a case where a male claimed irradiation of his genitals from an open waveguide in a radar on a bench. When the man was placed alongside the equipment (after it had been measured and found well within limits with the surveyor in his place) it was found that the small leakage beam from the open waveguide on the low power equipment had a radius of about 10 cm at his body, well above the navel, and as indicated already, within permitted limits.

This sort of inaccuracy is quite common in such a situation and implies a degree of panic on the part of the subject. It usually involves young men who are, perhaps understandably, worried about any possible harm in this region.

With the equipment radiating, a cautious survey recording levels in the area of interest is needed. If the levels expected significantly exceed permitted limits it may be necessary to reduce the power if possible, and scale up the consequent measurements results.

If the source is not known, probably a rare case, it is necessary to investigate the area in some detail, going back to the above actions when the source is established.

Reporting on incidents

The result of the survey should be a report giving details of the levels at a distance corresponding to that of the subject during the incident and at all parts of the body, not just the part mentioned by the subject.

Whilst the subject may have correctly identified the source equipment, it is important to allow for the possibility that he may be wrong both about the source and about the specific location of the leak. The surveyor should be careful not to be exposed due to such an incorrect judgement about the location of the radiation.

Where there are other sources of radiation nearby, it will usually be desirable to carry out measurements of them to avoid the possibility of other hazards co-existing and going undetected.

The use of diagrams in the report is important as it may be difficult for the report reader to visualise the equipment and the situation of the exposed subject. It has been said that one good diagram is better than several pages of text! When the report is complete it can be assessed by the appropriate person. This is usually done by first comparing the results with the relevant standard. If the standard has not been exceeded then there is no need for any further calculations. If a standard has been exceeded, but only a part of the body has been exposed, it may be necessary to estimate the SAR for the affected parts of the subject's body.

This is then compared with the standard to see whether such an exposure is permitted by any other clauses in the standard.

Reports should be clear, factual and frank. Where there are failures of the safety management system, it is usually better to define the failure in safety system terms so that any apportionment of individual blame is left to those who manage the people concerned.

The fact that an exposure proves to be within permitted limits should not be considered as ending the matter if a safety system failure caused the exposure. Consider the example a few paragraphs earlier, involving a man who believed that his genitals had been irradiated, but the irradiation was found to be near the navel and within permitted limits.

Analysis shows:

- 1 A failure in the control of the equipment – waveguide left open-ended by someone.
- 2 A failure on the part of the subject in not checking the equipment status before switching on.
- 3 Subject exposure in limits but not justified – unnecessary exposure is never justified.
- 4 Staff had no safety training – management failure.
- 5 If procedures existed for 1 and 2 above but were not followed, the matter is a disciplinary one; if not, it was a management failure (this was the case).
- 6 Other failures found: all side panels missing from equipment, no RF warning signs anywhere.

The final determination of any effects on the subject of the investigation will usually be the responsibility of the medical examiner or medical authority. There may also be other actions needed in the management of the activity if there are any adverse findings about safety provisions, safety procedures and disciplines and this may be the responsibility of the local management.

With frequencies under 100 MHz, there may be the additional complication of excessive induced currents in the body and it may be necessary to measure these. Since equipment to do such measurements has only become available in the last few years, experience is a little limited and many organisations do not have such equipment.

Finally, it should be noted that whilst undesirable exposures do occur from time to time, those having the responsibility for RF radiation safety are more likely to spend their time dealing with the psychological problems resulting from the secret worries of individuals about RF radiation which are fuelled from time to time by folklore and by the media, than with real incidents. (See also Chapter 3, Part 2 which deals with reported overexposures.)

X-ray exposures

The foregoing relates to RF radiation incidents. Where an abnormal X-ray exposure is suspected or a combined RF and X-ray exposure is involved, the national provisions for ionising radiation incidents should be followed. This may involve formal reporting to national government safety organisations, as in the UK where it is covered by the Ionising Radiations Regulations [41].

Appendix 1

Useful data and relationships

Quantities

<i>Unit</i>	<i>Unit name</i>	<i>Symbol</i>
Power, radiant flux	watt	W
Power density, irradiance	watt per sq. m	Wm^{-2}
Electric field strength	volt per sq. m	Vm^{-1}
Magnetic field strength	ampere per sq.m	Am^{-1}
Magnetic flux density	tesla	T
Specific energy	joule per kg	Jkg^{-2}
Electric resistance	ohm	Ω
Electric conductance	siemen	S
Electrical potential, Electromotive force	volt	V
Electric current	ampere	A
Frequency (Cycles or repetitive events per second)	hertz	Hz

Units - non-SI and SI unit relationships

1 kilowatt-hour = 3.6 MJ	1 hp (horsepower) = 745.7 W
1 inch = 25.4 mm	1 mm = 0.039 inch
1 foot = 0.305 m	1 cm = 0.394 inch
1 yard = 0.914 m	1 m = 1.094 yd
1 mile = 1.609 m	1 km = 0.621 mile
1 metre per second = 3.281 foot s^{-1}	1 foot s^{-1} = 0.305 ms^{-1}

Constants and other relationships

Velocity of light in free space = $2.997\,925 \times 10^8 \text{ ms}^{-1}$

(generally treated as being $3 \times 10^8 \text{ ms}^{-1}$)

Electron volt (eV) = $1.602\,17 \times 10^{-19} \text{ J}$

Planck's constant $h = hf$ where h = Planck's constant (above) and f = frequency (Hz); e.g. 10 eV corresponds to about $2.418 \times 10^9 \text{ MHz}$.

1 microtesla (μT) = 10 milligauss (mG)

$1 \mu\text{T} = 0.8 \text{ Am}^{-1}$

$1 \text{ mG} = 0.08 \text{ Am}^{-1}$

Ionising radiation – Si units

Absorbed dose gray (Gy) $1 \text{ Gy} = 1 \text{ Jkg}^{-1}$

Dose equivalent sievert (Sv) $1 \text{ Sv} = 1 \text{ Jkg}^{-1}$

Note: 1 sievert = 100 rem (old unit)

It is generally considered that 1 *millirem* = 1 *millirad* = 1 *milliroentgen* when dealing with instruments having these 'old unit' markings.

With the sievert, a useful relationship is: 1 millirem = $10 \mu\text{Sv}$.

A commonly met old specification figure was 0.75 mrem h^{-1} and is equal to $7.5 \mu\text{Svh}^{-1}$.

Dose equivalent = absorbed dose multiplied by the quality factor (QF) and QF for X-rays and gamma rays = 1. Hence in this case the absorbed dose and the dose equivalent are numerically equal.

Activity becquerel (Bq) $1 \text{ Bq} = 1 \text{ s}^{-1}$

$1 \text{ Bq} = 2.7 \times 10^{-11} \text{ Ci}$ (curie – old unit)

Power density and electric/magnetic field relationships (plane wave conditions)

Figure A1.1 provides a quick reference graph for the power density and electric field relationship, covering the range 1 to 1000 Wm^{-2} . If converting mWcm^{-2} , multiply by ten first to convert to Wm^{-2} : i.e. $1 \text{ mWcm}^{-2} = 10 \text{ Wm}^{-2}$.

Figure A1.2 is a similar quick reference graph for power density and magnetic field covering the range 1 to 1000 Wm^{-2} .

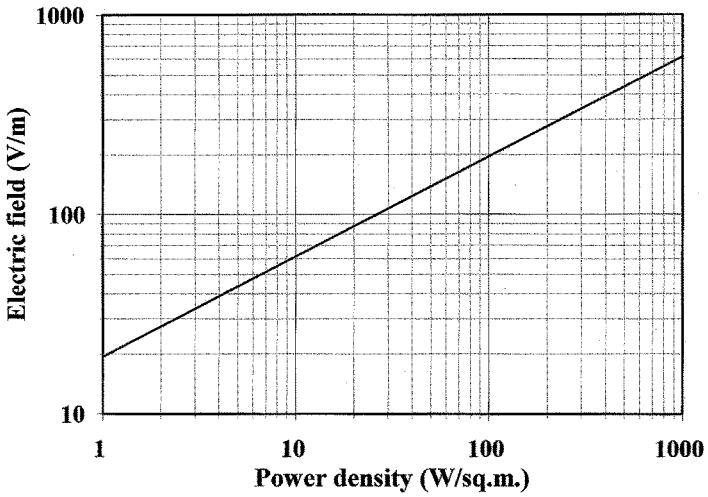

Figure A1.1 Power density values (Wm^{-2}) versus electric field plane wave values (Vm^{-1})

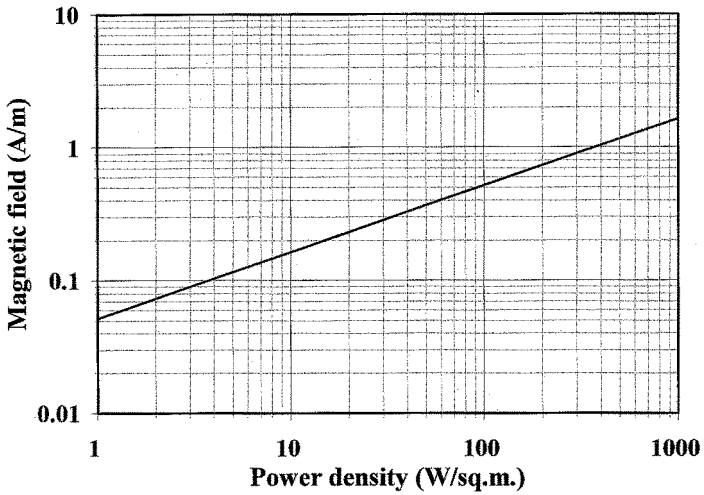

Figure A1.2 Power density values (Wm^{-2}) versus magnetic field plane wave values (Am^{-1})

Appendix 2

Technical and organisation abbreviations

Technical abbreviations

AC	alternating current
Am^{-1}	magnetic field strength (ampere per metre)
DC	direct current
EED	electro-explosive device
EIRP	equivalent isotropic radiated power
EMC	electromagnetic compatibility
ERP	equivalent radiated power (rel. to a dipole)
Jm^{-2}	Energy – Joule per square metre
PME	protective multiple earthing – power distribution systems
Radhaz	general term used for radiation hazards, particularly in the military field
RF	radio frequency
r.m.s.	root mean square value
pdf	power flux density; where used frequently this is usually shortened to ‘power density’ (Wm^{-2})
RFI	radio frequency interference (see EMC)
S	(in formulas unless otherwise noted) power flux density
SAR	specific absorption rate (Wkg^{-1})
Vm^{-1}	electric field strength (volt per metre)
Wm^{-2}	power flux density (watt per sq. m.)

Informal abbreviations used in this work

DF	duty factor (of a pulsed signal)
f.s.d.	full scale deflection (of a meter)
p.r.f.	pulse repetition rate (Hz)
SF	peak power density safety factor (overload protection for RF radiation instruments)

Modulation terms (may appear as upper or lower case)

AM	amplitude modulation
CW	unmodulated carrier
FM	frequency modulation
FSK	frequency shift keying
ISB	independent sideband transmission
MCW	amplitude modulated carrier
PM	phase modulation
SSB	single sideband transmission

General abbreviations used in this book

AGL	(of height) above ground level
AOD	(of height) above ordnance datum – in the UK this is Newlyn
GSM	global systems for mobile communications
PCN	private communications networks
PMR	private mobile radio

Organisations and systems

ACGIH	American Conference of Government Industrial Hygienists
ANSI	American National Standards Institution
ATC	Air Traffic Control
BBC	British Broadcasting Company
BNCE	British National Committee for Electroheat
BS	British Standard
BSI	British Standards Institution (UK)
CAA	Civil Aviation Authority (UK)
CENELEC	European Committee for Electrotechnical Standardisation
CISPR	International Special Committee on Radio Interference
CSF	Computer Suppliers Federation (UK)
DEF STAN	UK Defence Standards
DRPS	UK Defence Radiological Protection Service
DTI	Department of Trade and Industry (UK)
EC	European Community
EFTA	European Free Trade Association
EN	European Norm (European standard)
EU	European Union
FCC	USA Federal Communications Committee
ICNIRP	International Commission for Non-Ionising Radiation Protection
IEC	International Electrotechnical Commission

IEE	Institution of Electrical and Electronic Engineers (UK)
IEEE	Institution of Electrical and Electronic Engineers (USA)
ISO	International Organisation for Standardisation
ITU	International Telecommunications Union
NAMAS	National Measurement Accreditation Service (UK)
NAFTA	North American Free Trade Association
NATS	UK National Air Traffic Service
NIST	National Institute for Science and Technology (formerly NBS) USA.
NPL	National Physical Laboratory (UK)
NRPB	National Radiological Protection Board (UK)
OIML	International Organisation of Legal Metrology
OJEC	Official Journal of the European Community
SI	(1) Système Internationale (2) Statutory Instrument (UK)
VDE	Organisation of German Electrical Engineers
WHO	World Health Organisation
WTO	World Trade Organisation

Appendix 3

Information sources including the Internet

Standards, guides and associated documents

American National Standards Institute
1430 Broadway, New York NY 10018, USA.

British Standards
British Standards Institution, Sales Department, Linford Wood, Milton Keynes MK14 6LE United Kingdom.

European Broadcasting Union
Case Postale 67, CH-1218 Grand-Saconnex (Geneva) Switzerland.

IEC Standards*
IEC Central Office, 1, Rue de Varamb , P.O. Box 131, 1211 Geneva 20 Switzerland.

IEEE Standards
IEEE Service Center, 445 Hoes Lane, P.O. Box 19539, Piscataway, N.J. 08855 1331 USA.

National Radiological Protection Board (NRPB) documents
Chilton, Didcot, Oxford OX11 0RQ.

*Also available through National Standards organisations

Note: Standards organisations usually have agents around the world.

The Internet

Basic home page access information is given; actual pages dealing with relevant subjects may need to be found by 'search'. International bodies may have regional links.

World and governmental organisations

British Standards Institution (BSI)	bsi.org.uk
Brooks Air Force base	brooks.af.mil/AFRL/HED/hedr/reports
Department of the Environment UK (planning – masts and towers, etc.)	planning.detr.gov.uk
ICNIRP	icnirp.de
Legislation UK	legislation.hmso.gov.uk
New Zealand Government Dept of Health	moh.gov.nz
NRPB UK	nrpb.org.uk
Open government UK	open.gov.uk
USA FCC	fcc.gov/oet/info/documents
WHO	who.hq

Many of these provide free downloads of 'FAQS' documents and other relevant information. Formal standards documents and reports usually have to be purchased.

Suppliers referred to in this book who have an internet presence

General Microwave Corp. (Raham instruments)	generalmicrowave.com
Holiday Industries Inc.	holidayinc.com
Jaybeam	jaybeam.co.uk
Mini Instruments Ltd	mini-instruments.co.uk
Narda now 'Narda Safety Test Solutions'	nardamicrowave.com/east
Q-Par Ltd	q-par.co.uk
Victoreen	nucl.com/irm/products/vict

Note: Wandel & Goltermann Test Systems, Germany is now part of 'Narda Safety Test Solutions'.

Known training courses

<i>Type</i>	<i>Country</i>	<i>Organisation</i>	
Non-ionising & ionising radiation	UK	NRPB Chilton	nrpb.org.uk/training
RF radiation	UK	ERA Leatherhead	era.co.uk
RF radiation	UK	TUV Fareham Hampshire	djullien@tuvps.co.uk
RF radiation	USA	Narda	Nardamicrowave.com/east (also see Narda catalogue)

References

- 1 Wood, J., Desert sounds; *IEE Review*, pp.275–280, July/August 1991.
- 2 Barker, A., Electromagnetic therapies – real or imaginary? *Physics World*, January 1992, pp. G1–G2.
- 3 Saunders, R. D. et al., Biological effects of exposure to non-ionising electromagnetic fields and radiation: 3 *Radiofrequency and Microwave Radiation*; Report NRPB-R240 December 1991; ISBN 0–85951–332–7, HMSO Books, London.
- 4 IEEE Standard for safety levels with respect to human exposure to radio frequency electromagnetic fields; IEEE C95.1–1999; IEEE New York, USA. (IEEE Std C95.1–1999 Copyright ©1999 IEEE All rights reserved).
- 5 Stuchly, S. S. et al., Energy Deposition in a Model of Man: Frequency Effects; *IEEE Trans. on Biomedical Engineering*, Vol. BME–33, No. 7, July 1986, pp. B1–B10.
- 6 Speigel, R. J. et al., Comparison of Finite-Difference Time-Domain SAR Calculations with Measurements in a Heterogeneous Model of Man; *IEEE Trans. on Biomedical Engineering*, Vol. 36, No. 8, August 1989, pp. 849–855.
- 7 Ellis, F. P. et al., *Physiological Responses to Hot Environments*; special report, Series No. 298. Medical Research Council, London, pp.158–179.
- 8 Mumford, W. W., Heat stress due to RF radiation; *IEEE*, Vol. 57, No. 2, February 1969.
- 9 Adair, E. R., Thermophysical Effects of Electromagnetic Radiation; *IEEE Engineering in Medicine and Biology Magazine*, March 1987, pp.37–41.
- 10 Johnson, C. C. and Guy, A. W., *Non-ionising Electromagnetic Wave Effects in Biological Materials and Systems*; Proc. IEEE, Vol. 60, June 1972, pp.692–718.
- 11 Gandhi, O. P. and Riazi, A., Absorption of Millimetre Waves by Human Beings and its Biological Implications; *IEEE Trans. on Microwave Theory & Technology*, Vol. MTT-34 No. 2, February 1986, pp.228–235.

- 12 Suess, M. J. and Benwell-Morrison, D. A., eds, *Non-ionising radiation protection*, 2nd Edition, Copenhagen, WHO Regional Office for Europe, 1989 (WHO Regional Publications, European series No. 25). ISBN 92-890-1116-1115.
- 13 Gandhi, O. P., *Advances in Dosimetry of Radiofrequency Radiation and their Past and Projected Impact on Safety Standards*; IEEE Proc., IMTC San Diego USA, April 1988, pp. 109-113.
- 14 Gandhi, O. P., *State of the Knowledge for Electromagnetic Absorbed Dose in Man and Animals*; Proc. IEEE, Vol. 68, No. 1, January 1980, pp. 24-32.
- 15 Frey, A. H., Auditory system response to radiofrequency energy; *Aerospace Medicine*, 32 December, 1961, p. 1140.
- 16 Frey, A. H. and Messenger, R., Human perception with pulsed ultra high frequency electromagnetic energy; *Science*, Vol. 181, 27 July 1973, pp. 356-358.
- 17 Foster, K. R. and Finch, E. D., Microwave hearing: evidence for thermoacoustic auditory stimulation by pulsed microwaves; *Science*, Vol. 165, 1974, p. 256.
- 18 Gandhi, O. P. et al., Currents induced in a Human Being for plane-wave exposure conditions (0-50 MHz) and for RF sealers; *IEEE Trans. on Biomedical Engineering*, Vol. BME-33 No. 8, August 1986.
- 19 American National Standard ANSI C95.1-1982. *Safety levels with respect to RF electromagnetic fields 300 kHz to 100 GHz*.
- 20 Chen, J. and Gandhi, O. P., RF Currents induced in an anatomically-based model of a human for plane-wave exposures (20 to 100 MHz); *Health Physics*, Vol. 57, No. 1, July 1989, pp. 89-98.
- 21 Williams, T., *EMC for product designers*, Butterworth-Heinemann, 1992, ISBN 0-7506-1264-9.
- 22 Chatterjee, I. et al., Human Body Impedance and Threshold Currents for Perception and Pain for Contact Hazard Analysis in the VLF to MF Band; *IEEE Trans. on Biomedical Engineering*, Vol. BME-33, No. 5, May 1986, pp. 486-494.
- 23 *Electromagnetic Fields and the Risk of Cancer: Report of an Advisory Group on Non-Ionising Radiation*; NRPB Document Vol. 3, No. 1, HMSO Books, London ISBN 0-85951-346-7.
- 24 René de Seze et al., What do we know about accidents related to EM fields exposure? Laboratoire de Biophysique Médicale, Faculté de Médecine, Nîmes, France.
- 25 Heynick, L. N., Critique of the literature on bioeffects of radiofrequency radiation: Final Report USAFSAM-TR-87-3 (June 1987), Brooks Air Force Base, TX 78235.
- 26 ICNIRP 1998. Guidelines for limiting exposure to time-varying electric, magnetic and electromagnetic fields (up to 300 GHz); *Health Physics*, Vol. 74, No. 4, April 1998, pp. 494-522. Reproduced with permission.

- 27 Documents of the NRPB, volume 4, no. 5, 1993. Board Statement on Restrictions on Human Exposure to Static and Time Varying Electromagnetic Fields and Radiation; ISBN 0-85951-366-1. HMSO Books, London. *Should be read in conjunction with NRPB Report R301 July 1998 below (28).*
- 28 Chadwick, P. J., *Occupational exposure to electromagnetic fields: Practical application of NRPB guidance*; NRPB Report R301; ISBN 0 85951 421 8, HMSO Books, London.
- 29 Kowalczyk, C. I. et al., *Biological effects of exposure to non-ionising electromagnetic fields and radiation: 1. Static electric and magnetic fields; Chilton 1991*. Report no. NRPB-R238, HMSO Books, London.
- 30 Shinn, D. H., The avoidance of radiation hazards from microwave antennas; *The Marconi Review*, Vol. 34, No. 201, 2nd Quarter 1976. *Note: References to BS4992 therein are now invalid as BS6656 superseded it.*
- 31 BS6656:1991, *Guide to the prevention of inadvertent ignition of flammable atmospheres by radio-frequency radiation*; British Standards Institution.
- 32 BS6657: 1991, *Guide to the prevention of inadvertent ignition of electro-explosive devices by radio-frequency radiation*; British Standards Institution.
- 33 Aslan, E., Broadband Isotropic Electromagnetic Radiation Monitor; *IEEE Trans.*, Vol. IM-21, No. 4, November 1972, p. 421.
- 34 Hopfer, S., The Design of Broadband Resistive Radiation Probes; *IEEE Trans.*, Vol. IM-21, No. 4, November 1972, p. 416.
- 35 Hopfer, S. and Adler, D., An ultra broadband (200 kHz–26 GHz) high-sensitivity probe; *IEEE Trans.*, Vol. IM-29, No. 4, December 1980.
- 36 *IEEE Standard recommended practice for the measurement of potentially hazardous electromagnetic fields*, IEEE C95.3–1991, IEEE New York, USA.
- 37 Mantiplly, E. D., Characteristics of broadband radio frequency field strength meters; *Proc IEEE Eng. in Medicine and Biology Society*, November 1988.
- 38 Radiation Measuring Hazard Systems: paper available from General Microwave Inc., describing the design of Raham instruments.
- 39a Schilling, C. J., Effects of exposure to very high frequency radio frequency radiation on six antenna engineers in two incidents; *Occup. Med.* Vol. 50.
- 39b Schilling, C. J., Case report: Effects of exposure to very high frequency radio frequency radiation on six antenna engineers in two incidents; *Occup. Med.*, Vol. 50, No. 1, pp.49–56: 2000.
- 40 Système International d'Unités; International System of Units; General Conference of Weights and Measures (CGPM).
- 41 *The Ionising Radiations Regulations, 1999*; HMSO Books, London.
- 42 Davenport, E. M. et al., Prediction of field strengths near HF transmitters; *Radio & Electronic Engineer*, Vol. 53, No. 2, pp.75–80, February 1983.

- 43 Thomson Tubes Electroniques: *X-radiation from high power pulsed Klystron amplifiers reference NTH6111A*, June 1981. Quoted by permission of Thomson Tubes Electroniques.
- 44 Hunter B. E., X-ray Emission from Broadcast Transmitters: *IEEE Trans. on Broadcasting*, Vol. 36, No. 1, March 1990.
- 45 Philips Electronic Tubes catalogue; Philips Electronic Tubes.
- 46 Aslan, E., Non-ionising radiation – Measurement methods and artefacts; Loral-Narda Microwave Company, New York.
- 47 British Standard BS5175:1976 *Specification for the safety of commercial electrical appliances using microwave energy for heating foodstuffs*; British Standards Institution.
- 48 USA Government Centre for Devices and Radiological Health (CDRH) – criteria and qualification requirements.
- 49 *Radiofrequency radiation hazards, exposure limits and their implications for broadcasters*, Tech. 3278-E, February 1995.
- 50 Guidance note PM51 from the UK Health and Safety Executive, *Plant and Machinery 51*; January 1986. (Not considered current now.)
- 51 Johnson, R. et al., *Technology of E and H field sensors for measurements of pulsed radio frequency electromagnetic fields*; L3 Communications Narda Microwave East.
- 52 Aslan, E. et al., Electromagnetic radiation measurements; *Microwave Product Digest*, May/June 1989, pp.30–32.
- 53 BS4094 part 2: *Shielding from X-ray radiation*; British Standards Institution.
- 54 Manufacturer's specification for X-ray shielding glass reference RWB 46; Pilkington Special Glass, St Asaph, Clwyd, Wales, UK.
- 55 Mann, S. M. et al., NRPB Report R321, *Exposure to radio waves near mobile base stations*; NRPB Chilton, Didcot, Oxfordshire OX11 0RQ UK.
- 56 Amos, S. V., *Modelling of handset antenna interactions with the user and SAR reduction techniques*; Nortel Networks, UK; IEE conference on antennas and propagation 1999; Conf. Publication 461, pp. 8–11.
- 57 IEC562 1976 (subsequently re-numbered IEC60562), *Measurements of incidental ionising radiation from electronic tubes*; IEC.
- 58 Nicolaidis, G. et al., *TLM investigation of dielectric-loaded bifilar personal telephone antennas*; Navstar Systems UK and Loughborough University UK; IEE conference on antennas and propagation 1999; Conf. Publication 461, pp. 16–21.
- 59 Stewart, W., *Mobile phones and Health*; report of the UK Independent Expert Group on Mobile Phones (IEGMP) Chairman Sir William Stewart; May 2000.
- 60 National Physical Laboratory (NPL) leaflet on power density and field strength calibrations; *Electromagnetic Metrology*, Crown copyright 1999 NPL, Teddington, UK.

- 61 MIL Standard 45662 1980, Calibration system requirements; Department of Defense, USA.
- 62 Aslan, E., An electromagnetic radiation monitor calibration in accordance with MIL STD 45662; *Journal of Microwave Power and EM energy*, Vol. 24, No. 2, 1989, pp. 102–107.
- 63 Mild, K. J., Radiofrequency electromagnetic fields in Swedish radio stations and tall FM/TV towers; *Bioelectromagnetics 2*: pp. 61–69: 1981.
- 64 ISO 9000 series, *Quality System Standards*.
- 65 Jokela, K., Theoretical and measured power density in front of VHF/UHF broadcasting antennas; *Health Physics*, Vol. 54, No. 5 (May) 1988, pp. 533–543.
- 66 *The Active Implantable Devices Directive*, EEC Commission, Brussels.
- 67 Allen, S. G. and Harlen, F., *Sources of exposure to radiofrequency and microwave radiations in the UK*; Report NRPB-R144, March 1983; ISBN 0–85951–195–2, HMSO Books, London.
- 68 *The Electromagnetic Compatibility Directive (89/336/EC)*; European Commission, Brussels.
- 69 Abad-Alhameed, R. A. et al., *A two element phased array antenna for mobile handsets to reduce the mutual effects with the human head*; Telecommunications Research Centre, University of Bradford, UK; IEE conference on antennas and propagation 1999: Conf. Publication 461 291–294.
- 70 Hansen, R. C., Circular aperture axial power density; *Microwave Journal*, Vol. 19, February 1976, pp. 50–52.
- 71 BS5501 part 1 1977, *General requirements: Construction and testing of electrical apparatus to ensure that it will not cause an explosion of the surrounding atmosphere*. British Standards Institution.
- 72 ICNIRP Guidelines on Limits of Exposure to Static Magnetic Fields, *Health Physics*, Vol. 66, No 1, pp. 113–122, 1994.
- 73 Alexander, M. J., The design and performance of a large vertical aperture antenna for secondary surveillance radar; *GEC Review*, Vol. 4, No. 2, 1988, pp. 109–117.
- 74 Wandel & Goltermann, Standards – compliant test of non-ionising electromagnetic radiation on radar equipment; Wandel & Goltermann, Germany.
- 75 FCC Bulletin OET65, *Evaluating compliance with FCC guidelines for human exposure to radiofrequency electromagnetic fields*.
OET65 additional information supplements:
 - Supplement A for Radio and Television Broadcast Stations
 - Supplement B for Amateur radio stations
 - Supplement C for mobile and portable devices.
- 76 Durney, C. H. et al., *Radiofrequency radiation dosimetry handbook*: Brooks AFB.

-
- 77 Heppinstall, R. et al., The Inductive Output Tube (IOT) – a modern UHF amplifier for the Terrestrial Television Transmitter; *GEC Review*, Vol. 13, No. 2, 1998.
- 78 Guy, A. W., Dosimetry assessment with exposure to non-ionising radiation VLF to Microwave; *Health Physics* Vol. 53, No. 6, December 1987, pp. 569–584.
- 79 NRPB press release 12/97 NRPB Chilton.
- 80 Balanis, C. A., *Antenna theory, analysis and design*, 2nd Ed., Wiley.
- 81 EC Safety of Machinery Directive 98/37/EC (radiation emitted by machinery)
- (a) prEN 12198–2 98/37/EC Safety of machinery – Assessment and reduction of risks arising from radiation emitted by machinery – Part 1: *General principles* – (ratified).
 - (b) prEN 12198–2 98/37/EC Safety of machinery – Assessment and reduction of risks arising from radiation emitted by machinery – Part 2: *Radiation emission measurement procedure* (under approval).
 - (c) prEN 12198–3 98/37/EC Safety of machinery – Assessment and reduction of risks arising from radiation emitted by machinery – Part 3: *Reduction of radiation by attenuation or screening* (under approval).
- 82 *Code of Practice – Masts and aerials*, B5248 UK Dept. of the Environment.
- 83 *EMC shielding materials – a Designer’s guide*: J. W. Molyneux-Child, published by Newnes.
- 84 *Radio frequency hazards – Exposure limits and their implications for broadcasters*; European Broadcasting Union (EBU) publication Tech. 3278-E, Geneva, 1995.
- 85 Ackroyd, B., Earthing systems; *Communications International*, Sept. 1987, pp. 105–107.

Index

- Abbreviations, 416
- Aluminium:
 - foil, 320
 - sheet, 384, 386
- Amateur radio:
 - illustration, 173
 - safety limits UK, 116
 - safety limits FCC (USA) , 117
- Ambient temperature, 58
- Amplitude modulation, 11
- Amplitude (of currents and voltages), 4
- Antenna, microwave:
 - calculation examples for charts, 138, 142, 144
 - calculations, 130, 132, 137, 141
 - chart, circular apertures, far field zone, 134
 - chart decibel conversion, 137
 - chart summary table, 145
 - chart, far field, 134
 - charts, intermediate field, 135, 136
 - elliptical/rectangular apertures, 141
 - irregularly moving beams, 157
 - moving beams, 150
 - near field zone, 141, 158, 159
 - Rayleigh distance, 131
 - useful approximation formulae, 145
- Antenna, other:
 - arrays, 25, 26
 - collinear, 181
 - dipole, 24, 29, 158, 160, 168, 181
 - HF, 25, 26
 - sector, 182
 - television, 28, 30
 - UHF and VHF, 29, 30
 - wire antenna systems, 23–26
- Antenna field calculations:
 - Broadcasting – television, 165
 - Broadcasting – VHF, 164, 165
 - general, 160–162
 - HF and VHF (from BS6656), 166, 168
 - microwave frequencies, *see* microwave antennas
- Athermal effects of RF, *see* RF radiation effects on people
- Barriers and fences, 310
- Beams, rotational averaging, 149
- Beamwidth, 147
- Broadcasting transmitters:
 - MF and HF systems, 21
 - UHF and VHF systems, 26
- Cathode ray tubes, 253
- Checklists:
 - leakage surveys, 293
 - exposure surveys, 294
- Communications systems:
 - air traffic control, 33
 - satellite communication earth stations, 34
 - tropospheric scatter systems, 31

- Computer spreadsheets, 144
- Continuously moving RF beams, 150
- Control of changes, 375
- Controlled environments, 96
- Cranes, 120

- Decibel:
 - for power, 18
 - for voltage, 19
 - referencing ratios, 19
 - use of, 18
- Design to reduce radiation:
 - cabinet design, 376
 - components, 379
 - customer and national requirements, 371
 - design considerations, 371
 - design process, 366
 - design records, 375
 - design tests, 374
 - product maintenance, 373
 - product use, 372
 - radiation safety analysis, 374
 - safety interlocks and systems, 377
 - warning signs, 204, 245, 380
- Dummy loads, 24

- EEDs, 368
- Electric field, 7
- Electromagnetic compatibility (EMC), 369
- Electromagnetic spectrum, 14
- Electron volt, 246
- EMC Directive (EC), 251

- Field enhancements, 303
- Flammable vapours:
 - calculations, 122
 - examples of safety distances, 127
 - extractable power, 122
 - extractable energy, 125
 - gas group threshold values, 124
 - gas group threshold energies, 125
 - typical safe threshold diagram (CW), 125

- Frequency:
 - frequency–time relationship, 4
 - frequency–wavelength relationship, 9
 - microwave bands, 11
 - radio frequency bands, 10

- Gain, antenna, as dBi (dB rel isotropic ant.), 145
- Gain, antenna, as ratio (rel isotropic ant.), 145
- Geiger–Muller counter tube, 264
- graph–power density/electric field, 415
- graph–power density/magnetic field, 415

- Human thermo-regulation, 58
- Hyperthermia, 58

- Implantable devices in the human body, 74
- Infrared temperature scanning, 56
- Ionisation chamber, 261
- Irradiation from multiple sources, 168

- Machines, RF operated:
 - baking, 41
 - defrosting, 42
 - medical therapy, 43
- Marking, safety signs and warnings, 204, 244, 373
- Measurement:
 - calibration, 215, 217, 223, 404
 - electrostatic charge, 283
 - instrument correction factors, 223
 - traceability, 404
 - uncertainty of measurement, 223, 225, 284
- Measuring instruments, RF radiation:
 - alarm circuits, 220, 234, 236
 - ancillary equipment, 206, 243
 - ankle current monitor, 237
 - area monitors, 234
 - automated testing equipment, 230
 - battery charging, 222

- check test sources, 206
- choosing, 222, 223, 225
- combined E and H field sensors, 216
- construction and operation, 208
- electric field, 218, 240
- frequency coverage, 216 (*see also individual instruments*)
- handling and use, 282, 289
- induced body and contact current, 206, 237
- instrument features, 220
- instrument limitations, 220
- instruments for diagnostics, 230
- magnetic field, 218, 240
- maximum hold, 221
- measurement capability, 216
- measurement problems, 289
- meter scaling and colour coding, 217, 219
- personnel safety monitors, 205
- portability, 205
- power flux density, 216
- probe antennas, 208
- selection and preparation for use, 282
- sensor damage, 224, 286
- sensors, 207, 208–213
- sensors, isotropic, 209, 211, 212
- spatial and time averaging, 221
- special instruments, 219
- thermocouples, 210–212
- zero setting, 220
- Measuring instruments, X-ray radiation:
 - choosing, 273
 - energy response, 269, 275
 - Geiger–Muller tube instrument, 264
 - handling and use, 276
 - ionisation chamber instrument, 272
 - quartz fibre electrometer, 266
 - RF protection, 276
 - scaling of instrument, 275
 - scintillation counter instrument, 265
 - thermo-luminescent dosimeters, 266
- Medical therapy equipment, 43
- Microwave ovens, 88
- Mobile telephones:
 - antenna patterns, 182
 - antenna illustrations, 184
 - base stations, 181
 - coverage, user area, 180
 - delineation of safe distances-antennas, 191
 - experimental safety marking system, 201
 - handset design research, 197
 - handsets – public concern, 195
 - in public use, 177
 - measured radiation from towers, 188, 189
 - parasitic excitation rails, fences, etc., 193
 - safety on rooftop installations, 190
 - safety plans for installations, 194
 - shadowing of coverage from buildings, 188
 - shocks and burns, 193
 - startle response, 193, 194
 - Stewart report (UK) summary, 200
 - towers and masts 178, 179
 - tower diagram, 185
 - tower climbing, 194, 195
 - WHO ‘faqs’ documents, 199
- Modulation:
 - AM, 11
 - modulation index, 12
 - pulse, 13, 339, 347
- Occupational and public limits:
 - discussion, 54, 92
 - typical standards, 95
- Pain threshold, 70, 71
- Passive infrared detectors, 310
- Peak pulse energy, 125,
- Peak pulse power density, 95, 168, 170, 339, 347
- Permit-to-work, 321
- Phantoms, 363
- Plane waves, 7, 8
- Planning designs: *see* Design
- Practical survey methods:
 - beamwidth, 336
 - broadcasting systems, 359
 - characterising beam systems, 346

Practical survey methods – *continued*

- elevated workplaces, 363
- hazard avoidance, 318, 327
- man-clearance for access, 343
- MF and HF antenna systems, 318
- microwave beams, 333
- moving beam antennas, 333

Quality assurance, 397

Radiation incident investigation, 78,
267, 407

Recording test data, 311, 312, 399

Records and reports, 311, 375

Resonance:

- human, 60

RF leakage surveys,

RF process machines:

- illustrations, 41
- measurements, 329, 330
- protective measures, 331

RF radiation effects on people:

- absorption in the human body, 53
- athermal effects, 73
- aural effects, 65
- beneficial effects, 76
- direct effects, 52
- effects summary, 77
- eyes, 64
- hot spots, 62
- human resonance, 60
- implantable devices in the human body, 74
- indirect effects, 52,
- limb currents, 67
- penetration of human tissues, 59
- perception of heat, 72
- pulsed radiation, 72
- rectal temperature, 58
- RF radiation effects on ‘things’ 52
- SAR, 55
- shocks and burns, 69
- susceptible organs, 64
- testes, 65
- thermal effects, 57, 58
- ‘windowing effects’, 48

RF shielding:

- Beryllium–copper strip, 388
- honeycomb vents, 389
- lead glass, 374
- shielded windows, 374
- transparent shielding, 389

RF therapy machines:

- illustration, 44
- precautions, 43

Safety activities:

- audits, 399
- management, 393
- record retention, 399
- safety procedures, 396
- survey reports, 398
- training, 400

Safety survey planning:

- checklist, exposure surveys, 279
- checklist, leakage surveys, 278
- prevention of ignition of flammable vapours,* 119, 295
- prevention of ignition of EEDs,* 127
- * *see also relevant standard*

SI system prefixes, 5

Simultaneous irradiation from sources,
168Special test methods for rotating
beams, 150

Specific absorption rate, 55

Standard man, 55

Standards:

- basic restrictions, 97
- concepts, 86
- contact currents, 93
- examples of standards, 95
- exposure, 89
- FCC table of limits, 108, 109
- FCC radio amateur limits, 117
- leakage, 88
- limb/body currents, 93
- multiple irradiations, 110
- NRPB radio amateur limits, 116
- static magnetic fields, 115
- time averaging, 94
- tables of limits NRPB, IEEE and ICNIRP, 98, 99

Terms:

- antenna (aerial), 16
- antenna beamwidth, 17
- antenna, isotropic, 17
- directive gain of an antenna, 17
- electric field strength, 15
- energy density, 15
- equivalent radiated power (ERP), 17
- equivalent isotropic radiated power (EIRP) 17
- magnetic field strength, 15
- mean power, 15
- peak pulse power density, 16
- power, 14
- power flux density, 15
- pulse duty factor (DF), 16
- RF machines and plant, 17
- Specific absorption rate (SAR) 15
- Transverse electromagnetic mode wave, 14

Units of measurement:

- ionising radiation, 414
- general, 413

Waveguides, gain of open waveguide:

- circular, 148
- rectangular, 148

X-rays:

- dose and dose rate, 249
- effective energy assessment, 383
- energy, 246
- energy distribution, 247
- half-value layer of metal, 383, 385, 386
- harmful effects, 250
- Ionising Radiations Regulations (UK), 251
- klystron X-ray test results, 255
- production of X-rays, 254
- tenth-value layer of a metal, 383, 386
- tetrode test results, 258
- transmitter lead glass windows, 387

Zero adjustment of RF radiation meters, 220

