

# PHYSICS WITHOUT EINSTEIN

BY

HAROLD ASPDEN

Doctor of Philosophy of Trinity College  
in the University of Cambridge

SABBERTON PUBLICATIONS

P.O. Box 35, Southampton, England

# Contents

<i>Foreword</i>	xi
<i>Introduction</i>	xiii
1 THE ELECTRON	
Electron Charge	1
What is an Electron?	1
The Electron in Motion	2
X-ray Scattering by Electrons	3
Magnetic Energy of the Electron	4
Electrostatic Rest Mass Energy of Electron	5
Electric Field Induction by Motion of Electric Charge	5
Is Magnetic Energy Negative?	7
Accelerated Charge	8
Superconductivity	14
The Velocity-dependence of Mass	16
Fast Electron Collision	17
Electrons and Positrons as Nuclear Components	18
Summary	22
2 MUTUAL INTERACTION EFFECTS	
Reaction Effects	23
Mutual Kinetic Energy	24
The Nature of Induced EMF	27
Magnetocaloric Effects	28
Evidence of Magnetic Reaction Effects	30
The Gyromagnetic Ratio	32
The Aether	36
Thermonuclear Reactor Problems	37
The Law of Electrodynamics	39
Summary	47

3	THE NATURE OF FERROMAGNETISM	
	Heisenberg's Theory	48
	The Cause of Ferromagnetism	49
	Stress Energy Analysis due to Orbit-Orbit Interactions in a Ferromagnetic Crystal Lattice	50
	Discussion of New Theory	55
	Summary	57
4	WAVE MECHANICS	
	Universal Time	58
	The Michelson–Morley Experiment	59
	The Principle of Equivalence	60
	Energy and Angular Momentum of Space–time	61
	Heisenberg's Principle of Uncertainty	63
	Space–time Spin Vector	64
	Planck's Radiation Law	64
	The Bohr Atom	68
	Electron-Positron Annihilation	69
	The Schrödinger Equation	70
	Photon Momentum	75
	Anomalous Electron Behaviour	76
	Summary	77
5	GRAVITATION	
	The Nature of Space–time	78
	Tests of Einstein's General Theory	80
	Mercury's Perihelion	83
	The Nature of Gravity	88
	Summary	94
6	SPACE–TIME ANALYSIS	
	Space–time Motion	95
	Electromagnetic Wave Propagation	99
	Balance in Space–time	106
	Space Polarization Energy	111
	Derivation of Planck's Constant	111
	Electron Mass	116
	The Muon	117
	Summary	123

7	NUCLEAR THEORY	
	Electron-Positron Creation	125
	Mass of Aggregations of Electric Charge	127
	The Deuteron Reaction	128
	Particle Inversion	130
	The Proton	132
	The Neutron	133
	The Origin of the Basic Nucleons	139
	Atomic Nuclei	145
	Nuclear Bonds	147
	The Pion	149
	Proton Spin	152
	Neutron Spin	156
	Deuteron Spin	158
	Electron Spin	160
	Summary	164
8	COSMIC THEORY	
	Geomagnetism	166
	Jupiter	170
	The Sun	171
	The Zodiacal Light	172
	The Solar System	174
	Quasars	177
	The Origin of Matter	178
	Derivation of Graviton Mass	181
	Perihelion Motions	184
	Summary	186
9	GENERAL DISCUSSION	
	Relativity	187
	Electromagnetic Energy Transfer	198
	The Nature of Spin	202
	Electrodynamics	206
	APPENDICES	
I	Electrostatic Energy and Magnetic Moment of Spinning Charge	209

II Magnetic Field Angular Momentum Analysis	211
III Magnetic Spin Properties of Space–time	214
REFERENCES	217
INDEX	221

## *Foreword*

Relativity is presently on trial. If Einstein's theory cannot be sustained there is no recognized alternative. This book provides not only an alternative but a comprehensive unification of all physics. It is based upon a straightforward confrontation with the anomalies in accepted electromagnetic theory. These undisputed inconsistencies cannot be ignored if modern science is to progress. What is offered here is not a new theory but a reconciliation of existing theories. The starting point of this work was not a lofty-minded attempt to overthrow Relativity or explain gravitation. It was a desire to understand more about the nature of ferromagnetism. However, what emerged provided physical concepts embracing fundamental magnetism from its atomic environment to the cosmos. Gravitation is explained and is supported by the derivation of  $G$  in terms of the properties of the electron. Elementary particles are explained and there is support from the exact quantitative assessment of their spin magnetic moments. Wave mechanics are explained and there is support from the quantitative evaluation of the Fine Structure Constant. Atomic structure is explained and is supported by quantitative analysis of nuclear binding energy. The evaluation of the binding energy of the deuteron is particularly revealing. It will be shown that Einstein's theory is unnecessary.

## *Introduction*

At the end of the nineteenth century the well-tested mechanical principles of Isaac Newton were the very heart of physical theory. Electricity and magnetism still presented problems. The electron had been discovered but its charge had only just been measured. The photon light quantum and its source, the atom, attracted the attention. Electromagnetic waves had only recently been detected and their radiation pressure verified. However, Newton's principles of mechanics were firmly applied throughout physical theory. The aether was still a subject of speculation but interest in it was losing impetus. Its nature had become a great mystery, standing alongside the aged problems of the cause of gravitation and terrestrial magnetism. The great minds in physics were diverted to the atom and its quantum behaviour. Albert Einstein emerged in the midst of this diversion when, in 1905, he proposed new principles which were destined to limit the scope of application of Newton's mechanics. The already-recognized relationship between energy and mass was brought into the framework of Einstein's philosophy. A new way of looking at physics had been found. The aether had become an unnecessary integer since the mathematical structure of Einstein's theory provided the medium by which physical theory had to be linked. The Special and General Theories of Relativity became recognized aristocrats among physical theories. They have acquired and retained an undeniable elegance. However, in the past ten years, more and more voices have been raised in criticism. More is expected than the theories appear able to supply. Tests are becoming more exacting as new and better experimental techniques are developed. Relativity appears to be weakening even though it stands as a lone provider of physical understanding. There is, therefore, due cause for concern and this is an appropriate time to review physics as it could be without reliance upon Einstein's doctrines.

# 1. *The Electron*

## **Electron Charge**

Millikan, writing about the electron in 1935, stated, "We knew that there was a smallest thing which took part in chemical reactions and we named that thing the atom, leaving its insides entirely to the future. Precisely similarly the electron was defined as the smallest quantity of electricity which ever was found to appear in electrolysis, and nothing was then said or is now said about its necessary ultimateness. Our experiments have, however, now shown that this quantity is capable of isolation, and that all the kinds of charges which we have been able to investigate are exact multiples of it."

Millikan raised the question, "Is the electron itself divisible?" and discussed the affirmative support put forward from 1914 onwards, principally by Ehrenhaft, only to conclude from an analysis of the experimental evidence that "there has then appeared up to the present time no evidence whatever for the existence of the sub-electron".

At the present time, 1969, we find that physical theories are being developed on the assumption that there are particles of sub-electronic charge. We read about the quarks,\* which are hypothetical particles having charges of one third or two thirds that of the electron or positron. A neutron is then imagined to comprise an aggregation of two quarks each of charge  $-e/3$  and one quark of charge  $+2e/3$ , whereas the proton consists of two quarks of  $+2e/3$  and one of  $-e/3$ . Here,  $-e$  is the charge of the electron. This is most interesting speculation, but the fact remains that particles with these sub-electronic charges have yet to be discovered. The quarks are purely hypothetical and Millikan's contention that the electron charge is indivisible is not yet disproved by any direct experimental evidence.

## **What is an Electron?**

Although Millikan stated that the electron was the smallest quantity of electricity ever found to appear in electrolysis and thus characterized the electron by its quantum of charge  $-e$ , there are other

\* Burhop, 1967. (Note that references are listed on page 217 according to author's name and year of publication.)



elementary particles possessing this unique charge. The electron is further characterized by its small rest mass  $m$ , known to be about  $9.1 \cdot 10^{-28}$  gm. The charge  $e$  is approximately  $4.8 \cdot 10^{-10}$  esu, expressed in cgs. units.

Having thus introduced the electron and identified it by its discrete charge  $-e$  and discrete rest mass  $m$ , and shed a little uncertainty on the fundamental quantum nature of the electron charge, we are ready to consider the question, "What is an electron?" Firstly, if it is suggested to some physicists that an electron is a mere corpuscle of electric charge, this evokes a smile and a denial. An electron is not that simple. Some would present the electron as a kind of vector symbol. Others present it as a mathematical formulation. They have in mind the spin properties of the electron, or its wave characteristics, and they are not really answering the question "What is an electron?", but the question of how an electron manifests itself. Yet, its behaviour really depends upon its interaction with something else, be it only the observer! Then, we see that we might have mixed the electron up with the properties of something else. According to Heisenberg's Principle of Uncertainty, as quoted by Eddington (1929, a) "A particle may have position or it may have velocity but it cannot in any exact sense have both." Is Eddington really suggesting that a particle cannot have a position and a motion at the same time, or is he saying that our powers of observation are limited and preclude us from determining the exact position and velocity of the particle at any instant? It is submitted that the electron is not a mathematical symbol, nor is it a wave or group of waves. An electron is an elementary particle, almost by definition, and must be taken to be a corpuscle in any serious attempt to understand what it really is, meaning its size, shape and content. It can be asked why the real nature of the electron matters when physical theory need only be concerned with its behaviour as seen by an observer. The answer to this is that the electron presumably will still exist even when the observer is removed. Its properties cannot, therefore, be wholly related to the existence of the observer. The electron will still interact with other matter, and its interaction properties could well account for certain physical phenomena as yet unexplained in physical theory.

### The Electron in Motion

Assuming the well known relation  $E = Mc^2$  and that there is no loss of energy by radiation or otherwise when a particle of mass  $M$  is

accelerated to acquire kinetic energy itself augmenting the energy  $E$ , it may be shown that the mass of a particle increases to infinity as the particle approaches the limiting velocity  $c$ . The applicable formula for the mass of the particle when moving at velocity  $v$  is given by:

$$M = M_o/\sqrt{[1 - (v/c)^2]} \quad (1.1)$$

where  $M_o$  is the mass of the particle when at rest.\* The velocity  $c$  is the speed of light in vacuo.

Wilson (1946), after presenting the above result, writes "If the particle considered is an electron,  $M$  will be the mass of the electromagnetic field which it excites and which moves along with it, together with any additional mass which it may have. If the electron is merely an electric charge, it may have no additional mass, but if it has some internal energy besides its electrical energy, it will have some additional mass corresponding to this additional energy. In any case its mass should vary with its velocity in accordance with the expression found above for  $M$ , since this should hold for a particle of any kind. The experiments of Kaufmann, Bucherer and others on the variation of the mass of electrons with their velocity have shown that the mass does vary approximately in accordance with the above formula. These experiments confirm the idea that momentum is due to flux of energy, but they give no information as to the constitution of electrons."

Experiments on the increase of electron mass with velocity do, however, show that electron charge does not vary with velocity. It is mass which varies. The analysis used to derive equation (1.1) also suggests that an electron does not dissipate its energy by radiation when it is accelerated and this is a most important point to keep in mind because this is in conflict with other currently accepted theory.

### **X-ray Scattering by Electrons**

The role of electrons in X-ray scattering has been analysed by A. H. Compton. It is found that the wave-length of the scattered rays is not the same as that of the incident rays. Compton supposed that when a photon, as an incident radiation quantum, is intercepted by an electron, a photon quantum of scattered radiation of lower frequency is produced. Then, by assuming that both energy and momentum are conserved, results in conformity with observation are obtained. Since

\* The mathematical proof of this is presented in a later section of this chapter.

Compton only considers the electron's kinetic energy, this means that the energy supplied to the electron in this scattering process is wholly kinetic. Now, the electron has a charge and its velocity is changed when it absorbs momentum. Its magnetic field must therefore change and with this the magnetic field energy must change. Yet, as just stated, experiment shows that the energy form which is changed is wholly kinetic.

This result is, of course, compatible with the above theoretical explanation of the increase in mass with velocity. Magnetic energy must, presumably, be the whole or part of the kinetic energy itself. It is the implications of this which guide us to understand more about the real nature of the electron.

### Magnetic Energy of the Electron

The magnetic energy of an electron in motion is easily calculated if the electron of charge  $-e$  can be regarded as a sphere of radius  $R$  with the magnetic field energy wholly disposed outside the sphere. The field  $H$  distant  $x$  from a charge  $e$  moving at velocity  $v$  at an angle  $\theta$  to the  $x$  distance vector is:

$$H = (ev/c) \sin \theta / x^2 \quad (1.2)$$

This can be used in the following expression for the magnetic energy.

$$E = \int_{\theta=0}^{\pi} \int_{x=0}^{\infty} (H^2 / 8\pi) 2\pi x \sin \theta dx d\theta \quad (1.3)$$

Upon evaluation using (1.2) and (1.3), we find:

$$E = e^2 v^2 / 3 R c^2 \quad (1.4)$$

Nissim (1966), in reviewing the electromagnetic mass properties of this electron, writes: "Thus, by virtue of its electromagnetic field energy, an electron possesses an electromagnetic mass equivalent to  $2e^2/3Rc^2$ . This was held by J. J. Thomson to be in addition to the 'ordinary' mechanical mass of the electron but, as previously mentioned, Abraham and others subsequently advanced the hypothesis that the electromagnetic mass, or self-mass as it has been called, represents the total inertial mass of the electron. . . . Relativistic considerations, however, have caused physicists to abandon this idea and veer to the view that the electron possesses a certain mechanical inert mass in addition to an electromagnetic mass."

## Electrostatic Rest Mass Energy of Electron

If an electron is a charged sphere and the charge is taken to be uniformly spread over its surface of radius  $R$ , the intrinsic electric field energy is  $e^2/2R$ , corresponding to a rest mass of  $e^2/2Rc^2$ , which is less than the electromagnetic mass just deduced. To resolve this difficulty, we may follow the argument of Wilson (1946) that there are binding forces restraining the electron charge from expanding and these must also represent an energy term. He calculated the binding energy for the spherical shell electron model as  $e^2/6R$ , which exactly balances the discrepancy between the electric and magnetic rest mass calculations.

Alternatively, if an electron is regarded as constrained to occupy a fixed volume, it will be found to adopt spherical form for minimum electric field energy and, for uniform pressure throughout this volume, its charge will be so distributed that its total electric field energy becomes  $2e^2/3R$ . This again leads to equality in the rest mass calculations, allowing kinetic energy to be identified with magnetic energy. A proof of this is given in Appendix I.

This may seem to be mere speculation. If an electron is a sphere of charge, it must have a certain size and therefore a certain rest energy. There must be something holding it together, whether it is spherical or not. In established physical theory these facts cannot be avoided: they are implicit in our analysis of electron behaviour. Instead of assuming a quantized charge and a quantized rest energy, which is too easy a way of avoiding the problem, we may note that, although charge does not vary with velocity, energy does vary with velocity. Then we can consider assigning a quantum volume of space to the electron. Why not quantize space rather than energy? This volume will not have to change with velocity and the fact that it is constant accounts in a single assumption for rest mass energy quantization and for the binding force action restraining charge expansion, thus simplifying the model of the electron.\*

## Electric Field Induction by Motion of Electric Charge

When an electric charge is in motion at a steady velocity, its electric field moves bodily with it. According to the principles of Relativity,

\* The theory of quantum space has remarkable impact upon the understanding of elementary particles. See Chapter 7.

if an observer moves at this same steady velocity, he will not be able to detect any effects of the motion. If the velocity is measured relative to the observer, then the electron will induce the magnetic field just considered and, presumably, the energy of this field will account for its mass properties. However, will any electric field effect of a dynamic character also be induced? A single classical line of reasoning suggests that there is an electric dynamic field effect.

Referring to Fig. 1.1, consider a charge  $e$  located at  $O$  to be moving with a velocity  $v$ , as shown. At a point  $P$ , the strength of the field from  $e$  is  $e/x^2$ . Also at  $P$ , the electric charge  $e$  is really "seen" by an observer to be at  $Q$  because the disturbance set up by the charge in motion past  $P$  is propagated at the finite velocity  $c$ . There must,

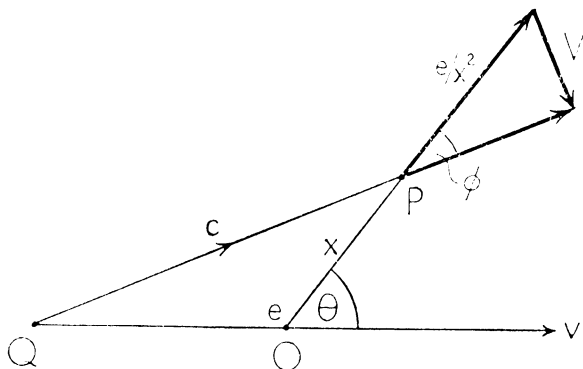

Fig. 1.1

therefore, be an electric displacement at  $P$ , denoted  $V$ . The position of  $Q$  is found from the relationship:

$$QP/QO = c/v \quad (1.5)$$

because the charge travels from  $Q$  to  $O$  in the time taken for the disturbance to travel from  $Q$  to  $P$ . When  $V$  is added vectorially to the radial field  $e/x^2$  from  $O$  to  $P$ , the resultant vector lies along  $QP$ . Further, since the displacement field will be in the direction needed for least energy, that is minimum  $V$ , this vector  $V$  will be normal to the radial field direction  $QP$ . It follows that  $V$  is given by:

$$V = (e/x^2) \sin \phi \quad (1.6)$$

Now,  $\phi$  is the angle between  $QP$  and  $OP$  and if  $\theta$  is the angle between  $QO$  and  $OP$

$$QO \sin \theta = QP \sin \phi \quad (1.7)$$

From (1.5), (1.6) and (1.7):

$$V = (ev/c) \sin \theta / x^2 \quad (1.8)$$

By analogy with equation (1.2), we find that the electric energy attributable to this is exactly as given by equation (1.4). Thus, the dynamic electric field energy is:

$$E = e^2 v^2 / 3 R c^2 \quad (1.9)$$

Curiously, the magnetic field energy density and electric field energy density due to the motion of the charge are identical everywhere in the field.

Now, this poses a problem. If magnetic energy is wholly identified with the kinetic energy, how can we now explain an additional component of dynamic energy which is exactly equal to the magnetic energy? This analysis draws attention to an anomaly facing the observations from the Compton Effect.

### Is Magnetic Energy Negative?

It is standard in physical theory to write the magnetic energy density of a field  $H$  as  $H^2 / 8\pi$ . However, it is equally standard to put a minus sign in front of magnetic energy terms when energy balance conditions are under study. According to Bates (1951, a): "The minus sign merely indicates that we have to supply heat in order to destroy the intrinsic magnetization." Put another way, since heat is really kinetic energy, we can say that:

$$\text{Kinetic energy} - \text{magnetic energy} = 0$$

However, this does not read kinetic energy equals magnetic energy, meaning that they are identical. It reads that when we have kinetic energy and magnetic energy together in equal measure, they constitute no overall energy whatsoever.

If this applies to the electron, we see that the total of the kinetic energy and the magnetic energy is zero, but since there is also a dynamic electric energy equal to either quantity, the net dynamic energy of the electron is given by equation (1.9) alone.

It follows that we really should take the experimental evidence afforded by the Compton Effect as a clear indication that kinetic energy, magnetic energy and dynamic electric energy exist in equal measure when an electron is in motion but that since one of these,

the magnetic energy, should always be considered as a negative quantity, the electron behaves as if it only possesses a normal kinetic energy related to its intrinsic electric energy.

This conclusion will now be fully supported by analysing the inertial effects of an electron when it is accelerated.

### Accelerated Charge

The effect of accelerating a slow-moving charge  $e$  will now be calculated. The electric field of a charge has the property of inertia and moves with the charge. The action of acceleration, however, means that the field motion is disturbed. The electric field is distorted. For example, if an electric charge is moving at uniform velocity and then undergoes acceleration to another uniform velocity during a short period of time  $dt$  then at time  $t$  later there will be a disturbance in the field region distant  $ct$  from the charge. This assumes such low velocity that the charge is effectively still located at the centre of the radiated wave disturbance. Essentially, there is a regular radial electric field from the new position of the electric charge within the sphere of radius  $ct$ . This field is moving at the same velocity as the charge and it is therefore not distorted. Outside the radius  $ct$  the field still centres on the position the charge would have had it not been accelerated. This field is still moving with the original charge velocity. The disturbance in the field is really wholly contained in a spherical shell of radius  $ct$  and radial thickness  $cdt$ . It contains the lines of electric field flux which join the two regular field regions. The key question we face is whether the total electric field energy in this shell is different from the energy content if there were no disturbance. If the shell has extra energy, then this is energy carried off by radiation as the disturbance is propagated outwards at the propagation velocity  $c$ .

Referring now to Fig. 1.2, consider a charge  $e$  to be moving in a straight line  $BC$  at velocity  $v$ . At the point  $C$  the charge is supposed to undergo sudden acceleration causing it now to move along  $CD$  at velocity  $v'$ .  $CD$  is inclined to  $BC$ . Both  $v$  and  $v'$  are taken to be very small compared with the propagation velocity  $c$ . At time  $t$  after acceleration a field disturbance has moved to a distance  $ct$  from  $C$ . The disturbance is contained within a radial distance  $cdt$ . Now consider a point  $P$  in this disturbance region. To pass through  $P$ , a line of force will be inclined to the vector  $v' - v$  at an angle  $\theta$ . This is

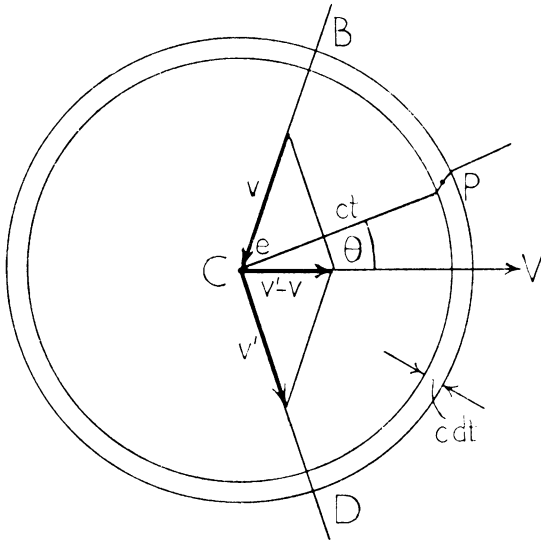

Fig. 1.2

the line of force emanating from the charge and traversing the wave region. In the region of *P*, however, the line of force has to undergo displacement. It is laterally displaced by the distance  $(v' - v)t \sin \theta$  because, for example, if  $v'$  and  $v$  are unidirectional the field change across the wave region is an advance to a new velocity which causes a displacement in the direction of  $v$  or  $v'$  equal to the change in velocity times time. This displacement is  $(v' - v)t$ . At right angles to the line of motion of the charge we find the direction of this displacement to be perpendicular to the lines of force emanating from *C* to the field region. Directly ahead of the charge in its line of motion we find that the displacement is along the lines of force emanating from *C*. The resulting lateral displacement of the field lines by  $(v' - v)t \sin \theta$  requires an electric field component in the disturbance at right angles to the propagation direction and in or parallel with the plane containing  $v' - v$ . This field component will give rise to a separate electric field energy component. The transverse field is calculated quite easily, since its ratio to the main radial field  $e/c^2t^2$  is the above lateral displacement divided by the radial disturbance distance  $cdt$ . By putting the acceleration  $f$  as  $(v' - v)t/dt$ , this transverse electric field becomes  $ef \sin \theta/c^3t$ . Thus, the electric field energy per unit volume in the disturbance region is:

$$\frac{1}{8\pi} \left( \frac{ef \sin \theta}{c^3t} \right)^2 \tag{1.10}$$



The total electric field energy in the disturbance region, that is, the total energy carried by the disturbance, is found by integrating this expression over the volume of the shell. An elemental volume formed by an annulus through  $P$  centred around the axis  $r' - r$  is  $2\pi(ct)^2 \sin \theta c dt d\theta$ . Performing the integration between  $\theta = 0$  and  $\theta = \pi$ , gives:

$$e^2 f^2 dt / 3c^3$$

Since  $dt$  is the time during which the disturbance is formed and since this energy quantity is independent of the distance travelled by the disturbance, it is deduced that this energy is radiated by the charge when subjected to acceleration  $f$  and during the time  $dt$ . Should the acceleration be sustained the rate of energy radiation in the electric field form becomes  $e^2 f^2 / 3c^3$ .

This result is that classically obtained by applying Maxwell's equations to the problem of radiation by accelerated charge. It has to be doubled to follow the usual wave propagation theories, according to which electric and magnetic field energies are equal for wave propagation through a vacuum. Classically, magnetic field energy has to be added to the expression deduced in order to evaluate the total rate of energy radiation.

Now, this feature of energy radiation by accelerated charge, particularly electrons, is relied upon in many accepted physical theories. It has been accepted quite readily because energy transfer by electromagnetic wave propagation is fundamental. Yet, the energy quanta are supposed to come along as photons according to other physical theory and factual observation. There is nothing of a quantum nature about the derivation of the energy radiation presented above, or about the classical derivation using Maxwell's equations. Hence, there is a problem. It is part of an accepted mystery in physics. Acceptance emerges from the reconciliation by the physicist in believing that there can be two ways of looking at the same thing. The duality of wave and photon principles of energy transfer is no longer treated as an absurdity. It is an accepted and fascinating feature of Nature. Yet, if one dares to ask the question of how an electron can radiate energy and still stay an electron, or how the energy radiated is fed to the electron, one is asking too much from physical theory. We should look, instead, at the broader energy balance and make our analysis by reference to the field equations. How is it that the physicist has given in to this problem? Surely, we

will never understand the real nature of the electron if we tolerate two conflicting explanations for the same phenomenon and stop asking the questions about the source of the electron's energy radiation.

One simple fact is evident. If electromagnetic wave propagation had not been discovered, energy radiation merely due to electron acceleration would be highly questionable. The physicist would retrace his theoretical steps, even revise his theory, before building his further theories on the notion that an electron can radiate energy. This should be even more a matter for concern in the light of the quantum features of energy transfer. Had the discovery of the photon preceded the theory of electromagnetic wave radiation, the conflict of the dual existence of wave and quantum theory could hardly have become a tolerable situation. At this stage, the author puts before the reader the clear proposition that *an accelerated charge does not radiate energy*. We will re-examine the above analysis to find out where it went wrong.

We do not have to look very far. It was postulated that the acceleration of the charge  $e$  was  $f$ . From the time of Newton it has been known that acceleration cannot be assumed. It results from a force. To apply a force to an electric charge demands a field acting on the charge. No such field was incorporated in the analysis. Our object was to calculate energy and energy is a quadratic expression and cannot be calculated if fields present are ignored. Here, then, is the source of the error. Now, it seems absurd to suggest that such a mistake could have gone without notice for so many years. Perhaps this can be understood if we argue that the wave disturbance set up by accelerated charge must eventually pass well outside the region of any local accelerating field. Then the analysis must be valid. If energy is carried along by the disturbance it must come from somewhere. It comes from the direction of the accelerated charge. Presumably it comes out of the field at the source. It does not have to come from the electron itself. It is just that the acceleration of the electron is a necessary adjunct to whatever it is that causes energy to be radiated. This is an argument, but it does not eliminate the duality problem and it does involve an all-important assumption that energy is in fact carried by an electromagnetic wave. This is an assumption having no analogy in other physics. Waves on water involve local interchanges between kinetic and potential energies and no forward migration of water or energy at the wave velocity. It seems a better

assumption to propose non-radiation of energy by the accelerated charge, non-transfer of energy by electromagnetic waves, and leave the physicist free to accept the quantum mechanism of energy transfer without ambiguity. At least, it is worth the effort of re-analysing the mechanism of wave propagation by an electron, allowing for the accelerating field. The method of analysis being used by reference to Fig. 1.2, incidentally, is a textbook method which is attributed to J. J. Thomson. It is only the following introduction of the accelerating field which is new.

An electric field  $V$  is applied in the direction of acceleration of the charge depicted in Fig. 1.2. This field  $V$  may be resolved at  $P$  into two components, one radial from  $C$  augmenting the regular field of  $e$ , and the other in opposition to the transverse field component from which the radiated energy is derived. Thus, expression (1.10) for the energy density in the disturbance region can be expressed as:

$$\frac{1}{8\pi} \left( \frac{ef \sin \theta}{c^3 t} - V \sin \theta \right)^2 \quad (1.11)$$

Although it is tempting to choose  $V$  so that this is zero for all  $\theta$ , we cannot do this because the square of the last term in the expression is an energy component belonging to the field  $V$  and it cannot be assumed to move with the disturbance. The rest of the expression, including the interaction term found when the expression is expanded, does denote energy moving with the disturbance. The energy density which can move with the disturbance is different from that previously calculated by the reducing amount:

$$\frac{1}{8\pi} (2V \sin \theta ef \sin \theta / c^3 t) \quad (1.12)$$

Upon integration, as before, this is  $2Vefdt/3$ . Thus, the total energy carried by the disturbance is:

$$e^2 f^2 dt / 3c^3 - 2Vefdt / 3 \quad (1.13)$$

Now, in considering the mass acted upon in charge acceleration, we must equate this mass to that of the electric field remaining to be accelerated. This is a function of  $ct$ . Expression (1.13) has to be zero on the basis of our assumption that the charge does not radiate energy. This means that:

$$Ve/f = e^2 / 2c^3 t \quad (1.14)$$

This expresses the ratio of force  $Ve$  to acceleration  $f$ , and is a measure of the effective mass of the electric field remaining to be accelerated. The energy of the electric field outside the disturbance region is  $e^2/2ct$ . Denoting this as  $E$ , we have from (1.14):

$$E = Mc^2 \quad (1.15)$$

where  $M$  is the mass involved.

It follows that the assumption that an electric charge does not radiate energy leads to the conclusion that an electric field energy has mass according to the relation  $E = Mc^2$ . If this latter relationship is not valid, then there should be radiation of energy by accelerated charge and we are led back into the duality problem confronting physics. The duality problem is avoided if we accept that  $E = Mc^2$  is a valid relation. Now, this latter expression is an accepted result in modern physics. It has been verified in its application to atomic reactions and electron-positron annihilation. Since it must be true, an accelerated charge cannot radiate energy. Therefore, if an electromagnetic wave carries energy with it, it must acquire this energy as it passes out of the field causing the charge acceleration. If it does this, we come back to the duality problem. Also, imagine two electric charges mutually attracted and accelerated towards one another. If both radiate energy generated somehow in their fields, they must lose some of their fields and so their charge. Note that they need not, theoretically, have much velocity but may have a high acceleration. In short, while it is not proved that there is no energy radiation from the field, it is certainly likely to present some peculiar problems to assume that the wave gets a supply of energy at some position remote from its source. If this assumption is avoided and we accept the validity of Maxwell's equations we are left with but one conclusion. The assumption made in applying the Poynting vector to deduce energy propagation by an electromagnetic wave is wrong. This assumption is that the energy of the wave is carried by the wave. In fact, the energy might come from a source in the medium through which the wave is propagated. It might come from the aether. Or it might not exist at all. If, in applying Maxwell's equations, we assume that because electric field and magnetic field are equal in a plane wave, we have an equal contribution of electric field energy and magnetic field energy *but only if both of these energy quantities are positive*. If magnetic energy is negative, the equality of field strengths predicted from Maxwell's theory corresponds to zero energy carriage by the

waves and we have a wholly consistent approach to our understanding of the electron and its behaviour when accelerated.

A word should be said about the assumption in the above analysis that the electric charge had a velocity which was small compared with the velocity of light  $c$ . It is submitted that if we can prove that there is no radiation of energy from the accelerated charge at a low velocity we should not expect a different situation at higher velocity. Rigorous analysis to cater for high velocity charge motion is not necessarily worth while. The author has not attempted it, mainly because it is necessary to claim that the velocity of light is relative to something. If it is measured relative to an observer and the charge moves at high velocity relative to this observer and is accelerated, one will possibly get energy radiation. If it is measured relative to a different observer, one will get a different energy radiation. This seems ridiculous. If it is measured relative to the charge  $e$ , one can forget the idea of the electric charge moving at high velocity. It is effectively at rest in the frame of reference which matters. Put another way, an electric charge might know that it is accelerated but it has no way of knowing that it is moving at any particular velocity. Its energy radiation cannot, therefore, depend upon its velocity. Since it is zero at low velocity from the above analysis, it must be zero at any velocity.

The argument that it cannot tell whether it has uniform velocity follows from Newtonian principles. The talk about observers follows from Einstein's approach to Relativity. If anything, therefore, the non-radiation of energy by accelerated charge is an indication that some arguments available from Einstein's Theory of Relativity cannot be relied upon, although there is the inevitable result that zero-energy radiation for all velocities is consistent with the Principle of Relativity.

It is noted that the mutual requirement for  $E=Mc^2$  and non-radiation of energy by accelerated charge was the subject of a contribution by the author to the discussion of a paper by P. Hammond, relating to the Poynting Vector (Aspden, 1958, a) see also Aspden (1966, a), where the author drew attention to this result in view of controversy about the proper formulation of electromagnetic radiation.

### **Superconductivity**

It has been concluded that an accelerated electron develops electromagnetic waves but need not radiate energy by these waves. This

explains why electrons can move about in atoms without radiating energy and why electrons can travel through a superconductor without developing heat. We need not have recourse to arbitrary quantum assumptions to explain these basic facts of physical science. It is true that the motion of electrons through materials at normal temperatures results in heat generation. There are collisions between the electrons and the atoms. The electrons have kinetic energy and may transfer some of the atoms. Then, the atoms could be the source of the heat and not the electrons. Atoms do radiate energy in quanta. They are the source of photon radiation and, as we shall see later, an electron has a role to play anyway in the photon action. However, to emit photons one has to have enough energy to form a quantum. Thus, when an atom is part of a cold substance it has a small amount of kinetic energy. No doubt this energy varies about a mean value and as long as it is at least occasionally above the threshold needed to excite the photon emission there will be radiation. Meanwhile, the general interaction between the atoms and the exchange of kinetic energy will assure the manifestation of a temperature, even without such radiation. Electron flow merely adds to this kinetic energy exchange process and by its collisions will trigger off more photon emissions. If this electron flow and its collision action does not lift the energy level of the atom up to the threshold for radiation, assuming the material is at a really low temperature, no photons will be emitted. The collisions will occur without energy loss. Since they will be between electrons, either those carrying the current or those surrounding the atomic nucleus, they will be between particles of equal mass. Elastic collisions of this kind result in an exchange of velocities. Momentum is conserved. The result is that electrons can move without any apparent restraint through a loss free medium. The current will be sustained because the momentum is sustained by the electrons.

The above theory for superconductivity is merely suggested as the possible explanation. If it is valid, one would expect that if two superconductors composed of different isotopes of the same element are compared the heavier isotope will remain superconductive to a higher temperature than the other. The reason for this is that at the same temperature the heavier isotope has possibly a vibration condition of its atoms at a lower maximum velocity. Being heavier these atoms do not have to move so fast to keep the temperature balance with an interface at a reference temperature. It follows that their

electrons are less likely to have the more highly energetic collisions with the conduction electrons. As a result, photons will be produced in such collisions at a lower temperature in the lighter isotope. This is mentioned because this is exactly what is found and because the recent discovery of this fact has disproved the conventional theory of superconductivity, which predicted the inverse. This was reported by Fowler *et al.* (1967), who found that uranium 235 becomes superconductive at  $2.1^{\circ}\text{K}$  and uranium 238 becomes superconductive at  $2.2^{\circ}\text{K}$ .

### The Velocity-dependence of Mass

The expression  $E = Mc^2$  applies to electric field energy. It follows that when we consider an electric charge in motion as having a kinetic energy, a magnetic energy and a dynamic electric field energy, as we did in explaining the problem with the Compton Effect, we are fortunate that one of these items, the magnetic energy, is negative and cancels one of the others. This really means that the dynamic electric field energy alone can be regarded as the motion energy of the charge. Since  $E = Mc^2$  applies to such energy, the problem we now face is that mass must increase as the electric charge increases velocity relative to the electromagnetic reference frame. Here, it is necessary to talk about motion relative to the electromagnetic reference frame because it is in this frame that the magnetic field is induced and with it the dynamic electric field. It remains to be seen in our later discussions what physical form is to be attached to the means sustaining the magnetic field. Whatever these means are, we must assume that they have a co-operative influence in determining both the dynamic electric field and the magnetic field. It may be that very close to the electron itself there is nothing to support the magnetic field. But this does not matter as far as the analysis of the energy radiation is concerned. Nor does it matter in the earlier calculations of magnetic energy and dynamic electric field energy, because these latter quantities cancel. It does matter in calculating the mass effect of the dynamic electric field, in view of the assumed equality of the dynamic electric field energy and kinetic energy. To proceed, it is assumed that, at least over a period of time, the statistical mean value of the dynamic electric field energy is equal to the kinetic energy so that the latter can be regarded as offset by the magnetic energy, leaving the electric field energy as the only mass-containing quantity.

On this basis, from  $E = Mc^2$  we can say that a mass  $M$  moving at velocity  $v$  has momentum  $Mv = Ev/c^2$ . Force is the rate of change of momentum and when this is multiplied by  $v$  we have rate of change of energy. Thus:

$$v \frac{d}{dt} (Ev/c^2) = \frac{dE}{dt} \quad (1.16)$$

When solved, this gives:

$$E = E_0/\sqrt{[1 - (v/c)^2]} \quad (1.17)$$

The corresponding mass relationship is:

$$M = M_0/\sqrt{[1 - (v/c)^2]} \quad (1.18)$$

This result shows that mass increases with velocity in the electromagnetic reference frame. It shows that there is a limiting velocity at which mass will become infinite. This is when  $v$  becomes equal to  $c$ , the speed of light. The increase of mass with velocity is well known from experiment, as already mentioned earlier in this chapter.

### Fast Electron Collision

A direct experimental support for the non-radiation of energy by an accelerated electron is also afforded by collisions between fast electrons and electrons at rest. Using a Wilson cloud chamber, Champion (1932) has shown that when an electron moving at high velocity (of the order of 90% of the speed of light) collides with an electron at rest the resulting motion of the electron satisfies the formula in (1.18). On simple Newtonian mechanics the angle between the electron tracks after collision should be  $90^\circ$ . Using the above relation between mass and velocity and specifying *no loss of energy by radiation*, the conservation of momentum in the collision process leads to the formula:

$$\cos(\varphi + \theta) = \frac{(m/m_0 - 1) \sin \theta \cos \theta}{[(m/m_0 + 1)^2 \sin^2 \theta + 4 \cos^2 \theta]^{\frac{1}{2}}} \quad (1.19)$$

where  $m$  is the mass of the incident electron as given in terms of its rest mass  $m_0$  using (1.18), and  $\theta$  and  $\varphi$  are the angles between the electron tracks after collision and the direction of motion of the incident electron.

By measuring the velocity of the electron before collision and these two angles, Champion was able to verify equation (1.19) as taken in



conjunction with (I.18). Now, although in such experiments one would expect quite significant radiation of energy by accelerated electrons using the classical formula discussed above, Champion was able to conclude as follows: "Considering the total number of collisions measured it would appear that, if any considerable amount of energy is lost by collisions during close encounters, the number of such inelastic collisions is not greater than a few per cent of the total number."

### **Electrons and Positrons as Nuclear Components**

So far, the electron has been the topic of interest. Presently, following this chapter, we will enquire into some of the field interaction properties of the electron and its electrodynamic behaviour as a current element. Thereafter, we will study its role inside the atom and later its role in the atomic nucleus itself. However, it is appropriate at this stage to outline briefly the potential which the electron, as portrayed in this chapter, has in nuclear theory. This will be done without recourse to quantum electrodynamics or even wave mechanics. An omission, to be rectified in a later chapter, is the analysis of the spin properties of the electron and its anomalous magnetic moment. An explanation of spin is important, if only as a check on the theory offered to account for any elementary particle. For the moment, spin is ignored.

As mentioned earlier in this chapter, quark theory invites us to believe that the proton consists of three elementary particles in close aggregation. This quark theory is untenable with the theory presented in this work. Here, there is complete reliance upon the indivisibility of the charge quantum  $e$ , so far as it appears in matter. It will, however, be a contention of this theory in Chapter 7 that the proton does comprise three elementary particles as required by quark theory, but these are the electron, the positron and a heavy elementary nucleon of positive charge  $e$ . The positron was discovered in 1932. It appeared in cosmic rays and is, of course, merely a particle exactly like the electron but with a positive charge  $e$ . Positrons are ejected from radioactive substances, which suggests their existence in the atomic nucleus. It has been found that a proton can lose a positive electron, or positron, and become a neutron. Also, a neutron can lose a negative electron and become a proton. This suggests that the proton and neutron must each contain an electron and a positron. Both

must contain the heavy nucleon just mentioned, and the neutron must have one electron in addition. Now, all this supposes that there are no interchanges of polarity or energy exchanges in these various transmutations. This is unlikely. Indeed, if we go on to consider the combination of the neutron and the proton, it has been suggested that they might be bound together by what is called an "exchange force" arising because they are rapidly changing their identity. The suggestion is that they are exchanging the electrons and positrons as described above, so that, according to a proposal by Fermi, the neutron and proton are really different quantum states of the same fundamental particle. Now, this may be true, but we should not blind ourselves to the other possibilities. If we know that these elementary particles are aggregations of electrons, positrons and some heavy particles, and we know the physical size of these particles, as explained earlier in this chapter, it is worth while examining what follows from this knowledge. The result contains a double surprise, and is all the more gratifying because of its simplicity.

The deuteron, the nucleus of heavy hydrogen, is the particle form to be expected when a proton and a neutron are bound together. We will assume that this deuteron, which has a mass of the order of two protons and a charge  $e$  which is positive, comprises two identical heavy particles and some electrons or positrons or a mixture of both. Then there are a number of possible configurations having electrostatic stability. For one of these the energy has a minimum value. This configuration is deemed to be that of the deuteron. Its electrostatic interaction energy is a measure of the nuclear binding energy. It is the energy needed to separate the nuclear components well apart from one another. How far apart is critical to the analysis if we wish to be exact, but for the initial study in this chapter we assume separation to infinity. The binding energy of the deuteron is known from measurements. Hence, the theory can be checked.

In Fig. 1.3 different models of possible deuteron configurations are shown. Model A depicts two heavy positively-charged particles of mass  $M$ . They have a very small radius because for a discrete charge  $e$  the electrostatic energy is inversely proportional to radius, as shown in Appendix I. In model A there is one electron located between the two heavy particles, or  $H$  particles as they will be denoted. Since the charges act from their particle centres, the radius  $a$  of the electron becomes the only significant dimension in the analysis. Then, the energy of deuteron model A is  $2M + 1$  electron

units plus the interaction energy. It is convenient to evaluate mass quantities in terms of the electron mass as a unit. The interaction energy comprises three components. Between one  $H$  particle and the electron there is an energy  $-e^2/a$ . Between the other  $H$  particle and the electron there is the same energy  $-e^2/a$ , and between the two  $H$  particles there is the positive energy  $e^2/2a$ . The total interaction energy is  $-1.5e^2/a$ . Now, we will put:

$$ke^2/a = mc^2 \quad (1.20)$$

where  $k$  is a constant and  $m$  is the mass of the electron. Then, in the units of mass for which  $m$  is unity we can express the total energy of model A as  $2M + 1 - 1.5/k$ .

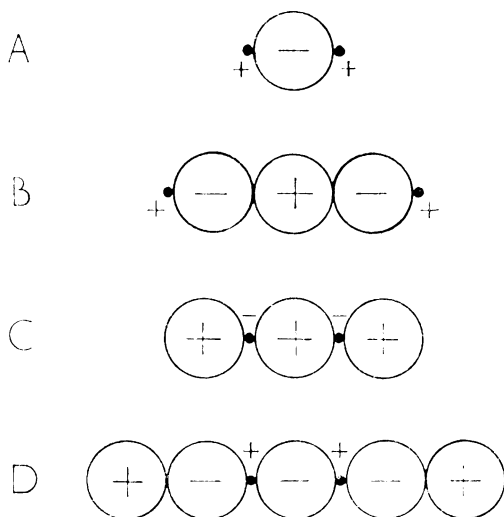

Fig. 1.3

In similar manner the other models of the deuteron presented in Fig. 1.3 can be analysed. An energy evaluation for each model shown results in the following masses:

- A  $2M + 1 - 1.5/k$
- B  $2M + 3 - 2.317/k$
- C  $2M + 3 - 2.917/k$
- D  $2M + 5 - 3.558/k$

For different values of  $k$  the deuteron could be different, since the deuteron will be the one of smallest total mass. Even so, the term

involving  $k$  is the binding energy of the deuteron, and it is known from experiment that this binding energy is about 2.22 MEV or 4.35 electron mass units. Thus, proceeding from this we can derive  $k$ . Firstly, if model A is the minimum mass model,  $k$  has to be about 0.35 to assure that  $1.5/k$  is 4.35. Then we can see that model C has lower energy still, which makes us rule out model A. Model B is ruled out on direct comparison with model C. If model C is chosen, then  $k$  will be about 0.67. This gives model C slightly less overall energy than model A. It has also less energy than the other models, as may be verified by continuing this exercise. It will be found that model C is the only one able to explain the measured binding energy of the deuteron. Thus, if this theory is correct  $k$  should be 0.67, which is verification of the  $2/3$  factor already deduced earlier in this chapter by reference to Appendix I.

If we pause to comment on this verification that  $k$  is  $2/3$ , we note that there are now available the following mutually-supporting points. Firstly, the magnetic field energy induced around a spherical electron of radius  $a$  in motion has a mass equivalence, if equated to kinetic energy, which puts  $k$  as  $2/3$ . Secondly, if we assume that the constraint or binding action at the surface of the electron is such that the repulsive forces within the electron develop a uniform pressure throughout its volume,  $k$  is  $2/3$ . This is proved in Appendix I. Thirdly, if we assume that the electric charge  $e$  of the electron is distributed throughout the body of the electron to cause the electric field or energy density to be uniform,  $k$  is  $2/3$ . This is mentioned in Appendix I. Fourthly, it so happens that if  $k$  is  $2/3$  the deuteron binding energy is explained and the deuteron is identified with the model C in Fig. 1.3. It follows that there is little scope for doubt about the real nature of the electron. There have, indeed, been two surprises from this analysis. The first is that the deuteron energy is calculable on such a simple model, one which happens to be the least mass form. The second is that although the form of the electron had been deduced by separate analysis, we were able to find an empirical approach using experimental data to verify that the energy of the electron is  $2e^2/3$  divided by its radius.

It is noted that a value of  $k$  of  $2/3$  used in connection with model C results in a binding energy of 4.375 electron units, or about 2.24 MEV. In Chapter 7 it will be shown that we can take this further to find the exact value of the deuteron binding energy. As it is, it suffices that the theoretical figure is within 1% of that measured.

## Summary

In this chapter the reader has been shown that there is purpose and merit in regarding the electron as a spherical ball of charge. The quantitative analysis has drawn attention to the need to regard magnetic energy as a negative quantity, a feature which is compatible with other physical theory, and this has led to an understanding of the mass properties of the electron. In previous textbooks the dynamic component of the electric field energy has not been considered. Another omission in the past has been an inclusion of the field needed to accelerate the electron when studying its radiation effects. By rectifying these omissions, a new insight into physics has become available, with consequent benefits. It is incredible to the author that the classical formula for the energy radiated by the accelerated electron could have been accepted when it has no dependence upon the mass or size of the electron, but, be that as it may, it has been proved that non-radiation leads us to understand the nature of mass and the derivation of the relation  $E = Mc^2$ . The increase in mass with velocity follows from this relation, as is well known. Accordingly, although the law  $E = Mc^2$  and the velocity dependence of mass are regularly ascribed to Einstein's theory, their existence in no way makes Einstein's theory an essential part of physics. They do not depend upon Einstein's Principle of Relativity. The chapter has been concluded by showing that the deuteron binding energy can be calculated to provide a result highly compatible with the model of the electron presented. This demonstrates one of the potential applications of this theory of the electron. The analysis of the atomic nucleus is an important subject in this work, as will be seen later in Chapter 7. Meanwhile, it is hoped that the reader may be beginning to realize that Nature is not quite as complicated in the realm of truly fundamental physics as might appear from modern mathematical treatments.

## 2. *Mutual Interaction Effects*

### **Reaction Effects**

It has been shown in the previous chapter that an electric charge in motion has three dynamic energy components. These are its kinetic energy, its dynamic electric field energy and its magnetic energy. Further, these are all equal in magnitude for observations in the electromagnetic reference frame and when the velocity is small relative to the velocity of electromagnetic wave propagation. Also, and most important, the magnetic energy is a negative quantity because it is energy supplied *from* the field medium. Thus, the total self-dynamic energy of an electric charge in motion under the conditions just specified is, for normal observations, simply its kinetic energy.

The same principles apply to any reacting charge in motion in the magnetic field set up by the above charge, but when additional charges are present there are mutual interaction effects to consider. It is of importance to consider the mutual interaction energy components present when a group of interacting electric charges is in a dynamic state. The basic principles of magnetism are founded in the physical understanding of these interactions.

By way of definition, it will be assumed that a discrete charge in the sense to be used in this study of mutual interaction effects is a unit which, if not spinning in the inertial reference frame, has all its constituents moving together at the same velocity. Such a charge might comprise a close-compacted aggregate of charged particles of both polarities. For example, if a proton consists of three quarks as already mentioned, we still regard this as a single unit of charge. The physical reason for this distinction will become evident below.

Discrete units of charge in a general interacting system may be classified as primary or reacting. By this is meant that any charge which forms part of the system and has a controlled motion is termed primary charge. Other charge present is merely disturbed and reacts to the motion of the primary charge so that it may be termed reacting charge. An example of this is the flow of current in a circuit. The

electrons carrying the circuit current comprise the primary charges. Electrons in any surrounding conducting medium comprise a reacting system. Even though the circuit current is steady, the conduction electrons in adjacent conductive media provide a system of charge capable of reacting in the sense intended here.

The three dynamic energy components will be denoted  $K$ ,  $E$  and  $H$  respectively applying to kinetic energy, electric energy and magnetic energy. Also, a suffix  $P$ ,  $R$  or  $M$  will denote primary charge, reacting charge and mutual interaction between charge, respectively. Thus, the total dynamic energy of the system under study is given by:

$$K_P + E_P + H_P + K_R + E_R + H_R + K_M + E_M + H_M \quad (2.1)$$

Now, we have already established that the self-electric and magnetic energies of the charges are equal. Further, the magnetic energy quantity is negative. Thus  $E_P$  and  $H_P$  in (2.1) sum to zero and  $E_R$  and  $H_R$  sum to zero. Physically, this is because the disturbance of the field medium which we term magnetism involves a redeployment of energy in the field itself. In fact, the terms in (2.1) are energy changes and the requirement that  $E_P$  and  $H_P$  sum to zero is merely a mathematical account of a situation in which the phenomenon of magnetism causes energy to be released from one form in the field medium and used to generate the dynamic electric field present where this energy is released. The mutual interaction between the charge causes a magnetic interaction energy term  $H_M$  which also must combine with  $E_M$  to sum to zero. The result is that the energy given by (2.1) can be simplified as:

$$K_P + K_R + K_M \quad (2.2)$$

The term  $K_M$  has been introduced for generality and denotes what we could term mutual kinetic energy. It is of interest to examine what is meant by mutual kinetic energy.

### Mutual Kinetic Energy

Kinetic energy can be said to be the intrinsic energy of motion which we associate with a particle. It has been shown in the previous chapter that the mass property of a particle is related to its intrinsic electric field energy. The law  $E = Mc^2$  was derived. The rest mass of the particle is found by dividing the electric field energy of the particle

by  $c^2$ . In the sense of (2.1) we have precluded consideration of effects internal to composite charge aggregations. These have self-balancing mutual dynamic interactions and the kinetic energy is that of the composite mass of the aggregations. We need only consider the mass effect of the mutual electric interactions in our open system. This has to take account of the implications in the analysis that mutual magnetic interaction involves field energy redeployment to produce dynamic mutual electric energy states. However, such energy can give no mass property to the system since the mutual dynamic *field* energy (electric and magnetic) sums to zero anyway. There are mutual non-dynamic electrostatic interaction energy components not included in (2.1) and these could be said to give rise to a mutual kinetic energy effect for a system in motion. However, in analysing interaction effects in a complete system, which is just what we are doing, effects are being analysed relative to the common inertial frame of the system. The total momentum of the system relative to its own inertial reference frame cannot vary if we consider only the effects of interaction and the self-action effects of the system itself. This is a well accepted fundamental rule of physics. Thus, if the electrostatic interaction energy is taken to be at rest in the inertial reference frame under study, simply because it is taken to define this frame by its very position, we cannot attribute kinetic energy to the motion of the interaction electrostatic energy with the system as a whole. In other words, we expect that there is no such thing as mutual kinetic energy in the context used above.

To relate this to the orthodox teachings in physics, consider two electric charges of opposite polarity but identical mass moving towards one another at equal speeds, the motions being in a common straight line. By accepted principles there are no magnetic forces between these two charges because there is no field along this line. This leaves us to accept that the mutual electrostatic attraction between the charges causes electrostatic energy to decrease as it is converted into the kinetic energy added by the accelerated motions of the charges. The analysis is simple and the reasoning quite straightforward. However, let us ask where the mutual electrostatic energy is located. Surely, it is in the field, that is, it is spread over the space surrounding the charges. As the charges come closer together, this field energy is released and converted to kinetic energy. Where is this kinetic energy located? As the charges come closer together, the mutual electrostatic field energy which is not yet released and



converted to kinetic energy has nevertheless been compacted into a region closer to the charges. The energy distributed in the field has moved to new positions. Does this involve any kinetic energy effects itself? Accepted physics does not answer these questions. They are not formulated so bluntly. Yet, the questions must be asked and answered if our understanding of physics is to develop.

Let us try to formulate some rules. Every fundamental electric particle has an associated electric field and an intrinsic electric field energy. This gives the particle a rest mass, found by dividing the energy by  $c^2$ . Kinetic energy is then the energy of motion of this intrinsic electric field energy. The velocity of such motion has to be measured in an inertial reference frame which we take to be a non-rotating frame in which the "centre of gravity" of the mutual electrostatic energy of the complete system of electric charge including the particle is at rest. There is no such thing as mutual kinetic energy on this definition. Mutual electrostatic energy can be redeployed in its distribution in space without involving any additional dynamic energy effects not summing to zero. Mutual electrostatic energy can be released to augment the kinetic energy of the charges in the system.

These rules cater for the simple example of the two approaching oppositely charged particles. They do not cater for the increase in mass of an electric charge as its speed increases. The rules will therefore be extended as follows. The intrinsic electric field energy of the particle moves with the particle. This energy accounts for the mass of the particle. In the field surrounding the particle there is a dynamic disturbance of the electric field which involves an increase in electric field energy. This added field energy moves with the particle and augments its mass. There is a deficit in the intrinsic energy of the field medium termed magnetic energy and there is kinetic energy in equal measure. Both of these move with the particle but they compensate one another and have no mass effect. The dynamic electric field energy remains to add increased mass to the system. Since it could be replaced in analysis by the equal valued kinetic energy, we may then speak as if kinetic energy is the sole dynamic energy quantity.

It is a conclusion at this stage that there is no such thing as mutual kinetic energy. Thus,  $K_M$  in (2.2) is zero. This leaves us with the interesting result that the total energy in any system of electric charge in motion, apart from the rest electrostatic energy, is the kinetic

energy of the charges. In particular, we can ignore magnetic energy which is somehow cancelled out by the properties of the system.

### The Nature of Induced EMF

Consistent with the above analysis we can say that (2.1) and (2.2) can be written as:

$$K_P + K_R + E_M + H_M \quad (2.3)$$

where:

$$E_M + H_M = 0 \quad (2.4)$$

To give a physical interpretation of this expression as applied to an electric current in a solenoid, we can say that the energy  $K_P$  is the energy needed to establish current flow merely to get the electrons moving to form the current circuit. In such a case, this energy is small compared with the mutual energy components. The energy  $E_M$  is the energy needed to overcome the back EMF, the induced electromotive force in the system. It is energy supplied and stored in the mutual interaction of the dynamic electric states of the system. It remains available to return energy when the current is stopped. This energy is known to equal the conventional magnetic field energy supplied to the system. It is numerically equal, but that is all. In fact, magnetic energy is not supplied to the solenoid when it is magnetized. The energy  $E_M$  is supplied and by this action the negative energy  $H_M$  of equal numerical magnitude is made available in the field to provide energy  $K_R$ . The energy supplied to the solenoid is thus merely:

$$K_P + E_M \quad (2.5)$$

and we find that:

$$K_R + H_M = 0 \quad (2.6)$$

The result arrived at now means that we can extend the rules we have formulated still further. Although for a discrete electric charge in motion we could say that the magnetic energy released in the field was deployed to provide the dynamic electric energy component in the field, we now find that where significant mutual interactions between charges occur, the release of mutual magnetic energy is applied to augment the kinetic energy of the reacting system of

electric charge present. In other words, we find that when a solenoid is magnetized, the core of the solenoid as the seat of the reacting charge should be heated to acquire a thermal energy exactly equal to the magnetic energy associated with the magnetization. This means that thermal energy is available to be radiated away from the core once it is magnetized, so that if the magnetic field is switched off after it is cooled down, we expect the solenoid energy to come from the term  $E_M$  right away, whilst the kinetic energy of the reacting charge in the system has to struggle to return the magnetic energy  $H_M$  to the field. The result should be a cooling of the solenoid core when it is demagnetized.

### **Magnetocaloric Effects**

It has been deduced that the process of magnetization and demagnetization must be associated with thermal effects in such a way that magnetization develops heat whereas demagnetization produces cooling. This is, of course, found to be supported by experiment. If a paramagnetic material is magnetized it is found that its temperature increases. The phenomenon is used in the process of cooling by adiabatic demagnetization. When magnetized, it seems that energy has been added to the conduction electrons in kinetic form which is shared with the kinetic energy of the atoms to increase the temperature of the body. When a ferromagnetic is magnetized, the intrinsic magnetic state of domains in the substance is being brought into alignment. This does not cause thermal change related to the apparent magnetic energy involved. However, the thermal effects are manifested in the change in specific heat near the Curie Point. Due to intrinsic magnetism being destroyed as the temperature is increased, the specific heat of a ferromagnetic is greater than that which would be exhibited by a normal metal under the same physical conditions. These are well known phenomena. Less known, perhaps, is what happens even to a ferromagnetic material when it is suddenly magnetized to a very high field strength which far outweighs its intrinsic ferromagnetic field. H. P. Furth (1961) has described a test procedure attributed to F. C. Ford in which a number of  $\frac{3}{4}$ -inch diameter rods were transiently subjected to fields of the order of 600 kilogauss. Some test samples showed signs of thermal damage as if they had melted and solidified again. Others were ruptured as if they had been broken in a tensile testing machine and also showed

signs of thermal damage. Furth demonstrates how these effects can be explained by relating the melting temperature in ergs per cc. with the energy density  $B_m^2/8\pi$  and the tensile stress in dynes per square cm. with the energy density  $B_s^2/8\pi$ . For hard copper, for example, he found  $B_m$  to be 500 kilogauss and  $B_s$  to be 300 kilogauss. Appropriately, the copper sample showed both mechanical deformation and surface melting in the 600 kilogauss field. For hard steel, with  $B_s$  and  $B_m$  both 700 kilogauss there is no damage at all in the 600 kilogauss field. For mild steel which has a lower  $B_s$  there is some deformation. Thus, the magnetocaloric effect imposes a limit on the fields which can be developed at least transiently in any material. There is ample evidence to show that when a magnetic field is produced in any substance, a thermal effect of energy equal to the change of magnetic field energy is developed. Since magnetic energy cannot be simply identified as thermal energy owing to the dispersal property of thermal energy not being contained like magnetic energy by the inducing current, we must recognize that magnetic energy and the related thermal energy are of separate character. If we do this we are forced to answer the problem posed by the mysterious source of the thermal energy. If we still have the magnetic energy in the inductive storage of the magnetized system, where has the thermal energy come from? The answer to this problem has been presented above. It is not a hypothesis. It is an inevitable conclusion to be drawn from the facts of experiment.

One question which inevitably emerges from the above analysis is whether the field medium can be caused to supply energy for practical application. For example, imagine a solenoid containing a movable non-ferromagnetic core to be magnetized. The core receives heat energy. The field medium releases magnetic energy. The induced EMF action requires retention of energy in the inductive system. What if we then withdraw the core before demagnetizing the solenoid? Do we not then find that we have a surplus of heat energy in the core and can get back the inductive energy put into the solenoid, leaving the vacuous field medium itself in a cooler state (whatever that means)? The answer to this is that as the core is withdrawn from the field it will cool down, thus thwarting the attempt to get energy from nowhere. Then one might say, why not wait for the thermal energy to be conducted away from or radiated by the core. Then, using this energy to perform a useful function, we can later demagnetize the solenoid to end up with a process in which temperature can

be cycled to do useful work without the expenditure of energy save to sustain copper loss in the solenoid. This should be possible. It is analogous to the heat pump in which energy comes from the ambient thermal source. What then if we add more thermal energy to the core in this cycle than is needed to cool the specimen down to absolute zero of temperature in the reverse process? If the core is at room temperature and then magnetized to a very high field which will raise its temperature to 500°C, say, what will happen if we then allow it to cool in this field back to room temperature and then demagnetize it? This is a most interesting question which experiment will one day answer. The best answer the author can give is that the field medium itself will be cooled down, meaning our energy balance problem can then show experimentally that there is an aether medium which acts as a source as well as a store of energy.

### Evidence of Magnetic Reaction Effects

As just explained, there is abundant evidence to support the expression in (2.6), the equality of kinetic energy in the reacting system and the negative measure of the magnetic field energy due to mutual interaction effects. However, it is of interest to enquire into the other evidence which should be available to demonstrate that there are kinetic properties linked with mass in motion and associated with the magnetic field. To proceed, imagine a magnetic field  $H$  to exist in the reacting system under study. We are, for example, considering the state of uniform magnetization within a ferromagnetic domain. Consider then each element of reacting charge as, for example, a conduction element in a ferromagnetic. Let its charge be  $q$  in electromagnetic units, and denote its mass  $M$  and its velocity  $v$ . In the field  $H$  it will move to provide maximum opposition to the field. Then, balancing centrifugal force against magnetic force:

$$Hqv = Mv^2/r$$

where  $r$  is the radius of the charge orbit. Now,  $qvr/2$  is, on classical theory, the magnetic moment of the reacting charge. Thus, the total reaction magnetic moment per unit volume becomes, from the above equation, the total kinetic energy of the reacting charge system per unit volume divided by  $H$ . Since this reaction field is not observed in experiment, it follows that the primary charge is really developing the field  $H$  plus a component to cancel this reaction effect. If the

primary action develops the field  $kH$ , where  $k$  is a mere numerical factor, we note that  $4\pi k$  becomes the factor relating the current moment to the induced field. Thus, we deduce:

$$H = kH - 4\pi k(K_R)/H \quad (2.7)$$

For maximum reaction kinetic energy, that is, the maximum energy transfer induced by the primary charge system, it may be shown by differentiating (2.7) with the primary field constant that  $k$  is 2. When  $k$  is 2,  $K_R$  becomes  $H^2/8\pi$ . Then, from (2.6), we find that:

$$H_M = -H^2/8\pi \quad (2.8)$$

This is a wholly consistent result. We have arrived at the usual expression for magnetic energy density. The magnetic energy has had to be taken as a negative quantity as we have predicted. Further, we have deduced that the magnetic field induced by any charge in motion is really invariably double that expected on conventional theory. However, as has been shown, reaction effects invariably halve this field to leave us with the value found in experiments.

For maximum reaction kinetic effect, reacting charges of larger mass will be favoured as those to provide the energy term  $K_R$ . Thus, when a magnetic field is induced in a metal, the heavier of any free electric charges will move to set up  $K_R$ . If there is free charge in the aether medium in quantum units of the electron charge  $e$ , then, whether or not these react, or the conduction electrons in the metal react, will depend upon which have the greater mass. If the conduction electrons have the greater mass they will provide the energy  $K_R$ . Then, the angular momentum of the reacting charge will manifest itself in magnetization changes. It follows that an experiment which can respond to the relation between magnetic moment and angular momentum of both the primary charge and the reacting charge will allow a direct measurement of the factor  $k$ . On the other hand, if there is *free* charge in the aether medium which *may* fill the voids between the atomic substance in the magnetized material and this charge has greater mass than electrons, this medium will itself provide the reaction effects and, although the magnetic field will be attenuated as the theory requires, the mechanical effects will not occur and the observation that  $k$  is 2 cannot be expected. This assumes the well known fact that the elusive aether does not provide any mechanical resistance to the motion of matter and so cannot communicate any angular momentum.\*

\* There are interesting exceptions to this rule discussed in Chapters 4 and 5.

In the latter event it will be difficult to explain how the magneto-caloric effects can occur. If the reaction kinetic energy is not provided by matter, it must occur in the aether medium and it cannot then cause thermal effects in matter. It must, therefore, be expected that if the aether has migrant charge free to move to react to magnetic fields, these charges must be of smaller mass than the electron. Further, the experimental derivation of the factor  $k$  from observation on magnetomechanical effects must then be possible.\*

Before discussing the evidence supporting this proposal, we note that the energy  $K_R$  has to be sustained in a steady magnetic field because (2.7) is applicable to the steady state. Thus the physical meaning of the equation is that  $K_R$  has to be maintained by the reacting electric charge system. This is assured if the thermal energy of the conduction electrons is adequate, that is, if the temperature is sufficiently high. If the temperature is too low because there has been cooling after magnetization occurred, it may well be that free charge in the aether takes over the role of  $K_R$  in (2.7). This means that at magnetic fields and temperatures low enough to permit the superconductive state in materials exhibiting this property, it could be that the charge in the aether takes over the role of reacting to cancel half of the magnetic field. Thus the magnetomechanical ratio should not be anomalous under these circumstances. Kikoin and Goobar (1938) have measured the gyromagnetic ratio, as it is called, for superconducting lead. They found  $k$  to be unity. In referring to this result, Bates (1951, b) said, "We conclude that the large diamagnetism of superconductors is due to electrons moving in orbits in the crystal lattice as if they were free in the sense of having ordinary values of  $e$  and  $m$ ." However, as will now be explained,  $k$  is greater than unity under normal circumstances.

### The Gyromagnetic Ratio

Richardson (1908) suggested that when the magnetism in a pivotally mounted ferromagnetic rod is reversed, the rod should sustain an angular momentum change. It was predicted that the gyromagnetic ratio, the ratio of the change of angular momentum to the change of magnetic moment, should be  $2mc/e$ , the quantity applicable to the electron in free orbital motion, where  $e$  is the electron charge,  $m$  is its mass and  $c$  is the velocity of light. Einstein and Haas (1915) first

\* The analysis was presented also by the author in ref. Aspden (1966, b).

observed the effect. Sucksmith and Bates (1923) then found that the effect was only one half of that predicted. The gyromagnetic ratio was only slightly greater than  $mc/e$ . Meanwhile, Compton (1921) had suggested that the electron possesses an intrinsic angular momentum or spin and a magnetic moment. Uhlenbeck and Goudsmit (1925) proposed an angular momentum of  $h/4\pi$ , and a magnetic moment of  $eh/4\pi mc$ , corresponding to the gyromagnetic ratio of  $mc/e$ . This spin property of the electron was found to help resolve problems in spectral theory, and the use of this concept is now firmly established in atomic theory. Later, Sucksmith (1930) took the experimental observations on ferromagnetic specimens as an indication that ferromagnetism is, in the main, due to electrons spinning on their own diameters. This conjecture has, however, not really been substantiated and is likely to be in error, while the spin concept remains to define a primary property of elementary particles having no clear physical interpretation.\*

When the direction of magnetism is reversed in a ferromagnetic rod, the electrons generating the magnetic flux undergo a change in angular momentum. However, the magnetic flux traverses the ferromagnetic medium and this contains free electrons in a state of agitation. Similarly, magnetic flux in vacuo may also traverse an aether medium in which (for all we know) there could be free electric charge in a state of agitation. Free conduction electrons satisfying Fermi–Dirac statistics are so numerous in a ferromagnetic conductive material that, as a little analysis shows, they should react to cancel any magnetic flux traversing the substance. The magnetic field deflects the electrons into orbital motion between collisions and, regardless of their velocity or direction, the arcuate motion invariably develops a reaction field component and a reaction angular momentum.

The field attenuation problem thus predicted does not show itself in our experiments and its absence, or apparent absence, requires explanation. In the above analysis it was shown that the magnetic field to be expected from orbital electrons in motion in a ferromagnetic is really double that normally predicted. There is then an attenuation in that reaction effects due to conduction electrons halve the field. Curiously, the analysis points to this halving effect as a

\* In a textbook on magnetism, Professor W. F. Brown (1962) wrote: "If later theoretical research succeeds in reinterpreting the 'spinning electron' as an actual system of spinning charge or as a system of poles, this . . ." His book was written without reliance on either interpretation, clearly having in mind the uncertainty surrounding the subject.



universal effect but leaves scope for variations in the magnetomechanical ratios involved in different circumstances. However, the analysis does show that the parameter  $k$  must be 2 and this means a gyromagnetic ratio of  $mc/e$  and not  $2mc/e$ . The predictions of the previous analysis are clearly supported by the gyromagnetic ratio. Also, it is then possible to say that ferromagnetism is due to the orbital motions of electrons in atoms and not to the mysterious spin property which is so much in dispute. What remains a mystery is the way in which the electron reaction effect in metals subject to magnetization has been overlooked in the researches on the subject. It is true that there is a magnetic anomaly facing researchers who try to compare theoretical eddy currents and those observed. This anomaly, termed the “eddy current anomaly” involves the study of reaction currents when there is changing magnetic flux. Its explanation is bound up with the behaviour of magnetic domains, as the author has demonstrated experimentally (1956). The mystery we are concerned with is how electrons can move about in a metal to set up a reaction effect without this having been recognized. The simple answer, given by the informed physicist, is that it has been recognized, but a correct analysis shows that the reaction sums to zero. However, it should be noted that such analysis was performed when it was expected that the result should sum to zero. It was later that the gyromagnetic anomaly was observed. If we examine how one can obtain the zero reaction result we find that the argument is somewhat equivalent to what is portrayed in Fig. 2.1. In this figure electrons are shown describing circular paths to develop the magnetic reaction effect opposing an applied magnetic field. Electrons at the boundaries are caused by collision with the boundaries to migrate around the whole magnetized region and so develop an opposite magnetic effect. They

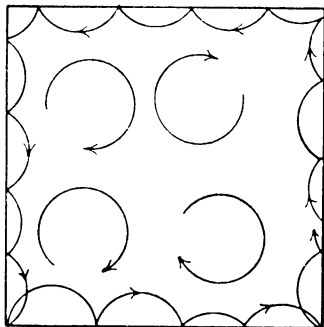

Fig. 2.1

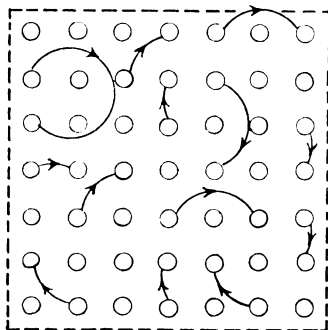

Fig. 2.2

migrate, as can be seen, in the opposite sense to the orbital reaction motion of the electrons in the body of the magnetized material. Of course, collisions are occurring between electrons and atoms and there is no clear boundary as indicated, but the effect is the same. Mathematical analysis shows that there is complete cancellation. It is a matter of statistics. Now, if we accept this explanation we have to dismiss the gyromagnetic explanation offered in the previous pages. But if we accept the explanation of this reaction cancellation we must accept that electrons bounce like billiard balls in their collisions with atoms. Furthermore, there is no boundary at the surface of any real substance. All there is to keep the electrons from going into space or into another material is an electric field or perhaps a magnetic field which deflects the electron back again. It suffices, then, to talk of collisions with atoms. Do electrons bounce back like billiard balls, recoiling from the heavy atoms as the billiard ball recoils from the edge of a billiard table? Alternatively, do electrons strike the electrons in an atom and transfer their momentum to these electrons just like a billiard ball exchanges momentum with another billiard ball in its collisions on the table? When superconductivity was discussed in Chapter 1, it was this latter argument that was followed. If electrons merely transfer momentum to other electrons and there is continuous electron exchange between atoms we get the situation depicted in Fig. 2.2.\* There is no countermotion of electrons to develop the cancelling effect. Is not this an important question? It is simply a question of whether, when an electron collides with an atom, it collides with a rigid body having the mass of the whole atom or collides with an electron having a mass like itself. In one case we have no field reaction effects and in the other we have those offered to explain the gyromagnetic ratio. The reader has his choice. On the conventional path he is led to the intricacies of quantum electrodynamics to seek his answers to the problems posed. On the other path, the one which assumes that an electron certainly must collide with one of the electrons acting as outer guard in the atom, he is led with the author along a virgin and unconventional path. However, this is a path well worth exploration, particularly in view of some of the uncertainties which now beset physical theory.

\* Clarricoats (1961) in discussing loss mechanisms in ferrites states, "In ferrite materials which contain iron in two valence states, certain electrons can move quite readily through the crystal lattice." The fact that the gyromagnetic ratio is still 2 in such non-conductive materials does not invalidate the argument that the gyromagnetic anomaly is due to electron exchange between atoms.

In this quest it has to be assumed that the magnetic field produced by any electric charge in motion relative to the electromagnetic frame will be exactly double that measured in experiment but that, invariably, there is something which reacts to halve the true field, whether in free space or in matter. This assumption is in line with the finding that magnetic field energy is a deficit of energy equivalent to the kinetic energy of reacting charge. There has to be a reacting charge in free space and it has to have a priming of energy to be able to assert a reaction. Having said this, the reader must understand that the double magnetic field can be ignored in further analysis. The gyromagnetic factor of 2 has to be used in certain magnetomechanical analyses but this is in line with normal physics. Furthermore, when we come to explain the anomalous magnetic moment of the electron, the gyromagnetic factor is merely assumed on the strength of the above explanation and the anomaly is explained by regular analysis.

### **The Aether**

Before going on to show how the above principles have immediate application to the derivation of the true law of electrodynamic force between charges in motion, it is appropriate to comment on the concept of the aether. It is usual to ignore this medium in modern physics. This is more a matter of convenience than anything else. Its existence is a matter for intuition. Electromagnetic waves travel through free space at a certain finite velocity. There must be a medium to sustain such waves. Hence, from time immemorial when the aether was a matter of philosophical hypothesis to today when it is more a question of logic, the aether has been ever present. To recognize its existence in any specific form causes the difficulties. If we have preconceived notions about the aether as a medium which provides an absolute frame of reference for light propagation, then the physicist rightly will reject such aether. There is experimental evidence to the contrary, notably the famous Michelson–Morley experiment. However, we do not intend to make such assumptions. The aether under review in this work is the one indicated by experiment, not an imaginary one conceived by hypothesis. The aether is the medium permeating space and having the property that it can store a magnetic field. Seemingly, from the foregoing analysis, it contains free electric charge in motion and able to react to the action of electric charge in matter. If we are not then to be led immediately into the trap of thinking that this reacting charge determines the

frame of reference for electromagnetic wave propagation, we must think in terms of wave *disturbance*. Something is disturbed. There must be something other than the reacting charge. Without the reacting charge the aether can be said to be unable to sustain a magnetic field, but it may still contain electric charge provided this can be regarded as primary in the sense used above. Such charge would have a *controlled* motion. With no reacting charge  $K_R$  in (2.3) is zero, and then from (2.4) it is seen that the only energy in the aether is  $K_P$ , the kinetic energy of its controlled primary charge. Adding what must be a relatively small energy in the form of the reacting system gives an energy priming of  $\psi$ , say, equal to the kinetic energy  $K_R$  of the reacting system. Then, since  $\psi$  fixes the limit on the energy which can be stored by a magnetic field we have to expect there to be a limit on the maximum magnetic field which can exist in space. In addition it can be said that since  $\psi$  is much less than  $K_P$  we have to think in terms of the probability that the intrinsic energy density of the aether is significant.

Is there any evidence of a limit of magnetic field strength? Already in this chapter there has been reference to fields of 700 kilogauss used in practice. Probably the highest magnetic fields are produced in thermonuclear reactor experiments in which a self-pinching electric discharge is used to focus the magnetic energy of an electric current. The object is to develop very high temperatures in an almost infinitesimal volume disposed along the current filament. Evidence of a limit on the temperature which can be obtained in practice would be evidence of a limit on magnetic field. However, the problem confronting such research is that of keeping the discharge stable during the collapse. Yet, even if the discharge can ever be stabilized sufficiently, there might be a limit on the maximum temperature which can ever be reached and this limit might be set by a *saturation effect in the aether*. This is speculation, it is true, but it might be worthwhile speculation in view of the cost of thermonuclear research. Later, in Chapter 6, it will be shown how evidence is forthcoming indirectly from the theory and experiment to indicate that there might well be such a limiting effect and to afford an estimate of the magnitude of  $\psi$ .

### Thermonuclear Reactor Problems

The research into the development of the thermonuclear reactor gave prominence to plasma physics. Electric and magnetic

phenomena in a plasma of ions and electrons need thorough analysis to study the behaviour of the processes being applied to induce high temperatures by thermonuclear reaction. As mentioned above, a strong current arc contracts under its self-pinch action to produce high temperatures. With a high energy concentration around atoms of heavy hydrogen, having the deuteron as nucleus, it is sought to produce a temperature of the order of  $300,000,000^{\circ}\text{K}$  for long enough to cause fusion into tritium and helium. Nuclear energy will then be released in excess of the energy supplied to stimulate this action.

As was announced in 1958, trouble was being encountered in stabilizing the electric arcs, with the result that they snaked around within the reaction chamber and were destroyed by contact with the walls. Using the accepted teachings of electrodynamics it was possible to devise systems which could, at least theoretically, overcome the stability problem. One simple proposal offered by the author (1958, b) was to induce the arc along the central axis of a hollow primary conductor, the arc being, in effect, the secondary circuit of a transformer. However, what has seemed a theoretical possibility has remained a practical impossibility. The attempts to stabilize the discharge have gone on without success, or at least without sufficient success to induce the high temperatures expected. It is not difficult to begin to wonder whether the laws of electrodynamics applied with such success in other fields have their limitations in this area. One is dealing with a closed electric arc which is not held in place by a conductor of solid material. The rigidity of the usual current conductor is not present. Further, there is scope for the arc to act on itself. Electrodynamics theory is usually applied to actions between currents where, invariably, one current is a closed circuit. Our simple formulations in electrodynamics depend upon this assumption. However, it does not apply if we can have one part of a current circuit acting on another and we have nothing to restrain the interaction. This introduces the next topic in this work, the law of electrodynamic force between two isolated charged particles in motion. It is an academic problem of classical importance. The practical motivation could be the problems of the thermonuclear reactor discharge. The encouragement available is the foregoing new approach to magnetic theory and a desire to see how far we can proceed without invoking Einstein's theory as a pillar in the analysis. Again, we will come to a seemingly heretical suggestion. It will be suggested that there was failure to realize the full implications of the

Trouton–Noble experiment. The result of the experiment was not surprising in the light of Einstein’s theory. However, had there been no Einstein’s theory the result of the experiment might have been used to provide the missing piece in the jigsaw posed by the electrodynamic problem.

### **The Law of Electrodynamics**

A summary of the early development of the law of electrodynamic action between current elements has been presented by Tricker (1965). He recites the basic paper of Ampère on this subject, and the criticisms sustained by Ampère’s law and alternative formulations by Biot and Savart and by Grassmann. Also mentioned is the general empirical formulation by Whittaker (1951, a) in which he proposes a simplified new law based upon new assumptions. The common problem is that none of these laws is fully consistent with Newton’s Third Law when applied to interactions between individual elements of current. Yet, all the formulations appear to give the correct answers when used in integrated form to apply to interactions involving a closed circuit. Tricker then reaches the seemingly inevitable conclusion that an isolated element of steady current is a contradiction in terms, and thus he leaves open the question of how two electrons in motion really react owing to their electrodynamic interaction. This question is important in any attempt to understand the physical behaviour of electric charge on a fundamental basis. Electrical measurements are based upon electric current flow in solid conductors. Forces can possibly be absorbed by such conductors. As explained above, there is unusual behaviour in the case of electrical discharges which are not constrained by a solid conducting path. Hence, it is the basic action between isolated charges in motion which has to be understood if the true physics of electrodynamic phenomena are to be discovered. It may well be that when we consider the interaction between two isolated current elements, the proper application of Newton’s Third Law requires us to consider a complete system. Then, if the facts of experiment do not match the results of applying this law to the two current elements, the inevitable conclusion is that the system is incomplete. In other words, perhaps the field or the aether medium has to be brought into the analysis. Here, it is proposed to apply Newtonian principles to the problem of two interacting electrical particles. From very simple considerations a formulation

of the law of interaction is deduced which is fully consistent with the empirically derived general formula of electrodynamics. It has a specific form which is identical with that which can be derived empirically if we introduce the experimental result afforded by the experiment of Trouton and Noble (1903). Curiously this latter experiment does not appear to have been applied in previous analyses of this problem. The specific law of electrodynamics deduced is different from the laws deduced, by assumption, by Ampère, Biot and Savart, Grassmann, and Whittaker. The new law of electrodynamics has a most valuable feature. It indicates that there should be an inverse square law of attraction operative between like current vectors, the force acting directly along the line joining the currents. This feature is not shared by the other laws and it is exactly such a feature which is needed to contemplate the eventual explanation of gravitation in terms of electromagnetic effects. Apart from this, the law has another very significant feature when applied to the study of interaction effects between electric particles of different charge-mass ratios. This may have value in explaining certain hitherto unexplained anomalies in electric discharge phenomena.

Four basic empirical facts were relied upon by Ampère in deriving his law:

- (a) The effect of a current is reversed when the direction of the current is reversed.
- (b) The effect of a current flowing in a circuit twisted into small sinuosities is the same as if the current were smoothed out.
- (c) The force exerted by a closed circuit on an element of another circuit is at right angles to the latter.
- (d) The force between two elements of circuits is unaffected when all linear dimensions are increased proportionately, the current strengths remaining unaltered.

Ampère combined with the above the assumption that the force between two current elements acts along the line joining them, and thus he obtained his law:\*

$$F = kii' \left\{ \frac{3(ds \cdot r)(ds' \cdot r)}{r^5} - \frac{2(ds \cdot ds')}{r^3} \right\} r \quad (2.9)$$

In the equation  $F$  denotes the force acting upon an element  $ds'$  of a circuit of current strength  $i'$  and due to a current  $i$  in an element  $ds$ .

\* Note that expressions in  $r$  are vectors, whereas  $r^3, r^5$  etc. are scalar.

The line from  $ds$  to  $ds'$  is the vector distance  $r$ ;  $k$  is arbitrary and depends upon the limits chosen, although its polarity may be determined by using the law to verify the observation:

- (e) Two extended parallel circuit elements in close proximity mutually repel one another when carrying current in opposite directions, or attract when carrying current in the same direction.

From the analysis by Whittaker, disregarding Ampère's assumption, the general formulation consistent with observations (a) to (d) is found to be:

$$F = kii' \left\{ \frac{3(ds \cdot r)(ds' \cdot r)r}{r^5} - \frac{2(ds \cdot ds')r}{r^3} + \frac{A(ds \cdot r)ds'}{r^3} - \frac{B(ds' \cdot r)ds}{r^3} - \frac{B(ds \cdot ds')r}{r^3} + \frac{3B(ds \cdot r)(ds' \cdot r)r}{r^5} \right\} \quad (2.10)$$

Here,  $A$  and  $B$  denote arbitrary constants. Whittaker then assumed linear force balance as represented by symmetry in  $ds$  and  $ds'$ . This involves equating  $A$  and  $-B$ . In its simplest form, with  $k$  and  $A$  both equal to unity, the law becomes:

$$F = \frac{ii'}{r^3} \{ (ds \cdot r)ds' + (ds' \cdot r)ds - (ds \cdot ds')r \} \quad (2.11)$$

Inspection shows that this formulation satisfies observation (e). However, Whittaker made no mention of the all-important experimental discovery of Trouton and Noble. Their experiment demonstrated that separated charges in a capacitor do not cause the capacitor to turn when in uniform linear motion transverse to its suspension. Put another way:

- (f) There is no out-of-balance interaction torque between anti-parallel current elements.

This balance of torque action is not assured by the simple formulation of Whittaker in (2.11). To satisfy observation (f), terms other than those in  $r$  must cancel when  $ds$  is equal to  $-ds'$ . This applies to the general formulation when  $A = B$ . Using the general formulation (2.10) and putting  $A = B = -1$ , and  $k = 1$  to obtain the simplest version using all the empirical data, we find:



$$F = \frac{ii'}{r^3} \{(ds' \cdot r)ds - (ds \cdot r)ds' - (ds \cdot ds')r\} \quad (2.12)$$

According to this law, when  $ds = ds'$ , meaning that the current elements are mutually parallel, the last term only remains to indicate a mutual force of attraction, inversely proportional to the square of the separation distance, and directed along the line joining the two elements. Now, it will be shown how this can be explained from Newtonian principles without knowledge of any electromagnetic phenomena, but assuming that there is a fully-balanced interaction force of some kind acting directly along the line joining the elements. This force will then be explained in terms of magnetic field theory, so combining with the Newtonian argument to provide a truly basic explanation of the empirical law in (2.12).

Consider two particles of mass  $m$  and  $m'$ . They are separated by the distance vector  $r$ . The centre of inertia of this two-particle system is taken to be distant  $x$  and  $y$  respectively from  $m$  and  $m'$ . Then,

$$m'y = mx \quad (2.13)$$

Let  $v$ , the velocity of  $m$ , tend to change, decreasing by  $dv$ . This must arise from a force  $-m(dv/dt)$  acting on  $m$  in the direction  $v$ . Let  $v'$ , the velocity of  $m'$ , tend to change, decreasing by  $dv'$ . This must arise from a force  $-m'(dv'/dt)$  acting on  $m'$  in the direction  $v'$ .

These two forces on  $m$  and  $m'$  will, in the general case, produce a turning moment in the system. Since there is no evidence that any system can begin to turn merely by its own internal interactions, the forces in the system must be such as to prevent out-of-balance couple from asserting itself. Accordingly, there are restrictions on the proper relationship between the two forces just specified. These restrictions can be allowed for analytically by adding force components to the two particles to compensate, as it were, for any turning effects. On  $m$  we add the force:

$$-m' \frac{dv'}{dt} \frac{y}{x} = -m \frac{dv}{dt}$$

from (2.13). On  $m'$  we add the force:

$$-m \frac{dv}{dt} \frac{x}{y} = -m' \frac{dv'}{dt}$$

The total force on  $m'$  now becomes:

$$-m' \frac{dv'}{dt} \text{ in } v' \text{ direction,}$$

$$-m' \frac{dv}{dt} \text{ in } v \text{ direction,}$$

$$-F' \text{ in } r \text{ direction,}$$

where  $-F'$  is the force we now assume to act directly on  $m'$  as a result of its electromagnetic field interaction with  $m$ . This force is a fully balanced interaction force. It will be discussed in detail later. In summary, we now have three force components acting on each particle. One is the prime direct electromagnetic force which induces acceleration in a particle and therefore inertial reaction. The other two are components of force representing this inertial reaction, but, notwithstanding initial generally-directed motion of the particles, subject to the condition that the system cannot develop any out-of-balance couple about its centre of inertia.

Consider the rate of energy change at  $m'$ , that is:

$$-m' \left( \frac{dv'}{dt} \cdot v' \right) - m' \left( \frac{dv}{dt} \cdot v' \right) - \frac{F'}{r} (r \cdot v') \quad (2.14)$$

We then remove the kinetic energy term and equate the remainder to zero. Thus,

$$m' \frac{dv}{dt} = -\frac{F'}{r} \frac{(v' \cdot r)v}{(v \cdot v')} \quad (2.15)$$

Similarly for  $m$ ,

$$m \frac{dv'}{dt} = \frac{F'}{r} \frac{(v \cdot r)v'}{(v \cdot v')} \quad (2.16)$$

We can now evaluate the resultant force acting on each particle. For the particle of mass  $m'$ , equations (2.15) and (2.16) may be used to derive the general force expression:

$$F = \frac{F'}{(v \cdot v')r} \left\{ (v' \cdot r)v - \frac{m'}{m} (v \cdot r)v' - (v \cdot v')r \right\} \quad (2.17)$$

If it is now assumed that the particles are electrons, the masses  $m$  and  $m'$  become equal, and since the effective current elements  $ev$  and  $ev'$  may be written  $ids$  and  $ids'$ , respectively, where  $e$  denotes the electron charge in the appropriate units, (2.17) becomes:

$$F = \frac{F'}{(ds \cdot ds')r} \{ (ds' \cdot r)ds - (ds \cdot r)ds' - (ds \cdot ds')r \} \quad (2.18)$$

Comparison with (2.12) shows this to be of the same form as that found empirically. It is identical if:

$$F' = \frac{kii'(ds \cdot ds')}{r^2} \quad (2.19)$$

From observation (e), with  $ds = ds'$ , (2.18) shows that  $k$  in (2.19) is positive and unity with the right choice of dimensions. Of interest then, is the fact that the force given by (2.19) is exactly the force deduced theoretically by evaluating the interaction component of the integrated magnetic field energy due to the two current elements.

Whittaker (1951, b) explains how Neumann published in 1845 a memoir showing how the laws of induction of currents were deduced by the help of Ampère's analysis. Neumann proposed to take a potential function as the foundation of his theory, the nature of which was expressed by Whittaker in the form:

$$ii' \iint \frac{(ds \cdot ds')}{r} \quad (2.20)$$

where the integrations are performed over closed current circuits. This expression represents the amount of mechanical work which must be performed against the electrodynamic ponderomotive force in order to separate the two circuits to an infinite distance apart, when the current strengths are maintained unaltered. It therefore accounts for the force *component* between current elements, as presented in (2.19). Then, later in his book at page 233, Whittaker refers to a series of memoirs published between 1870 and 1874 by Helmholtz and refers to Helmholtz's observations that for two current elements  $ds$ ,  $ds'$ , carrying currents  $i$ ,  $i'$ , the electrodynamic energy is:

$$\frac{ii'(ds \cdot ds')}{r} \quad (2.21)$$

according to Neumann, but different according to other writers, as, for example, Weber. Again, it is noted that all formulations meriting attention give the same result when applied to entire circuits. The failing seems to be that, although it was recognized long ago by Neumann that the true electrodynamic effect is that given by (2.19),

the mechanical effects of inertial reactions in discrete charge systems have not been appreciated. It is wrong to assume that current strength remains constant when we talk of discrete charges in motion and subject to forces. There has been heavy reliance upon hypothetical formulations, without true appreciation of the simple mechanical implications of the problem.\*

One of these implications, the key difference between the Whittaker formulation in (2.11) and the author's formulation in (2.12), is that Whittaker forbids out-of-balance linear force. The author forbids out-of-balance torque, with experimental backing, but allows out-of-balance linear force. This is seen by the lack of symmetry in  $ds$  and  $ds'$  in (2.12). Interchanging  $ds$  and  $ds'$  gives different results for the total force. Then the force on  $m$  does not balance the force on  $m'$ . Now, this does not mean that we have argued against Newton's Third Law. Action and reaction still have to balance in a complete system. It merely means that the system of two particles is incomplete unless, perchance, they move mutually parallel or anti-parallel, a circumstance which does eliminate the first two terms in (2.12) and thereby leaves the equation symmetrical. This tells us that the field medium itself, or space-time, has to be regarded as a part of the system separate from the particles under study. It also tells us that, if space-time contains electrical particles in motion, then, being collectively a complete system, they must have a motion which is always mutually parallel or anti-parallel as, for example, a harmonious circular motion.

The thought that space-time can exert an out-of-balance linear force is feasible. It is well known that photons convey linear momentum. Photons are disturbances of space-time and they exert linear forces on matter in their creation and absorption. The thought that space-time cannot exert out-of-balance torque is feasible. If space-time has the force transmission characteristic similar to that of a solid body it can be understood how a part of it can be caused to turn within the whole without steady restraint, once the slip action is developed and the inertial action overcome. This does not mean that we are precluded from acknowledging that space-time can accept some angular momentum. This is needed to sustain inertial action.

This type of argument may seem to be fanciful, but, be that as it may, a law of electrodynamic force applicable to actions between

\* Note that (2.14) declares that a free electric charge can only store its own kinetic energy, as shown on page 26.

isolated charges in relatively steady motion has been developed and has empirical support. It remains for us to use the law to prove its value. It has already been indicated that the law may have value in gravitational theory. This is deferred until Chapter 5. It will be shown in Chapter 3 that the law has application to the understanding of the nature of ferromagnetism. To conclude this chapter, since it has been suggested that the law might have value in understanding electrical discharges, it is appropriate to draw attention to the significance of the middle term in (2.17). This middle term represents a force component along the direction of current flow, and we may predict that in a discharge circuit, where electrons carry current in a cathode and positive ions contribute to the current to the cathode, there will be an electrodynamic force manifested along the discharge. Similarly, some manifestation of the predicted anomalous forces should appear in plasma work.

Many authors have found anomalous cathode reaction forces in discharge studies. For example, Kobel (1930) found an anomalous cathode reaction force of 250 dynes at 16 amps and 1,400 dynes at 35 amps. This is of the order of  $100i^2$ , where  $i$  is the current in absolute units. This quadrature current phenomenon has defied explanation. Mere reaction momentum considerations lead to a relatively small cathode reaction force which is linearly dependent upon current. Even using equation (2.9), for example, any element of current in a continuous filament is subjected to balancing forces from the filament current on either side. There is no force action along the filament. This also applies to the classical formulations of the electrodynamic law. However, bearing in mind that in a discharge at least some of the current at the electrodes suddenly is transported by ions and not electrons, the  $m'/m$  factor to be used with the middle term of equation (2.12) assumes importance. On one side of this current junction, at the cathode, electrons act upon ions in the discharge, and on the other side ions act on ions. It works out that there is an out-of-balance force productive of a cathode reaction by impact from the ions. This force is the product of the constituent ion current component squared and the ratio of the ion mass to the electron mass. Forces of the order of  $100i^2$ , as found by Kobel, are therefore readily explained.

It may be concluded that the resolution of this long-standing problem of the true nature of this basic electrodynamic law is not a mere academic topic. Some deeper understanding of the law will have practical consequences in discharge and plasma control. For

comment on this see Aspden (1965). Also note that the law was first suggested by the author some years previously (Aspden, 1960) in connection with gravitational theory. The analysis in this chapter is substantially the same as that in a paper published by the *Journal of the Franklin Institute* (Aspden, 1969).

### Summary

In this chapter the principles developed in Chapter 1 have been extended to a study of mutual interaction effects rather than effects only concerned with isolated charge. It has been shown that the idea that there are three separate energy components to consider in field calculations is wholly compatible with more general phenomena. The concept that magnetic energy is a deficit of an energy level throughout space is, no doubt, a step which the conservative physicist will hesitate to take. Even so, there are rewards in accepting this and there are many avenues opened for further advances. The gyromagnetic ratio ceases to be a problem needing specialist treatment in the analysis of the spinning electron. The electron has a spin property but it need not have this property to account for the factor of 2 found in gyromagnetic ratio measurements. Spin will be discussed later in Chapter 7. Also, the law of electrodynamic force between two isolated charges has been formulated from empirical experimental data and verified by separate analysis using the theory thus developed. The law is simple but different from previous proposals. It has features which may have practical importance and its form is such that it gives new hope for explaining gravitation by an electrodynamic approach, our quest in Chapter 5. The inevitable conclusion, however, is that attention has to be paid to the aether medium. It would be folly to continue efforts to try to cancel it out of our theoretical studies, because, though many would say that it has cancelled itself out, the fact remains that there are four basic discoveries in the last two chapters which owe their origin to the fact that omissions in existing theory have eliminated the need to recognize the aether. This is a reference to the omission of the accelerating field in calculating the energy radiated by an electron, the failure to recognize the existence of a dynamic electric field induced by charge in motion, the failure to give weight to the potential reaction effect of free electrons in a magnetized substance, and even the alleged misinterpretation of the Trouton–Noble experiment.

### 3. *The Nature of Ferromagnetism*

#### Heisenberg's Theory

Heisenberg's theory of ferromagnetism attributes the ferromagnetic state to an alignment of electron spins in atoms due to exchange forces. In wave-mechanical terms, the probability that an electron in one atom will change places with an electron in an adjacent atom is given by an exchange integral which is positive or negative according to the ratio of the radius of the relevant electron shell  $r$  and the atomic spacing  $d$ . In general, this integral is negative since the attractions between the atomic nuclei and the electrons are greater than the repulsions between the nuclei and between the electrons. It is positive when there exists a certain ratio  $d/r$  of the distance between the adjacent atoms of the crystal and the radius of the electron shells containing the uncompensated electron spin. Slater (1930) presents the data:

Metal	Fe	Co	Ni	Cr	Mn	Gd
$d/r$	3.26	3.64	3.94	2.60	2.94	3.10

The conclusion drawn from this is the empirical presumption that, for ferromagnetism to exist,  $d/r$  must be greater than 3.0 but not much greater.\*

As Bates (1951, c) points out, in Heisenberg's theory the exchange forces depend upon the alignment of the electron spins but the forces between the spins themselves are not responsible for the ferromagnetic state. Ferromagnetism is presumed to be due to interaction forces between the atoms because these forces apparently have a common feature if the ratio  $d/r$  has an approximately common value, evidently greater than 3.0 but not much greater. However, is this a

\* In this chapter the symbols  $r$  and  $d$  are used to denote dimensions in an atomic lattice, whereas in the remainder of this book they are used consistently to denote dimensions of the space-time lattice. The coincidental feature that the ratio  $d/r$  is slightly more than 3 in the space-time lattice is deemed to be fortuitous.

sufficient explanation of the ferromagnetic state? Also, accepting that the exchange forces do have values coming within certain limits which are conducive to the ferromagnetic state in the ferromagnetic substances, what really is the link between these forces and the intrinsic magnetism? How do the electron spins get aligned and why is it that so few electrons in each atom have their spins set by action of the exchange forces? Why is Heisenberg's theory so vague in its quantitative account of the ferromagnetic state? Also, since in Chapter 2 it has been argued that ferromagnetism is not primarily associated with electron spin, as is popularly believed, but is in fact due to the orbital motion of electrons, how is this to be related to Heisenberg's theory?

### The Cause of Ferromagnetism

In considering the nature of ferromagnetism, the idea that magnetic energy is a negative quantity, presented in the previous chapter, has immediate significance. Magnetism may have a tendency to become the preferred state and ferromagnetism will result if the other forms of energy which go with this magnetic state can be fully sustained by the source of magnetic energy itself. This is simple physics without recourse to exchange integrals defining probabilities of electron interchanges between atoms.

On this point of negative magnetic energy, it is appropriate to note that it is included as a negative term in magnetic domain theory where the equilibrium states of magnetic domain formation are evaluated (see Kittel, 1949). "The minus sign merely indicates that we have to supply heat in order to destroy the intrinsic magnetization."\*

To say that energy has to be supplied to *destroy* intrinsic magnetism is to say that energy is needed to restore the undisturbed state of the field medium (the aether) since the disturbance, which is magnetism, has yielded energy and needs it back to be restored to normal. If ferromagnetism, meaning an alignment of the magnetic moments of adjacent atoms in a crystal, needs other energy to sustain it, such as strain energy, this other form of energy can participate in the return to the demagnetized state. But the question of whether a substance is or is not ferromagnetic must depend upon the ratio of the available energy from the magnetic source and the sustaining

\* See page 7.



energy needed, as by the strain. If this ratio is greater than unity, there is ferromagnetism. Otherwise there is no ferromagnetism.

Why is iron ferromagnetic to the exclusion of so many other elements? The answer to this question is that it so happens that in the atomic scale iron is positioned to have properties for low interaction forces between atoms, with a significant alignment of certain electron states. In addition, iron is strong enough to withstand the effects of these forces, which are many tons per square inch and do approach the normal breaking stresses of metallic crystals. Further, iron, as well as nickel and cobalt, does happen to have a rather high modulus of elasticity so that the energy needed to sustain the strain is relatively low.

Why does the ferromagnetic property disappear as temperature is increased through the Curie point? There are the conventional explanations for this in the standard works on magnetism (such as that of Smart, 1966). A simple alternative answer which appeals to the writer is that, since the modulus of elasticity does decrease rather rapidly with increase in temperature, by the right amount, the strain energy needed to sustain magnetism increases to cross the threshold set by the ratio mentioned above. This threshold is at the Curie point.

If ferromagnetism is so closely related with internal strain, and if this internal strain is high, and if at high strain the modulus of elasticity becomes non-linear, all of which are logical, then, at least in some ferromagnetic substances, there should be significant changes in the modulus of elasticity at the Curie point. This is found to be the case. The phenomenon has been discussed by Döring (1938).

It is shown below how the elements of a theory of ferromagnetism can be based on the above argument. The analysis is simplified by the expedient of regarding the Bohr theory of the atom as applicable. This merely serves to allow easy calculation of the stresses mentioned.

### **Stress Energy Analysis due to Orbit-Orbit Interactions in a Ferromagnetic Crystal Lattice**

In view of the different account of the gyromagnetic ratio given above, the ferromagnetic state can be regarded as due to electrons in an orbital motion, rather than a mixture of spin and orbit actions. The electron in orbit traversing a circular loop at a steady speed will be taken seriously, notwithstanding the wave-mechanical aspects and the accepted improbability of such steady motion in an atom. The

purpose of this is to facilitate the approximate calculations presented here. Offset against this also, one can argue that the Principle of Uncertainty, as used in wave mechanics, may well only have meaning when viewing events in atoms on a statistical basis. This principle is no warranty that, in some atoms, those of certain size, arranged in certain crystal configurations and under certain energy conditions, just one electron could not defy the principle, *as viewed by an electron in an adjacent atom*, and actually be in a harmonious state of motion with such electrons in adjacent atoms. The motion of electrons in atoms is not random. Statistically, wave mechanics helps us to understand the systematic behaviour of atomic electrons, but they are a mere mathematical tool used for this purpose and not a set of laws which a particular electron has to obey. If, energetically, it suits the electron to move steadily in an orderly orbit, it will do so. Such is the premise on which the model to be studied is based, and with it the Bohr theory of the atom will be used.

Imagine two adjacent atoms arranged in a crystal lattice with their electron orbits aligned along the crystal direction linking the particles. This is illustrated in Fig. 3.1. Only one electron per atom is taken to be in this state. The atoms are spaced apart by a distance

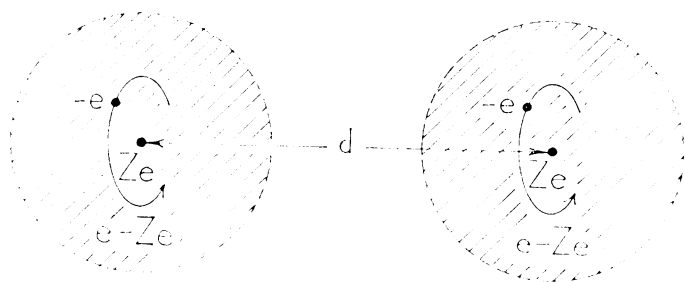

Fig. 3.1

*d*. Each atom has a nuclear charge  $Ze$ , an electron system depicted as a cloud, shown shaded, of charge  $e - Ze$ , and a single electron of charge  $-e$  describing a circular orbit of radius  $r$  and velocity  $v$ . In effect, it is assumed that one electron in each atom has adopted a motion in strict accordance with Bohr's theory, whereas the other electrons form, statistically, a charge centred on the nucleus, but not screening the orbital charge from the electric field set up by the nucleus.

The orbital electrons are taken to move in synchronism in view of

their mutual repulsion. Then the following components of interaction force between the two atoms may be evaluated in terms of the radius  $r$  of the electron orbits and the velocity  $v$  of the electrons.

- (a) Between the orbital electrons:  $e^2/d^2$  repulsive,
- (b) Between the orbital electrons:  $(ev/c)^2/d^2$  attractive,
- (c) Between the remaining atoms:  $e^2/d^2$  repulsive,
- (d) Between the orbital electrons and the atoms:  $2e^2d/(r^2 + d^2)^{3/2}$  attractive.

These force components are, simply, the electrostatic and electrodynamic interaction forces between the two electrical systems defined. If the last term is expanded, then, neglecting high order terms in  $r/d$ , since  $r$  is less than  $d$  for all cases and very much less for most, it becomes  $2e^2/d^2 - 3e^2r^2/d^4 \dots$ . Combining the force components, the total force between the two atoms becomes, approximately,  $(v/c)^2 - 3(r/d)^2$  times  $e^2/d^2$ , as an attractive force.

On Bohr theory:

$$v/c = aZ/n \quad (3.1)$$

where  $a$  is the Fine Structure Constant  $7.298 \cdot 10^{-3}$ , and  $n$  is the quantum number of the electron level in the atom. Also:

$$r = n^2 r_H / Z \quad (3.2)$$

where  $r_H$  is  $5.29 \cdot 10^{-9}$  cm.

It follows that as  $Z$  increases, the attractive force component diminishes and the repulsive force component increases. The zero force state occurs when:

$$Z^4/n^6 = 3r_H^2/a^2d^2 \simeq 4,000$$

if  $d$  is  $2 \cdot 10^{-8}$  cm. This gives, for  $n=2$ ,  $Z=23$ . For iron,  $Z=26$ , and it so happens that the measured value of the effective value of  $n$  is  $2.2$ . This represents the number of Bohr Magnetons per atom applicable to iron in its state of intrinsic magnetization.

The above calculation is merely to demonstrate that the approach being pursued may prove profitable.

To develop the theory on more realistic, though still approximate, terms, the transverse forces have to be taken into account in stress energy considerations. The force in the lateral sense between two atoms in the crystal lattice will be effectively all electrodynamic. The electrostatic action of the orbital electron of one atom will, on

average, tend to act from a point close to the nucleus when its action on the other atomic nucleus is considered. It follows from the law of electrostatics developed in Chapter 2, that the force  $(ev'e)^2/d^2$  will act in the lateral sense. This will create components of stress energy precluding the total stress energy from passing through zero as  $Z$  increases. This will make the ferromagnetic state less likely to occur and very much will depend upon the value of the related magnetic field energy and stress energy.

To proceed, the stress in the substance will be taken to be of the order of  $1/d^2$  times the elemental force just deduced. This is taking into account only forces between adjacent atoms in a cubic lattice. The actual force will be greater than this, perhaps by a factor of two or three. Although there are many atoms interacting, when the spacing doubles the forces are reduced in inverse square proportion. Further, the harmonious nature of the electron motions may not be seen as such for interactions over large distances. In travelling a distance  $d$  of  $2 \cdot 10^{-8}$  cm at velocity  $c$  of  $3 \cdot 10^{10}$  cm/sec, the electrodynamic action, for example, involves a transmission time of  $0.67 \cdot 10^{-18}$  seconds. In this time, for  $Z = 23$  and  $n = 2$ , equation (3.1) shows that the electron may move  $1.7 \cdot 10^{-9}$  cm. This is slightly more than one quarter of a revolution. This really means that this approach to explaining ferromagnetism requires a redefinition of the synchronous state assumed in Fig. 3.1. In fact, since energy considerations are involved, the mutual repulsion forces between the electrons in orbit urge maximum separation, subject to the propagation velocity. This velocity may be different from  $c$ , but this does not matter. We take it that synchronism exists as viewed by each individual atom. This means that electrons in adjacent atoms are out-of-phase in their motion as viewed from remote positions. It also means that atoms not adjacent to the one under study will be seen by that atom to have orbital electrons also out-of-phase. There is an exception for successive atoms along the magnetization direction and transverse to it along the crystal axis, because the effective value of  $d$  increases in integral steps. From considerations such as this, it may be shown that the prime term is the energy due to interaction with atoms adjacent in the crystal lattice directions. The energy will be greater than this only provided the surrounding atoms are seen to be in synchronism and make a significant contribution to the energy required. If these atoms are out of synchronism, they may add to, or subtract from, the energy, but, overall, should have little effect.

Along the direction of magnetization, there will be a stress  $F_x$  given by:

$$F_x = (e^2/d^4)[(v/c)^2 - 3(r/d)^2] \quad (3.3)$$

In the orthogonal directions, there will be forces  $F_y$  and  $F_z$ , both given by:

$$F_y = F_z = (e^2/d^4)(v/c)^2 \quad (3.4)$$

From (3.3) and (3.4):

$$F_x = F_y = F_o \quad (3.5)$$

where:

$$F_o = 3(e^2/d^4)(r/d)^2 \quad (3.6)$$

In terms of Young's Modulus  $Y$  and Poisson's Ratio  $\sigma$ , the strain energy density is:

$$E = \frac{1}{2Y} [F_x^2 + F_y^2 + F_z^2 - 2\sigma F_x F_y - 2\sigma F_y F_z - 2\sigma F_x F_z]$$

and, if  $\sigma$  is approximated as 1/3, from (3.4), (3.5) and (3.6):

$$E = \frac{1}{2Y} [F_y^2 - \frac{2}{3}F_o F_y + F_o^2] \quad (3.7)$$

From equations (3.1), (3.2), (3.4), (3.6) and (3.7), it is possible to evaluate  $2YE/e^4$  as a function of  $Z$  for different values of  $n$ , provided  $d$  is known. The value of  $d$  depends upon the nature of the crystal, the atomic weight and the density of the substance. Consistent with the degree of approximation involved in deriving (3.7), it seems feasible to assume that  $d$  changes linearly with increasing  $Z$ . It will be taken as the cube root of the atomic weight divided by the density, and referred to two substances, say, iron and lead, for which  $Z$  is 26 and 82 respectively. The crystal lattice will be taken to be simple cubic, even though iron is body-centred, with lattice dimension  $2.8 \cdot 10^{-8}$  cm. The value of  $d$ , derived as indicated, is given by:

$$d = (1.93 \pm 0.0143Z) \cdot 10^{-8} \quad (3.8)$$

The plot of  $2YE/e^4$  is shown in Fig. 3.2 for  $n = 1, 2, 3$  and 4. In the same figure, along the abscissa, the short lines indicate those atoms for which the atomic susceptibility has been found to exceed  $10^{-4}$ . The broken lines indicate the values of  $2YE_{\text{mag}}/e^4$ , plotted for

different values of  $n$  and on a base value of  $Y$  of  $2 \cdot 10^{12}$  cgs units.  $E_{\text{mag}}$  is the magnetic energy density, evaluated as  $2\pi n^2/d^6$  times the value of the Bohr Magneton (in cgs units) squared. The Bohr Magneton is  $9.274 \cdot 10^{-21}$ .

The pattern of the high susceptibility atoms has a grouping matching the minima of the strain energy curves. This encourages the strain analysis approach to explaining ferromagnetism. The minima of the strain energy curves corresponds to the increased likelihood of ferromagnetism, though this latter state can only occur if the magnetic energy (being negative) exceeds in magnitude the strain energy. Of importance here is the fact that the strain energy density and the magnetic energy density are of the same order of magnitude, thus making select states of ferromagnetism feasible in some materials but not in others. The strain energies of the order of  $10^7$  ergs per cc, correspond to stresses of tens of tons per square inch. This means that selectivity for the ferromagnetic state may also depend on the rupture strengths of the materials; ferromagnetism clearly being more likely in strong materials of high Young's Modulus.

### Discussion of New Theory

Theoretically, ignoring the error factor in the under-estimation of the strain energy, the curves show that a simple cubic crystal of oxygen ( $Z=8$ ), if it could exist and if its Young's Modulus was  $2 \cdot 10^{12}$  or higher, would be ferromagnetic. For  $n=1$ , the prospect of a ferromagnetic state has to be ruled out for other atoms, except possibly carbon. Diamond has an extremely high Young's Modulus, some five times that assumed for the comparison curve. However, with  $Z=6$ , carbon, to be ferromagnetic, would have to sustain very high internal stresses and these probably preclude ferromagnetism. For  $n=2$ , iron, nickel and cobalt have to be given favoured consideration. They all have a relatively high Young's Modulus, some 50% higher than for copper, for example. They are all strong enough to sustain stresses accompanying the ferromagnetic state. Note that for Fe, Co, Ni and Cu,  $Z$  is 26, 27, 28 and 29 respectively. The broken curve in Fig. 3.2 has to be placed 20% or so higher for Fe, Ni and Co and the same amount lower for Cu. Fig. 3.2, therefore, explains why iron is ferromagnetic and copper non-ferromagnetic. Of course, in applying the curves in Fig. 3.2, it should be noted that

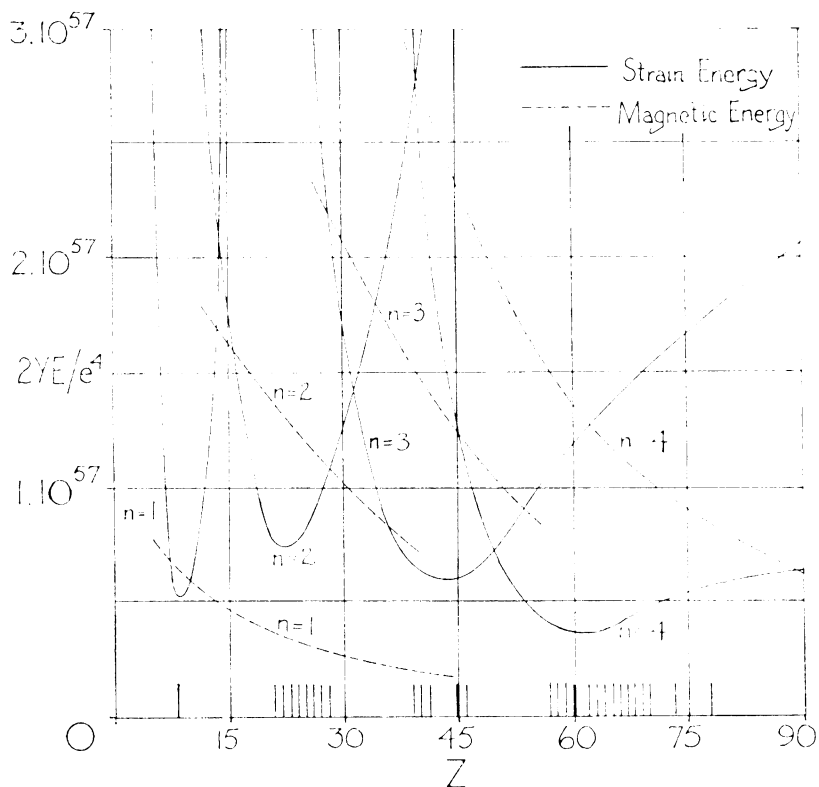

Fig. 3.2

the analysis has only been approximate. Perhaps, also, it was wrong to ignore the screening action of some of the electrons in inner shells or perhaps this, and an accurate evaluation of the strain energy allowing for surrounding atomic interaction, will shift the minima of the curves very slightly to the right. This would better relate the minima to the susceptibility data and permit a higher error factor in the strain energy evaluation. Note that if the strain energy is underestimated by much in Fig. 3.2, nickel is only marginally ferromagnetic. With  $n=3$  and 4, the screening action of electrons will assume more importance and the evident prediction of a theoretical state of ferromagnetism in several substances shows some qualification of the actions to be necessary. It is significant that Gd with  $Z$  of 64, located near the minimum of the  $n=4$  curve, is ferromagnetic. It may well be that the higher  $n$  and the higher  $Z$ , the more electrons there are in the shell which can be ferromagnetic. Then, the less likely it is for the synchronous action to remain as a preferred energy

state. The interference from the effects of other electrons could well suppress this condition in the larger atoms.\*

The understanding of ferromagnetism by its relation to stress properties may prove of interest in that it may be that under the very high pressures prevailing inside the earth, even materials which are not ferromagnetic at the surface may become ferromagnetic. Young's Modulus may then be of no importance and a compression modulus may be the factor which is deciding the state of balance between stress energy and magnetic energy.

### Summary

In this chapter, it has been shown how the nature of ferromagnetism can be explained without recourse to wave mechanics. The law of electrodynamics developed in Chapter 2 and the principles of negative magnetic energy are applied successfully in the analysis. In the next chapter we will explain how the theory is reconciled with wave-mechanics. It will be shown that an electron can spend some time in a Bohr orbit and some time in its wave mechanical state. Thus, a factor has to be applied to lower the magnetic energy curves in Fig. 3.2, so limiting the elements in the ferromagnetic state still further.

\* In *Physical Review Letters*, v. 22, p. 1260, June 1969, E. Bucher *et al.* report the discovery that Pr and Nd, of atomic numbers  $Z = 59$  and  $60$ , respectively, are ferromagnetic in their face centred cubic phases.



## 4. *Wave Mechanics*

### **Universal Time**

One of the long standing problems of the Theory of Relativity is the clock paradox. Does time differ according to what happens to us and where we go as we use it? Relativity does not provide a clear, consistent and definite answer to this question. On the contrary, its application in different ways leads to conflicting results. The theory may not be wrong in its essential principles but the fact that it can be interpreted in different ways to produce conflicting results limits its immediate value in extending theoretical physics. The paradox has not been overcome during the first half century of Relativity. Experts on Relativity still come together to discuss their different views on the same problem of what happens to a clock when it goes on a journey through space. How, then, can one have confidence that Relativity is the proper foundation for the ultimate in physical theory? Is it not better to reject Relativity and start with a sound foundation providing a clear concept of time and space, building on this the pillars of a theory which is consistent with the experimental support for Relativity?

The clock paradox is avoided if we recognize that the time of a universal clock is woven into the properties of space. The principle that time is universal is a far better start for a physical theory than is the Principle of Relativity. Time has to do with change in form or position of something. It is meaningless without motion. If time is a property of space it must be related to something which moves in space. Free space is devoid of matter. Modern scientists prefer to believe that there is no aethereal medium filling space. At least, they earnestly believe that it is futile to speculate about such a medium. This is so in spite of the fact that "aether" is just a word and there is little to argue about until one becomes specific about its form. However, recognizing the prejudice against the aether, we can remain on common ground with all physicists and still refer to something capable of motion in and belonging to free space. Space contains an inertial reference frame and provides an electromagnetic reference

frame. Time, as a property of space, could be quantified universally as the relative periodic motion of these two frames. This is the simple, logical proposition on which a new theory of physics can be built. It is hardly hypothesis. Time has to be defined in terms of motion. Motion is relative. Two “something” are needed to have relative motion. Only two features of space are available, the inertial and electromagnetic reference frames. To believe these frames to be one and the same is mere assumption. The reader having this belief denies himself the means for understanding Nature’s means for making time universal. He is left with his problems with clocks, and even if he ever succeeds in reconciling the clock paradox and the Theory of Relativity he has then to explain why time and the fundamental constants of physics are the same for the same conditions throughout the universe.

Guided by this introduction we may now formulate the following proposition.

*The electromagnetic reference frame in any part of the universe and all matter wherever located in the universe have in common a harmonious component of circular motion about an inertial reference frame.*

This will be termed the “Hypothesis of Universal Time”. It will be shown to unify physical theory.

### **The Michelson–Morley Experiment**

Einstein chose to interpret this experiment as meaning that light travels at the same velocity  $c$  in all directions relative to an earthly observer. He was aware that from the standpoint of mechanics physically equivalent inertial frames of reference can exist and that an observer can expect to make observations in mechanics independent of his motion if it is uniform. The result of the Michelson–Morley experiment appeared to warrant the extension of this characteristic of mechanical laws to the more general observation that the laws of nature are in concordance for all inertial systems not in relative motion or relatively accelerated. Einstein thus formulated his Principle of Relativity. Curiously, however, he made an unwarranted assumption. He presumed that in a vacuum light is propagated with the velocity  $c$  relative to an *inertial* reference frame. It is not. Light is an electromagnetic phenomenon. It is propagated

relative to an electromagnetic reference frame. This distinction is of fundamental importance. Einstein's theory has developed into a hopeless state of confusion simply because of the failure to distinguish inertial and electromagnetic frames of reference. The notion of time is implicit in the separation and relative periodic motion of the two frames. The Michelson–Morley experiment should have indicated that the light studied travelled at the same velocity  $c$  relative to an electromagnetic reference frame moving with the earth. This indication that there is a common translational motion of the electromagnetic reference frame and earthly matter is consistent with the above proposition that matter shares the intrinsic superimposed harmonious motion of the electromagnetic reference frame. We are then led immediately to the mass properties of matter and gravitation.

### The Principle of Equivalence

If all elements of matter share the common circular motion of the electromagnetic reference frame (to be denoted the  $E$  frame) and move in harmony, there is centrifugal force producing an out-of-balance condition. This puts a mass-related disturbance into space. It will be proved to be the basis of gravitation in the next chapter. By its very nature, we thus see that inertial mass and gravitational mass must be identical, consistent with the Principle of Equivalence.\*

The disturbance due to the out-of-balance is provided by something in space. The reader who is unwilling to believe that there is such a “something” in space is left with mere principles. His starting point to understanding gravitation is the Principle of Equivalence: a principle we have also had for half a century without understanding the nature of the force of gravity. To proceed here and retain generality, we will assume that there is something in space moving about the inertial reference frame in juxtaposition with the  $E$  frame and providing centrifugal balance. This we will term the  $G$  frame. Whatever it is, it must have a mass property used to balance the mass of any matter present in the  $E$  frame. Further, it could provide balance for any mass property of the  $E$  frame itself. At this stage, mass has been introduced in a form with which we are not familiar. The

\* The mass of an element of matter can vary. Except for some unusual conditions occurring in nuclear reactions and dense stars, this mass is the sole cause of gravitational effects. Also, as later analysis will show, except under similar very exceptional conditions the Constant of Gravitation is invariant.

suggestion is that space itself has mass properties. Matter has mass properties. The inertial effects of the mass in space and the mass of matter interact so that space is disturbed by matter. The disturbance characterizes gravitation. Gravitation, as we know it, is only associated with the mass of matter as a result of this disturbance characteristic. In the absence of matter space is balanced and undisturbed. If there are forces between mass in free space these contribute to the uniformity of the system and pass undetected in our experiments with matter. It is most important to note, therefore, that though reference will be made to the mass properties of free space we are talking about a medium which is apparently weightless. Abundant evidence is available to support the proposed mass character of free space. This is reserved for Chapter 5.

### **Energy and Angular Momentum of Space-time**

Space is really the emptiness, the void or the three-dimensional expanse in distance around us. Time is the motion of something in this space. This tangible medium which must exist in space is termed space-time. It comprises an  $E$  frame and a  $G$  frame moving about a common inertial frame in balance with one another. We now assign the symbol  $\Omega$  to denote the universal angular velocity of this motion.

A system such as this, that is one capable of disturbance without change of the periodic time parameter, has the same characteristics as two masses subject to a mutually attractive force proportional to their displacement distance. An oscillatory mass having a restoring force proportional to displacement has a fixed oscillation period independent of the amplitude of displacement. Logically, therefore, if the  $E$  and  $G$  frames can be disturbed without affecting their oscillation period, their nature is likely to be such that they are subject to a mutually restoring force proportional to their separation distance.

Space-time has angular momentum. This follows from the above proposition. Now, it is a fundamental law that energy is conserved in all physical processes. It is equally fundamental that angular momentum is conserved in a mechanical system of the kind just described. If, as appears from such mechanical analogies, both energy and angular momentum in space-time are conserved, it is interesting to ask how space-time reacts with matter.

To understand this, we first note that matter lies in the  $E$  frame. Any motion of elements of matter relative to the  $E$  frame develops kinetic energy, magnetic energy, etc., and, according to the analysis in Chapters 1 and 2, adds mass properties to the matter. We can, therefore, speak simply in terms of matter moving with the  $E$  frame. This matter has motion at the angular velocity  $\Omega$  in the orbit of the  $E$  frame. This adds kinetic energy, but as an energy component which appears to be devoid of mass properties since it does not arise from motion relative to the  $E$  frame. From similar reasoning it is calculable in terms of simple Newtonian mechanics. To facilitate analysis, let us assume a proposition, proved later, that the  $E$  and  $G$  frames have, when undisturbed, the same mass density  $\rho$  and rotate in the same sized orbits of radius  $r$ . The kinetic energy of unit volume of undisturbed space is then  $2(\frac{1}{2}\rho v^2)$  or simply  $\rho v^2$ , where  $v$  is the orbital velocity  $\Omega r$ . The mass energy density of space-time is  $2\rho c^2$ , from the relation  $E = Mc^2$ . If, now, energy is added to cause the orbital radius  $r$  of both frames to expand equally, the velocity  $v$  is increased. Work is done against the restoring force between the  $E$  and  $G$  frames. This is calculated from the centrifugal force as  $2\rho v^2/r$  times the increase of  $r$ . Note, however, that the angular momentum  $2\rho v r$  per unit volume can be written in the form  $2\rho v^2/\Omega$ . If angular momentum remains constant when energy is added to space-time  $\rho v^2$  remains constant, since  $\Omega$  is constant. Hence no kinetic energy can have been added although  $v$  has increased. It follows that  $\rho$  has diminished and, since the mass energy density  $2\rho c^2$  of free space is likely to be conserved, it also follows that  $c$  has increased in proportion to  $v$ . The conclusion from this is that  $v$  is, in fact, a parameter of space-time related directly to the velocity of light  $c$ . Later, it will be proved that  $c$  is the relative velocity of the  $E$  and  $G$  frames, making  $v = \frac{1}{2}c$ . A consequence of this is that the energy added to free space all goes into doing work against the restoring force. Thus, if the velocity of light increases by  $\delta c$ , corresponding to an increase of  $r$  by  $\delta r$  equal to  $\delta c/2\Omega$ , the energy added per unit volume is  $(2\rho v^2/r)\delta c/2\Omega$  which is  $\rho v \delta c$ . Since  $v$  is  $\frac{1}{2}c$  this can be written as  $2\rho v \delta v$ , which is effectively the increase in kinetic energy if  $\rho$  were constant.

This result will be used in the next chapter to explain several phenomena associated with gravitation. The immediate objective is to understand the nature of the photon and the principles of wave mechanics. In this regard, it is noted that space-time can accept energy without changing its angular momentum. Since matter

possesses an angular momentum due to its motion with the  $E$  frame, the radiation of energy by matter in a photon event must involve a process of angular momentum exchange. This is the entry point to wave mechanics.

### Heisenberg's Principle of Uncertainty

In order to extend the theory we need to evaluate  $\Omega$  or  $r$ . This can be done in a preliminary way by considering an electron moving with the  $E$  frame. Because of this motion it has a position which changes constantly. It is never at rest in the inertial frame. Its position is uncertain by an amount equal to the diameter of the orbit of motion  $2r$ . Its momentum is uncertain since its motion at velocity  $\frac{1}{2}c$  constantly reverses. The uncertainty of momentum is twice its instantaneous momentum  $\frac{1}{2}mc$ . Here,  $m$  denotes the mass of the electron. Thus, the product of uncertainty of position and uncertainty of momentum is  $2mcr$ . Now, according to Heisenberg's Principle of Uncertainty, the product of these two parameters is  $h/2\pi$ , where  $h$  is Planck's constant. This is an accepted postulate in quantum mechanics. It is used here merely to estimate  $r$  and  $\Omega$ . Since  $\Omega$  is  $c/2r$ , we can deduce from the data just given that:

$$r = h/4\pi mc \quad (4.1)$$

and

$$\Omega = 2\pi mc^2/h \quad (4.2)$$

As already noted on page 2, Heisenberg's Principle of Uncertainty has been expressed by Eddington in the words: "A particle may have position or it may have velocity but it cannot in any exact sense have both." In the sense of our analysis, a particle at rest in the electromagnetic reference frame does have velocity in the inertial frame. In an exact sense it has velocity and position, but we must not think it is at rest when it is always moving and we cannot, nor do we ever need to, say exactly where it is in its motion about the inertial frame because all matter shares the same motion. The basis of the uncertainty is eliminated by recognizing the separate existence of the electromagnetic reference frame and the inertial frame.

Our analysis so far does tell us that an electron has an intrinsic motion when at rest in the electromagnetic reference frame. Its own angular momentum is  $mcr/2$  but there is an equal associated angular

momentum due to the balance afforded by the  $G$  frame. Thus, the total angular momentum intrinsic to the electron and due to motion with the space-time system is  $mcr$ , which is  $h/4\pi$ , from (4.1). This is of importance when we come to discuss the nature of electron spin.

It is appropriate to mention here that something quite close to this theory of space-time is implicit in a physical interpretation of de Broglie waves once presented by Einstein (1925). The electron in the atom was deemed to be at rest with respect to a Galilean system oscillating at a frequency  $mc^2/h$  which is everywhere synchronous. This corresponds exactly with the result given in (4.2).

### Space-time Spin Vector

The universal motion at the angular velocity  $\Omega$  defines a fixed direction in space. There is not really any evidence of a fixed direction having preferred properties in space. Space is not deemed to be anisotropic. However, in Chapter 8 we will see that at least from this theory we can expect the axes about which space-time spins to be approximately normal to the plane in which the planets move about the sun. The evaluation of the earth's magnetic moment provides the evidence of this. It is probable from this that the spin motion at angular velocity  $\Omega$ , though the same throughout all space in magnitude, may be directed in different directions in the environment of different and widely spaced stellar bodies. When the nature of gravitation is explained it will be seen that this implies that widely spaced stars do not mutually gravitate in strict accordance with Newton's universal law. Gravitation exists everywhere and between all matter, but two elements of matter separated by several light years may not be mutually attracted in strict accordance with Newton's Law.

For the analysis in this chapter the direction of  $\Omega$  is of little significance. No angular momentum is added to this motion in the photon processes under study. Though reference will be made to angular momentum in connection with the space-time system, the reader should not restrict his thoughts of this angular momentum to an association with  $\Omega$  and consequently a fixed direction in space.

### Planck's Radiation Law

An electromagnetic wave is a propagated disturbance of the  $E$  frame. The  $E$  frame can be disturbed if a discrete non-spherical unit

of it rotates and so sets up a radial pulsation. This is depicted in Fig. 4.1. The  $E$  frame is shown in lattice form and a cubic unit is

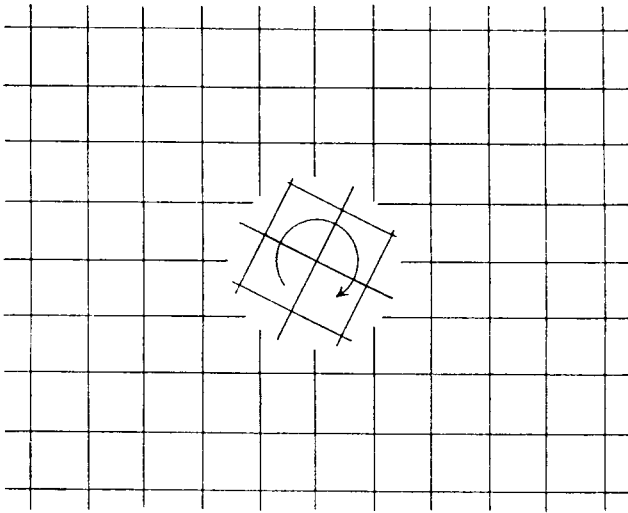

Fig. 4.1

deemed to be in rotation. Any axis of rotation through the centre of the cubic unit can be chosen. The  $E$  frame will be disturbed at a frequency proportional to the speed of rotation of the unit. We presume that the cubic unit of space-time is such that it has the same moment of inertia about any axis through its centre. Therefore, the propagated disturbance frequency  $\nu$  will be directly related to the angular momentum of the unit and independent of the direction of this angular momentum vector. The conditions just assumed will be proved to be applicable in Chapter 6, where it will also be shown that the unit has discrete unique form. Below, it is termed a photon unit.

A little consideration will show that if the unit rotates at an angular velocity  $\Omega/4$  it will develop an electromagnetic pulsation at the frequency of the universal motion of space-time. Under these conditions there is no electromagnetic wave propagation since a little local adjustment of the  $E$  frame can contain the disturbance. A photon unit rotating at the angular velocity  $\Omega/4$  will be termed a standard photon unit. If the unit rotates at an angular velocity differing from  $\Omega/4$  there will be electromagnetic wave propagation at a frequency corresponding to four times this difference quantity. Thus:

$$\nu = 4\omega/2\pi \quad (4.3)$$



where  $\omega$  is the amount by which the angular velocity of the photon unit differs from  $\Omega/4$ , denoted  $\omega_0$  below.

Having specified the existence of a standard photon unit we will now speculate about the possible existence of a unique particle form in association with this unit. Firstly, the angular momentum of the unit may have some exchange relationship with such a particle. Angular momentum cannot be absorbed by space-time for the reasons already given. Therefore, if the angular velocity of the unit is to change we must have angular momentum drawn from some other source. Secondly, we now presume that this particle form can exist in either of two states. In one state it has its association with a photon unit. In the other state it is transferring from association with one photon unit to association with another somewhere else in the  $E$  frame. We take a simple case in which this transfer is linear and presume that during such linear transfers the particle has lost its motion with the  $E$  frame. When moving with the  $E$  frame the particle of mass  $m'$  has an angular momentum of  $\frac{1}{2}m'cr$  plus any intrinsic spin  $s$  plus the associated component  $\frac{1}{2}m'cr$  linked by the balance action of the  $G$  frame. This is taken to be zero on the assumption that angular momentum is conserved and is zero for the linear motion. This gives the condition:

$$s = -m'cr \quad (4.4)$$

The kinetic energy associated with the motion with the  $E$  and  $G$  frames is released when the particle is in transit to its new location. This energy is  $\frac{1}{2}m'(\frac{1}{2}c)^2$  for each frame or a total of  $\frac{1}{4}m'c^2$ . Since the transit of the particle from one part of the  $E$  frame to another is an observable phenomenon, the energy of the particle in transit is drawn from "observable" sources. The particle will not move without the reason causing movement and the energy source associated with it. Thus, the energy  $\frac{1}{4}m'c^2$  is surplus for the very short transit state of the particle.

Essentially, the particle, once it has left its association with a photon unit, is looking for another one. The proposition we now have is that the energy just freed is used to produce two counter-rotating standard photon units along the trajectory of the particle. Thus, when the particle reaches the outermost of these photon units it has the opportunity to revert to its state of motion with such a unit by virtue of the collapse of the remaining pair of photon units. The energy is redeployed as if the process is reversible. This is illustrated

in Fig. 4.2. Note that the particle can move in any direction in space. The spin  $s$  has a set direction in space but the photon unit spins, though all parallel or anti-parallel, can be in any orientation. If  $I$  denotes the moment of inertia of the standard photon unit, the kinetic energy of the two created units is twice  $\frac{1}{2}I\omega_o^2$ . Thus:

$$\frac{1}{4}m'c^2 = I\omega_o^2 \tag{4.5}$$

From the fact that  $\omega_o$  is  $\Omega/4$  we can use (4.2) and (4.5) to show that:

$$I\omega_o = (m'/m)h/2\pi \tag{4.6}$$

From (4.1) and (4.4):

$$s = -(m'/m)h/4\pi \tag{4.7}$$

Unless we recognize fractional units of the fundamental spin angular momentum quantum  $h/4\pi$  we must, therefore, take  $m'$  to be equal to  $m$  or a multiple of it. The logical conclusion is that the photon-related particle is the electron, of mass  $m$ .

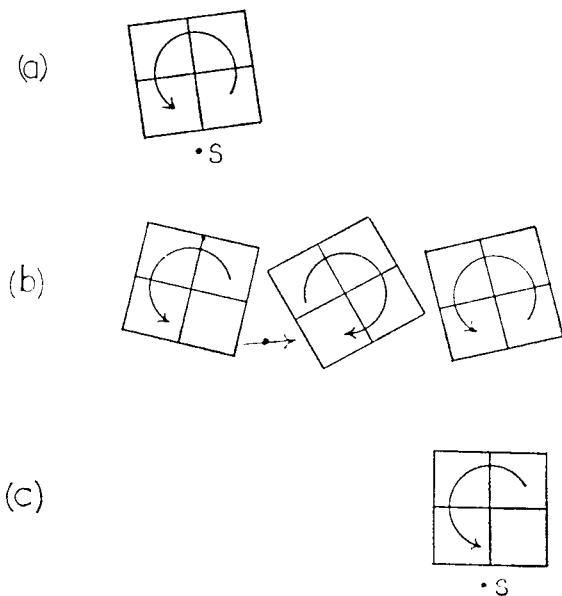

Fig. 4.2

This gives us the angular momentum of the standard photon unit. It is  $h/2\pi$ . An electron is, presumably, normally associated with a photon unit of spin  $h/2\pi$ . As it moves linearly through the  $E$  frame it induces counter-rotating photon units in its path which collapse

behind it as it transfers between its pauses in a successively-new, but ever present, standard photon unit. This has been shown in Fig. 4.2 where at (a) the electron has its spin  $s$  and is associated with the single photon unit. At (b) it has lost its spin and is moving in a path in which two new counter-rotating photon units have been formed. At (c) the electron has reached the outermost photon unit, reassumed its spin, and the units left behind have been eliminated. Note that the electron can only settle with a photon unit having a rotation in a specific sense.

At this stage it should be said that the atom is the home for photon units having this special affinity for settled electrons. When the electron is in its settled state in association with a photon unit it complies with wave mechanical criteria. When the electron is in transit to another photon unit it complies with Bohr's analysis of the atom. Wave mechanics determine the probable position of the electron when it is in its settled or pause state. Full analysis requires a substantial insight into the mechanisms within the atom and leads to the explanation of the photon itself and Planck's radiation law. As a preliminary we will explore the state in which the theory of the Bohr atom is applicable.

### The Bohr Atom

If an electron in an atom can move almost anywhere within reasonable limits about the nucleus according to a probability condition set by a wave mechanical formula, we have to accept that it is not moving in a simple orbit with fixed angular momentum. However, the effect of the nuclear charge will cause its successive transits from one photon unit to the next to be small arcs of different, but nevertheless simple, orbits. Where does this angular momentum come from? The answer to this is that in the atom it may be that when the electron moves out of spin and goes into transit the energy released is deployed into forming two photon units which spin in the same direction. Then, there will be a reaction angular momentum of twice  $h/2\pi$  imparted to the mass energy. This mass energy comprises the energy  $mc^2$  of the electron, or multiples of this in a many-electron atom. The angular momentum will really come in quanta of  $h/2\pi$ , even though made available in pairs in the transition phases of an atom or molecule. Note the existence of the single photon unit state implicit in (a) of Fig. 4.2. By this mechanism we expect that an

electron can move about around the atomic nucleus sporadically complying in its motion with successive sections of Bohr orbits.

In a multi-electron atom or in a single electron atom in an energetic environment primed by free electrons, there is the possibility that some electrons in transit between rest positions may move linearly even though their surplus energy has gone to form a pair of photon units having the same direction of rotation. The surplus angular momentum is then available in units of  $h/2\pi$  to be added to the angular momentum of another electron in orbital transit. The result is that integral quantization of angular momentum in multiples of  $h/2\pi$ , as assumed in Bohr's theory, is to be expected.

According to Bohr's theory of the atom, an electron describing a circular orbit around a nucleus of charge  $Ze$  moves so that its centrifugal force  $mv^2/R$  is in balance with the electrostatic force of attraction  $Ze^2/R^2$ . Here,  $R$  is the distance of the electron from the nucleus and  $v$  is the electron velocity. By assuming that the angular momentum of the electron is quantized in units of  $h/2\pi$  it is then possible from simple algebra to deduce that the kinetic energy of the electron is given by:

$$\text{K.E.} = \frac{1}{2}mv^2 = \frac{2\pi^2}{h^2} Z^2 e^4 m \quad (4.8)$$

where  $n$  is the number of units of the angular momentum quantum.

This kinetic energy quantity is the energy possessed by the electron during its transit between photon unit positions. When it reaches such a position and is put into its wave mechanical state this energy is deployed to prime the electron with a different motion. The electron loses its quantum of angular momentum but, as will be seen below, it has interplay with the photon unit. Angular momentum is exchanged. There is interaction with the nucleus and the properties of the atom and its nucleus can be explained.

The applicability of Bohr theory intermittently in the successive transits of the electron shows that the argument used in Chapter 3 to account for ferromagnetism has good basis in atomic theory and, as will emerge, is not inconsistent with wave mechanical treatments of the atom.

### Electron-Positron Annihilation

It may be asked whether the two counter-rotating photon units shown in Fig. 4.2 can split. As long as they are so close together they

are ready to mutually cancel. In Fig. 4.3 it is shown how an electron and a positron which pass through the transit state together may form photon unit pairs and then mutually annihilate one another. The

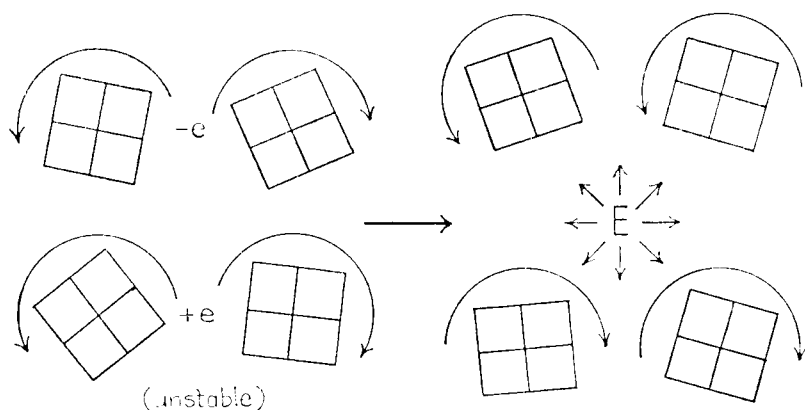

Fig. 4.3

reaction is deemed to divide the photon units into pairs having the same spin direction. As the energy  $E$  released by the mutual cancellation of the electron and positron is dispersed the pairs of standard photon units are left with their angular momenta. They are available for capture by atoms. It is a matter for speculation to ask whether an atom could contain photon units having stable spin states in opposite directions. Already, we have seen that the angular momentum priming of the Bohr atom can involve standard photon units with spins in the same direction. At least here we have the storage medium for paired photon units with the same spin direction. This is possibly the source of the photon units needed for the reverse process of electron-positron creation.

It is, perhaps, appropriate here to note that in the transit state of the electron or positron depicted in Fig. 4.3 the energy  $mc^2$  will transform according to Planck's law (Energy =  $h\nu$ ) into radiation at a frequency corresponding to the angular velocity  $\Omega$ . This follows from (4.2). The electron and the positron have this intimate physical connection with the properties of the space-time system which determine Planck's constant.

### The Schrödinger Equation

This equation is the basic formula of wave mechanics. It will now be shown how it results from the physical theory presented above. In

simple terms, the atom captures a pair of standard photon units, having the same direction of spin, for each electron position. These units are divided. One is located with the electron. The other is located in the nucleus.

Referring to Fig. 4.4, consider a photon unit rotating at an angular velocity different from  $\omega_0$  and at a distance from the nucleus of an atom. Assume that an electron moves about the centre of this unit and that, provided it moves to compensate the electric field disturbance of the unit normally associated with wave propagation, the

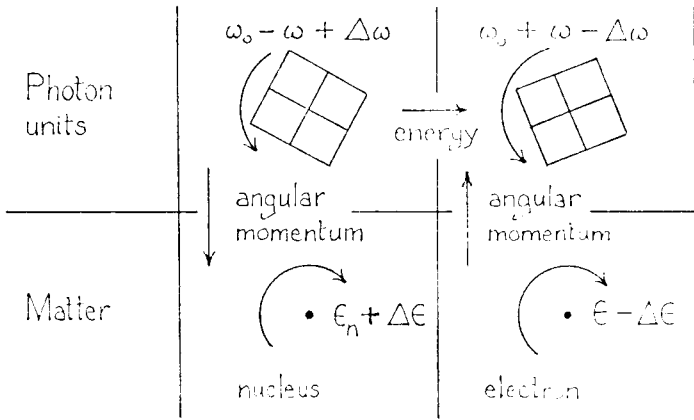

Fig. 4.4

system will not be radiating uncompensated electromagnetic waves and so may be stable. There is also a second photon unit which is positioned with the nucleus. This second unit also rotates at an angular velocity different from  $\omega_0$  but is complementary with the other unit in the sense that it generates a pulsating disturbance at exactly the same frequency. It does this by rotating slower than  $\omega_0$  by the amount by which the other unit rotates faster. The electron is thus able to compensate the propagation tendencies of both photon units. This action will occur because the priming of the two photon units by their high velocity rotation in the same direction allows this complementary change in angular velocity by mere energy transfer between the units. Angular momentum is conserved between the photon units and their respective particles, the electron or the nucleus.

Our problem is to analyse the motion of the electron. This comprises the regular motion to compensate the rotation of the photon

units and leads to the derivation of the Schrödinger Equation. It also comprises a migratory motion about the nucleus as determined statistically by the solution of this equation. Even so, as has been explained, this migration is by way of a transit between photon units on trajectories determined according to Bohr's theory of the atom. This, then, is the physical picture of what is happening inside a stable atom. Stability prevails until some quantum event happens to prevent the electron from affording the compensation. Then, since the photon units are not rotating at the non-disturbance frequency  $\omega_0$ , there is wave propagation. The quantum event will be discussed later in connection with photon emission.

When the stable state is merely perturbed, as by the electron rotating at a lower frequency about its photon unit centre, we find that there is still no radiation. The photon unit changes its rotation speed by exchanging angular momentum with the electron. They are both rotating about the same centre. Any change of kinetic energy by the electron involves interchange of energy with other matter forms. The mass energy of the system is conserved. Thus, the energy change of the photon unit is accommodated by energy transfer between the two photon units. The result of this is the change in angular velocity of the photon unit in the nucleus and the related angular momentum exchange between it and the nucleus. On balance, therefore, both energy and angular momentum are conserved in the matter of the atom, but we have a process of transfer of angular momentum indirectly between the nucleus and the electron.

The electron is deemed to have an angular momentum  $\varepsilon$ , which is deployed in a motion to compensate the photon unit rotation. Let  $\varepsilon$  decrease by  $\Delta\varepsilon$  as angular momentum is transferred to the photon unit of the electron. This unit has the standard angular velocity  $\omega_0$ , corresponding to an angular momentum  $h/2\pi$ , and an additional angular velocity  $\omega$  which complements the motion of the electron. In this sense it is to be noted that the standard angular momentum  $h/2\pi$  has to be changed to provide the electron with any angular momentum in its compensating state. The photon spin is taken to be opposite to that of the electron because energy transfer to a limited degree is needed between the matter and the photon units due to the second order energy considerations, and this is more likely to occur in the electron environment. To understand this, note that energy terms in  $\omega^2$  need to be added to the photon units. In the nucleus this energy can be drawn from the reduction in angular velocity of the

standard photon unit as the electron is adopted by the outer photon unit. In this latter position, energy is needed in addition to the surplus from the nuclear photon unit. It is available from the motion of the electron. However, this situation requires the opposed motions of the electron and its associated photon unit. Returning to our analysis of the perturbed state, the transfer of  $\Delta\varepsilon$  to the photon unit of the electron slows it down by a small amount of angular velocity  $\Delta\omega$ . Neglecting second order terms, for energy conservation and wave compensation, we find that the nuclear photon unit will then spin at the angular velocity  $\omega_0 - \omega \pm \Delta\omega$ . It will interact with the nucleus to give it the angular momentum  $\Delta\varepsilon$ . This is added to its intrinsic angular momentum  $\varepsilon_n$  which probably will be some basic quantum as adjusted by an initial priming as the electron entered the condition under analysis.

The process described provides some remarkable results when we come to evaluate quantitatively the magnetic moments and spin properties of atomic nuclei. This subject is treated in Chapter 7.

To provide compensation in its non-transit state the electron describes a circular orbit at a frequency  $\nu$  which matches the angular velocity  $\omega$  of the photon unit. Thus, from (4.3) we have a relation between  $\nu$  and  $\omega$ . From (4.6), with  $m = m'$  and  $\omega_0 = \Omega/4$ , we have a value of the moment of inertia  $I$  of the photon unit. Thus:

$$I\omega = h\nu/\Omega \quad (4.9)$$

The kinetic energy  $W$  of the electron can be expressed in terms of its angular momentum in its orbit. Thus:

$$W = \pi\nu\varepsilon \quad (4.10)$$

Since the angular momentum  $\varepsilon$  is equal and in balance with  $I\omega$ , these equations give:

$$W = \pi h\nu^2/\Omega \quad (4.11)$$

The electron moves to compensate a wave disturbance which would be developed by the photon units and which would have the frequency  $\nu$  but for the action of the electron. To make this compensation complete for both photon units, the position of the electron must move about the nucleus so that there is effective compliance of position with the amplitude of a wave tending to be developed at the frequency  $\nu$ . It is noted that in Chapter 1 it has been explained that an electromagnetic wave does not need to convey energy. It is a



disturbance in which energy is exchanged between different states without being propagated. The wave is propagated, if not compensated, but the energy involved in the wave disturbance is not carried away at the wave velocity. Thus, so long as the electron can wander around the nucleus by its transits between photon units and satisfies the conditions of circular orbital motion as specified by equation (4.10), there is no sustained unbalance of radiation. The statistical position of the electron is governed by its need to comply with the form of the wave amplitude.

The standard wave equation of frequency  $\nu$  is:

$$\Delta A + (4\pi^2\nu^2/c^2)A = 0 \quad (4.12)$$

where  $A$  is wave amplitude. Eliminating  $\nu$  from (4.11):

$$\Delta A + (4\pi\Omega/hc^2)WA = 0 \quad (4.13)$$

This becomes the well-known Schrödinger Equation:

$$\Delta A + (8\pi^2m/h^2)(E - V)A = 0 \quad (4.14)$$

when, consistent with (4.2):

$$\Omega = 2\pi mc^2/h \quad (4.15)$$

$E - V$  denotes the kinetic energy  $W$  as the difference between the total energy  $E$  assigned to the electron in the atom and the potential energy  $V$ .

Physically, instead of the electron moving in an orbit about the nucleus to balance centrifugal force against the electric field of the nucleus, as in the Bohr state, it is moving under the influence of the induced electric fields in the wave field. Its total energy is conserved but it has exchanged its angular momentum with photon units, as already explained.

The Schrödinger Equation is the basic equation of wave mechanics and much of the success of physical theory which may be termed "non-classical" has resulted from the valid application of the equation. As is well known by students of quantum theory, it is possible to develop the theory of electron structure of the atom by using the Schrödinger Equation. However, particularly in respect of the quantitative priming of the energies of the discrete energy levels of the electrons, the Bohr theory has to be used in conjunction with wave mechanics for a complete understanding of the atom.

### Photon Momentum

We will now consider those events in which there is an unbalanced state, where the electron is somehow jolted in its successive transits between photon units so that it might move to another energy level and fail to provide full compensation for wave propagation. In short, we consider the mechanism of the photon.

From (4.10) and (4.11):

$$\varepsilon = hv/\Omega \quad (4.16)$$

Since  $\varepsilon$  is  $2\pi v$ , the angular velocity, times the moment of inertia of the electron,  $m x^2$ , about the centre of its orbit of radius  $x$ :

$$\varepsilon = 2\pi v m x^2 \quad (4.17)$$

These two equations and the fact that  $\Omega$  is  $c/2r$  give:

$$x = 2r \quad (4.18)$$

When the electron is in transit from one photon unit to another its kinetic energy corresponds to its velocity and momentum. However, these quantities are very much contained by the atom if it is not radiating. Momentum has direction and as the electron moves about in the atom this will somehow be exchanged, absorbed and balanced by other motions. This sort of momentum is lost from the atom when the electron goes out of the atom as well. It is not radiated.

When the electron, in its normal migration around the atomic nucleus, goes out of transit and moves into association with a photon unit it acquires angular momentum  $\varepsilon$  in an orbit of radius  $2r$ . Consequently there is a sudden change of the linear momentum of the electron equal to  $\varepsilon/2r$ . This linear momentum arises from direct interaction with space-time. It is not a reaction with other matter. From (4.16) this momentum is  $hv/2r\Omega$ , or since  $\Omega$  is  $c/2r$ ,  $hv/c$ . It follows that each time the electron goes in and out of transit there is a momentum exchange with space-time. In a stable atom these exchanges occur alternately with alternate compensations of momentum. However, if the atom is disturbed to become radiating, and some of this momentum is lost by the electron, it cannot assume a compensating state. There will be a difference in the frequencies of the electron motion and the photon units giving rise to a propagated wave disturbance. The frequency of the radiated wave will be related

to the lost momentum. The lost momentum will be simply  $h/c$  times the radiation frequency. This is the simple mechanism of the photon. A photon is an event in which momentum is exchanged between matter and space-time. An exchange in one location results in the emission of a wave radiation throughout space. This primes space at the disturbance frequency and encourages atomic systems elsewhere to restore balance and compensate the radiation by inverting the process and exchanging, in the opposite sense, the same momentum quantum with space-time. The overall result, of course, is that it appears that a photon is a corpuscle which moves with momentum  $h/c$  times the radiation frequency. In fact, the momentum has been imparted to space-time. Probably the  $E$  frame is given a push which on balance tends to be cancelled by successive actions in the opposite sense. On this theme, it would be interesting to know whether this momentum of space-time can be deployed to generate photons of different frequencies not in the same proportion as those imparting the momentum. Experiments seem to be restricted to the study of a radiation momentum in relation to energy absorbed or a single emission frequency. However, this is mere speculation and is beyond the scope of the present work. Suffice it to say, the analysis of the atom discussed above is wholly consistent with the momentum properties of the photon.

### **Anomalous Electron Behaviour**

Before leaving this chapter, it is worth noting that an uncertainty jittering of the electron at the Compton wavelength related to the angular velocity  $\Omega$  has been proposed as a basis for explaining the anomalous spin moment of the electron (Harnwell, 1966). Precise measurement of the ratio of the magnetic moment and spin angular momentum of the electron shows that it differs slightly from the mere ratio of  $eh/4\pi mc$  to  $h/4\pi$ , or  $e/mc$ , as previously expected. The quantum-mechanical explanation is rather complicated and is not wholly accepted, but it appears to predict that the ratio is greater by the factor  $1 + a/2\pi$ , where  $a$  is the fine structure constant. The physical basis of the explanation is that the electron may be thought of classically as exchanging radiant energy with its surroundings. This makes the electron mass appear different for its linear accelerated motion and its spin.

The above account, however, is hardly acceptable from the theory presented in this work. This, therefore, sets us the task of finding the

reason for the anomalous magnetic moment of the electron. It is a challenge which can be met, and, indeed, the explanation is really quite simple. However, since its quantitative aspects require some further analysis of the parameters of space-time, it is reserved for Chapter 7. Even so, it is appropriate here to evaluate some data of later use in this exercise. This is the angular momentum component of the photon unit due to the balance of the electron angular momentum in the non-transit state. Put another way, we will evaluate  $\epsilon$ .

From (4.9) and (4.11):

$$I\omega = \sqrt{Wh/\pi\Omega} \quad (4.19)$$

Since the kinetic energy  $W$  is given by (4.8) we then have:

$$I\omega = (Ze^2/nc)\sqrt{(2\pi mc^2/h\Omega)} \quad (4.20)$$

Simplifying this from (4.2) and putting  $Z = 1$  and  $n = 1$ , we have:

$$I\omega = 2a(h/4\pi) \quad (4.21)$$

where  $a$  is the fine structure constant  $2\pi e^2/hc$ .

## Summary

To summarize, in this chapter we have developed a notion of space-time which lends itself to the linking of gravitation and wave mechanics. A common feature of space-time has provided the clues to the Principle of Equivalence, the disturbance in dependence upon mass of matter, and, most important, the basic motions and spin relationships operative in wave mechanics. The analysis has led to the Schrödinger Equation and supported it by a clear physical picture of the structure of the atom. The mechanism of photon momentum has emerged from the analysis. A key feature has been the development of the space-time properties by which energy can be added to space-time without augmenting its angular momentum. This makes the theory ready for extensive development in the next chapters. Energy added to space-time has the effect of increasing the velocity of light. This is our starting point in Chapter 5. It is feasible to regard space-time as primed by a small amount of such energy. Though not discussed in this chapter, this priming energy, briefly introduced already in Chapter 2, will be later seen to be of fundamental importance. It will be termed space polarization energy and denoted  $\psi$ . It is small compared with the intrinsic mass energy of space-time but its depletion from its normal value is, seemingly, the state of magnetism and also the indirect source of gravitational force.

## 5. *Gravitation*

### **The Nature of Space–time**

It has been said by Hoyle (1964) that “there is no such thing as gravitation apart from geometry . . . the geometrical relationship between different localities is the phenomenon of gravitation”. If we fall down it is because we are involved in geometry. It seems absurd to say this, but it makes sense according to Einstein. Gravitation is deemed to be a phenomenon due to the interplay between matter and space–time. Matter distorts the space–time metric. In Einstein’s theory this distortion finds a way of expression which, in effect, makes gravitation a geometrical property of a mathematical formulation of space–time. Below, it is sought to portray the metric of what we call space–time in a truly physical form with a view to explaining gravitation in more meaningful terms.

It is convenient, by way of introduction, to imagine space as if it is a three-dimensional lattice of physical substance. Any physical portrayal of space with an added time dimension must still be three-dimensional even though mathematical space can be multi-dimensional. As already suggested in Chapter 4, a simple way of introducing time is to assume that the lattice has a rhythmic harmonious motion such as a regular cyclic motion. Since space–time is, almost by definition, the frame of reference for light propagation and the famous Michelson–Morley experiment shows that an observer at rest in the earth frame shares the motion of the light reference frame, the lattice of our space–time moves with the earth. However, there is no evidence that space–time has linear momentum. Therefore, it is probably true to say that the centre of mass of any substance forming space–time can be deemed to be at rest in an absolute frame of reference. Now, how can this be possible while we have motion of the space–time lattice in a linear sense with the earthly observer? This is a most basic question in physics.

The answer is equally basic and quite logical. If the lattice moves but the centre of mass is at rest, something associated with the lattice must be moving in the opposite direction. One of the earliest observa-

tions connected with gravity was that the water on the earth always moves downwards towards the earth's centre. Yet, the levels of the seas tend to remain constant as if their centres of mass remain a fixed distance from the centre of the earth. As is well known, there is something associated with the water moving upwards and this is water vapour. Whatever it is that forms the propagation velocity determining lattice of space-time may move but there may be a counter-motion of it in different form which does not affect the propagation properties. It can be said that with the earth's water we need the sun's heat to sustain the circulation. This implies energy and resistance in the space-time analogy. However, in reply it can be argued that the lattice has its rhythmic motion and that if parts of the lattice come loose these parts could deploy their motion to speed them in the reverse direction so fast that they hardly disturb the properties of the lattice as a whole. This is depicted in Figs. 5.1 and 5.2. Fig. 5.1 shows a lattice which may be regarded in the rest state.

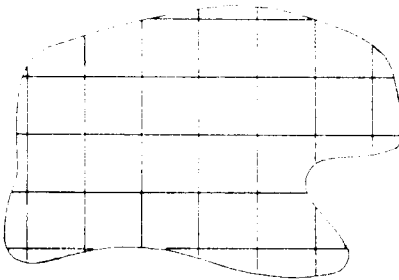

Fig. 5.1

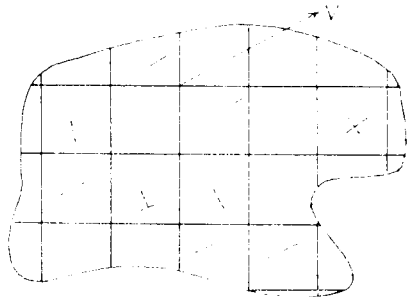

Fig. 5.2

It has a cyclic circular motion, not shown, which is like a vibration and which does not affect this argument. The lattice is the  $E$  frame of Chapter 4. The boundary is an arbitrary boundary enclosing any volume of space. Now, if we imagine that somehow this lattice moves with a velocity  $v$ , say, as shown in Fig. 5.2, it may shed some of its substance, expanding a little, and thereby allowing linear momentum to be balanced by the reverse motion of such substance. This reverse-moving substance is shown by the dotted elements in the figure. They are not held in a regular lattice pattern and have lost their vibration state. Thus, they may use their kinetic energy to sustain their high velocity motion in the inertial frame in the direction opposite to  $v$ . In the same volume of space such lattice motion could occur indefinitely because this substance could reform into lattice structure at the rear

boundary of the lattice and yet constantly hold the centre of mass of space–time fixed in the inertial frame (vibration being ignored).

It is thus seen that in any volume of space we *can* have motion of the light reference frame without motion of the centre of mass of the carrier medium. The above account is not hypothesis. It is the only feasible physical answer to a basic problem in physics. We cannot be too rigid about what we mean by “lattice”, and the question of its physical nature will be kept open until, later in this chapter, we adduce support for the above proposal. For the moment, it suffices to say that as long as one is prepared to use the words “space–time” we must be prepared to recognize that something termed “space–time” exists, as otherwise we would not need to refer to it. It is elusive. Though it apparently has mass properties it does not reveal itself in linear momentum interchange. It offers no resistance, inertial or frictional. We know that it does provide the carrier medium for light waves and that its frame of reference moves with the earthly observer. We suspect that its distortion by matter is the cause of gravitation. Furthermore, in the previous chapter it was shown that it had its own harmonious motion, two frames being, in effect, in dynamic balance. It was shown to have angular momentum yet could store energy without addition of angular momentum. It was suggested that it could have discrete units of its lattice structure in rotation to cause electromagnetic disturbance. These are our starting points in an effort to apply a physical interpretation of space–time to the explanation of what appear to be gravitational properties.

### **Tests of Einstein’s General Theory**

Einstein’s General Theory of Relativity is supported by four quantitative tests. These are:

- (a) The solar red shift;
- (b) The deflection of stellar light by the sun’s gravitational field;
- (c) The slowing down of radar waves when subject to the sun’s gravitational field; and
- (d) The account of the anomalous component of the perihelion motion of the planet Mercury.

Tests (a), (b) and (c) have never really been supported by measurements accurate enough to be conclusive. Recently, measurements reported by Gwynne (1968) according to test (c), however, do look

like affording fairly good evidence in favour of Einstein's results. Test (d) is the most important. It has really carried Einstein's General Theory for many years, though, as will be explained later, it has been challenged with some success in the last few years.

Now, in fact, tests (a), (b) and (c) are all closely related because they all stem from a common aspect of Einstein's theory which requires the velocity of light to be smaller in a gravitational field. As Fock (1964) interprets the equation:

$$n = 1 + 2GM_s/Rc^2 \quad (5.1)$$

"The fictitious medium of refractive index  $n$  is optically more dense in the vicinity of the sun than it is far away from it. Therefore, light waves will bend around the sun. . . ." In the equation,  $M_s$  denotes the mass of the sun and  $R$  is distance from its centre of gravity.  $G$  is the constant of gravitation.

It follows that if we can now derive the equation without using Einstein's Theory, any evidence supporting tests (a), (b) and (c) equally supports this new theoretical analysis. We have an entry to the problem because early in Chapter 4 it was shown that the velocity of light depended upon the energy density of space-time. Test (d) concerning the planetary motion is more challenging. However, we have our entry here, too, because, although space-time has no linear momentum property, it would seem that the lattice in Fig. 5.1 could rotate about a central axis without having to shed any of its substance and while keeping its centre of mass at the same point in the inertial frame. In the study of planetary motion we are dealing with angular momentum. Perhaps the angular momentum of the space-time in a planet cannot be ignored. If we allow for it, perhaps we can explain the problem with Mercury's perihelion.

Before proceeding, it should be mentioned why the red shift test is embraced by (5.1). A photon has conserved momentum  $h\nu/c$  and the fundamental quantum of a photon is really momentum. It is not energy. This has been explained near the end of the previous chapter. With Planck's constant  $h$  invariant, the value of  $\nu$  for a particular quantum will be set in proportion to  $c$  at the source. Thus  $\nu$ , the radiation frequency, which must be constant throughout transit (ignoring any doppler effects), will be determined for any characteristic spectral emission according to the way  $c$  is determined *at the source*. In a strong gravitational field, according to (5.1),  $c$  will be reduced because  $n$  is increased, making  $\nu$  lower also. It follows that



light spectra emitted by the sun, which has a gravitational field at its surface much stronger than that on earth, will have lower frequency than spectra of earthly origin. This phenomenon is termed "red shift" because it corresponds to a displacement of spectral lines towards the red end of the spectrum.

In Chapter 2 it has been suggested that gravitation is a magnetic phenomenon. This is our basic assumption. We take gravitational energy to be magnetic energy. In Chapter 2 it was argued that magnetic energy was a condition of depletion of the primed energy level of the aether or space-time, as it is termed here. Magnetic energy is a *deficit* of kinetic energy in space-time, that is, a reduction of the space-time kinetic energy from its normal level. This kinetic energy is, of course, the energy of the harmonious rhythmic motion of the space-time lattice. Thus, following the analysis in Chapter 4, we may calculate the kinetic energy density of space-time as:

$$\frac{1}{2}(2\rho)(c/2)^2 \quad (5.2)$$

since the  $E$  and  $G$  frame each have the same mass density  $\rho$  and each move at velocity  $c/2$ . A reduction in this energy density by  $\varphi$  corresponds to a reduction of  $c$  by  $\delta c$ , where:

$$\varphi = \frac{1}{2}\rho c \delta c \quad (5.3)$$

In such a region the refractive index  $n$  of the space-time medium, normally deemed to be unity, may be expressed as:

$$n = c/(c - \delta c) \quad (5.4)$$

From (5.3) and (5.4):

$$n = 1 + 2\varphi/\rho c^2 \quad (5.5)$$

On the above argument about the relationship of kinetic energy change and magnetic or gravitational energy,  $\varphi$  may be equated to the gravitational potential energy per unit volume. This can be expressed by:

$$\varphi = GM\rho/R \quad (5.6)$$

where  $M$  is a mass developing the gravitational field and  $R$  is the distance between  $M$  and the region of the  $E$  frame under study. It is to be noted that only mass in the  $E$  frame has gravitational properties. This follows from the discussion of the Principle of Equivalence in Chapter 4. For this reason the mass density  $\rho$  of only the  $E$  frame is

used in the above equation. From (5.5) and (5.6) the equation (5.1) is obtained, showing that this theory leads directly to the same result as Einstein's without recourse to the geometry of a four-dimensional or multi-dimensional space-time medium.

To digress a little, it is important to bear in mind that this analysis has been pursued by reference to kinetic energy changes, even though it was shown in the analysis of space-time energy in Chapter 4 that it is really potential energy and not kinetic energy which is stored by doing work against the restoring forces between the frames of the space-time metric. It was there explained how it was equivalent to work from the kinetic energy analysis. This aspect of the theory will be further considered when the derivation of the fine structure constant is discussed in Chapter 6.

We turn next to the fourth test of Einstein's General Theory to see what alternative can be offered by the straightforward physical approach being pursued in this work.

### **Mercury's Perihelion**

The mainstay of Einstein's theory is the explanation for the small anomaly in the motion of the planet Mercury about the sun. Newton's laws fail to provide the exact estimation of the perihelion motion of Mercury due to the perturbations of other planets. They fail if the assumption of conserved angular momentum is correct as applied to the matter constituting the solar system. The measured anomalous value of the perihelion advance for Mercury is 42.56 seconds of arc per century. Einstein's theory, which is inflexible in its estimation, gives a theoretical value of 43.03 seconds of arc per century. This is a most remarkable result. However, the measured value is really the difference between the measured motion of the planet and predictions of its motion as perturbed by the masses of other planets. Some of these masses have been of questionable accuracy. Least certain, in the past, has been Mercury's mass but this has had no effect on the calculation of its own perturbation, though it has made estimates for Venus's perihelion anomaly uncertain. Strangely, however, the calculations of the measured anomaly for Mercury have failed to cater for the possibility that the sun itself may not be oblate. Being such a massive body even a small degree of oblateness can cause a small perturbation affecting the anomaly. The problem of solar oblateness has caused Einstein's theory to come under attack

in recent years. Dicke (1965) has argued that if the sun is oblate by as little as 0.005%, then the numerical estimate afforded by Einstein will be in error by 10%. Dicke said: "It must be emphasized that Einstein's General Relativity is without a single definitive quantitative test until the possibility of non-negligible solar oblateness is excluded." Then Dicke (1967) reported measurements of solar oblateness which point to a discrepancy of 8% in Einstein's result. The sun must, of course, be oblate because it is rotating and is gaseous. Centrifugal forces at its equator will, of necessity, develop the oblate form. Furthermore, the expected oblateness on this account is of the order measured by Dicke. Indeed, if the sun were not oblate we would be confronted with a problem of more significance than that presented by the perihelion anomaly.

It is submitted that, since three of the four tests of Einstein's theory have ready alternative explanation and since the theory fails to retain its validity in respect of the fourth test (and if invalid for one it is invalid for all), we must of necessity reject the General Theory of Relativity. The perihelion anomaly has to be re-examined and perhaps the best approach is along new fundamental lines. It seems unlikely that one can modify Einstein's ideas in some way, when after fifty years of effort to expand his theory to unify physics little of value has emerged. From the fundamental point of view it is important to ask whether we are concerned with an anomaly in gravitation or an anomaly in mechanics. Attention is diverted to the question of the conservation of angular momentum in the planetary system, bearing space-time in mind.

Rotating space-time has angular momentum whereas it does not have linear momentum. The reason is that the lattice system shown in Fig. 5.1 can rotate about a central axis without disturbing the lattice structure of any surrounding space-time lattice. It cannot move linearly without causing such disturbance unless it crumbles away at the interface and some of its substance travels in the reverse direction to reform behind the moving lattice. Alternatively, the lattice of the space-time system in the path of the moving lattice may crumble and be deployed in the same way. The result is the space-time property of no linear momentum but possible angular momentum.

Now, consider the motion of a spherical volume of space-time about a remote axis. If this space-time is rotating at a steady velocity within its own spherical bounds there is a steady angular momentum

due to this. Also, however, we have to consider what happens to the displaced lattice substance in the reverse motion. This moves about the remote axis in an arc, whereas the centre of mass of the lattice is effectively a point in which the lattice mass in motion is concentrated. In effect, the lattice moves in one direction with its angular momentum about the remote axis given by  $MX^2\omega$ , whereas the lattice substance in reverse motion has an angular momentum in opposition of  $M'(X^2 + 2R^2/5)\omega'$ , where  $M\omega = M'\omega'$ . Here,  $M$  is the mass of the lattice and  $\omega$  its angular velocity about the remote axis distant  $X$  from  $M$ .  $M'$  is the mass of the displaced substance and  $\omega'$  its angular velocity in the reverse direction. This has involved the use of the parallel axes theorem. It is like having a compound pendulum having a spherical bob of radius  $R$  fixed to the arm of the pendulum in counter motion with a simple pendulum having a pivotal spherical bob rotating at a steady speed. Assuming the bobs are the same size, the total angular momentum per unit mass is evidently:

$$2\omega R^2/5 \quad (5.7)$$

If this argument is applied to the space-time contained within a planet rotating about the sun it becomes clear that (5.7) is a measure of the angular momentum of space-time due to such motion. If the orbit of the planet is truly circular, meaning that  $\omega$  is constant, then the space-time angular momentum is constant, as is the component due to the rotation of the planet about its own axis. Then it would pass unnoticed. On the other hand, if the planet moves in an elliptical orbit so that  $\omega$  varies we must expect space-time to make a contribution to the balance of angular momentum in the matter system itself. It is easy to calculate the effect of this contribution.

The Newtonian equation representing the motion of a planet around the sun, neglecting perturbation by other planets, is given in polar co-ordinates by:

$$\frac{d^2}{d\theta^2} \left( \frac{1}{X} \right) + \frac{1}{X} = GM_s/H^2 \quad (5.8)$$

$M_s$  denotes the mass of the sun, taken as a point mass much larger than that of the planet,  $G$  is the constant of gravitation and  $X, \theta$  are the polar co-ordinates.  $H$  is the moment of velocity of the planet in its orbit. If  $H$  is constant as applied to the planet only, (5.8) represents an ellipse with the sun at one focus. If, however, angular momentum

is constant as applied to the system of matter *and* space-time,  $H - \Delta H$  is constant, where  $\Delta H$  is the expression in (5.7). Then (5.8) represents an ellipse which advances progressively in the plane of the orbit as the planet describes successive orbits. There is an advance of perihelion. The advance, measured in radians per revolution, may be evaluated as:

$$\frac{8\pi}{5} \frac{M}{P} \frac{R^2}{X^2} \quad (5.9)$$

where  $P$  is the mass of the planet.  $R$  has become the radius of the space-time lattice of the planet and  $X$  is distance from the sun.

An anomalous advance of perihelion must, of course, follow if we ignore the effect of space-time. There is, therefore, nothing surprising about the perihelion motion of Mercury. Indeed, the fact that the discrepancy between the measured and theoretical value neglecting space-time is detected is a clear indication that (5.7) is not negligible. The mass of the space-time lattice can be deduced from observation. Attempting this, we note that it is unlikely that the space-time volume of the planet will be simply co-extensive with its physical form. It will be somewhat larger. The ionosphere limits of the earth suggest a location for the boundary. Let us guess that for the planet Mercury the space-time lattice has a radius 10% larger than that of the planet. Mercury has a radius of 1,500 miles, so this assumption puts the boundary 150 miles above its surface, about the same height as the ionosphere above the earth. Then, available data enable the mass density of the space-time lattice to be calculated. The mass  $P$  of Mercury is  $3.27 \cdot 10^{26}$  gm.  $X$  is  $5.7 \cdot 10^{12}$  cm. The radius of Mercury is  $2.495 \cdot 10^8$  cm. The orbital period is 88 days. The anomalous perihelion advance measured, allowing for the solar oblateness, is 38 seconds of arc per century. From (5.9) it may then be shown that the mass density of the space-time lattice is about 150 gm/cc.

This is not conclusive until it is shown that the space-time lattice has a mass density of this order calculable from physical observation *in the laboratory*. Atomic physics affords all the data needed to evaluate the mass density of space-time, as will be shown in the next chapter. For the moment, it is worthy of note that the above explanation can be applied satisfactorily to the earth's perihelion motion and that of other planets, including Venus. But, more than this, we can take what seems to be an absurd result, this very high density of space-time, and make sense out of it in two immediate respects.

Firstly, common sense must tell us that, if the explanation of the Principle of Equivalence in Chapter 4 has merit, then the presence of ordinary matter in space-time is a mere disturbance in a heavier medium. The substance of the  $G$  frame has to balance the extra disturbance of matter which, as we know from observation, can have densities up to about 10 or 15 gm/cc. Space-time must be more dense, appreciably more dense, than this. 150 gm/cc is highly reasonable. Secondly, on the basis that the sun has a density of about 1.4 gm/cc and an angular momentum which is only 1% that of the planets in their orbits, we see that to add the angular momentum of the rotating space-time will make the sun have about the same angular momentum as the total of that of the planets. More will be said about this in Chapter 8. In the meantime, the reader should not underestimate the importance of the really great anomaly which has confronted us since the time of Newton. Angular momentum is supposed to be conserved in a complete system. If the solar system has been a complete system since the birth of the planets and before, how is it that the sun has so little of the angular momentum now belonging to the solar system? There is no problem if we recognize the role of space-time. Not only will it solve the anomalous perihelion difficulty, but we can see a sensible basis for explaining the creation of the solar system.

Another point which may have occurred to the reader is that this theory might preclude the existence of very high densities of matter. The reader who can visualize gravitational collapse of stars and contraction of matter to almost infinite mass densities should remember that he is assuming that  $G$ , the constant of gravitation, remains constant under such conditions. It is a convenient assumption encouraged by the inflexibility of Einstein's theory, but if gravitation has its origins in a real physical disturbance of space-time, as we believe, it may well not cater for some of the mathematical fantasies of the astrophysicist. After all, the physicist does not understand what gravity is, so he is being rather bold to assert that its action has no dependence upon the concentration of the substance exhibiting gravitation. All the author can offer ahead is an argument explaining *why*  $G$  cannot be constant when we consider really dense matter, and the encouragement that gravitation is explained and  $G$  is *evaluated* from atomic data.

Already, it has been shown that Einstein's General Theory of Relativity has no advantages over the present theory. All four of its

quantitative tests have been derived by other means. The tests provide equal support for the theory under review and the theory under review has very many more advantages. Already, it has been shown that this theory has application to atomic theory. We have the link with wave mechanics and with field theory. We are ready also to turn attention now to the serious analysis in this work, leading us to the derivation of  $G$  in terms of the properties of the electron. This, of necessity, involves us in an explanation of the nature of gravitational force.

### **The Nature of Gravity**

If space-time is not something real, then it is simply imaginary and serves as a mere exercise for the imagination. If it is real we cannot dispose of it, as Einstein does, by mere mathematics. It has, therefore, to be portrayed in physical terms. Above, the lattice of space-time has been deemed to become crumbled at its forward boundaries when in motion. What does this mean physically? The simple answer is that the lattice is probably an array of electrically charged particles. At the boundary, particles come out of their lattice positions and travel through the lattice. This can be fully supported by a rigorous analysis of an electrical space-time system. Imagine the lattice to comprise identical particles of electric charge permeating a uniform electric continuum of opposite charge. The particles mutually repel. For zero electrostatic interaction energy, these particles form into a simple cubic array. Their arrangement is different for minimum electrostatic energy, the normal assumption in physics. However, we are dealing here with space-time. In laboratory experiments, where electric charge can be separated to store energy and provide a system which tends to be restored to its original state by tending to minimum energy, we deal only with relative quantities. Negative energy in a relative sense is possible in such analysis. On an absolute basis, in space-time, negative energy is beyond imagination. We are not dealing in relative terms. The system is absolute. This is the key to the analysis, because it means that the stable state of space-time is not one of rest. The zero energy condition is not the one of zero restoring force. Electrostatic forces will occur in the system of electric particles and continuum described above and will be finite for zero electrostatic interaction energy. Such forces are balanced by the centrifugal forces of an orbital motion, the harmonious motion of space-time

already introduced. The time dimension comes into space-time because the rest condition of space-time would have minimum energy which is *negative*. The fundamental energy condition applies everywhere in space. The interaction energy cannot be negative in some parts and positive in others. Each lattice particle in the  $E$  frame of space-time must satisfy the same energy condition. This assures a kind of symmetry and causes the particles to be arranged in a simple cubic array.

When the lattice is in linear motion, some particles must exist in a free state. They are the lattice "substance" displaced by the motion. They do not form part of the lattice array (see Fig. 5.3), but because they are present the lattice will have expanded. This follows from electrostatic charge balance considerations. Space is electrically neutral on a macroscopic scale. This will be further analysed in Chapter 8. The freed particles can deploy their kinetic energy to travel at speed in the direction opposite to the linear motion of the lattice, as shown by the arrows in Fig. 5.3.

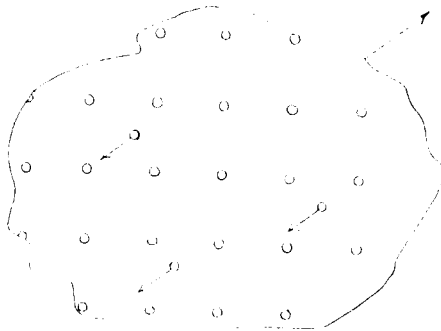

Fig. 5.3

Ignoring the existence of free particles, which, because of their rapid transit through the lattice, tend to meld statistically into the background charge of the electric continuum, we can now illustrate the harmonic motion of the  $E$  frame. Firstly, note that each electric particle in this frame is attracted to a neutral rest position in the continuum. Each particle is held displaced by a state of motion. The whole particle lattice forming the  $E$  frame moves in a circular orbit so that each particle is subjected to the same centrifugal action and can retain its position against the electric forces urging it to the rest position in the continuum. As is evident from the analysis already presented, this continuum is part of the  $G$  frame which provides the



counter-balance to the motion of the  $E$  frame. Indeed, both the  $E$  frame and the  $G$  frame move in counter-balance in the same circular orbit relative to the inertial reference frame. In Fig. 5.4 the broken

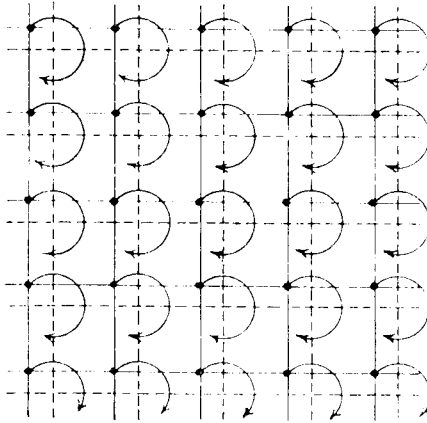

Fig. 5.4

lines show the position of the inertial frame and the full lines show the position of the  $E$  frame. The electric particles forming this frame are depicted each in circular motion with the frame. Fig. 5.5 shows the way in which the orbits of the  $E$  frame particles are diminished around a gravitating system of matter not illustrated but deemed to be centrally located in the system shown. Gravitation involves magnetic forces, and these affect the balance between the centrifugal

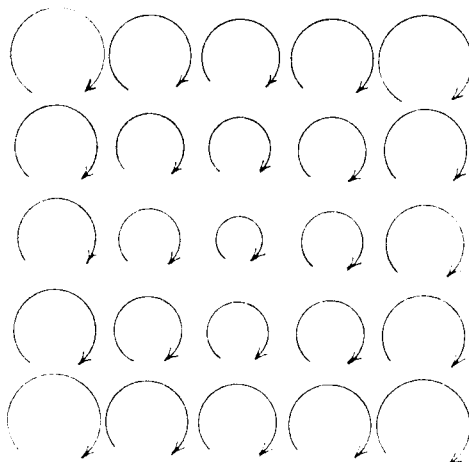

Fig. 5.5

force and electrostatic force on each  $E$  frame particle. Said another way, in the light of the argument in Chapter 2, the diminution of the kinetic energy or, more correctly, the diminution of the electrostatic energy is the magnetic effect corresponding with gravitation. Remember that in Chapter 2 it was suggested that there was a small priming energy in space-time which set the condition from which a reduction of energy corresponding to magnetism was possible. This is consistent with the zero electrostatic interaction energy condition discussed above. This is the lower limit of energy reduction, or the upper limit of magnetization or gravitation. It will be better understood when Planck's constant is evaluated in Chapter 6.

Since the  $E$  frame is the electromagnetic reference frame, there can be no direct magnetic force between these particles forming the lattice. In contrast, since the charge of the continuum in the  $G$  frame is moving at velocity  $c$  relative to the  $E$  frame it has its own mutual magnetic interaction which exactly cancels its mutual electrostatic action. This follows using the law of electrodynamics presented in Chapter 2. At any instant the charge is in parallel motion. Exact cancellation of the mutual forces in the continuum explains why it can form into a continuum. It is unlike the behaviour of charge in a particle subject principally to self-repulsion.

We are now ready to explain gravitation, subject to two minor comments. Firstly, note that there is no question of propagation delays in the magnetic interaction forces between  $G$  frame substance. Motions are mutually parallel but constantly changing direction. Yet, field energy between interacting charge is the same even though the directions of the current vectors are changing. Hence, unless the sources of these vectors move in the electromagnetic reference frame, either by coming together or separating further apart, there is no reason for a propagation phenomenon. It can be said that gravitation, as a magnetic force, is propagated at the velocity  $c$ , but this requires motion of the gravitating bodies and is not related to the universal motion of space-time. Secondly, note that, if the  $G$  frame comprises the same magnitude of charge as that of the lattice particles in the  $E$  frame, it is difficult to understand how the  $G$  frame can have the same mass density and so have the same orbital radius. These are requirements of the balance condition under study. The only answer available is to assume that the  $G$  frame has some rather heavy elementary particles of charge  $e$  (positive polarity), sparsely populating the  $G$  frame, but providing the mass needed for balance. These

particles are termed “gravitons”. Their existence is supported by abundant evidence to be presented. They are the seat of the reaction which causes gravitation.

Now consider a particle of matter at rest in the  $E$  frame. In Fig. 5.6, this particle denoted  $P$  is shown with the continuum of positive charge streaming past it at velocity  $c$  relative to  $P$ . Note that we take the lattice particles to be negative. The approach velocity of the continuum relative to  $P$  is  $c$  and the recession velocity is  $c$ , but to maintain continuity the continuum has to speed up a little in passing

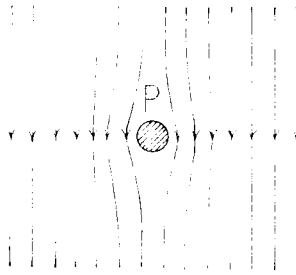

Fig. 5.6

the particle owing to its effect as an obstruction. This means that the integral of the current vector quantity or charge-velocity parameter applicable to the continuum is *independent* of the physical size of the particle  $P$ . It is like saying that the quantity of gas passing through a pipe in unit time can be measured at either end of the pipe without worrying about the nature of any partial obstructions *en route* within the pipe. The charge-velocity parameter or current vector is what gives rise to electrodynamic action. It therefore follows that there is no direct electrodynamic action seated in a particle of matter at rest in the electrodynamic reference frame. However, there is an indirect effect. Since  $P$  is at rest in the  $E$  frame it moves with the space-time universal motion about the inertial frame. It needs to be balanced. It is balanced by something in the  $G$  frame. As already indicated, the mass of the  $G$  frame is attributed to “gravitons”. These are all that is available to accept disturbance due to  $P$  and provide balance. Their disturbance consists in their contraction slightly to become a little heavier. Mass is inversely proportional to radius. As is shown in Appendix I, electric energy is inversely proportional to radius, for any charged particle. Since  $E = Mc^2$  applies to such energy, mass is an inverse function of the physical radius of a

charged particle. Now, if the particle of matter  $P$  causes a nearby graviton in the  $G$  frame to alter slightly in size, we do have an electrodynamic effect. A current vector parallel with all current vectors associated with all other elements of matter is developed. The current vector is directly determined by the mass of the matter causing it. Consequently, there is a mutual force of electrodynamic attraction between regions of space-time containing matter. Effectively, there is a mutual force of attraction between all elements of matter. This is the force of gravitation.

The test of this theory is the evaluation of the constant of gravitation. To proceed in this direction, let  $dE$  denote the rest mass energy of a particle of matter causing the graviton disturbance. To balance this, the graviton has to increase its energy by  $dE$  also. From equation (6) in Appendix I, the energy of a graviton charge  $e$  can be expressed as:

$$E = 2e^2/3x \quad (5.10)$$

where  $x$  is the radius of the graviton. If  $E$  increases by  $dE$ ,  $x$  is reduced and there will be a continuum charge increase by the elemental volume change  $4\pi x^2 dx$  times the continuum charge density  $\sigma$ . The electrodynamic current vector developed by  $dE$  is then:

$$(6\pi x^4 \sigma / e^2) dE \quad (5.11)$$

as is found by differentiating (5.10) and substituting  $dx$ . Note that, since the charge moves at  $c$  relative to the electromagnetic reference frame, though in its small space-time orbit which does not give rise to relativistic mass considerations, the electrostatic charge is equal in magnitude to the electrodynamic current vector.

Using the electrodynamic law developed in Chapter 2, it follows that the force of attraction between two spaced mass energy quantities like  $dE$  is the product of two quantities such as (5.11) divided by the square of the separation distance. By analogy with Newton's gravitational force, we find that the constant of gravitation  $G$  is, simply:

$$G = (6\pi x^4 \sigma c^2 / e^2)^2 \quad (5.12)$$

$c$  has been introduced to convert energy into mass, using  $E = Mc^2$ .

This equation shows that in order to evaluate the constant of gravitation it is necessary to determine the mass of the graviton, and so  $x$ , as well as the lattice spacing of the  $E$  frame, and so  $\sigma$ . In short,

$G$  becomes a simple property related to the parameters of the system comprising space-time. It is important to note that the gravitons have not merely been invented to provide this explanation of gravitation. They are the energy source for the creation of matter, and much of the analysis in the following pages is concerned with their role in creating elementary particles. The mass of the graviton is calculable in terms of the mass of the electron. It depends upon the *geometry* of space-time, curiously enough. It gives the *exact* value of  $G$  when used in (5.12). Further, there is experimental evidence indicating the existence of this unusual particle.

### Summary

The concepts on which wave mechanics were explained in Chapter 4 have been presented in a manner more dependent upon the physical form of space-time. It has been shown that all four quantitative tests of the General Theory of Relativity can be explained by this new space-time theory. The potential of this new theory in explaining the nature of gravitation and evaluating the constant of gravitation has been outlined. It remains to analyse space-time rigorously now, in order to deduce theoretical values of the fundamental physical constants.

## 6. *Space–time Analysis*

### **Space time Motion**

From the foregoing account of various physical phenomena it has become quite clear that we cannot evade the need to analyse the details of space–time structure. The existence of the aether is not a matter for speculation. It is subject to straightforward analysis in simple and logical terms. What has been presented already serves merely to show that we need not be deterred by the presence of Einstein's Relativity, by Quantum Theory or Wave Mechanics. The aether, or space–time, as it has been termed, can make these various theories, or at least the experimental evidence supporting them, fit together in one unified structure. Now, guided by the contents of the previous chapters, it is necessary to attack the problem of analysing this aether. It would, of course, have been more logical to start with this analysis, but the author would have perhaps been taxing the reader's patience to embark upon such a task without first showing where accepted theory is weak and demonstrating some of the potential of a new approach.

To proceed, space–time has been shown to comprise a uniform continuum of electric charge permeated by a cubic array of electric particles of opposite polarity. Any normal motion of these constituents of the aether has, at all times, to be parallel or antiparallel. This means that motion is harmonious, probably in circular orbits. The requirement for the mutually parallel or antiparallel motion state comes from the law of electrodynamics presented in Chapter 2. With such motion the forces between charges act directly along the line of separation. There are no torques in the space–time system. Action and reaction must be balanced. Hence this basic motion condition. With it comes the condition of universal time, the *Hypothesis of Universal Time* introduced in Chapter 4. This is consistent with the property of the electrical system by which the positive charge is attracted to the negative charge by a force proportional to displacement. This is the feature of the linear oscillator, the cause of the fixed period oscillation of the universal time. It is this condition that

force is proportional to displacement which tells us that we are not dealing with particles of charge in both of the polarity systems. Instead, we note that if a particle of charge is located in a uniform continuum of opposite charge, and is displaced from a neutral position, it is subject to a restoring force proportional to displacement. If a lattice array of such charge contained in particle form is displaced as a whole from the neutral position, then each particle in the array will, in effect, be subject to its own interaction force with the continuum. There are constraints operative to hold the array cubic in form, as already explained, but essentially the lattice remains as a kind of whole unit capable of motion as a whole. It may be subject to local disturbance in the presence of matter and under the effects of electric fields due to matter, but we are speaking of an entity, which has properly been termed a *frame*, the *E* frame, in previous analysis. This means that the lattice particle constituent in space-time is formed like the atoms in a crystal and can withstand *linear* force, whereas there is less restraint on the development of spin or rotation within the lattice. Note that this is a most important feature. The need to balance linear force in the application of Newton's Third Law of Motion has misled physicists who cannot admit the aether. Without it, there is no complete system, as required by Newton. With it, there is a complete system and Newton's law holds. The true law of electrodynamics is then derivable from experimental results, and the Trouton-Noble experiment can be utilized to verify the reasoning. The aether, or, more properly, the lattice of space-time cannot withstand turning forces. The fact that it can turn has been the basis of the general account of the photon phenomenon. This is to be developed further below to derive Planck's constant. However, in connection with photon radiation, it is observed that momentum is propagated in quantum form. The lattice of space-time provides the rigid structure able to carry this momentum. On the other hand, energy is not transported by the photon. Nor is it transported by electromagnetic waves. Space-time is primed with energy. It takes and gives energy in quanta as it accepts and releases momentum quanta. Otherwise energy merely diffuses to be uniformly distributed, as in a gas communicating thermal energy by diffusion. In such a gas, energy released as heat can promote the transmission of a sound wave well in advance of the thermal migration of energy.

Returning to the electrical features of space-time, we note that motion is essential to its character. There is a definite displacement

distance between the positive charge and the negative charge. The restoring force proportional to this displacement is in balance with the centrifugal force of the motion. The ground state, or basic motion state, is taken to be that in which the interaction energy between the opposite charges is *zero*. The electrostatic interaction energy would be negative for minimum energy conditions. This is ruled out because for minimum energy conditions there is no displacement of charge needing balance by centrifugal force action. Any motion is then random. There would be no basis for saying that time or anything else had association with universal physical constants. The zero energy condition is the most logical state, in the circumstances, at least if we consider only the two space-time constituents so far discussed in this chapter. Later, we will see that Nature is just a little more complicated than this.

Next, it is necessary to formulate the motion state of the space-time charge. Accordingly, let  $m_o$  denote the mass of each lattice particle of charge  $e$ . Let  $\rho$  denote the mass density of the substance providing the balance and moving with the continuum charge, the latter being uniform and having a density denoted  $\rho$ . This is charge density, and it is opposite in polarity compared with the lattice particle charge. Let  $x - r$  denote the radius of the orbit of  $\sigma$ , that is, the orbit of the  $G$  frame, whereas the particles form the  $E$  frame. Also, let  $\Omega$  denote the angular velocity of their motions, as before. Then, since the restoring force on charge  $e$  is  $4\pi\sigma e$  times displacement distance, balance of centrifugal force for both systems gives:

$$4\pi\sigma e x = m_o \Omega^2 r \quad (6.1)$$

$$N4\pi\sigma e x = \rho \Omega^2 (x - r) \quad (6.2)$$

where  $x$  is the total displacement, the sum of the radii of the orbital motions of the two charge systems.  $N$  is the number of lattice particles in unit volume.

Before proceeding with this analysis, it is appropriate to note that previously, particularly in Chapter 5, it was assumed that the orbital radii of the  $E$  and  $G$  frames were identical. This remains to be proved. In the meantime, consider the following. Take two systems in dynamic balance at angular velocity  $\Omega$ . Let their mass densities be  $\rho$  and  $\rho'$ , and their orbital velocities  $v$  and  $v'$ . Then, balance of centrifugal force gives:

$$\rho \Omega v = \rho' \Omega v' \quad (6.3)$$



Angular momentum is:

$$\rho v^2 / \Omega + \rho' v'^2 / \Omega \quad (6.4)$$

Kinetic energy is:

$$\frac{1}{2} \rho v^2 + \frac{1}{2} \rho' v'^2 \quad (6.5)$$

Differentiating (6.5), a change in kinetic energy is given by:

$$\rho v dv + \rho' v' dv' \quad (6.6)$$

From (6.3) and (6.6), the change in kinetic energy is:

$$\rho v (dv + dv') = \frac{1}{2} \rho c \delta c \quad (6.7)$$

approximately, if the systems move at velocities approximately equal and if the relative velocity between the two systems,  $v + v'$ , is  $c$  exactly.

By comparing (6.7) with (5.3), it is seen that the results obtained in Chapter 5 do not depend upon maintained equality of the orbital radii of the two systems in balance. Only one system need be disturbed. Also, taking angular momentum given by (6.4) as conserved, comparison with (6.5) indicates conservation of kinetic energy. However, as previously explained, we need take only one of the two energy factors. If we assume invariable mass, we can take kinetic energy change and ignore the energy stored in opposing the restoring forces, as well as ignoring conservation of angular momentum. If we allow variable mass but constant kinetic energy and constant angular momentum, we are left with the same result by considering only the restoring force energy action. This is  $\rho \Omega v$  times the distance increment  $\delta c / \Omega$ . It is the same as (6.7), and again does not impose any condition that both system radii should change together.

The whole point of this analysis is to show that the findings in Chapter 5 can be retained even though we specify that only the lattice particle system is disturbed by energy storage due to field action and matter. It allows the assumption that the charge density  $\sigma$  remains always uniform. Any distortion of the motion state of  $\sigma$  resulting in a change of radius of motion in one region compared with that in another would require a variable  $\sigma$ . This is precluded in the whole of this analysis. It is a firm assumption that the radius of the orbit of the continuum charge is fixed. It is assumed that velocity in this orbit is  $c/2$ . This is a matter for later proof.

## Electromagnetic Wave Propagation

The particle lattice is the  $E$  frame of space-time. It is the electromagnetic reference frame. It is now necessary to show how disturbances are propagated at finite speed relative to this frame.

To proceed, the fundamental harmonious motion of space-time in its undisturbed state is ignored. Any forces needed to sustain such motion in the inertial frame are deemed to be present, but they are ignored because the analysis will consider only effects relative to the  $E$  frame. Then, we may follow the usual line of argument in electromagnetic theory. First, the force on an electric charge  $e$  is the product of  $e$  and what is termed the electric *displacement* of other charges present. Denoting this displacement  $D$ , the force on the element is:

$$F = 4\pi e D \quad (6.8)$$

The quantity  $4\pi$  is introduced to keep the units right. Secondly, from the inverse square law of force between electric charge, Coulomb's law, the charge density  $\sigma$  of a system of charge giving rise to  $D$  may be evaluated from the relationship:

$$\text{div } D = \sigma \quad (6.9)$$

This expression  $\text{div } D$  is the divergence of the vector quantity  $D$ , since it represents the rate at which  $D$  changes with distance. Thus, if the charge  $e$  is initially at rest in a neutral position and is unrestrained against the action of the charge forming  $\sigma$ , a displacement of  $e$  through a distance  $x$  will cause  $D$  to become  $\sigma x$ , from (6.9). The restoring force acting on  $e$  will then be, from (6.8):

$$F = 4\pi e \sigma x \quad (6.10)$$

This explains the basis of (6.1).

If a quantity  $H$  is defined by an equation of the form:

$$\oint H ds = 4\pi \int C dS \quad (6.11)$$

where the integral of  $H$  is taken around the boundary  $s$  of the surface area  $S$  over which the integral of the quantity  $C$  is taken, and  $C$  denotes the electric charge conveyed through unit area of  $S$  and normal to it in unit time, an observation by Faraday may be formulated thus:

$$\int D ds = -\frac{1}{4\pi c^2} \frac{d}{dt} \int H dS \quad (6.12)$$

Here,  $D$  is the component of electric displacement parallel to  $ds$ . The quantity  $c$  is a constant having the dimensions of velocity. It is the ratio of electromagnetic and electrostatic units, since  $H$  is magnetic field. In the above equation  $t$  denotes time.

Equations (6.11) and (6.12) may be written in the forms:

$$4\pi C = \text{curl } H \quad (6.13)$$

$$-\frac{1}{4\pi c^2} \frac{dH}{dt} = \text{curl } D \quad (6.14)$$

These equations represent Faraday's laws of induction. The motion of electric charge is shown, by these equations, to induce electric displacement elsewhere. The quantity  $H$  establishes the coupling in this process. It arises from the action of electric charge in motion. What  $H$  is, physically, is not explained by this conventional treatment. In the early chapters it has been suggested that the magnetic field  $H$  is a condition in which energy priming space-time, probably, as we have just seen, in a form of stored energy linked with the restoring action between the  $E$  and  $G$  frames, is deployed into a dynamic electric field energy associated with moving charge.

Now, the process of producing a magnetic field does not imply the radiation of electromagnetic waves. Faraday's analysis applies to the reversible energy exchange conditions we associate with magnetic phenomena in dynamo-electric machines and transformers. Historically, equations (6.13) and (6.14) were found to be inadequate if applied to current flow in an open circuit. Thus, a circuit which includes a capacitor undergoing discharge has current flow in which the charge does not traverse the open part of the circuit between the capacitor plates. To overcome this problem, Maxwell recognized that there could be a motion of charge *in the aether*. Such charge could give rise to a *displacement current*. Then, the expression  $C$  is replaced by  $C + dD/dt$  to produce the equations:

$$4\pi \left( C + \frac{dD}{dt} \right) = \text{curl } H \quad (6.15)$$

$$-dH/dt = 4\pi c^2 \text{curl } D \quad (6.16)$$

The term  $dD/dt$  introduces the electrical character of the aether and allows these equations to be used to account for the observed electromagnetic wave propagation phenomena of the aether medium.

In the absence of the effect  $C$ , that is, well away from an electric source, the equations can be put in the form:

$$dV/dt = c \operatorname{curl} H \quad (6.17)$$

$$-dH/dt = c \operatorname{curl} V \quad (6.18)$$

provided we put  $V$  as  $4\pi D$ , and put  $H$  as a quantity in electromagnetic units rather than electrostatic units, by dividing by  $c$ . The quantity  $V$  is electric field intensity.

In a plane wave propagation, both  $V$  and  $H$  are constant in magnitude and direction in a plane normal to the direction of propagation. Taking co-ordinates  $x, y, z$  at right angles and assuming propagation in the  $x$  direction, equations (6.17) and (6.18) give:

$$dV_y/dt = -(dH_z/dx)c \quad (6.19)$$

$$-dH_z/dt = (dV_y/dx)c \quad (6.20)$$

There is also a pair of similar equations relating  $V_z$  and  $H_y$ , the electric field intensity in the  $z$  direction and the magnetic field intensity in the  $y$  direction, respectively. Derivatives of the fields in the  $y$  and  $z$  directions are zero in view of the constancy applicable to the plane wave.

The combination of (6.19) and (6.20) to eliminate  $H_z$ , for example, produces:

$$d^2V_y/dt^2 = (d^2V_y/dx^2)c^2 \quad (6.21)$$

The general solution of this may be written as:

$$V_y = f_1(x - ct) + f_2(x + ct) \quad (6.22)$$

where  $f_1$  and  $f_2$  are functions of the single arguments  $x - ct$  and  $x + ct$ , respectively. Then, assuming that the wave disturbance is moving in the direction of  $x$  increasing, it is only the solution in  $x - ct$  which needs to be considered. This solution indicates that the electric field intensity in the  $y$  direction is constant if measured at a position which advances in the  $x$  direction at the velocity  $c$ . The velocity of wave propagation is  $c$ .

This does not mean that whatever it is that forms the field is advancing too. The solution shows that, if a detector travelled at

velocity  $c$  in the  $x$  direction, the field intensity would appear constant, whereas, if the detector remained at rest, the field intensity would vary in dependence upon the nature of the wave disturbance.

Now, this theory according to Maxwell, based as it is upon Faraday's observations, explains how it is that electromagnetic waves are propagated at the velocity  $c$ , which is also a parameter we find relates electromagnetic and electrostatic units. As is well known,  $c$  can be measured in the laboratory without even examining any propagation phenomena. The theory does not explain the mechanics of the aether which give rise to the phenomenon of finite velocity wave propagation. Maxwell's theory is really empirical. It involves a displacement current concept, and it is accepted, even though physicists are reluctant to assign charge in the aether as the source providing the displacement current. In the author's interpretation under review, charge in space-time has been specified. Now, we will proceed to derive the disturbance propagation velocity of the  $E$  frame lattice of this space-time medium. The parameter  $c$  relating electromagnetic and electrostatic units will be shown to equal this propagation velocity. Maxwell's equations will be used, though it will be sought to interpret them to provide physical insight into the nature of the displacement current.

Initially, the following analysis uses the accepted principles of electron theory. Remember that the analysis is with respect to the electromagnetic reference frame. The medium under analysis is, typically, a system of  $N$  electrons per unit volume. The electrons have charge  $e$  and mass  $m$ , and are all subject to a similar restraining force proportional to displacement distance, denoted  $ky$ , where  $k$  is the force rate and  $y$  is distance. The equation of motion of the electron is:

$$m(d^2y/dt^2) + ky - eV_y = 0 \quad (6.23)$$

Here,  $V_y$  is the electric field intensity in the  $y$  direction. It is given by:

$$V_y = V_{oy} - 4\pi Ne^2 y \quad (6.24)$$

$V_{oy}$  is the component of electric field intensity due to charge displacement in the aether. These two equations have the following solutions for  $V_y$  and  $y$ :

$$V_y = \left\{ \frac{k - p^2 m}{k - p^2 m + 4\pi N e^2} \right\} V_{oy} \quad (6.25)$$

$$y = \left\{ \frac{e}{k - p^2 m + 4\pi N e^2} \right\} V_{oy} \quad (6.26)$$

$p$  is the angular velocity of a simple periodic disturbance imposed upon the system. To eliminate  $k$ , it is convenient to put:

$$k = p_o^2 m \quad (6.27)$$

noting that  $p_o$  is the angular velocity of a free vibration of the electron, that is, one for which  $V_y$  is zero.

From (6.19), as modified to cater for the motion of electron charge, by reference to (6.15):

$$4\pi Ne(dy/dt) + dV_y/dt = -(dH_z/dx)c \quad (6.28)$$

Hence, from (6.24) and (6.28):

$$c \frac{d^2 H_z}{dt dx} = -\frac{d^2 V_{oy}}{dt^2} \quad (6.29)$$

From this and the differential of (6.20) with respect to  $x$ :

$$d^2 V_{oy}/dt^2 = c^2 (d^2 V_y/dx^2) \quad (6.30)$$

By analogy with (6.21), it may then be shown that, since  $V_u$  and  $V_{oy}$  are proportional, the propagation velocity of the electron medium is:

$$c\sqrt{(V_y/V_{oy})} \quad (6.31)$$

From (6.25) and (6.27), this velocity, denoted  $v$ , may be written as:

$$v = c\sqrt{[1/(1 + \varphi)]} \quad (6.32)$$

where  $\varphi$  is given as:

$$\varphi = 4\pi Ne^2/m(p_o^2 - p^2) \quad (6.33)$$

This is a formula used in electron theory to determine the refractive index of a medium in terms of the electron systems in its crystalline atomic structure. If no electrical matter is present, the propagation velocity  $v$  becomes  $c$  because  $\varphi$  is zero. If a plurality of different electrical systems exists, then  $\varphi$  becomes a summation of a series of terms like (6.33).

If, now, we analyse the space-time system itself on the assumption that it contains electrical systems reacting to disturbances just as the electron system described, we see that the unity term in the denominator of (6.32) may itself have the form of (6.33) or be a summation of such terms. To be unity, there must be no dependence upon propagation frequency. Thus,  $p$  must be very small compared with  $p_o$ . Earlier in this chapter, it was argued that the  $G$  frame moved in a

fixed orbit. This was consistent with the charge density  $\sigma$  remaining uniform. Wave disturbance, therefore, no doubt involves displacement of the particle lattice. This lattice sets the  $E$  frame by its ground state, its undisturbed state. If it is displaced, each particle of charge  $e$  will be subject to a restoring force towards its ground position in the  $E$  frame. This force will be  $4\pi\sigma e$  times the separation distance, making this term the rate  $k$  applicable in (6.27). Thus, for the lattice particle of mass  $m_0$ :

$$4\pi\sigma e = p_0^2 m_0 \quad (6.34)$$

Since  $Ne$  becomes  $\sigma$ , in the sense of this equation, it is seen how  $\varphi$  becomes unity in (6.33) when  $p$  is negligible. Thus, the theory of space-time presented will explain why the velocity of electromagnetic waves in free space is the parameter  $c$  relating electromagnetic and electrostatic units. It is to be noted that  $p_0$  is not equal to  $\Omega$  in (6.1).

The above account explains why electromagnetic waves are propagated by the space-time lattice at the velocity  $c$ . It is important, however, to note that this wave propagation cannot be connected with the electrodynamic interaction of gravitation. Electromagnetic waves are attenuated in inverse proportion to distance from their source. Gravitation is an inverse-square-of-distance phenomenon. We are not, therefore, concerned with the problem of wave propagation by the space-time particle lattice, when we analyse effects at frequencies of the order of  $\Omega$ . Propagation at such high frequencies involves another mechanism. This is the mechanism by which disturbances are propagated through the medium separating the lattice particles.

In Chapter 1 the effect of accelerating an electric charge was considered on the basis that a wave disturbance was radiated from the surface of the electric charge at the propagation velocity  $c$ . In Appendix I it is shown, by equation (4), that the pressure  $P$  within an electric charge  $e$  is given by:

$$P = e^2/4\pi b^4 \quad (6.35)$$

where  $b$  is the radius of the charge, assumed spherical. If this applies to the lattice particles forming the  $E$  frame of space-time, there is the conclusion that a pressure  $P$  given by (6.35) pervades space. It is this pressure which holds the lattice particle charges, all quantized at  $e$ , together in their discrete quanta, and ensures that all the particles have the same mass. Now, whatever this substance might be,

if it exerts a pressure it must contain energy. Since energy is conserved, we may write:

$$\text{Energy density times volume} = \text{constant} \quad (6.36)$$

If the substance is nothing but mere energy, and the substance is primordial, it cannot be considered as a gas or fluid. It cannot store more energy, nor can it be considered as expanding adiabatically or isothermally. Nevertheless, it can be displaced to fill voids in space. It can expand, if it has space to move into. Let us suppose that there is a pressure  $P$  urging the energy into motion at a limiting velocity  $v$ . Then, in unit time the energy flowing across unit area will be  $v$  times the energy's mass density. The rate of change of momentum will be  $v^2$  times the mass of the energy density. Since this is across unit area, it is the pressure  $P$ . Thus, if energy is mass times  $c^2$ , as shown in Chapter 1, where  $c$  is the propagation velocity of disturbance in this medium, the energy density is  $c^2P/v^2$ . Thus (6.36) becomes:

$$\text{Pressure times volume} = (v/c)^2 \text{ times a constant} \quad (6.37)$$

From the theory of sound propagation in a gas satisfying this relationship, assuming  $v/c$  is a constant also, the disturbance propagation velocity is given by:

$$v_o = \sqrt{(P/\rho_o)} \quad (6.38)$$

where  $\rho_o$  is the mass density of the medium. But  $\rho_o c^2$  is  $c^2P/v^2$ . Therefore,  $v_o$  is the velocity  $v$ . Also,  $v_o$  is  $c$ , since all three of these velocities are propagation velocities of disturbances in the medium.

It is concluded that the space surrounding the lattice particles is filled with energy, the density of which is equal to the pressure given by (6.35). A lattice particle has a volume  $4\pi b^3/3$ . From (6.35), it displaces energy of  $e^2/3b$ . This energy has the effect of giving buoyancy to the lattice particle. It is exactly half the mass energy of the particle, from equation (6) in Appendix I, and so, the effective mass of the lattice particle is given by:

$$m_o = e^2/3bc^2 \quad (6.39)$$

This is a most important result. In the following analysis all other charged particles are taken to have a mass given according to equation (6) of Appendix I. The reason is that we will find that the lattice particle  $m_o$  is the lightest of all particles. The electron is about twenty-five times heavier and since it displaces about 1/1,840 of the



volume displaced by the lattice particle any correction for the buoyancy effect is quite negligible. For heavier particles the effect is even smaller.

At this stage, it has been shown that the space-time system will sustain propagation of disturbances at the velocity  $c$ . Electromagnetic waves are carried by the lattice constituent of space-time. Electric field propagation at the velocity  $c$  occurs in the medium which surrounds the lattice particles and provides the pressure holding them in balance. It is this mechanism which operates according to the inverse-square-of-distance law. The action of this electric field disturbance is converted by lattice reaction into the Maxwell-type waves, which are onwardly propagated according to the direct-inverse-of-distance law. Lattice reaction is also effective in generating any standing magnetic fields.

### Balance in Space-time

We are now ready to consider the dynamic balance in space-time. The lattice particle system and the  $G$  frame are in balance. Thus, we may equate the right-hand sides of (6.1) and (6.2):

$$Nm_or = \rho(x - r) \quad (6.40)$$

after allowing for the factor  $N$ .

In view of the common angular velocity, the kinetic energy of unit volume of these constituents of space-time is proportional to:

$$Nm_or^2 + \rho(x - r)^2 \quad (6.41)$$

From (6.40), this is proportional to  $Nm_orx$  or  $\rho x(x - r)$ . Now, kinetic energy tends to increase in a dynamic system, just as potential energy tends to decrease. The latter condition fixes  $x$ , the total separation distance between the charged systems involved. We take  $\rho$  as fixed, as reference. Then, if  $\rho$  is greater than or equal to  $Nm_o$ , from (6.40)  $2r$  is greater than or equal to  $x$ . The maximum kinetic energy term is then  $\rho x(x - r)$ , but the limit condition for  $r$  makes  $r$  equal to  $x/2$ . If  $Nm_o$  is greater than  $\rho$  or equal to it, from (6.40)  $2r$  is less than or equal to  $x$ . The maximum kinetic energy term to use is  $Nm_orx$ , but the limit condition then gives  $r$  equal to  $x/2$ , as before. It follows that  $x$  must equal  $2r$ , for the normal undisturbed state of space-time. This then makes the mass densities of the  $G$  frame and the lattice particle frame equal, as assumed in the early chapters.

Since the charge continuum which moves with the  $G$  frame is deemed to have the velocity  $c$  relative to the  $E$  frame, to account for its uniform dispersion, the fact that the  $E$  and  $G$  frames move in the same orbit of radius  $r$  means that both move at velocity  $c/2$ .

From (6.1), putting  $x$  as  $2r$ , and  $\Omega$  as  $c/2r$ :

$$m_0c^2 = 32\pi\sigma er^2 \quad (6.42)$$

Since space-time is electrically neutral, if  $d$  is the lattice spacing:

$$e = \sigma d^3 \quad (6.43)$$

From (6.42) and (6.43):

$$m_0c^2 = 32\pi(r/d)^2e^2/d \quad (6.44)$$

The evaluation of  $r/d$  is the prime task at this stage. It is readily found because, neglecting for a moment the space polarization energy  $\psi$  (mentioned at the end of Chapter 4), we know that the spacing between the charges  $e$  and  $\sigma$  corresponds to zero electrostatic interaction energy.

The equation of electrostatic energy in space-time, neglecting the self-energy of any particles, is:

$$E = \sum\sum e^2/2x - \sum\int(e\sigma/x)dV + \iint(\sigma^2/2x)dVdV' \quad (6.45)$$

The factors 2 in the denominators are introduced because each interaction is counted twice in the summation or integration. The summations and integrations extend over the whole volume  $V$  of the space-time system.  $x$  denotes distance between charge. The inter-particle lattice distance  $d$  is taken to be unity, as is the dielectric constant.

Differentiation with respect to  $\sigma$  allows us to set  $\sigma$  so that  $E$  is a minimum. This minimum not only depends upon a condition almost exactly expressed by (6.43), but also depends upon the separation distance between the frames of  $e$  and  $\sigma$ .

The differentiation and equation to zero gives:

$$\sum\int(e\sigma/x)dV = \iint(\sigma^2/x)dVdV' \quad (6.46)$$

From (6.45) and (6.46):

$$E = \sum\sum e^2/2x - \sum\int(e\sigma/2x)dV \quad (6.47)$$

This is zero, according to our set condition. To proceed, we will evaluate:

$$\int(e\sigma/x)dV - \sum e^2/x \quad (6.48)$$

as it would apply *if* the charge  $e$  were at the rest position. The calculation involves three stages.

*Stage 1: The evaluation of  $\Sigma e^2/x$  between one particle and the other particles.*

Regarding  $d$  as unit distance, the co-ordinates of all surrounding particles in a cubic lattice are given by  $l, m, n$ , where  $l, m, n$  may have any value in the series  $0, \pm 1, \pm 2, \pm 3, \pm 4$ , etc., . . . but the co-ordinate  $0, 0, 0$  must be excluded. Consider successive concentric cubic shells of surrounding particles. The first shell has  $3^3 - 1$  particles, the second  $5^3 - 3^3$ , the third  $7^3 - 5^3$ , etc. Any shell is formed by a combination of particles such that, if  $z$  is the order of the shell, at least one of the co-ordinates  $l, m, n$  is equal to  $z$  and this value is equal to or greater than that of either of the other two co-ordinates. On this basis, it is a simple matter to evaluate  $\Sigma e^2/x$  or  $(e^2/d) \Sigma(l^2 + m^2 + n^2)^{-\frac{1}{2}}$  as it applies to any shell. It is straightforward arithmetic to verify the following evaluations of this summation.  $S_z$  denotes the summation as applied to the  $z$  shell.

$$S_1 = 19 \cdot 10408$$

$$S_2 = 38 \cdot 08313$$

$$S_3 = 57 \cdot 12236$$

$$S_4 = 76 \cdot 16268$$

$$S_5 = 95 \cdot 20320$$

By way of example,  $S_2$  is the sum of the terms:

$$\frac{6}{\sqrt{4}} + \frac{24}{\sqrt{5}} + \frac{24}{\sqrt{6}} + \frac{12}{\sqrt{8}} + \frac{24}{\sqrt{9}} + \frac{8}{\sqrt{12}}$$

Here,  $6 + 24 + 24 + 12 + 24 + 8$  is equal to  $5^3 - 3^3$ .

*Stage 2: The evaluation of components of  $\int(e\sigma/x)dV$  corresponding to the quantities  $S_z$ .*

The limits of a range of integration corresponding with the  $z$  shell lie between  $\pm(z - \frac{1}{2})$ ,  $\pm(z - \frac{1}{2})$ ,  $\pm(z - \frac{1}{2})$  and  $\pm(z + \frac{1}{2})$ ,  $\pm(z + \frac{1}{2})$ ,  $\pm(z + \frac{1}{2})$ . An integral of  $e\sigma/x$  over these limits is denoted  $e\sigma d^2 I_z$ . The expression  $I_z$  may be shown to be:

$$I_z = 24z \int_0^1 \sinh^{-1} (1 - y^2)^{-1/2} dy$$

Upon integration:

$$I_z = 24z(\cosh^{-1} 2 - \pi/6)$$

Upon evaluation:

$$I_l = 19.040619058z \quad (6.49)$$

Within the  $I_l$  shell there is a component  $I_o$  for which  $z$  in (6.49) is effectively  $1/8$ . Thus:

$$I_o = 2.380077382 \quad (6.50)$$

*Stage 3: Correction for finite lattice particle size.*

The lattice particles have a finite size. They occupy only a small part of the unit volume under study, but we are dealing with the fundamental constants of space-time and the analysis has to be taken as far as is reasonable.

Equation (6.43) is not strictly true if we allow for the finite volume of the charge  $e$ . However, for the purpose of the analysis in stages 1 and 2 it is easier to define  $e$  so that it satisfies (6.43). In effect,  $e$  is made  $e + \sigma V$ , where  $V$  is here the volume of the charge  $e$ . Allowing for this, the particles can be taken as point charges, except for the one at the origin of co-ordinates. Here, we must avoid including interaction energy on the assumption that it is generated *within* the particle volume. The correction term to be subtracted from  $I_o$  is:

$$\int_0^b 4\pi\sigma e x dx$$

where  $b$  is the radius of the particle. This is:

$$2\pi(b/d)^2(e^2/d) \quad (6.51)$$

From (6.39) and (6.44):

$$b/d = (d/r)^2/96\pi \quad (6.52)$$

Thus, in the units of  $e^2/d$ , the correction, found from (6.51) and (6.52), is:

$$(d/r)^4/4608\pi \quad (6.53)$$

Now, these three sets of results can be combined to complete the evaluation of (6.48). To relate (6.48) with (6.47), note that the two

systems of opposite charge have been displaced relative to one another through the distance  $2r$  from the rest position. For each charge  $e$ , this involves increasing the electrostatic energy by  $4\pi\sigma e\lambda dx$ , integrated from 0 to  $2r$ . This is:

$$8\pi\sigma er^2$$

or, in the units of  $e^2/d$  being used:

$$8\pi(r/d)^2$$

The value of  $E$  given by (6.47) may now be written as:

$$E = 8\pi(r/d)^2 - I_0 + (d/r)^4/4608\pi - \sum I_z + \sum S_z \quad (6.54)$$

The difference between the two summations in this expression is readily calculated by comparing (6.49) with the table of values of  $S_z$ . The  $S$  terms are all slightly greater than the  $I$  terms, but the difference converges according to the following series. It starts with the difference between  $S_1$  and  $I_1$ .

$$0.06346 + 0.00189 + 0.00050 + 0.00020 + 0.00010 \dots$$

To sum the series, note that the difference terms converge inversely as the cube of  $z$ . The matching convergent series, from  $z$  of 3 onwards, is:

$$0.01350 \left\{ \frac{1}{3^3} + \frac{1}{4^3} + \frac{1}{5^3} + \frac{1}{6^3} \dots \right\}$$

or:

$$0.00050 + 0.00021 + 0.00011 + 0.00006 \dots$$

This sums to 0.00105. However, note that above we have been dealing with the differences in large terms. Even this matching convergent series may be a little high-valued. Possibly a sum of 0.00100 would be more appropriate. To proceed, it seems better to round off this estimate of the sum of terms for  $z$  of 3 and above at 0.0010, and avoid taking the calculation through further digits. Then, collecting these data with (6.50), gives:

$$I_0 + \sum I_z - \sum S_z = 2.3801 - 0.0663 = 2.3138$$

Putting this in (6.54) and remembering that  $E$  is zero, if space-time has no priming energy  $\psi$ , we obtain an equation in  $r/d$  which can be solved by ordinary numerical methods. It is found that:

$$r/d = 0.30289 \quad (6.55)$$

### Space Polarization Energy

If space has a polarization energy  $\psi$  per unit volume  $d^3$ , and  $\psi$  is expressed as  $\psi$  units of  $e^2/d$ , this becomes equal to the expression in (6.54).  $E$  is then not zero. Provided  $\psi$  is small, it may then be shown that  $r/d$  is increased thus:

$$r/d = 0.30289 + 0.0657\psi \quad (6.56)$$

At this stage, we could proceed by assuming that  $\psi$  is zero. Then, the basic constant of space-time, this factor  $r/d$ , would be used extensively but would only be approximate. Eventually, our analysis will take us to an evaluation of  $\psi$  in terms of quantities deduced from  $r/d$ . Then, a better value of  $r/d$  can be obtained and the whole process repeated until exact results emerge. In the interests of keeping this analysis as simple as possible, the author proposes to introduce the value of  $\psi$  at this stage without proof. Later, it will be derived. It will be shown to be given by:

$$\psi = 0.000456 \quad (6.57)$$

measured in units of  $e^2/d$  per unit volume  $d^3$  of the lattice. Hence, (6.56) becomes:

$$r/d = 0.30292 \quad (6.58)$$

As is seen, the correction is very small. It demonstrates the very stringent accuracy demanded from this theory.

### Derivation of Planck's Constant

In Chapter 4 a cubic lattice unit, termed a photon unit, was assumed to be in rotation to develop a pulsating disturbance in atomic systems. Compensation of these pulsations by the motion of an electron was the basis of the Schrödinger Equation. Our next objective is to determine the exact nature of this cubic lattice. Indeed, we will seek to explain why it is cubic in form and why it exists at all.

Rotation of the lattice, meaning rotation of a group of particles which tend to stay in their relative positions, is a possibility. If energy has to be stored in quanta and two such units can have balanced angular momentum by their counter-rotation, it is likely that this can happen. At any rate, it is the assumption which has proved of

such value in deriving a physical understanding of wave mechanics in Chapter 4. Also, it is this assumption which sustains the analysis of the magnetic spin moments in the next chapter. Now, to determine the size of the photon unit, we will, only for the moment, make the assumption that there has to be symmetry in three dimensions. This will be proved below. Next, we will assume that the photon unit is as small as possible. To support this assumption, remember from equation (4.18) that the electron which exchanges angular momentum with the photon unit moves at radius  $2r$  about the centre of the unit. From (6.58),  $2r$  is only  $0.6 d$ . Thus, for the photon lattice unit to remain a rigid grouping of particles having a lattice spacing  $d$ , the unit must necessarily be the smallest possible. Otherwise the changes in angular velocity of the electron at radius  $2r$  would cause sub-groups of lattice particles to rotate within the main unit. The radius of gyration of the unit, being equal to or greater than  $d$ , has to exceed  $0.6 d$ , but it really should be as near a match as is possible. This makes the determination of the true size of the photon unit a relatively simple task. The smallest unit is one having three-dimensional symmetry matching the two dimensional form shown in Fig. 6.1. The next smallest unit is a 3 by 3 by 3 array of particles as depicted in Fig. 6.2. The circle in Fig. 6.1 denotes the boundary of a sphere

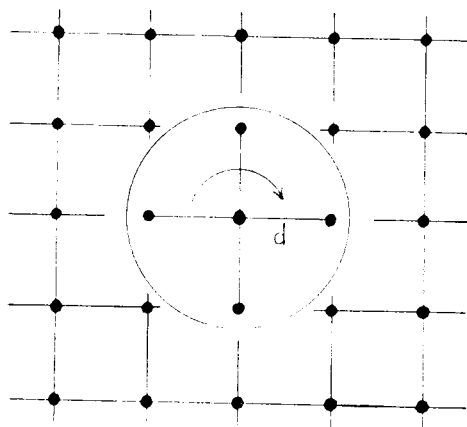

Fig. 6.1

containing the charge belonging to the continuum, of charge density  $\sigma$ . This rotates with the lattice unit and is of such size as to compensate its magnetic moment due to rotation relative to the  $E$  frame. A similar sphere of continuum charge contains the array in Fig. 6.2.

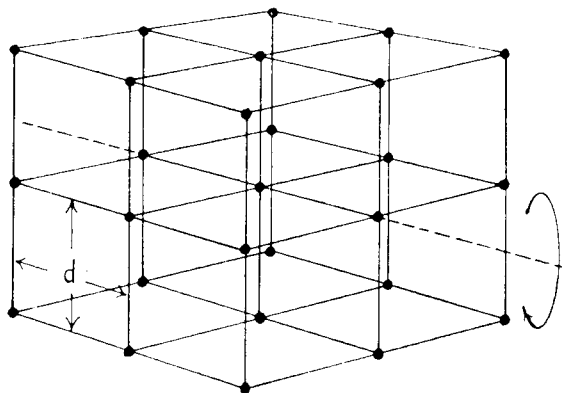

Fig. 6.2

It is not shown. Note that, since the electrostatic interaction energy in space-time is virtually zero, there is no problem about any angular momentum due to such interaction energy. This is provided the lattice and the continuum rotate together. The absence of such angular momentum is probably a more basic feature of the system than any need to balance magnetic moment. Magnetic moment will be balanced, except transiently, but angular momentum is always conserved. This argument really amounts to saying that the only angular momentum possessed by a rotating photon unit is that due to the intrinsic mass of the lattice particles. In effect, however, from an expression such as (6.45) one could say that there are three other angular momentum quantities present but they are mutually compensating. The interaction energy between the particles adds a positive angular momentum. The self-energy of the spherical continuum charge adds a positive angular momentum. The mutual electrostatic energy between the particles and the sphere of continuum is negative and provides the negative angular momentum in the balance. This is important if we explore the problem of the changes of rotation speeds. If the lattice changes its angular velocity by some interaction with the electron, how does the continuum pick up the same angular velocity? If the action is by direct contact, is there a time delay? If it is indirect and operates by magnetic moment balance, is there not then a time delay because of energy transfers with the field medium? Assuming some delay in the process, it is suggested that the preferred photon system should have the best intrinsic ability to conserve its angular momentum transiently when the lattice angular velocity slips relative to that of the continuum



sphere. What this means is that if the photon lattice rotates and the continuum sphere does not, then the angular momentum is about the same as it would be if the continuum sphere rotated at the same speed and the lattice did not rotate. In either case, interaction energies are ignored. This applies even between the particles in the rotating lattice because it is matched by some negative interaction energy, and though this latter energy may not be rotating at the same speed it will mitigate to some extent. Our analysis is not rigid here, anyway. The object is to find out which photon unit Nature has chosen, and, as indicated by the comments on radius of gyration, it is a small unit, the likely choice being restricted to those shown in Fig. 6.1 or 6.2

Let  $Nd^3$  be the spherical volume of continuum. The charge corresponding to this is  $Ne$ . The electrostatic energy of such a sphere of uniform charge is  $3N^2e^2/5x$ , where  $x$  is the radius of the sphere. The mass of such a sphere is found by dividing by  $c^2$ . Then, the moment of inertia calculation becomes a problem, because we have to work out where the mass is distributed, and guess how this mass distribution might move as the charge rotates. To avoid this, let us just suppose that the total mass is about the same as that of the lattice particles encompassed by the sphere, or, more logically, the mass of the number of particles having the compensating charge. In other words, we equate the mass calculated above to  $Nm_0$ .

From the above and (6.44):

$$Nm_0c^2 = 32\pi(r/d)^2Ne^2/d = 3N^2e^2/5x$$

Thus:

$$N = 160\pi(r/d)^2x/3d$$

Since  $Nd^3$  is  $4\pi x^3/3$ , we can find  $N$ . (6.58) is used to replace  $r/d$ .  $N$  is 29.5.

This suggests that the system shown in Fig. 6.2, which has twenty-seven lattice particles, is more likely to exist than the one containing seven particles presented in Fig. 6.1. It also rules out larger photon units, which are unlikely anyway if they have to interact with the electron moving at radius  $0.6d$ .

The very simple cubic 3 by 3 by 3 lattice is thus argued to be the fundamental photon unit introduced in Chapter 4. Below, it will be shown that three-dimensional symmetry as assumed above is a necessary condition for the moment of inertia of a photon lattice to

be independent of the direction of the axis of rotation of the unit. This is consistent with the need to have photon radiation in any direction independent of the lattice orientation of general space-time. Before proving this, we will evaluate Planck's Constant.

The moment of inertia of the photon lattice, when considered to rotate about an axis through the centre and parallel with a cube direction, is  $36m_0d^2$ . There are twelve particles distant  $d$  and twelve distant  $\sqrt{2}d$  from this axis. Since the standard photon unit, that is one rotating to produce pulsations at the universal frequency of space-time, has an angular momentum of  $h/2\pi$  as shown in Chapter 4, we know that the moment of inertia of the photon unit must be  $h/2\pi$  divided by one quarter of  $c/2r$ . Thus, there is a relationship between  $m_0d^2$  and  $h$ :

$$36m_0d^2 = 4hr/c\pi \quad (6.59)$$

From this and (6.44), we eliminate  $m_0$  and obtain:

$$\frac{hc}{2\pi e^2} = 144\pi r/d \quad (6.60)$$

From this and (6.58):

$$\frac{hc}{2\pi e^2} = 137.038 \quad (6.61)$$

This is the reciprocal of the fine structure constant. It is exactly the value measured. Hence, this theory has led us to an evaluation of Planck's constant in terms of the charge of the electron and the velocity of light.

We will now prove that the moment of inertia of the photon unit is independent of the axis about which it spins.

Consider co-ordinates referenced on the centre of the unit. Imagine a particle with co-ordinates  $x, y, z$  distant  $p$  from the origin. Take spin about the  $x$  axis. The moment of the particle about this axis is  $y^2 + z^2$ . This is  $p^2 - x^2$ . Now take spin about an axis inclined at an angle  $\theta$  with the  $x$  axis. The moment about this new axis is  $p^2 \sin^2 \theta$ , or  $p^2 - p^2 \cos^2 \theta$ . Let  $l, m, n$  denote the direction cosines of this new axis of spin, relative to the  $x, y, z$  axes. Then, the moment about the new axis, found from the direction cosine formula for  $\cos \theta$ , is:

$$p^2 - (lx + my + nz)^2$$

If now we apply this to a group of particles having three-dimensional

symmetry, there is a particle with co-ordinate  $-x$  for every one with co-ordinate  $+x$ . Thus, cross-multiples of  $x$ ,  $y$  and  $z$  cancel. The above expression then becomes a summation, thus:

$$\sum p^2 = (l^2 \sum x^2 + m^2 \sum y^2 + n^2 \sum z^2)$$

Cubic symmetry means that it does not matter if  $x$ ,  $y$  and  $z$  are interchanged. Consequently, their summations must be equal. Then, since the sum of the squares of direction cosines  $l$ ,  $m$  and  $n$  is unity, we find that the expression becomes the summation of  $p^2 - x^2$  for all particles in the group. This is independent of the direction of the axis of spin.

### Electron Mass

From Chapter 4, when the electron moves at radius  $2r$  its moment of inertia in its orbit is equal to that of the photon unit. Hence  $m(2r)^2$  is equal to  $36m_0d^2$ .

From this:

$$m/m_0 = 9d^2/4r^2 \quad (6.62)$$

From (6.58) we then have:

$$m/m_0 = 24.52 \quad (6.63)$$

This is a fundamental relation between the mass  $m$  of the electron and the mass  $m_0$  of the lattice particle of space-time. The lattice particle thus has a mass of about  $3.7 \cdot 10^{-29}$  gm. Such particles may have been observed in experimental work, but they have probably been passed by on the assumption that they are "holes". For example, Galt (1961) in a paper on cyclotron resonance presents data of measured power absorption coefficients in bismuth. A small peak occurred in his measurements at different frequencies and in proportion to magnetic field strength. At 24,000 Mc/sec. the peak appears between 600 and 700 oersted. This corresponds to a mass of  $He \cdot 2\pi fc$ , where we assume the electron charge  $e$ , the field is  $H$  and  $f$  is the frequency. The data give a value of mass of about  $7 \cdot 10^{-29}$  gm. He stated that this was due to the presence of holes. It is double the mass we have deduced for the lattice particle. Yet, if this can be passed by as a mere hole then perhaps direct evidence of such a particle has been overlooked. On the other hand, it may well be that the basic particle of space-time eludes any direct measurement

inasmuch as it may perform a role of reference itself. Its disturbance when in a lattice characterizes a magnetic field. Hence, it may meld into that field and defy detection.

It is of interest to calculate the mass density of the space-time lattice. From (4.1) we know that  $r$  is  $1.93 \cdot 10^{-11}$  cm. From (6.58),  $d$  then becomes  $6.37 \cdot 10^{-11}$  cm. This means that there are  $3.87 \cdot 10^{30}$  lattice particles per cc. From (6.63) this is equivalent to the mass of  $1.58 \cdot 10^{29}$  electrons or 144 gm/cc. This is almost exactly that expected from the analysis of Mercury's anomalous perihelion motion in the previous chapter.

It is also worthy of note that if  $d$  had come out to be ten times larger than predicted above, the electron population of heavy atoms would have precluded photon formation as described. The photon units of about  $10^{-10}$  cm radius are a perfect dimension on the basis of known atomic sizes. If  $d$  were one-tenth that found, it is not possible to accept the angular momentum exchange between the photon unit and the electron while retaining the electron appropriately quantized. Quantitatively, the predicted dimensions of space-time seem to be in perfect accord with what one might term one's sense of things. Some theories lead to quantities which are so far removed from those experienced that it is difficult to accept them on this account alone. This theory has indicated the existence of a particle which is 0.0408 times the mass of the electron. Next, we will examine the other particle, already mentioned. This is the graviton. It will be seen to have a mass which is just right in that it is a little greater than the masses of the basic nucleons. Indeed, the basic principle we are approaching is that space-time comprises a heavy particle form and a light particle form and all matter exists as a kind of transient between these two forms as space-time expands and allows the sporadic degeneration of the heavy particles.

## The Muon

In presenting equation (6.38) we introduced the density  $\rho_0$  of the energy medium surrounding the lattice particles and keeping the pressure balance effectively binding the charge  $e$  of each particle. For each lattice particle the quantum of energy in the medium is the pressure  $P$  multiplied by the volume  $d^3 - 4\pi b^3/3$ . This is the unit volume of the lattice less that occupied by one particle. From (6.35), the energy quantum is:

$$e^2 d^3 / 4\pi b^4 - e^2 / 3b \quad (6.64)$$

Now, if  $K$  denotes the volume of the medium per lattice particle as a ratio to that of the particle, from (6.39) we see that the energy quantum just derived is:

$$K m_0 c^2 \quad (6.65)$$

To evaluate  $K$ , note that (6.44) applies for point charges  $e$ . The equation (6.43) really should be:

$$e = K \sigma d^3 / (K + 1) \quad (6.66)$$

if  $e$  is true charge of finite size. Also, since  $\sigma$  cannot exert force on itself owing to its balance of magnetic and electrostatic force, the finite size of the particle has no effect upon (6.42). The "hole" in  $\sigma$  filled by  $e$  does not develop a force component. This means that (6.44) should be increased by the factor  $(K + 1)/K$ . Then, from this and (6.39):

$$d/b = 96\pi (r/d)^2 (K + 1) / K \quad (6.67)$$

But,  $K$  is  $3d^3/4\pi b^3 - 1$ , so we can use (6.67) to evaluate  $K$ , bearing in mind that  $r/d$  is known from (6.58). It is found that  $K$  is 5062.0. From (6.63) and this result, the value of the energy quantum under study can be evaluated as 206.4 electron energy units. This happens to be the same energy as is possessed by the muon. This meson has a mass some 206.7 times that of the electron.

What this means is that if something happens in space-time to cause a charge  $e$ , concentrated in a very small and therefore heavy particle, to expand to become part of the charge  $\sigma$  filling space around the lattice particles, then it must deploy the energy of the muon to provide the energy of the added medium around the particles of the lattice. If space is full, ruling out the general expansion process, the lattice particles must share in a transient compaction. This involves displacement against the same pressure  $P$  of space-time and, accordingly, the energy of another muon is stored transiently on the lattice particles. This brings us into a line of thought which imagines a heavy source particle able to release its energy by creating pairs of muons and providing energy quanta which are somehow determined by (a) energy balance, (b) angular momentum conservation, and (c) space conservation. One is led into speculations such as, what is the total mass of electrons and positrons which

jointly share a volume equal to that of the lattice particle? From (6.39) and the fact that the electron satisfies equation (6) of Appendix I, the answer is the volume ratio  $(m/2m_0)^3$ . From (6.63) this is 1,843. We have a mass quantity only slightly greater than that of the proton or neutron. Then, one can speculate on an energy balance equation such as:

$$xg = 2y (\text{muon}) + 2xX + yzY \quad (6.68)$$

where  $x$  and  $y$  are integers and  $z$  is either zero or becomes unity if  $X$  is 1,843.  $g$  is the mass of the source particle in electron mass units and the muon quantity is the mass quantum 206 deduced above. When  $z$  is zero  $X$  is the size of a particle form produced as a by-product of the reaction. Otherwise,  $Y$  is the particle by-product. This is all empirical analysis, but it so happens that there is a value of  $g$  which gives the results tabulated below.

$x$	$y$	$z$	$X$	$Y$	<i>Particle</i>
1	1	0	2,326		$\Sigma^{\circ} = 2,326$
1	1	1	1,843	965	$K^{\circ} = 965$
1	2	1	1,843	276	$\pi = 276$
2	1	1	1,843	2,342	$\Sigma = 2,342$

The stated masses of the particles are those given in Kaye and Laby Tables, 12th Edition, with the exception of the mass of the pion. This has been put as 276 as the average of the following data sources. They are obtained from Marshak (1952), who has written authoritatively on meson physics.

The mass of the positive pion:

$$\begin{aligned} &277.4 \pm 1.1 \text{ (Berkeley workers)} \\ &276.1 \pm 2.3 \text{ (Birnbaum } et \text{ al.)} \\ &275.1 \pm 2.5 \text{ (Cartwright)} \end{aligned}$$

The mass of the negative pion:

$$276.1 \pm 1.3 \text{ (Barkas } et \text{ al.)}$$

The above table concerns particles which are among the most important in elementary particle physics. It is significant that they come out in such a neat form in the table. More significant, however, is the quantity  $g$ . It is 5,063. This is almost the same as the value of  $K$ . Indeed, it is  $K + 1$ .

It is claimed that this result has significance. The basis of equation (6.68) is not explained, apart from the likely involvement of pairs of muons, and a guess at something which has led us to the figure 1,843. Even so, there can be no denying the curious and interesting result developed in the table. Even if the numerical values of certain particle masses are non-integral, there is very close agreement. The mystery becomes even more interesting when one examines the third item in the table. This shows that the energy  $g - 2$  (pion) is a package of energy surplus to the generation of a pair of pions. If this package of energy is absorbed by the proton, of mass 1,836 units, the resultant composite particle has a mass of 6,347 electron units or 3,245 MEV, when  $g$  is 5,063. Now, when protons are supplied to an environment in which pions are being produced, such a particle is actually formed. Krusch *et al.* (1966) have claimed that this reaction produces the largest elementary particle to be discovered. They write: "We believe that this is firm evidence for the existence of a nucleon resonance with mass  $3,245 \pm 10$  MEV. . . . It seems remarkable that such a massive particle should be so stable."

The author is tempted to claim that the above argument provides strong evidence favouring the existence of an elementary particle of 5,063 electron masses. In Chapter 8 we will see how this can be explained from basic principles. For the moment, our interest must turn to gravitation. This quantum could be the graviton. If it is, we can calculate the Constant of Gravitation from (5.12). From (5.10) and the corresponding formula for the electron, we know that  $x$  is  $a/g$ , where  $a$  is the radius of the electron. From (4.1) and (6.60),  $r$  can be eliminated to give:

$$e^2/mc^2 = d/72\pi \quad (6.69)$$

However, from the energy of the electron as given by (6) in Appendix I:

$$e^2/mc^2 = 3a/2 \quad (6.70)$$

From (6.43), we can write (5.12) in the form:

$$G = [6\pi x^4 e^2 / ed^3]^2 \quad (6.71)$$

Since  $x$  is  $a/g$ , and since (6.69) and (6.70) combine to show that  $a$  is  $d/108\pi$ , we can then write  $G$  as:

$$G = [4\pi/(108\pi)^3 g^4]^2 (3ac^2/2e)^2 \quad (6.72)$$

Replacing  $g$  by 5,063 and putting (6.70) and (6.72) together:

$$G = \left[ \frac{4\pi}{(108\pi)^3(5,063)^4} \right]^2 (e/m)^2 \quad (6.73)$$

Since  $e/m$  is  $5.273 \cdot 10^{17}$  esu/gm, we can evaluate  $G$ . It is found to be  $6.67 \cdot 10^{-8}$  cgs units.

This is the measured value of  $G$ . This theory has, therefore, provided a quantitative and qualitative account of gravitation. All the evidence points to the existence of gravitons, particles of charge  $e$  having a mass 5,063 times that of the electron. Further argument, and proof, of this will be provided in Chapter 8, after we have explored in more depth the nature of the atomic nucleus and the processes of matter creation. These involve a deeper study of spin properties and are best treated separately. Further, in Chapter 8, the account of the graviton reaction process from which the mass of the graviton is deduced is a good introduction to cosmic phenomena.

Before leaving this chapter, it is appropriate to summarize the constituents of space-time. Also, we have to determine the value of the space polarization energy. Space-time comprises:

1. *Gravitons*. They have charge  $e$  and a mass about 5,063 times that of the electron. They are located in the  $G$  frame and they are the seat of the mass providing the dynamic balance for matter and the lattice particles.
2. *The continuum charge  $\sigma$* . This is uniformly dispersed throughout space. A unit volume of the lattice has enough of the charge  $\sigma$  to balance an opposite polarity charge quantum  $e$ . The polarity of  $\sigma$  is the same as that of the graviton charge. This charge is relatively insignificant from the point of view of dynamic mass balance. It moves with, and forms part of, the  $G$  frame.
3. *The lattice particles*. These have a charge  $e$  opposite to that of the graviton. Each has a mass of 0.0408 times that of the electron. These particles form a cubic lattice which is the electromagnetic reference frame. They are the  $E$  frame. They are in dynamic balance with the gravitons. Since the orbits of both frames are almost equal, there are about 124,000 lattice particles in space-time for every graviton. This explains why the graviton charge does not affect the electrical analysis of space-time presented above.
4. *The energy medium*. This is the system of energy density  $\rho_0 c^2$



which is at rest in the inertial frame and which provides the pressure balance for the lattice particles. It has no charge and it is the medium determining the propagation velocity of electric field disturbance. Its true nature is not understood. Nor is it understood how the heavier particles of charge forming matter or the gravitons, etc., are restrained from expanding to release their energies. They are subject to higher internal pressure than the lattice particles. However, this problem is no weakness. It is a problem confronting any theory which retains accepted laws of electric action.

5. *Electrons.* On the assumption that the lattice particles have negative charge  $e$ , it is likely that there are electrons in the  $E$  frame. These have not been introduced above. They are needed to provide a kind of symmetry. There is one such particle for each graviton, that is, there are very few indeed of these particles under normal conditions, so the lattice system is not disturbed. Symmetry is needed because the mass of the continuum charge is effectively zero due to its involvement with the interaction within the lattice. Then, for each lattice particle we have 5,062 units of mass in the energy medium, with charge balance from the continuum. Now, if we have the electrons as suggested, we have about 5,063 units of their mass in the graviton and the facility for direct charge balance. Without the electron, the graviton could not migrate relative to the lattice, to spread its mass effect, unless it moved a lattice particle with it.

It is suggested that the electron is paired electrically with the graviton and migrates with it.

The presence of the electron in the  $E$  frame provides a minor disturbance to the dynamic balance of the system of space-time. If we think in terms of kinetic energy and centrifugal force balance by electrostatic interaction with the  $G$  frame charge, we see that the electron tends to expand the  $E$  frame orbit because it is heavier than the lattice particles. The interaction between the electrons and the lattice particles will keep the electron in place, in the sense of the harmonious motion component of space-time. It must, if the electron is to be as near to rest in the  $E$  frame as is possible. However, if the electrons urge expansion of the  $E$  frame orbit, the lattice particles react to contract the orbit. It has been contended that such contraction is not possible because electrostatic interaction energy

cannot be zero anywhere in space. Therefore, there must be only outward expansion and this must be due solely to the dynamic effects of the electron. The electron adds energy, in effect, to the interaction energy of space-time. It sets up a polarization energy equal to the electrostatic energy corresponding with this small orbital expansion. Again, since mass varies to keep mass energy constant as  $c$  varies, as was discussed in Chapter 5, we need only consider one of the energy forms, either electric or kinetic. This leads to the energy  $\frac{1}{2}m(c/2)^2$  for each electron. The  $E$  frame moves at this velocity  $c/2$ . Since there are 5,063 ( $m/m_o$ ) lattice particles per electron, the energy per lattice particle is:

$$\frac{m_o c^2}{8(5,063)} \quad (6.74)$$

Then, this has to be doubled because the  $G$  frame provides a centrifugal balance and it must, therefore, contain the same energy. Doubling (6.74) we have, from (6.44), a total priming energy per particle of:

$$\left( \frac{8\pi(r/d)^2}{5,063} \right) e^2/d \quad (6.75)$$

Substituting the value of  $r/d$  from (6.58), this becomes  $0.000456(e^2/d)$ , as presented in equation (6.57). This energy is enough to sustain a magnetic field of the order of  $10^{10}$  oersted. Therefore, although it is small enough not to cause any significant disturbance of the space-time system, it will, nevertheless, not unduly limit the ability of space-time to carry strong magnetic fields.

## Summary

In this chapter the difficult problem of analysing the aether has been confronted. The zero electrostatic energy condition has been the entry point to the subject. Minimum energy has been avoided, because it is relative, whereas space-time has to be absolute. This has given us the parameter  $r/d$ . This key quantity enables the evaluation of basic energy quanta. Masses matching those of the muon and other elementary particles emerge from the arithmetic quite easily, though a complete physical understanding has to await us in Chapter 8. The fine structure constant, and, therefore, Planck's constant has been evaluated exactly. The constant of gravitation has also been

evaluated exactly. These results can but speak for themselves. The chapter has also offered an account of the mechanism of the finite propagation velocity  $c$ . This is important qualitatively because it has helped us to develop a comprehensive understanding of the constituents of pure space-time. In the next chapter, our attention is turned to the atomic nucleus and the quantities involved in atomic theory. We will seek to verify the concept of the deuteron presented in Chapter 1. The mass of the neutron and the proton will be evaluated. The results are as remarkable as those in the above chapter, particularly as we will go on to evaluate the magnetic spin moments of the particles under study. The difficult part of this whole work has been covered in this Chapter 6. It is the real core of the whole theory in this book. It is a theory of the aether, an unpopular subject, but an inevitable one. It is difficult to accept, perhaps because, in a sense, truth can be harder to believe than fiction. Yet, any statement is fiction until shown to be truth.

## 7. Nuclear Theory

### Electron-Positron Creation

In Chapter 4 the process by which photons transfer momentum was introduced. When a photon event occurs an electromagnetic wave is propagated and a momentum quantum  $h/c$  times the radiation frequency  $\nu$  is imparted to space-time by matter releasing the photon. It is a statistical possibility that the reverse event will occur anywhere in the wave region. The likelihood of a photon being intercepted in this way probably depends on the wave amplitude and on the rate of flow of momentum locally. Another way of looking at this is to regard space as full of energy. If it contains a uniform distribution of energy, say  $E_0$  per unit volume, and is a veritable sea of energy which is ruffled by wave disturbances, the waves may travel at the high propagation velocity  $c$  but the displacement of the energy  $E_0$  to convey momentum will be slow. If a photon traverses a particular unit volume in unit time, the energy  $E_0$  in this volume (of mass  $E_0/c^2$ ) will be moving at a velocity  $h\nu c/E_0$  to convey an energy quantum per photon of  $E_0$  times this velocity divided by the photon velocity  $c$ . This energy quantum is, simply,  $h\nu$ . Hence, the energy-frequency relationship of Planck's law  $E = h\nu$ .

Since  $E_0$  tends to be uniform, photons "tend" to move from their source to where they are absorbed. Energy quanta are merely exchanged with the energy content of space-time in these photon events. One can say that energy is transferred, but this transfer is indirect and energy certainly does not travel at the velocity  $c$ . If it did it would have infinite mass, which would be absurd. The wave travels at the velocity  $c$ . Momentum quanta are transferred, as is energy, via the space-time medium. However, momentum is a vector quantity and, although statistically the preservation of the uniform energy distribution in space will bring about momentum balance, it is not likely that a simple energy distribution mechanism can assure that all photons received have the same momentum vector as one emitted. Again, this leads to speculation and we will not dwell on this here.\* The point

\* Enough was said on page 76.

has been made that the photon mechanism involves emission and absorption of photon quanta in equal numbers if there is not to be a build-up of energy in space-time.

When we consider photon events involving creation or annihilation of electron-positron pairs there are not only the questions of energy balance and momentum balance but, in addition, the problems of what happens to the electric charges and where they come from. These actions are photon events. The photon frequency is given by  $mc^2 = hv$ , since two photons (or gamma rays) are involved in the reaction. Now, it is absurd for anyone to think that two electric charges, one positive and one negative, can possibly vanish into nothing. If this could happen there would be no physics because everything, if it ever existed, would be gone in one big bang. It is nonsense to think that the energy available could recreate charge and matter. There would be no structure, no nuclei on which to rebuild the system. Without the lasting existence of the discrete element of charge  $e$  we have no firm foundation to hold the physical universe together. Mass can vary and can come in numerous basic forms. The velocity of light varies according to the media it traverses and it even varies in free space. Planck's constant appears invariable, but would it if  $e$  varied? Physics and our existence depend upon something remaining constant and the electron charge is about all we can look to as providing this anchor. The electron and the positron might interact to become something else but their electric charges are conserved and at least one, be it the charge of the electron or the charge of the positron, must retain its discrete form.

Having declared this we have an additional constraint governing the photon events involved in electron-positron annihilation and creation. We have also the constraint introduced in Chapter 1 and discussed in detail in Chapter 6. The volume of space available to house electric charge is limiting. This tells us that if an electron and a positron change into some other particle form, by expanding, then similar particle forms elsewhere must probably contract to create an electron and positron at that other location. If these two events do not occur simultaneously, the adjustments of the structure of space-time will need extra energy to act as a buffer. The transmutations involving electrons and positrons do take place in a highly energetic environment and this buffer action can be expected. However, on balance it is to be expected that for every electron-positron annihilation there is a matching electron-positron creation elsewhere. The

process is akin to the photon transfer and, via the photon actions, momentum and energy are balanced also.

With this introduction we can say that when an electron and a positron annihilate one another they meld into space-time, the negative charge of the electron becoming a particle of the  $E$  frame lattice and the positive charge of the positron melding into the uniform continuum of charge density  $\sigma$ . It follows that the energy needed to create an electron and a positron is not, in matter terms,  $2mc^2$ . It is less than this because the constituent elements from which they are created have energy themselves. However, when we think of energy transfer and momentum transfer we have to remember that the adjustment in physical size of the background constituents in space-time cause supplementary energy and momentum transfer exactly as if the  $2mc^2$  energy was involved.\* Thus, the frequency of the gamma radiation is exactly the frequency we would expect if there were total annihilation. This not only meets some of the perplexing philosophical aspects of this problem but, in addition, there is quantitative evidence in direct support of the theory just propounded. This will be presented below when we explain the results of Robson's experiments.

### Mass of Aggregations of Electric Charge

In Chapter 4 it was noted that mass can vary according to its state of motion with the  $E$  frame of space-time. In this context the reader is reminded that the relative velocity of the space-time frames can vary slightly, adjusting the speed of light, and since energy ( $E = Mc^2$ ) is conserved it follows that mass may vary. The  $E$  and  $G$  frames are therefore reference frames for mass quantities. The intrinsic mass energy of any particle is the same whichever of these two frames it occupies. Thus, if we take positive charge in the  $G$  frame and negative charge in the  $E$  frame and these exist at these locations in discrete particle form, we have no difficulty analysing their respective mass properties. The problem comes when we consider the mass contribution of their mutual electrostatic interaction, particularly when they come together to form a composite mass aggregation in the  $E$  frame. If we know that the zero-reference ground state is with positive charge in the  $G$  frame and with negative charge in the  $E$  frame, the change of electrostatic energy in coming together is

\* See also discussion on page 204.

calculable and the net mass energy of the aggregation can be evaluated. If we take the ground state to be their separation to infinity, as is normal in physical theory, we have postulated something which is out-of-line with reality. If we wander into philosophical argument and imagine that the universe came about by all electric charge starting at infinite separation and coming together, we face enormous problems. If everything started compacted together and then separated with a bang the analysis is even worse. It seems so neat to have derived a system of space-time in which an  $E$  frame formed by practically all the negative charge is effectively displaced by a definite distance from a  $G$  frame formed by practically all the positive charge. It seems logical that at the start of things, before some of this charge got out of place to create matter, all the negative charge was effectively spaced by the same distance from all the positive charge. However, logical or not, there is experimental evidence available to demonstrate that the ground state for mass calculation of aggregations of charged particles is the condition in which opposed particle pairs are each separated by the separation distance of the  $E$  and  $G$  frames of the space-time system. This will now be presented in a more detailed analysis of the deuteron.

### The Deuteron Reaction

At the end of Chapter 1 the form of the deuteron was discussed. It was shown that if it comprises electrons or positrons or both in combination with heavy fundamental particles and all have the charge quantum  $e$  then there is one favoured aggregation which could be the deuteron. This aggregation has a binding energy matching that actually measured. In this chapter this approach is taken further to develop a theory of the atomic nucleus and other basic particle systems. It is also to be noted that at the time of writing this book the author has not attempted to take the scope of this research further than that described in this chapter. The further potential of the theoretical approach being presented has, therefore, not been probed, although it does look highly promising.

Fig. 7.1 shows possible forms of the neutron and proton, as well as the deuteron. Also shown is the expression for the mass of each particle in terms of the interaction energy quantities  $E_1$ ,  $E_2$ , etc.

In the case of the deuteron,  $E_5$  has been evaluated approximately as  $-4.375 mc^2$ . This approximation is due to two factors not allowed

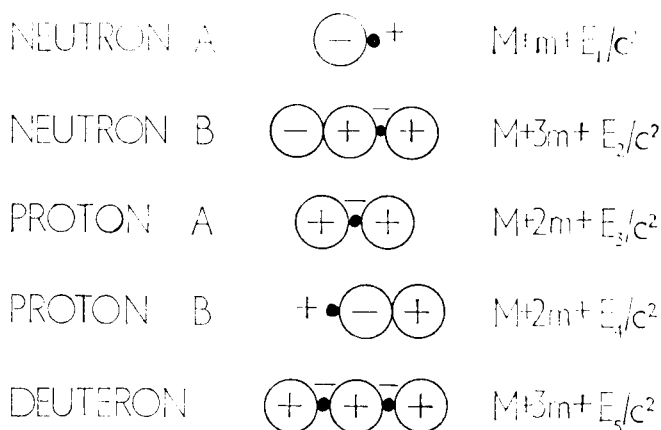

Fig. 7.1

for in the analysis. Note that  $mc^2$  is the rest mass energy of the electron or positron.  $M$  is the mass of the fundamental heavy particle deemed to be present in these basic particle aggregations. This heavy particle is termed an H particle.

Since the mass  $M$  is about 1,836 times that of the electron, and since the radius of the H particle, being inversely proportional to mass, is  $1/1,836$  that of the electron, the particles forming the deuteron are spaced a little further apart than was assumed in Chapter 1. The result is that the estimated binding energy is reduced in the same ratio. The corrected value of  $E_5$  is then  $-4.373 mc^2$ . Next, we need to consider the ground state correction. When the deuteron is broken by gamma radiation its constituent parts do not go off to infinity before recombining in another form. However, there is a fairly definite cut-off value of the gamma ray frequency which will disrupt the deuteron and this suggests that there is a fairly definite separation of the constituent particles which has to be reached before the transmutation is triggered. According to Wilson (1963), the measured binding energy of the deuteron is 2.22452 MEV. Data sources differ on the proper conversion of MEV to units of  $mc^2$ , but this measured binding energy seems to be approximately  $4.352 mc^2$ . The difference between this quantity and the theoretical value  $4.373 mc^2$  is  $0.021 mc^2$  and can be taken as the error in assuming separation to infinity in the theoretical calculation. We take this as experimental evidence from which to deduce the spacing of the opposed-charge pair elements in the ground state. Thus, the three positive charges will go to their ground state each pairing with a



negative H particle or, for balance, an electron to form three particle pairs of interaction energy  $e^2/x$ . If we equate  $0.021 mc^2$  to  $3e^2/x$ , we find the separation distance  $x$  from the experimental data. This shows that  $x$  is close to  $2r$ , as expected, because  $3e^2/2r$  is, from (4.1),  $3amc^2$ , where  $a$  is the fine structure constant. Since  $a$  is 0.007298, the  $2r$  spacing would give a correction  $0.022 mc^2$ .

This result is remarkably close, having regard to the fact that it relies upon such a small difference between the measured binding energy and the uncorrected estimate from this theory. It must be taken as giving clear support for the postulated separate  $E$  and  $G$  frames of the space-time. Further, the analysis of the mass of the deuteron has been shown to be rigorously applicable. The deuteron binding energy is predicted by the theory with extreme accuracy and this encourages the further analysis of other particle aggregations.

Experiment shows that when the deuteron is disintegrated a proton and a neutron are produced. This leads us to understand the composite nature of these particles. A step to be taken at this stage is to realize that for any stable nucleon to change its form, except transiently, there has to be a fundamental change in character of at least two of the constituent particles. The change we contemplate is one in which the energies of two particles of different mass are exchanged. This will be termed particle inversion.

### Particle Inversion

Particle inversion is depicted in Fig. 7.2. Here, a positive H particle and an electron interchange energies to form a positron and



Fig. 7.2

a negative H particle. This can only occur in a highly energetic environment, but when it has occurred the individual particles have adopted a stable form. Overall, there is no total energy change or change in volume of space occupied. Charge is conserved. The physical process has involved some other particle in the environment becoming compacted as it stores energy supplied. This makes a volume of space available which allows the H particle to expand and

so release some of its energy. The electron can take a little of this energy and be compacted a little in this process. The form to which this system will revert when balance is restored will probably depend upon which of the two particles, the H particle or the electron, is physically the larger when the reversion process begins. This action is, of course, highly unstable and it has to be remembered that there is no freedom for the various particles to adopt any mass value by appropriate sharing of space and energy. Fundamental particles have discrete forms and, although interchange between these discrete forms is possible, there are a limited number of such forms which can be adopted by a stable particle. We exclude unstable systems and mere particle aggregations in considering this limited number of particle forms, because, as is well known, there seem to be numerous varieties of elementary, though unstable, particles and there are many isotope nuclei. The important point under review is that unless there is particle inversion the disintegrated elements of a particle aggregation will come together again to form the same unit.

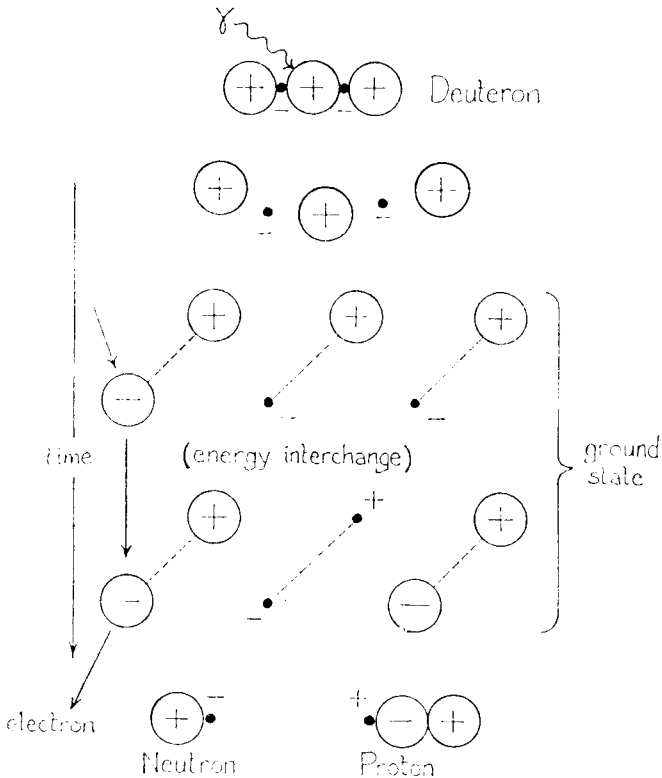

Fig. 7.3

This leads us to the sequence of events depicted in Fig. 7.3. A gamma ray  $\gamma$  acting on the deuteron results in kinetic energy being added to the deuteron. At a certain stage in the process energy inversion occurs, as noted, and this results in there being two heavy H particles of opposite polarity. This is facilitated if it occurs in the ground state, as depicted, because there can be balance, at least transiently, in a dynamic sense if there is a heavy H particle in each of the  $E$  and  $G$  frames. When this particle system reverts to a normal state we find that the product is a proton and a neutron. We are, therefore, able to investigate the forms of these newly-formed particles.

### The Proton

The H particle cannot exist alone for very long. The reason is that an electron or positron, whichever has opposite polarity, will combine with it to form an aggregation having even less energy than the H particle itself. The binding energy exceeds in magnitude the rest mass energy of the electron. Such a neutral system must eventually come into collision with another charged particle. Then, further combination will occur because the total energy of the aggregation can be less than that of its constituent parts.

Referring to Fig. 7.1, for neutron A we can calculate  $E_1$  as approximately  $-1.5 mc^2$ . This follows because the electrostatic energy of the electron is  $2e^2/3a$ , where  $a$  is its radius, and the electrostatic energy of the coupling between the electron and a point charge  $e$  at its surface is  $-e^2/a$ . This makes  $E_1$  1.5 times the rest-mass energy of the electron. For proton A,  $E_3$  is  $-3 mc^2$ , doubling the above because there are two positrons involved, plus the interaction energy between the two positrons of  $0.75 mc^2$ , because they are at a spacing of  $2a$ . Thus,  $E_3$  is  $-2.25 mc^2$ . Similarly, for proton B,  $E_4$  is  $-1.75 mc^2$ .

Since the binding energy of proton A is greater than that of proton B, proton A is more stable. However, there is a much higher probability of forming proton B. This is because in an environment of H particles a combination of such a particle with an electron-positron pair is far more likely than a combination with two electrons or two positrons. Also, there are less positrons than electrons available in free form. When we discuss the origin of the H particle we will see that it is formed by pairing with an electron or positron of

opposite polarity. More electrons implies a greater likelihood of forming the positive H particle initially. Then, we have the increased likelihood of combination with the easily induced electron-positron pair. A less likely event is the combination of the positive H particle with two electrons to form an anti-proton of form A. Least likely, is the formation of proton A.

Following this line of reasoning, we have presented in Fig. 7.2 a proton form B as the product of the deuteron reaction. Therefore, the negative H particle formed by inversion has gone into the neutron product. Before discussing the neutron and neutron decay, it is to be noted that we have deduced a relationship between the mass of the H particle and the mass of the regular proton. Since  $E_4$  is  $-1.75 mc^2$ , the proton mass, from Fig. 7.1, is  $M = 0.25 m$ . Thus, the mass of the H particle is less than that of the proton by 0.25 electron mass units. Since, later, we will deduce the mass of the H particle from the teachings of this theory, we have thereby explained the mass of the proton. Note that spin is something which depends upon what is happening to a particle. When the proton is in an atom it has spin properties because of its interplay with the photon units and electrons in the atom. When the proton is isolated, spin cannot be precluded because it might depend upon what the proton brings with it from wherever it has been. Proton spin will be dealt with in detail later in this chapter.

## The Neutron

It has just been stated that the positive H particle is the more fundamental. It is the most likely one to be formed. The fact that the deuteron models shown in Fig. 1.3 of Chapter 1 all comprise positive H particles with the exception of model C may seem inconsistent. In discussing the proton we argue in favour of the one having the least binding energy on the grounds that the H particle in positive form has abundance and ease of combination. Why are things different for the deuteron? Why did we not choose between models A, B and D and ignore C, the one with the negative H particles. The reason is clear, now that H particle inversion has been explained. H particles are the origin of matter. They are as fundamental as electrons and positrons. Preponderantly, they are produced in positive form. They first form neutrons by aggregation with electrons or protons by aggregation with electron-positron pairs. Indeed, as will be shown, H particles can, in fact, be actually created in their association with an

electron-positron pair. If anything, one would expect the proton really to be formed in much greater abundance than the neutron. It is easier to develop an electron-positron pair if there is an inflow of energy creating matter. Electrons are not produced in isolation. So far as they do exist they can combine with the positive H particle to form a neutral aggregation and then this will join another electron to form an anti-proton because this anti-proton has the least total energy compared with the neutron or the normal proton and has also the strongest binding energy.

The result of this is that the process of matter creation has to be explained in terms of the creation of an abundance of protons of form B with a few anti-protons of form A. In an energetic environment some of these protons and anti-protons will undergo inversion and then combine to form the deuteron as illustrated in Fig. 7.4. Some protons will couple with an electron to form a hydrogen atom or go into the nucleus of a heavy atom. Some protons will undergo inversion and then aggregate with an electron to form a neutron of the form B, shown in Fig. 7.1. Then these will probably go into the formation of heavier atoms or decay back again by ejection of an electron. The anti-protons are possibly preserved until they invert, whereupon they are captured by inverted protons to form deuterons. If the protons and anti-protons aggregate before inversion of the latter they form something less stable than the deuteron and the process of disruption and regeneration can be expected to occur. In the basic matter creation process, the main product is the proton B, the neutron B and the deuteron according to model C in Fig. 1.3 or as shown in Fig. 7.1. Fig. 7.4 shows how a proton and an anti-proton may invert and combine to form the deuteron, ejecting an electron. Then, with the input of a gamma ray, it is shown how this deuteron disrupts to form proton A and a neutron. The neutron may invert and couple with an electron-positron pair in view of the energy available and then may eject an electron, decaying into a proton B. Similarly, the proton A may invert to develop proton B. If the reaction does not go in the way outlined in Fig. 7.4, what are the alternatives? Firstly, could the proton combine with the anti-proton? It might form a particle aggregate, electrically neutral overall, and of the order of mass of the deuteron. Now, it will be contended\* that any particle aggregate which has a mass of the order of three or more times that of the proton and which is highly compacted cannot be

\* See page 203.

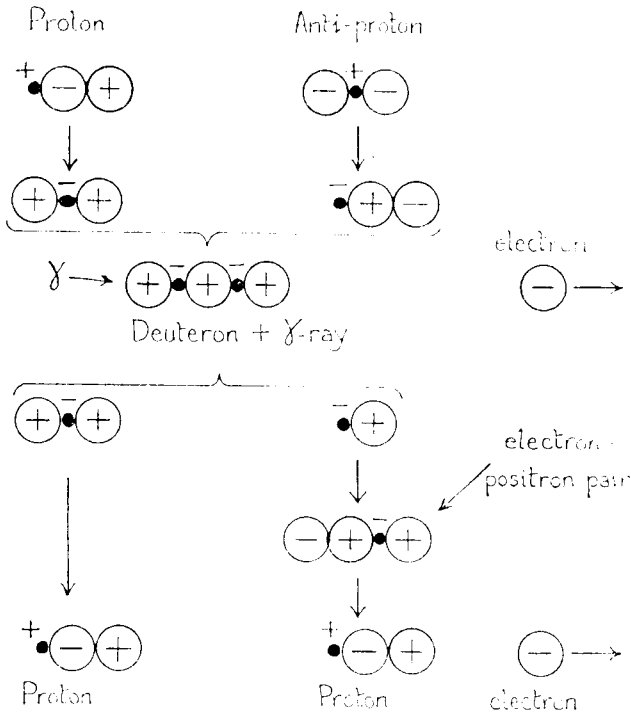

Fig. 7.4

effectively balanced by the interaction of gravitons in the  $G$  frame. Two gravitons separated by the lattice dimension  $d$  of space-time might share in the balance of a double-proton sized particle, but it is unlikely that three could co-operate in this way. Thus, since we shall later see that one graviton is needed per proton mass unit, we have to preclude aggregations of three or more H particles of the same polarity. We allow but one, the most stable, aggregation of two such particles. At this level the most stable is the deuteron according to model C in Fig. 1.3. To keep the analysis general, but at the level of mass of the deuteron, we can show that model C is favoured even if we involve H particles of opposite polarity in the selection. The mass level requirement is dealt with by allowing the H particles to be no closer than the diameter of an electron. In Fig. 7.5 several possible combinations including two H particles are shown and the total mass value applicable to each is given. None has as low a mass as the deuteron according to model C.

If the proton and anti-proton of Fig. 7.4 combine directly we expect the aggregation shown in Fig. 7.5(b). If the proton inverts its form

and combines with the anti-proton the model shown in Fig. 7.5(c) results. If the anti-proton inverts and combines with the proton another model not shown is produced, but all have greater total mass than that depicted in Fig. 7.5(e), which is the model C deuteron. It is a similar story when we consider the possibility of combinations of the products of the deuteron when disrupted by gamma radiation. If anything forms having a mass approximately that of the deuteron it must decay into a deuteron. Effectively, the gamma radiation is dispersed without an end product. If there is an end product we would expect protons and neutrons (in form B) because these are the product of the basic matter creation reaction. These emerge from nuclear processes. Neutrons of the form B have transient stability. They decay via inversion into proton B and an electron.

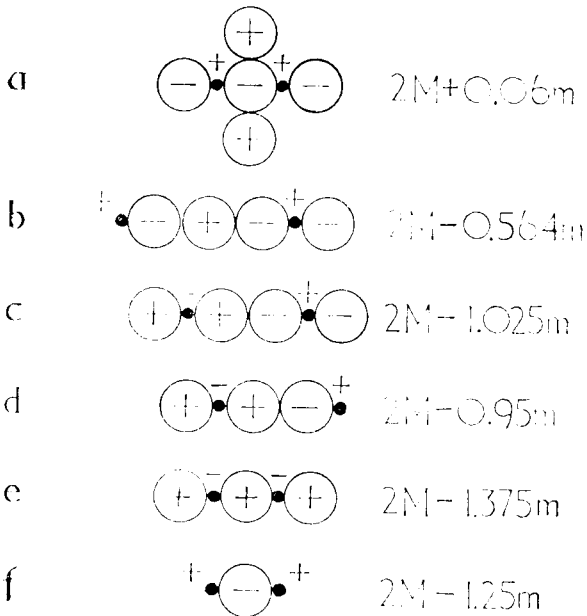
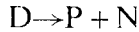

Fig. 7.5

An interesting speculation is whether the deuteron with all polarities reversed, the anti-deuteron, could form from two anti-protons or from some products of the reaction. Let us assume that the answer is affirmative. It is unlikely to happen because the anti-protons are scarce, but it can happen. The result could be an atom with a negative nucleus and a satellite positron. Such an atom would be a misfit in the system of matter we know. Probably such an atom would

interact with a normal atom, with the electrons and positrons around their nuclei wiping one another out to develop energy which would stir up more reactions and work the “anti-bodies” out of the system. In the end, only one form of atom can win and that is apparently the one we have assigned a positive nucleus.

The deuteron mass augmented by gamma radiation which puts it into the ground state is simply  $2M + 3m$ . Then, from the known reaction:



which indicates that the deuteron  $D$  converts to a proton  $P$  and a neutron  $N$ , we can deduce the mass of the neutron. We note that the mass of the proton is  $M + 0.25m$ , as already shown, but subject to a small correction. The mass of the deuteron is really  $2M + 3m - 4.373m + 3\alpha m$ , the latter term being the ground state correction due to the triple pair of charge elements. Similarly, the mass of the proton  $B$  is  $M + 2m - 1.75m + 2\alpha m$ , because the ground state correction arises from interaction between two positive charges in the  $G$  frame and two negative charges, if we include the transient electron, in the  $E$  frame. It follows that the mass  $2M + 3m$  available can go to create a proton and will leave mass  $M + 2.75m - 2\alpha m$  as the mass we can associate with the neutron. Compared with the proton, we find that the neutron is heavier by  $2.5m - 4\alpha m$ , or  $2.4708m$ . This is, of course, pure theory. An exact check with experiment is not possible because the absolute masses of these two quantities are not known to sufficient accuracy. Roughly, however, the predicted value seems correct. For example, if the proton-electron mass ratio is, say, 1,836.2, the neutron-mass ratio should be 1,838.67. These figures are fairly representative on existing data sources.

If we consider neutron decay, there is a check on the analysis. The neutron can produce a proton and eject an electron, as mentioned above. However, as Fig. 7.4 shows, it has to create and absorb an electron-positron pair. This returns us to the rather complex problem of the energy features of space-time. It was stated early in this chapter that the energy needed to create an electron and a positron is not, in matter terms,  $2mc^2$ . It is less because the constituent elements from which they are created have energy themselves. We have to digress a little to analyse this.

Firstly, the origin of the electron-positron pair is the lattice particle and a unit volume of continuum in space-time. As was explained



in Chapter 6, there is a difference between mass balance and energy balance when we think of these elements. Energy in the form of lattice particles has its proper measure of mass but these particles move in a medium which itself has mass. There is a certain buoyancy effect, the result of which is that dynamic balance in free space comes about from energy in the  $G$  frame which is only half that in the  $E$  frame, as far as the relatively large lattice particles only are concerned. Hence, if we take four units of energy from the lattice particle system we take two from the  $G$  frame system, and we can deploy these six units of energy to create matter and an equal energy balance in the  $G$  frame. Hence, for each lattice particle and its related  $G$  frame continuum substance deployed to create the electron and the positron there is available from space-time the energy of 1.5 lattice particles, half of which goes into matter form. That is, the energy of 0.75 lattice particles or  $0.75(2e^2/3b)$ , where  $b$  is the radius of the lattice particle, is released to matter in the electron-positron creation process. From the equation (6.39) this is  $1.5 m_0 c^2$ , where  $m_0$  has the value of  $0.0408 m$ , as already shown.

Thus, the energy needed to generate an electron-positron pair corresponds to a mass of  $2m - 0.0612 m$  or  $1.9388 m$ . From the neutron we have  $2.4708 m$ . If  $1.9388 m$  of this is used to create an electron and a positron, and we allow for the fact that the mass  $m$  of the positron has been included already in the mass assigned to the proton, we must subtract  $0.9388 m$  from  $2.4708 m$  to obtain the mass of the surplus energy. The surplus energy is, therefore,  $1.532 mc^2$  and this is released alongside the electron and the proton as a decay product of the neutron.

This energy quantity is 0.782 MEV, and this happens to be *exactly* the value measured by Robson (1951) from end point measurements in the beta spectrum derived from neutron decay. This result shows that the theoretical approach we are following has substantial experimental support. The minor ground state correction needed to understand the exact binding energy of the deuteron, and the energy corrections needed to understand the role of electron-positron creation in neutron decay, both give direct verification of the space-time system on which this whole theory is founded. These exact quantitative results are to be followed by many more in this chapter. Next, we will calculate from basic theory the mass of the particle H. Knowing this mass, we have, from the above analysis, the mass of the deuteron, the proton and the neutron.

## The Origin of the Basic Nucleons

To explain the formation of matter as we know it, it is necessary to explain the origin of the basic nucleons, the H particles of the above analysis. The quantization of angular momentum is basic to atomic systems. With this in mind, it can be assumed that in a highly energetic reaction in space-time where nuclear actions are in process almost any energy quantum between that of the graviton and that of the lattice particle can be formed. However, even transient stability requirements pose the need for appropriate disposition of quanta of angular momentum. Owing to angular momentum criteria, certain energy quantized systems are favoured and from these certain stable particle forms can develop. Both the neutron and the deuteron featured in the above analysis contain a negative H particle. To be formed from space-time, the H particle is likely to come from the energy released by an expanding graviton. The graviton provides the gravitational property of the space-time lattice, even in the absence of matter. This is necessary in view of the argument leading to equation (5.6) in Chapter 5. The  $E$  frame has gravitational effects according to its mass density. Thus, when the graviton expands, and so loses energy and mass, it is less able to balance mass in the space-time lattice. Graviton expansion must, therefore, accompany some break-up of the lattice. Now, all that this means is that the translational motion of a space-time system and graviton expansion both require lattice particles to be freed from their orbital motion with the  $E$  frame. Graviton expansion implies release of energy. This implies the formation of matter. Hence, translational motion of space-time has some fundamental association with the existence of matter. To provide dynamic balance and gravitational effects in an undisturbed space-time, the graviton must, before expansion, be effectively compacted through a definite volume from a gravity-free reference state. The compaction of the graviton through a certain volume produces a related electrodynamic effect causing gravitation. If the graviton provides a basic gravitational effect according to the mass density of the space-time lattice, it must already be compacted through the related volume. Since  $G$  is, apparently, the same for gravitation between space-time and matter, the volume compaction of the graviton from its zero-gravitation state to its normal condition must have a ratio to the graviton mass equal to its incremental

rate of volume compaction to mass ratio. From simple analysis based on equation (5.10), it can be shown that the total volume compaction of the graviton is three times its final and normal volume. In other words, the action of balancing the space-time lattice causes each graviton to be a compacted version of its gravity-free form and to occupy only one-quarter of its gravity-free volume. The corresponding energy and mass states of the graviton are in the ratio of the cube root of one quarter to unity. Thus, if the mass of the graviton is  $5,063m$  in the normal gravitating state, it is  $3,189 m$  in the non-gravitating state, that is,  $1,874 m$  less.

What this tells us is that, when a part of the lattice is displaced to the inertial frame to form free particles accompanying translational motion of the lattice, there is dynamic out-of-balance allowing graviton expansion to release energy in quanta of  $1,874 mc^2$ . The value of  $G$  has to be the same throughout such transitions, otherwise there would be problems explaining loss of gravitational potential. Hence, a quantum condition is imposed upon energy release.

Remember that in deriving equation (4.4) it was assumed that any angular momentum of the  $G$  frame was part of the zero angular momentum balance of a particle in the  $E$  frame. When this part comes out of its  $E$  frame orbit it deploys the corresponding orbital angular momentum from the  $G$  frame graviton to cancel its spin. This applies to the electron, as was shown in Chapter 4. It may also apply to the lattice particles. Hence, the release of the energy by the graviton in the manner just described does not release any angular momentum so as to cause a surplus. The graviton itself has no spin. Furthermore, since the graviton has no spin and since the freed lattice particles or electrons, in the sense of Chapter 4, have no spin either, the basic formation of matter occurs under zero-spin conditions.

Now, without elaborating further on the reasons, let us assume that a package of energy of up to  $1,874 mc^2$  is nucleated by a positive charge  $e$  and that an orbital electron having the basic angular momentum  $h/2\pi$  goes into orbit around it. Note that the energy need not be wholly associated with the positive charge. It could develop electron-positron pairs by its catalytic action in promoting such events in space-time. We may assume that most of the energy does find itself stored by the positive nucleating charge.\* Then, we have a

\* In Chapter 9 we will discuss the source of this positive charge. As will be explained, it is a positron. The source of the positron can be better understood when certain cosmic properties have been analysed.

simple problem. The nucleus thus formed needs to have some angular momentum itself. How does it get it? A dynamic system has been formed. There has to be balance. Space-time is not reacting in this case to provide the balance. The lack of angular momentum is the root of the problem anyway. Does it share some of the angular momentum with the electron. If so, how? It is not as if the electron originated from the central nucleus and developed the reaction. If interaction does operate to cause the angular momentum to be shared, which is the normal assumption, then the electron will not have the exact quantum  $h/2\pi$ .

The next problem with this system is that it will radiate electromagnetic waves because of the electron motion unless we can provide a photon unit to compensate. This is not feasible because such units are located in the  $E$  frame and the electron is moving in the inertial frame, in the strictly relative sense. Therefore, the only answer to turn to is that the electron is moving at an angular frequency exactly equal to the universal angular frequency  $\Omega$ . Then there should be no radiation problem.

This then raises other problems. There is motion relative to the  $E$  frame. This means that there are magnetic effects to consider. Curiously, however, it is possible for us to analyse the system without considering the magnetic force between the charges. There is, instead, a radiated wave of *angular field momentum*. This has its reaction in the system and this will be analysed. The proposition is that the electron retains its quantum angular momentum  $h/2\pi$  and that exactly the angular momentum needed by the nucleus is that in balance with the field angular momentum radiated. There is a mass-dependence in the analysis. This condition is only met for a definite nuclear mass quantity. It is this quantity which leads us to the mass of the H particle, and Nature happens to make this quantity just a little less than the energy quantum of  $1,874 m$  available for its creation.

In Fig. 7.6 a charge  $e$  carried by a particle of mass  $M$  is depicted in a dynamically balanced state with an electron of charge  $-e$  and mass  $m$ . The motion of the electron in the inertial frame is circular and has velocity  $v$  in an orbit of radius  $x$ . From the above introduction:

$$mvx = h/2\pi \quad (7.1)$$

The angular momentum of the particle of mass  $M$  will, therefore, be  $m/M$  times  $h/2\pi$ , from simple dynamic considerations. It is to be

noted that Newtonian dynamics are deemed to be strictly applicable because we are not dealing with a translational motion through the electromagnetic reference frame. There is the cyclic motion at the

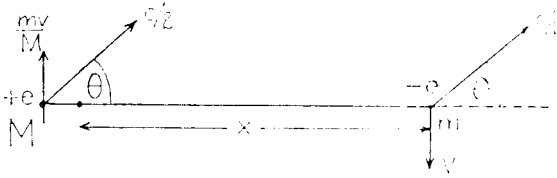

Fig. 7.6

frequency of space-time to consider. In fact, in some direction, say at angle  $\theta$  to the line joining  $M$  and  $m$ , we must add the velocity vector  $c/2$  to relate the motion in the inertial frame with one relative to the electromagnetic frame. The angle  $\theta$  does not change during the successive cycles of the  $E$  frame since the motion of the  $E$  frame and that of the dynamic system under study are both at the angular velocity  $\Omega$ . Note that the nature of the forces holding the two charges in this mutual orbital condition are not to be discussed. One must presume some kind of electric field interaction with space-time as we did in considering the physical basis of the Schrödinger Equation. There is some distinct similarity because the orbital radius can be shown to be  $2r$  from the data just presented and this is the same radius as that of the orbit of the non-transit electron discussed in developing the explanation of wave mechanics.

It is shown in Appendix II that where there are two interacting current vectors in the same plane there must be a radiated field angular momentum equal to the product of the two vectors multiplied by:

$$\frac{1}{c} \left( \frac{\pi}{12} - \frac{1}{9} \right) \sin \theta_o \tag{7.2}$$

where  $\theta_o$  is the angle between the vectors. The two current vectors have, of course, to be developed by separate charges. Since a current vector is charge times velocity divided by  $c$ , the quantity of interest from Fig. 7.6 is:

$$- \left( \frac{\pi}{12} - \frac{1}{9} \right) \frac{e^2}{c^3} \left( 1 + \frac{m}{M} \right) \frac{vc}{2} \sin \left( \theta \cdot \frac{\pi}{2} \right) \tag{7.3}$$

Note that  $v$  is the velocity of the electron and that the field angular momentum has two components because there are two pairs of interacting current vectors.

For maximum angular momentum reaction consistent with a minimum energy deployment to form the mass  $M$ , the angle  $\theta$  must be zero. This gives the total field angular momentum as:

$$-\left(\frac{\pi}{12} - \frac{1}{9}\right)\left(1 + \frac{m}{M}\right)\frac{e^2 v}{2c^2} \tag{7.4}$$

On the principles introduced this quantity should compensate the angular momentum of  $M$  itself. That is, it should balance  $(m/M)h/2\pi$ . Since  $v/x$  is  $\Omega$  or  $c/2r$ , (4.1) and (7.1) show that  $r$  is, simply,  $c$ . Thus, putting this in (7.4) and balancing with the angular momentum of  $M$ , we have a relation which can be rearranged as:

$$\frac{M}{m} = \frac{hc}{2\pi e^2} \frac{2}{\left(\frac{\pi}{12} - \frac{1}{9}\right)} = 1 \tag{7.5}$$

Upon evaluation, simplified by the fact that  $2\pi e^2/hc$  is the dimensionless fine structure constant (approximately 1/137), we find that  $M/m$  is 1,817.8.

Later in this chapter it will be shown that particles having this mass of 1,817.8  $m$  have an important role to play in the nuclei of heavy atoms. Such particles, being of extremely small radius, can readily combine with other particles, mesons, electrons, positrons, etc. For the moment, our interest must turn to the event in which an electron-positron pair, developed as the particle is actually formed, participates in the angular momentum reaction in the field. The proton is the prime system under study, so we will analyse the system presented in Fig. 7.7.

In Fig. 7.7 an electron-positron pair is shown to be in the near

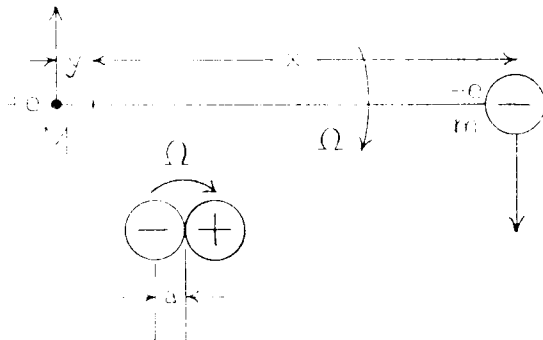

Fig. 7.7

vicinity of the heavy particle and the electron. This heavy particle, termed the H particle, moves in balance with the electron as described already by reference to Fig. 7.6. The electron-positron pair forms its own dynamic balance system and also rotates about its own centre of inertia at the angular frequency  $\Omega$ . These motions are about parallel axes and are synchronous in the sense that the velocity vectors of the particles in the two systems are at all times mutually parallel or anti-parallel, but in such relative direction as to assure the maximum combined angular momentum reaction in the field.

The purpose of this analysis is really to determine the mass of the heavy particle formed in the event of its creation being in close association with an electron-positron pair. The previous analysis led us to the mass of such a particle when created in isolation. Also, before proceeding too far, it is as well to realize that later we will be confronted with the problem of how, once the heavy particle is formed, it ever gets into the  $E$  frame to become normal matter. It will need angular momentum then in much larger quantities than can be induced by reaction with the field radiation. This problem will be discussed in Chapter 9.

Now, referring to Fig. 7.7, it is necessary to calculate the angular momentum of the field radiation due to the mutual interaction of the four particles. Any particle will react with the compounded  $c/2$  current vectors of the other three. The result is four terms in the angular momentum expression:

$$-\left(\frac{\pi}{12} - \frac{1}{9}\right) (y - a - a + x) \left(\frac{c}{2}\right) \frac{\Omega e^2}{c^3} \quad (7.6)$$

It is noted that the paired electron has a radius  $a$ , and therefore a velocity vector  $-a\Omega$ , whereas the positron has a velocity vector  $a\Omega$ . Since they have opposite polarity charge they combine to provide unidirectional current vectors.

As before, the value of  $x$  is  $2r$ , and  $y$  is  $(m/M)2r$ , where  $M$  is now the mass of the H particle. From (6.60), (6.69) and (6.70), the electron radius  $a$  is  $4/3(ar)$ , or  $r/103$ .  $\Omega$  is  $c/2r$ . Thus (7.6) is simply:

$$-\left(\frac{\pi}{12} - \frac{1}{9}\right) \left(1 + \frac{m}{M} - \frac{1}{103}\right) \frac{e^2}{2c} \quad (7.7)$$

As before, we equate this in magnitude to  $(m/M)h/2\pi$  and find that  $M/m$  is  $103/102$  times the value given by (7.5). It is thus deduced that  $M$  is  $1,835.6 m$ . The mass of the H particle we seek is about  $0.25 m$

less than the mass of the proton. The mass of the proton is about  $1,836.2 m$ , so the  $H$  particle mass should be about  $1,835.9 m$ , say. This is near enough to exact agreement with the theoretical value, so it can be said that very probably this analysis is well founded. The mass of the  $H$  particle has been derived from fundamental principles and it has been shown that there are two such heavy particle forms. They both are likely to have positive charge  $e$ . The heaviest is formed in close association with an electron-positron pair and has a mass a little less than  $1,836 m$ . The lightest is formed in isolation and has a mass of about  $1,818 m$ . This happens in the presence of an available energy quantum of about  $1,874 m$  released from the graviton, which, possibly, provides the nucleus for the formation of these heavy particles. As might be expected, the electron-positron pair can join with the  $H$  particle once formed to create the proton form  $B$ , already deduced as being the most prevalent in the process of matter creation.

### Atomic Nuclei

Before studying the spin properties of the proton, neutron and deuteron and providing further verification of the theoretical approach so far followed, it is convenient to pause here to explain the nature of the binding forces in heavier atomic nuclei.

The atomic nucleus comprises an aggregation of elementary particles. Principally, the nucleus is composed of protons and neutrons. We believe this because all atomic nuclei have masses which increment by approximately the same amount relative to their neighbours in the atomic mass scale. This mass increment is approximately the mass of the neutron or proton. Mass incrementation by the addition of a proton increases the electric charge of the nucleus by the unit  $e$ . It follows that if a nucleus has charge  $Ze$  it is most likely composed of  $Z$  protons. If its atomic mass is approximately  $X$  times that of the proton (after adding a little to account for binding energy) it is most likely composed also of  $X - Z$  neutrons.

Our problem is to determine how the mutually repulsive charges are held together and to examine what other elementary particles are in the nuclear composition. This problem is readily answered by this theory and is supported by the appropriate quantitative and qualitative findings.

The analysis of the deuteron has shown how nuclei might be formed from elementary particles. There is, however, a problem in



suggesting that heavy nucleons can become closely compacted. This is the problem of gravitational balance. It was shown in Chapter 6 that the gravitons in the  $G$  frame provide the gravitational mass balance in space-time. These particles have a mass which is about 2.7 times that of the proton. Further, these gravitons, being mutually repulsive, cannot compact without losing their space-time character. The statistical probability of the proximity of a graviton to any element of matter is related to the mass of that element so that the balance condition is assured. The gravitons are effectively melded with the distributed charge of the continuum element of space-time. They have a distribution which makes the mass density of this continuum  $G$  frame system uniform save where mass of matter present requires some concentration. The gravitons are, therefore, spaced apart on some statistical basis. However, the closest spacing where balance is needed within a well-compacted atomic nucleus is deemed to be the metric spacing  $d$ , the spacing of the lattice forming space-time. This will be discussed further in Chapter 9, since it involves possibilities which are a little speculative but, suffice it to say, we will assume that the proper spacing of gravitons in a nucleus has a lattice form with spacing  $d$ . The gravitons can move about in their statistical pattern but favour certain relatively spaced discrete positions matching the spacing of the space-time system. On this basis, we will also preclude more than two heavy nucleons from forming a compacted nucleus. The gravitons cannot balance three nucleons in a closely compact state. Further, in atomic nuclei containing more than two heavy nucleons, it seems more logical for them to have the regular spacing introduced above. In short, our hypothesis is that a loosely compacted nucleus can be formed of many nucleons provided it has a dynamic affinity with a graviton spacing matching the lattice spacing of the particles forming the  $E$  frame of space-time. This allows the nucleons to occur singly (or perhaps in pairs as well) in an atomic nuclear lattice also of cubic form and of spacing  $d$  of  $6.37 \cdot 10^{-11}$  cm.

We may then portray an atomic nucleus as in Fig. 7.8, where the bonds between the nucleons are all of length  $d$  and are aligned with the fixed directions of the space-time lattice. This means that an atomic nucleus lattice cannot spin, even though the individual nucleons may spin about their own diameters and the whole nucleus can move linearly or in an orbit relative to the  $E$  frame lattice. The nucleus lattice retains its fixed spatial orientation.

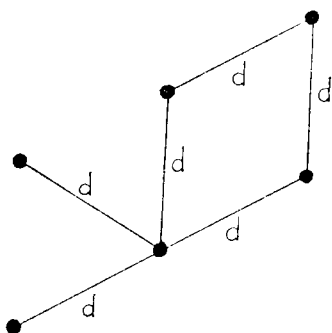

Fig. 7.8

### Nuclear Bonds

What is the form of the nuclear bonds? Each of the six nucleons in Fig. 7.8, three protons, say, and three neutrons, identified by the full bodied circles, has a bond of its own providing one of the links. These bonds are the real mystery of the atomic nucleus. We will assume that their most logical form is merely a chain of electrons and positrons arranged alternately in a straight line. The reason for the assumption is that electron-positron pairs are readily formed in conjunction with matter, and we have seen how an in-line configuration of alternate positive and negative particles has proved so helpful in understanding the deuteron. Stability has to be explained. Firstly, the chain is held together by the mutually attractive forces between touching electrons and positrons. Secondly, it will be stable if the ends of the chain are held in fixed relationship. This is assured by the location of the nucleons which these bonds interconnect. In Fig. 7.9 it is shown how the bonds connect with the basic particles. In the examples shown, the nucleons are positioned with a chain on either side and are deemed to be spinning about the axis of the chain. Intrinsic spin of the chain elements will not be considered. It cancels as far as observation is concerned because each electron in the chain is balanced by a positron. In Fig. 7.10 it is shown how, for the neutron, for example, the spin can be in a direction different from that of the chain. Also, it is shown how another chain may couple at right angles with this one including the neutron. Note, that the end electron or positron of the chain does not need to link exactly with the nucleon. Therefore, it need not interfere with the spin.

We will now calculate the energy of a chain of electrons and positrons. For the purpose of the analysis we will define a standard

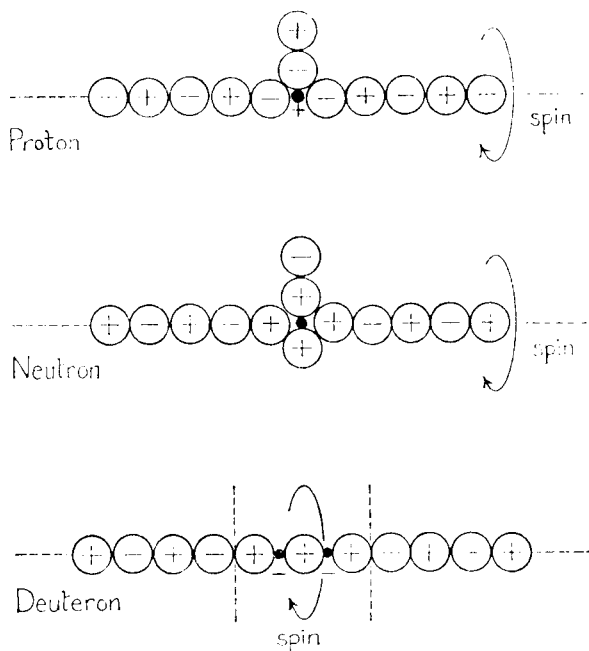

Fig. 7.9

energy unit as  $e^2/2a$ . This is the conventional electrostatic energy of interaction between two electric charges  $e$  of radius  $a$  and in contact. Since  $2e^2/3a$  is  $mc^2$ , as applied to the electron, this energy unit is  $0.75 mc^2$ . On this basis, a chain of two particles has a binding energy of  $-1$  unit. If there are three particles the binding energy is the sum of  $-1$ ,  $\frac{1}{2}$  and  $-1$ , since the two outermost particles are of opposite polarity and their centres are at a spacing of  $4a$  and not  $2a$ .

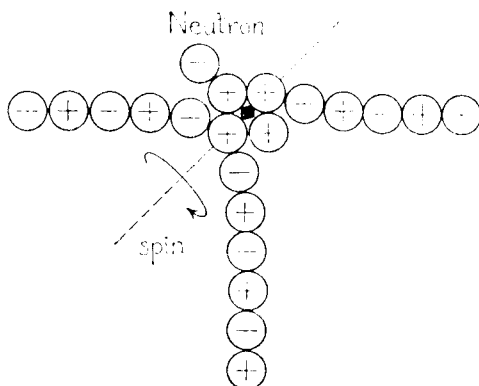

Fig. 7.10

For  $N$  particles, with  $N$  even, the total interaction energy is:

$$-(N-1) + \frac{(N-2)}{2} - \frac{(N-3)}{3} + \dots - \frac{2}{(N-2)} - \frac{1}{(N-1)}$$

which is  $-N \log 2$ , if  $N$  is large. If  $N$  is odd, the last term in the above series is positive and the summation, for  $N$  large, is  $1 - N \log 2$ . To find  $N$  we need to know how many particles are needed for the chain to span a distance  $d$ .  $d$  can be related to  $m$  by eliminating  $r$  from (4.1) and (6.60). Then  $d/2a$  is found using  $2e^2/3a = mc^2$ . It is  $54\pi$ , so  $N$  may be, say, 169, 170 or possibly 168, particularly if  $N$  has to be even and there has to be space for any nucleons. For our analysis we will calculate the binding energy of the chain and the actual total energy of the chain for all three of these values of  $N$ . The data are summarized in the following table.

$N$	168	169	170
$-N \log 2$	-116.45	-117.14	-117.83
Binding Energy (units)	-116.45	-116.14	-117.83
Binding Energy ( $mc^2$ )	-87.34	-87.11	-88.38
Add Self Energy ( $mc^2$ )	168	169	170
Total Chain Energy	80.66	81.89	81.62
Ground State Correction	0.61	0.62	0.62
Corrected Energy ( $mc^2$ )	81.27	82.51	82.24

In the above table the binding energy has been set against the self energy of the basic particles and a correction has been applied of  $amc^2$  per pair of particles to adjust for the fact that mass is not referenced on separation to infinity, as was discussed earlier in this chapter. The total mass energy of the chain is seen to be about 81 or 82 electron mass energy units, depending upon its exact length.

This shows that while the electron-positron chain proposed will provide a real bond between nucleons linked together to form an atomic nucleus, it will nevertheless add a mass of some 81  $m$  per nucleon. This seems far too high to apply to the measured binding energies. Furthermore, it is positive and the nature of binding energy is that it must be negative. This can be explained by introducing the  $\pi$  meson or pion, as it is otherwise termed.

### The Pion

When an electron becomes attached to a small but heavy particle of charge  $e$ , the interaction energy is very nearly  $-e^2/a$  or 1.5 times

the energy unit  $mc^2$ . This means that the mass of the heavy particle is effectively *reduced* when an electron attaches itself to it and becomes integral with it. If we go further and seek to find the smallest particle which can attach itself to a heavy nucleon to provide enough surplus energy to form one of the above-mentioned electron-positron chains, we can see how this nucleon plus this particle plus this chain can have an aggregate mass little different from that of the initial nucleon. This can reconcile our difficulties. The fact that an electron can release the equivalent of about half its own mass indicates that to form the chain of mass  $81 m$  we will need a meson-sized particle of the order of mass of the muon or pion. To calculate the exact requirement we restate the inverse relationship between the mass  $m$  of a particle of charge  $e$  and its radius  $a$ :

$$2e^2/3a = mc^2 \quad (7.8)$$

This applies to the electron, but it can also be used for other particles such as the meson and the H particle.

It may then be shown that if two particles of opposite polarity charge  $e$  are in contact, their binding energy,  $e^2$  divided by the sum of their radii, is  $3c^2/2$  times the product of their masses divided by the sum of their masses. Let  $M_o$  be the mass of the meson involved and  $M$  be the mass of the H particle. The following table then shows the value of the surplus energy:

$$\frac{3M_oMc^2}{2(M_o + M)} - M_o c^2 \quad (7.9)$$

in terms of units of  $mc^2$ , for different values of  $M_o/m$  and the two values of  $M$  of  $1,818 m$  and  $1,836 m$ .

$M_o/m$	$M = 1,818 m$	$M = 1,836 m$
230	76.1	76.4
240	78.0	78.3
250	79.7	80.0
260	81.2	81.5
270	82.6	83.0
280	84.0	84.5

This shows that the energy of the formation of the meson will be adequate to form the chain if the meson is in the mass range of  $M_0/m$  between 260 and 270. The only meson available in this range is the neutral  $\pi$  meson of mass  $264.6 \pm 3.2 m$ , according to Marshak (1952). However, this is a neutral meson. The best available meson, that is the one of lowest mass and having a charge but yet sufficient to form a chain of energy  $82 mc^2$ , is the charged  $\pi$  meson which has a measured mass of about  $276 m$ . According to the above table, this affords an energy of slightly less than  $84 mc^2$ , which is sufficient to form a chain while providing a surplus of one or two electron mass units. This means that the combination of such a meson, a nucleon and a chain has a total mass which differs from that of the nucleon itself by only one or two electron mass units. The total mass will be less by this amount so that this really is a measure of the binding energy involved.

This gives us an approach to calculating the mass of an atomic nucleus. The nucleus can be regarded as an aggregation of some protons containing H particles of mass  $1,818 m$  or  $1,836 m$  or a mixture of both, some neutrons which may also comprise either H particle, and as many  $\pi$  mesons and chains as there are nucleons (except for the deuteron and the hydrogen nucleus). There is the clear indication that the  $\pi$  meson has an important role to play in nuclear physics. In fact, it has been believed for some years that it is involved in the binding mechanism of the atomic nucleus, and this theoretical finding is, therefore, by no means unexpected.

It is of interest to speculate about the electron-positron chain coming free from the nucleus. With an even value of  $N$  the chain would be a neutral entity having a mass of  $81.27$  or  $82.24$  times that of the electron. If this latter energy is deployed to remove a meson attached to an H particle of mass  $1,836 m$ , the above table shows that it could develop a meson of mass  $265 m$ . If the meson came from the lighter H particle, it would be  $267 m$ . It is possible, therefore, that the nuclear chain could be created by the formation of a charged  $\pi$  meson of mass  $276 m$ , as the latter comes into aggregation with the H particle. Energy of some one or two electron mass units is surplus from this reaction. However, in the reverse direction, it might happen that the  $\pi$  meson can, in nuclear reactions, expand to lose some of its energy and, then, just as it reaches the stage where a chain can collapse to provide the energy needed to drive the meson away from the H particle, it is released. At this stage its mass would be about

265  $m$  or 267  $m$ . Although it would still have a charge, it could be that this process has some relation with the formation of the neutral  $\pi$  mesons. These do have this lower mass value.

This is, of course, mere speculation. It is open to criticism because it is not clear how a long series of electrons and positrons can just vanish and release all their mass energy. If they meld into space-time, as with the annihilation of the electron-positron pairs, there is still about 3% of the energy of  $mc^2$  of each electron and positron needed to sustain the charge in its new form (see page 138). Thus, about  $5mc^2$  is to be subtracted from the energy released by the chain. Also, if we examine Fig. 7.9 closely and ask how a meson is attached to the heavy H particle in each of the systems shown, we see that it is easy in the case of the proton but in the case of the neutron or deuteron an oppositely-charged particle would make it difficult to have the particle configuration shown. Even in the case of the proton, the presence of a negative meson attached to the positive H particle opposite the electron-positron pair, would alter the polarity sequence of the chain ends.

These are not problems which invalidate the theory. They are indications that we cannot expect to have the atomic structure fit together easily to provide simple and convincing results. It is possible that we should not be thinking in terms of protons and neutrons when we analyse heavy atoms. Perhaps we should consider only H particles connected by chains and having the mesons attached to them, possibly in the chain. The answers can probably best be found by indirect analysis. For example, the spin properties of the proton and neutron can be studied under different conditions. This type of approach seems more appropriate at the present stage of development of the theory.

### Proton Spin

The nuclear theory presented so far in this chapter might seem to be elaborate in certain respects. However, it has been supported by the following quantitative results:

- (a) The derivation of the observed binding energy of the deuteron,
- (b) The derivation of the observed energy of the electron ejected in neutron to proton decay,
- (c) The derivation of the observed mass of the  $\pi$  meson, in the

approximate sense and on the assumption that the  $\pi$  meson serves a prime role in nuclear binding,

- (d) The derivation of the mass of the H particle from first principles, this quantity being then available to obtain from this theory the masses of the neutron, proton and deuteron, all stated as a ratio in terms of the mass of the electron.

The question now faced is whether these same principles guide us to the magnetic moments and spin angular momenta of these nuclear particles.

Consider the spin condition of the proton shown in Fig. 7.11. The spin condition is deemed to be that in which a particle rotates about a centre within the particle. Thus a single sphere of charge rotating about a diameter is said to *spin*. An aggregation of such charge spheres rotating about the common centre of mass can be said to spin also. *Intrinsic spin* will be used to represent the sum of the spins of the individual spheres of charge in such a particle aggregation. Thus, in Fig. 7.11 we denote the spin angular velocity about the

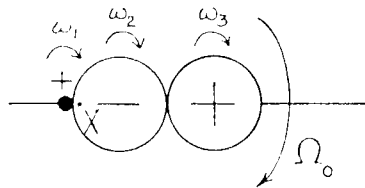

Fig. 7.11

point  $X$  as  $\Omega_0$ .  $X$  is the centre of mass of the proton and is distant approximately two H particle radii from the centre of the H particle. The particles in the proton are deemed to be in rolling contact. Let  $\omega_1, \omega_2, \omega_3$  denote the angular velocities of the H particle, the electron and the positron in the inertial frame. Then, relative to the line of centres which rotates at  $\Omega_0$ , the angular velocities become  $\omega_1 - \Omega_0, \omega_2 - \Omega_0, \omega_3 - \Omega_0$  respectively. For rolling contact, taking radii as  $r_1, r_2, r_3$  respectively:

$$(\omega_1 - \Omega_0)r_1 = -(\omega_2 - \Omega_0)r_2 = (\omega_3 - \Omega_0)r_3 \quad (7.10)$$

The spin angular momentum of each component particle is proportional to its mass, angular velocity and radius squared. Since mass is inversely proportional to radius, spin angular momentum is proportional to  $\omega_1 r_1, \omega_2 r_2, \omega_3 r_3$  for the three particles respectively. The



intrinsic spin angular momentum of the proton is thus proportional to the sum of these quantities. This spin angular momentum is assumed to be zero, as will be discussed later. Accordingly:

$$\omega_1 r_1 + \omega_2 r_2 + \omega_3 r_3 = 0 \quad (7.11)$$

Now,  $r_2$  and  $r_3$  are respectively the radius of the electron and positron, both denoted  $a$  elsewhere in this book.  $r_1$  is the radius of the H particle and is  $(m/M)a$ , where  $m/M$  is the mass ratio of the electron and H particle. Since  $M$  is about 1,836  $m$ ,  $r_1$  can be assumed negligible for a first analysis, making  $\omega_1$  very high and allowing  $(\omega_1 - \Omega_0)r_1$  in (7.10) to be replaced by  $\omega_1 r_1$ . From (7.10) and (7.11) it is then simple algebra to show that  $\omega_1$ ,  $\omega_2$ ,  $\omega_3$  are respectively  $-2\Omega_0(M/m)$ ,  $3\Omega_0$ ,  $-\Omega_0$ .

We can now consider the magnetic moment of the proton. From Appendix I the spin contribution of each component particle is  $e/6c$  times angular velocity and radius squared. For orbital motion  $e/6c$  has to be replaced by  $e/2c$ , as is well known. Also, it must be remembered from Chapter 2 that, strictly, these quantities may have to be increased by a factor to explain certain anomalous behaviour.

The spin contribution just mentioned is one-third that of the related orbital contribution simply because the charge within the sphere is distributed over its volume. Accordingly it cannot be regarded as all being at the specified radius, as it can in the case of orbital motion. In evaluating the spin magnetic moment of the composite particle shown in Fig. 7.11, we find that there is a component due to the intrinsic spin and a component due to the spin about the point  $X$ . This latter component is evaluated from the above mentioned orbital formulation. Thus, it consists approximately of only two major elements,  $e/2c$  times  $9a^2\Omega_0$  for the positron and  $-e/2c$  times  $a^2\Omega_0$  for the electron. Note that  $r_2 + 2r_3$  is  $3a$ . The H particle makes a very small contribution to magnetic moment and it can be ignored. Due to intrinsic spin, there are also two major elements,  $e/6c$  times  $a^2\omega_3$  for the positron and  $-e/6c$  times  $a^2\omega_2$  for the electron. Again, the H particle can be ignored. Since  $\omega_2$  is  $3\Omega_0$  and  $\omega_3$  is  $-\Omega_0$  the total contribution due to intrinsic spin is  $-4(e/6c)a^2\Omega_0$ . Collecting the components due to motion about X gives  $8(e/2c)a^2\Omega_0$ . Thus the total magnetic moment should be  $20(e/6c)a^2\Omega_0$  times the appropriate anomalous factor. Putting this as  $\gamma$  we have a proton magnetic moment of:

$$20\gamma(e/6c)a^2\Omega_0 \quad (7.12)$$

In connection with Fig. 4.4 it was explained how the nucleus of an atom has an angular momentum exchange relationship with a nuclear photon unit. Applying this to the proton, it is to be expected that the rotation about the point  $X$  will be synchronous with the rotation of the photon unit. The reason is that the proton has a non-symmetrical distribution of its charge. A small electric disturbance developed by the rotation of the proton can probably be compensated by an appropriate but very small perturbation of the motion of the associated electron. This tells us that:

$$\Omega_o = 4(\omega_o - \omega) \tag{7.13}$$

where  $\omega$  now has the meaning given in Fig. 4.4. The sense of “synchronous”, as just used, therefore means that the rotation frequency of the proton about its centre of mass is exactly *four* times that of the photon unit. The reason is that the photon unit generates four pulsations every revolution. For the standard photon unit,  $\omega_o$  is  $\Omega/4$  and  $I\omega_o$  is  $h/2\pi$ . For the simple electron-proton system, (4.21) shows that  $I\omega$  is  $ah/2\pi$ . This shows that (7.13) becomes:

$$\Omega_o = (1 - a)\Omega \tag{7.14}$$

The magnetic moment of the proton is evaluated from (7.12) and (7.14). To test this analysis it has to be noted that the measured magnetic moment involves a pre-knowledge of the proton spin angular momentum. This angular momentum is finite, even though we have assumed a total intrinsic spin component to be zero. There is a basic angular momentum quantum of  $h/4\pi$ . In interpreting proton magnetic moment measurements this quantum is assumed to apply. However, remembering the mechanism presented in Fig. 4.4, we have to note that an angular momentum  $\varepsilon$  is transferred between the electron and the proton. This quantity  $\varepsilon$  is  $I\omega$  in (4.21). Thus, it is to be expected that the proton angular momentum is really  $(1 + 2a)h/4\pi$  and the electron angular momentum  $(1 - 2a)h/4\pi$  in this particular system. The magnetic moment of the proton is measured by a resonance technique in which the ratio of the *actual* magnetic moment and the *actual* angular momentum is observed. If the angular momentum has been underestimated then the measured magnetic moment will be too high. To facilitate comparison with reported measurements based upon the assumed half-spin quantum, the proton magnetic moment given by (7.12) and (7.14) should be

adjusted by multiplying it by  $(1 + 2a)$ . Thus, the proton magnetic moment can be written as:

$$20\gamma(e/6c)a^2(1 - a)(1 + 2a)\Omega \quad (7.15)$$

At this stage, we pause to introduce a result derived in Appendix III. The value of  $\gamma$  is 9.6, a quantity much higher than the factor of 2 derived for the large-scale orbital motions in Chapter 2. It seems that in order to generate the kinetic reaction effects in the field medium the spins of elementary particles have to be higher than one would expect from normal theory. This result is deduced from the analysis of the balance conditions of magnetic field and angular momentum in the space-time system. It can be put to immediate test in applying (7.15).

Putting  $\gamma$  as 9.6 in (7.15) and noting that  $a/r$  is  $4a/3$ ,  $\Omega$  is  $c/2r$  and  $a$  is  $1/137$ , the expression for the measured proton magnetic moment becomes:

$$\frac{256}{9} a^2(1 - a)(1 + 2a)er$$

where  $er$  is the Bohr Magneton. When evaluated this gives:

$$1.525 \cdot 10^{-3}$$

Bohr Magnetons, which is very close to the measured value of  $1.521 \cdot 10^{-3}$ . The fact that the H particle has been taken to be of negligible size may account for the slight difference in these results. Certainly, it seems that there is evidence to support the proton form presented, besides affording verification of the theoretical evaluation of  $\gamma$ .

### Neutron Spin

To calculate the spin properties of the neutron we have to know the form assumed by the neutron in the experimental environment of nuclear resonance. If another electron is added to the proton system in Fig. 7.11 on the left-hand side of the H particle and the proton spins are retained, we can easily calculate the neutron magnetic moment. In the case of the proton magnetic moment the electron contributed  $-6$  units to the parameter 20. Thus, for the neutron just developed the parameter 20 in (7.12) becomes 14. The ratio of the neutron magnetic moment to that of the proton should therefore be

about 14.20 or 0.7. In fact, from experiment it is  $-0.6850$ . The minus sign means that we should have inverted all the polarities in the neutron model just proposed. It must comprise a negative H particle, two positrons and one electron. It has the form used in Fig. 7.4 and as depicted as form B in Fig. 7.1.

It is possible that when the ratio of the magnetic moments of the proton and neutron is measured they are so close together that the proton is not bound by the photon unit coupled with the electron action but the neutron is. The neutron does not really qualify for pairing with an electron, and thereby being detected, since it has no resultant charge. However, it can assert an association with an electron if it is paired with a proton and if it takes over the electron associated with the proton. The affinity between the neutron and the electron may be favoured from their magnetic interaction. This means that the proton will have the half spin quantum  $h/4\pi$  whereas the neutron will take the angular momentum  $(1 + 2a)h/4\pi$  and rotate with a photon unit to comply with (7.14). We then expect the measured ratio of neutron and proton magnetic moments to be  $-0.7$  times  $(1 - a)/(1 + 2a)$  or  $-0.6849$ . This seems close enough to the measured value of  $-0.6850$  to give adequate satisfaction. It is further gratifying because in evaluating a ratio we avoid dependence upon the parameter  $\gamma$ .

We now turn attention to Figs. 7.9 and 7.10. The neutron is there shown in its bound state in the atomic nucleus coupled to the electron-positron chains by attachment to the positron terminations of the chains. These illustrations were merely diagrammatic. The coupling needs to be considered more closely. In Fig. 7.12 an electron and a positron are shown attached to the neutron along the spin axis. They are ready to form the connections with any chains in the nucleus. It may be shown that a pair of electrons or a pair of positrons cannot

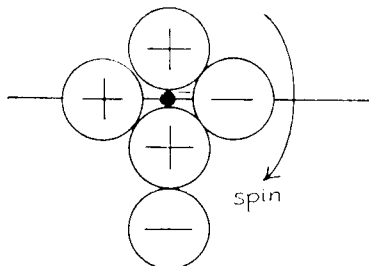

Fig. 7.12

replace the added electron-positron pair and yet form an arrangement in which the forces between the component particles will hold things together. We must assume, therefore, that a neutron can capture an electron-positron pair to form the system shown in Fig. 7.12 or, at least, that it joins to nuclear bonds through an electron on one side and a positron on the other. If the neutron spins there will be rolling contact with these end particles. For no slip they must rotate and so become a feature of the neutron spin. This is the other reason why they should have opposite polarity. Their magnetic moments will cancel and so not affect the above analysis.

Neglecting the finite size of the H particle, and remembering that the adjacent particles have spin at  $3\Omega_0$  besides rotating about the neutron spin axis at  $\Omega_0$ , we see that the contact with the end particles causes them to spin on the neutron spin axis at  $-2\Omega_0$ . The point about this is that for electrons or positrons on a spin axis an angular velocity of  $2\Omega_0$  is to be expected.

### Deuteron Spin

The deuteron has symmetry and is therefore not involved in a spin governed by photon units. The problem, therefore, is to decide how to determine any spin of the three positron constituents in its composition. From the foregoing comments one could guess that each positron may have a spin of  $2\Omega_0$  where  $\Omega_0$  is put equal to  $\Omega$ . The parameter of magnetic moment is then 6 units compared with 20 for the proton and  $-14$  for the neutron. Alternatively, since the deuteron is little different from a proton and a neutron combined we can possibly combine 20 and  $-14$  to obtain the same parameter 6.

To apply this to experiment we note that in terms of a measured separate proton resonance for which the proton magnetic moment parameter is slightly less than 20 and its spin angular momentum slightly more than  $h/4\pi$ , the deuteron magnetic moment is:

$$\frac{6}{20}(1+2a)(1-a) \quad (7.16)$$

Upon evaluation, this is 0.3066, which compares with a measured value of 0.3070. Again, allowing for the fact that the dimensions of the H particle are ignored, this result is excellent.

The difficulty with the deuteron is to understand how it contributes to the magnetic resonance experiment. Are we even certain that the

deuteron which performs in such experiments is quite the same as the one which undergoes transmutation in nuclear processes? May it not be that a proton and a neutron have become locked together in a state of spin? Going back to the basic deuteron model, let us examine what has to happen to a neutron and a proton for the compacted deuteron to form. In Fig. 7.13 the neutron and the proton are shown

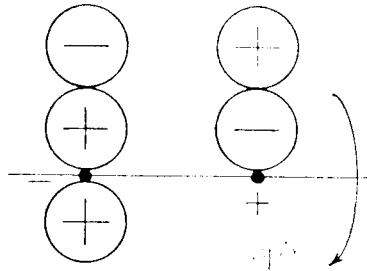

Fig. 7.13

side by side spinning about the same axis. Note that the spin motions of the outer electron in the neutron and the outer positron in the proton are identical from the foregoing analysis. Since these two particles have opposite polarity they effectively cancel one another's magnetic moment. Now, if the neutron and the proton become locked together in a spin motion state, the combined magnetic moment is independent of the presence of the electron and positron just mentioned. If the neutron and proton fuse together and eject the electron and the positron we have the inverse process to that shown in Fig. 7.4. There, the deuteron absorbed an electron and a positron to form a neutron and a proton. Here, once the electron and positron are removed, we are left with the same total magnetic moment. Also, by the inversion of the positive H particle and its electron, we can expect aggregation to form the deuteron comprising two negative H particles and three positrons. If each positron adopts a  $2\Omega$  spin, or thereabouts, sharing the magnetic moment of the neutron and proton, the magnetic moment of the deuteron is still as given by (7.16) in comparison with that measured for the free proton. It follows that it is possible to explain spin magnetic properties of the deuteron in terms of the same model as was used to calculate the binding energy. This affords a double check on the nature of the deuteron and its constituent nucleons.

## Electron Spin

Before leaving this chapter we must consider the rather complicated problem of electron spin.

In the analysis in Chapter 4 it was found appropriate to assume that the total angular momentum of a basic particle (the lattice particle or the electron) is zero. This meant that there was a spin component and an orbital component compensating each other, as formulated in equation (4.4). It will also be found in Appendix III that we will apply this concept of total angular momentum being zero for the lattice particle when we analyse the residual spin frequency of the particle. Quite apart from angular momentum balance, we will there use the particle spin to explain the source of a magnetic moment balancing the magnetic moment of the continuum charge in space-time. The latter moves cyclically relative to the electromagnetic reference frame set by the lattice particles. Now, the balance conditions just mentioned are subject to small residual effects. In the main these can be ignored in the analysis. However, to explain certain phenomena and discrepancies in quantitative analysis we do have to pay attention to them.

The anomalous spin properties of the electron *may* be due to this cause. For the orbital electron we have seen in Chapter 2 that an angular momentum of  $h/2\pi$  can develop a magnetic effect equivalent to that of two Bohr Magneton. The magneto-mechanical ratio is  $e/mc$  and this leads to a magnetic moment based on  $h/2\pi$  of twice  $eh/4\pi mc$ , the Bohr Magneton. It was there shown that reaction effects cancelled half the field, thus making the *apparent* magnetic moment of an orbital electron of angular momentum  $h/2\pi$  seem to be that of the Bohr Magneton. When we turn to the problem of spin we find evidence of half-spin quanta of angular momentum  $h/4\pi$  and the measured magneto-mechanical ratio of the electron appears still to be  $e/mc$ , though only approximately. Indeed, the anomaly factor of 2 becomes, when measured, slightly higher than 2 by the factor  $1.001146 \pm 0.000012$  or  $1.001165 \pm 0.000011$ . Sommerfield (1957) has presented the experimental data and mentions these two conflicting measurements. The anomalous component in this factor is assumed to be in the magnetic moment and not in the angular momentum. Also, Farley *et al.* (1966) have measured the same anomaly for the negative muon and found the anomalous component to be  $0.0011653 \pm 0.0000024$ .

There is, therefore, a fundamental problem to answer. It is associated with spin, and yet spin seems to be some property merely attributed to the half-quantum  $h/4\pi$ , whereas the main anomalous effect is associated with the mysterious doubling of the magneto-mechanical ratio. The anomalous properties of the electron may still be seated in what can just as well be termed orbital motion.

Quantum electrodynamics already provides an answer for the anomaly. By a rather complex treatment, which has not been wholly accepted by the physicist, quantum electrodynamics gives a value of  $a/2\pi$  or 0.001161, subject to slight upward revision to allow for higher order terms in the calculations. As before,  $a$  is the fine structure constant. It is therefore not really necessary to challenge this explanation in this work. Quantum theory is linked to the concepts newly introduced in the previous pages. Thus the anomalous magnetic moment of the electron and the not-unrelated phenomenon known as the Lamb Shift which already have explanation in physics need not strictly be pursued here. However, the author has relied upon the space-time reaction as offering explanation for the anomalous factor of 2 in electron magneto-mechanical studies. Also, the quantum electrodynamic explanation presents some doubts. Therefore, the reader may be interested in a little speculative enquiry into the anomalous electron spin properties.

In the analysis of the formation of the H particle it was found that some field angular momentum due to radiation would be developed. Thus, there can be change in angular momentum according to the different states of transmutation of the system of particles involved. A basic angular momentum quantum due to field radiation is that given by (7.4). Ignoring the small component  $m/M$  and introducing the value of  $r$ , this expression gives the angular momentum quantum:

$$\left(\frac{\pi}{12} - \frac{1}{9}\right) \frac{e^2}{2c} \tag{7.17}$$

This angular momentum quantum has some association with the existence of the H particle. Now, consider an H particle and an electron as shown in Fig. 7.14 spinning in rolling contact and turning at the universal angular velocity  $\Omega$  about their common centre of mass. Neglecting terms in  $m/M$ , the mass ratio of the electron and H particle, the angular momentum of the system is  $ma^2\Omega$  or  $\frac{1}{2}mcr(a/r)^2$ , which is  $\frac{1}{2}(h/4\pi)(4a/3)^2$ .

We thus have, as it were, a need for these small angular momentum



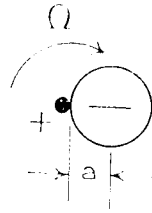

Fig. 7.14

quantities when we think of the transmutation of particles involving heavy nucleons, the H particles, in motion at the angular velocity  $\Omega$ . The motion states considered involve balance with an electron. Consequently, it may be that these angular momenta have some residual association with the electron even when it has transferred to perform other roles. Guided by the quantitative implications, we will evaluate the two angular momentum quantities just derived. That just presented is simply  $8/9$  divided by  $137$  squared in units of  $h/4\pi$ . This is:

$$0.000049$$

(7.17) is simply evaluated since  $e^2/2c$  is  $a(h/4\pi)$ . It is:

$$0.001100$$

Together, the angular momenta total  $0.001149$  half-spin units which could possibly be an anomalous angular momentum component of the electron. Furthermore, as already discussed, the electron participating in balance in magnetic nuclear resonance measurements can have an angular momentum of  $(1 - 2a)h/4\pi$  owing to transfer action with the nucleus. This is mentioned in deriving (7.15). On this basis it is possible that in some situations the anomalous parameter  $0.001149$  is referenced on  $1 - 2a$  instead of unity. This would increase its effect, as a ratio, to  $0.001166$ .

This is mere speculation. No attempt is made to explain the physical processes by which the electron acquires its residual spin properties. Further, no attempt is made to explain the true nature of the magnetic moment of the electron. There are problems remaining. Suffice it to say that we need not be surprised that the electron behaves anomalously. It may be coincidence that the analysis just presented leads to anomalous factors of  $0.001149$  and  $0.001166$  according to the two possible states of the electron in its nuclear balance role. The fact that two conflicting measurements of  $0.001146$  and  $0.001165$  have emerged in practice is certainly of interest. Although, as yet, the argument presented is not conclusive, it is

possibly sufficient to show the reader that the success of the quantum electrodynamic approach may not be the last word on the subject. What is offered here may lead to a better explanation.

The outcome of this review is that residual spin properties are a feature of the electron produced in transmutations. Apart from this, the zero total angular momentum condition is retained and can be applied both to the space-time lattice particles and, at least to close approximation, to the electron moving with the  $E$  frame. The half-spin quantum  $h/4\pi$  remains standard either as the basic approximate quantum of electron spin or as the balancing orbital effect due to  $E$  frame motion and  $G$  frame balance. The proton in the  $E$  frame has zero intrinsic spin. Other heavy composite particles, the neutron and the deuteron, for example, appear to have a small intrinsic spin. Thus, it appears that, apart from any intrinsic spin, heavy particles containing nucleons have a total spin property not merely set by their mass and not merely in balance with the  $E$  and  $G$  frame motion components. These particles somehow get primed with spin angular momentum in multiples of  $h/4\pi$ . The proton has a spin angular momentum of  $h/4\pi$  in spite of its zero intrinsic spin. The neutron has the same spin angular momentum with non-zero intrinsic spin. The deuteron has a spin angular momentum of  $h/2\pi$ . This topic will be discussed further in Chapter 9. The quantum nature of the spins of heavy particles has been assumed in the above analysis of spin magnetic moments. There were minor modifications of the spin quantization to allow for transfers of angular momentum. These involved the fine structure constant  $\alpha$ . Accordingly, though it is claimed that an adequate account of magnetic moment of the spin states of nuclear particles has been developed, there is no explanation given for the angular momentum quantization. Also, the heavy particles containing nucleons do have angular momentum from their motion with all matter in the  $E$  frame. It is not true to say that their angular momentum sums to zero. Thus an out-of-balance of the angular momentum is a feature of the presence of matter in space-time. It is not surprising, therefore, to find astronomical bodies turning without there being any apparent balance of angular momentum amongst matter.

The problem of the spin magnetic moment of the electron has not been analysed directly. It will be shown in Appendix III that a lattice particle develops, by spin, a magnetic moment equal to two Bohr Magnetons. Perhaps the electron does the same for the same reason when it is set in the  $E$  frame. Perhaps, however, since this magnetic

moment is locked in a fixed direction in space and is acting to cancel that developed by other electric charge in space-time, this property passes undetected. We do not need to speculate about it further. Little is likely to emerge. It is true that spin magnetic moment of the electron has been explained on established theory as being due to two separate components of charge differently distributed over the electron. One is deemed to rotate while the other remains at rest. This is bold assumption, indeed. It is analysed by Page and Adams (1965). It is demonstrative of the difficulties which the physicist has given himself by refusing to have anything to do with a real space-time medium and retaining inflexible electrodynamic principles.

### Summary

The ideas developed in Chapter 4 on the wave mechanical model of the atom have been melded with the thoughts on the electron and deuteron presented in Chapter 1. The object has been to provide an insight into the structure of the atomic nucleus. The nature, mass and magnetic moment of the proton, neutron and deuteron have been explained. It is to be expected that the properties of atomic nuclei, as aggregations of protons and neutrons, should become explicable on this theory. Though this remains to be explained, progress has been made in finding the bonds between such nucleons. These bonds appear to be electron-positron chains and this is evidenced by the essential role played by the pion in their formation. The pion latches on to a heavy basic particle, a nucleon, and so releases a binding energy which is enough to account for the self-energy of the pion and provide a surplus needed to create the chain. The result is that the mass effect of the binding energy, being negative, just overcompensates the mass of the pion itself and that of the related chain forming one of the bonds between the protons and neutrons. The result, of course, is that any atomic nucleus appears from its mass relation with other atoms to be a mere aggregation of neutrons and protons and little else. The fact that pions, which have significant mass, can appear to come from nuclei is, therefore, no longer perplexing. This problem has been overcome, with the most encouraging result that the length of the electron-positron chains forming the bonds has to equal the lattice spacing of space-time for the pion binding energy to a nucleon to provide the right answers.

The calculation of the energy released in neutron to proton decay

has been an important feature of this chapter. The prediction of the existence of a fundamental particle, the so-called H particle, is important. The indication that it can have two forms, one slightly less massive than the other, can have important bearing upon the explanation of the packing fraction curve in further development of this account.

Electron spin has been discussed. Anomalous properties of the electron are consistent with the ideas presented in the analysis of the magnetic moments of the proton, neutron and deuteron. Also, the argument was linked with the explanation of the gyromagnetic ratio presented in Chapter 2. This in turn involved further support for the basic features of space-time as outlined in Chapter 6, since the analysis in Appendix III has a basic dependence upon these features.

We must next turn attention to the magnetic properties of much larger bodies. Terrestrial magnetism can be explained without difficulty from the same principles as used above. This is pursued in the next chapter. It shows that gravitation is not the sole link in the application of this new concept of space-time to both the atom and the cosmos.

## 8. *Cosmic Theory*

### **Geomagnetism**

The discovery of the pole-seeking properties of the lodestone antedates the discovery of the phenomenon of gravitation. It is quite remarkable that the great progress of physical science in the past hundred years has not been marked by a wholly acceptable account of these two fundamental properties of the earth. In this work, new comprehensive explanations for gravitation and ferromagnetism have been presented, but to meet the challenge of the lodestone we now need to understand geomagnetism. Even though ferromagnetism can be explained, whether by Heisenberg's theory or the author's theory in Chapter 3, we have no explanation of the earth's magnetism. It is true that there is a theory of hydromagnetism, but this has hardly been accepted. Large astronomical bodies rotating at significant speeds all exhibit intrinsic magnetism. Some, the sun is an example, exhibit a magnetic moment which reverses direction from time to time. Such behaviour is hardly accountable for in terms of hydromagnetism. Hydromagnetism has been reviewed in detail by Elsasser (1955, 1956).

It is of interest to see whether the theory introduced in the foregoing pages can offer a better explanation. There is some encouragement to believe that it may, because there is the immediate question of what happens to the Hypothesis of Universal Time if the "clock", meaning the cyclic motion of the lattice particles, is rotating, as with the earth. Clearly, as the earth rotates, the space-time within the earth rotates as well. The particle lattice rotates as a whole and so does the continuum. Thus, there is basically a balance of charge in motion. The gravitons, electrons and energy medium do not have to share this earthly rotation, any more than they share the linear motion of the space-time lattice. These latter space-time constituents define the inertial frame of reference. Apart from this, the lattice particles do have to rotate at their universal angular velocity  $\Omega$  to keep in register with the harmonious motion of all space. Now, how can the particles within the earth's aether do this if the whole lattice

which they form has to rotate with the earth? The answer to this is simple. To keep in register they have to undergo a slight radial displacement. This will be understood by reference to Fig. 8.1.

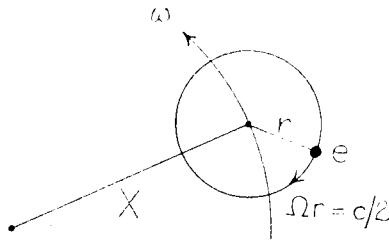

Fig. 8.1

Imagine a particle to be describing its regular orbit at a distance  $X$  from the centre of the earth as it moves with the earth about the earth's axis of rotation. The axes of the two motions are deemed to be parallel. Then, compounding the two components of particle velocity, we find that, as the particle rotates, its orbital speed in its space-time orbit varies between  $c/2 + \omega X$  and  $c/2 - \omega X$ , where  $\omega$  is the angular velocity of the earth. For constant angular velocity of the particle relative to the inertial frame, a condition we associate with the harmonious motion or in-register state of the particles, the variation of the above speed has to be accompanied by a proportional variation of the radius of the particle orbit. The radius is found by dividing the orbital speed by the angular velocity  $c/2r$ . Thus, the radius varies between  $r(1 + 2\omega X/c)$  and  $r(1 - 2\omega X/c)$ . It follows that the whole orbit of the particle behaves as if its radius remains unchanged but its centre has been displaced radially with respect to the axis of the earth by an amount  $\delta X$  of  $2\omega Xr/c$ . This means that the effect of the charge  $e$  is changed as if the charge were simply displaced by this amount.

Now, although the charge continuum and the lattice particles are aether rotating with the earth, there is good reason for believing that there are unbound particles moving through the earth and compensating its linear momentum effects of its space-time due to its motion about the sun. This was implicit in the explanation of the perihelion anomaly in Chapter 5. Thus, we are free to expect that the electrostatic effects of the charge displacement can be wholly balanced by an appropriate distribution of these free charges. The

electrical balance is assured, but the magnetic effects of the displaced charge will not be balanced. The free particles are not moving with the earth as it rotates. They move through the earth to compensate the motion of the earth in its orbit around the sun. This means that there will be some magnetic effect set up due to the rotation of the space-time in the earth.

We will calculate the magnetic moment of this displaced charge. The change in magnetic moment due to one displaced particle is  $\frac{1}{2}(e_1/c)\delta(\omega X^2)$  or  $e\omega X\delta X/c$ . Since  $\delta X$  has been evaluated as  $2\omega Xr_1/c$ , the elemental magnetic moment arising from a single particle is  $2e\omega^2 X^2 r_1/c^2$ . Since  $R$  may denote the radius of the earth's aether, following the same argument as we used in Chapter 5 for perihelion anomalies, and since there are  $1/d^3$  particles per unit volume of the earth's aether, the magnetic moment of the earth should be:

$$\frac{16\pi}{15} erR^5\omega^2/d^3c^2 \quad (8.1)$$

This derivation has involved integrating the function in  $X$  over the whole volume of the earth's aether.

The expression can be evaluated quite readily. From (4.1),  $er$  is the Bohr Magneton, known from experiment to be  $9.27 \cdot 10^{-21}$  cgs units. From (6.58), we know that  $r/d$  is  $0.30292$ . This tells us that  $d$  is  $6.37 \cdot 10^{-11}$  cm, since  $e$  is known to be  $4.8 \cdot 10^{-10}$  esu. We know  $c$ . It is  $3 \cdot 10^{10}$  cm/sec. For the earth  $\omega$  is  $7.26 \cdot 10^{-5}$  rad/sec. The radius of the earth is  $6.378 \cdot 10^8$  cm, but since the earth's aether evidently terminates somewhat above the earth's surface, say in the ionosphere, we could round  $R$  off at  $6.45 \cdot 10^8$  cm. This puts the earth's aether boundary 72 km above the earth's surface, at the locality of the lower ionosphere layer. These data give an estimate of the geomagnetic moment, since, from (8.1), our theory suggests that it is  $7.9 \cdot 10^{25}$  cgs units. In fact, the measured geomagnetic moment is  $8.06 \cdot 10^{25}$ . Again we have excellent results. Of course, it is not exact. We have made some assumptions and these need rectifying. Firstly, it has been assumed that the earth's axis is parallel with that of the motion of space-time. The earth's axis rotates itself. It changes direction by precessing about a mean direction over a long period of time. The earth's axis tends to be tilted relative to a reference direction normal to the plane of the earth's motion about the sun. Thus, one has to accept that there is some angular displacement between

the axis of space-time and that of the earth. If  $\theta$  is this angle of tilt and it is the angle measured relative to the perpendicular to the orbit,  $\theta$  is  $23.5^\circ$ . This will reduce the estimate of the geomagnetic moment given by (8.1) in proportion to the factor  $\cos 23.5^\circ$ . This is 0.917. Then, if we also use the uppermost ionosphere layer as the boundary of the earth's aether, which is 250 km above the earth's surface, the geomagnetic moment becomes  $8.25 \cdot 10^{25}$  cgs units. Clearly, one correction reduces the original estimate, which was slightly low, and the other more than compensates. It seems that if the successive ionosphere layers represent different boundaries of slip of the earth's aether relative to the aether surrounding the earth, then the geomagnetic field can be explained exactly.

There is also the question of whether the field will be of the right form. The magnetic moment might be correct, but will the shape of the field match that measured? Will the seat of the magnetic moment match that observed? This has been discussed elsewhere by the author (1966), but it is important to note here that the earth's magnetic moment comprises the quantity deduced in (8.1) and a quantity in the opposite direction which is exactly double and so gives the same numerical result when combined. This is because we are talking about charge which is *displaced*, but only displaced *in effect*. The result is that there is an effective charge density distributed throughout the earth due to this displacement and the balance of this charge is found at the ionosphere layers. This balance is opposite in sign and will generate its own magnetic moment. In fact, the magnetic moment of a charge at the surface of the ionosphere, as displaced from the volume enclosed, will be opposite and exactly double that calculated above. The total magnitude therefore remains unchanged. Note that the radial displacement of charge is from the axis about which the earth rotates. It is not radial from the earth's centre. For this reason, the effective radius of gyration of the earth's distributed charge is  $1/\sqrt{2}$  times the radius of the earth's aether. Remember that although there is magnetic moment, the electric field effects of this charge displacement are not apparent because there are free lattice particles in motion along set paths through the earth, due to the translational velocity of the earth in its orbit about the sun. These charges do effectively compensate the electric field. They do not compensate the magnetic field because they do not share the earth's rotation. This is the whole basis of the account of the anomalous perihelion problem, as explained in Chapter 5.



## Jupiter

It is reasonable to ask if we can explain the magnetic moments of other planets. The problem is the provision of adequate data. We need to know the magnetic moment of a large planet spinning at a high rate. Otherwise the magnetic fields produced are too small to be measured. For a large planet, the estimate of the magnetic field may also be indirect. It may depend upon other theory and this could be defective. For example, consider the planet Jupiter. A problem confronting radio astronomers is the nature of radio emission by Jupiter. Whereas thermal action can be regarded as the energy source for generating radio emission by stars, the planet Jupiter has a temperature of  $-143^{\circ}\text{C}$  and, analysed as a "black-body" radiator, it is found that at a wave-length of 100 cm the actual radiation is 1,000 times stronger than predicted theoretically (see *New Scientist*, March 17, 1966, p. 702). This hardly confirms one's belief in the sources of radio emission by stars. The question is seemingly still an open one. However, looking elsewhere for the explanation, the above article refers to theoretical analysis which attributes the radio emission to "synchrotron emission" produced by electrons moving at highly relativistic speeds close to the velocity of light. On the same analysis the polar magnetic field of Jupiter is believed to be about 60 gauss.

Now, on the author's theory of magnetic moment, as presented above, we see from (8.1) that magnetic moment is proportional to the fifth power of radius and the square of speed of rotation. Jupiter has ten times the radius and 2.4 times the rotation speed of the earth. Since polar field varies inversely as the cube of radius, the polar magnetic field of Jupiter should be about 600 times that of the earth. This is, say, 300 gauss, which is five times that estimated on the basis of Relativistic electron emission. However, the radio emission of Jupiter may not be attributable to electrons assumed to move at ultra-high velocity. Instead, on this theory, it could be due to the reaction effect of electrons responding to provide the reaction energy associated with Jupiter's field. A cyclotron frequency corresponding to an angular velocity of  $eH/mc$  does occur and, assuming that this is the source of Jupiter's radio emission, the wave-length will be  $10,700/H$  cm.

It will be remembered that in discussing the reaction effect of

electrons or other charge carriers in the presence of a magnetic field in Chapter 2, the kinetic energy of this reacting charge was deemed to be equal to the magnetic field energy. The operative equation was:

$$\frac{Hev}{c} = \frac{mv^2}{R} \quad (8.2)$$

where  $e$  and  $m$  apply here to the electron. The angular velocity is the ratio of the velocity  $v$  of the electron to the radius  $R$  of its orbit when reacting to the field  $H$ . This angular velocity is then seen to be  $eH/mc$ , as used above.

For Jupiter, if  $H$  is 300 gauss the emission frequency will be at a wave-length of 35 cm. If  $H$  varies over the disc of Jupiter, decreasing away from the poles, then this wave-length will also vary over a range slightly above 35 cm. Radio emission from Jupiter does appear to be strongest over a range of frequency corresponding to such wave-lengths. Therefore, reacting electrons could well be its cause. However, it is not necessary to expect the electron velocities to be "relativistic". In so far as they can develop motion in harmony they will develop magnetic disturbances and wave radiation. We are not concerned with their emission of energy on this theory.

It is concluded that there is a feasible explanation for the magnetic moment of the planet Jupiter. The account presented explains a rather higher magnetic moment than has been observed indirectly from studies of radio emission. However, it is based upon the same analysis as that used to explain the earth's magnetic moment. Also, it is shown that there is another way of interpreting the indirect evidence of radio emission experiments. Also, this other interpretation adds support to the concepts of space-time on which this work is based and does not involve any assumptions about electrons moving at ultra-high velocities in Jupiter's field.

## The Sun

We can next test the theory of magnetic moment of astronomical bodies by applying it to the sun. The sun rotates once every 25 days and has a radius 108 times that of the earth. Its magnetic moment should then be  $(108)^5/(25)^2$  that of the earth's magnetic moment, or  $1.9 \cdot 10^{33}$  cgs units. Estimations of the solar magnetic moment have to take into account sporadic magnetic fields produced in sun spots. A reliable estimate of solar magnetic dipole moment was probably

made by Sakurai (1959), who measured it as  $5 \cdot 10^{32}$  egs. This is less than predicted, but there has been evidence that the solar magnetic field changes with time. It is believed that in some stars the magnetic field reverses cyclically, in some cases every few days. Thus, though the explanation offered for the solar field is of the right order, it is perplexing to seek to explain the possible reversals. Presumably this variable magnetic moment rules out any question of the magnetism depending upon thermal-electric effects. The theory presented is no worse in this regard than one depending upon magneto-hydrodynamic possibilities. On the other hand, it is at least much better since it gives the right quantitative results. Further, perhaps the reversals can be explained, particularly as the magnetic moment developed on this account is produced by the *difference* between an effect within the rotating system and one at its surface. We will come back to this problem later in this chapter.

### **The Zodiacal Light**

The zodiacal light is a dim glow visible in the night sky in the region of the ecliptic shortly after the sun has set in the evening and shortly before it rises in the morning. It is seen as a cone of light which may rise half way to the zenith and extend at its base along the horizon for an angular distance of normally some  $20^\circ$  to  $30^\circ$  but sometimes as much as  $45^\circ$  each side. Under other conditions the light is evident as a zodiacal band running along the ecliptic normally some  $5^\circ$  to  $10^\circ$  wide but sometimes as much as  $20^\circ$  wide.

Along the zodiacal band at a point directly opposite the sun there is a region where the band is both brighter and wider than at any other point. This brighter region is known as the gegenshein, or counter-glow, and is sometimes seen when the band itself is not visible. The nature of this light is still an enigma. One theory stipulates that it is a reflection of light from millions of tiny meteoritic particles, but this puts the source of light well away from the earth's atmosphere and makes it difficult to reconcile some of the characteristics of the phenomenon.

The new ideas presented in this book could provide an answer. Might it be that the slip between the earth's space-time and the surrounding space-time occurring in the ionosphere regions can generate light? On the theory developed, a cubic lattice of space-time rotates within a surrounding cubic lattice. If the slip occurs

neatly and is not spread over a region of turbulence, there could be a disturbance of the electromagnetic reference frame as the lattices 'notch along' relative to one another. If there were turbulence, we might have to expect something to go wrong with the laws of physics over this turbulent region. Since there is no evidence of this, one can reasonably expect an electromagnetic disturbance to be produced at the boundary of the earth's space-time. To calculate the frequency of this disturbance is quite simple. Consider Fig. 8.2. At a point A at the boundary of the earth's space-time, positioned over the equator, the lattice structure of the inner and outer space-time systems are in register. The disturbance frequency here is  $\omega R/d$ , where  $\omega$  is the earth's

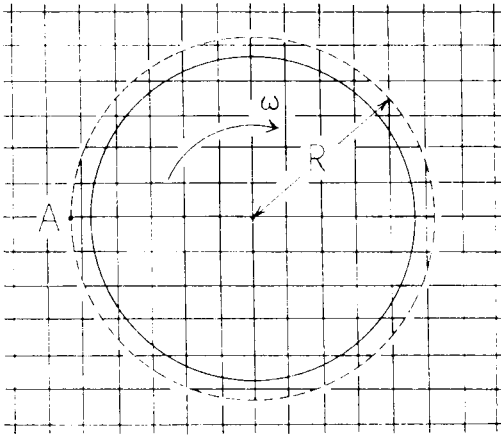

Fig. 8.2

angular velocity,  $R$  is the radius of the earth's space-time, and  $d$  is the lattice distance parameter. Since  $\omega$  is  $7.26 \cdot 10^{-5}$  rad/sec and  $R$  is about  $6.5 \cdot 10^8$  cm, we find that the frequency of the boundary ripple is  $7.4 \cdot 10^{11}$  cycles per second. This corresponds to a wave-length of 4,060 Ångstroms. However, this is an upper limit. When the earth has turned through  $45^\circ$  relative to the surrounding space-time lattice, the ripple action at the boundary will be less, because successive lattice particles are spaced at  $\sqrt{2} d$ . Also, there are factors such as the tilt of the axis of rotation of the earth's space-time, the reduction in frequency if the sky in non-equatorial regions is examined and the possible successive stages of ionosphere slip. Even so, there will be generation of *visible* radiation in the night sky. It is submitted that the above explanation is the answer to the problem of the zodiacal

light. The phenomenon has the following features, all of which are consistent with the theory.

1. The visible light frequencies appear to vary in certain regions of the night sky according to different occasions of viewing. This may evidence the interaction of the outer space–time system. The orientation of the lattice of space–time outside the earth system is a factor in determining the frequency of the light generated.
2. The fact that the phenomenon is manifested more in the direction of the ecliptic is consistent with the theory. At positions over the earth where there is high latitude the boundary velocity of the earth's motion is reduced. This means emission of light at lower frequency.
3. The gegenshein phenomenon is more readily explained if the light causing it is generated where it is seen and not reflected from the sun. Assuming that the zodiacal light is generated by the boundary slip process described, it would be more easily seen in the absence of diffused light from the sun, that is, it would be more evident in the region of the gegenshein. Also, however, it would be seen on the horizon owing to the increased intensity resulting from viewing a slip region obliquely.

It is of interest to note that the form of light generation suggested here is different from the action of the photon. It is possible, therefore that such light cannot be traced to any original photon quanta. It is possible that its absorption in photon form will occur, because the photon action is concerned with generation and absorption, but not propagation. The result could be that anomalous effects may occur if one thinks in terms of energy conservation and Planck's radiation law. In short, Planck's law need not, and probably does not, apply to radiation in the form of the zodiacal light.

### **The Solar System**

The orbital angular momentum of the planets is almost wholly due to Jupiter (94%) and Saturn (3·8%). In comparison, the sun has negligible orbital angular momentum and an angular momentum due to rotation of less than 1% of that shared by the planets. By recognizing that the space–time in the sun is rotating too and that it has a mass density of 100 times that of the sun, we see the possibility that the sun might have nearly as much angular momentum as the planets. Ideally, these angular momenta should be equal and opposite. This

must be the case if the planets came from the sun by some action wholly contained by the matter of the solar system as we know it. Apparently, this is not possible because the sun appears to rotate in the wrong direction. The reader might feel that there is too much speculation involved in arguing that the core of the sun might be rotating in the direction opposite to that observed at its surface. The surface happens to rotate at different angular velocities at different latitudes. Since angular velocity is not constant, it is not impossible to imagine that the hidden core moves at a different angular velocity to its surface. If this can happen, then it may even rotate in the opposite direction. This is speculation, but we need to understand the problem of balance of angular momentum and the alternative is possibly greater speculation. If the planets were ejected as particles of cosmic matter which has been collected in the locality of the planets, it is curious that all this matter should rotate about the sun in the same direction. Unless, of course, it was thrown off the sun in the direction in which the sun rotates at its surface. The reaction effect is in the sun as a whole. If matter is ejected from a near-rigid sun, the sun would have to rotate in the opposite direction to keep the angular momentum balance right. However, on this basis the successive emissions of cosmic matter would tend to be in random direction and the sun would tend to be at rest. Also, the matter might eventually come back to the sun without going into orbit. By having the core of the sun rotating in the opposite direction to its surface, even before any matter is ejected, we have a system which can prevail and increase in its spin as matter forming the planets is thrown off. This idea can be taken much further, with very interesting consequences, but it is beyond the scope of this work and is, undeniably, speculation, though interesting speculation.

For the time being, the reader may prefer to accept the more conventional ideas involving the influence of some star no longer with us. For example, there is the thought that the planets are all that is left of a large star companion to the sun which exploded. When the dust settled, the earth and the other planets were left behind, sharing the angular momentum of the exploded star. On such a theme Hoyle (1950) wrote:

So this is the sort of thing that happened to the parent of our planets. Calculation tells us a good deal about its state just before the outburst. The collapse must have gone on very far before this

happened. In spite of the enormous amount of material in the companion star, it must have become considerably smaller in volume than the earth. It emitted hard X-rays from its surface into surrounding space. It was so enormously dense that a match-box full of material taken from its central regions would have contained about 1,000,000,000 tons. Its surface rotated with a speed of about 100,000,000 miles an hour. And the time required for its catastrophic outburst was as little as one minute.

Ideas such as this stimulate the imagination. However, the thought of 1,000,000,000 tons of matter being compacted into a match-box is really taking liberties with Newton's discovery of the law of gravity. It is bold assumption to imagine that, whatever gravity is, the constant of gravitation  $G$  will, in fact, remain constant under *all* conditions. The ideas about gravitational collapse are all suspect until we can explain the reason behind the constancy of  $G$  and the *limitations* on its constancy. The analysis presented in this work has, at least, provided an explanation of the nature of gravitation coupled with an evaluation of  $G$ . Thus, we *can* have the boldness and confidence needed to explore what happens in dense matter. We find that space-time has a density itself. It is not going to be compacted by gravitation in matter, because it provides this gravitation. Its disturbance is the phenomenon of gravitation. It is impossible to have matter compacted to a density of the order of 100 gm/cc and still expect  $G$  to be constant. Such an idea has no support from experiment and it only comes into modern physics because mathematics allow it and can be applied freely until the physicist discovers the limits to be imposed on the laws formulated. It has to be remembered that so much of theoretical astrophysics is founded upon the physics we know in the laboratory that, if and when limitations are found to be necessary, these may have a profound effect upon what it is *believed* is seen to happen in the outer parts of space. Gravitational collapse is an interesting idea, but to think that massive stars can go on and on collapsing to become a point in space, at which matter of infinite mass density could form, is hardly credible. Yet, if one can believe that sort of thing, one could be prepared to believe that the sun might have a core rotating in the opposite direction to the gases at the radiating surface. Then, the balance of angular momentum in the solar system becomes possible and progress can be made towards further understanding of our creation.

## Quasars

The quasar is a star which exhibits a tremendous red shift. The spectral displacement in some cases is found to exceed 0.5. To explain this in terms of doppler effects resulting from the expansion of the universe and the related motion of the star and our system is ruled out. The stars exhibiting the anomaly appear too close for this. To explain the shift as a gravitational red shift, on the theory presented in Chapter 5, requires, for constant  $G$  and a mass of the order of that of the sun, that the density of the star should be about  $10^{16}$  times that of the sun. The quasar is then a potential anomaly, even on this theory.

We have an answer, however. Gravitation has been shown to be an electrodynamic property. It is due to the disturbance of electric charge in the  $G$  frame of space-time arising indirectly from matter in the  $E$  frame. We have not considered the effect of a charge which happens to be pushed into the  $G$  frame. Our study of the break up of the deuteron in the previous chapter showed us that in such nuclear situations charged matter could move transiently over to the  $G$  frame. We will thus analyse the effect of a charge  $e$ , sitting in the  $G$  frame and constituting a disturbance. Immediately, since the polarity of the charge is the same as that of the continuum in the  $G$  frame, we see that there is an effective gravitational mass due to  $e$  of  $e\sqrt{G}$ . Remember that the  $G$  frame moves at velocity  $c$  relative to the  $E$  frame. The force between two parallel-moving charges  $e$  is then  $e^2$  at unit distance, ignoring electrostatic action. This is equivalent to  $G$  times the product of their effective gravitational masses. Now, if the particle of charge  $e$  is a positron, we see that transiently its presence in the  $G$  frame will increase its mass by the factor  $e\sqrt{G}$ , as measured gravitationally. This is  $2 \cdot 10^{21}$ .

It follows that if, say, one part in 2,000 of an atom makes such a transient contribution in a nuclear situation,  $10^{18}$  is a measure of the increase of the effective constant of gravitation if all atoms are in this nuclear state. Now, to explain a red shift of 0.5, if one of this magnitude existed on the sun, we would need  $G$  to be greater by a factor of 250,000. Thus, one atom in  $10^{13}$ , say, would have to be in the nuclear reaction state. This, then, may be the difference between the sun and the quasar. It is merely a question of the degree of nuclear activity in process.



## The Origin of Matter

Nuclear processes must occur in stars. However, this does not mean that the creation of matter on a really fundamental basis involves nuclear action. Nuclear action is the transmutation of matter between its various elementary forms. It is known that atoms can change their form and release energy. Hydrogen is an atomic form able to release energy by forming other elements. Accepting that there is hydrogen already in existence in a star we can expect that there will be energy available for radiation as the hydrogen converts into heavier atoms. This leads to the belief that a star radiates energy by virtue of the nuclear processes of atomic transmutation. Nevertheless, this belief is founded upon assumption. If it is necessary to recognize that there is a more fundamental process by which hydrogen itself is created, it is not improbable that there could be energy surplus to this non-nuclear reaction. Then, on the assumption that a star may be in its creation phase, it is possible that energy available for radiation may, indeed, have its origin, for the most part, in a really fundamental process, different from that currently accepted.

The idea of space-time already presented requires the presence of electrons, negative lattice particles, positive gravitons, an expanded uniform continuum of positive charge and an electrically-neutral energy medium. The latter medium forms the inertial frame, whereas the negative charge constituents define an electromagnetic reference frame, the  $E$  frame, and move harmoniously about the inertial frame in balance with the positively-charged substance forming the so-called  $G$  frame. The gravitons are compact and have a high energy content. As space-time expands, the gravitons can expand. Energy is available. However, there is a fundamental balance between the number of gravitons and the number of lattice particles in the space-time system studied. The analysis has shown that we can calculate the relative masses of the lattice particle, the electron and the graviton. Due to the dynamic balance conditions, the ratio in the numbers of these particles in the  $E$  frame and the  $G$  frame is a definite quantity. It cannot change merely because space-time expands. The graviton cannot change into some other form, unless this condition of balance is kept. It can be retained provided the transmutation of the graviton is accompanied by the related large number of lattice particles moving out of their normal  $E$  frame positions. This corresponds to a

linear motion of the space-time lattice with the reverse flow of *free* lattice particles, already discussed in Chapter 5 by reference to the perihelion anomaly of Mercury. It is also the key to reconciling the Michelson-Morley experiment with the aether form of space-time. The only problem with this graviton energy release process is that it implies an ever increasing translational motion of the space-time lattice in the vicinity of the graviton. It appears that the motion of a space-time lattice is a characteristic associated with matter in motion. Consequently, the gravitons in the vicinity of matter are the favoured ones to accept the expansion possibilities accompanying the expanding universe. Matter is created from space-time in the vicinity of other matter. The velocity in space of such matter has to *increase* to keep the balance condition. On this basis, stars should have a translational motion through space-time. They could be the seat of energy transfer from space-time to matter form, and their translational velocities should constantly increase. If they are clustered together, their increasing velocities will cause them to move in a spiral sense. This may explain the spiral form of some galaxies.

It is natural to suppose from this that in a star the process of deriving matter energy from space-time energy is proceeding steadily. What is the property, however, which determines the nature of a star? It is suggested that there is something special about a star which is conducive to the graviton expansion process. Possibly other bodies, such as the planets, can increase their mass slowly by a less active participation in the graviton decay process, but, in a star, a large and highly energetic system has passed through a critical size and the graviton decay has become accelerated. A high energy state might permit polarity inversion in space-time itself, and this might allow rapid graviton reaction. By polarity inversion of space-time we mean polarity change from a space-time in which there are positrons and positive lattice particles forming the *E* frame, and negative gravitons and negative continuum forming the *G* frame. The *E* frames of the two types of space-time would need to move  $180^\circ$  out of phase to keep gravity acting across the boundaries, with the harmonious motion condition of universal time unaltered. This brings us to the hypothesis that the sun might comprise, in addition to its matter content, systems of space-time of both polarities. By having this, there are two advantages. Firstly, there is scope for explaining the reversals of the solar magnetic field. Secondly, there is scope for considering reactions involving graviton decay in the

presence of electrons, positrons, and lattice particles of both polarities. This is the only feasible way one can come to provide the sources of the electron-positron chains, deduced in Chapter 7 as key components in atomic nuclei.

Termining the two space-time forms positive or negative, one can say that if positive space-time rotates clockwise whilst an adjacent negative space-time rotates anti-clockwise then both will develop magnetic moment in the same direction. Equation (8.1) shows that magnetic moment of the rotating space-time is proportional to volume times peripheral velocity squared. Thus, for a system of regions of space-time in general contact so that their peripheral velocities are all about equal, the total magnetic moment will be the same as if the whole space-time volume rotates with the same peripheral velocity. This is provided positive space-time rotates in the opposite direction to negative space-time. If this is not assured because the polarities can invert cyclically for some reason, then the magnetic moment can fluctuate and can have either direction, subject to the limit on the total magnetic moment as calculated from (8.1) on the basis of a single space-time form. In Fig. 8.3 it is shown how

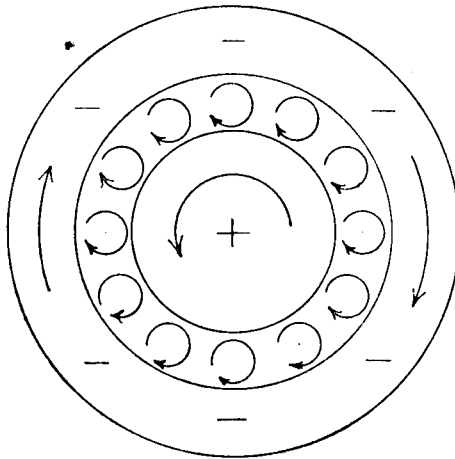

Fig. 8.3

different forms of space-time may be formed in the sun. The outer space-time shell is assumed to be of negative form rotating as is seen from inspection of the sun's surface. The core of the sun comprises positive space-time rotating in the opposite direction. Intermediate space-time zones rotate with a kind of idler-wheel action. If these

zones comprise negative space-time, the maximum magnetic moment is to be expected. If, however, the polarity fluctuates in a system, which, of course, will be turbulent and by no means as simple as that depicted, fluctuations of magnetic moment are bound to occur. The angular momentum must remain constant, but could be oppositely directed from that judged by observation of surface velocity. Also, if the core is substantial in size, the angular velocity of the core would be somewhat higher and in the opposite direction to that observed at the surface. This would be highly consistent with the requirements for balance of angular momentum in the solar system.

Such thoughts are mere speculation. Our objective is really to justify bringing electrons and positrons as well as lattice particles of both polarities into account in the matter creation process. The fact that we have come to expect this to occur at the boundaries between positive and negative space-time, and that such boundaries are to be expected within the sun, is the result emerging from the speculation. This introduces the analysis of the true mass of the graviton. It has to have a certain energy to be able to undergo transmutation at the boundary between the two types of space-time.

### **Derivation of Graviton Mass**

It has been suggested in Chapter 6 that the formation of the muon is connected with graviton expansion. Also, in Chapter 7 we have seen how large numbers of electrons and positrons are required to provide bonds in the atomic nucleus. It will now be supposed that at the boundary between the two polarity forms of space-time two gravitons of opposite polarity react together to store the energy of a muon on the lattice particles in the  $E$  frame. The loss of the gravitons makes a great many lattice particles of both polarities unstable in their  $E$  frames. Many become free and many are available to absorb the surplus energy released by the graviton expansion.

The buoyancy of the lattice particles storing the muon energy is reduced by their compression. This means that, not only has the muon energy quantum to be balanced by a similar quantum in the  $G$  frame, but, also, extra energy in equal measure is needed in the  $G$  frame to balance this loss of buoyancy. It follows that the energy of three muons  $5062 m_0 c^2$  is deployed from the two gravitons, leaving the remainder of the energy surplus to provide electrons and positrons.

When several lattice particles are compressed slightly to store the energy of the muon, their total volume reduction is  $d^3 - 4\pi b^3/3$ . The two gravitons and, of course, their associated electron and positron expand to determine two new units of volume  $d^3$  in forming two new lattice particles and related continuum. Two units of expanded space-time are generated when two gravitons decay in the manner described. Matter is formed as a product of this space accommodation process. Allowing for the volumes of the initial electron and positron, the volume of space required for the deployment of the surplus energy is  $d^3 - 4\pi b^3/3$ .

Let  $g$  denote the energy of the graviton. Then  $2g - 3(5.062) m_{oc}^2$  is the energy needed to compact enough lattice particles to take up the volume  $d^3 - 4\pi b^3/3$ . When one lattice particle is compressed into an electron or positron its volume is reduced by  $4\pi(b^3 - a^3)/3$  and the energy required is  $2mc^2 - 3 m_{oc}^2$ . This energy requirement follows because the electron needs its own rest mass energy and the secondary energy to sustain the  $G$  frame balance. As explained in discussing the processes in which electrons and positrons are transmuted, the energy available from a lattice particle is  $2 m_{oc}^2$  from the  $E$  frame and  $m_{oc}^2$  from the  $G$  frame. This is due to the buoyancy effect of the energy medium, which makes the dynamic mass of the lattice particle only half that found for other particle forms on the basis of their electrostatic energies.

It is seen from the above that we can write:

$$2g - 3(5.062) m_{oc}^2 = N(2mc^2 - 3m_{oc}^2) \quad (8.3)$$

$$d^3 - 4\pi b^3/3 = 4\pi N(b^3 - a^3)/3 \quad (8.4)$$

where  $N$  is the number of lattice particles converted to electron or positron form. Note that to conserve charge we must have  $N$  as an even integer. Also note that in this process we have taken lattice particles from the  $E$  frame. If we take lattice particles from the inertial frame, that is the unbound particles in free motion, we are involved in many difficulties of angular momentum and energy balance. It seems that the energy relation (8.3) is best kept in the  $E$  and  $G$  frames to conserve angular momentum. This means deployment of  $E$  frame lattice particles in the initial reaction processes. However, the muons are unstable and there has to be deployment of  $E$  frame lattice particles anyway, since many go into the free state, so our equations look well founded. From the data we have for  $d$ ,  $b$  and

$a$ , (8.4) gives a value of  $N$  slightly less than 5,065. If  $N$  has to be an integer, one then sees from (8.3) that  $g$  is slightly less than  $5,064 mc^2$ . This result is consistent with the empirical value of  $5,063 mc^2$  presented at the bottom of page 119. In a reaction in the laboratory environment we must expect single gravitons, with their associated electrons, to provide the nuclear energy quantum. In such reactions the electron is separated and must take with it an amount of energy adequate to provide the  $G$  frame balance originally provided by the graviton. The energy left is  $5,063 mc^2$ .

A value slightly less than  $5,063 mc^2$  gives the right answer for the constant of gravitation in (6.73). Therefore, this evaluation of the energy of the graviton is reasonably satisfactory. However, even the small difference thus obtained requires explanation. The best explanation which the author can offer is that there has been error in neglecting the presence of free particles. The constant of gravitation  $G$  is measured in the solar system. It may be very slightly dependent upon the general motion of the solar system in the galactic reference frame. Also, the energy of the graviton may, indeed, vary with this motion. After all, the graviton is carrying the secondary  $G$  frame energy due to the presence of matter. If its energy can be so varied as matter passes by it, then its base energy quantum, which is the unit under analysis, may have some dependence upon the motion state of the space-time present. To calculate this, let there be a translational motion of the space-time lattice at  $k$  times the speed of light  $c$ . Then, since the reverse motion of free lattice particles is at the velocity  $c/2$ , the orbital velocity they have when in the  $E$  frame, there are  $2k$  free particles for each bound particle in the lattice. These free particles will distort the lattice in their vicinity. Assuming that  $2k$  is small, there will be substantial regions where one can ignore the presence of free particles and there will be localized regions where significant distortion will occur. Above, we are trying to calculate the value of the graviton mass energy, as set initially. The graviton energy is being calculated from analysis of the reaction process, but it does not depend upon this process. The factor  $k$  will affect  $N$  as derived from (8.4), unless we can apply the analysis to regions devoid of free particles. This seems logical. The value of  $g$  cannot vary according to the presence of free particles. Hence, it must have the value of something just smaller than  $5,064 mc^2$ , notwithstanding the factor  $k$ . Accepting this, we turn back to Chapter 5. It is seen that  $G$ , as given by (5.12), is increased in proportion to the square of  $\sigma$ . Now,  $\sigma$  does

depend upon the presence of free lattice particles. It has to be greater, the more free particles there are, to allow the general analysis to remain applicable. It must be greater in proportion to  $2k$ . Then,  $G$  is increased in proportion to  $4k$ , whereas, to keep  $G$  the same, the mass of the graviton has, according to (5.12), to be increased by one-eighth of  $4k$ . In other words, all is well with the analysis if the discrepancy between 5,063 and 5,064, which must be explained to reconcile (6.73) with the above evaluation of  $g$ , is simply equivalent to the factor  $0.5k$ . This means that  $k$  has to be two parts in about 5,064, or that the space-time velocity involved is this fraction of the velocity of light. The velocity of the space-time system has to be about 120 km/sec. This, of course, is only rough approximation, but the theory does indicate that the earth should have a motion relative to surrounding space-time of this general order. This means that cosmic background radiation referenced on this space-time electromagnetic frame, if isotropic, should evidence a relative motion by the earth of this order of 120 km/sec.\*

On this evidence, one can see that this theory has tremendous scope for application to cosmic phenomena. As shown, the value of the mass of the graviton can be deduced from the theoretical foundations of the theory, and, indeed, the right value is obtained to provide the quantitative explanation of the constant of gravitation. This is a result which is totally beyond the scope of the Theory of Relativity, and one on which the author bases his beliefs that the theory under review is the correct theory of gravitation and that the Theory of Relativity has nothing to contribute to the understanding of gravitational phenomena.

### Perihelion Motions

From (6.69), the value of the lattice spacing  $d$  can be calculated in terms of the known parameters of the electron. From (6.63), the mass of the lattice particle is known in terms of the mass of the electron. Hence, we can calculate the mass density of the lattice of space-time. It is 144 gm/cc. Note that it was shown from (5.9) that the anomalous motion of the perihelion of the planet Mercury could be explained if the mass density of the space-time lattice were to be

\* It is reported in *Nature*, June 7, 1969, page 971 by E. K. Conklin that measurements of the cosmic background radiation show the earth to be travelling at 160 km/sec.

about 150 gm/cc. The theory has, therefore, excellent support from the perihelion anomaly.

It is appropriate to check (5.9) as it applies to the earth. Using the value of space-time lattice density of 144 gm/cc., and noting that the earth has an average mass density of 5.52 gm/cc and a radius of  $6.378 \cdot 10^8$  cm, the value of the earth's "anomalous" perihelion motion should be given by;

<i>perihelion</i> <i>motion</i>	<i>R</i>
5.2	$6.45 \cdot 10^8$
5.4	$6.50 \cdot 10^8$
5.6	$6.55 \cdot 10^8$

The perihelion motion is given in seconds of arc per century. *R* is the radius of the earth's space-time lattice. One has to conclude that the theory indicates a perihelion advance of perhaps 5.4 seconds of arc per century. This compares with the observed anomaly according to Clemence (1948) of 8.62 seconds of arc per century. The earlier-derived anomaly according to Doolittle (1925) was 2.52 seconds of arc per century, but Doolittle used an assumed mass of Mercury, in calculating the perturbation of the earth's motion, of 1,750,000 times the solar mass. Rabe (1951) has shown that the mass of Mercury is 1/6,120,000 times the solar mass. The effect of this is to increase Doolittle's estimate of the earth's perihelion anomaly to 5.0 seconds of arc per century. Further, since Clemence used an assumed mass of 1/6,000,000 times the solar mass, his figure should be reduced slightly. It has to be remembered that the measured anomaly is hardly accurate on such analysis. It can be said, however, that the explanation afforded by this theory is better than the value of 3.83 seconds of arc per century afforded by Einstein's theory.

For the planet Venus, this theory gives a value of the order of 15 seconds of arc per century for a radius of about 6,000 km. Clemence obtained a value of 15.15 seconds of arc from observation, and the radius of Venus is somewhat greater than 6,000 km, probably 6,100 km. Nevertheless, bearing in mind the uncertainties in observation and the indirect analysis in such observations, it is appropriate to claim that this theory does offer a feasible account of the anomalous perihelion behaviour of the planets.



## Summary

After demonstrating the power of this theory in explaining phenomena associated with the atomic nucleus, we have come in this chapter to the problem of the cosmos. The concept of a large volume of space-time in rotation with an astronomical body has been explored. The principle that the harmonious cyclic motion of the lattice is retained, notwithstanding such rotary motion, has provided an explanation of the nature of intrinsic magnetism in such bodies. The geomagnetic moment has been explained quantitatively, with remarkable results. The principles have been extended successfully to Jupiter and the sun. The idea that the earth has a space-time lattice terminated in the ionosphere has been explored in relation to the zodiacal light. An explanation of the generation of light at the boundary between the earth's space-time and surrounding space-time has given the right quantitative results. In considering the solar system, further support for the theory has emerged since the balance of angular momentum in the solar system is feasible, if we recognize the presence of space-time. The reversals of the magnetic field of the sun have been explained. An account of the extra-gravitational properties of the quasar has been outlined. Also, we have been led to consider the origins of matter and to the thought that there are opposite-polarity forms of space-time. In this way the reactions which are the source of matter, and probably cosmic radiation, have been analysed. The mass energy of the graviton has been deduced and found to be in agreement with that derived empirically earlier in this work. Finally, a little more has been said about the perihelion anomalies of the planets. These have been of such importance in supporting Einstein's Theory of Relativity that they have deserved rather special attention in the analysis. In fact, the observational data is in such doubt that exact analysis has not been possible. Yet, exact analysis is a real strength of this theory, as has been shown in earlier chapters where basic physical constants have been calculated. It is concluded that this theory will have potential in the cosmic field, and that it can claim to be a unified theory since it does embrace basic principles of field behaviour and has application from the sub-atom to the galaxy. This concludes this work, save for a discussion of some general features of the theory in the light of recent discoveries. This discussion is the subject of the next chapter.

## 9. *General Discussion*

### **Relativity**

The theory presented in the foregoing pages has developed steadily over several years. It will continue to develop, no doubt, at least as long as the author can see scope for its further advancement and has not been confronted with any refuting evidence. Certainly, the theory is not in its final form. This book is a stage in its development. In this final chapter some features worthy of review and which have emerged, in the main, after the previous chapters were written, are presented. Some are reserved for this last chapter because they have not yet stood the test of time and are perhaps more speculative than the main body of this work. This chapter is also the place where some questions can be asked. The anticipation of a few questions might help the reader's understanding.

Proceeding in this vein, we first pay attention to the subject of Relativity. Relativity is synonymous with the name Einstein. This book is entitled *Physics Without Einstein* because the theory presented offers an account of physical phenomena which does not need Einstein's theory at all. However, the author was not motivated to produce an alternative to Einstein's theories when he embarked upon these researches. The motivation was the understanding of a problem in magnetism and the pursuit of an idea concerning ferromagnetism, a subject not remotely related to Relativity. What is described in this book emerged as the author came more and more to believe in the aether medium. It was this belief which made Einstein's theory a factor to consider. According to Relativity, we can get by without speaking of the aether, though, as some say, Einstein's theory is a theory of the aether. Mathematically, there is no need for the physical aether. According to the author's theory, we can get by without speaking of Relativity. Physically, there is no need for sterile mathematical principles. It all depends upon one's outlook, and the reader can only be guided by whatever it is that suits him best. In this book, the author has made extensive use of the words "space-time". These words are used instead of "aether" simply because the

reader might find them more acceptable. A well-known physicist advised the author that it was better to use "space-time". He said: "There is an aether, but it gets people's backs up to refer to it; it is better to call it 'space-time'." Having said this, the author does offer one comment to correct any false impression. The aether has come to have a classical meaning in people's minds. There are fixed ideas about the properties of the aether of the last century. It is a kind of mechanical medium providing the single and absolute reference frame in space. Yet, the aether should really be nothing more than that something which fills space. Its properties are a matter for observation, not preconception. All that has to be believed is that space is not a void, it is a kind of plenum. The words "space-time" imply a less definite notion of what it is that permeates space, and their use is, therefore, more consistent with the author's objectives. The question of whether space is a void or a plenum is not a matter of opinion. Philosophers can go wrong in wrestling with such a problem in the absence of factual information. The early Greeks believed that there had to be a void as, otherwise, there could be no motion. Commenting on this, Bertrand Russell (1946) has written in his *History of Western Philosophy*:

*"It will be seen that there was one point on which everybody so far was agreed, namely that there could be no motion in a plenum. In this, all alike were mistaken. There can be cyclic motion in a plenum, provided it has always existed."*

The author's theory has shown how everything observed in fundamental physics can point to the existence of a cyclic motion, harmonious, universal and constant through cosmic time. Bertrand Russell's observation is, therefore, most important. He points out that philosophers can be wrong in interpreting the physics of space, even when using simple words as explanation. How much scope is there then for error in the mathematics of Relativity? Mathematics can be wrong when incorrectly applied just as words can be misleading if wrongly used. Can we really accept Hoyle's comment, quoted in Chapter 5, that "there is no such thing as gravitation apart from geometry"? The answer to this is that scientists have accepted Relativity as the explanation of gravitation. Perhaps they are a little unhappy with some of the recent discoveries, which do cast some doubt upon the theory, but it is still common belief that Relativity, if in a slightly modified form, is the tool for explaining the phenomenon of gravitation.

This introduces the next comment in a discussion. The question is why any alternative to Relativity is needed. If it gives satisfaction, why develop a new theory which lacks the elegance of Relativity and which presents ideas of a tangible aether having special properties which seem to depend upon too much hypothesis. Logically, whether or not there is an aether is not a matter of mere choice to a true physicist. It could be optional to a mathematician. If there is a tangible substance filling space, we may or may not need to refer to it in our efforts to unify physics. Relativity tries to avoid it, almost by cancelling its effect out of the mathematical equations. This is all very well, but the unification we all seek has not been forthcoming. There are too many mysteries in fundamental physics. Gravitation and electromagnetism were not unified by Relativity, much as Einstein and others have tried. In the field of elementary particle physics there is developing frustration because the theories are not advancing fast enough to cope with the experimental discoveries. The thought of unification in physics seems, therefore, that much more remote. Relativity has to advance rapidly if it is to adapt to the wider developing spectrum of fundamental physics.

The author's theory is an alternative to Relativity and, as has been seen, it covers the whole spectrum of physics, from the nature of elementary particles to gravitation on a cosmic scale, besides covering field theory and wave mechanics. However, where does this leave Relativity, if the author's theory comes to be accepted in its present or a modified form? One comment conceded by the physicist today is "General Relativity may be wrong, but Special Relativity is as firmly established as ever." It would be an easy matter to pass over this question of the validity of Special Relativity. In the words of Einstein (1921), the "principle of special relativity" can be expressed in the following proposition:

*"If  $K$  is an inertial system, then every other system  $K'$ , which moves uniformly and without rotation relatively to  $K$ , is also an inertial system; the laws of nature are in concordance for all inertial systems."*

Newton's mechanics can be used to show that this principle applies to mechanics. The question is whether it really applies to electromagnetic phenomena. A practical aspect of the principle is that it is not possible, if the principle is true, to determine the velocity of a system in uniform motion, without reference to something outside the system. Any measurement within the system should not permit evaluation of motion of the system relative to something

else. Now, in the previous chapter, it was suggested that a very small difference between the mass of the graviton expected from the set number ratios of space-time and the mass needed to explain the value of  $G$ , as measured on earth, can be explained by the motion of the solar system in our galaxy. This means that analysis and experiment wholly performed in the earth laboratory can indicate the velocity of about 120 km/sec of the earth system in galactic space. This velocity can be measured separately from a study of the optical behaviour of surrounding stars. The fact that a similar result is obtained from direct observation and from the internal observation and analysis, if given credence, is wholly inconsistent with the assumption that special relativity precludes the determination of motion of one inertial system relative to another.

Einstein has jumped from an observation based upon mechanics and inertial frames of reference to one which involves electromagnetic wave propagation and electromagnetic frames of reference. The Michelson-Morley experiment is his key support. However, this experiment relates only to the observed behaviour of electromagnetic waves in the test apparatus of the laboratory. In detecting the velocity of the solar system, we can use the whole of the system as our laboratory. The velocity of light transmitted between the planets is our concern. Does this move at the velocity  $c$  relative to the solar system or relative to the space-time medium permeating space between the planets? There is new experimental data of importance to this question, and it may well disprove Einstein's Special Relativity. It stems from some unexplained problems in observations made by new radar measurements, as will be explained below.

The author has explained the Michelson-Morley experiment on the basis that an astronomical body might have its own aether, or space-time, rotating with it and having a boundary some distance above its surface. This idea might sound old fashioned, but it is different from the idea of aether drag. Aether drag implies a slip or turbulence of the aether medium at the surface of a body. It is reminiscent of the attempts of Miller (1925) in performing the Michelson-Morley experiment at high altitude on Mount Wilson. Miller did not obtain the null result found normally. However, the results, though definite, did not indicate the full slip to be expected if the experiment were performed fully outside the earth's aether. It may be that the Theory of Relativity had become so well accepted by then that it did not fit the pattern of progress to pay attention to a

small aether effect, which, notwithstanding the experimental care and skill of Miller, could be left for possible verification and likely rejection by others. This remark should be read in conjunction with some comments by Whittaker (1953), who writes:

“The idea of mapping the curved space of General Relativity on a flat space, and making the latter fundamental, was revived many years after Whitehead by N. Rosen (1940). He and others who developed it claimed that in this way it was possible to explain more directly the conservation of energy, momentum, and angular momentum, and also possibly to account for certain unexplained residuals in the repetitions of the Michelson–Morley experiment (reference to Miller, 1925).”

One may well wonder about the support for Special Relativity in the face of admitted weaknesses in General Relativity. If General Relativity collapses, the residuals in the Michelson–Morley experiment cannot be dismissed in this way. Then surely Special Relativity is open to question.

Now, to avoid this type of discussion, we can argue that, though there could well be some degree of aether slip between the earth's surface and the ionosphere, it would be risky speculation to explore that topic here. The author's theory does not require anything other than the null result of the Michelson–Morley experiment so long as it is performed anywhere in an earth-based environment. The earth's ionosphere is the boundary of the earth's aether. This is not an assumption made by the author to dispose of the Michelson–Morley problem. The quantitative analysis of the geomagnetic moment made it necessary to have the earth's space–time boundary at the appropriate height. Even so, a critic may then ask whether we can detect the motion of the earth's space–time. Would not a radio wave grazing past the earth through the earth's space–time not travel faster or slower, according to its direction, in comparison with one travelling just outside this medium? The answer is affirmative and, of course, the author's theory stands to be tested from such experiments.

We can consider whether experimental data are available from the delaying of radar waves grazing past the sun's surface. This is particularly interesting because it has bearing upon the recently reported tests of the Dicke–Brans theory, put forward as an alternative to the General Relativity of Einstein. Early in 1968, it was reported that a new and fourth test to verify Einstein's General Relativity quantitatively had been made by Shapiro and his

collaborators. This is summarized by Gwynne (1968). The experiment consists in measuring the effect of the sun's gravitational field on a radar beam passing close to it. General Relativity predicts that the gravitational field should slow down the beam. The delay for the return journey of a radar pulse passing the sun in transit between earth and Mercury, a journey lasting about 25 minutes, should be of the order of 160 microseconds, depending upon how close the beam comes to the solar surface. As Mercury moves into and out of conjunction with the sun, the delay should rise gradually to a peak over several days and then fall in a similar manner after conjunction.

Now, before commenting upon what was actually observed, the reader is asked to consider two separate possibilities suggested by the author's theory, but which have, of course, not been taken into account in the reported analyses. Firstly, if the solar system is moving at a high velocity through space and if light waves travel *relative* to the medium in space, the sun will move appreciably during the period between the close transits of the outward and inward beams. If the sun has an aether extending some distance above its surface then it could be that one direction only of the beam might pass through this aether, causing the beam to be retarded or accelerated in its overall journey. Note that a transit distance of some half-million miles through the sun's aether rotating at a peripheral velocity of about 1.25 miles per second, the surface velocity due to the sun's rotation, implies a delay or advance of about 18 microseconds. This is found by noting that the beam is in transit at the extra velocity of 1.25 miles per second for a little less than three seconds, the time taken to traverse half a million miles at the speed of light. The time of 18 microseconds is the time taken to cover the 3.4 miles added in these few seconds. It follows that any errors of the order of 20 microseconds in the experimental observations are of interest to the author's theory. Secondly, if the sun moves through space at a high velocity, the path of the outward beam will not be where we expect it to be. It is the return beam which is seen in proper relation to the position of the sun. The distance of the beam from the sun in its close transit is important to the estimation of the Relativistic estimate of the delay, or to any estimate dependent upon the effect of solar gravitation. If the beam is not where we believe it to be, the theory is misdirected. To understand this, consider Fig. 9.1. Assume that the whole solar system moves steadily relative to the surrounding medium through which radar waves are propagated at a velocity  $c$  subject to solar

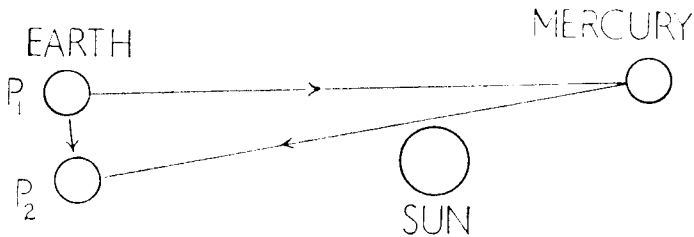

Fig. 9.1

gravitation, as explained in Chapter 5. In the figure, the earth is deemed to be at  $P_1$ , when it transmits a radar signal to Mercury. This signal is reflected when Mercury has the position shown, so the reflected radar signal returns along the linear path shown. Since light travels at the same speed as radar waves, the sun has the apparent position shown, at the time the radar beam passes it on its return journey. The return beam reaches the earth when the earth is at  $P_2$ . The radar beams are not truly linear near the sun, owing to the gravitational deflection, but we assume that this is allowed for in the separate calculations made in connection with the experiments. Also, the planets are moving within the solar system and doppler effects have to be accounted for. Our objective is only to consider corrections to be imposed upon the measurements if the motion of the solar system through a surrounding aether medium is introduced. From Fig. 9.1 it can be seen that the motion of the solar system is accounted for by the motion of the earth from  $P_1$  to  $P_2$ . Because of this displacement between  $P_1$  and  $P_2$ , there is a separation of the outward and inward radar beams adjacent the sun. However, we only see the position of the inward beam in relation to the position of the sun. Consequently, depending upon the direction of motion of the solar system, and depending upon which side of the sun the planet Mercury is seen, the outward radar beam will pass closer or further away from the sun than we believe. The result should be an increased overall delay of the radar signal on one side of the sun and a decreased overall delay of the radar signal on the other side. In any event the peak signal will be reduced in its total delay indication, because when one beam direction grazes the sun, the other is spaced away from the sun. This tells us that the observed delay should be less than that predicted and also that it should be shifted in phase as measurements are made over the period when the planet Mercury passes through conjunction. Furthermore, the results will depend upon the time of



year when the observations are made. The solar system is moving in a certain direction in our galaxy. Sometimes this direction will have a maximum component, possibly at right angles to the radar beams. At other times it will have a minimum component in this direction. Thus, sometimes there will be a significant phase shift, whereas at other times of year there will be a less significant phase shift.\* If the solar system moves at 230 km/sec, as believed, then since the two transit times between the sun and Mercury total about 400 seconds, we are speaking of a distance which could be as much as 90,000 km. This is enough to modify the gravitational calculations of the effect of the sun upon the radar beams by one or two per cent. This is small but, probably more important, could be the effect of bringing one beam outside the sun's own space-time. 90,000 km is significant enough for us to expect this. Then there could well be the 18 micro-second effect mentioned above and it would also correspond to the phase-shift just mentioned. Furthermore, if the velocity of the solar system were directed along radar beam paths, then, on such occasions, the outward and inward beams would both pass inside or outside the space-time of the sun. Then, there would be no modification of the delay.

It may be concluded that any evidence of anomalous delays of 20 microseconds or so is evidence possibly pointing to the galactic motion of the solar system and the rotation of the sun's own space-time. Any evidence of a phase-shift of the delay on some conjunctions and not others is strong evidence in support of both these features. If these properties are found then we may have means for estimating the speed of the solar system in our galaxy as well as its direction. If the measurements are made wholly within the frame of reference of the solar system, as they are, then we have evidence disproving the Principle of Relativity and proving the existence of the aether.

In the reports of Shapiro's 1967 experiments, as quoted by Gwynne (1968), it is clear that:

1. The measured delay was about 10% less than that predicted on Einstein's theory,

\* There will also be a doppler shift and a slight deflection when a plane wave passes through rotating space-time. The doppler shift will result in an amplitude pulsation at very low frequency due to wave interference effects. A pulsar may be a star seen through a rotating space-time region located between the earth and the star.

2. The April–May measurements showed a lower peak delay and a distinct phase-shift of one or two days between the observed delays and those predicted from the apparent positions of the sun and the beams,
3. The August–September measurements gave higher results and showed little or no phase-shift, and
4. It was claimed that there were a number of “*slowly varying systematic differences in the results (about 20 microseconds on average)*”, and stated that these have not yet been explained.

The author merely suggests that these radar experiments *might* provide the long-awaited test of aether theory. It might be that, quite apart from the author’s interpretations providing a possible alternative to Relativity, we already have the elements of the proof that Einstein’s theories are invalid. It should not, however, be overlooked that the author’s theory does give the same result for the gravitational deflection of light waves and the gravitational delay of radar waves in transit past the sun. What the author is pointing out is that there are corrections which have to be made to overcome the scatter on the measurements. These corrections are not available to Einstein’s followers. Their use depends upon the recognition of a real aether medium. When they are made, it looks as if the formulae of the Einstein analysis and the author’s analysis are correct, but Relativity has then lost its coherence. The author’s theory may then have to be favoured. In making the corrections and finding a corrected result in line with Einstein’s values, a result will emerge which is out-of-line with the proposals of the new Dicke–Brans theory, which predicts a smaller delay in the radar experiment of about the right order, but which does not explain the phase-shift effects.

Returning to the problem of the effects of aether drag, it has been suggested to the author that the assumption of a local aether is contradicted by the observed aberration of fixed stars. Due to the motion of the earth about the sun, distant stars appear to move in orbits approximately 20·5 seconds in angular radius. This is to be expected since the orbital velocity of the earth of  $10^{-4} c$  gives a value of the angle through which the star appears to move of  $\text{arc tan } 10^{-4}$ , in agreement with observation. It is contended that if aether is dragged by the earth no such aberration would be expected to occur. Also, the author has been told that the Fizeau effect provides evidence supporting Einstein or Lorentz theories. Experiment shows that

with respect to the laboratory the velocity of light in water moving with velocity  $u$  is increased by  $u(1 - 1/\mu^2)$ , a result predicted from the relativistic addition of velocities.  $\mu$  denotes the refractive index of water. With aether drag it is supposed that the velocity increase would either be the velocity  $u$  of the water or zero, according to whether aether is merely being dragged by the earth or dragged by water. Now, if this type of comment is typical of the general reaction to the author's proposals, the author can but ask the reader to take note of the fact that many phenomena were explained once in terms of aether theory. The aether has gone out of fashion and new textbooks have been produced with all kinds of proofs that Relativity can be applied to explain phenomena. So much so, that even phenomena which once supported aether theory are taken to prove the validity of Relativity. Books on electrodynamics are regularly based upon Relativity as the starting point. The results are fascinating, but they cannot displace history. Aberration was discovered in 1725. If Bradley's aberration experiment ruled out the thought of aether, would there have been the tremendous interest in the nineteenth century that was displayed in aether theory? The light from the star is refracted at the boundary between the earth's aether and surrounding aether. Bradley's result fits the author's theory very nicely. The Fizeau result was explained on aether theory before Einstein was born. The velocity of light within a transparent medium in motion is determined partly by the properties of the substance and partly by the properties of the aether. Refractive index  $\mu$  is  $c/c_1$ , where  $c_1$  is the velocity of light measured relative to the substance and  $c$  is the velocity of light in vacuo. Then, two densities can be specified. The density  $\rho$  of the aether medium in vacuo and  $\rho_1$ , the effective density of the combined medium of aether and the material substance. In this sense, we can take density as something proportional to  $(1 + \varphi)$  in equation (6.32), so that, from this equation:

$$\rho_1 = \mu^2 \rho \quad (9.1)$$

As Whittaker (1951, c) explains, Fresnel assumed (9.1) and that when a body is in motion the part of the total density in excess of that of vacuous aether is carried along with it, whilst the remainder remains stationary. Thus, the density of aether carried along is  $(\rho_1 - \rho)$  or  $(\mu^2 - 1)\rho$ , while a quantity of aether of density  $\rho$  remains at rest. The velocity at which the centre of gravity of the aether within the body moves forward in the direction of propagation is therefore  $(\mu^2 - 1)/\mu^2$

times the velocity of the substance,  $u$ . As Whittaker also explains, it was many years later that Stokes arrived at the same result from a slightly different supposition. He supposed that the whole of the aether in a body moves together but that, as the body moves, the aether entering in front augments the substance of the body to cause the aether within it to have a drift velocity  $-u\rho/\rho_1$  relative to the body. This leads to the same result for the velocity of light relative to the body. This is also consistent with the author's proposal, which admits the space-time lattice to have mass energy associated with it so as to modify its propagation properties. The propagation velocity is fixed relative to the lattice frame in vacuo, but when matter is present, the disturbance of the lattice depends upon the energy of such matter and motion of this matter relative to the lattice. The predicted results of Fresnel and Stokes were verified experimentally by Fizeau in 1851, long before Einstein's ideas about Relativity.

At this stage in the discussion it is necessary to draw the distinction between large bodies, such as the earth, which can take their lattice with them as one rigid unit, and small bodies, such as the moving column of water, which cannot. This distinction is essential, otherwise it would be possible to detect aether properties from measurements on gyroscopes, pendulums, etc. The earth has been rotating long enough and is large enough to have its own special aether. Small bodies in the laboratory are not so privileged. The author cannot explain, as yet, where the line can be drawn to determine whether a body has its own aether system or not. More experimental research, particularly in outer space, will help to resolve this question, but it is another matter to explain the reasons for any line of demarcation. It is safe to say that in the environment of earthly laboratory experiments the aether lattice appears fixed with that of the whole earth. Aether drag cannot be detected in the laboratory. It cannot be expected to occur. In the Fizeau experiment there is really no special motion of aether. It is simply that the velocity of light is governed jointly by the presence of aether at rest in the earth frame and by matter at motion with a body. To an extent, then, velocity of light can be said to be determined partly with respect to its material source, if it is generated in the earth frame. A gas atom excited to radiate light will, in its own reference frame, "see" the propagation velocity of its waves have some dependence upon its own velocity relative to the earth. For this reason, although the space-time lattice does not move relative to it, there can be doppler frequency shifts according

to its velocity relative to an observer. This is in spite of the fact that, as shown in Chapter 4, the photon action is formed in the lattice of space-time whilst the atomic electrons are in their non-migratory state about the nucleus. More will be said about this in the next section.

### **Electromagnetic Energy Transfer**

Not only is Relativity in trouble today. There are increasingly-apparent difficulties with the problems of electromagnetic radiation. The duality of wave and particle theory is a contradiction in physics which has come to be accepted without concern. However, there are other questions. When a photon travels through a material medium is its momentum  $h\nu/c$  or does it change as the propagation velocity in the medium changes? The same problem posed by the electromagnetic waves is a matter of concern to Penfield (1966). Cullwick (1966) analyses this momentum difficulty and calls the resulting discrepancy in the formulations “virtual momentum”, because “it cannot be regarded as true momentum”. Waldron (1966) shows little patience with wave theory by presenting a new corpuscular theory of light; photons and even energy quanta in radio waves are deemed to travel as ballistic particles. These references are all of recent date. They do serve to demonstrate that there is something lacking about our understanding of the processes of electromagnetic energy transfer. The author is, therefore, very much in line with the trend of looking for something better to provide answers to the conflicts surrounding the subject. In the early chapters of this book it has been suggested that waves do not convey energy at their propagation velocity. This sounds heretical, but it is logical if we retain the duality theory. Energy quanta, or, more correctly, momentum quanta, are a feature of the author’s ideas about energy transfer. The photon action has been explained in a manner consistent with the evaluation of Planck’s constant and the derivation of the basic formulation of wave mechanics. All that the reader is asked to accept is that electromagnetic waves are a mere disturbance of the energy already permeating space. Waves travel without carrying the energy along with them. It is not a new idea. Indeed, the idea that waves need not carry momentum or energy was put forward long ago by de Broglie (1924). It was also proposed by Bohr, Kramers and Slater (1924). The waves become mere disturbances of space and are able to trigger off

events involving quantized interaction with space itself. Experimental facts, such as electron-positron creation from the vacuum state, or theories such as Dirac's (1958) ideas about holes in a "sea of charge", all fit together in a pattern encouraging the belief that space itself provides the action and the energy associated with wave propagation, whereas the photon event is merely triggered by these waves. The phenomenon of energy transfer in quanta was expressed quite simply by Eddington (1929, b) when he contrasted his "*collection box*" theory with his "*sweepstake*" theory. When waves are intercepted, do we have to wait until enough energy has arrived and been collected to trigger the photon event? Do we collect energy separately for each frequency before releasing the quanta? Eddington argued that the photoelectric effect disproved this. Instead, he submitted that the waves contribute energy to "*buy a ticket in a sweepstake in which the prizes are whole quanta*". Even here, the physicist has an answer. Experiment has shown that photoelectrons do not accumulate energy transmitted to them by electromagnetic waves, nor do they exchange energy in a kind of sweepstake. The time scale needed for such exchanges makes the idea untenable (see discussion of Yoffe and Dobronravov experiments by Kitaigorodsky, 1965). All the evidence shows that energy transfer is in discrete quanta. The energy transfer is between matter and space or space and matter. In space, electromagnetic waves do certainly appear to exist. Wave theory is so successful in explaining interference and diffraction phenomena. Where the energy quanta come from or go to in photon-wave interaction is not discussed in modern physics. The best we have is the problematic Poynting vector, our tool for understanding how energy is transported by electromagnetic waves. However, we have no insight into the way in which this energy collects and is focussed to generate the quantum. The author has offered an explanation and supported it by quantitative evidence. The reader who does not like what the author is offering in Chapters 1 and 2 has an uncertain alternative in what is already available.

The author has contended that it is absurd to expect there to be energy radiation from the accelerated electron. The absurdity is underlined by pointing out that no accelerating field is allowed for in the analysis and that remote from the electron one relies upon assumptions about energy transfer which have no foundation in truth. Why should we assume that an electromagnetic wave conveys energy? Experiment shows energy transfer to be in quanta. The

reader who cannot reject the formulation for the energy radiated by the accelerated electron should ask if it is ever used. Surely, it is used in numerous theoretical treatments. Yet, has it ever been verified? If the formula is applied to a typical radio transmitter and all the conduction electrons in the aerial co-operate in developing a high current at a high frequency it will be difficult to derive enough radiated energy to sustain one photon per minute or per million wave-lengths. To apply the radiation equation and arrive at sensible results, one has to assume collective oscillation of the *collective charge* of all the electrons. Their interaction is vital to the analysis. Therefore, why do we talk about electrons radiating energy? Electric current oscillations generate electromagnetic waves. These are energy oscillations in the aether. The waves are propagated and the waves are the catalyst in the process of energy transfer.

A wave will seldom be produced by one single photon event at the source. In practice, millions of photons of similar frequencies contribute to develop wave radiation. Further, their actions overlap in time, either because the energy release mechanism has a finite lifetime or because the energy is released at different positions in a radiating source and the wave takes time to travel from one such position to the next. This means that even if all the photons produce exactly the same frequency radiation, it is likely that their occurrence is conditioned by the wave itself. The first photon in a series will presumably release its energy without experiencing any external conditioning action, but the wave component developed by this photon must affect the timing of energy release by other photons. Otherwise, their occurrence at random phase will substantially cancel the wave amplitude by their mutual wave interference. It is essential that the existing wave disturbance of the same frequency must influence the time of each photon event contributing to the wave component at this frequency. The photons will, therefore, tend to develop radiation in phase with one another, and will inject their momenta into the radiation field additively.

Now, bearing in mind that photons are liberated from excited atoms, and that such atoms may be moving at velocities of the order of  $10^4$  cm/sec owing to their thermal energy oscillations, the actual frequency of the wave in the observer's reference frame will differ from that sensed by each atom. This arises from doppler effects. To understand this it is better to think in terms of the key quantity, photon momentum. The frequency of a photon in the space-time

reference frame is determined by the momentum imparted to the frame in the energy transfer process. If the atom is moving, the release of more or less energy is needed to develop the same momentum reaction because, relative to the atom, the photon will move at more or less than the speed of light. It moves at the speed of light relative to the frame determined by the space-time lattice and any bulk effect of matter present (a reference to the Fizeau experiment). The frequency of the photon is dependent upon the velocity of the atom emitting it, since momentum has to be velocity-dependent for energy quantization in the transfer process. It is not surprising, therefore, to find a thermal broadening of spectral lines generated by hot gas. The point of this discussion is to show that waves are an essential part of the process of forming photons. The timing of the emission of a photon is conditioned by the phase of waves of similar frequency. The timing of the absorption of a photon is similarly conditioned.

Although it is not necessary to wait until enough energy is collected from a wave before a photon can be absorbed, a certain very small time must elapse. The weaker the wave amplitude, the longer the period during which the absorbing electron is absorbing momentum. In this time the momentum of the electron can change, and in its interaction with the wave one could expect to receive a slightly weaker photon, meaning less momentum transfer or lower frequency, due solely to the very weak wave. It is possible that there could be a frequency shift apparent when waves transmitted over long distances are intercepted. It is absurd to think that the frequency can change in transit between two points not in relative motion. We should, however, not be surprised if measurements of very weak signals indicate an *apparent* frequency reduction. This is worthy of note here because there have been some recent claims that there is a frequency shift of spectral lines in passing massive objects, it being implied that light from stars is caused to lose some of its frequency in grazing past the sun. Such a phenomenon is outside the scope of the author's theory, though it is consistent with the author's opinions to believe that possibly with very weak signals one appears to receive a lower frequency than is really received.

As indicated in the footnote on page 194, the pulsar may possibly be nothing more than a star which happens to be seen through a rotating space-time region. Since it has been shown that an astronomical body can have its own electromagnetic reference frame rotating with it, light in close transit will undergo both gravitational



deflection and doppler shift. The two effects will interfere, causing the transmitted light to be amplitude-modulated and pulsate at a low frequency. Pulsars are rare because their line of sight has to pass close to a massive non-radiating, but rotating, astronomical body. The doppler frequency shift incurred by the wave is a function of angle of incidence between the wave and the space-time velocity at interception. But for the gravitational deflection in transit through the rotating space-time, the doppler shift at exit would cancel that at entry. However, the small angle of gravitational deflection causes a small doppler shift in the stellar light seen after transit. This shift varies across the light beam. As a result, parts of the wave interfere at a frequency which is very small. This causes the radiation from the star to pulsate at this low frequency.

The fact that the pulsar is causing such problems to theoretical physicists at this time is merely an indication that they really should rethink some of their ideas about the aether. The above explanation is, of course, rather speculative, but it seems to be more in keeping with the rest of physics than some of the current ideas on the cause of pulsar behaviour.

### **The Nature of Spin**

Spin angular momentum is one of the most perplexing problems. The standard half-spin angular momentum quantum has been assigned to particles without regard to the direct effect on magnetic moment, though with regard to its effect on the measured ratio of spin magnetic moments. Much of Chapter 7 has been founded upon such analysis. Now, how is it that spin angular velocity and spin angular momentum need not be directly related for the right answers to emerge from these studies? An attempt at a reconciliation will be made below, though not without reliance upon hypothesis.

First, in Chapter I the electric charge in linear motion was considered and found to have kinetic energy, magnetic energy and a velocity-dependent electric field energy. These energies were all of equal magnitude, but one was negative. A separate electric field energy exists in association with the charge. It moves with the charge and it determines its mass. One of the positive velocity-dependent energies moves with the charge. It causes mass to increase "relativistically" with increasing velocity. The other two compensating velocity-dependent energies belong to the field or space-time. They are a

mere field disturbance. If now such a charge is deemed to be spherical and at rest in the electromagnetic reference frame, what happens if it rotates about an axis through its centre? Is there any magnetic effect? There must be, because we found the right answers for magnetic moments on this assumption in Chapter 7. Since there is no charge outside the spherical surface bounding the charge, the magnetic spin moment must originate *within* the sphere of charge. On the other hand, mass, which is a scalar quantity, unlike magnetic action of a current vector developed by the motion of charge, is related to the electric field energy, the total of which is fixed with the mass and does not depend upon spin. Therefore, when we talk of spin, meaning that the charge is spinning, we expect magnetic effects, but need we expect mass effects or angular momentum? If we do think of angular momentum, are there two components, one due to rotation of charge and contained wholly within the charge sphere, and the other due to rotation of field energy outside the sphere? It can be shown that if we merely assume that all the field energy, within and outside the sphere, rotates with the charge at the same angular velocity, then the angular momentum is infinite. Therefore, we are forced to recognize that any rotation of the field energy outside the charge sphere must involve a limiting boundary or a slip action by which the angular velocity decreases with radial distance.

It seems very probable that there is an angular momentum within the charge sphere due to the charge rotating with its electric field. Also, there must be scope for another angular momentum component determined by the angular velocity and extent of its effect upon the electric field outside the charge. This latter component of angular momentum may well be independent of that possessed by the charge itself within the charge sphere. This argument is consistent with the use of the zero spin condition and its inter-relation with mass in the composite particle forms discussed in Chapter 7. It is also consistent with the assignment of a standard half spin angular momentum quantum to such a particle form. All that this means is that the surrounding field has its own rotation pattern. See also Appendix III.

It is of interest to ask how the proton and the neutron acquire their half spins. In discussing the origins of nucleons it must be remembered that the creation process involves graviton expansion. If one graviton expands to its lower quantum state of mass  $3,189 m$  (see page 140) and then stores the energy of a nucleon of mass of the order of

1.836  $m$ , this graviton can provide dynamic balance and gravitation for the nucleon while still having a total mass and an angular momentum with the  $G$  frame roughly equal to those of the normal graviton. This leads to the rule that there is one graviton in close association with each nucleon. The nucleon assumes the spin  $h/4\pi$  because it takes up a place in juxtaposition with a graviton and thus replaces an electron of spin  $h/4\pi$ . In taking up this position it probably exchanges its zero angular momentum state, developed during its creation, with that of the electron. On this basis, the neutron and proton each have a spin of  $h/4\pi$ , but the deuteron has a double half spin, probably because it forms in the manner depicted in Fig. 7.13 and needs two gravitons to balance it.

Where does the  $E$  and  $G$  frame angular momentum of the nucleon come from if it only has a spin  $h/4\pi$ ? The lattice particle and the electron have been presumed to have zero or negligible total angular momentum, because spin was in balance with the  $E$  and  $G$  frame orbital quanta. The quantum  $h/4\pi$  is the spin needed by the electron for balance. It is insufficient for a heavy nucleon. By the action of formation of the approximately normal graviton, just described, a quantum of energy of  $1,874 mc^2$  is released, but this order of energy has to be reabsorbed if the graviton is to provide proper gravitational balance and dynamic balance for a nucleon and other  $E$  frame substance. In fact, it is inappropriate to imagine that there are both normal and "approximately" normal gravitons. All gravitons are the same. It is just that, for each nucleon accounting for about  $1,874 mc^2$  as gravitating mass energy, there is a certain continuum volume adjustment, that is, a continuum charge which can be allowed in the gravity calculation. The gravitational effect of the nucleon mass can, therefore, be catered for without special compaction of a graviton beyond its normal size. Minor volume differences will exist between gravitons in the presence of matter, but on balance the gravitons will retain their basic size, corresponding to their mass of about  $5,064 m$ . It follows that any angular momentum considerations involve us in examining the action of full graviton expansion to form the charge continuum or, at least, some well expanded form such as the positron. Now, the angular momentum of such a graviton is really taken away by the lattice particles which come out of motion with the  $E$  frame. They have zero total angular momentum, including their claim to that carried by the balancing graviton. As long as these lattice particles remain lattice particles, there is no angular momen-

tum available. The graviton energy can be deployed into forming some lattice particles as electrons or positrons. This has been suggested in Chapter 8. However, this will do nothing for our angular momentum problem because electrons and positrons have little, if any, residual angular momentum when spin, orbital  $E$  frame and  $G$  frame balance are considered. Finally, if we use the energy to form nucleons, there is still no angular momentum available to prime the  $E$  frame motion. This problem will not be answered. It is a matter for further speculation. Possibly there is a clue from the fact that stars rotate. Where does their angular momentum come from? Can it be that their formation involves a reaction by which the  $E$  and  $G$  frame angular momenta of matter and even some of the space-time substance itself is set in balance? This is hypothesis, and best left for the future.

A question of more immediate importance is the explanation of how graviton energy can exist without direct evidence other than the nuclear processes or gravitation. Why is it that matter can move without there being evidence of energy of gravitons moving also? How can the extra energy in space-time which is needed to provide the  $G$  frame balance for matter in the  $E$  frame move with this ordinary matter and go undetected? The simple answer to this question is that, when matter moves, electric charge constituting such matter is in motion. Mass in motion requires charge to be in motion. When the energy of  $G$  frame balance moves, it is being transferred from one graviton to another. Possibly, even, the gravitons are not migrant charges but migrant energy quanta which settle at successive locations by forming the charge continuum into singularities corresponding with the existence of the graviton. Energy in motion need not develop momentum. It has to be carried by electric charge to convey momentum. In this regard the photon is carried by the  $E$  frame lattice, which is a metric formed from lattice particles, an array of electric charges. It is submitted that one graviton can form by compaction of electric charge as another expands. If the volumes sum to the same amount, before and after this event, then energy has been transferred without the motion of electric charge.

Another problem might seem to be that of gravitational effects of free migrant lattice particles. Such particles are needed to provide the reverse motion balancing the general motion of a lattice. If the free particles are loose in the inertial frame, there is motion relative to the

*E* frame. How is it that this does not upset the gravitational analysis? Firstly, relative to the *E* frame the linear motion balances that of the continuum charge. There is no resultant electromagnetic effect due to linear motion. There is, in theory, an effect due to the apparent motion of the free particles at the angular velocity  $\Omega$  relative to the *E* frame. The free particles have deployed their velocity in the *E* frame orbit into a linear motion in the inertial frame. Hence, they move relative to the *E* frame in an apparent orbital sense which should develop an electromagnetic effect interfering with gravitation. To answer this, remember that the linear motion of the space-time system which causes the particles of the lattice to be freed is, in fact, only caused by graviton transmutation. The continuum volumes are adjusted in this process, as matter is created. In fact, the basic parameters of the space-time effects are readjusted. It must, therefore, be assumed that in this process the electromagnetic effects of any free charge are allowed for in the balance, just as the effects of the graviton charge are allowed for.

### Electrodynamics

In Chapter 2 the distinction was made between primary charge and reacting charge. The analysis leading to equation (2.8) can be criticized on the ground that reacting charge will have a velocity component in the direction of the applied magnetic field. This makes it difficult to contend that the term  $K_R$  is the true kinetic energy. In fact, this problem is merely part of the greater problem that the actual kinetic energy of charge present and available to react may exceed the magnetic field energy requirements. The answer to this difficulty appears to be that  $K_R$  is a component of kinetic energy added as a result of the application of the magnetic field. Further, not all free charge can be classed as reacting. All charge is presumably primary unless it is needed for reaction purposes. Heavier free particles will react in preference to lighter ones of the same polarity, but only a proportion of the heavier free particles present may be deflected by the field to become reacting.

This is tantamount to saying that not all free charge in motion in a magnetic field is subject to electrodynamic force action, at least at the same instant. Undoubtedly, this is a difficult proposition to accept, but, if Nature is pointing in this direction, we should not be unwilling to explore its further meaning. Also, the reader is reminded

that in this book we are confronting electromagnetic problems, many of which are hidden unnoticed in the subtleties of mathematics in other treatments.

One currently accepted argument is that the diamagnetic moment of free charge is constant (see, for example, *Handbook of Physics*, 2nd edition, 1967, McGraw-Hill, p. 4-193). Analysis shows that as the applied magnetic field increases, electric field induction occurs along the orbit of the reacting charge. This is deemed to accelerate charge to keep the angular momentum, and so the magnetic moment, constant. Kinetic energy increases to keep in proportion to the applied field strength, as equation (2.7) requires if the reaction magnetic moment is not to change.

Now, what does this prove? Does it mean that free electrons in a metal are not diamagnetic? It merely indicates that a single electron will provide a definite magnetic moment in opposition to an applied magnetic field. Diamagnetism, as such, has to do with a multiplicity of electrons. We are concerned in (2.7) with a summation of all the effects of many reacting charges. The reacting or non-reacting state of a particular charge can be determined selectively, as suggested above. Hence, whereas the above regular argument proves that there should be a constant magnetic moment opposing any applied field action, if all charges behave alike, the author prefers the statistical selection as a better alternative. It then becomes irrelevant to argue that the reacting moment of a single electron is unchanged by changing field.

Some authorities require all charge to react in the same way and then invoke statistical argument to explain an overall compensation of magnetic moment. This is contrary to the authority of the above reference which specifies that free electrons react to oppose a magnetic field by developing a magnetic moment which does not vary as the field changes. Complete statistical compensation is, however, impossible to justify. Those who claim it, exemplified by Van Vleck (1957), seem primarily concerned with field-dependence of energy and not magnetic moment. They seem to make their error, a rather grave error, in using a formulation of the form:

$$\sum M = -\frac{\partial E}{\partial H}$$

to show that the energy quantity  $E$  does not vary with a change of the magnetic field  $H$  when the magnetic moment of free electrons is

statistically evaluated. It is a most curious mistake because this formula itself contains the implicit assumption that there is no diamagnetism present. To be correct the value of  $M$  should include also the magnetic moment directly attributable to the applied field  $H$ . History may one day show that this particular error has been a major set-back to the progress of theoretical physics. It has prevented the earlier development of the analysis on pages 30 and 31, analysis which could have helped considerably in the understanding of the gyromagnetic difficulties later to be discovered.

To conclude this discussion, a few final words could be said about the relevance of the Trouton–Noble experiment to the new law of electrodynamics presented in Chapter 2. The experiment did not involve the translational movement of the capacitor *relative* to the earth. The motion of the earth around the sun was taken as the motion which should induce any manifestation of electrodynamic action. It follows, therefore, that, if the electromagnetic reference frame can be said to be moving with the earth, there is no experimental electrodynamic effect to be expected anyway. As none was found, nothing has been proved. The empirical derivation of the law of electrodynamics is open to criticism on this account. There remains the theoretical derivation and the evidence of its successful application to phenomena, such as ferromagnetism and the explanation of gravitation. These should be sufficient to establish the law. As to the empirical derivation, can it really be expected that a charged capacitor should tend to turn *in its own inertial reference frame* if moved linearly through space relative to an observer? This is an impossibility. It is a contradiction in terms since there could be many observers with different relative linear motions, all involving different amounts of turning action (in different directions) but in the same inertial reference frame. Then, the electrodynamic reference frame alone remains as the reference for such actions. It either moves linearly with the capacitor, or it does not. If there is no measurable linear motion, and there were to be a turning action of the charged capacitor varying according to different uniform velocities of such motion, then Einstein's Principle of Relativity is disproved. It seems, therefore, fairly safe to accept that the experimental data are consistent with the empirical derivation of the new law of electrodynamics presented in Chapter 2.

## APPENDIX I

### Electrostatic Energy and Magnetic Moment of Spinning Charge

Consider a sphere of radius  $a$  containing an electric charge  $e$ . The charge distribution within this sphere is determined by the condition of uniform pressure. The electric charge has an intrinsic mutual repulsion and it is constrained against the action of such internal forces to occupy the limited volume of the sphere. Pressure has to be uniform inside this charge. The charge distribution must be radial due to symmetry. Within any spherical shell concentric with the centre of the sphere the charge distribution is uniform over the solid angle subtended. Thus, if  $e_x$  denotes the charge contained within radius  $x$  and  $de_x$  is the charge in the shell of radial thickness  $dx$ , we may calculate the outward repulsive force due to their interaction as  $e_x de_x/x^2$  from Coulomb's law. This is the force differential across the shell and it must equal the pressure, denoted  $P$ , multiplied by an increment in surface area across the shell. This is the differential of  $4\pi x^2$  or  $8\pi x dx$ . From the equality:

$$8\pi P x^3 dx = e_x de_x \quad (1)$$

Since  $P$  is constant, it follows from this that:

$$4\pi P x^2 d(x^2) = e_x de_x \quad (2)$$

whence:

$$e_x = x^2 \sqrt{4\pi P} \quad (3)$$

This gives:

$$P = e^2/4\pi a^4 \quad (4)$$

From (3), the electric field intensity  $e_x/x^2$  within the charge may be shown to be constant and equal to  $\sqrt{4\pi P}$ . The internal electrostatic energy of the charge is then found by multiplying its volume  $4\pi a^3/3$  by this field intensity squared and dividing by  $8\pi$ . The energy  $E'$  is then:

$$E' = 2\pi a^3 P/3 \quad (5)$$



From (4) and (5) this is simply  $e^2/6a$ . This is to be added to the well-known value of the field energy outside the charge radius of  $e^2/2a$  to obtain the total electrostatic energy  $E$  of the charge given as:

$$E = 2e^2/3a \quad (6)$$

It is to be noted that the charge must adopt spherical form because it would otherwise occupy the same volume and have a higher electrostatic energy. It is the contention of the theory presented in this work that space is strictly quantized. The volume available for the charge  $e$  is limited. According to this volume, the energy of the particle is determined on the assumption that it is a minimum. Thus, taking the spherical form as reference, imagine an element of charge to be pushed out to distort the sphere at some point. Then elsewhere an element of charge must recede inwards to keep the occupied volume constant. Electrostatic energy is decreased less for the outward displaced element than it is increased for the inward displaced one. As a result, minimum energy means a spherical charge. This facilitates spin about an axis through the centre of the charge sphere, since rotation about this axis can occur without disturbing the medium outside the sphere containing the charge.

By differentiating (3) with respect to  $x$  and dividing by the volume of a spherical shell  $4\pi x^2 dx$ , it can be shown that the charge density within the sphere of charge varies inversely with distance from the charge centre. The charge  $de_x$  of the shell is  $2x\sqrt{4\pi P} dx$ , so, noting that the velocity moment of a spherical shell is  $\frac{2}{3}$  times its radius squared per unit angular velocity, the magnetic moment of the charge  $e$  becomes:

$$\frac{\omega}{2c} \int_0^a \frac{2}{3} x^2 2x \sqrt{4\pi P} dx \quad (7)$$

or:

$$\frac{a^4}{6c} \sqrt{4\pi P} \omega \quad (8)$$

$\omega$  denotes angular velocity. To explain the parameter  $2c$ , remember that the magnetic moment of unit electromagnetic charge is  $4\pi$  times its velocity moment times its frequency of rotation,  $1/2\pi$  per unit angular velocity.

From (4) and (8), the magnetic moment of the charge  $e$  is:

$$\frac{ea^2\omega}{6c} \quad (9)$$

## APPENDIX II

### Magnetic Field Angular Momentum Analysis

Referring to Fig. 1, consider two charges  $q_1$  and  $q_2$  in close association at  $O$  moving at right angles at velocities  $v_1$  and  $v_2$  respectively. The frame of reference is that in which magnetic field reaction is induced. That is, the velocities are measured in the  $E$  frame, in the sense in which this term is used in Chapter 4. Thus, the magnetic field induced at a point  $P$  distant  $OP$  from  $O$  may be expressed as the vector sum of two components  $H_1$  due to  $q_1$  and  $H_2$  due to  $q_2$ ,

Let  $q_1$  be taken as moving along the axis  $Ox$ .

Let  $q_2$  be taken as moving along the axis  $Oy$ .

Take axes  $Ox$ ,  $Oy$  and  $Oz$  as orthogonal.

Let the angles  $\theta$ ,  $\varphi$ ,  $\varepsilon$ ,  $\eta$  be as shown.

The magnetic field at  $P$  due to  $q_1$  is:

$$H_{1y} = +(q_1 v_1 / c) \sin \varepsilon \sin \eta / (OP)^2 \text{ in the } y \text{ direction}$$

$$H_{1z} = -(q_1 v_1 / c) \sin \varepsilon \cos \eta / (OP)^2 \text{ in the } z \text{ direction}$$

The magnetic field at  $P$  due to  $q_2$  is:

$$H_{2z} = -(q_2 v_2 / c) \sin \theta \sin \varphi / (OP)^2 \text{ in the } z \text{ direction}$$

$$H_{2x} = +(q_2 v_2 / c) \sin \theta \cos \varphi / (OP)^2 \text{ in the } x \text{ direction}$$

Now, imagine that the field due to  $q_1$  exists but that the field due to  $q_2$  has only just been established by  $q_2$  having been suddenly accelerated from rest to assume the velocity  $v_2$ . This means that the magnetic field energy density at  $P$  changes from  $(H_{1y}^2 + H_{1z}^2) / 8\pi$  to  $[H_{1y}^2 + H_{2x}^2 + (H_{1z} + H_{2z})^2] / 8\pi$  as the wave passes. At the point  $Q$  it may be shown that the same effect produces a change of magnetic field energy density from  $(H_{1y}^2 + H_{1z}^2) / 8\pi$  to  $[H_{1y}^2 + H_{2x}^2 + (H_{2z} - H_{1z})^2] / 8\pi$ .

The point now to note is that there is a component of energy density which has to be added in equal measure at  $P$  and  $Q$  by the passage of the wave. This is  $(H_{2z}^2 + H_{2x}^2) / 8\pi$ . Also, there is a component to be added at  $P$  and an exactly equal component to be subtracted at  $Q$ . It is:



Movement from  $P$  to  $Q$  is through an arc subtending the angle  $2\varepsilon$  at radius  $OP$  but projected by multiplication by  $\cos \eta$ . This movement is completed in the time taken for the wave to cross the region contributing to the energy interchange. Let  $w$  be the angular velocity of the energy transfer. Then the projected velocity moment is  $w(OP)^2 \cos \eta$ , and, since  $w$  is  $2\varepsilon/dt$ , where  $dt$  is the time taken by the transfer, this velocity moment is:

$$2\varepsilon(OP)^2 \cos \eta / dt \quad (11)$$

The radial thickness of the region under study is  $c dt$  and an elemental volume at  $P$  or  $Q$  can be formed by multiplying  $c dt$  by  $2\pi(OP) \sin \varepsilon$  and  $(OP)d\varepsilon$ . Thus, the elemental energy being transferred between these volumes at  $P$  and  $Q$  is found, from (10), as:

$$\frac{1}{2}(OP)^2 c dt (H_{1z} H_{2z}) \sin \varepsilon d\varepsilon \quad (12)$$

We divide this by  $c^2$  to obtain mass and multiply the result by (11) to determine the angular momentum as:

$$\frac{1}{c} (H_{1z} H_{2z})(OP)^4 \varepsilon \sin \varepsilon \cos \eta d\varepsilon \quad (13)$$

Substituting now the originally stated values of  $H_{1z}$  and  $H_{2z}$  gives:

$$(q_1 q_2 v_1 v_2 / c^3) \varepsilon \sin^2 \varepsilon \sin \theta \cos \varphi \cos^2 \eta d\varepsilon \quad (14)$$

It may be seen from Fig. 1 that:

$$\cos \varepsilon = \sin \theta \cos \varphi \quad (15)$$

From (14) and (15) the elemental field angular momentum given by (14) is obtained in terms of  $\varepsilon$  and  $\eta$ . When averaged for all values of  $\eta$ ,  $\cos^2 \eta$  becomes  $\frac{1}{2}$ . Thus the total angular momentum may be found by evaluating:

$$\frac{1}{2} (q_1 q_2 v_1 v_2 / c^3) \int_0^{\pi/2} \varepsilon \sin^2 \varepsilon \cos \varepsilon d\varepsilon \quad (16)$$

This is:

$$\left( \frac{\pi}{12} - \frac{1}{9} \right) q_1 q_2 v_1 v_2 / c^3 \quad (17)$$

Consideration shows that if  $v_1$  and  $v_2$  are not at right angles, as shown in Fig. 1, the expression has to be multiplied by the sine of the angle between them. Thus (17) is a measure of the maximum angular reaction between the charges.

## APPENDIX III

### Magnetic Spin Properties of Space–time

The lattice particle system of space–time is the electromagnetic reference frame. The charge continuum moving about this frame at the universal angular velocity  $\Omega$  develops magnetic moment. Here, we assume that this is balanced by the spin of the lattice particles. This spin motion must be in the same direction but it will, of course, have to be at much higher frequency.

From Chapter 2 we have seen that the magnetic moment of any fundamental system in orbital motion has to be doubled. Thus unit charge  $e$  of the continuum moving at  $\Omega = c/2r$  in an orbit of radius  $2r$  relative to the lattice produces a magnetic moment of twice  $(e/2c)$  times  $\Omega$  times  $(2r)^2$  or  $2er$ . From Appendix I the lattice particle spinning at angular velocity  $\omega$  develops a magnetic moment  $(e/6c)b^2\omega$ , where  $b$  is the particle radius. This has to be multiplied by a factor  $\gamma$  to correct for anomaly. Equating the magnetic moments:

$$\gamma(e/6c)b^2\omega = 2er \quad (18)$$

Next, we note that the spin angular momentum of the lattice particle plus its orbital angular momentum ( $E$  and  $G$  frame components) sum to zero. The problem here is that the distribution of the angular momentum due to the mass in the field is uncertain. However, we assume that we can apply the same criterion to the mass components defined by and within the sphere of the lattice particle. The field is excluded. Now, the rest mass energy of the lattice particle is  $2e^2/3b$ , of which  $e^2/6b$  is within the sphere of radius  $b$  and  $e^2/2b$  outside. The effective mass of the particle is halved because of the “buoyancy” due to the density of the energy medium surrounding the particle. Thus, ignoring the field outside the radius  $b$ , the effective orbital mass energy of the non-field constituent, to which our zero angular momentum condition is applied, is  $-e^2/3b$  due to the buoyancy effect and  $e^2/6b$  due to the energy within the sphere. This tells us that the mass effect within the sphere and able to spin at  $\omega$  is exactly equal and opposite in polarity to that to be considered in

orbital motion with the  $E$  frame. Note that the field effects and the  $G$  frame effects are all separate. Thus, we can equate the spin moment and the velocity moments of the motion, thus:

$$\frac{2}{5} b^2 \omega = \Omega r^2 \quad (19)$$

The mass effect within the sphere is uniformly distributed, as shown in Appendix I. Note also that this negative mass effect of the orbital motion is most important for angular momentum balance. Otherwise, the unidirectional motion demanded for magnetic balance due to opposite charge polarity could not be reconciled with zero angular momentum. As it is, the field energy can have counter spin without affecting the magnetic moment and this has important bearing upon the discussion of angular spin momentum in Chapter 9.

From (18) and (19), since  $\Omega$  is  $c/2r$ , we see that  $\gamma$  is 9.6. This result is used to evaluate the magnetic moment of the proton in Chapter 7.

The result that the factor relating conventional magnetic moment and true magnetic moment can be 9.6 is, to say the least, most surprising. It ought to be 2, one would think, if the assumptions in Chapter 2, as used to derive (2.7), are to be believed. Let us examine this. Rewrite (2.7) as:

$$H = C - 4\pi k(K_R)/H \quad (20)$$

Keeping  $C$  constant and differentiating for maximum  $K_R$  gives:

$$C = 2H \quad (21)$$

Then, from (20) and (21):

$$K_R = \frac{H^2}{4\pi k} = \frac{H^2}{8\pi} \quad (22)$$

if  $k$  is 2, as in Chapter 2. This result applies strictly to reaction due to *orbital* motion of charge. There is no basis for applying it if the reaction is due to spin. Hence, if the primary field  $C$  is developed by charge in spin, any parameter can relate field and charge velocity moment, as far as this particular analysis is concerned. Far from being surprised, therefore, we should be content that a way has been found for deducing the necessary constant in the case of spin.  $\gamma$  is 9.6, not 2, under these circumstances.

As a final word, it is to be noted that the distinction thus made between orbital motion and spin is nothing to do with the geometrical

form of any movement of charge. It concerns more the ability of a magnetic field to act upon charge. Magnetic field is physically interdependent upon reaction effects in space-time. It appears that a charge moving in an orbit of radius  $r$ , that is about  $10^{-11}$  cm, experiences normal magnetic field actions and so can develop normal magnetic field effects. A charge moving in a path of radius of the order of the electron radius, about  $10^{-13}$  cm, has different behaviour in a magnetic field and so behaves differently in developing a magnetic field. The factor of 9.6 applies to spin and orbital motion of electric charge at small radii, probably even up to radii of the order of the lattice particle and certainly applies to the charge within this particle itself. Whether the factor of 9.6 changes abruptly to 2 at some critical radius, or whether the transition is gradual, is a matter for further research.

## REFERENCES

- ASPDEN, H. (1956), *Proc. I.E.E.* **103C**, p. 272.
- ASPDEN, H. (1958, a), *Proc. I.E.E.* **105C**, p. 359.
- ASPDEN, H., (1958, b), U.K. Patent No. 892333.
- ASPDEN, H. (1960), *The Theory of Gravitation*, 1st edn., Sabberton, Southampton, p. 13.
- ASPDEN, H. (1965), *Electronics and Power* **11**, p. 137 and p. 202.
- ASPDEN, H. (1966, a), *Electronics and Power* **12**, p. 236.
- ASPDEN, H. (1966, b), *Electronics and Power* **12**, p. 288.
- ASPDEN, H. (1966, c), *The Theory of Gravitation*, 2nd edn., Sabberton, Southampton, p. 97.
- ASPDEN, H. (1969), *Jour. Franklin Inst.* **287**, No. 2, p. 179.
- BATES, L. F. (1951, a), *Modern Magnetism*, 3rd edn., Cambridge Univ. Press, p. 327.
- BATES, L. F. (1951, b), *ibid.*, p. 274.
- BATES, L. F. (1951, c), *ibid.*, p. 281.
- BOHR, N., KRAMERS, H. A. and SLATER, J. C. (1924), *Phil. Mag.* **47**, p. 785.
- DE BROGLIE, M. L. (1924), *Phil. Mag.* **47**, p. 446.
- BROWN, W. F. (1962), *Magnetostatic Principles in Ferromagnetism*, North-Holland, Amsterdam, p. 4.
- BURHOP, E. H. S. (1967), *Science Journal* **3**, p. 40.
- CHAMPION, F. C. (1932), *Proc. Roy. Soc. Lond.* **136A**, p. 630.
- CLARRICOATS, P. J. B. (1961), *Microwave Ferrites*, Chapman and Hall, London, p. 70.
- CLEMENCE, G. M. (1948), *Astron. Jour.* **53**, p. 169.
- COMPTON, A. H. (1921), *Phil. Mag.* **41**, p. 279.
- CULLWICK, F. G. (1966), "The Problems of Radiation Pressure and Associated Mechanical Forces", *I.E.E. Colloquium*, p. 1.
- DICKE, R. H. (1965), *Astron. Jour.* **70**, p. 395.
- DICKE, R. H. (1967), *Scientific American*, March 1967, p. 48.
- DIRAC, P. A. M. (1958), *The Principles of Quantum Mechanics*, 4th edn., Clarendon Press, Oxford, p. 293.
- DOOLITTLE, E. (1925), *Trans. Am. Phil. Soc.* **22**, p. 37.
- DORING, W. (1938), *Ann. Phys. Leipzig.* **62**, p. 465.



- EDDINGTON, A. S. (1929, a), *The Nature of the Physical World*, Cambridge Univ. Press, p. 220.
- EDDINGTON, A. S. (1929, b), *ibid.*, p. 186.
- EINSTEIN, A. (1921), *The Meaning of Relativity*, Princeton Univ. Press, p. 25 of 5th edn., 1956.
- EINSTEIN, A. (1925), *Berlin Sitz.*, p. 3.
- EINSTEIN, A. and HAAS, W. J. (1915), *Verhh. d. Deutsch. Phys. Ges.* **17**, p. 152.
- ELSASSER, W. M. (1955), *Am. Jour. Phys.* **23**, p. 590.
- ELSASSER, W. M. (1956), *Am. Jour. Phys.* **24**, p. 85.
- FARLEY, F. J. M. *et al.* (1966), *Il Nuovo Cimento* **45A**, p. 281.
- FOCK, V. (1964), *The Theory of Space Time and Gravitation*, 2nd edn., Pergamon, London, p. 222.
- FOWLER, R. D. *et al.* (1967), *Physical Review Letters* **19**, p. 892.
- FURTH, H. P. (1961), "High Magnetic Fields", *Proceedings of the International Conference on High Magnetic Fields*, Wiley, New York, pp. 235-48.
- GALT, J. K. (1961), *ibid.*, p. 474.
- GWYNNE, P. (1968), *New Scientist* **37**, p. 535.
- HARNWELL, G. P. and STEPHENS, W. E. (1966), *Atomic Physics*, Dover, New York, p. 78.
- HOYLE, F. (1950), *The Nature of the Universe*, Blackwell, Oxford, p. 79.
- HOYLE, F. (1964), *A New Kind of Physics*, B.B.C. publication, London, p. 22.
- KIKOIN, I. K. and GOOBAR, S. V. (1938), *C.R. Acad. Sci. U.R.S.S.* **19**, p. 249.
- KITAIGORODSKY, A. (1965), *Introduction to Physics*, Dover, New York, p. 429.
- KITTEL, C. (1949), *Rev. Mod. Phys.* **21**, p. 9.
- KOBEL, E. (1930), *Physical Review* **36**, p. 1636.
- KRISCH, A. D. *et al.* (1966), *Physical Review Letters* **16**, p. 709.
- MARSHAK, R. E. (1952), *Meson Physics*, Dover, New York, p. 131.
- MILLER, D. C. (1925), *Proc. Nat. Ac. Sci.* **11**, p. 306.
- MILLIKAN, R. A. (1935), *Electrons (+ and -), Protons, Photons, Neutrons and Cosmic Rays*, Univ. Chicago Press, p. 158.
- NISSIM, J. A. (1966), *A New Physics of Matter and Energy*, Lewis, London, p. 97.
- PAGE, L. and ADAMS, N. L. (1965), *Electrodynamics*, Dover, New York, p. 186.

- PENFIELD, H. (1966), *Proc. I.E.E.* **113**, p. 1875.
- RABE, E. (1951), *Astron. Jour.* **55**, p. 112.
- RICHARDSON, O. W. (1908), *Physical Review* **26**, p. 248.
- ROBSON, J. M. (1951), *Physical Review* **78**, p. 802.
- ROSEN, N. (1940), *Physical Review* **57**, p. 147.
- RUSSELL, BERTRAND (1961), *History of Western Philosophy*, 1961 edn., Allen and Unwin, London, p. 86.
- SAKURAI, K. (1959), *J. Geomag. Geoelect.* **11**, p. 21.
- SLATER, J. C. (1930), *Physical Review* **36**, p. 57.
- SMART, J. S. (1966), *Effective Field Theories of Magnetism*, W. B. Saunder Co., U.S.A.
- SOMMERFIELD, C. M. (1957), *Physical Review* **107**, p. 328.
- SUCKSMITH, W. (1930), *Proc. Roy. Soc.* **128A**, p. 279.
- SUCKSMITH, W. and BATES, L. F. (1923), *Proc. Roy. Soc.* **104A**, p. 499.
- TRICKER, R. A. R. (1965), *Early Electrodynamics*, Pergamon, Oxford; New York.
- TROUTON, F. T. and NOBLE, H. R. (1903), *Phil. Trans. Roy. Soc. Lond.* **202A**, p. 165.
- UHLENBECK, G. E. and GOUDSMIT, S. (1925), *Naturwiss* **13**, p. 953.
- VAN VLECK, J. H. (1957), *Nuovo Cimento Suppl.*, p. 857.
- WALDRON, R. A. (1966), "The Problems of Radiation Pressure and Associated Mechanical Forces", *I.E.E. Colloquium*, p. 61.
- WHITTAKER, SIR E. (1951, a), *Aether and Electricity, The Classical Theories*, Nelson, London, p. 87.
- WHITTAKER, SIR E. (1951, b), *ibid.*, p. 199.
- WHITTAKER, SIR E. (1951, c), *ibid.*, p. 109.
- WHITTAKER, SIR E. (1953), *Aether and Electricity, The Modern Theories*, Nelson, London, p. 175.
- WILSON, H. A. (1946), *Modern Physics*, 2nd edn., Blackie, London, p. 11.
- WILSON, R. (1963), *Nucleon-Nucleon Interaction*, Wiley, New York, p. 16.