

Installing Deck Stairs

OVERVIEW

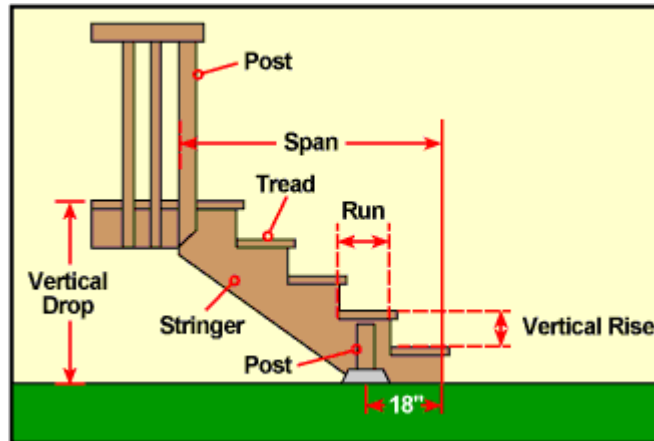

Introduction

Most likely you have planned one or two flights of stairs from your deck to the surrounding yard. Steps can be built a number of different ways depending on your aesthetic preference, however most municipalities have specific codes that must be taken into consideration when you design and build your steps. For instance, many cities require a minimum width of 3 feet for the stairs.

From a design standpoint, your stairs can have notched stringers or solid stringers. You can have deep tread runs of 16" or a more standard run of 11". At the foot of the stairs, you can use posts on concrete pads like the rest of the deck or build a solid base of concrete or stones. Design stairs that suit your style.

To understand this tutorial, note the main illustration and the following terms:

- Vertical rise - distance between 2 steps. Usually 6" to 7"
- Run - depth of each tread. Can range from 11" to 16"
- Vertical drop - height of stairs from the ground to the deck surface
- Span - distance the stairs cover from the deck to the foot of the stairs

BEFORE YOU START...

SKILL LEVEL & TIME TO COMPLETE

Time to complete this project depends on the size of the deck and the level of help available, the times listed here are for two people on a 10'x 30' deck with the house defining two sides of the deck.

- Beginner - 4 to 6 hours
- Intermediate - 3 to 5 hours
- Advanced - 2 to 4 hours

CAUTION

Check with your local building department to get the deck railing requirements for your area.

STEPS

1. On the side of your deck, mark the location that the two stair stringers will attach. They should be at least 36" apart.

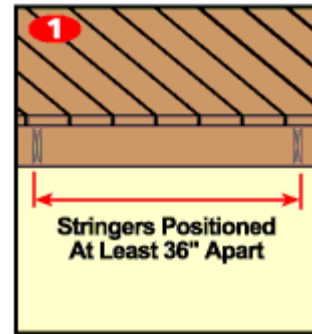

2. Measure the vertical drop from the deck surface to the ground. Divide this number by 7 to determine the number of steps. For instance, if the deck is 33" off the ground, you need 4.7 steps. Since you can't have 4.7 steps, round it to 5 steps. Now divide 33" by 5 steps. You get 6-1/2". This will be the vertical rise of your steps.

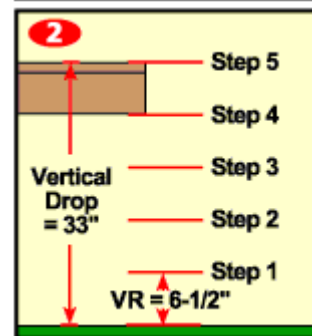

3. Determine the run you prefer. Using two 2x6's is a good choice. That means your step treads will be 11-1/4" deep. So your run is 11-1/4". Multiply 5 (steps) times the run (11-1/4"), you get 56-1/4". This is the span of your stairs.

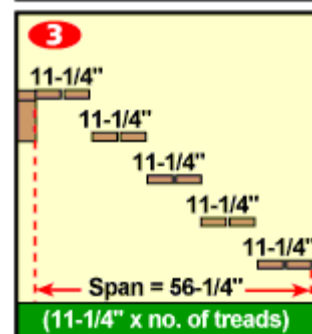

4. Now it is time to mark the post locations. Using a 2x4 and a square, lay the 2x4 on the deck about 2" on the outside of one of the stringer marks. Measure out the distance of your span calculation minus 18". Drop a plumb bob and mark the ground. Follow the same procedure for the other stringer mark.

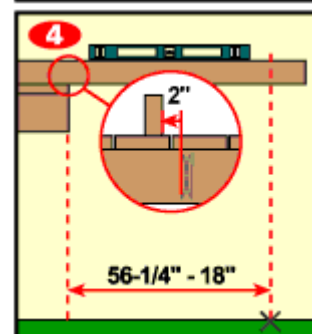

5. At the marks on the ground, dig round postholes and pour concrete footings. Attach the post piers and posts as described in the Digging Deck Post Holes tutorial.

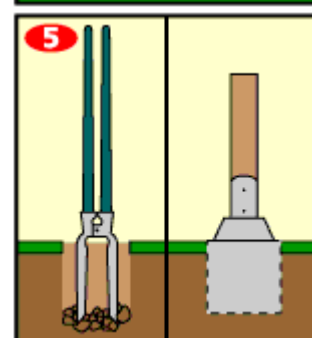

- Take 2x12 boards and a square to mark out your stringers. If the deck surface overhangs the frame of the deck, factor that into the top step. The other steps should be 10-1/4" to allow a 1" overhang on each step. The rise measurement in this example is 6-1/2" as calculated above.

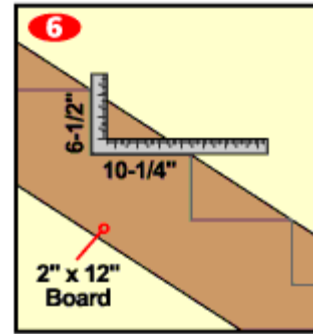

- Use a circular saw to cut the stringers. Since a circular saw can't get all the way into the corners, use a hand saw to finish each cut.



- Attach each stringer to the deck frame using an angle bracket. Use lag bolts and washers to secure the foot of the stringers to the support posts.

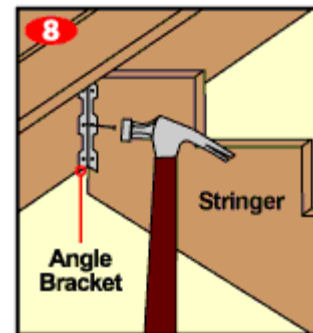

- To build the stair treads, cut 2x6 boards to span the stringers. If you factor in a 1" overhang on each side, cut the boards to 38" per this example. Allow 1/4" gap in between the two boards on each tread. Screw the boards into place with two screws per board per stringer.

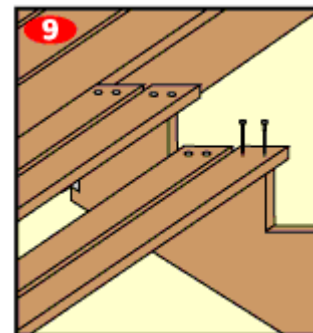

- As an alternative to the stringers used in the above example, you can use solid stringers with angle brackets to support each tread. With solid stringers, the first step tread is one step below deck level. That means you will have 1 fewer tread in your flight of stairs. In step 2, subtract 1 from your step calculation (5-1=4 in the example above).

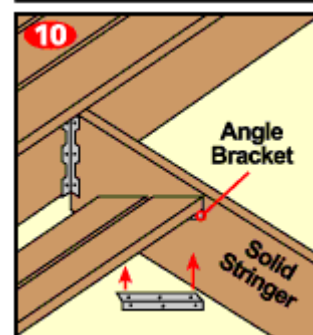

SHOP LIST

Materials Needed

- 4" x 4" Posts
- 2" x 12" Lumber
- 2" x 6" Lumber
- Lag bolts
- Washers
- Screws
- Angle Brackets

Tools Needed

- Miter saw
- Circular saw
- Hand saw
- Plumb bob
- Square
- Socket wrench
- Screw gun/Drill
- Drill bits
- Level
- Tape measure