

# Owner's Manual

Instruction Book for:  
MODEL 597 & 597 MAGNUM  
.22 LONG RIFLE CALIBER RIMFIRE  
OR .22 WIN. MAG. CALIBER  
RIMFIRE AUTOLOADING RIFLES

*Remington*®

## **IMPORTANT!**

READ ALL INSTRUCTIONS  
AND WARNINGS IN THIS  
BOOK BEFORE USING THE FIREARM.



PAGE 2.....THE TEN COMMANDMENTS OF  
FIREARM SAFETY

PAGE 7.....IMPORTANT PARTS OF THE FIREARM

PAGE 10.....HOW TO LOAD AND UNLOAD

PAGE 11 .....LUBRICATION AND MAINTENANCE

PAGE 15.....HOW TO OBTAIN PARTS AND SERVICE

# A Tradition of Performance and Safety.

In 1816 Eliphalet Remington was confident he could make a flintlock that was as good or better than any he could buy. His confidence was well founded. The barrel he handcrafted set a new standard for firearm accuracy and spawned generations of products that have made Remington® Arms America's leading gunmaker. While performance and style are certainly hallmarks of Remington firearms, one factor ultimately drives their performance. Safety. Eliphalet Remington never lost sight of the fact that his rifles were potentially lethal and could kill someone if handled improperly. And after more than 180 years the same holds true for any firearm, including your new Remington. Eliphalet Remington's first flintlock launched a proud tradition of accuracy and responsibility.



*Eliphalet Remington's first flintlock launched a proud tradition of accuracy & responsibility.*

## Safety is Critical to Performance.

A superbly crafted gun is only as good as the hands that hold it. You can never be too careful. Shooting accidents are often caused by careless oversights such as failing to control the direction of the muzzle, failing to fully engage the safety, leaving ammunition in the chamber or using improper loads. These oversights can result in the destruction of life, limb or property. There's no calling back a bullet once it's been fired, so it's critical that you know the principles of safe gun handling and storage before you ever take your new Remington firearm out of the box.

The proper use and performance of your firearm depends on correct assembly and maintenance, so it's critical that you familiarize yourself with the information in this instruction book. Even if you're a veteran shooter with a collection of Remington firearms, take the time to read this literature. Not all firearms are the same. That means the first step in safe handling is to learn the features and requirements of your new Remington.

### THE TEN COMMANDMENTS OF FIREARM SAFETY

The Ten Commandments of Firearm Safety should be etched in your memory forever. Let them govern your action wherever and whenever you're involved with firearms. In the field. On the range. Or in your home. Please take the time to review and understand these rules.

#### 1st COMMANDMENT

### Always Keep the Muzzle Pointed in a Safe Direction.

*This is the most important gun safety rule.* A safe direction is one in which an accidental discharge will not cause injury to yourself or others. Never allow your gun to point at anything you don't intend to shoot. Be especially careful when you're loading or unloading. Treat every gun as if it were loaded. And make it a habit to know where the muzzle is pointed at all times, even when your firearm is unloaded. No one will be injured by an accidental discharge if you keep your firearm pointed in a safe direction. It's as simple as that.

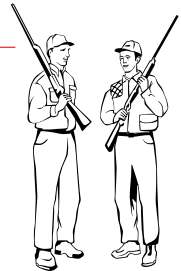

#### 2nd COMMANDMENT

### Firearms Should be Unloaded When Not Actually in Use.

*Load your firearm only* when you're in the field or on the target range and ready to fire. Never let a loaded gun out of your sight or out of your hands. Unload it as soon as you're finished shooting – before you bring it into your car, camp or home. Remember, unloading your firearm means unloading it completely, so there is no ammunition in the chamber or in the magazine. Before handling a firearm or passing it to someone else, visually check the chamber, receiver and magazine to be certain they do not contain ammunition. Always keep the gun's action open when not in use. Never assume a gun is unloaded even if you were the last person to use it. Always check for yourself.

*Let common sense rule* when you carry a loaded gun. If you're in a situation that could risk accidental discharge – such as crossing a fence, wading through a stream or climbing a tree – always unload your gun. Never pull or push a loaded firearm toward yourself or another person. And never carry a loaded gun in a scabbard, detached holster or gun case.

*Certain firearms* (including some Remington® rifles and shotguns) are equipped with internal security devices to prevent unauthorized use. In addition, some firearms owners use external devices, such as cable locks and trigger blocks, for the same purpose. Even if you use such a device, you should still keep your firearm unloaded when stored or not in use. And using internal or external devices cannot substitute, however, for securing your firearms and ammunition in a separate, locked location.

*Safe storage of firearms* is just as critical as safe handling. Never store guns loaded. Be sure to keep your firearms in a secure place where unauthorized persons cannot get their hands on them without your knowledge.

*Take special care* if there are children around. Kids are fascinated by guns. It's a natural curiosity that can have tragic consequences when not properly supervised. Store your firearms in a locked gun safe or some other location that physically bars a child from gaining access.

*Ammunition should be stored* and locked in a location separate from your firearm. Never leave an unsecured firearm or ammunition in a closet, dresser drawer or under the bed. Remember, it is your responsibility to make sure that children and others unfamiliar with firearms cannot get access to your firearm and ammunition.



*Firearms should be stored in a secure place where children cannot access them. A gun safe is an ideal way to secure your firearm.*

### 3rd COMMANDMENT

#### **Don't Rely on Your Gun's Safety.**

*Treat every gun* as if it can fire at any time, whether or not there's pressure on the trigger. Your firearm has been carefully designed to maximize performance and safety. However, because a gun's safety is a mechanical device, it could fail.

*Human error* is a more likely reason for a gun safety to fail. By mistake, you may think the safety is on when it really isn't. Or the safety may have been disengaged without your knowledge. Or you could think your gun is unloaded when there's actually a cartridge or shell in it. A mechanical safety is not a substitute for common sense. It's merely a supplement to your proper handling of a firearm.

*Never touch the trigger* on a firearm until you are ready to shoot. Keep your fingers away from the trigger when you're loading or unloading. And don't pull the trigger when the safety is engaged or positioned between safe and fire.

*Before using your gun*, read this instruction book to understand the exact location and operation of your firearm's safety. Even when the safety is on, maintain control of your loaded firearm and control the direction of the muzzle. In other words, don't rely on your safety to justify careless handling. If your firearm's internal mechanisms are broken or have been altered, your firearm may fire even when the safety is on. Remember, you and your safe gun handling practices are your gun's best safety.

### 4th COMMANDMENT

#### **Be Sure of Your Target and What's Beyond It.**

*You can't stop a shot in mid-air*, so never fire unless you know exactly where your shot is going and what it will strike. Never fire at a sound, a movement or a patch of color. A hunter in camouflage can easily be mistaken for a target by an impulsive shooter. Before you pull the trigger be absolutely sure of your target and what's behind it.

Make sure the shot has a backstop such as a hillside or dense material like sand. Remember, bullets can travel great distances with tremendous velocity. Know how far your shot will go if you miss your target or the bullet ricochets.

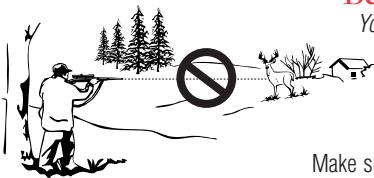

## **Use Proper Ammunition.**

*Every firearm is designed* to use a certain caliber or gauge of ammunition. Using the wrong ammunition, mixing ammunition or using improperly reloaded ammunition can cause serious personal injury or death. And it only takes one cartridge or shotshell of the incorrect caliber or gauge, or which has been improperly reloaded, to destroy your firearm. It's your responsibility to make sure the ammunition you use exactly matches the caliber or gauge of your gun. Refer to this instruction book to find out the specific requirements of your firearm. Always read and heed the instructions on ammunition boxes.

*Confusing shells* or cartridges can cause serious personal injury or death and destroy your firearm. Examine your shells or cartridges closely and use only the precise caliber or gauge for your specific firearm. For example, suppose you accidentally loaded a 20 ga. shell into a 12 ga. shotgun. Because the 20 ga. shell is too small for the chamber, the 20 ga. shell could travel down the barrel and get lodged in the bore. If you then loaded a standard 12 ga. shell behind it and fired, the 12 ga. shot will slam into the lodged 20 ga. shell and may cause the barrel to explode right in your hand. This is commonly called a 12/20 burst, and it can kill you.

*Check all ammunition* before you load it to make sure it matches your gun's requirements. Every Remington® cartridge and shell is head-stamped with its caliber or gauge for easy identification. Likewise, you'll find the caliber or gauge of your new Remington firearm imprinted on the barrel.

### **Reloading Requires Extra Diligence.**

*If you're an ammunition reloader*, you are responsible for personally assuring that the loads and components of your reloaded ammunition meet your gun's factory-tested standards. Never use ammunition which has been reloaded by someone else!

*Many shooters handload* as a hobby or to save money on commercial, factory-made ammunition. However, it requires a thorough knowledge of reloading procedures and a deep respect for the explosive potential of gunpowder.

*Firearms are designed*, manufactured and proof-tested to standards based on factory-loaded ammunition. Handloaded or reloaded ammunition that deviates, either intentionally or accidentally, from load or component recommendations can be very dangerous.

*Reloaders must observe* all possible safety precautions and practices related to the proper handling of explosives. Whether you're a seasoned reloader or just starting out, you should study the subject, watch reloading demonstrations and talk to experienced reloaders.

*The first rule of reloading* is to always follow the manufacturer's instructions for the components you're using. They'll tell you to follow certain guidelines. Namely:

1. Don't mix or substitute powders or primers.
2. Don't use unknown or substandard components.
3. Use only suitable components that have been factory-tested by reputable ammunition, powder and bullet manufacturers.
4. Always be sure to use the manufacturer's recommended recipe when reloading.

*Not following these guidelines* could result in severe injury to yourself or severe damage to your firearm. Dangerously high pressure and explosions can result from an overcharge of powder or other deviations from established reloading guidelines. Be very careful. The process of reloading exposes you to environmentally hazardous material. Lead, which is known to cause cancer and birth defects, is the most common substance in bullets and shot. It is important to handle lead bullets and shot with extreme care. Work only in a well-ventilated area and always wash your hands after exposure and before eating. Never smoke while reloading.

*Primers and powders* are also highly toxic and flammable. So after reloading be sure to clean up all materials from your work area. Don't leave primer or powder spills anywhere on the floor or bench top. Dispose of all waste material in accordance with the manufacturer's recommendations.

*Finally, when reloading* or handloading concentrate on what you're doing at all times. Do not be distracted by talking to others, listening to the radio or watching TV while reloading. Never reload after consuming alcoholic beverages or drugs of any kind. You are working with extremely hazardous materials and you can't risk even a few seconds of distraction. Remember, if you reload, you are the ammunition manufacturer and you are responsible for the performance and safety of your reloaded ammunition.

## 6th COMMANDMENT

### If Your Gun Fails to Fire When the Trigger is Pulled, Handle With Care.

If for some reason the ammunition doesn't fire when you pull the trigger, stop and remember the 1st Commandment of Firearm Safety – always keep the muzzle pointed in a safe direction. Keep your face away from the breech, then put the safety on, carefully open the action, unload the firearm and dispose of the cartridge safely. Remember that anytime there's a shell in the chamber, your gun is loaded and ready to use. Even if you tried to shoot and your gun didn't fire, treat your firearm as if it could still discharge.

## 7th COMMANDMENT

### Always Wear Eye and Ear Protection When Shooting.

Your sight and hearing risk injury from shooting and should be protected at all times. Wear protective shooting glasses to guard against falling shot, clay target chips, powder residue, ruptured cartridge cases and even twigs and branches in the field. Also be sure to wear eye protection when you're disassembling or cleaning a gun so that tensioned parts (like springs) and cleaning solvents don't come in contact with your eyes. Continued exposure to shooting noise can permanently damage your hearing. On the range, where shooting volume is the loudest, be sure to use the maximum protection of a headset. And learn to use ear protection in the field, especially in confined locations like duck blinds.



## 8th COMMANDMENT

### Be Sure the Barrel is Clear of Obstructions Before Shooting.

Before loading your gun, open the action and make sure there's no ammunition in the chamber or magazine. Check the barrel for any obstructions or debris. Even a small amount of snow, mud, excess lubricant or grease in the bore can dangerously increase pressure and cause the barrel to bulge or burst when firing. Use a cleaning rod and patch to wipe away anti-rust compounds or any other residues or obstructions in the barrel. Never try to shoot out an obstruction by loading another shell and firing!

When firing, rely on your instincts. If the noise or recoil of your firearm seems weak, stop everything, unload your firearm and be sure nothing is lodged in the barrel. Remember the 12/20 burst? That's what can happen when the barrel is obstructed. So always be sure you're using the correct ammunition in your firearm and that it's free of obstructions.

## 9th COMMANDMENT

### Don't Alter or Modify Your Gun and Have it Serviced Regularly.

Your firearm has been designed to operate according to certain factory specifications. You'll jeopardize your safety and that of others around you by attempting to alter its trigger, mechanical safety or other mechanisms. So never alter or modify your firearm in any way.



Like any mechanical device, a firearm is subject to wear. It must be maintained and periodically serviced to assure optimum safety and performance. Only a qualified service facility should service, repair or modify your Remington® firearm. Consult your instruction book for instructions on how to send your firearm to the factory or for the location of the nearest Remington repair station.

Proper cleaning and lubrication are also important to firearm maintenance and are necessary to assure accuracy, safety and reliability. Before cleaning, always make sure that your gun is completely unloaded. And always clean the barrel from the chamber end to the muzzle when possible.



*Make it a practice* to clean your bore every time you're going to shoot. Be sure to clean your entire gun before and after long-term storage and no less than once a year. It's also important to clean your gun whenever it's been exposed to adverse conditions such as rain, dirt, mud, snow, sleet or saltwater.

*For safe and dependable* operation of your firearm, all parts of your gun must be properly cleaned and lubricated. Periodically inspect the internal workings of your firearm to be sure they're clean and free of rust, unwanted dirt and debris.

*Use recommended lubricants* on your gun and do not over-lubricate. Excessive use of a non-recommended lubricant could adversely affect the function and safe operation of your firearm. Remember, you are responsible for the proper care and maintenance of your firearm. Failure to properly maintain your firearm can not only damage or ruin your firearm, it can expose you and others to unnecessary risks of personal injury or death.

*Remington® has a wide range* of firearm care products and resources for best results when cleaning your gun. Everything from solvents and lubricants to rods and patches. They're all available from your Remington dealer.

## 10th COMMANDMENT

### Learn the Mechanics and Handling Characteristics of Your Firearm.

*Not all guns are alike.* They have different mechanical characteristics that dictate how you should carry and handle them. Anyone who plans to use a firearm should first become totally familiar with the type of firearm it is and the safe handling procedures for loading, unloading, carrying, shooting and storing it.

*Before you even unpack* your new Remington firearm, read this instruction book from cover to cover and familiarize yourself with the different component parts of the gun. Then read, understand and follow the Ten Commandments of Firearm Safety in this book.

**WARNING!** Discharging firearms in poorly ventilated areas, cleaning firearms or handling ammunition may result in exposure to lead, a substance known to cause birth defects, reproductive harm, cancer and other serious physical injury. Have adequate ventilation at all times. Wash hands thoroughly after exposure.



### SHOOT SOBER!!

*There's one other rule* that must be followed when handling firearms. In fact, respect for this rule is necessary in order to effectively practice the Ten Commandments of Firearm Safety. The rule is: SHOOT SOBER! Guns and alcohol or drugs make a deadly combination. Never consume anything that would mildly impair your judgment or physical coordination when you're using a firearm. A staggering percentage of the shooting accidents that occur every year involve alcohol or drugs. Be smart. Always shoot sober and stay alive.

**WARNING!** Failure to follow any of these safety rules may cause personal injury or death to the shooter or bystander and damage to property. Do not use a firearm until you fully understand and practice the Ten Commandments of Firearm Safety. If you have any questions about the safe use of a Remington firearm, write to us at Remington Arms Company, Inc., Consumer Service, P.O. Box 700, Madison, NC 27025-0700, or call us at 1-800-243-9700.

### DON'T KEEP THIS TO YOURSELF.

*Now that you're a gun owner* you have the obligation to help ensure that shooting sports are safe for everyone – participants and bystanders alike. You can do that by practicing these principles of firearm safety and passing them on to others – especially new shooters. Set an example for beginners. Be a guide to their safe entry into the exciting world of shooting sports. Invest your time and patience for the love of the sport and for its future. After all, it's your love of the sport that led you to buy a new Remington.

*Firearm ownership* is a right and privilege. It's a right guaranteed in this nation's Constitution. It's a privilege which carries with it a personal responsibility to use your firearm in a way which will ensure your safety and the safety of others. The preservation of this right and privilege depends on the personal commitment of you and your fellow shooters to the safe and responsible use of firearms. Let the Ten Commandments of Firearm Safety outlined in the book guide you at all times. Teach and promote these rules whenever you can. Remember, firearm safety depends on you! That's the only way to really enjoy your new Remington firearm and to preserve sport shooting as we know it today.

# Remington® Autoloading Rifle

*Congratulations on your choice of a Remington®. With proper care, it should give you many years of dependable use and enjoyment. For best results, we recommend that you use Remington Ammunition – the ammunition used in factory testing your firearm against our exacting function and performance standards.*

**PICTURE 1** This picture shows the main parts of a REMINGTON AUTOLOADING RIFLE. The picture will aid in understanding the instructions in this book.

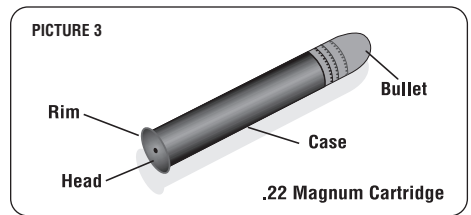
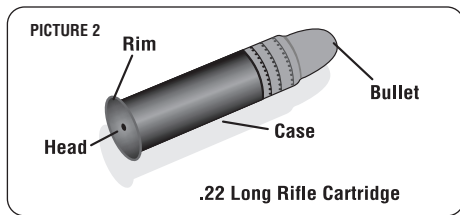
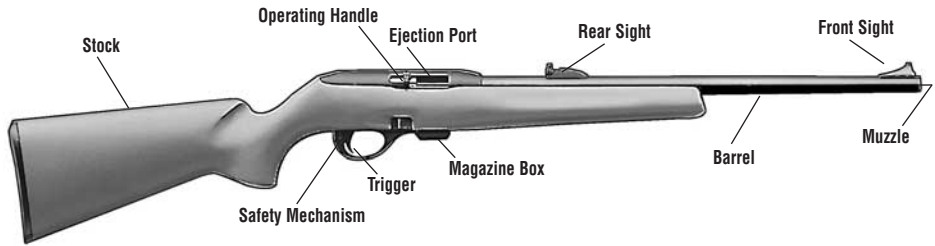

## Important Parts of the Firearm

### The Safety Mechanism

*The safety mechanism on the Model 597™ Autoloading Rimfire Rifle is a button located behind the trigger. See Pictures 4 and 5.*

*The safety mechanism provides additional protection against accidental or unintentional discharge under normal usage when properly engaged and in good working order.*

*To put the safety mechanism in the "ON" or "SAFE" position, push the button so the **RED BAND MARKING CANNOT BE SEEN**.*

*Always put the safety mechanism in the "ON" or "SAFE" position before you handle, load or unload the rifle. Keep the safety mechanism in the "ON" or "SAFE" position until you have the muzzle pointed in a safe direction toward your target and until you are actually ready to shoot.*

*Do not pull the trigger when the safety mechanism is in the "ON" or "SAFE" position. Your fingers and all other objects should be kept outside of the trigger guard and away from the trigger until you are actually ready to fire by pulling the trigger.*

*When you are ready to fire the rifle, push the safety mechanism so that the **RED BAND MARKING IS SHOWING**. The safety mechanism is now in the "OFF" or "FIRE" position. Do not touch the trigger while moving the safety mechanism.*

**NOTE:** Extensive dry firing (firing the rifle without a round in the chamber) may cause damage to the rifle.

**WARNING!** The rifle will fire when the trigger is pulled and the safety mechanism is in the "OFF" or "FIRE" position. Even when you think the safety mechanism is in the "ON" or "SAFE" position, careless handling can cause the firearm to fire. See the *Ten Commandments of Firearm Safety*.

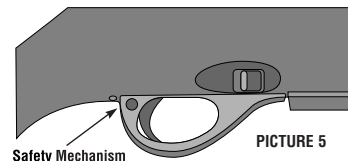
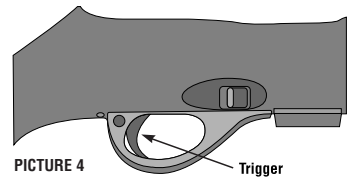

# The Security System

The firearm you have purchased is equipped with an integrated security system. The security system enables the owner to lock the safety mechanism on the firearm in the "SAFE" position with the use of a special key.

**THIS SECURITY SYSTEM DOES NOT ELIMINATE THE NEED FOR SAFE GUN HANDLING AND STORAGE, INCLUDING KEEPING THIS AND EVERY GUN UNLOADED AND LOCKED IN A SECURE PLACE WHEN NOT IN USE. READ AND FOLLOW THESE AND OTHER SAFETY RULES IN THIS INSTRUCTION BOOK. FAILURE TO READ, UNDERSTAND AND OBEY THESE RULES CAN RESULT IN SERIOUS PERSONAL INJURY OR DEATH TO YOU OR OTHERS. SEE THE TEN COMMANDMENTS OF FIREARM SAFETY ON PAGE 2.**

The safety mechanism on the firearm you have purchased is a button located behind the trigger, commonly known as the cross-bolt safety. See Picture 6.

The safety mechanism provides additional protection against accidental or unintentional discharge under normal usage when properly engaged and in good working order.

On the safety mechanism there is a "J" shaped slot. See Picture 6. This "J" slot is the key hole for securing your safety mechanism. Also on the safety mechanism is a pointer which will point and line up with either the **RED** or **WHITE DOT** on the trigger plate when the safety mechanism is turned. See Picture 6. The position of the pointer indicates whether or not the security system is engaged. The existence of the security system does not change the basic operation of the safety mechanism, nor does it change the manner in which the safety mechanism should be used.

With your new firearm you will receive a capped key. To use the key remove the cap. On the key is an indicator line which will line up with the pointer on the safety mechanism. See Picture 7.

To engage the security system, press the safety mechanism to the "SAFE" position so the **RED BAND DOES NOT SHOW**. Insert the key into the "J" slot as far as it can go. Next, turn the key counter-clockwise so that the indicator line on the key and the pointer on the safety mechanism line up with the **WHITE DOT** on the trigger plate.

## THE SECURITY SYSTEM IS NOW ENGAGED.

In operating the security system, **NEVER** use excessive force to turn the key. If the key will not turn freely, contact a Remington® authorized repair center.

Keep your security system engaged and your safety mechanism in the "SAFE" position when your firearm is not in use. Keep your key in a secure place, inaccessible to others. **DO NOT** leave your key or any ammunition with your firearm, which should be kept unloaded and locked in a safe place.

If you lose the key, **DO NOT** attempt to disengage the safety mechanism using a foreign object. This will damage your firearm. Contact your Remington authorized dealer for a replacement key.

Even if you think the security system and safety mechanism are engaged, careless handling can cause the firearm to fire. See the *Ten Commandments of Firearm Safety* on page 2.

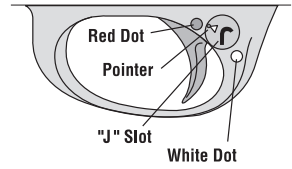

PICTURE 6

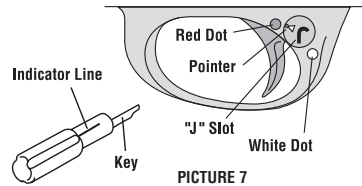

PICTURE 7

# The Operating Handle

The operating handle is used to pull the bolt rearward to open the action. See Picture 8.

**WARNING! When the operating handle is forward, the bolt is closed and the rifle is ready to be fired.**

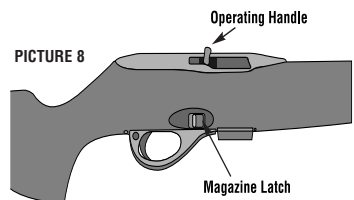

PICTURE 8



# The Magazine

## I. TO REMOVE AN EMPTY MAGAZINE:

1. Point the firearm in a safe direction.
2. Engage the safety mechanism in the “ON” or “SAFE” position.
3. Retract the operating handle to visually check the chamber to make sure it is empty.
4. Pull the magazine latch rearward. See Picture 8.
5. Remove the magazine from the firearm.

**NOTE:** Once the last shot hold-open has been engaged, the magazine can be removed without the bolt closing.

## II. TO REMOVE A LOADED MAGAZINE:

**WARNING!** If you pick up the firearm and the action is closed, there may be a live round in the chamber.

1. Point the firearm in a safe direction.
2. Engage the safety mechanism in the “ON” or “SAFE” position.
3. Retract the operating handle to visually check the chamber to make sure it is empty.
4. Pull the magazine latch rearward. See Picture 8.
5. Remove the magazine.

**NOTE:** The bolt will not stay locked in the open position unless an empty magazine is reinserted.

**WARNING!** Removing the magazine from the rifle does not prevent the rifle from being fired. If a cartridge is in the chamber and the safety mechanism is “OFF”, the cartridge in the chamber can be fired by pulling the trigger. This is true even if the magazine is not in the rifle. **THE RIFLE WILL FIRE WITH THE MAGAZINE REMOVED!**

# The Trigger Assembly: Pulling the trigger fires the firearm.

The trigger assembly and other parts of the firing mechanism are preset at the factory and must never be altered or adjusted.

**WARNING! NEVER alter or modify any part of the trigger assembly or any part of the firing mechanism. Improper alterations can make the rifle unsafe and result in personal injury or death.**

**WARNING! NEVER put your finger on the trigger unless you are going to fire the firearm.**

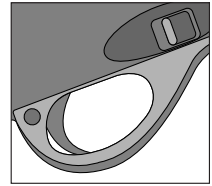

# The Barrel

**WARNING!** The inside of the barrel must be clean and free of obstructions. See the *Ten Commandments of Firearm Safety*.

## I. TO CHECK THE INSIDE OF THE BARREL:

1. Point the firearm in a safe direction.
2. Put the safety mechanism in the “ON” or “SAFE” position.
3. Insert an empty magazine and pull the operating handle rearward until the bolt engages the last shot hold-open mechanism. Visually check the chamber to make sure the rifle is completely unloaded.
4. Remove the magazine from the firearm.
5. Check the chamber again to make sure it is empty.
6. Insert a cleaning rod into the muzzle. Push the rod completely through the barrel until the rod can be seen in the ejection port.

## II. TO REMOVE OBJECTS FROM INSIDE THE BARREL:

**WARNING! NEVER try to remove an object from the barrel by loading a cartridge and firing. This may cause the barrel to burst or a cartridge case to rupture and cause serious personal injury or death.**

1. Point the firearm in a safe direction.
2. Put the safety mechanism in the “ON” or “SAFE” position.
3. Insert an empty magazine and pull the operating handle rearward until the bolt engages the last shot hold-open mechanism. Visually check the chamber to make sure the rifle is completely unloaded.

4. Remove the magazine from the firearm.
5. Check the chamber again to make sure it is empty.
6. Insert the correct size cleaning rod into the muzzle and lightly tap rod to free object from the barrel.
7. Push the cleaning rod all the way through the barrel until the rod can be seen in the ejection port.
8. If an object can not be easily pushed out of the barrel with a cleaning rod, return the firearm to the factory or a REMINGTON® RECOMMENDED GUNSMITH.

### III. TO CLEAN THE BARREL FOLLOW INSTRUCTIONS SHOWN ON PAGE 12.

**BEFORE LOADING THE FIREARM:** Make sure the inside of the barrel is free of dirt or other objects.

## To Load the Firearm

**WARNING!** The Model 597™ is designed to use .22 “Long Rifle” standard velocity or hyper velocity cartridges only. The Model 597 Magnum is designed to use .22 Win. Mag. cartridges only. The two calibers CAN NOT be interchanged. Do not use any other .22 caliber ammunition, as this can cause a jam or severe gun malfunction and result in serious personal injury or death. See the *Ten Commandments of Firearm Safety*.

### TO LOAD THE CHAMBER AND MAGAZINE:

**NOTE:** The barrel should be cleaned before loading and firing the firearm the first time. Follow cleaning instructions shown on page 12.

1. Point the firearm in a safe direction.
2. Put the safety mechanism in the “ON” or “SAFE” position.
3. Pull the operating handle rearward until the bolt engages the last shot hold-open mechanism. Visually check the chamber to make sure the chamber is empty.
4. Pull the magazine latch rearward.
5. Remove the magazine from the bottom of the firearm. The bolt will remain open.

**WARNING!** Always check the cartridge for the correct caliber before loading the firearm.

6. Load up to ten cartridges, or up to eight for the Model 597 Magnum, one at a time into the magazine. Keep the bullets aligned toward the chamber. See Picture 9.

**NOTE:** Read important information below about loading the magazine.

7. Put the loaded magazine into the firearm.
8. Make sure the magazine is fully latched into position.
9. Pull back on the operating handle to disengage the last shot hold-open mechanism. The bolt will close and feed the first cartridge into the chamber.

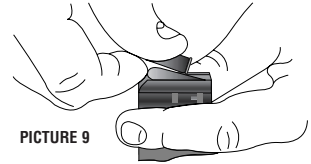

**WARNING!** The rifle is now cocked and loaded. Make sure the safety mechanism is still in the “ON” or “SAFE” position.

**BOTH THE CHAMBER AND MAGAZINE ARE NOW LOADED.**

## Loading The Magazine

Due to variations in .22 Long Rifle ammunition, care should be taken when loading the magazine not to overlap the rims of the cartridges. See right. If rims overlap, a failure to feed a round from the magazine may occur. The loaded round should be inserted into the magazine by putting pressure near the rim. See Picture 9. Do not insert by pushing near the nose of the bullet.

If the magazine becomes hard to load to full capacity, unload magazine, disassemble and clean the magazine components. Do not use solvents that are harmful to plastic materials. For cleaning instructions see pages 13 and 14.

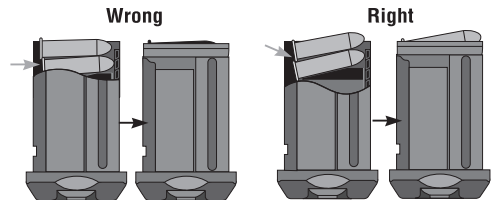

**Rounds with overlapping rims will not protrude above the top of the magazine.**

**Correctly loaded rounds will protrude above the top of the magazine.**

## To Unload The Firearm

1. Point the firearm in a safe direction.
2. Put the safety mechanism in the "ON" or "SAFE" position.
3. Pull the magazine latch rearward and remove the magazine from the firearm.
4. Pull the operating handle rearward to remove the cartridge remaining in the chamber. Visually check the chamber to make sure it is empty.
5. Holding the magazine separate and apart from the firearm, slide the top cartridge forward and out of the magazine. Repeat until the magazine is completely empty. See Picture 10.
6. Replace the empty magazine in the rifle and pull the operating handle rearward to engage the last shot hold-open. Visually check the chamber to make sure it is empty.

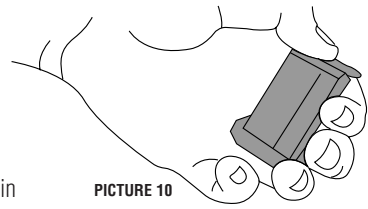

PICTURE 10

**WARNING!** Visually check the chamber and receiver to make sure the chamber and magazine are completely empty. Make sure the safety mechanism is still in the "ON" or "SAFE" position.

**WARNING!** NEVER assume your rifle is unloaded to justify careless handling. Always control the direction of the muzzle of your rifle, even if you think it is completely unloaded.

## To Adjust Sights



All models with sights are adjusted at the factory to hit a target at 100 yards.

**WARNING!** Before adjusting the sights, make sure the rifle is completely unloaded and put the safety mechanism in the "ON" or "SAFE" position.

### TO ADJUST THE REAR SIGHT:

For elevation (up and down adjustments) and windage (left and right adjustments), move the rear sight in the same direction as you need to move the bullet on the target.

**NOTE:** For more on ballistics and trajectory, see the REMINGTON® catalog.

### TELESCOPIC SIGHTS:

The top of the Model 597™ receiver has a scope rail and threaded holes for the installation of telescopic sights.

## Cleaning, Lubrication and Maintenance

**WARNING!** Before cleaning, make sure your rifle is completely unloaded (both the chamber and the magazine) and put the safety mechanism in the "ON" or "SAFE" position.

**WARNING!** After each use, follow the lubrication and maintenance direction in this instruction book. If the firearm is immersed, it must be thoroughly cleaned and lubricated as soon as possible. In case of saltwater immersion, first flush all parts with fresh water, then dry, clean and lubricate the firearm. If the firearm does not function properly, have it checked and corrected by a competent gunsmith before further use. Failure to obey this warning may lead to firearm malfunctions which could result in serious personal injuries or death.

**NOTE:** The chamber and bore should be cleaned before loading and firing the firearm the first time.

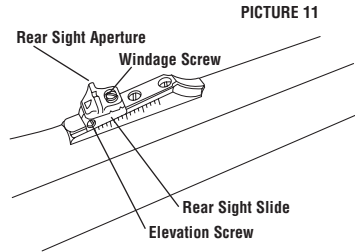

PICTURE 11

POSITION ON TARGET	ADJUSTMENTS
<p>Bullet hits above the center.</p>	<ol style="list-style-type: none"> <li>Loosen the elevation screw on the rear sight.</li> <li>Slide the rear sight down (backward) on the ramp.</li> <li>Tighten the elevation screw.</li> </ol>
<p>Bullet hits below the center.</p>	<ol style="list-style-type: none"> <li>Loosen the elevation screw on the rear sight.</li> <li>Slide the rear sight up (forward) on the ramp.</li> <li>Tighten the elevation screw.</li> </ol>
<p>Bullet hits to the left.</p>	<ol style="list-style-type: none"> <li>Loosen the windage screw on the rear sight.</li> <li>Slide the rear sight aperture to the right.</li> <li>Tighten the windage screw.</li> </ol>
<p>Bullet hits to the right.</p>	<ol style="list-style-type: none"> <li>Loosen the windage screw on the rear sight.</li> <li>Slide the rear sight aperture to the left.</li> <li>Tighten the windage screw.</li> </ol>

## LUBRICATION:

*Over-lubrication should be avoided at all times. A light application of Rem™ Oil helps to prevent rusting. See note below.*



**WARNING! Excessive use of a non-recommended lubricant could adversely affect the function and safe operation of your rifle. Failure to properly maintain your rifle can not only damage your rifle, it can expose you and others to unnecessary risks of personal injury or death.**

When the firearm is to be stored, it should be carefully cleaned and thoroughly oiled. Outside metal surfaces should be wiped with Rem™ Oil occasionally.

When the firearm is to be reused, all excess lubrication must be removed. The chamber and bore must be thoroughly swabbed clean and dry.

For safe and dependable operation of your rifle, the chamber and action must be cleaned periodically.

## To Clean the Barrel

**WARNING! Visually check the chamber and magazine to make sure there are no cartridges in the firearm.**

1. Point the rifle in a safe direction.
2. Put the safety mechanism in the "ON" or "SAFE" position.
3. Pull the operating handle rearward to engage last shot hold-open.
4. Pull the magazine latch rearward and remove the magazine from the firearm. Visually inspect chamber and action to make sure rifle is completely unloaded.
5. Use the instructions and equipment provided in a good cleaning kit such as Remington® Sportsman™ Cleaning Kits. For recommendations, see your dealer or Remington Authorized Gunsmith.
6. Attach cleaning patch saturated with Brite Bore™ to cleaning rod tip.
7. Pass patch through bore several times to remove loose residue and fouling.
8. Select the correct caliber cleaning brush and attach the brush to the cleaning rod.
9. Spray bore brush with Brite Bore.
10. Push the cleaning rod through the barrel several times.
11. Remove the brush from the rod, attach tip with cleaning patch and push through the bore.
12. Repeat several times, using a new cleaning patch each time until the patch is clean.
13. Push a clean patch saturated with Rem™ Oil through the barrel.
14. Push a clean dry patch through the barrel to remove excess lubricant.
15. Apply a light application of Rem™ Oil to the outside of the barrel with a soft clean cloth.

**WARNING! After cleaning, make sure the barrel is free of obstructions.**

## To Disassemble The Firearm For Cleaning

**CAUTION:** The Model 597™ or Model 597 Magnum rifle should not be disassembled beyond what is described in this instruction book, except by the factory or a REMINGTON® RECOMMENDED GUNSMITH.

**WARNING! Unload before cleaning. Visually check the chamber and magazine to make sure there are no cartridges in the firearm. Always wear eye protection when disassembling and reassembling the firearm.**

1. Put the safety mechanism in the "ON" or "SAFE" position.
2. Pull the operating handle rearward to engage last shot hold-open.
3. Pull the magazine latch rearward and remove the magazine from the firearm. Visually check the chamber and action again to make sure the rifle is completely unloaded.
4. Pull rearward on operating handle and release the bolt forward.
5. Remove the front and rear takedown screws, using a 1/8" Allen Wrench. See Picture 12.
6. Lift and remove the action from the stock.

PICTURE 12

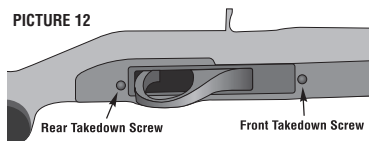

**NOTE:** The action has two (2) major parts, the receiver assembly and the housing assembly.

7. Tap out assembly pin from either side. See Picture 13.
8. Rotate the housing downward, pivoting around front of housing, slowly separating the housing from the receiver. See Picture 13.

## To Clean The Receiver/Barrel Assembly

**WARNING!** Excessive use of a non-recommended lubricant could adversely affect the function and safe operation of your rifle.

1. Remove two guide rail screws from rear of receiver.
2. Cycle bolt several times until bolt guide rails protrude from rear of receiver. See Picture 14.

**WARNING!** Use extreme care when disassembling bolt guide rails as the action springs are under compression. Wear eye protection to avoid serious personal injury.

3. Pull bolt guide rails out. Care should be taken with guide rail springs.
4. Pull out on operating handle to remove handle from bolt.
5. Remove bolt from receiver.
6. Brush the inside of the receiver and end of the barrel with gun cleaning solvent and wipe dry. See Picture 14.
7. Apply a light application of Rem™ Oil to the inside of the receiver. See Picture 14.

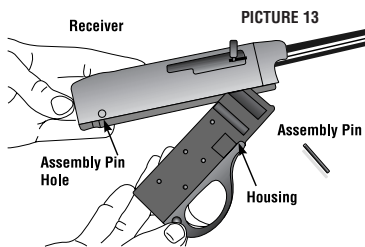

PICTURE 13

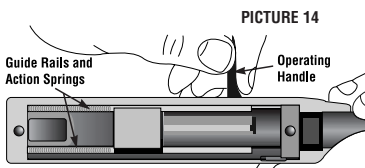

PICTURE 14

## To Clean the Housing Assembly

**CAUTION:** Clean the housing as a unit using Rem™ Oil. **DO NOT PULL TRIGGER WHILE HOUSING IS OUT OF FIREARM.**

1. Put the safety mechanism in the "ON" or "SAFE" position.
2. Spray the housing assembly with Rem™ Action Cleaner and allow to dry.
3. Spray the housing assembly with Rem™ Oil at parts shown. See Picture 15. Let stand for 15 minutes. Spray again to wash off components. Wipe or blow off excess lubricant.

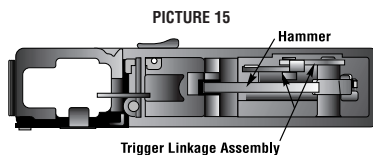

PICTURE 15

## To Clean The Magazine Assembly

**WARNING!** Visually check to make sure there are no cartridges in the magazine box. For instructions on how to remove the magazine from the rifle, see instructions on page 9.

1. Depress the sides of the magazine box and pull the magazine bottom downward and off of the magazine. As the spring becomes exposed, hold it with your thumb to prevent it from flying out.

**WARNING!** Use extreme care when removing the magazine bottom, as the magazine spring is under compression. Wear eye protection to avoid serious personal injury.

2. Remove the magazine spring.
3. Remove the magazine follower.
4. Clean the magazine and follower with brush or cloth in warm water and household dishwashing detergent. Do not use lubricant in magazine.
5. Reassemble the magazine follower into the magazine.
6. Insert the magazine spring into the magazine with the coils aligned as shown. See Picture 16.

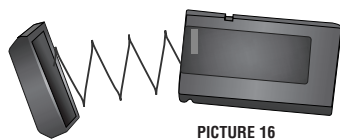

PICTURE 16

7. Position the posts of the magazine box bottom into the last coil of the magazine spring.
8. Push the magazine box bottom onto the magazine box until the bottom snaps into place.

**WARNING!** After each use, follow the lubrication and maintenance directions in this instruction book. If the firearm is immersed in water, it must be thoroughly cleaned and lubricated as soon as possible. In case of salt-water immersion, first flush all parts with fresh water, then dry, clean and lubricate the firearm. If the firearm does not function properly, have it corrected by a competent gunsmith before further use. Failure to obey this warning may lead to firearm malfunctions which could result in serious personal injury or death.

## To Reassemble The Firearm

**WARNING!** Visually check the chamber and magazine box to make sure there are no cartridges anywhere in the firearm.

**CAUTION:** Do not reassemble the firearm with the magazine box in the rifle.

### I. RECEIVER/BARREL ASSEMBLY:

1. Insert the breech bolt into the receiver with the bolt face toward the barrel.
2. Slide the bolt forward until it makes contact with the barrel.
3. Insert bolt guide rails into rear of receiver until they protrude approximately 1/2" from inside face of receiver. See Picture 17.
4. Insert one action spring (action spring set for Win. Mag.) into recess of bolt and over bolt guide rail. Work spring over guide rail while pushing guide rail towards barrel. See Picture 18.

PICTURE 17

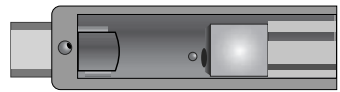

**NOTE:** Rail should slide through slot on side of bolt.

5. Repeat for second action spring(s).
6. Insert operating handle through ejection port and into bolt.
7. Pull bolt rearward and ensure bolt guide rails are retained in barrel extension.
8. Insert set screws and tighten with torque wrench (torque = 10-12 in-lb).
9. Lightly spray guide rails with Rem™ Oil.

PICTURE 18

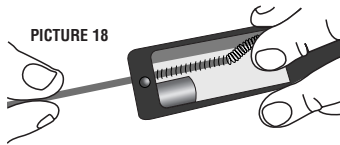

**NOTE:** Breech bolt must slide freely in the receiver.

### II. RECEIVER AND HOUSING:

1. Insert key on front of housing into mating slot in barrel extension. See Picture 19.
2. Rotate rear of housing into receiver, aligning assembly pin clearance holes.
3. Insert assembly pin.

### III. ACTION TO STOCK ASSEMBLY:

1. Assemble the action into the stock.

**WARNING!** Put the safety mechanism in the "ON" or "SAFE" position.

2. Insert the front and rear takedown screws.
3. Tighten both screws, using a 1/8" Allen Wrench (torque = 45 in-lb).
4. The magazine may be placed back into the firearm. If the magazine is NOT in the firearm, the bolt will not engage the hold-open mechanism.
5. Pull the operating handle rearward until the bolt engages the hold-open mechanism.

PICTURE 19

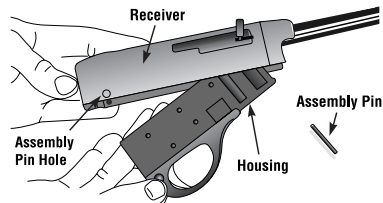



# How to Obtain Parts and Service From Remington® Arms Co.

## TO ORDER PARTS:

Many Remington® Dealers and Authorized Repair Centers carry a full line of parts. Please check with them first before ordering parts.

To expedite your PARTS order or request REPAIR SERVICE visit our web site at [www.remington.com](http://www.remington.com). Detailed instructions are provided along with parts and/or service order forms. You may also reach Remington by calling our toll free customer service number, 1-800-243-9700, Mon.-Fri., 9:00 AM-5:00 PM Eastern time.

1. Fax completed order form (from the web site) to 1-336-548-7801.
2. To order by phone without the order form call 1-800-243-9700.

## Please have the following information ready before you call.

- Firearm model and serial number.
- Part description and quantity. Part descriptions can be found on the parts listing page in this manual.
- Your complete mailing address (P.O. Box and Street Address) including zip code, telephone number and e-mail address.
- Method of payment: Mastercard, Visa, Amex or Discover card number and expiration date. Prepayment may be made by check or money order. A quote may be made to you over the phone. (Sorry, no C.O.D.s.)

## WARNING! USE ONLY REMINGTON PARTS IN REMINGTON FIREARMS.

**NOTE:** SOME PARTS MAY BE RESTRICTED. See parts list for details. Owner's manuals/instruction books may be requested via our web site at: [www.remington.com](http://www.remington.com) or by calling 1-800-243-9700.

## REPAIR SERVICES

1. To locate the Remington Authorized Repair Center nearest you visit our web site at [www.remington.com](http://www.remington.com) and use our Repair Service Locator. If you need additional on-line assistance, e-mail us at [info@remington.com](mailto:info@remington.com) to obtain a listing of Authorized Repair Centers. Contact the Authorized Repair Center of your choice for evaluation of your firearm and/or additional shipping instructions.
2. If your Remington Authorized Repair Center cannot provide the service or repair you require and you need further assistance, please call our toll free number 1-800-243-9700, Mon.-Fri., 9:00 AM-5:00 PM Eastern time and select the option for repairs. Then, if shipment of your firearm is required, please:
  - Record the serial number of your firearm before sending it to us.
  - Pack your firearm for safety and to prevent further damage in shipping and handling. Preferably, ship in a firearm box.
  - Remove all accessories from the firearm to prevent loss or damage.
  - Enclose a letter with the firearm detailing the model name or number of your firearm and serial number along with a full description of the problem. Be sure to include your full name and address (P.O. Box and Street Address), including zip code, daytime telephone number and e-mail address.
  - Ship your firearm by either United Parcel Service (UPS) or Parcel Post (US Post Office). Remington is not responsible for damage or loss during shipment, so you may elect to purchase insurance from your carrier.

## Ship to:

Remington Arms Company, Inc.  
Attn: Arms Service Division/Repairs  
14 Hoefler Ave.  
Ilion, NY 13357

**WARNING! DO NOT SEND LIVE OR SPENT SHELLS IN YOUR FIREARM OR IN THE SAME BOX WITH THE FIREARM. THIS IS A VIOLATION OF FEDERAL LAW. IF YOU FEEL YOU MUST SEND SPENT SHELLS, PLEASE SEND THEM IN A SEPARATE PACKAGE AND INCLUDE NAME, ADDRESS (WITH ZIP CODE), TELEPHONE NUMBER, MODEL AND SERIAL NUMBER OF YOUR FIREARM.**

# MODEL 597™/MODEL 597 Magnum

## Autoloading Rifle

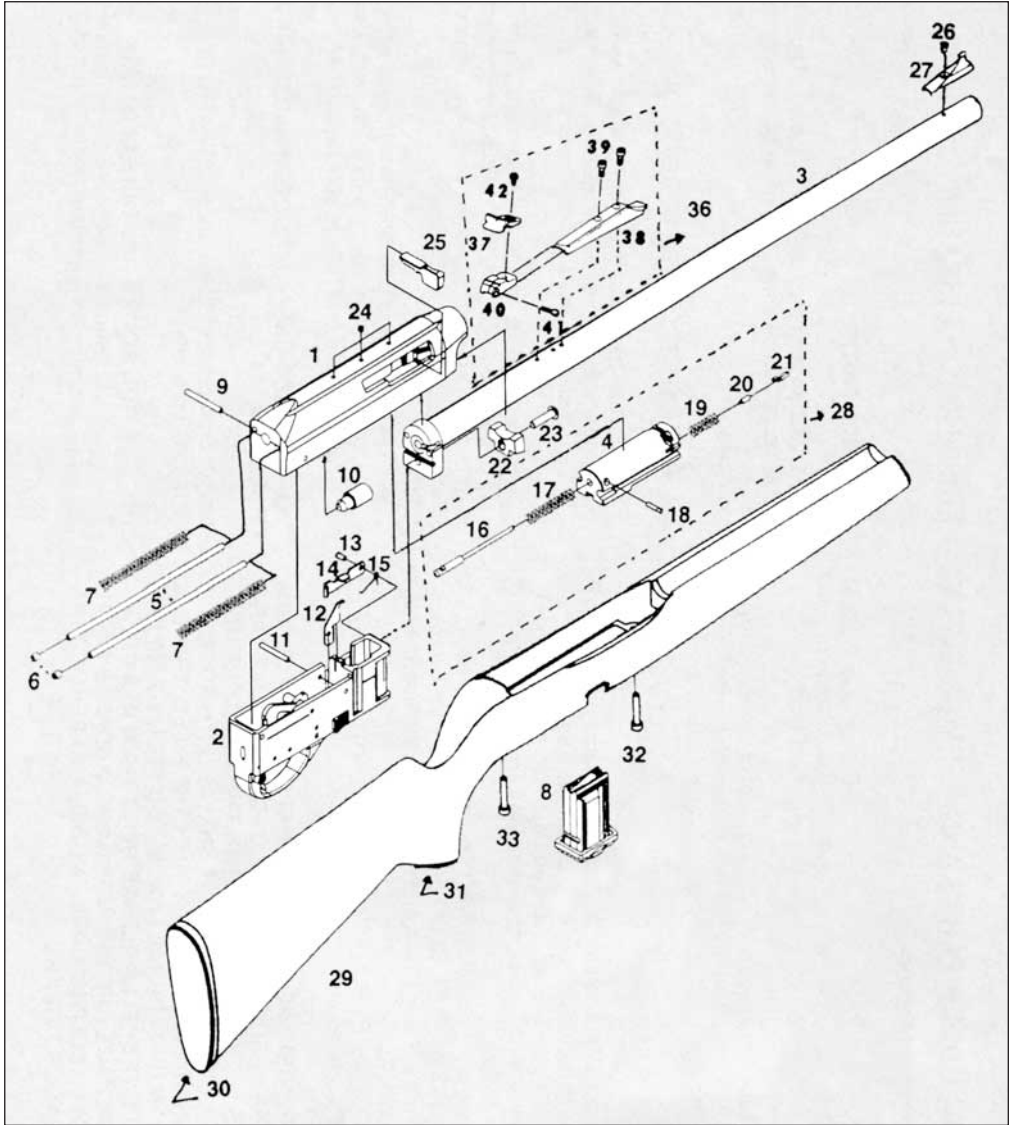



# Firearm Owner's Record

---

Model \_\_\_\_\_ Serial # \_\_\_\_\_ Date Purchased \_\_\_\_\_

Purchased From \_\_\_\_\_ Price Paid \_\_\_\_\_

Remember to complete and return the Firearm Warranty Registration Card in order to obtain full benefit of your Limited Two Year Firearm Warranty.

## **A WORD ON THE MAINTENANCE AND CARE OF YOUR REMINGTON FIREARM**

### **Don't Alter or Modify Your Gun and Have it Serviced Regularly.**

*Your firearm has been designed to operate according to certain factory specifications. You'll jeopardize your safety and that of others around you by attempting to alter its trigger, mechanical safety or other mechanisms. So never alter or modify your firearm in any way.*

*Like any mechanical device, a firearm is subject to wear. It must be maintained and periodically serviced to assure optimum safety and performance. Only a qualified service facility should service, repair or modify your Remington® firearm. Consult your instruction book for instructions on how to send your firearm to the factory or for the location of the nearest Remington repair station. Remington recommends that you have your firearm professionally serviced annually. You should also have your firearm professionally serviced after prolonged storage, or if there is ever any question pertaining to the proper functioning characteristics of your firearm.*

*Proper cleaning and lubrication are also important to firearm maintenance and are necessary to assure accuracy, safety and reliability. Before cleaning, always make sure that your gun is completely unloaded. And always clean the barrel from the chamber end to the muzzle when possible.*



*Remington*®

REMINGTON IS A TRADEMARK REGISTERED IN THE UNITED STATES PATENT AND TRADEMARK OFFICE BY REMINGTON ARMS COMPANY, INC.