

# INSTRUCTION MANUAL FOR

BLUED &  
STAINLESS  
STEEL



CALIBER  
.22 LONG RIFLE

## *RUGER*<sup>®</sup> *MODEL 10/22*<sup>®</sup> *CARBINE* STANDARD, DELUXE SPORTER, INTERNATIONAL, TARGET AND ALL-WEATHER MODELS

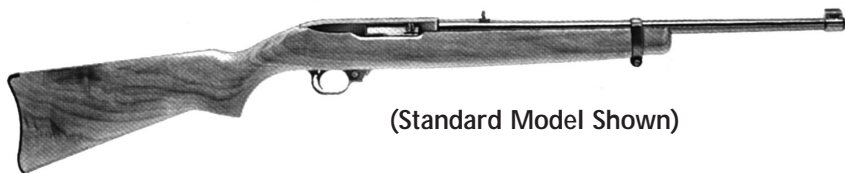

(Standard Model Shown)



READ THE INSTRUCTIONS AND  
WARNINGS IN THIS MANUAL CAREFULLY  
BEFORE USING THIS FIREARM

For Product Service on This Model Please Call:  
(603) 865-2442 (See p. 28)

**STURM, RUGER & Company, Inc.**  
**Southport, Connecticut 06890 U.S.A.**

THIS INSTRUCTION MANUAL SHOULD ALWAYS ACCOMPANY THIS FIREARM AND BE  
TRANSFERRED WITH IT UPON CHANGE OF OWNERSHIP, OR WHEN THE FIREARM IS LOANED OR  
PRESENTED TO ANOTHER PERSON.

## State-By-State Warnings

Certain states require by law that their own specified warning notices in larger-than-normal type be conspicuously included by the manufacturer, distributor, or retail dealer with firearms sold in that state. Sturm, Ruger sells its products in compliance with applicable laws and regulations. Because our products may be sold in these states, we include the following:

### California:

#### **⚠ WARNING**

“Children are attracted to and can operate firearms that can cause severe injuries or death. Prevent child access by always keeping guns locked away and unloaded when not in use. If you keep a loaded firearm where a child obtains and improperly uses it, you can be fined or sent to prison.”

#### **⚠ ADVERTENCIA**

“A los niños los atraen las armas de fuego y las pueden hacer funcionar. Ellos pueden causarse lesiones graves y la muerte. Evite que los niños tengan acceso a las armas de fuego guardándolas siempre con llave y descargadas cuando no las esté utilizando. Si usted tiene un arma de fuego cargada en un lugar en que un niño tiene acceso a ella y la usa indebidamente, le pueden dar una multa o enviarlo a la cárcel.”

### Connecticut:

“UNLAWFUL STORAGE OF A LOADED FIREARM MAY RESULT IN IMPRISONMENT OR FINE.”

### Florida:

“IT IS UNLAWFUL, AND PUNISHABLE BY IMPRISONMENT AND FINE, FOR ANY ADULT TO STORE OR LEAVE A FIREARM IN ANY PLACE WITHIN THE REACH OR EASY ACCESS OF A MINOR UNDER 18 YEARS OF AGE OR TO KNOWINGLY SELL OR OTHERWISE TRANSFER OWNERSHIP OR POSSESSION OF A FIREARM TO A MINOR OR A PERSON OF UNSOUND MIND.”

## **Maine:**

“ENDANGERING THE WELFARE OF A CHILD IS A CRIME. IF YOU LEAVE A FIREARM AND AMMUNITION WITHIN EASY ACCESS OF A CHILD, YOU MAY BE SUBJECT TO FINE, IMPRISONMENT OR BOTH. KEEP FIREARMS AND AMMUNITION SEPARATE. KEEP FIREARMS AND AMMUNITION LOCKED UP. USE TRIGGER LOCKS.”

## **Maryland:**

“WARNING: Children can operate firearms which may cause death or serious injury. It is a crime to store or leave a loaded firearm in any location where an individual knew or should have known that an unsupervised minor would gain access to the firearm. Store your firearm responsibly!”

## **Massachusetts:**

“WARNING FROM THE MASSACHUSETTS ATTORNEY GENERAL: This handgun is not equipped with a device that fully blocks use by unauthorized users. More than 200,000 firearms like this one are stolen from their owners every year in the United States. In addition, there are more than a thousand suicides each year by younger children and teenagers who get access to firearms. Hundreds more die from accidental discharge. It is likely that many more children sustain serious wounds, or inflict such wounds accidentally on others. In order to limit the chance of such misuse, it is imperative that you keep this weapon locked in a secure place and take other steps necessary to limit the possibility of theft or accident. Failure to take reasonable preventive steps may result in innocent lives being lost, and in some circumstances may result in your liability for these deaths.”

“IT IS UNLAWFUL TO STORE OR KEEP A FIREARM, RIFLE, SHOTGUN OR MACHINE GUN IN ANY PLACE UNLESS THAT WEAPON IS EQUIPPED WITH A TAMPER-RESISTANT SAFETY DEVICE OR IS STORED OR KEPT IN A SECURELY LOCKED CONTAINER.”

**New Jersey:**

“IT IS A CRIMINAL OFFENSE TO LEAVE A LOADED FIREARM WITHIN EASY ACCESS OF A MINOR.”

**New York City:**

“THE USE OF A LOCKING DEVICE OR SAFETY LOCK IS ONLY ONE ASPECT OF RESPONSIBLE WEAPONS STORAGE. ALL WEAPONS SHOULD BE STORED UNLOADED AND LOCKED IN A LOCATION THAT IS BOTH SEPARATE FROM THEIR AMMUNITION AND INACCESSIBLE TO CHILDREN AND ANY OTHER UNAUTHORIZED PERSONS.”

**North Carolina:**

“IT IS UNLAWFUL TO STORE OR LEAVE A FIREARM THAT CAN BE DISCHARGED IN A MANNER THAT A REASONABLE PERSON SHOULD KNOW IS ACCESSIBLE TO A MINOR.”

**Texas:**

“IT IS UNLAWFUL TO STORE, TRANSPORT, OR ABANDON AN UNSECURED FIREARM IN A PLACE WHERE CHILDREN ARE LIKELY TO BE AND CAN OBTAIN ACCESS TO THE FIREARM.”

**Wisconsin:**

“IF YOU LEAVE A LOADED FIREARM WITHIN THE REACH OR EASY ACCESS OF A CHILD YOU MAY BE FINED OR IMPRISONED OR BOTH IF THE CHILD IMPROPERLY DISCHARGES, POSSESSES, OR EXHIBITS THE FIREARM.”

\* \* \* \* \*

Please check with your licensed retailer or state police for additional warnings which may be required by local law or regulation. Such regulations change constantly, and local authorities are in the best position to advise you on such legal matters.



## WARNING – LOCKING DEVICES

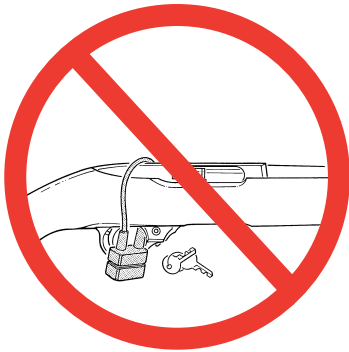

**DO NOT INSTALL  
INSIDE TRIGGER GUARD**

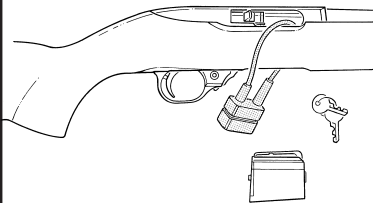

**INSTALL LOCK  
AS SHOWN HERE**

This firearm was originally sold with a key-operated locking device. While it can help provide secure storage for your **unloaded** firearm, any locking device can fail. All guns are designed to fire if they are loaded and the trigger is pulled. Therefore, **never install the locking device inside the trigger guard or in any way that it can possibly pull the trigger!** Do not leave the keys in the lock.

The ultimate responsibility for secure storage of any firearm must depend upon its owner and his or her individual circumstances. **Guns should be securely stored unloaded, in a secure location, separate from their ammunition.**

See “Storage Warning”, page 25.

**NEVER INSTALL  
LOCKING DEVICE  
INSIDE TRIGGER GUARD**

# **FIREARMS SAFETY-YOUR RESPONSIBILITY**

## **SAFETY MUST BE THE FIRST AND CONSTANT CONSIDERATION OF EVERY PERSON WHO HANDLES FIREARMS AND AMMUNITION.**

This Instruction Manual is designed to assist you in learning how to use and care for your *RUGER® MODEL 10/22® CARBINE* properly. Please contact us if you have any questions about it.

Only when you are certain you fully understand the Manual and can properly carry out its instructions should you practice loading, etc. with live ammunition. If you have any doubts about your ability to handle or use a particular type of gun safely, then you should seek supervised instruction. Such personalized instruction is often available from gun dealers, gun clubs or police departments. If none of these sources can help you, write to the National Rifle Association, 11250 Waples Mill Road, Fairfax, VA 22030-7400. They will assist you.

The person possessing a gun has a full-time job. You cannot guess; you cannot forget. You must know how to use your firearm safely. **Do not use any firearm without having a complete understanding of its particular characteristics and safe use.**

Remember: There is no such thing as a foolproof gun.

### **TABLE OF CONTENTS**

	Page
General Information .....	8
Operation of Safety .....	10
The Bolt Lock .....	11
Ammunition .....	12
Special Safety Note - 10/22 Target Rifle Only .....	13
To Load and Fire (With Magazine) .....	14
To Load and Fire (Without Magazine) .....	16
To Unload .....	17
To Extract and Eject a Chambered Cartridge .....	18
To Clear a Malfunction ("Jam") .....	18
To Minimize Malfunctions ("Jams") .....	19
To Disassemble .....	20
Special Disassembly Instructions for International Model .....	21
Reassembly .....	22
Magazine Inspection and Care .....	22
Care and Cleaning .....	23
Storage .....	24
Maintenance of Stainless Steel Rifles .....	26
Attaching Scope Base Adapter .....	26
Sight Adjustment .....	27
Service and Parts Policy .....	28
Parts Drawing .....	36, 37 & 38
<b>The Basic Rules of Safe Firearms Handling .....</b>	<b>39</b>
Warranty Information .....	44

"RUGER" and "10/22", are registered U.S. trademarks.



## WARNINGS OF GREAT IMPORTANCE ARE FOUND ON THE FOLLOWING PAGES:

Locking Devices	6	Handling	16
Alterations	8	Unloading	16
Manual Safety	11	Malfunctions	20
Lead Exposure	12	Disassembly	20
Ammunition	12	Lubrication	24
"Stinger" Ammunition	13	Storage	25
Target Trigger	13	Parts Purchasers	29
Firing	15		

**OTHER CAUTIONS AND WARNINGS APPEAR THROUGHOUT THE MANUAL.**

**FIREARMS ARE DANGEROUS WEAPONS—  
READ THE INSTRUCTIONS AND WARNINGS  
IN THIS MANUAL THOROUGHLY AND  
CAREFULLY BEFORE USING.**



## WARNING—ALTERATIONS



This product was designed to function properly in its original condition. Alterations can make it unsafe. Do not alter any part or add or substitute parts or accessories not made by Sturm, Ruger & Co. Inc.

**DO NOT ALTER ANY GUN**

## GENERAL INFORMATION AND MECHANICAL CHARACTERISTICS

The *RUGER® MODEL 10/22® CARBINE* is an autoloading rifle chambered for the .22 Long Rifle cartridge. It is recoil operated and uses a 10-shot rotary magazine. Retracting the bolt handle cocks the internal hammer and compresses the recoil spring. When the bolt is manually released, it moves forward (driven by the recoil spring), strips a cartridge from the magazine, if a loaded magazine is in place, and chambers the cartridge. The bolt is held against the chambered cartridge by the recoil spring.

When the trigger is pulled, the hammer is released and strikes the firing pin. The firing pin indents the cartridge case rim and ignites the priming compound inside the rim. This ignites the powder in the cartridge case and a great volume of gas is instantly generated, which acts on the interior of the cartridge case in all directions.

Because the bullet offers the least resistance, it moves out of the cartridge case and exits the muzzle. The bolt then moves rearward automatically, extracting and ejecting the fired cartridge case, and at the same time cocking the hammer and compressing the recoil spring, etc., as described above. Once the trigger is released, the rifle is ready to fire again.

Each time the trigger is pulled and released, the same cycle is repeated until there are no more cartridges in the magazine or in the chamber.

The rifle will fire if there is a cartridge in the chamber and the trigger is pulled, whether or not there is a magazine in place! Removing the magazine does not unload the rifle. Never assume the rifle is unloaded. Visually inspect the chamber and the magazine each time the rifle is handled to be certain there are no cartridges in either.

All models have the same basic operation mechanism and include the following features with which the gun user should be thoroughly familiar.

## NOMENCLATURE

(Standard Model Shown)

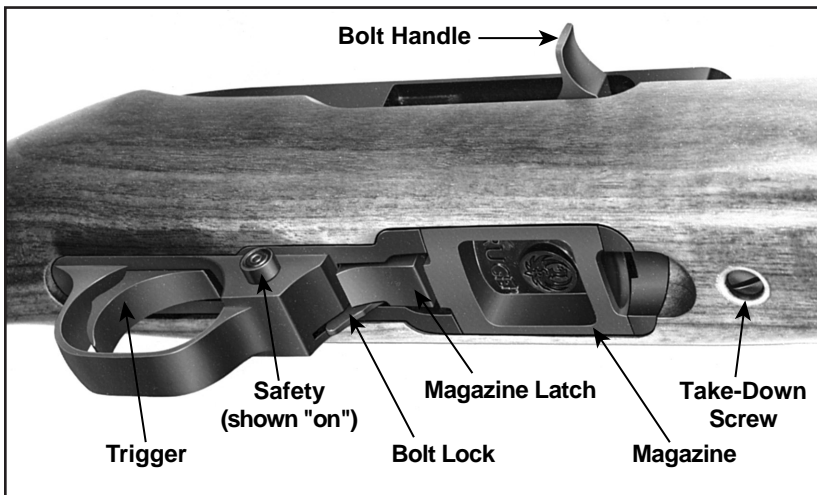
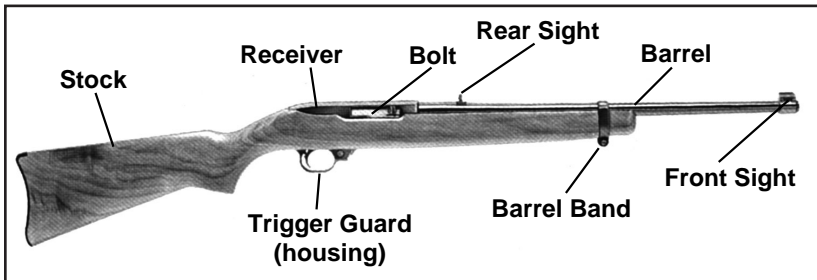

**Figure 1.** In these illustrations the frequently used operating components are identified. Note that the safety is protruding fully from the right side of the trigger guard and is therefore in its "on" (safe) position.



The *Standard Model* is identified by its curved carbine-style buttplate and barrel band. The *Deluxe Sporter Model* has a flat buttplate, cut checkered stock, and no barrel band. *International Models* feature a full-length stock with cut checkering, European-style sling swivels, and a steel muzzle cap held onto the tip of the stock and barrel by a screw (see pp. 21 & 22). The *Target Model* has a heavyweight, hammer forged barrel, laminated target style stock, and a special target trigger (see p. 13). The *All-Weather Model* has a carbine style stock with barrel band and is checkered on the forearm, pistol grip and butt plate. The black composite stock is made of a thermoplastic polyester resin, reinforced with fiberglass for strength, durability, and resistance to the elements.

## OPERATION OF SAFETY

The *RUGER® MODEL 10/22® CARBINE* has a cross-button safety which is located in the forward portion of the trigger guard (Figure 1, p. 9). The safety can be operated only when the hammer is cocked.

The safety is “on” when it protrudes fully from the right side (the bolt handle side) of the trigger guard assembly, as shown in Figure 1. In this position the sear is blocked, and the gun cannot be fired from a normal pull on the trigger.

The safety should always be in the “on” (safe) position except when the shooter is actually firing the gun. The safety should be moved to the “on” position whenever the shooter ceases firing, even temporarily.

The safety is “off” (fire) when it protrudes from the left side of the trigger guard assembly, as shown in Figure 2. When the safety is off, the red band shows on the safety button, but do not totally rely on the appearance of the red band to indicate that the safety is off. In poor light or if dirt is present, the red band may not be visible. **If the safety is “off” and the trigger is pulled, the rifle will fire.**

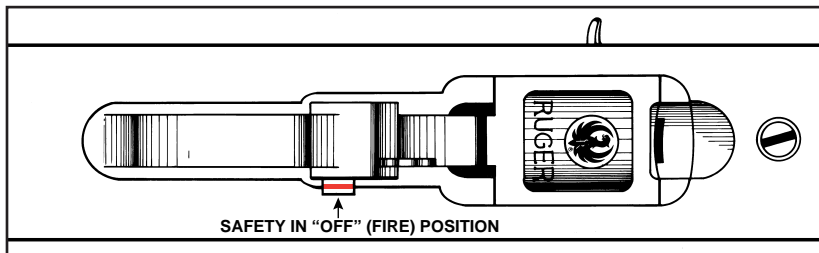
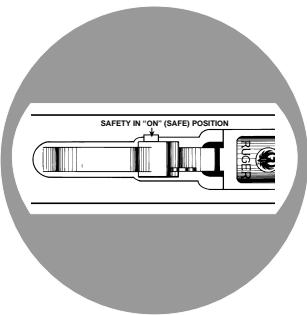

**Figure 2.** The underside of the trigger guard section of the rifle. In this illustration the safety is shown in the “off” (fire) position. The position of the safety and red band indicate the safety is “off.” **It should be in this position only when you are actually firing at a target.**

The safety is held in its “on” or “off” position by a plunger that is under spring tension. When the safety is moved to either the “on” or “off” position, a distinct “click” should be heard. Frequently check the position of the safety to be certain the safety has not been inadvertently moved. If the safety seems to move too easily, or if the click is not heard when the safety is moved, stop using the rifle and return it to the Newport Product Service Department for repair (see p. 28).



## WARNING – MANUAL SAFETY



Keep the safety on unless actually firing. Always move the safety fully to its intended position and **check** it. The safety is not “ON” unless it is completely “ON”. Never depend on a safety mechanism or any other mechanical device to justify careless handling or permitting the rifle to point in an unsafe direction. The only “safe” rifle is one in which the bolt is open, the chamber is empty, and there is no magazine in the gun.

**KNOW HOW TO USE THE SAFETY**

## THE BOLT LOCK

The bolt lock is located in the forward section of the trigger guard (see Figure 1, p. 9). The bolt lock is the manually operated means of retaining the bolt in the rearward (open) position. When the bolt is locked open, the rifle is in an inoperative safe condition for inspection of the chamber, cleaning, etc.

**To lock the bolt open:** Retract the bolt handle to its extreme rearward position and, while holding it there, press in on the lower section of the bolt lock. Release pressure on the bolt handle and it will move forward a fraction of an inch, and then be locked in its open position.

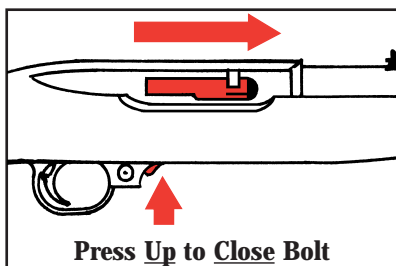
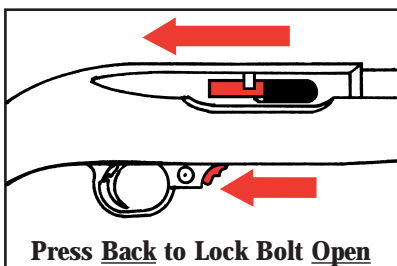



**To release the bolt:** Retract the bolt handle to its extreme rearward position and then press in on the upper section of the bolt lock. Release the bolt and it will move fully forward.



**NOTE:** Simply retracting the bolt will not disengage the lock. The bolt lock must be deliberately pressed up while the bolt is held fully to the rear. Only then will the bolt close when released. This is designed to prevent accidental release of the bolt from its open position.

## AMMUNITION



The *RUGER® MODEL 10/22® CARBINE* is chambered for, and designed to properly function with, only the 22 caliber Long Rifle rimfire cartridge, standard, high velocity, or hyper-velocity, manufactured to U.S. industry standards.

		<b>WARNING – LEAD EXPOSURE</b>
	Discharging firearms in poorly ventilated areas, cleaning firearms, or handling ammunition may result in exposure to lead and other substances known to the state of California to cause birth defects, reproductive harm, and other serious physical injury. Have adequate ventilation at all times. Wash hands thoroughly after exposure.	
	<b>SHOOTING OR CLEANING GUNS MAY EXPOSE YOU TO LEAD</b>	

Do not use .22 short, .22 long, .22 shot, or .22 cartridges loaded with blunt-nosed, sharp-shouldered, or “explosive” bullets. They will not function reliably and may jam the mechanism or discharge before being fully chambered. Use only ammunition that functions correctly in your rifle. See “Malfunction Warning”, p. 20.

		<b>WARNING – AMMUNITION</b>
	Death, serious injury, and damage can result from the use of wrong ammunition, bore obstructions, powder overloads, or incorrect cartridge components. .22 cases are very thin and sometimes split when fired. <u>Always</u> wear shooting glasses and hearing protectors.	
		<b>IMPROPER AMMUNITION DESTROYS GUNS</b>



**NOTE:** The following warning applies to *RUGER® 10/22 Target* rifles *only*.

 <b>WARNING – “STINGER” AMMUNITION</b>	
 <p><b>.22LR</b>      <b>.22 "Stinger"</b></p>	<p>“Stinger” cartridges have a longer case than .22 LR cartridges loaded to U.S. Industry specifications. They can stick in the tighter chambers of target rifles, including the Ruger 10/22 Target Rifle, which can result in a hazardous ruptured case and release of hot powder gasses and brass when fired.</p>
<p><b>DO NOT USE “STINGER” AMMUNITION IN 10/22 TARGET RIFLES</b></p>	

### SPECIAL SAFETY NOTE 10/22 TARGET RIFLE ONLY

The special model you have selected is specifically designed for rapid fire precision target shooting. As such, it demands that you take extra safety precautions.

The trigger of the Target version of the *RUGER® 10/22®* has a lighter, target trigger pull than standard 10/22 rifles, for more precise placement of shots. You should practice “dry-firing” an empty rifle (with it pointing in a safe direction) to learn the “feel” of the trigger before ever loading it with ammunition.

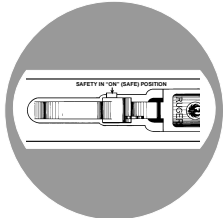
 <b>WARNING – TARGET TRIGGER</b>	
	<p>10/22T Models have a target trigger that has been carefully set at the factory to a minimum safe weight of pull for precision target shooting. Do not alter any factory setting! You can create an unsafe condition and the rifle may fire unexpectedly.</p>
	<p>You should be especially careful to <b>keep the safety on at all times except when actually firing and keep your finger off the trigger</b> unless you are squeezing it to fire, in order to minimize the possibility of accidental discharge.</p>
<p><b>DO NOT TAMPER WITH TRIGGER - KEEP SAFETY ON UNLESS FIRING</b></p>	

## TO LOAD AND FIRE (WITH MAGAZINE)

Practice this important aspect of gun handling (with an unloaded rifle) until you can perform each of the steps – described below – with skill and confidence. But before you do anything with the rifle, please first read completely through this manual.

1. **Keep the muzzle pointed in a safe direction. (See Rule 2, p. 39).**
2. Pull the bolt handle rearward. Engage the bolt lock so that the bolt is held open. Check the chamber to be certain it is empty. Engage the safety. (See Figure 1, p. 9).

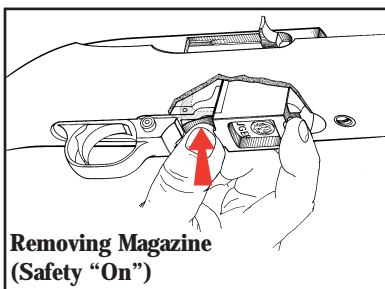



**Figure 3.** The safety should be "on" when the magazine is being removed or inserted. When the forward section of the magazine latch is pushed in (pivoted upward), the magazine is released. Depress the latch with the thumb and at the same time grasp the magazine between the thumb and forefinger and draw it out of the gun.

3. Remove the magazine by using thumb to depress magazine latch and at the same time grasp the magazine between thumb and forefinger of the same hand to draw it out of the magazine well. (See Figure 3).
4. Load the magazine by sliding up to ten (10) cartridges into the magazine throat-opening. (See Figure 4). The Ruger 10/22 is designed to function properly only with standard Ruger 10-shot rotary magazines loaded with .22 Long Rifle cartridges of the correct type. (See "Ammunition", p. 12)

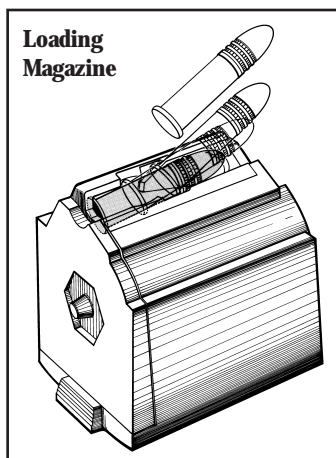
**Figure 4.** To load the magazine, press the rim of the cartridge against the magazine rotor at the widest section of the magazine throat until the cartridge enters far enough to be pushed to the rear end of the magazine. Each succeeding cartridge is pressed against the body of the top cartridge and slid to the rear of the magazine until a maximum of ten cartridges are in the magazine



5. Insert magazine into the firearm, with bullet end of the cartridges toward the muzzle. (Magazine cannot be seated if reversed).
6. Load a cartridge into the chamber by fully retracting the bolt handle, releasing the bolt lock, and then releasing the bolt handle. **Don't touch the trigger.** Do not 'ride' the bolt handle as it moves forward. Do not apply force to the bolt handle to chamber a cartridge. If a cartridge does not readily chamber, eject it from the rifle, lock the bolt open, remove the magazine and see MALFUNCTION WARNING, p. 20.
7. The rifle is now fully loaded. **If the rifle is not to be fired immediately, the safety should remain "ON"** (See Figure 1, p. 9). When the safety is moved to the "off" position, the rifle will fire each time the trigger is pulled until all the cartridges in the magazine, and the one in the chamber, have been fired. Firing will automatically reload and recock the rifle. **Note that every time the trigger is pulled, if a cartridge is in the chamber, the rifle will fire – be careful!**
8. **Immediately following the firing of a shot, and if a subsequent shot is not to be fired at once, put the safety "ON" while the rifle is still pointing in a safe direction down range.** The safety should be moved to the "on" position as soon as firing is completed, and it should be "on" at all times except when the rifle is on target and being fired.
9. The bolt does not remain open after the last shot has been fired, nor does the bolt automatically lock open when the magazine is empty. When firing is completed, manually retract the bolt, lock it open, and visually check the chamber to be sure it is empty. **If the bolt is shut, the shooter should always assume that there is a cartridge in the chamber. Don't rely on your memory to know if a gun or magazine is loaded. Visually inspect the magazine and the chamber.**

 <b>WARNING – FIRING</b>	
	The bolt automatically opens and shuts quickly while firing. Keep face and hands away from it. Hot brass and powder gas are ejected quickly and can burn you. The rifle should be fired from the right shoulder. Always wear shooting glasses and hearing protectors.
	<b>BOLT OPENS FAST– HOT BRASS EJECTED</b>

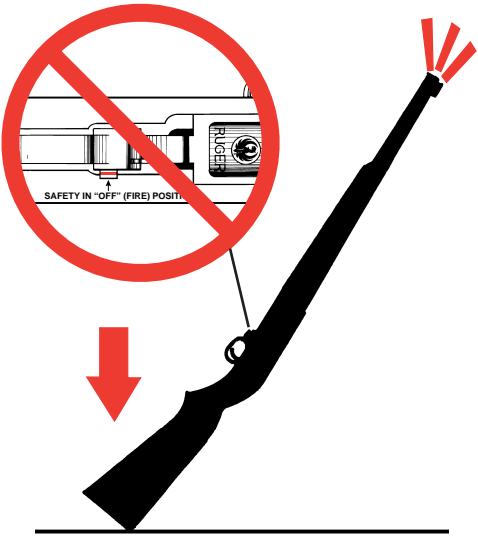
 <h2 style="margin: 0;">WARNING – HANDLING</h2>	
	<p>If dropped or struck with the safety “off”, the rifle may fire. Keep chamber empty unless actually firing! Keep safety “on” unless actually firing!</p>
<p><b>ANY GUN MAY FIRE IF DROPPED</b></p>	

## TO LOAD AND FIRE (WITHOUT MAGAZINE)

The rifle can be used as a single shot rifle in the absence of a magazine or for safety or training purposes. To do so, follow step 1, p. 14. Then load a cartridge into the chamber, and follow steps 6 and 7, p. 15, disregarding the magazine. Engage the safety between shots.

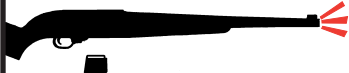
 <h2 style="margin: 0;">WARNING – UNLOADING</h2>	
	<p>So that the rifle can be used as a single loader, it will fire whether or not a magazine is in the gun if a cartridge is chambered. Removing magazine does not unload rifle! To unload, first remove magazine, then pull bolt to rear, eject chambered cartridge, and visually inspect chamber. <b>The safety should always be in the “on” (safe) position when loading or unloading the rifle.</b> Keep safety “on”.</p>
<p><b>GUN WILL FIRE WITH “MAGAZINE” OUT</b></p>	

## TO UNLOAD

**NOTE:** This sequence must be followed exactly as spelled out. Failure to do so can result in the rifle's chamber becoming unintentionally loaded with a cartridge!

1. Keep the muzzle pointed in a safe direction at all times and keep fingers outside the trigger guard. If the rifle is cocked, **move the safety to the "on" position.**
2. Remove the magazine. **Remember that even though the magazine has been removed, a cartridge remaining in the chamber can still be fired!**
3. Retract the bolt to its open position and lock it there. This should eject any cartridge in the chamber, but...
4. **Always visually double check the chamber to be certain it is empty.**
5. The only "safe" rifle is one in which the bolt is open and the chamber and magazine are empty.
6. Cartridges can be removed from the magazine by simply pushing them lightly downward and forward with the thumb, forefinger, or the rubber eraser end of a pencil against the rim of the top cartridge. **Do not use a loaded cartridge as a 'tool' to strip cartridges from the magazine.**
7. If desired, the bolt can be left in the open position, being held there by the bolt lock. If it is desired to close the bolt, again look to be certain the chamber is empty. Put the safety "on", retract the bolt to its rearmost position, release the bolt lock and let the bolt snap forward. Keep your fingers out of the receiver!
8. **With the muzzle pointed in a safe direction,** push the safety to the "off" position and pull the trigger to decock it. The rifle can be "dry fired" for practice as long as it is empty and pointed in a safe direction.
9. Push empty (unloaded) magazine into the rifle until the catch locks it in place.

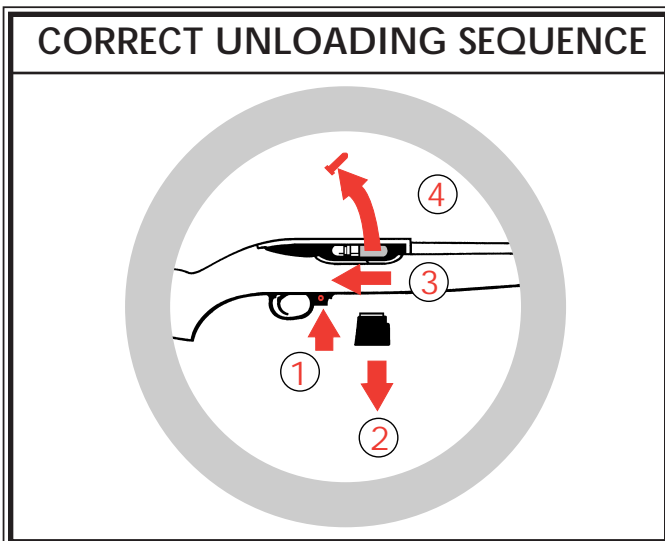



## TO EXTRACT AND EJECT A CHAMBERED CARTRIDGE

When the rifle is fired, the same gas pressure which drives the bullet forward also acts through the cartridge case to push the bolt to the rear. That action causes extraction and ejection of the fired cartridge case. But, when the bolt is operated by hand, there can be a failure to extract the cartridge from the chamber, or a failure to eject the cartridge clear of the rifle. These failures usually are the result of the bolt not being pulled rearward vigorously, coupled with an accumulation of bullet lubricant in the chamber. From the foregoing it is clear that the gun user must:

1. **Always visually check the chamber after opening the bolt to eject a chambered cartridge.** If the bolt is not vigorously retracted when being operated by hand, the extracted cartridge can be 'ejected' into the magazine area, instead of outside the rifle.
2. Thoroughly clean the chamber and the extractor as often as necessary to prevent the accumulation of grease and dirt.
3. If an empty magazine is in the rifle when the bolt is being hand retracted to extract a cartridge, the cartridge may drop on top of the magazine. Then when the bolt goes forward, the cartridge will be chambered again! **Always remove the magazine before clearing the chamber, and visually ensure that no cartridges remain in the gun.**

## TO CLEAR A MALFUNCTION ("JAM")

Any autoloading firearm may occasionally malfunction. If it does:

1. **Be certain the muzzle is pointed in a safe direction and the safety is "on".**
2. If possible, first remove the magazine. It may be necessary to manually remove a jammed cartridge which has only partially been stripped from the magazine.

If so, use extreme care. Lock the bolt open with the bolt stop before attempting to clear the jam. Drawing the bolt fully to the rear may bring the jammed cartridge along. **Keep your face away from the ejection port during this operation.** When attempting to clear a jam, use only wood 'tools' so that a cartridge will not be ignited if you strike a primer, and so that the chamber and magazine will not be damaged. A 3/16" wood dowel rod with a point on one end is useful.

3. Visually check to make sure all cartridges have been removed from the rifle. Safely dispose of any cartridges involved in a malfunction incident. Do not use damaged ammunition in any firearm.



## TO MINIMIZE MALFUNCTIONS (“JAMS”)

Most malfunctions are caused by improper or damaged magazines, incorrect ammunition, or poor maintenance.

1. If it appears that the gun and magazine are not at fault and that the jam was caused by the type of cartridge being used, then try another type.
2. If changing to another type or brand of cartridges does not at once eliminate malfunctioning, then the following steps should be taken:
  - a. **Make certain the gun and the magazine are unloaded and that the safety is “on”. Remember, the magazine should be removed first, then check the chamber and be certain it and the magazine-well are clear of cartridges.**
  - b. Thoroughly clean the magazine (See “Magazine Inspection and Care”, pp. 22 & 23) and bolt mechanism, paying particular attention to removing accumulated grease. Use a bristle brush and solvent to remove grease and fouling from the bolt face, the extractor, the chamber, and the feed ramp. (See the “Care and Cleaning” section of this manual for detailed cleaning instructions).
  - c. Check to see that the magazine rotor spring tension is adequate.
  - d. Check the magazine throat to be certain they are free of nicks and burrs and are not deformed.
  - e. Remove excess oil and solvent from all cleaned components, load the magazine, and try the firearm again. As always, proceed slowly. **Be certain bystanders are not close and that you are wearing eye and hearing protection and that your face is a safe distance from the rifle so that any discharge resulting from a jammed cartridge will not injure anyone.**

If the above procedures do not result in a smooth and reliably functioning firearm, don’t use the gun. The rifle can be returned directly to our Newport, New Hampshire Product Service Department for repair. See the Service and Parts Policy section (p. 28) of this manual for packing and shipping information.

**Another precaution:** When using any firearm chambered for rimfire cartridges, form the habit of examining fired cartridge cases. If they have bulged heads or frequently show splits on any part of the case, the rifle or pistol should be returned to the factory for inspection.

 <h2 style="margin: 0;">WARNING – MALFUNCTIONS</h2>	
	<p>The .22 Long Rifle rimfire cartridge fires when the firing pin impacts the relatively soft cartridge case rim, and also can be “discharged” before it is chambered if its rim receives a sharp blow. If a cartridge hangs up, jams, or binds when being chambered or when being fed from the magazine into the chamber, <b>do not attempt to force it into the chamber by pushing or striking the bolt.</b> Any jam or feeding problem is a signal to immediately stop using the gun until it can be determined what is wrong. Most failures of a cartridge to feed or to chamber are caused by a damaged magazine, improper gun handling, or defective ammunition. <b>Whatever the cause, rimfire cartridge jams can result in the potentially dangerous situation of a cartridge discharging before it is chambered. If this occurs, the cartridge case will rupture and its fragments will fly out of the gun with sufficient force to cause injury. Always wear shooting glasses and hearing protectors! Keep face away from chamber!</b></p>
	<p><b>CRUSHING RIM CAN BURST AMMO</b></p>

## TO DISASSEMBLE

(For Disassembly of International Model, See “Special Instructions” p. 21)

**Make Sure Rifle is Unloaded!**

1. With the rifle pointing in a safe direction, remove the magazine, open the bolt and visually make certain there is not a cartridge in the chamber. Then allow the bolt to close. The rear sight leaf should be down, and the hammer should be cocked.

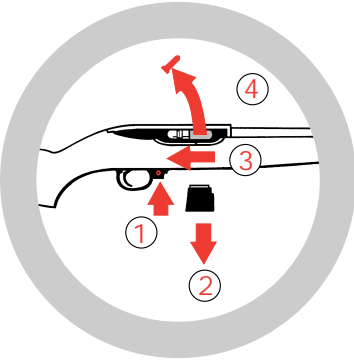
 <h2 style="margin: 0;">WARNING – DISASSEMBLY</h2>	
	<p>Always unload a firearm before cleaning, lubrication, disassembly or assembly.</p>
<p><b>UNLOAD BEFORE CLEANING</b></p>	

2. Loosen the barrel band screw (B-69) and remove the barrel band (B-68). (Does not apply to the Sporter Model).
3. Loosen (don't remove) the take-down screw (B-65).
4. Position the safety so an equal amount of the button is exposed on each side. If the safety is not in the middle when the barrel-receiver assembly is lifted out of the stock, the stock will be damaged.
5. Swing the barrel-receiver assembly upward away from the forearm of the stock. Be careful the two receiver cross pins (B-5) and bolt stop pin (B-46) do not fall out.
6. Remove the trigger guard by simply drifting out the two receiver pins. It is recommended that the components of the trigger guard assembly not be disassembled from the trigger guard.

This is the extent of disassembly required for routine inspection, cleaning and lubrication.

If it is desired to thoroughly clean the inside of the receiver by removing the bolt, be aware that although removing and installing the bolt (along with the bolt handle-recoil spring assembly) is simple, it must be done correctly.

7. To remove the bolt:
  - a. Position the rifle upside down so the bolt is fully accessible.
  - b. Drift out the bolt stop pin, located at the rear of the receiver.
  - c. Pull the bolt handle fully to the rear of the receiver with the left hand, and while it is in that position, using the right hand, lift up the front of the bolt until it is disengaged from the bolt handle.
  - d. Remove the bolt handle assembly through the ejection port.
  - e. Lift bolt out of receiver. If it does not come out readily, turn the rifle over and the bolt will drop out of the receiver.

## SPECIAL DISASSEMBLY INSTRUCTIONS FOR INTERNATIONAL MODEL

1. Follow steps 1 through 3 of the standard disassembly instructions above.
2. Before attempting to remove the barreled action from the stock (see steps 4 and 5 above) be sure to unscrew and remove the muzzle cap screw, part #D13200 (located in the underside of the muzzle cap).

Once the screw has been removed, gently tap the muzzle cap forward off of the barrel with a non-marking object (plastic, leather or wood mallet). Do not "pry" the muzzle cap off of the stock with a screwdriver or similar object between the stock and the muzzle cap – you will create an unsightly permanent gap in the stock-muzzle cap fitting line.

The Rifle is now ready for further disassembly in accordance with steps 4 - 6, above, once the muzzle cap has been removed!

## FAILURE TO DO SO WILL IRRETRIEVABLY DESTROY THE STOCK WHEN THE BARRELED ACTION IS SWUNG UPWARD FOR DISASSEMBLY IN STEP #5!

The rest of the disassembly and reassembly procedures are the same as for the standard carbine. Don't forget to reinstall the muzzle cap and its screw once reassembly is otherwise complete.

### REASSEMBLY

**Again, Be Sure Rifle is Unloaded!**

#### 1. Reassembly of bolt into receiver:

- a. To reassemble bolt handle and bolt in the receiver, position the rear end (cone pointed) of the recoil spring guide rod in the mating recess near the rear right side of the receiver. The recoil spring must be flat against the side and "bottom" of the receiver.
- b. Maintain the guide rod in its proper position by keeping pressure on the bolt handle with the left forefinger and thumb. At the same time, use the flat side of the screwdriver blade to compress the recoil spring by drawing it against that area of the bolt handle near to the spring. In accomplishing this spring compression it is necessary to maintain the same pressure on the screwdriver with the right hand as that being maintained (rearward and inward) on the bolt handle with the left hand.
- c. When the spring is fully compressed, maintain it in that position with the left hand and with the right hand lay the recessed section of the top of the bolt on the section of the bolt handle that mates with it. Press down on the bolt until a 'click' is heard. At this point allow the bolt handle (with bolt attached) to move forward slowly.
- d. Cycle the bolt handle a few times to be certain the components are correctly assembled.

#### 2. Reassembly of rifle:

- a. Install bolt stop pin and then lay the trigger guard in place and install the two receiver pins.
- b. Assemble the barrel-receiver to the stock by following, in reverse order, steps 1 through 5 under the "Disassembly" instructions on pages 20 & 21.

**Guns should not be stored loaded or cocked!**

## MAGAZINE INSPECTION AND CARE

Check the magazine frequently. The rotor must move freely and have adequate tension so that each cartridge is quickly raised to the feeding position. At the time of manufacture, proper rotor tension is set by rotating the magazine cap nut until the rotor stops turning. Then the nut is turned an additional 1 1/4 turns beyond the 'stop' position.

To test the rotor tension, load one cartridge into the magazine and then firmly press against the side of the cartridge case. Remove your finger quickly. The cartridge should instantly and fully move in to the feeding position. If it does not, the magazine should be cleaned. **If cleaning does not restore proper rotor tension, do not use the magazine.** (NOTE: After testing, remove the test cartridge).

When cleaning is necessary, use a solvent that will not rust the metal components or adversely affect the plastic magazine box. After the magazine has been soaked in solvent to loosen foreign matter, be certain to shake it vigorously (with the loading opening away from you) to remove solvent or residue from within the magazine.

After cleaning, always check to be certain that rotor movement and tension are correct, and that no solvent or debris remain. Do not disassemble the magazine.

**Improper reassembly or improper tensioning of the rotor spring can cause a potentially dangerous malfunction. If you experience a problem with the magazine, don't use it. Get a new one.**

**DAMAGED, NON-STANDARD, OR IMPROPERLY ASSEMBLED MAGAZINES SHOULD NOT BE USED. THEY CAN CAUSE THE RIFLE TO MALFUNCTION.**

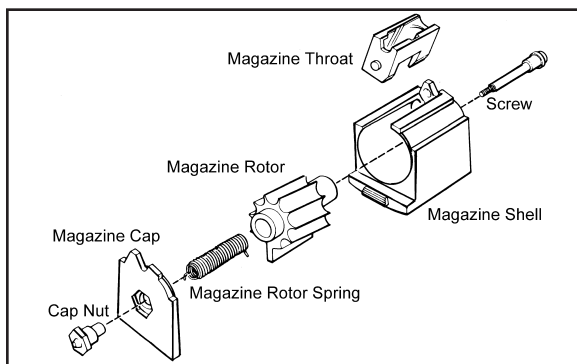

Exploded view of the 10/22 magazine components. This illustration is included to show the relationship and names of the magazine components. As noted in the text above, the magazine should not be disassembled.

## CARE AND CLEANING

### Make Sure Gun is Unloaded!



**Before cleaning, be certain the rifle and its magazine contain no cartridges.**

At regular intervals, or whenever the rifle has been exposed to sand, dust, extreme humidity, condensation, immersion in water, or other adverse conditions, disassemble, clean and oil it. Proper periodic maintenance is essential to the reliable functioning of any firearm.

To clean the rifle, proceed as follows:

1. Disassemble (field-strip) the rifle to the extent described on pages 20 & 21.
2. Using a cleaning rod, run a solvent-wetted patch through the bore several times. Then attach a solvent-wetted bristle brush to the rod and run it back and forth the full length of the bore as many times as necessary to remove grease and dirt from the bore and chamber. Clean bore with dry patches and examine. Bore fouling can contribute to reduced accuracy, and grease accumulation in the chamber can interfere with proper feeding of cartridges from the magazine.

- Using powder solvent on a clean patch or bristle brush, remove powder residue from all components of the mechanism. After cleaning, run a dry patch through the bore, then follow with a patch that is very lightly oiled. Wipe all surfaces clean with cloth, then wipe all surfaces with a patch or cloth that has been very lightly oiled.
- NOTE: Only a light application of oil is needed to provide adequate lubrication of moving parts and to prevent rust. Excess accumulations of oil tend to attract particles of dust and dirt and may congeal in cold weather which can interfere with the safe and reliable functioning of the rifle.

 <b>WARNING – LUBRICATION</b>	
	Firing a rifle with oil, grease, or any other material even partially obstructing the bore may result in damage to the rifle and serious injury to the shooter and those nearby. Do not spray or apply lubricants directly on ammunition. If the powder of a cartridge is affected by the lubricant, it may not be ignited, but the primer firing may push the bullet into the bore where it may be lodged. Firing a subsequent bullet into the obstructed bore may damage the rifle and cause serious injury or death to the shooter and those nearby. Use lubricants properly. You are responsible for the proper care and maintenance of your firearms.
	<b>IMPROPER LUBRICATION DESTROYS GUNS</b>

## STORAGE

**GUNS SHOULD NOT BE STORED LOADED!**

**USE THE LOCKING DEVICE SUPPLIED WITH THE RIFLE FOR STORAGE.  
(SEE PAGE 6)**

*Do not* store the rifle in a leather case or scabbard. Leather attracts moisture, even though it may appear to be dry.

### TO RENDER THE RIFLE INOPERATIVE FOR SAFE STORAGE

With the muzzle pointed in a safe direction, remove the magazine, open the bolt, and check the chamber to be sure the rifle is completely unloaded! Loosen barrel band screw and slide barrel band forward off stock. Unscrew, but do not remove, takedown screw on underside of stock. Move safety button to centered position and carefully lift barrel/receiver assembly out of the stock. Drift out receiver cross pins to the left and remove trigger housing assembly. Reassemble rifle without trigger housing assembly, which contains most of the firing mechanism.

Store the rifle and the trigger housing assembly in different locations. When disassembled in this manner, the rifle is inoperable. It is impossible to fire the rifle until the trigger housing assembly has been correctly replaced into the rifle.

To reassemble the rifle for firing, remove the barrel/receiver assembly from the stock as above and reinstall the trigger housing. Replace the receiver cross pins to secure the trigger housing to the receiver. With the safety in the centered position, carefully reinstall the barrel/receiver/trigger housing into the stock. Check to be sure the bolt, trigger, and safety mechanisms can be operated fully and freely. The rifle is now reassembled and can be loaded and fired normally.

**While the rifle is less likely to be used by unauthorized persons when disassembled in the above manner, it is always safest to store a firearm with the supplied locking device correctly installed, or to store the firearm in a gun safe or other secure location, away from children and unauthorized adults. Guns should always be stored securely, unloaded and separate from their ammunition.**

 <b>WARNING – STORAGE</b>	
	<p><b>Never place or store any firearm in such a manner that it may be dislodged. Firearms should always be stored securely and unloaded, away from children and careless adults. Use the locking device originally supplied with this firearm for storage.</b></p> <p><b>The use of a locking device or safety lock is only one aspect of responsible firearms storage. For increased safety, firearms should be stored unloaded and locked in a location that is both separate from their ammunition and inaccessible to children and any other unauthorized person.</b></p>
<b>STORE SECURELY &amp; UNLOADED</b>	



## MAINTENANCE OF STAINLESS STEEL RIFLES

Firearms and components made of stainless steel are relatively more resistant to corrosion than those of blued steel. However, in the interest of proper operation and long life of a stainless steel firearm, inspect it frequently and clean, lubricate and apply an appropriate rust preventative.

Sometimes discoloration occurs from perspiration or from contact with some types of gun cases. Rusting may occur as a result of the firearm being exposed to moisture, salt air or chemicals.

Minor discoloration can usually be removed by rubbing the stainless area with an abrasive ink eraser, crocus cloth, or a "metal polishing" compound. When using any of these abrasives, proceed with care and use light pressure to achieve a blending of "color" with those areas that are not discolored. Do **NOT** use abrasives on the clear coating of the aluminum alloy receiver and trigger housing.

External surfaces most subject to rusting from handling, or from exposure to the elements, should be cleaned and wiped dry after use or after exposure to adverse conditions. If the rifle is to be stored, coat it with a light film of oil or preservative. Where the rifle is in continuing use, and the presence of oil or grease would be objectionable, then the external surfaces can be coated (after cleaning and drying) with a paste wax formulated for use on metals. Apply the wax sparingly, allow time for it to dry hard, then buff lightly with a soft cloth. When applying the wax, take care that it does not get into the mechanism or on the functioning parts or in the bore.



### ATTACHING SCOPE BASE ADAPTER

To attach Scope Base Adapter to rifle receiver:

1. Retract slide handle, lock bolt open and push safety to "on" position. **Be sure gun is completely empty.**
2. Unscrew the four filler (headless) screws from the receiver. These screws may be quite tight.

3. Position Adapter on receiver and place a base-mounting screw in each hole of the Adapter. Turn each screw until it just catches the threads in the receiver hole, but don't tighten the screws at this point.
4. Starting at the first screw, turn each screw part way in; then move to the next screw, repeating the procedure until all four screws are snugly tightened.
5. Release the bolt handle; then retract it several times, permitting it to snap forward. If the bolt seems to bind, determine which screw is binding the top of the bolt. If it is necessary to shorten a screw, be certain to chamfer its top so it does not cross thread the hole in the receiver.
6. Attach scope bases and scope to the adapter in accordance with their instructions.

**Scope mounting precautions:** Do not remove the scope base filler screws (there are four in the receiver) unless the supplied scope base adapter or other suitable base is to be mounted with properly fitting screws. Do not deepen or alter the screw holes that are in the Ruger 10/22. Do not place any sealant into the screw holes in the receiver, as the sealant can drip into the bolt or receiver and cause potentially dangerous malfunctions.

## SIGHT ADJUSTMENT

The folding leaf rear sight is adjustable for elevation. The slide must be moved one graduation to change the point of impact by approximately one inch at 25 yards. Use a small screwdriver with a blade tip that exactly fits the screw-head. Loosen the screws only slightly so the slide doesn't move too freely. Move the slide in the direction you want the point of impact of the bullet to move. When the slide is positioned at the desired height, carefully tighten both screws.

Lateral (windage) adjustment is made by 'drifting' the sight base in its slot. Place a short brass rod against the sight base (and only the base) and tap the sight in the direction you wish to move the point of bullet impact. Before moving the sight, pencil mark an index line on the sight base and rib so that sight movement can be detected.

### SUGGESTED SIGHT PICTURE

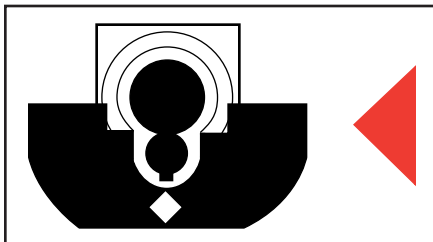

Top of front sight even with top of rear sight slide. Front sight centered in notch of rear sight slide. Target bulls-eye centered on top of front sight.

## SERVICE AND PARTS POLICY

If you have any question regarding the performance of your *RUGER® MODEL 10/22® CARBINE* rifle please write or call (603-865-2442) our Product Service Department in Newport, New Hampshire 03773, fully describing all circumstances and conditions involved. If you should return your rifle to the factory for repair, or order parts for it, please comply with the following suggestions for prompt service:



**WARNING: BEFORE SHIPPING ANY FIREARM, BE ABSOLUTELY CERTAIN THAT IT AND ITS MAGAZINE ARE UNLOADED. DO NOT SHIP CARTRIDGES WITH A FIREARM.**

## SHIPPING FIREARMS FOR REPAIR

*RUGER® MODEL 10/22® CARBINE* rifles returned to the factory for repair should be sent to: Sturm, Ruger & Company, Inc., Product Service Department, 411 Sunapee St., Newport, New Hampshire 03773. Telephone (603) 865-2442.

Guns should be sent prepaid. We will not accept collect shipments.

The Federal Gun Control Act, as well as the laws of most States and localities, do not prohibit an individual (who is not otherwise barred from purchasing or possessing a firearm) from shipping a firearm directly to the manufacturer for repair. However, before you ship your rifle to us, be certain that your State or locality does not have a law or regulation which will prohibit you from receiving the rifle from us after it has been repaired. If such receiving is prohibited, then please have a Federally Licensed firearms dealer ship the gun to us. If your rifle is sent to us by a dealer, it will be returned to him after being repaired. If a handgun (pistol or revolver) is shipped by an individual who does not hold a Federal Firearms License, it must be shipped via U.P.S.(Next Day Air) Persons who do not hold a Federal Firearms License are prohibited by Federal law from shipping a handgun by Mail. Handguns mailed in violation of the law are impounded by the Post Office.

Please do not include rifle case, sling, telescopic sights or custom accessories with a firearm being shipped to the factory for service. **DO NOT SEND GUN BOXES OR LITERATURE THAT YOU CONSIDER TO BE COLLECTOR'S ITEMS – THESE ARE INVARIABLY DAMAGED OR DESTROYED IN SHIPMENT.** Rifles and shotguns may be shipped via Parcel Post. Always insure your shipment.

Enclose a letter which includes your name, address, telephone number, serial number and model of the firearm. Describe in detail the trouble you have experienced with your firearm, or the work you wish to have done. Merely stating that the firearm “needs repair” is inadequate information.

Work performed will bear a net minimum labor charge of \$20.00 plus a \$12.00 shipping and handling charge. The charge for rebluing the *RUGER® MODEL 10/22® CARBINE* rifle is \$50.00 plus a \$12.00 shipping and handling charge. Custom gunsmithing service or nonstandard alterations are NOT AVAILABLE from Ruger Product Service Departments.

	<b>WARNING – PARTS PURCHASERS</b>
	<p>It is the purchaser's responsibility to be absolutely certain that any parts ordered from the factory are correctly fitted and installed. Firearms are complicated mechanisms and <b>IMPROPER FITTING OF PARTS MAY RESULT IN A DANGEROUS MALFUNCTION, DAMAGE TO THE FIREARM, AND SERIOUS INJURY TO THE SHOOTER AND OTHER PERSONS.</b> The purchaser and installer of parts must accept full responsibility for the correct adjustment and functioning of the firearm after such installation.</p> <p><b>PARTS MUST FIT CORRECTLY</b></p>

## ORDERING PARTS

Please contact the New Hampshire Product Service Department for parts availability and current prices. All parts ordered for the *RUGER® MODEL 10/22® CARBINE* should be sent to: Sturm, Ruger & Co., Inc., Product Service Department, 411 Sunapee Street, Newport, New Hampshire 03773, 603-865-2442. We cannot comply with open account or C.O.D. orders. Payment in the form of a check, money order, Visa or Mastercard must accompany your order. Credit Card orders must include the account number, expiration date and whether it is a Visa or Mastercard account. Minimum parts order is \$1.00 plus \$3.50 shipping and handling charge. Order parts by Part Name and Part Number and include the entire serial number of the firearm for which the parts are being ordered. There is a minimum net labor charge of \$20.00 plus \$12.00 shipping and handling charge if the parts are factory fitted. All factory fitted parts are fit on an exchange basis only. We will not return the replaced parts.

Because the 10/22 Carbine receiver (part number B-1) is a serial numbered component, it is defined as a “firearm” by Federal law and is not sold as a separate component.

\*Parts designated by an asterisk must be factory fitted. These parts are fitted on an exchange basis only. We will not return the replaced parts. We will not return any part that is broken, malfunctioning, badly worn or has been modified. See “Warning – Parts Purchasers” above.

	<b>CAUTION: A gun containing modified, broken, malfunctioning, or badly worn parts should not be fired.</b>
---	---

# *RUGER® MODEL 10/22® CARBINE*

## PARTS LIST

Design, prices and specifications subject to change without notice.

SPECIFY MODEL AND CALIBER WHEN ORDERING

(See Exploded Views on Pages 36, 37 & 38)

30

<b>Part Name</b>	<b>Part No.</b>	<b>Model</b>
Barrel	0B8001	Standard, Deluxe Sporter, International & All-Weather - Blued Models
Barrel	K0B8001	Standard, International & All-Weather - Stainless Models
Barrel	0B8003	Target - Blued Model
Barrel	K0B8003	Target - Stainless Model
Barrel	K0B8006	Target - Silhouette Model
Barrel Band	B-68	Standard & All-Weather - Blued Models
Barrel Band, Clear Coated	B06802	Standard & All-Weather - Stainless Models
Barrel Band Screw	B-69	Standard & All-Weather
Barrel Retainer, V-Block	B-66	All Models
Barrel Retainer Screw, 2 Req'd.	B-67	All Models
Bolt Only	B-10	All Models
Bolt Assembly, Complete, Standard Finish	B-10A	Standard, International & All-Weather
Bolt Assembly, Complete, Color Buffed	B-10C	Deluxe Sporter & Target
Bolt Lock	B-41	All Models
Bolt Lock Spring	B-42	All Models
Bolt Stop Pin	B-46	All Models

<b>Part Name</b>	<b>Part No.</b>	<b>Model</b>
Butt Plate	C-63	Standard
Butt Plate Screw, 2 Req'd.	B-64	Standard
Cocking Handle, Guide Rod & Recoil Spring Assembly	B-48A	All Models
Disconnecter	B-25	All Models
Disconnecter & Trigger Pivot Pin	KE02800	All Models
Ejector	B-8	All Models
Ejector Cross Pin, Not Illustrated	B-22	All Models
Escutcheon, Not Illustrated	B-51	All Models
Extractor	B-14	All Models
Extractor Plunger	B-16	All Models
Extractor Spring	B-15	All Models
Firing Pin	B-11	All Models
Firing Pin Rebound Spring	A20000	All Models
Firing Pin Stop Pin	B-13	All Models
Front Sight	B27501	Standard, Deluxe Sporter, International & All-Weather
Hammer	B-17A	Standard, Deluxe Sporter, International & All-Weather
Hammer	B01703	Target
Hammer Bushing, 2 Req'd.	B-43	All Models
Hammer Pivot Pin	B-19	All Models
Hammer Spring	B-44	All Models
Hammer Strut	B-18	All Models
Hammer Strut Washer	B-45	All Models

<b>Part Name</b>	<b>Part No.</b>	<b>Model</b>
Magazine, Complete, 10-Shot Capacity	BX-1	All Models
Magazine, Complete, 5-Shot Capacity	BX-1-5	All Models
Magazine Latch	B-34	All Blued Models
Magazine Latch	B03401	All Stainless Models
Magazine Latch Pivot & Ejector Pin, 2 Req'd.	B-35	All Models
Magazine Latch Plunger	B-36	All Models
Magazine Latch Plunger Spring	B-37	All Models
Muzzle Cap	D01340	International
Muzzle Cap Escutcheon	D13300	International
Muzzle Cap Screw	D13200	International
Pistol Grip Cap	D-80	International
Pistol Grip Cap Medallion	D-82	International & All-Weather
Pistol Grip Cap Screw	C-96SM	International
Rear Sight, Open	B-76	Standard, Deluxe Sporter, International & All-Weather
Receiver Cross Pin, 2 Req'd.	B-5	All Models
Receiver Filler Screws, 4 Req'd., Not Illustrated	C-83	All Models
Recoil Pad	D06304	Deluxe Sporter, International & Target
Recoil Pad Screws, 2 Req'd.	D-84	Deluxe Sporter, International & Target
Safety	B-52	All Models

<b>Part Name</b>	<b>Part No.</b>	<b>Model</b>
Safety Detent Plunger	B-53	All Models
Safety Detent Plunger Spring	B-54	All Models
Scope Base Adapter,	SBA	All Blued Models
Scope Base Adapter, Clear Coated	KSBA	All Stainless Models
Scope Base Screws, 4 Req'd., Not Illustrated	B-89	All Models
Sear	B-23	Standard, Deluxe Sporter, International & All-Weather
* Sear	B02302	Target
Sear Spring	B-24	All Models
Sling Swivel, Front	MS07601	Deluxe Sporter
Sling Swivel, Front	D13100	International
Sling Swivel, Front	MS07602	Target
Sling Swivel, Rear	MS07601	Deluxe Sporter, International & Target
Sling Swivel Escutcheon, 2 Req'd.	D12900	International
Sling Swivel Screw	D13000	International
Stock Assembly, Complete — Birch	B-4-1	Standard
Stock Assembly, Complete — Black Laminate — See <b>“Note A”</b> on page 30.	B00405	Standard
Stock Assembly, Complete — Walnut	B09201	Deluxe Sporter
Stock Assembly, Complete — Laminated American Hardwood	B00430	Target



<b>Part Name</b>	<b>Part No.</b>	<b>Model</b>
Stock Assembly — Synthetic Stock, Not Illustrated	B30425A	All-Weather
Stock, Black Laminate	BOYDS-600-333	Target Silhouette Model
Stock, Mannlicher, Birch — See “ <b>Note A</b> ” below	B00421	International
Stock, Mannlicher, Laminated — See “ <b>Note A</b> ” below	B00420	International
Take-Down Screw	B-65	All Models
Trigger	B-20	All Blued Models
Trigger	B02001	All Stainless Models
Trigger Assembly, Complete	B-20D	Standard, Deluxe Sporter, International & All-Weather - Blued Models
* Trigger Assembly, Complete	B02002D	Target - Blued Model
Trigger Assembly, Complete	B02001D	Standard, International & All-Weather - Stainless Models
* Trigger Assembly, Complete	B02003D	Target - Stainless Model
Trigger Guard	B-2	Standard, Deluxe Sporter, International & All-Weather - Blued Models
Trigger Guard	B00202	Target - Blued Model
Trigger Guard	B00201	Standard, International & All-Weather - Stainless Models

**\* PARTS SO MARKED MUST BE FACTORY FITTED**

**NOTE A:** The black laminate stock assembly (B00405) is sold only on an exchange basis. That is, the “old” black laminate stock must accompany the payment and order for a new B00405 stock. Also, the birch Mannlicher stock (B00421) and laminated Mannlicher stock (B00420) for the International models are sold only on an exchange basis. The old stock must accompany the payment and order for a new stock.

<b>Part Name</b>	<b>Part No.</b>	<b>Model</b>
Trigger Guard	B00203	Target - Stainless Model
Trigger Guard Assembly, Complete	B-2C	Standard, Deluxe Sporter, International & All-Weather - Blued Models
Trigger Guard Assembly, Complete	B00202C	Target - Blued Model
Trigger Guard Assembly, Complete	B00201B	Standard, International & All-Weather - Stainless Models
Trigger Guard Assembly, Complete	B00203C	Target - Stainless Model
Trigger Pivot Pin	B-21	All Models
Trigger Plunger	B-39	All Models
Trigger Plunger Spring	B-40	All Models

# RUGER® MODEL 10/22® CARBINE

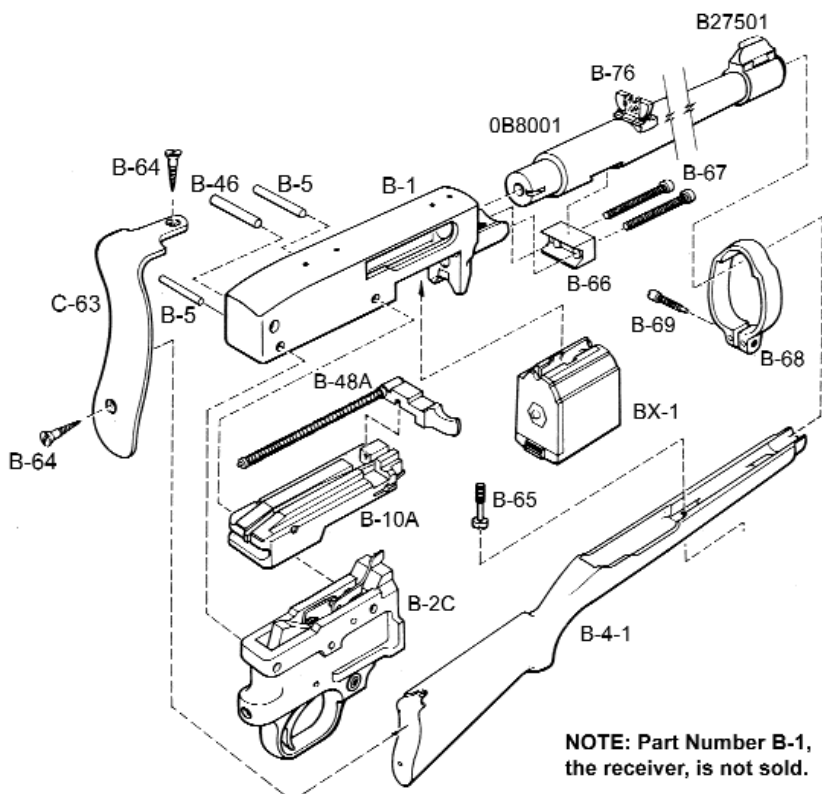

## 10/22® CARBINE BOLT ASSEMBLY

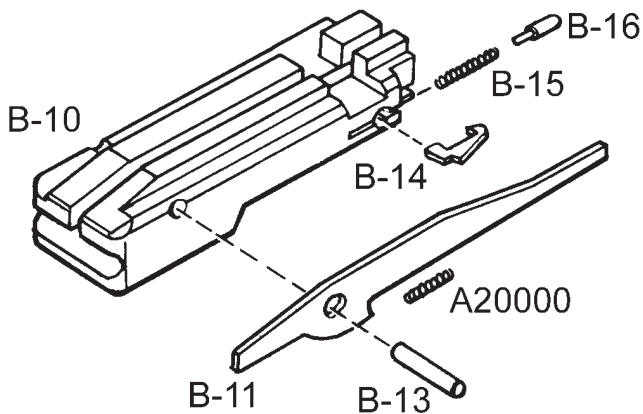

# 10/22® CARBINE TRIGGER GUARD ASSEMBLY

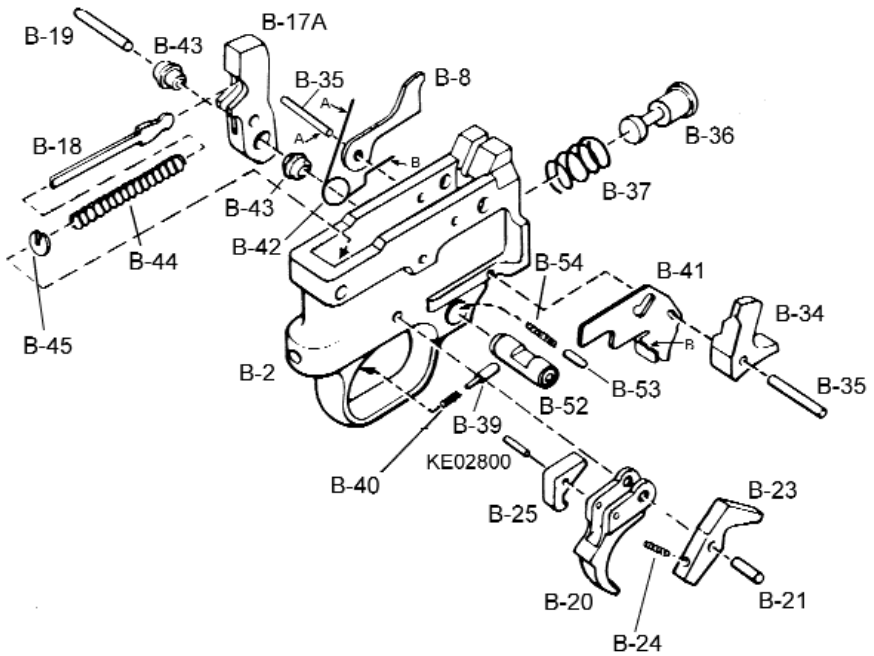

## RUGER® 10/22® CARBINE INTERNATIONAL MODEL

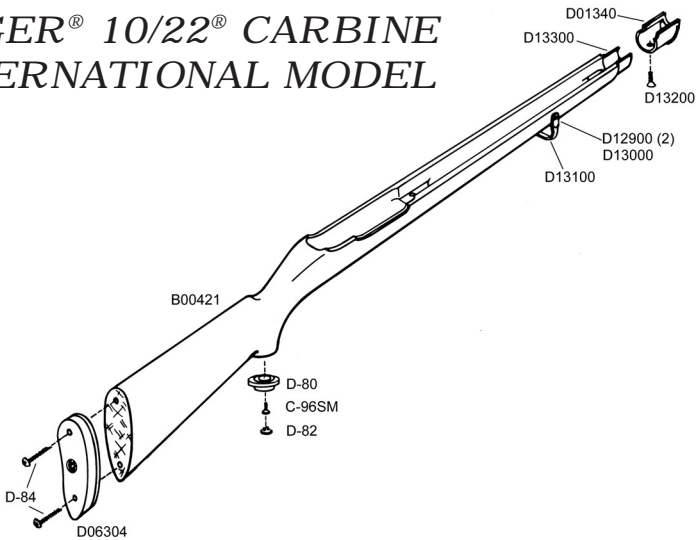

*RUGER® 10/22®  
DELUXE SPORTER*

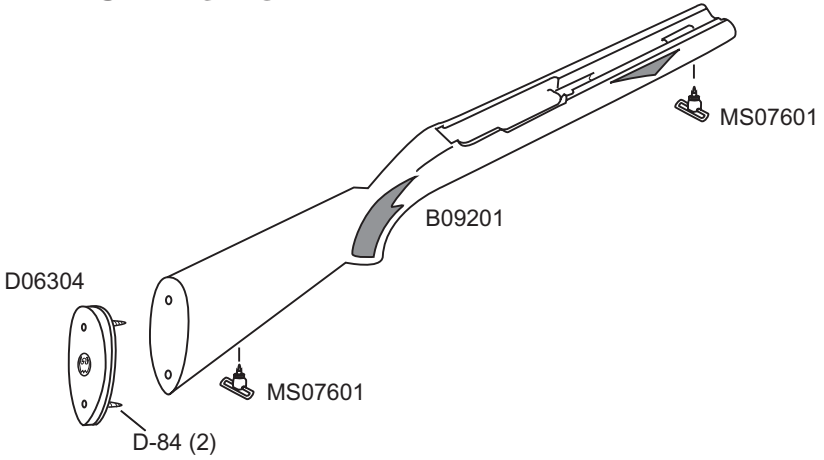

*RUGER® 10/22®  
TARGET RIFLE*

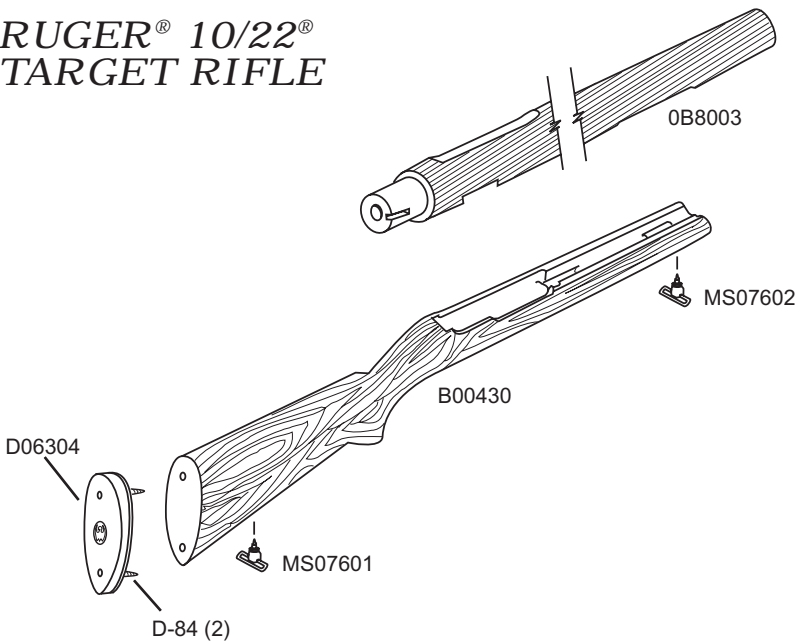

## THE BASIC RULES OF SAFE FIREARMS HANDLING

We believe that Americans have a right to purchase and use firearms for lawful purposes. The private ownership of firearms in America is traditional, but that ownership imposes the responsibility on the gun owner to use his firearms in a way which will ensure his own safety and that of others. When firearms are used in a safe and responsible manner, they are a great source of pleasure and satisfaction, and represent a fundamental part of our personal liberty.

Firearms do not cause accidents! Firearms accidents are almost always found to have been the result of carelessness, or ignorance on the part of the shooter of the basic rules of safe gun handling.

The following rules must be observed by gun users at all times. Safe gun handling is not just desirable, it is absolutely essential to your safety, the safety of others, and the continuation of gun ownership and sport shooting as we know it today.

### 1. LEARN THE MECHANICAL AND HANDLING CHARACTERISTICS OF THE FIREARM YOU ARE USING.

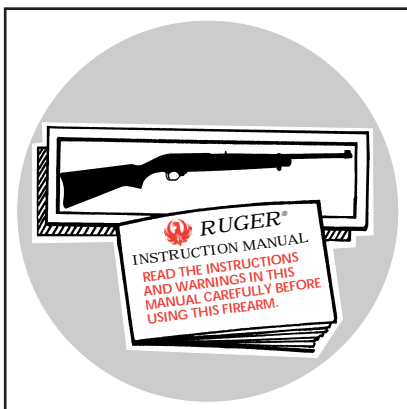

Not all firearms are the same. The method of carrying and handling firearms varies in accordance with the mechanical provisions for avoiding accidental discharge and the various proper procedures for loading and unloading. No person should handle any firearm without first having thoroughly familiarized himself with the particular type of firearm he is using, and with safe gun handling in general.

### 2. ALWAYS KEEP THE MUZZLE POINTED IN A SAFE DIRECTION.



Be sure of the bullet stop behind your target, even when dry-firing. Never let the muzzle of a firearm point at any part of your body or at another person. This is particularly important when loading or unloading a firearm. In the event of an accidental discharge, no injury can occur as long as the muzzle is pointing in a safe direction. A safe direction means a direction which will not permit a

discharged bullet to strike a person, or to strike an object from which the bullet may ricochet.

A safe direction must take into account the fact that a bullet may penetrate a wall, ceiling, floor, window, etc., and strike a person or damage property. Make it a habit to know exactly where the muzzle of your gun is pointing whenever you handle it, and be sure that you are always in control of the direction in which the muzzle is pointing, even if you fall or stumble. Keep your finger off the trigger until you are ready to shoot.

### 3. FIREARMS SHOULD BE UNLOADED WHEN NOT IN USE.

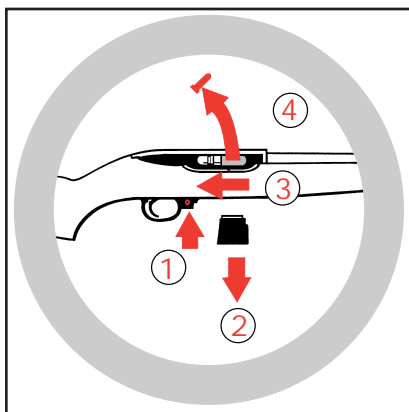

Firearms should be loaded only when you are in the field or on the target range or shooting area, ready to shoot. Firearms and ammunition should be securely locked in safes, racks or cabinets, or by using the locking device supplied with the firearm, when not in use. Ammunition should safely be stored separate from firearms. Store your firearms out of sight of visitors and children. It is the gun owner's responsibility to be certain that children and

persons unfamiliar with firearms cannot gain access to firearms, ammunition, or components.

### 4. BE SURE THE BARREL IS CLEAR OF OBSTRUCTIONS BEFORE SHOOTING.

Even a bit of mud, snow or excess lubricating oil or grease in the bore may cause the barrel to bulge, or even burst on firing, and can cause serious injury to the shooter and bystanders. Be sure that you are using ammunition of the proper caliber and loading for the gun you are using. If the report or recoil on firing seems weak, or doesn't seem quite right, CEASE FIRING IMMEDIATELY, unload your firearm, and check to be sure that no obstruction has

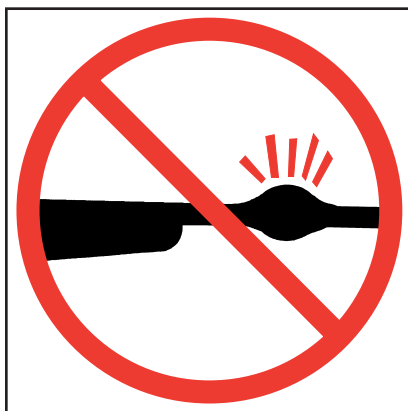

become lodged in the barrel. Never try to shoot out an obstruction!



## 5. BE SURE OF YOUR TARGET BEFORE YOU SHOOT.

Don't shoot unless you know exactly where your bullet is going to strike. Be sure of the bullet stop behind your target, even when dry-firing with an unloaded gun. If you are in the field hunting, do not fire at a movement or noise. Take the time to be absolutely certain of your target before you pull the trigger.

## 6. WEAR SHOOTING GLASSES AND HEARING PROTECTORS WHEN YOU SHOOT.

All shooters should wear protective shooting glasses and adequate hearing protectors when shooting. Exposure to shooting noise can damage hearing, and adequate eye protection when shooting is essential.



## 7. NEVER CLIMB A TREE OR FENCE WITH A LOADED FIREARM.

Put the firearm down carefully before climbing a fence, and unload it before climbing or descending a tree or jumping over a ditch or other obstruction. Never pull or push a loaded firearm toward yourself or another person. When in doubt, or whenever you are about to do anything awkward, unload your gun!



## 8. DON'T SHOOT AT A HARD SURFACE, OR AT WATER.

Bullets can glance off many surfaces like rocks or the surface of water and travel in unpredictable directions with considerable velocity.

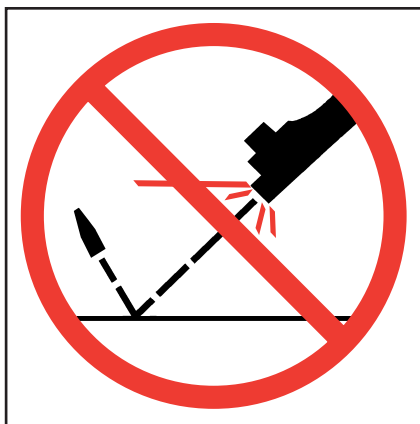

## 9. NEVER TRANSPORT A LOADED FIREARM.

Firearms should always be unloaded before being placed in a vehicle. A suitable carrying case or scabbard should be used to carry an unloaded firearm to and from the shooting area.

## 10. AVOID ALCOHOLIC BEVERAGES WHEN SHOOTING.

Don't drink until the day's shooting is over. Handling firearms while under the influence of alcohol in any form, or medications that could affect your judgement or co-ordination, constitutes a criminal disregard for the safety of others. Also, do not handle or use firearms while taking any drugs or medication which may impair your ability to act safely.



## A BRIEF ACCOUNT OF AN EXTRAORDINARY ACHIEVEMENT: RUGER FIREARMS

One of the few American firearms manufacturers whose management has remained in the same family since starting in business, Sturm, Ruger & Company, Inc., had its beginning in a small machine shop occupying a rented frame building in Southport, Connecticut. In January, 1949, with an initial investment of only \$50,000 and an idea, William B. Ruger and Alexander M. Sturm started production of a .22 caliber autoloading pistol—a design which was so successful that it became the cornerstone upon which one of the most comprehensive lines of sporting firearms ever made in America was established. After Alex Sturm's death in 1951, William B. Ruger continued to direct the company alone and today, William B. Ruger, Jr. continues to provide guidance which has made this company a sound and successful enterprise.

Sturm, Ruger & Company, in this relatively short time, has established itself as a leading small arms design organization, developing a unique and broad line of fine quality sporting, military and police firearms to become one of the world's most famous producers of revolvers, pistols, rifles and shotguns. Since 1949 Ruger craftsmen have built many millions of firearms.

During its five decades of growth and progress under the leadership of William B. Ruger, the company developed a business philosophy and implemented policies which represent a constructive influence in the life of modern America. From the beginning, Sturm, Ruger & Company played a positive role in conservation efforts and has supported the interests of shooters through such groups as the National Rifle Association, National Shooting Sports Foundation, and many regional sportsmen's organizations.

The company has always endeavored to market its firearms for constructive and recreational purposes, to emphasize the traditional aspects of shooting, to render meaningful public services and to encourage shooters in constructive, responsible, and safe participation in the shooting sports. Its motto is "Arms Makers For Responsible Citizens."

Today, Sturm, Ruger & Company is particularly mindful of those elements which have contributed to the creation of its success, and extends heartfelt thanks to its many loyal employees and customers.

A current catalog of Ruger firearms is available free upon request to  
Sturm, Ruger & Co., Inc., Southport, CT 06890

## **WHY NO WARRANTY CARD HAS BEEN PACKED WITH THIS NEW RUGER FIREARM**

The Magnuson-Moss Act (Public Law 93-637) does not require any seller or manufacturer of a consumer product to give a written warranty. It does provide that if a written warranty is given, it must be designated as "limited" or as "full" and sets minimum standards for a "full" warranty. Sturm, Ruger & Company, Inc. has elected not to provide any written warranty, either "limited" or "full", rather than to attempt to comply with the provisions of the Magnuson-Moss Act and the regulations issued thereunder. There are certain implied warranties under state law with respect to sales of consumer goods. As the extent and interpretation of these implied warranties varies from state to state, you should refer to your state statutes. Sturm, Ruger & Company wishes to assure its customers of its continued interest in providing service to owners of Ruger firearms.



**STURM, RUGER & Company, Inc.**  
**Southport, Connecticut 06890 U.S.A.**  
**<http://www.ruger.com>**

**“Arms Makers For Responsible Citizens”<sup>®</sup>**

**A COPY OF THE INSTRUCTION MANUAL FOR ANY RUGER  
FIREARM IS AVAILABLE FROM THE FACTORY FREE ON REQUEST.  
THESE INSTRUCTION MANUALS CONTAIN IMPORTANT  
WARNINGS WHICH MUST BE UNDERSTOOD  
BEFORE USING THESE FIREARMS.**

22/45", "Model 96", "77/17", "Gold Label", and "Target Grey" are RUGER TRADEMARKS. "RUGER", "THE STURM, RUGER LOGO", "10/22", "All-Weather", "Arms Makers For Responsible Citizens", "Bearcat", "Blackhawk", "GP-100", "M77", "Mini Thirty", "Mini-14", "Old Army", "P90", "P93", "P94", "Redhawk", "77/22", "77/44", "77/50", "SP101", "Vaquero", and "Single Six" are REGISTERED U.S. TRADEMARKS. "DEERFIELD" is a registered trademark of Blount, Inc.