

Thompson/Center

Fire Hawk™

Owner's Manual

Note:
This Model is Out of Production.
For Reference Use Only.

⚠ DANGER

The material in this booklet must be read and understood before attempting to use your Thompson/Center firearm. If pertinent safety information is not read, and the -**⚠WARNING**- statements are not understood and adhered to, death or injury could result.

READ THIS MANUAL IN ITS ENTIRETY BEFORE USING YOUR FIREARM.



Thompson/Center Arms Co., Inc.
P.O. Box 5002
Rochester New Hampshire 03866



Table Of Contents



Subject:	Page Number
General Rules for Use and Handling of Muzzleloading Firearms	2
Nomenclature.....	8
Assembly & Disassembly of Your Fire Hawk.....	9
Basic Equipment Needs For The Muzzleloading Shooter	11
Understanding Black Powder and Pyrodex™	12
Ignition.....	17
Black Powder Pressures and Velocities	18
Bullet Molds.....	21
Patching the Round Ball	22
Understanding the Fire Hawk Trigger & Striker Mechanism	25
Adjusting the Fire Hawk Trigger	27
Charging and Priming the Fire Hawk	30
In-Line Muzzleloader Loading Diagram	31
Summary of Charging and Priming	37
Pulling a Charge	38
Cleaning Your Fire Hawk	40
Iron Sight Adjustment	46
Scope Mounting.....	46
Service Department	46
Statement of Liability	47
Limited Warranty.....	48
Bullet Data.....	49
Suggested Loads for the Fire Hawk.....	52
Loading Information for Break-o-Way™ Sabots	55

Fire Hawk™, Maxi-Hunter®, Maxi-Ball®, Break-o-Way™ Sabots and Natural Lube 1000 Plus Bore Butter™, Woods Rifle™, Mag Express™ and PTX™ are Trademarks of Thompson/Center Arms. Copyright 1992 Thompson/Center Arms Co., Inc.

IMPORTANT NOTE: *Separate Owner's Manuals for any other models of muzzleloaders which Thompson/Center offers are available free from the factory upon request. Call or write with your specific needs.*



This booklet contains information that is essential to the safe use and maintenance of Thompson/Center's modern-style in-line muzzleloaders. **You must read this material in its entirety and fully understand its significance before you can safely use your muzzle-loader.** If a Thompson/Center muzzleloading firearm is loaned or sold (by an individual or a dealer), this booklet must accompany the firearm. Replacement booklets are available at no charge from our factory.

If, after reading this booklet, you still have questions concerning the safe use of your Thompson/Center firearm, write or call our Customer Service Department at:

Thompson/Center Arms Company, Inc.
P.O. Box 5002
Rochester, New Hampshire 03866
Telephone: 1-603-332-2333

• **And Remember •**
The Fundamental
National Rifle Association
Rules for Safe Gun Handling Are:

- 1 - Always keep the gun pointed in a safe direction.**
- 2 - Always keep your finger off the trigger until ready to shoot.**
- 3 - Always keep the gun unloaded until ready to use.**

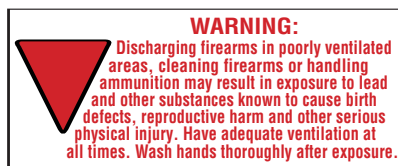

General Rules for Use and Handling of Thompson/Center Black Powder Muzzleloading Firearms

1 If you are unfamiliar with muzzleloading firearms seek professional instruction. Qualified organizations such as local gun clubs, The National Rifle Association, The National Muzzleloading Rifle Association and state Hunter Safety Programs offer approved courses which teach safe gun handling and proper hunting procedure. Those who are unfamiliar with muzzleloading firearms should seek guidance from an instructor who is qualified by one of these organizations.

2 If you are uncertain of the terminology or meaning of any word used in this booklet, write to Thompson/Center Arms. Throughout this booklet the term “Prime” or “Primed” applies to the act of placing a percussion cap on the nipple of a cap lock rifle or the pouring of priming powder into the pan of a flint lock rifle. “Unprime” or “Unprimed” refers to the opposite condition and indicates the percussion cap or primer (cap lock) or priming charge (flint lock) has been removed or is not in place. In addition, the frizzen on the flint lock must be open and the hammer at half-cock to put the firearm in an unprimed condition. “Charge” or “Charged” applies to the presence of a propellant powder charge and projectile in the bore of the rifle. “Uncharge” or “Uncharged” refers to the opposite condition and indicates that the powder charge and projectile have been either fired or removed and that the bore is completely clear.

3 Know the muzzleloading firearm before attempting to use it. The overall functioning and safety features of a muzzleloading firearm are different from modern rifles, shotguns, and pistols. Because of these differences the user must exercise caution and skill in the use of a muzzleloading gun. You must read and understand the workings of the muzzleloading firearm as explained in this booklet before attempting to use it.

4 Use Black Powder or Pyrodex only to load your muzzleloading firearm. **WARNING: The use of smokeless powder, or a mixture of smokeless and Black Powder (duplex loads) or the wrong type or granulation of Black Powder or Pyrodex or overloading may cause serious injury and/or death to the shooter or bystanders and damage to property. See section on “Black Powder and Pyrodex” in this booklet.** Thompson/Center muzzleloaders are designed and intended to be used only with a commer-

cially manufactured Black Powder or Pyrodex propellant of the specific granulation or type called for in this booklet. By Black Powder we mean a powder which is manufactured specifically for use in muzzleloading firearms as opposed to smokeless powder which is manufactured for use in metallic cartridges or shotshells. NO smokeless powder, even those which appear black in color, should ever be used in a muzzleloading firearm. Be sure you know what type and granulation of powder you are loading. Never buy or use powder unless you have seen it poured from the original manufacturer's container which is clearly identified on the label. Use Black Powder or Pyrodex only of the type and granulation specified in this booklet and never load charges heavier than those listed.

5 Always point the muzzle of your Black Powder Gun downrange. The possibility of accidental discharge is a constant danger when using a firearm. If the muzzle is pointed downrange, away from yourself, other people, domestic animals or property, then injury and/or death and damage to property from an accidental discharge is less likely to occur.

6 Be sure of your target. Never fire a muzzleloading firearm unless there is a backstop behind your target. Never fire your muzzleloader in the field unless you have a clear view of your target. Never fire at noise or movement in the brush. If hunting with companions or in an area where there are other hunters, know where members of your party and/or hunters are located. Never fire your muzzleloader if there is a possibility that other hunters are downrange. Never shoot at flat, hard surfaces such as rocks or water. **WARNING: A projectile may ricochet off these surfaces and may cause serious injury and/or death to the shooter or bystanders and damage to property.**

7 Never prime your muzzleloading gun until you are ready to fire it. Your muzzleloader should remain unprimed until the instant before firing. After you prime the firearm, your full concentration should be on the target and the act of firing. **WARNING: Failure to follow this rule can result in an accidental discharge which may cause serious injury and/or death to the shooter or bystanders and damage to property. Uncharge the firearm by firing it into a suitable backstop before returning to the road or vehicle.**

8 Never transport or carry a charged muzzleloading firearm in a vehicle. **WARNING: Uncharge the firearm by firing it into a suitable backstop before returning to the road or vehicle. Failure to follow this rule may cause serious injury and/or death to the shooter or bystanders and damage to property.** Due to the large number of firearms accidents which occur in or near vehicles, this is a most important rule. The game laws in most states prohibit the taking of game from a road or vehicle. The rules of sportsmanship and common sense dictate that the firearm should not be charged

until you are a safe distance away from the vehicle, road and companions. Never prime the firearm until you are actually ready to fire.

9 The T/C Fire Hawk™ is a modern "striker action" cap lock rifle, and does not have the half-cock notch that traditional cap locks have. There are two striker handle positions for the Fire Hawk; they are; "Cocked" and "Fired". In the "Cocked" position, the striker is held rearward by the trigger sear which is in turn blocked by the manual thumb safety. In the "Fired" position, the striker will be at rest against the nipple - once the thumb safety is pushed fully forward and the trigger is pulled to the rear. **WARNING: The Fire Hawk should be carried with the striker handle in the "Cocked" position, with no cap on the nipple. The thumb safety should be moved to the "Fire" position only after a percussion cap has been installed and you are ready to fire. Failure to follow this rule may cause serious injury and/or death to the shooter or bystanders and damage to property.**

→ **⚠ WARNING** ←

A sharp or heavy blow to the external striker handle can fracture parts and cause a malfunction or discharge of the firearm. **AN ACCIDENTAL DISCHARGE MAY RESULT IN INJURY AND/OR DEATH TO THE SHOOTER OR BYSTANDERS AND DAMAGE TO PROPERTY.**

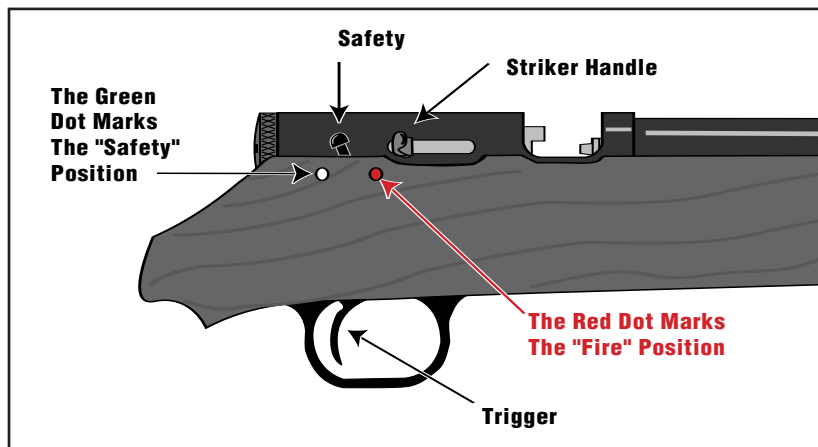

10 Never hand a charged muzzleloading firearm to another person. Once charged, a muzzleloading firearm requires your complete attention. Never charge the firearm and then hand it to another shooter. Equally you should never shoot a muzzleloading firearm that has been charged by someone else. Only the person doing the loading knows whether the firearm has been charged properly. **WARNING: Overloads and/or improper loading**

may cause serious injury and/or death to the shooter or bystanders and damage to property.

11 Never lean a charged and primed rifle against a tree, wall or any surface. Once the rifle has been charged it is your responsibility to guard it against accidental bumps.

12 Never store a charged muzzleloading firearm in a home, camp, vehicle or building. **WARNING: After use, a muzzleloading firearm should be discharged (fired) into a suitable backstop before returning to the home or camp. Failure to follow this rule may cause serious injury and/or death to the shooter or bystanders and damage to property.**

13 Never attempt to clean a charged or primed muzzleloading firearm.

14 Use pure lead only when casting round balls, Maxi-Balls® or Maxi-Hunters®. Lead alloys which contain large amounts of antimony or other metals are not suitable for muzzleloading projectiles. Do not use commonly found alloys such as wheel weights or Linotype because they produce hard, oversize projectiles that are difficult to load. **WARNING: Improper loading (projectile not seated on powder charge) may cause serious injury and/or death to the shooter or bystanders and damage to property. See section on "Bullet Molds" in this booklet.**

15 Wear protective gear when firing your muzzleloading firearm. Always wear shooting glasses to protect your eyesight from air borne particles and ear protectors to guard against hearing loss due to loud noise when firing your muzzleloader. Protect your arms from flying particles of percussion caps or priming powder by wearing a heavy shirt or jacket with long sleeves. **WARNING: When firing, stand well forward of all bystanders to ensure that they are not struck by particles of powder or caps. Failure to follow this rule may cause serious injury and/or death to the shooter or bystanders and damage to property. Those wearing long hair or beards should use extra caution when firing a flint lock. A flint lock can torch hair.**

16 Do not load or prime your muzzleloading firearm directly from a can, horn or flask. A spark from a previous firing may ignite the stream of powder being poured into the gun and cause the container to explode. **WARNING: The explosion of powder can, horn or flask may cause serious injury and/or death to the shooter or bystanders and damage to property. Use a separate pre-calibrated measuring device containing small quantities of powder to load and prime your gun and keep your face, hands and body well away from the muzzle when loading and the pan when priming.**

17 Do not smoke while using your muzzleloader. The spark from a lighted cigarette, cigar or pipe can ignite Black Powder, Pyrodex, Percussion Caps or Primers. **WARNING: Smoking around a charged and/or primed muzzleloader, percussion caps, priming powder or supply of powder may cause premature firing of the gun or an explosion of the powder can, horn or flask causing serious injury and/or death to the shooter or bystanders and damage to property.**

18 Keep powder, percussion caps, or primers well away from a firing position or shooting bench. A powder horn, flask, can of powder, box of percussion caps or primers can ignite with deadly force if exposed to sparks or intense heat. Follow the manufacturer's instructions for safe handling and storage of powder or caps. **WARNING: Keep unused caps, primers and powder well away from firearms that are being discharged. Sparks from the discharge of a muzzleloading firearm may cause an unused supply of powder, caps or primers to ignite causing serious injury and/or death to the shooter or bystanders and damage to property.**

19 Give the firearm your complete concentration. Never cross a fence, jump a ditch or engage in any activity which distracts your attention while holding or carrying a charged and primed muzzleloading firearm.

20 Know the condition of your muzzleloading firearm before charging, priming or firing. Function the striker and trigger of your gun to be sure that the parts are working properly before loading a charge. Be sure the muzzleloading firearm is properly loaded. Use recommended loads of **BLACK POWDER OR PYRODEX ONLY** for your specific model and caliber. Mark your ramrod as explained in this booklet and always be certain that the ball, bullet or shot charge is seated properly on the powder charge. Be sure the barrel is clear of obstructions (including excess oil, mud, dirt, snow or any foreign material). **WARNING: Failure to observe any of these rules may cause serious injury and/or death to the shooter or bystanders and damage to property.**

21 Be physically fit and mentally alert when using your muzzleloading firearm. The use of your muzzleloader involves forceful physical actions which require strength and concentration. Never use alcoholic beverages or drugs before or when shooting or handling your muzzleloader. Never use your muzzleloading firearm when you are overly tired. If you use medication or have medical implants, consult your physician before using your muzzleloading firearm.

22 At their very best, tree stands are potentially hazardous. Even with good equipment, safety depends upon the age, health, dexterity and sound judgement of the user. If you feel that you must use a tree stand, purchase a

top quality brand only and follow the manufacturer's instructions to the letter. **WARNING: Never climb to or descend from a tree stand with a primed muzzleloading firearm. Never raise or lower a primed muzzleloading firearm to or from a tree stand. Failure to follow this rule may cause serious injury and/or death to the shooter or bystanders and damage to property.**

23 Respect the muzzleloading firearm. Used properly your muzzleloader will give you years of pleasure. Used improperly, carelessly or abused, your muzzleloading firearm is a dangerous instrument and is capable of causing serious injury, death or property damage. Always treat your muzzleloader as if it were loaded. Do not drop your muzzleloader or allow it to be struck a blow. Dropping or striking it may cause movement and/or damage to internal parts in such a manner as to cause an accidental discharge. If the gun is dropped it should be examined. **WITH THE FIREARM UNPRIMED** slide your ramrod into the bore to ensure that the barrel is not obstructed. Check your ramrod mark to be certain that the projectile is seated firmly on the powder charge. Check the firearm for external damage. Check the firing mechanism to be sure that hammer and trigger are functioning properly.

24 Use extreme care in the selection and/or use of accessories, implements or components. Thompson/Center muzzleloaders are manufactured to a controlled tolerance and are intended for use with accessories and implements of Thompson/Center brand only. For example, Thompson/Center mold dimensions are carefully calculated to produce cast (pure lead) round balls, Maxi-Balls® or Maxi-Hunters® of a proper size and hardness which are consistent with the specific caliber requirements of our product line. Patch material bearing the T/C brand is of the proper size and thickness for the caliber and round balls specified in this booklet and in our catalog. The reader is warned against the use of any unauthorized accessories, implements or components which are not of our manufacture and over which we have no control. Before purchasing or using accessories, implements or components, the reader must assure himself that such items are safe to use with Thompson/Center firearms. Responsibility for the safe use of such items rests totally with their manufacturer and/or dealer selling these products. If you are unsure as to the safety or compatibility of accessory items to use with our firearms, write to us at the address shown on page 8.

25 The reader is warned against custom alterations and conversions. Thompson/Center does not endorse or recommend any type of alteration other than those performed by the Thompson/Center Custom Shop. Replacement nipples, replacement barrels, priming devices or any other unit not of Thompson/Center manufacture and used as a replacement part or attachment to a Thompson/Center firearm is potentially dangerous. Responsibility for such devices rests totally with the manufacturer of the device and/or with

the dealer selling the device or the person or persons installing it.

26 Use Thompson/Center scope mounts only. The Thompson/Center Catalog lists a series of scopes and mounts which are designed specifically for use with our firearms. These mounts make use of existing screw holes. Those who desire a scope sight should make use of Thompson/Center mounts. **WARNING: Do not drill additional holes in the barrel as this could weaken the barrel structure leading to a rupture. A ruptured barrel can cause serious injury and/or death to the shooter or bystanders and damage to property.**

27 Follow Kit instructions carefully (where applicable). A copy of this booklet is included with all Thompson/Center factory finished muzzleloaders - both kit and finished models. Readers who purchase kits must realize that Thompson/Center Arms Co., Inc. has no control over the final finishing and assembly of kit products. The kit builder must follow instructions to the letter. Alteration of factory parts, the drilling of additional holes in the barrel, excessive heat and/or removal of excess quantities of metal from the barrel can weaken the firearm or cause it to malfunction.

The foregoing general rules and cautions are printed to contribute to your safety when using Thompson/Center muzzleloading firearms. These rules must be read, understood and adhered to. The remainder of this book is equally important. It contains information which is essential to the proper use and care of your muzzleloading firearm. **Do not attempt to load or fire your muzzleloading firearm until you have read this booklet in its entirety.** If, after reading this booklet, you still have questions concerning the safe use of your Thompson/Center firearm, write or call our Customer Service Department at:

Thompson/Center Arms Co., Inc.
P.O. Box 5002
Rochester, New Hampshire 03866
Telephone: 1-603-332-2333

T/C Fire Hawk Nomenclature

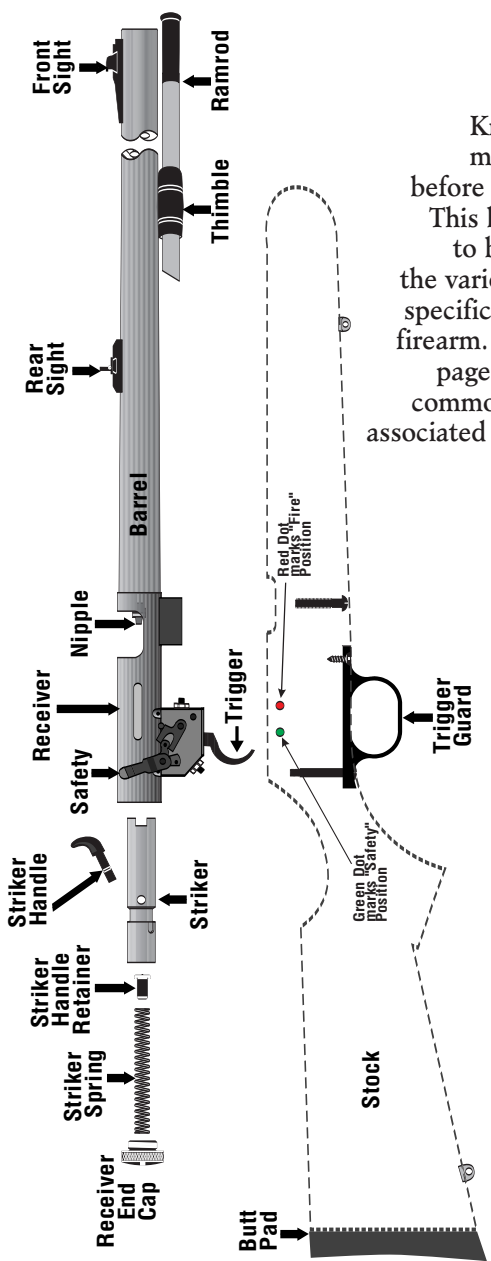

Know your Fire Hawk muzzleloading firearm before attempting to use it. This booklet will help you to become familiar with the various terms associated specifically with this type of firearm. The diagram on this page points out the more commonly mentioned parts associated with the Fire Hawk.

Assembly & Disassembly Of The Fire Hawk™

This Fire Hawk has four (4) basic parts groups:

1. The Barrel and Receiver Assembly - This assembly is held in the stock by two stock screws; one is located about 1" in front of the trigger guard and the other is the rear trigger guard screw.

2. The Stock Assembly - With sling swivel studs, trigger guard butt pad.

3. The Striker Assembly - The striker assembly is housed in the receiver, under spring tension. It is secured by the large receiver end cap at the rear end of the receiver.

4. The Trigger Assembly - Adjustable for let-off and over-travel.

Fire Hawk™ TAKEDOWN PROCEDURE

1st Step - After making sure that the gun is unprimed and uncharged, lower the striker to the "fired" position by pulling the trigger while holding the striker handle and slowly letting the striker go forward until it contacts the bare nipple.

2nd Step - Remove the ramrod from the thimble(s).

3rd Step - Remove the front stock assembly screw by turning it out counter-clockwise (as viewed from the bottom of the gun). Then remove the screw from the back of the trigger guard (the front trigger guard screw holds the trigger guard to the stock, it does not hold the barrel/receiver assembly to the stock).

4th Step - The barrel and receiver may now be lifted out of the stock.

5th Step - The large receiver end cap at the rear of the receiver can now be removed by turning it counter-clockwise. This cap is under spring tension so be sure to maintain a firm grip on it while turning it out. Remove the receiver end cap, the spring and the striker handle retainer.

Now, remove the striker handle by pulling it out of the striker body. Once the striker handle is removed, the striker body can be removed from the receiver by sliding it out the back. Next, remove the Trigger Assembly from the receiver. The trigger housing is held to the receiver by two pins. To remove the entire assembly from the receiver, use a 1/16" punch to drive these pins out.

Under no circumstances should the trigger mechanism be disassembled. Nor should the barrel be removed from the receiver. Further disassembly will void the warranty. If service is required, contact the factory at (603) 332-2333. To reassemble, reverse the above procedure, making sure that you check for proper functioning of the trigger, striker & safety mechanism prior to loading and firing. (See page 27)

Fire Hawk™ Takedown Procedure

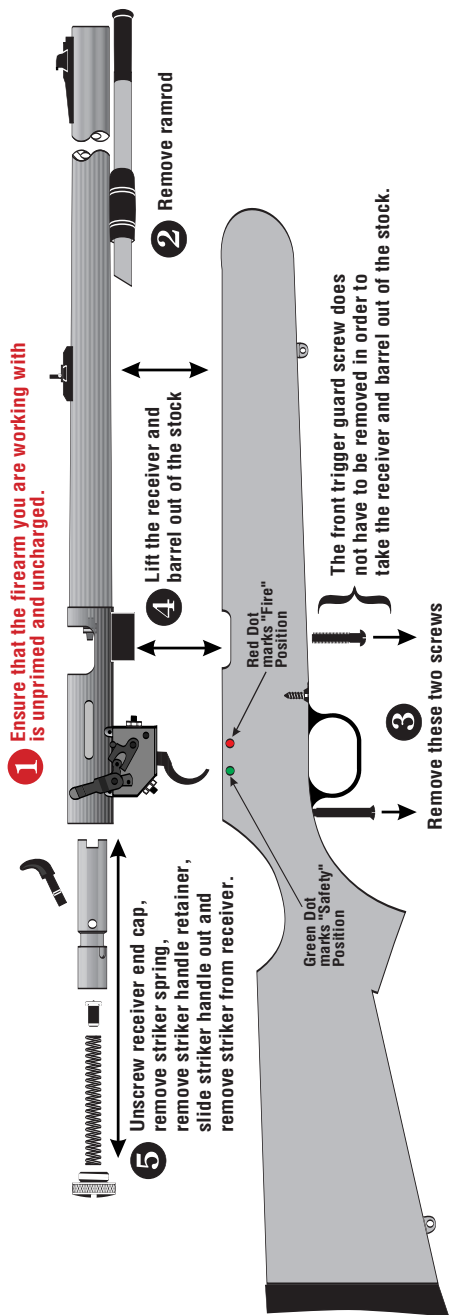

Basic Equipment For Shooting Your Thompson/Center Fire Hawk

In order to shoot your Fire Hawk™ muzzleloading rifle, a minimum of accessories or equipment will be necessary, these items include:

→ **⚠ WARNING** ←

Do Not attempt to shoot your muzzleloading firearm until you have read this manual in its entirety and understood it fully. FAILURE TO READ AND FOLLOW THESE INSTRUCTIONS COULD RESULT IN AN ACCIDENTAL DISCHARGE, CAUSING INJURY AND/OR DEATH TO THE SHOOTER OR BYSTANDERS AND DAMAGE TO PROPERTY. If you are unable to understand any or all of this material, call the Customer Service Department at Thompson/Center Arms at (603) 332-2333.

1. Proper eye protection
2. Proper ear protection
3. Black Powder or Pyrodex only, in the appropriate granulation for your particular firearm.
4. Powder Measure.
5. Projectiles: Appropriate for your firearm.
6. #11 Percussion Caps.
7. Patch worm for retrieving lost cleaning patches.
8. Cleaning patches
9. Jag for cleaning patches (One comes with each new Thompson/Center muzzleloader)
10. An appropriate bore cleaner and lubricant.

Understanding Black Powder And Pyrodex™

Make no mistake about it, Black Powder or Pyrodex are the only propellant powders that are safe to use in a muzzleloading firearm. Oh, you will hear, or possibly read, advice to the contrary but don't follow it for you will never hear such advice from a competent source.

The reason for using a low yield powder such as Black Powder or Pyrodex is quite basic and it is related to firearm design. When used as a propellant, Black Powder or Pyrodex generates a relatively low breech pressure. Muzzleloading firearms, even those with modern steel barrels, are not designed to withstand the high pressures produced by a Smokeless Powder charge. Think about it for a minute and you will understand why. The ignition hole in a muzzleloading firearm is a direct port into the combustion chamber. This port is sealed only by the thin foil of a cap and weight of the hammer in the cap lock model. In the flint lock design this port is not sealed at all. The high pressure of a Smokeless Powder charge would destroy this ignition system and the gun itself.

To avoid any misunderstanding on the part of the reader let us explain further why Smokeless Powder cannot be used in a muzzleloader in any quantity. People who become interested in muzzleloading tend to research and to seek out some of the early journals which describe loading implements, components and powders of yesterday. **Reading these old books can be pleasurable. Never assume, however, that obsolete printed material has a safe application in today's world.**

In the early days of the breech loader there were powders manufactured which were called "Bulk Smokeless". These powders were measured by the volume and used interchangeably with Black Powder in early cartridge firearms. Even in their time these powders were never used in muzzleloading firearms.

Early "Bulk Smokeless" powders are not available today and, even if they were, their erratic performance (extreme variations in pressure) would not meet current industry standards. By modern standards, such early bulk powders were unsafe, even in the days of their use. The same type of misinformation exists concerning "duplex loads" or the mixing of Smokeless Powder with quantities of Black Powder. This practice was popular in the days of the early breech loaders. It was dangerous then and it is even more dangerous now for modern Smokeless Powders are far more complex in their composition.

All presently available Smokeless Powders are designed for use with metallic cartridges and shotshells in strong modern breech loading

firearms. They should never be used in a muzzleloading firearm of any type. Some of these powders are “Black” in color making proper identification extremely important. It is the characteristic of Smokeless Powders to burn in a controlled manner within a given pressure range. Control of this pressure range requires the proper application of the powder to the specific purpose and in the quantities for which it was designed to be used.

→ **⚠ WARNING** ←

Never use smokeless powder of any type or in any quantity in a muzzleloading firearm, and never mix powders. The use of any smokeless powder could result in a detonation or explosion WHICH COULD CAUSE INJURY AND/OR DEATH TO THE SHOOTER OR BYSTANDERS AND DAMAGE TO PROPERTY.

Confine your use to Black Powder or Pyrodex and learn how to identify these powders and to use them correctly in your muzzleloading firearm. Here we will deal first with Black Powder for certainly it is the oldest of our propellant powders.

Black Powder is manufactured in four specific types or granulations for use in firearms. Generally speaking, it is the granule size which determines the appropriate use of Black Powder. Coarsest granulations are naturally the slowest burning and, therefore, work best in large caliber rifles and shotguns. Pistols or small caliber rifles require a finer or faster burning powder. The priming powder used in the pan of a flint lock is extremely fine and fast burning. The accompanying chart will help you to recognize the various granulations of Black Powder and to relate them to their proper use.

Black Powder Chart Showing The Appropriate Use Of The Various Granulations



FG (commonly called Single "F")
The muzzleloading enthusiast finds little use for this very coarse black powder. Its use is restricted to the large bore (10, 8, 4 gauge) shotguns of yesterday.



FFG (commonly called Double "F")
This is a very popular powder for the larger (.45 to .58 cal) rifles. It is also used for 12, 16, and 20 gauge muzzleloading shotguns. While it is not considered a pistol powder, it is sometimes used in very large caliber single shot pistols. It is recommended for use in the T/C Fire Hawks.



FFFG (commonly called Triple "F")
Due to its wide range of uses, Triple "F" is the black powder that is most commonly found on a dealer's shelf. It is used in all percussion revolvers, most single shot pistols, and most of the smaller (under .45 caliber) rifles. In a pinch, it can also be used to prime a flint lock.



FFFFG (commonly called Four "F")
The finest of all currently available black powders, Four "F" is best used for priming flint locks. Due to its limited use, it is sometimes difficult to obtain.

When purchasing Black Powder be certain that it is in the original manufacturer's container and that its granulation or type is clearly marked on the label. Follow the storage and handling precautions which are on the label. If you have any questions concerning the safe handling or storage of Black Powder, write to the manufacturer of the powder. Additional information on powder storage is available from the National Fire Protection Association, P.O. Box 9146, Quincy, Mass. 02269. Or call 1-800-344-3555. Ask for pamphlet #495.

This instructional booklet lists a range of Black Powder loads which are proper for your Thompson/Center firearm. Use only the granulation of Black Powder that is listed for your specific caliber and model. You will note that a series of charges are shown in each instance. The lightest charge shown for your firearm is the **starting load**. The heaviest charge listed is the maximum load. Start with the lightest load and work upwards gradually until you reach your best performing load. **You will find that the best shooting load is well below the maximum charge listed.**

→ **⚠ WARNING** ←

Never exceed the maximum load listed for your particular firearm. OVERLOADS MAY CAUSE DAMAGE TO THE FIREARM AND INJURY AND/OR DEATH TO THE SHOOTER OR BYSTANDERS AND DAMAGE TO PROPERTY.

Pyrodex is a propellant powder designed for use in muzzleloading cap lock rifles, pistols and shotguns. Pyrodex is not a Black Powder. In accordance with the manufacturer's instructions, Pyrodex relates closely to Black Powder on a **volume to volume basis (not weight of charge)**. In other words, a black powder measure set to dispense 70 grains of black powder will, in fact, dispense approximately 52 grains of Pyrodex (by weight). **However, this lighter charge of Pyrodex will provide a charge which is ballistically similar to 70 grains of Black Powder. For all practical purposes, knowing the actual weight of a charge of Pyrodex may be informative, but not necessary. Your black powder measure will dictate the proper amount by its graduations according to volume.** If you want to know the actual comparative weight of a Pyrodex charge, contact the manufacturer, Hodgdon Powder Co. Inc., Shawnee Mission, KS. 66201.

Pyrodex does not ignite as easily as Black Powder and, consequently, it is not recommended for use in flint lock firearms. Flint locks require strong, positive ignition and should be charged and primed with Black Powder of the appropriate granulation only.

Chart Showing Various Grades of PYRODEX™ and Their Intended Use ...

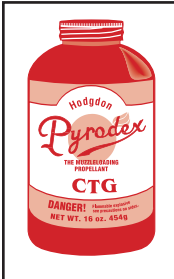

PYRODEX® CTG -
FOR BLACK POWDER CARTRIDGES. This powder was designed to be used in early model breech loading cartridge firearms (rifles, pistols & shotguns) which were intended for use with Black Powder only. It has no application in Thompson/Center muzzleloading firearms. It is listed here simply for identification purposes.

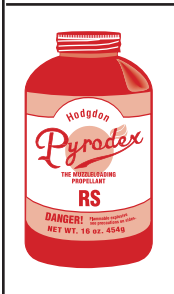

PYRODEX® RS (or PYRODEX SELECT "RS")
RIFLE & SHOTGUN POWDER. Designed for use in all calibers of percussion muzzleloading rifles and shotguns, this powder has a wide application. It may be used with all Thompson/Center cap lock rifles and shotguns including the T/C Fire Hawk. Pyrodex Select (RS) may also be used in this application.

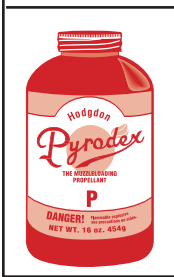

PYRODEX® P -
PISTOL POWDER. Designed for use in some percussion muzzleloading pistols and cap and ball revolvers, this powder has application in the Thompson/Center Patriot™ Pistol.

→ **WARNING** ←

The reader should bear in mind that Thompson/Center does not manufacture or sell powder of any type. If there is ever a question as to the proper application of a particular powder or the safety of a given charge, write to the manufacturer of the powder. Adhere to the safe handling and storage precautions printed on the manufacturer's container and never purchase or use powders which have been removed from their original container. **USE OF THE WRONG PROPELLANT MAY CAUSE INJURY AND/OR DEATH TO THE SHOOTER OR BYSTANDERS AND DAMAGE TO PROPERTY.** For information on Pyrodex write to Hodgdon Powder Co., Inc., Shawnee Mission, Kansas 66202.

Ignition in a Muzzleloader

Considering that Black Powder ignites easily and burns almost instantaneously, it would not seem that ignition could create problems for the muzzleloading enthusiast. Yet, it was in the age of Black Powder that such terms as misfire, hangfire and flash in the pan found their origins. The problem, of course, is that the muzzleloader requires a great deal more care in its cleaning and handling than does a modern cartridge firearm (see section on “Cleaning Your Muzzleloading Firearm.”)

The propellant Black Powder charge may not ignite if the nipple port is blocked by fouling, if the charge is dampened by oil or water or if the powder and/or caps have been allowed to deteriorate by improper storage (exposure to extreme temperature changes and/or dampness). Maintain the high quality of your Thompson/Center muzzleloader by meticulous cleaning. Make certain that the chamber, nipple port, pan and flashhole are free from oil, water or powder fouling. An appropriate nipple pick is a handy tool for cleaning nipple ports and flashholes. Thompson/Center cap lock rifles, shotguns and pistols use a No.11 percussion cap or in some instances, a musket cap or #209 shotgun primer and it is important that the caps or primers fit properly on their respective nipples. Use only high quality caps or primers and make certain that the cap is pushed securely onto the nipple, or the primer securely into the adapter.

→ **⚠ WARNING** ←

Pyrodex, while cleaner burning, is somewhat harder to ignite than Black Powder. If while shooting, you should experience a misfire, hold the firearm downrange and treat the firearm as if it could go off at any minute - it might. After waiting at least one minute, clean out the nipple port or flashhole using your nipple pick. Replace the priming charge (flint lock) or percussion cap (or primer) and try firing the rifle again. Continue to point the firearm downrange while clearing ignition ports and repriming to prevent injury in the event of a discharge. If, after several tries, the firearm still refuses to fire, then the charge must be deactivated and pulled (See section on “Pulling a Charge”). FAILURE TO FOLLOW THESE INSTRUCTIONS MAY CAUSE DAMAGE TO THE FIREARM AND INJURY AND/OR DEATH TO THE SHOOTER OR BYSTANDERS AND DAMAGE TO PROPERTY.

Black Powder Pressures And Velocities

It is not the purpose of this manual to delve deeply into the complex subject of chamber pressure or how it relates to all firearms. There are, however, some basic differences between a muzzleloader and a modern cartridge firearm. The reader must understand and respect these differences if he or she is to use their T/C muzzleloader in a safe manner.

→ **⚠ WARNING** ←

Shooting muzzleloading firearms requires rethinking all that you have learned about firearms. It requires discipline to cope with the requirements of being a reloader and rifleman at the same time. It requires strict adherence to the instructions set forth in this booklet. FAILURE TO FOLLOW THESE INSTRUCTIONS MAY CAUSE DAMAGE TO THE FIREARM AND INJURY AND/OR DEATH TO THE SHOOTER OR BYSTANDERS AND DAMAGE TO PROPERTY.

Odd as it sounds, your safe introduction to muzzleloading firearms requires a good deal of reverse thought. Our forefathers, trained in the use of muzzleloaders, had little difficulty using the products of their day or adapting to improved concepts as each new idea presented itself in a normal progression. The transition from flint lock to cap lock to breech loader each represented a step forward toward a more technically sophisticated era. Users of firearms had hundreds of years to adapt to these changes. In a single lifetime, no one was exposed to drastic change.

The muzzleloading enthusiast of today, however, has been trained in the use of cartridge firearms. To safely use a muzzleloader he must adjust his thinking backward - bridging hundreds of years of product development - in one giant step! Those reading this booklet must face the realization that the design of a muzzleloading firearm is rooted in tradition. In other words, a manufacturer of muzzleloading firearms, while he does have the benefit of using modern steel, proper heat treating and other technical advances, does not have the option of drastically altering a design which is centuries old. To use a muzzleloader safely requires considerable mental adjustment on the part of today's shooter.

Modern cartridge firearms depend heavily upon the strength of a brass cartridge case to seal the chamber and to safely confine expanding gas. Equally it is the cartridge case which holds the bullet in a fixed position,

confines the powder charge to a given volume and controls headspace. Modern cartridge firearms are designed to withstand high working pressures since these same pressures make possible the high velocities, flat trajectories and increased range of modern ammunition. Yet, the modern firearm is no stronger than the cartridge case that is used in its chamber. If the case ruptures, the primer punctures or if the headspace is altered, hot powder gases under extreme pressure will flow back through every seam in the action possibly destroying the firearm and causing injury to the shooter

The propellant charge in a muzzleloader is poured directly into the barrel of the firearm and then compressed by the projectile in the chamber area. Think about this for a minute! Lacking the restraints and protection supplied by a modern cartridge case, the muzzleloading charge rests directly against the steel chamber walls and the face of the breech area. The ignition port in a cap lock or flint lock is a simple hole leading directly into the chamber. Certain surfaces of the breech area and nipple are directly exposed to chamber pressure. Judged by the design standards set for modern firearms, the muzzleloader is extremely primitive. Its design will not tolerate high pressure.

The following text applies to the use of your Thompson/Center muzzleloader with Black Powder or Pyrodex charges properly restricted to the loading information shown in this booklet. It deals with those conditions which singularly or cumulatively can affect muzzleloading pressures.

For years it has been assumed that it is impossible to overload a firearm using Black Powder. The theory was that only a certain portion of a heavy Black Powder charge will burn and that the remaining powder is blown out of the bore in unburned condition. This thinking led to the belief the pressures created by a Black Powder charge would reach a certain (undetermined) range and climb no higher. **Our testing indicates that this theory is completely unfounded.** As heavier and heavier charges were loaded our pressure readings climbed accordingly. At no time was there any indication of a leveling off of pressure. **Unreasonably heavy charges of Black Powder or Pyrodex can be dangerous.** Restrict yourself to the loads listed in this booklet and start with the lightest load shown for your particular model and caliber. Bear in mind that the following conditions can be cumulative. If you load the heaviest charge listed without following instructions (working slowly upward) then other conditions such as powder fouling, hard projectiles and improper loading, can carry you well beyond the maximum safe pressure range of muzzleloading firearms. All propellant powders (depending upon their design and composition) will function most efficiently within a given pressure range. Our testing indicates that the Black Powder used in our testing operated most efficiently at or near the midway point in our loading charts, and

recorded the highest velocity in relation to the lowest pressure. **Heavier loading showed marked increases in pressure and substantially more recoil for only minor gains in velocity.**

Fouling in the bore of a muzzleloader will increase pressure. When shooting a muzzleloader, consecutive shots without cleaning will display rapid shot-to-shot increases in pressure, a variation in velocity and a resultant decrease in accuracy. As Black Powder fouling builds in the bore of your muzzleloader, loading will become more difficult until it reaches the point where it becomes impossible to properly seat the projectile.

Different types of lubricants used in cleaning, or in conjunction with lubing patched round balls and conical projectiles will produce different degrees of fouling when they react to the combustion of Black Powder. Generally, petroleum based (or synthetic) lubricants will produce far more fouling, and cleaning the bore between shots will be necessary in order to maintain consistent pressures, or ease the loading process from shot to shot. A natural lubricant such as T/C's Natural Lube 1000 Plus Bore Butter will season the bore from shot to shot, drastically reducing fouling. The shooter will not have to clean between shots, and pressures will remain consistent.

Muzzleloading projectiles must be cast from pure lead. Many lead alloys, such as those found in Linotype and wheel weights, resemble lead but will cast hard, oversize projectiles. Such projectiles will prove extremely difficult to load and raise pressures even in a clean bore (see section on "Bullet Molds"). Never use lead alloys to cast muzzleloading projectiles.

Any increase in bullet weight with a given powder charge will always increase pressure. If a shooter has been loading a patched round ball and then decides to use the heavier Maxi-Ball or Maxi-Hunter he must go back to the starting charge and work up slowly to the best performing load.

Improper loading can lead to a serious and dangerous pressure condition. To function properly the muzzleloading projectile (Maxi-Ball, Maxi-Hunter or Patched Round Ball) must be seated tightly against the powder charge. **Never fire a muzzleloading firearm if the ball or bullet is only part way down the barrel.** Mark your ramrod, as explained in the "Loading Section", and follow instructions carefully.

Variations in patch lubricants and bullet lubricants will effect velocity and accuracy, as well as having an effect on the amount of fouling which develops. Use of T/C's Natural Lube 1000 Plus Bore Butter, an all natural lubricant, developed far less fouling, and permitted extended reloading between shots without the necessity to clean between these shots. Velocity and accuracy improved over other lubricants used.

The preceding text is offered in an attempt to guide the novice and to help him obtain optimum results from his muzzleloading firearm. The reader must bear in mind that a muzzleloader is not capable of developing the high velocity or handling the high pressures of a modern firearm. Restricted to a primitive design, the muzzleloading hunter takes game by depending upon a large caliber, heavy bullet traveling at a mild velocity.

	<p>WARNING: Discharging firearms in poorly ventilated areas, cleaning firearms or handling ammunition may result in exposure to lead and other substances known to cause birth defects, reproductive harm and other serious physical injury. Have adequate ventilation at all times. Wash hands thoroughly after exposure.</p>
---	---

Thompson/Center Muzzleloader Bullet Molds

→ **⚠ WARNING** ←

When using T/C molds, follow the instructions supplied with the mold block. Lead is a potent, systemic poison that serves no known useful function once absorbed by your body. Lead can be absorbed into your body by inhalation (breathing) and ingestion (eating). Taken in large enough doses, lead can kill you in a matter of days. Even in small quantities, lead dust, fumes or mist can be inhaled or ingested and cause serious injury in the respiratory system. Children are especially vulnerable to this.

Never allow children to be present in the room where you are casting bullets. Ensure that your work area is well ventilated so that hazardous vapors are ported away from you.

Lead can also be absorbed through your digestive system if lead gets in your mouth and is swallowed. If you handle food, cigarettes, chewing tobacco, or make-up which have lead on them, or handle them with hands contaminated with lead, this will contribute to ingestion. Always be sure to wash your hands after handling lead.

No eating, drinking or smoking should take place in any area you are working with lead.

When casting lead bullets, use only pure lead (PB). Wear long sleeves, safety glasses, gloves, and a canvas apron to protect you against lead splatters. Molten lead will react violently if it comes into contact with water or other liquids. The molten lead can erupt, with steam and hot lead spewing in all directions. Keep your bullet casting furnace away from possible sources of water such as the condensation from overhead pipes. Be certain that any new lead being added to the old lead is absolutely dry.

FAILURE TO FOLLOW THESE INSTRUCTIONS MAY RESULT IN INJURY AND/OR DEATH TO THE BULLET CASTER OR BY-STANDER, AND DAMAGE TO PROPERTY.

Muzzleloading projectiles must be cast from pure lead. Most lead al-

loys commonly found in Linotype and wheel weights contain antimony. While such alloys are very desirable for fixed cartridge projectiles, they are impractical for muzzleloading use. Alloys containing antimony are harder and lighter than pure lead. Consequently projectiles cast from such materials will be overly hard (depending on the amount of antimony present) and somewhat lighter than the bullet weight listed for the mold. The biggest problem, however, is that **antimony alloys have less a shrinkage factor than pure lead. Antimony alloys produce an extremely hard, over size projectile which is very difficult to load properly. Pure lead can be obtained from a plumbing supply house.**

This booklet and the Thompson/Center Catalog lists a series of round ball, Maxi-Ball and Maxi-Hunter molds that are proper for use with our firearms. All T/C bore diameters, patch thickness and mold dimensions are carefully calculated to produce a safe result when used with our recommended Black Powder charges and a pure lead projectile in the appropriate caliber.

The reader must realize that Thompson/Center has no control over cast projectiles, bullet molds or patch material offered by other sources. Before using such items, the user must assure himself that the components or molds are proper and safe to use with our firearms. If you have questions concerning the correctness of a product or component, write to the Customer Service Department, Thompson/Center Arms, P.O. Box 5002, Rochester, New Hampshire 03866.

For bullet specifications and loading data, refer to page 54 of this booklet.

Patching The Round Ball

→ **⚠ WARNING** ←

To shoot properly, the round ball must be tightly patched. If the round ball is not tightly patched, it may, by movement of the firearm, work its way off the powder charge and up the bore. UNDER SUCH A CONDITION THE BALL WILL ACT AS A BARREL OBSTRUCTION AND FIRING CAN CAUSE INJURY AND/OR DEATH TO THE SHOOTER OR BYSTANDERS AND DAMAGE TO PROPERTY.

The novice at muzzleloading is often perplexed by the problem of trying to figure out the correct patch and ball combination for his firearm. More often than not, he ends up using a loose fitting combination which loads easily but leaves something to be desired in the way of accuracy and safety.

Accuracy with a muzzleloader is based on a paradox: an undersize ball is spun by rifling that it never touches! It is the job of the patch to hold the ball tightly against the powder charge until firing and to securely grip both the ball and the rifling so as to transfer the spin of the rifling to the projectile itself. If the patch fits too loosely, the ball will not spin and its flight will be unstable. **If the patches vary in thickness, or manner of loading, or the amount of lubricant they carry, shot to shot stability and accuracy will be affected.**

To perform its task properly, the patch material must be extremely tough and it must be under considerable compression- not only in the area where it bears on the lands but also at the bottom of each groove.

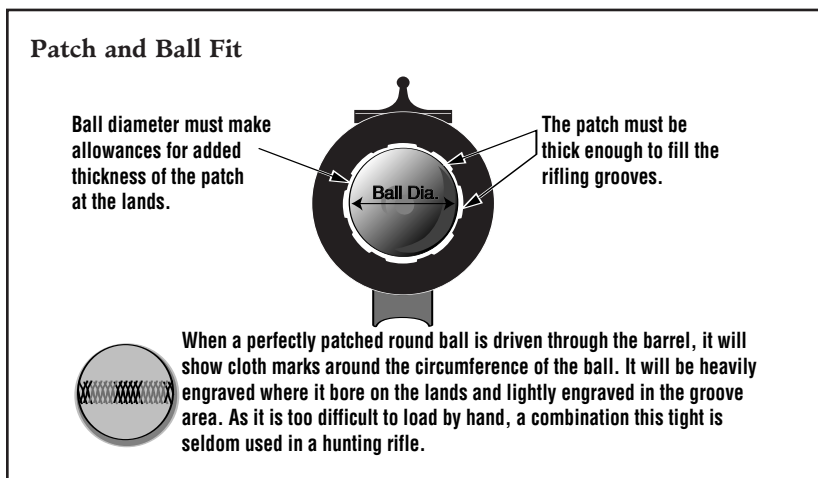

For target shooting, an extremely tight fitting combination of patch and ball is sometimes used. Often a bullet starter, shaped to the contour of the ball, is employed and a hammer is used to start the projectile. Such a combination is, naturally, too difficult to load under field conditions and, therefore, most hunting rifles use a slightly looser fit.

T/C Patch Material is available (unlubricated or prelubricated) in sizes which relate directly to the proper round ball diameter and barrel dimensions of each specific caliber. (See the current T/C catalog). T/C Patch Material represents an optimum compromise between tight fit and loadability. Bear in mind that the ball must be seated firmly against the powder without excessive battering or flattening of the projectile itself. To obtain accuracy it is essential that the front of the ball remain round. When used with the proper size (lead) round ball, T/C patch material allows the shooter to load under field conditions and obtain fine accuracy.

When targeting a muzzleloading firearm, it is wise to recover a few of the fired patches and to check their condition. Fired patches can usually be found lying on the ground about 10 yards in front of the muzzle. The following illustrations will help you to determine whether your patch and/or lubricant is doing its job.

Lubricant is required to ease loading and prevent the patch material from burning. The "spit" patch (wet with saliva) should be avoided as it will dry out and cease to function as a lubricant. Thompson/Center recommends the use of our Natural Lube 1000 Plus Bore Butter. It should be rubbed into the patch material with the fingers. Saturation of the patch material should be complete but not excessive. Excessive lubricant may deactivate the powder charge.

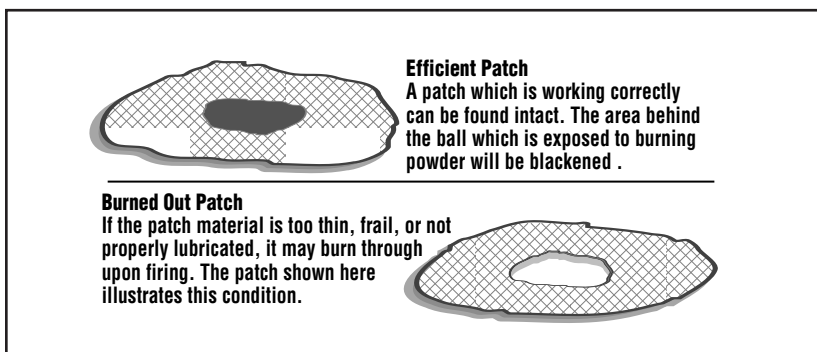

→ **⚠ WARNING** ←

Do not use any type of plastic patch or sabot with a ROUND BALL in any Thompson/Center firearm. When such patches or sabots are used, it is possible, even under optimum tolerance conditions, for the ball and patch or sabot to disengage themselves from each other. This results in the ball moving forward (leaving air space between the patch or sabot and the ball). UNDER SUCH CONDITIONS, THE BALL WILL ACT AS A BARREL OBSTRUCTION AND FIRING CAN RESULT IN INJURY AND/OR DEATH TO THE SHOOTER OR BYSTANDERS AND DAMAGE TO PROPERTY. Various manufacturers have introduced plastic sabots which are used with pistol bullets in muzzleloading firearms. Thompson/Center Arms and others have tested these sabots. Satisfactory results have been obtained when following the instructions as provided by the manufacturer of the sabots. It is important to note that only those bullets recommended by the manufacturer of the sabot should be used. Sabots must not be used with round balls.

For specific loading information on Thompson/Center's Break-o-Way Sabots see page 62 of this manual.

Understanding The Fire Hawk™ Trigger, Striker and Safety Mechanism

The Fire Hawk™ muzzleloading firearm is a modern cap lock rifle that combines both the functional aspects of an old-time cap lock with the looks of a modern bolt-action rifle. The Fire Hawk™ has several design features which are different than traditional muzzleloading firearms, and must be understood before you attempt to use and fire your Fire Hawk™. See the illustrations on page 28.

The striker mechanism consists of several parts which reside within the receiver. When the safety is in the “Fire” position, the striker is released when the trigger is pulled, allowing the striker to move forward quickly under spring tension and strike the percussion cap that was placed on the nipple by the shooter.

The “Thumb Safety” lever has two positions, all the way rearward where it is lined up with the green dot on the stock and all the way forward where it is lined up with the red dot on the stock.

The “Thumb Safety” in the rearward position is the condition that the Fire Hawk must be carried in, with no cap on the nipple.

While the striker handle is in the “Cocked” position and the thumb safety is in the “Safe” (rearward) position, a percussion cap can be placed on the nipple immediately prior to firing the Fire Hawk.

Pushing the thumb safety forward brings the mechanism to the “Fire” position, Pulling the trigger at this point will cause the striker to fall forward and strike the cap on the nipple - thereby igniting the powder charge and firing the gun.

→ **⚠ WARNING** ←

Never prime your Fire Hawk™ until you are ready to fire it. Your muzzleloading rifle should remain unprimed until the instant before firing. After you prime your Fire Hawk™, your full concentration should be on the target and the act of firing. FAILURE TO FOLLOW THIS RULE CAN RESULT IN ACCIDENTAL DISCHARGE WHICH CAN CAUSE INJURY AND/OR DEATH TO THE SHOOTER OR BYSTANDERS AND DAMAGE TO PROPERTY.

Photo #1 Striker is in the “Fired” position. The safety lever is fully forward and the striker is also fully forward and in contact with the nipple.



Photo #2 Striker handle in the “Cocked” position with the thumb safety engaged (fully rearward). The thumb safety will now be lined up with the green dot on the stock.



Photo #3 The Striker handle in the "Cocked" Position with the thumb safety in the “Fire” position. The thumb safety will now be in line with the red dot on the stock. A pull rearward on the trigger will now release the striker and cause it to strike the cap on the nipple.



Trigger Adjustment For The Fire Hawk™



Any adjustments are to be made to Screws "A" and "B". A 5/64" hex wrench and a 1/4" open end wrench are required to perform adjustments.

The trigger of the Fire Hawk™ is factory set for optimal weight of pull, sear engagement and over-travel. If further adjustment is required, the Fire Hawk™ is equipped with two trigger adjustment screws that can be adjusted by the shooter. If the shooter is not able to make the appropriate adjustments the adjustments should be made by a qualified gunsmith.

In the diagram above, Screw "A" is used to adjust the sear engagement. Sear engagement adjustment refers to the distance the trigger has to be moved rearward to release the sear which in turn allows the striker to fall from the "Cocked" position to the "Fired" position.

Screw "B" is used to adjust over-travel. Over-travel is described as the amount of rearward trigger movement after the trigger releases the striker.

→ **⚠ WARNING** ←

The Fire Hawk™ triggers are factory set to an optimal pull. Physical alteration of the trigger, or adjustments other than those described above with Screw "A" and Screw "B" may lead to a situation where a dangerously light trigger pull results. A TRIGGER PULL THAT IS TOO LIGHT CAN CAUSE PREMATURE FIRING WHICH MAY LEAD TO INJURY AND/OR DEATH TO THE SHOOTER OR BYSTANDERS AND DAMAGE TO PROPERTY.

Trigger Adjustment for Sear Engagement
(Screw "A" in diagram on page 29)

→ **▲ WARNING** ←

Make sure that the firearm you are working with is uncharged and unprimed prior to making any trigger adjustments. FAILURE TO HEED THIS WARNING COULD RESULT IN ACCIDENTAL DISCHARGE WHICH MAY CAUSE INJURY AND/OR DEATH TO THE SHOOTER OR BYSTANDERS AND DAMAGE TO PROPERTY.

Adjustment of the Fire Hawk trigger requires that the receiver/barrel be removed from the stock. To do this, follow the takedown instructions found in the assembly and disassembly section of this manual.

Important: The Fire Hawk should not be dry fired without a nipple protector. To avoid damage to the nipple caused by the striker contacting it, install a 3/8" long piece of rubber hose over the nipple.

Important: Any adjustment to the sear engagement adjustment screw (Screw "A" in the diagram on page 29) should always be made first. Only after this adjustment is made should the shooter adjust the over-travel screw (Screw "B" in the diagram on the page 29).

TO LESSEN THE AMOUNT OF SEAR ENGAGEMENT, FOLLOW THESE INSTRUCTIONS:

Step 1. Ensure that the striker handle is in the "Cocked" position and that there is a nipple protector in place on the nipple.

Step 2. Loosen the 1/4" lock nut on Screw "A" (See diagram on page 29) by turning it **counter-clockwise** as viewed from the rear of the trigger housing.

Step 3. Using a 5/64" hex wrench, turn Screw "A" clockwise slowly until the striker handle falls forward to the "Fired" position (keeping fingers clear of the striker and striker handle as it falls).

Step 4. Turn the 5/64" hex wrench one-third (1/3) turn counterclockwise. **THIS IS THE ABSOLUTE MINIMUM SETTING FOR SEAR ENGAGEMENT.**

Step 5. Return the receiver/barrel assembly into the stock. Draw the striker handle rearward into the "Cocked" position. Should the rifle and dry fire it to check the "feel" of this adjustment. If this adjustment is satisfacto-

ry remove the receiver/barrel assembly from the stock.

Step 6. After sear engagement adjustment is finalized, retighten the 1/4" lock nut, making sure that sear engagement adjustment screw (Screw "A") remains in the same position.

Step 7. Reassemble the rifle.

To increase sear engagement from this minimum setting, the 5/64" hex screw (Screw "A") should be turned counterclockwise further than the one third minimum turn stated above.

Trigger adjustment for Over-travel (Screw "B" in diagram on page 29)

**TO LESSEN THE AMOUNT OF TRIGGER OVER-TRAVEL,
FOLLOW THESE INSTRUCTIONS:**

Step 1. Ensure that the striker handle is in the "Fire" position and that there is a nipple protector in place on the nipple.

Step 2. Loosen the 1/4" lock nut on Screw "B" (See page 29) by turning it counterclockwise as viewed from the front of the trigger housing.

Step 3. Turn the hex Screw "B" with a 5/64" allen wrench clockwise until it meets resistance (stops). Then, while holding the trigger back, turn the screw counter clockwise until the striker falls to the "fired" position. Back the screw up (counterclockwise) from this position one-quarter (1/4) turn. **THIS IS THE MINIMUM SETTING FOR OVER-TRAVEL.** Retighten the lock nut.

Step 4. Return the receiver/barrel assembly into the stock. Draw the striker handle rearward into the "Fire" position. Shoulder the rifle and dry fire it to check the "feel" of this adjustment. If this adjustment is satisfactory remove the receiver/barrel assembly from the stock.

Step 5. After the over-travel adjustment is finalized, retighten the 1/4" lock nut, making sure that the over-travel adjustment screw (Screw #2) remains in the same position.

Step 6. Reassemble the rifle.

To increase trigger over-travel, the 5/64" hex screw (Screw "B") should be turned counterclockwise further than the one quarter minimum turn.

Charging And Priming The Thompson/Center Fire Hawk™

→ **⚠ WARNING** ←

If you have not read this manual in its entirety, do so before attempting to load your firearm. IMPROPER LOADING AND USE OF YOUR FIREARM CAN CAUSE INJURY AND/OR DEATH TO THE SHOOTER OR BYSTANDERS AND DAMAGE TO PROPERTY.

The photo on page 33 shows a shooter in the process of loading a Fire Hawk™. Study this photo carefully and read all the captions before you proceed to charge your Fire Hawk™.

Before charging, insert the ramrod into the barrel and tap it up and down several times. You will hear the ramrod “clink” as it contacts the steel face of the breech. Note exactly how far the ramrod goes into the barrel and how much of the rod extends beyond the muzzle when the barrel is uncharged. Commit this exercise to memory and practice it every time that you handle a muzzleloading firearm. Before you attempt to load it - before you store it away - before you hand it to a friend or leave it unattended, **always check to ensure that the firearm is unprimed and uncharged.**

The next precharging exercise is to wipe the bore free of all oil. **Be meticulous with your cleaning for the presence of any amount of oil in the barrel or chamber can dampen the powder charge and cause the rifle to misfire or hangfire (see section on “Cleaning”).** Point the muzzle in a safe direction and snap several caps on the nipple before charging. This will ensure ignition and clear away any oil that may have accumulated in the nipple port.

Adjust the powder measure to the desired charge and fill it with Black Powder (or Pyrodex). To achieve accuracy, consistency in the powder charge is required. Fill the measure exactly the same each time. Set the rifle on its butt and **hold the muzzle away from your face and body as pictured on page 33.** Pour the measured charge down the barrel and strike the side of the barrel several sharp raps with the heel of your hand. This will settle the powder into the chamber area of the barrel.

Loading & Use of a Fire Hawk™

→ **▲ WARNING** ←

IMPROPERLY CHARGING YOUR T/C MUZZLE-LOADING RIFLE CAN BE DANGEROUS. STUDY THIS PHOTO CAREFULLY BEFORE PROCEEDING.

Barrel held securely with muzzle upwards - directed away from your body.

**Use Black Powder or Pyrodex ONLY!
Use a T/C graduated powder measure only and do not overcharge. NEVER charge directly from a powder flask, can or powder horn.**

Rifle unprimed with the striker in the "Cocked" position and the thumb safety engaged (fully rearward).



Stay mentally alert. This task requires your complete attention.

Eyes, ears & arms protected.

Do Not Smoke while loading any muzzle-loader.

Keep components & reserve powder well away from the firearm.

Butt resting firmly on the ground & supported by the side of the shooter's foot to prevent slipping.

Loading And Use of a Fire Hawk™

IF YOU ARE LOADING A ROUND BALL WITH A CLOTH PATCH, PROCEED AS FOLLOWS.

Lay your lubricated cloth patch over the muzzle and place the round ball in the center of the patch. Uniformity is important. Be certain that the patch is centered and that the weave of the cloth is placed exactly the same each time. Also, the sprue mark (flat section on a cast ball) should be in the up position and carefully centered.

Place the stubby end of the bullet starter on the top of the ball, as shown in Photo "A", and apply pressure until the ball starts into the barrel. A tightly patched ball will require a good deal of pressure and it starts suddenly. It will usually "snap" smartly into the barrel flush with the muzzle.

PHOTO A

Start the ball with the stubby end of the Bullet Starter. A tight fitting combination will load smartly. Never attempt to start the ball with the ramrod. Used improperly the ramrod will break and possibly injure your hand.



Once the ball is started, reverse the bullet starter, as shown in Photo "B", and place the rod end on the top of the ball. With a sharp blow of the hand, drive the ball down about four inches into the barrel. The ball and patch have now been formed to the rifling and will (if the bore is not fouled) load easily from this point.

PHOTO B

Drive the ball down into the barrel with one sharp blow. Never attempt to start the ball with the ramrod. Used improperly the ramrod will break and possibly injure your hand.



Using short strokes with the ramrod, push the ball the remainder of the

way down the barrel until it contacts the powder charge. **Seat the ball firmly against the powder charge but do not pound on it.** Pounding on the ramrod will deform the ball. A deformed ball will not shoot accurately. Load and seat each ball with exactly the same pressure, shot after shot. **With successive shots, fouling in the bore may build up in sufficient quantity to make loading more difficult, or even impossible.** When using a petroleum based lubricant, the buildup will be much more apparent, and cleaning between shots will be necessary. When using an all-natural lubricant such as T/C Natural Lube 1000 Plus Bore Butter in keeping with the “all natural approach, this buildup will be far less, and cleaning between shots will not be necessary. **BUT, if for any reason you experience progressively more difficult loading due to buildup of fouling, you must clean the bore, or safe loading will become impossible.** See the sections on “Cleaning” and on “Pulling a Charge”.

PHOTO C

Use the ramrod to push the ball down the barrel and to seat it against the charge.



Once the ball has been loaded, it is necessary to carefully mark your ramrod at the muzzle. A reference mark on the ramrod will allow you to ensure that all projectiles are seated to the same depth (Photo “D”).

PHOTO D

Mark the ramrod at the muzzle. Use a marking pencil to mark the ramrod. This will allow you to ensure that each ball is seated to the same depth. Erase and remark each time you adjust the charge or change projectiles. when you arrive at the desired charge, cut a clean notch in the ramrod so you will have a permanent reference mark. This reference mark will serve as an indicator only with the charge and projectile used when it was marked. When the charge and/or projectile change, the reference mark will also change.



If you are loading an all-lead conical like T/C's MAXI-BALL® or MAXI-HUNTER® or a sabot like T/C's Mag Express Sabot, proceed as follows; Do not use a cloth patch with these projectiles. Wipe the oil from the bore and follow the precharging instructions given for your particular style of rifle. Use Black Powder or Pyrodex only.

Start with the lightest charges listed in our loading chart for your caliber. Use T/C graduated powder measure and measure each charge carefully. Lubricate conical bullets with Natural Lube 1000 Plus Bore Butter as shown in Photo "E". Sabots do not have to be lubricated. **The Maxi-Ball® and Maxi-Hunter® are designed to be shot as cast (not sized).** Sizing will alter the diameter of the forward bearing band. This destroys the accuracy of the projectile and dangerously decreases its diameter (a loose fitting projectile can move off the powder charge). When loading a Maxi-Ball or Maxi-Hunter bullet, you will note how only the forward most bearing band graves to the rifling when loading. The base of the bullet upsets (increases in diameter) on firing causing it to fill the grooves thus stabilizing the projectile.

PHOTO E
FORWARD BEARING BAND
(SLIGHTLY OVER BORE DIA.)
GRAVES TO RIFLING WHEN
LOADING. THE BASE & REAR
BEARING BAND ARE SLIGHTLY
UNDER BORE DIAMETER TO
ENSURE THAT THE BULLET
STARTS EASILY AND ALIGNS
PROPERLY. The base of the bullet enters the bore (straight) with only thumb pressure. Pressure of the bullet starter graves the forward bearing band to the rifling as it enters the muzzle.



Hold the rifle as pictured on page 33 and pour your measured powder charge into the barrel. Start the lubricated bullet or sabot into the bore with your fingers. The base of the bullet and the rear bearing band will enter the bore easily with finger pressure. The projectile will hang-up when the forward bearing band reaches the muzzle. The diameter of the forward bearing band is somewhat larger than the rest of the bullet and must be engraved to the muzzle to ensure a snug fit. Start the projectile into the muzzle with the stubby end of the bullet starter. Reverse the starter and drive the projectile down about four inches into the barrel with the rod end of the starter. Using short strokes with the ramrod, push the projectile the remainder of the way down the barrel until it contacts the powder charge. **As with the round**

ball, the lead bullet or sabot must be seated firmly against the powder charge. Seat the projectile with exactly the same pressure shot after shot. Study Photo “F”. **Remove the ramrod before you prime the firearm.**

PHOTO F

Use the ramrod to push the bullet down the barrel and to seat it against the powder charge.

PROJECTILES MUST ALWAYS BE SEATED FIRMLY AGAINST THE POWDER CHARGE.



After the projectile is seated tightly against the charge, mark your ramrod in the same manner as previously instructed when loading a round ball.

→ **WARNING** ←

Never fire a muzzleloader unless you are sure the projectile is firmly seated on the powder charge and the ramrod has been removed from the bore. Shooters should bear in mind that the muzzleloading projectile is not crimped into position as is the fixed cartridge projectile. If a projectile does not fit tightly then jarring or movement of the firearm can cause it to move forward. If the firearm is fired when a projectile is forward or off the powder charge, or the ramrod is still in the bore, then the projectile or ramrod may act as a bore obstruction. This can cause a ruptured or burst barrel. **A RUPTURED OR BURST BARREL MAY CAUSE INJURY AND/OR DEATH TO THE SHOOTER OR BYSTANDERS AND DAMAGE TO PROPERTY.** If, due to fouling, a bullet or ball becomes lodged part way down the barrel, the firearm must be disassembled and the charge removed. See section on “Cleaning”. Also see section on “Pulling a Charge”.

Priming Your Charged Fire Hawk™. If you have followed the preceding instructions your firearm will now be charged with Black Powder or Pyrodex and a projectile will be firmly seated against the powder charge. Your ramrod will be marked to the exact seating depth allowing you to ensure that each future projectile is seated in the same careful manner. The striker handle of your Fire Hawk will be in the “Safety” position.

→ **⚠ WARNING** ←

Do not prime the firearm until you are actually ready to fire and you have double checked to ensure that the striker handle is in the “cocked” position, the thumb safety is engaged (fully rearward) and ramrod has been removed from the bore. Thompson/Center does not recommend priming the firearm until the instant before actual firing. Carrying a charged, primed Fire Hawk can be dangerous. **ACCIDENTAL DISCHARGE IS A CONSTANT HAZARD WHICH, IF IT OCCURS, CAN CAUSE INJURY AND/OR DEATH TO THE SHOOTER OR BYSTANDERS AND DAMAGE TO PROPERTY.** The only safe way to guard against an accidental discharge is to carry your Fire Hawk unprimed, with the striker in the “cocked” position and the thumb safety engaged (fully rearward).

WHEN YOU ARE READY TO FIRE YOUR Fire Hawk™, PRIME IT AS SHOWN IN PHOTO “G” below.



With the striker in the “cocked” position and the safety engaged (fully rearward) hold the Fire Hawk with the muzzle pointed in a safe direction and press the No.11 percussion cap down tightly onto the nipple. Slide the thumb safety fully forward to disengage it. **The rifle is now ready to fire. RAISE THE Fire Hawk™ AND FIRE THE SHOT!**

→ **⚠ WARNING** ←

When firing the Fire Hawk™, hold it tightly against the shoulder, allowing your body weight to absorb and buffer the force of the recoil. **AN IMPROPERLY HELD FIREARM CAN “KICK” UPWARDS CAUSING FACIAL INJURY AND/OR BRUISING.**

If you decide not to fire, engage the thumb safety by pulling it fully rearward. Then remove the cap from the nipple.

→ **⚠ WARNING** ←

If the firearm is no longer going to be used, uncharge it by firing it into a suitable backstop or pull the charge before returning it to your vehicle, camp or home (see section on “Pulling a Charge”). **AN ACCIDENTAL DISCHARGE CAN CAUSE INJURY AND/OR DEATH TO THE SHOOTER OR BYSTANDERS AND DAMAGE TO PROPERTY.**

Summary of Charging & Priming Your Thompson/Center Fire Hawk™

1. Check to ensure that the firearm is uncharged.
2. Wipe the bore free of all oil.
3. Pointing the muzzle in a safe direction, snap several caps on the nipple, clearing away any oil residue which may be in the nipple channel.
4. Ensure that the striker handle is locked into the “Cocked” position and the thumb safety is engaged (fully rearward) and that it is aligned with the green dot on the stock.
5. Set firearm on its butt, holding muzzle away from your face and body.
6. Pour pre-measured powder charge down the bore and settle powder by rapping the side of the barrel with your hand.
7. Load a round ball by placing a patch over the muzzle, centering it, and placing the round lead ball on top of the patch. Load a conical bullet or sabot by placing the projectile in muzzle; straight.
8. Drive the projectile into muzzle with an appropriate short starter.
9. Push the projectile the remainder of the way down the bore using short strokes with the ramrod.
10. Firmly seat the projectile on the powder charge.
11. Remove the ramrod from the bore and return it to its proper location in the thimbles under the barrel of the rifle..
12. Carefully place a No.11 percussion cap on the nipple prior to pushing the safety forward to the “Fire” and shooting the rifle.

Pulling a Charge From Your Thompson/Center Fire Hawk™

→ **⚠ WARNING** ←

Never attempt to pull a charge from your Fire Hawk™ until you are absolutely certain that the firearm is deprimed (percussion cap, removed from the nipple). Do not attempt to pull a charge from any gun until the powder charge has been rendered inert (barrel removed and its breech section submerged in water for at least one-half hour) as explained in the following text dealing with pulling a charge. **AN ACCIDENTAL DISCHARGE CAN CAUSE INJURY AND/OR DEATH TO THE SHOOTER OR BYSTANDERS AND DAMAGE TO PROPERTY.**

PULLING A CHARGE FROM A MUZZLELOADING RIFLE

Under normal conditions your Fire Hawk™ is unloaded simply by firing it into a suitable and safe backstop. There are, however, some conditions under which the firearm cannot be fired and the charge must be pulled.

SOME OF THE MOST COMMON CONDITIONS ARE AS FOLLOWS:

1. If the projectile is not seated firmly against the powder charge, stop immediately! Do not attempt to fire the rifle. You must pull the charge and clean the barrel.
2. If the rifle is loaded in a proper manner yet fails to fire after repeated repriming and clearing of the ignition ports (explained in "Ignition" section).
3. If you are at a location that is unsuitable for discharging the firearm before transporting it.

To pull a charge from your Fire Hawk™ it will be necessary to take the rifle down - separating the barrel/receiver assembly from the stock.

Fire Hawk™ TAKEDOWN PROCEDURE

1st Step - After making sure that the gun is unprimed and uncharged, lower the striker to the "fired" position by pulling the trigger while holding the striker han-

dle and slowly letting the striker go forward until it contacts the bare nipple.

2nd Step - Remove the ramrod from the thimble(s).

3rd Step - Remove the front stock assembly screw by turning it out counter-clockwise (as viewed from the bottom of the gun). Then remove the screw from the back of the trigger guard (the front trigger guard screw holds the trigger guard to the stock, it does not hold the barrel/receiver assembly to the stock).

4th Step - The barrel and receiver may now be lifted out of the stock.

5th Step - The large receiver end cap at the rear of the receiver can now be removed by turning it counter-clockwise. This cap is under spring tension so be sure to maintain a firm grip on it while turning it out. Remove the receiver end cap, the spring and the striker handle retainer.

Now, remove the striker handle by pulling it out of the striker body. Once the striker handle is removed, the striker body can be removed from the receiver by sliding it out the back. Next, remove the Trigger Assembly from the receiver. The trigger housing is held to the receiver by two pins, To remove the entire trigger assembly from the receiver, use a 1/16" punch to remove these pins.

Once the gun is disassembled, it is now possible to proceed with the process of pulling a charge.

Secure a pail of water (hot if possible) and submerge the breech section of the barrel into the water. Make certain that at least 8 inches of the breech section is under water and allow the barrel to remain submerged for at least one-half hour. The barrel should be transported only after water has totally saturated the powder charge and rendered it inert.

The charge should be pulled by using a Thompson/Center Ball & Bullet Puller as follows:

Carry the barrel to an area where you have access to a strong vise and where you can work without distraction. To ensure that the charge has not dried out and that it is completely inert, re-soak the breech section in very hot water. While the breech is soaking, pour some hot water into the muzzle end (flush with the muzzle). This will soften the powder fouling which has accumulated in the bore and ease removal of the projectile.

After one-half hour, remove the barrel from the water. Pour the water out of the muzzle and wipe excess water with a rag. Pad the jaws of your vise with two blocks of wood and securely clamp your barrel so that you have access to

the muzzle end. Use care to ensure that the barrel is not marred in the process of clamping it. Be equally certain that it is clamped securely.

Thread a T/C Ball & Bullet Puller of the proper caliber onto your ramrod and slip the ramrod into the bore until the screw on the puller contacts the projectile. Rotate the ramrod slowly clock wise as you tap lightly on the end of the ramrod with a hammer. As the puller screw bites deeper and deeper into the soft lead projectile, the ramrod will become difficult to turn and it will require the use of pliers. Pad the jaws of the pliers so that you do not mar the ramrod. Once the puller screw has embedded itself firmly into the projectile, pull out on the ramrod and extract the ball or bullet. In actuality, this process is somewhat tedious and it will require your patience. When working with a badly fouled bore, the puller screw may pull free from the projectile several times before you can successfully extract the projectile. If you are persistent, you will succeed!

After the projectile has been removed from the bore, clean the bore, barrel and parts as explained in the "Cleaning" section and reassemble the firearm.

If for any reason you are unable to remove the charge in the manner recommended, soak the barrel in very hot water for one-half hour. Once the powder has been rendered inert, take the barrel to a qualified gunsmith. Explain the condition and ask that he clear the barrel.

**Thompson/Center Arms Company, Inc.,
Farmington Road,
Rochester, New Hampshire 03867**

Cleaning Your Thompson/Center Fire Hawk™

→ **⚠ WARNING** ←

Never attempt to clean a charged or primed muzzleloading firearm. AN ACCIDENTAL DISCHARGE CAN CAUSE INJURY AND/OR DEATH TO THE SHOOTER OR BYSTANDERS AND DAMAGE TO PROPERTY.

Completely Disassemble your Fire Hawk by following the five-step procedure as detailed on page 9 and page 42. You are now ready to thoroughly clean your Fire Hawk™.

The recommended cleaning method is as follows:

1. Remove the nipple by using the special Fire Hawk nipple wrench (a T/C accessory item) as shown below. Thompson/Center makes a nipple wrench specifically for the Fire Hawk rifle. It is used as shown in the diagram below. The receiver end cap and the striker must be removed to gain access to the nipple (this is discussed earlier in this manual).

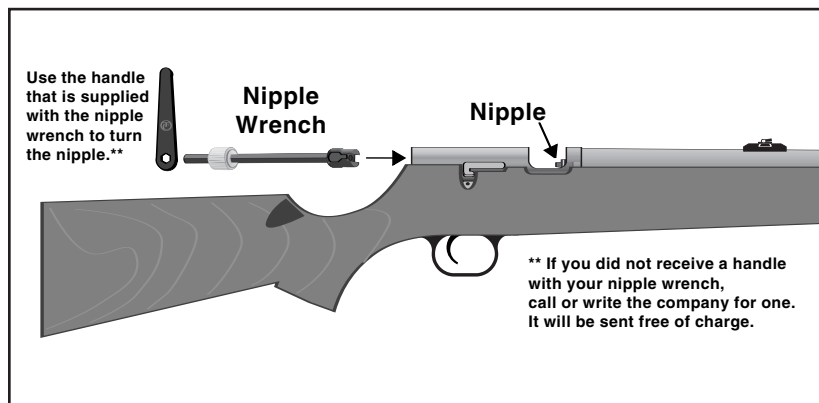

2. Fill a pan with very hot, soapy water. Submerge the breech of the barrel in the water and push a wet patch down the barrel on the end of your cleaning rod. Pump the rod and patch up and down in the barrel. This will draw water into the barrel and flush it out through the nipple hole. Clean the inside of the receiver, being careful to remove all powder residue which may have built up on the interior surfaces. When the barrel is clean, wipe off the excess water and set the barrel aside to dry (it is advisable to remove your scope before submerging the breech area of the barrel in any water to avoid damage to the scope).

3. Thoroughly wipe all the powder residue from the striker. You may want to submerge the striker in hot soapy water when scrubbing it. Dry the parts thoroughly. After cleaning your Fire Hawk rifle, it is recommended that you lightly lubricate the striker and trigger area of the rifle upon reassembly. Do Not use heavy grease or oil, as during cold weather, excessive lube may congeal and slow the striker fall (or keep it from striking the cap on the nipple altogether) when the trigger is pulled. This may cause the rifle's striker handle to appear to be in the "fire" position when in reality the striker has already moved forward, past the engagement sear. If this condition happens, the gun may go off when the lubricant is softened by heat from a vehicle or building.

→ **⚠ WARNING** ←

The striker and inside of the receiver must be thoroughly cleaned and lightly oiled to ensure reliable and safe operation. Corrosion and rust that result from improper cleaning, or lack of cleaning, could alter the proper functioning of the striker mechanism. This could lead to a condition whereby the gun will not operate correctly. AN ACCIDENTAL DISCHARGE MAY OCCUR RESULTING IN INJURY AND/OR DEATH TO THE SHOOTER OR BYSTANDERS AND DAMAGE TO PROPERTY.

4. Now that the barrel is completely dry, lightly lube the bore with a quality lubricant or, in keeping with the all-natural method, T/C's Natural Lube 1000 Plus Bore Butter. Reinstall the nipple being careful not to cross-thread or over-tighten it.

5. Fouling on the stock, receiver and exterior parts should be wiped off with an oily cloth or T/C's Wonder Cloth saturated with Natural Lube 1000 Plus Bore Butter.

6. Your Fire Hawk may now be reassembled in the reverse order of the takedown procedure detailed on page 41 and 42.

7. After your Fire Hawk has been reassembled, check the striker to ensure that there is no excess lubricant on the surface which could impede safe performance.

→ **⚠ WARNING** ←

Make certain that the striker is in the “Cocked” position, the safety is engaged (fully rearward) and aligned with the green dot on the stock and the firearm is unprimed before attempting to clear any lubricant or debris from the receiver of your Fire Hawk. FAILURE TO FOLLOW THIS WARNING MAY RESULT IN INJURY AND/OR DEATH TO THE SHOOTER OR BYSTANDERS AND DAMAGE TO PROPERTY.

Black Powder and Pyrodex are very corrosive and the residue or fouling left in the bore after firing your firearm can be very destructive to the steel, causing oxidation, rust and pitting. Leaving your firearm uncleaned with this fouling present can lead to a ruined firearm.

When using petroleum based lubricants, the build-up of this fouling is much more apparent and often it is necessary to clean the gun between shots. Cleaning between shots will be necessary whether using black powder or Pyrodex®. Failure to eliminate this residue will be destructive to the bore if left for any length of time.

When using an all natural, non-petroleum based lubricant such as T/C's Natural Lube 1000+ , the bore becomes seasoned with use, much like the surface of a cast iron skillet. Fouling is greatly reduced, and as a result it is not necessary to clean between shots, or even immediately after extended firing. The reduction of fouling present and the void of any petroleum combine to eliminate the corrosive effects on the steel. This does not mean that your obligation to clean the firearm after use is eliminated. The use of T/C's Natural Lube 1000+ merely eliminates the need to clean between shots as excessive fouling will not build up. You can also delay cleaning after you have shot for at least the duration of your hunting trip without fear of damaging your firearm. You should clean your firearm after use prior to storing it away, and in order that you do not lose the “seasoned” characteristics already imparted to your bore, you should clean it with a non-petroleum based cleaner such as T/C's all natural #13 Bore Cleaner. Once a petroleum based solvent is introduced, the “seasoning” process is neutralized, much like washing your cast iron skillet with detergent.

Often, when using petroleum based lubricants, consecutive shots with black powder will produce shot-to-shot increases in pressure with the build up of fouling. This will greatly affect accuracy. Eventually, (if not cleaned) the muzzleloading firearm will become impossible to load properly. Driven part way down the bore and blocked by powder fouling, the projectile will hang up and refuse to budge further.

However, no matter what you use for a lube, consistency is the key to accuracy; so much that target shooters will use the tightest combination of patch and ball they can load, and they will wipe the bore between each shot. A good all natural bore cleaner like T/C's No.13 Bore Cleaner will work extremely well in these situations, and because it contains no petroleum base, it is highly compatible for use with an all natural lube such as Natural Lube 1000 Plus Bore Butter.

Depending upon the specific load (heavier charges burn less consistently creating more fouling) and temperature, a series of shots with Black Powder can be fired before it becomes necessary to wipe the bore. How many? Under favorable conditions **five shots** can usually be fired without adverse affect on loading. Under less favorable conditions, loading may become difficult **sooner**. If you are using a natural lubricant such as Natural Lube 1000 Plus Bore Butter, with no petroleum base, you will be able to shoot many more shots without the need to wipe the bore. In fact, T/C's test gun had over 1000 rounds shot through it without the need to wipe the bore even once. Bear in mind though, that the pressure does build and accuracy falls off as fouling builds in the barrel. So, regardless of your lube, if you feel that it is getting more difficult to load as a result of excessive fouling, it will be necessary to wipe the bore. The best method is to pay close attention to loading (and group size). If the ball seems to drag or is somewhat difficult to seat then you must clean the bore before you load the next charge.

For complete cleaning when using either Pyrodex or Black Powder the best solvent is hot soapy water. It is necessary that the water be very hot so that it heats up the barrel metal. A hot barrel will dry rapidly without rusting.

GENERAL COMMENTS ON CLEANING

You will note that throughout this manual, references are made about using lubricants (patch lubricant, bullet lubricants and bore cleaners) which are both petroleum based such as T/C Maxi Lube, and non petroleum based like our Natural Lube 1000 Plus Bore Butter.

While we have no intention of changing your successful practices of lubing or cleaning, we do want to point out that our experience in using non-petroleum based lubes has shown us that it does improve performance and ease of loading, while also eliminating the need to clean between shots. Natural products were used in the early 1800's with a great deal of success, and it wasn't until petroleum based lubes were used that the corrosive nature of black powder fouling seemed to present a problem in both maintenance and in reloading. Fouling is fouling, and regardless of the system used to lube and clean your muzzleloader (petroleum based oils versus all natural non petroleum based products) exces-

sive fouling will be evident to the shooter as he experiences more difficulty in loading from shot to shot.

The advantages to using all natural non-petroleum based lubes and cleaning products are many; the elimination of having to wipe your bore between shots or of having to immediately clean your gun after use; and the increase in accuracy due to more consistent velocities and more uniform pressures.

However, the responsibility to clean your muzzleloader thoroughly before putting it away still exists. It's a tradition that has always existed and for good reason. A well maintained firearm is a safer firearm, and it's up to the owner/user to keep it that way.

Using Cleaning Implements With Your Thompson/Center Fire Hawk™

Thompson/Center muzzleloading rifles and pistols are supplied with a cleaning jag which is the proper size for the particular caliber. For cleaning use commercial cleaning patches (round or square) or pieces of discarded clothing.

When using the cleaning jag, keep in mind that patch size and thickness are important. Start with a patch that is approximately 2 1/2" square (or in diameter). Position it over the jag as pictured in the illustration and try it in the bore of the firearm (wet patches will enter more easily than dry ones). If it seems to be too tight - don't force it. If your trial patch proves to be too tight, use a smaller size patch and/or thinner material.

A patch which is too small or thin will pull free from the jag teeth during the cleaning process. Such "lost patches" can be quickly retrieved by use of the worm (see illustration). Cleaning will go easier, however, if you establish and maintain an optimum patch/jag/bore fit.

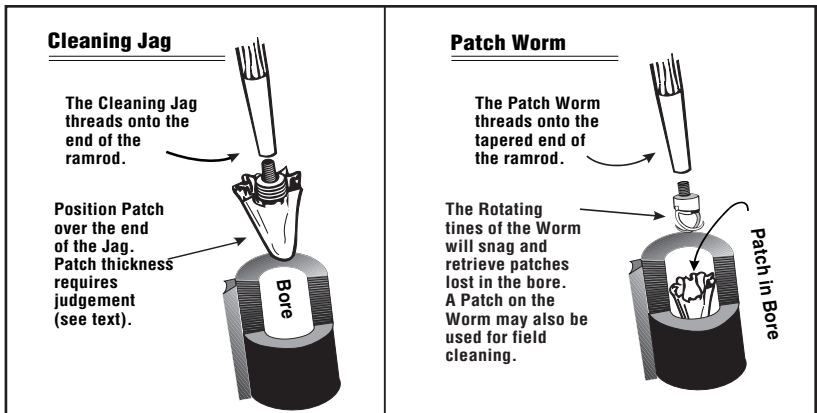

Thompson/Center does not package the worm with each firearm. This is an optional tool and must be purchased separately (one size fits all calibers - see current catalog). The worm is an extremely important muzzleloading tool and every shooter should carry one in his implement bag. While its prime purpose is to retrieve "lost patches", it can also be used for field cleaning. To do so you simply catch the cleaning patch on the tines of the worm and push it into the bore in the conventional manner.

Iron Sight Adjustment For The Fire Hawk™

The Fire Hawk™ is equipped with the a standard rifle rear sight as shown below which is adjustable for elevation by sliding the elevation blade up to raise the point of impact and down to lower the shot's impact. It is necessary to loosen the elevation lock screw (by turning it counterclockwise, as viewed from the rear) before sliding the sight blade to the desired setting. To adjust the windage it is necessary to move the entire rear sight leaf left or right by using the slotted screw head on the right side of the rear sight (as viewed from the receiver end of the sight). Move the rear sight blade in the direction you want your shots to hit-- (Example; Turn the screw clockwise - thereby moving the sight blade to the right, to move your shots to the right and counter-clockwise to move the shots to the left).

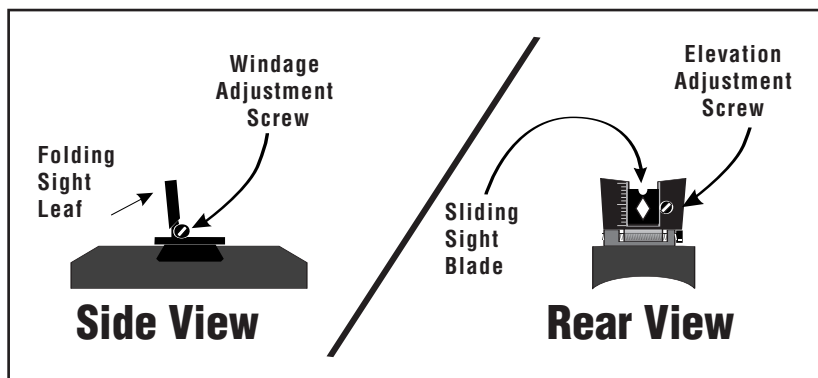

Mounting A Scope On The Thompson/Center Fire Hawk™

→ **WARNING** ←

Do not drill additional holes in the barrel as this could weaken its structure and contribute to a rupture CAUSING INJURY AND/OR DEATH TO THE SHOOTER OR BYSTANDERS AND DAMAGE TO PROPERTY.

See the current T/C Catalog for scope mounting systems which can be used on your Fire Hawk. The receiver is factory drilled and tapped for these accessories.

Service Department

Service Department, Telephone #603-332-2333.

Should your firearm require adjustment, repair or refinishing, we strongly recommend that the firearm be returned to the factory. There is no other way to ensure that the work will be done by a competent staff of trained technicians.

Firearms returned to the factory should be marked to the attention of the service department. A letter of instructions should be enclosed to facilitate handling. Firearms should be uncharged, disassembled and shipped via United Parcel Service (U.P.S.).

Our Service Department will give your firearm a complete inspection and evaluate the problem. If the work required is not covered by our "Lifetime Warranty" you will receive a quotation which must be authorized by you. No actual work will be done without your approval.

Statement Of Liability From Thompson/Center

This gun is classified as a **FIREARM OR DANGEROUS WEAPON** and is surrendered by us with the express understanding that we assume no liability for its resale or unsafe handling under local laws and regulations. Thompson/Center Arms assumes no responsibility for physical injury or property damage resulting from either intentional or accidental discharge, or for the function of any gun subject to influences beyond our control, and will honor no claim which may result from careless or improper handling, unauthorized adjustments, improper loading, use of improper powder or components, corrosion or neglect.

For your protection, examine your firearm carefully at the time of purchase. Fill out and mail the registration card promptly. Be certain that it bears the firearm's serial number which you will find on the receiver.

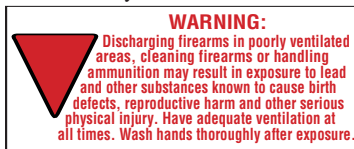

→ **⚠ WARNING** ←

Thompson/Center does not approve or recommend any type of custom conversion or alteration other than those performed by the T/C Custom Shop. Muzzleloading firearms subjected to alteration are not covered by our factory warranty. Responsibility for alterations rests totally with the gunsmith or individual performing the work. The consumer is warned that if such work is done improperly or without proper judgement, the firearm can malfunction or rupture **CAUSING INJURY AND/OR DEATH TO THE SHOOTER OR BYSTANDERS AND DAMAGE TO PROPERTY.**

Thompson/Center Arms Company, Inc. - Limited Warranty -

THOMPSON/CENTER ARMS provides a warranty for all factory finished firearms for the **LIFETIME OF THE ORIGINAL CONSUMER PURCHASER**. Any firearm or part thereof returned, postage paid, to the factory at Farmington Road, Rochester, New Hampshire 03867, will be repaired or replaced to our commercial standard free of charge, and returned to the consumer purchaser postage prepaid. This warranty is established by return of our authorized warranty card which should be done within (30) days of purchase. **This warranty does not cover any damage caused by custom alteration of the firearm other than those performed by the T/C Custom Shop!** Thompson/Center Arms reserves the right to refuse to repair or replace firearms, or parts thereof, damaged by abuse or misuse.

This warranty does not cover "Kit models. While Thompson/Center does guarantee the quality and workmanship of the parts contained in each kit (and will replace any part which is proven, by our inspection, to be faulty in either workmanship or material) we have no control over the final finishing and assembly of these products. Therefore, no responsibility for either the construction or use of kit models is implied or assumed. This warranty gives you specific legal rights, and you may also have other rights which vary from State to State. Address all correspondence and inquiries to:

**THOMPSON/CENTER ARMS
P.O. Box 5002,
Rochester, New Hampshire 03866**

Parts Lists available upon request. Specify model, caliber and serial number.

Bullet Data For The Various Thompson/Center Muzzleloading Rifles

Round Balls For T/C Firearms

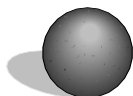

.315" DIAMETER (47 grs.) Use with patch material No.7036, No.7042, No.7131, or No.7135 in .32 caliber models.

.350" DIAMETER (65 grs.) Use with patch material No.7036, No.7042, No.7131, or No.7135 in .36 caliber models.

.440" DIAMETER (127 grs.) Use with patch material No.7030, No.7043, No.7132, or No.7136 in .45 caliber models.

.490" DIAMETER (175 grs.) Use with patch material No. 7030, No. 7043, No.7132, or No.7136 in .50 caliber models.

.530" DIAMETER (230 grs.) Use with patch material No. 7034, No. 7044, No.7133, or No.7137 in .54 caliber models.

.550" DIAMETER (265 grs.) Use with patch material No.7034, No.7044, No.7133, or No.7137 in .56 caliber models.

.570" DIAMETER (279 grs.) Use with patch material No.7035, No.7041, No.7134, or No.7138 in .58 caliber models.

Maxi-Balls® For T/C Firearms

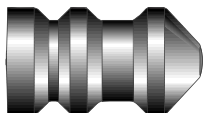

.45 Caliber (240 grs.) For small to medium (deer-sized) game. Now factory lubricated with T/C Natural Lube 1000 Plus Bore Butter.

.50 Caliber (320 grs.) A medium game (deer-sized) bullet for .50 caliber rifles. Factory lubricated with T/C Natural Lube 1000 Plus Bore Butter.

.50 Caliber (370 grs.) A medium and big game bullet for .50 caliber rifles. Factory lubricated with T/C Natural Lube 1000 Plus Bore Butter.

.50 Caliber (460 grs.) A big game bullet for .50 caliber rifles. Now factory lubricated with T/C Natural Lube 1000 Plus Bore Butter.

.54 Caliber (365 grs.) A medium (deer-sized) and big game .54 caliber bullet. Factory lubricated with T/C Natural Lube 1000 Plus Bore Butter.

.54 Caliber (430 grs.) For medium (deer-sized) and large game, this .54 cal. Factory lubricated with T/C Natural Lube 1000 Plus Bore Butter.

.54 Caliber (530 grs.) For large game. Factory lubricated with T/C Natural Lube 1000 Plus Bore Butter.

.58 Caliber (555 grs.) For the large game encountered in North America and the world. Factory lubed with Natural Lube 1000 Plus Bore Butter.

**Maxi-Hunters®
For T/C Firearms**

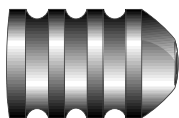

**For Maximum expansion
on deer-sized game!**

.45 Caliber (255 grs.) A bullet designed specifically for medium (deer-sized) game. Factory lubed with Natural Lube 1000 Plus Bore Butter.

.50 Caliber (275 grs.) A bullet designed for .50 caliber T/C rifles and deer sized game. Lubed with Natural Lube 1000 Plus Bore Butter.

.50 Caliber (350 grs.) A bullet designed for .50 caliber rifles and deer sized game. Factory lubed with Natural Lube 1000 Plus Bore Butter.

.50 Caliber (470 grs.) A bullet designed for .50 caliber T/C rifles and medium (deer-sized) to large game. Factory lubed with T/C Natural Lube 1000 Plus Bore Butter.

.54 Caliber (360 grs.) Designed for maximum expansion on deer sized

game. Factory lubricated with T/C Natural Lube 1000 Plus Bore Butter.

.54 Caliber (435 grs.) Designed for maximum expansion on deer sized game. Factory lubricated with T/C Natural Lube 1000 Plus Bore Butter.

.54 Caliber (540 grs.) Designed for medium (deer-sized) to large game. Now factory lubricated with T/C Natural Lube 1000 Plus Bore Butter.

.58 Caliber (560 grs.) Maximum expansion in a heavy big game bullet. Now factory lubricated with T/C Natural Lube 1000 Plus Bore Butter.

**Thompson/Center's
Break-o-Way™ Sabots**

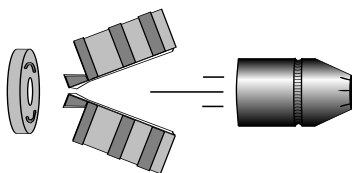

.50 Caliber (For .429" to .430" Bullets) Designed for using jacketed pistol bullets in a muzzleloader. With a Woven Wool "doughnut" that is factory lubricated with Natural Lube 1000 Plus Bore Butter.

.54 Caliber (For .429" to .430" Bullets) Designed for using jacketed pistol bullets in a muzzleloader. With a Woven Wool "doughnut" that is factory lubricated with Natural Lube 1000 Plus Bore Butter.

Suggested Black Powder Loads For The Thompson/Center Fire Hawk™

The following charts show recommended charges for Thompson/Center In-Line muzzleloading rifles. Charges are listed by caliber and type of projectile. *Note that in each instance a series of charges are listed. More than one charge is shown in each category to clearly illustrate the safe loading range for that particular caliber, model and projectile.*

→ **⚠ WARNING** ←

Maximum loads are not to be exceeded nor is a substitution of powder or granulations to be attempted! Only use loads that are listed for your particular caliber, model and bullet style. FAILURE TO FOLLOW THESE INSTRUCTIONS MAY RESULT IN INJURY AND/OR DEATH TO THE SHOOTER OR BYSTANDERS AND DAMAGE TO PROPERTY.

The shooter is instructed to start with the lightest charge listed. As you become familiar with the firearm, increase your charges gradually until you reach your best performing load (most accurate). In all instances the most accurate load will be found approximately half-way through our loading chart. The large asterisk indicates that charge which, in our testing, proved to be the most accurate. Your optimum charge will be at or near this point. **NEVER EXCEED THE MAXIMUM CHARGE LISTED.** Thompson/Center Arms is not responsible for loading information printed in sources other than this booklet.

NOTE: All loading data contained in this book is the result of testing by Thompson/Center Arms. Testing was done under carefully controlled conditions with the components specified in the text. 26 inch barrels were used to produce the data (unless otherwise specified).

Since Thompson/Center has no control over the components or equipment which may be used with this information, no responsibility is implied or assumed for the results obtained.

Suggested Black Powder Loads For The Thompson/Center Fire Hawk™

For Use With .50 Caliber T/C Fire Hawk Patches Lubricated with Bore Butter Use Musket Cap, #11 Cap or 209 Primer		.50 Caliber Rifle Using Round Ball Loads	
.490" Diameter Lead Ball Weight (Grains)	Black Powder Charge (Grains)	Muzzle Velocity (Feet Per Second)	Muzzle Energy (Foot Pounds)
175 Grain Lead Ball	50 grs. FFG	1357 F.P.S.	716 Ft. Lbs.
	60 grs. FFG	1434 F.P.S.	799 Ft. Lbs.
	70 grs. FFG	1643 F.P.S.	1050 Ft. Lbs.
	80 grs. FFG	1838 F.P.S.	1313 Ft. Lbs.
	90 grs. FFG	1950 F.P.S.	1478 Ft. Lbs.
	100 grs. FFG	2052 F.P.S.	1637 Ft. Lbs.
	110 grs. FFG	2135 F.P.S.	1772 Ft. Lbs.
Load Shown in Red is Maximum			

For Use With .54 Caliber T/C Fire Hawk Patches Lubricated with Bore Butter Use Musket Cap, #11 Cap or 209 Primer		.54 Caliber Rifle Using Round Ball Loads	
.530" Diameter Lead Ball Weight (Grains)	Black Powder Charge (Grains)	Muzzle Velocity (Feet Per Second)	Muzzle Energy (Foot Pounds)
230 Grain Lead Ball	60 grs. FFG	1263 F.P.S.	815 Ft. Lbs.
	70 grs. FFG	1469 F.P.S.	1102 Ft. Lbs.
	80 grs. FFG	1654 F.P.S.	1397 Ft. Lbs.
	90 grs. FFG	1761 F.P.S.	1584 Ft. Lbs.
	100 grs. FFG	1855 F.P.S.	1758 Ft. Lbs.
	110 grs. FFG	1931 F.P.S.	1905 Ft. Lbs.
	120 grs. FFG	1983 F.P.S.	2009 Ft. Lbs.
Load Shown in Red is Maximum			

For Use With .50 Caliber T/C Fire Hawk Bullets Lubricated with Bore Butter Use Musket Cap, #11 Cap or 209 Primer		.50 Caliber Rifle Using T/C .50 Caliber Maxi-Ball & Maxi-Hunter Loads	
For Use With .50 Cal. Lead Bullets	Black Powder Charge (Grains)	Muzzle Velocity (Feet Per Second)	Muzzle Energy (Foot Pounds)
275 Grain Maxi Hunter® and 320 Grain Maxi-Ball® Lead Bullet	80 grs. FFG	1395 F.P.S.	1383 Ft. Lbs.
	90 grs. FFG	1455 F.P.S.	1504 Ft. Lbs.
	100 grs. FFG	1509 F.P.S.	1618 Ft. Lbs.
	110 grs. FFG	1570 F.P.S.	1751 Ft. Lbs.
	120 grs. FFG	1618 F.P.S.	1860 Ft. Lbs.
	130 grs. FFG	1663 F.P.S.	1965 Ft. Lbs.
	140 grs. FFG	1686 F.P.S.	2020 Ft. Lbs.
	150 grs. FFG	1723 F.P.S.	2109 Ft. Lbs.
350 Grain Maxi Hunter® and 370 Grain Maxi-Ball® Lead Bullet	80 grs. FFG	1327 F.P.S.	1447 Ft. Lbs.
	90 grs. FFG	1418 F.P.S.	1652 Ft. Lbs.
	100 grs. FFG	1465 F.P.S.	1764 Ft. Lbs.
	110 grs. FFG	1525 F.P.S.	1911 Ft. Lbs.
	120 grs. FFG	1533 F.P.S.	1931 Ft. Lbs.
	130 grs. FFG	1580 F.P.S.	2051 Ft. Lbs.
	140 grs. FFG	1609 F.P.S.	2127 Ft. Lbs.
	150 grs. FFG	1645 F.P.S.	2273 Ft. Lbs.
Load Shown in Red is Maximum			

For Use With .50 Caliber T/C Fire Hawk Bullets Lubricated with Bore Butter Use Musket Cap, #11 Cap or 209 Primer		.50 Caliber Rifle Using T/C .50 Caliber Maxi-Ball & Maxi-Hunter Loads	
50 Grain Pyrodex® Pellet Loading Data			
For Use With .50 Cal. Lead Bullets	Powder Charge (50 Gr. Pellet)	Muzzle Velocity (Feet Per Second)	Muzzle Energy (Foot Pounds)
275 Gr. Maxi Hunter® & 320 Gr. Maxi-Ball®	2 Pellets	1694 F.P.S.	2039 Ft. Lbs.
	3 Pellets	1995 F.P.S.	2828 Ft. Lbs.
350 Gr. Maxi Hunter® & 370 Gr. Maxi-Ball®	2 Pellets	1634 F.P.S.	2194 Ft. Lbs.
	3 Pellets	1866 F.P.S.	2861 Ft. Lbs.
470 Gr. Maxi Hunter® & 460 Gr. Maxi-Ball®	2 Pellets	1485 F.P.S.	2253 Ft. Lbs.
	3 Pellets	1752 F.P.S.	3163 Ft. Lbs.
Load Shown in Red is Maximum			

For Use With .54 Caliber T/C Fire Hawk Bullets Lubricated with Bore Butter Use Musket Cap, #11 Cap or 209 Primer		.54 Caliber Rifle Using T/C .50 Caliber Maxi-Ball & Maxi-Hunter Loads	
For Use With .50 Cal. Lead Bullets	Black Powder Charge (Grains)	Muzzle Velocity (Feet Per Second)	Muzzle Energy (Foot Pounds)
360 Gr. Maxi Hunter® and 365 Gr. Maxi-Ball® Lead Bullet	80 grs. FFG	1308 F.P.S.	1368 Ft. Lbs.
	90 grs. FFG	1375 F.P.S.	1511 Ft. Lbs.
	100 grs. FFG	1461 F.P.S.	1706 Ft. Lbs.
	110 grs. FFG	1506 F.P.S.	1813 Ft. Lbs.
	120 grs. FFG	1563 F.P.S.	1953 Ft. Lbs.
430 Gr. Maxi Hunter® and 435 Gr. Maxi-Ball® Lead Bullet	80 grs. FFG	1188 F.P.S.	1363 Ft. Lbs.
	90 grs. FFG	1270 F.P.S.	1558 Ft. Lbs.
	100 grs. FFG	1319 F.P.S.	1680 Ft. Lbs.
	110 grs. FFG	1377 F.P.S.	1813 Ft. Lbs.
	120 grs. FFG	1425 F.P.S.	1962 Ft. Lbs.
530 Gr. Maxi Hunter® and 540 Gr. Maxi-Ball® Lead Bullet	80 grs. FFG	1158 F.P.S.	1578 Ft. Lbs.
	90 grs. FFG	1229 F.P.S.	1778 Ft. Lbs.
	100 grs. FFG	1281 F.P.S.	1931 Ft. Lbs.
	110 grs. FFG	1344 F.P.S.	2126 Ft. Lbs.
	120 grs. FFG	1384 F.P.S.	2255 Ft. Lbs.
Load Shown in Red is Maximum			

Assembly And Loading Of T/C Break-O-Way™ Sabots

→ **⚠ WARNING** ←

When loading T/C's Break-O-Way Sabots, make sure that your gun is unprimed, and that your Break-O-Way Sabot has been properly assembled. Failure to assemble and load your sabot correctly could result in the bullet, sabot halves, or woven wool doughnut separating and disengaging from themselves. This could result in an air space between the components. Under such a condition, one or more of the components may act as a barrel obstruction and firing can result in a damaged firearm and **POSSIBLE INJURY OR DEATH TO THE SHOOTER OR BYSTANDERS AND DAMAGE TO PROPERTY.**

To properly assemble your T/C Break-O-Way Sabot, position 2 sabot halves together forming a complete sabot cup. Press the woven wool "doughnut" firmly on the base, allowing the flange to protrude through the hole. Your sabot is now ready to accept a .429" - .430" diameter .44 cal bullet. Use only bullets of these dimensions.

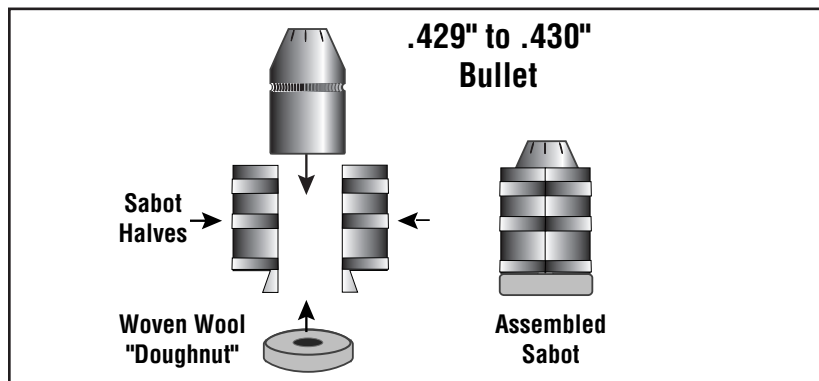

→ **⚠ WARNING** ←

Use only bullets measuring .429" - .430" designed for use in .44 caliber pistols or rifles. Using bullets of lesser diameter may cause the bullet to separate from the sabot resulting in a barrel obstruction. Using bullets of larger diameter could result in difficult loading, or a condition where the sabot is not seated all the way down in the powder charge, resulting in a barrel obstruction. Either case can result in a damaged firearm and **POSSIBLE INJURY AND/OR DEATH TO THE SHOOTER OR BYSTANDERS AND DAMAGE TO PROPERTY.**

The photo on page 31 pictures a shooter in the process of loading a muz-

zleloading rifle. Study this photo carefully and read all the captions before you proceed to charge your rifle.

The complete sabot unit should be seated firmly on the powder charge as indicated in the illustration below.

→ **⚠ WARNING** ←

Do not exceed the recommended loading data in this manual when using T/C Break-O-Way Sabots in Thompson/Center rifles. When using rifles not manufactured by Thompson/Center, do not exceed the recommended loads provided by the manufacturer of your rifle.

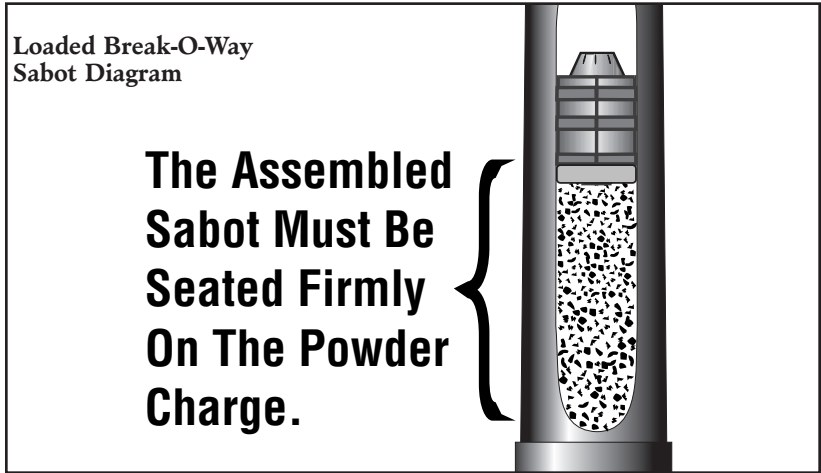

Suggested Black Powder Loads For Break-O-Way™ Sabots in the Fire Hawk™ Rifle

For Use Only With .50 Caliber T/C In-Line Muzzleloading Rifle Using .429" - .430" Bullets Use Musket Cap, No.11 Cap or 209 Primer		.50 Caliber Rifle Using T/C .44 Caliber Break-O-Way™ Sabot Loads	
For Use With .429" - .430" Bullets	Black Powder Charge (Grains)	Muzzle Velocity (Feet Per Second)	Muzzle Energy (Foot Pounds)
200 Grain Bullet	80 grs. FFG	1634 F.P.S.	1186 Ft. Lbs.
	90 grs. FFG	1673 F.P.S.	1243 Ft. Lbs.
	100 grs. FFG	1730 F.P.S.	1329 Ft. Lbs.
240 Grain Bullet	80 grs. FFG	1466 F.P.S.	1146 Ft. Lbs.
	90 grs. FFG	1606 F.P.S.	1375 Ft. Lbs.
	100 grs. FFG	1640 F.P.S.	1434 Ft. Lbs.
275 Grain Bullet	80 grs. FFG	1435 F.P.S.	1257 Ft. Lbs.
	90 grs. FFG	1489 F.P.S.	1354 Ft. Lbs.
	100 grs. FFG	1574 F.P.S.	1513 Ft. Lbs.
300 Grain Bullet	80 grs. FFG	1417 F.P.S.	1337 Ft. Lbs.
	90 grs. FFG	1466 F.P.S.	1432 Ft. Lbs.
	100 grs. FFG	1519 F.P.S.	1537 Ft. Lbs.
Load Shown in Red is Maximum			

For Use Only With .50 Caliber T/C In-Line Muzzleloading Rifle Using .429" - .430" Bullets Use Musket Cap, No.11 Cap or 209 Primer		.50 Caliber Rifle Using T/C .44 Caliber Break-O-Way™ Sabot Loads	
For Use With .429" - .430" Bullets	Powder Charge (50 Gr. Pellet)	Muzzle Velocity (Feet Per Second)	Muzzle Energy (Foot Pounds)
200 Gr. Bullet	2 Pellets	1816 F.P.S.	1465 Ft. Lbs.
240 Gr. Bullet	2 Pellets	1665 F.P.S.	1478 Ft. Lbs.
275 Gr. Bullet	2 Pellets	1611 F.P.S.	1585 Ft. Lbs.
300 Gr. Bullet	2 Pellets	1422 F.P.S.	1347 Ft. Lbs.
Load Shown in Red is Maximum			

Suggested Black Powder Loads For Break-O-Way™ Sabots in the Fire Hawk™ Rifle

For Use Only With .54 Caliber
T/C In-Line Muzzleloading Rifle
Using .429" - .430" Bullets
Use Musket Cap, No.11 Cap or 209 Primer

.54 Caliber Rifle
Using T/C .44 Caliber
Break-O-Way™ Sabot Loads

For Use With .429" - .430" Bullets	Black Powder Charge (Grains)	Muzzle Velocity (Feet Per Second)	Muzzle Energy (Foot Pounds)
200 Grain Bullet	80 grs. FFG	1652 F.P.S.	1212 Ft. Lbs.
	90 grs. FFG	1709 F.P.S.	1297 Ft. Lbs.
	100 grs. FFG	1795 F.P.S.	1431 Ft. Lbs.
240 Grain Bullet	80 grs. FFG	1620 F.P.S.	1399 Ft. Lbs.
	90 grs. FFG	1662 F.P.S.	1472 Ft. Lbs.
	100 grs. FFG	1728 F.P.S.	1592 Ft. Lbs.
Load Shown in Red is Maximum			

T/C Shipping Address:

**Thompson/Center Arms Company, Inc.
Farmington Road
Rochester, New Hampshire 03867**

T/C Mailing Address:

**Thompson/Center Arms Company, Inc.
P.O. Box 5002
Rochester, New Hampshire 03866**

WARNING:



Discharging firearms in poorly ventilated areas, cleaning firearms or handling ammunition may result in exposure to lead and other substances known to cause birth defects, reproductive harm and other serious physical injury. Have adequate ventilation at all times. Wash hands thoroughly after exposure.

For Your Records

Important Note: For fire, theft and insurance purposes, retain this record with your important papers in a safe place.

My Thompson/Center: _____

Was Purchased From: _____

On (date): _____ 20_____

Serial Number: _____ Caliber: _____

Accessories: _____

Owner Registration Card Mailed on: _____

Notes: _____

This area is provided for your convenience. We suggest that you make a list of important information that pertains to your specific firearm (best performing load, etc.). Keep this booklet with your firearm and review your notes before each hunting season or whenever the firearm has not been used for extended periods of time.



Thompson/Center Arms Co., Inc.
P.O. Box 5002
Rochester New Hampshire 03866



Black Powder and Pyrodex Are
The Only Suitable Propellants
For T/C Muzzleloading Firearms

12/94



Manual Part Number 00016870