

SELECT FIRE AK-47

TABLE OF CONTENTS

HISTORICAL BACKGROUND.....	1
INTRODUCTION	3
SIMILAR AK WEAPONS	4
BEFORE YOU BEGIN	5
FULL AUTO CONVERSION METHOD #1	6
FULL AUTO PARTS KIT	9
DRILLING THE RECEIVER	10
MODIFYING THE BOLT RAIL GUIDE	12 - 13
REWORKING THE SAFETY LEVER STOP	14
CREATING A SELECTOR LEVER DETENT	16
FULL AUTO VS. SEMI AUTO BOLT CARRIERS	18
MODIFYING THE SEMI AUTO BOLT CARRIER	19
FULL AUTO CONVERSION METHOD #2	20
CUTTING AND RELOCATION THE AUTO SEAR.....	22
WELDING THE AUTO SEAR	24
REASSEMBLY.....	27
TIMING THE BOLT WITH THE AUTO SEAR	28

SELECT FIRE AK-47

CAUTION!

The legal construction and possession of a fully automatic weapon is controlled by the Bureau of Alcohol, Tobacco, and Firearms division of the U.S. Treasury Department.

All conversions must be done by a licensed Class II manufacturer. In addition, an authorized application must be secured from the B.A.T.F. governmental agency before any construction begins. (State and local laws may prohibit ownership of this type weapon).

Information provided in this book is for academic purposes only. The publisher, Butickukal, assumes no responsibility or liability for illegal or improper firearm modifications, which may result in any gun damage or bodily harm.

AK-47 HISTORICAL BACKGROUND

The current AK-47 and similar designed weapons have evolved from the MP 43, a select fire carbine chambered for the 7.92mm cartridge.

During World War II, Russian Troops captured the German army facility where the MP 43 assault rifles were manufactured. Also seized were several prototype weapon designs, as well as the personnel working at the facility. The newly acquired information, products, and captives were sent to Russia.

The first Soviet weapon manufactured in 1946, was the semi automatic SKS, which has a 7.62mm X 39mm cartridge. The SKS was soon replaced by the Automat Kalashnikov or AK-47, named after the weapons designer, Sgt. Mikhail T. Kalashnikov.

The AK-47 rifle was used by the Soviet Army between 1949 and 1951. In 1959, Kalashnikov redesigned the AK-47 and the weapon was then known as the AKM. The main differences between the two weapons are the AKM has a stamped, rather than a milled receiver, a ribbed receiver cover, fluted gas cylinder tube and a rear sight graduating to 1,000 meters.

SELECT FIRE AK-47

Currently the Soviets have again modified the basic AK design into the AK-74. It is chambered with a new 5.45 X 39mm round with very high velocity. The AK-74 action is scaled down somewhat to accommodate the new round and is the first AK to have a muzzle brake.

Another version of the AK is the Swedish Valmet and is available in both 7.62mm X 39mm and 5.56mm X 45mm Nato calibers.

The Israeli made Gilli is still another Kalashnikov copy, available in 7.62 Nato, as well as .223.

A semi auto only AKM is produced in Egypt and is pure Kalashnikov design, right down to the Russian machinery, which Egypt acquired in its Pro-Soviet days.

Other countries offering weapons with the AK design are East Germany, Poland, Bulgaria, South Africa, and North Korea.

The basic design of the AK-47 has not been changed in over 40 years, only improved. The weapon proves to be durable, extremely reliable and will probably be used in combat well into the 21st century.

SELECT FIRE AK-47

INTRODUCTION

This manual contains necessary blueprints and manufacturing information to make a semi automatic AK-47 or similar AK design into a select fire, fully automatic weapon. (Select fire means the weapon has a lever that allows the operator to fire the weapon in either one shot bursts, or may select to fire the weapon in the fully automatic mode).

SELECT FIRE AK-47

DEFINING THE TERM "SIMILAR WEAPON"

There are many different manufacturers from different countries that use the AK-47 design. Conversions #1 and #2 should work on the following rifles:

Valmet Any Calibre
Gill All Calibres Except 308 Winchester (7.62 X 51mm)
Yugoslave Any Calibre
Hungarian With (7.62 X 39mm)
Maadi With (7.62 X 39mm)

Please Note: Due to the large amount of "similar weapons" all are not listed.

The above information has been provided just as a guide, before you attempt to modify any "similar" AK weapon, be very sure that the internal parts are the same as the original design.

SELECT FIRE AK-47

BEFORE YOU BEGIN

STEP #1 Get the proper license and approval from the U.S. Government B.A.T.F.

STEP #2 Purchase an AK-47 full auto kit.

STEP #3 Read through the book several times so you are familiar with each step of the conversion.

STEP #4 Acquire the tools and equipment needed.

STEP #5 Note: This step is very important! If you are not completely familiar with the design and function of the trigger disconnect assembly, you should study it very carefully. Make diagrams, take still pictures or even video tape the location of all of the various parts. Whatever it takes, you must be able to reassemble the complete trigger mechanism.

SELECT FIRE AK-47

SELECT FIRE AK-47

FULL AUTO CONVERSION METHOD #1

This conversion may be used with the machined receiver (receiver is machined from one solid piece of metal) or may be used with the stamped receiver (receiver is made from stamped sheet metal).

1. Remove the bolt carrier group and the gas piston from the receiver.

2. Remove the gas piston from the gas piston tube. The gas piston tube is attached to the receiver by the gas piston tube nut. The gas piston tube nut is attached to the receiver by the gas piston tube nut screw. The gas piston tube nut screw is attached to the receiver by the gas piston tube nut screw.

SELECT FIRE AK-47

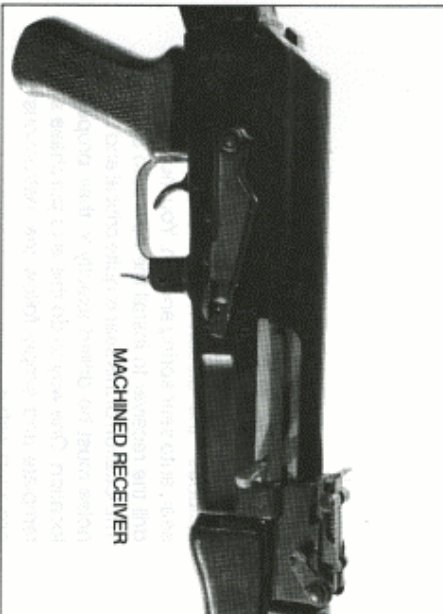

SELECT FIRE AK-47

The most common method of conversion is to purchase the required select fire parts kit. This includes the disconnect, hammer, auto sear, auto sear spring and pin. You must also drill the receiver to install the new auto sear. The location of this sear is quite critical and the holes must be drilled exactly in their proper location. One way to do this is to purchase a template and simply follow the instructions provided with it.

SELECT FIRE AK-47

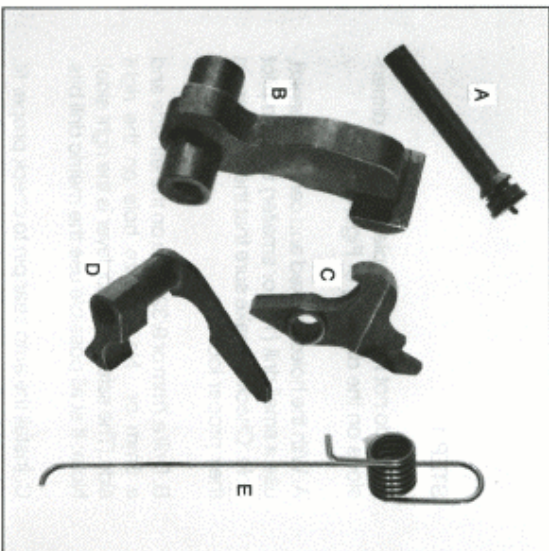

- FULL AUTO PARTS KIT**
- A. Pin
 - B. Hammer
 - C. Disconnect
 - D. Auto Sear
 - E. Spring

SELECT FIRE AK-47

STEP 1

If you do not have a template, use the dimensions on the drawing of Figure 1.

A. With the holes marked and center punched, use a small drill (1/8" or smaller) to drill a pilot hole. Check to make sure that the holes are in their proper location.

B. Drill a 7mm or 9/32" hole on the left side and a 5mm or No. 11 size hole on the right side. (The safety/selector lever is the right side). Note: If at all possible use the metric drill bits.

C. Install the auto sear pin to check proper fit. You may have to trim the length of this; it should fit flush or just slightly beyond the receiver on the right side.

SELECT FIRE AK-47

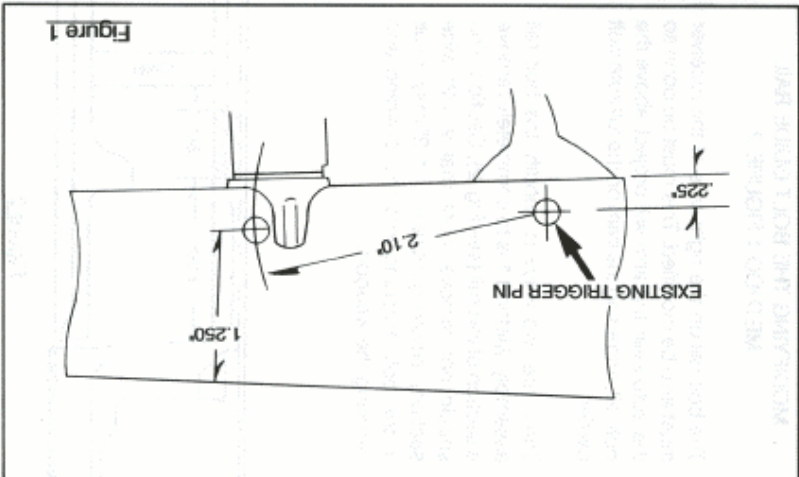

Figure 1

SELECT FIRE AK-47

STEP 2

MODIFYING THE BOLT GUIDE RAIL METHOD 1 FIGURE 2

The bolt rail on the right side of the receiver must also be modified. This must be done so the auto sear trip arm will project above the bolt rail, engaging the cam on the full auto bolt carrier.

There are two ways to modify the bolt rail assembly. Method 1 is to completely remove a section of this rail (see Fig. 2). Caution: You should not remove more than a 1/2" wide section, removing more than 1/2" may result in the bolt dropping into this opening and jamming the weapon.

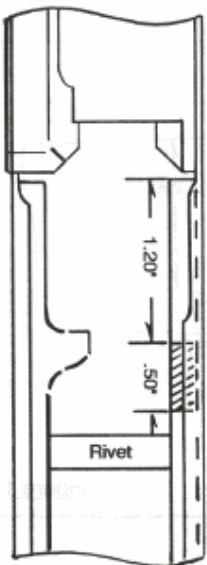

Figure 2

SELECT FIRE AK-47

MODIFYING THE BOLT GUIDE RAIL METHOD 2 FIGURE 2A

The second way to accomplish this is to create a slot that the trip lever arm of the auto sear will pass through. This slot method is the best way, but takes a little more work. It also works better on the second conversion method included in this book, as the length of the slot can be made longer to accommodate the altered angle of the auto sear. The length of the slot can be increased to end just above the rivet location, which, is reworked to accept the auto sear.

1. To create this slot you must drill a series of holes with a 1/16" drill. Caution: This must be done slow and easy so you do not break the drill bit or distort the holes.

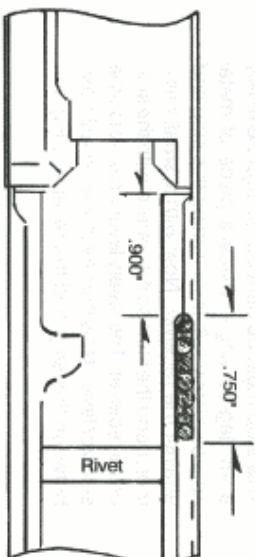

Figure 2-A

SELECT FIRE AK-47

2. With a file or dremel tool, remove the metal between the holes (see Fig. 2A). You may find it easier to drill up from the magazine well when drilling these holes.
3. You must also remove the side portion of the rail directly below the series of holes, allowing the auto sear to rest against the inside of the receiver.

STEP 3

**REWORKING THE SAFETY
LEVER STOP**
FIGURE 3

This stop must be bent out at approximately a 45 degree angle. Place a piece of metal approximately 1/8" thick behind this stop and against the receiver. Now with a small hammer, bend the stop so it's parallel with the side of the receiver. The safety lever now is also the selector lever. Now the selector lever will pass between this stop and the receiver (Fig. 3).

SELECT FIRE AK-47

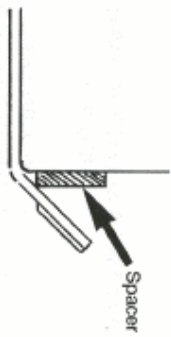
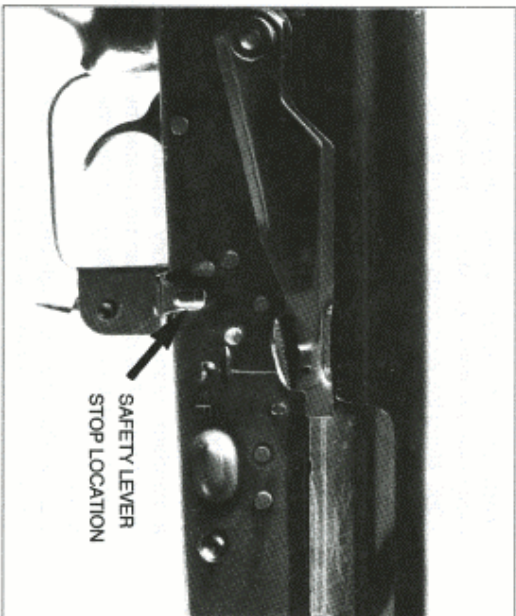

Figure 3



SELECT FIRE AK-47

STEP 4

CREATING A SELECTOR LEVER DETENT

FIGURE 1

To find the location of the select fire detent, move the safety/selector from the upper most position down to its lowest position passing behind the stop. The safety lever protrusion will automatically create a mark against the receiver, showing its arch of travel. You may need to move the safety lever several times to easily see the mark. Locate the dimension 1.060 along the arch measured from the top of the receiver, as in drawing, Figure 1. The safety/selector lever will now click into a third position which is just below the semi automatic position.

After you have found the location, you must create a detent that the selector lever will set into (on most guns this is an elongated groove). You may wish to duplicate this detent by using a standard rotary file, readily available for dental tools. This detent can be created by using 1/4" drill bit and drilling just into the metal.

Caution: Do not drill through the metal. For the location of this detent, see Figure 1-A.

SELECT FIRE AK-47

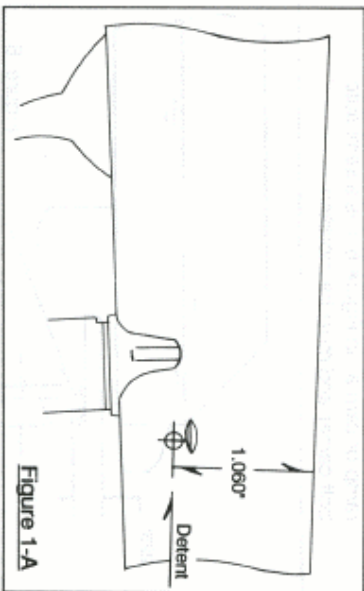
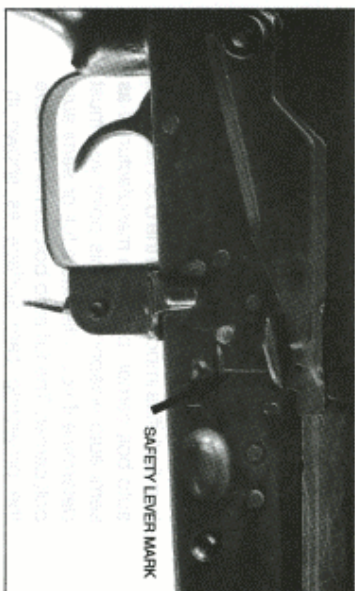

SELECT FIRE AK-47

STEP 5

FULL AUTO VS. SEMI AUTO BOLT CARRIERS

To complete the conversion, your rifle must have a full auto bolt carrier. Many AK or "similar" rifles imported into the U.S. have a full auto bolt carrier, but were manufactured as semi auto weapons. At this point you must determine if your rifle has a full or semi auto bolt carrier. The full auto bolt carrier will have the projecting cam surface as shown in Figure 6.

If your bolt carrier does not already have the ramp or cam as in Figure 6, it is a semi auto bolt carrier and must be modified.

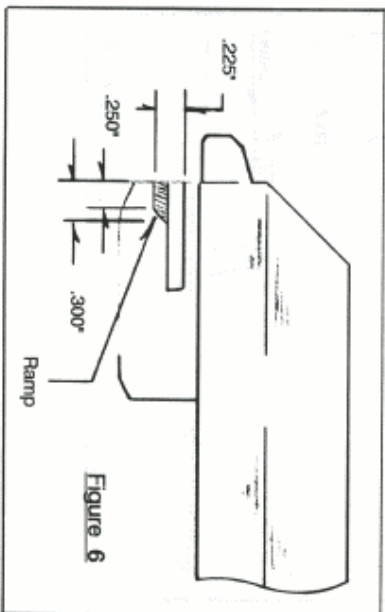

18

SELECT FIRE AK-47

MODIFYING THE SEMI AUTO BOLT CARRIER - METHOD 1 FIGURE 6

The semi auto bolt carrier does not have the auto sear cam surface on the right side, so one must be created. To do this simply build up the surface by welding, which can easily be done with a wire welder. Fill this area in with weld, then grind off the excess.

See Figure 6.

MODIFYING THE SEMI AUTO BOLT CARRIER METHOD 2 FIGURE 6

This cam surface can be created by grinding a separate piece of hardened steel, which is then placed onto the carrier, as in Figure 6 and silver soldered into place. This method will give you years of trouble free service.

19

SELECT FIRE AK-47

STEP 6 REASSEMBLY

The final step in your conversion to select fire is to reassemble your rifle using the parts provided in the full auto parts kit. Do not reuse the semi auto hammer. Assemble the trigger disconnect assembly.

You are ready to check the timing of the bolt with the movement of the auto sear, which should release the hammer when the bolt is approximately 1/16" to 3/32" from being completely closed. If adjustment is needed, simply add to or remove some of the ramp or cam surface that was added to the bolt carrier in the previous steps.

FULL AUTO CONVERSION METHOD #2

Important!!! This conversion method will not work with a machined receiver. It can only be used with a stamped (sheet metal receiver). You may however, use conversion method #1 on the stamped receiver.

SELECT FIRE AK-47

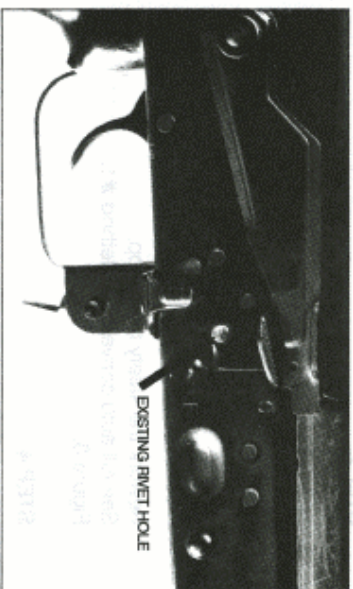

STEP 1

If you are not comfortable drilling new holes in your stamped receiver, there is another way. Rather than drilling a new sear hole, you can use the existing rivet hole on the stamped semi auto receiver located just in front of the hammer. To do this you must first remove the rivet, then enlarge the small rivet holes to accept the new auto sear pin you received in your parts kit. Drill a 7mm or 9/32" hole on the left side and a 5mm or No. 11 size hole on the right side.

Note: If at all possible use the metric drill sizes.

SELECT FIRE AK-47

STEP 2

Modify the bolt guide rail.
See full auto conversion method #1.
Method 2 Figure 2 A.

STEP 3

Rework the safety lever stop.
See full auto conversion Method #1.
Figure 3.

STEP 4

Create a selector lever detent.
See full auto conversion Method #1.
Figure 1.

STEP 5

CUTTING AND RELOCATING

THE AUTO SEAR FIGURE 4, ITEM 1& 2

Now the tricky part of this conversion method. The auto sear must be cut and relocated as shown in Figure 4, Item 1 & 2. The auto sear must be cut in half along the inside edge of part A, Figure 4, Item 3, so that Part A can be flipped over or reversed so that the spring hole is now on top.

SELECT FIRE AK-47

Next cut off the lower portion of Part A as shown in Figure 4, Item 2, leaving approximately .200" height on the sear face that connects with the hammer.

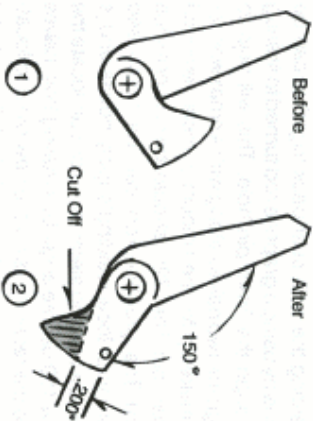
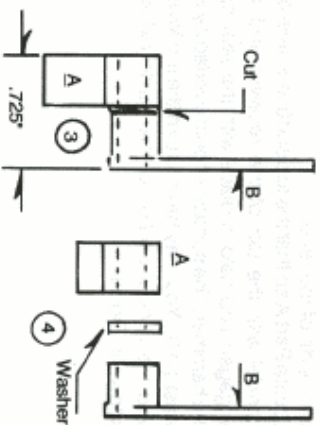

Figure 4



SELECT FIRE AK-47

WELDING THE AUTO SEAR BACK TOGETHER FIGURE 4 ITEM 3 & 4

Welding the auto sear back together can be done by using a graphite rod turned to fit snug through the 5mm pin hole. This will help to align the two halves along with a small washer to make up for the amount of metal removed when cut. The .725" should be plus or minus .010". The graphite rod can be purchased from your local welding supply house and is called a welding electrode. You can locate the new 150 degree angle by installing both halves into the receiver using the new pin and locating the trip lever, Figure 5, Part B, so that it rests against the top rail of the receiver. The trip lever must pass through the slot that was cut out of the guide rail and must rest against the inside of the receiver.

Locate Part A so that the top surface is level or parallel with the top of the receiver and is engaged and held in place with the sear on the hammer. The surface should overlap by at least 1/16". You may have to trim the trip lever and the vertical portion of the guide rail as shown in Figure 5.

SELECT FIRE AK-47

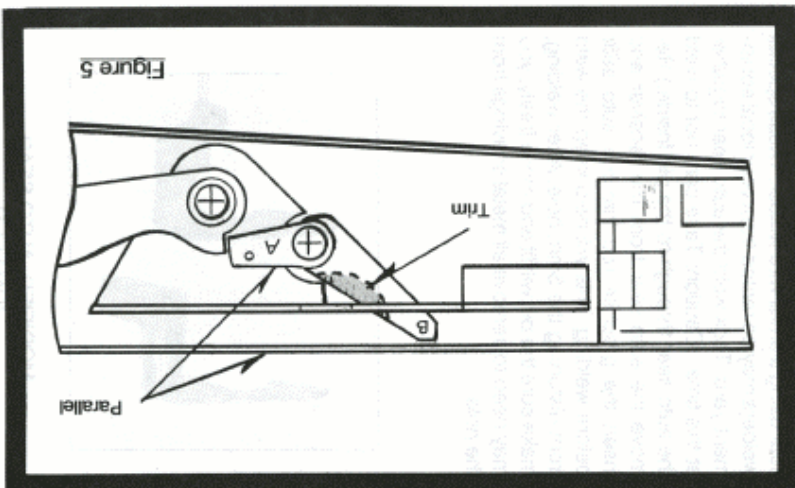
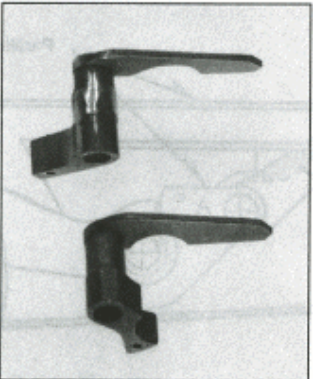

Figure 5

SELECT FIRE AK-47

After making sure everything is aligned and held in place, you may now spot weld the auto sear using a small wire welder. These special welders may be rented from your local equipment yard. Tack weld the auto sear together at this time. (Caution: Take care not to weld the auto sear through to the pin inside.) Remove the auto sear from the receiver and insert the graphite rod into the auto sear before welding. This will help keep the weld from distorting the 5mm hole. After welding, make sure the pin will fit and move freely, you may need to remove all metal shavings from the hole.



MODIFIED AUTO SEAR
(ON LEFT)

26

SELECT FIRE AK-47

STEP 6

REASSEMBLY

You are now ready to reassemble and check for proper alignment. Install the auto sear along with the spring and insert the pin. Replace the bolt and carrier into the receiver and check for proper movement. With the bolt closed, check to see if the hammer sear will clear and move under the auto sear. If this does not occur, remove the auto sear and grind just a little more off the bottom of Part A, Figure 5. You may have to do this several times until the hammer just passes under the auto sear when the bolt is closed.

27

SELECT FIRE AK-47

SELECT FIRE AK-47

STEP 7

**TIMING THE BOLT
WITH THE AUTO SEAR**

The final step. Time the bolt with the movement of the auto sear, which should release the hammer when the bolt is approximately 1/16" to 3/32" from being completely closed.

This should be accomplished by grinding off just the front corner of the semi auto bolt carrier, Figure 6 A.

Caution: Be very careful not to remove too much.

You are now ready to test fire and put your weapon to work.

