



DEPARTMENT OF THE ARMY
FRANKFORD ARSENAL
Philadelphia, Pa. 19137

SILENCERS

PRINCIPLES AND EVALUATIONS

REPORT R-1896

SILENCERS

by

LEONARD W. SKOCHKO
HARRY A. GREVERIS

AMCMS Code 5542.12.46801.02

August 1968

ABSTRACT

This report presents physical and functional descriptions and acoustical evaluation of various domestic and foreign silencers and silenced small arms weapons. Included are cross-sectional drawings and external view photographs of all systems tested. An acoustical evaluation of each system is given in the form of far field sound pressure-time records. All major constituents of sound signatures are identified and time-correlated with their sources in the system. Additionally, the report presents a record of silencing principles and a theoretical analysis of the various noise generating phenomenon.

TABLE OF CONTENTS

	<u>Page No.</u>
INTRODUCTION.	1
SILENCER PRINCIPLES.	2
DESCRIPTION AND EVALUATIONS OF SILENCERS TESTED	7
Caliber . 22 Hi-standard Pistol/French Silencer	10
Caliber . 22 Silenced Hi-standard Pistol	16
Caliber . 22 Silenced AAI Experimental Test Fixture	23
Caliber . 22 Hi-standard Pistol/FA Silencer	31
Caliber . 30 M1903 Rifle/Maxim Silencer	37
Caliber . 30 Silenced M1 Carbine.	47
Caliber . 32 Silenced Sleeve Gun	52
Caliber . 32 Silenced Welrod Pistol.	58
9 mm Silenced Welrod Pistol	66
9 mm Silenced Sten Submachine Gun	72
Silenced Sten Barrel, Type I.	76
Silenced Sten Barrel, Type II	82
9 mm P38 Walther Pistol/AAI Silencer.	88
9 mm Walther MPK Submachine Gun/West German Silencer.	94
Caliber . 45 Silenced M3 Submachine Gun	100
Bell Laboratories Silenced Barrel	100
AMF Silenced Barrel	112
CONCLUSIONS	119
RECOMMENDATIONS	123
APPENDIX A - Ballistic Crack Field	125

	<u>Page No.</u>
APPENDIX B - Subsonic Projectile Flight Noise.	128
APPENDIX C - Gun Muzzle Blast	132
APPENDIX D - Gun Silencers	145
APPENDIX E - Silencer Techniques & Representative Patents	158
APPENDIX F - Relative Loudness of Discreet Sound Pulses	189
BIBLIOGRAPHY.	193
LIST OF PATENTS.	198
DISTRIBUTION.	206

List of Tables

<u>Table</u>		<u>Page No.</u>
I. Caliber .22 Hi-standard Pistol/French Silencer		13
II. Caliber .22 Silenced Hi-standard Pistol		22
III. Caliber .22 Silenced AAI Experimental Test Fixture		28
IV. Caliber .22 Hi-standard Pistol/FA Silencer		35
V. Caliber .30 M1903 Rifle/Maxim Silencer		42
VI. Caliber .30 Silenced M1 Carbine.		50
VII. Caliber .32 Silenced Sleeve Gun		57
VIII. Caliber .32 Silenced Welrod Pistol		63

<u>Table</u>		<u>Page No.</u>
IX. 9 mm Silenced Welrod Pistol		69
X. 9 mm Silenced Sten Submachine Gun, Type I Barrel		79
XI. 9 mm Silenced Sten Submachine Gun, Type II Barrel.		86
XII. 9 mm P38 Walther Pistol/AAI Silencer.		91
XIII. 9 mm MPK Walther Submachine Gun/West German Silencer		98
XIV. Caliber .45 M3 Submachine Gun/Bell Laboratories Silenced Barrel.		109
XV. Caliber .45 M3 Submachine Gun/AMF Silenced Barrel.		117
XVI. Physical, Functional, and Acoustical Parameters of Silenced and Unsilenced Small Arms Weapons		121

List of Illustrations

<u>Figure</u>		<u>Page No.</u>
1. Cross section, Caliber .22 Hi-standard Pistol/French Silencer		11
2. Caliber .22 Hi-standard Pistol/French Silencer		12
3. Sound Pressure-Time History, five meters to side, Caliber .22 Hi-standard Pistol (Unsilenced), Using Long Rifle Cartridge.		14
4. Sound Pressure-Time History, five meters to side, Caliber .22 Hi-standard Pistol (Unsilenced), Using Long Rifle Cartridge.		15

<u>Figure</u>		<u>Page No.</u>
5.	Sound Pressure-Time History, five meters to side, Caliber .22 Hi-standard Pistol/French Silencer, Using Long Rifle Cartridge	17
6.	Sound Pressure-Time History, five meters to side, Caliber .22 Hi-standard Pistol (Unsilenced), Using Short Cartridge (29-gr projectile; velocity, 1050 fps; peak pressure, 16000 psi).	18
7.	Cross section, Caliber .22 Silenced Hi-standard Pistol	19
8.	Caliber .22 Silenced Hi-standard Pistol	20
9.	Caliber .22 Silenced Hi-standard Pistol, Disassembled.	21
10.	Sound Pressure-Time History, five meters to side, Caliber .22 Silenced Hi-standard Pistol, Using Long Rifle Cartridge	24
11.	Cross section, Caliber .22 Silenced AAI Experimental Test Fixture.	25
12.	Caliber .22 Silenced AAI Experimental Test Fixture	26
13.	Caliber .22 Silenced AAI Experimental Test Fixture, Disassembled	27
14.	Sound Pressure-Time History, five meters to side, Caliber .22 Silenced AAI Experimental Test Fixture, Using Long Rifle Cartridge	30
15.	Cross section, Caliber .22 Hi-standard Pistol/FA Silencer	32
16.	Caliber .22 Hi-standard Pistol/FA Silencer.	33
17.	Caliber .22 Hi-standard Pistol and FA Silencer (with Tape Removed), Disassembled.	34

<u>Figure</u>		<u>Page No.</u>
18.	Sound Pressure-Time History, five meters to side, Caliber .22 Hi-standard Pistol/FA Silencer, Using Long Rifle Cartridge	36
19.	Cross Section, Caliber .30 M1903 Rifle/Maxim Silencer	38
20.	Caliber .30 M1903 Rifle/Maxim Silencer	39
21.	Maxim Silencer for Caliber .30 M1903 Rifle.	40
22.	Maxim Silencer for Caliber .30 M1903 Rifle, Disassembled	41
23.	Sound Pressure-Time History, five meters to side, Caliber .30 M1903 Rifle (Unsilenced) Using Subsonic Cartridge.	44
24.	Sound Pressure-Time History, five meters to side, Caliber .30 M1903 Rifle/Maxim Silencer, Using Subsonic Cartridge	45
25.	Sound Pressure-Time History, five meters to side, Caliber .30 M1903 Rifle/Maxim Silencer, Using Subsonic Cartridge	46
26.	Cross section, Caliber .30 Silenced MI Carbine	48
27.	Caliber .30 Silenced MI Carbine.	49
28.	Sound Pressure-Time History, five meters to side, Caliber .30 Silenced MI Carbine.	51
29.	Cross section, Caliber .32 Silenced Sleeve Gun	53
30.	Caliber .32 Silenced Sleeve Gun, side view.	54
31.	Caliber .32 Silenced Sleeve Gun, top view	55

<u>Figure</u>		<u>Page No.</u>	<u>Figure</u>		<u>Page No.</u>
32.	Caliber .32 Silenced Sleeve Gun, Disassembled	56	44.	9 mm Silenced Sten Submachine Gun, Showing Type I and Type II Silenced Barrels	75
33.	Sound Pressure-Time History, five meters to side, Caliber .32 Silenced Sleeve Gun with Old Rubber Baffles	59	45.	Sound Pressure-Time History, five meters to side, 9 mm Silenced Sten Submachine Gun Bolt Slap, without Cartridge	77
34.	Sound Pressure-Time History, five meters to side, Caliber .32 Silenced Sleeve Gun with New Rubber Baffles	60	46.	Cross section, 9 mm Silenced Sten Submachine Gun Barrel (Type I)	78
35.	Cross section, Caliber .32 Silenced Welrod Pistol	61	47.	Assembly, 9 mm Silenced Sten Submachine Gun Barrel (Type I) in Test Fixture	80
36.	Caliber .32 Silenced Welrod Pistol	62	48.	Disassembly, 9 mm Silenced Sten Submachine Gun Barrel (Type I) and Test Fixture	81
37.	Sound Pressure-Time History, five meters to side, Caliber .32 Silenced Welrod Pistol	65	49.	Sound Pressure-Time History, five meters to side, 9 mm Silenced Sten Submachine Gun Barrel (Type I) in Test Fixture.	83
38.	Cross section, 9 mm Silenced Welrod Pistol	67	50.	Cross section, 9 mm Silenced Sten Submachine Gun Barrel (Type II)	85
39.	9 mm Silenced Welrod Pistol	68	51.	Sound Pressure-Time History, five meters to side, 9 mm Silenced Sten Submachine Gun Barrel (Type II) in Test Fixture	87
40.	Sound Pressure-Time History, five meters to side, 9 mm Silenced Welrod Pistol (less Silencer Section), Using Reduced Charge Round	70	52.	Cross section, 9 mm P38 Walther Pistol/AAI Silencer	89
41.	Sound Pressure-Time History, five meters to side, 9 mm Silenced Welrod Pistol with Old Rubber Baffles, Using Reduced Charge Round	71	53.	9 mm P38 Walther Pistol/AAI Silencer.	90
42.	Sound Pressure-Time History, five meters to side, 9 mm Silenced Welrod Pistol with New Rubber Baffles, Using Reduced Charge Round	73	54.	Sound Pressure-Time History, ten meters to side, 9 mm P38 Walther Pistol without Silencer, Using Subsonic Cartridge.	92
43.	Sound Pressure-Time History, five meters to side, 9 mm Silenced Welrod Pistol with New Rubber Baffles, Using Standard NATO Round (Projectile Muzzle Velocity, 930 fps)	74	55.	Sound Pressure-Time History, ten meters to side, 9 mm P38 Walter Pistol/AAI Silencer, Using Subsonic Cartridge.	93

<u>Figure</u>	<u>Page No.</u>	<u>Figure</u>	<u>Page No.</u>
56. Cross section, 9 mm MPK Walther Subma- chine Gun and West German Silencer	95	66. Disassembly, Caliber .45 Bell Labora- tories Silenced M3 Submachine Gun Barrel.	108
57. 9 mm MPK Walther Submachine Gun and West German Silencer	96	67. Sound Pressure-Time History, ten meters to side, Caliber .45 Submachine Gun Barrel (Standard, 7.5 inches long) in Test Fixture	110
58. 9 mm MPK Walther Submachine Gun/ West German Silencer	97	68. Sound Pressure-Time History, 4.6 meters to side, Caliber .45 Bell Laboratories Si- lenced M3 Submachine Gun Barrel in Test Fixture	111
59. Sound Pressure-Time History, five meters to side, 9 mm MPK Walther Submachine Gun without Silencer, Using Subsonic car- tridge	99	69. Cross Section, Caliber .45 AMF Silenced M3 Submachine Gun Barrel.	113
60. Sound Pressure-Time History, five meters to side, Bolt Slap, 9 mm MPK Walther Submachine Gun/West German Silencer, without Cartridge	101	70. Caliber .45 M3 Submachine Gun/AMF Si- lenced Barrel.	114
61. Sound Pressure-Time History, five meters to side, 9 mm MPK Walther Submachine Gun/West German Silencer, Using Subsonic Cartridge	102	71. Assembly, Caliber .45 AMF Silenced M3 Submachine Gun Barrel and Test Fixture	115
62. Sound Pressure-Time History, five meters to side, 9 mm MPK Walther Submachine Gun/West German Silencer, Using Sub- sonic Cartridge and with Weapon and Si- lencer Wrapped with Attenuating Mate- rial	103	72. Disassembly, Caliber .45 AMF Silenced M3 Submachine Gun Barrel and Test Fixture	116
63. Caliber .45 M3 Submachine Gun	104	73. Sound Pressure-Time History, ten meters to side, Caliber .45 M3 Submachine Gun Barrel (5.6 in. long), without Silencer, in Test Fixture	118
64. Cross section, Caliber .45 Bell Labor- atories Silenced M3 Submachine Gun Barrel	106	74. Sound Pressure-Time History, five meters to side, Caliber .45 AMF Silenced M3 Sub- machine Gun Barrel in Test Fixture.	120
65. Caliber .45 M3 Submachine Gun/Bell Laboratories Silenced Barrel	107		

INTRODUCTION

Throughout the history of firearms, gun noise has been of considerable concern to the military. Prior to firing, anticipation of the ear shattering effects tends to make the gunner flinch, resulting in a consequent deterioration of his aim. After firing, the gunner is usually in a state of temporary deafness. To the enemy, gun noise reveals presence and, often, the location of the firer, thus inviting defensive or offensive reaction. From the above alone it becomes evident that a "silent" weapon is to be found indispensable in covert operations.

Of the various noises associated with firing a conventional small arms weapon, the most significant is the muzzle blast caused by escape of propellant gases after the projectile exits from the barrel. Hundreds of patents, war and police records, and other literature are witness to the efforts, for nearly a century, to eliminate small arms muzzle blast. Notwithstanding time, effort, and interest, no completely satisfactory silenced weapon has yet been produced.

The lack of theoretical literature on silencing a firearm testifies to the still inadequate understanding of the principles of sound generation and attenuation in a small arms weapon. Perhaps the failure to theoretically define noise problems can be attributed to the virtual non-existence of thorough and reliable experimental sound data from existing silenced and unsilenced weapons. This lack of experimental data is partially due to only recent development of adequate sound measuring equipment^{18*} and partially due to the complexity of the problem.

This report is intended to give an insight into the present state of knowledge of silencing a small arms weapon. Essentially, the contents consist of physical, functional, and acoustical data on an array of silenced weapons felt to be representative. The sound evaluation presented here is cursory, primarily because of the complexity of the problem. First, the gun muzzle noise is only one** of the many possible noises being generated by each given system. Second, the sound of interest is directional and attenuates nonlinearly with distance.

*See Bibliography.

**See, for example Appendices A and B

Third, terrain and weather have a paramount effect on the noise being perceived in the far field. Fourth, the physiological response of a listener to a given sound is very strongly dependent on the background noise and on his current psychological state. Many of the above problems are too involved; others are beyond the scope of present theoretical knowledge. The results presented herein are only those felt to be essential and experimentally reproducible.

All sound measurements presented were taken in the far field and directly to the side of the weapon. This permitted application of the linearized acoustic theory and presented an undistorted sequence of acoustical events. The sound signature of each weapon described was recorded in pressure-time coordinates sufficiently expanded to show each major constituent of the muzzle noise. Identification of each major sound source was accomplished through time-correlation of the sound scope trace with the various weapon functions occurring during the firing cycle.

A bibliography of books, reports, and patents pertinent to silencing a weapon is included for reference. Works pertaining more to basic sciences were included only when specific reference was made to such works in preparation of this report. A few of the fragmentary theoretical efforts, directly pertinent to silencing a weapon, are presented as appendices.

SILENCER PRINCIPLES

Muzzle noise of small arms weapons, silenced or unsilenced, occurs due to the following:

1. Air or propellant gas discharge preceding the projectile exit. This consists primarily of the precursor wave phenomenon and the propellant gas blow-by (and, of course, reflections of these two inside the system).

2. Projectile emergence and abrupt volumetric displacement of the air mass by the projectile at the weapon muzzle. This effect, although insignificant in unsilenced weapons, requires attention in silenced systems.

3. Air or propellant gas discharge (or inflow) following projectile exit. This consists essentially of the initial uncorking of internal system pressure, the subsequent discharging jet turbulence, and the effects due to reflections of these inside the system.

The three noise sources are relatively independent of each other and, consequently, require different techniques for their attenuation. Thus, when designing or evaluating a silenced weapon it is usually necessary to treat each noise source individually.

A projectile traveling in a gun barrel accelerates and compresses the air immediately ahead of it. The precursor pressure wave thus generated is substantial in most weapons, even the ones with subsonic projectile velocities. Prior to exit from the gun barrel, the precursor wave front generally consists of a shock which reaches a pressure of several atmospheres. Upon exit from the gun barrel, the precursor wave gives rise to a positive sound pulse in the far field. The sound pulse is generally of a sawtooth configuration, beginning with a shock and ending with an exponential pressure decay with time. In some silenced weapons this precursor sound pulse constitutes the dominant noise source.

The abrupt exit of the projectile itself generates a substantial noise in some silenced weapons. This is especially common in weapons whose silencer exits are partially or completely restricted by flexible materials, such as sponge, rubber, felt, etc. In these cases the exterior surfaces of deforming flexible material and the moving projectile generate sound. To a certain extent the same phenomenon also exists when the projectile emerges through a hole in a baffle. These effects can be expected to occur even when the projectile is neither followed nor preceded by high gas or air pressures. The sound signature in the far field due to abrupt projectile emergence from the muzzle consists usually of an N-wave pulse. The magnitude of this pulse depends primarily on the projectile velocity, diameter, and length, and on the silencer muzzle configuration.*

In an unsilenced subsonic weapon, the hot propellant gases discharging into the atmosphere after the projectile exit constitute the dominant source of muzzle noise. The initial sound pulse is generally similar in shape to the precursor pulse described above, but substantially

*This phenomenon is not to be confused with designations on scope traces where "Projectile Exit" is meant to represent the general time of an event.

greater in magnitude. In many unsilenced weapons this muzzle blast exceeds the limits of the firer's auditory safety and can be of sufficient magnitude to stun him. In silenced weapons, the major portion of the propellant gas generally escapes into the atmosphere after the projectile exits from the silencer. However, by this time the gases have expanded to the total volume of the system and the gas pressure behind the exiting projectile is low with a correspondingly low resulting sound pulse pressure. The sound pulse is again similar in shape to the precursor pulse; however, it may be further modified by wave reflections within the silencer.

Blow-by is the leakage of propellant gases past the projectile while it is still inside the weapon. This condition occurs due to any significant clearance between the projectile and the gun barrel or silencer. Since the accuracy of the weapon is generally impaired if the projectile touches any hard surface after leaving the gun barrel, most silencers are designed with an adequate projectile clearance. In some silencers this clearance is so large that a good portion of the propellant gas escapes prior to projectile exit, and blow-by represents a significant sound source in the system. The blow-by sound pulse is generally a positive shock, followed by an exponential pressure decay. In some cases, when the projectile velocity is high, the blow-by can arrive at the silencer exit at almost the same time as the projectile. In this case the blow-by sound pulse will merge with, rather than precede, the main gas discharge sound pulse.

Theoretically, a gas or air jet discharging into the atmosphere at a steady rate should not generate any significant noise. However, due to turbulence,³⁰ vorticity, and reverberation within the jet orifice, some flow fluctuation usually does occur. In some cases, this flow fluctuation is a significant source of noise (jet planes, turbines, etc., are examples). In silencers, jet noise is generally substantially lower than precursor, blow-by, or blast noise. However, in some silencers the jet noise becomes predominant. This is especially the case when precursor, blow-by, and blast effects are substantially attenuated, as in the Maxim and Sten gun silencers. The jet noise can also become significant when the silencer baffle spacing is such that the baffled chamber resonance corresponds to the natural frequency of the discharging jet. In such cases both the amplitude and the dominant frequency of the jet noise can be substantially altered by changing the baffle spacing within the silencer.

Presently the exact relationship between a sound signature and the corresponding effects occurring in a silenced weapon is only vaguely defined. It is known, however, that generally the magnitude and duration of any given sound pulse are primarily dependent on the area through which a quantity of propellant gas or air is discharged to the atmosphere and on how this discharge varies with time.*

In most silenced weapons the gas discharge area of interest is the silencer muzzle opening. However, to predict the gas discharge from the muzzle prior to projectile exit, consideration must also be given to blow-by clearances, volume, and internal configuration of the silencer. The gas discharge rate of a pressurized chamber or tube is determined by both the discharge area and the stagnation pressure of the gas.² The stagnation pressure varies inversely with the volume containing the gas. Thus, the silencer volume becomes a primary factor in determining the gas discharge rate immediately following projectile exit. Any significant change in the silencer volume results in a corresponding change of the projectile exit sound pulse magnitude. In the case of system blow-by, the sound pulse is more dependent on the blow-by clearances, although often other factors also become significant. With the precursor wave, much lower pressures are encountered, and the more dominant role is played by silencer length.**

The propellant gas pressure can also be reduced by heat absorption. One method of effecting substantial heat absorption in the silencer is to increase the contact surface between the hot propellant gas and the heat absorbent silencer material. The heat conduction is maximized by using materials with high heat conductivity (e.g., copper is good) and by exposing the gas to the heat absorbent material early in the expansion process when the temperature differential is greatest. A good example of the heat absorbing technique is found in silencers utilizing steel wools and wire screening. In most cases, however, the heat absorption is limited by the short ballistic cycle times encountered in small arms weapons.

Another method of effecting large heat losses in the silencer is to introduce a foreign substance, preferably a highly volatile solid or liquid, into the propellant gas just prior to projectile exit from the

*Appendix C

**Appendix D

silencer. The substance evaporates by absorbing heat from the propellant gas thus reducing the internal pressure. The presumably successful application of this technique is to soak the silencer wire screening in oil. Water is also usable, but may present corrosion problems. The general principle, although not thoroughly investigated in the past, seems to have good possibilities.

From the foregoing it becomes evident that the sound signatures of most conventional silenced weapons are primarily determined by the silencer length, volume, blow-by clearance, and heat absorbing capability. Since in most silencers the heat losses are small, the usual silencer components (such as baffles, "devious passages," etc.) have their main significance only in altering or reducing blow-by.

Several exceptional silencing techniques* deserving mention may now be added to the above described principles. H. P. Maxim, in the early 1900's, patented and manufactured a relatively successful silencer with specially formed baffles. These baffles channeled the expanding propellant gases into a peripheral motion within the silencer. The generated vortex reduced the pressure at the center, thus reducing the propellant gas discharge rate from the silencer. Although to date the principle lacks conclusive theoretical and experimental verification, superficially it seems sound. Except for the vortical gas motion, the Maxim silencer performed according to the principles previously described.

During World War II, Germany developed several experimental silencers. One interesting version incorporated conical baffles, equally spaced along the silencer and inclined rearward. Although this technique would not be expected to reduce the initial propellant gas discharge rate after projectile exit, it does have a natural tendency to reduce the precursor and the blow-by. This reduction can be attributed to the efficient inward reflection of all outgoing pressure waves within the silencer.

Some of the above German World War II silencers incorporated a flexible (sponge, rubber, etc.) disk at the silencer exit (patented 1936 in Germany). The disk closes off the internal silencer cavity unless forced open by the exiting projectile. In this way the propellant gas is retained within the system until it slowly seeps out. The rigidity of the disk ideally would be such that the precursor, blow-by, and expanding blast pressures would not deform it and yet the projectile could

force its way through. A variation of the technique is to distribute a series of these flexible disks throughout the length of the silencer. This design was utilized in some versions of British World War II Sten guns and Welrod pistols.

Most silencers discharge the propellant gas solely through the silencer opening. A variation of this, not often encountered, is discharging pressurized gas through the periphery of the gun barrel or silencer. Although the technique as described in some silencer patents was probably unsuccessful, with proper gas discharge distribution and timing this silencer type could prove very effective acoustically.

A few of the early silenced weapon patents described mechanical means for restricting the rapid propellant gas discharge after projectile exit from the weapon. One of these prescribed the use of a metal gate to close the gun barrel immediately after projectile passage. The gate in this case was to be driven directly by the propellant gas following the projectile. Other patents described the same principle, but added a side-branch, gas-driven piston to activate the gate. Another patent described a weapon in which the projectile was driven by a piston of slightly larger diameter. The piston was to be stopped at the choked barrel muzzle while the projectile would proceed to exit. In this way the piston would trap the propellant gas inside the gun barrel. The patent did not prescribe an expedient method for extracting the piston from the barrel. Still another patent described an expansion chamber at the barrel muzzle which would allow expansion and eventual trapping of an expandable piston driving the projectile. The propellant gas was to be trapped behind the piston and gradually released through small openings in the chamber. Although all of the above techniques seem sound, more often than not they are plagued by insurmountable design problems. Even if the above systems could be made operable, as described they would not be expected to effect any exceptional attenuation in noise.

DESCRIPTION AND EVALUATIONS OF SILENCERS TESTED

An array of readily available silencers and silenced weapons was tested at Frankford Arsenal. Since the information was collected over an

*Appendix E

extended period of time, some of the sound histories were recorded at distances other than five meters. All measurements were made with either a Bruel and Kjaer (B&K), 1/4 inch (Model 4135) or an Altec, 1/2 inch (Model BR150) condenser microphone. The microphone output was fed into an oscilloscope (Techtronix) and photographed for record. In a few cases the weapon sound history was first recorded by a tape recorder (Ampex 351) and then transferred to the oscilloscope and the camera film. In each case sufficient cross-correlation existed between various transducers and recording techniques to render the presented data, for all practical purposes, valid and reproducible.

Throughout the tests the microphone, preamplifier, recording equipment, and recording technique were found to have a paramount effect on the validity of recorded sound data. Some microphone systems were found to have insufficient response while others distorted the signal with resonance. Both Altec and B&K microphone systems showed a pronounced tendency to distort the signal when measuring low intensity shock waves. They were almost completely free from resonance at higher sound levels. Although the specified frequency responses of Altec and B&K microphones are, respectively, 11,000 and 75,000 cps, both gave relatively comparable results for the purpose at hand. The tape recorders are generally not recommended for recording shock type sounds, primarily because of their slow response (usually not higher than 20,000 cps) and vulnerability to overloading. With care, however, useful data can be recorded.

Another problem encountered during the tests was the sound reflection from the ground. In cases where both the direct and reflected sound signals were recorded, no perceptible loss seemed to occur through reflection from loose sand and sparse grass. The reflected signal was simply slightly smaller in amplitude for having traveled a longer distance from the source. Consequently, it was found necessary to place the microphones and weapon sufficiently far from the ground to insure receipt of only the primary signal. The further from the gun the measurements were taken, the higher the microphones had to be placed off the ground.

Most silencers and silenced weapons tested were intended for standard subsonic ammunition, available commercially. Some systems, however, required special reduced charge cartridges. For tests, these rounds were prepared with appropriate type and quantity of propellant to yield projectile velocities substantially below the speed of sound. Since in some cases the projectile velocities intended

by the system designers were not known, it is possible that the prepared and tested ammunition may have deviated slightly from that intended. It is doubtful, however, that this factor could significantly alter the sound results presented herein. Some systems, such as the Sten gun, were designed for standard supersonic ammunition. In these cases the barrel usually had propellant gas bleed holes to reduce the internal pressure, thus reducing the projectile muzzle velocity.

It is appropriate at this point to describe the methods whereby the weapon's major noise constituents, listed with each of the following sound scope traces, were identified. In most cases the first step consisted of examination of a sufficient number of the weapon's scope traces to establish the recurrent character of the overall weapon noise. Next, scope traces were taken with the whole weapon, except the muzzle, wrapped with attenuating material (a suede leather jacket was found to be a remarkably good attenuator). Noting the noise components on the trace thus attenuated or completely eliminated, positive identification was made of the weapon's breech noise and the first noise emitted from the weapon muzzle. Following this, scope traces were made with the weapon muzzle taped over with heavy elastic tape. This determined the relative time of projectile exit from the weapon.

The mechanical noises due to the weapon hammer and firing pin fall alone were determined by dry firing the weapon. In weapons with detachable silencers, the precursor shock exit time was established from scope traces of the weapon fired without the silencer. Next, an impulse-time diagram was constructed from the scope trace of the overall unmodified weapon noise. This established an approximate relationship between the propellant gas discharge history of the weapon and the scope trace.

The times of the various noise-producing processes occurring in the weapon during the ballistic cycle were calculated from the known or estimated projectile travel-time history. Analysis of all calculated and experimentally established data led to identification of the major weapon noise sources listed with the following sound scope traces.

In practice, all sound measurements and loudness judgements are made in the presence of some type of background noise. Although the apparent loudness of a signal can often be altered substantially

by the background noise, presently there is no satisfactory means for predicting this masking effect. However, it is known that when the sound pressure level (SPL) of a continuous signal exceeds the SPL of background noise by more than 10 db, the effects of background noise, for all practical purposes, can be neglected. If the same criterion is assumed for transient noises, then masking of the weapon noise by the background noise should become significant only when the background sound pressure exceeds about a third of the weapon sound pressure. All Frankford Arsenal sound traces were made with the background noise well below this limit.

Caliber .22 Hi-standard Pistol/French Silencer

The "French" silencer is a recently manufactured item, designed for a caliber .22 or a slightly larger caliber weapon. In all respects other than that its baffles are not perforated, this silencer of French origin is identical to a Parker-Hale "Sound Moderator" presently being manufactured commercially in Britain. History and exact origin of the "French" silencer are unknown.

The all-metal silencer tested (Figures 1 and 2) was adapted to a caliber .22 Hi-standard semi-automatic pistol by threading the barrel. Inside, the silencer contained a series of metal baffles, spaced 0.43 inch apart. The first baffle was located 2.37 inches from the gun barrel muzzle, presumably to reduce stresses on the baffles and to provide an initial expansion chamber. The projectile passage diameter throughout the silencer was 0.28 inch. Outside, the silencer diameter and length were, respectively, 0.94 and 7.31 inches. Table 1 lists some of the more important physical and functional parameters of the Hi-standard pistol and the "French" silencer.

Figures 3 and 4 show scope traces of the sound pressure-time history of the pistol without the silencer firing a Long Rifle cartridge. The traces were recorded five meters from and directly to the side of the pistol muzzle. The three primary acoustical effects - primer initiation, precursor shock exit, and propellant gas blast - are distinctly visible on the traces. The highest sound impulse and peak sound pressure level (136 db) were due to the propellant gas discharge occurring after the projectile exited the barrel. The peak sound pressure level due to exiting of the precursor shock was 113 db. The primer initiation sound pulse was approximately 98 db.

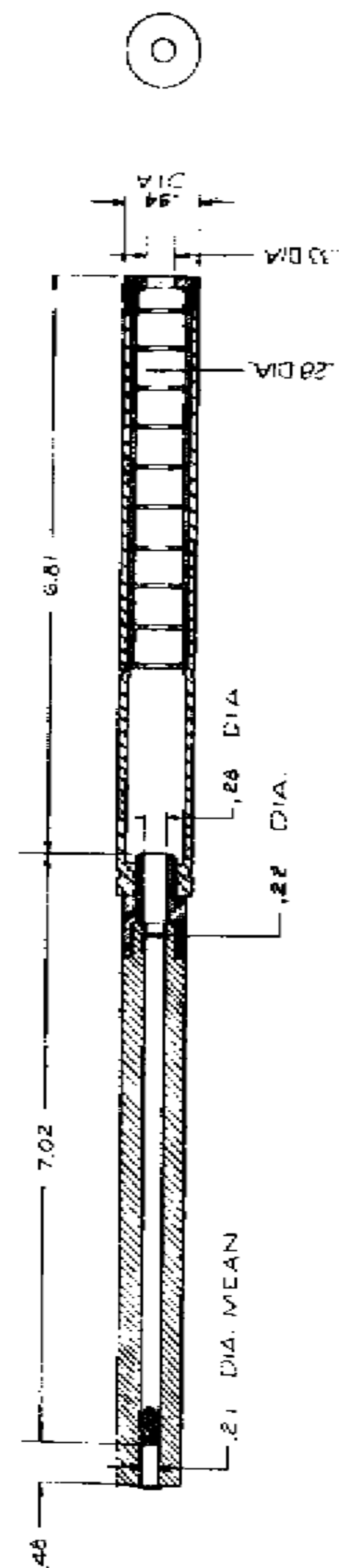

Figure 1. Cross section, Caliber .22 Hi-standard Pistol/French Silencer

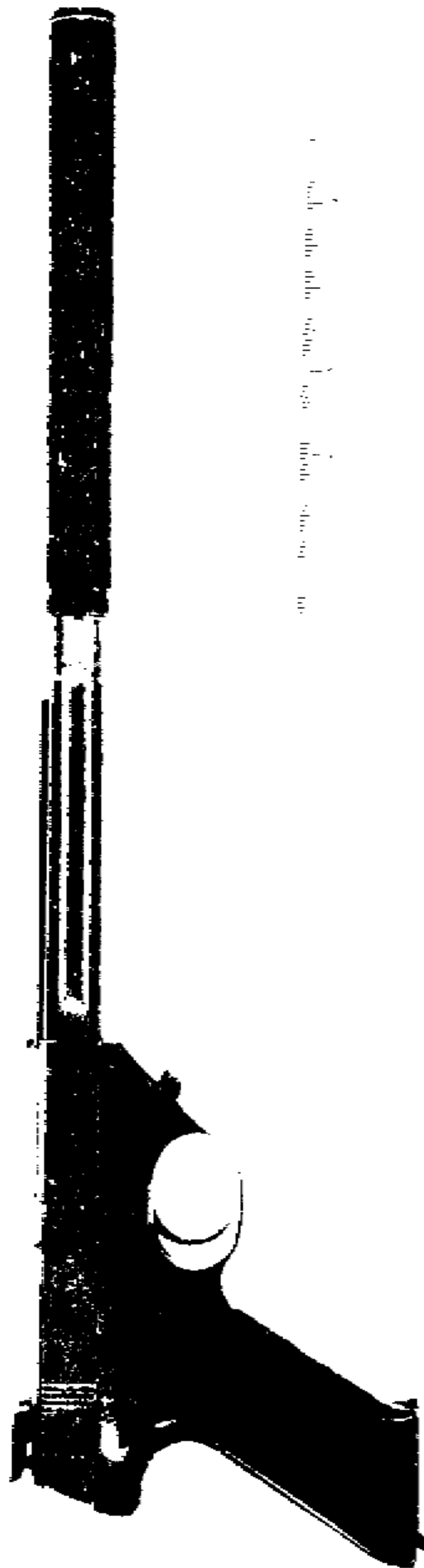
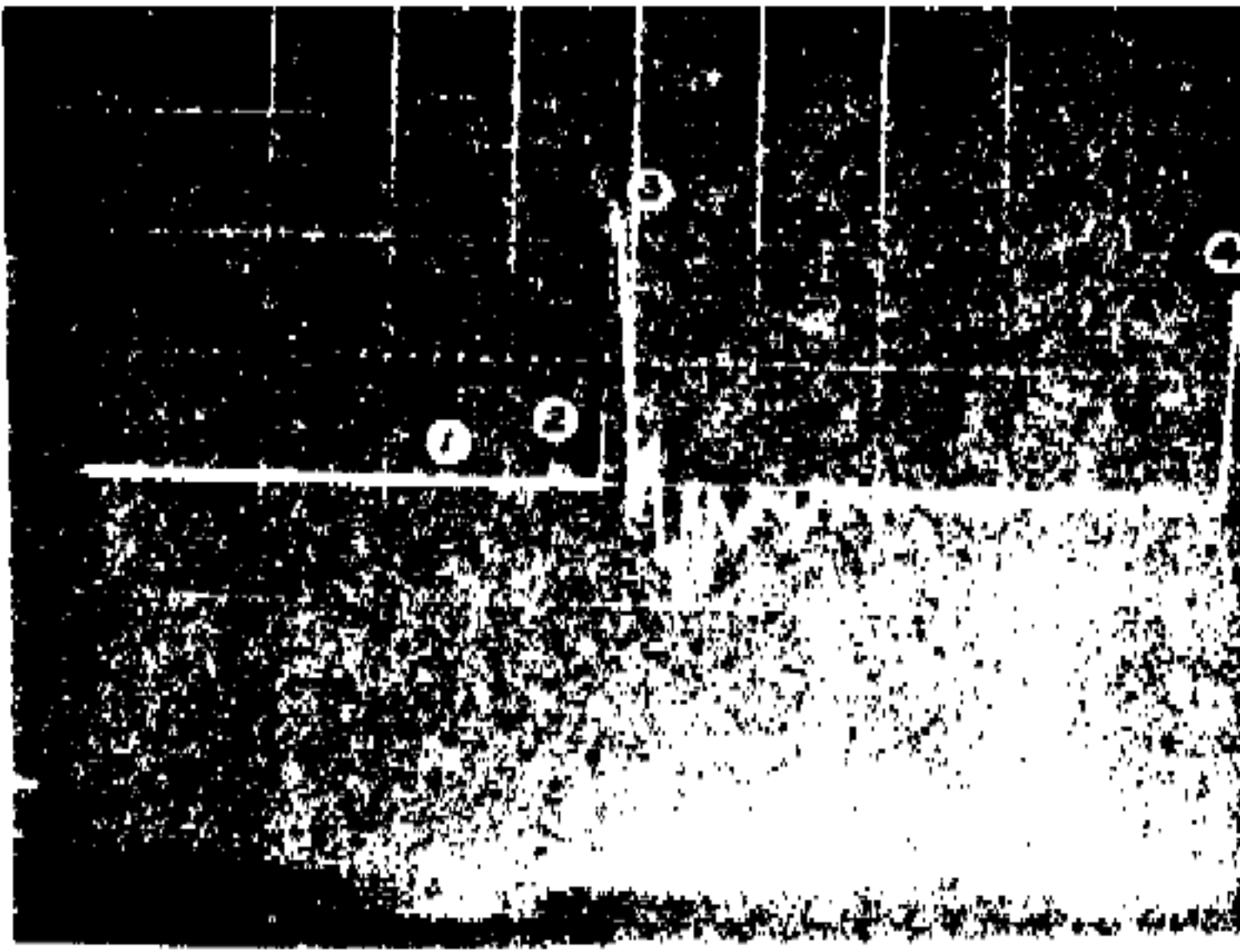

Figure 2. Caliber .22 Hi-standard Pistol/French Silencer

TABLE 1. Caliber .22 Hi-standard Pistol/French Silencer

Projectile	
Weight (Long Rifle)	40 gr
Diameter	0.225 in
Velocity (at silencer exit)	1050 fps
Energy (at silencer exit)	98 ft-lb
Travel at peak ballistic pressure (estimated)	0.4 inch
Travel in barrel	7.0 inch
Travel time in barrel	0.65 ms (approx)
Travel time in silencer	0.55 ms
Propellant	
Weight (double base, flake, web ~ 0.003 in.)	1.7 gr (+0.2 gr primer)
Chamber volume	0.016 in. ³
Ballistic pressure	
Peak	24,000 psi
At barrel muzzle (estimated)	1,000 psi
Silencer	
Passage diameter (for projectile)	0.28 in.
Weight	0.25 lb
Free volume	2.38 in. ³
Pistol weight (without silencer)	2.75 lb
Time between precursor and projectile exits from silencer (estimated)	0.95 ms



$$y = 540 \mu\text{bars/cm}$$

$$x = 0.5 \text{ ms/cm}$$

1 cm = 1 major division

Microphone: B&K 4135

- | | |
|-------------------------------|-----------------------------|
| ① Primer Initiation | $L_1 \approx 98 \text{ db}$ |
| ② Precursor Exit from Barrel | $L_2 = 113 \text{ db}$ |
| ③ Projectile Exit from Barrel | $L_3 = 136 \text{ db}$ |
| ④ Ground Reflection | |

Figure 3. Sound Pressure-Time History, five meters to side, Caliber .22 Hi-standard Pistol (Unsilenced), Using Long Rifle Cartridge

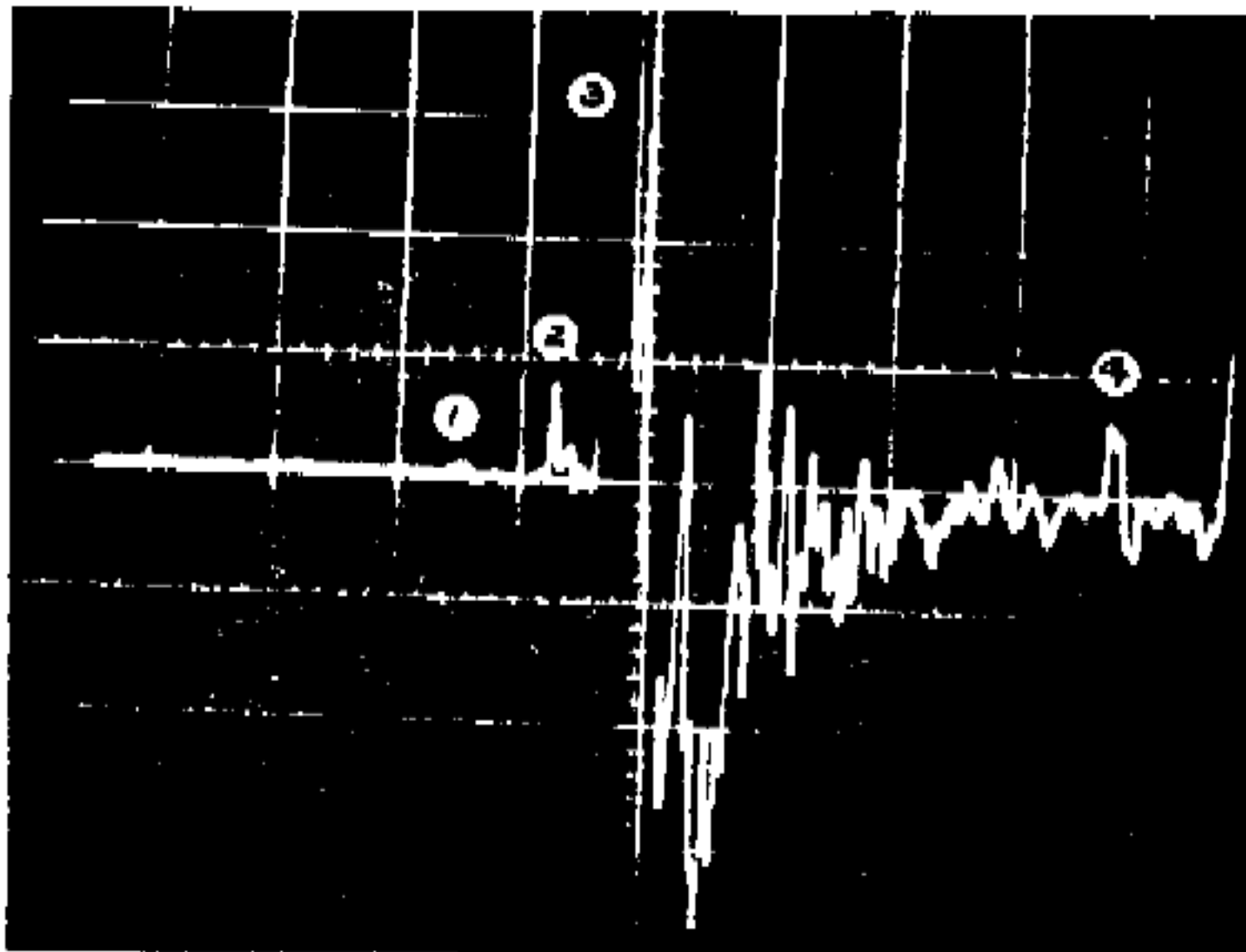

$$y = 108 \mu\text{bars/cm}$$

$$x = 0.5 \text{ ms/cm}$$

1 cm = 1 major division

Microphone: B&K 4135

- | | |
|-------------------------------|------------------------------|
| ① Primer Initiation | $L_1 = 98 \text{ db}$ |
| ② Precursor Exit from Barrel | $L_2 = 113 \text{ db}$ |
| ③ Projectile Exit from Barrel | $L_3 \approx 136 \text{ db}$ |
| ④ Precursor Ground Reflection | |

Figure 4. Sound Pressure-Time History, five meters to side, Caliber .22 Hi-standard Pistol (Unsilenced), Using Long Rifle Cartridge

The sound signature of a Hi-standard pistol with the French silencer and using a Long Rifle cartridge is shown in Figure 5. In this case the sound pressures were substantially lower than with the unsilenced pistol. The first distinct sound perceived during the firing cycle was a pulse (pt 1, Figure 5) generated about the time the firing pin hit the primer. Since at this time four successive functions - hammer fall, firing pin striking primer, primer explosion, and gas leakage around the cartridge case - occurred, the exact source of the first sound pulse is not definite. However, experiments with other systems indicate that, generally, by far the loudest pulses are generated by the gas leakage around the cartridge case and by the hammer fall. The firing pin striking the primer is generally somewhat louder in weapons without a hammer.

The next sound after primer initiation was the precursor wave exiting from the silencer muzzle. This sound pulse (pt 2), because of its low amplitude, is barely distinguishable in the trace. Shortly after the precursor, the blow-by pressure wave (generated by the leakage of propellant gases past the projectile) exited. Exit of this pressure wave gave rise to a pulse of 117 dp peak SPL. The projectile exited the silencer 0.3 millisecond after the blow-by wave. Its exit was followed by the main efflux of gases, which resulted in the positive pulse of 119 dp peak SPL. Following the projectile exit and initial gas efflux, the steady discharge of propellant gases gave rise to turbulence which, combined with reverberations within the silencer, generated a prolonged noise (pt 5) of approximately 105 db peak SPL.

Sound signature of the caliber .22 Hi-standard pistol without silencer, firing a Short cartridge, is shown for reference in Figure 6.

Caliber .22 Silenced Hi-standard Pistol

During World War II, the U.S. Infantry Board established interest in silenced weapons.³⁷ A variety of weapons, including the silenced caliber .22 Hi-standard pistol (Figures 7, 8, and 9, and Table II), were given consideration. It was concluded that all silenced weapons were bulky and still detectable at close ranges. Because of low lethality, it is doubtful if the Hi-standard pistol described herein found very wide application.



y = 108 μ bars/cm
 x = 0.5 ms/cm
 1 cm = 1 major division
 Microphone: B&K 4135

- ① Primer Initiation L₁ = 100 db
- ② Precursor Exit from Silencer L₂ ≈ 95 db
- ③ Blow-by Exit from Silencer L₃ = 117 db
- ④ Projectile Exit from Silencer L₄ = 119 db
- ⑤ Propellant Gas Discharge Turbulence and Reverberations within Silencer L₅ = 105 db (average)

Figure 5. Sound Pressure-Time History, five meters to side, Caliber .22 Hi-standard Pistol/French Silencer, Using Long Rifle Cartridge

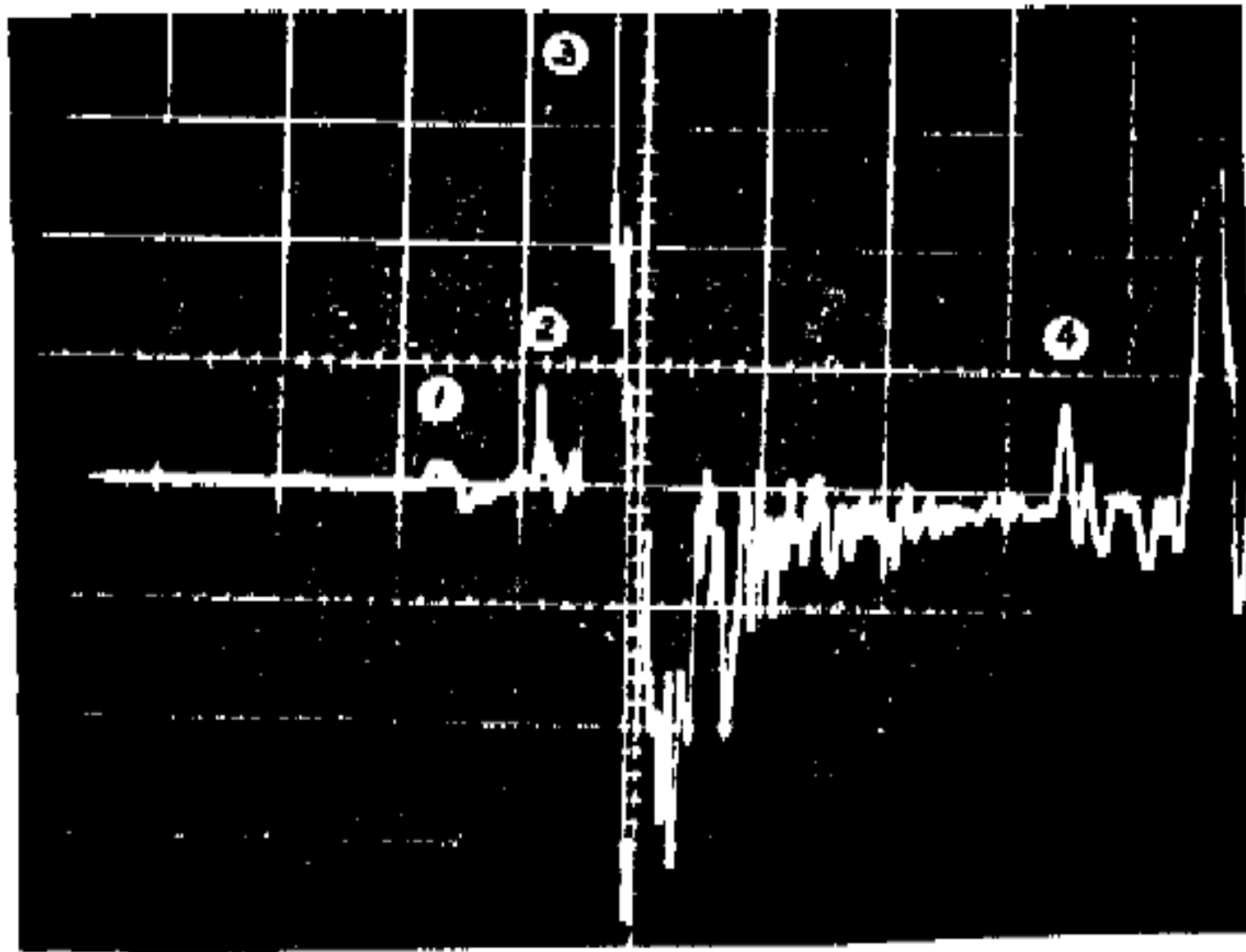

$y = 108 \mu\text{bars/cm}$
 $x = 0.5 \text{ ms/cm}$
 1 cm - 1 major division
 Microphone: B&K 4135

- | | | |
|---|-----------------------------|------------------------------|
| ① | Primer Initiation | $L_1 = 101 \text{ db}$ |
| ② | Precursor Exit from Barrel | $L_2 = 113 \text{ db}$ |
| ③ | Projectile Exit from Barrel | $L_3 \approx 135 \text{ db}$ |
| ④ | Precursor Ground Reflection | |

Figure 6. Sound Pressure-Time History, five meters to side, Caliber .22 Hi-standard Pistol (Unsilenced), Using Short Cartridge (29-gr projectile; velocity, 1050 fps; peak pressure, 16000 psi)

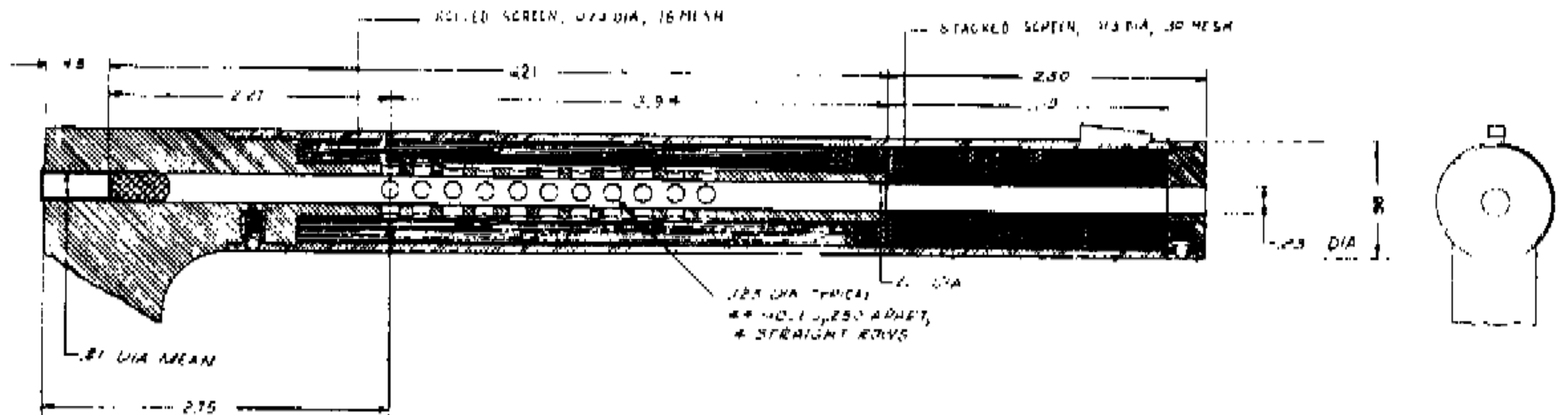

Figure 7. Cross section, Caliber .22 Silenced Hi-standard Pistol

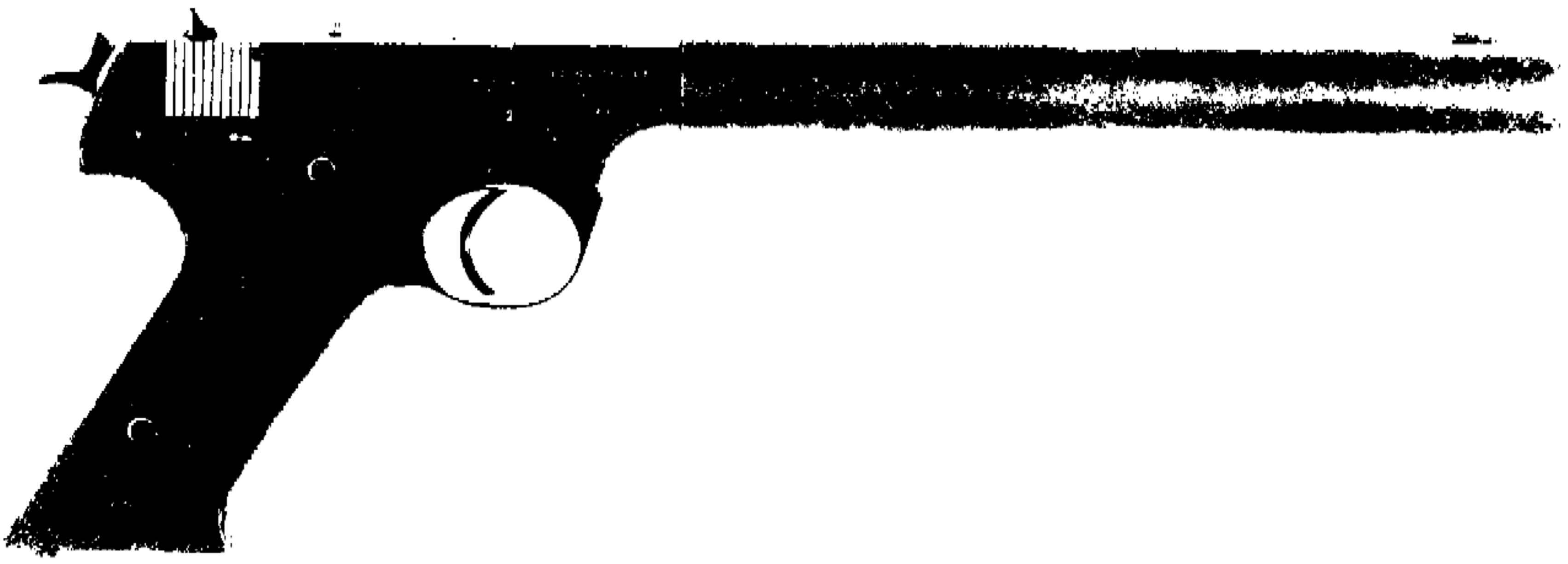

Figure 8. Caliber .22 Silenced Hi-standard Pistol

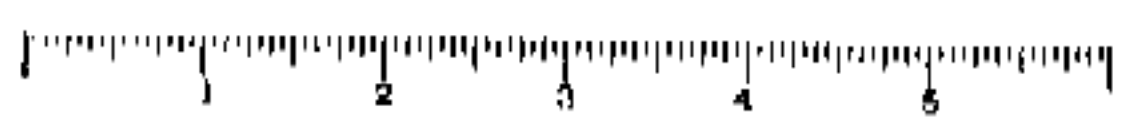
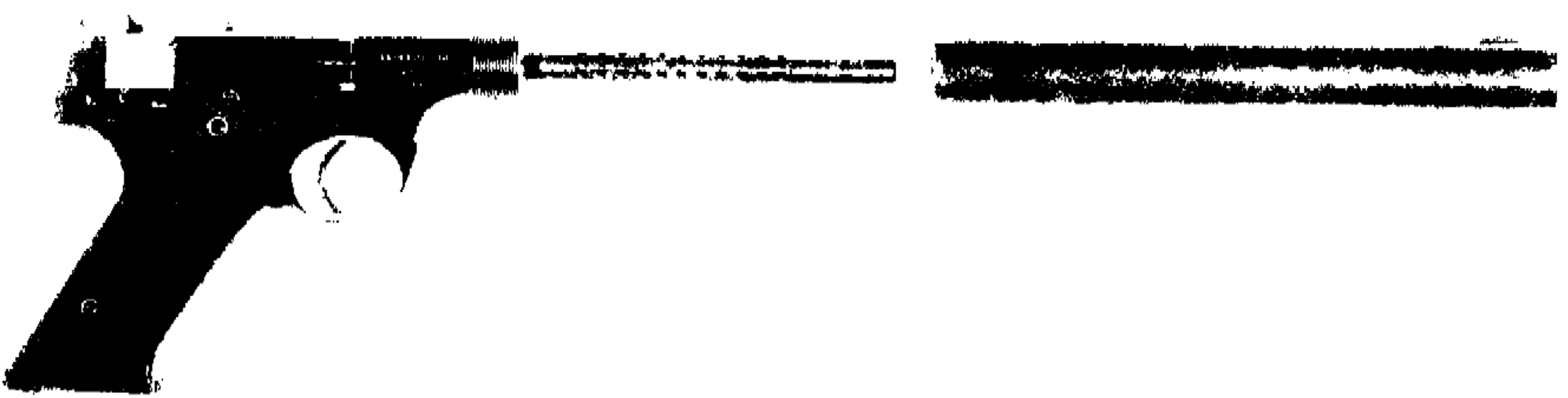

Figure 9. Caliber .22 Silenced Hi-standard Pistol, Disassembled

TABLE II. Caliber .22 Silenced Hi-standard Pistol

Projectile	
Weight (Long Rifle)	40 gr
Diameter	0.225 in.
Velocity (at silencer exit)	930 fps
Energy (at silencer exit)	75 ft-lb
Travel at peak ballistic pressure (estimated)	0.4 in.
Travel in barrel	6.2 in.
Travel time in barrel	0.65 ms (approx)
Travel time in silencer	0.22 ms
Propellant	
Weight (double base, flake, web ~ 0.003 in.)	1.7 gr (+ 0.2 gr primer)
Chamber volume	0.016 in. ³
Ballistic pressure	
Peak	24,000 psi
At barrel muzzle (estimated)	90 psi
Silencer	
Passage diameter (for projectile)	0.234 in.
Weight (excluding gun barrel and pistol)	0.63 lb
Free volume	
Around gun barrel (including barrel holes)	1.84 in. ³
In front of gun barrel	0.76 in. ³
Wire mesh volume	
Rolled (around gun barrel)	0.79 in. ³
Discs (front of barrel)	0.35 in. ³
Gun barrel and pistol weight	2.37 lb

Silencing of the Hi-standard pistol has been accomplished essentially by drilling the barrel and enclosing it in a silencing tube. The barrel has four longitudinal rows of "bleed" holes, 0.125 inch in diameter and spaced 0.250 inch apart. The primary function of the holes is reduction of the ballistic pressure which, in turn, also reduces the velocity of a supersonic Long Rifle cartridge below the speed of sound.

The silencing tube surrounds and extends beyond the pistol barrel. At the rear it is attached to the threaded receiver extension, while at the front it terminates with a threaded cap. Inside, the tube contains a roll of brass wire mesh surrounding the barrel and a stack of wire mesh discs extending beyond the barrel muzzle. The wire screening is presumably intended for cooling of the propellant gases. Projectile passage through the front portion of the silencing tube is 0.234 inch in diameter. The silencing tube diameter and length (beyond gun barrel) are, respectively, 1.0 and 2.5 in.

Figure 10 shows the sound pressure-time history of the silenced Hi-standard pistol. The sound trace, like that of the French silencer, was taken five meters to the side of the pistol muzzle. As can be seen from the scope trace, the pistol's main sound sources were: primer initiation (pt 1, Figure 10), bleed hole blow-by (pt 2), and projectile exit (pt 3). The primer initiation pulse, which was predominately due to propellant gas leakage around the cartridge case, had a peak SPL of 98 db. The next sound pulse (pt 2) was generated when the blow-by occurring through the bleed holes exited from the muzzle. Although this sound pulse had a relatively large impulse, its peak SPL was only 101 db. Shortly after, the blow-by wave, originated at the gun barrel muzzle, exited. This event occurred almost simultaneously with the projectile exit. The combined effect of blow-by and gas discharge following the projectile exit resulted in a positive pulse (pt 3) of 113 db peak SPL. Following this, several sound pulses occurred (pt 4) due to propellant gas discharge turbulence and reverberations within the silencer.

The magnitude of these sound pulses varied from round to round. In the majority of cases it was somewhat lower than that of Figure 10. The general negative trend of sound pressure after sound pulse (pt 3) was more consistent, representing the eventual decrease of propellant gas discharge from the weapon. In general, the relatively uncluttered sound scope trace of the silenced caliber .22 pistol correlated well with its quiet performance.

Caliber .22 Silenced AAI Experimental Test Fixture

The AAI caliber .22 silenced test fixture (Figures 11, 12, 13, and Table III) was designed by Aircraft Armaments, Incorporated, in 1965. The study was conducted as part of a Frankford Arsenal contract issued to investigate unconventional use of small arms.

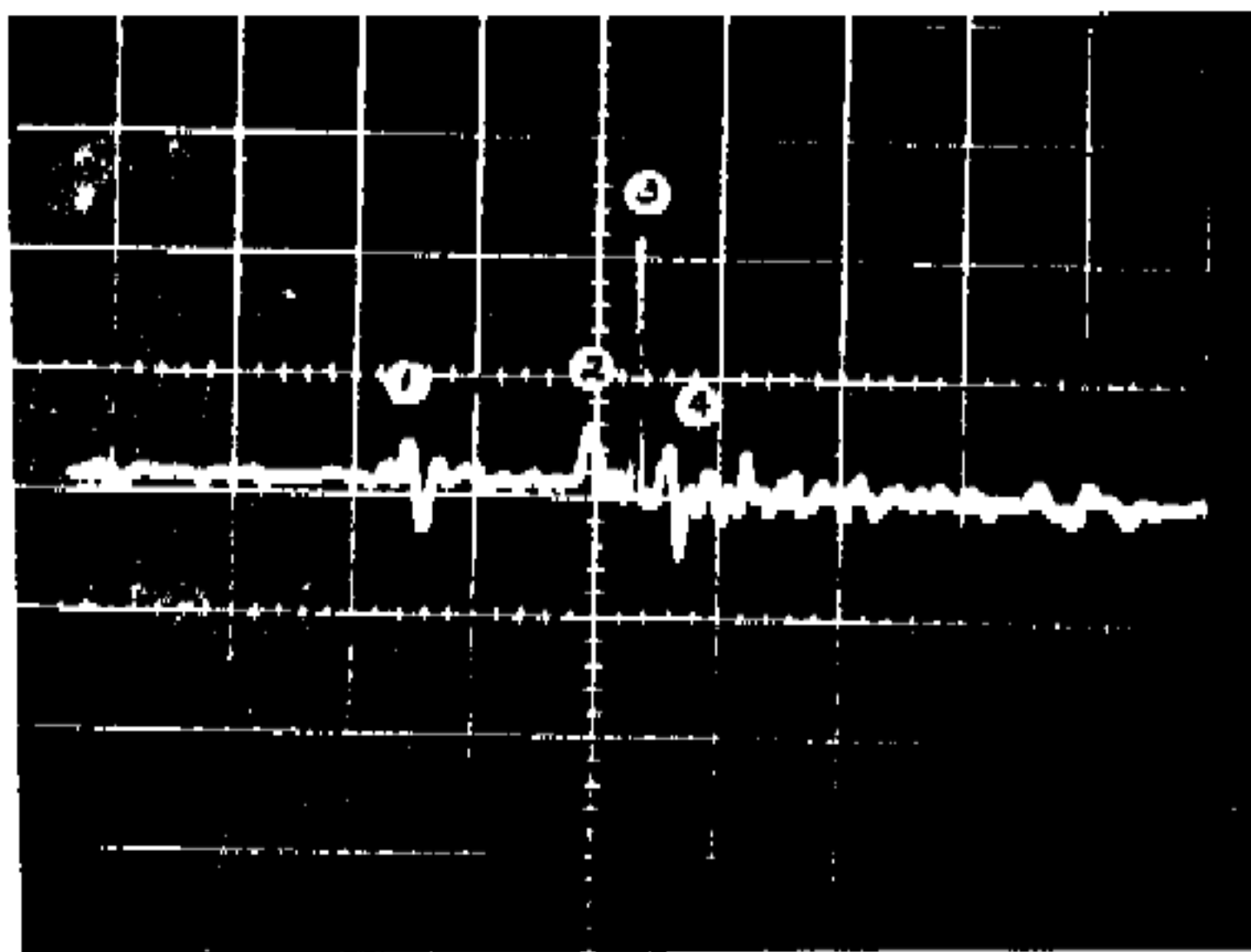

$x = 45 \mu\text{bars/cm}$

$y = 0.5 \text{ ms/cm}$

1 cm - 1 major division

Microphone: B&K 4135

- | | | |
|---|--|------------------------|
| ① | Primer Initiation | $L_1 = 98 \text{ db}$ |
| ② | Bleed hole Blow-by Exit from Silencer | $L_2 = 101 \text{ db}$ |
| ③ | Projectile Exit from Silencer | $L_3 = 113 \text{ db}$ |
| ④ | Propellant Gas Discharge Turbulence and Reverberations within Silencer | $L_4 = 99 \text{ db}$ |

Figure 10. Sound Pressure-Time History, five meters to side, Caliber .22 Silenced Hi-standard Pistol, Using Long Rifle Cartridge

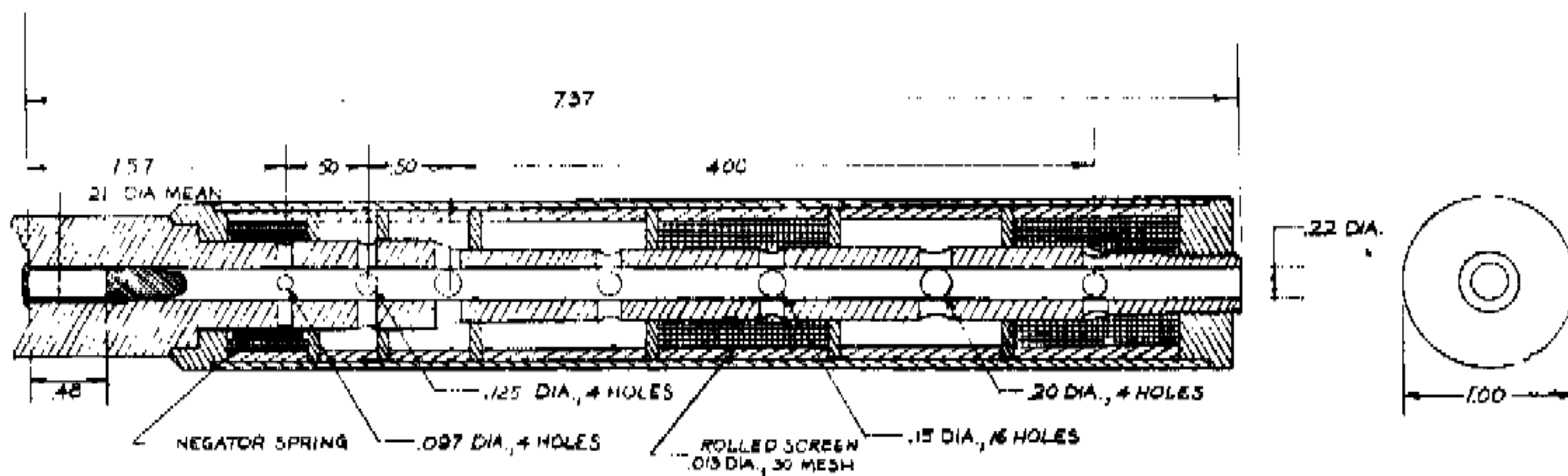

Figure 11. Cross section, Caliber .22 Silenced AAI Experimental Test Fixture

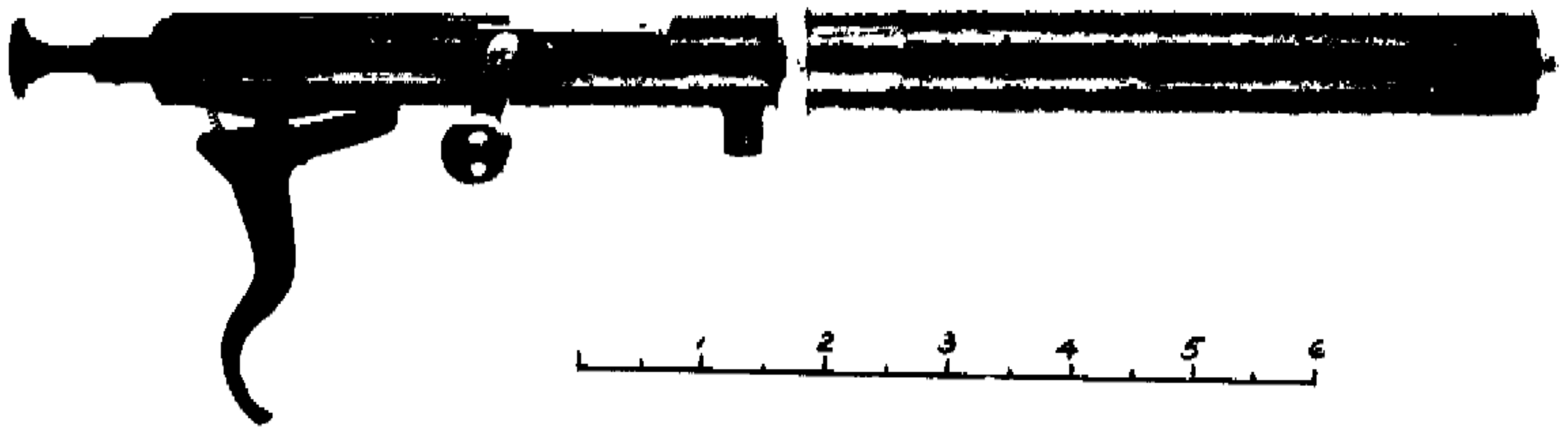

Figure 12. Caliber .22 Silenced AAI Experimental Test Fixture

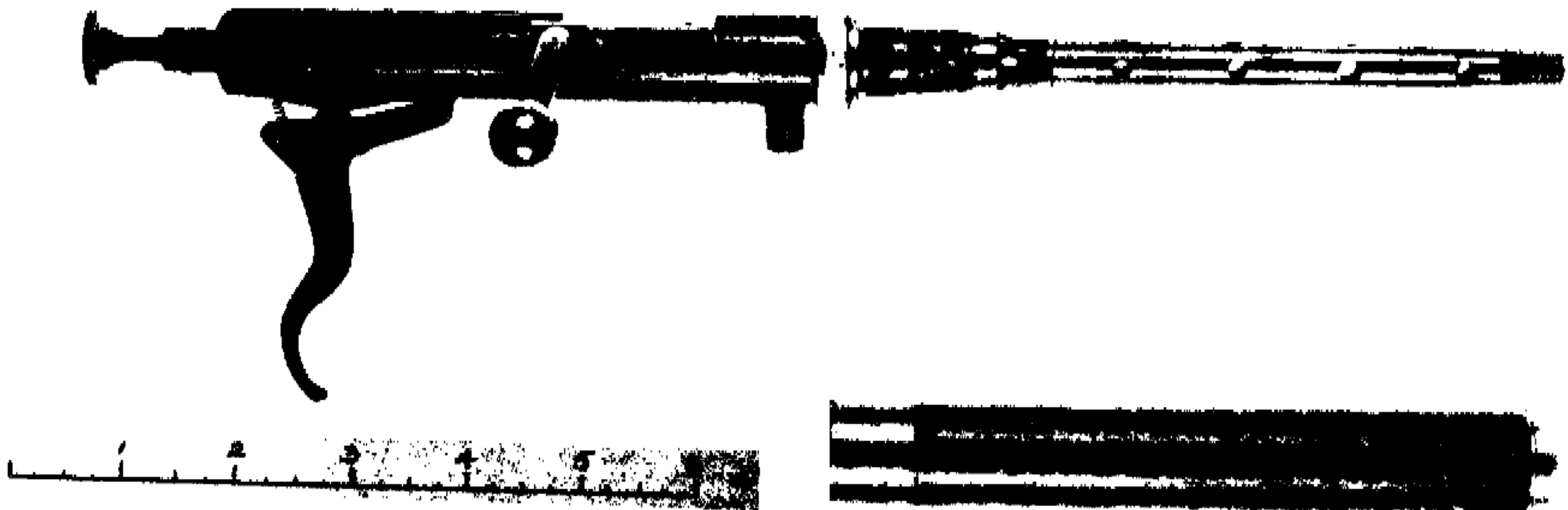

Figure 13. Caliber .22 Silenced AAI Experimental Test Fixture, Disassembled

TABLE III. Caliber .22 Silenced AAI Experimental Test Fixture

Projectile	
Weight	40 gr
Diameter	0.225 in.
Velocity (at silencer exit)	990 fps
Energy (at silencer exit)	88 ft-lb
Travel at peak ballistic pressure (estimated)	0.4 in.
Travel in barrel	6.9 in.
Travel time in barrel (estimated)	0.72 ms
Propellant	
Weight (double base, flake, web ~ 0.003 in.)	1.7 gr (+ 0.2 gr primer)
Chamber volume	0.016 in.
Ballistic pressure	
Peak	24,000 psi
At barrel muzzle (estimated)	130 psi
Silencer	
Outside diameter	1.0 in.
Length	6.5 in.
Weight (excluding action and gun barrel)	0.5 lb
Free volume (including gun barrel holes)	4.69 in. ³
Total fixture and silencer weight	1.5 lb

The AAI fixture is essentially a caliber .22 single shot rifle action with a 7-inch barrel. The barrel has a total of 28 holes of various diameters drilled along its length. The first four holes are enclosed by a section of a Negator spring, presumably to give adaptability to both the Short and the Long Rifle cartridges. Surrounding the barrel is a silencing tube which forms an expansion space for the propellant gas escaping through the barrel bleed holes. The expansion space is divided by six baffles which isolate each set of bleed holes

and thus prevent excessive blow-by. Some chambers surrounding the bleed holes contain rolled steel wire mesh, presumably intended to cool the expanding gases.

The performance of the AAI silenced fixture is simple in principle. As the projectile travels down the barrel, the propellant gas bleeds off through the barrel holes and expands into the space around the gun barrel. The expansion of propellant gas is accompanied by a reduction in the ballistic pressure behind the projectile. By the time the projectile exits from the barrel, the propellant gas pressure has been reduced to that dictated by the total expansion space (and slight heat absorption). The lower pressure behind the projectile at exit results in a lower initial propellant gas discharge sound pulse.

The advantage of this design is that with proper sizes, number, and placement of bleed holes, both the precursor and the blow-by sound pulses can be minimized. The system's disadvantages are: (1) the premature propellant gas bleeding results in a reduction of projectile velocity; (2) the eventual abrupt uncorking of the barrel is acoustically undesirable; and (3) the projectile (especially a lead projectile) is susceptible to deformation and erosion by propellant gases if bleeding is accomplished too abruptly or while the gas pressure is still high.

The sound pressure-time history of the AAI test fixture is shown in Figure 14. The trace was recorded five meters directly to the side of the weapon. As with the silenced Hi-standard pistol, the first sound pulse (pt 1, Figure 14) recorded corresponded to the time of firing pin fall. The peak SPL of this pulse was 93 db. Since the time between this event, primer explosion, and gas leakage around the cartridge was small, the three events are not readily distinguishable on the scope trace. However, the pulse due to leakage around the cartridge seems to be in the vicinity of 103 db.

The second and loudest sound pulse (pt 2) was due to gas leakage from the joint between the silencer tube and fixture breech. The gas leakage, occurring as soon as the projectile passed the first set of barrel bleed holes, resulted in a peak SPL of 116 db. This sound pulse could be eliminated by a tighter fit between the tube and breech.

The next pulse (pt 3) was due to exiting of the precursor wave and the propellant gases which found their way through the bleed holes ahead of the projectile. This sound pulse was relatively small, with a peak

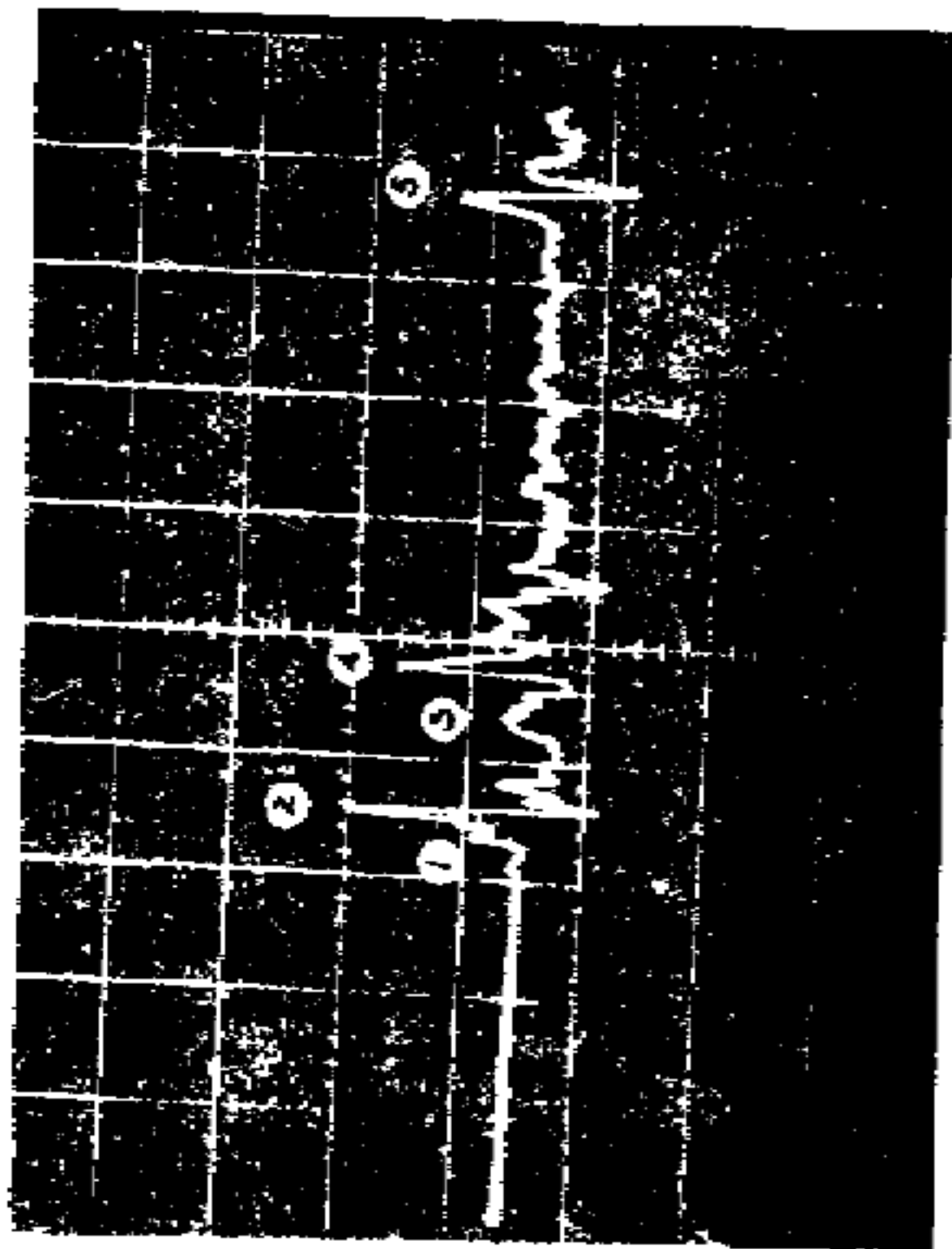

$y = 78 \mu\text{bars/cm}$
 $x = 0.5 \text{ ms/cm}$
 1 cm = 1 major division
 Microphone: B&K 4135

- | | |
|--|------------------------|
| ① Primer Initiation | $L_1 = 93 \text{ db}$ |
| ② Gas Leakage from Silencer Tube Base
(through initial bleed holes) | $L_2 = 116 \text{ db}$ |
| ③ Precursor and Blow-by Exit from Muzzle
(via bleed holes) | $L_3 = 101 \text{ db}$ |
| ④ Projectile Exit from Muzzle | $L_4 = 114 \text{ db}$ |
| ⑤ Ground Reflection | |

Figure 14. Sound Pressure-Time History, five meters to side, Caliber .22 Silenced AAI Experimental Test Fixture, Using Long Rifle Cartridge

SPL of 101 db. Shortly after the precursor and blow-by, the projectile exited. This resulted in the main efflux of gases from the muzzle and the consequent blast pulse (pt 4) of 114 db peak SPL. Following this initial blast pulse were the various sound pulses emitted from the muzzle due to the reverberations within the barrel and the silencer. The last sound pulse (pt 5) was a ground reflection of the pulse due to gas leakage at the silencer tube base. As can be seen, reflection of the sound pulse from the ground (sand and sparse grass) occurred with almost negligible attenuation.

Caliber .22 Hi-standard Pistol/ FA Silencer

The experimental silencer shown in Figures 15 through 17 was designed by two Frankford Arsenal employees in 1967. It evolved concurrently with the availability of low cost porous metal machining stock. The porous metal manufacturing techniques, which only recently were refined, consist of casting the molten metal over a salt configuration and dissolving the salt after the metal hardens. Presently, a number of metals can be cast into almost any porosity, density, or shape. The silencer described herein is probably a fair representative of its type.

The caliber .22 Frankford Arsenal silencer was tested with the same Hi-standard pistol used for evaluation of the French silencer. It is all-aluminum, and measures 1.4 inches in diameter and 6.5 inches in length. The silencer is machined from stock which is partially solid and partially porous (see Figures 15 through 17 and Table IV). Outside, the porous section of the silencer is wrapped with electrical tape, which limits the propellant gas discharge to only the 0.23 in. diameter projectile exit at the silencer muzzle. Inside, the silencer consists of three chambers of different lengths and diameters.

The outstanding characteristics of the caliber .22 Frankford Arsenal silencer are small weight, low manufacturing cost, and relatively quiet acoustical performance. The undesirable features of the silencer are its bulkiness and high erosion rate. Other physical and functional characteristics of the tested silencer are listed in Table IV.

The general acoustical performance of the Frankford Arsenal silencer can be surmised from the sound scope trace shown in Figure 18

32

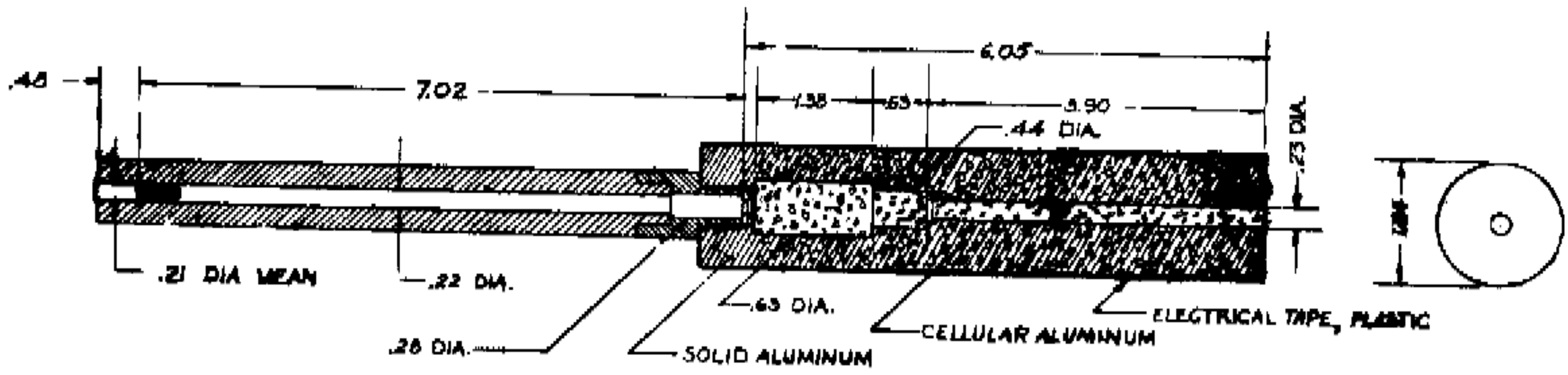

Figure 15. Cross section, Caliber .22 Hi-standard Pistol/FA Silencer

33

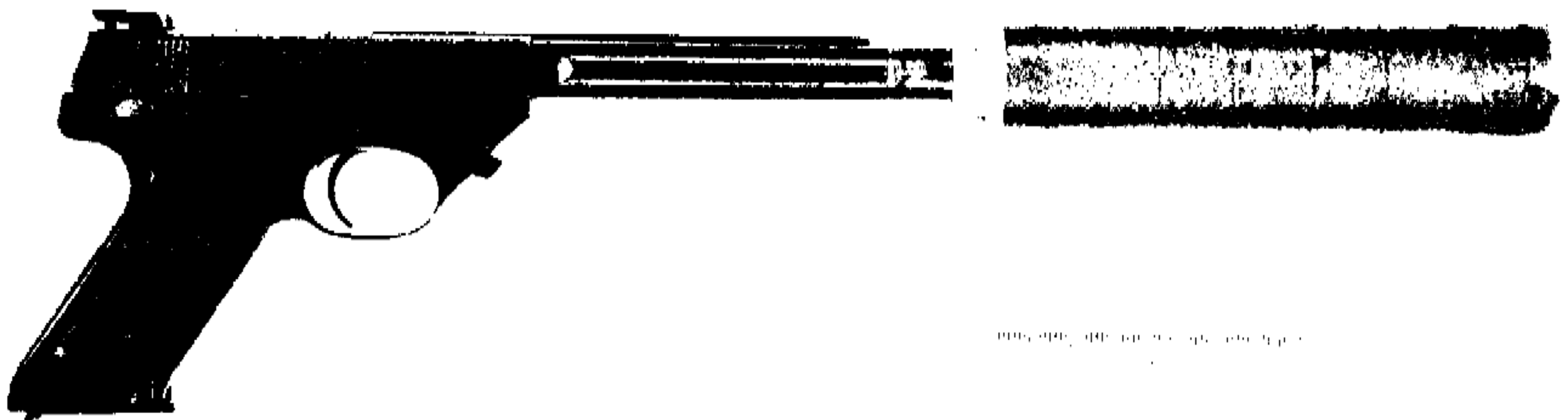

Figure 16. Caliber .22 Hi-standard Pistol/FA Silencer

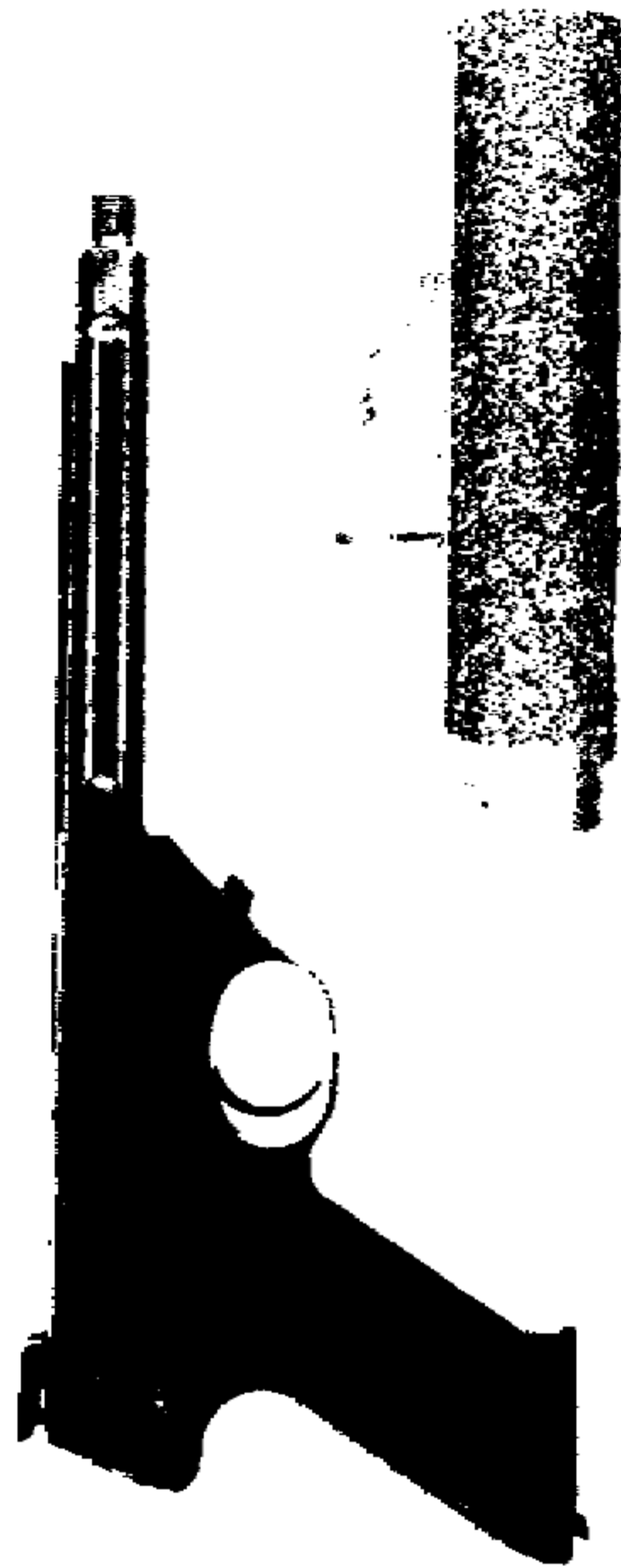

Figure 17. Caliber .22 Hi-standard Pistol and FA Silencer (with Tape Removed), Disassembled

TABLE IV. Caliber .22 Hi-standard Pistol/FA Silencer

Projectile	
Weight (Long Rifle)	40 gr
Diameter	0.225 in.
Velocity (at silencer exit)	1050 fps
Energy (at silencer exit)	98 ft-lb
Travel at peak ballistic pressure (estimated)	0.4 in.
Travel in barrel	7.0 in.
Travel time in barrel	0.65 ms (approx)
Travel time in silencer	0.47 ms
Propellant	
Weight (double base, flake, web ~ 0.003 in.)	1.7 gr (+ 0.2 gr primer)
Chamber volume	0.016 in. ³
Ballistic pressure	
Peak	24,000 psi
At barrel muzzle (estimated)	1,000 psi
Silencer	
Passage diameter (for projectile)	0.23 in.
Weight	0.47 lb
Total free volume	5.6 in. ³
Total pore volume	4.9 in. ³
Mean pore diameter (approx)	0.04 in. ³
Porous aluminum density	0.043 lb/in. ³
Pistol weight (without silencer)	2.75 lb
Time between precursor and projectile exits from silencer (estimated)	0.90 ms



y = 20 μ bars/cm

x = 0.5 ms/cm

1 cm = 1 major division

Microphone: B&K 4135

- | | |
|---------------------------------------|-------------------------|
| ① Primer Initiation | L ₁ = 103 db |
| ② Precursor Exit from Silencer | L ₂ = 89 db |
| ③ Blow-by Exit from Silencer | L ₃ = 108 db |
| ④ Projectile Exit from Silencer | L ₄ = 100 db |
| ⑤ Primer Initiation Ground Reflection | |

Figure 18. Sound Pressure-Time History, five meters to side, Caliber .22 Hi-standard Pistol/FA Silencer, Using Long Rifle Cartridge

(see Figures 3, 4, and 6 for sound scope traces of the pistol without silencer). The main sound sources of the silenced pistol were primer initiation (pt 1, Figure 18), blow-by (pt 3), and gas discharge following projectile exit (pt 4). The noise due to precursor (pt 2) was relatively insignificant. The primer initiation sound pulse (as previously described) occurred due to gas leakage around the cartridge case. The peak SPL of this pulse was 103 db. The next and largest sound pulse was that due to the exit of propellant gases which by-passed the projectile. This pulse had a peak SPL of 108 db. The projectile exited approximately 0.4 ms after the blow-by. The gas efflux following the projectile exit gave rise to a sound pulse of 100 db peak SPL.

In general, the sound signature of the caliber .22 pistol with Frankford Arsenal silencer could be described as a relatively mild, muffled hand clap. The system sounded somewhat quieter than the silenced Hi-standard pistol.

Caliber .30 M1903 Rifle/Maxim Silencer

The all metal caliber .30 Maxim silencer herein described was designed by H. P. Maxim. The first versions of this U. S. silencer were patented and manufactured commercially in 1909. At the time, the use of the Maxim silencer was considered by the Army, and issue of two silencers per platoon was recommended for training recruits. However, due to the ballistic crack of the supersonic round, the Maxim silencer, as well as several other designs, never found wide application. It is doubtful if, at that time, the use of a modified (subsonic) cartridge was given much consideration except for special missions.

The Maxim silencer version recently tested at Frankford Arsenal (see Figures 19 through 22 and Table V) is the "Model 15" supposedly issued to National Guard units during World War I. It is approximately 9 inches long and 1 inch in diameter. The silencer is 0.16 inch eccentric with respect to the rifle bore. It attaches to the military Springfield rifle by an end nut and two tapering half-sleeves. The front rifle sight must be removed and replaced during the mounting operation. Inside, the Maxim silencer is composed of an initial expansion chamber followed by 19 equally spaced baffles. The baffles are indented rearward and off-center from the silencer and the rifle bore axes.

38

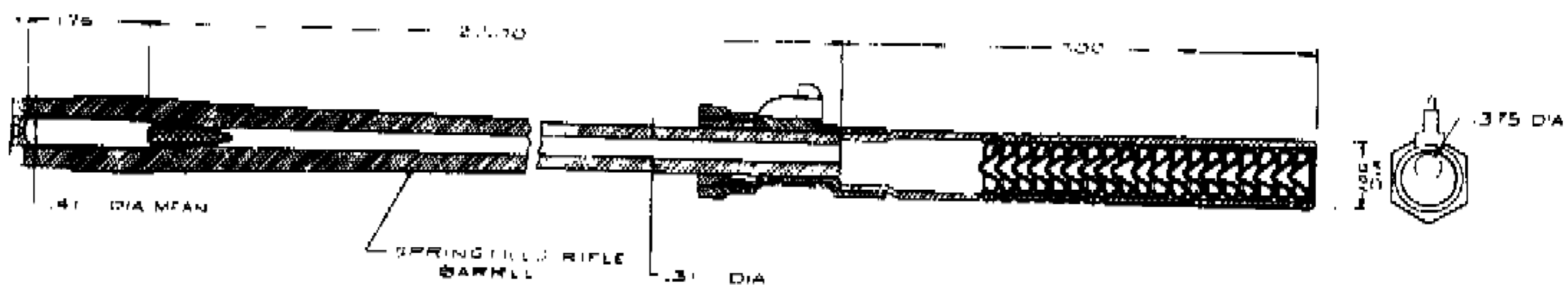

Figure 19. Cross section, Caliber .30 M1903 Rifle/Maxim Silencer

39

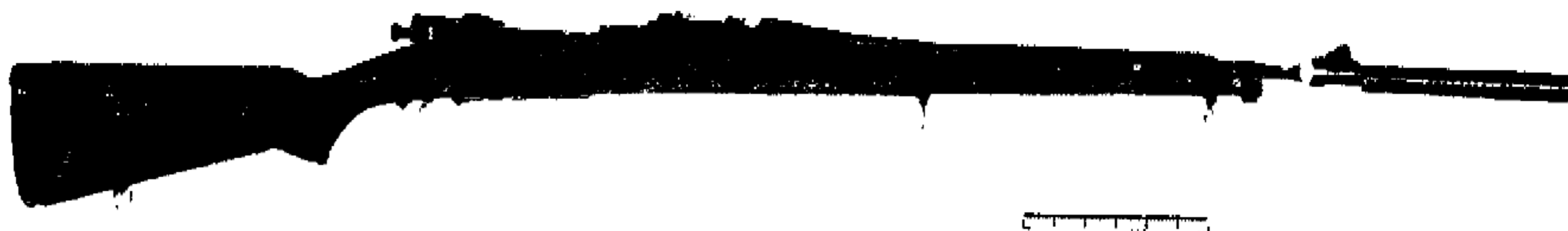

Figure 20. Caliber .30 M1903 Rifle/Maxim Silencer



Figure 21. Maxim Silencer for Caliber .30 M1903 Rifle

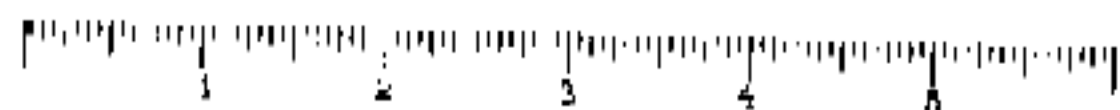

Figure 22. Maxim Silencer for Caliber .30 M1903 Rifle, Disassembled

TABLE V. Caliber .30 M1903 Rifle/Maxim Silencer

Projectile	
Weight (Match)	175 gr
Diameter	0.309 in.
Velocity (at silencer exit)	1050 fps
Energy (at silencer exit)	431 ft-lb
Travel at peak ballistic pressure (estimated)	0.4 in.
Travel in barrel	22.0 in.
Travel time in barrel	2.3 ms (approx)
Travel time in silencer	0.56 ms
Propellant	
Weight (M9 double base, flake, web ~ 0.003 in.)	7.6 gr (+ 0.5 gr primer)
Chamber volume	0.30 in. ³
Ballistic pressure	
Peak	20,000 psi
At barrel muzzle (estimated)	1,000 psi
Silencer	
Passage diameter (for projectile)	0.375 in.
Weight	0.63 lb
Free volume	4.0 in. ³
Outside diameter	1.0 in.
Length (beyond gun barrel)	7.0 in.
Rifle weight (without silencer)	9 lb
Time between precursor and projectile exits from silencer (estimated)	1.44 ms

The Maxim silencer baffle configuration induces the gases, propagating down the silencer, into a vortical spin. No data seem to be available on the actual effectiveness of the principle. However, it is conceivable that pressures at the silencer projectile passage could thus be substantially reduced. The Maxim silencer's acoustical performance (Figure 25) is much better than would be expected from its clearances, volume, and length alone. Thus, some effectiveness must be attributed to the silencer's eccentricity and the askew baffles. However, the value of the vortical spin principle still remains questionable.

Figure 23 shows the sound pressure history of the caliber .30 M1903 rifle without the silencer, using a subsonic cartridge. As can be seen from the scope trace, the main sound sources are precursor shock (pt 2, Figure 23) and propellant gas discharge following the projectile exit (pt 3). The corresponding SPL of these pulses are, respectively, 119 and 137 db five meters to the side of the weapon.

The sound pressure-time history of the M1903 rifle with the Maxim silencer and subsonic cartridge is shown in Figures 24 and 25. The system's main noise sources are primer initiation, precursor shock, blow-by, and propellant gas discharge after projectile exit. The primer initiation noise, from firing pin fall to the first muzzle sound, is shown in Figure 24. The absence of the usually high initial positive sound pulse suggests that gas leakage around the cartridge case is very low and that most of the system's initial noise is mechanical. Sound pulses due to the blow-by and the propellant gas discharge after projectile exit are shown more distinctly in Figure 25. Here the blow-by and gas discharge pulses are, respectively, 102 and 112 db peak SPL. Following these pulses, there is a prolonged, seemingly random, noise of approximately 102 db peak SPL due to gas discharge turbulence and reverberations inside the silencer.

The general sound history and apparent loudness of the tested Maxim silencer are comparable to the better silenced systems. This is especially significant in view of the relatively high projectile energy (431 ft-lb) and velocity (1050 fps). Combining this with the silencer's adaptability to standard weapons, its relatively small size, and its construction (requiring no maintenance or replacement of parts), the WW I Maxim silencer is one of the better items tested at Frankford Arsenal.

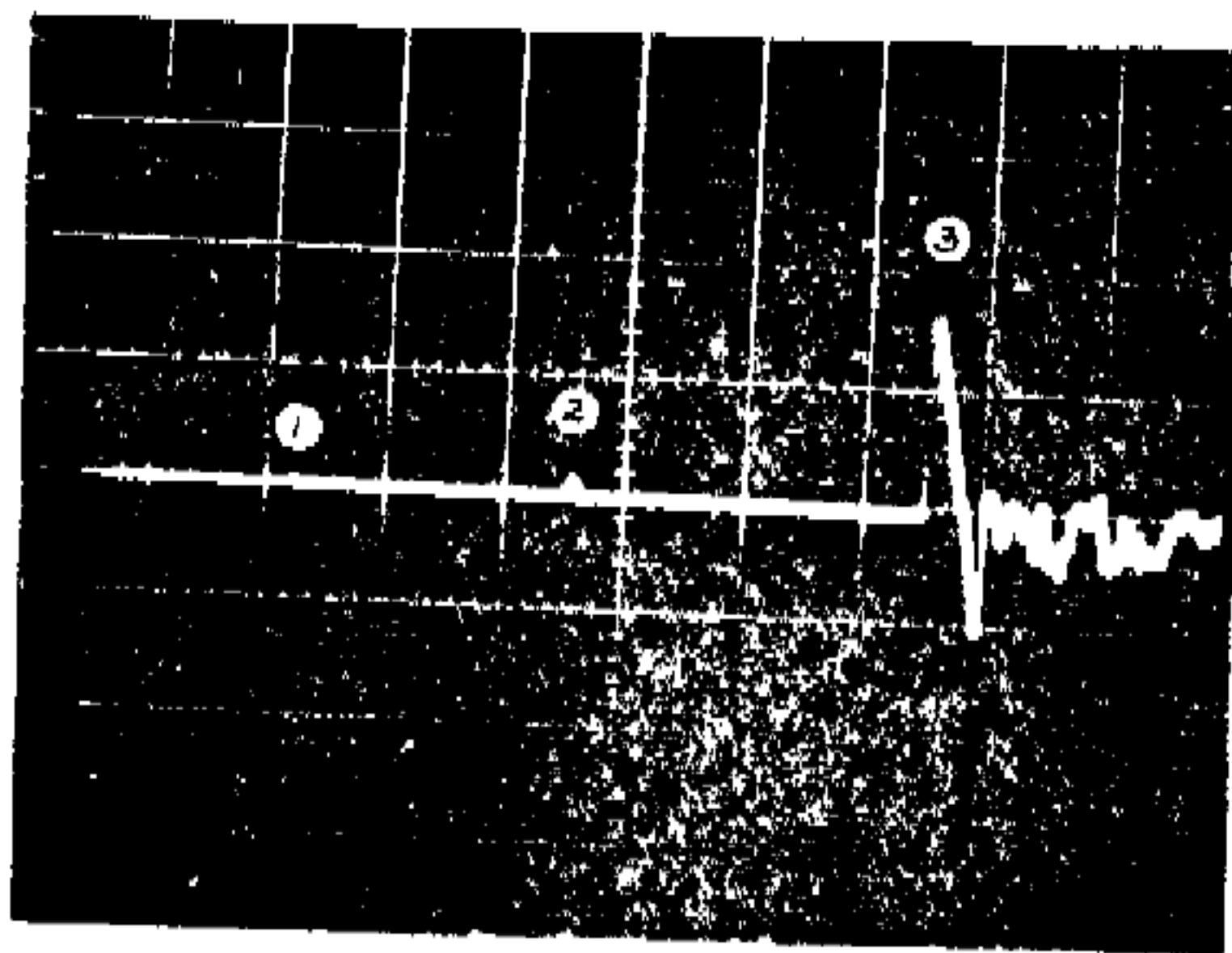

$$y = 896 \mu\text{bars/cm}$$

$$x = 0.5 \text{ ms/cm}$$

1 cm = 1 major division

Microphone: B&K 4135

- ① Primer Initiation
- ② Precursor Exit from Barrel
- ③ Projectile Exit from Barrel

$$L_1 \approx 93 \text{ db}$$

$$L_2 = 119 \text{ db}$$

$$L_3 = 137 \text{ db}$$

Figure 23. Sound Pressure-Time History, five meters to side, Caliber .30 M1903 Rifle (Unsilenced), Using Subsonic Cartridge

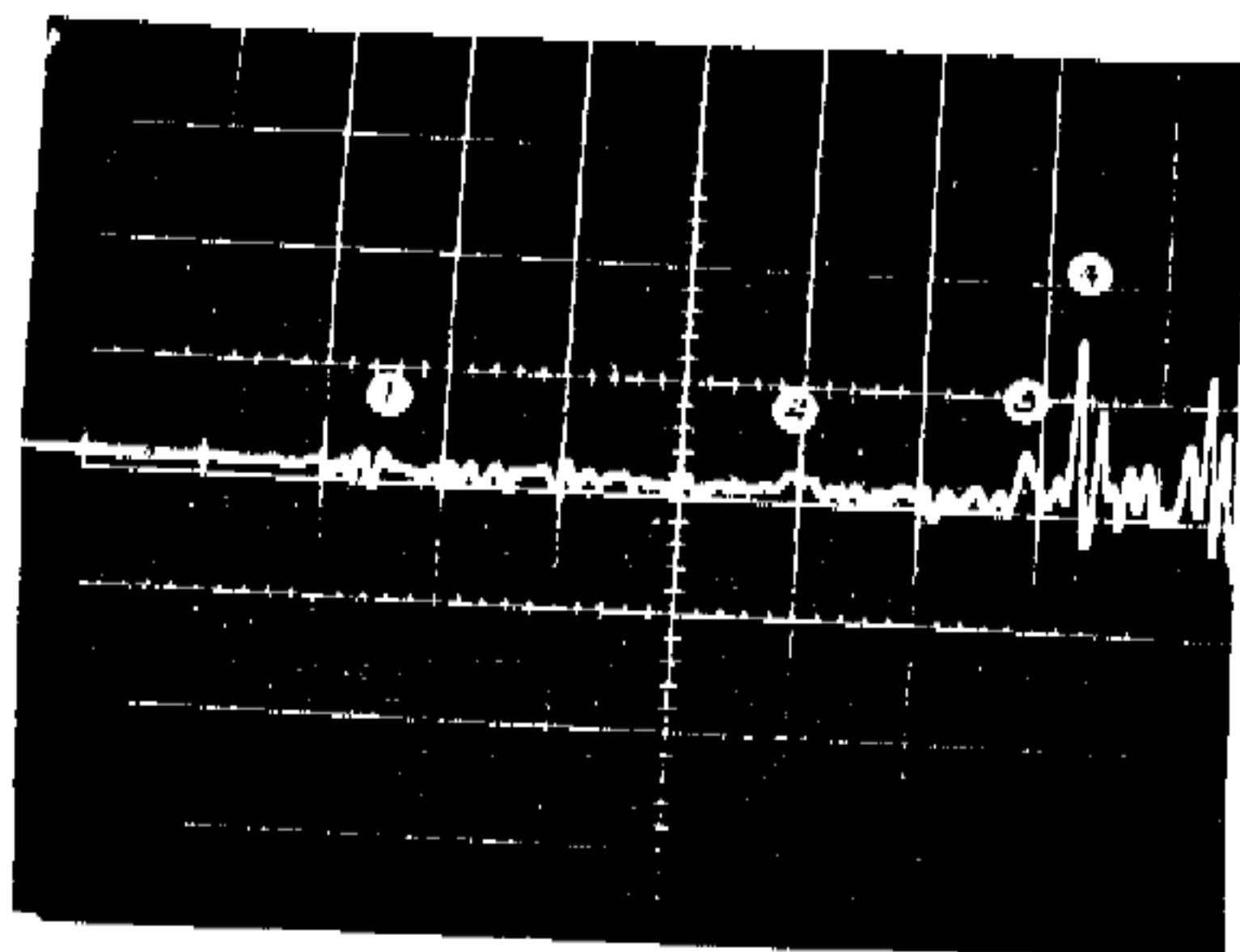

$$y = 43 \mu\text{bars/cm}$$

$$x = 0.5 \text{ ms/cm}$$

1 cm = 1 major division

Microphone: Altec BR 150

- ① Primer Initiation
- ② Precursor Exit from Silencer
- ③ Blow-by Exit from Silencer
- ④ Projectile Exit from Silencer

$$L_1 = 93 \text{ db}$$

$$L_2 = 93 \text{ db}$$

$$L_3 = 100 \text{ db}$$

$$L_4 = 113 \text{ db}$$

Figure 24. Sound Pressure-Time History, five meters to side, Caliber .30 M1903 Rifle/Maxim Silencer, Using Subsonic Cartridge

$y = 90 \text{ } \mu\text{bars/cm}$

$x = 0.5 \text{ ms/cm}$

1 cm = 1 major division

Microphone: B&K 4135

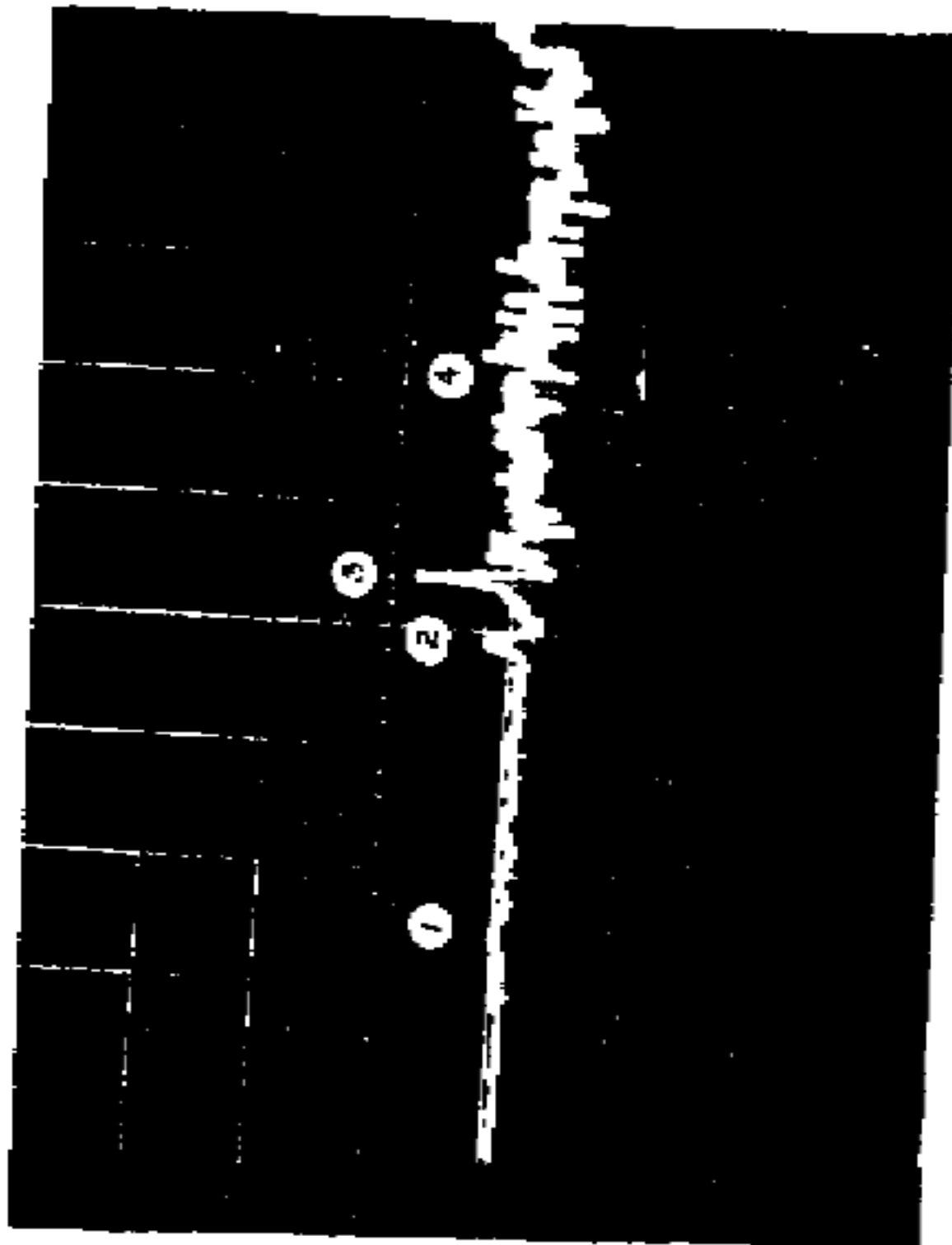

① Precursor Exit from Silencer

② Blow-by Exit from Silencer

③ Projectile Exit from Silencer

④ Propellant Gas Discharge Turbulence and Reverberations within Silencer

$L_1 = 93 \text{ db}$

$L_2 = 102 \text{ db}$

$L_3 = 112 \text{ db}$

$L_4 = 102 \text{ db (average)}$

Figure 25. Sound Pressure-Time History, five meters to side, Caliber .30 M1903 Rifle/Maxim Silencer, Using Subsonic Cartridge

Sound pressure-time history of the tested carbine, five meters to the side of the weapon, is shown in Figure 28. The main constituents of the noise are: primer initiation (pt 1, Figure 28), bleed-hole blow-by (pt 2), gun barrel muzzle blow-by (pt 3), blast immediately following projectile exit (pt 4), and continuous noise emitted from silencer after projectile exit (pt 5).

The primer initiation noise (barely visible on the trace) was approximately 94 db peak SPL and was primarily due to the hammer fall. The gas blow-by around the cartridge case seems relatively insignificant.

Following primer initiation, the first significant sound pulse (pt 2) was caused by the exit of the pressure wave generated by the gases finding their way out through the barrel bleed holes. This was a positive sound pulse of 112 db peak SPL. The secondary blow-by, which occurred at the gun barrel muzzle, exited the silencer approximately 0.6 ms after the bleed hole blow-by. This generated a positive sound pulse of 122 db peak SPL.

The projectile followed the secondary blow-by by about 0.4 ms. The immediate acoustical effects associated with the projectile exit (pt 4) are barely distinguishable from the scope trace. This is due to the masking effect of reverberations within the silencer and

The silenced M1 carbine (Figures 26 and 27 and Table VI) was developed in Enfield, England, about 1945. It is believed to have been designed for the Office of Strategic Services. The carbine is manually operated and takes standard supersonic ammunition. Because of its bulkiness, manual feeding, and not too impressive acoustical performance, it is doubtful if the weapon was widely utilized.

Since standard supersonic ammunition was to be used in the silenced carbine, seven holes of 0.125 inch diameter were drilled in the barrel close to the breech. This allowed the gases to be bled off through the holes, with a consequent reduction in ballistic pressure and projectile muzzle velocity. The original barrel length was also reduced to ten inches, presumably to minimize the final length of the carbine. The carbine's silencer surrounds and extends seven inches beyond the gun barrel. Inside, the silencer has a series of conical baffles, positioned throughout its whole length. The overall length and diameter of the silenced barrel are 17 and 1.4 in., respectively.

48

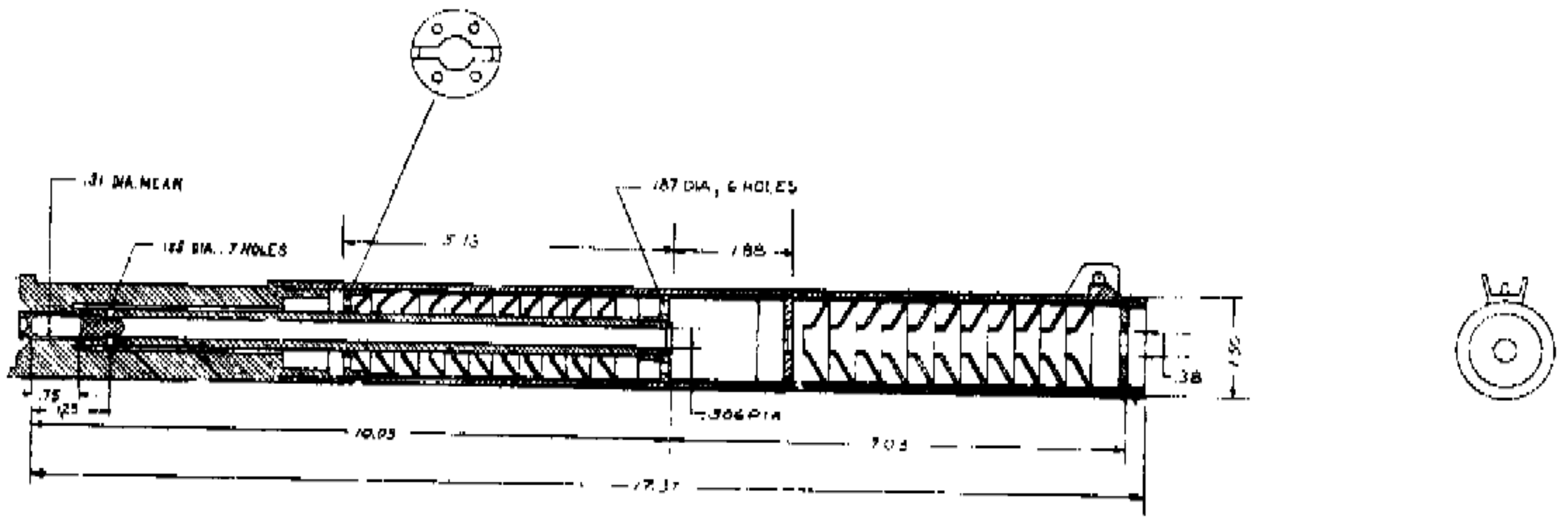

Figure 26. Cross section, Caliber .30 Silenced MI Carbine

49

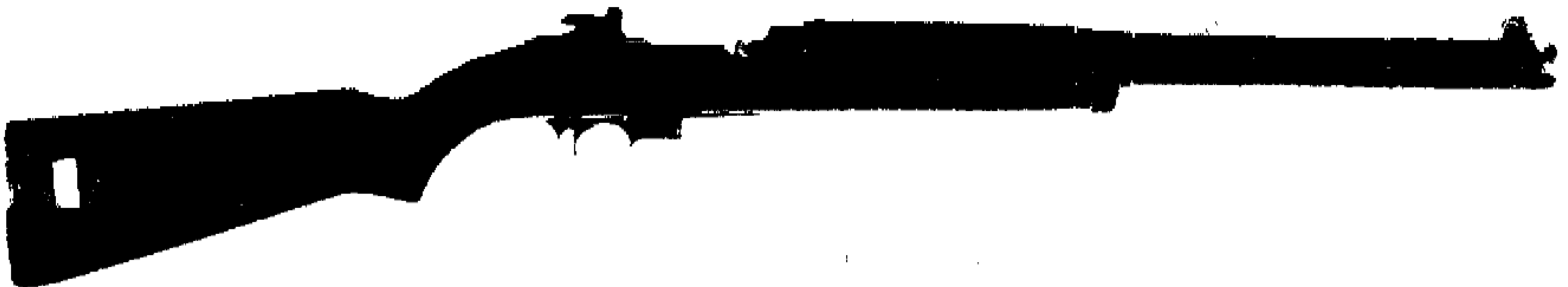
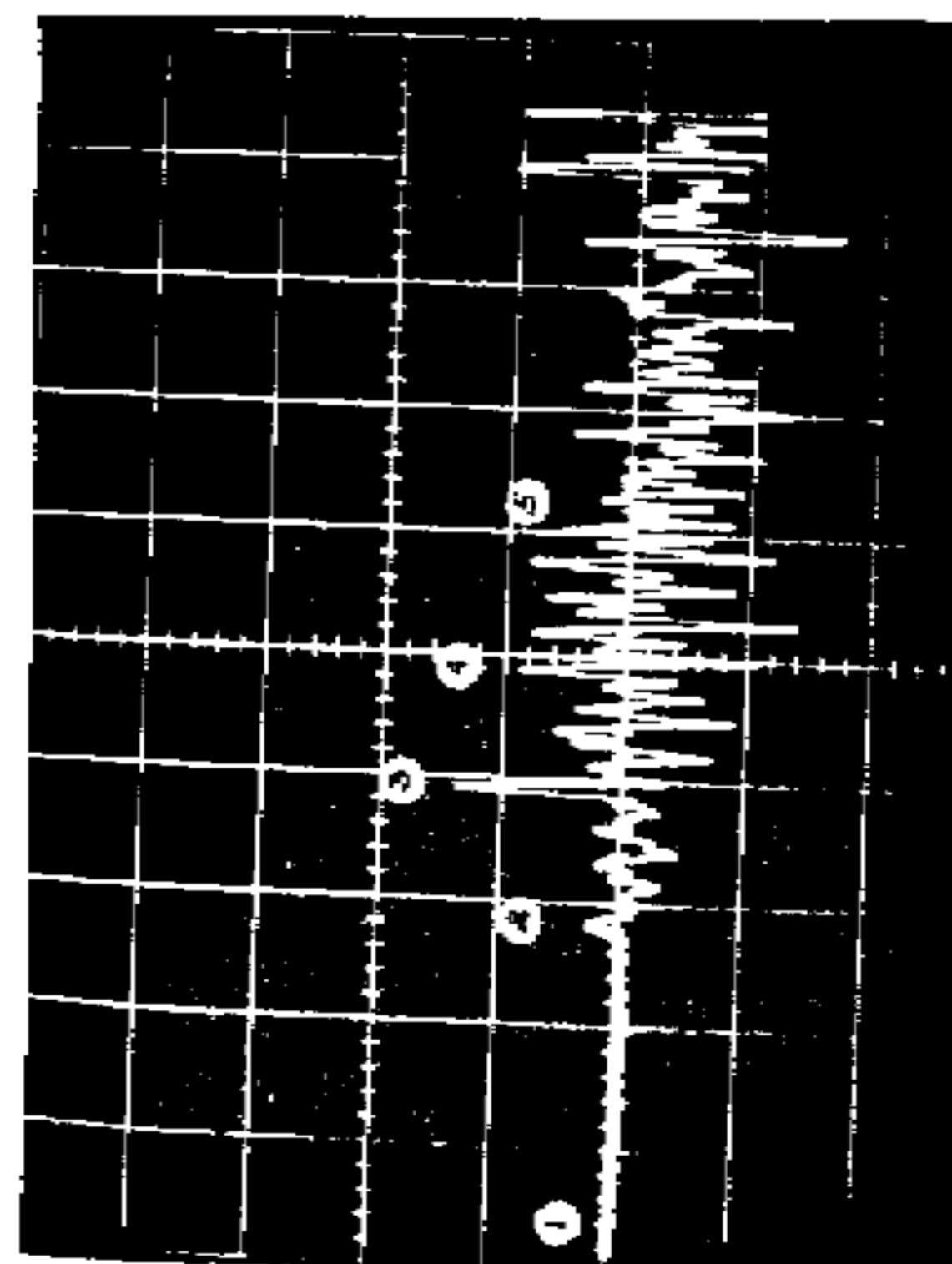

Figure 27. Caliber .30 Silenced MI Carbine

TABLE VI. Caliber .30 Silenced M1 Carbine

Projectile	
Weight	108 gr
Diameter	0.306 in.
Velocity (at silencer exit)	1058 fps
Energy (at silencer exit)	270 ft-lb
Travel at peak ballistic pressure (estimated)	0.5 in.
Travel in barrel	9.2 in.
Travel time in barrel	1.30 ms (approx)
Travel time in silencer	0.56 ms
Propellant	
Weight (WC820 double base, spherical granulation 0.013 by 0.009 in.)	13 gr (+ 0.3 gr primer)
Chamber volume	0.062 in. ³
Peak ballistic pressure	31,800 psi
Silencer	
Passage diameter (for projectile)	0.375 in.
Free volume	10.3 in. ³
Carbine weight (without magazine)	
Silenced	6.75 lb
Standard unsilenced	5 lb
Time between precursor and projectile exits from silencer (estimated)	0.41 ms

$y = 195 \mu\text{bars/cm}$
 $x = 0.5 \text{ ms/cm}$
 1 cm = 1 major division
 Microphone: B&K 4135



- ① Primer Initiation
- ② Bleed Hole Blow-by Exit from Silencer
- ③ Gun Barrel Muzzle Blow-by Exit from Silencer
- ④ Projectile Exit from Silencer
- ⑤ Propellant Gas Discharge Turbulence and Reverberations within Silencer

$L_1 \approx 94 \text{ db}$
 $L_2 = 112 \text{ db}$
 $L_3 = 122 \text{ db}$
 $L_4 = 119 \text{ db}$
 $L_5 \approx 118 \text{ db (average)}$

Figure 28. Sound Pressure-Time History, five meters to side, Caliber .30 Silenced M1 Carbine

discharge turbulence occurring at this time. An approximate value of 119 db peak SPL was assigned to the projectile exit pulse. Following the projectile exit from the silencer, there was a continuous noise of about 118 db peak SPL. This high frequency noise, which again can be attributed primarily to internal reverberations, persisted for several milliseconds. It is superimposed on a gradual trend into the negative sound pressure region. This, of course, signifies the eventual decrease of gas discharge from the weapon.

To a subjective listener, the firing of the silenced carbine sounded like a sharp hand clap followed by a distinct hissing sound.

Caliber .32 Silenced Sleeve Gun

Little is known about the origin and history of the silenced sleeve gun. It bears close similarity in design and workmanship (Figures 29 through 32 and Table VII) to the caliber .32 Welrod pistol. The sleeve gun is a single shot item, requiring considerable time for reloading. To reload and cock the weapon, the three rearmost threaded sections have to be disassembled. Independent operations are required for rechambering the cartridge and resetting the firing pin spring. The weight (1.7 lb) and general configuration of this gun suggest that it was also intended for use as a club.

Firing of the weapon is accomplished by moving a latch toward the weapon muzzle. A rod, attached to the latch and running along the top of the sleeve gun, releases the plunger holding the firing pin at the rear of the gun. At the base, the sleeve gun is provided with an eyelet, presumably for a string to support the weapon in a coat sleeve.

The internal configuration of the sleeve gun, except for dimensions, is exactly the same as that of the caliber .32 Welrod silenced pistol.* The 3.25 inch gun barrel contains a series of 20 holes, 0.063 inch in diameter, positioned in five rifling grooves. The holes lead into an expansion chamber formed by the tube surrounding the gun barrel. The tube also extends beyond the gun barrel muzzle by 2.85 inches, thus forming the forward silencer section. Inside, the silencer section contains a series of metal and rubber baffles which provide the silencing effect.

*See Figure 35.

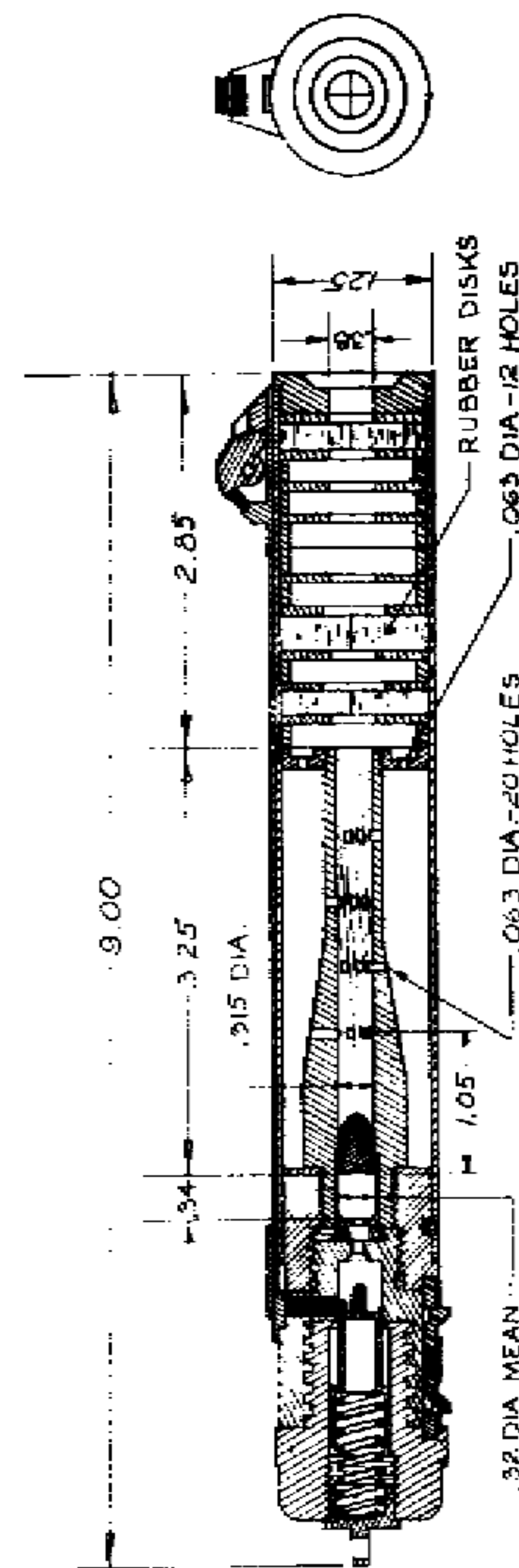

Figure 29. Cross section, Caliber .32 Silenced Sleeve Gun

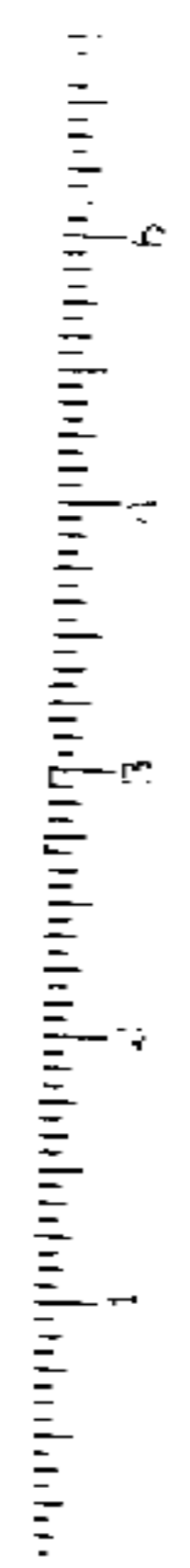

Figure 30. Caliber .32 Silenced Sleeve Gun, side view

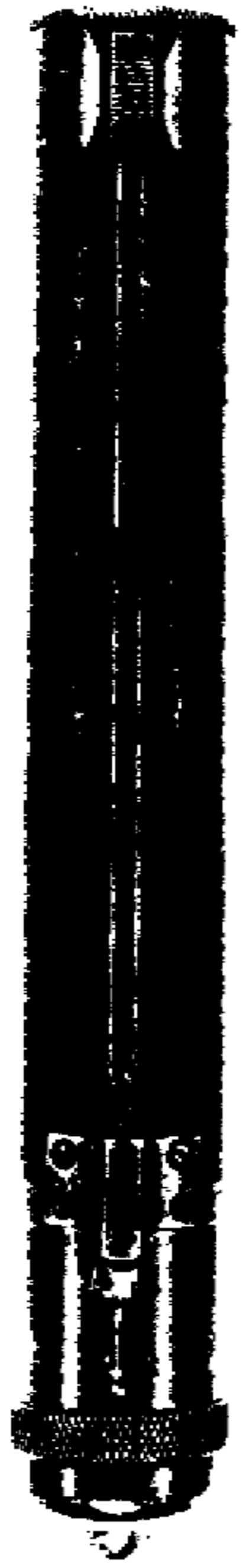

Figure 31. Caliber .32 Silenced Sleeve Gun, top view

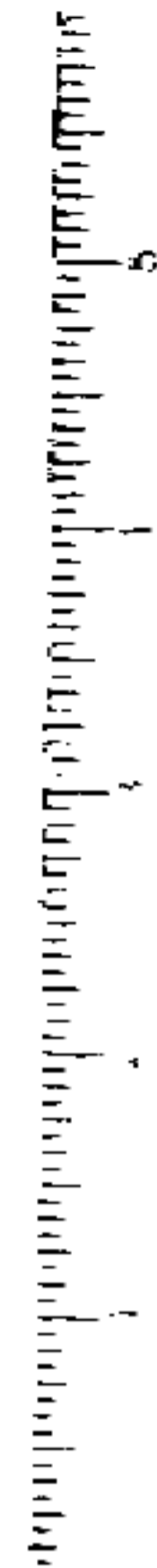

Figure 32. Caliber .32 Silenced Sleeve Gun, Disassembled

TABLE VII. Caliber .32 Silenced Sleeve Gun

Projectile	
Weight	77 gr
Diameter	0.315
Velocity (at silencer exit)	700 fps
Energy (at silencer exit)	82 ft-lb
Travel at peak ballistic pressure (estimated)	0.35 in.
Travel in barrel	3.25 in.
Travel time in barrel (estimated)	0.54 ms
Travel time in silencer	0.34 ms
Propellant	
Weight (Norma, ACP, double base, web ~ 0.003 in.)	3 gr (+ 0.3 gr primer)
Chamber	0.026 in.
Peak ballistic pressure	14,000 psi
Projectile passage diameter	
In steel baffle	0.38 in.
In old rubber baffles	0.25 in. (approx)
In new rubber baffles	X-slit
Free volume	
Around gun barrel	1.18 in. ³
In front silencer portion	1.2 in. ³
Total weapon weight	1.7 lb

When examined, the rubber baffles of the sleeve gun herein described were already old so that passage through them was approximately 0.25 inch in diameter. When new, the rubber baffles probably completely closed off the silencer cavity. Therefore, a record was also made with a new baffle containing only an X-slit through the center.

Figure 33 shows and identifies the various sound constituents of the tested caliber .32 sleeve gun with old baffles. The first small sound pulse on the trace (pt 1, Figure 33) corresponded to the time of primer initiation. This pulse, as well as other small pulses immediately following it, was approximately 87 db peak SPL (unpublished data), and was primarily due to firing pin fall. Gas leakage around the cartridge case seemed negligible.

The next significant sound pulse (pt 2) was emitted from the silencer muzzle. It was identified as the pressure wave due to the propellant gases exiting through the bleed holes and finding their way ahead of the projectile. The peak SPL of this pulse was 118 db, the same as that for the caliber .32 Welrod pistol.

The blow-by occurring at the gun barrel muzzle inside the silencer followed the bleed hole blow-by by about 0.25 ms. This pulse was 114 db peak SPL. The projectile exited approximately 0.3 ms later. The efflux of propellant gas immediately following the projectile resulted in a positive pulse (pt 4) of 126 db peak SPL. The positive sound pulse 0.2 ms after pt 4 was due to reverberation inside the weapon.

The sound scope trace of the sleeve gun with new rubber baffles is shown in Figure 34. As can be seen, practically all noise preceding and following projectile exit was eliminated by the new baffles. Also, the projectile noise was reduced to 120 dp peak SPL. In-general, the sleeve gun with old baffles sounded like a somewhat loud snap. Fired with new baffles, it sounded likewise snappy, but substantially quieter.

Caliber .32 Silenced Welrod Pistol

The caliber .32 pistol (Figures 35 and 36 and Table VIII) bears close resemblance to the 9 mm Welrod pistol* developed in Britain

*See Figures 38 and 39.

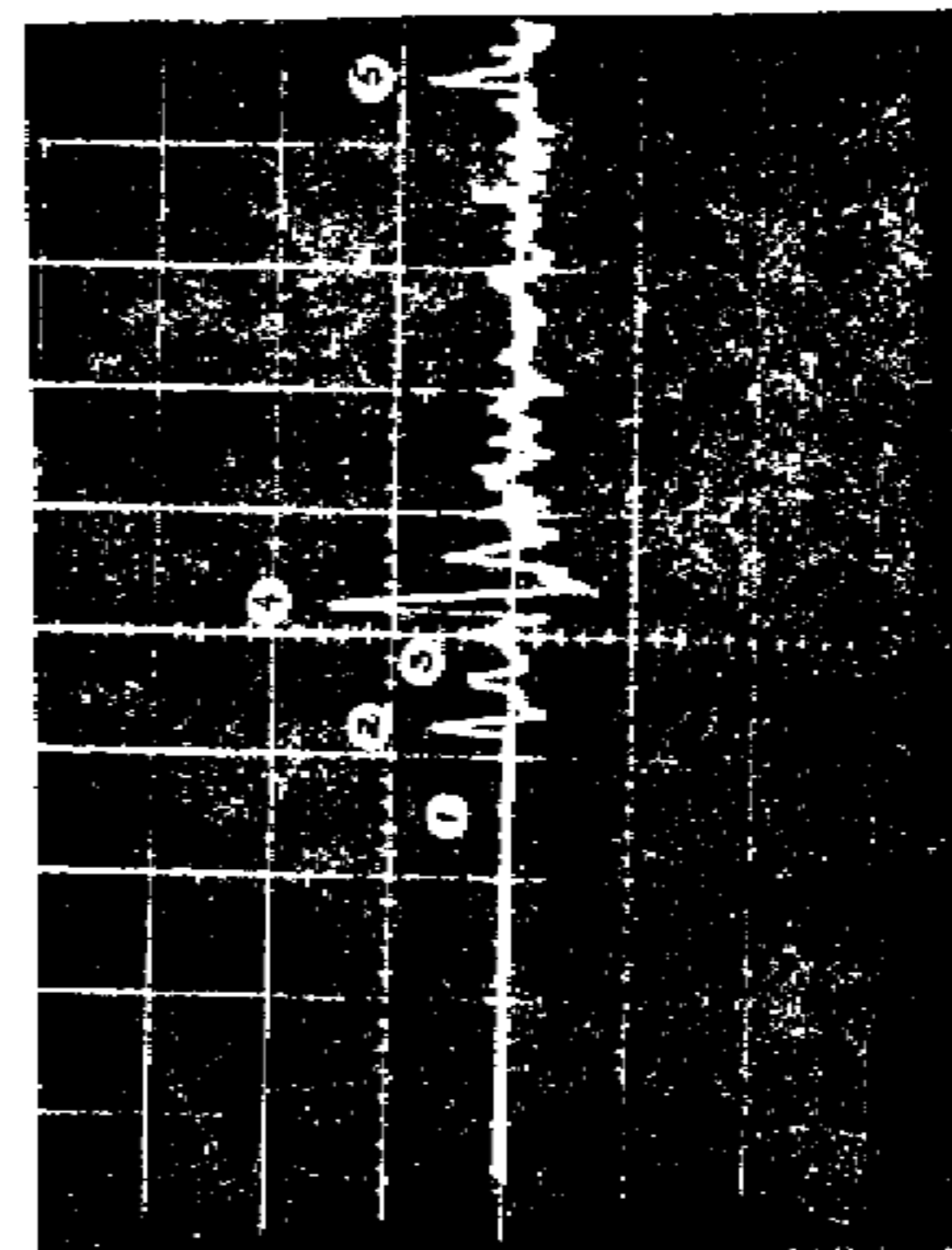

y = 270 μbars/cm

x = 0.5 ms/cm

1 cm = 1 major division

Microphone: B&K 4135

L1 ≈ 87 db
L2 = 118 db
L3 = 114 db
L4 = 126 db

- ① Primer Initiation
- ② Bleed Hole Blow-by Exit from Silencer
- ③ Gun Barrel Muzzle Blow-by Exit from Silencer
- ④ Projectile Exit from Silencer
- ⑤ Projectile Exit Ground Reflection

Figure 33. Sound Pressure-Time History, five meters to side, Caliber .32 Silenced Sleeve Gun with Old Rubber Baffles

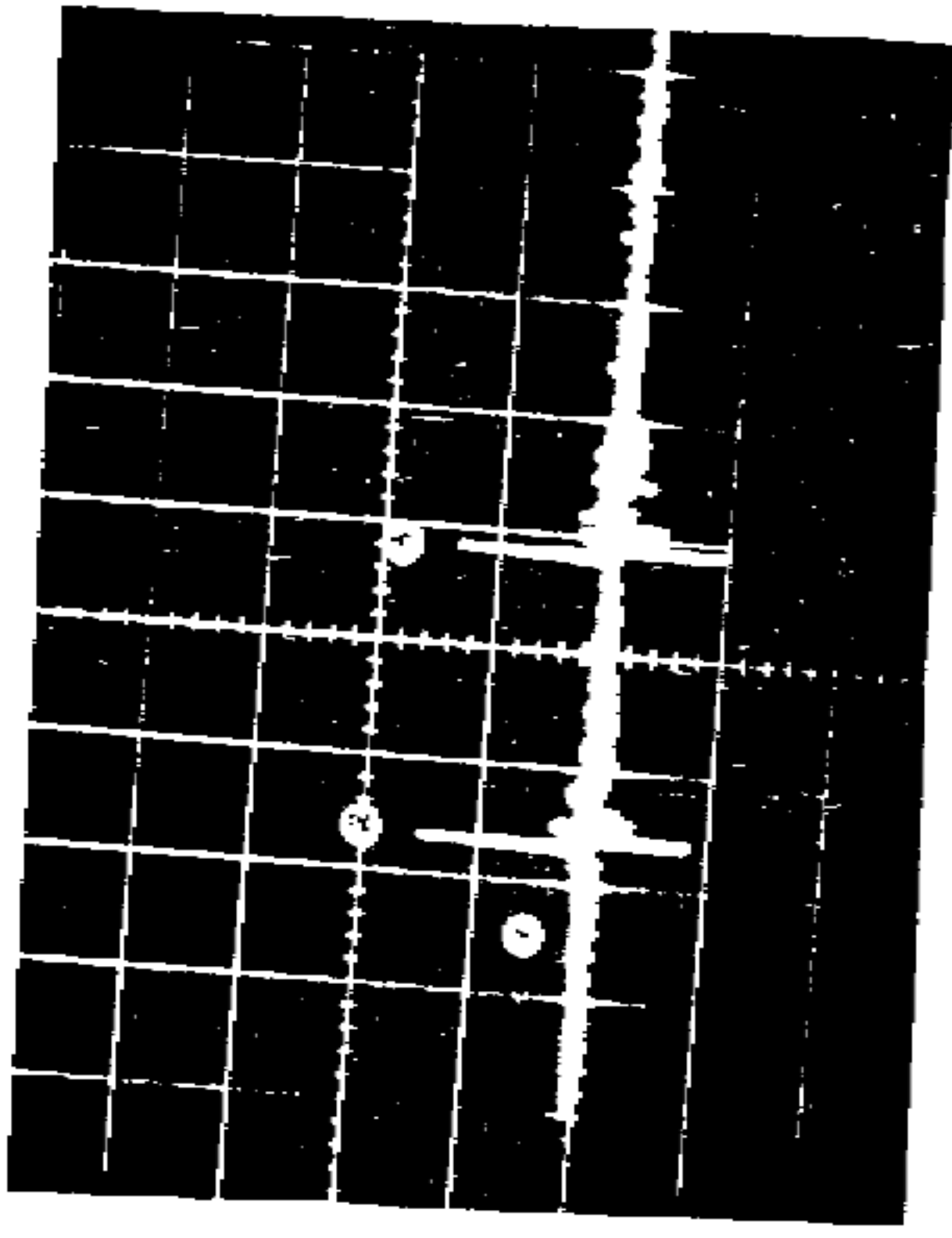

y = 195 μ bars/cm

x = 1 ms/cm

1 cm - 1 major division

Microphone: B&K 4135

- ① Primer Initiation
- ② Projectile Exit
- ③ Ground Reflection

L1 \approx 87 db

L2 = 120 db

Figure 34. Sound Pressure-Time History, five meters to side, Caliber .32 Silenced Sleeve Gun with New Rubber Baffles

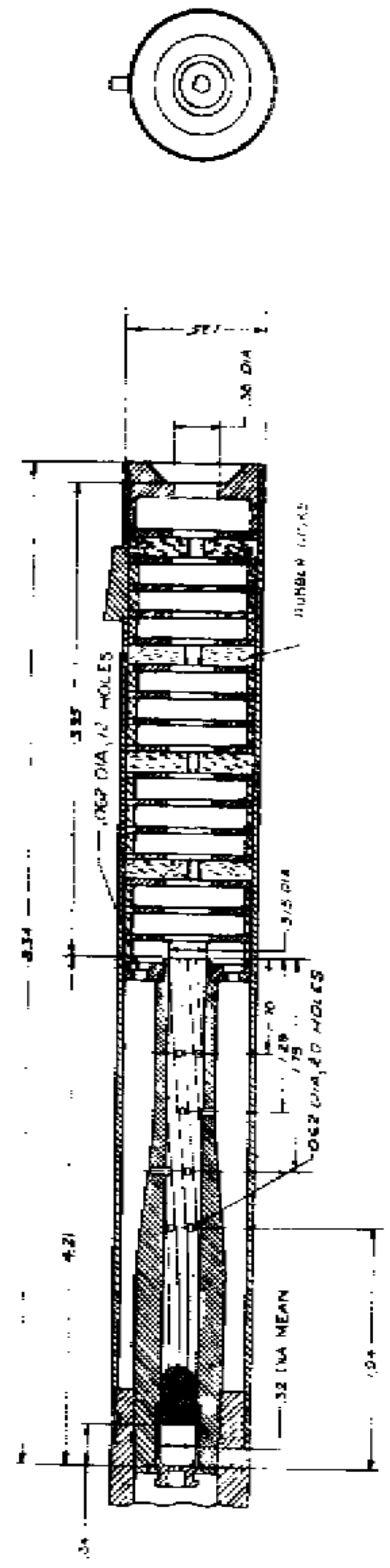

Figure 35. Cross section, Caliber .32 Silenced Welrod Pistol

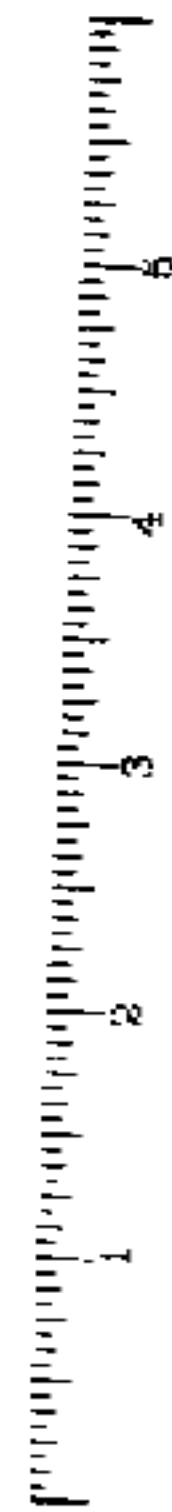
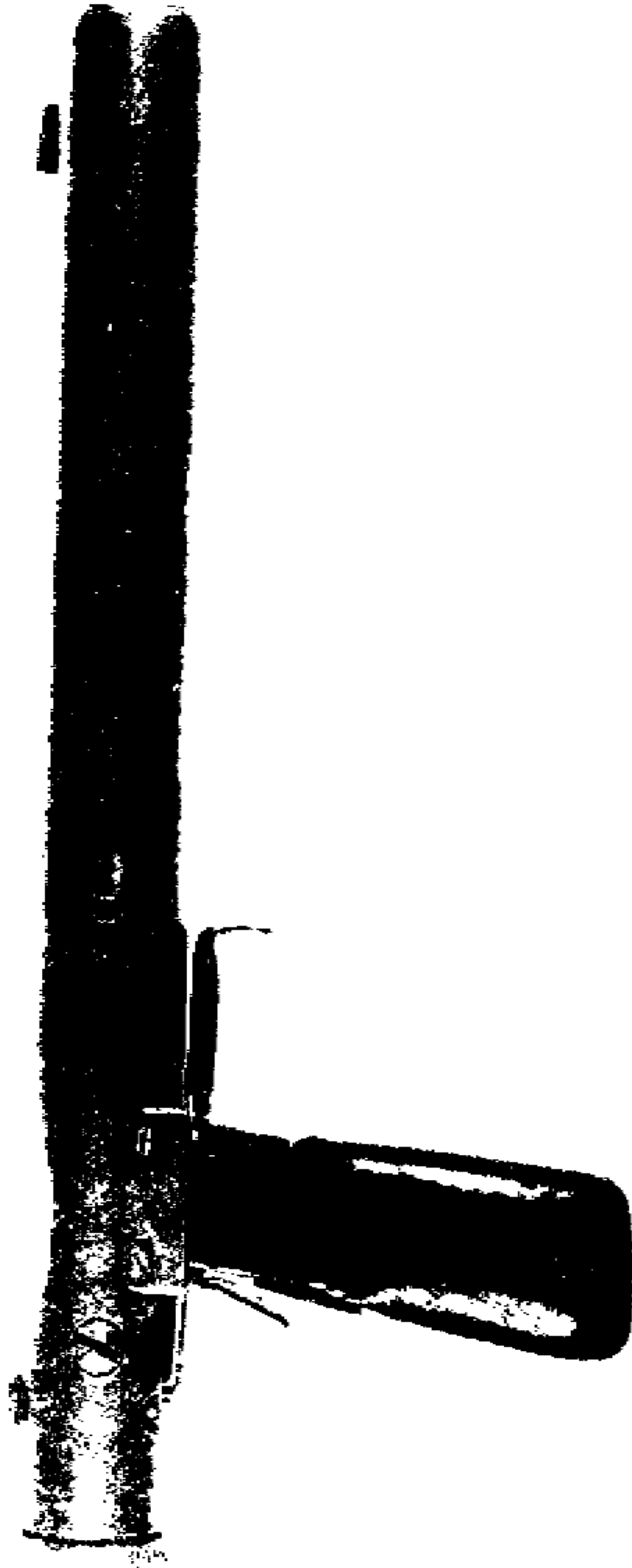

Figure 36. Caliber .32 Silenced Welrod Pistol

TABLE VIII. Caliber .32 Silenced Welrod Pistol

Projectile	
Weight	77 gr
Diameter	0.315 in.
Velocity (at silencer exit)	770 fps
Energy (at silencer exit)	102 ft-lb
Travel in barrel	3.9 in.
Travel time in barrel (estimated)	0.54 ms
Travel time in silencer	0.43 ms
Propellant	
Weight (Norma, ACP, double base, web ~ 0.003 in.)	3 gr (+ 0.3 gr primer)
Chamber volume	0.026 in. ³
Peak ballistic pressure	14,000 psi
Projectile passage diameter	
In steel baffle	0.375 in.
In old rubber baffle (when tested)	0.25 in (approx)
Free volume	
Around gun barrel	2.6 in. ³
In front silencer portion	2.5 in. ³
Total pistol weight (unloaded)	2.5 lb

during World War II. Externally, the primary difference between the two is that the caliber .32 is somewhat smaller and does not have a trigger guard. The Welrod pistol is one of the few weapons specifically designed to be "silent." It had been provided with a suitable silencer and a relatively quiet breech mechanism. Although its clip (the pistol handle) holds eight rounds, the pistol requires slow manual reloading for each shot.

Internally, the caliber .32 Welrod pistol consists of a metal tube surrounding and extending beyond the pistol barrel. The barrel has a series of 20 holes (0.062 inch in diameter) drilled around its periphery. The holes are positioned in the five rifling grooves and lead to the surrounding expansion chamber. This chamber is separated from the front silencer section by a baffle which has 12 holes (0.062 inch in diameter). The silencer section, extending beyond the barrel muzzle, is four inches long and contains a series of metal and rubber baffles. The rubber baffles are spaced intermittently between the metal baffles (Figure 35). The projectile passage diameter in the steel baffles is 0.375 inch. The passage diameter in the old rubber baffles, when tested, was approximately 0.25 inch; when new, the rubber baffles probably completely closed off the silencer interior.

Figure 37 shows and identifies the various sound pulses generated by firing the caliber .32 Welrod pistol. The main sound pulses were due to primer initiation (pt 1, Figure 37), bleed hole blow-by (pt 2), and projectile exit (pt 3). The high SPL (~112 db) and positive nature of the first sound pulse (pt 1) identify it as that caused by gas leakage around the cartridge case. The blow-by wave (generated by the propellant gas by-passing the projectile through the barrel bleed holes) exited approximately 0.4 ms later. This gave rise to the pulse (pt 2) of 118 db peak SPL. The blow-by wave occurring at the gun barrel muzzle exited from the silencer approximately 0.3 ms after the bleed hole blow-by. From the scope trace, it is seen that this blow-by is almost insignificant. The last and largest sound pulse, with its peak SPL of 122 db, was due to the gas discharge immediately following the projectile exit. Following this, there was a prolonged high frequency noise of about 104 db peak SPL due to turbulence and reverberations within the system.

In general the caliber .32 Welrod sound signature could be described as a sharp snappy crack.

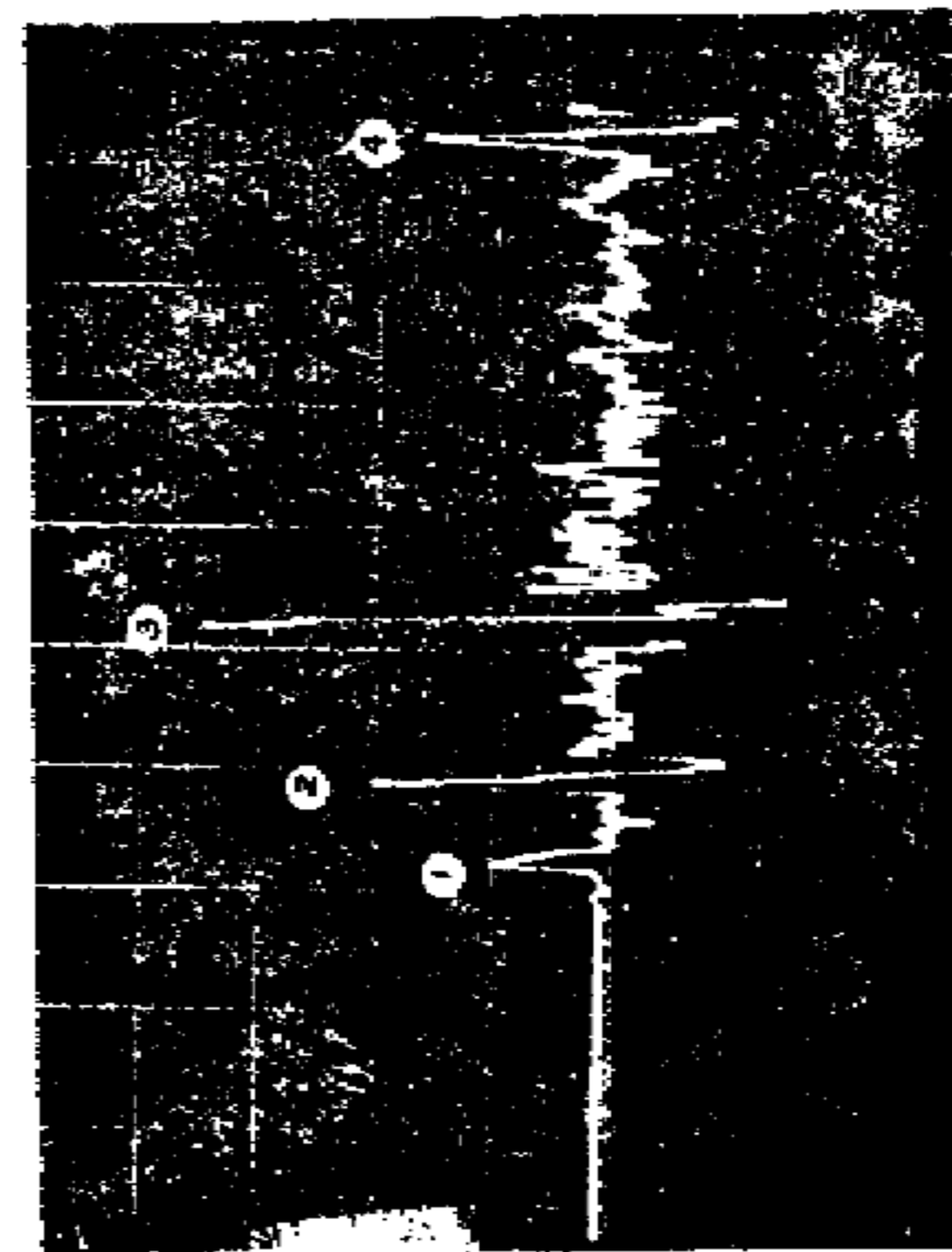

① Primer Initiation

② Blow-by Exit (through Bleed Holes) from Silencer

③ Projectile Exit from Silencer

④ Bleed Hole Blow-by Ground Reflection

y = 78 μ bars/cm

x = 0.5 ms/cm

1 cm = 1 major division

Microphone: B&K 4135

L₁ = 112 db

L₂ = 118 db

L₃ = 122 db

Figure 37. Sound Pressure-Time History, five meters to side, Caliber .32 Silenced Welrod Pistol

9 mm Silenced Welrod Pistol

The 9 mm Welrod pistol, except for size, is externally very similar to its caliber .32 counterpart. Internally, however, the two pistols are quite different (see Figures 35, 36, 38, 39, and Table IX). The 9 mm Welrod barrel consists of two sections, front and rear. The rear portion contains the gun barrel, which has sixteen 0.052 inch diameter bleed holes at its breech end. The gun barrel is surrounded by a tube which, together with the threaded front bushing, forms an expansion chamber for the gases escaping through the bleed holes. The front portion of the pistol barrel is essentially the bleed holes. The front portion of the pistol barrel is essentially the weapon's silencer. It attaches to the pistol by means of a threaded bushing. The inside of the silencer section contains a series of metal, rubber, and felt baffles separated by a perforated, spool-like steel spacer. The passage through the steel baffles and spool is approximately 0.43 inch in diameter.

The pistol examined at Frankford Arsenal contained three flexible baffles - two rubber and one felt. The projectile passage through these baffles was approximately 0.35 inch in diameter. When new, however, the flexible baffles probably completely closed off the silencer cavity; therefore, records were also made with new baffles containing only an X-slit. Not knowing the condition of the tested weapon, most firings were made with a reduced charge cartridge (described in Table IX).

Figure 40 shows the sound pressure-time history of the 9 mm Welrod pistol without the forward silencer section and firing the reduced charge round. The first noise detectable (and barely visible on the trace shown) occurred at about the time the firing pin hit the primer. This noise (pt 1, Figure 40) had a peak SPL of approximately 105 db, and was due to gas leakage around the cartridge case. The next sound pulse (pt 2) was due to the precursor shock exiting from the gun. The high SPL of this pulse (131 db) suggests a possibility of gas leakage past the projectile. Any bypassing of the propellant gas naturally reinforced the precursor, giving rise to the high SPL. The last pulse (pt 3) was due to propellant gas discharge immediately following the projectile exit. This pulse had a peak SPL of 131 db, the same as that of the precursor pulse.

The sound performance of the 9 mm Welford with the silencer containing old baffles is shown in the sound pressure-time trace of Figure 41. Here the main noise constituents were primer initiation

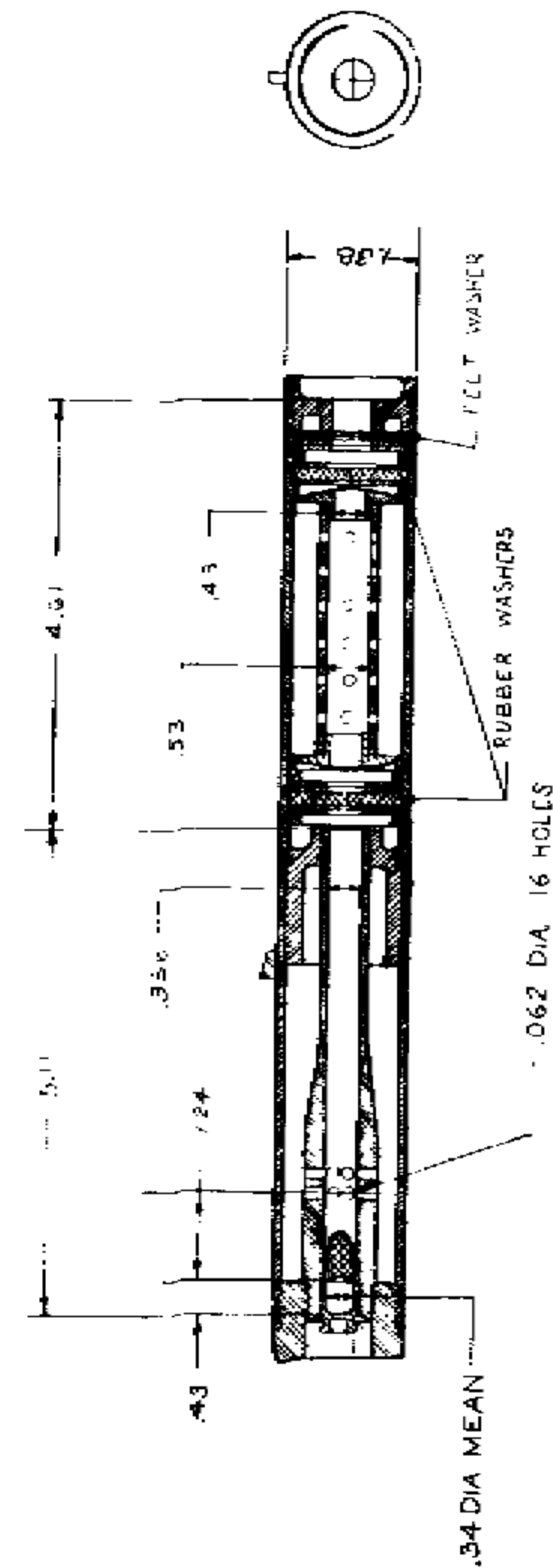

Figure 38. Cross section, 9 mm Silenced Welrod Pistol

TABLE IX. 9 mm Silenced Welrod Pistol

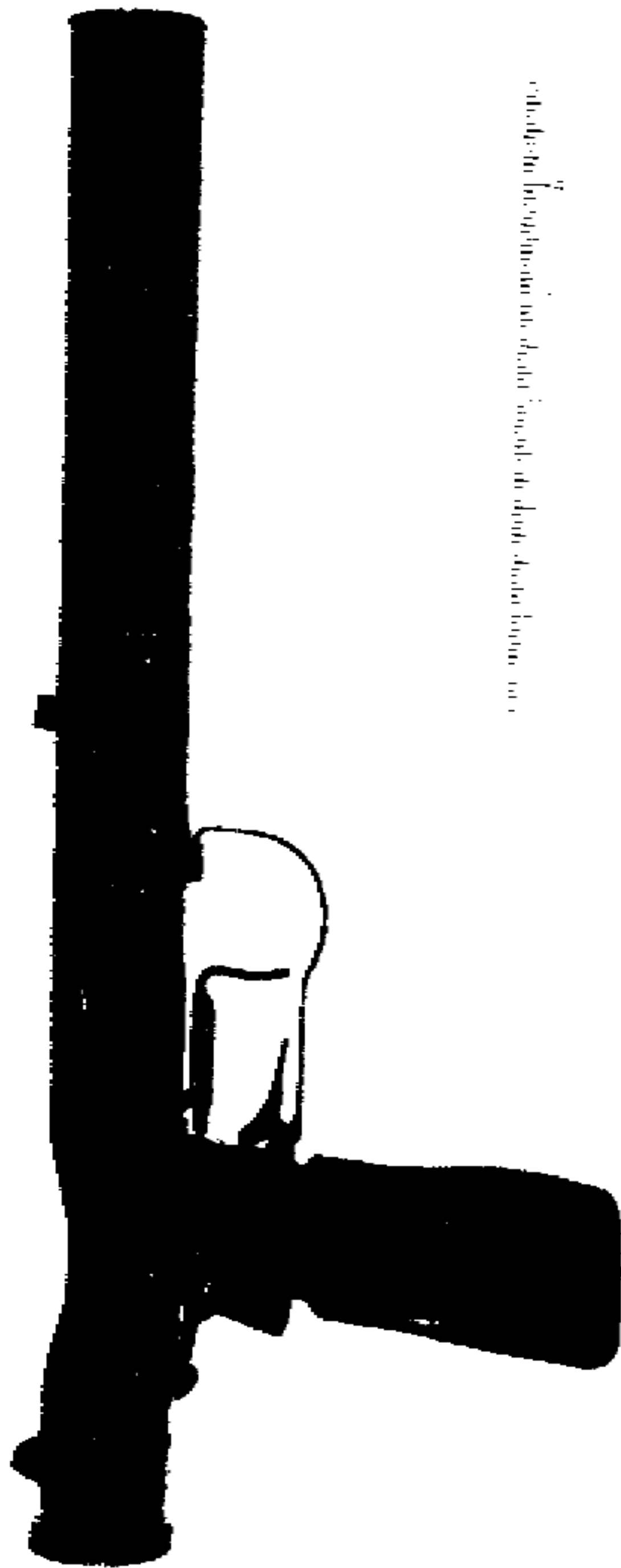
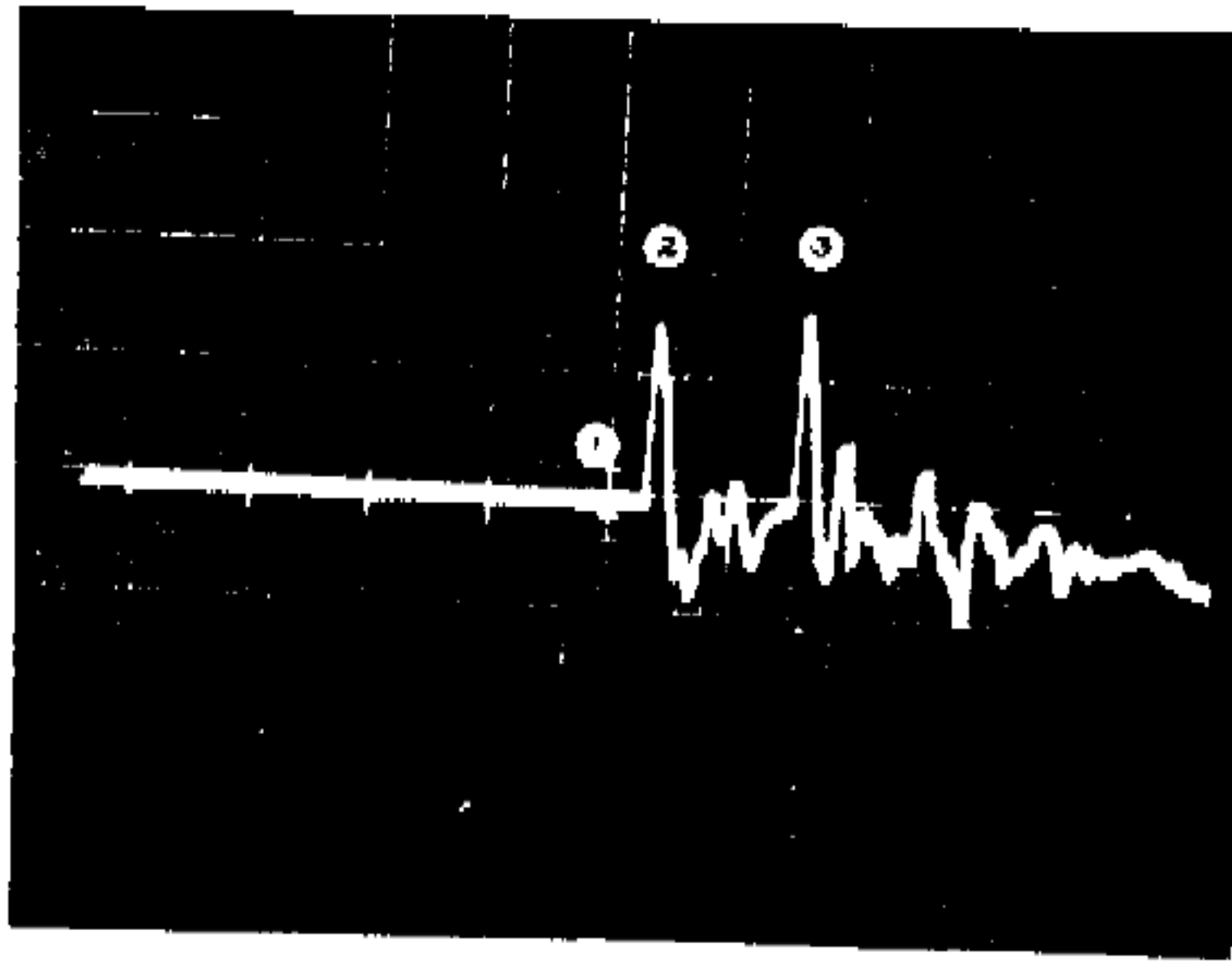

Figure 39. 9 mm Silenced Welrod Pistol

Projectile	
Weight	115 gr
Diameter	0.357 in.
Velocity (at silencer exit)	640 fps
Energy (at silencer exit)	106 ft-lb
Travel at peak ballistic pressure (estimated)	0.4 in.
Travel in barrel	4.7 in.
Travel time in gun barrel (estimated)	0.71 ms
Travel time in silencer	0.60 ms
Propellant	
Weight (M9, double base, flake, web ~ 0.003 in.)	3 gr (+ 0.3 gr primer)
Chamber volume	0.038 in. ³
Ballistic pressure	
Peak	22,400 psi
At first hole (estimated)	10,600 psi
At gun barrel muzzle (estimated)	200 psi
Silencer	
Weight (front portion)	0.63 lb
Free volume around gun barrel	2.3 in. ³
Free volume in front portion	4.3 in. ³
Projectile passage diameter	
Silencer spool	0.43 in.
In old rubber baffles	0.35 in. (approx)
Through new rubber baffles	X-slit
Total pistol weight (with the silencer)	3.5 lb
Time between precursor and projectile exits from silencer (estimated)	0.91 ms



$y = 450 \mu\text{bars/cm}$

$x = 0.5 \text{ ms/cm}$

1 cm = 1 major division

Microphone: B&K 4135

- | | | |
|---|--|------------------------|
| ① | Primer Initiation | $L_1 = 105 \text{ db}$ |
| ② | Precursor Exit from Gun Barrel Muzzle | $L_1 = 131 \text{ db}$ |
| ③ | Projectile Exit from Gun Barrel Muzzle | $L_3 = 131 \text{ db}$ |

Figure 40. Sound Pressure-Time History, five meters to side, 9 mm Silenced Welrod Pistol (less Silencer Section), Using Reduced Charge Round

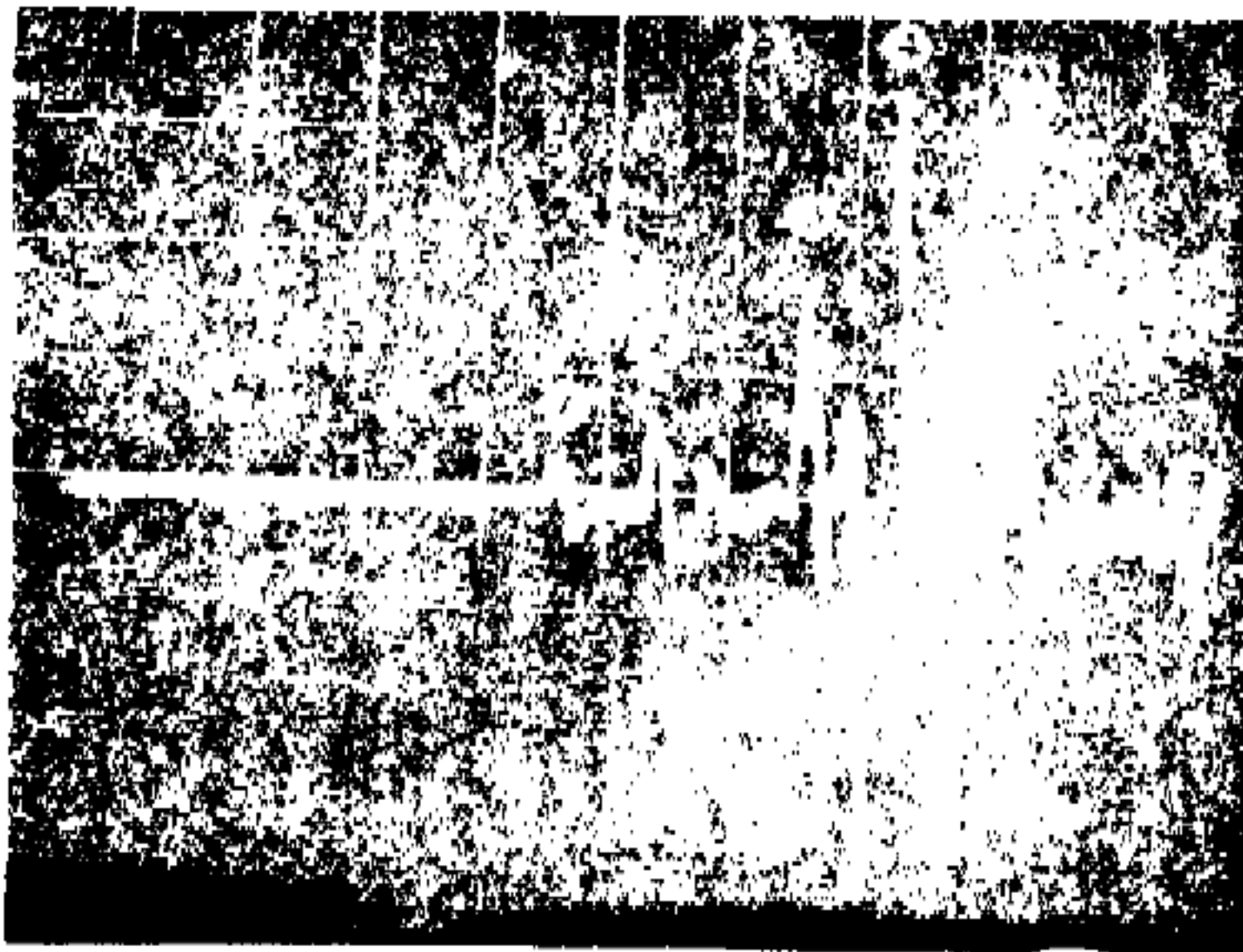

$y = 90 \mu\text{bars/cm}$

$x = 0.5 \text{ ms/cm}$

1 cm = 1 major division

Microphone: B&K 4135

- | | | |
|---|-----------------------------|------------------------|
| ① | Primer Initiation | $L_1 = 105 \text{ db}$ |
| ② | Precursor Exit from Muzzle | $L_2 = 111 \text{ db}$ |
| ③ | Blow-by Exit from Muzzle | $L_3 = 119 \text{ db}$ |
| ④ | Projectile Exit from Muzzle | $L_4 = 124 \text{ db}$ |

Figure 41. Sound Pressure-Time History, five meters to side, 9 mm Silenced Welrod Pistol with Old Rubber Baffles, Using Reduced Charge Round

(pt 1, Figure 41), precursor exit (pt 2), blow-by exit (pt 3), and projectile exit (pt 4). The relatively low SPL (~ 105 db) of primer initiation suggests that leakage around the cartridge case was much smaller than that of the caliber .32 Welrod. The precursor sound pulse had a peak SPL of approximately 111 db. The blow-by wave, which originated from the propellant gases bypassing the projectile in the spool spacer, constituted the second loudest sound source of the system. This blow-by sound pulse (pt 3) had a peak SPL of approximately 119 db. The last and largest sound pulse (pt 4) originated at the time the projectile exited from the silencer. It had a peak SPL of 124 db, and was due to the abrupt propellant gas discharge following the projectile exit.

A record of the silenced Welrod with new rubber baffles, firing a reduced charge cartridge, is shown in Figure 42. As can be seen, the primer noise was unaffected, but the precursor and blow-by were practically eliminated by the new baffles. Also, the projectile exit pulse was reduced to 120 db peak SPL. Figure 43 shows the trace of the silenced Welrod with new baffles, firing a standard 9 mm NATO cartridge (silencer muzzle velocity ~ 930 fps). Here the peak SPL of the projectile exit was 125 db.

In general, the 9 mm Welrod with old baffles sounded similar to, although somewhat louder than, the caliber .32 Welrod pistol. With new baffles it sounded appreciably quieter than before.

9 mm Silenced Sten Submachine Gun

The silenced Sten submachine guns (Figure 44) were first developed and manufactured in Britain during World War II. They were successfully used by both the British Commandos and the guerrillas operating behind German lines. A few of the silenced Stens eventually found their way into German hands but, contrary to strong recommendations by some, the German High Command did not adopt the Sten for general use.* More recently, silenced Stens were reportedly used by Allied troops in Korea.

Basically, the silenced Sten (designated Mark IIS) is a modified version of a standard unsilenced Sten submachine gun. The modification consisted essentially of reducing the bolt weight, shortening

* However, see Appendix E.

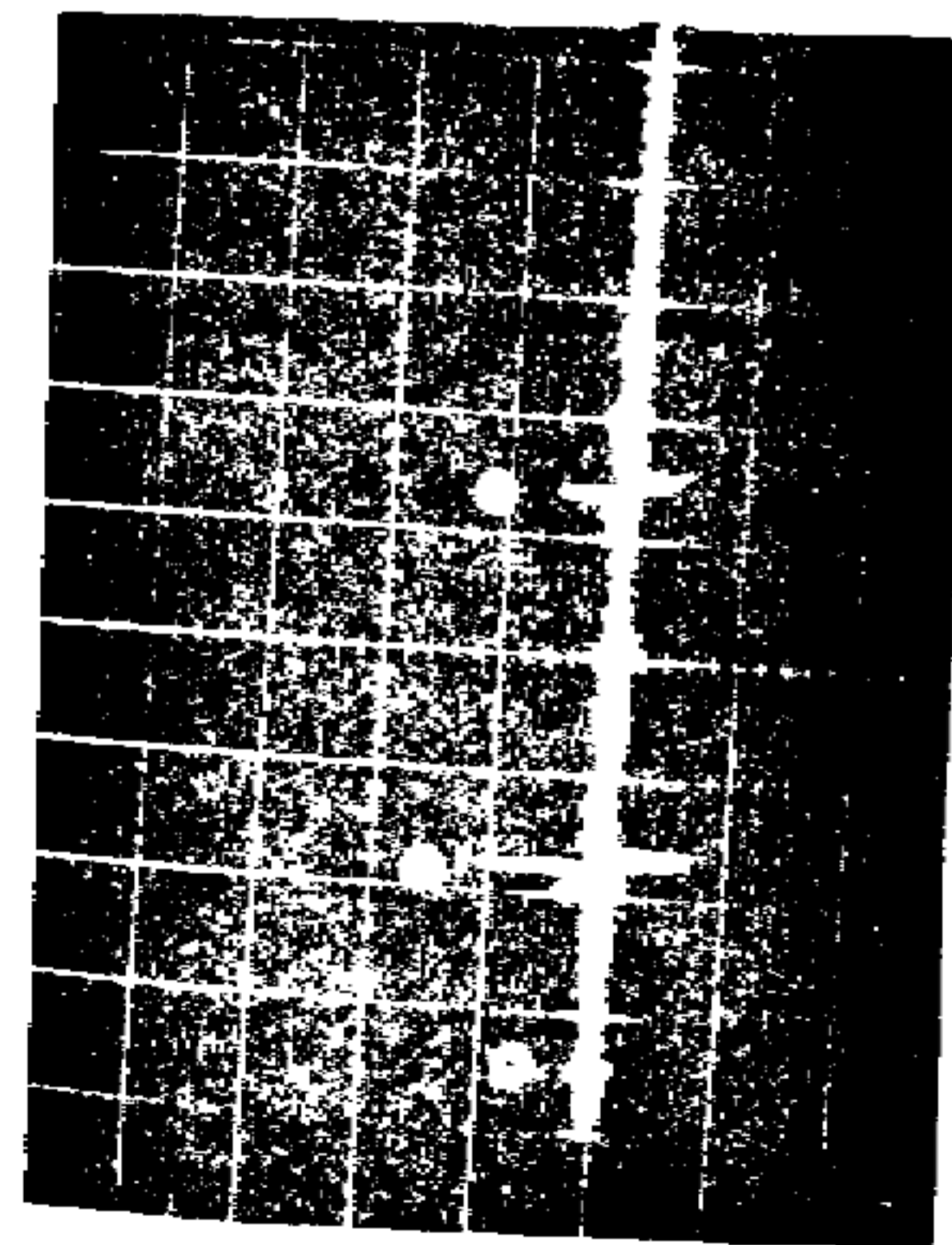

- ① Primer Initiation
- ② Projectile Exit
- ③ Ground Reflection

y = 195 μ bars/cm

x = 1 ms/cm

1 cm = 1 major division

Microphone: B&K 4135

L₁ = 105 db

L₂ = 120 db

Figure 42. Sound Pressure-Time History, five meters to side, 9 mm Silenced Welrod Pistol with New Rubber Baffles, Using Reduced Charge Round

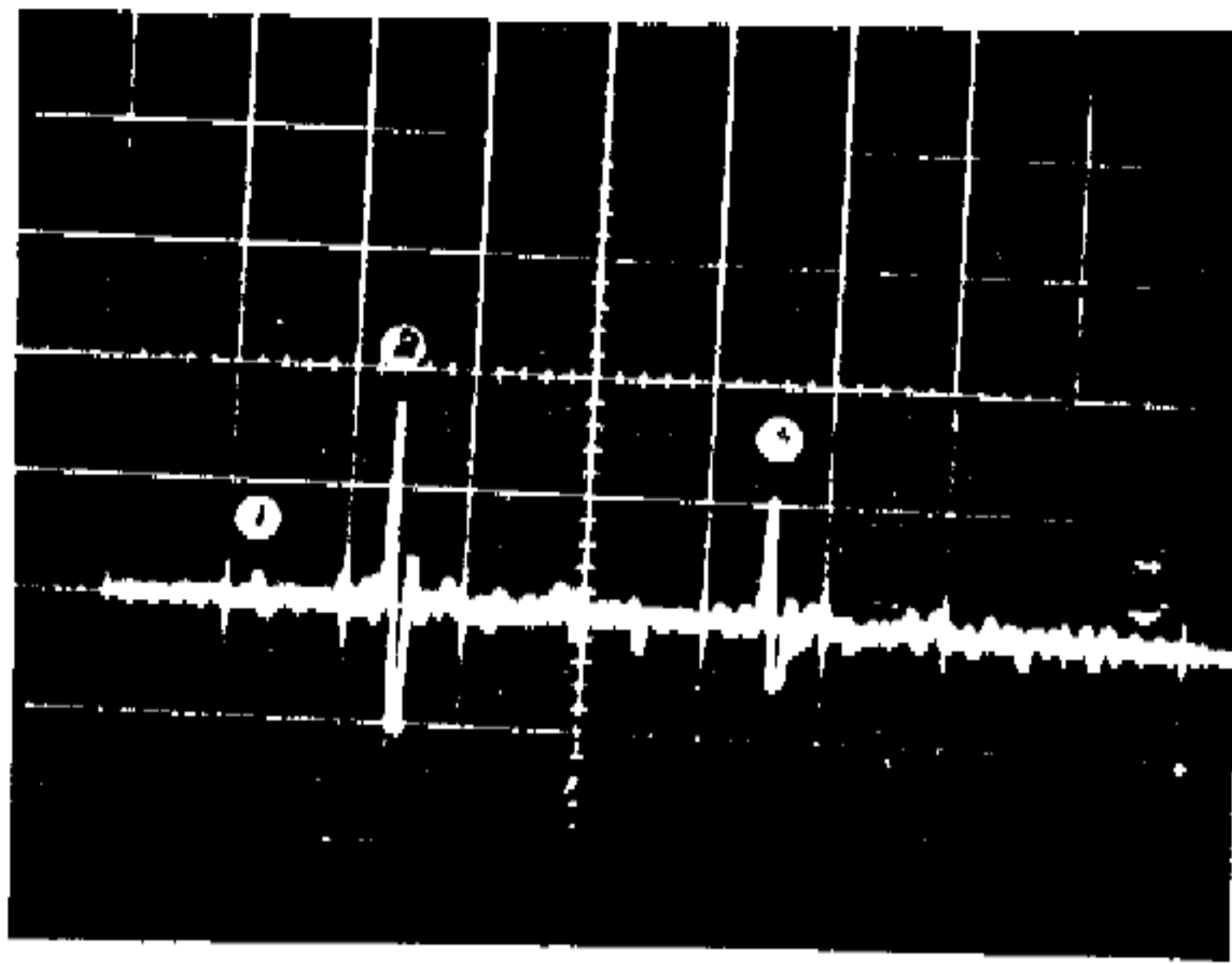

$y = 195 \mu\text{bars/cm}$

$x = 1 \text{ ms/cm}$

1 cm - 1 major division

Microphone: B&K 4135

- ① Primer Initiation
- ② Projectile Exit
- ③ Ground Reflection

$L_1 = 105 \text{ db}$

$L_2 = 125 \text{ db}$

Figure 43. Sound Pressure-Time History, five meters to side, 9 mm Silenced Walrod Pistol with New Rubber Baffles, Using Standard NATO Round (Projectile Muzzle Velocity, 930 fps)

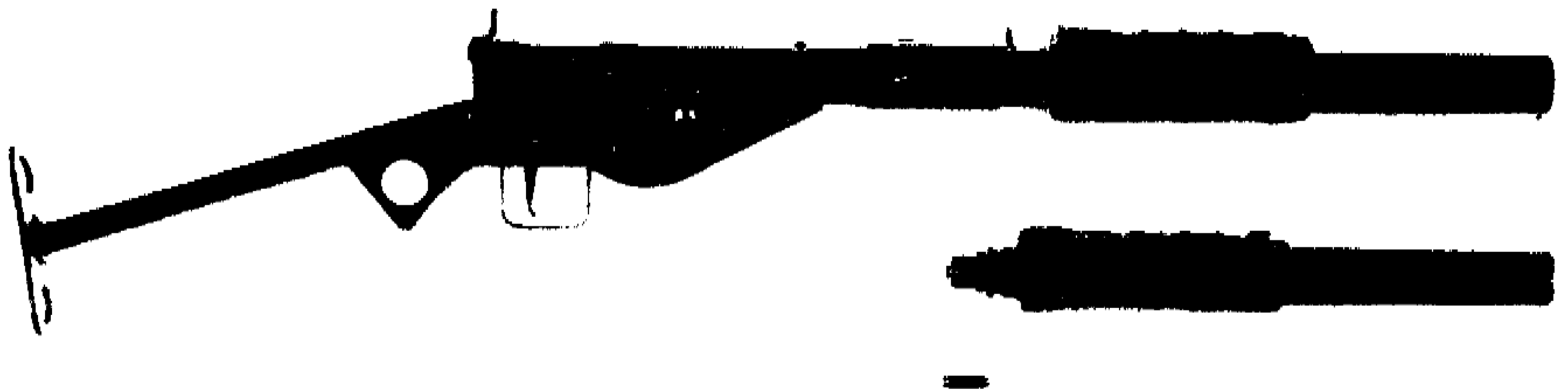

Figure 44. 9 mm Silenced Sten Submachine Gun, Showing Type I and Type II Silenced Barrels

the bolt spring, and substituting the replaceable barrel with a silenced one. Since the new barrel reduced projectile velocity below the speed of sound, the bolt modifications were necessary to insure proper weapon operation and to maintain the rate of fire at standard 450 rpm. Some modified weapons reportedly had their breech insulated with acoustical material, this to attenuate the weapon's mechanical noise (Figure 45). Many versions of the silenced Sten barrel are known to have been developed. Two types, both similar, were tested at Frankford Arsenal.

Silenced Sten Barrel, Type I

The Type I silenced Sten barrel (Figure 46) consists essentially of a drilled length of standard 4 inch long gun barrel and a surrounding silencing tube which extends beyond the gun barrel muzzle. The gun barrel has six holes (0.11 inch in diameter) located 0.72 inch from the initial projectile base position, and opening into the expansion chamber surrounding the gun barrel. The early bleeding of propellant gases is primarily intended to reduce the velocity of the standard supersonic round below the speed of sound.

The front end of the silencing tube forms the secondary expansion chamber, which is divided by 30 straight, equally spaced, metal baffles. The first and last baffles (0.25 inch thick) consist of stacked wire screen discs. The passage through the baffles provides the projectile with a diametral clearance of 0.040 inch. Outside, the silenced barrel is partially covered by asbestos rope, electrical tape, and canvas cover to protect the hands from the tube which becomes excessively hot with automatic firing. The overall silenced barrel is 13 inches long and 1.5 inches in diameter. By comparison, the standard unsilenced Sten barrel is only 6 inches long. Some of the more significant physical and functional parameters of the silenced Sten with the Type I barrel are listed in Table X.

On firing, the forward (and rearward) motion of the Sten bolt terminates with a considerable slap. This impact of bolt against breech and the consequent vibration of the weapon's various components generated prolonged noise of about 100 db peak SPL, lasting a few milliseconds (Figure 45). To avoid the overshadowing effects of mechanical noise, the Frankford Arsenal sound tests were conducted with the silenced Sten barrels held and fired in a special, relatively quiet, single shot test fixture (Figures 47 and 48). Since the mechanical noise of the fixture is relatively low, the recorded scope traces essentially contain only the system muzzle noise.

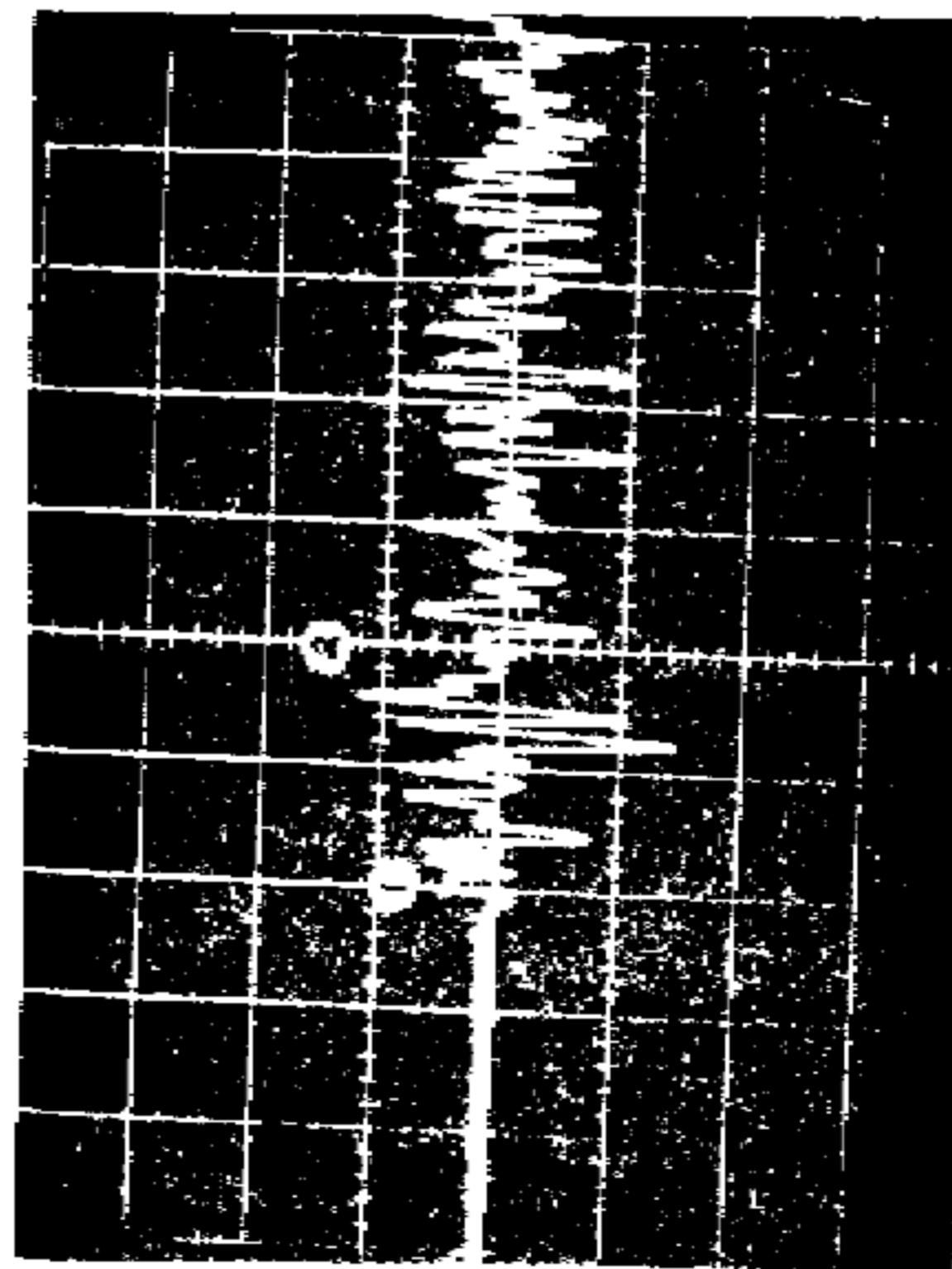

- ① Forward Bolt Slap (no Cartridge)
- ② Mechanical Noise Following Bolt Slap

$$y = 21.5 \text{ } \mu\text{bars/cm}$$

$$x = 0.5 \text{ ms/cm}$$

1 cm = 1 major division

Microphone: Altec Br 150

$$\left\{ \begin{array}{l} L_1 \approx 93 \text{ db} \\ L_2 = 101 \text{ db (maximum)} \\ L_2 \approx 95 \text{ db (average)} \end{array} \right.$$

Figure 45. Sound Pressure-Time History, five meters to side, 9 mm Silenced Sten Submachine Gun Bolt Slap, without Cartridge

TABLE X. 9 mm Silenced Sten Submachine Gun, Type I Barrel

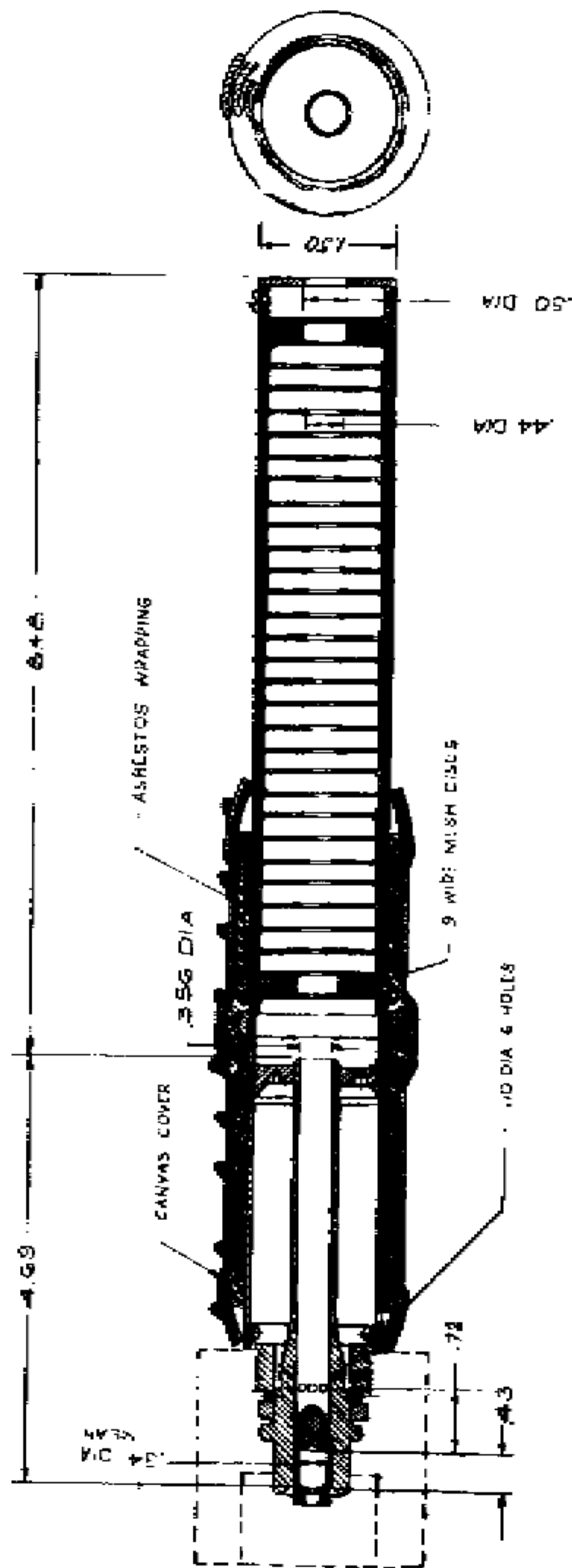

Figure 46. Cross section, 9 mm Silenced Sten Submachine Gun Barrel (Type I)

Projectile	
Weight	115 gr
Diameter	0.356 in.
Velocity (at silencer exit)	1000 fps
Energy (at silencer exit)	258 ft-lb
Travel at peak ballistic pressure (estimated)	0.3 in.
Travel in barrel	4.25 in.
Travel time in barrel (estimated)	0.42 ms
Travel time in silencer	0.71 ms
Propellant	
Weight (WCC-6102, doublebase, web ~0.003 in.)	6 gr (+ 0.3 gr primer)
Chamber volume	0.038 in. ³
Ballistic pressure	
Peak	31,000 psi
At barrel muzzle (estimated)	250 psi
Silencer Characteristics	
Passage diameter (for projectile)	0.50 in.
Free volume in front silencer portion	11.0 in. ³
Free volume around gun barrel	4.4 in. ³
Silenced barrel	
Weight	2.25 lb
Length	13 in.
Diameter	1.5 in.
Standard Sten gun barrel length	6 in.
Total weight of silenced Sten submachine gun (without magazine)	7.7 lb
Time between precursor and projectile exits from silencer (estimated)	0.3 ms

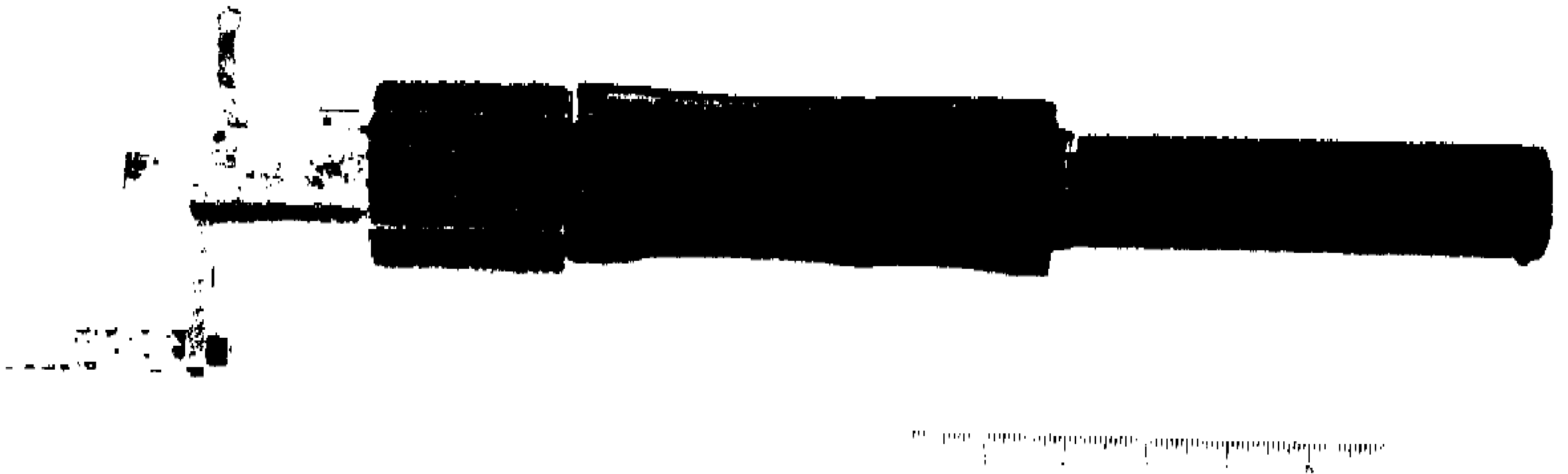

Figure 47. Assembly, 9 mm Silenced Sten Submachine Gun Barrel (Type I) in Test Fixture

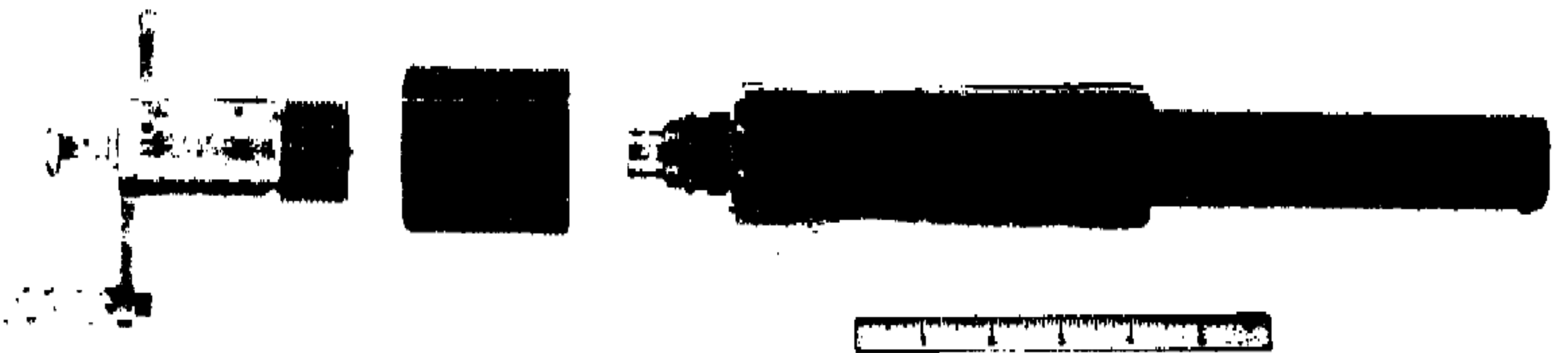

Figure 48. Disassembly, 9 mm Silenced Sten Submachine Gun Barrel (Type I) and Test Fixture

The sound pressure history of the Type I silenced Sten barrel, fired with the test fixture is shown in Figure 49. Time correlation of the trace with the various functional effects occurring in the system during firing indicated that the five principal noise sources were: primer initiation (pt 1, Figure 49), precursor wave exit (pt 2), blow-by exit (pt 3), projectile exit (pt 4), and reverberation and jet noises after projectile exit (pt 5).

The primer initiation noise started and continued after the firing pin hit the primer. The high frequency, long duration, and low amplitude indicate that it was primarily mechanical in nature. The peak SPL of this noise five meters from the system was approximately 93 db. The precursor wave formed in the gun barrel exited from the silencer approximately one ms after the firing pin bottomed. The precursor sound pulse, although not very distinct, seems to have had a peak SPL of about 94 db. The blow-by wave, caused by gases by-passing and the projectile in the silencer, exited 0.3ms later. The sound pulse (pt 3) due to this blow-by had a peak SPL of 104 db. The projectile exited approximately 0.4 ms after the blow-by wave. The efflux of gases following the projectile exit was fairly mild since the event was barely distinguishable from the secondary acoustical effects (such as reverberations and turbulence) occurring at this time. The noise generated during this event seems to have been about 106 db peak SPL. Following the projectile exit, there was a relatively random prolonged noise generated by the reverberations inside the silencer and the jet turbulence. The sequence and magnitude of the various sound pulses of this noise are inconsistent, varying from round to round. In general, for any one given round the maximum and average peak SPLs of this noise are in the vicinity of 112 db and 104 db, respectively.

Although the silenced Sten barrel is somewhat bulky, in general it compensates for this by very good acoustical performance and long service life. To a subjective listener, the system sounded as an abrupt initiation and gradual cessation of a relatively mild hiss. Compared to other silencers and silenced barrels with respectable energy outputs, the Sten was one of the quieter systems tested at Frankford Arsenal.

Silenced Sten Barrel, Type II

Externally, the Type I and Type II silenced Sten barrels are almost identical. The two barrels are also similar in principle;

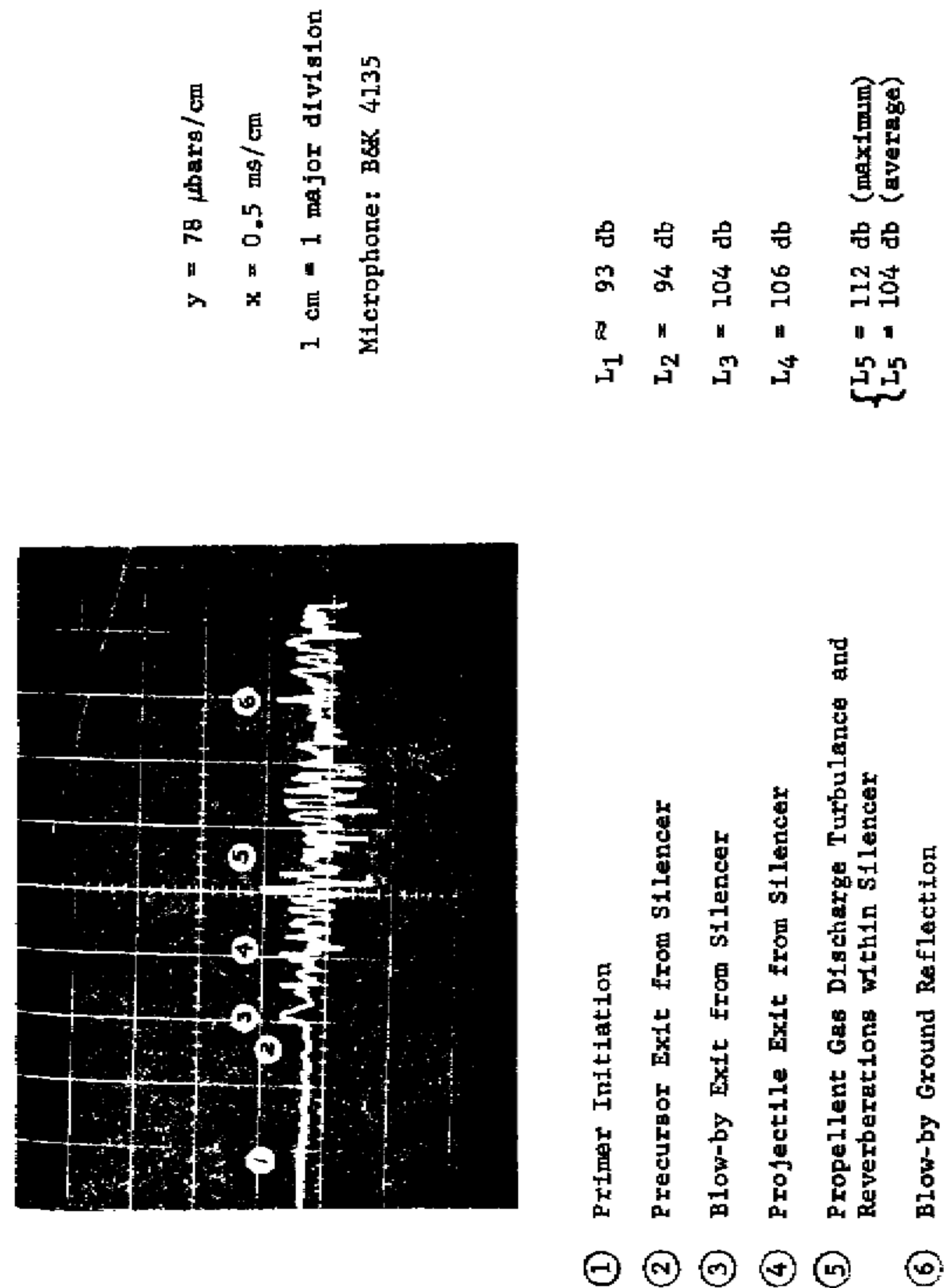

Figure 49. Sound Pressure-Time History, five meters to side, 9 mm Silenced Sten Submachine Gun Barrel (Type I), in Test Fixture

however, each contains a slightly different set of internal components (Figures 46 and 50 and Tables X and XI). The Type II is distinguishable primarily in that its gun barrel is slightly shorter and contains two sets of bleed holes; its metal baffles (fewer in number) are somewhat conical in shape; and, at the forward end, it holds three felt washers.

In the barrel tested at Frankford Arsenal, the front conical baffles had been modified previously, as shown in Figure 50, presumably for experimental purposes. Acoustically there seems to be little apparent reason for this modification; if anything, it made the system slightly louder. Originally, acoustical performance of the two barrel types was probably very similar.

Figure 51 shows and identifies the sound constituents of the silenced Type II Sten barrel, fired with the test action shown in Figure 48. The trace was recorded five meters directly to the side of the weapon. The first distinct noise recognizable on the trace (pt 1, Figure 51) was a sound generated approximately when the firing pin hit the primer. This series of pulses, with its relatively low peak SPL of 93 db, was essentially mechanical in nature. The next sound pulse (pt 2) was the first noise emitted from the silencer muzzle. This pulse of 101 db peak SPL was generated by the blow-by occurring through the gun barrel bleed holes.

The next sound pulse (pt 3) corresponded to the time when gun barrel muzzle blow-by exited the silencer. This sound pulse had a peak SPL of 104 db. The next, and highest, sound pulse (pt 4) was generated by the exit of propellant gas which bypassed the projectile through the modified front baffles. Exit of this blow-by wave gave rise to a pulse of 113 peak SPL. The projectile exited approximately 0.01 ms later.

The initial efflux of gases following the projectile exit resulted in a positive pulse (pt 5) of 104 db peak SPL. Following this, the steadily discharging gas gave rise to turbulence which, combined with reverberations within the silencer, generated a prolonged noise (pt 6) of approximately 100 db peak SPL. Characteristically, this noise was of random nature, varying from round to round.

To a subjective listener, the Type II Sten sounded like a clap-initiated, gradually diminishing hiss. In general, it seemed somewhat louder than the Type I Sten.

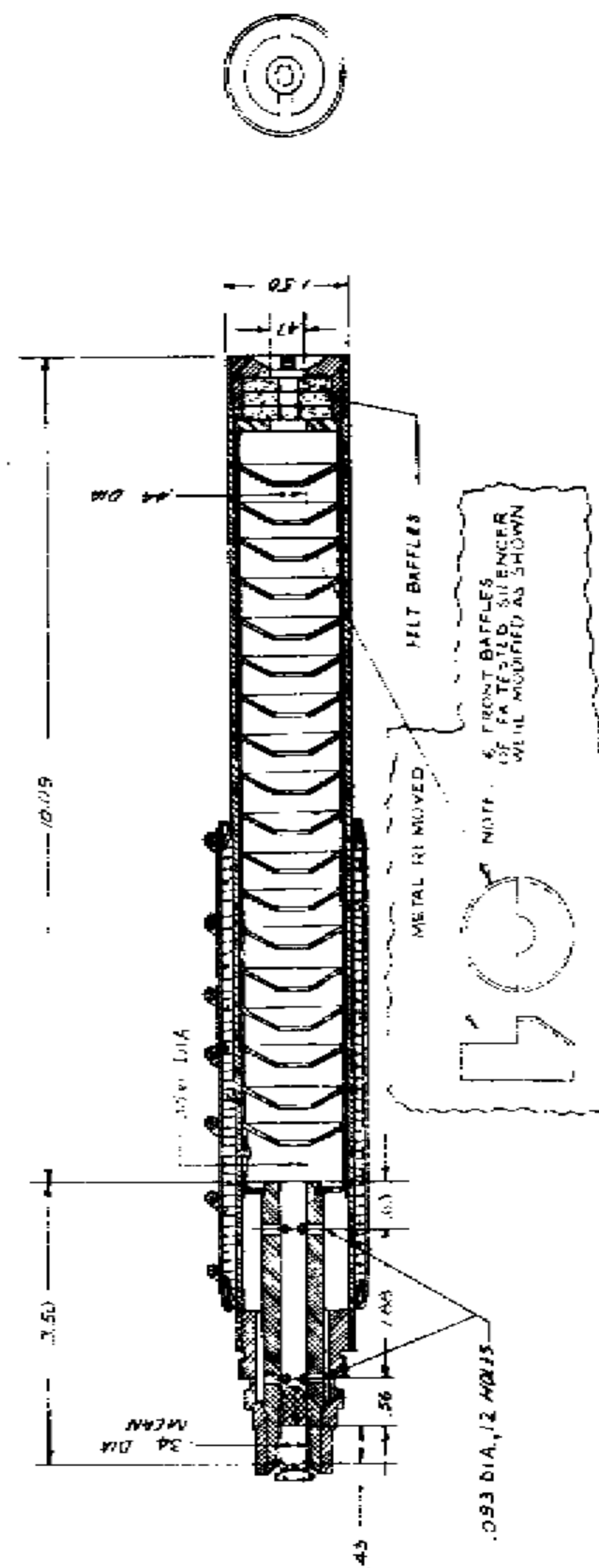

Figure 50. Cross section, 9 mm Silenced Sten Submachine Gun Barrel (Type II)

TABLE XI. 9 mm Silenced Sten Submachine Gun, Type II Barrel

Projectile	
Weight	115 gr
Diameter	0.356 in.
Velocity (at silencer exit)	1000 fps
Energy (at silencer exit)	258 ft-lb
Travel at peak ballistic pressure (estimated)	0.3 in.
Travel in barrel	3.1 in.
Travel time in barrel (estimated)	0.3 ms
Travel time in silencer	0.91 ms
Propellant	
Weight (WCC-6102, double base, web ~ 0.003 in.)	6 gr (+ 0.3 gr primer)
Chamber volume	0.038 in. ³
Ballistic pressure	
Peak	31,000 psi
At barrel muzzle (estimated)	400 psi
Silencer Characteristics	
Passage diameter (for projectile)	0.50 in.
Passage diameter in old felt baffles (when tested)	0.3 in.
Free volume around gun barrel	2.7 in. ³
Free volume in front silencer portion	13.0 in. ³
Silenced barrel	
Weight	2.5 lb
Length	13.5 in.
Diameter	1.5 in.
Standard Sten gun barrel length	6 in.
Silenced submachine gun weight (without magazine)	7.9 lb

y = 43 μ bars/cm

x = 0.5 ms/cm

1 cm = 1 major division

Microphone: Altec BR 150

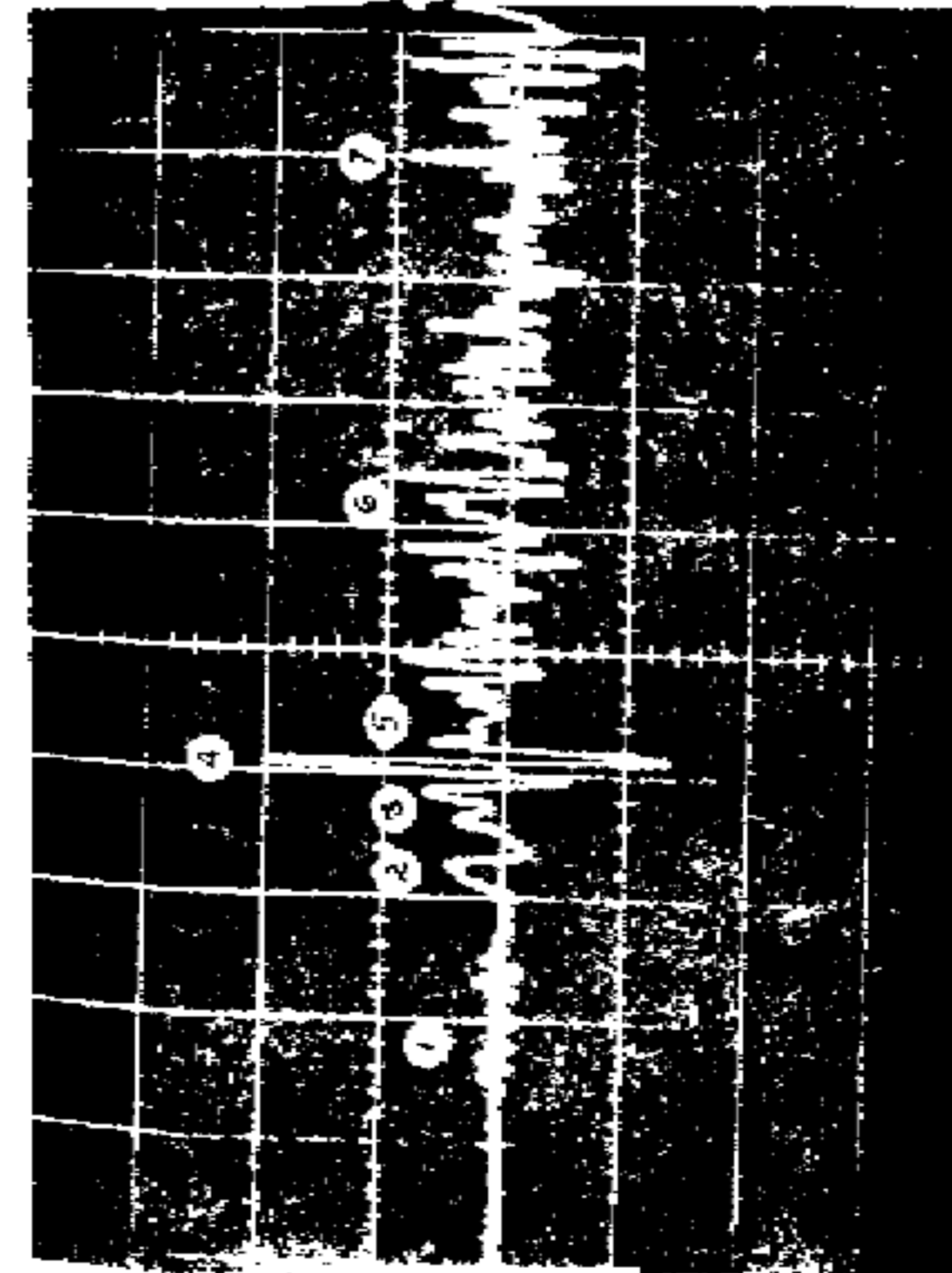

- | | |
|--|---|
| ① Primer Initiation | L ₁ = 93 db |
| ② Blow-by (through Bleed Holes) Exit from Silencer | L ₂ = 101 db |
| ③ Blow-by (at gun barrel muzzle) Exit from Silencer | L ₃ = 104 db |
| ④ Blow-by (through front cut-away baffles) Exit from Silencer | L ₄ = 113 db |
| ⑤ Projectile Exit from Silencer | L ₅ = 104 db |
| ⑥ Propellant Gas Discharge Turbulence and Reverberations within Silencer | { L ₆ = 105 db (maximum)
L ₆ = 99 db (average) |
| ⑦ Bleed Hole Blow-by Ground Reflection | |

Figure 51. Sound Pressure-Time History, five meters to side, 9 mm Silenced Sten Submachine Gun Barrel (Type II), in Test Fixture

The 9 mm AAI experimental silencer (Figures 52 and 53 and Table XII) was manufactured by Aircraft Armaments, Inc. about the same time as the caliber .22 silenced AAI test fixture (see page 21). This silencer is adaptable to a P38 Walther pistol by removing the front sight and securing the silencer to the barrel muzzle with an adaptor sleeve. Although it is rather bulky and acoustically not too impressive, its data are deemed useful for comparison with other silencers and silencing fixtures.

The 9 mm AAI silencer is essentially a simple, baffled, expansion chamber, 5 inches long and 2.5 inches in diameter. The steel silencer housing holds eight baffles and nine spacers, all aluminum. Seven of the equal chambers formed by the baffles contain loosely packed steel wool, removal of which does not seem to affect the system acoustically. There is a rubber diaphragm with an X-slit at the silencer muzzle, presumably to restrict gas flow. At Frankford Arsenal this diaphragm required frequent replacement as it was easily destroyed by the exiting projectile. Later it was found that the diaphragm had little acoustical effect even when new, probably because it was too thin.

The outstanding features of the AAI silencer are its very large volume (19 in.³) and the surprisingly large projectile clearances (a 0.5 inch diameter passage for a 0.35 inch diameter projectile). The following sound data are from the firings made with a special subsonic cartridge (see Table XII).

Figure 54 shows the sound pressure-time history of the 9 mm P38 pistol without the silencer, recorded 10 meters to the side of the weapon. The first sound pulse (pt 1, Figure 54) was due to the precursor exit from the gun muzzle. This pulse had a peak SPL of 127 db. The projectile exited the gun muzzle approximately 0.4 ms after the precursor. The accompanying propellant gas discharge gave rise to a sound pulse (pt 2) of 139 db peak SPL. The positive pulse (pt 3) is a ground reflection of the blast pressure wave.

The sound signature of the P38 pistol with the AAI silencer is shown in Figure 55. The main noise constituents of the system were identified as: primer initiation (pt 1, Figure 55), precursor exit (pt 2), blow-by exit (pt 3), and projectile exit (pt 4). The first significant noise during firing was that due to gas leakage around the cartridge case. The peak SPL of this noise was approximately 99 db. The next

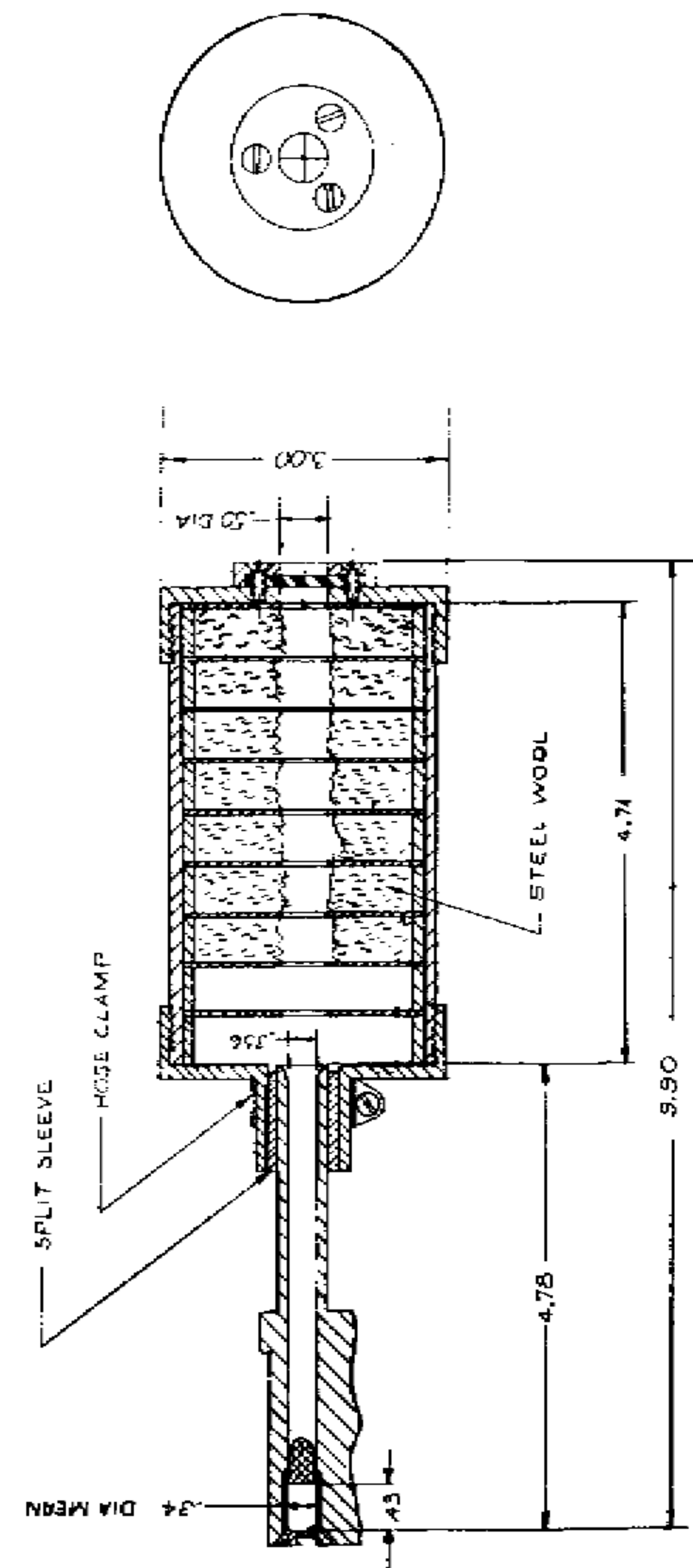
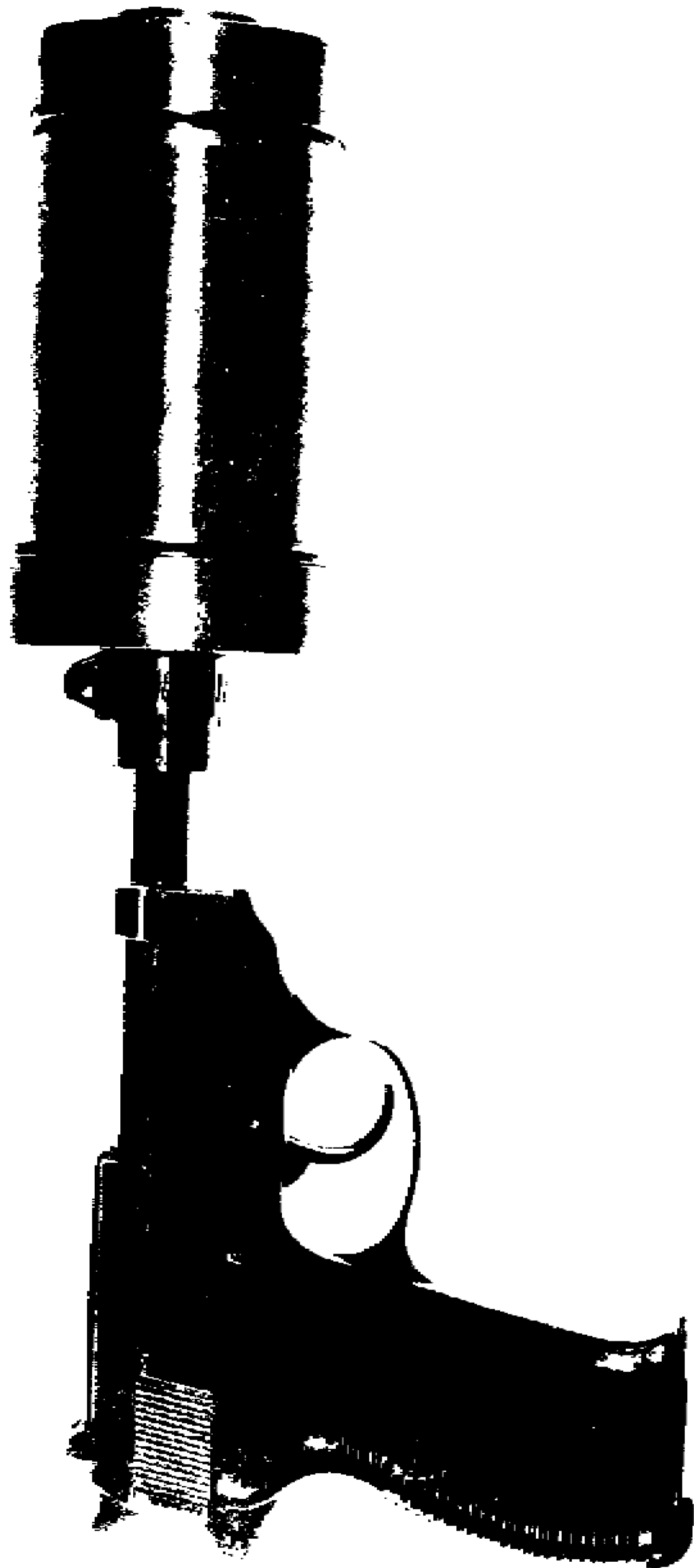

Figure 52. Cross section, 9 mm P38 Walther Pistol/AAI Silencer



1
2
3
4
5

Figure 53. 9 mm P38 Walther Pistol/AAI Silencer

TABLE XII. 9 mm P38 Walther Pistol/AAI Silencer

Projectile	
Weight	115 gr
Diameter	0.356 in.
Velocity (at silencer exit)	925 fps
Energy (at silencer exit)	220 ft-lb
Travel at peak ballistic pressure (estimated)	0.4 in.
Travel in barrel	4.35 in.
Travel time in barrel	0.46 ms (approx)
Travel time in silencer	0.43 ms
Propellant	
Weight (M9, double base, flake, web ~ 0.003 in.)	3 gr (+ 0.3 gr primer)
Chamber volume	0.038 in. ³
Ballistic pressure	
Peak	22,400 psi
At barrel muzzle	1,800 psi
Silencer	
Passage diameter (for projectile)	0.50 in.
Weight	3 lb.
Free volume	19 in. ³
Pistol weight (without silencer)	2.1 lb
Time between precursor and projectile exits from silencer	0.43 ms

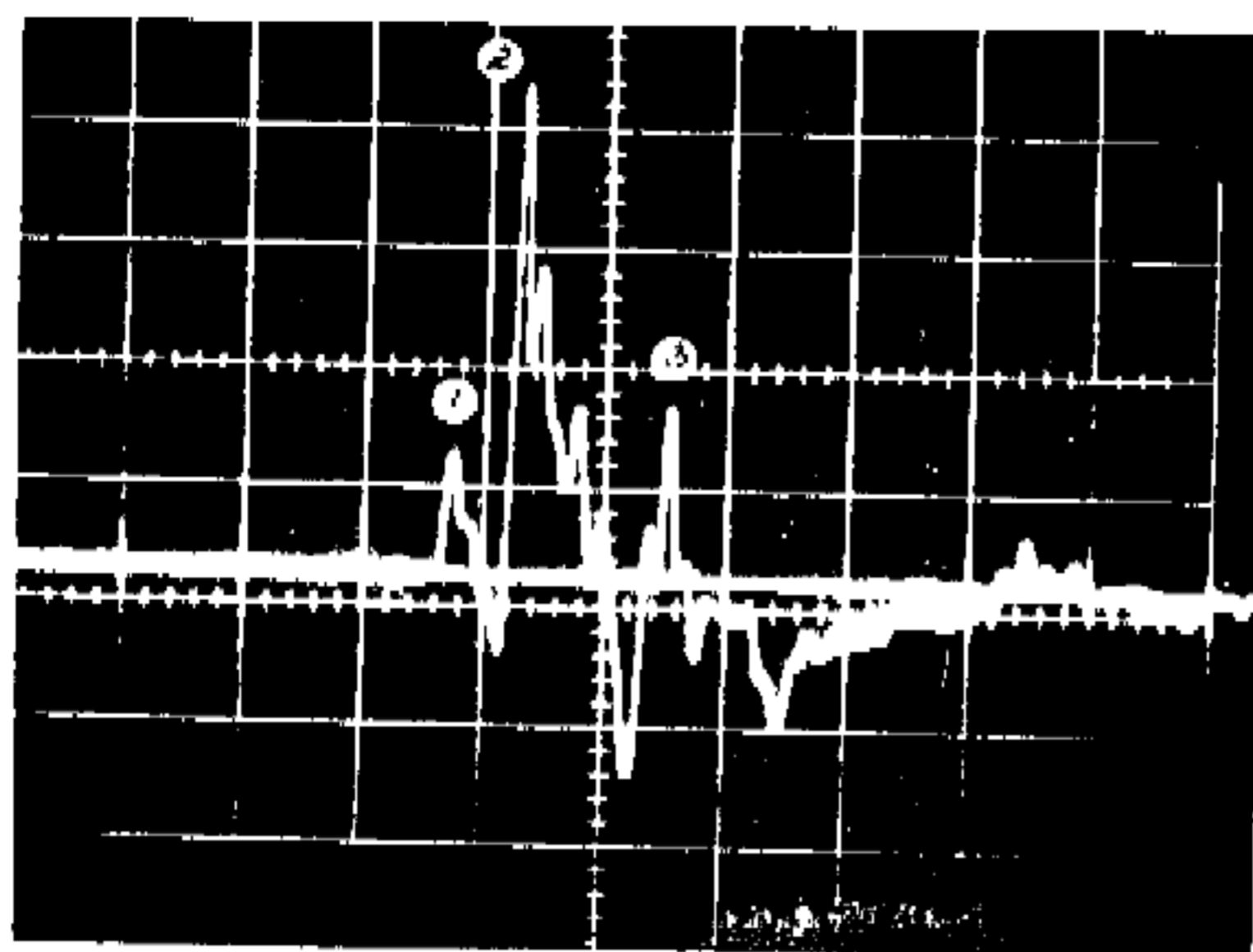

$y = 450 \mu\text{bars/cm}$

$x = 0.5 \text{ ms/cm}$

1 cm - 1 major division

Microphone: Altec BR 150

- ① Precursor Exit from Muzzle
- ② Projectile Exit from Muzzle
- ③ Projectile Exit Ground Reflection

$L_1 = 127 \text{ db}$

$L_2 = 139 \text{ db}$

Figure 54. Sound Pressure-Time History, ten meters to side, 9 mm P38 Walther Pistol without Silencer, Using Subsonic Cartridge

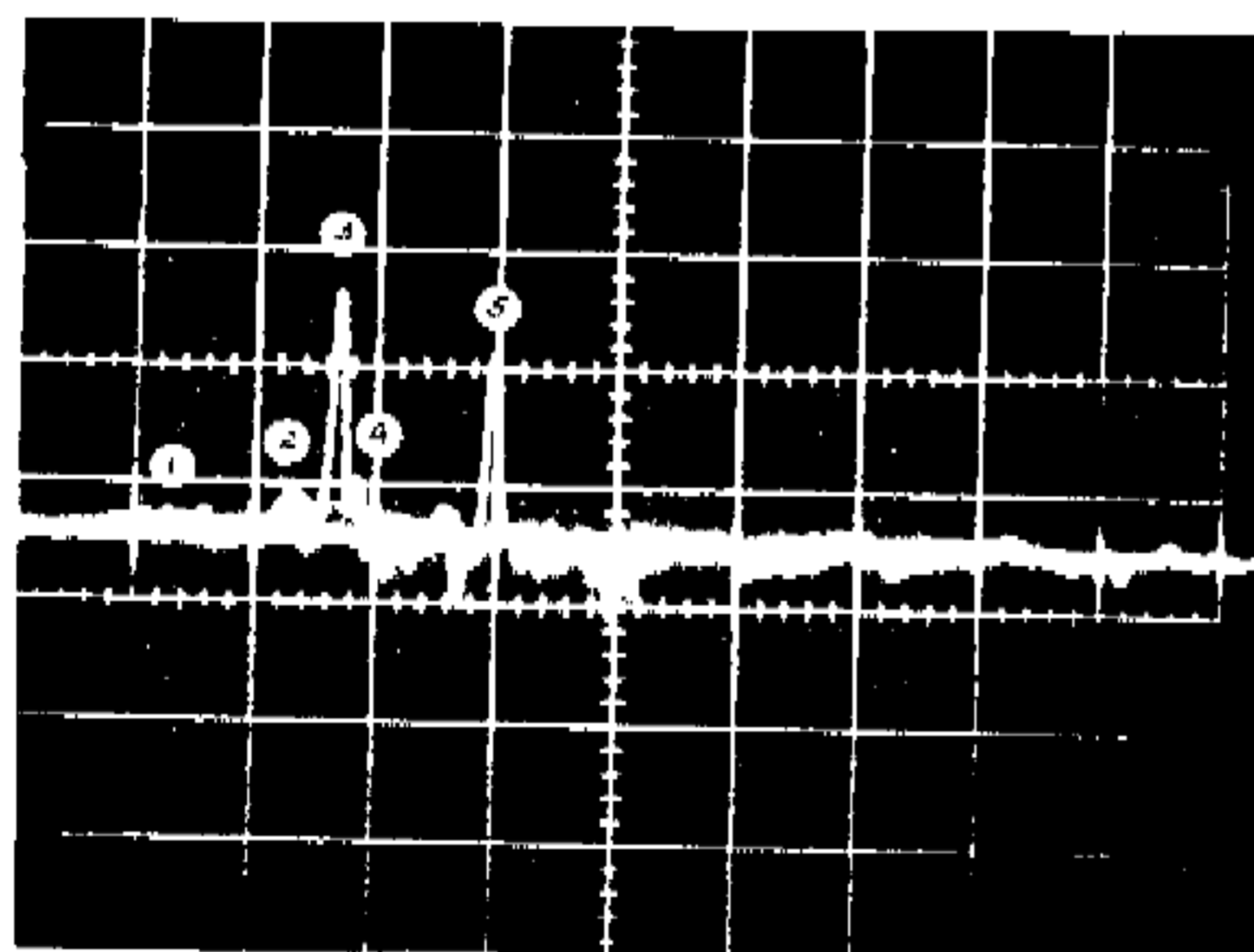

$y = 90 \mu\text{bars/cm}$

$x = 0.5 \text{ ms/cm}$

1 cm = 1 major division

Microphone: Altec BR 150

- ① Primer Initiation
- ② Precursor Exit from Silencer
- ③ Gun Barrel Muzzle Blow-by Exit from Silencer
- ④ Projectile Exit from Silencer
- ⑤ Blow-by Ground Reflection

$L_1 = 99 \text{ db}$

$L_2 = 105 \text{ db}$

$L_3 = 120 \text{ db}$

$L_4 \approx 105 \text{ db}$

Figure 55. Sound Pressure-Time History, ten meters to side, 9 mm P38 Walther Pistol/AAI Silencer, Using Subsonic Cartridge

sound pulse (pt 2) was generated when the precursor exited from the silencer. Its peak SPL was 105 db. The blow-by wave generated at the gun barrel muzzle exited from the silencer after the precursor. This blow-by pulse, with its peak SPL of 120 db, represented the system's loudest effect. The projectile exited about 0.2 ms after the blow-by wave. Gas flow at the silencer exit evidently was altered little by the projectile since the event is not discernable on the scope trace. This, of course, was to be expected with the large blow-by clearances and volume. To a subjective listener, the system sounded unquestionably loud.

9 mm Walther MPK Submachine Gun/West German Silencer

The MPK silencer (Figures 56, 57, and 58) was reportedly developed in West Germany sometime after 1963, when the 9 mm MPK submachine gun itself was introduced. Although somewhat bulky and internally elaborate, it is ruggedly constructed, well finished, and readily adaptable to a standard MPK weapon. The construction of the silencer, its size and acoustical performance suggest that it was built as an experimental model-shop item.

Internally, the MPK silencer (Figure 56) consists of a 10 inch long by 2 inch diameter expansion chamber containing an elaborate assortment of geometrically complex tubes, vanes, and cones. Except for two steel end pieces and the steel turbine-like vanes, the silencer is made entirely of aluminum. Beginning at the rear, the silencer starts with a simple 1.5 inch long expansion chamber, followed by a tubular spool, outside-vaned at the rear and closed at the front. The steel vanes forming one end of the spool are brazed to the aluminum tube. After the spool come two cones, an expansion chamber, and another cone.

All Frankford Arsenal sound tests on the MPK were made with special rounds loaded for subsonic velocities (Table XIII). The sound history of the MPK without the silencer is shown in Figure 59. The weapon's main noise, like that of most other unsilenced systems, was due to the precursor wave and the projectile exit blast. The two positive pulses five meters to the side of the MPK were, respectively, 131 and 140 db peak SPL.

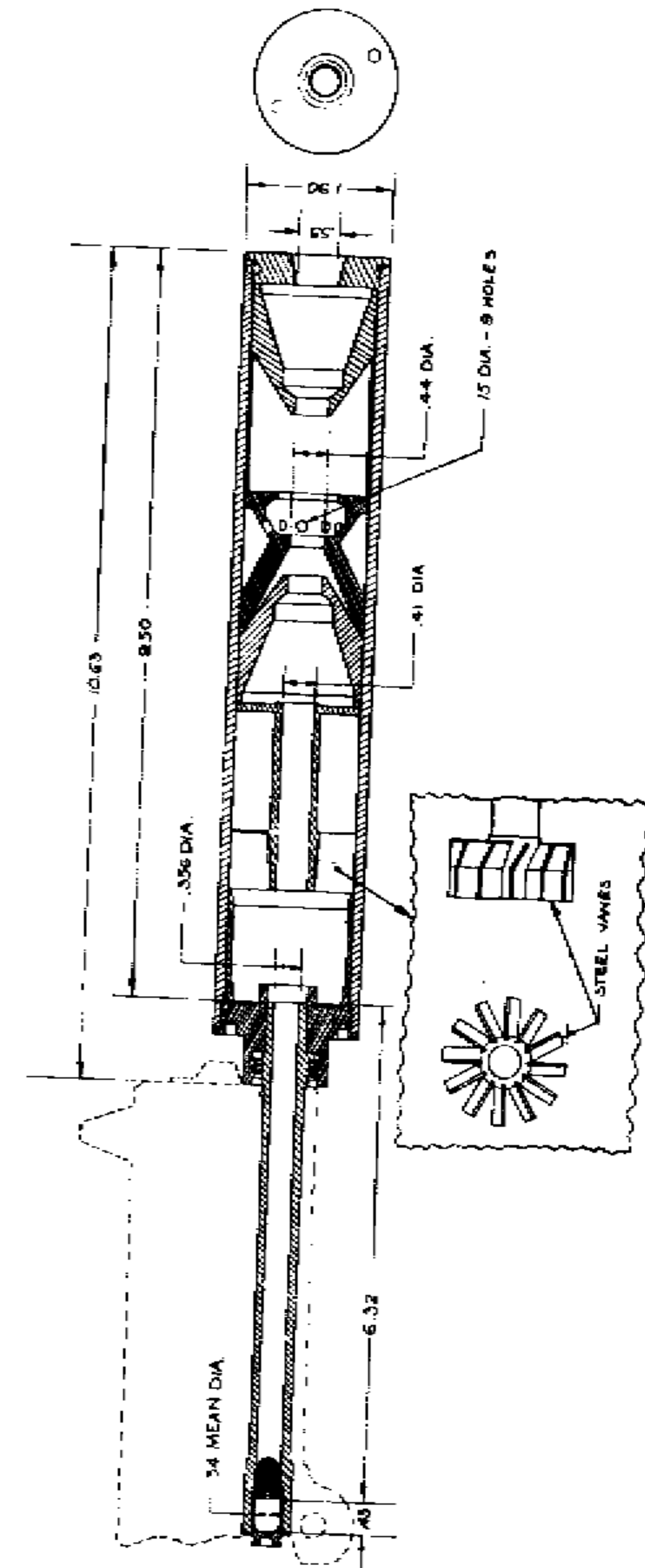

Figure 56. Cross section, 9 mm MPK Walther Submachine Gun and West German Silencer

96

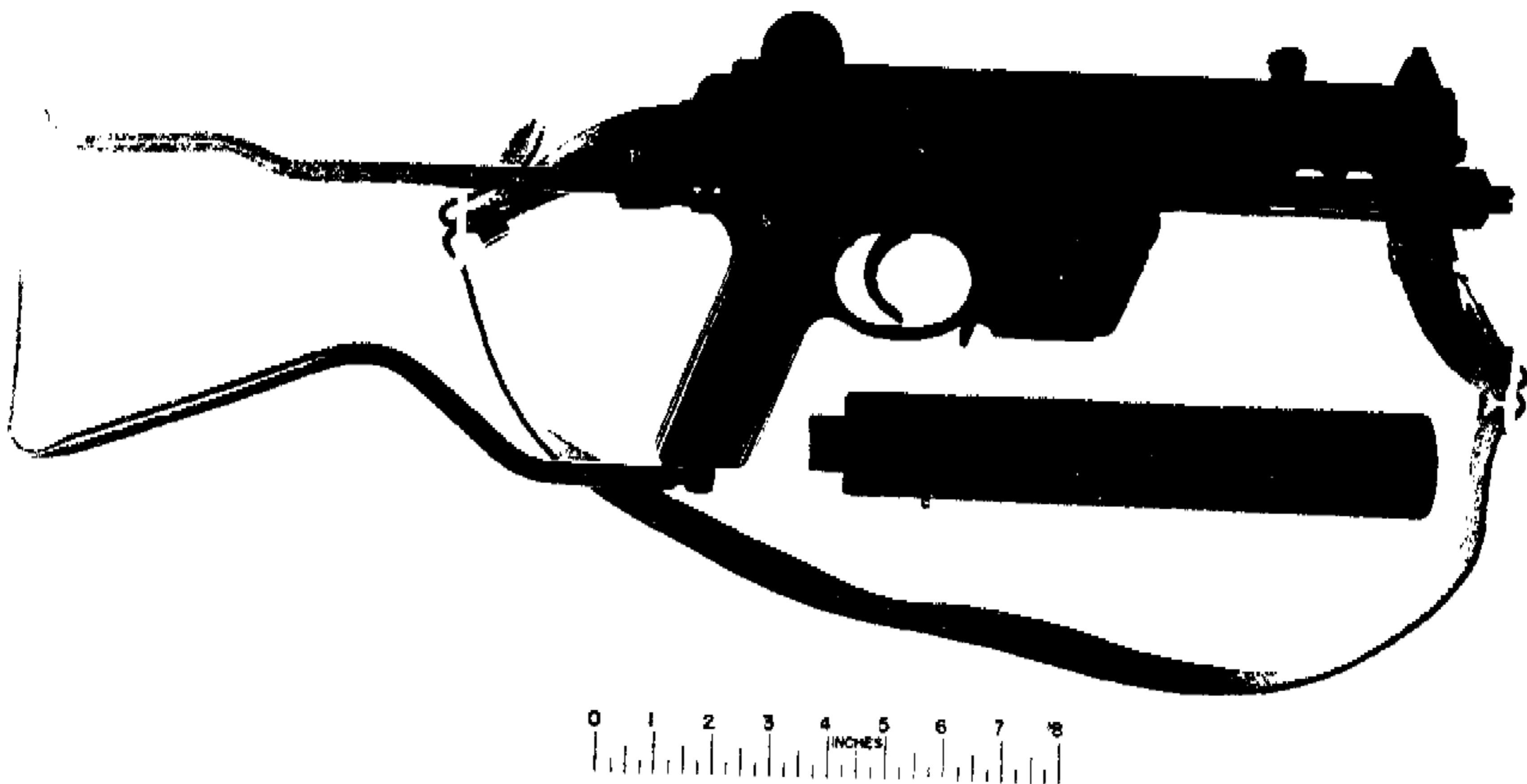

Figure 57. 9 mm MPK Walther Submachine Gun and West German Silencer

97

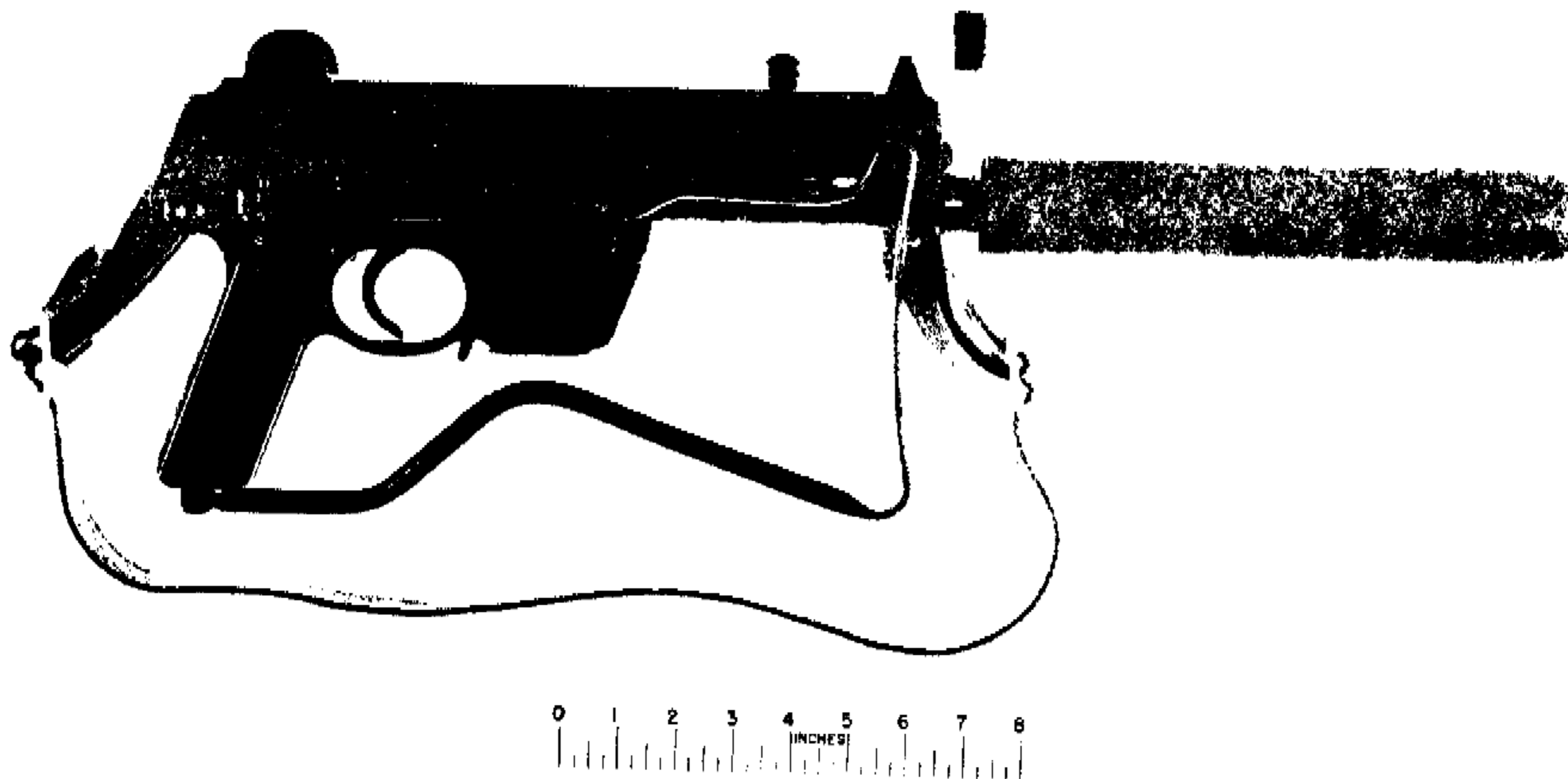

Figure 58. 9 mm MPK Walther Submachine Gun/West German Silencer

TABLE XIII. 9 mm MPK Walther Submachine Gun/German Silencer

Projectile	
Weight	115 gr
Diameter	0.356 in.
Velocity (at silencer exit)	1000 fps
Energy (at silencer exit)	255 ft-lb
Travel at peak ballistic pressure (estimated)	0.4 in.
Travel in barrel	6.32 in.
Travel time in barrel (estimated)	0.62 ms
Travel time in silencer	0.79 ms
Propellant	
Weight (M9, double base, flake, web ~ 0.003 in.)	3 gr (+ 0.3 gr primer)
Chamber volume	0.038 in. ³
Ballistic pressure	
Peak	22,400 psi
At barrel muzzle (estimated)	1,400 psi
Silencer	
Passage diameter (for projectile)	0.41 in., 0.44 in. and 0.55 in.
Weight	1.5 lb (approx)
Free volume	15.0 in. ³
Unsilenced submachine gun weight (without magazine)	6.2 lb.
Time between precursor and projectile exits from silencer (estimated)	0.69 ms

y = 830 μ bars/cm

x = 0.5 ms/cm

1 cm = 1 major division

Microphone: B&K 4135

L₁ = 131 db

L₂ = 140 db

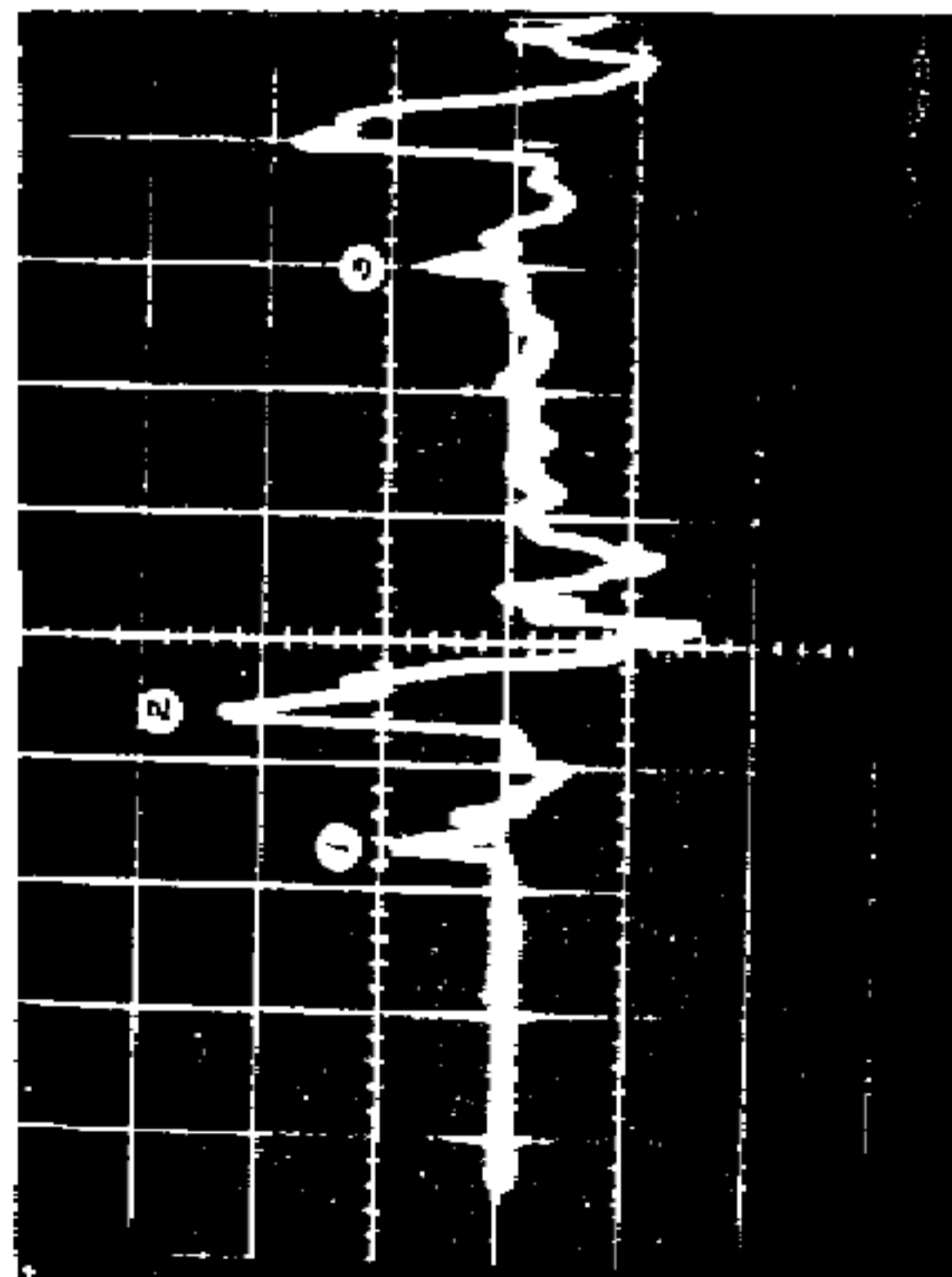

- ① Precursor Exit from Barrel
- ② Projectile Exit from Barrel
- ③ Precursor Ground Reflection

Figure 59. Sound Pressure-Time History, five meters to side, 9 mm MPK Walther Submachine Gun without Silencer, Using Subsonic Cartridge

Although not visible in the trace of Figure 59, the MPK has a relatively loud, prolonged, mechanical noise. This noise is due primarily to the forward slap of the bolt against the breech and consequent vibration of the weapon's mechanical components. The sound trace of the weapon, fired dry, without a cartridge, is shown in Figure 60. The peak SPL of the MPK's mechanical noise was approximately 106 db five meters from the weapon.

The sound history of the silenced MPK, firing a subsonic cartridge, is shown in Figure 61. The system's first significant sound (pt 1, Figure 61) corresponded to the time of primer initiation. The first positive pulse of this sound (approximately 106 db), five meters from the weapon, was due to the forward slap of the bolt against the gun breech. Approximately 0.2 ms after the bolt bottomed, there was a second positive pulse of 114 db peak SPL due to rearward gas leakage around the cartridge case. Following primer initiation came the first noise emitted from the silencer muzzle. This was a pulse (pt 2) of 108 db peak SPL due to the exiting of the precursor wave generated in gun barrel. The blow-by occurring in the silencer exited from the muzzle approximately 0.4 ms later. This gave rise to a positive pulse (pt 3) of 116 db peak SPL. The projectile exited about 0.4 ms later. This generated the system's largest pulse - 118 db peak SPL. Following this there was a series of smaller random sound pulses due to reverberations inside the silencer.

Figure 62 shows, essentially, only the muzzle noise of the silenced MPK. The record was obtained by wrapping the weapon with a suede coat. The effect can be seen most readily in the barely visible primer initiation noise (pt 1, Figure 62) and the more clearly defined precursor pulse (pt 2).

In comparison to other systems, the silenced MPK sounded somewhat louder than the 9 mm Stens and quieter than the caliber .32 and 9 mm Welrods. Qualitatively, the MPK sound signature could be described as a somewhat muffled clap, immediately followed by a diminishing hiss.

Caliber .45 Silenced M3 Submachine Gun (Figure 63)

Bell Laboratories Silenced Barrel

During World War II, Bell Laboratories investigated silencing of various weapons, including the caliber .45 M3 submachine gun.

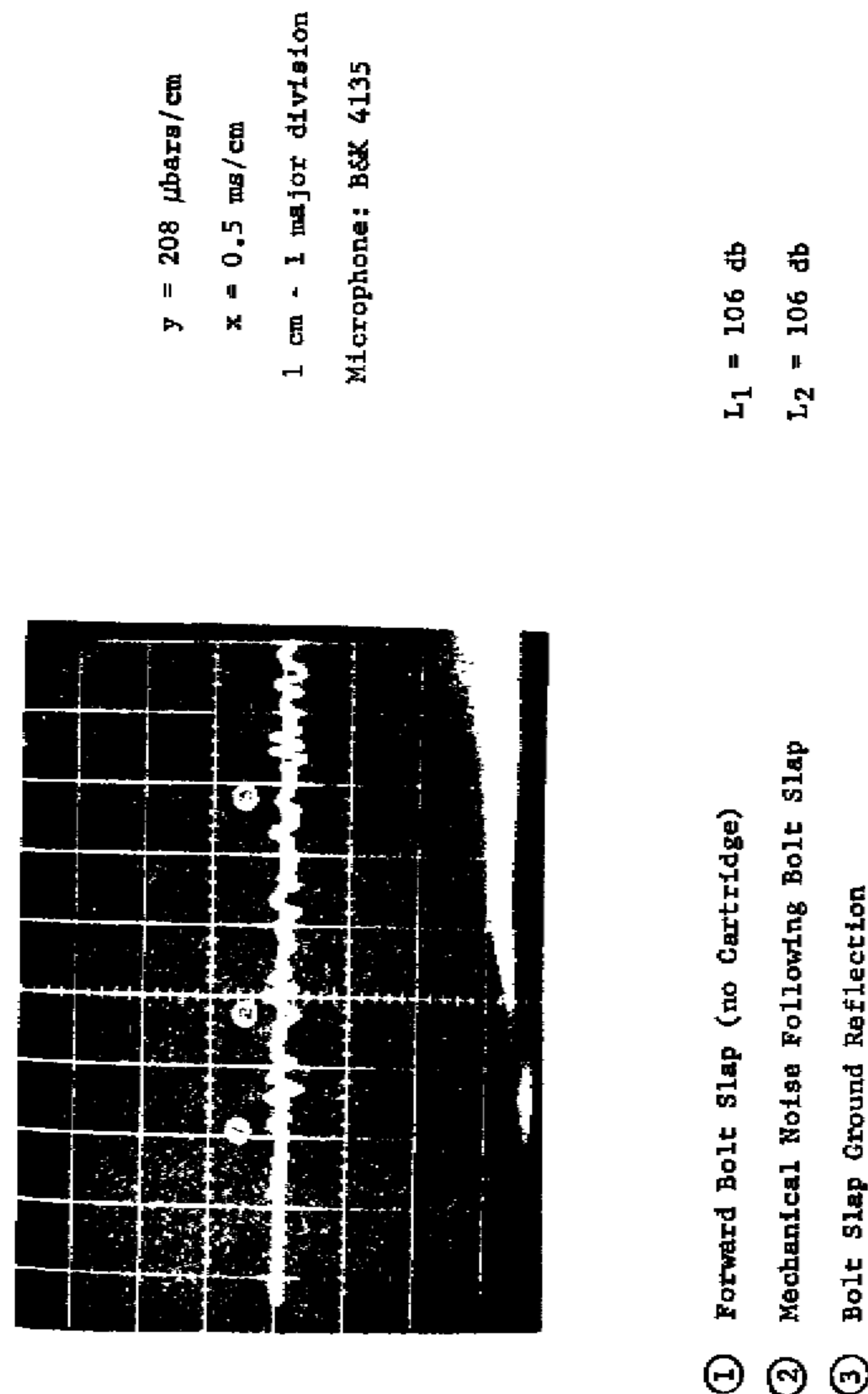
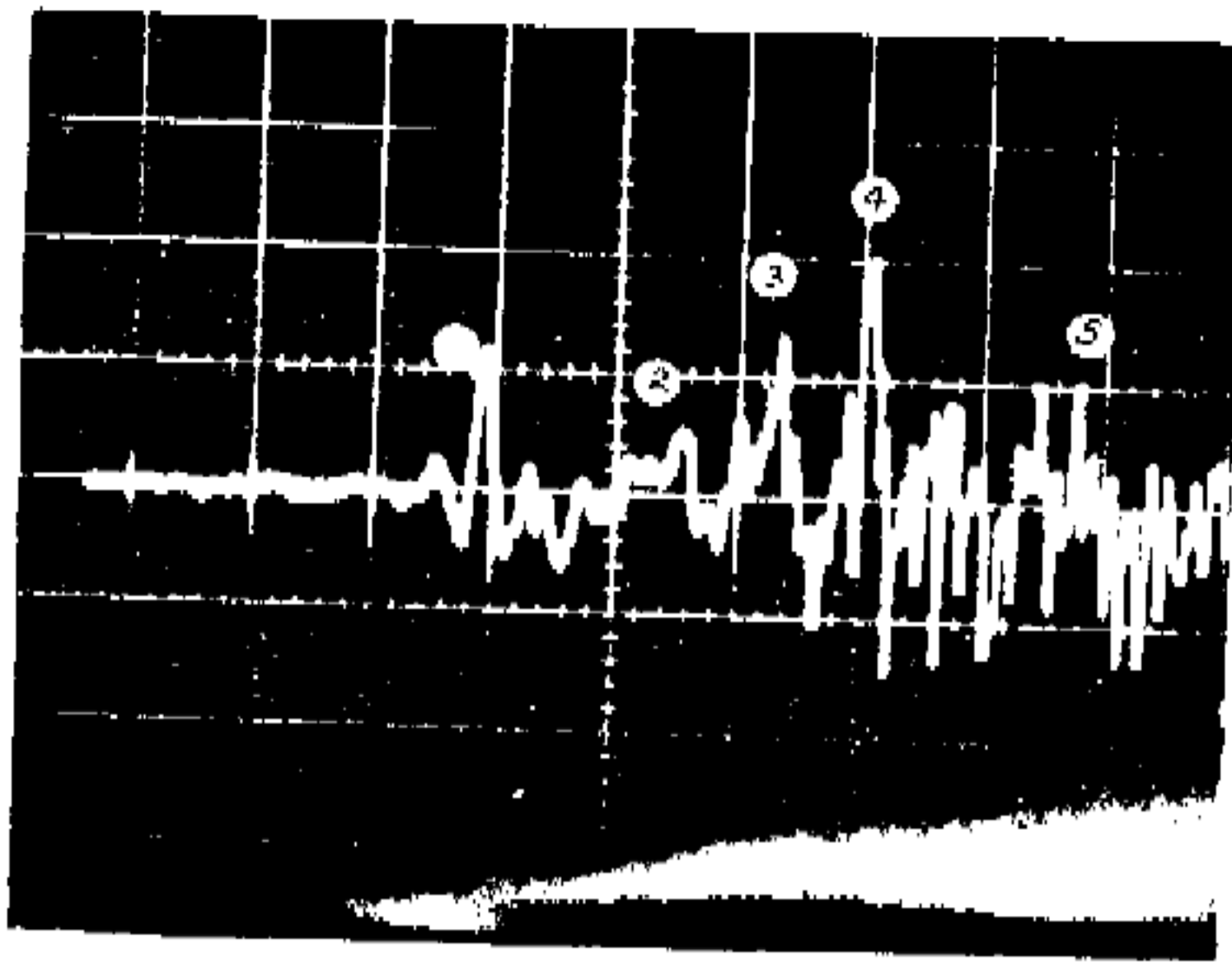

Figure 60. Sound Pressure-Time History, five meters to side, Bolt Slap, 9 mm MPK Walther Submachine Gun/West German Silencer, without Cartridge



$$y = 83 \mu\text{bars/cm}$$

$$x = 0.5 \text{ ms/cm}$$

1 cm = 1 major division

Microphone: B&K 4135

- ① Primer Initiation
- ② Precursor Exit from Silencer
- ③ Blow-by Exit from Silencer
- ④ Projectile Exit from Silencer
- ⑤ Primer Initiation Ground Reflection

$$L_1 = 114 \text{ db}$$

$$L_2 = 108 \text{ db}$$

$$L_3 = 116 \text{ db}$$

$$L_4 = 118 \text{ db}$$

Figure 61. Sound Pressure-Time History, five meters to side, 9 mm MPK Walther Submachine Gun/West German Silencer, Using Subsonic Cartridge

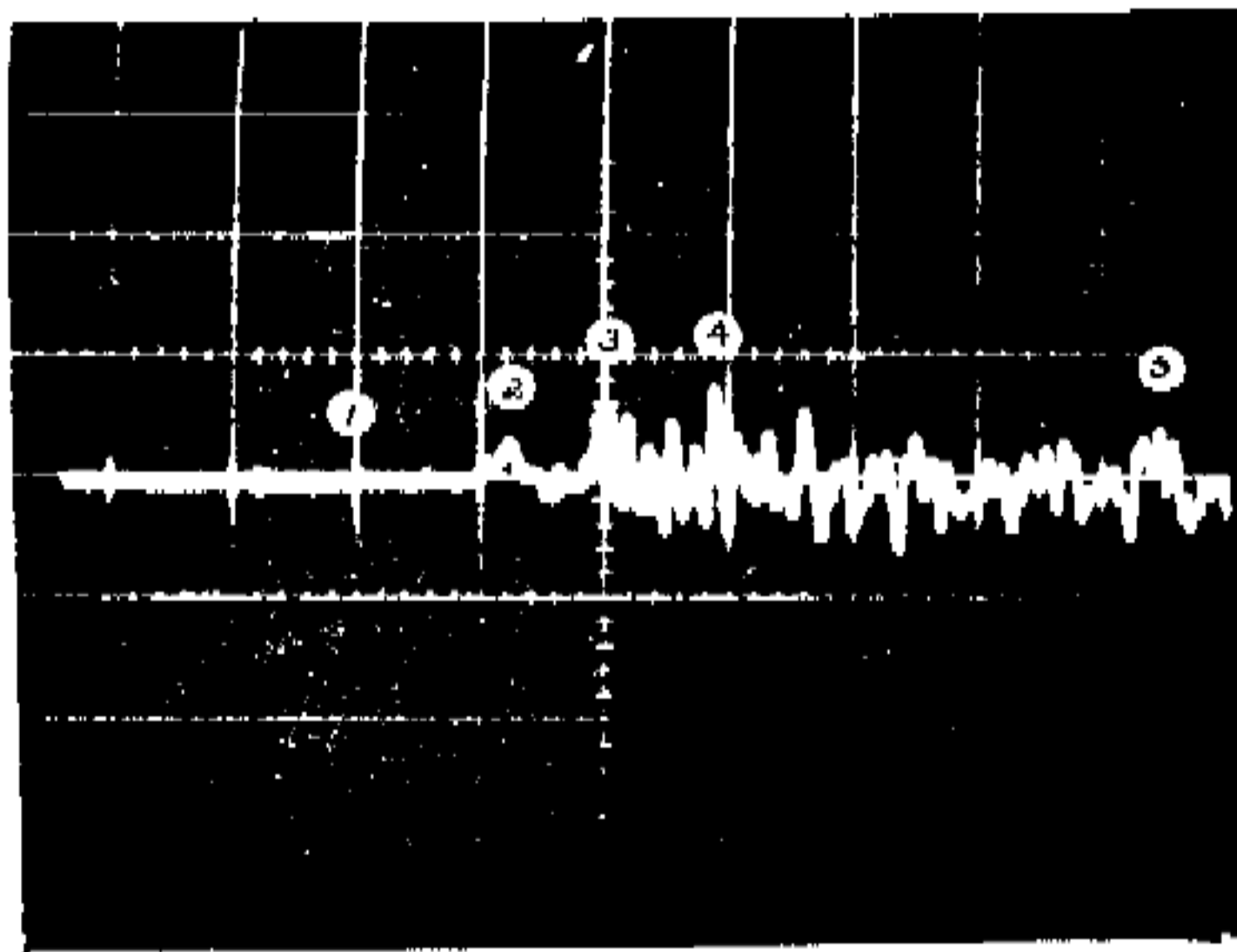

$$y = 210 \mu\text{bars/cm}$$

$$x = 0.5 \text{ ms/cm}$$

1 cm = 1 major division

Microphone: B&K 4135

- ① Primer Initiation
- ② Precursor Exit from Silencer
- ③ Blow-by Exit from Silencer
- ④ Projectile Exit from Silencer
- ⑤ Blow-by Ground Reflection

$$L_1 \approx 95 \text{ db}$$

$$L_2 = 107 \text{ db}$$

$$L_3 = 116 \text{ db}$$

$$L_4 = 118 \text{ db}$$

Figure 62. Sound Pressure-Time History, five meters to side, 9 mm MPK Walther Submachine Gun/West German Silencer, Using Subsonic Cartridge and with Weapon and Silencer Wrapped with Attenuating Material



Figure 63. Caliber .45 M3 Submachine Gun

A silenced M3 barrel (Figures 64, 65 and 66, and Table XIV) was designed and presented to the Infantry Board for evaluation. Conclusions from the tests were that the silenced M3 was quiet, but still detectable at close ranges. A thousand silenced barrels were reportedly built and supplied for use by the Office of Strategic Services (OSS).

The Bell Laboratories silenced barrel consists essentially of a drilled gun barrel and a silencing chamber surrounding and extending beyond the gun barrel muzzle. Along its length, the gun barrel has 48 holes (0.25 inch diameter) which are positioned in four straight rows. During firing, some of the gases are bled off through the holes, with a consequent reduction in the ballistic gas pressure and the projectile muzzle velocity.

The silencing chamber is composed of two sleeves of different lengths and diameters, connected by means of a reducing bushing. The rear sleeve encloses a roll of wire mesh which surrounds the drilled gun barrel; the forward sleeve, which extends beyond the gun barrel muzzle, contains a stack of wire mesh discs. The projectile passage through the wire mesh discs is 0.05 inch in diameter.

The mechanical noise associated with firing the silenced M3 submachine gun is substantial, if not dominant. As with the Sten gun, it was found more realistic to evaluate the silenced M3 barrel without the overshadowing mechanical noise. Consequently, the sound results described herein were obtained with the silenced barrel held in a special single shot test fixture.* The following sound records were recorded by an Ampex 351 tape recorder before being transferred to the oscilloscope and the camera film.

Figure 67 shows a scope trace of the sound pressure-time history of a standard caliber .45 M3 barrel (7.5 inches long) fired with a test fixture. The trace was recorded ten meters to the side of the weapon. The two prominent sound pulses on the trace were due to exiting of the precursor wave (pt 1, Figure 67) and the gas discharge following the projectile exit (pt 2). The two pulses were, respectively, 115 and 130 db peak SPL.

Sound signature of the Bell Laboratories silenced barrel and test fixture is shown in Figure 68. The main sound pulses were:

*See Figures 71 and 72

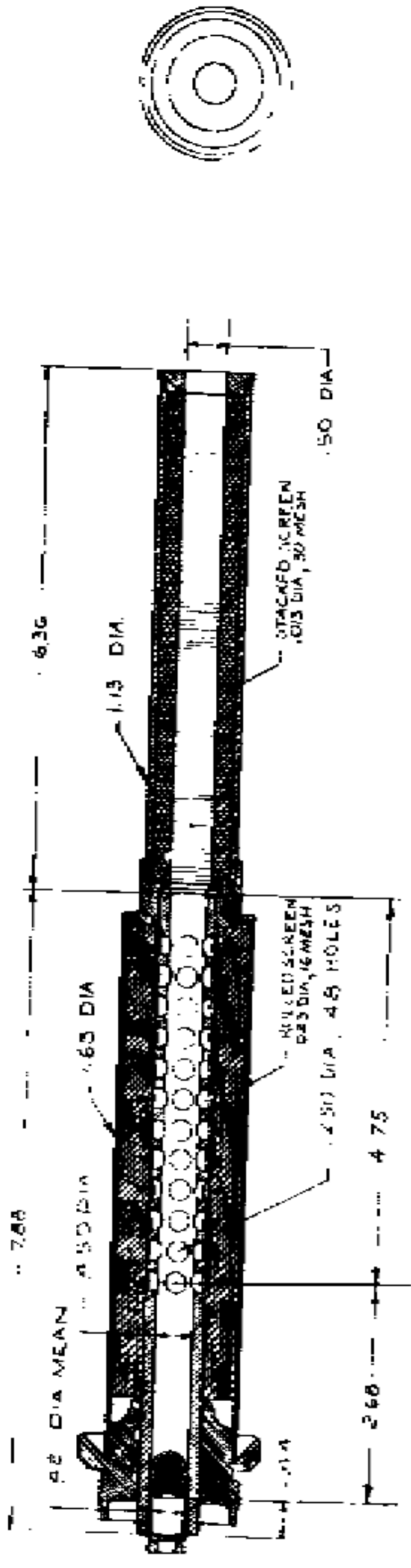

Figure 64. Cross section, Caliber .45 Bell Laboratories Silenced M3 Submachine Gun Barrel

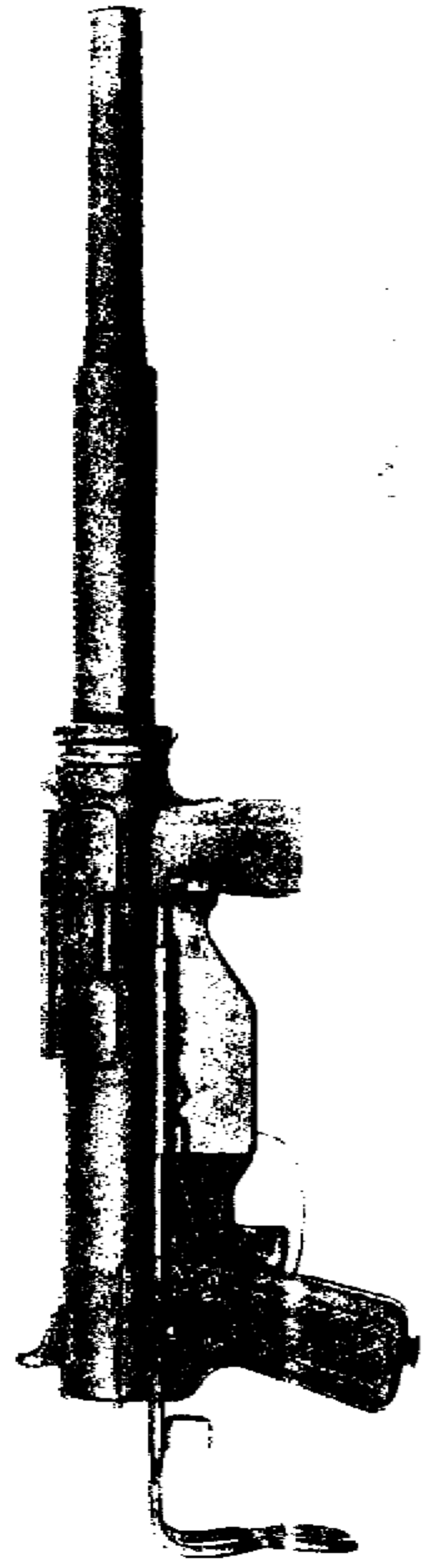

Figure 65. Caliber .45 M3 Submachine Gun/Bell Laboratories Silenced Barrel

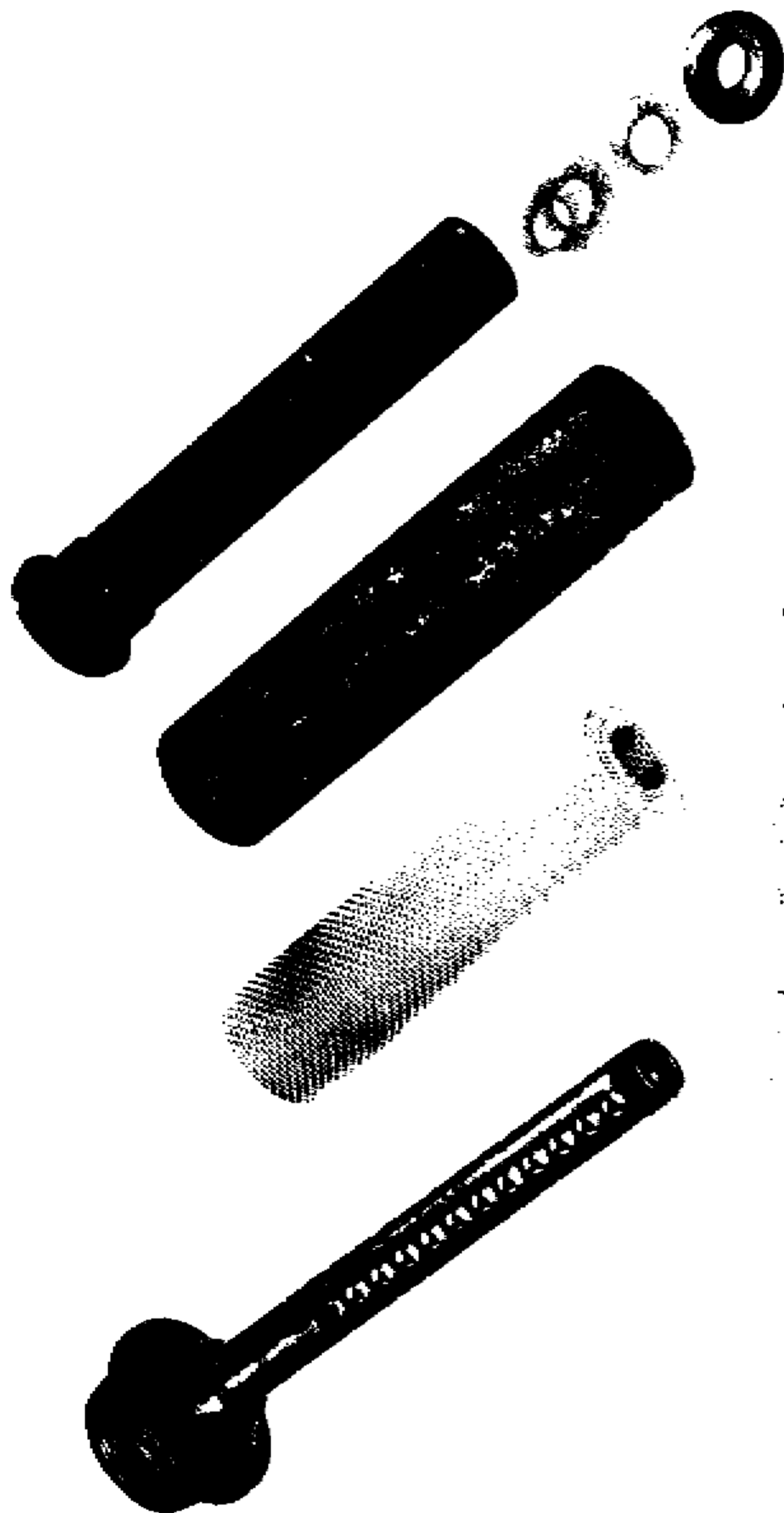
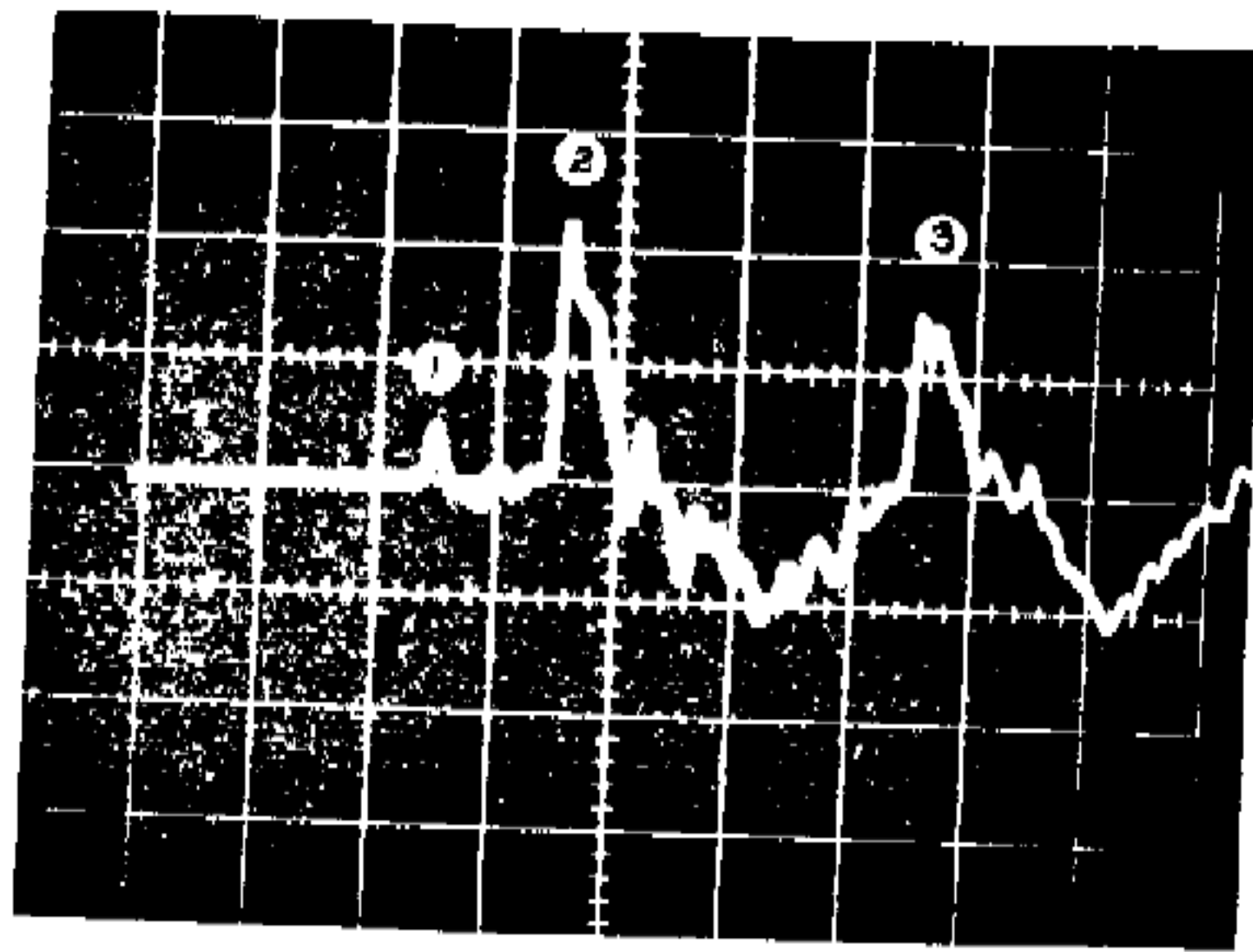

Figure 66. Disassembly, Caliber .45 Bell Laboratories Silenced M3 Submachine Gun Barrel

TABLE XIV. Caliber .45 M3 Submachine Gun/Bell Laboratories Silenced Barrel

Projectile	
Weight	235 gr
Diameter	0.450 in.
Velocity (at silencer exit)	768 fps
Energy (at silencer exit)	310 ft-lb
Travel at peak ballistic pressure (estimated)	0.22 in.
Travel in barrel	7.4 in.
Travel time in barrel (estimated)	0.95 ms
Travel time in silencer	0.69 ms
Propellant	
Weight (HPC1, double base, flake, web ~ 0.003 in.)	5 gr (+ 0.4 gr primer)
Chamber volume	0.061 in. ³
Ballistic pressure	
Peak	20,000 psi
At gun barrel muzzle (estimated)	200 psi
Silencer	
Passage diameter (for projectile)	0.50 in.
Free volume around gun barrel	7.2 in. ³
Free volume in front portion	2.5 in. ³
Volume, rolled wire mesh (brass)	2.9 in. ³
Volume, stacked wire mesh discs (brass)	2.8 in. ³
Silenced barrel	
Weight	2.63 lb
Total length	14.2 in.
Standard M3 barrel	
Weight	1.25 lb
Length	7.9 in.
Standard M3 submachine gun weight (without magazine)	8.1 lb



$y = 230 \mu\text{bars/cm}$

$x = 0.5 \text{ ms/cm}$

1 cm = 1 major division

Microphone: Altec Br 150
Tape Recorder: Ampex 351

- 1 Precursor Exit from Muzzle
- 2 Projectile Exit from Muzzle
- 3 Ground Reflection

$L_1 = 115 \text{ db}$

$L_2 = 130 \text{ db}$

Figure 67. Sound Pressure-Time History, ten meters to side, Caliber .45 Submachine Gun Barrel (standard, 7.5 inches long) in Test Fixture

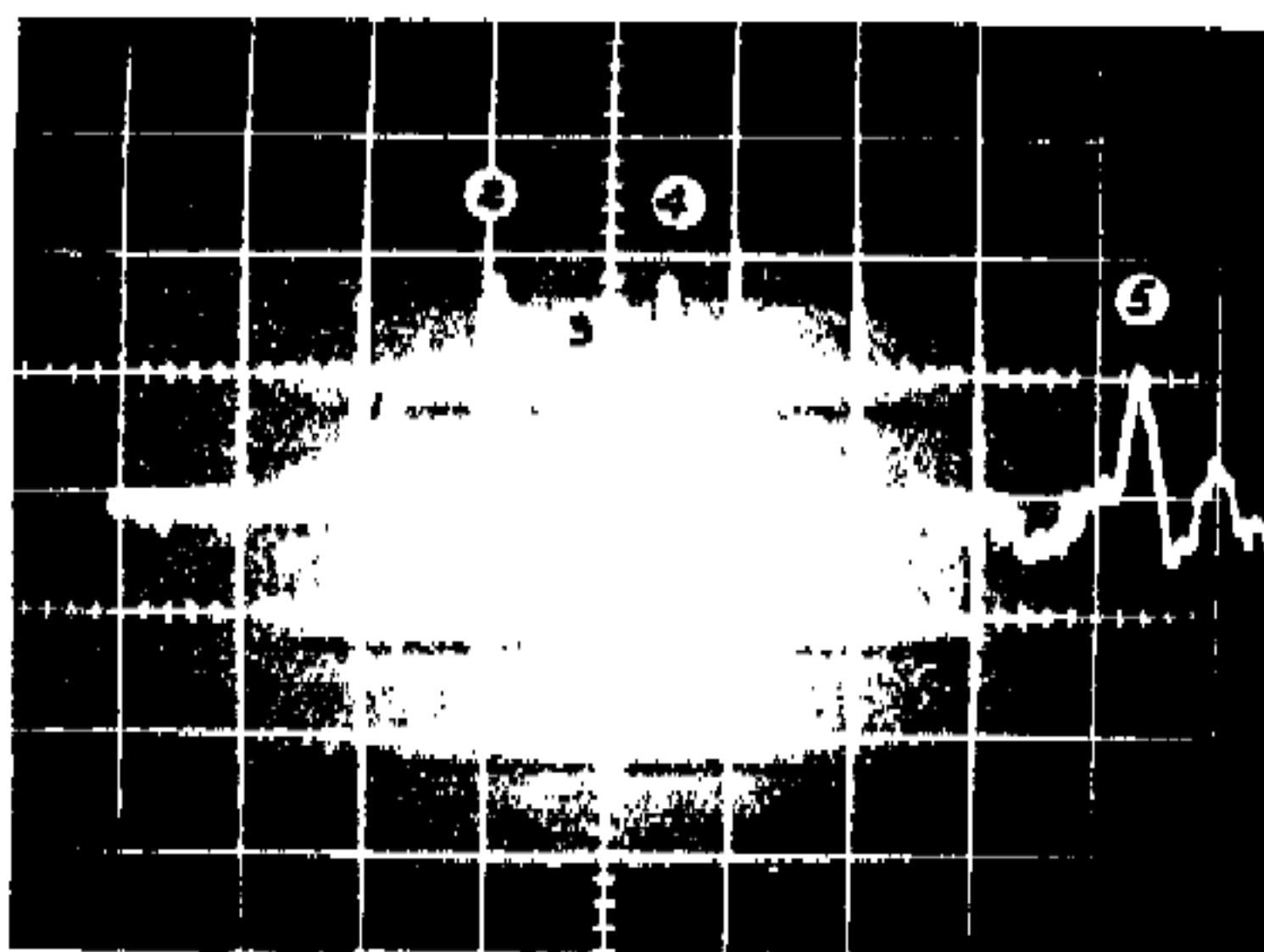

$y = 23 \mu\text{bars/cm}$

$x = 0.5 \text{ ms/cm}$

1 cm = 1 major division

Microphone: Altec BR 150
Tape Recorder: Ampex 351

- ① Primer Initiation $L_1 \approx 93 \text{ db}$
- ② Bleed Hole Blow-by Exit from Silencer $L_2 = 107 \text{ db}$
- ③ Blow-by (at Gun Barrel Muzzle) Exit from Silencer $L_3 = 101 \text{ db}$
- ④ Projectile Exit from Silencer $L_4 = 107 \text{ db}$
- ⑤ Bleed Hole Blow-by Ground Reflection

Figure 68. Sound Pressure-Time History, 4.6 meters to side, Caliber .45 Bell Laboratories Silenced M3 Submachine Gun Barrel in Test Fixture

primer initiation (pt 1, Figure 68), bleed hole blow-by exit (pt 2), gun barrel muzzle blow-by exit (pt 3), and projectile exit (pt 4). The bleed hole blow-by (pt 2) and the gas discharge following projectile exit (pt 4) constituted the main noise sources of the system. Both pulses had a 107 db peak SPL. The gun barrel muzzle blow-by resulted in a sound pulse (pt 3) of 101 db peak SPL.

Although the Bell Laboratories silenced barrel reduced projectile velocity of the standard M3 submachine gun from 920 of 770 fps, the projectile muzzle energy still remained a respectable 310 ft-lb. This is only slightly less than the energy of a caliber .45 pistol and 50 ft-lb more than the energy of the tested 9 mm silenced Sten gun.

To a subjective listener, both systems (Bell Laboratories M3 and the 9 mm silenced Sten) sounded comparable in loudness. However, each weapon had its own characteristic sound signature - the M3, a mild clap; the Sten, a distinct hiss. A disadvantage of the M3 is that the wire mesh requires periodic cleaning and replacement.

AMF Silenced Barrel

The AMF silenced M3 barrel (Figures 69 through 72 and Table XV) is an experimental item manufactured in the 1960's by American Machine and Foundry Company (AMF). It utilizes a 5.6 in. long gun barrel and a 1.25 in. diameter silencing tube which surrounds and extends 9 inches beyond the gun barrel. Whereas the space surrounding the gun barrel is not utilized, the front portion of the tube forms the system's silencer. This front section is filled throughout its length with closely stacked wire mesh discs, separated by five irregularly positioned rubber discs. In the silenced barrel tested at Frankford Arsenal, the projectile passage through the rubber discs was approximately 0.5 inch in diameter. Originally, these discs probably partially or completely closed off the silencer interior. The gun barrel of the AMF system is 2 inches shorter than that of a standard M3 weapon. This, however, results in only a slight reduction in projectile velocity.

The AMF silenced barrel was tested at Frankford Arsenal with a single shot fixture, shown in Figures 71 and 72. Figure 73 shows the scope trace of the sound pressure-time history of the 5.6 inch

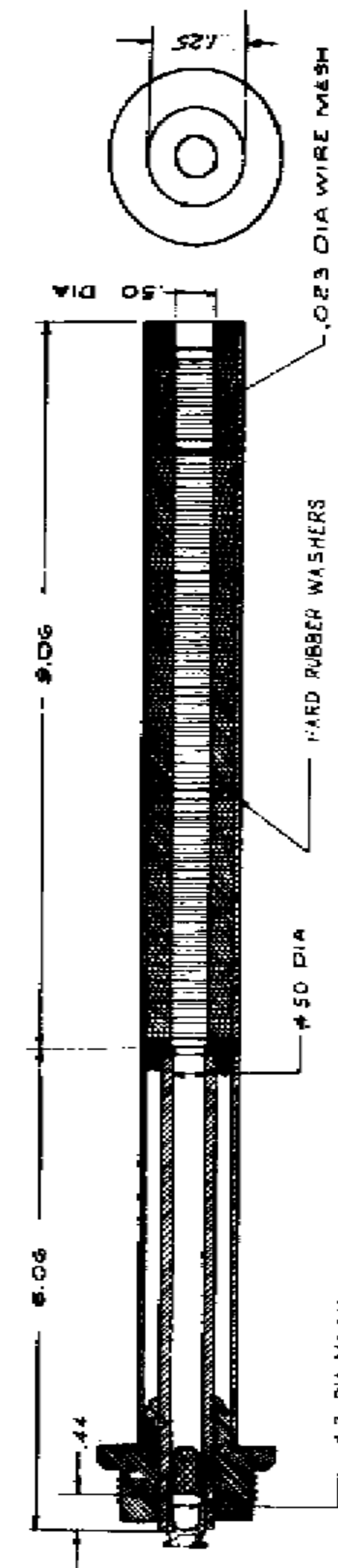

Figure 69. Cross section, Caliber .45 AMF Silenced M3 Submachine Gun Barrel

114

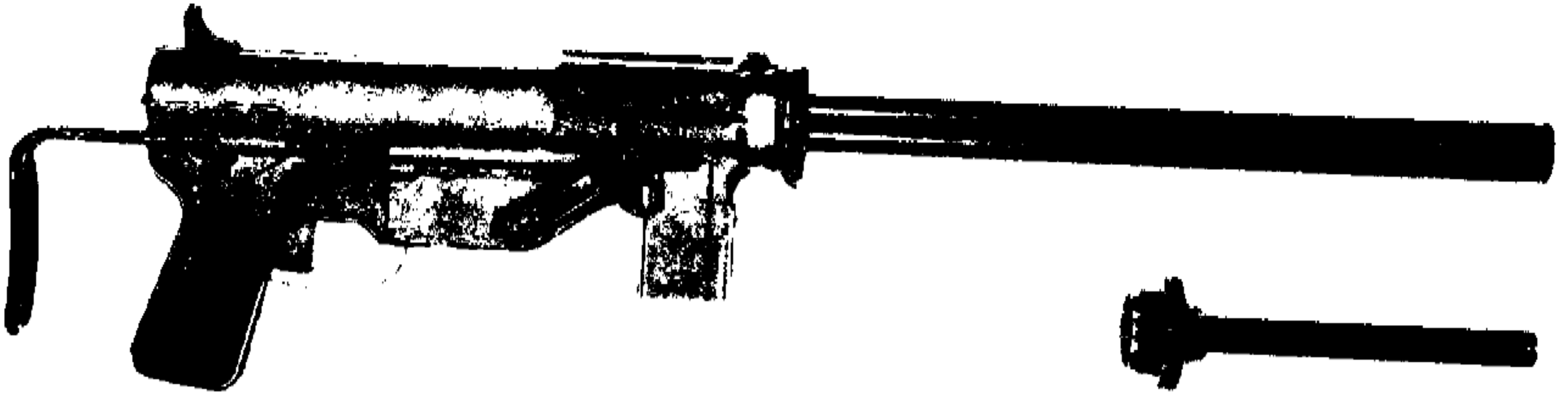

Figure 70. Caliber .45 M3 Submachine Gun/AMF Silenced Barrel

115



Figure 71. Assembly, Caliber .45 AMF Silenced M3 Submachine Gun Barrel and Test Fixture



Figure 72. Disassembly, Caliber .45 AMF Silenced M3 Submachine Gun Barrel and Test Fixture

TABLE XV. Caliber .45 M3 Submachine Gun/AMF Silenced Barrel

Projectile	
Weight	235 gr
Diameter	0.45 in.
Velocity (at silencer exit)	910 fps
Energy (at silencer exit)	435 ft-lb
Travel at peak ballistic pressure	0.22 in.
Travel in barrel	5.6 in.
Travel time in barrel	0.85 ms
Travel time in silencer	0.83 ms
Propellant	
Weight (HPC1, double base, flake, web ~ 0.003 in.)	5 gr (+ 0.4 gr primer)
Chamber volume	0.061 in. ³
Ballistic pressure	
Peak	20,000 psi
At barrel muzzle	1,600 psi
Silencer	
Projectile passage diameter in wire mesh discs	0.50 in.
Projectile passage diameter in old rubber discs	0.50 in.
Free volume (front of barrel)	4.9 in. ³
Free volume around barrel (unused)	2.9 in. ³
Volume, stacked brass wire mesh and rubber discs	4.5 in. ³
Silenced barrel	
Weight	2.5 lb
Length	15.1 in.
Standard M3 barrel	
Weight	1.25 lb
Length	8.0 in.
Standard M3 submachine gun weight (without magazine)	
	8.1 lb
Time between precursor and projectile exits from silencer (estimated)	
	0.56 ms

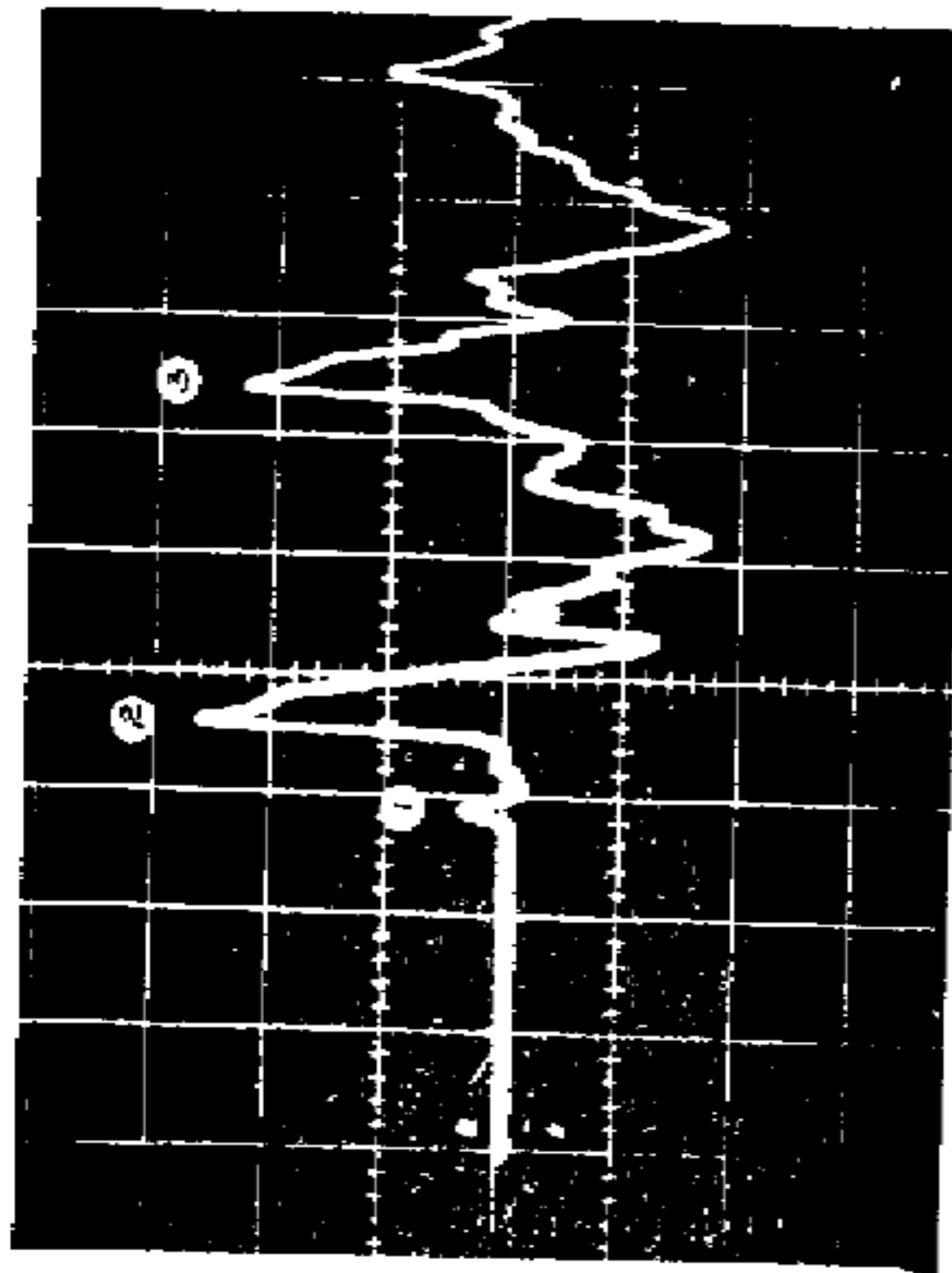

y = 230 μ bars/cm

x = 0.5 ms/cm

1 cm = 1 major division

Microphone: Altec BR 150
Tape Recorder: Ampex 351

- ① Precursor Exit from Muzzle
- ② Projectile Exit from Muzzle
- ③ Projectile Exit Ground Reflection

L₁ = 113 db

L₂ = 130 db

Figure 73. Sound Pressure-Time History, ten meters to side, Caliber .45 M3 Submachine Gun Barrel (5.6 in. long), without Silencer, in Test Fixture

long gun barrel without a silencer. The trace was recorded ten meters to the side of the weapon. The two prominent sound pulses on the trace were due to precursor wave exit (pt 1, Figure 73) and gas discharge following the projectile exit (pt 2). The corresponding peak SPL's of the two pulses were 113 db and 130 db.

Sound pressure-time history of the AMF silenced M3 barrel (with old rubber baffles) is shown in Figure 74. The first sound recorded upon firing the system was generated at the time of primer initiation. The low peak SPL (~93 db) of this sound indicates that it was primarily mechanical in nature. The next sound pulse (pt 2, Figure 74) was generated when the blow-by wave exited from the silencer. This wave, formed by gases bypassing the projectile, resulted in a peak SPL of 127 db. Projectile exited from the silencer approximately 0.65 ms later, giving rise to the positive pulse (pt 3) of 121 db peak SPL.

In general, firing of the AMF silenced barrel was characterized by a relatively sharp crack, perhaps only slightly quieter than that of a standard caliber .22 Short pistol. Better acoustical results would possibly have been realized if the rubber discs were new. However, the system's loudness would probably still be limited by noise due to abrupt emergence of the massive projectile. (See data on 9 mm Welrod.)

CONCLUSIONS

The more important physical, functional, and acoustical data of the tested silenced and unsilenced weapons are tabulated in Table XVI. The peak SPL's of the various pulses in this table were taken from the preceding sound scope traces. In cases where the sound scope trace was recorded at a distance other than five meters, the data were extrapolated for comparative purposes.

Although in most weapons the major sound pulse was generated at the time of projectile exit, there were some weapons (such as the caliber .22 Frankford Arsenal silencer, caliber .30 carbine, etc.) which generated the largest pulse because of blow-by. Some weapons

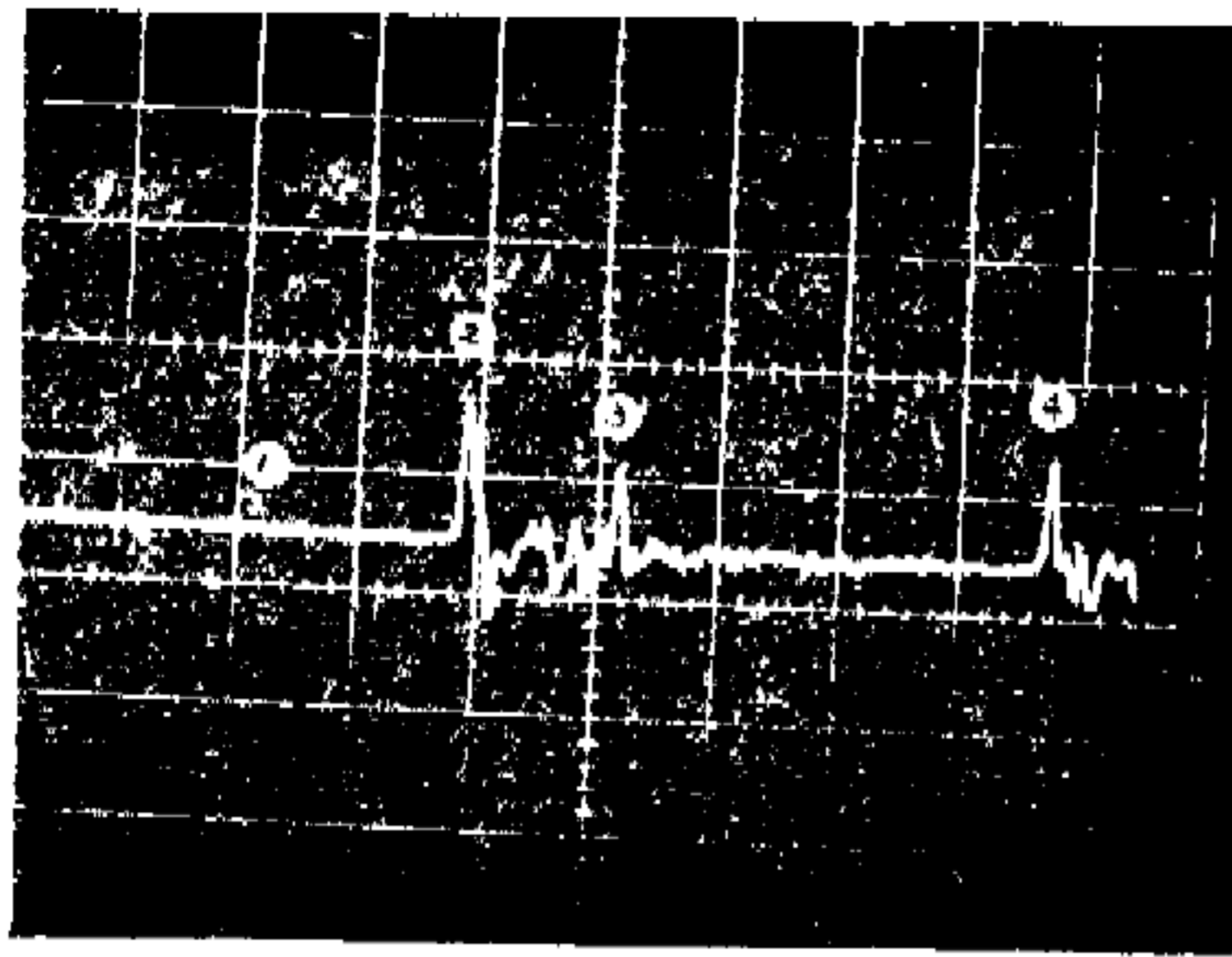

y = 390 μbars/cm

x = 0.5 ms/cm

1 cm = 1 major division

Microphone: B&K 4135

- ① Primer Initiation L₁ ≈ 93 db
- ② Blow-by Exit from Silencer L₂ = 127 db
- ③ Projectile Exit from Silencer L₃ = 121 db
- ④ Ground Reflection

Figure 74. Sound Pressure-Time History, five meters to side, Caliber .45 AMF Silenced M3 Submachine Gun Barrel in Test Fixture

TABLE XVI.
Physical, Functional, and Acoustical Parameters of Silenced and Unsilenced Small Arm Weapons

NOTE: All sound pressure levels are for a distance of five meters from and to the side of the weapon.

Weapon	Gun Barrel Length (in.)	Silencer	Projectile			Pre-expansion Ballistic Pressure (psi)	Silencer			Peak Sound Pressure Level (db)				
			Weight (gr)	Velocity (fps)	Energy (ft-lb)		Length (in.)	Weight (lb)	Total Free Volume (in. ³)	Primer Initiation	Bleed Hole Blow-by	Projectile	Silencer Blow-by	Max Blast
Cal. 22 Hi-standard Pistol	7.0	None	40	1,000	98	1,500	-	-	-	98	-	113	-	136
Cal. 22 Hi-standard Pistol	7.0	French	40	1,000	98	1,500	6.8	.25	2.4	100	-	95	117	119
Cal. 22 Hi-standard Pistol	6.4	Silenced	40	940	76	1,300 ^a	8.7 ^b	.61	2.6	98	101	-	-	113
Cal. 22 AAI Paper Test Fixture	6.9	Silenced	40	980	88	10,000 ^a	7.4 ^b	.50	4.7	93	-	101	-	114
Cal. 22 Hi-standard Pistol	7.0	FA	40	1,050	98	1,700	5.9	.47	5.6	103	-	89	108	100
Cal. 30 M1903 Rifle	24.0	None	175	1,050	411	1,000	-	-	-	93	-	119	-	137
Cal. 30 M1903 Rifle	22.0	Maxim	175	1,050	411	1,000	7.2	.65	4.0	91	-	93	102	112
Cal. 30 M1 Carbine	9.2	Silenced	108	1,050	270	31,000 ^a	17.0 ^b	6.75 ^c	10.3	94	112	-	122	119
Cal. 32 Steeve Gun	3.1	Silenced	77	700	82	15,000 ^a	8.1 ^b	1.7 ^c	3.0	87	-	-	-	120 ^f
Cal. 32 Weirud Pistol	3.5	Silenced	77	770	102	5,000 ^a	8.1 ^b	2.5 ^c	5.3	112	118 ^g	-	-	122 ^h
9 mm Weirud Pistol	4.7	None	115	640	104	10,000 ^a	-	-	4.3	105	-	131	-	131
9 mm Weirud Pistol	4.7	Silenced	115	640	104	10,000 ^a	9.3 ^b	3.5 ^c	6.6	105	-	-	-	120 ^f
9 mm Sten Gun Barrel Type I	4.3	Silenced	115	1,000	258	23,000 ^a	12.6 ^b	2.28 ^d	15.4	93	-	94	104	106
9 mm Sten Gun Barrel Type II	3.1	Silenced	115	1,000	258	26,000 ^a	13.0 ^b	2.50 ^d	13.3	92	101 ^g	-	113 ^h	104 ^g
9 mm P38 Walther Pistol	4.4	None	115	925	220	1,800	-	-	-	105 ^g	-	135 ^a	-	145 ^g
9 mm P38 Walther Pistol	4.4	AAI	-	925	220	1,800	4.7	3.0	19.0	105 ^a	-	111 ^g	126 ^g	111 ^g
9 mm MPK Submachine Gun	6.3	None	115	1,000	255	1,400	-	-	-	114	-	131	-	140
9 mm MPK Submachine Gun	6.3	W. German	115	1,000	255	1,400	9.5	1.5	15.0	114	-	108	116	118
Cal. 45 M3 Submachine Gun Barrel (Std)	7.5	None	235	920	445	1,000	-	-	-	92 ^g	-	121 ^g	-	136 ^g
Cal. 45 M3 Submachine Gun Barrel	7.5	Bell Lab bbl	235	768	310	4,000 ^a	14.0 ^b	2.63 ^d	9.7	92 ^g	104 ^g	-	100 ^g	106 ^g
Cal. 45 M3 Submachine Gun Barrel	5.4	None	235	910	435	1,600	-	-	-	93	-	119 ^g	-	136 ^g
Cal. 45 M3 Submachine Gun Barrel	5.8	AMF barrel	235	910	435	1,600	9.1	2.5 ^d	4.9	93	-	-	127	121

a - At fire bleed-hole
 b - Total gun barrel & silencer length
 c - Total weapon weight
 d - Total silenced barrel weight
 e - Extrapolated to 5 meter from data recorded at other range
 f - New flexible baffles
 g - Old flexible baffles

(with gun barrel bleed holes) generated a large sound pulse due to bleed hole blow-by. In all weapons except the caliber .45 Bell Laboratories silenced barrel, this pulse was secondary in magnitude.

The primer initiation peak SPL was found to vary from weapon to weapon. There were even substantial differences between similar weapons. However, since in most cases the largest primer initiation pulse was due to gas leakage around the cartridge case, substantial differences in SPL could be attributed to minute differences in cartridge chamber clearance or simply to dirt accumulation in the weapon. The highest primer initiation SPL was that of the 9 mm MPK (114 db). The caliber .32 sleeve gun had the lowest initiation pulse with a peak SPL of only 87 db.

For some of the silenced weapons, sound scope traces were taken at various distances (1, 5, and 10 meters). Although the data are not included herein, it is worth mentioning that with some silenced weapons the peak SPL readings at 1 and 5 meters were found to differ by as much as 18 db. This is a 4-db greater attenuation than would be expected from a simple spherical expansion. From 5 to 10 meters, the peak SPL of some weapons was attenuated by nearly 7 db instead of the normal 6 db. It was also noticed that with distance, some changes occurred in the general shape of the various sound signals. In each case many of the short sound pulses tended slowly to coalesce, thus defining more and more clearly such pulses as precursor, blow-by, etc.

The above effects can be attributed to the fact that high sound pressures propagate at a slightly faster velocity than lower sound pressures.* Although the phenomenon may bear little significance in general acoustics, in Frankford Arsenal tests it was found sufficient to induce a slow, but noticeable, change in the shape of the various major pulses toward that of a balanced N-wave.

Throughout the sound tests, efforts were made to note how each weapon sounded to a listener, particularly in terms of quality and relative loudness. These impressions were later compared with the corresponding sound scope traces. Although, at most, only several listeners were involved, the consensus is nevertheless interesting. Almost invariably sound signatures with one or several shock pulses

sounded sharp and snappy; the signatures containing a large number of pulses or simply more "hash" also sounded snappy, but less sharp, more prolonged, more muffled, and more random in quality. Sound signatures which were predominately "hash" (such as those of the Sten, Maxim, and carbine) sounded like an abrupt initiation of a hiss (or hiss). All sound signatures containing distinct and recognizable shocks seemed more piercing.

Although the quality of each sound signature was definitely recognizable, the primary factor determining the relative loudness was found to be the signal's peak SPL.* Whether by coincidence or design, the weapons with higher peak SPL almost invariably sounded louder and more perceptible. This, of course does not discount the fact that there may be other dominant factors affecting a given weapon's detectability at large distances. As an example one could consider the faster attenuation of short pulses with distance.

Compiled experimental sound data indicate that the better silenced systems registered a peak SPL of approximately 110 db five meters from the weapon. In most weapons, the main sound source was the abrupt discharge of propellant gas. In some weapons (those with flexible baffles) the noise due to gas discharge was relatively low; however, the abrupt projectile emergence at the muzzle generated a noise just as undesirable. The precursor wave of an unsilenced weapon generated a peak SPL in the vicinity of 120 db. Most of the straight-through silenced weapons tested attenuated the precursor down to about 90 db. The mechanical noise was found to depend on system design. In some of the quieter weapons, mechanical noise was in the vicinity of 90 db.

Evaluation of the compiled experimental and theoretical data indicates that a silenced system quieter than the weapons tested at Frankford Arsenal is feasible. However, a system with noise level below 90 db at five meters will most likely evolve gradually and only with a fuller understanding of the noise-generating mechanisms.

RECOMMENDATIONS

1. Conduct analytical design of an optimum silenced small arms weapon based on experimental and analytical data generated to date.

*See Appendix C

*See Appendix F

2. Continue analytical study of noise-generating and attenuating mechanisms in small arm weapons.

3. Acoustical evaluation of small arm weapons should be based on identification and interpretation of individual noise sources determined from oscilloscope traces of the overall weapon sound history. Peak sound pressure level should be established as a factor of primary significance.

APPENDIX A BALLISTIC CRACK FIELD

When a supersonic projectile exits an unsilenced gun barrel, the uncorked propellant gases generate a spherically expanding blast wave. The wave initially bypasses the projectile; however, dissipating rapidly, it slows down to almost sonic velocity and is overtaken by the projectile within a matter of a few feet from the muzzle. Later, in the free far field, the initial projectile lag is overshadowed by the linear geometric expansions, and projectile, muzzle blast, and ballistic crack acquire approximately the proportional relationship shown below.

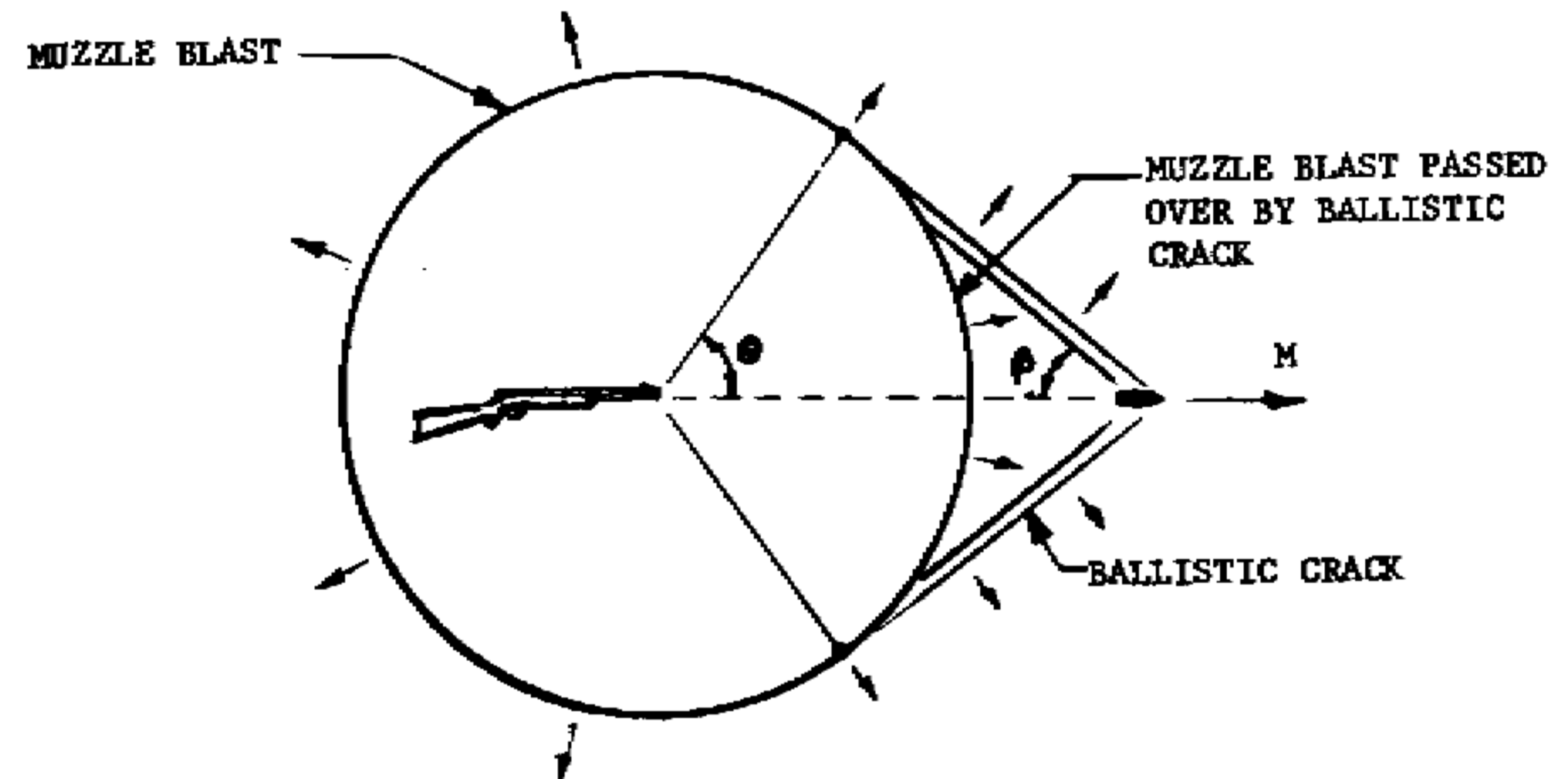

Here the sound field consists essentially of ballistic crack, muzzle blast, and muzzle blast passed over by ballistic crack. The acoustical significance of ballistic crack and muzzle blast have been previously considered.* It only remains to mention that the section of muzzle blast wave, having been passed over by the ballistic crack,

*See Appendix C and Reference 46.

essentially suffers only slight refraction and scattering by turbulence.

In the far field, the ballistic crack cone is nearly tangential to the blast wave sphere.

The angle between the ballistic wave envelope and the projectile trajectory depends solely on the projectile velocity.⁴⁶ It is expressed by:

$$\beta = \tan^{-1} \left(\frac{1}{\sqrt{M^2 - 1}} \right) \quad (1)$$

where M = projectile Mach No.

The azimuth angle from the weapon to the tangency point of blast and ballistic wave envelopes is expressed by:

$$\theta = \tan^{-1} \left(\sqrt{M^2 - 1} \right) \quad (2)$$

The plot of the ballistic crack field half-angle, θ , is shown below.

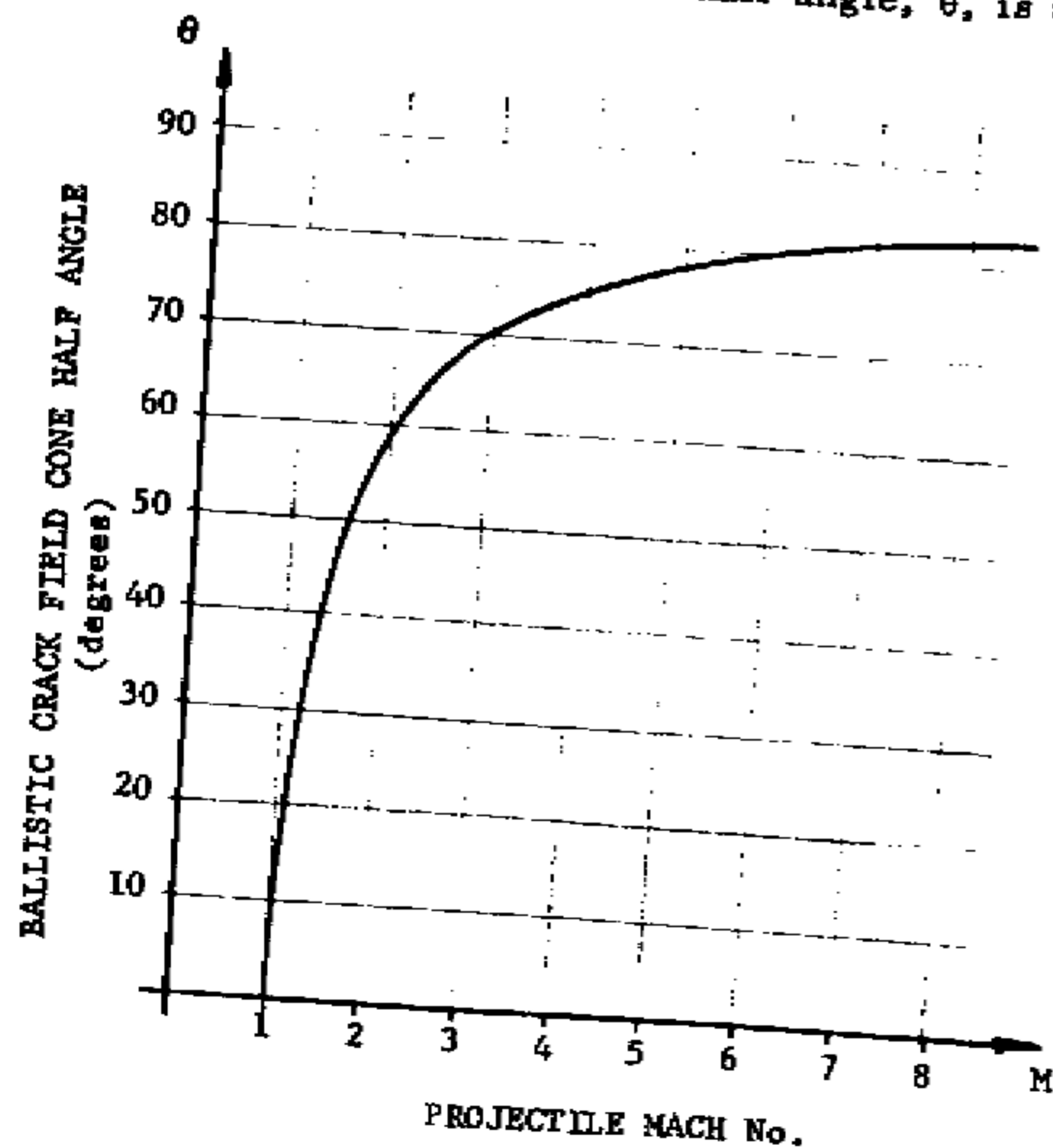

Thus, it is seen that, with the usual supersonic projectile velocities, the ballistic crack is confined to approximately a 130° cone to the front of the weapon. The cone increases to 160° with projectile Mach number of 6. At Mach 1.5, the cone decreases to about 100°, and at Mach 1 it vanishes altogether.

The above data find application when silencing a supersonic weapon. Thus, although the silencer will effectively attenuate muzzle blast the usually loud and far ranging ballistic crack will still persist within the defined frontal cone. To the side and the rear will be heard the somewhat weaker, spherically expanding ballistic crack reflecting from the weapon.

APPENDIX B

SUBSONIC PROJECTILE FLIGHT NOISE

Subsonic projectiles generate noise in flight. Although this noise is much quieter than that of supersonic projectiles, it can be quite loud and detectable at large distances from the projectile trajectory. To the side of the passing subsonic projectile, one hears the characteristic swish; first increasing, then diminishing in intensity. Although this noise, like all turbulence-initiated noises, can have a seemingly random quality, in the far field it is generally found to be periodic.⁴¹ Its frequency depends primarily on the flow velocity and the diameter of obstruction in the flow; however, as will be seen, several other factors must also be given consideration. A typical subsonic, small caliber, flat based projectile generates about 95 db peak SPL at 10 meters from its trajectory. In comparison, the more streamlined projectiles are generally found substantially quieter.

The basic noise-generating mechanism of subsonic projectiles consists, briefly, of the following. Throughout the projectile flight a certain amount of air within the turbulent boundary layer follows the projectile. (See simplified figure below.)

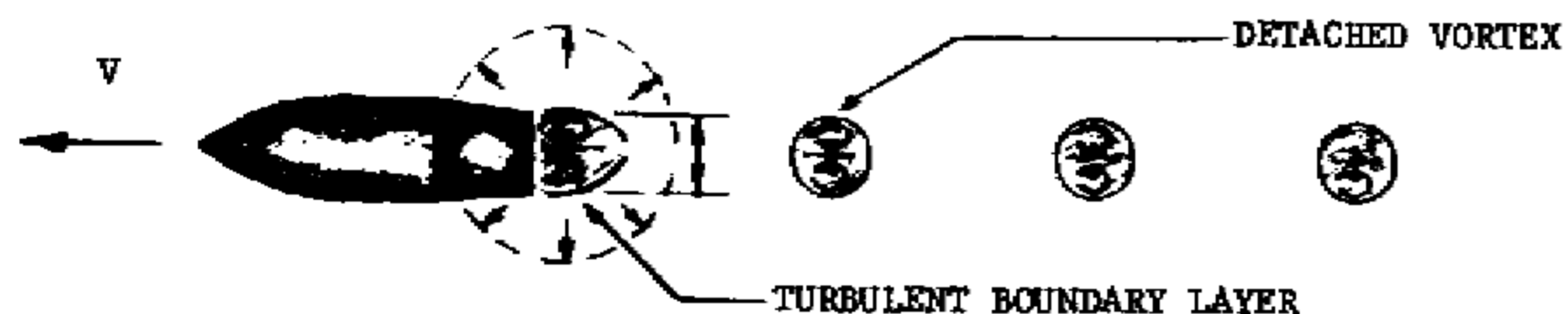

The velocity differential between the surrounding air and the air traveling with the projectile generates shear forces which accelerate the air within the boundary layer into a vortical spin. The attached spherical vortex size increases simultaneously with increased spin until the vortex is finally washed downstream. Thus, the amount of air traveling with the projectile decreases and the process repeats.

The energy of the attached spherical vortex²⁷ propagating at the velocity of the projectile is

$$E_v \approx \frac{5\pi}{28} b^3 \rho_0 V^2 \quad (1)$$

where

b = vortex diameter, projectile wake diameter;
 ρ_0 = air density;
 V = projectile velocity.

The energy expended by the projectile to generate a single vortex is:

$$E_b \approx \left(C_b \frac{\pi b^2 \rho_0 V^2}{4} \right) \frac{V}{f} \quad (2)$$

where

C_b = projectile wake area drag coefficient, $P_b / \frac{\rho_0 V^2}{2}$;
 f = projectile vortex shedding frequency.

Upon equating the above two equations, it is found that

$$f = \left(\frac{7C_b}{10} \right) \frac{V}{b} \quad (3)$$

Thus, the projectile vortex shedding frequency acquires the familiar form of Strouhal frequency, $f = (\text{const}) V/b$. For flat tailed projectiles C_b has a typical value of 0.2. When the flow is fully attached, which is the case with projectile boat tail tapers not exceeding about 15° , the wake diameter can generally be assumed equal to that of the projectile base flat. If the flow separates before the tail end, then the wake cross-section area can be taken as approximately the average projectile area between tail and point of separation.

Representing the sound generating projectile as a moving monopole source, the far field sound pressure to the side of the projectile becomes

$$p = \frac{1}{4\pi r} \left(\frac{d^2 m}{dt^2} \right) \quad (4)$$

where

r = distance from projectile trajectory;
 $\frac{d^2m}{dt^2}$ = time change of air mass flow rate, from and toward projectile.

The sound pressure, as a function of time, can be represented by

$$p = P_m \sin 2\pi ft \quad (5)$$

where

P_m = peak sound pressure;
 t = time.

Combining Equations 4 and 5 and integrating, the air mass flow rate at the projectile is found to be represented by

$$\left(\frac{dm}{dt}\right) = -\frac{2rP_m}{f} \cos 2\pi ft. \quad (6)$$

Integration of above equation over a time period of half a cycle yields the periodic change in air mass attached to the projectile as

$$M = \frac{2rP_m}{\pi f^2} \quad (7)$$

Thus, the peak sound pressure as a function of frequency and periodically transferrable mass becomes

$$P_m = \frac{\pi f^2 M}{2r} \quad (8)$$

But, the transferred mass at the projectile is that of the spherical vortex; i. e.,

$$M \approx \frac{\pi}{6} b^3 \rho_0 \quad (9)$$

Combining Equations 3, 8, and 9, the peak sound pressure generated by the subsonic projectile is found to be

$$P_m = \frac{49\pi^2}{1200} \frac{b C_b^2 \rho_0 V^2}{r} \quad (10)$$

Thus, knowing the projectile shape and velocity, Equation 10 may be used to estimate the peak sound pressure. Comparison of such estimates with experimental data available to date* from a few variously shaped projectiles indicated relatively good agreement.

*Unpublished Frankford Arsenal data

APPENDIX C

GUN MUZZLE BLAST

In the far field, a noise generating tube can often be treated as a simple acoustical monopole source;^{26, 34} that is, its sound diverges as a symmetrical sphere. This is most readily borne out by the schlieren photographs of discharging shock tubes and abruptly uncorked pressurized cylinders (including small arm weapons).^{5, 18} Each of these cases almost invariably shows the initial shock expanding spherically from the tube mouth. It may naturally be further inferred that the air or gas behind the expanding shock also moves spherically away from the source.

Physically, a monopole source can be envisioned as a spherical balloon expanding or contracting uniformly in all directions, thus generating sound pressures which also diverge uniformly in all directions. The far field sound pressure for such a source³⁴ is given by

$$p = \frac{\rho_o}{4\pi r} \left(\frac{d^2Q}{dt^2} \right) \quad (1)$$

where

- p = far field sound pressure
- ρ_o = ambient air density;
- r = distance from source;
- Q = volume of ambient air being displaced by source;
- t = time.

Algebraic manipulation and integration of the above equation yields

$$\int p dt = \frac{\rho_o}{4\pi r} \left(\frac{dQ}{dt} \right) \quad (2)$$

where

$$\left(\frac{dQ}{dt} \right) = \text{instantaneous air volume displacement rate at the source;}$$

$$\int p dt = \text{cumulative area under the sound signal's pressure-time trace.}$$

With a source (such as a porous sphere, a nozzle, etc.) of constant discharge area emitting gas, the air displacement depends on the quantity of gas being discharged and on how this gas expands from discharge to atmospheric pressure. In cases of interest the expansion process is generally very nearly isentropic. Thus, the instantaneous air volume displacement rate can be expressed by

$$\left(\frac{dQ}{dt} \right) = \left(\frac{P_t}{P_o} \right)^{1/\gamma} A_t u_t \quad (3)$$

where

- P_t = absolute pressure of gas at discharge;
- P_o = ambient air pressure;
- γ = gas ratio of specific heats;
- A_t = gas discharge area;
- u_t = gas flow velocity at discharge.

The sound signal pressure-time area becomes related to the source gas flow parameters by

$$\int p dt = \frac{\rho_o}{4\pi r} \left(\frac{P_t}{P_o} \right)^{1/\gamma} A_t u_t \quad (4)$$

Thus, it is seen that the cumulative sound signal impulse is directly proportional to the volumetric air or gas flow rate at the source. That is, the positive and the negative sound pulses represent, respectively, an increase and a decrease in gas flow rate. Further, since a given increase in gas flow must eventually be followed by an equal decrease in gas flow, it follows that a transient signal must necessarily consist of both a positive and a negative portion. Each, however, may be variously distributed throughout time. Although Equation 4 is sufficient to describe the sound field due to change in gas flow over a finite time, it is insufficient for application to problems involving abrupt initiation or cessation of gas flows.

Consider a point source of spherical discharge area, A_t . If the source abruptly starts and continues discharging gas at a steady rate, a sawtooth sound pulse will emanate from the source (see sketch).

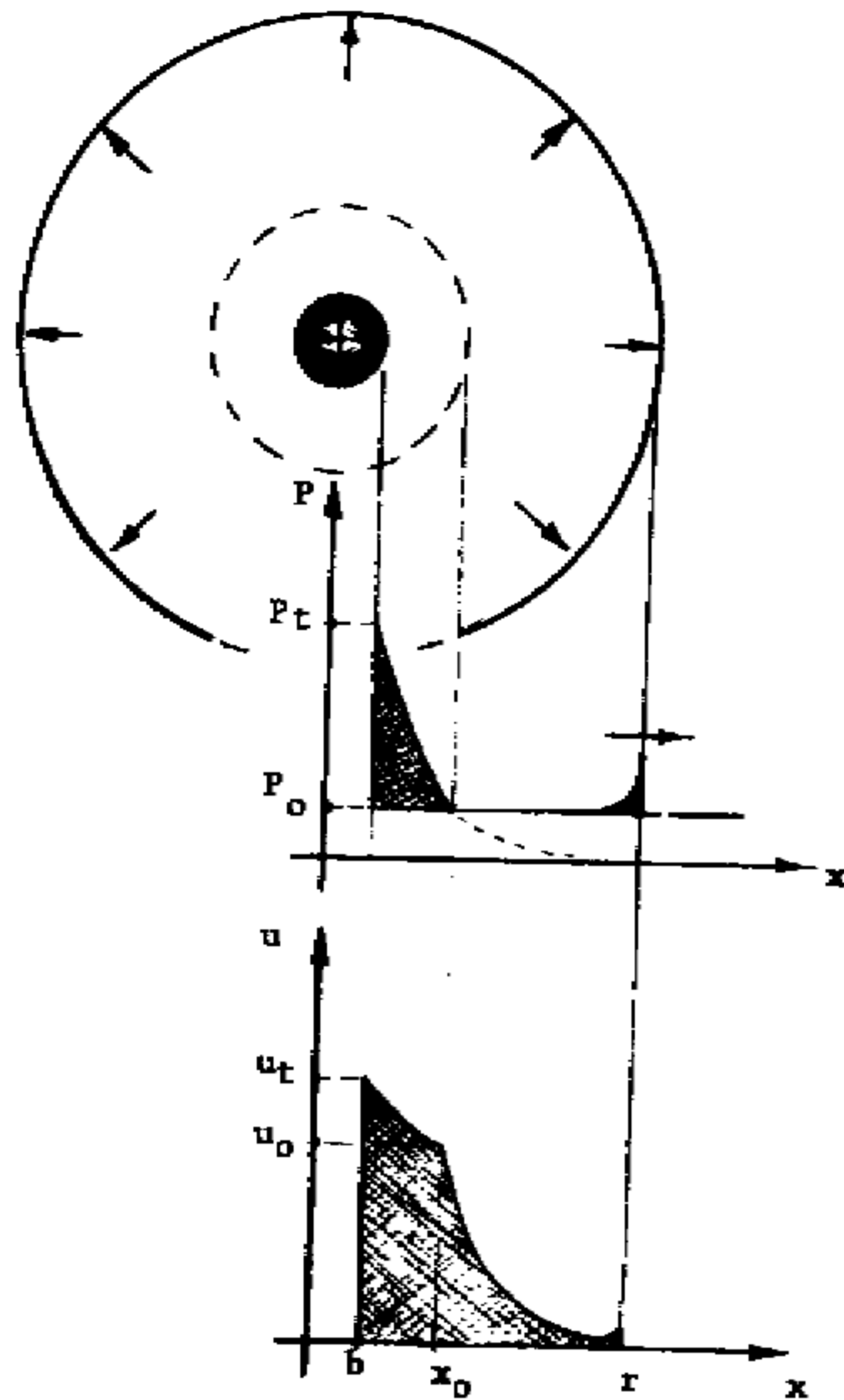

Steady flow conditions will be established behind the sound pulse, where gas flow rate will be

$$A_t \rho_t u_t = A \rho u \quad (5)$$

where

- A_t = source gas discharge area, $4\pi b^2$;
- ρ_t = gas discharge density;
- u_t = gas discharge flow velocity;
- A, ρ, u = area, density, and flow velocity at some distance from the source.

If, at the source, the discharge conditions are supersonic, i. e., flow velocity is equal to local sonic velocity, then in the range $b \leq x \leq x_0$,

$$\rho = \rho_t \left(\frac{P}{P_t} \right)^{1/\gamma} \quad (6)$$

and

$$u = u_t \left(\frac{a}{a_t} \right) = u_t \left(\frac{P}{P_t} \right)^{\frac{\gamma-1}{2\gamma}} \quad (7)$$

From Equations 5, 6, and 7,

$$P = P_t \left(\frac{A_t}{4\pi x^2} \right)^{\frac{2\gamma}{\gamma+1}} \quad (8)$$

and

$$u = u_t \left(\frac{A_t}{4\pi x^2} \right)^{\frac{\gamma-1}{\gamma+1}} \quad (9)$$

where

- P_t = absolute pressure of gas at discharge;
- a_t = discharge sonic velocity;
- x = distance from center of source;
- P, a = absolute pressure and sonic velocity at some distance, x , from source.

At distance x_0 from the source, the gas will have fully expanded to atmospheric pressure. At this location, $x = x_0$,

$$P = P_o \quad (10)$$

From Equation 8,

$$x_0 = \sqrt{\frac{A_t}{4\pi}} \left(\frac{P_t}{P_o} \right)^{\frac{\gamma+1}{4\gamma}} \quad (11)$$

and from Equation 9,

$$u_o = u_t \left(\frac{P_o}{P_t} \right)^{\frac{\gamma-1}{2\gamma}} \quad (12)$$

where

u_o = flow velocity at pt x_o .
 P_o = ambient air pressure.

Beyond the distance x_o , the gas remains at constant density and atmospheric pressure. Thus, for $x_o \leq x$,

$$P = P_o \quad (13)$$

and

$$\rho = \rho_t \left(\frac{P_o}{P_t} \right)^{1/\gamma} \quad (14)$$

and, from Equation 5,

$$\frac{dx}{dt} = u = u_o \left(\frac{x_o}{x} \right)^2 = u_t \left(\frac{P_t}{P_o} \right)^{1/\gamma} \left(\frac{A_t}{4\pi x^2} \right) \quad (15)$$

Integrating Equation 15 for the boundary conditions of $x = x_o$ at $t = 0$,

$$x = x_o \left[\frac{3u_o t}{x_o} + 1 \right]^{1/3} = \sqrt{\frac{A_t}{4\pi}} \left(\frac{P_t}{P_o} \right)^{\frac{\gamma+1}{4\gamma}} \left[3u_t \sqrt{\frac{A_t}{4\pi}} \left(\frac{P_o}{P_t} \right)^{\frac{3\gamma-1}{4\gamma}} t + 1 \right] \quad (16)$$

and

$$u = \frac{u_o}{\left[\frac{3u_o t}{x_o} + 1 \right]^{2/3}} = \frac{u_t \left(\frac{P_o}{P_t} \right)^{\frac{\gamma-1}{2\gamma}}}{\left[3u_t \sqrt{\frac{A_t}{4\pi}} \left(\frac{P_o}{P_t} \right)^{\frac{3\gamma-1}{4\gamma}} t + 1 \right]^{2/3}} \quad (17)$$

which describes the location and velocity of a given discharge gas particle with time. Consider now an abruptly initiated gas flow

and the air particles immediately in front of the advancing gas front. The air velocity and location can be described by Equations 16 and 17. The pressure of the air is related to its velocity. Thus, if it is assumed that the air acquired its velocity by virtue of a passing shock,²⁹ then the overpressure will be given by

$$\Delta P = \frac{\gamma+1}{4} \gamma P_o M^2 \left[1 + \sqrt{1 + \frac{8}{\gamma(\gamma+1)M^2}} \right] \quad (18)$$

where

$M = u/a_o$, air flow Mach No.

ΔP = static gauge pressure.

For $M \geq 1$, the overpressure may be estimated by

$$\Delta P \approx \frac{\gamma+1}{2} \gamma P_o M^2 \quad (19)$$

If it is assumed that the air in front of the advancing gas front acquired its velocity through isentropic wave compression, then the overpressure can be expressed by

$$\Delta P = P_o \left\{ \left[1 + \frac{\gamma-1}{2} M \right]^{\frac{2\gamma}{\gamma-1}} - 1 \right\} \quad (20)$$

For $M \leq 1$, this overpressure may be estimated by

$$\Delta P \approx \gamma P_o M \quad (21)$$

Whichever case is assumed, shock or isentropic wave compression (the actual case will be someplace between the two), it is evident that a reasonable overall representation of the overpressure in terms of velocity is obtainable with

$$\Delta P \approx k_1 M^{k_2} \quad (22)$$

where

k_1 and k_2 = appropriate constants.

Now, a spherical pressure wave diverging from its source can be described by

$$p = \frac{\Delta P x}{r} \quad (23)$$

where

ΔP = overpressure at given distance x from center of source;

p = overpressure (or sound pressure) at distance r .

Substituting Equations 16, 17, and 21 into Equation 23, the far field sound pressure due to abrupt initiation of gas flow becomes

$$p = \frac{\gamma P_0 x_0 u_0}{a_0 r \left[\frac{3u_0 t}{x_0} + 1 \right]^{1/3}} = \frac{P_m}{\left[\frac{3u_0 t}{x_0} + 1 \right]^{1/3}} \quad (24)$$

Equation 24 describes a family of curves depending on magnitude of (u_0/x_0) (see sketch below).

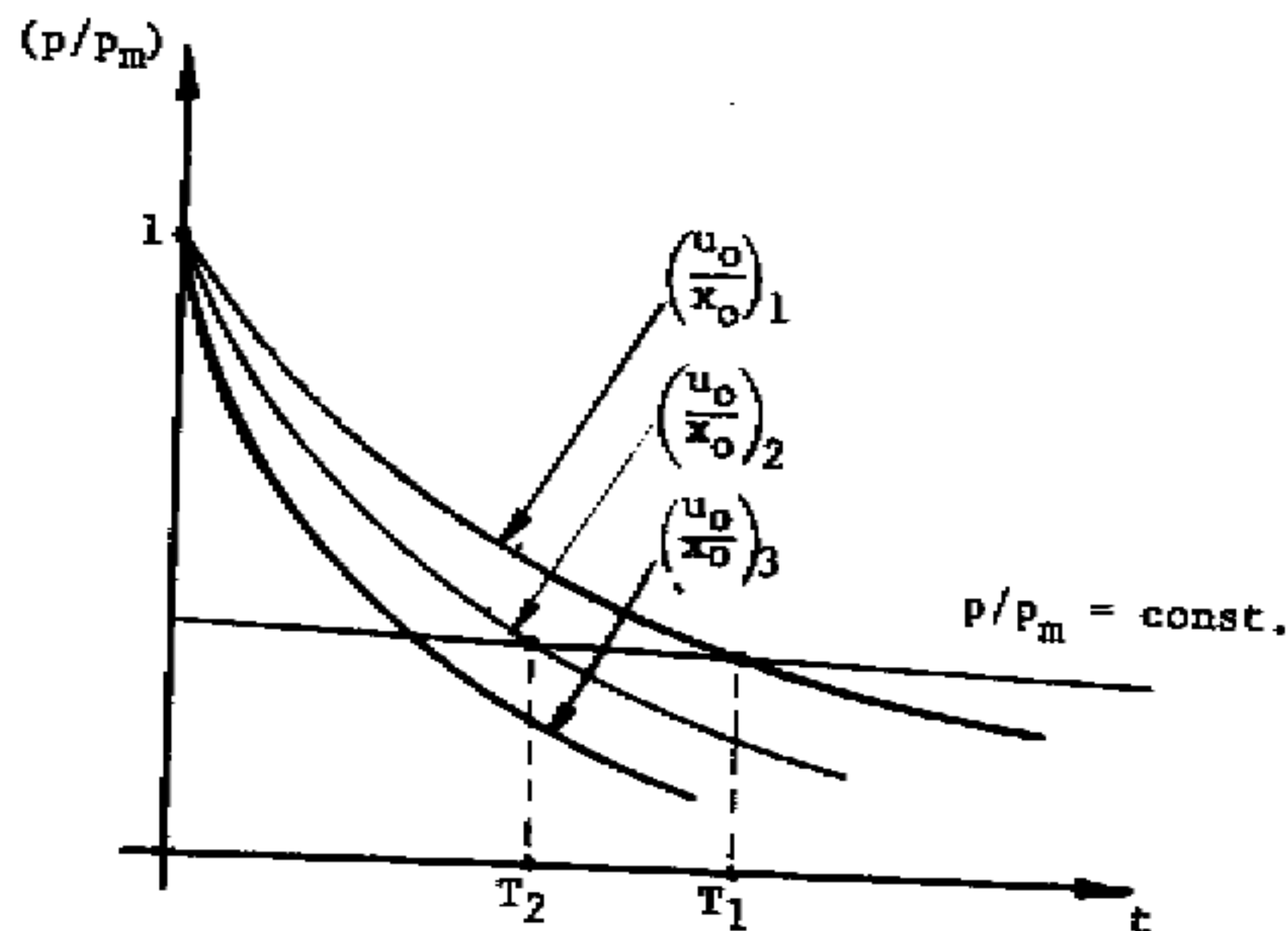

It can be seen that in each case the sound pressure decreases exponentially with time. The rate of decrease, however, depends on the characteristic flow parameters of the source. Except at the time when the sound pressure is very near P_m , the factor $3u_0 t/x_0$ is

substantially larger than 1, and the sound pressure can be estimated by

$$p \approx \frac{P_m}{\left[\frac{3u_0 t}{x_0} \right]^{1/3}} \quad (25)$$

Taking the time t as the representative time period of the sound pulse and rearranging Equation 25,

$$t \approx \frac{\left(\frac{P_m}{p} \right)^3 x_0}{3u_0} = \frac{\left(\frac{P_m}{p} \right)^3 \sqrt{\frac{A_t}{4\pi}} \left(\frac{P_t}{P_0} \right)^{\frac{3\gamma-1}{4\gamma}}}{3u_t} \quad (26)$$

If the time period is established at a constant pressure ratio (p_m/p) , then it will depend only on the source discharge area, discharge pressure, and discharge velocity, and can be expressed, generally, as

$$T = C \frac{\sqrt{\frac{A_t}{4\pi}} \left(\frac{P_t}{P_0} \right)^{\frac{3\gamma-1}{4\gamma}}}{u_t} \quad (27)$$

where

C = an arbitrary constant.

This equation is seen to be similar in form to the "Strouhal" frequency except for the additional factor $(P_t/P_0)^{3\gamma-1/4\gamma}$. It is to be noted that the sound pulse duration remains relatively independent of the equation used for relating the air pressure to its velocity. The only prerequisite is that it is of the form described by Equation 22.

Some insight into the above problem is to be gained by considering the nonlinear propagation of strong sound pulses.¹³ Consider a relatively strong sawtooth sound pulse (shown in the following sketch).

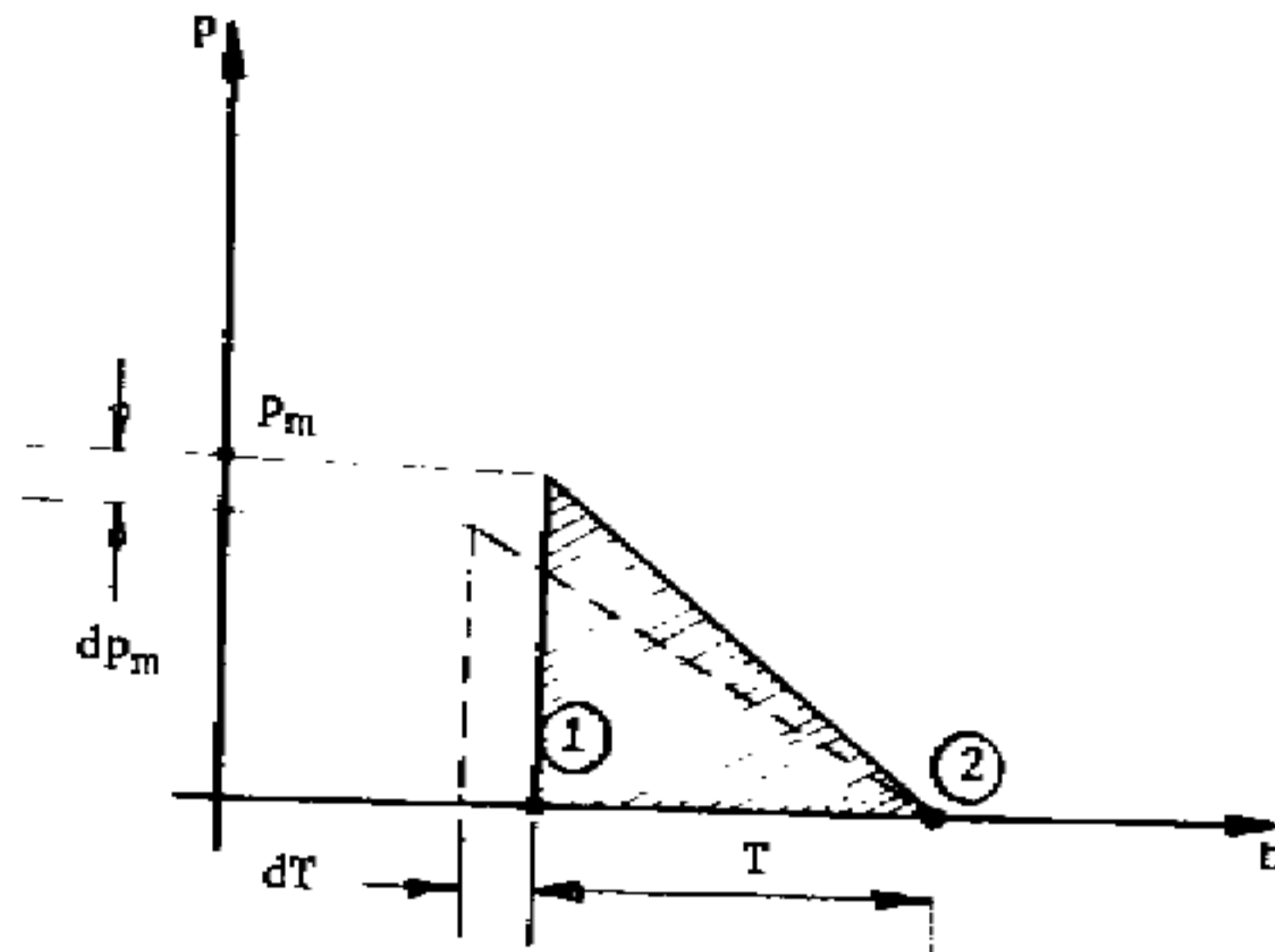

By virtue of higher pressure, the shock front (point 1) will propagate faster than the pulse tail (point 2). The velocity of the shock front is

$$C_s = a_0 \left[1 + \frac{\gamma + 1}{4\gamma} \frac{P_m}{P_0} \right] \quad (28)$$

The pulse tail, of course, propagates at approximately ambient sonic velocity, a_0 . Due to this velocity differential, the pulse will tend to stretch out with time (and travel). Change in the pulse time duration can be represented in differential form by

$$dT = \frac{\gamma + 1}{4\gamma} \frac{P_m}{P_0 a_0} dr \quad (29)$$

Corresponding to this increase in pulse time duration, the peak sound pressure will decrease. For the spherically expanding wave front the relationship between pulse pressure, duration, and travel can be represented by

$$T P_m r = T_1 P_{m1} r_1 \quad (30)$$

where

T_1 and P_{m1} = pulse duration and pressure at some reference location, r_1 ;

T and P_m = pulse duration and pressure at some location, r .

Solution of Equations 29 and 30 indicates that the instantaneous peak sound pressure of a sawtooth pulse can be represented in terms of its travel by

$$P_m = \frac{P_{m1} r_1}{r \left[\frac{\gamma + 1}{2\gamma} \frac{P_{m1} r_1}{P_0 a_0 T_1} \ln \left(\frac{r}{r_1} \right) + 1 \right]^{1/2}} \quad (31)$$

The sound pulse time duration, as a function of travel, is

$$T = T_1 \left[\frac{\gamma + 1}{2\gamma} \frac{P_{m1} r_1}{P_0 a_0 T_1} \ln \left(\frac{r}{r_1} \right) + 1 \right]^{1/2} \quad (32)$$

Thus, it is seen that the relative time duration of a sound pulse with long wave length and small amplitude changes little with distance from its source. On the other hand, short sound pulses, especially those of high amplitude, can significantly increase in time duration. This time increase is accompanied by a proportionate decrease in amplitude beyond that of the simple spherical expansion.

Consider now a long pressurized cylinder (sketch following) containing a gas. Initially, the gas is at some absolute pressure, P_1 , and absolute temperature, T_1 . Initial velocity of gas is zero. As the cylinder is suddenly uncorked, a sawtooth sound pulse emanates from the mouth of the cylinder while a rarefaction wave travels inward. Until the rarefaction wave reflects from the bottom of the cylinder, the discharge conditions at the tube exit remain relatively constant and dependent on the initial gas conditions.

If the initial sound pulse due to abrupt initiation of gas flow is represented by a right triangle of amplitude, P_m , and time duration, T , then

$$\int p dt \approx \frac{P_m T}{2} \quad (33)$$

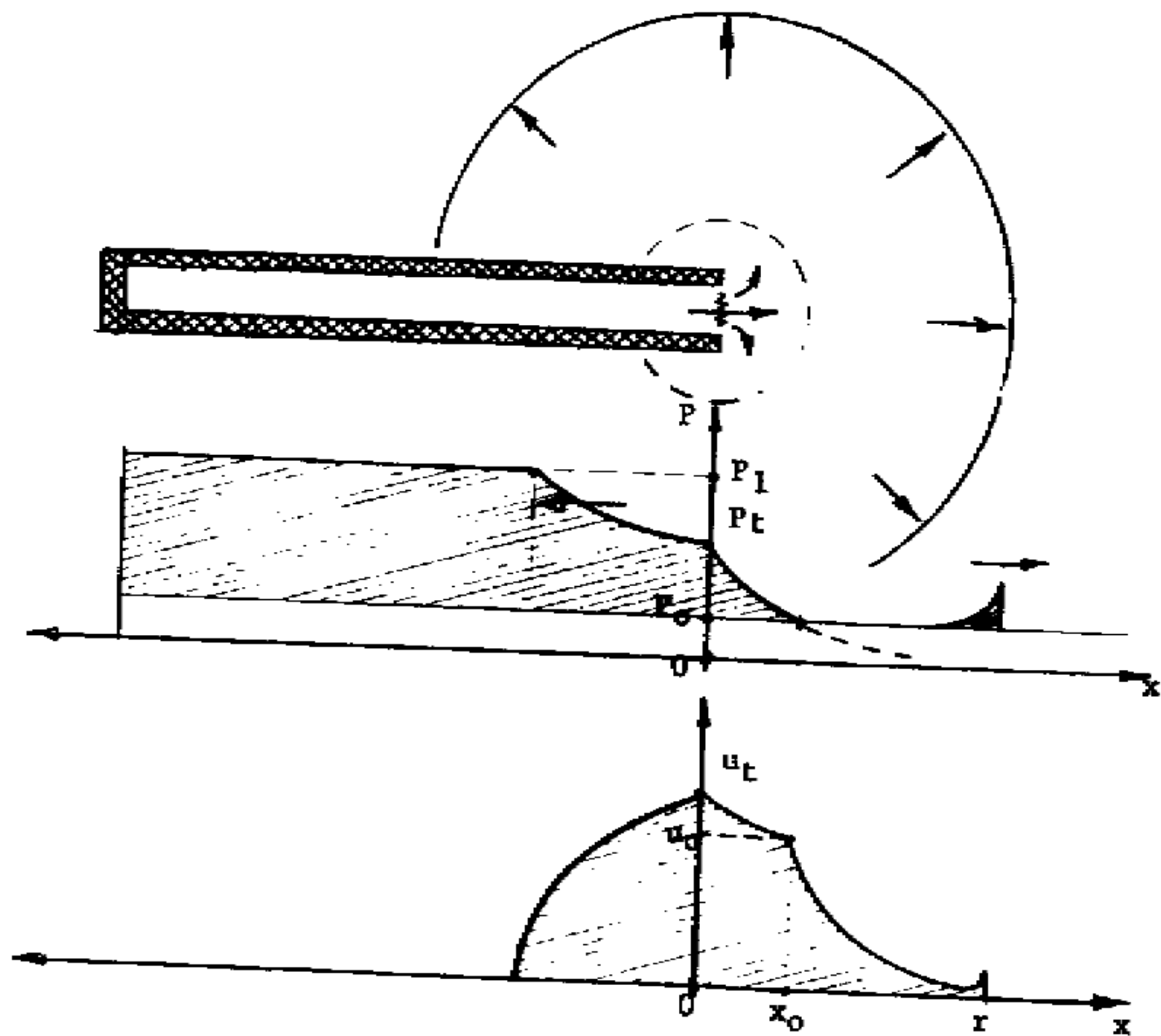

and subsonic conditions prevail at the tube exit, i. e., locally, flow velocity is smaller than sonic velocity.

If the initial gas pressure is $P_1 \geq P_o \left(\frac{\gamma+1}{2} \right)^{2\gamma/(\gamma-1)}$

$$P_t = P_1 \left(\frac{2}{\gamma+1} \right)^{\frac{2\gamma}{\gamma-1}} \approx .28 P_1 \quad (37)$$

$$u_t = \frac{2a_1}{(\gamma+1)} \approx \frac{2a_o}{\gamma+1} \sqrt{\frac{T_1}{T_o}} \quad (38)$$

In this case the gas is discharged at a velocity just equal to its local sonic velocity. This is the usual case found in unsilenced (and most silenced) weapons, as here the pressures encountered are generally above critical. From Equation 27 the time duration of the sound pulse due to uncorking of a pressurized cylinder is

$$T = k \frac{d \left(\frac{P_t}{P_o} \right)^{\frac{3\gamma-1}{4\gamma}}}{u_t} \quad (39)$$

where

d = diameter of the cylinder;

$k \approx 3$, an empirical constant.

Combining Equations 34, 37, 38, and 39, the peak sound pressure due to an uncorked cylinder becomes

$$P_m = \gamma \left(\frac{2}{\gamma+1} \right)^{\frac{\gamma+1}{2(\gamma-1)}} \frac{P_o d}{8kr} \left(\frac{T_1}{T_o} \right) \left(\frac{P_1}{P_o} \right)^{\frac{5-3\gamma}{4\gamma}} \quad (40)$$

and it is seen that the peak sound pressure is directly proportional to the initial absolute gas temperature and only weakly dependent on the initial gas pressure, as long as it is above critical. However, since in the gun, high pressure is generally accompanied by high temperature, the peak sound pressure is not completely independent of the initial

and, from Equation 4, the peak sound pressure becomes

$$P_m \approx \frac{P_o}{2\pi r T} \left(\frac{P_t}{P_o} \right)^{1/\gamma} A_t u_t \quad (34)$$

where A_t , P_t , and u_t are, respectively, discharge area ($\pi d^2/4$), pressure, and velocity.

Gas discharge from the cylinder depends on the initial gas conditions. 2, 29
If $P_1 \leq P_o \left(\frac{\gamma+1}{2} \right)^{2\gamma/(\gamma-1)} \approx 3.6 P_o$,

$$P_t = P_o \quad (35)$$

$$u_t = \frac{2a_1}{(\gamma-1)} \left[1 - \left(\frac{P_o}{P_1} \right) \right]^{\frac{\gamma-1}{2\gamma}} \approx \frac{2a_o}{(\gamma-1)} \sqrt{\frac{T_1}{T_o}} \left[1 - \left(\frac{P_o}{P_1} \right) \right]^{\frac{\gamma-1}{2\gamma}} \quad (36)$$

cylinder pressure. If it is assumed that the gas being discharged was compressed isentropically to its initial condition, then $T_1 = T_0 (P_1/P_0)^{(\gamma-1)/\gamma}$, and Equation 40 can express the peak sound pressure in terms of only the initial cylinder pressure. The result is that $P_m \propto p_1^{(\gamma+1)/4\gamma}$. This seems to correlate reasonably well with experimental data available to date.

The sound pressure field of the uncorked pressurized cylinder is directional, pressure being higher toward the front and lower rearward. Directly to the side, it is approximately a representative average. This directional effect can be approximately represented by

$$P_{m\theta} = \frac{P_m}{\left[1 - \frac{M_t}{n} \cos \theta\right]} \quad (41)$$

where

$P_{m\theta}$ = peak sound pressure at given azimuth angle, θ ;

$M_t = u_t/a_0$, discharge Mach No.;

n = constant equal to approximately 2;

P_m = peak sound pressure directly to the side.

And the peak sound pressure level at given azimuth angle, of course, becomes

$$L_{m\theta} = 20 \log \left[\frac{P_{m\theta}}{.0002} \right] \quad (42)$$

APPENDIX D

GUN SILENCERS

Consider a typical silenced weapon, consisting of a gun barrel of volume v_1 and a baffled silencer of volume v_2 (see sketch below). During its cycle, the projectile is accelerated by the high pressure gases in the barrel. Following this, the projectile travels through the silencer while the propellant gas expands into the silencer cavity behind the projectile. Just prior to exiting from the gun barrel, the propellant gases are typically in the vicinity of 2000° F and 3000 psi.

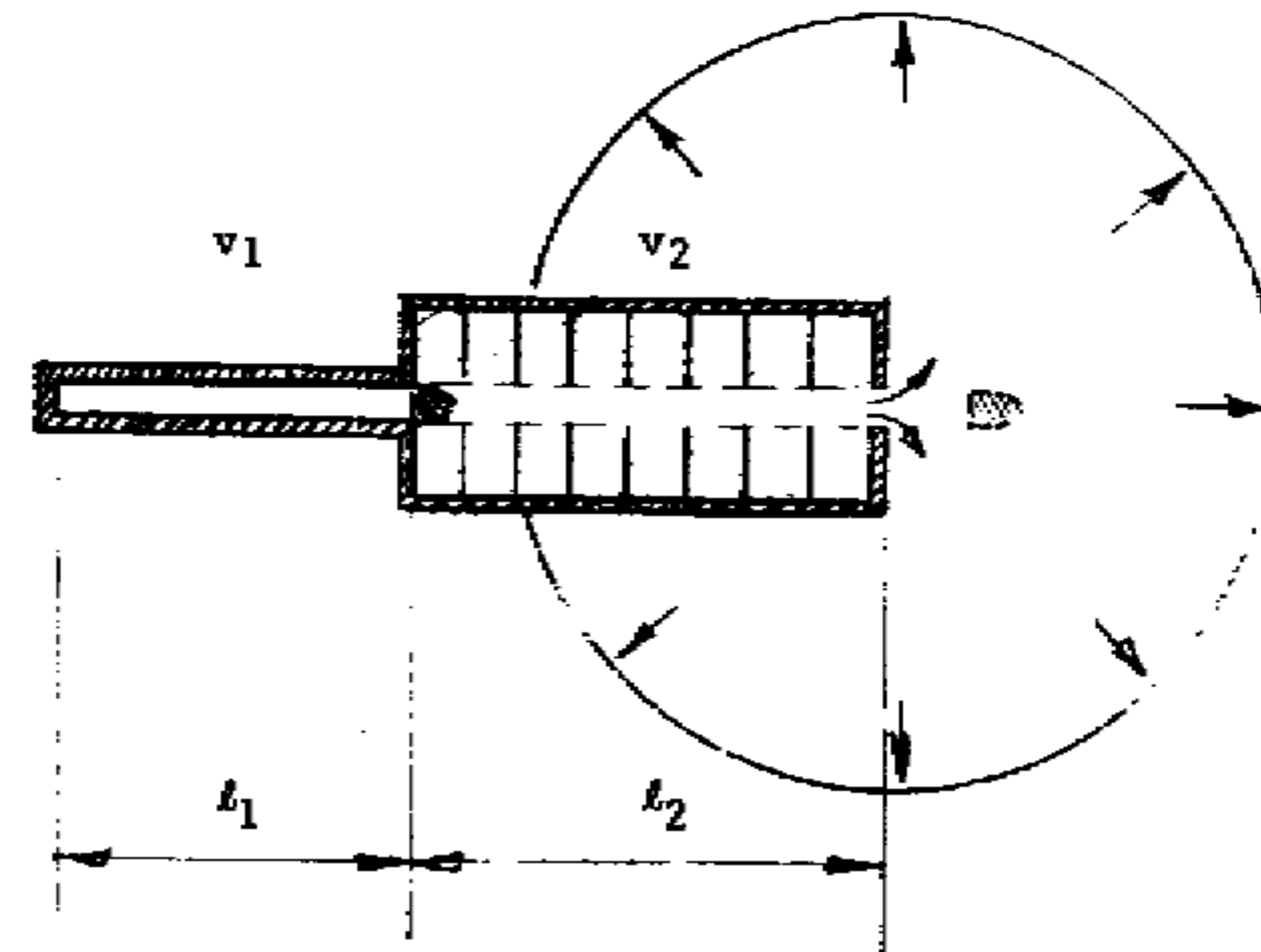

During its expansion into the silencer cavity, the propellant gas mixes with the air contained within the silencer. The air, originally at ambient pressure and temperature, is compressed while the propellant gas pressure and temperature naturally decrease. In a typical silenced system, with the silencer volume of the order of 20 times that of its gun barrel, the conditions within the silencer just prior to projectile exit are of the order of 60 psi and 300° F. The projectile, being subsonic (presumably), travels through the silencer at a velocity close to 1000 fps. Just

how quickly the gas behind the projectile expands into the silencer cavity can be gathered from the following graph which shows the shock, sonic, and flow velocities of air or gas similar to air, as a function of pressure.

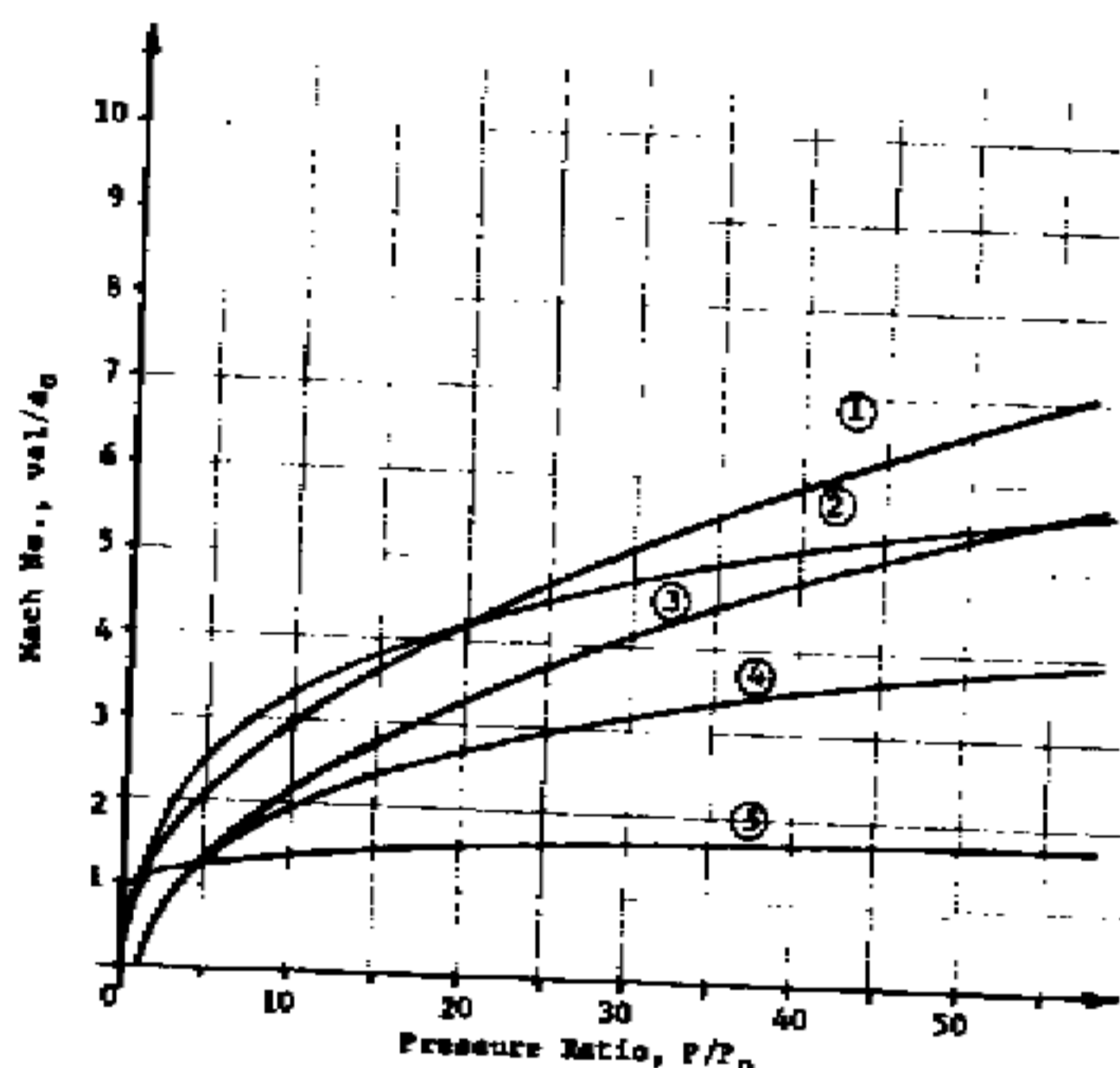

- ① Shock Velocity:

$$c_s = a_0 \left[\frac{\gamma-1}{2\gamma} + \frac{\gamma+1}{2\gamma} \frac{P}{P_0} \right]^{1/2}$$
- ② Isentropic Wave Velocity:

$$c_w = \frac{\gamma+1}{\gamma-1} a_0 \left[\left(\frac{P}{P_0} \right)^{\frac{\gamma-1}{2\gamma}} - \frac{1}{\gamma+1} \right]$$
- ③ Flow Velocity Following Shock:

$$u_s = \frac{a_0}{\gamma} \left(\frac{P}{P_0} - 1 \right) \left[\frac{2\gamma}{\gamma+1} \left(\frac{P}{P_0} + \frac{\gamma-1}{\gamma+1} \right) \right]^{1/2}$$
- ④ Isentropic Wave Flow Velocity:

$$u_w = \frac{2a_0}{\gamma-1} \left[\left(\frac{P}{P_0} \right)^{\frac{\gamma-1}{2\gamma}} - 1 \right]$$
- ⑤ Isentropic Wave Sonic Velocity:

$$s = a_0 \left(\frac{P}{P_0} \right)^{\frac{\gamma-1}{2\gamma}}$$

From the graph it is found not unreasonable to assume that, in a typical silencer, the gas pressure is very nearly uniform along its length at the time the projectile exits the silencer.* Considering the propellant gas and air undergo isentropic expansion and compression, respectively, the absolute pressure in the silencer at the time of

*Other assumptions may be necessary in the case of a supersonic projectile.

projectile exit will be

$$P_2 = P_0 \left[\frac{\left(\frac{P_1}{P_0} \right)^{1/\gamma} + \frac{v_2}{v_1}}{1 + \frac{v_2}{v_1}} \right]^\gamma \quad (1)$$

which can be simplified to

$$P_2 \approx P_0 \left[\frac{\left(\frac{P_1}{P_0} \right)^{1/\gamma} + \frac{v_2}{v_1}}{\frac{v_2}{v_1}} \right]^\gamma \quad (2)$$

where

P_1 = absolute propellant gas pressure in gun barrel at the time of projectile exit from gun barrel.

P_0 = ambient air pressure (14.7 psi);

v_2 = silencer volume;

v_1 = gun barrel volume;

γ = ratio of specific heats for air and propellant gas (actually for air, $\gamma = 1.4$; for propellant gas, $\gamma \approx 1.2$).

Similarly, the absolute temperature of propellant gas in the silencer at the time of projectile exit is

$$T_2 = T_1 \left[\frac{\left(\frac{P_1}{P_0} \right) + \left(\frac{v_2}{v_1} \right)}{\left(\frac{v_2}{v_1} \right) \left(\frac{P_1}{P_0} \right)^{1/\gamma}} \right]^{(\gamma-1)} \quad (3)$$

where

T_1 = absolute temperature of propellant gas at the time of projectile exit from the gun barrel.

The absolute temperature of air compressed in the silencer is $T_2 \frac{(P_1/P_0)^{(\gamma-1)/\gamma}}{(\nu_2/\nu_1)}$, which is very nearly equal to T_2 . Thus, the air temperature may be assumed to be the same as that of propellant gas (i. e., that given by Equation 3).

Projectile exit from the silencer will be followed by an efflux of gases. If, at the time of this exit, the silencer pressure is $P_2 \leq P_0 \left(\frac{\gamma+1}{2}\right)^{\gamma/(\gamma-1)} \approx 1.9 P_0$, then

$$P_t = P_0 \quad (4)$$

and

$$u_t = \sqrt{\frac{2}{\gamma-1}} a_2 \left[1 - \left(\frac{P_0}{P_2}\right)^{\frac{\gamma-1}{\gamma}} \right] \approx \sqrt{\frac{2}{\gamma-1}} a_0 \sqrt{\frac{T_2}{T_0}} \left[1 - \left(\frac{P_0}{P_2}\right)^{\frac{\gamma-1}{\gamma}} \right] \quad (5)$$

where P_t = absolute discharge pressure;
 u_t = discharge velocity;
 a_2 = sonic velocity within silencer at time of projectile exit;
 a_0 = ambient sonic velocity.
 T_0 = absolute ambient temperature.

In this case the discharge conditions will be subsonic; that is, gas flow velocity will be lower than sonic at the point of discharge ($u_t \leq a_t$). If, on the other hand, the silencer pressure at the time of projectile exit is $P_2 \geq P_0 \left(\frac{\gamma+1}{2}\right)^{\gamma/(\gamma-1)} \approx 1.9 P_0$

then

$$P_t = P_2 \left(\frac{2}{\gamma+1}\right)^{\frac{\gamma}{\gamma+1}} \quad (6)$$

and

$$u_t = \sqrt{\frac{2}{\gamma+1}} a_2 \approx \sqrt{\frac{2}{\gamma+1}} a_0 \sqrt{\frac{T_2}{T_0}} \quad (7)$$

Now the discharge conditions will be supersonic, with the flow velocity at discharge being equal to the local sonic velocity ($u_t = a_t$). This, in fact, is the typical condition to be expected in most conventional silencers. As the projectile exits from the silencer, the abrupt uncorking of internal pressure will generate a sawtooth sound pulse. The time duration of this pulse is given by Equation 39 of Appendix C,

$$T = \frac{kd \left(\frac{P_t}{P_0}\right)^{\frac{3\gamma-1}{4\gamma}}}{u_t} \quad (8)$$

where

$k \approx 3$, an empirical constant;
 d = silencer exit diameter.

The peak sound pressure of the sound pulse is described by Equation 23 of Appendix C,

$$P_m = \frac{\rho_0}{2\pi r T} \left(\frac{P_t}{P_0}\right)^{1/\gamma} A_t u_t \quad (9)$$

where

ρ_0 = ambient air density;
 r = distance from the weapon;
 $A_t = \pi d^2/4$, silencer discharge area.

Combination of Equations 6, 7, 8, and 9 yields the peak sound pressure of an abruptly uncorked silencer, to the side of the weapon, as

$$P_m = \left(\frac{2}{\gamma+1}\right)^{\frac{\gamma+1}{4(\gamma-1)}} \frac{\gamma P_0 d}{8kr} \left(\frac{T_2}{T_0}\right) \left(\frac{P_2}{P_0}\right)^{\frac{5-3\gamma}{4\gamma}} \quad (10)$$

where

P_2 and T_2 are the absolute silencer pressure and temperature, respectively, established by Equations 2 and 3.

If the silencer temperature is related to the silencer pressure by $T_2 = T_0 (P_2/P_0)^{(\gamma-1)/\gamma}$, which is not an unreasonable estimate, then $p_m \propto P_2^{(\gamma+1)/4\gamma}$. The peak sound pressure level of the uncorked silencer (from Equation 10) can be described as

$$L_m = 20 \log \left[\frac{\left(\frac{2}{\gamma+1}\right)^{\frac{\gamma+1}{4(\gamma-1)}} \frac{\gamma P_0 d}{8kr} \left(\frac{T_2}{T_0}\right) \left(\frac{P_2}{P_0}\right)^{\frac{5-3\gamma}{4\gamma}}}{.0002} \right] \quad (11)$$

It is interesting to note the effect of heat absorption in the silencer on the peak sound pressure. If, similarly to the above, the silencer's pressure is related to its temperature by $P_2 \approx P_0 (T_2/T_0)^{\gamma/(\gamma-1)}$, then the peak sound pressure can be expressed as a function of only the silencer temperature, which gives $p_m \propto T_2^{(\gamma+1)/4(\gamma-1)}$. With maximum heat absorption in the silencer, temperature T_2 will have been reduced to ambient temperature T_0 . From Equation 10, the attenuation of peak sound pressure level thus to be attained in a typical silencer is in the vicinity of 6 db.

A certain amount of blow-by in a silenced system is unavoidable. Since, for the sake of system accuracy, a clearance must exist between the silencer and projectile, some propellant gas usually bypasses the projectile in the silencer. The effect of this blow-by on gas discharge from the silencer immediately after projectile exit can be surmised from the following.

The gas discharge following projectile exit from the silencer is primarily dependent on the quantity of gas contained in the system at that time, which, in turn, is determined by the percentage of gas lost through blow-by. The percentage of gas lost can be represented by

$$\left(\frac{\Delta m}{m}\right) = \frac{\int_0^t (A_t \rho_t u_t) dt}{\rho_2 (v_1 + v_2)} \quad (12)$$

where Δm = gas mass lost through blow-by during time projectile traverses silencer;
 m = initial total mass of gas in system;
 t = time;
 ρ_2 = gas density in system at time projectile exits silencer.

The duration of blow-by is limited to the time it takes the projectile to traverse the silencer. If, during this time, a constant and unrestricted (maximum) gas flow rate is assumed, then

$$\int_0^t (A_t \rho_t u_t) dt = A_t \rho_t u_t t \quad (13)$$

where

A_t = silencer discharge area;
 ρ_t = discharge gas density;
 u_t = discharge gas velocity;
 t = time it takes projectile to traverse silencer.

With maximum discharge conditions,

$$\rho_t = \rho_2 \left(\frac{2}{\gamma+1}\right)^{1/\gamma-1} \quad (14)$$

$$u_t = \sqrt{\frac{2}{\gamma+1}} a_0 \sqrt{\frac{T_2}{T_0}} \quad (15)$$

The silencer discharge area is approximately

$$A_t \approx \frac{v_1}{l_1} \quad (16)$$

where

v_1 = volume of gun barrel;
 l_1 = length of gun barrel;

The time it takes the projectile to traverse the silencers is

$$t = \frac{l_2}{a_0 M} \quad (17)$$

where

l_2 = silencer length;
 M = projectile Mach No.

With these definitions, Equation 12 reduces to

$$\left(\frac{\Delta m}{m}\right) = \frac{\left(\frac{2}{\gamma+1}\right)^{\frac{\gamma+1}{2(\gamma-1)}} \sqrt{\frac{T_2}{T_0}} \left(\frac{l_2}{l_1}\right)}{M \left(1 + \frac{v_2}{v_1}\right)} \quad (18)$$

Substitution of typical quantities into Equation 18 reveals that, within the time restraint, the maximum percentage of gas a typical silencer can lose through blow-by is in the order of 5 percent. From this it may be concluded that the blow-by has a very small effect on the gas discharge occurring at the time the projectile exits from the silencer.

Examination of Equation 9 reveals that the peak sound pressure is inversely proportional to the time duration of a given sound pulse. In a system where gas discharge is initiated slowly, the sound pulse time duration is governed by the time it takes the system to reach a given discharge rate rather than by the system's maximum discharge rate (Equation 8). Thus, it becomes evident that the longer the system takes to reach its maximum gas discharge rate, the quieter it will be. Practically, it means that it is desirable to start the gas discharge from the silencer slowly and early in the process, gradually increasing the discharge to when the projectile exits from the silencer. If it is assumed that the gas discharge from the silencer can be initiated at the time projectile exits the gun barrel, the time restraint is imposed by the silencer length and projectile velocity. The time in which the discharge can increase from zero to maximum will be

$$T \approx \frac{l_2}{a_0 M} \quad (19)$$

With this time period (and Equations 6 and 7), Equation 9 gives the peak sound pressure as

$$p_m = \left(\frac{2}{\gamma + 1} \right)^{\frac{\gamma + 1}{2(\gamma - 1)}} \frac{\gamma P_0 d^2}{8 l_2 r} \left(\frac{T_2}{T_0} \right) \left(\frac{P_2}{P_0} \right)^{1/\gamma}$$

This relationship gives the minimum peak sound pressure of a system whose gas discharge was initiated gradually, rather than abruptly. Comparison of this equation with Equation 10 and substitution of typical system quantities reveals that attenuations of as much as 15 db are obtainable with the controlled discharge technique.

Attenuation of a precursor wave in the silencer is somewhat different from that of a blast wave. Whereas the latter involves high pressures which present a formidable gas mass transfer problem, the former can be expected to expand through the silencer at almost

ambient sonic velocity. This allows the assumption that the reflections of the precursor within a properly designed silencer will have practically no effect on the forward wave front. In a properly designed silencer, the baffles or other silencer components would be such as would not impede the natural spherical expansion of the wave front within the silencer. Example of this can be seen with the rearward-slanted, conical baffles.

Consider now two gun barrels identical in all respects except that one is equipped with a silencer (see sketch below).

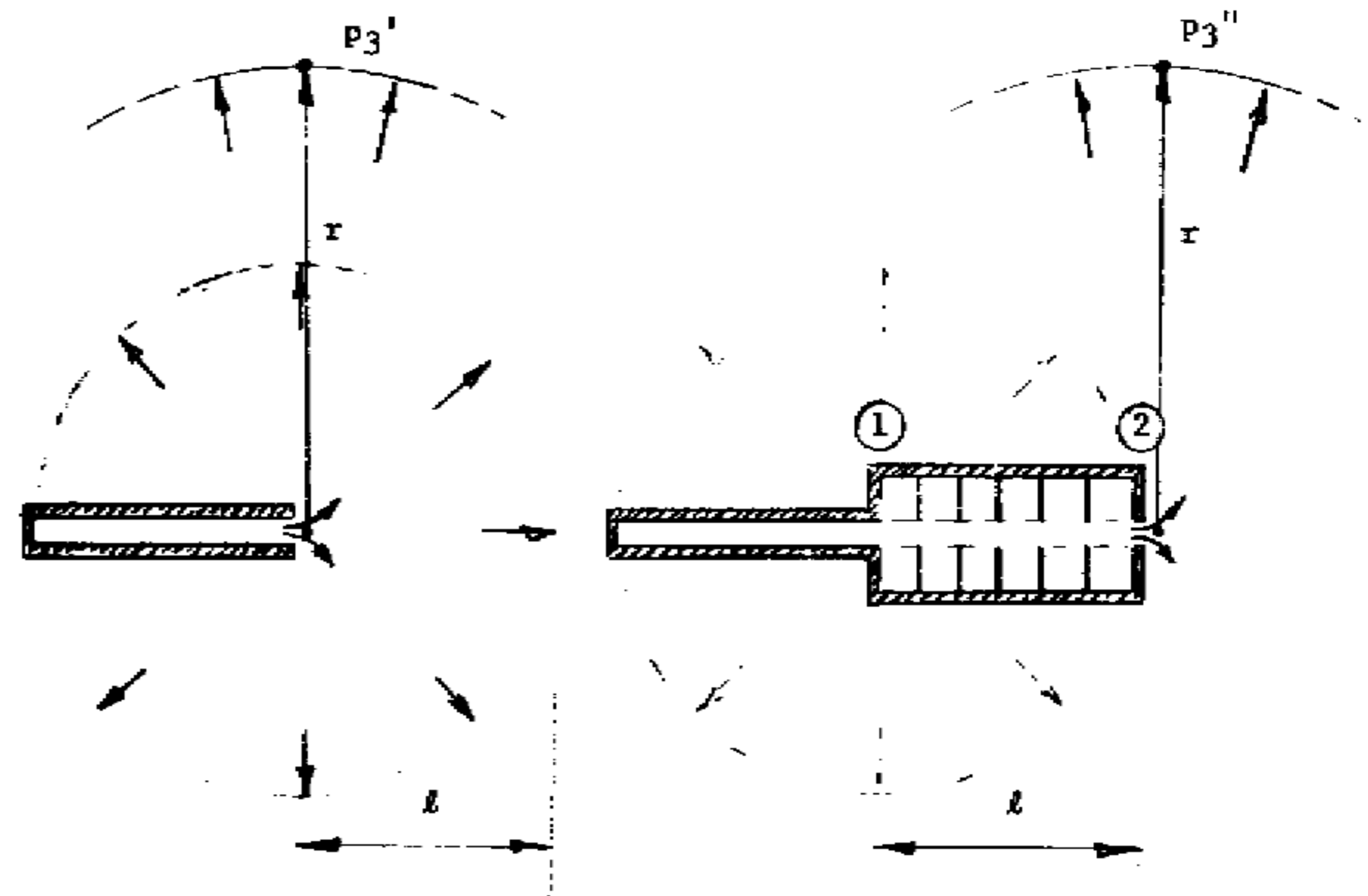

In the first case the precursor wave generated in the gun barrel will be unattenuated. At some distance r , in the far field, its sound pressure will be

$$p_3' = \frac{P_2 l_2}{r} \quad (21)$$

where

- l_2 = silencer length;
- P_2 = precursor sound pressure (gauge) at distance l from gun muzzle.

In the second case, the precursor wave will first expand unimpeded (spherically) in the silencer prior to expansion into the atmosphere. At the front end of the silencer, the precursor wave front will generate an absolute pressure, which can be estimated by

$$P_2 \approx P_0 + 2p_2 \quad (22)$$

This pressure will induce a flow of air through the silencer muzzle. The velocity of this flow will be given by

$$u_t = \sqrt{\frac{2}{\gamma+1}} a_0 \left[1 - \left(\frac{P_0}{P_2} \right)^{\frac{\gamma-1}{\gamma}} \right] \quad (23)$$

Expansion of this equation and elimination of lower order terms reduces the flow velocity to

$$u_t \approx \sqrt{8(\gamma-1)} \frac{a_0}{\gamma P_0} P_2 \quad (24)$$

Corresponding to this flow velocity, the discharge pressure (gauge) at the silencer exit will be

$$P_t = \frac{\gamma P_0 u_t}{a_0} = \sqrt{8(\gamma-1)} P_2 \quad (25)$$

Spherical expansion of this overpressure to the far field represents the attenuated precursor sound pressure, which can be written as

$$p_3'' \approx \frac{P_t d}{4r} = \frac{\sqrt{8(\gamma-1)} P_2 d}{4r} \quad (26)$$

where

d = diameter of silencer muzzle opening.

Combining Equations 21 and 26 gives the attenuated precursor sound pressure in terms of the unattenuated quantity

$$\frac{P_3'}{P_3''} = \sqrt{\frac{2}{\gamma-1}} \frac{t_2}{d} \quad (27)$$

The attenuation of the precursor, in decibels, is

$$\Delta L = 20 \log \left(\frac{P_3'}{P_3''} \right) = 20 \log \left[\sqrt{\frac{2}{\gamma-1}} \frac{t_2}{d} \right] \quad (28)$$

Substitution of typical quantities in Equation 28 indicates that a properly designed silencer, approximately 6 in. long and .35 caliber, can be expected to attenuate the precursor by some 30 db.

An interesting problem presents itself in considering attenuation of the silencer type shown in the first diagram of the following sketch.

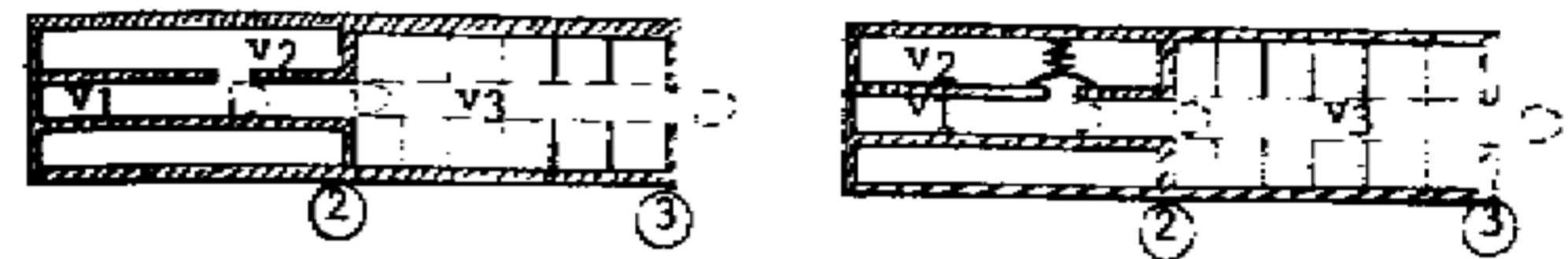

Here, the silencing volume is separated into two chambers, one in front of and one surrounding the gun barrel. A bleed hole (or series of bleed holes) leading to the surrounding chamber is provided in the gun barrel. As the projectile passes the bleed hole, the propellant gases in the gun barrel expand into the surrounding chamber. When the projectile exits into the front silencer section, the pressure in the gun barrel decreases and the gas flow in the bleed hole reverses. If the bleed hole is sufficiently small, then, because of the greater initial pressure differential, gas flow will be faster into the surrounding chamber than out of it. This technique is capable of substantially reducing the pressure in the front silencer at the time of projectile exit. An optimum exploitation of this technique would be to introduce a one-way valve in the bleed hole leading to the surrounding silencer cavity. Consider the silencer with a relatively large bleed hole, so that gas flow into and out of the surrounding chamber is relatively rapid. The gas expansion processes will be very nearly isentropic so that the silencer pressure at the time of projectile exit from the silencer (from Equation 2) will be

$$P_3' \approx P_0 \left[\frac{\left(\frac{P_1}{P_0} \right)^{1/\gamma}}{\left(\frac{v_2 + v_3}{v_1} \right)} + 1 \right]^\gamma \quad (29)$$

where

- P_o = ambient air pressure;
- P_1 = pressure in gun barrel just before bleed-off;
- v_1 = volume of gun barrel before bleed-off;
- v_2 = volume of silencer chamber surrounding gun barrel;
- v_3 = volume of front silencer chamber.

In a silencer with a bleed hole valve, the expansion process up to the projectile exit from the gun barrel will be similar to that above. Beyond this point, however, the gases remaining in the gun barrel will expand into the forward silencer section while the gases in the surrounding chamber will be trapped pending possible slow release. Isentropic expansion up to the gun barrel muzzle gives the gas pressure as

$$P_2 \approx P_o \left[\frac{\left(\frac{P_1}{P_o}\right)^{1/\gamma} + 1}{\left(\frac{v_2}{v_1}\right)} \right]^\gamma \quad (30)$$

Expansion of the gases remaining in the gun barrel into the forward silencer section gives the silencer pressure as

$$P_3'' \approx P_o \left[\frac{\left(\frac{P_2}{P_o}\right)^{1/\gamma} + 1}{\left(\frac{v_3}{v_1}\right)} \right]^\gamma \quad (31)$$

This, combined with Equation 30, gives the silencer pressure at time of projectile exit as

$$P_3'' = P_o \left[\frac{\left(\frac{P_1}{P_o}\right)^{1/\gamma} + \frac{v_2}{v_1}}{\left(\frac{v_2}{v_1}\right) \left(\frac{v_3}{v_1}\right)} + 1 \right]^\gamma \quad (32)$$

Solving for minimum P_3'' , it is found that the greatest reduction in pressure occurs when

$$v_2 = v_3 \sqrt{\frac{\left(\frac{P_1}{P_o}\right)^{1/\gamma}}{\left(\frac{P_1}{P_o}\right)^{1/\gamma} + \left(\frac{v_2 + v_3}{v_1}\right)}} \quad (33)$$

Substitution of typical quantities found in silencers into Equation 33 indicates that in order to obtain maximum attenuation, the surrounding silencer chamber should be approximately 0.7 times that of the forward chamber. The difference in attenuation of the silencer with a bleed hole valve and the simple volumetric silencer can be estimated* from

$$\Delta L \approx 20 \log \left[\frac{P_3'}{P_3''} \right]^{(\gamma+1)/4\gamma} \quad (34)$$

where P_3' & P_3'' are as defined by Equations 29 and 32. In a silenced system with gun barrel pressure of 2500 psi and silencer-to-gun barrel volume ratio of 20, the bleed hole valve technique yields approximately an additional 4 db attenuation in peak SPL. The technique can be expected to be more effective with small volume silencers and less effective with larger ones.

* See Equations 10 and 11.

UNITED STATES PATENT OFFICE.

READE MACON WASHINGTON AND ALFRED WILLIS CAPY, OF DALLAS, TEXAS, ASSIGNORS OF ONE-FOURTH TO SAID WASHINGTON.

ATTACHMENT FOR BARRELS OF FIREARMS.

SPECIFICATION forming part of Letters Patent No. 658,934, dated October 2, 1900.

Application filed January 6, 1899. Serial No. 701,340. (No model.)

To all whom it may concern:

Be it known that we, READE MACON WASHINGTON and ALFRED WILLIS CAPY, of Dallas, in the county of Dallas and State of Texas, have invented a new and useful Attachment to the Barrels of Firearms, of which the following is a full, clear, and exact description.

One object of my invention is to provide a simple, light, yet durable device adapted for attachment to the muzzles of rifles, muskets, and other arms adapted to fire bullets, and to so construct the attachment that it will materially modify or entirely prevent the noise made when a weapon is discharged, and will also act to suppress the smoke almost entirely when black powder is used.

A further object of the invention is to attain the ends above set forth without impairing the power or accuracy of the weapon.

The invention consists in the novel construction and combination of the several parts, as will be hereinafter fully set forth, and pointed out in the claims.

Reference is to be had to the accompanying drawings, forming a part of this specification, in which similar characters of reference indicate corresponding parts in all the figures.

Figure 1 is a side elevation of a rifle and the attachment applied thereto. Fig. 2 is a longitudinal section through the attachment, drawn on a larger scale than in Fig. 1, and also a longitudinal section through that portion of the barrel to which the attachment is applied; and Fig. 3 is a transverse vertical section taken practically on the line 3-3 of Fig. 2.

A represents a casing, which is usually made oval in cross-section, as shown in Fig. 3. This casing is provided with a collar 10 at the rear end of its body portion, and the said collar is adapted to be screwed upon or otherwise attached to the forward or muzzle end of the barrel A' of a gun, as shown particularly in Fig. 2. At the rear lower portion of the body-casing A a tubular extension 11 is formed, which is usually circular in cross-section, but may have other cross-sectional contour. The extension 11 from the casing is adapted to extend rearwardly beneath the barrel a necessary distance when the casing is attached to the barrel and is fastened to

the barrel by a strap or its equivalent. In order that the extension 11 of the body and in fact the chamber in the body proper may be readily cleaned when desired, the rear end portion of the extension 11 is closed by a plug 12, screwed therein or otherwise detachably secured in place. The upper surface of the casing A is flush with the corresponding surface of the barrel in order that the sight of said barrel shall not be interfered with. The space within the casing A and the extension 11 may be termed an "expansion-chamber," but certain portions of this expansion-chamber are shut off, as will be hereinafter stated.

The body-casing A is adapted to receive a cap B, the cap being at the forward or delivery end of the casing, and this cap is adapted to slide within the body-casing and is held in engagement therewith in any approved manner—as, for example, through the medium of spring clips or tongues 13—as shown in Figs. 1 and 3. The inner face 14 of the cap B is inclined, the inclination being from the upper edge downwardly and forwardly, and the inner face of the cap is open from a point at or near its bottom to a point near the top. The upper portion of the inner inclined face of the cap B is provided with a deflecting-plate 15, and the said deflecting-plate has an opening 16, the center of said opening being in longitudinal alinement with the axis of the bore A' of the barrel.

Immediately forward of the opening 16 in the deflecting-plate and at the forward upper end of the cap a chamber 16* is formed provided with an inlet 17, the center of which inlet is in a plane with the center of the axis of the opening 16 in the deflecting-plate and the axis of the bore A' of the barrel. This alinement of the openings 17 and 16 with the bore of the barrel is in order that the bullet discharged from the barrel may pass through the said openings 16 and 17 and out through the chamber 16* without interfering in the slightest degree with any of the mechanism designed to confine the gases.

The inner face or wall of the chamber 16* is inclined, and a flange 18 is formed upon this wall around the inlet-opening 17. The flange 18 is adapted as a seat for a valve 19, which valve closes the inlet 17 of the cham-

ber 16* immediately after the discharge of the bullet; but normally the valve is made to bear against the inner face of the lower portion of the deflecting-plate 15, assuming a position parallel with the line of the inner face of the cap B, as shown in positive lines in Fig. 2. The opening 16 in the deflecting-plate is made in its lower edge, and in order that the discharge of the bullet shall not be impeded a corresponding opening 20 is made in the upper end of the valve, and when the valve 19 has bearing against the deflecting-plate 15 the opening in the valve and the opening in the edge of the deflecting-plate register, forming an opening of sufficient size to permit the uninterrupted passage of the bullet.

An arm 21 is secured to the front face of the lower portion of the valve 19, the arm being at right angles to the outer face of said valve, and the valve is pivoted in the cap B by a pin 22, that is passed through the cap and through the said arm, as shown in Figs. 2 and 3. The valve 19 is held in its open position—that is, in engagement with the deflecting-plate—by means of a spring 23, usually attached to the bottom outer wall of the chamber 16*, the spring having bearing against the upper surface of the arm 21, as shown in Fig. 2. In order that the spring 23 may be repaired or replaced when necessary, an opening is made in the front of the cap below the chamber 16*, and this opening is normally closed by a block 24.

In the operation of the attachment when a gun is fired the bullet is discharged as usual, and in passing out from the barrel does not touch or interfere with the mechanism of the attachment, as has heretofore been stated. The expanding-gases strike the deflecting-plate 15 and the valve 19 at the same instant. The deflecting-plate being rigid and inclined toward the valve turns the flow of gas downward in direction of the valve, and the valve being free to move outward is thrown against its seat 18, as shown in dotted lines in Fig. 2, and is held there until the inside pressure of the gas in the expansion-chamber and barrel of the gun becomes equal to the outside pressure of the atmospheric air plus the tension of the spring 23, whereupon the valve again opens and the gun is ready for another shot. The gas, instead of rushing into the air as usual, is turned by the valve back into the expansion-chamber, which the gas itself had closed. The action is very quick, the various steps described following each other in practically a moment of time.

The expansion-chamber, which includes the cubic contents of the bore of the gun, acts substantially as a condenser, and at the time of firing no smoke is visible. Upon throwing open the breech of the gun as soon as possible after firing a bullet the expansion-chamber will be found practically filled with a light smoke; but the deposit upon the lands and grooves is not more than usual, as the

greater portion of the deposit will be found upon the valve in nearly a direct line with the axis of the bore of the gun.

Having thus described our invention, we claim as new and desire to secure by Letters Patent—

1. A casing arranged for attachment to the barrel of a gun, and having an outlet for a bullet, an inclined deflecting-plate in said casing and a valve normally held in an open position and operated by the gases to close the outlet for the bullet after said bullet has escaped from the casing, substantially as described.

2. A casing provided with a gas-condensing chamber and arranged for connection with the barrel of a gun, the said chamber having an outlet for a bullet, the said casing having a tubular extension forming part of the gas-condensing chamber and extending rearwardly beneath the barrel of the gun, a closure for the rear end of said tubular extension, a valve operated by the gases to close the outlet for the bullet after said bullet has escaped and a support against which said valve normally rests, the said support being located between the end of the gun-barrel and the outlet for the bullet, substantially as described.

3. A casing adapted for attachment to the barrel of a gun, a chamber at the forward end of said casing and having an inlet in its inner or rear wall in line with the bore of the gun, a plate in said casing between the rear end of said chamber and the end of the gun-barrel and a pivoted valve normally resting on the said plate, the plate and valve being constructed to permit of the passage of a bullet, the said valve being adapted to close the opening in the rear end of said chamber immediately after the escape of the bullet, being carried to said closing position by the action of the gases, substantially as described.

4. A device adapted to control the noise of the explosion of a charge and prevent the escape of smoke from the muzzle of a gun, said device consisting of a casing arranged for attachment to the muzzle of a gun, the casing being provided with a downwardly and forwardly extending deflecting-plate having an opening in line with the axis of the barrel, the casing being provided with a passage-way for a bullet forward of the deflecting-plate and a valve normally resting with its upper end on said deflecting-plate, and adapted to be moved to close said passage-way by the accumulation of gases within the said casing, as described.

5. The combination, with the barrel of a gun, a casing attached to the muzzle of said barrel, and a cap removably secured in the forward end of the casing, the cap being provided with an inclined deflecting-plate having an opening therein in line with the axis of the barrel, of a chamber forward of the deflecting-plate, provided with an opening also in line with the axis of the bore of the

APPENDIX E

SILENCER TECHNIQUES & REPRESENTATIVE PATENTS

The following silencer photographs and patents are presented as reflecting the various silencing techniques and concepts.

The photographs (pgs 159 through 163) of sectioned WW II German experimental silencers show some outstanding silencing techniques, such as flexible baffles, vortex-inducing channels and rearward slanted steel baffles. Also shown are quick attaching silencer clamps.

U.S. Patent No. 658,934, issued 2 October 1900 to Reade Macon Washington and Alfred Willis Cagy, "Attachment for Barrels of Firearms."

Austrian Patent No. 5478, issued 1 June 1901 to Josef Hutfless, "Device for Silencing a Firearm." (Translation)

U.S. Patent No. 958,935, issued 24 May 1910 to Hiram Percy Maxim, "Silent Firearm."

U.S. Patent No. 1,000,702, issued 15 August 1911 to Eugene Thurler, "Device for the Suppression of the Report of Firearms."

German Patent No. 629,404, issued 13 March 1933 to Hans Eissfeldt, "Silencers for Hand Weapons." (Translation)

U.S. Patent No. 2,448,382, issued 31 August 1948 to Warren P. Mason, "Silencer."

U.S. Patent No. 3,138,991, issued 30 June 1964 to Richard L. Malter, "Firearm Muzzle Attachment and Projectile with Expansible, Detachable Husk."

158

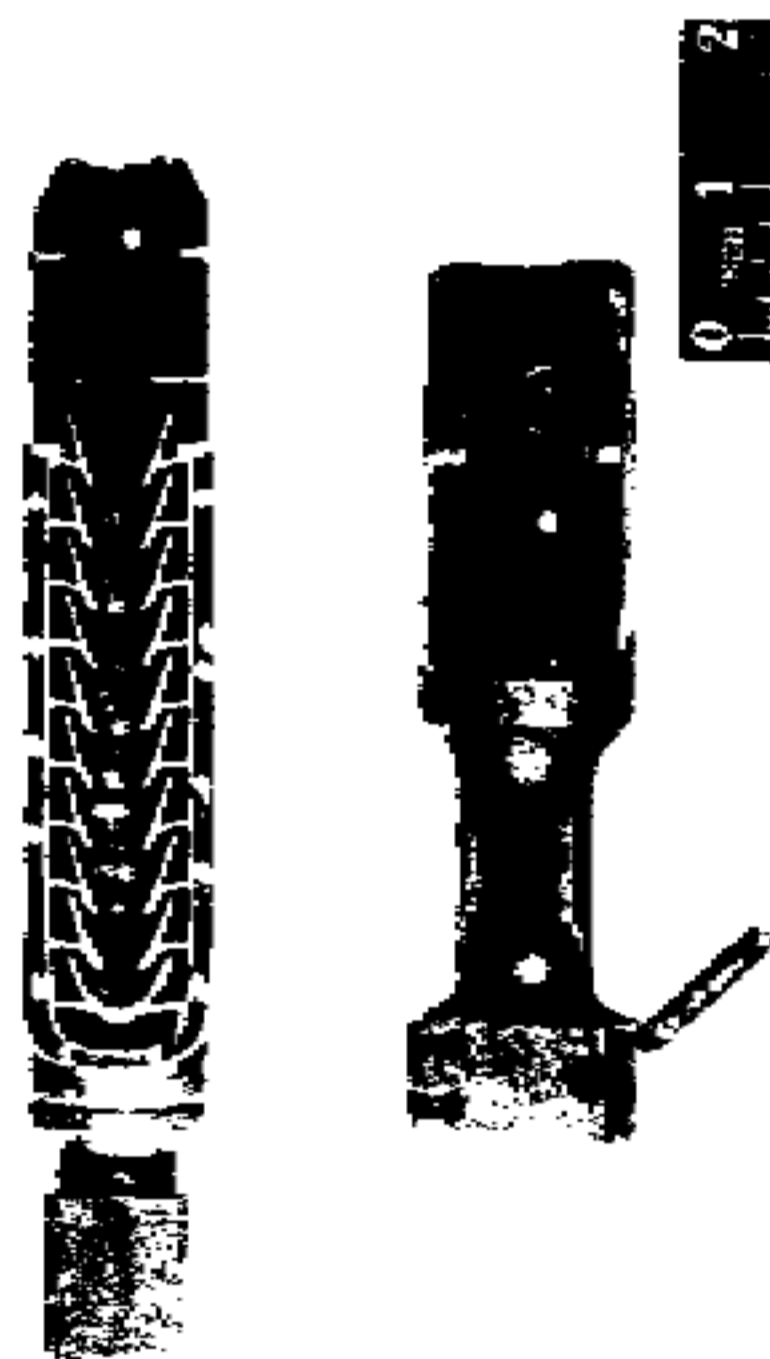

44487
German Rifle Silencer (sectionalized), PATENT-351.

44488
German Rifle Silencer (sectionalized), PATENT-351.

21 JAN 1947

21 JAN 1947

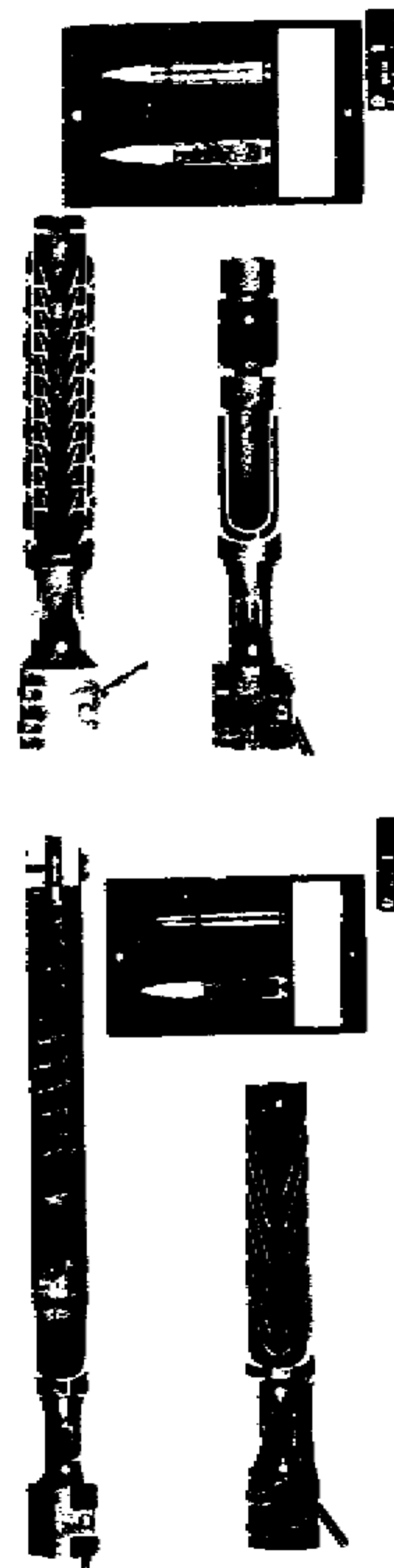

44489
German Rifle Silencer (sectionalized), PATENT-351. Silencer from 44488.

44490
German Rifle Silencer (sectionalized), PATENT-351. Silencer from 44488.

160

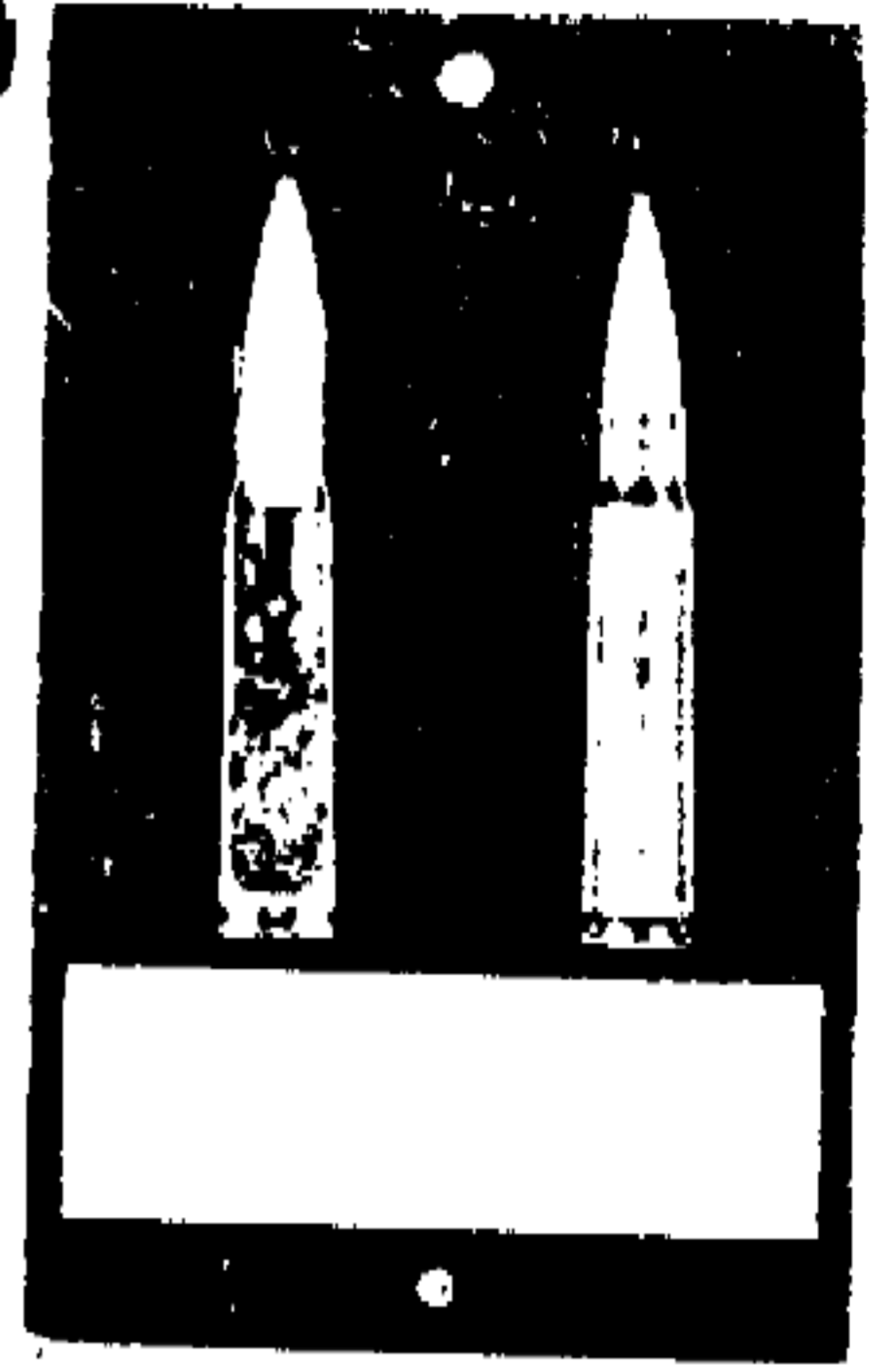

A44668

ABERDEEN PROVING GROUND

21 January 1947

German Rifle Silencers (sectionalized). FMMISC-731. (Silencer round also shown)

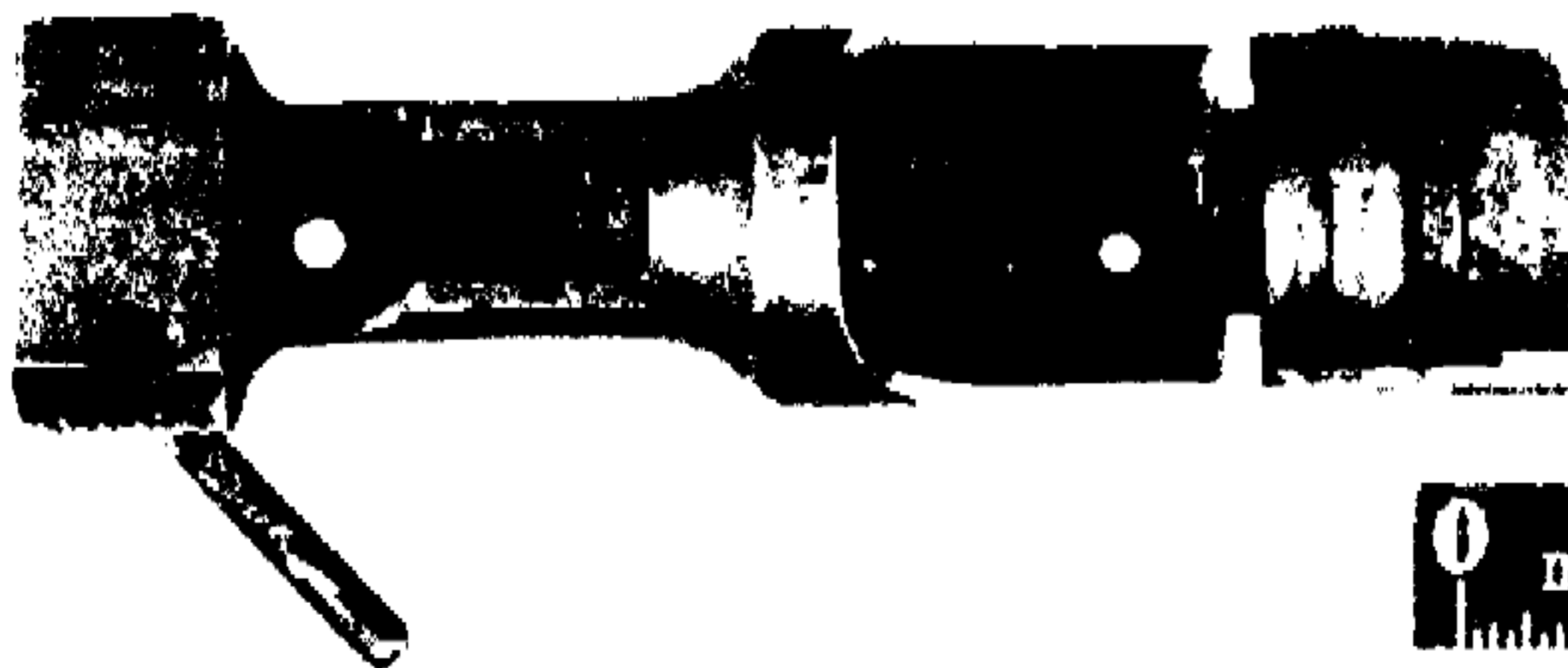

161

A44667

ABERDEEN PROVING GROUND

21 January 1947

German Rifle Silencers (sectionalized). FMMISC-731.

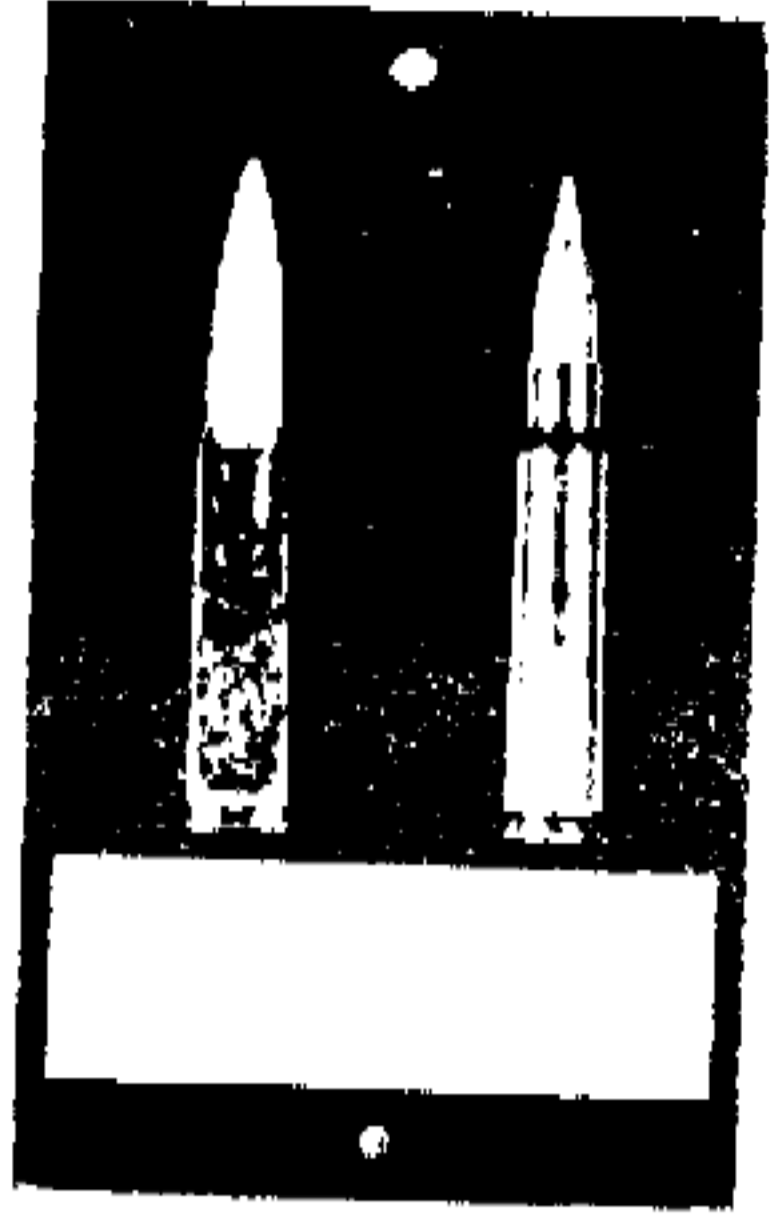

162



A44669

ABERDEEN PROVING GROUND

21 January 1947

German Rifle Silencers (sectionalized). FMVISC-731. (Silencer round also shown)

163

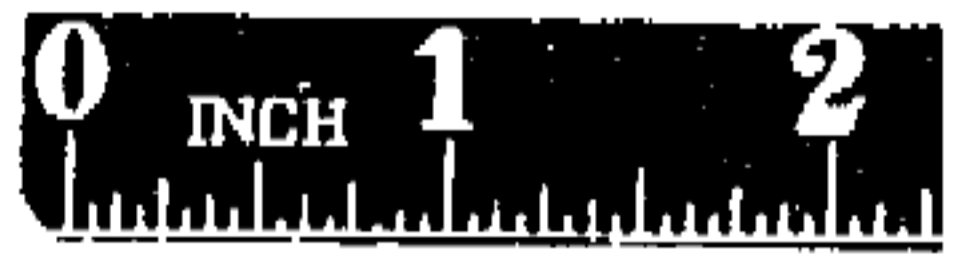
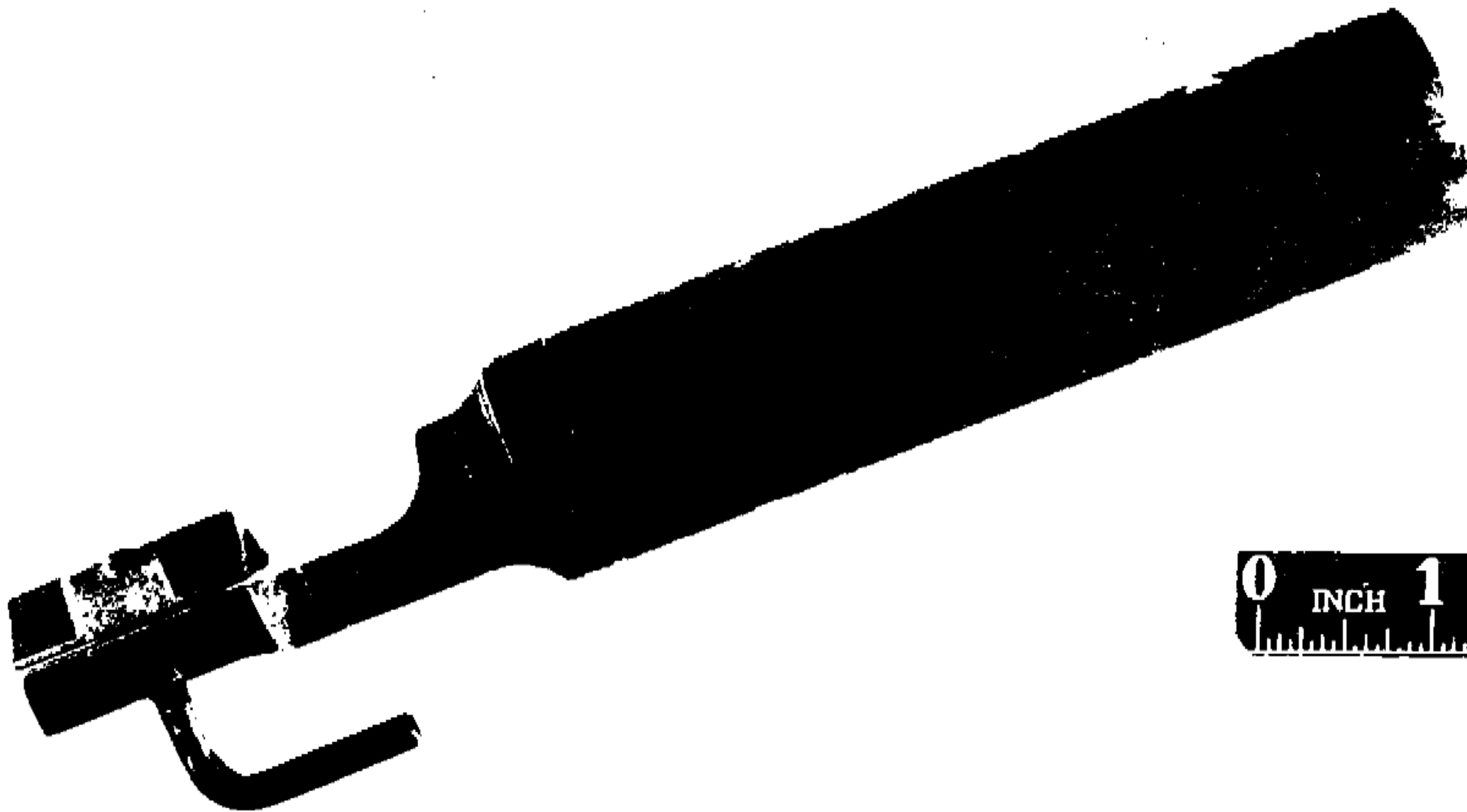

A47419

ABERDEEN PROVING GROUND

12 May 1947

Rifle Silencer, German. FMVISC 731.

gun, and a valve having bearing normally against the deflecting-plate, the said valve being forced to a seat at the inlet of the said chamber, by the action of the gas accumulated in the barrel and back of the said valve and deflecting-plate, after a bullet has been discharged, as described.

6. The combination with the barrel of a gun, of a casing attached to the muzzle of said barrel, a cap secured in the forward end of the casing and provided with an inclined deflecting-plate having an opening therein in line with the axis of the barrel, a chamber forward of the deflecting-plate and provided with an inlet-opening also in line with the bore of the gun-barrel and formed with a valve-seat and a spring-pressed valve normally resting against the deflecting-plate and adapted to be forced against said valve-seat, substantially as described.

7. The combination with the barrel of a gun, and a casing attached to the muzzle of the barrel and having a tubular extension at the rear lower portion provided with a removable closure at its rear end, of a cap removably secured in the forward end of the casing, the inner face of said cap being inclined from the upper edge downwardly and forwardly and the said inner face being open from a point at or near its bottom to a point near the top, an inclined deflecting-plate at the upper portion of the inclined inner face of the cap, the said plate having an opening in its lower edge in longitudinal alinement with the axis of the bore of the barrel, a chamber formed at the forward upper end of said cap and forward of the plate, the said chamber being provided with an inlet in its inner wall in line with the opening in the plate and the bore of the barrel, the inner wall of said chamber being inclined and having a flange formed thereon around the inlet-opening and constituting a valve-seat, and a pivoted and spring-pressed valve normally resting at its upper end against the lower portion of the deflecting-plate and having an opening at its upper edge forming with the opening in the lower edge of the deflecting-plate, a passage for the bullet, the said valve being forced to its seat at the inlet-opening of said chamber by the action of the gases after a bullet has been discharged, the front of said cap below the chamber having an opening provided with a removable closure, for the purpose set forth.

8. A casing arranged for attachment to the barrel of a gun and provided with a gas-condensing chamber, and a cap removably secured in the forward end of said casing and provided with a chamber having an opening in line with the axis of the bore of the gun and forming a passage for a bullet, a valve pivoted in said cap and operated by the gases to close the outlet for the bullet immediately after the escape of the bullet, the said cap being provided with an opening in its front below the said chamber, and a closure for said opening, substantially as described.

9. A device adapted to control the noise of the explosion of a charge and prevent the escape of smoke from the muzzle of a gun, the said device comprising a casing arranged for attachment to the muzzle of a gun the casing being provided with a passage-way for a bullet, a valve for closing said passage-way, a spring for normally holding said valve open, and a deflecting-plate for turning the flow of gas toward the valve, the valve being carried to closing position by the gases.

10. A casing for attachment to the muzzle of a gun, a cap removably secured in the forward end of said casing and having a valve-seat with an opening for the passage of the bullet and a valve carried by said removable cap and free to swing, the said valve being normally held in an open position, and adapted to be moved by the action of the gases to a closed position, substantially as described.

11. A casing arranged for attachment to the muzzle of a gun, a removable cap fitted in the forward end of the casing and having a valve-seat with an opening for the passage of the bullet, the axis of said opening coinciding with the axis of the bore of the gun, a valve carried by said cap and free to swing to close said opening, a spring for normally holding said valve in the open position, and a deflecting-plate carried by the cap and arranged to deflect the gases toward the valve, the said valve being closed by the action of the gases, whereby the said casing receives and confines for a time the gases resulting from firing the gun.

READE MACON WASHINGTON.
ALFRED WILLIS COPY.

Witnesses:
O. A. HEBBERER,
H. W. KELLY.

Corrections in Letters Patent No. 658,934.

It is hereby certified that in Letters Patent No. 658,934, granted October 2, 1900, upon the application of Reade Macon Washington and Alfred Willis Copy, of Dallas, Texas, for an improvement in "Attachments for Barrels of Firearms," errors appear requiring correction, as follows: In the grant and in the printed head of the specification, it is stated that they have assigned one-fourth of their right to said Washington, whereas it should have been stated that said Copy assigned one-fourth of the entire right to said Washington; and that the said Letters Patent should be read with these corrections therein that the same may conform to the record of the case in the Patent Office.

Signed, countersigned, and sealed this 16th day of October, A. D., 1900.

[SEAL.]

F. L. CAMPBELL,
Assistant Secretary of the Interior.

Countersigned:

C. H. DUELL,
Commissioner of Patents.

Fig 1

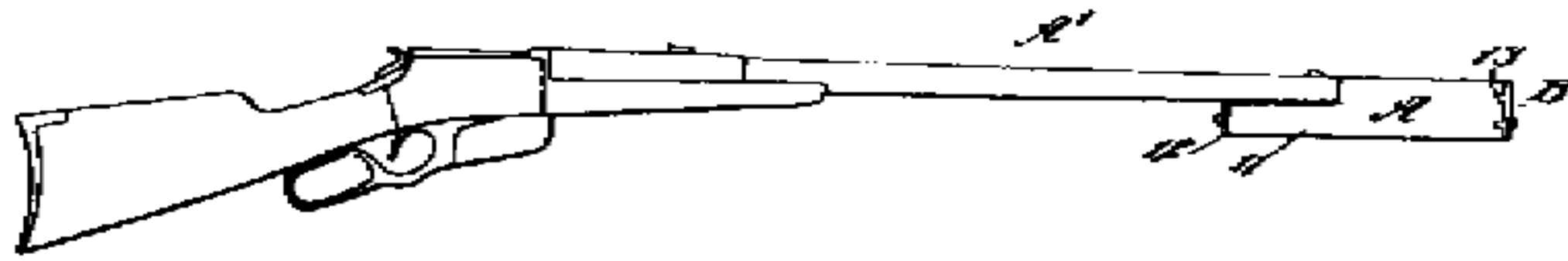

Fig 2

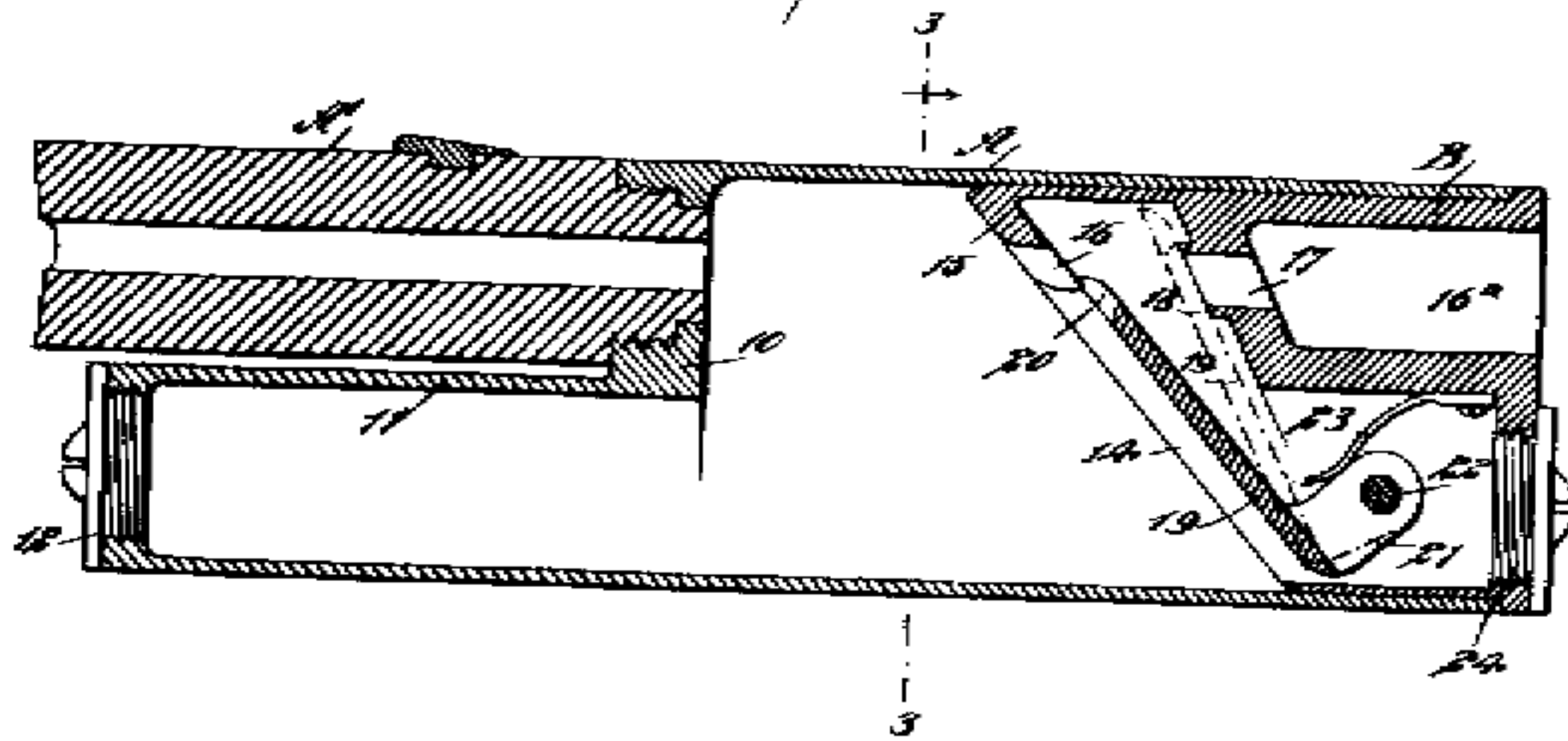
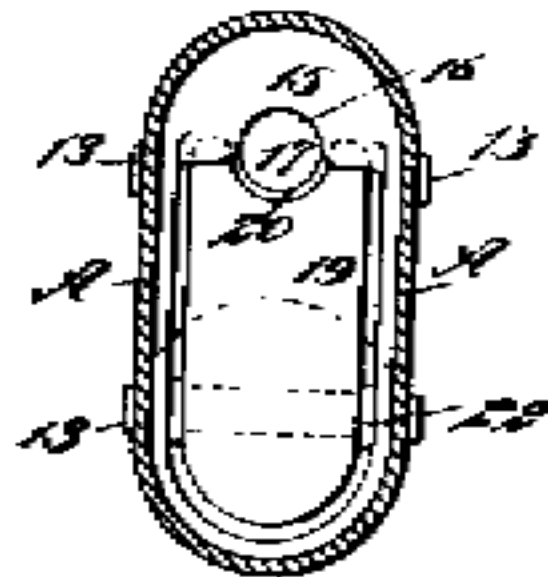

Fig 3



KAIS. KÖNIGL.  PATENTAMT.

Oesterreichische

PATENTSCHRIFT N^o 5478.

CLASSE 12: SCHUSSWAFFEN, GESCHOSSE, VERSCHANZUNG.

a) Handfeuerwaffen sammt Zubehör.

WITNESSES:
H. Walker
Ch. Walker

INVENTORS:
R. M. Washington
A. W. Capy
BY
M. M. M.
ATTORNEYS

The proposed innovation has to do with reduction of noise due to the sudden discharge of propellant gases after firing a weapon. It is hereby claimed that the barrel will close after projectile exit. The propellant gases will be released after passing through two or more regulating tubes running parallel to the barrel. In this way, the pressure will be reduced and the gas exit will cause only an insignificant noise.

The invention, for application to sporting guns, is shown in Fig. 1 through 4, the sketches showing the longitudinal side view and front views of the barrel cross section, A-B, of Figure 1.

As is evident, the muzzle of the barrel forms into a funnel. At the bottom of the barrel, a, are arranged two parallel thin walled tubes, b and c, which are connected together at their ends.

Tube b is connected to the muzzle end of the funnel shaped barrel, a, while the same end of the other tube, c, is equipped with a row of holes, d.

This weapon requires the use of special projectiles which are made up of two loosely connected parts, m and n. The charge is directly behind part m, which is of the same caliber as the straight tube, while the front part of the projectile, n, matches the narrow part of the tube and is connected to the heavier projectile, part m, by a fixed pin.

The operation of the device is as follows. Upon firing the weapon, the developing propellant gases in the tube push both projectile parts m and n up to the narrow tube. Arriving there, the heavier projectile, m, will be forced in the narrow barrel (position m') and thereby held back. The front projectile, n, in consequence of its acquired velocity, will free itself from the back projectile, m, passing and exiting through the remaining portion of the barrel (position n').

The propellant gases do not pass into the atmosphere through the muzzle of the barrel but, because of the obstruction, they enter tube c through the opening g. From here they pass into tube b and leave the latter, with essentially reduced pressure, through the arranged holes, d, in the front end of tube b, whereby only a hissing noise is produced.

As the result of this operation, a loud noise will be avoided and the propellant gases will leave the tube producing a damped, unnoticed noise. The remaining projectile part, m, in the tube can be removed through the insertion of a charging rod.

1. A device for silencing the noise produced by firing a weapon, in the following manner. The barrel near the muzzle is to be funnel shaped, and to this are to be connected one or more interconnected tubes from which the gases discharge through many small openings.

2. Two-part projectile, which is described above. The powder charge is to be behind the rear part, which is of the same caliber as the straight barrel, and the front part, which is to be loosely connected to the first part, will have the same caliber as the narrow portion of the barrel.

UNITED STATES PATENT OFFICE.

HIRAM PERCY MAXIM, OF HARTFORD, CONNECTICUT, ASSIGNOR TO MAXIM SILENT FIREARMS COMPANY, OF NEW YORK, N. Y., A CORPORATION OF NEW JERSEY.

SILENT FIREARM.

958,935.

Specification of Letters Patent. Patented May 24, 1910.

Application filed November 20, 1908. Serial No. 485,051.

JOSEF HUTFLESS in WIEN.
Vorrichtung zur Schalldämpfung bei Feuerwaffen.

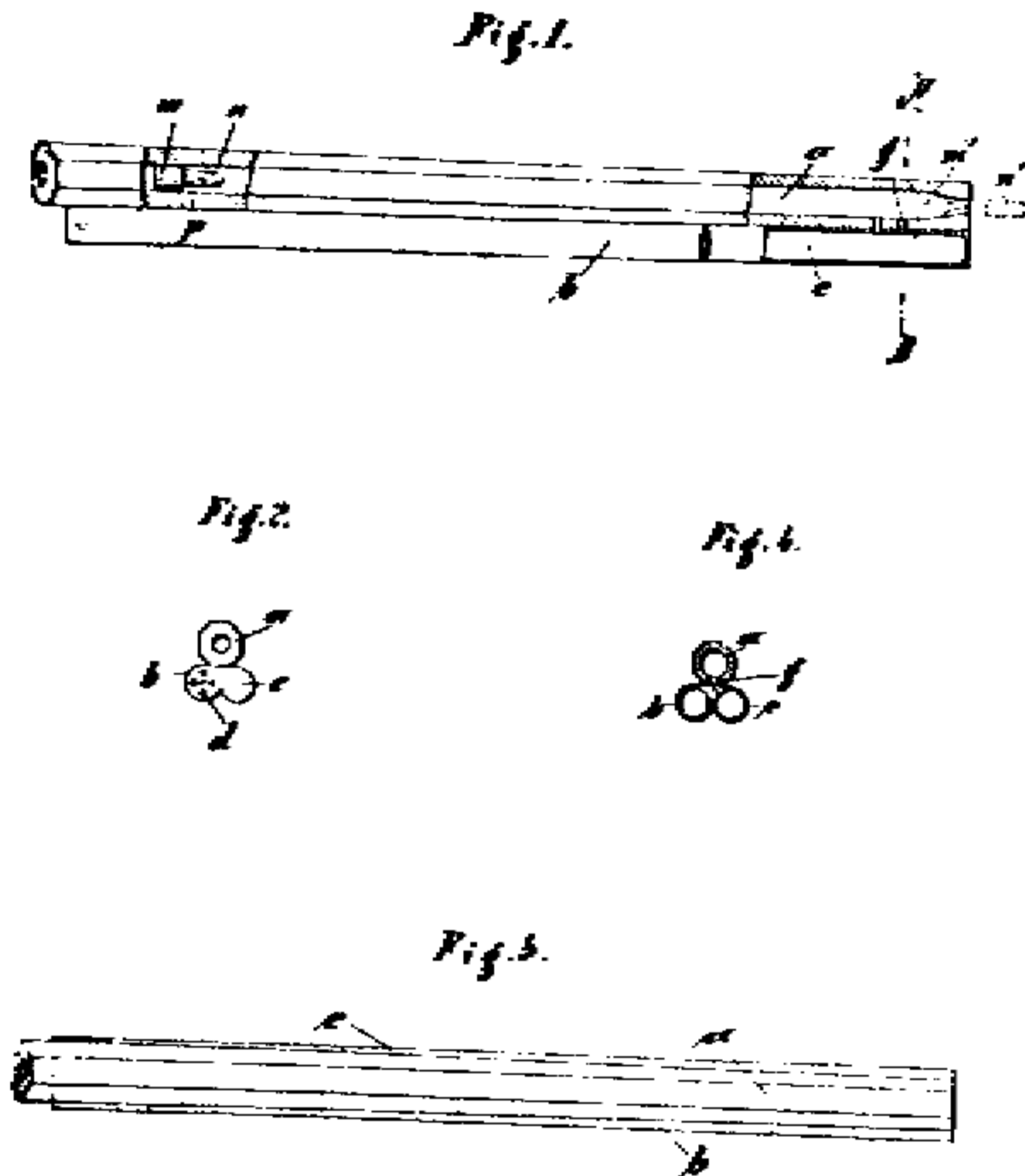

Zu der Patentchrift
N^o: 5478.

To all whom it may concern:

Be it known that I, HIRAM PERCY MAXIM, a citizen of the United States, residing in the city of Hartford, in the State of Connecticut, have invented certain new and useful Improvements in Silent Firearms, of which the following is a specification, reference being had to the accompanying drawing, forming a part hereof.

In the continued use of silencers for firearms in which the energy of the powder gases is dissipated in rotary or whirling movement of the gases before they pass into the atmosphere, and in which a series of partitions, diaphragms or spreaders are supported by a shell or casing at the muzzle of the firearm, the rotary or whirling movement of the gases taking place in the chambers formed thereby, the partitions, diaphragms or spreaders nearest the true muzzle of the barrel of the firearm are exposed to the highest gas pressure, while those more remote from the muzzle are exposed to much less gas pressure. Lightness in the silencer can be secured by making the partitions, diaphragms or spreaders in the zone of high gas pressure of sufficient strength to withstand such pressure and by making the partitions, diaphragms or spreaders more remote from the muzzle of thinner and even of lighter material. It is found, however, that it is necessary to provide an abutment for the heavier and stronger diaphragms near the muzzle to support them against the impact of the gases and to relieve from great pressure the successive lighter diaphragms, which are liable to be crushed eventually if the resistance is through them.

One object of the present invention, therefore, is to provide such a construction of silencers of this character as shall be capable of withstanding the impact of the gases while at the same time the minimum of weight in the silencers is secured. Furthermore, in silencers of this character which are eccentric with respect to the axis of the gun barrel, it is necessary to assure accurate alinement of the openings through the successive diaphragms for the passage of the projectile.

It is, therefore, a further object of this invention to provide a construction by which such alinement of the openings through the

diaphragms shall be secured without requiring great labor in the assembling of the diaphragms and casing.

The invention will be more fully explained hereinafter with reference to the accompanying drawing in which it is illustrated and in which—

Figure 1 is a view in side elevation of an ordinary sporting rifle equipped with a silencer which embodies the invention. Fig. 2 is a detail view in section and on a larger scale of the silencer shown in Fig. 1, a portion of the barrel being also represented. Fig. 3 is a face view of one of the diaphragms, showing the recesses in the circumference thereof. Fig. 4 is a transverse section of the supporting shell or casing, showing the longitudinal key.

In the embodiment of the invention shown in the drawing there is secured to the extremity of the barrel *a* of the gun, in any suitable manner, as by screw threads, a casing *d*, which is preferably substantially circular in cross section and of greater or less length as may be required and forms a support and inclosure for the series of single silencing devices or partitions or diaphragms or spreaders *e* by which the gases, which escape at the muzzle of the barrel *a*, are compelled to acquire, within successive cells or chambers formed by the diaphragms *e*, a rotary or whirling movement.

In the embodiment of the invention shown each single silencing device *e* is generally circular or annular with reference to the axis of the shell or casing *a*, and is spiral or conchoidal in cross section, an opening *e'* being formed for the passage of the projectile. In the construction shown, such opening is eccentric with respect to the axis of the shell or casing. As is now well understood, the powder gases are directed by the frusto-conical portion of each diaphragm or spreader, or single silencing device, into the annular chamber formed by the diaphragm and acquire therein a rapid rotary motion in which their energy is dissipated. The diaphragms or spreaders, as *e'*, nearest the muzzle of the gun are naturally subjected to the highest pressure of the gases, while those more remote from the muzzle are subjected to a considerably lower pressure. Those more remote from the

muzzle of the gun may, therefore, be less capable of resisting high pressure than those nearer the muzzle and may be made of much lighter sheet steel than those near the muzzle, or may even be made of aluminum, while those nearer the muzzle are made of steel. However, should the diaphragms or spreaders nearer the muzzle rest directly against those more remote from the muzzle, so that the latter receive the pressure transmitted through the former, they would eventually be broken down. To obviate this, an abutment is formed in the shell or casing *d* to receive the pressure of the diaphragms or spreaders in the zone of high gas pressure. Such abutment may be variously formed, but as a convenient and inexpensive, but effective construction, the shell or casing *d*, after the lighter diaphragms or spreaders *e* have been placed therein, is formed with an inner circumferential ridge or shoulder *d'*, as by spinning, and against such abutment the heavier diaphragms or spreaders *e'* rest. It will be understood that the number of heavier or stronger diaphragms or spreaders employed will depend upon the character of the gun to which the silencer is applied. For a light power gun it is sufficient to provide one heavy, steel diaphragm or spreader *e'*, as shown in Fig. 2 of the drawing, but with a gun of higher power two or more of the heavy steel diaphragms or spreaders may be required. Of course the number of the lighter diaphragms or spreaders employed will also depend upon the character of the gun to which the silencer is applied and the effect to be produced. In the construction shown in Fig. 2 space is provided within the shell or casing *d* for more than one heavy or strong diaphragm or spreader and a spacing sleeve *d''* is introduced to hold the single diaphragm or spreader in place.

It will be understood that the provision of an abutment for the heavier diaphragms or spreaders is equally desirable, whether the silencer be concentric with the axis of the gun barrel or eccentric with respect thereto. In the construction shown in the drawing, however, the silencer is eccentric and it therefore becomes desirable to provide means for readily assuring the accurate alinement of the openings *e'* in the several diaphragms or spreaders with the bore of the gun barrel. For this purpose, in the construction shown, each of the diaphragms or spreaders is provided in its circumference with a key-way, as shown at *e''* in Fig. 3, and the shell or casing *d* is provided with an internal longitudinal ridge or key *d''*, which may be conveniently formed by rolling or pressing a suitably shaped tool into the outer wall of the casing. With this construction the diaphragms or spreaders cannot be introduced

proper relative position with the openings *e'* in accurate alinement with the bore of the barrel *a*.

I claim as my invention:

1. A silencing device for firearms, comprising a shell or casing, a series of diaphragms or spreaders disposed in the shell or casing remote from the muzzle and forming a succession of chambers, each of the diaphragms or spreaders having an opening for the passage of the projectile, and a relatively heavy or strong diaphragm or spreader disposed in the shell or casing adjacent to the muzzle of the firearm and also having an opening for the passage of the projectile, the shell or casing having an abutment to resist the forward pressure of such heavier diaphragm or spreader, whereby the lighter diaphragms or spreaders remote from the muzzle of the firearm are relieved of the pressure of the heavier diaphragm or spreader.

2. A silencing device for firearms, comprising a supporting shell or casing, a series of diaphragms or spreaders disposed in the shell or casing remote from the muzzle and forming a succession of chambers, each of the diaphragms or spreaders having an opening for the passage of the projectile and forming an annular cell substantially conchoidal in cross section, and a heavier diaphragm or spreader disposed in the shell or casing adjacent to the muzzle of the firearm and also having an opening for the passage of the projectile and also forming an annular cell substantially conchoidal in cross section, the supporting shell or casing having an abutment to receive the pressure of such heavier diaphragm or spreader, whereby the lighter diaphragms or spreaders remote from the muzzle of the firearm are relieved of the pressure of the heavier diaphragm or spreader.

3. A silencing device for firearms, comprising a supporting shell or casing, a series of diaphragms or spreaders disposed in the shell or casing remote from the muzzle of the firearm, each of the diaphragms or spreaders forming an annular cell substantially conchoidal in cross section and having an opening for the passage of the projectile, and a heavier or stronger diaphragm or spreader disposed in the shell or casing adjacent to the muzzle of the firearm and also forming an annular cell substantially conchoidal in cross section and having an opening for the passage of the projectile, the supporting shell or casing having an interior circumferential ridge forming an abutment to receive the pressure of such heavier diaphragm or spreader, whereby the lighter diaphragms or spreaders remote from the muzzle of the firearm are relieved of the pressure of the heavier diaphragm or spreader.

4. A silencing device for firearms, comprising a supporting shell or casing and a series of diaphragms or spreaders disposed in the shell or casing and forming a succession of chambers, each of the diaphragms or spreaders having an opening eccentrically disposed for the passage of the projectile, the shell or casing having an interior ridge or key and each of the diaphragms or spreaders having a key-way to cooperate therewith.

5. A silencing device for firearms, comprising a supporting shell or casing and a series of diaphragms or spreaders disposed in the supporting shell or casing and form-

ing a succession of chambers, each of the diaphragms or spreaders forming an annular cell substantially conchoidal in cross section and having an opening eccentrically disposed for the passage of the projectile, the shell or casing having an interior ridge or key and each of the diaphragms or spreaders having a key-way to cooperate therewith. This specification signed and witnessed this 27th day of November, A. D., 1908.

HIRAM PERCY MAXIM.

Signed in the presence of—
JOSEPHINE H. MAXIM,
LENA E. BERKOVITCH.

H. P. MAXIM.
SILENT FIREARM.

APPLICATION FILED NOV. 30, 1908.

958,935.

Patented May 24, 1910.

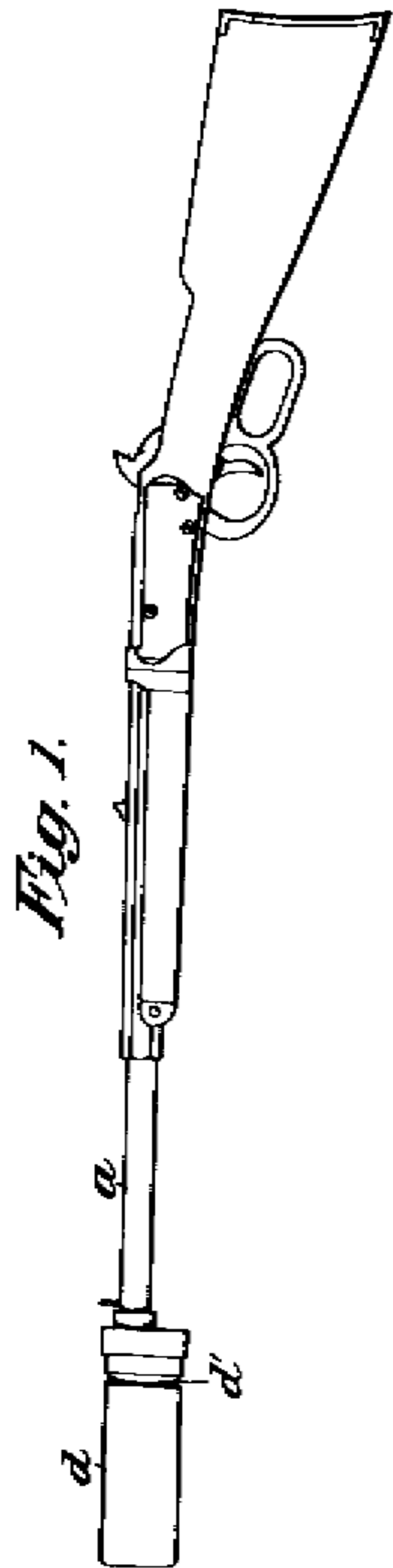

Fig. 1.

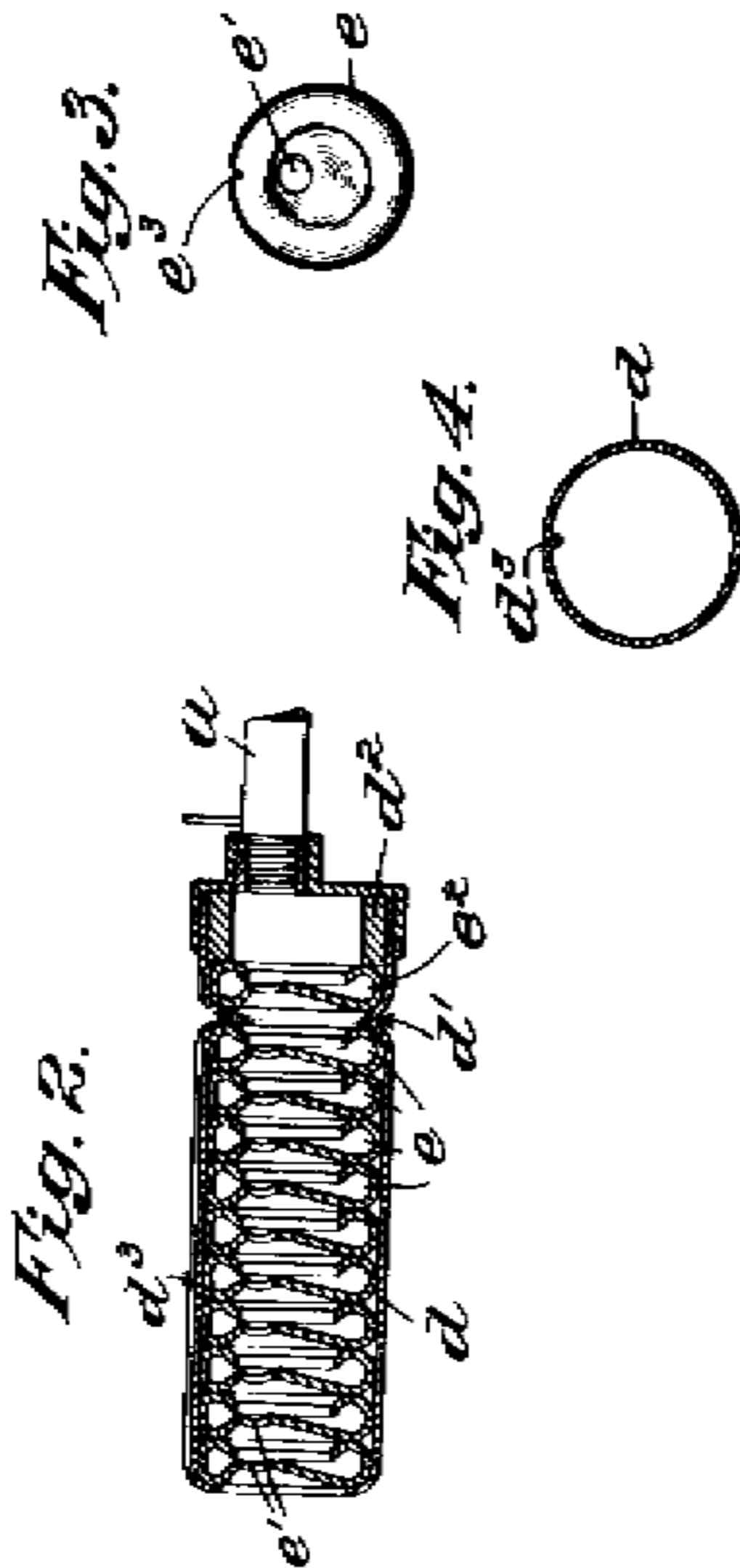

Fig. 2.

Fig. 3.

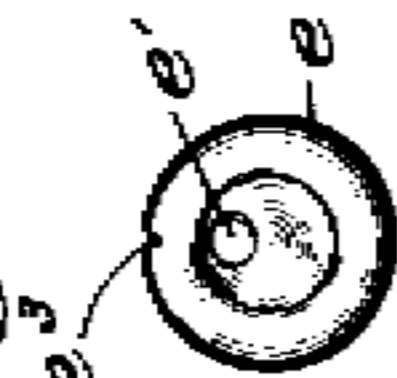
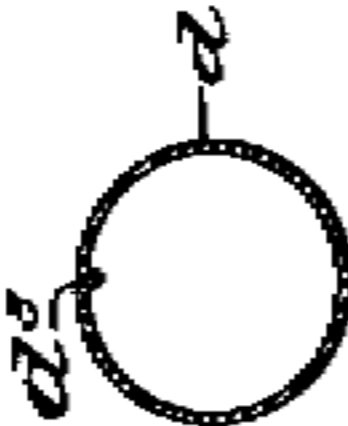

Fig. 4.



Attest:
H. P. Maxim
Wm. J. Kruger

Inventor:
by *Hiram Percy Maxim*
Redding, Greeley Austin
Attys.

UNITED STATES PATENT OFFICE.

EUGÈNE THURLER, OF FRIBOURG, SWITZERLAND.

DEVICE FOR THE SUPPRESSION OF THE REPORT OF FIREARMS.

1,000,702.

Specification of Letters Patent. Patented Aug. 15, 1911.

Application filed November 2, 1910. Serial No. 599,347.

To all whom it may concern:

Be it known that I, EUGÈNE THURLER, a citizen of the Swiss Confederation, residing at Fribourg, of the Swiss Confederation, have invented certain new and useful Improvements in Devices for the Suppression of the Report of Firearms, of which the following is a specification.

This invention relates to devices for lessening the report of fire-arms. According to this invention the energy with which the gases of combustion travel is destroyed by guiding said gases through a certain number of chambers which are arranged at a certain distance apart the one before the other and which have passages for the projectile. The gases are thus deviated from the trajectory and made to expand generally in said chambers.

The devices according to this invention differ from the devices of known types and serving for the same purpose by the arrangement that the said expansion chambers have the shape of conical sleeves which are mounted in a casing the rear end of which is perforated or formed of wire gauze for $\frac{1}{3}$ of its length. The inner casing is further inclosed in one or more mantles which are alternately perforated at the front or at the rear end. The gases which are compressed at a very high degree of pressure when they are being generated are thus quickly deviated from the trajectory of the projectile. The gases escaping through the perforations of the casings, getting hot of the conical sleeves is prevented.

In the accompanying drawing, a plan of execution of the object of the present invention is shown as applied to a rifle-barrel.

Figure 1 represents a horizontal longitudinal section of the apparatus. Fig. 2 shows a cross section along the line II-II (see Fig. 1). Figs. 3 and 4 have reference to the details of the device shown in Figs. 1 and 2. Figs. 5 to 7 show the details of three modifications.

The device represented in Figs. 1 to 4 has a sleeve *a* the internal diameter of which is equal to the outer diameter of the barrel *b*. An angular slot *a'* (Fig. 3) at the free end of the sleeve *a* serves to fix the device to the barrel *b*, said slot being pushed over the sight *c*. The interior of the apparatus is provided with a series of tubular sleeves *d* placed co-axially in the tube *e*. This tube

e is doublewalled and it is made for two-thirds of its height of fine net-work, the remaining third being of sheet metal. The sleeves *d* are conically enlarged toward the front end. The narrow rear ends are all turned toward the barrel *b* and constitute together a canal for the projectile *f*. The sleeves *d* have at the front end four slots through which are passed four rods *f* fixed on the inside of the tube *e* and serving to maintain the sleeves *d* at a given distance from each other so that each two succeeding sleeves form a curved passage for the compressed gas. The tube *e* is surrounded by a second tube *g* of a greater diameter than *e*, the position of which is eccentric with regard to the common axis of the tubular sleeves *d*. This tube *g* is perforated at the first part *g'* for one-third of its length. A third tube *h* perforated at its rear part for one-third of its length surrounds the tube *g*. The space between *g* and *h* is filled with shavings of metal, such as aluminium. The position of the tube *h* is also eccentric with regard to the axis of the sleeves *d* so that the sight *c* projects over the device for a few millimeters.

The direction followed by the compressed gas is shown by the arrows. The projectile *f*, on leaving the barrel *b*, enters into the channel formed by the narrow extremities of the sleeves *d* closing this channel to the compressed gas which rushes consequently through the annular openings of the tube *e* into the space between the tubes *e* and *g* where it partially expands. From there the gas escapes through the narrow openings of the first or forward third of the tube *g* into the space between *g* and *h* where the gas is prevented from expanding instantly owing to the filling of metal shavings, the escape of gas through the openings in the tube *h* taking place without any report. The solid wall of the forward part of the tube *e* prevents the gas from entering the sleeves *d* thus escaping by the central channel before the shot. The more elongated the form of the sleeves the less the gas will endeavor to penetrate into the passage for the projectile.

It is observed that the tube *e* does not touch the wall of the tube *g* at its upper part; there is still a space of a few millimeters between *e* and *g* which is necessary for the free passage of the gas around the

tube *e*. If this tube were to touch the tube *g* the result would be a pressure on the projectile causing the same to deviate.

Experiments have shown that the recoil of a gun fitted with the above described device is only very slightly diminished, the automatic reloading by recoil could therefore be accomplished.

Fig. 5 shows a modified construction according to which the tubular sleeves are differently shaped than in the first instance. According to Fig. 6 the tube *g* on this device has been suppressed. The entire space between the tubes *e'* and *h'* is filled with metal shavings. A network *h²* has been applied to the inside of the perforated portion of the tube *h'*. Fig. 7 shows slots *h³* provided in the tube *h'* for the escape of the gas.

I claim:—

An improved device for lessening the report of fire-arms in which the compressed gases are deviated from the trajectory of

the projectile by means of consecutive elements which form a channel for the passage of the projectile, comprising in combination a certain number of elements consisting of conical sleeves, a tube inclosing said elements and perforated for two thirds of its length from the front end to the rear, an eccentric casing surrounding said tube and composed of two tubes of which the inner one is perforated at the front part about one third of its length, the outer tube being perforated at the rear part for about one third of its length and a filling of metal shavings in the space between said tubes substantially as described and shown and for the purpose set forth.

In witness whereof I have hereunto set my hand in the presence of two witnesses.

EUGENE THURLER.

Witnesses:

ALBERT DE CARSLADE,
H. C. COXE.

E. THURLER.

DEVICE FOR THE SUPPRESSION OF THE REPORT OF FIREARMS.

APPLICATION FILED NOV. 2, 1910.

1,000,702.

Patented Aug. 15, 1911.

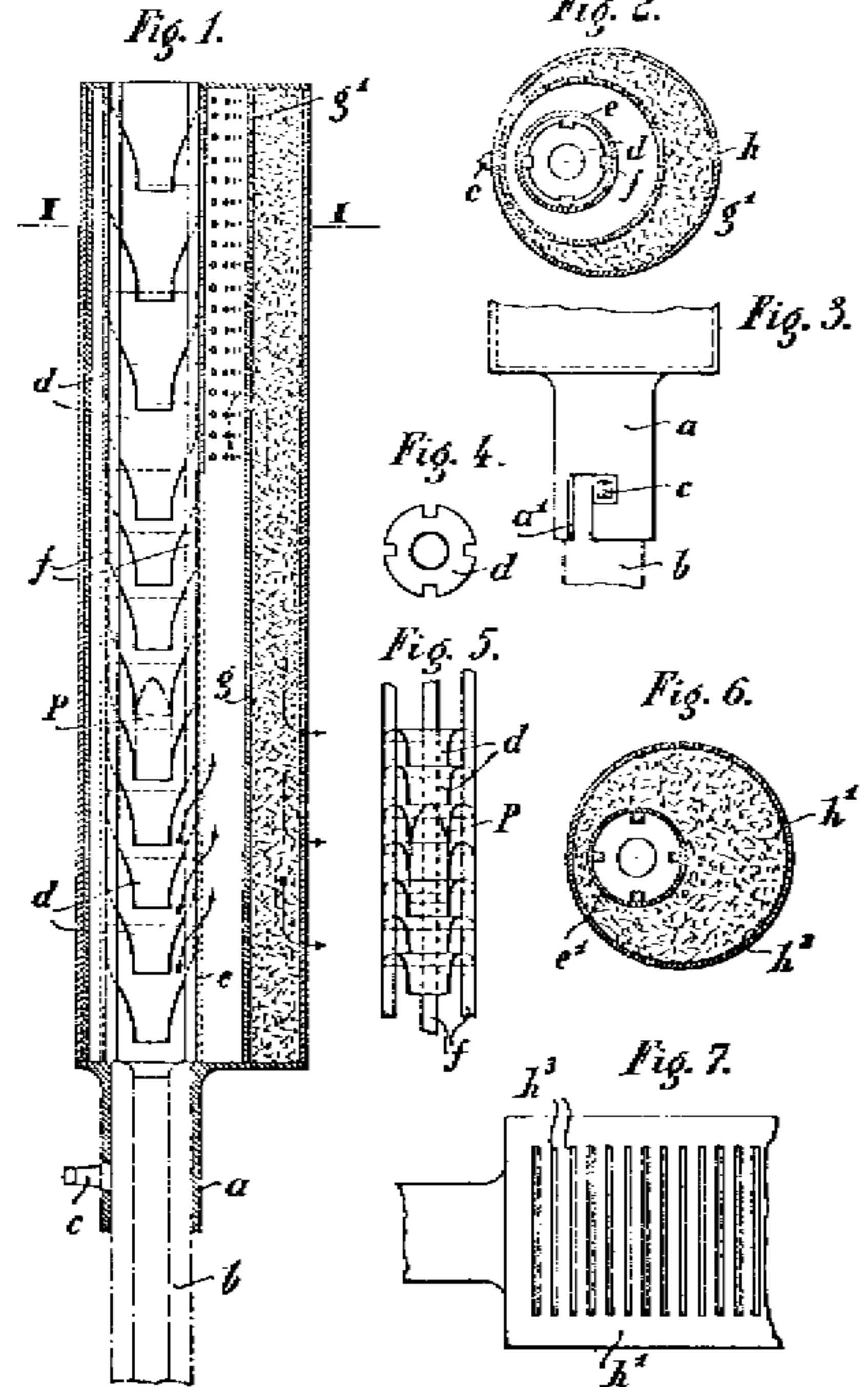

Witnesses:

*Alfred
Pasquet*

Inventor:

Eugene Thurler
by *Karl H. Wood*
his attorney N. 1116



DEUTSCHES REICH



AUSGEGEBEN AM
30. APRIL 1936

REICHSPATENTAMT
PATENTSCHRIFT

№ 629404

KLASSE 72a GRUPPE 28

E 44045 XI/72a

Tag der Bekanntmachung über die Erteilung des Patents: 9. April 1936

Hans Eissfeldt Nfl. in Hamburg

Schalldämpfer für Handfeuerwaffen

Translation: Patent No. 629404, "Silencers for Hand Weapons"
Issued to Hans Eissfeldt, 13 March 1933, in Germany.

Silencers for hand weapons are already known. Generally, they consist of an elongated hollow cylinder with baffles, which either partition the chamber or close it off from the atmosphere by use of elastic washers. Either way, good results are not obtained because the noise, even though somewhat attenuated, always remains.

In relation to such silencers, the following improvement and discovery is contained herein. The inner chambers will be completely filled with a porous material, such as viscous sponge, rubber sponge, or a similar material. This material offers no resistance to the passing projectile and closes immediately behind it. The gas following the projectile will be forced into the many small cavities, where it will be delayed prior to arrival at the closing washer until such time as the projectile will have passed through and the washer will have closed. In this manner, a substantial attenuation of the noise will be obtained.

The objective of this discovery is illustrated in the following sketch.

Fig. 1 shows a longitudinal view of the silencer in which the walls, d, separate the hollow cylinder into separate chambers. The chamber, b, is filled with porous material, followed by packing washers, c, and the elastic closing washer, a.

Fig. 2 shows the view of the muzzle of the silencer with the notched closing washer.

Fig. 3 shows a view of the silencer end attachable to the barrel of the weapon.

Patent Claim

Silencer for a hand weapon is described as follows. The closing packing washers in front of the hollow cylinder are to be made of a material which is capable of closing the hole produced by the passage of the projectile. One of the divided chambers of the hollow cylinder is to be completely filled with rubber sponge, viscous sponge, or other similar porous material.

UNITED STATES PATENT OFFICE

2,448,382
 SILENCER

Warren P. Mason, West Orange, N. J., assignor
 to Bell Telephone Laboratories, Incorporated,
 New York, N. Y., a corporation of New York

Application October 26, 1944, Serial No. 569,456

2 Claims. (Cl. 89-14)

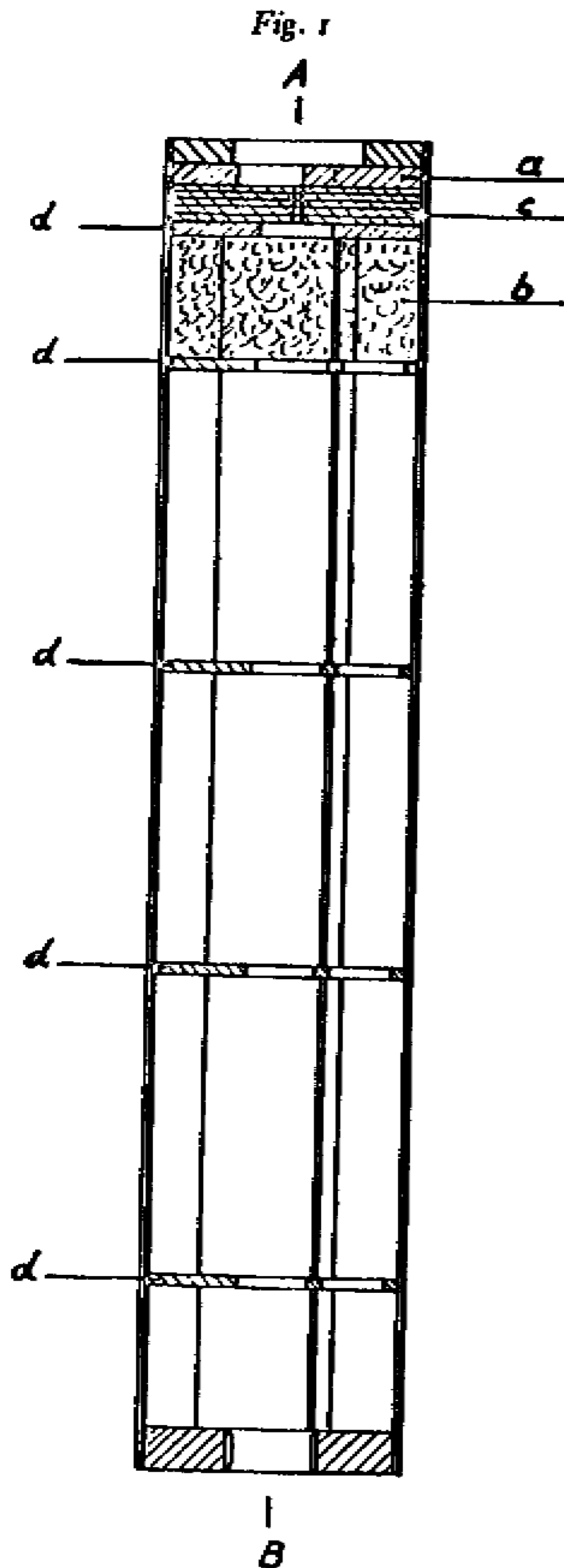

Fig. 2
 Ansicht von A

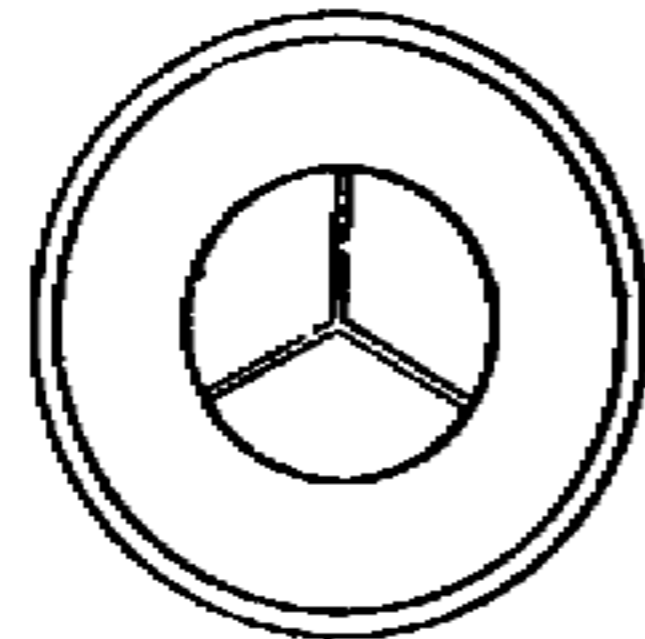
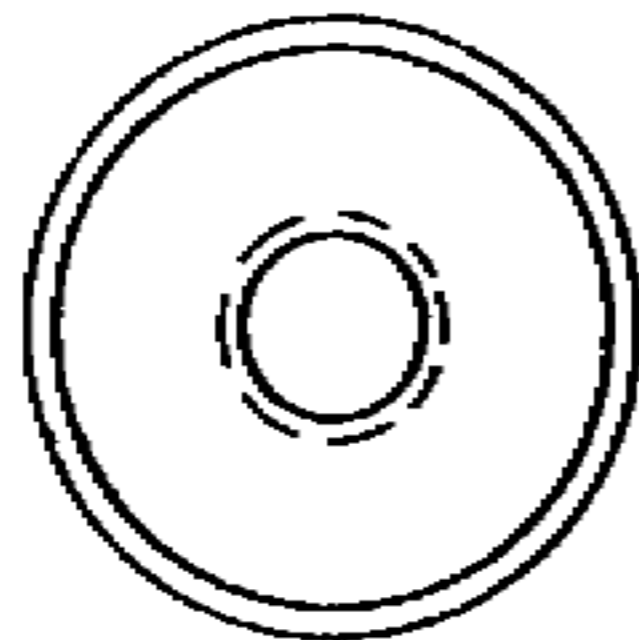

Fig. 3



Ansicht von B

Flexible Baffles and Sponge Rubber at the Silencer Exit
 German Patent No. 629404

This invention relates to firearms and more particularly to a silencer for reducing the muzzle blast.

The principal object of the invention is to reduce the noise associated with the muzzle blast of a firearm. Other objects are to reduce the weight, size and cost of a silencer and improve the stability of performance.

Important factors in silencing the muzzle blast of a firearm are the rapid cooling of the power gases and the reduction of pressure before they emerge. An effective silencer utilizing these principles comprises a chamber containing heat absorbing material through which the bullet passes. The effectiveness of such a device depends, among other things, upon its cross-sectional area. Applicant has discovered, however, that the importance of having a large cross-sectional area diminishes considerably toward the front end of the silencer.

In accordance with the invention, therefore, the chamber has at its front end a section of reduced cross-sectional area. Weight, size and cost are reduced without seriously affecting the efficiency of noise reduction. The silencer may be built as an attachment or, preferably, the rear portion of the chamber may be built around the barrel of the firearm, with communicating holes through the barrel. The heat absorbing material may be metal screen, which may take the form of apertured discs, stacked one upon another and preferably held in compression. Plating the screen with some metal such as tin before punching the discs will increase the stability of performance.

The nature of the invention will be more fully understood from the following detailed description and by reference to the accompanying drawings, in which like reference characters refer to similar or corresponding parts and in which:

Fig. 1 is a side view, partly in section, of a silencer in accordance with the invention attached to a firearm;

Figs. 2 and 3 are cross-sectional views, to larger scale, of the silencer of Fig. 1 taken along the lines 1-1 and 2-2, respectively;

Fig. 4 is a side view, partly in section, of a modified form of the silencer of Fig. 1 in which the rear portion of the chamber is built around the barrel; and

Fig. 5 is a cross-sectional view, to larger scale, of the silencer of Fig. 4 taken along the line 5-5.

Fig. 1 shows one form of the silencer 10 attached to the end of the barrel 11 of a firearm 12. The silencer 10 comprises a cylindrical

chamber having a rear section 12 and a front section 21, both containing heat absorbing material through which the bullet passes with minimum clearance. The side walls of the rear section 12 are formed by the metal tube 14 which is securely fastened at the rear to the apertured end piece 16 and at the front end is internally threaded to receive the apertured connector 17. The heat absorbing material in the section 12 is in the form of a number of annular discs 15 of metal screen stacked one upon another and held in compression by the connector 17. The end piece 16 includes as an integral part thereof an internally threaded collar 19 which screws onto the threaded muzzle of the barrel 11 to hold the silencer 10 securely in position.

The front section 21 comprises a metal tube 22 securely attached at its rear to the connector 17, threaded at its front end to receive the annular end piece 23, and filled with annular discs 24 of metal screen. A forward sight 26 is provided at the front end of the silencer 10. In order to save drawing space parts of the sections 12 and 21 have been removed. Figs. 2 and 3 are cross-sectional views.

The effectiveness of the silencer 10 depends upon its length and cross-sectional area. However, applicant has found that the cross-sectional area may be reduced at the front end of the silencer without a proportional reduction in its ability to silence the muzzle blast. This is due to the fact that the powder gases have already been considerably lowered in temperature and pressure before they reach the front portion of the silencer and so it takes a smaller cross-sectional area to cool them a given additional amount. Therefore, in accordance with the invention, the front section 21 has a smaller cross-sectional area than the section 12. Furthermore, the original efficiency may be restored by a comparatively slight addition to the length of the silencer 10. There results, however, a considerable reduction in weight and volume. This reduces the cost of the silencer and, more importantly, improves the balance of the firearm.

Figs. 4 and 5 show a modified form of the silencer 10 in which the rear section 12 is built around the barrel 11 of the firearm 12. The side walls of the section 12 are formed by the metal tube 14 which is closed at the rear by an end piece 16 securely fastened to the barrel 11 and at its front end by an apertured and flanged metal disc 17. The section 12 is substantially filled with heat absorbing material in the form of layers of metal screen 15 wrapped around the

3

barrel 11. To permit the powder gases to enter the section 27 there are provided a number of holes 28 through the wall of the barrel 11. These may, for example, be drilled and, as shown, are arranged in four rows spaced 90 degrees apart. The distance of the first hole 28 from the breach of the firearm 12 largely determines the muzzle velocity of the bullet, assuming a given weight of bullet and a given powder charge. It has been found that, in order to save weight, the outer diameter of the standard barrel may be turned down somewhat without unduly weakening it. As shown, the section 27 may be eccentrically mounted, with the larger part under the barrel 11, so that it may be of larger diameter without interfering with the line of sight.

The front section 24 comprises a metal tube 25 internally threaded at its rear to screw onto the threaded end of the barrel 11, internally threaded at its front end to receive the annular end piece 22, and filled with annular discs 23 of metal screen.

The screen is preferably plated with some metal such, for example, as tin before the discs 18 and 24 are punched. It has been found that this will largely overcome the tendency of the discs to develop loose wire ends which might accidentally come into contact with the bullet as it passes through them and adversely affect the dispersion pattern. The holes in the discs 18 and 24 are preferably made only large enough to insure clearance for the bullet.

What is claimed is:

4

1. A silencer for firearms comprising a chamber and a plurality of annular discs of metal screen positioned within said chamber transversely with respect to the longitudinal axis thereof, said discs being stacked one upon another under compression and substantially filling said chamber except for a passageway therethrough providing only minimum clearance for a bullet.

2. A silencer in accordance with claim 1 in which said discs are plated with tin.

WARREN P. MASON.

REFERENCES CITED

The following references are of record in the file of this patent:

UNITED STATES PATENTS

Number	Name	Date
227,341	Zellner	May 4, 1880
1,000,702	Thurier	Aug. 15, 1911
1,127,250	Humm	Feb. 2, 1915
1,173,887	Thompson	Feb. 29, 1916
1,229,675	Thompson	June 12, 1917
1,331,474	Master	Feb. 17, 1920
1,482,805	Maxim	Feb. 5, 1924
1,497,553	Dickman	June 10, 1924
1,687,308	Paradise	Oct. 9, 1928
1,838,645	Voigt	Dec. 29, 1931
2,043,731	Bourne	June 9, 1936

FOREIGN PATENTS

Number	Country	Date
685,167	Germany	Sept. 22, 1938

Aug. 31, 1948.

W. P. MASON

2,448,382

SILENCER

Filed Oct. 26, 1944

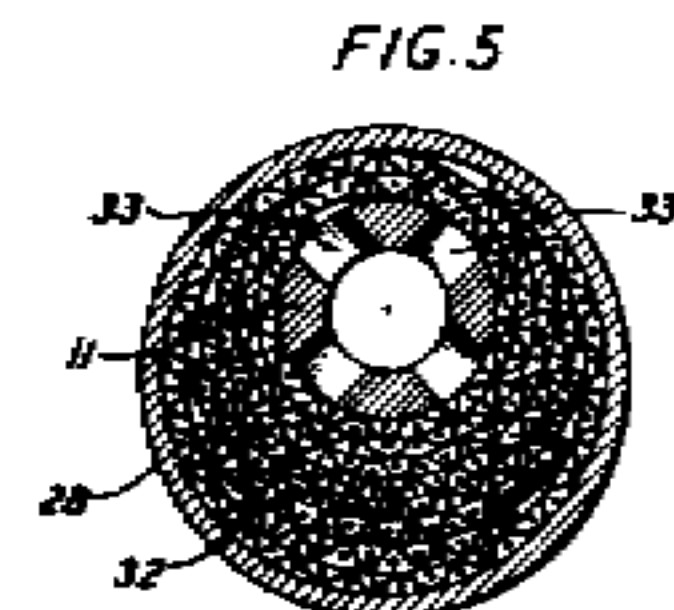
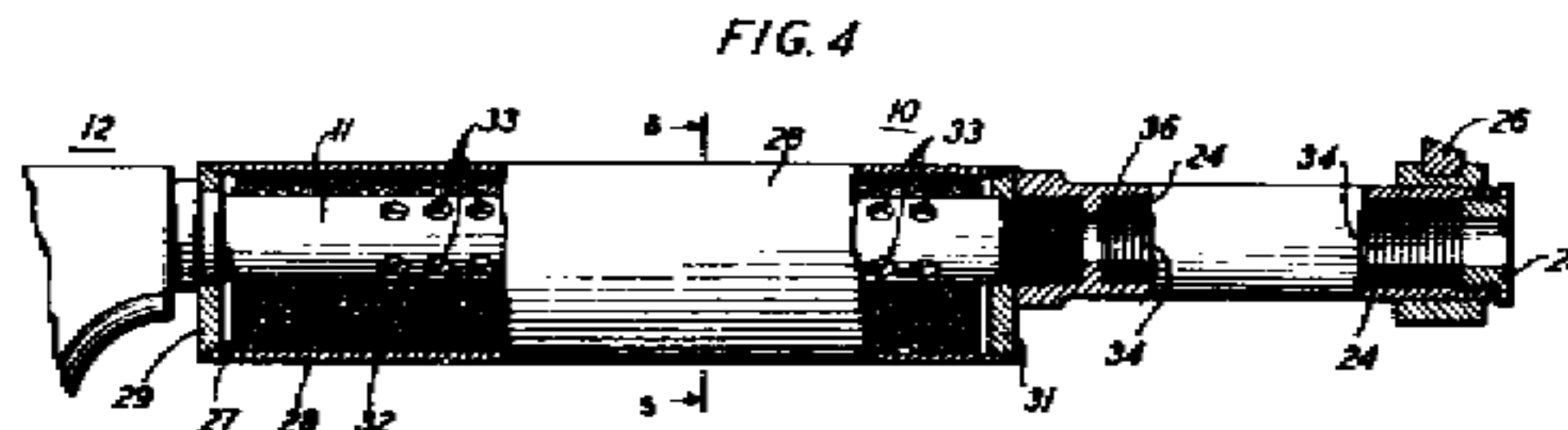
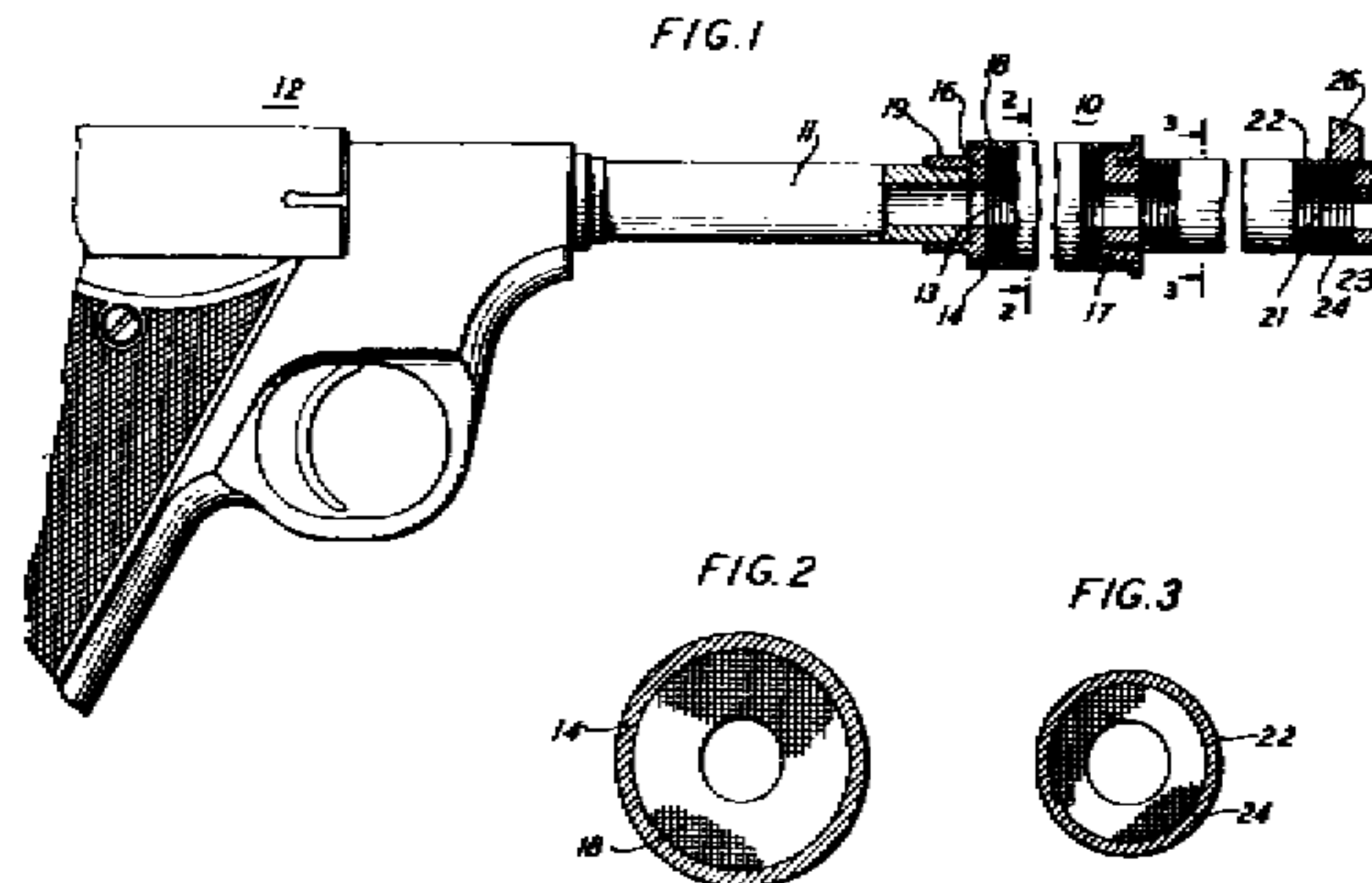

INVENTOR
W. P. MASON

BY
Ralph J. Holcomb
ATTORNEY

1

3,138,991

FIREARM MUZZLE ATTACHMENT AND PROJECTILE WITH EXPANSIBLE, DETACHABLE HUSK
 Richard L. Malter, 241 Ocean Parkway, New York, N.Y.
 Filed Jan. 10, 1962, Ser. No. 165,334
 1 Claim. (Cl. 89-14)

This invention is for a novel combination generally characterized as a firing piece, as for example, a rifle, which is particularly adapted to the firing of a husk bullet and husk shot.

Another object of the invention involves novel methods of projecting such bullets with a view to increasing the range, accuracy and recoil reduction of the firing piece.

As is well understood in the art of firearms, the inertia of the bullet or projectile at the moment of firing sets up enormous stresses in the bullet or projectile which cause it to try to move off to one side or the other of the axis of the bore of the weapon and to turn so as to cause it to wobble or yaw as it moves down the bore and issues from it.

Since the conventional bullet is made relatively soft and ductile so that it will properly engage the rifling of the barrel of the firing piece, these enormous stresses also cause it to become deformed and imbalanced. Upon its exit from the bore of the firing piece the bullet retains these distortions or wobbling and cocked conditions, causing a resultant undesirable inaccuracy at range.

These various undesired conditions and effects are increased the shorter the bearing surface of the projectile in relation to its overall length.

An important object of this invention is to provide either a permanent or removable attachment for the barrel muzzle of a rifle, for example, which guides the bullet back onto the axis of the rifle bore after its exit therefrom and separation from its husk.

Additional objects include reduced weight of husk due to reduced length; increased ductility of husk due to decreased bulk; reduced bearing surface of the bullet proper in relation to its overall length due to the virtual elimination of acceleration at the muzzle; and increased variability of attachment due to displaceable guide nose pieces.

A further object is to provide such an attachment which in combination with a husk bullet will greatly reduce the recoil of the gun.

Still another object of the invention is to provide such an attachment which in combination with a husk bullet will serve to protect the projectile proper from the disturbances normally caused by the trailing cloud of gases at the time of the issuance of the bullet proper from the gun and its attachment.

A further object of this invention is to provide such an attachment which permits of the use of husk bullets having a relatively shorter bearing surface of the husk, in relation to their overall length while avoiding the inaccuracies resulting from imbalance, wobbling and cocking of the bullet proper generated during its period of acceleration.

Other objects of this invention include novel methods of accelerating and projecting bullets under conditions of extreme accuracy.

Still another object is to provide novel methods of obtaining maximum recoil neutralization.

Other and more detailed objects of the invention will be apparent from the following description of the embodiment of the invention illustrated in the accompanying drawings.

In the drawings,

FIGURE 1 is a vertical, central, cross-sectional view through a portion of a husk bullet cartridge positioned in

2

the firing chamber of a rifle to which the anti-recoil and guiding attachment of this invention has been applied.

FIGURE 2 is a similar view of the muzzle end of the barrel showing the husk bullet about to emerge from it;

FIGURE 3 is a similar view showing successive stages of the firing and illustrating the separation of the bullet proper from the husk; and

FIGURE 4 is a similar view showing a still later stage in the operation of the device, namely just after the bullet proper has issued from the attachment but with the husk still in the attachment and momentarily trapping the gases behind it.

The subject matter of this invention has its prime utility in connection with the firing of husk bullets. Such a bullet is illustrated in one form in the drawings attached hereto.

As illustrated in FIG. 1, the barrel 10 of a rifle, for example, is provided with a suitably rifled bore 12, which communicates with the firing chamber.

The husk bullet consists of a short cylindrical soft metal cup 26 which is secured around the trailing edge of the projectile proper 28. This projectile will be made of any of the materials usually available for this purpose, and can, of course, include pellet shot such as used in shot guns. The cup 26 can be made in various forms, but as illustrated, is of cylindrical form and longitudinally split on opposite sides from its open end to and adjacent its closed end, as is clear from FIG. 3. This cup is crimped, cemented, or otherwise attached to the projectile proper so as to form a unitary assembly prior to firing.

As is clear from FIG. 2, the external diameter of the cup is properly adjusted to the bore of the rifle to form the usual fit while the projectile proper 28 is of lesser diameter and can have different forms, as for example a long point or a short point, as illustrated. The length of the cup 26, as will appear later, can be considerably shorter than would be required in the normal case to prevent wobble, turning, yawing, and the like. The shell proper 28, see FIG. 1, is of course provided with the usual explosive contents and firing cap, not shown.

In the form illustrated the terminal end 14 of the barrel 10 is shown of reduced external diameter and provided with external threads by means of which the sleeve 16 of the recoil and guiding attachment is secured thereto by complementary internal threads. In turn, the end of the sleeve 16 is internally threaded to receive a core or nose piece 18 by means of complementary threads, as shown. The core 18 is provided with a cylindrical passage, the axis of which lies on the axis of the bore of the barrel. This passage consists of a truncated conical section 20 and a concentric cylindrical guide bore section 22. The diameter of the guide bore section 22 is less than the diameter of the bore of the barrel and is preferably related in its diameter to the diameter of the projectile 28 so as to provide a light press fit therewith. The diameter of the entrance end of the conical portion 20 is equal to the internal diameter of the sleeve 16, so as to form a simple transition point therewith for a purpose to be explained later. The cylindrical guide bore section 22 of the nose piece preferably has a length about equal to the length of the bearing surface of the bullet proper 28.

The sleeve 16 is provided with a series of radial passages 24 which provide escape ports for the explosive gases. These passages may be of various forms such as cylindrical apertures, slots, and the like, and they may be distributed in various patterns circumferentially around the sleeve 16. These ports 24 correspond to the similar type of ports now widely used in various forms of gun chokes, recoil eliminators, muzzle brakes and the like, and, of course, as is sometimes done, they may be made adjustable in the discharge area.

3

When a firing piece in accordance with this invention is fired the explosive in the cartridge casing is activated in the usual manner, generating tremendous gas pressure behind the husk 26 containing the projectile 28. The husk bullet is therefore rapidly accelerated down the barrel 10 in the usual manner and moves into the casing formed by the sleeve 16 and the core 18 to a condition illustrated in FIG. 3. As soon as the husk bullet is released from the discharge end of the barrel 10, the husk 26 opens up under the forces attendant at high velocity, separates substantially from the projectile 28, and slides along the interior surface of the passage in the sleeve 16 until it engages the entrance end of the conical portion 20, as illustrated in FIG. 3. This causes the husk to be relatively decelerated with respect to the projectile 28, so that the projectile progresses onwardly as an independent piece into the passage 22. This passage being accurately positioned on the axis of the barrel and having a light press fit with the projectile 28 steadies it, taking away from it any wobbling or off course movement that it may have.

At the same time the decelerated husk 26 blocks the movement of the explosive gases issuing from the barrel behind it sufficiently to increase their pressure. These gases therefore tend to discharge through the ports 24 at an increased velocity which discharge continues and is aided when the condition illustrated in FIG. 4 is reached where the husk has been forced into the guide bore 22 and further tends to block the escape of the gases except through the ports 24. It will be apparent, therefore, that the minimum of recoil afforded by this device is enhanced by the momentary forward deceleration of the rapidly moving explosive gases and their resultant increased velocity discharge laterally through the ports 24.

Going back it will be seen that as the expanded husk 26 reaches the tapered passage 20 it will be gradually contracted or closed back to its original condition. In addition it will be compressed as the force of the gases drives it through the guide bore passage 22. The husk being hollow and of soft, deformable, ductile material such as copper, for example, can be squeezed or contracted sufficiently so that it will be forced through the guide bore passage 22 and ejected behind the projectile 28. During the period of compression and ejection of the husk the explosive gases will be relatively impeded in their forward motion, thereby increasing their tendency, as previously explained, to being ejected at even higher velocities through the ports 24.

4

FIG. 4 illustrates another advantage of utilitarian feature of the subject matter of this invention; as is well known in this art the explosive gases which surround the trailing edge of the projectile at the moment of issue from the barrel tend to engulf and disturb the flight of the projectile and to that extent reduce the accuracy of flight. As illustrated in FIG. 4, the trapping of the explosive gases within the attachment by the husk 26, although momentary, is sufficient to permit the projectile 28 to get well started on its flight before the husk is emitted and the gases begin to escape. The result is that little if any disturbance of the flight of the projectile results from these gases.

In view of the above description of one embodiment of this invention illustrating the principles thereof, it will be apparent to those skilled in the art that many of the structural details herein disclosed can be varied without departing from the novel subject matter of this invention. It is preferred, therefore, that the scope of protection afforded hereby be determined by the claim as the selected embodiment is provided for illustrative purposes only.

What is claimed is:

A firearm comprising in combination a projectile, an expansible, detachable husk secured to said projectile, said husk being cup shaped and having an end wall and a plurality of integral, separable, curved wall portions, a gun barrel having a projectile bore, and a projectile stabilizing means at the exit end of said barrel having an apertured husk and gas confining cylindrical wall forming a chamber with an internal diameter greater than that of said bore, said means having a projectile guiding exit passage having a diameter less than that of said bore and providing a light press fit for said projectile and a compression fit for said husk, said means also having a conical passage converging into said exit passage and acting to contract said husk for movement through said passage, said husk being detached in and expanded into contact with the wall of said chamber and being contracted and delayed by said conical passage for trailing movement through said exit passage behind said projectile.

References Cited in the file of this patent

UNITED STATES PATENTS

868,938	Puff	Oct. 22, 1907
2,112,831	Cuts	Apr. 5, 1938
2,115,028	Logan	Apr. 26, 1938
2,315,207	Janecek et al.	Mar. 30, 1943
2,842,024	Mutter	July 8, 1958

RELATIVE LOUDNESS OF DISCREET SOUND PULSES

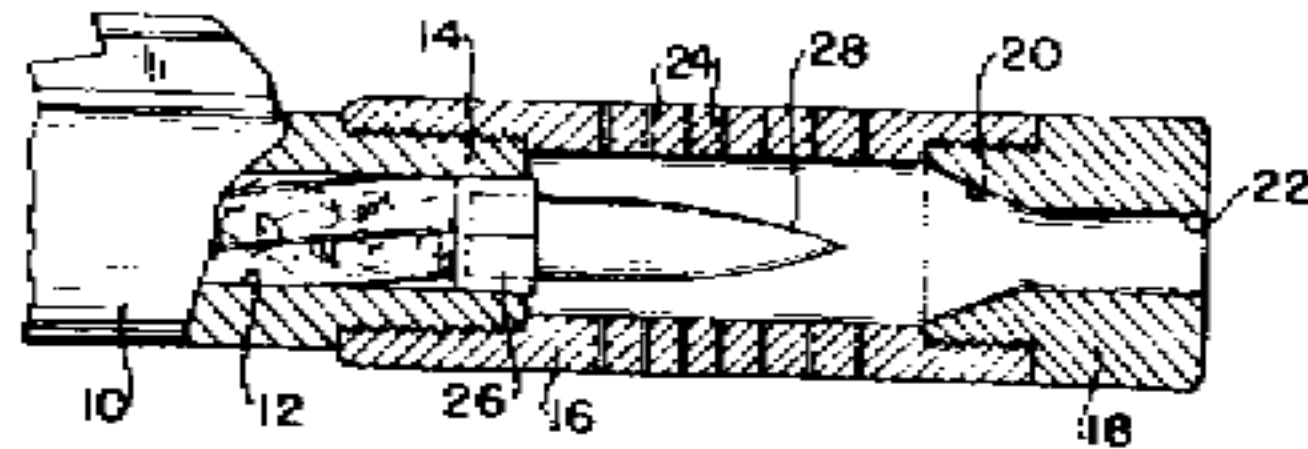

FIG. 2

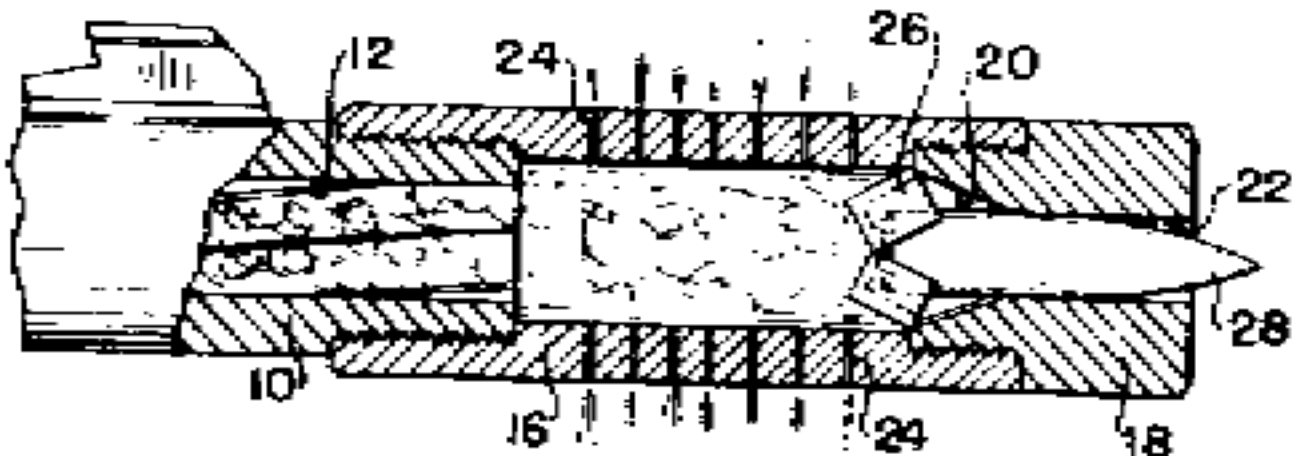

FIG. 3

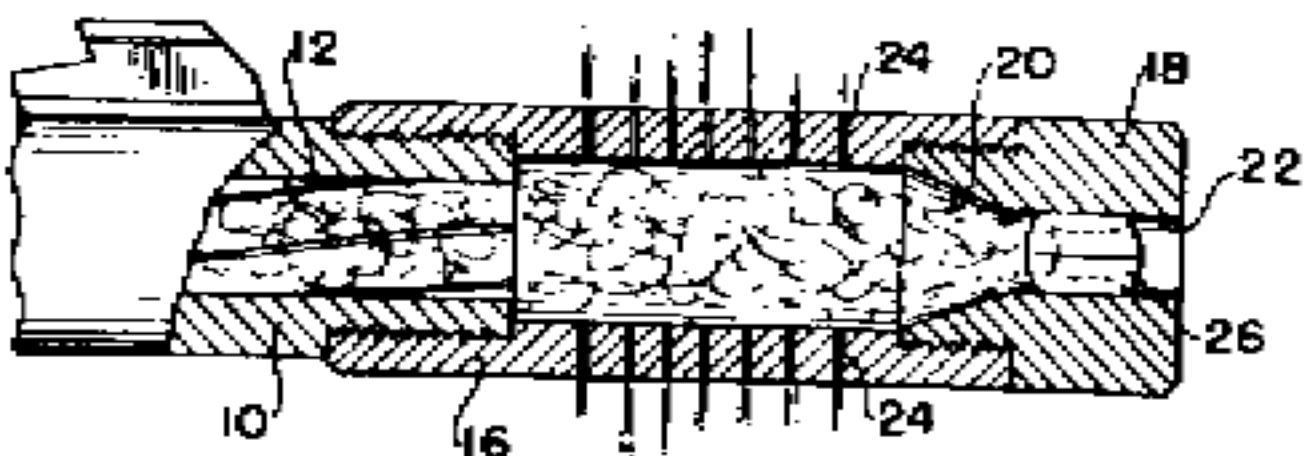

FIG. 4

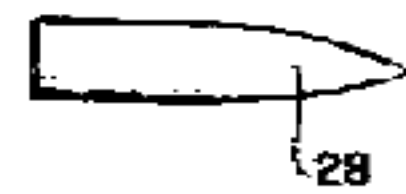
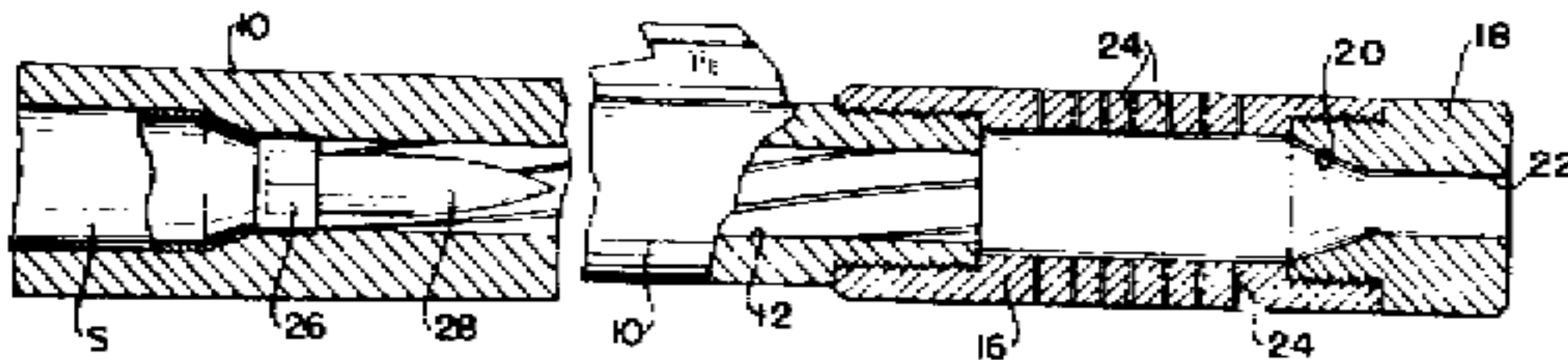

FIG. 1



Presently there exists no analytical criterion for estimating loudness of a transient sound signal from its pressure-time history. The usual means of measuring and specifying such signals is by their peak SPL's. Since loudness of a discreet sound signal is also time dependent, it is important to re-examine the qualitative significance of this dependence. The most reliable and revealing data are to be found in the commonly used equal-loudness-level contours for continuous pure tones.²⁶ The frequency range below approximately 200 cps is of little use here, since the single cycle time periods of these tone are well above that to be found in small arms sound signatures. Within the frequency range from 200 to 8000 cps, the loudness level (phons) of a pure tone of given SPL is approximately independent of frequency. Above this range the loudness level decreases, to a first approximation, directly with frequency. All attempts to exemplify the human ear by a damped spring-mass system seem to fail in explaining the above frequency-loudness relationship. However, through inductive reasoning, the whole loudness level spectrum as described above can be represented by:

$$200 < f < 8000,$$

$$LL \approx 20 \log \frac{P_m}{.0002}, \text{ phons} \quad (1)$$

and

$$f > 8000,$$

$$LL \approx 20 \log \frac{P_m}{.0002} - 30 \left(\frac{f - 8000}{8000} \right), \text{ phons} \quad (2)$$

where

LL = loudness level in phons;

P_m = peak sound pressure;

f = pure tone frequency, cps.

The pressure-time area ($\int p dt$) of the positive half-cycle of a sinusoidal tone is

INVENTOR
 RICHARD L. MALTER
 BY *Darby & Darby*
 ATTORNEYS

$$A = \frac{P_m}{\pi f} = \frac{2P_m(T/2)}{\pi} \quad (3)$$

where

$$T/2 = 1/2f, \text{ half-cycle time duration.}$$

Thus, the loudness levels can be defined in terms of the recurrent character of the pure tone i. e. ,

$$\begin{aligned} 200 < f < 8000, & \quad LL \approx 20 \log \frac{P_m}{.0002} \\ f > 8000, & \quad LL \approx 20 \log \frac{P_m}{.0002} - 30 \left(\frac{A_{8000} - A}{A_{8000}} \right) \end{aligned} \quad (4)$$

Or, in terms of the positive half-cycle time durations,

$$\begin{aligned} 200 < f < 8000, & \quad LL \approx 20 \log \frac{P_m}{.0002} \\ f > 8000, & \quad LL \approx 20 \log \frac{P_m}{.0002} - \left[\frac{(T/2)_{8000} - (T/2)}{(T/2)_{8000}} \right] \end{aligned} \quad (5)$$

where

$$(T/2)_{8000} = 1/2(8000) = .063 \text{ms.}$$

The last equations indicate that:

1. Up to approximately 8000 cps, the tone loudness level is essentially equal to peak SPL.
2. Above approximately 8000 cps, the tone loudness decreases almost proportionately to the tone's half-cycle time duration.

If the same conclusions are applied to the singular sound pulses, their loudness levels can be expressed by:

$$\begin{aligned} .063 \text{ ms} < t < 2.5 \text{ ms}, & \quad LL \approx 20 \log \frac{P_m}{.0002} \\ t < .063 \text{ ms}, & \quad LL \approx 20 \log \frac{P_m}{.0002} - 30 \left(\frac{.063 - t}{.063} \right) \end{aligned} \quad (6)$$

where

t = time duration of the sound pulse in ms.

This suggests that the loudness level of a sound pulse longer in time duration than approximately 0.063 millisecond is numerically equivalent to the peak SPL. The loudness level of a sound pulse shorter in time duration than 0.063 millisecond decreases approximately as its time duration. This is partially borne out by the records of silencers fired at Frankford Arsenal and partially by the widespread tendency to specify transient sounds by their peak SPL. Although qualitatively significant, to date the above equations are based only on a somewhat boldly assumed analogy between transient and continuous sounds.

It is interesting to note that the "loudness level" (phons) is not representative of how loud a signal sounds. In other words, the loudness of a signal does not double with doubling of number of phons. The true loudness is represented by sones, which are related to phons by

$$L = 10^{.033(LL - 40)} \quad (7)$$

where

L = loudness in sones.

From previous analysis, if the sound pulses to be dealt with are longer than 0.063 millisecond, the loudness in sones can be represented by,

$$L = 10^{.033[(SPL)_{\max} - 40]} \quad (8)$$

which is dependent only on the peak sound pressure level. A plot of loudness (L) vs peak SPL follows. Here may be seen the true relationship between peak SPL and how loud the signal actually sounds. As an example, a signal of 102 db peak SPL sounds twice as loud as a signal of 90 db, since the latter is half the number of sones of the former.

BIBLIOGRAPHY

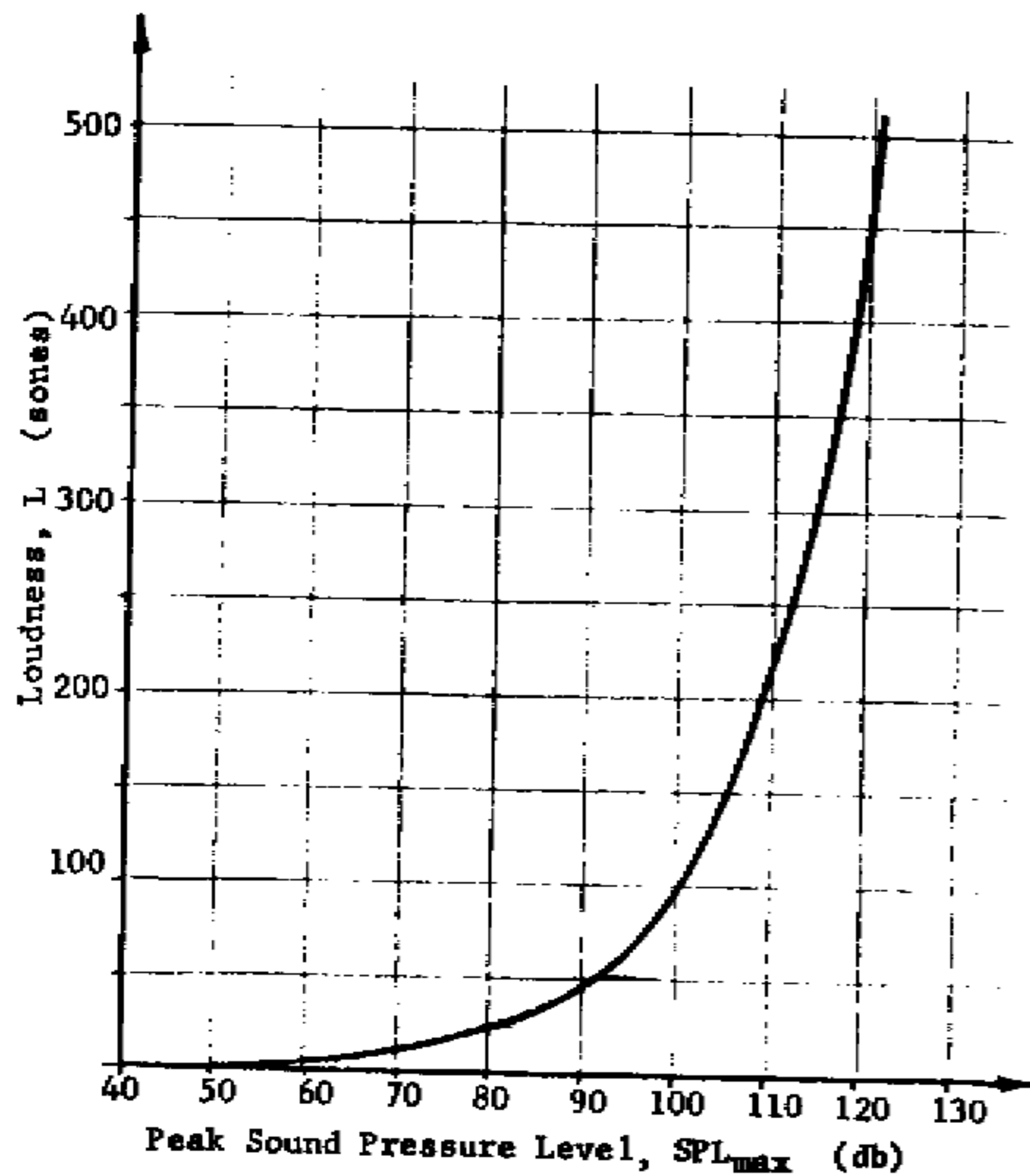

1. Allen, W. G. B., Pistols, Rifles & Machine Guns; London: English University Press, Ltd.; pp 170-172, 1953.
2. Bannister, F., et al: "Wave Action Following Sudden Release of Compressed Gas from a Cylinder;" Proc Inst Mech Engrs, Vol 159, War Emergency Issue No. 42, (1948).
3. Bauer, R., et al, "Auditory Localization of Noises;" Aberdeen Proving Ground, HEL Technical Memorandum 4-65, July 1963.
4. Bertrand, B., et al, "Overpressures and Durations of Shock Waves Emerging from Open Ended Shock Tubes;" Aberdeen Proving Ground, BRL Report MR-1724 (AD 633 161), November 1965.
5. Bixler, O. C., et al, "Analytical & Experimental Studies of Weapon Muffling;" Ling-Temco-Vought, Inc., Final Report (Contract DAA FO5-67-C-0048), August 1967.
6. Campbell C., The '03 Springfield; Beverly Hills, Calif: Fadco Publishing Co.; pp 41-43, 1957.
7. Chaillet, R., et al: "High-Intensity Impulse Noise: A Major Problem;" Aberdeen Proving Ground, HEL Technical Note 4-64 (AD 450 726), August 1964.
8. Corner, J., Theory of Interior Ballistics of Guns; New York: Wiley & Sons, Inc.; pp 395-400, 1950.
9. Crossman, E. B., "Silencer for SMG, Cal. .45; Flash Hider for SMG, Cal. .45," Test Section, The Infantry Board, Record of Test (AD 472 094), 29 September 1945.
10. DoD IIR 2836023764, "Small Caliber Weapons Silencing Devices," July 1964.
11. Davis, D., et al, "Theoretical and Experimental Investigations of Mufflers, with Comments on Engine Exhaust Muffler Design;" NACA Report No. 1192, 1954.

12. Doelling, N., et al, "Characteristics of Noise Produced by Several Contemporary Army Weapons;" Bolt, Beranel & Newman, Inc. (Contract DA-49-007-MD-885, March 1959.
13. Dumond, J., et al, "A Determination of the Wave Forms and Laws of Propagation and Dissipation of Ballistic Shock Waves;" JASA, Vol 18, No. 1, July 1946.
14. Dunham J., "Development of Cartridge, Caliber .30 XM76" (U); Frankford Arsenal Report R-1794, March 1966. (Confidential)
15. Fulton, C., "Silent Weapon System Cartridge Design and Development Phase I: Design" Frankford Arsenal Report R-1654, November 1962. (Confidential)
16. Fulton, C., "Small Arms Silencers," DDC Demand Bibliography, ARBO32041, 16 March 1965.
17. Garinther, G., et al, "Auditory and Acoustical Evaluation of Several Shoulder Rifles;" Aberdeen Proving Ground, HEL Technical Note 1-65, January 1965.
18. Garinther, G., "Transducer Techniques for Measuring the Effects of Small Arms Noise on Hearing;" Aberdeen Proving Ground, HEL Technical Note 11-65, July 1965.
19. Glass, I., "Aerodynamics of Blasts;" Institute of Aerophysics, University of Toronto, UTIA Review No. 17 (AD 247 445), September 1960.
20. Gustafson, G. A., "Tests of Silencer for .45 Caliber M3 and M1928A1 Submachine Guns;" Aberdeen Proving Ground, Firing Record, 12 March 1944.
21. Hammer, E. W., "Muzzle Brakes: I - History; II - Theory;" Franklin Institute (Contracts W-36-034-ORD-7652, -7705), June 1949.
22. Harrison, E. H., "NRA Firearms & Ammunition Fact Book - Silencers;" National Rifle Association, Washington, D. C., 1964.
23. Heising, R. A., and W. P. Mason, "An Investigation on Silencers for Small Arms;" Bell Telephone Laboratories, Inc., Final Report (Contract OEMsr-906 SAC-14); Part I, December 1943 and Part II, May 1944.
24. Hughes, F. K., "Demolition Devices and Accessories: Silencer for Submachine Gun, Cal. .45, M3A1;" Psychological Warfare Center, Fort Bragg, Interim Test and Evaluation Report No. 1 on Project No. 11006 (AD-57 237), September 1954.
25. Hughes, F.K., "Test & Evaluation of OSS Silencer for Sub-machine Gun, Caliber .45, M3 and M3A1;" Psychological Warfare Center, Fort Bragg, Interim Report No. 2, Project No. 11006 (AD 68 828), June 1955.
26. Kinsler, L. E., and A. R. Frey, Fundamentals of Acoustics; New York: Wiley & Sons; 1962.
27. Lamb, H., Hydrodynamics; New York: Dover Publications, Inc.; 1945.
28. Levin, S., "Concept and Feasibility Studies of Muzzle Brake Blast Suppression Devices for 105 mm and 155 mm Howitzers;" Ordnance Engineering Associates, Inc. (AD 601 728), February 1964.
29. Liepman, H. W., and A. Roshko, Elements of Gas Dynamics; New York: Wiley & Sons; 1957.
30. Lighthill, F.R.S., "On Sound Generated Aerodynamically;" "I - General Theory," Proc Roy Soc, A, 211, p 564 (1952); "II - Turbulence as a Source of Sound," Proc Roy Soc, A, 222, p 1 (1954).
31. McLean, D., "Firearm Silencers, Vol I - U.S.;" Normount Armament Co., Forest Grove, Oregon, 1968.
32. Moore, L.F., "A Test of Silencer, Caliber .22, T2;" Aberdeen Proving Ground, Second Report on Project No. TS2-2026, February 1952.
33. Moore, L., "Feasibility Test of a Silenced Shotgun;" Aberdeen Proving Ground, Report DPS-1330 (AD 350 280), May 1964.
34. Morse, P.M., Vibration and Sound; New York: McGraw-Hill Book Co., Inc.; p 312, 1948.

35. Nelson, Thomas B., The World's Submachine Guns; Cologne, Germany; International Small Arms Publishers; pp 10, 11, 44, 54, 98, 99, 498, 499, 500; 1963.
36. Office, Chief of Ordnance; Annual Reports; 1909-1912.
37. Office, Chief of Ordnance; "Small Arms and Small Arms Ammunition;" Record of Army Ordnance Research & Development, Vol 2, Book 1, Sec 2, pp 135-137, January 1946.
38. Ostatitsch, K, "Intermediate Ballistics;" USAMC Translation, FSTC 381-T65-372, October 1965.
39. Petersen, H. L., Encyclopedia of Firearms; New York: E. P. Dutton & Co., Inc.; pp 299-303, 1966.
40. Pols, L. C. W., "Sound Measurement on Small Arms I;" Instituut voor Zintuigfysiologie Rve-Tao (AD 811 290), Netherland, 1966.
41. Prandl, L., and O. G. Tietjens, Hydro- and Aero-Mechanics; New York: Dover Publications, Inc.; 1957.
42. Rudiner, G., Wave Diagrams for Non-Steady Flow in Ducts; New York: D. VanNostrand, Inc.; 1955.
43. Salsbury, M., "Effects of a Muzzle Brake's Diameter and Length on Overpressure and Efficiency;" U.S. Army Weapons Command, Rock Island Arsenal, Technical Report 66-2920 (AD 803 417), October 1966.
44. Schlenker, G., "Theoretical Study of the Blast Field of Artillery with Muzzle Brakes;" Rock Island Arsenal, Report No. 62-4257 (AD 296 587), December 1962.
45. Schlenker, G., "Contribution to the Analysis of Muzzle Brake Design;" Rock Island Arsenal, Report No. 62-1794 (AD 276 154) May 1962.
46. Skochko, L., "Sound Analysis of Ballistic Shock Waves" (U); Frankford Arsenal, Report R-1798, January 1966. (Confidential)
47. Skochko, L., and H. Greveris, "A Source of Small Arm Muzzle Noise" (U); Frankford Arsenal Report R-1860, August 1967
(Confidential)
48. Smith, F., "Model Experiments on Muzzle Brakes;" Royal Armament Research & Development Establishment, RARDE Report 2/66 (AD 487 121), February 1966.
49. Sonier, A. J., "Evaluation of Gun, Submachine, 9 mm (Modified U.S. Caliber .45 SMG, M3A1), with Silencer Attachment, North Vietnam (Viet Cong)" (U); Springfield Armory, Report MR 8-1132, January 1965. (Confidential)
50. Sterett, L. S., "Silencers," Gun Digest, 18th ED., pp 135-138, (1964).
51. Watling, W., "Acoustical and Visual Attenuation Through Dynamic Regulation of Muzzle Gas Flow;" Springfield Armory, Report SA-TR3-1911 (AD 634 649), June 1966.

LIST OF PATENTS
Patents - United States

198

<u>No.</u>	<u>Date</u>	<u>Inventor</u>	<u>Title</u>
381 950	1 May 88	N. W. Pratt	Pneumatic Ordnance
618 901	7 Feb 99	L. Peterson	Gun Barrel
658 934	2 Oct 00	R. M. Washington, etc	Attachment for Barrels of Firearms
692 819	11 Feb 02	J. E. Bissell	Means of Effecting Noiseless Discharge of Guns
785 975	28 Mar 05	S. N. McClean	Means for Controlling Recoil and Muzzle Blast of Guns
786 230	28 Mar 05	S. N. McClean	Recoil Controlling Means for Guns
832 695	9 Oct 06	J. O. Nygaard	Attachment to Barrels of Firearms
855 439	4 Jun 07	J. Adrianson	Extensible Jacket for Revolvers
880 386	25 Feb 08	H. P. Maxim	Silent Firearm
916 885	30 Mar 09	H. P. Maxim	Silent Firearm
951 770	8 Mar 10	J. M. Miller	Silencer
953 943	5 Apr 10	B. B. Childress	Gun Muffler
955 694	10 Apr 10	G. P. Riggs	Gun Attachment
956 717	3 May 10	R. A. Moore	Silencer for Firearms
958 934	24 May 10	H. P. Maxim	Silent Firearm
958 935	24 May 10	H. P. Maxim	Silent Firearm
959 400	24 May 10	J. H. Stinson	Gun Muffler
971 083	27 Sep 10	A. C. Shipley	Muffler for Firearms
984 750	21 Feb 11	H. Craven	Gun Silencer
984 890	21 Feb 11	D. W. Duddebar	Noise Muffler for Exhaust Pipes
989 158	11 Apr 11	B. W. King	Combined Silencer and Bayonet
1 000 702	15 Aug 11	E. Thurler	Device for Suppression of the Report of Firearms
1 003 531	19 Sep 11	L. C. Smoot, etc	Engine Muffler

Patents - United States

199

<u>No.</u>	<u>Date</u>	<u>Inventor</u>	<u>Title</u>
1 006 595	25 Oct 11	C. Red	Muffler
1 017 003	13 Feb 12	C. H. Kenney	Silencer for Firearms
1 018 720	27 Feb 12	H. P. Maxim	Silencing Device for Firearms
1 021 742	26 Mar 12	R. A. Moore	Silencer for Firearms
1 054 434	25 Feb 13	H. P. Maxim	Firearm
1 111 202	22 Sep 14	W. E. Westfall	Silencer Construction for Firearms
1 127 250	2 Feb 15	H. Humm	Silencer
1 127 892	9 Feb 15	F. Hornquist	Muffler
1 130 609	2 Mar 15	S. T. Jones	Muffler for Shotguns
1 143 814	22 Jun 15	P. J. DeVries	Gun Muffler
1 171 242	8 Feb 16	A. T. Prather	Attaching Means for Gun Silencers
1 173 687	29 Feb 16	E. W. Thompson	Firearm
1 207 264	5 Dec 16	O. J. Bailey	Silencer for Firearms
1 229 675	12 Jun 17	E. W. Thompson	Gun Silencer and Recoil Reducer
1 259 251	12 Mar 18	B. Love	Firearm Attachment
1 289 750	31 Dec 18	F. J. Hauman	Muffler
1 331 474	17 Feb 20	S. D. Master	Gun
1 341 363	25 May 20	A. Fiala	Silencer and Flash Obscurer
1 342 978	8 Jun 20	F. W. Young	Flash & Recoil Reducer for Firearms
1 351 960	7 Sep 20	O. C. Moyers	Flash Eliminator
1 354 416	28 Sep 20	S. Oliver	Silencer Coupling
1 363 058	21 Dec 20	Schneider	
1 390 658	13 Sep 21	R. M. Towson	Recoil Neutralizer & Muffler
1 406 404	14 Feb 22	J. C. R. McCrudden	Machine Gun
1 427 802	5 Sep 22	B. A. Goodwin	Gun Silencer, Flash Cover & Recoil Check
1 462 158	17 Jul 23	F. Wildner	Silencer for Firearms
1 477 315	11 Dec 23	A. Combet	Exhaust Silencer

Patents - United States

200

<u>No.</u>	<u>Date</u>	<u>Inventor</u>	<u>Title</u>
1 482 805	5 Feb 24	H. P. Maxim	Silencer for Guns
1 487 214	18 Mar 24	R. L. Detendorf	Firearms & Ammunition Therefor
1 497 553	10 Jun 24	J. Dickman	Exhaust Silencer
1 525 846	10 Feb 25	L. E. Wurtzbach	Silencing Device for Firearms
1 554 051	15 Sep 25	O. Walker	Firearms
1 605 393	2 Nov 26	R. M. Cutts	Climb Arrester
1 605 864	2 Nov 26	R. Steinegger	Muzzle Attachment
1 636 357	19 Jul 27	Cutts	
1 667 186	24 Apr 28	W. R. Bluedorn	Muzzle Attachment for Guns
1 736 319	19 Nov 29	H. P. Maxim	Silencer
1 763 287	10 Jun 30	Z. Wilman	Damping Apparatus for Prevention of Noise, etc.
1 773 443	19 Aug 30	Z. Wilman	Silencer, etc.
1 874 326	30 Aug 32	W. P. Mason	Sound Muffler
1 939 700	19 Dec 33	C. F. Hopsetter	Muzzle Attachment for Guns
1 972 065	28 Aug 34	Q. G. Noblitt	Muffler
1 990 837	12 Feb 35	S. H. Morgenstern	Exhauster for Internal Combustion Engine
2 043 731	9 Jun 36	R. B. Bourne	Sound Attenuating Device
2 087 594	20 Jul 37	M. E. Evans	Projectile
2 101 849	14 Dec 37	S. G. Green	Muzzle Attachment for Guns
2 101 850	14 Dec 37	S. G. Green	Muzzle Attachment for Guns
2 112 831	5 Apr 38	R. M. Cutts	Compensation for Ordnance
2 128 936	6 Sep 38	S. G. Green	Muzzle Attachment for Guns
2 143 596	10 Jan 39	N. J. A. Galliot, etc.	Recoil Absorber for Firearms
2 150 161	14 Mar 39	S. G. Green	Muzzle Attachment for Guns
2 184 595	26 Dec 39	Hughes	
2 194 484	27 Feb 40	Hughes	

Patents - United States

201

<u>No.</u>	<u>Date</u>	<u>Inventor</u>	<u>Title</u>
2 191 648	27 Feb 40	N. J. A. Galliot, etc.	Recoil Absorber for Firearms
2 208 093	16 Jul 40	J. L. Brown	Gun Silencer & Scavenger
2 212 685	27 Aug 40	R. H. S. Hughes	Control Device for Control of Recoil
2 212 686	27 Aug 40	R. H. S. Hughes	
2 216 653	1 Oct 40	J. Sauer	Suction Muffler
2 223 014	26 Nov 40	N. J. A. Galliot, etc.	
2 233 804	4 Mar 41	R. B. Bourne	Fluid Silencer
2 241 768	13 May 41	F. E. Deremer	Silencer Construction
2 283 607	19 May 42	A. J. Ludwig	Muffler Device
2 348 114	2 May 44	A. M. Dow	Gun Stabilizer
2 351 037	13 Jun 44	S. G. Green	Stabilizer for Guns
2 375 617	8 May 45	R. B. Bourne	Gun Silencer
2 403 699	9 Jul 46	E. E. Wilson	Resonator Silencer
2 442 773	8 Jun 48	W. P. Mason	Sound Suppressor
2 448 382	31 Aug 48	W. P. Mason	Silencer
2 449 571	21 Sep 48	B. Walker	Silencer for Firearms
2 451 514	19 Oct 48	J. E. Sieg	Compensator for Guns
2 457 802	4 Jan 49	A. Bauer	Silencer & Recoil Reducer, etc.
2 501 306	21 Mar 50	P. E. Bessiere	Silencer with Flat Semicylindrical Expansion Chamber
2 503 491	11 Apr 50	R. Janz	Gun Silencer Including Side Branch Chamber
2 514 996	11 Jul 50	C. H. Faust	Flash Eliminator & Silencer for Firearms
2 625 235	13 Jan 53	C. P. Caulkins	Discharge Silencer & Recoil Compensator
2 868 078	13 Jan 59	W. J. Jarrett	Noise Reducer for Gun
3 134 330	26 May 64	B. Batou	Projectile
3 138 991	30 Jun 64	R. L. Malter	Firearm Muzzle Attachment & Projectile

Patents - France

<u>No.</u>	<u>Date</u>	<u>Inventor</u>	<u>Title</u>
12,850	26 Nov 10	M. R. A. Moore	Silencer
74,757	17 Sep 17	E. Berthoud	Silencer
401,168	20 Aug 09	M. H. S. Maxim	Silencer
492,535	25 Mar 19	E. Rossignol	Silencer
493,462	9 Aug 19	M. J. Barlowatz	Silencer
498,339	8 Jan 20	M. R. Brevpaire	Silencer
510,683	9 Dec 20	M. J. Brun	Silencer
634,990	3 Mar 28	M. L. Bielecki	Silencer
644,379	5 Aug 28	J. Duchenet	Silencer
647,561	26 Nov 28	M. F. Wilman	Silencer
684,938	2 Jul 30	M. J. Vergne	Silencer
737,125	7 Dec 32	A. G. I. R.	Silencer
786,143	27 Aug 35	Kagan, etc.	Silencer
786,895	11 Sep 35	E. G. Caron, etc.	Silencer
856,238	18 Mar 40	H. Liberia	Silencer
858,032	15 Nov 40	A. Chantreux	Silencer
864,735	3 May 41	E. Pister	Silencer
866,587	20 Aug 41	P. C. F. DuBois	Silencer
911,148	28 May 46	M. Marcel	Silencer
918,658	14 Feb 47	J. J. Stapelle	Silencer
981,733	30 May 51	H. A. J. Guarniery	Silencer
981,869	31 May 51	J. A. Mouret	Silencer
1,003,025	14 Nov 51	S. A. Silto	Silencer
1,021,270	26 Nov 52	L. Baer	Silencer
1,123,835	18 Jun 56	J. M. Lefebore	Silencer

202

Patents - Germany

<u>No.</u>	<u>Date</u>	<u>Inventor</u>	<u>Title</u>
8 453	5 Jun 28	C. A. Aeppeli	Silencer
144 415	3 Mar 01	R. Schultz	Silencer
150 359	20 Dec 02	H. Bandish	Silencer
172 498	21 Sep 05	F. Haussner	Silencer Attachment
191 758	2 Jun 19	A. M. Low	Improved Silencers for Guns
210 314	19 Apr 08	B. Gavriloff	Gun Silencer
212 126	14 Feb 08	E. K. Kloesz	Gun Silencer
214 226	3 Nov 08	W. Kristandt	Gun Silencer & Muffler
215 488	16 Apr 08	P. Schader	Gun Silencer
231 957	4 Sep 09	P. Klan	Gun Muffler
241 846	11 Jul 09	C. Billerbeck	Silencer
298 935	19 Jan 15	P. Schauer	Silencer
301 229	30 May 16	F. Stendenbach	Silencer for Small Arms
303 306	2 Jun 17	B. Hass	Muffler
314 192	4 Aug 17	O. Hoffmann	Gun Muffler
314 842	29 Nov 17	K. W. Hess, etc	Silencer
316 274	25 Oct 18	K. Schenkl	Muffler
317 577	9 Jan 17	G. Nothiger, etc.	Muffler for Pistol
351 625	1 Dec 17	W. Altendorf	Muffler
629 404	9 Apr 36	H. Eissfeldt	Muffler
665 167	4 Mar 36	Sewais Silencers, Ltd.	Absorbtion Material
695 929	28 Feb 39	K. Rehor	Silencer
732 487	20 Apr 38	W. Klaus, etc.	Silencer & Muffler

203

Patents - England

<u>No.</u>	<u>Date</u>	<u>Inventor</u>	<u>Title</u>
104 199	21 Feb 17	E. W. Thompson	Gun Silencer
125 148	17 Apr 19	D. Samia	Improvements in or Relating to Mortars and Like Firearms
166 851	28 Jul 21	J. Taliaferro	Improvements in Small Arms & Machine Guns
308 572	1 May 30	Col I. Worobjeff, D. S. O.	Improvements in or Relating to Silencers in Firearms
498 775	13 Jan 39	F. G. Barnes	Improvement in & Connected with Attachment to Firearms
581 974	31 Oct 46	W. A. Kulikowski, etc.	Improvements in & Relating to silencing of Firearms

204

Patents - Norway

20 302	3 Dec 08	H. P. Maxim	Silencer
47 405	30 Apr 28	Bror Witt	Silencer

Patents - Denmark

35 748	15 Mar 26	F. S. Anderson	Silencer
--------	-----------	----------------	----------

Patents - Austria

41 383	1 Oct 09	F. Nemet	Silencer
--------	----------	----------	----------

Patents - Italy

<u>No.</u>	<u>Date</u>	<u>Inventor</u>	<u>Title</u>
401 021	2 Jan 43	A. B. aTorino	Silencer
401 755	30 Jan 41	L. M. aCastel Verres	Silencer
402 478	10 Mar 43	E. A. aMadellio Lario	Silencer
415 686	28 Oct 46	E. G. aBologna	Silencer
472 688	27 Jun 52	A. T. aGrisolera	Dissipative Silencer

205

UNCLASSIFIED

Security Classification

DOCUMENT CONTROL DATA - R & D

(Security classification of title, body of abstract and indexing annotation must be entered when the overall report is classified)

1. ORIGINATING ACTIVITY (Corporate author)		2a. REPORT SECURITY CLASSIFICATION	
FRANKFORD ARSENAL Philadelphia, Pa. 19137		UNCLASSIFIED	
3. REPORT TITLE		2b. GROUP	
SILENCERS			
4. DESCRIPTIVE NOTES (Type of report and inclusive dates)			
Technical Research Report			
5. AUTHOR(S) (First name, middle initial, last name)			
LEONARD W. SKOCHKO HARRY A. GREVERIS			
6. REPORT DATE		7a. TOTAL NO. OF PAGES	7b. NO. OF REFS
AUGUST 1968		209	19 51
8a. CONTRACT OR GRANT NO.		9a. ORIGINATOR'S REPORT NUMBER(S)	
AMCMS Code 5542, 12, 46801, 02 b. PROJECT NO.		R-1896	
c.		9b. OTHER REPORT NO(S) (Any other numbers that may be assigned this report)	
d.			
10. DISTRIBUTION STATEMENT			
This document may be further distributed by any holder only with specific prior approval of the Commanding Officer, Frankford Arsenal, Philadelphia, Pa., Attn: SMUFA J8100.			
11. SUPPLEMENTARY NOTES		12. SPONSORING MILITARY ACTIVITY	
		ASAWECOM	
13. ABSTRACT			
<p>This report presents physical and functional descriptions and acoustical evaluation of various domestic and foreign silencers and silenced small arms weapons. Included are cross-sectional drawings and external view photographs of all systems tested. An acoustical evaluation of each system is given in the form of far field sound pressure-time records. All major constituents of sound signatures are identified and time-correlated with their respective sources in the system. Additionally, the report presents a record of silencing principles and a theoretical analysis of the various noise generating phenomenon.</p>			

DD FORM 1473

REPLACES DD FORM 1473, 1 JAN 64, WHICH IS OBSOLETE FOR ARMY USE.

UNCLASSIFIED

Security Classification

14. KEY WORDS	LINK A		LINK B		LINK C	
	ROLE	WT	ROLE	WT	ROLE	WT
Silencers Silenced Weapons Small Arms Noise Pressure-Time Sound Records Scope Traces Noise Sources Sound Pressure Levels Noise Attenuation						