

AT MICROFICHE REFERENCE LIBRARY

A project of Volunteers in Asia

Charcoal Making for Small Scale Enterprises: An
Illustrated Training Manual

Published by:
International Labour Office
CH-1211 Geneva 32
Switzerland

Paper copies are \$ 3.60 or 6 Swiss francs.

Available from:
International Labour Office
CH-1211 Geneva 32
Switzerland

Reproduced by permission of the International
Labour Office.

Reproduction of this microfiche document in any
form is subject to the same restrictions as those
of the original document.

CHARCOAL MAKING FOR SMALL SCALE ENTERPRISES

AN ILLUSTRATED TRAINING MANUAL



**INTERNATIONAL LABOUR OFFICE
GENEVA 1975**

INTRODUCTION

CHAPTER 1

Uses of charcoal
For domestic purposes
For industrial heating purposes
Other important uses of charcoal

CORRIGENDUM

Page 6, under Tools, item (27) please
read Saw setting pliers

CHAPTER 2

Methods of small-scale charcoal-making

CHAPTER 3

Preparation of wood
Choice of raw material
Preparation
Tools

CHAPTER 4

Construction and operation of earth kilns
Tools
Construction and operation of the kiln
Operation

CHAPTER 5

Operation of the portable steel kiln
Component parts

CHAPTER 6

Models for calculation of production costs

CHAPTER 7

Marketing of charcoal
Marketing organization
Safe-guarding the business
Transport
Packaging

CHAPTER 8

Charcoal-making co-operative

CHAPTER 9

Training of charcoal-makers
Training course for charcoal-makers
Outline of contents

INTRODUCTION

The art of making charcoal is at least 6000 years old. Interest in charcoal as a fuel, both for domestic use and for industrial purposes, has recently increased because of the steep rise in the prices of all fuels and power.

This manual, based upon the draft prepared by D.E. Earl and A. Earl, sets out to inform trainers of charcoal-workers about methods of charcoal-making requiring low capital inputs and will, therefore, be found most appropriate to workers in developing countries.

Charcoal is made from wood, a renewable resource and its manufacture may promote socially desirable development provided that its organization is well planned.

It should be noted, however, that charcoal industries may cause large scale environmental damage, for example, an increase in the rate of desertification, unless the ecological effects of removing trees are understood and measures taken to prevent such damage.

Photo (1) shows Eucalyptus trees grown for fuel in Uganda, aged 5 years.

Photo (2) shows damage which followed after a forest area had been opened up, through the construction of a new road.



(1)



(2)

USES OF CHARCOAL

Although wood burns readily to produce heat, *the heat value from charcoal is approximately twice as great as that from the same weight of wood.*

Moreover, charcoal burns with very little smoke and can be used in smaller or more efficient stoves than those generally used for burning wood.

FOR DOMESTIC PURPOSES

In many countries it provides the necessary heat for the preparation of meals as well as for hot water.

Photo (3) shows a typical stove, easily produced from old cans (4).

In some countries charcoal is used in stoves designed to provide also central heating (5).

Charcoal is also a very popular fuel for grilling and barbecuing (6), because it imparts a particularly nice flavour to the food.

FOR INDUSTRIAL HEATING PURPOSES

It replaces coke or fuel oil which in many countries are very expensive and have to be imported.

Charcoal is used:

- for drying produce such as hops, tobacco and fish, in special kilns or barns;
- in stoves to heat water to be circulated for the indirect drying of many different crops;
- as a fuel in the process of manufacturing lime and cement;
- for the extraction of metals, particularly iron, from their ores. Iron and steel made with the use of charcoal is generally higher in quality than that produced by means of mineral coal and several countries are using charcoal to produce very good quality castings.

OTHER IMPORTANT USES OF CHARCOAL

- For forging, drawing purposes and sewage systems.
- In horticulture, charcoal fines (small pieces and dust), are used in the vegetable garden, for increased yields in potting compounds where it "sweetens" the soil and as a top dressing around established plants such as roses and bougainvilles where it has been found that the colours are much improved. Charcoal should not be used however in the preparation of seed beds.
- A further important use of charcoal is in the control of pollution, but it is necessary to treat it with selected chemicals and steam when it is then known as activated charcoal.

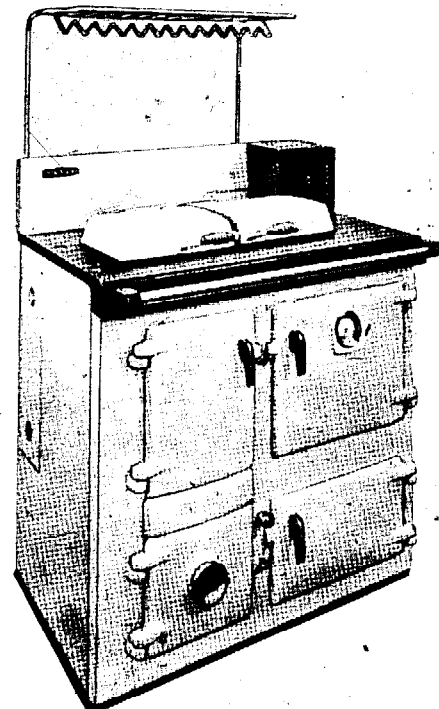

(5)



(3)



(4)

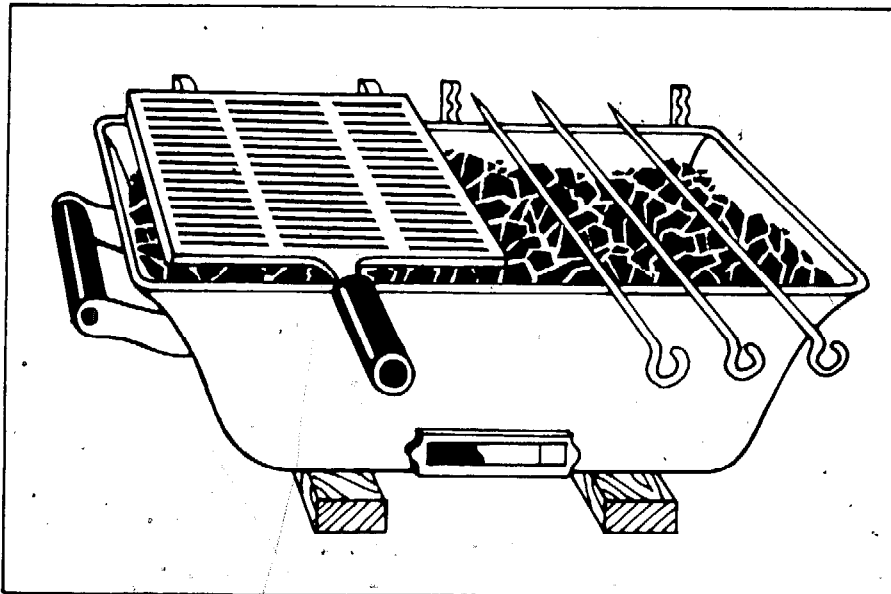

(6)

METHODS OF SMALL-SCALE CHARCOAL-MAKING

Charcoal is produced when wood is burned or heated in a restricted air supply.

Although techniques differ widely and the types of appliances are many, the most common methods of small-scale charcoal-making can be classified as follows: kilns, in which the energy source for converting wood into charcoal is provided by burning some of the wood; and apparatus (retorts), in which the wood is converted to charcoal by means of heat supplied from outside the container (generally expensive and needing careful maintenance).

The simplest way of making charcoal is in earth (7) or pit kilns (8).

Earth kilns are dealt with in detail in Chapter 4.

Pit kilns are used more particularly in hilly regions as it is easy to dig out a hole in the side of a hill (9).

On flat ground it is usually time-consuming to dig pits and, moreover, pits easily fill with water in the rainy season or if the water-table is high.

Kilns may be divided into two categories: fixed and portable.

Fixed kilns can be made of brick (10), cement (11), or clay (12).

The Missouri kiln (11) is a very efficient fixed kiln used successfully in the USA.

Because it can be very expensive to bring wood from the forest, *fixed kilns for small-scale charcoal-making operations should be restricted to those places where there is an abundant and continuing supply of wood, for example, saw-mills.*

Portable kilns can easily be taken to the wood supply and assembled on the spot.

The most popular, easily usable type consists of interlocking cylinders (13) which can be rolled from one place to another (14).

Some portable kilns consist of plates which bolt together and these kilns can be rectangular or have multiple sides (15).

For small-scale charcoal-making, earth kilns and cylindrical portable steel kilns are usually the most practical.



(7)



(8)



(9)



(10)

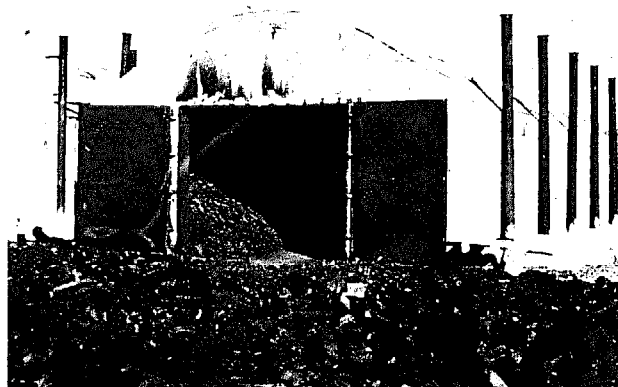

(11)



(12)



(13)



(14)



(15)

PREPARATION OF WOOD CHOICE OF RAW MATERIAL

Almost any wood can be made into good domestic charcoal.

The most abundant raw material for charcoal-making is found in savanna woodlands or tropical rain forests and can often be obtained very cheaply as a result of land-clearing schemes or in the course of forestry operations.

The tops, branches and stems from softwoods, hardwoods and palms can all be utilized. Softwoods, usually produce soft, bulky charcoals, and hardwoods, if they are heavy, give rise to charcoals which are long-lasting when burnt and are preferred for that reason.

Residues from sawmill operations often contain a high proportion of bark, but apart from giving rise to slightly more dusty and easily broken charcoal, the quality is generally high enough for domestic use.

Occasionally the bark of some trees produces charcoal which emits sparks when burned and this may be considered unsuitable for indoor use.

PREPARATION

The preparation of wood is of great importance to the production of good charcoal (16).

The pieces of wood for most practical purposes should be 1-1.5 metres in length for traditional earth kilns and 0.5-1 metre for portable steel kilns.

The diameter generally should not exceed 20 centimetres for both types of kiln.

It may be worth-while to split the wood if it is greater than 20 centimetres in diameter and not too knotty, although it may be reasonable to use larger pieces where these do not involve much handling if the alternative is to leave them to rot.

Rotten wood should be rejected as it is likely to make very poor charcoal and continue to burn in the kilns during the cooling stages.

Saw-dust is usually unsuitable for making into charcoal but can be used most effectively to cover wood in earth and pit kilns in the vicinity of sawmills.

TOOLS

The tools required for the preparation of wood are as follows:

- cross-cut saw (17)
- bush saw (18)
- axe (19)
- matchet (20)
- hammer, 3 kgs (sledge) (21)
- wedges: steel (22)
- steel and wood (23)
- twisted (24)
- sharpening stone (25)
- sharpening file (26)
- saw set (27)

Felling and cross-cutting is usually best done with an axe and matchet for wood less than 10 centimetres in diameter, but above this size saws are more economical and less tiring.

The bush saw (18) is preferred for wood between 10 and 20 centimetres in diameter.

The cross-cut saw (17) should be used for large pieces which it is later possible to split.

Splitting can be accomplished with the use of a hammer and wedges (21-24).

The twisted wedge (24) is particularly useful in this respect as it rotates in the initial opening and thus avoids the need to use more than one other wedge.

It is important to reduce the moisture content of wood from that found in living trees, and in tropical countries it has been found that *wood should be cut and left to dry for about 6 weeks if good yields of charcoal are to be obtained.*

The wood should be cross-cut immediately after felling where possible because it is easier to cut then and moisture evaporates much faster from wood cut into small lengths.

The rate of moisture-loss from wood is proportional to time but slows down considerably after about 3 months in the tropics and from then on nothing much is gained by further air-drying and loss of charcoal yield may be caused by the action of fungi or insects.

It is often convenient to cut wood into 1 m or 0.5 m lengths, (28) and (29), and stack in cubic metres (stères); stacking makes it much easier to control the progress of work, to calculate the payment earned by the men and also assists in forecasting the amount of charcoal likely to become available. Wherever possible, stacking should be made in the open where there is ample sunlight and wind to facilitate rapid drying (30).

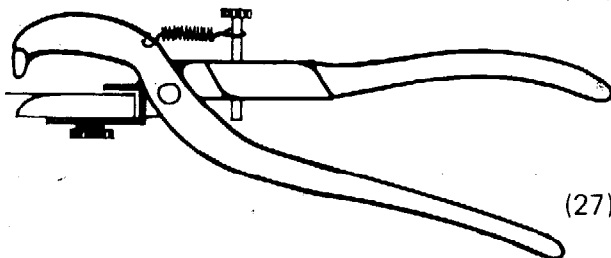
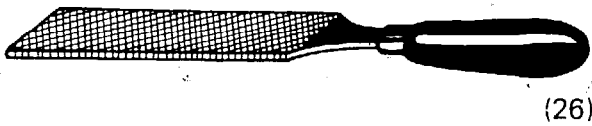
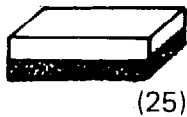
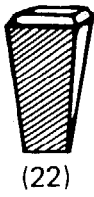
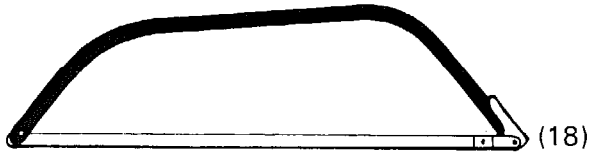
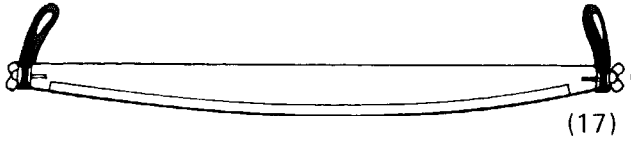

CONSTRUCTION AND OPERATION OF EARTH KILNS

Earth kilns (see page 7) are simple to construct and operate, and produce good results when managed by experienced people.

The chief advantage of earth kilns over other methods is that almost no capital is required as the kilns are constructed entirely from locally obtainable raw materials.

The main disadvantages are that yields are often low and the quality of charcoal is difficult to control.

Although there are many different types of earth kilns in common use, there are a few basic rules which apply to all of them in order to obtain good results.

1. All wood used should be sound and at least partly seasoned.
2. The wood should be packed as tightly as possible.
3. The earth covering it should be sufficiently thick so as to prevent complete combustion; to ensure that the required thickness is maintained, the kiln should be examined frequently throughout the carbonization/cooling cycle. This will necessitate an occasional visit during the night.

The description in this manual is for one of the simplest types of earth kilns which has given good results in several different countries.

TOOLS

The tools required for a two-men operation are as follows:

- 2 shovels (31)
- 2 spades (32)
- 2 hoes (jembes) (33)
- 2 matchets (34)
- 2 axes (35)
- 2 rakes (36)
- sacks (37)
- needle (38)
- string (39)

CONSTRUCTION AND OPERATION OF THE KILN

1. Select a site as near as possible to the wood supply.

Clear away all vegetation and level an area approximately 4 x 2 metres (40).

2. Place billets of wood (stringers) approximately 1.5 metres long by 5 centimetres diameter at about 0.5 metre intervals across the main axis of the cleared ground (40).

3. Commence piling wood at right angles to the stringers, threading small pieces in the gaps between larger logs in order to make a compact pile 3 to 5 metres long by 1.5 metres wide and 1 metre high (41).

The total wood content is thus about 4.5 to 7.5 cubic metres (stères).

4. At one end of the wood pile, preferably the end away from the direction of the prevailing wind, mix into the top small pieces of inflammable material such as dead twigs and partly burnt wood from previous kiln firings. This will be the point where lighting will take place.

5. Cover the pile of wood, excepting the lighting point, with vegetation such as leafy branches, herbs, moss or grass, to a depth of approximately 30 centimetres (42).

6. Make some stakes about 1.5 metres long and knock them in around the sides and ends of the kiln at 0.5 metre intervals.

Thread loose branches between the stakes to form a wall with the object of preventing soil from escaping when the kiln is covered (42). Alternatively, build a rough wall around the kiln using large pieces of timber or stones.

8. Make a small fire near the kiln and when it is well alight take two or three shovels of burning wood and embers to the lighting point of the kiln and drop them in.

Feed small pieces of wood into the lighting point to ensure a fierce blaze and continue until smoke is seen to emerge from various points through the soil of the kiln.

If little or no smoke issues after 10 or 15 minutes, remove some of the soil from 4 or 5 positions around the kiln in order to encourage the spread of smoke.

7. Cover the vegetation completely with soil to a depth of about 15 centimetres (43) (43a) again leaving the lighting point free (44).

9. Prepare a load of vegetation large enough to cover the lighting point and after the fire has become well established, seal it off with the prepared vegetation and immediately heap on soil to shut off most of the draught.

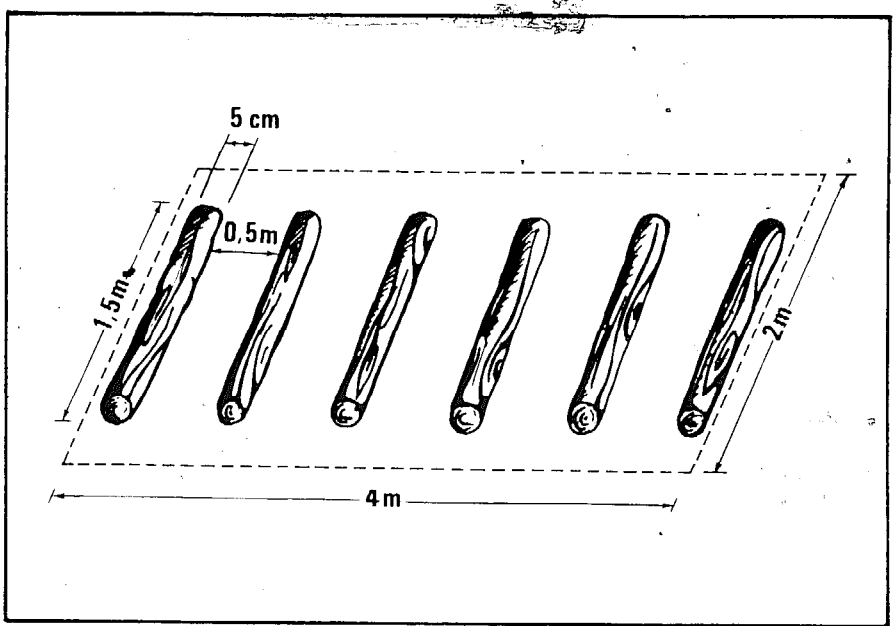
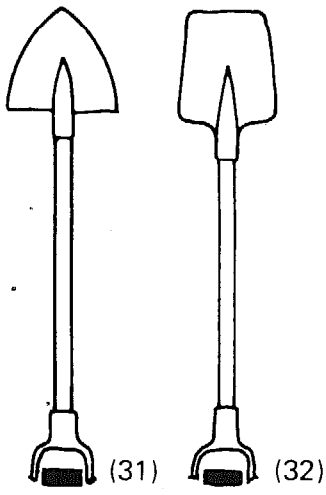

(40)

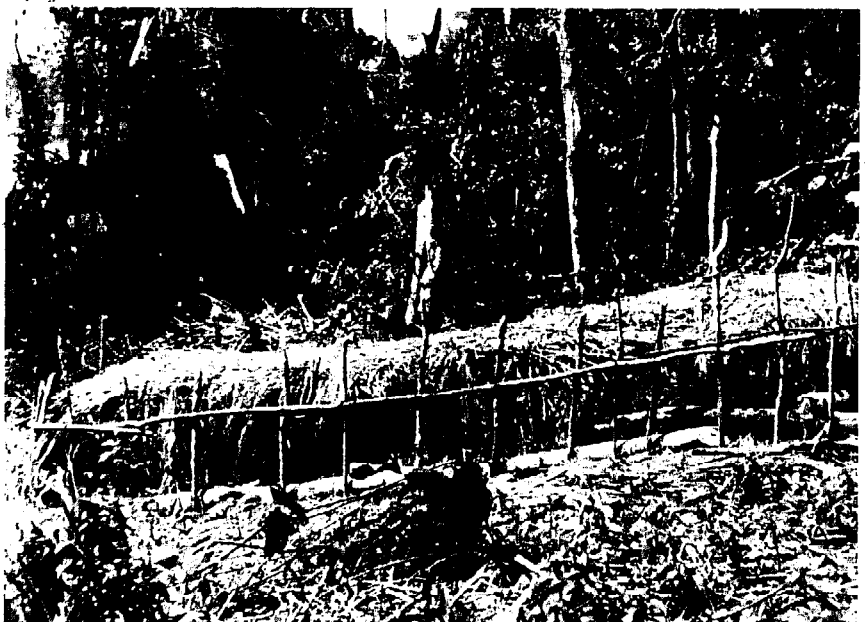
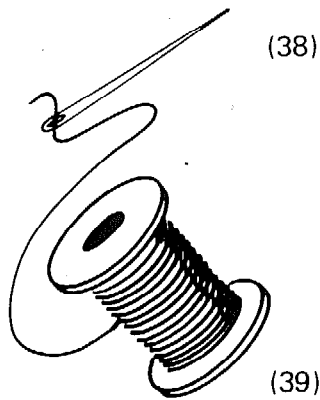
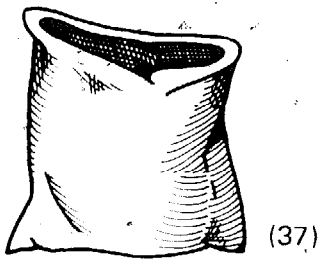
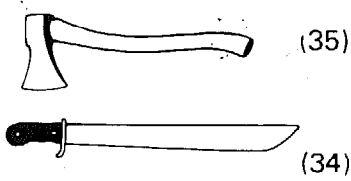
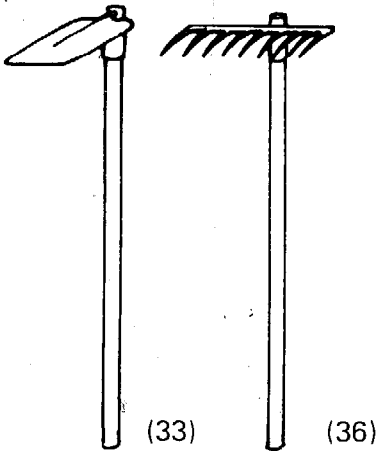

10. The kiln should be inspected at regular intervals (say every 2 or 3 hours) (45), to ensure that carbonization is progressing at a slow but steady rate.

If thick *white smoke* emerges from several places around the kiln, then carbonization is progressing well.

Blue smoke indicates that too much air is getting into the kiln and more soil needs to be added to the covering.

If smoke becomes feeble and thin before carbonization is completed, soil should be removed from one or more points around the base of the kiln.



(43)

11. The signals that carbonization is finished, after about 2 days, are *the kiln sinking to about half of its original height and at the same time smoke becoming thin and much reduced* (46), (47).

The kiln should then be completely sealed by adding more soil to exclude all air.

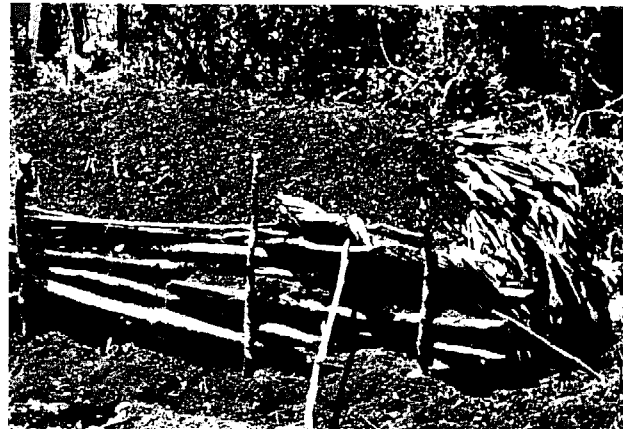

(44)

12. When the kiln is cold, about 3-4 days after sealing, depending upon the weather and type of wood and soil used, soil should be removed cautiously from one side of the kiln to expose the charcoal and unloading may commence (47).

Some of the charcoal may be hot, but unless it is actually alight it should soon cool in the open air, if pieces begin to smoke and burn they should be covered with soil.

Water should not be used as it affects the quality of the charcoal, but it is a good precaution to have a bucket of water available in case of emergencies.

The charcoal can be safely put into sacks if it has remained cold after being exposed to the open air for 3 hours.



(45)

Yields should be about 30-40 kilograms per cubic metre (stère).

Two experienced charcoal-makers should be able to produce and load into sacks about 5 to 6 tons of charcoal per month.

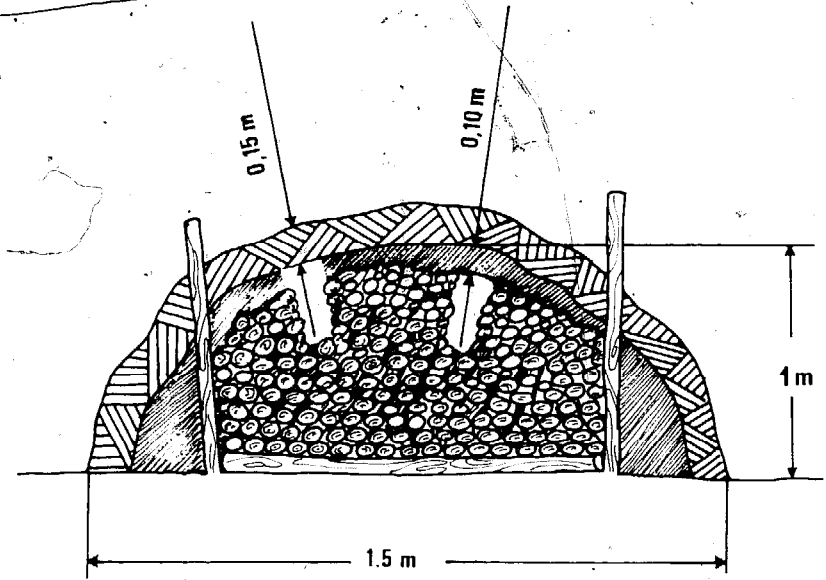

(43 a)



(46)



(47)

OPERATION OF THE PORTABLE STEEL KILN

There are several different makes of portable steel kiln available.

Some of them have a simple air supply system, whereas the majority operate on a reverse draught principle with the aid of chimneys situated around the base of the kiln and these have generally been found to produce *better control and greater yields of charcoal*.

The kiln described here has been found to be suitable for use in many different countries.



(48)

COMPONENT PARTS (48, 49, 50)

- 2 cylinders A 2.32m diameterx0.91m high
- B 2.32m diameterx0.76m high
- 1 cover B 2.32m diameterx0.46m high
- at center (46)
- 1 cap C 0.45m diameter
- 8 smoke boxes D 0.15x0.9x0.7 m
- with closeable
- caps and collars
- 4 chimneys E 2.30m highx0.10m diameter

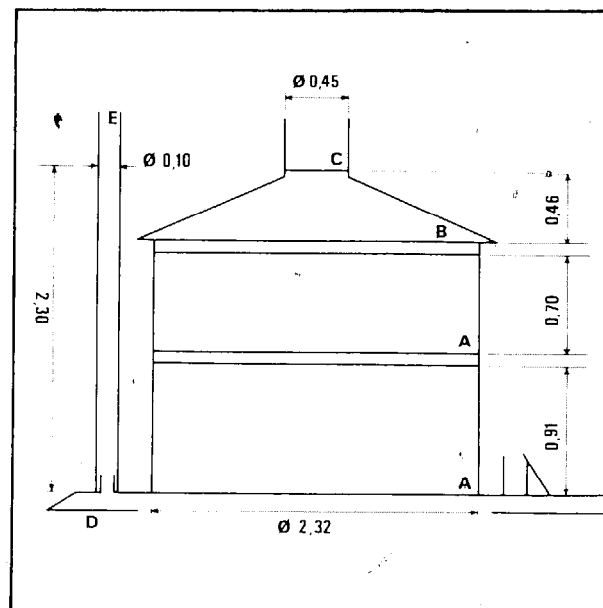

(49)

The tools required for a two-man team are as follows:

- 2 shovels (51)
- 2 spades (52)
- 2 hoes (jembes) (53)
- 2 matchets (54)
- 2 axes (55)
- 2 rakes (56)
- crow-bar 2m (57)
- ladder (not longer than 3 meters) (58)
- sacks (59)
- needle (60)
- string (61)
- 50 kgs spring balace or scales (62)
- face masks (63)
- bucket of water (64)
- industrial gloves (65)

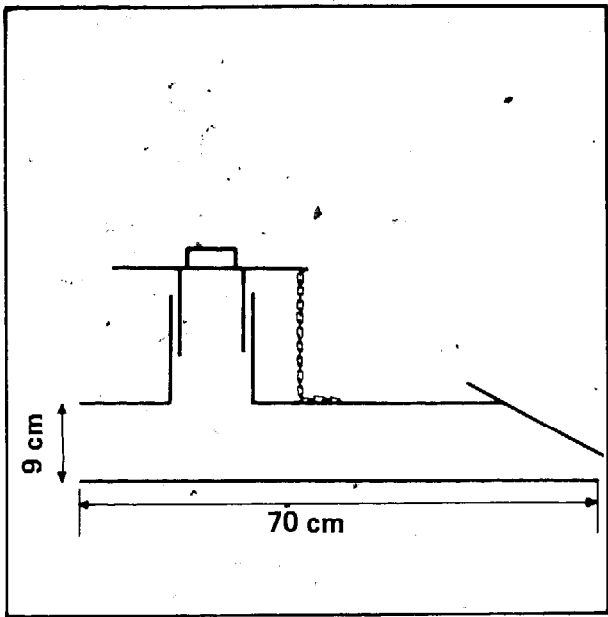

(50)

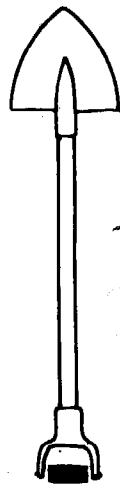

(51)

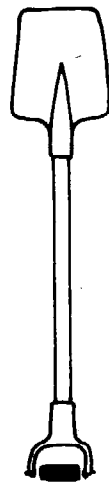

(52)

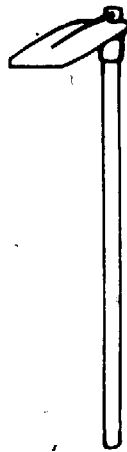

(53)

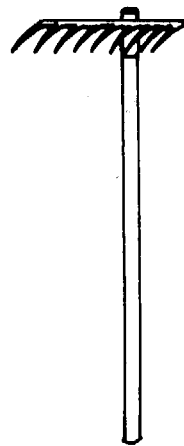

(56)

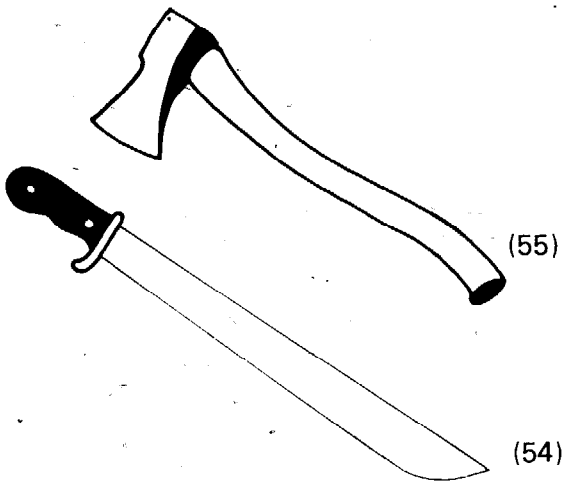

(55)

(54)

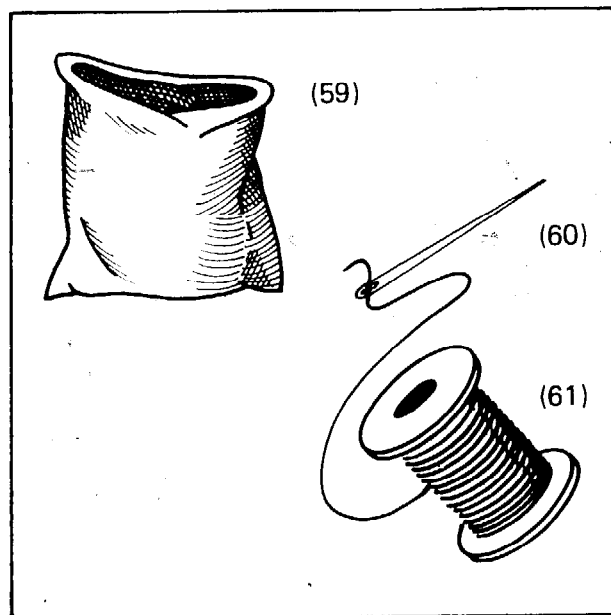

(59)

(60)

(61)

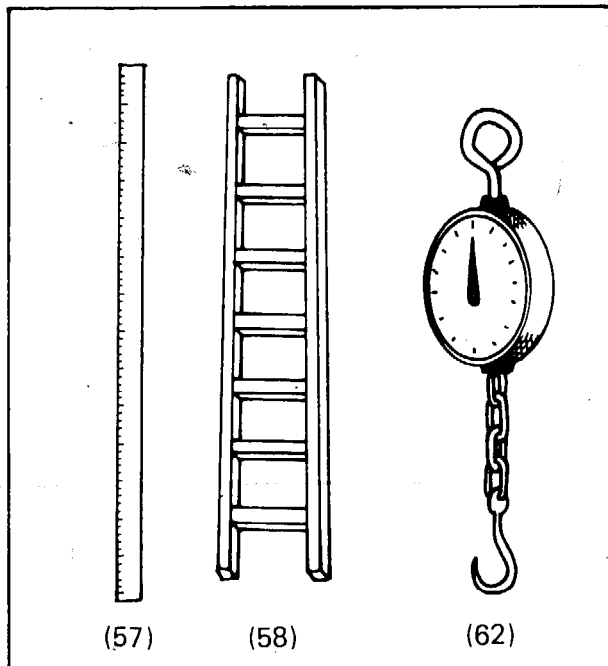

(57)

(58)

(62)

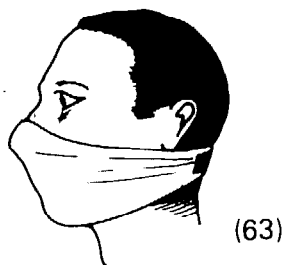

(63)

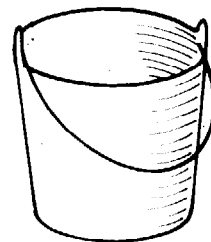

(64)

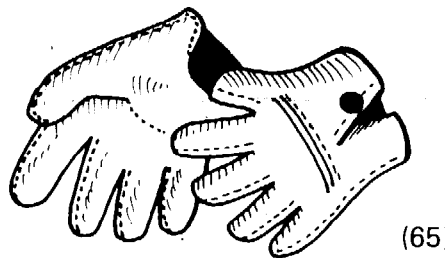

(65)

OPERATION

Wood for the kiln should be preferably cut into 0.5 metre lengths and left to *dry for at least 6 weeks*.

The kiln can be operated in the full-size version which takes about 6 cubic metres (stères) of wood (66), or in the "mini" version (67) which needs only 3 cubic metres (stères) of wood.

The instructions which follow apply equally well to both versions except that the note regarding fitting on the second cylinder does not apply to the "mini".

1. Select a dry site free from stumps near the wood supply.

Remove vegetation and level it roughly to produce a circular platform of about 3 metres diameter.

2. Place the bottom cylinder on the ground and then with the aid of a lever, fit the 8 smoke boxes underneath it at equidistant intervals (68).

3. Billets of wood (stringers) should be arranged radially from the circumference to the centre of the cylinder (69 A).

Dry kindling wood or split brands from a previous firing together with any other inflammable waste material should be placed between the stringers (69 B).

The stringers should then be covered with a layer of wood placed cross-ways upon them (69 C), and then loading can continue, with the wood packed as tightly as possible until the bottom cylinder is full (70).

The hollow rim at the top of this cylinder should now be filled with sand (71) and the second cylinder lifted on.

Loading should continue until the wood forms a conical shape above the top cylinder (72) so that the cover, when lifted on, leaves approximately 10 centimeters between its lower flange and the rim of the top cylinder (73) which in turn should be filled with sand (71) and (73 A).

If the wood is wet it may be necessary to increase the distance between the cover and the top cylinder. The amount to leave can be determined only with experience.



(66)

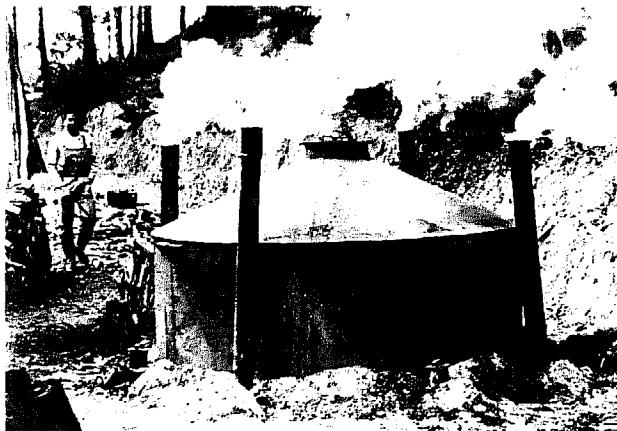

(67)

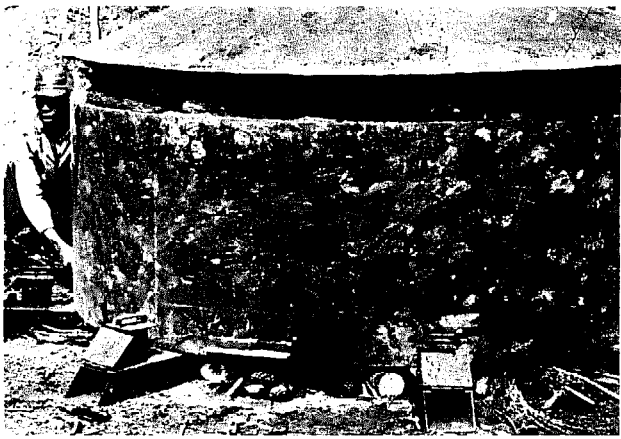

(68)



(70)

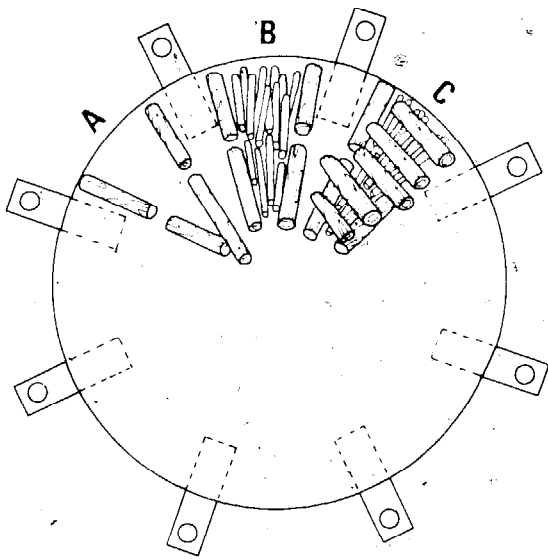

(69)

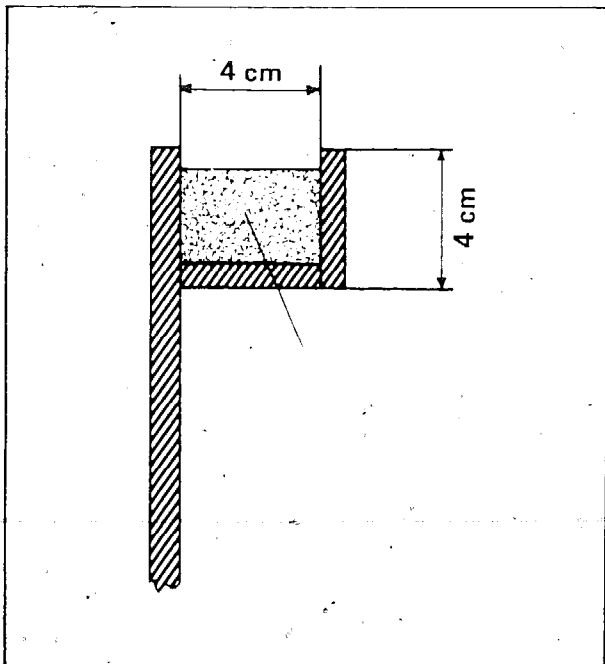

(71)

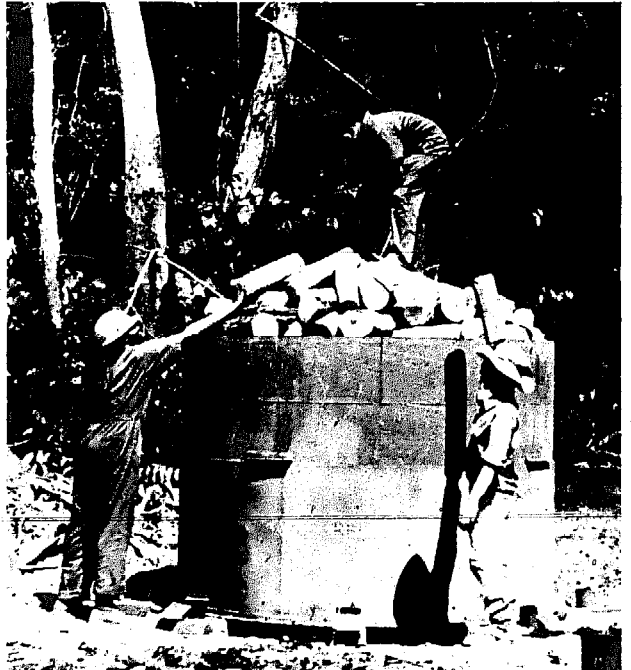

(72)

4. With all flaps and lids of the smoke boxes open (73) apply a flame to the 8 lighting points in between them. After lighting, dead wood, twigs and other dry material should be pushed into the lighting points to make sure there is a good blaze. When the kiln is well alight, copious smoke will issue from the circumference and the uncapped center of the cover.

5. When the surface of the kiln at each lighting point becomes sufficiently hot (this is indicated when spittle applied to the side of the kiln evaporates immediately), pieces of wood immediately covered with soil should be used to close the lighting point gaps.

In approximately 30-60 minutes the cover will have settled so that its flange fits into the sand-filled hollow rim of the top cylinder (73 A).

Occasionally the cover will have to be moved slightly to ensure a good fit, this can be assisted with the use of a pole about 2.6 metres long. Once the cover has become firmly sealed, the following action should be taken: fit chimneys on the collars of four alternate smoke boxes whose flaps should now be closed.

If there is a great deal of wind, the flaps of the smoke boxes not fitted with chimneys should also be closed on the side facint the prevailing wind. The caps of the collars, however, should be left open.

Fit the cap on the cover with the aid of a pole and the ladder. Air will be able to enter only through the four open smoke boxes and after circulating through the kiln will be emitted from the chimneys (reverse draught) (74).

6. The kiln may now be left while the men get on with other work.

It should, however, be inspected from time to time to ensure that carbonization is progressing in a satisfactory manner.

Thick white smoke from all the chimneys is an indication that things are going well. If, however, *blue smoke* is produced from a chimney, that chimney should be removed and the cap put on the collar for about 15 minutes or so before the chimney is replaced as normally this will be long enough to ensure that the fire in the vicinity is extinguished. If there is a *slowing down of smoke production* from a chimney, soil should be removed from the bottom of the kiln by that chimney to enable extra air to enter the kiln.

When the smoke from that chimney has thickened again, the soil can be replaced. After a period of time, normally 8-10 hours, all the chimneys should be moved to the smoke boxes to their right and the collars of the

vacated smoke boxes left open. This will have the effect of avoiding the production of excessive ash at the air inlets and unburnt wood at the points near the chimneys.

After approximately 16-24 hours, the smoke from one or more of the chimneys will cease or become very thin and transparent. As this happens the relevant chimneys should be removed and the smoke boxes closed. When all chimneys have been removed, soil should be used to cover the lowest 30 centimetres of the kiln, including the smoke boxes (75).

After the wood in the vicinity of the kiln has been utilized, the cylinders can easily be rolled and the other parts carried to a new site without the need for mechanical aid (76).

With dry wood, carbonization is normally from 16-24 hours and cooling 8-12 hours.

Yields should be about 50-70 kgs per cubic metre (stère).

Two experienced men can produce and load into sacks about 9-12 tons of charcoal per month.



(73)

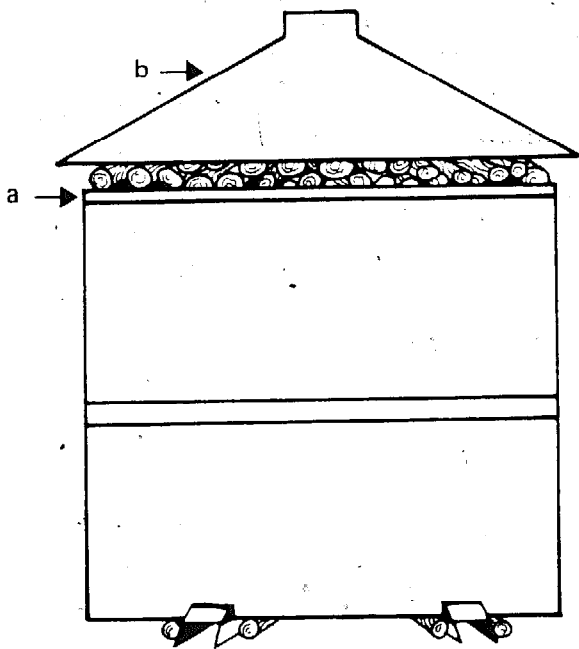

(73 a,b)

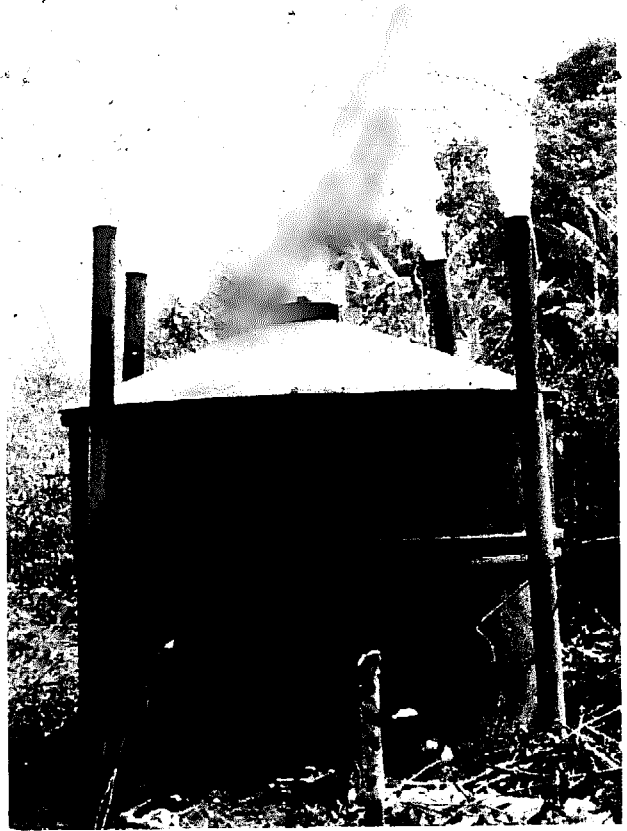

(74)



(75)



(76)

MODELS FOR CALCULATION OF PRODUCTION COSTS

In order to be able to check that all parts of the operation are being carried out efficiently, it is necessary to keep good records.

The basic record sheets (forms 1, 2 and 3) can help the entrepreneur to control the efficiency of his operation and indicate where improvements should be introduced.

The forms should be amended, if necessary, to suit local conditions.

Form 1 is used to record the amount of wood being prepared in advance of the charcoal-making teams. It is helpful in keeping check of the payments made to the wood-cutters and controlling the time allowed for wood to dry.

FORM 1
TEAM N. 2

WOOD PREPARATION
MONTHLY PRODUCTION

MONTH: APRIL
YEAR: 1975

Date	Names of men	N. stères	Checked
3	MOWENGA	2	Mokana
	ATTOH	3	Mokana
30			
Total		124	Mokana

Form 2 is used to record the results of each team for payment purposes and also for checking upon the performance of kilns. The total production should check with the amount received in the store each month (form 3).

FORM 2
TEAM N. 3

CHARCOAL
MONTHLY PRODUCTION

MONTH: APRIL
YEAR: 1975

Kiln type	N. of stères	Date fired	Date unloaded	N. sacks 25 Kg. Av.	Checked in store
Maxi 1	6	3/4	5/4	18	Mafuta
Mini 3	3	4/4	6/4	10	Mafuta
Totals	109	-	-	298	Mafuta

CHARCOAL STOCKS IN STORE

FORM 3 MONTH: APRIL
YEAR: 1975

Date	N. sacks received	Received from	N. sacks sold	N. sacks left in store	Checked
<i>Carried forward</i>				312	<i>Mafuta</i>
<i>1/4</i>	<i>16</i>	<i>3</i>	<i>25</i>	<i>303</i>	<i>Mafuta</i>
~~~~~					
<i>30</i>	<i>25</i>	<i>2</i>	<i>2</i>	<i>183</i>	<i>Mafuta</i>
<b>Totals</b>	<i>598</i>	<i>1-2-3</i>	<i>727</i>	<i>183</i>	<i>Mafuta</i>

The following two models are for calculating the costs of charcoal production in earth and portable steel kilns.

The costs assume that five men will be employed, three on wood preparation and two on carbonization.

The salaries and costs shown do not refer to any particular country. It should be noted that a high output of charcoal lowers the production costs per ton very considerably. It is, therefore, well worth-while providing efficient tools and equipment as this benefits the business as well as the workers, but it can be seen that unless the equipment is fully used, money is wasted because of the effects of loan repayment and interest charges on final costs.

**MODEL 1  
EARTH KILNS. MODEL RECORD OF PRODUCTION COSTS**

Number of men : 5	\$	\$ US
Cost of wood : 156 stères at \$ 0.25	39.00	
Preparation of wood : 78 man/days 1.00	78.00	
Kiln operation : 52 man/days 1.00	52.00	
	169.00	
Equipment : (amortised cost) tools, sacks and string	34.00	
<b>Total operating costs</b>		<b>203.00</b>
With monthly production of 6 tons, cost per ton = 33.83		
With monthly production of 5 tons, cost per ton = 40.60		
With monthly production of 4 tons, cost per ton = 50.75		

N.B. The monthly production for the same inputs of men and raw material varies as to knowledge, teamwork and management, as well as quality of wood.

## PORTABLE STEEL KILNS. MONTHLY RECORD OF PRODUCTION COSTS

Unit of 2 kilns			
Number of men : 5			
Cost of kiln : 2 at \$ 2000 = \$ 4000		\$	\$ US
Depreciation of kilns over 5 years (loan repayments)		66.66	
Interest on loan, average of diminishing loan for 5 years		20.00	
		<hr/>	
		86.66	
Cost of wood :	156 stères at \$ 0.25	39.00	
Preparation of wood :	78 man/days 1.00	78.00	
Kiln operation :	52 man/days 1.00	52.00	
		<hr/>	
		169.00	
Equipment: (amortised cost) tools, sacks and string		68.00	
Total operating costs			<u><u><u>323.66</u></u></u>
With monthly production of 12 tons, cost per ton = 26.97			
With monthly production of 9 tons, cost per ton = 35.96			
With monthly production of 6 tons, cost per ton = 53.94			

See note on preceding page.

## MARKETING OF CHARCOAL

Although it is quite easy to manufacture charcoal, it is much more difficult to sell the results at a price which will give an adequate return to the producer to enable him to provide for his own and his family's needs and also to save some of the returns for the future expansion of his business.

In order to obtain increased sales of charcoal it is necessary for the producer to *establish good standards of quality and reliability*.

It is sometimes easier for the charcoal-maker to market charcoal of a standard quality if he blends his softer, less desirable produce with harder, more sought after charcoal. He should also grade it by size and should not attempt to cheat the customer by placing the large, heavy pieces at the top of the sack and the dusty, small pieces at the bottom. This practice brings a bad name to the person concerned and also plunges the whole industry into disavour.

Most countries have an effective demand for domestic charcoal but industries and export can often provide a large outlet if marketing is sufficiently well organized. Where the prospects for the export of charcoal are good, it is often necessary to briquette it in order to save on transport costs.

The advantages of briquetting are that all the charcoal, including dust, can be utilized and the briquettes contain approximately the same amount of heat as lump charcoal twice their size.

Briquetting machines are usually expensive and large but work is progressing on the preparation of small machines, some of them hand-operated, of which details will be circulated as they become available.

## MARKETING ORGANIZATION

The general flow of charcoal is from producer to transporter to wholesaler to retailer before it reaches the consumer. At each of these stages the price of the charcoal rises considerably and if the full number of steps is present the final price may be 3 or 4 times greater than the price obtained by the charcoal-maker.

The charcoal-maker may sell his produce directly to the consumer and this method has certain advantages and disadvantages.

The advantages are that the charcoal-maker has maximum control over the final market price of

his produce and has great job satisfaction, however, because selling to the consumer is usually highly competitive, it is time-consuming. It is moreover extremely difficult to sell very small quantities except in an established market. The charcoal-maker with no facilities for storage or market stall may find himself compelled to sell his produce when the market is flooded and the price is consequently very low.

Charcoal is likely to deteriorate if it is left in the open air and therefore the small charcoal-maker is at a grave disadvantage if he is to sell his charcoal when the price is high (see Chapter 8).

The second possibility is to sell the charcoal to the wholesaler or retailer at the market place. Here, prices will be lower but products can generally be sold very quickly and it is consequently less time wasting than if the charcoal-maker has to do the retailing.

The charcoal-maker has the advantage of variety in his work and the ability to make essential contacts in the town which is often desirable after long hours in the forest away from other people.

The third possibility is to sell all the produce at the site. The advantages are that the charcoal-maker can come to an arrangement with a transporter or wholesaler to buy large amounts and he therefore has very few worries and can get on with the work of making more charcoal.

The disadvantages of this method are that he is obliged to accept a low price for the charcoal and he does not have the chance to make business and social contacts.

Yet another possibility is to join a co-operative, this will be discussed in Chapter 8.



## TRANSPORT

Transport is a vital ingredient in the marketing of charcoal as the material is bulky and rather difficult and expensive to carry.

In many countries it is taken by bicycle (77) to the nearest town.

Quite recently, a bicycle fitted with trailer has been developed by OXFAM in collaboration with S.S. Wilson of Oxford University (78).

It has a pay load of 150 kilograms (6 large bags of charcoal), this is double the amount which can be safely carried on an ordinary bicycle.

Other forms of transport are hand carts, donkey carts, lorries and rail.

The latter is more appropriate to co-operatives or to the large business man and is not often utilized by the small individual charcoal-maker.

## PACKAGING

The most usual form of packaging is the jute sack or gunny bag.

It is unfortunate that in most countries charcoal is sold by volume and not by weight but there are signs that this practice is changing.

*Wherever possible the charcoal-maker should weigh his produce with a spring balance or scales. The weight should be written on a label attached to the bag and in this way he can establish confidence between himself and the person buying from him.*

The gunny bag is far from ideal as a container for charcoal because it is unable to prevent any dust from escaping, thus making handling a dirty task. It is also permeable to water and affords little protection to the contents.

Usually gunny bags are closed with the aid of needle and string. In many countries the string forms a lace-work over the charcoal which can be examined through it by the would-be purchaser.

Although they are far from ideal, it is doubtful that gunny bags will be replaced for a long time because they are readily available in most countries and form part of the exchange system in some markets. Strong paper sacks are practical provided that they can be kept dry. They are clean to handle, easy to close with staples and provide a good surface for labelling (79).

Boxes made of wood, plastic or tin (80b) are also used successfully for smaller quantities than the 20-30 kilograms normally needed to fill a gunny bag. When charcoal is sold for industrial use on a large scale, it is sometimes unnecessary

to package it as the charcoal can be transported from the site to the industry concerned where it is weighed and tipped straight into a hopper or store.

## SAFEGUARDING THE BUSINESS

It is important for the charcoal-maker or entrepreneur to keep records of his production costs and sales in order to know how his business is progressing and to plan for possible expansion (see Chapter 6).

Cash obtained from sales should be put in a safe place and not kept at home or carried around.

Not only is it safer but it is also easier to keep account of the cash flow if an account is opened at a bank in the town where the charcoal is sold and monthly statements are obtained.

Regular savings can be put aside towards expanding the business and make it very much more likely that a loan from the bank will be granted if required.



(77)



(78)



(79)

## CHARCOAL-MAKING CO-OPERATIVE

Charcoal-makers can often obtain business security and a better return from their produce if they are able to form themselves into a co-operative in which responsibilities are shared. The term "co-operative" is used here in its specific sense of an association of persons, usually of limited means, who have voluntarily joined together to achieve a common economic goal through the creation of a business organisation democratically controlled by the members.

Co-operative members make equal contributions to the capital required, share the benefits and — within prescribed limits — the risks of the undertaking.

A co-operative differs from a private business in that it is owned and controlled by those who do their business through it, in other words the charcoal-makers. They alone are entitled to become members. Membership in a co-operative is voluntary and the members exercise their authority over the undertaking by themselves through the management committee which is elected by all members.

One of the main advantages of belonging to a co-operative is that members are able to improve their bargaining power and thereby obtain more stable prices and secure markets; furthermore by doing away with a number of individual operations they save time and avoid much worry. The co-operative is thus able to offer larger quantities of charcoal for sale than is possible by an individual charcoal-maker and to set standards as to quality, grades and packing.

This, together with the provision of transport and storage facilities, opens marketing possibilities well outside the limits of the nearest town and permits to search new outlets (industries; export).

The co-operative can also provide its members with equipment at lower prices because the co-operative is able to buy in quantity and thus obtain substantial discounts. By facilitating the purchase of modern equipment such as the steel-kilns, the co-operative, also contributes to improve charcoal production techniques and increases quality and quantity.

If the co-operative is well established, it may be able to obtain loans at favourable rates for its members for the purchase of specialised equipment, such as weighing and briquetting machines, trucks and loaders, as well as for the construction of stores.

The co-operative is also able to advertise and promote sales much more easily than is the case if individual members are left to do this for themselves. The co-operative can also provide book-keeping and recording services to the individual members.

Yet it should not be forgotten that the organisation of a co-operative is not easy. Various steps should be completed before formal registration of the co-operative is made.

One of these is to make available the proper information about the co-operative to prospective members.

The purpose of the co-operative and the means it uses should be brought to the knowledge of the charcoal-workers at the very initial stages of organisation. The same applies to the understanding of the rights and duties of members of a co-operative, and the power and tasks of the management committee and the general meeting, etc.

Prospective members should also be prepared to accept group discipline, financial involvement and/or managerial responsibilities. The understanding of and keeping to these basic issues by the members are the most essential conditions of their willing and active participation and loyalty to their co-operative.

Most of these points are reflected in the rules of co-operatives which should be explained and discussed at several preparatory informative meetings before the eventual meeting when the co-operative is founded.

Another important preparatory step is to study the economic conditions of the co-operative.

This study should include an assessment of the services required by the members, minimum number of members and the initial capital needed, prospective charcoal markets, members' production capacity, storage procedures, price policy, means of delivery, expected sales and expenditure, etc.

It is also of importance that there should be real benefit prospects in the form of improved income and/or dividends which would be given out to the members at frequent intervals in order to stimulate their interest in the joint undertaking.

Much attention should also be given to the training needs of the members of the management committee and/or staff of the co-operative, in particular those who take up the task of providing management for the co-operative and watching over its activities.

It is obvious that the co-operative can succeed only if able staff are engaged to run it. To overlook this aspect at the start of a co-operative society is dangerous.

It is important to seek out for managerial tasks, persons who will "stay on the job"; rapid turnover of managers is one of the major causes of co-operative failures.

It should be kept in mind in this connection that basic managerial talent and know-how may exist in the locality, even amongst the charcoal producers themselves. The upgrading of local talents through training may be the best way to ensure stable management.

Membership education is another vital aspect of a co-operative society.

Members should be given intensive education about the principles and practices of co-operation. This would develop among them the power to find out and answer their own problems on the basis of the co-operative practice and promote active participation in the business of the co-operative.

Apart from the strictly business aspects of the co-operative, the human relations between its members plays a most important part in the success of the co-operative. This element must therefore be considered fully when organising a workers' co-operative. Experience has shown that a continued keeping in touch between the management of the co-operative and its members accounts for an essential contributory factor in the strengthening and progress of the co-operative. This could be partly achieved through the organisation of monthly meetings for members to consider current matters and solve related problems. In addition, both the management committee meetings and the general meetings should be used as a forum to give out knowledge and general understanding among the members, while at the same time encouraging a fuller taking part in the joint activities.

Another factor that is equally vital is leadership in each society. This requires at least one devoted leader to stimulate the interest and confidence of the members, to see that periodic meetings are held, and to ensure that the elected management committee devotes time, thought and effort to the society and its business operations, otherwise the co-operative might gradually go out of existence, or become the private business of the manager (one man's co-operative).

Finally, it should be recalled that technical advice and assistance from the government co-operative department, as to the possibility of having the co-operative organised is usually sought — and obtained — by the promoters.

An officer of the co-operative department would be given the task of helping prospective mem-

bers to gather needed information regarding the business of the proposed society; prepare and discuss rules of the co-operative; set out a job description for the manager and assess the qualifications of candidates; determine economic and legal requirements of the co-operative; and identify other factors which belong to the organisation of the co-operative.

To sum up, the organisation of a charcoal-co-operative requires the following:

- (a) an assessment of the members' needs and the services that could be rendered by the co-operative;
- (b) a study of the economic viability of the undertaking;
- (c) a number of preliminary informative meetings with a view to:
  - (i) discussing points (a) and (b);
  - (ii) giving a basic knowledge about co-operative principles and practices among the prospective members;
  - (iii) defining the purpose of the society, and ways and means of achieving them through joint action;
  - (iv) making clear the tasks of the management committee;
  - (v) identifying — among the members or otherwise — the person who would, under existing conditions, efficiently take up the responsibilities of running the co-operative;
  - (vi) discussing and adopting the rules of the co-operative;
- (d) a common will to achieve the betterment of personal economic and social conditions through self-help and mutual help;
- (e) a common will on behalf of the members to accept group discipline and the provisions of the rules;
- (f) members' readiness to participate in the relevant programmes of members' training and education;
- (g) good working relationship and the outcome of responsible leaders.

**TRAINING OF CHARCOAL-MAKERS**

In planning training activities on charcoal making there is, in most cases, a need to give priority to courses and extension or advisory services for self-employed charcoal-makers or small-scale entrepreneurs. The aim of such training would be to improve actual methods of work and to introduce new methods and equipment, such as the steel kiln.

An example is given below of the content of a two-week long training course for charcoal-makers. As courses of this type would be aimed primarily at adults already active in charcoal making, it is necessary to plan and adapt the programme in accordance with their specific needs. This involves advance studies of the actual methods of work and identification and analysis of weaknesses and faults. With this information the scope for improvements and introduction of new methods can be identified, and the content and means of training to achieve this be decided. Only with a thorough knowledge of the experience, skills and motivation of the trainees can the trainer or extension officer successfully bring about a change.

**TRAINING COURSE FOR CHARCOAL-MAKERS****OUTLINE OF CONTENTS**

1. Explanation of the principles of charcoal-making.
  - The correlation between the drying period and the moisture content of wood and its effect upon charcoal yields.
  - Size of wood and influence upon yields of charcoal.
  - The type of wood used and its effect on charcoal quality.
2. Explanation of construction and operation of earth kilns.
  - Practical work.
3. Explanation of operation of portable steel kilns
  - Practical work.
4. Demonstration of use and care of tools and practical work with hand saws, axes, mat-chets, wedges, spring balances and/or scales.
  - If thought desirable, chain saws should be included in the syllabus.

5. Safety precautions and first aid.
  - Treatment of burns.
6. Names of important timber trees, elementary silviculture.
  - The need to ensure that charcoal-making contributes to good management of forests and does not hasten their destruction should be stressed.
7. Unloading kilns and packaging charcoal.
  - Practical work.
8. Costings, book-keeping and marketing.
  - Simple accounts, marketing methods, controls and records, promotion.