

AT MICROFICHE
REFERENCE
LIBRARY

A project of Volunteers in Asia

Jojoba and Its Uses

by: Edward F. Haase and William G. McGinnies, eds.

Published by:

Office of Arid Lands Studies
University of Arizona
845 North Park
Tucson, AZ 85721 USA

Paper copies are \$ 5.00.

Available from:

Office of Arid Lands Studies
University of Arizona
845 North Park
Tucson, AZ 85721 USA

Reproduced by permission of the Office of Arid
Lands Studies/University of Arizona.

Reproduction of this microfiche document in any
form is subject to the same restrictions as those
of the original document.

JOJOBA AND ITS USES

**AN INTERNATIONAL CONFERENCE
TUCSON, ARIZONA**

**UNIVERSITY OF ARIZONA
JUNE, 1972**

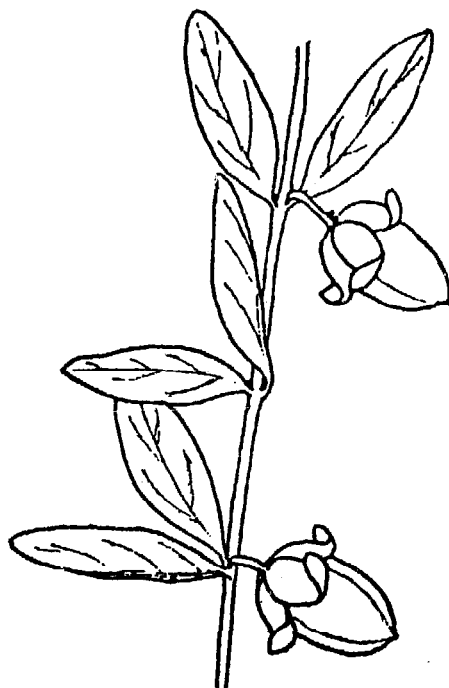

**OFFICE OF ARID LANDS STUDIES
COLLEGE OF EARTH SCIENCES
UNIVERSITY OF ARIZONA
AND
INDIAN DIVISION
OFFICE OF ECONOMIC OPPORTUNITY**

JOJOBA AND ITS USES

**AN INTERNATIONAL CONFERENCE
JUNE, 1972**

**Technical Editors
Edward F. Haase
and
William G. McGinnies**

**OFFICE OF ARID LANDS STUDIES
COLLEGE OF EARTH SCIENCES
UNIVERSITY OF ARIZONA
TUCSON, ARIZONA**

FOREWORD

The first International Conference on Jojoba and Its Uses was held at the University of Arizona, Tucson, Arizona, June 1-3, 1972. This meeting, arranged by the University of Arizona, Division of Continuing Education and Office of Arid Lands Studies and sponsored by the Indian Division, Office of Economic Opportunity, included two days devoted to conference papers and discussion and a one-day field trip to Superior, Arizona to see natural stands of jojoba.

The purpose of the conference was to bring together scientists and technologists interested in jojoba and its potentialities for production of useful products. The conference was aimed toward a full discussion of available information on previous investigations on the plant itself, on chemistry of the seed, utilization of the wax contained in the seed, problems involved in the collection of seeds and production under cultivation.

Major topics were introduced by invited speakers followed by contributed papers pertinent to the subjects under discussion.

The conference was divided into four main sessions: (1) Distribution of Jojoba, (2) Cultivation of Jojoba, (3) Utilization of Jojoba, and (4) a summing-up session during which all present were encouraged to contribute. Unfortunately the recordings of this last session were so poor that the discussion cannot be included in the Conference Proceedings.

Previous to the conference there were several smaller conferences, one at the Boyce Thompson Arboretum attended by people knowledgeable of the history of jojoba, its culture and derived products. This was followed by a meeting in Riverside, California at which representatives of Arizona and California Indian tribal leaders participated and indicated their interest in development of a jojoba program that initially would be centered around harvesting the native crop, and that over the period of years might involve jojoba culture and industrial production. As an initial step in bringing together existing knowledge on all aspects of jojoba, its availability, culture, chemistry and potential uses, the conference was arranged at the University of Arizona.

At the time of the conference, plans were made for publication of the Proceedings which would have been out earlier except for two things: (1) some authors were slow in turning in copies of their papers, and (2) at the time of the meeting it was hoped that additional material could be added to constitute a monograph covering all aspects of jojoba from botanical sciences to the lubricating sciences. There have been so many advances and increases in knowledge that it was recognized that this was a larger task than expected, so it was decided to get out the Proceedings without embellishment. The editors thought there was a great amount of useful information in the conference papers, and it appeared better to put off the publication of the monograph until later.

W.G. McGinnies
Conference Chairman
Office of Arid Lands Studies

TABLE OF CONTENTS

	Page
FOREWORD	11
EXPERIMENTS WITH PLANTING JOJOBA	
N.T. Mirov	1
STUDIES OF <u>SIMMONDSIA CHINENSIS</u> AT THE BOYCE THOMPSON SOUTHWESTERN ARBORETUM	
Frank S. Crosswhite	5
SUPPLEMENT TO THE NATURAL HISTORY OF JOJOBA	
Howard Scott Gentry	11
<u>SIMMONDSIA</u> STUDIES IN ISRAEL	
Meir Forti	13
JOJOBA SEED PRODUCTION POTENTIAL: ARIZONA, 1972	
C.S. Tomoff and J.D. Johnson	27
OUTLINES OF A RESEARCH AND TRAINING PROGRAM ON JOJOBA	
Quentin Jones	29
NEEDS FOR HORTICULTURAL RESEARCH ON PROPAGATION, CULTURE AND BREEDING OF JOJOBA	
A.E. Thompson	33
RESEARCH NEEDS FOR NATIVE PLANTS	
Edward F. Haase	37
RUNOFF FARMING FOR INCREASED JOJOBA YIELDS	
C. Brent Cluff	39
PREPARATION OF JOJOBA PRODUCTS AND THEIR POTENTIAL USES	
J.J. Spadaro and M.G. Lambou	47
SAPONIFICATION AND GAS CHROMATOGRAPHIC ANALYSIS OF JOJOBA WAX ESTERS	
Thomas K. Miwa	61
JOJOBA OIL AND MEAL SUBACUTE TOXICITY STUDY WITH RATS	
A.N. Booth	73
SUMMARIZING REMARKS	
Noel D. Vietmeyer	75
LITERATURE CITED	79

EXPERIMENTS WITH PLANTING JOJOBA

N.T. Mirov

Department of Geography
University of California
Berkeley, California

Very little had been known about the Sonoran Desert shrub, jojoba, before Greene and Foster (1933) at the University of Arizona reported in the Botanical Gazette on the chemical composition of its seed oil. They found that jojoba is the only plant in the world whose seed oil is not a tri-glyceride, but a mixture of two monobasic esters of two long chain alcohols, each one hooked up to a long-chain fatty acid. In chemical parlance, jojoba oil was not a common vegetable oil (a fat), but a liquid wax.

After this spectacular discovery, articles began to appear in trade journals and abstract publications, reporting possible uses of jojoba oil. Three years later (in 1936) the laboratories of two outstanding authorities on vegetable oils (Hilditch in England and Jamieson in the United States) almost simultaneously reported on the chemistry of jojoba oil. Both confirmed Greene and Foster's findings that the oil is indeed a liquid wax, similar to sperm whale oil, which itself occupies a peculiar place among animal fats.

In the late 1930's, I was much interested in the chemistry of pine seed oil and had to read the oil and fat publications. There I discovered jojoba. Its oil intrigued me and I wanted to grow it, chiefly to find out if the common fat-digesting enzyme, lipase, would hydrolyze its seed oil.

Little was known at that time about domestication and cultivation of jojoba. The University of California Agricultural Experiment Station reported in 1903 that jojoba had been planted in French Africa as a drought enduring plant, but the experiment was apparently not successful. Attempts to cultivate jojoba in Argentina also were a failure.

In the early 1900's the California Agricultural Experiment Station distributed jojoba seeds among cooperators throughout the warmer parts of California but I was unable to find out anything more about this project.

In later years, jojoba was planted in several botanical gardens in California and Arizona as a specimen plant and in parks and gardens of both states as an ornamental. I saw some planted jojoba at the Boyce Thompson Arboretum in Superior, Arizona and on the campus of the University of Arizona. Some bushes were also planted at the University of California Citrus Experiment Station, Riverside, California and in some Los Angeles parks. One large and grotesque jojoba bush, reportedly over one hundred years old, is found in the Elysian Park of Los Angeles.

Magnificent jojoba were planted in the cactus garden of the Huntington Estate in San Marino, near Pasadena, California. When I saw them in the 1930's, they were about fifteen years old. The northernmost locality of cultivated jojoba in California was in the Santa Barbara Botanical Garden.

There were also places in Southern California where jojoba was grown naturally in fenced pastures or in backyards of suburban dwellers. That was all I had to go by when I decided to cultivate jojoba. The planted bushes gave me some information how my "Cinderella of the Sonoran Desert" would respond to domestication and the wild bushes in fenced holdings showed me how mere protection of jojoba would influence its development.

I procured jojoba seed from wild bushes harvested by Indians around Globe, Arizona. The seed collection was organized by Fred Gibson, former Director of the Boyce Thompson Arboretum. There and then I learned how difficult it was to depend on wild bushes to procure enough seeds for industrial research. I decided that the only way to create a market for jojoba oil was to grow jojoba in plantations and treat it as a horticultural plant. I was waiting for an opportunity to finance my project. Meanwhile, I tried to plant jojoba seeds or seedlings everywhere my official duties (as a plant physiologist for the U.S. Forest Service) would take me.

I planted jojoba in the Bay region and inland valleys of California, in northern Florida, and at least I found where jojoba would not grow. The best place for its growth was in the citrus belt of the Southwest. In Florida, the hot humid climate and summer rains were not suited to jojoba.

The opportunity to establish a jojoba plantation came in 1940 when a friend of mine set aside about one half of an acre in his orange grove in Arlington, California and paid for the starting and maintaining of a modest jojoba plantation.

Everything was new for us in cultivation of jojoba. First we had to find out about the germination behavior of jojoba seed. We found that to assure germination, it was sufficient to soak the seeds in water overnight.

There were rumors that jojoba was an apogamic plant, i.e., that it could produce seeds without pollination, but our greenhouse experiments showed that pollination was necessary to set the seeds. Gibson (1938) reported in the Boyce Thompson Arboretum publication that jojoba was a dioecious plant. It meant that theoretically out of one hundred seeds planted, only fifty would result in female seed-bearing plants.

We prepared 175 "hills" and in each hill we planted three seeds. When the seedlings were three or four years old they started to show their sex with pollen catkins on male bushes and seed initials on the female bushes. Out of 175 hills, only two were all male. We culled the seedlings five or six years later, leaving one female plant per hill. In each fifth hill we also kept one male bush to provide the pollen.

When the female bushes reached the age of six years, they started to bear seeds regularly. At the age of ten years the plantation was in full production and not a single bush had died.

The plantation was irrigated approximately once a month from April through September and moderately fertilized with calcium nitrate when the surrounding orange grove was fertilized. Too much watering caused sucker formation at the expense of seed production. Irrigation had to be stopped towards the end of summer, otherwise tender growth developed which on one occasion was nipped by frost.

Shortly after the Arlington plantation had been established, I moved to Minnesota for the three winter months to do some forestry work. Winter in St. Paul is not an exciting time; the evenings were long and I spent them in the then famous Dr. Gortner's biochemical laboratory trying to hydrolyze jojoba oil enzymatically. Lipase had no capacity to do this.

I prepared a manuscript on physiology of oil formation in jojoba seed and its use during germination and suggested the role played by the unusual oil in the metabolism and the ecology of jojoba. However, my bread-and-butter project on pine turpentine prevented me from finishing the manuscript and publishing it.

Meanwhile, a California organic chemist and friend, H.D. Bruce, started to work with jojoba oil and sought people who would be interested in growing jojoba. I believe he was the first man who hydrogenated jojoba oil. In 1950, I predicted that jojoba would someday be a valuable domesticated plant (Mirov, 1950).

I published another article in Economic Botany (Mirov, 1952) in which I reported on our chemical and horticultural experience. My thesis was that the only solution to obtaining a steady source of jojoba oil was to plant jojoba, because gathering wild seed was not certain or economical. The market for jojoba products was no problem. We could sell as much oil as we could produce. The problem was to develop suitable methods of jojoba cultivation.

After ten years of cultivation we were able to select bushes with a high yield of seeds, and seeds with a high yield of oil. I recall that the highest yield was 56 percent of oil in the dry seeds.

We have done some greenhouse experiments with root development and found that the optimum temperature of nutrient solution was 25° C. Experiments with vegetative propagation of jojoba showed that cuttings can be rooted easily and conventional grafting methods were successful. We also started to think of methods of harvesting wild jojoba seeds. The chief difficulties encountered were that seeds ripened and fell on the ground continuously throughout the second part of the summer.

I corresponded with Dr. C.O. Erlanson, Head of the United States Department of Agriculture, Division of Plant Exploration and Introduction, regarding jojoba. It was he who induced the USDA to investigate the jojoba possibilities.

The Georgia Institute of Technology was commissioned by USDA to prepare a report on jojoba, which was published by Daugherty, et al. (1953). It included our experimental work, with references to my two publications, and I cooperated wholeheartedly.

On the basis of the report by Daugherty, et al. (1953), the government financed a project to investigate possibilities of jojoba oil. The chemical aspects of the project were handled by the USDA New Orleans Southern Regional Laboratory; the ecological studies and field work were accomplished by Dr. Howard Gentry, who did an excellent and thorough job of collecting jojoba seeds throughout the extensive range of the plant.

Our experiments at the Arlington plantation continued; the agricultural firm of Babcock and Sons, who managed the plantation, distributed our jojoba seeds to interested people. Among them was Dr. J. Elliott Coit, who started a modest plantation in 1952 at his "Demonstration Orchard" in Vista, California.

In 1943, Mr. H.D. Bruce and I convinced the "Durkee Famous Food" Oil Company (the Berkeley subsidiary of Glidden Oil Company) to start a jojoba plantation. They selected a location near Florence Junction, Arizona, acquired 640 acres of land and started to plant jojoba. It was at the time of the Second World War and their project was abandoned in favor of growing vegetables for military needs.

In 1953 at our Arlington plantation, when the bushes were about ten feet tall, handsome and bearing, the owner of the land asked us to discontinue our experiments and the plantation was destroyed. On the whole, our experiment was a failure, but no doubt it contributed to the knowledge of cultivating jojoba.

The reason for failure was the lack of financial support and the time was just not right for the industry to invest in jojoba cultivation. Also, we could not devote our full time to the project. After that period of 1940-1950 activity there was another lull of at least fifteen years. Then the interest in jojoba was renewed.

In any project of this sort, at least four prerequisites are necessary:

1. Demand for the product
2. Sound financial support
3. Familiarity with the plant and
4. The personal interest of a man who is technically trained to visualize the industrial possibility of the project and who is a good organizer and promoter.

STUDIES OF SIMMONDSIA CHINENSIS
AT THE BOYCE THOMPSON SOUTHWESTERN ARBORETUM

Frank S. Crosswhite

University of Arizona
Boyce Thompson Southwestern Arboretum
P.O. Box AB, Superior, Arizona

The University of Arizona and the Arboretum have long cooperated in studying Simmondsia. Although the Arboretum has officially been affiliated with the University only since 1965, I shall try to show that the roots of a joint effort with the plant extend back more than 40 years.

F.J. Crider, first director of the Arboretum, established cooperative studies with the University of Arizona in the late 1920's. Dean P.S. Burgess of the University's College of Agriculture was quick to visit the Arboretum to discuss cooperative work. Cooperation was most intense in agricultural chemistry and some University studies were conducted at the Arboretum and some Arboretum studies were done at Tucson. Guest houses were made available to University faculty and their students in the 1920's and 1930's and technical assistance, advice, and supplies were freely dispensed. Experiments were watched and results recorded by Arboretum staff when investigators were away. Several University botanists and chemists stayed at the Arboretum for a week at a time, and at least one biochemist for 6 weeks.

During this period it was customary for the Arboretum to send soil samples, water samples, pieces of plants, or practically anything down to the University to be analyzed. Rather complete analyses were quickly sent up to the Arboretum in almost all cases. In the early thirties the University had fully embraced the Boyce Thompson Arboretum. Director Crider was a regent of the University and President Shantz had conferred a Doctor of Science degree on Colonel William Boyce Thompson himself.

During this early period, great progress was made on many fronts and many classic studies resulted which we tend to forget today. Yes, indeed, jojoba studies were a part of that cooperative program-- and the discovery that jojoba oil was actually a wax similar to sperm whale oil came from seeds sent down for analysis from the Arboretum.

Ralph O. Baird published a note in 1948 telling how early Spaniards in the Southwest had pressed oil from jojoba for use as a hair dressing and mustache wax. He described how this had led him and Fred Gibson to grind up jojoba seeds in 1929 when he worked at the Arboretum and extract the oil for chemical analysis. This, he modestly recorded, was the forerunner of hundreds of samples that were later sent to institutions and individuals for study.

But the story of jojoba at the Boyce Thompson Arboretum has not yet been told. So little has been published concerning the Arboretum's activities with this plant, that we are taking this opportunity to hit the highlights of nearly 50 years of activity. Fortunately, the botanical correspondence of the Arboretum, the journal of the propagator, the daily record, the monthly reports and the annual summaries are extant. These have been used in constructing the following summary.

On April 5, 1925, the first jojoba seedlings came up in the Arboretum nursery. The next day Colonel Thompson and J.F. Crider personally staked out an experimental jojoba planting east of Picket Post House, along the road near the Indian Village. This area was seeded on April 16. Emergence of the seedlings on May 12 followed a slow soaking rain on April 22 that measured 1.6 inches. Although jojoba may start germinating in 10 days, stragglers may come up at the end of a month. It was later found that seed held at low temperatures before planting germinates more regularly.

The plants on the dry lands were watched and compared with those started under cultivation and irrigation. By September 30, the cultivated plants had tripled their size over those in the wild and by 1931, J.F. Crider wrote that he had gotten jojoba to come into bearing in 5 years from seed, producing satisfactory oil-bearing nuts. These Arboretum plants produced about 1/2 pound of seed the first year after coming into bearing. These had been grown following Crider's opinion that for the plants to do best under irrigation, they should be given water comparable to about 30 inches of rainfall.

In 1935, the Arboretum had a row of plants in its nursery that was 10 years old from seed. These were 6 feet high and 6 feet broad and had been bearing for 4 years. The planting had been made using seed from a selection of large nuts. It was estimated that the dry-land planting would not bear seed until 25 years old.

By 1937 the plants seeded in 1925, on undisturbed upland areas of rock and clay, ranged from 6-18 inches in height. Other plants from the same seed harvest were cultivated in a sandy creek bottom, but were planted 4 years later. They fruited and were already 4-5 feet high after 8 years.

By 1940, the 15-year-old seedlings planted in the wild had only become 2 feet high, whereas those under cultivation had matured to 7 feet in height and were bearing abundantly.

At an early date it was discovered that jojoba plants will not live if dug up and transplanted, regardless of how small the plants might be. This is because the taproot grows rapidly and important feeder roots may be 18 inches deep before significant shoot development occurs. These feeder roots are invariably lost in digging out the plant. It was found that if rains are likely or irrigation possible, the plant should be directly seeded in the field. When planting arid hillsides, where irrigation might be difficult, plants started in gallon cans may be set out as year old transplants. Director Crider found that very tall pot substitutes allowed best growth of the long taproot. Roots of jojoba were studied by Crider in specially-designed concrete lysimeters having glass windows for observation. Significant winter growth of roots was observed. Crider developed a theory that growth of the root alternated with growth of the shoot.

Although one Arboretum botanist, Bernard Benson, is cited in the literature as stating that jojoba has only one season of growth, namely that of winter and spring, Fred Gibson recorded that growth was continuous except for the coldest winter months.

Most of the Arboretum experiments in jojoba growth compared the dry-land plants on clay with cultivated plants on sandy silt. However, in 1943 Gibson observed that a few plants irrigated on heavy clay grew as well or better than those on sandy silt. In the Arboretum area the wild plants generally grow on clay soils rather than the sands and silts of the creek bottoms.

Director Crider became intensely interested in erosion control planting at a time when no such work had ever been done. After conducting extensive experiments in root growth, dry-land plantings, and reforestation at the Arboretum for five years, he agitated widely for conserving soil by planting covers on the land. He developed a cooperative program whereby a large nursery of erosion control plants was established by the Forest Service on Arboretum property for distribution largely to Indian Reservations. Labor was provided by the Civilian Conservation Corps. The Arboretum paid for physical improvements such as drilling two new wells in Arnett Canyon and, most importantly, provided technical know-how and most of the seeds.

Jojoba was considered a valuable erosion control plant and was seeded widely. The soil conservation nursery became so successful at the Arboretum that the Federal Government saw need for duplicating it elsewhere. The program mushroomed quickly and was administered by several different government agencies in a cooperative manner. Success meant consolidation and formation of the new U.S. Soil Conservation Service. In 1934, Dr. Crider left the Arboretum to help begin the new agency. He was for many years in charge of the greenhouses, gardens and several assistants at Beltsville, Maryland. We can all be proud that the Arboretum was an important breeding ground for the Soil Conservation Service and that jojoba played some role.

Most of the botanists who worked at the Arboretum were bitten by the jojoba bug and in moving on to other better paying positions, infected those around them. Like the Spanish Padres or Johnny Appleseed, they planted seed wherever they went. Fritz Berger, formerly the cactus expert at the Arboretum, planted jojoba bushes at the Huntington Botanical Gardens. These famous bushes from Arboretum seed were seen by thousands and under irrigation came into production at an early date with unusually large seed yields.

Likewise, Palmer Stockwell, the former chief propagator at the Arboretum, spread knowledge of jojoba at the California Range and Experiment Station at Berkeley, California. Certainly the Arboretum cannot take credit for the monumental work on jojoba done at that station by N.T. Mirov and H.D. Bruce, but we do hope that our seed shipments and cooperation were of help.

J.W. Davis left an account at the Arboretum showing that in 1936 the new Soil Conservation Service sent six men into the Tucson Mountains to pick jojoba. The crew gathered 2,374 pounds of seed. Many more seeds could have been collected but the intense July heat suggested picking further north. Three men were therefore sent to the Roosevelt Lake area where 766 pounds of seed were collected from July 9 to July 16. Most of these seeds were planted out in the foothills and mountains of Arizona in areas needing soil erosion control.

Nat Patterson, a San Carlos Apache Indian, worked at the Arboretum for approximately 40 years and became something of a living legend. He was a tribal doctor trained after the old style and delighted in the herbs and medical plants at the Arboretum. These plants were his friends and he was given wide latitude in determining the care each one should receive. One Arboretum director recorded that Patterson believed he owned the water supply and would dole out irrigation to each shrub and tree as he thought it deserved. He clearly held the power of life or death over the plants of the Arboretum and his favorites were indeed well cared for.

The lush growth of jojoba in the Arboretum today partly testifies to Patterson's interest in the plant. He left a written record describing the medical use of jojoba seed after the old Apache knowledge.

Colonel Thompson knew Natchilta (as was his proper name) personally and asked that he be allowed to establish an Indian Village at the east boundary of the Arboretum. It is recorded in the Exchange records of the Arboretum that the first request for plant materials or seed came not from a university or botanical garden but rather from an Apache Indian who lived in the Village.

In 1931 there existed a company in Pasadena, California, known as Stilehoba Laboratories, which specialized in making a cosmetic from jojoba oil. Two tons of seeds were collected at Superior by women and children in 1931. The company paid 20¢ per pound F.O.B. Superior. The Arboretum furnished data on jojoba at the request of the company, but it never could be ascertained just what type of cosmetic was being made. Inquiries came to the Arboretum in 1931 from a physician in Nogales wanting information on jojoba as a hair oil, and it has been widely stated that Sonqrans have long used it for that purpose.

The 1931 Superior harvest was successful because a very good price was paid. Women could reach the higher seeds on the bushes and children could get the lower ones or those on the ground.

At an early date Director Crider took a sample of jojoba seeds to the Agricultural Chemistry laboratories of the University of Arizona and requested an analysis. The results of this analysis were sent to the Arboretum on January 28, 1931 and consisted of a breakdown of the nut as to percentage of moisture, ash, protein, oil, crude fiber and nitrogen-free extract. Together with this rough analysis was a promise that the results of tests on the oil itself would be forthcoming soon. Upon request, more seeds were sent and periodically replenished until Robert A. Greene finally announced the startling discovery that the oil was in fact a liquid wax similar to sperm-whale oil.

In 1931 or before, agricultural chemists from the University of Wyoming were presented a bottle of jojoba oil pressed at the Arboretum. They too forwarded reports to the Arboretum on other aspects.

In 1935, Carleton Ellis, an oils chemist, was staying at the San Marcos Hotel in Chandler, Arizona. The Arboretum invited him to visit its facilities to become acquainted with jojoba and to discuss the possible utilization of the seed oil. Mr. Ellis came to the Arboretum and thought so much of jojoba that he was given a 20 pound carton of seeds. He promised to let the Arboretum know the results of his investigations. Later Ellis agreed to submit the findings to be published as a contribution of the Boyce Thompson Institute if desired. At about this same time, jojoba seeds from the Arboretum were analyzed in relation to certain enzymes at the Boyce Thompson Institute at Yonkers, New York.

Through the years, literally tons of jojoba seeds were shipped by Director Gibson to chemical laboratories for experimentation. For instance, in 1936, 100 pounds went to the chemist of a Chicago company dealing in oils. In 1937 seeds went to a chemist in Glendale, California, also to a New York company specializing in pigments and colors, and 500 pounds went to a watchmaker in Washington, D.C. In 1940, 75 pounds went to Chicago for experimentation by a manufacturer of printing press rollers.

Bags of seeds began to flow at an increasing rate from Superior, being sent to a large soap company, a well-known meat-packing company in Chicago, a large photographic chemical company, the National Research Council of Canada, a large chemical company in Midland, Michigan, a motor control company in Milwaukee, Wisconsin and to many chemists and individuals for unknown purposes. All of these persons had been led by their reading or research to think that jojoba oil might prove useful in their particular products or processes.

But Fred Gibson also had a talent for drawing chemists and industries into jojoba studies. For example, during World War II the Crown Cork and Seal Company operated a rather large cork-oak nursery in Arnett Canyon on Arboretum property. This was part of a cooperative arrangement whereby the government shipped seed of cork oaks to the Arboretum to be raised by Crown Cork using Arboretum facilities and technical advice. Young oaks were given away free to the public in an attempt to establish a cork-oak industry in Arizona. This was all in the best traditions of the Arboretum and was a thoughtful step toward emergency preparedness brought on by the war. Officials of Crown Cork and Seal Company frequently visited the Arboretum and became so bitten by the jojoba bug that they tried to arrange the collection of several tons of jojoba seed in 1943. They had their Phoenix agents determine the density of jojoba bushes in the McDowell area and along the Apache Trail in Central Arizona.

Crown Cork planned to press the oil at an olive press in Phoenix, use the press-cake in a cattle-feeding experiment, and use the oil in its own experiments in the East. Difficulties in collecting cancelled the enterprise, but 328 pounds of seed sent by the Arboretum in 1944 allowed experimentation on the oil itself.

In 1942, Dr. Ilona Taussky was referred to the Arboretum by Dr. William Crocker, Director of the Boyce Thompson Institute at Yonkers, New York. Although that year's crop was already committed or perhaps doubly committed and the harvest was practically a failure, 87 pounds were held out and shipped to her New York Laboratory. In a biographical letter to Fred Gibson, Miss Taussky described herself as a consulting and research chemist in oils, fats and waxes working particularly with hydrogenated products. Before World War II she had worked in over 50 oil plants in Europe and had also consulted in Great Britain, India and Egypt. Dr. Taussky's early work with jojoba was done with seeds from Mexico.

Her first U.S. Patent, applied for in 1942 and granted in 1944, was concerned mostly with cake batters but the patent clearly stated that she could obtain sulphonated, elaidinated and hydrogenated jojoba nut oils, saponified unhardened, saponified elaidinated and saponified hydrogenated jojoba nut fatty acids, as well as unhardened, elaidinated and hydrogenated jojoba nut alcohols.

It has been rumored that before World War II, the Germans were experimenting with jojoba and trying to get large tonnages from Mexico. In 1938, Harry M. Pickering inquired of the Superior crop. He had been importing from Sonora, Mexico since 1933 where he had a government cooperative concession and had put several tons into the hands of four well-known U.S. corporations for experimental purposes. He wanted to turn to U.S. sources because of the difficulties involved in importing, which he detailed as consisting of \$160 per ton U.S. Customs duty, \$30 per ton railroad rate, a stamp tax, a concession tax, and "many other nagging fees." Aside from the fees he had been hit with a ruling that the seeds had to be cracked into pieces before entering the United States. One supposes that such a U.S. policy did little to keep jojoba away from Germany!

Jojoba oil pressed at the Arboretum in 1929 was used for years to lubricate a fan. Some of the oil was given to a dentist for use on high speed mouth instruments where taste of other oils was objectionable.

John Finn, a consulting chemist for the Magma Copper Company, a mining enterprise set up at Superior by Colonel William Boyce Thompson, visited the Arboretum and was bitten by the jojoba bug. He went to San Francisco, California, where he worked with Dr. B.L. Freedlander of the Harold Brunn Research Institute, Mount Zion Hospital in some profound experiments in the chemotherapy of tuberculosis using jojoba nuts. Sprouting jojoba seeds were crushed and fed to guinea pigs that had been infected with human tuberculosis. It was reasoned that germinating seed contained enzymes to digest the wax which was similar to the waxy sheath which conferred virulence to tuberculosis organisms. In 1943, Dr. Freedlander sent a rather detailed letter to the Arboretum outlining his experiments which were not complete. The letter was clearly one of appreciation and cooperation by a man of unselfish character devoted to the advancement of science. The letter ended, "Your agents here have kindly been supplying me with the nuts for which I am very grateful."

John Finn himself set up a little jojoba laboratory in California and manufactured several items for display at the Boyce Thompson Arboretum. These display items consisted of a large piece of jojoba rubber, an alcohol fraction that was a perfume, and a sample of hardened hydrogenated wax.

In 1944, Fred Gibson suggested to a New York medical doctor that he do research with jojoba oil on prolonging the action of drugs such as penicillin. Gibson had followed the jojoba race for so long that he saw himself behind the scenes pulling all the strings. He concluded, "will be glad to have your opinions about so using the oil and if you want to try it for such specific purpose, I will not ask other doctors to try the same experiments."

During World War II, a much-publicized commercial jojoba plantation was established at Magma, Arizona adjacent to the Southern Pacific tracks, by a famous salad-dressing company which was a division of a well-known paint and varnish company. Rumors flew right and left as to the use contemplated for the jojoba oil. Newspaper accounts of the day are inaccurate. In looking back now, our best evidence is that most or all of the oil was intended to be sold to yet another company. Although the Arboretum tried to help with advice and consultation at no charge, Director Gibson could only frown at the way the plantation was developed.

Seed for the plantation consisted of 1800 pounds of Mexican origin shipped to the Alabama warehouse at Superior. Literally tons of jojoba seed had been shipped out of Superior before, but no one had yet conceived of shipping it in!

Shortly after the seedlings came up (at T3S, R8E, Sect. 36), Fred Gibson counted 60 cows having a picnic all over the place, as he put it. Gibson advised that for the plantation to be successful it would have to be taken better care of.

Gibson believed that the seeds planted every 6 1/2 feet in rows 12 1/2 feet apart were too sparse to allow later weeding-out of excess males. Germination proved poor and replanting insufficient. Gibson advised in vain not to rely on transplanting field-grown seedlings. Fall seed

rotted in the ground. In 1946 Gibson noted that the plantation had not been planted right at all and that the operators were not replanting where needed. Furthermore, they were irrigating and cultivating areas where no plants were growing.

Gibson had warned against using Mexican seed, since the plants might not be cold-hardy. Sure enough, after three years' cultivation, a heavy frost wiped out most of the plants. Eventually the field was dug up to plant potatoes.

The failure of the Magma plantation cast an ugly shadow on Gibson's lifetime ambition of creating a jojoba industry benefiting people living in this part of Arizona and putting marginal lands to use. But after this bitter experience, and shortly before his death, Gibson still advocated jojoba plantations. He particularly advocated planting seed from bushes having desirable genetic traits, such as cold-hardiness, large seeds, clustered seeds, and so forth. The seeds could not just be thrown in the ground. This was a job for experts.

Gibson realized all too well the expenses necessary for a successful plantation. Genetic improvement and propagation must precede it. On behalf of the Arboretum, Judge Charles F. Ayer, long of 14 Wall Street in New York, tried unsuccessfully to interest monied people in financing jojoba studies at the Arboretum or in establishing plantations in Arizona. He discussed jojoba twice with Bernard Baruch but to no avail. Judge Ayer was long a board member and benefactor of the Arboretum and our reservoir is named Ayer Lake in his honor.

It was certainly a cruel twist of fate that placed a plantation practically in the Arboretum's backyard but away from the reach or control of Fred Gibson. Just before Director Gibson died he recommended that jojoba plantations be made by planting seed at six inch intervals in rows 12 feet apart as if to make a hedge-row or ornamental hedge. He recommended planting in flat borders or in slightly depressed ditches so that the seed could be kept moist enough to germinate in 10 days to two weeks. The seed should be drilled in and planted 1-2 inches deep with a modified cotton planter having a hole in the disc large enough to handle the seed graded to size. As soon as the sexes are determined, males should be grubbed out to leave one male bush to about ten female bushes. At least in the Superior region, the distribution of sexes is very uneven, there being many more males than females. Thick seeding in plantations is thought to be necessary in case excess males appear.

During 1950, jojoba seed was sent twice from the Arboretum to an industrialist in New York who was interested in the wax. It was learned that the first batch had actually been forwarded to Dr. Oved Shifriess of the Weizmann Institute for possible culture in the desert country of South Israel. Fred Gibson was apparently quite pleased, as he forwarded information on care and irrigating to the industrialist and a larger shipment of seed.

Although both the Eddy and Coit plantations in California were planted with seed and advice from N.T. Mirov, I believe that in each case, Superior seed was used, although this is partially contradicted by the literature.

Following World War II, the Research and Marketing Act of 1946 paved the way for the USDA Division of Plant Exploration and Introduction to initiate new jojoba research. A contract for the study of industrial raw materials of plant origin was awarded to the Georgia Institute of Technology. In characteristic fashion, Fred Gibson made his notes and jojoba bibliography available. The Institute's well-known literature survey entitled "A Survey of Simmondsia chinensis (Jojoba)" appeared almost simultaneously with Director Gibson's death in the summer of 1953.

Fred Gibson saw the Arboretum through a very difficult period in its history, assuming management at a time when the operating budget had plummeted and prospects for funding of research were bleak. For 20 years Gibson made jojoba his special interest and an area of concentration in the Arboretum's workaday routine. He made the Arboretum a clearinghouse for information of all kinds on jojoba. His own notes and ever-increasing manuscript material on the natural history of jojoba were constantly revised and made available without formal publication, other than a fragmentary note in the Contributions from the Boyce Thompson Institute and numerous references in the Reports to the Directors of the Boyce Thompson Southwestern Arboretum. Unbelievable quantities of jojoba nuts were picked year after year to be used for chemical research. He was intensely proud that the Arboretum initiated the research at the University of Arizona which unexpectedly resulted in the original discoveries that jojoba oil was chemically a wax and that its properties were similar to those of sperm-whale oil. He was fired with enthusiasm when Carleton Ellis of Montclair, New Jersey received the first U.S. Patent for a chemical process with jojoba using oil pressed from seeds which Gibson had sent him.

Each time the Arboretum shipped seeds to laboratories requesting them, Director Gibson asked that he be informed generally of the research to avoid duplication and that the Arboretum be advised of any new patents arising from discoveries. To each new correspondent, Gibson sent an ever improving bibliography which he had compiled on all aspects of jojoba together with a list of patents on chemical processes relating to the wax. Gibson clearly abhorred duplication and inefficiency in science and

accepted his own role as one of hard work with little glory. Just three months before Fred Gibson died, he quite fittingly was made a Fellow of the American Association for the Advancement of Science in an expression of approval by his fellow scientists.

For 50 years the Arboretum has seen oil brokers come and go from Superior looking for jojoba oil. Many wanted tens of tons of jojoba seed per year. Some wanted hundreds of tons and a few naively expected thousands of tons to materialize. Collection points were set up at Superior, Tucson and Nogales, but speculators soon learned the cruel truth that commercial tonnages were simply not available, particularly at 2 or 3 cents per pound, which is all many wanted to pay.

Fred Gibson gave aid to them all. He put jojoba displays in store windows and lined up lists of prospective workers. Although Superior could always be counted on for a ton or two of seeds, unless the crop simply failed, picking in other localities usually failed altogether, probably because of poor organization.

The Forest Service once set a fee of \$5.00 per ton for commercial picking. Gibson worked to get this reduced to \$2.00 per ton. But the Forest Service had no authority to issue an entirely free permit.

Although thousands of tons do indeed mature annually, no one has even gotten more than a few tons in any one year. Director Gibson felt that at a high price and with good organization, 65 tons per year was the maximum possible from the wild crop in Arizona. From Superior could come 10 tons, from the Ray district the same, and from the San Carlos Reservation half that amount. The Papago Reservation maybe 20 tons. Tucson about the same. However, these estimates are indeed generous and there is no record of more than 2 tons coming from any locality in any one year.

Commercial picking at Superior often interfered with Gibson's program of buying the seed to send to chemists. One year chemists simply got no seed because a commercial company got the Superior crop. To assure a supply for the steady requests from laboratories, Gibson resorted to personally buying a year's crop of about 3000 pounds even though research requests for one year would rarely total that much. The seeds do not deteriorate for years although they do lose a small percentage of water.

Moisture content is high in fresh seeds, but diminishes as they hang on the bushes during the hot summer. It is usually necessary to dry fresh seeds for ten days before bagging them.

Shipping records after Fred Gibson's death are incomplete, but most significant jojoba shipments from the Arboretum seem to have been to the Southern Utilization Research and Development Division of the USDA, including 200 pounds in 1953, 230 pounds in 1954, and over 1,000 pounds for the 6-month period ending March 20, 1957.

Bernard Benson experienced difficulty getting another 1,000 pounds requested that year. I am not certain, but I believe from this point on, Dr. Howard Scott Gentry supplied most of the seed.

When Colonel William Boyce Thompson set up the Arboretum, he said, "Find one plant that will add to the welfare, comfort, and happiness of the people of this less favored, sadly neglected region, and we will have done a great service." Fred Gibson thought that he had found the plant. I am sure that we all hope together that the present renewed interest in jojoba will bear fruit.

SUPPLEMENT TO THE NATURAL HISTORY OF JOJOBA

Howard Scott Gentry

Desert Botanical Garden
Phoenix, Arizona

Jojoba, or Simmondsia chinensis (Link) Schneider, blends quite naturally into the background of the arborescent vegetation of the Sonoran Desert. The dense leafy form and the acorn-shaped fruits give it a recognizable image. Man's curiosity led him to investigate the fruits and to analyze the peanut-sized seeds within. He found a unique oil, looked at jojoba with a new respect, and began getting exploitative ideas. These ideas have eventuated in this first International Conference on Jojoba. My place on the agenda here is to show some of jojoba's characteristics as they have evolved in its natural environment. My observations must be brief and will supplement rather than repeat my earlier writings on jojoba (Gentry, 1958, 1965). Other contributors to this conference provide more specific information bearing on the problems of domestication.

Jojoba is one of six genera in the family Buxaceae. It is the only xerophyte among them and has no close relatives geographically or otherwise. The origin of jojoba is obscure in geologic history. There is no fossil record. Its area of distribution approximates that of the Sonoran Desert and it should be considered as a regional endemic. It appears quite thoroughly adapted to all but the drier centers of the Sonoran Desert. Where annual precipitation averages drop below 7 or 8 inches it is confined to more favorable moisture sites, as along arroyos or coastal dew fall. By relapsing into leafless dormancy, it can survive 1 to 2 years of rainless periods, which commonly occur in some parts of the desert, and rebud from old wood when rain does appear.

Stebbins and Major (1965), on the basis of jojoba distribution, regard it as a paleoendemic. If jojoba is an old relic species, it is difficult to explain its absence in the north Mexican desert region. Koeberlinia and Holocantha, as two examples among many such paleoendemics, are represented in both the Sonoran and Coahuilan Deserts. The obvious suitability of jojoba to the Sonoran Desert environments, its habit of growing and flowering with the winter-spring rains, and the maturation of seed in the dry summer, all indicate jojoba had its origins along or near the Pacific Coast in the Mediterranean type of climate. The cold of the highlands along the continental divide apparently has been a barrier to migration eastward. Other obvious barriers are the closed climactic communities of Chaparral to the northwest and Thorn Forest to the south. Jojoba likes the open spaces, the milder climate, and moister margins around the Sonoran Desert. The drier centers of this desert outline the limits of jojoba tolerance to drought. The depauperate plants in the desert are an inverse measure of environmental stress.

Another and quite different stressful condition is represented by the fauna associated with jojoba. Jojoba is nutritious browse. Deer, antelope, sheep, and especially man's cattle can consume jojoba faster than it can grow. In the long prehistory of jojoba this is nothing new. One has only to recall Scott's "History of Land Mammals" (1937), or Frick's Ruminants of North America (1939), or a visit to the La Brea Quarternary tar pits to revisualize the abundant fauna that grazed, browsed, and champed the Upper Tertiary vegetation of North America. Those mammals must have worked over the palatable jojoba very destructively again and again, according to increasing ruminant populations. The general absence of jojoba in Mesquite Grassland, which appears in many areas a most appropriate habitat, may be due to overuse by the ruminant fauna of the Pleistocene. During such periods, the drier portions of the desert, where jojoba could survive while ruminants died of thirst, would have provided a jojoba refuge and seed reservoir for periodic resurgence of jojoba populations. This is a considered assumption, not a provable case, but in any event, it is obvious that the ability of jojoba to withstand drought has been a strong factor in its survival. The fact that jojoba now occupies about the entire limits of its range all around the Sonoran Desert indicates it has been here for a geologic-long time. The many irregularities in distribution within the area are due to local factors, some of which are indicated above.

There are certain requirements that any wild plant must meet before it can become a cultivate:

1. It must yield a product in relative abundance.
2. It must be responsive to the artificial environments of man.
3. It must have a genetic endowment that will support intensive selection of varieties.

Jojoba meets the first requirement of productivity very well. It produces a high yield of seed oil during seasons of high rainfall, and has already produced seeds in limited culture trials, with and without irrigation.

Jojoba has met the second condition of man's environment in a qualified way. The earliest trials at cultivation were failures, but the failures were due to the ineptitude and neglect of the cultivators.

Overuse of water is reported to have seriously injured the 1943 planting near Florence, Arizona, and the later Eddy planting at Arlington, California. Later plantings by Coit (1962) at Vista and the Agronomy Department of the University of California at Riverside, California, showed jojoba as productively responsive to both dry-farmed and irrigated test plantings.

The third requirement regarding the genetic versatility of jojoba has been conjectural because of the lack of specific information. In 1965 Raven and Kyhos reported jojoba as having $n=26$ chromosomes, while Stebbins and Major (1965) reported a sporophyte count of ± 100 and classified it as a paleopolyploid. The variability of characters in habit and in fruiting have also been observed to recur in cultivated progeny. Fascicled-fruited plants and openly branched plants have been repeated in seeded progeny. We do not yet know if and how polyploidy is responsible for these variables, or for any other observable or cryptic characters. However, it is clear that these characters have genetic base and the presence of polyploidy does assure us of a large potential for breeding varieties for agricultural use. Jojoba adequately meets the three requirements set forth above. We need only to liberate jojoba from the rigorous restraints of arid environment and the indirections of its genes.

Man cultivating his crops can be considered as in a symbiotic relationship; as he provides protection and substance for his plant, the plant yields up food and substance for his man. This cozy condition appears particularly appropriate to the digging stick and the plow and oxen stages of agriculture. While the modern planter, with his mathematics and machinery, seems more remote from his subjects, successful agriculture still demands unremitting attention. Man must live with his cultivates. This is even more strongly requisite when a new plant subject is brought into cultivation. Jojoba will make its demands and provide many problems. They can be recognized and satisfied only with man's cohabitation. The farmer can receive messages he would not otherwise get. At this incipient stage of jojoba development, we should not only ask, what jojoba can do for us, but rather what we can do for jojoba.

Finally, for scene one of the stage set here, there comes a message borne as upon a western wind. Chief Jojoba has heard the singing of the whale. Chief Jojoba has a message. The message is: Young man, careers are looking up. Get with Jojoba. Be a Jojoba symbiont!!

SIMMONDSIA STUDIES IN ISRAEL

Meir Forti

Division of Life Sciences
The Negev Institute
Beersheba, Israel

INTRODUCTION

Any plant species which could grow in an arid area and contribute to its economic viability is worth investigating. Various ecological and economic considerations have drawn attention to the possibility of cultivating Simmondsia chinensis (Link) Schneider in Israel. Certain aspects of the Negev, the arid and semi-arid area in southern Israel, resemble the native habitat of Simmondsia in the southwestern United States. The liquid wax obtained from its seeds appears to have promising industrial potential. However, adapting a wild species to cultivation is a protracted, expensive and uncertain process. Thus in Israel, as in other countries, interest in Simmondsia fluctuates, and research has been slow and irregular.

Simmondsia had already been introduced in Israel before the Negev Institute began its trials. Dr. Gindel of the Volcani Institute--Beit Dagan included it in his introduction program, and some of his plants are still growing in that part of the arboretum which became the garden of the Faculty of Agriculture in Rehovoth. In 1958, Professor Shifris of the Department of Plant Genetics of the Weizmann Institute of Science, Rehovoth, obtained six seed lots from Dr. H.S. Gentry for purposes of investigating sex heredity. They were collected in 1957 from wild populations and individual plants in California and Arizona (Dr. D. Atsmon, personal communication). These seeds were apparently the source of some 50 seedlings planted in 1959 by Mr. Y. Orev, of the Ministry of Agriculture, Beer Sheva, in the nursery of the Soil Conservation Service in Nevatim, southeast of Beer Sheva (loessial soil, 150 mm or 6 in. rainfall). They were irrigated by an underground system and grew satisfactorily. When irrigation was stopped in 1969 the plants declined sharply. Production varied widely between individual plants: yields of up to 800 gr. (1.7 pounds) per plant were registered.

In the early sixties Simmondsia seedlings were grown on the Demonstration Farm of the Ministry of Agriculture in Zrifin, near Tel Aviv. The origin of the seeds and the fate of the seedlings could not be ascertained.

Plants propagated from seeds sent from Davis were transplanted in 1960 in the Botanical Garden of the Negev Institute in Beer Sheva. They grew well until May 1972, when virtually the entire garden was destroyed in the wake of new urban development.

THE NORTHERN NEGEV: CLIMATE, TOPOGRAPHY AND LAND USE

The northern Negev is characterized by a Mediterranean climate. Rainfall occurs only in the months from November through April. Precipitation decreases sharply over a short distance from north to south and from the Mediterranean shore eastwards to the interior. Beer Sheva has an average annual rainfall of about 200 mm (8 in.). Some 25 km to the south, the rainfall decreases to about 100 mm (4 in.) and in the east, in the Dead Sea area, it drops to 50 mm (2 in.).

Temperatures are high in summer (average monthly maximum in Beer Sheva: May, 39° C., 102° F.) and sometimes reach 45° C. (113° F.) and more. They seldom drop below 0° C. (32° F.) in winter (average monthly minimum in Beer Sheva: January, 1.8° C. or about 35° F.), although temperatures under 0° C. may occur from end November until beginning April. The average daily range is wide throughout the year (15.5° C. or 60° F. in May in Beer Sheva).

Relative humidity is low (annual average in Beer Sheva, 58%) and may drop to 10-20% and less, with the dry, hot inland winds of May and June.

The area comprises a system of hills and undulating plains, broken by the beds of intermittent water courses. Soil is mostly of aeolian origin, calcareous, generally coarser south and southwest of Beer Sheva and finer elsewhere. It is deep in the plain and shallow and eroded on the hill slopes.

This is traditionally a range area, with pasture consisting mainly of annuals. Under higher rainfall and in favorable topographical conditions, winter crops are grown. The sharp deviations of rainfall from the mean (339 mm or 13.5 in. in winter 1964-65, 42 mm or 1.6 in. in 1962-63) or its erratic annual distribution, or both, make land utilization uncertain under natural conditions.

The soil in the plain is fertile and crops respond well to irrigation. The resources of good quality water, however, are exhausted. Hence the interest in drought resisting or salinity tolerant crops or both, particularly those presumed to benefit from specific aspects of the area.

ORIGIN OF THE NEGEV INSTITUTE PLANT MATERIAL

The Simmondsia material used by the Plant Introduction Department of the Negev Institute has two main sources:

1. Dr. Gentry. This material belongs to the same six seed lots, which, as already mentioned, Dr. Gentry sent to Professor Shifris. It was collected in Santo Tomas and in Santa Marta, Baja California, in Aguanga, California and three lots at Camp Creek, Arizona. The seeds were taken from single shrubs or local populations. Some of the seeds were used for propagating the seedlings transplanted by Mr. Orev in Nevatim, and others were given to the Negev Institute. The seedlings obtained were transplanted by Mr. A. Kadish in the Institute grounds in Beer Sheva in 1961.
2. Dr. R.G. Stanley (then of the Institute of Forest Genetics, Placerville, Calif.) and Mr. A. Kadish. This collection consisted of 75 seed lots and comprised about 50 different sources. It was collected in 1959 and in 1960 in California from wild populations and single plants as well as from individuals cultivated in various gardens. The seeds were propagated in the Department nursery in Beer Sheva in 1960 and 1961. The seedlings obtained were transplanted in experimental plots at the Negev Institute and at Gilat, a nearby forestry nursery, in 1961, 1962 and 1963.

EXPERIMENTAL PLOTS IN THE NEGEV

Seven experimental plots of Simmondsia were planted in the Negev by the Negev Institute. Five are growing satisfactorily. Planted over the years 1961 through 1969, all of them are in loessial, non-saline or slightly saline soils and differ mainly in soil characteristics, rainfall, and the origin and purpose of the material utilized. Table I shows the main characteristics of the different sites.

1. Beer Sheva, Introduction plot

The plot covers an area of about 2.5 dunams (about 3/5 acre) and was planted during 1961 and 1962 with about 2,300 seedlings. Since inferior specimens had to be eliminated early, spacing was very close: 1.5 x 0.5 m (60 in. x 20 in.). The initial furrow watering has now been replaced by sprinkler irrigation. Abundant water was supplied at the beginning, and was gradually reduced to one irrigation per summer. Various surveys were carried out on this plot. The yield data in particular, and observations on vegetative and morphological characteristics enabled a first selection of plants in 1967. About 50% of the original material was eliminated.

2. Gilat, northwest of Beer Sheva

This plot was planted by Mr. A. Kadish in January 1963 in the nursery area of the Jewish National Fund and is a joint project of this Fund and the Negev Institute. Its 1,300 seedlings were propagated from the seeds collected in California by Stanley and Kadish. It covers an area of about 7 dunams (1,3/4 acres) and its wider spacing (4 m x 1.25 m; 13 ft. x 4 ft.) enables mechanical cultivation between rows. The furrow irrigation initially used was replaced by a simplified drip irrigation system in 1967. Since 1964 three water regimes have been applied for preliminary information on plant response to water:

- a. Rainfall only. Supplementary irrigation in drought years up to the annual mean was considered, but never applied;
- b. An additional 200 mm of water in one irrigation at mid-summer;
- c. An additional 200 mm of water in two applications, one at mid-summer and one at the beginning of the fall.

In 1971 no irrigation was given, as rainfall approximated the total amount of water planned for the experiment.

Individual harvesting, together with morphological observations provided sufficient data for a preliminary selection. In this way about 50% of the seedlings (70% males and 30% females) were eliminated in 1969. The same data enabled the initiation of an hybridization program for producing new improved types combining high yields with other favorable characteristics, particularly shapes suitable for easy and quick harvesting.

3. Omer, 7 Km. northeast of Beer Sheva

This small plot (about 1.5 dunam or 2/5 acre) was planted in 1966 with about 100 seedlings propagated from seeds of good producers from the Beer Sheva and Nevatim plots. Spaced at 3 x 3 m (10 ft. x 10 ft.) and not irrigated at all from the very beginning, this plot was part of a more comprehensive project for observing growth and production of a large collection of species under the natural conditions of different environments. In addition to the Omer site, this scheme included two other areas:

- a. Gvulot, west of Beer Sheva (170 mm or 6.5 in. rainfall), loamy sand overlaying a loessial soil;
- b. Wadi Secher (about 150 mm or 6 in.), deep sand dunes south of Beer Sheva. In the two latter plots the seedlings died shortly after transplanting. In Omer the development was fair: several plants started producing in the third year after transplanting (1969) and yields of 300-360 gr. (0.6-0.8 pounds) were recorded in 1971.

4. Beer Sheva, hybrids 1967 and 1968

&

5. These two plots were planted in the Negev Institute grounds in 1968 and 1969, respectively. The hybrids were produced by Dr. M. Tal of the Negev Institute, by crossing individuals which in the old Beer Sheva and Gilat plots had shown promise in regards to yield, morphology, accessibility, etc. The two plots covered an area of 1 dunam (1/4 acres) each and were originally planted with 1,100 and 700 seedlings respectively. Several irrigations during the year were intended to hasten growth and to allow inferior and superfluous plants to be eliminated early and within a relatively short period. The 1967 hybrids started yielding in summer 1970. Several 1968 crosses gave a few fruits in 1971.

PHENOLOGY OF SIMMONDSIA IN THE NEGEV

1. Sex differentiation

Table II gives the results of a survey carried out in 1964 (one year after transplanting) in the Gilat plot. Surveys in other plots gave similar results.

A relationship exists between the development of the plants, time of sex differentiation, and yield. Most of the seedlings differentiate during the second year. Males apparently tend towards more rapid and vigorous growth and earlier maturity. In females differentiation occurs mainly later in the season and largely after the flowering period. Flowering females rarely produce any fruits in the second year. Fruiting usually starts only in the third year. The final sex ratio in Gilat was about 52% males and 48% females. Similar values were obtained in other plots.

2. Floral bud formation and flowering

Flowering takes place over quite a long period, usually from end January to end April, and varies from plant to plant.

Irrigation, probably in conjunction with other factors, seems to induce out-of-season, later flowering in summer and fall. Early flowering is also reported. An exceptionally large number of plants flowered at the end of January 1971 in Beer Sheva, probably owing to the high temperatures and the high rainfall which prevailed that winter.

The ability of Simmondsia to react quickly to environmental phenomena and to flower in different periods of the year, could be related to its typical characteristic of setting floral buds over a large period of the year; and in certain individuals almost constantly. These buds, which normally remain closed until the next flowering season, open as soon as favorable conditions occur. In turn, the new buds set largely on fresh plant growth. They appear in the axil of newly developed leaves, shortly after these have formed, and often along with the twig elongation process which produces a new internode. Hence yield is directly associated with the vegetative activity of the plant.

3. Fruit ripening

The fruits do not ripen simultaneously either on the same plant or on different individuals. In Gilat and Beer Sheva at least two harvests are carried out in summer between end June and end August. Sometimes a third harvest is necessary in September for individual plants. Heavy yields are often associated with slow and prolonged ripening.

4. Vegetative and reproductive cycle

For a more detailed study of Simmondsia phenology, ten plants (five males and five females) were randomly selected from the Beer Sheva plot, and observed from January 1964 through January 1965. Tables III a and b report the data for four of them. Two branches on each plant were studied for reproductive activity, and three chiefly for vegetative activity. Rainfall during the period specified was 318 mm (12.7 in.) in winter 1963-64 and 270 mm (10.8 in.) from October 1964 through January 1965. Two irrigations were given, one in June and one in September 1964. Despite the atypical conditions prevailing during both winters and the considerable individual variation already mentioned, the survey did establish certain features.

- a. Flowering reaches a peak over March and April.
- b. Most of the flower buds formed close to the flowering season do not open, but remain dormant until the next spring. The great majority of buds which do open are those which were set during the previous year.
- c. Far fewer fruits reach maturity than the number of floral buds set. In the survey described, failure was often due to injuries caused by parasites (particularly an unidentified borer).
- d. Vegetative activity peaks over March and April and increases again, although less markedly, in about October.

The fall increase is particularly associated with new twig growth. The renewed vegetative activity at the end of the hot season is characteristic of many Israeli species.

- e. Floral buds are formed throughout the year. Formation reaches its height in April and May, with sometimes a mild resurgence in November. Bud formation peaks usually follow after peaks of vegetative activity, thus indicating that bud formation is largely connected with and dependent on new growth.
- f. The behavior of male and female plants is similar, although fruit-bearing seems to affect several aspects of the phenology of the females. Thus setting of floral buds and growth in female plants often appear less conspicuous and last a shorter time than in males.

YIELD

Although individual seedlings already produce a few nuts in the second summer after planting, most start yielding more consistently in the fourth year under dry conditions as well as under irrigation. Plants from the same seed source do not generally exhibit common characteristics and this includes yield levels. Yield is an individual characteristic. It varies from plant to plant and from year to year, and seems to be partially affected by environmental fluctuations.

Table IV gives production data from 1964 to 1971 for selected individuals growing at Gilat and chosen for their relatively high yields. On the whole, production increased. However, in both 1969 and 1970, or in at least one of these years, yields declined. This decrease may have been due to low seasonal rainfall. In turn, the high yields of 1968 and especially of 1971 could be related to the rainy winters of 1967-68 and 1970-71. It is worth noting that the 1971 yields were high despite the fact that no irrigation was given at all.

A detailed study of the effects of irrigation on production was not possible. The heterogeneity of the material precludes any comparison between different water levels. Considered individually, plants like 879/154 (Table IV), which was not irrigated since 1964, gave one of the highest and least variable yields obtained so far. However, observation of the total yield indicates that watering has a favorable effect. Table V shows the total production in Gilat from 1965 to 1971. Low seed weight seems to be associated with high yield. In unfavorable years not only is the total production reduced, but also the number of fruiting plants (see also Table IV).

Irrigation in summer and fall appears to stimulate at least certain individuals to additional flowering and fruiting, although there may be other contributory factors. A closer survey was carried out in Beer Sheva in summer 1970 in which a large number of out-of-season flowering plants were observed. It was found that at harvesting time (end June) 40 plants, both female and male, were flowering. Of the 26 females, 13 ripened fruits in late October and early November. Yields of up to 350 and 450 gr. were registered. Plants flowering still later were harvested in late November and early December. With a few exceptions the late-flowering individuals did not produce any nuts in the normal season. The use of suitable material and intensified agricultural practices may possibly enable more than one harvest per year. However, the biological and subsequent economic effects of these practices cannot be foreseen.

GERMINATION AND SEED PROPAGATION

In the Gilat and Beer Sheva plots numerous volunteers were found under and close to the adult plants. In Omer, an experimental sowing carried out in situ and without any irrigation, even at sowing time, gave a very high germination rate. Plant growth, however, was very slow as compared with that of transplanted seedlings produced in the nursery.

In open-air nurseries the winter conditions, especially when combined with bad drainage, were detrimental. More controlled conditions produced a favorable response. Germination was then higher and less sporadic. Loss from disease was smaller. In the rainy winter 1964-65 (339 mm, 13.5 in. rainfall and 45 rain days as against an average of 204 mm, 8 in. and 33 days), sowing was done in Beer Sheva at the end of October 1964. Seeds were placed in plastic bags set into open-air beds. Germination was low to very low (6-52%, according to seed lots), and was spread over the period from the end of November until the end of April and even later. Seeds sown in flats under glass in December 1965 showed up to 100% germination by the beginning of March 1966. Hybrids sown at the end of October 1968, in plastic bags protected by plastic covers, germinated from 60-100%, depending on seed lots, by the end of November. In all instances the seeds were fresh and had been produced locally in Israel. No treatment was given to seeds before sowing.

SELECTION AND IMPROVEMENT

1. Variability

Material gathered from a considerable number of provenances and grown under uniform conditions offers a good opportunity of distinguishing between genetic characteristics and those conditioned by environment. The Israel collection displays a broad spectrum of types. Plants obtained from seeds harvested in the United States in the wild seldom show common characteristics, even if the seeds were produced by a single individual or by plants growing in the same environment. Differences in yield and phenology have already been mentioned. Variability in morphological traits is no less important and striking.

Sexual and fruit characteristics in the Israel collection are highly heterogeneous. Monoecious and hermaphrodite individuals, plants with nodal fruits or with fascicled clusters or both can be found. These characteristics seldom involve whole plants. Alternate and nodal floral buds, for instance, may be produced on the same branch at different periods of the year, and are probably associated with environmental phenomena (nodal buds in late summer). Seed shape and color are constant in individual plants, but there is considerable variation between different plants. The size and weight of seeds are also characteristics of individual plants, although they do fluctuate in the same plant in different years and are probably conditioned by the rate of the yield.

Wax content has been found to vary considerably, and up to 58.8% wax could be extracted from certain samples. (Extraction carried out by Dr. G. Alumot, Department of Animal Nutrition, Volcani Institute of Agricultural Research, Rehovoth.)

Amongst the Israeli material one provenance in particular is notable for its relative uniformity. This is the group identified as number 1180 Q, which was obtained from seeds collected at the Huntington Garden, Pasadena, California. Males and females are generally similar in size and in their characteristic shape. They develop long, flexible shoots at the juvenile stage, have relatively few stems and at the more adult stage show a fairly open canopy produced by the regular horizontal distribution of lateral branches. Internodes are long and leaves are pale olive green. Some plants are good seeders (see Table IV) and show a trend towards increasing yields and relatively slight production fluctuation. Seed weight is often high.

A high yield and a habit suitable to manual or mechanical harvesting are among the most sought-after features in the development of economically viable Simmondsia. The Negev Institute has undertaken an initial selection program in which these two features are receiving particular attention. However, the various characteristics desired are rarely found in the same plant and in any case they cannot be reproduced by seed propagation. Plant improvement and vegetative propagation are at present at different stages of development.

2. Plant improvement

A hybridization program was started in 1967 and continued in 1968. The work was done in conjunction with Dr. M. Tal. A preliminary survey of the reproductive and vegetative characteristics of the individuals growing in Gilat and Beer Sheva supplied the basic information. The hybrids obtained were planted a year later in the area of the Negev Institute in Beer Sheva (Table I). A first selection of the 1967 hybrids took place in May 1972. About 250 plants were eliminated. A further selection is about to be carried out.

In spring 1971 males and females of the same F₁ progeny were crossed to uncover desirable traits recessive in the F₁ plants. The seedlings obtained are at present ready for transplanting. A further series of crosses between F₁ individuals is planned for the coming spring.

3. Vegetative propagation

Vegetative propagation is essential for the reproduction of the characteristics of outstanding plant types. Preliminary trials carried out under various non-controlled conditions indicate that apical soft wood can be used successfully for propagation. Rooting of up to 30% was obtained. Plants could not be propagated from hard-wood cuttings.

No differences have so far been observed in the behavior of rooted cuttings as compared with that of seedlings, when both are grown under the same field conditions.

SALT TOLERANCE

The water and soils in arid areas are often saline. If Simmondsia could successfully be irrigated with brackish water, more intensive cultivation of this plant could be afforded in the Negev where there are no reserves of fresh water, while the resources of saline water at 2500-3000 ppm TDS are abundant and unexploited.

The effects of salinity on the development and anatomy of Simmondsia have been reported by Yermanos *et al.* Its effect on production was tentatively checked in Beer Sheva under hydroponic conditions (M. Schwarz and Forti M, 1968). The two saline nutrient solutions used (3380 and 2580 mg/l salts, respectively) had a composition similar to that of the brackish water of the Negev. A standard nutrient solution was used as control. The seedlings were irrigated with the different solutions after being placed in gravel-filled containers in September 1966. By the end of the experiment (summer 1968) 100% mortality had occurred among the plants in the more concentrated salt solution. At 2580 mg/l salts establishment was similar to that of the controls and growth was satisfactory. The plants flowered in spring 1967, but, as in the control, no fruits were produced. In July 1968 yields ranging from a few gr. up to 60 gr/plant were obtained. They did not differ substantially from those of the standard solution.

PRELIMINARY CONCLUSIONS

1. Over 10 years of experimental cultivation of Simmondsia under different environmental conditions and with application of different agricultural practices show that this plant can grow satisfactorily in the northern Negev.
2. The species starts yield in the third or fourth year after transplanting. It can develop and produce in loessial soil under a winter rainfall of 200 mm/year. Excellent yields were obtained from single plants without any irrigation although supplementary watering seems to increase production.
3. Introduction trials in sandy soils under the completely natural conditions of the site have so far proved negative. Irrigation was not tried, but the species is apparently at least moderately salt tolerant, and hence the coarse-textured sand could be an excellent substrate for cultivation in brackish water.
4. Plants seem to respond well to a high winter rainfall, while summer irrigation could induce additional flowering and fruiting. Yields could therefore be regulated by appropriate manipulation of watering.
5. Heterogeneity is an obstacle to both agricultural experimentation and commercial utilization. The full potential of the species is unknown. The information currently available is in many instances only an indication of the performance and behavior of the species. The real response of Simmondsia to irrigation, fertilization, pruning and other agricultural and environmental factors will remain obscure, if not checked on a uniform basis. If the promising types already identified are vegetatively propagated, they could form the first stage of a detailed research program.
6. Variability offers extremely attractive breeding prospects. Improved types adapted to given conditions and agricultural practices could be produced. Factors such as uniformly high yields, a high content and quality of wax, characteristics enabling easy and cheap harvesting, should all be part of an improvement program. Screening and trial of a broad range of types from the wild should be continued and enhanced together with intensification of the breeding work.

7. Hand picking is tedious and expensive and weighs heavily in production cost. Improved harvest systems should be studied if the plant is to be used competitively for other than very sophisticated purposes.
8. Cultivation and improvement of any new crop involves a long and expensive process of research and trials. The essential worth of Simmondsia chinensis lies in its liquid wax. The real development of Simmondsia and of research into its agricultural utilization depends entirely upon more vigorous promotion of its industrial potential.

ACKNOWLEDGEMENT

The assistance of Mrs. Cynthia Bellon in editing this report is greatly appreciated.

Table I - MAIN CHARACTERISTICS OF *SITRO'DSIA*

EXPERIMENTAL SITES

Experimental site and Year planted	Coordinates	Mean annual rainfall mm (in.)	Altitude m (ft)	Topography	Soil	CaCO ₃	pH	E.C. ² mmhos/cm
Negev Institute grounds Beer Sheva 1961 and 1962	34° 48'E 31° 15'N	204 (8"1)	280 (840)	Near a wadi. Broken area, partially levelled.	Deep loess. Sandy loam grading to clay-loam.	18 to 22%. Lime con- cretions.	8.1-8.4	Data not available
Beer Sheva hybrids 1968 and 1969	34° 48'E 31° 15'N	204 (8"1)	280 (840)	Flat or partially levelled.	Deep loess. Sandy loam to loam.	Data not available. Lime con- cretions.	8.2-8.7	Data not available
Gilat January 1963	34° 39'E 31° 20'N	228 (9"1)	150 (450)	Flat	Deep loess. Sandy loam grading to loam with under- lying gypseous soil at approx- imately 2 m depth.	Up to 30%. Lime con- cretions.	8-8.5	Seldom > 2
Omer May 1966	34° 50'E 31° 17'N	206 (8"2)	325 (975)	Alluvial depression near a wadi.	Deep loess. Sandy loam to silty clay in the upper layer. Loam to clay at 150 cm.	17 to 30%. Lime con- cretions.	8-8.5	Seldom 2-5 in deep layers

TABLE II - DEVELOPMENT, SEX DIFFERENTIATION AND FLOWERING (3)

GILAT 1964

Development 26.4.64 (a)	Differentiated 26.4.64		Flowering 26.4.64		Differentiated 2.7.64		Differentiated 6.8.64		Differentiated 11.10.64						
	Total (%)	P (c)	M (c)	F (d)	M (d)	Total (%)	P (c)	F (c)	Total (%)	P (c)	F (c)	Total (%)	P (c)	F (c)	Total (%)
6	100.0	-	100.0	-	30.0	100.0	-	100.0	100.0	-	100.0	100.0	-	100.0	100.0
5	74.5	29.5	45.0	33.0	32.5	39.0	43.0	56.0	100.0	43.0	57.0	100.0	43.0	43.0	57.0
4	58.5	21.0	37.5	22.5	89.5	92.0	42.0	50.0	95.0	44.0	51.0	98.5	46.5	46.5	52.0
3	37.5	13.0	24.5	10.0	75.0	83.0	38.0	45.0	92.0	44.0	48.0	96.5	47.0	47.0	49.5
2	14.0	3.5	10.5	-	95.0	51.0	21.5	32.5	73.5	33.5	48.0	88.0	44.0	44.0	44.0
1	-	-	-	-	-	25.5	9.0	16.0	44.0	15.0	29.0	58.0	23.5	23.5	25.0
Total (c)	38.0	13.5	24.5	20.0	34.0	75.5	33.0	42.5	85.0	38.5	46.5	92.0	43.0	43.0	49.0

(a) plants were graded according to development : 6 - excellent; 5 - very good; 4 - good; 3 - fair; 2 - weak; 1 - very weak.

(b) total plants differentiated as % of all plants included in a given grade.

(c) females (or males, respectively) differentiated as % of all plants included in a given grade.

(d) % of all females (or males, respectively) differentiated in a given grade.

(e) for differentiation : % of differentiated plants, males and females in the entire population. For flowering : % of flowering plants among all the females or males differentiated in the plot.

Table III a - REPRODUCTION AND GROWTH (BLER SHEVA, JANUARY 1964-JANUARY 1965)*

		FEMALE PLANTS												
		Jan.	Feb.	Mar.	Apr.	May	June	July	Aug.	Sept.	Oct.	Nov.	Dec.	Jan. Total
		1964												1965
		Plant 622 b/37 (Origin : California)												
22	Total floral buds, Jan. 1, 1964 ^(a)	24												24
	New floral buds ^(a)	-	1	4	11	10	4	1	-	-	-	-	-	31
	Open flowers ^(a)	-	-	19	5	-	-	-	-	-	-	-	-	24
	Fruits ^(a)	-	-	-	-	-	-	10	-	-	-	-	-	10
	New lateral twigs ^(b)	-	1	5	1	-	-	-	-	-	-	1	-	8
	Floral buds on new lateral twigs ^(b)	-	-	-	-	1	2	2	-	-	-	-	-	5
	Average elongation, mm ^(c)	-	2.3	31.0	69.6	25.0	22.3	2.3	-	-	-	-	-	152.5
	New floral buds on elongation ^(c)	-	-	1	2	1	1	1	1	1	-	-	-	8
	New twigs on elongation ^(c)	-	-	7	1	-	-	-	-	-	-	-	1	9
		Plant 1176 G/48 (Origin : # 2 - Rancho Santa Ana Botanical Garden, California)												
	Total floral buds, Jan. 1, 1964 ^(a)	48												48
	New floral buds ^(a)	-	8	8	36	47	5	-	1	-	-	3	-	108
	Open flowers ^(a)	-	-	22	28	-	-	-	-	-	-	-	-	50
	Fruits ^(a)	-	-	-	-	-	-	26	-	-	-	-	-	26
	New lateral twigs ^(b)	-	1	19	36	3	-	-	-	-	-	-	-	59
	Floral buds on new lateral twigs ^(b)	-	-	-	8	17	5	-	1	-	-	3	-	34
	Average elongation, mm ^(c)	-	5.0	64.6	36.3	10.3	3.0	1.6	-	-	-	-	-	120.8
	New floral buds on elongation ^(c)	-	-	5	2	-	-	-	-	-	-	-	-	7
	New twigs on elongation ^(c)	-	1	14	3	2	1	-	-	-	-	-	1	22

*Observations were carried out on five branches (1, 2, 3, 4, 5) according to the following scheme:

(a) on branches 1 and 2

(b) on branch 3 only

(c) on the elongation only of branches 3,4,5

Table III - REPRODUCTION AND GROWTH (BEER SHEVA, JANUARY 1964-JANUARY 1965)*

M A L E P L A N T S													
Jan.	Feb.	Mar.	Apr.	May	June	July	Aug.	Sept.	Oct.	Nov.	Dec.	Jan.	Total
1 9 6 4												1965	
Plant 599 A/33 (Origin : 16749 - Santo Tomas, Baja California)													
Total floral buds, Jan. 1, 1964 ^(a)	53												53
New floral buds ^(a)	-	4	6	17	66	21	4	-	-	2	2	2	124
Open flowers ^(a)	-	-	20	33	-	-	-	-	-	-	-	-	53
Fruits ^(a)	-	-	-	-	-	-	-	-	-	-	-	-	-
New lateral twigs ^(b)	-	1	1	23	3	-	-	-	-	2	-	1	31
Floral buds on new lateral twigs ^(b)	-	-	1	4	26	7	1	-	-	1	1	1	42
Average elongation, mm ^(c)	-	1.6	17.6	58.6	34.0	15.5	6.0	2.5	-	-	-	-	135.8
New floral buds on elongation ^(c)	-	-	1	3	-	2	-	-	-	1	-	-	7
New twigs on elongation ^(c)	-	-	-	7	2	-	-	-	-	2	-	-	11
Plant 622 B/43 (Origin : California)													
Total floral buds, Jan. 1, 1964 ^(a)	29												29
New floral buds ^(a)	-	1	-	23	37	26	12	1	3	-	8	1	113
Open flowers ^(a)	-	-	4	22	-	-	-	-	-	-	-	-	26
Fruits ^(a)	-	-	-	-	-	-	-	-	-	-	-	-	-
New lateral twigs ^(b)	-	-	1	16	4	-	-	-	1	1	1	-	24
Floral buds on new lateral twigs ^(b)	-	-	-	6	14	13	4	1	2	-	7	1	48
Average elongation, mm ^(c)	-	3.0	77.6	74.6	37.6	21.3	7.6	1.0	17.0	11.3	3.0	2.3	254.9
New floral buds on elongation ^(c)	-	-	2	4	3	2	1	1	1	1	-	1	17
New twigs on elongation ^(c)	-	-	3	3	-	-	-	-	2	-	1	-	9

*Observations were carried out on five branches (1, 2, 3, 4, 5) according to the following scheme:

(a) on branches 1 and 2

(b) on branch 3 only

(c) on the elongation only of branches 3, 4, 5

Table IV - YIELDS AND YIELD FLUCTUATIONS OF SELECTED PLANTS

GILAT 1964-1971 (9²)

Plant	Irrigation ^(a)	1964	1965	1966	1967	1968	1969	1970	1971	Total	Seed weight ^(b)	Origin of Seeds
879/154	no	-	428.0	793.0	934.0	1171.0	598.0	807.0	3134.0	7865.0	0.40	California
1130 1/41	1	-	25.0	453.0	1422.0	2202.0	-	2566.0	603.0	6668.0	0.39	California
11802/106	1	-	1.5	164.0	643.0	919.0	2170.0	95.0	2129.0	6121.5	0.71	Huntington Gardens, Pasadena, California
879/85	2	0.5	339.0	163.0	1408.0	963.0	39.0	484.0	2240.0	5636.5	0.68	California
879/60	2	-	24.0	235.0	276.0	1026.0	139.0	353.0	3188.0	5241.0	0.34	California
879/70	2	-	63.0	447.0	572.0	646.0	149.0	33.0	2897.0	4812.0	0.33	California
879/89	2	-	7.0	173.0	334.0	690.0	1391.0	689.0	1228.0	4502.0	0.36	California
1176 No3/5	2	-	-	-	1651.0	198.0	22.0	253.0	2329.0	4453.0	0.47	California
11802/104	1	-	5.0	67.0	242.0	808.0	1097.0	104.0	1990.0	4359.0	0.67	Huntington Gardens, Pasadena, California
1125/79	2	-	145.0	605.0	479.0	1222.0	-	53.0	1754.0	4258.0	0.40	Rancho Santa Ana, California
1176 No3/37	2	-	173.0	200.0	1145.0	729.0	-	-	1970.0	4217.0	0.32	California
879/55	2	-	35.0	402.0	272.0	1110.0	2.0	8.0	2103.0	3932.0	0.27	California
1176 No3/12	2	-	29.0	159.0	402.0	371.0	5.0	6.0	2357.0	3839.0	0.40	California
1176 No3/48	no	-	4.5	-	1221.0	229.0	-	222.0	1225.0	2901.5	0.27	California

(a) no = no irrigation; 1 = one irrigation of 200 mm; 2 = two irrigations of 100 mm each.

(b) Average seed weight in the year of highest yield.

Table V - WILK PLOT, TOTAL YIELDS ACCORDING TO IRRIGATION GIVEN

1965 - 1971

Year	2 irrigations of 100 mm each				1 irrigation of 200 mm				No irrigation			
	Yielding plants (No.)	Total yield (kg)	Average yield/plant (gr)	Average seed weight (gr)	Yielding plants (No.)	Total yield (kg)	Average yield/plant (gr)	Average seed weight (gr)	Yielding plants (No.)	Total yield (kg)	Average yield/plant (gr)	Average seed weight (gr)
1965	71	3.7	52	0.74	71	1.1	16	0.69	56	2.0	35	0.81
1966	77	8.4	109	0.60	76	5.9	77	0.69	52	4.6	88	0.72
1967	123	37.6	306	0.58	110	26.9	244	0.58	97	20.4	210	0.58
1968	117	38.0	325	0.56	111	30.4	273	0.60	93	11.6	125	0.63
1969 ^(a)	46	6.3	138	0.68	46	9.5	205	0.74	13	1.9	150	0.71
1970	45	8.0	177	0.47	51	13.3	260	0.55	16	1.5	95	0.54
1971 ^(b)	62	52.8	852	0.43	79	60.0	760	0.50	66	35.7	541	0.44

(a) Number of plants decreased drastically due to elimination of poor producers and other inferior plants.

(b) No irrigation given 1971 because of high winter rainfall.

JOJOBA SEED PRODUCTION POTENTIAL: ARIZONA, 1972

C.S. Tomoff
J.D. Johnson

Office of Arid Lands Studies
University of Arizona
Tucson, Arizona

The objectives of our studies are to locate and map the distributions of jojoba populations in order to provide the information needed to select the most productive areas to be used for harvesting this year's jojoba fruit.

We are attempting to map the geographical distributions of jojoba populations, expressing them in terms of their population densities, sex ratios, present fruiting conditions, and then estimating the seed production potential for each population on a weight per acre basis. The total projected production is then calculated for the combined stands in each area. Other factors we are considering are topographic relief, as it relates to picking efficiency, and accessibility by car to the picking areas.

At this time we are unable to provide accurate estimates of seed production for the State of Arizona, although tentative estimates from a few localities are available. Many of the areas of known jojoba occurrence which we have surveyed so far have had no or very low seed production, and accordingly have been eliminated from further consideration at this time. Other areas with high population densities have been located from the air and may have high production potential; these stands will soon be investigated from the ground to determine the extent of fruiting conditions.

Due to jojoba population variability, we have encountered problems in developing methods which will provide meaningful field data for interpretation and estimation of jojoba seed production. This variability results from macrogeographical differences between stands in different areas and from microenvironmental differences within specific stands. Factors which complicate our work include stand density, sex ratio, the quantity of seed set per shrub, and the size of the seeds.

Our approach has been to locate stands of jojoba which have high densities, either by flying over areas unfamiliar to us, or by travelling by car to areas of known occurrence. We are concerned with high densities in order to concentrate harvesting activities in as few areas as possible. Once dense stands are located, we determine the sex ratio by examining 50 or more plants. In areas where roads or trails are present, we estimate the density of fruiting plants per acre by counting all fruiting shrubs within 100 feet of the car, on each side of the road, for 0.1 mile segments; each such sample is about 1 acre. This gives us some quantitative idea of the variability and extent of the stand. One difficulty with this method is that the results may be biased due to increased runoff associated with the road and may indicate higher fruit production than is generally present in the area as a whole. To check the validity of this method, we walk through square acre plots established away from the road and count the fruiting shrubs per acre of habitat.

To estimate the fruit production or yield per plant, we pick a bush clean, count and weigh the seeds, and use this as a basis for judging the yield of other shrubs. When the seeds on the shrubs in other areas are much larger or smaller than those previously measured, another shrub is stripped and weighed. Multiplying the number of fruiting shrubs per acre times the average total weight of seeds per shrub, we obtain the number of pounds per acre for a stand.

The distribution of the stand is then mapped on a topographic map and the number of acres measured, giving the number of pounds projected for the area.

We have found areas with high jojoba densities in several parts of south central Arizona, but many are not producing fruit. Some stands apparently set fruit early in the year, but are now aborting or have already aborted their fruit. This is probably due to this year's drought. Others apparently didn't set fruit at all. Based on the sites we've visited so far, it appears that dense fruiting stands are situated predominately on northeast, north, and northwest facing slopes, along steep slopes immediately adjacent to washes or runoffs, or on relatively flat terrain which is fed with considerable runoff from nearby slopes.

To date we have located and marked areas suitable for picking which have projected yields ranging from 1,000 pounds to 5,000 pounds. A total of 15,000 pounds may be available west and south of Superior. Depending on a variety of conditions, this region may yield up to 25,000 pounds.

In addition to our field studies we are conducting biochemical analyses to monitor lipid composition of the seeds during their development. Labeled shrubs will be sampled at regular intervals and

analyzed for percent lipid content and for the composition of the fatty acids and alcohols which form the lipid. These determinations will outline the sequence of maturation and should indicate any changes in lipid structure which may affect the physical properties of the oil.

In conclusion, we are refining our methods for field estimation of seed production and based on our most recent results, are optimistic about locating and harvesting 50,000 pounds or more of jojoba seed from south central Arizona.

OUTLINES OF A RESEARCH AND TRAINING PROGRAM ON JOJOBA

Quentin Jones

National Program Staff
Agricultural Research Service
U.S. Department of Agriculture
Beltsville, Maryland

Several months ago when I had the temerity to offer a paper for this Conference I did not know who would be preceding me to the speakers' rostrum nor, of course, the special subjects they would be addressing. After seeing the printed program it was not difficult to arrive at the conclusion that my remarks might be, on the whole or in large measure, superfluous. This likelihood produced an unsettling feeling that has persisted to the present moment.

You could well ask why I did not bow out gracefully. The thought crossed my mind. My reasons for rejecting this more prudent course may be no more substantive than what I will go on to say in this paper but they were these: (1) In some 16 years of experience in working with "new crops," I have found, as have most of my colleagues, that they all have a number of problems in common; (2) I have been intrigued with jojoba and its largely unexplored potential for about the same number of years (I might admit to a degree of brain washing by my friend and colleague, Howard Scott Gentry, with whom I was closely officed during the period); and (3) Sometimes the ideas of those who are innocent of any personal involvement in a problem are found to be useful just because they are not cluttered with facts nor wedded to established concepts on the subject.

Looking over the program of speakers and the titles of their papers, I tried to detect any gaps in coverage that I might attempt to bridge. I concluded that if all the speakers fully developed the topics on which they were to speak, there were no apparent gaps. It seemed to me the only contribution I could possibly make to this Conference would be to outline a research program having as its objective the establishment of jojoba as an economically viable, cultivated crop for the southwestern United States.

If nothing else, I would hope to put up a target for the rest of you to shoot at. And who knows, we may get a reshaped target to focus on and help us answer the question: "Where do we go from here?"

I think it should be made quite clear that I am not recommending the immediate implementation of the research program I am about to outline, nor any other long-range program on jojoba. An assessment of the information presented at this Conference, the results of the planned project to harvest enough jojoba nuts to produce a tank-car load of oil for industrial testing, and the conclusions reached from a dispassionate evaluation of the long-term competitive and socioeconomic prospects for jojoba, should collectively provide the basis for future planning.

A RESEARCH AND TRAINING PROGRAM ON JOJOBA

Obviously, in the allotted time I can hardly do more than outline a program. If it is considered to have some merit, then those of you with expertise in the discipline areas involved should build in the fine structure. Certain truisms probably bear repeating at this point. Eventual establishment of any new crop requires many years of continuous, cooperative, and coordinated research and development activities involving research and extension people, producers, processors, and consumers. Immediate, far-reaching results cannot be expected. Unless all facets of such an endeavor are properly programmed and adequately supported, one can count on a long, drawn-out, inconclusive effort that will result only in a waste of resources. And in 1992 another group will be holding a conference on what can be done with jojoba.

I have entitled this a research and training program because I think that in the final analysis, success of jojoba as a cultivated crop for the southwestern United States will depend about as much on training as on research. Let me be more specific. Every new industrial crop goes through an "awkward" stage. Farmers are reluctant to grow it unless they have an assured market and at a fair price; users are reluctant to shift to new raw materials of uncertain supply. Another truism of critical importance in resolving this impasse is a superior extension effort by people thoroughly trained in the production, processing, and utilization requirements of the new crop and its products. I believe that the best way to provide this training is to involve local youths (hopefully Indians) in work-study experiences under the supervision and guidance of program scientists. For this and other obvious reasons, as much as possible of the evaluation and developmental research on jojoba should be done in those areas where the crop will be produced. Then at least some of the funds spent in the program will have spin-off benefits where they are most needed.

The order in which program elements are taken up in the following outline is not meant to imply a straight-line, sequential phasing of the work involved. The entire program, including presently ongoing research, will have to be orchestrated so that information and research materials will become available in timely fashion to minimize lag time in any sector of the program. As Gentry remarked in 1958: "There are several first steps necessary for the domestication of jojoba and they all need doing at once." I would propose a 3-pronged program.

I. Field Research

A good beginning has been made in this area, notably by Dr. Howard S. Gentry during the 1957 growing season. But in my opinion more extensive and intensive field study will pay large dividends in getting the program started off in the right direction and will save the greatest amount of time.

Field studies should be considered as attempts to interpret the results of experiments that have been underway for tens of thousands of years. Observational and analytical methods of modern plant taxonomy, cytogenetics, ecology, geology, soil science and hydrology permit us to go a long way toward reliable interpretation of nature's experiments.

Selection and collection of superior propagation stock (seed and cuttings) based on observation and analysis of diversity in and between populations throughout the natural range of the species is an especially important timesaver when dealing with a plant having such a long generation cycle and as much genetic variability as does jojoba. The same can be said of site selection. We can establish from field studies the parameters of the plant's soil, water, temperature and light requirements, and the interplay of compensating factors.

I have alluded to only the broad categories: the biology and ecology of jojoba--and their interactions. Under these we could list disciplinary sub-categories and many problem areas or questions on which field study could be expected to shed considerable light. A few examples will have to suffice:

1. Why within its natural range is jojoba completely absent from areas which appear to be ideally suited to it? Can the causal factor(s) be manipulated by man?
2. What combinations of characters appear to be linked in inheritance? Population samples (mass collections) taken during field studies and subjected to character association studies in the laboratory can provide clues to guide subsequent breeding and selection work.
3. According to reports, Arizona populations tend to be characterized by a sex ratio of 4 or 5:1 in favor of male plants and by female plants that flower at alternate nodes while California populations tend to be characterized by a sex ratio approaching 1:1 and by female plants that flower at every node. Is pollen production per plant comparable between the two areas? What about pollen viability? If the disparity in sex ratios is real and is due to differential survival, what physiological differences are there between male and female plants in Arizona? (Presumably they are subjected to the same environmental stresses.) Answers to these questions could have an important bearing on the choice of pollinators for commercial plantings.
4. From analytical data reported by Gentry (1958), there appears to be at least a tendency for large seed to have a higher percentage of oil than smaller seed. Seed size appears to be genetically determined but subject to some degree of environmental influence. A large number of seed samples collected at full maturity from throughout the range of jojoba and analyzed for oil content would probably provide a definitive answer on the importance of seed size to oil yield and give us a headstart on a selection and breeding project.
5. It is not inconceivable that careful field study would suggest approaches to control of jojoba pests. Does the female microlepidopteron (moth) whose larvae destroy the young ovules of jojoba show preferences for ovipositioning sites? Are glabrous buds selected over pubescent? When does egg-laying begin and end? Could delaying irrigation and hence delaying spring growth and flower bud appearance, throw the moth and plant out of synchronization?

Imaginative field researchers will come up with many times this number of questions for which answers or partial answers can be sought among the wild-growing jojoba.

I would judge that three, 3-man teams could essentially complete the field studies in two years--spending March to October in the field collecting materials and data and October to March in the laboratory analyzing them and comparing notes among teams.

The temptation will be to give less emphasis to field study in favor of spending more resources on experimental work under controlled conditions. In my opinion this would be unwise. One problem

that has been common to all new crop projects we have undertaken is that of having too narrow a base of germ plasm with which to work. (This is even true of many of our long established crops.) It either results in a good deal of wasted effort in crop development work because it was based on inferior material or, even worse, abandonment of a crop prospect without having given it a fair trial.

II. Laboratory, Greenhouse, Experimental Garden Studies

Under this heading I am including the whole gamut of problems, and the disciplines involved in their solution, relating to the successful culture of the jojoba plant and the harvesting of its fruit. What are the best ways of handling jojoba from seed to seed?

It is this sector of the program that should, I think, have a sizable complement of trainees. The research should be carried on at a university and/or an experiment station within or proximate to the potential jojoba production areas. Every opportunity should be taken for capturing the interests and energies of graduate students in the plant sciences, entomology, soil science, etc., through providing guidance, materials and, where needed, financial support on thesis problems that can help fill gaps in the program.

Under laboratory studies I would include, in addition to the usual investigations of the soil scientist, the hydrologist, the plant physiologist, the engineer, and the data analysis work of the field study teams, horticulturists, plant breeders, etc., research in anatomy and developmental morphology. The latter might well include tissue culture studies to determine the feasibility of this route to propagation of superior clones.

Greenhouse studies are here intended to include investigations under controlled environments as provided by growth chambers or phytotrons as well as the more routine lines of greenhouse work. Leads, ideas, impressions garnered from studying natural populations in the field can be checked out under manipulated environments. What are the factors that bring on leaf drop in some populations as fruit maturity approaches? What are the soil temperatures--moisture and air temperature relationships that favor establishment in the field of greenhouse- or nursery-grown stock? Many other questions could be programmed for answers from controlled environment studies.

Experimental gardens should be carefully located so that in total they encompass as many as possible of the types of sites to which jojoba can be expected to be adapted. Obviously some of these should be situated where the benefits of natural runoff can be evaluated.

Long-term clonal repositories should be established to insure future availability of documented genetic material. Spatially isolated breeding nurseries will need to be established to avoid interference from wild pollen. It would be desirable to have some all-male plantings for evaluation of pollinator stock and to provide a documented source of pollen for breeding and selection work.

These plans suggest an optimism that jojoba will succeed. Whether it eventually does or not, we must in the beginning assume that it will and provide for continued integrity of a wealth of documented genetic raw material. To do otherwise would be assuring the nonsuccess of the crop.

III. Processing and End-Use Research

The pattern is well established that as a new industrial raw material gets into the hands of more and more chemists and product engineers more and more uses will be found for it. Jojoba will need everything going for it that it can get. Obviously the economic picture for the crop is materially affected by the value of its products and by the size and stability of the market for them. For these reasons this third "prong" of the program should be launched concurrently with the other two.

A one-shot evaluation of jojoba oil--say as a substitute in some of the uses for which sperm whale oil was employed--is an inconclusive as a limited attempt to grow the plant. Yet it may, if results are not encouraging, kill or weaken the interest and support of potential users while the real trouble may have been the processor or the formulator because he was working with a material with which he was unfamiliar. Only a long-term utilization effort, supported by adequate supplies of seed for oil extraction, will bring jojoba oil before enough screening tests to permit an intelligent evaluation of its potential in the market place.

Utilization research must also include the seed cake and fruit hulls. (Mechanical harvesting may bring these into the picture.) What uses can be made of these and what do they contribute to the economics of production? It is already known that the leaves and twigs of jojoba contain a compound that has confirmed anticancer activity. This compound is known to occur in other plants also, but should jojoba become a plantation crop, and good management dictate considerable pruning, it could be the most economical source of the compound and this by-product would help pay-the-way for the crop.

I have not costed-out the program I have described. Adequately staffed and funded, I would guess that an annual budget of three-fourths of a million dollars would be needed. But in 10 years' time we would know definitely one way or the other whether or not we had the makings of a viable new crop.

NEEDS FOR HORTICULTURAL RESEARCH ON PROPAGATION, CULTURE AND BREEDING OF JOJOBA

A.E. Thompson

Department of Horticulture and Landscape Architecture
University of Arizona
Tucson, Arizona

I was very pleased to hear Dr. Quentin Jones' presentation. He did an excellent job of outlining the type of program necessary if jojoba is to become a crop of economic significance. We believe that we have the capabilities here at the Arizona Agricultural Experiment Station to effectively tackle some of the important aspects of the problem.

Considerable horticultural research will be needed since to date only sporadic attempts have been made to grow the plant under some form of cultivation; mostly with a marked lack of success. Relatively little is known regarding the cultural requirements of jojoba other than rather general information as to its ecological range.

The proposed research to be conducted by the Horticulture Department of the University of Arizona, Tucson, is under three general areas: breeding and genetics, asexual and sexual propagation and plant establishment, and methods of culture. These three areas are not mutually exclusive and in fact are rather interdependent. The successful culture of jojoba will depend upon an interdisciplinary program of research involving Horticulturists as well as research specialists of the Arizona Agricultural Experiment Station in the Department of Soils, Water and Engineering, Agronomy and Plant Genetics, Watershed Management, Entomology, Plant Pathology and Agricultural Economics. Close cooperation with the research efforts at the University of California at Riverside will also be needed and sought.

PLANT BREEDING AND GENETICS

Jojoba is a dioecious species. This factor creates numerous problems in the improvement of the species by breeding and selection as well as its culture. However, it also opens up certain possibilities that might be exploited. Being dioecious enforces cross pollination, and one can safely infer that considerable genetic variability must exist in the unselected populations throughout its natural range. Gentry (1958) and others have cited evidence for useful variability that most probably has a genetic basis, and should be amenable to selection.

The breeding program would consist of the following essential elements.

1. Evaluation of variability in naturally occurring populations of jojoba for plant characteristics of possible interest from a breeding standpoint. Such characters would include plant type and vigor, adaptability of plant to mechanical harvesting, salt tolerance, drought tolerance, flowering habit to determine the existence and utility of intersexual or monoecious flowering types, position of flowers and seeds either at alternate nodes, every node, fascicled or racemose, variation in size and number of seeds per capsule, and number of seeds per plant or total yield per plant.
2. Selection of promising plant types in the field.
3. Site selection and establishment of experimental plantings to evaluate selections. Possible sites would include the Campbell Avenue Farm and Page Ranch at Tucson, the Yuma and Mesa Branch Experiment Stations, Sells on the Papago reservation, and possibly at the Boyce Thompson Arboretum at Superior. Usage and evaluation of asexually propagated clones at each location should yield considerable information.
4. Evaluation of the potential of selections using laboratory techniques as a means of minimizing the length of the breeding cycle.
 - a. Biochemical measurement of cellular energy production (mitochondrial activity) including measurement of combining ability of different plant types for a crossing and subsequent selection program.
 - b. Adaptation and utilization of physiological tests developed for other crops to select for drought and salt tolerance, and tolerance of temperature extremes.
 - c. Use of biochemical methods such as protein electrophoresis to separate staminate from pistillate plants and possible identification of intersexual types without the necessity

of waiting until plants are mature and flowering. Usage of cytological techniques and possible differences in the anatomy and morphology of seedling and mature plants for the same purpose should be explored.

- d. Laboratory analysis of the oil and protein quality and quantity of seeds. The possible usage of nondestructive NMR (nuclear magnetic resonance) techniques for measurement of oil content of single seeds as a tool in selection should be explored. These characters would be expected to vary depending upon the genotype of the plant and the environment under which it will be grown.
5. Evaluation of disease and insect resistance of jojoba as grown under irrigated cultural conditions.
6. Logical and efficient usage of laboratory data by a competent plant breeder is an essential step in this project. Information will be utilized to design and test appropriate and efficient breeding and selection methods. These might include sibmating, mass selection, some form of recurrent selection, topcross and polycross progeny testing and possible development of synthetic varieties, and usage of F₁ hybrid seed production. Appropriate plantings will be necessary under various environments to adequately test the efficacy of these breeding methods and the performance of progeny for second cycle selection and commercial production.

ASEXUAL AND SEXUAL PROPAGATION AND PLANT ESTABLISHMENT

Stem Cuttings

Some form of asexual propagation undoubtedly will be of value in the rapid propagation of promising selections as well as a method of providing planting stock for commercial production. Some preliminary work has been done by the Horticulture Department indicating that jojoba can be propagated with relative ease by using softwood stem cuttings. Use of stem cuttings for propagation may alter the root structure of the plants by changing the predominance of the taproot to one with a lateral spreading habit. This change in rooting behavior may present a serious obstacle in establishing plants under rain-fed conditions by limiting the root system to the upper strata of the soil which may be lower in soil moisture and subject to extreme moisture fluctuations. The lateral type of root system may be advantageous under irrigated culture and may make more efficient usage of moisture and fertilizer. Some method of root pruning may be used to modify the rooting habit of stem cuttings to reestablish a dominant taproot if such is necessary.

Plant Production by Use of Seeds

Efficient methods of producing vigorous seedling plants must be developed, especially if maintenance of the taproot characteristic of the plant is important. This would involve experimentation on growing media, types of containers, water and nutritional regime, and possible usage of growth regulators to stimulate seedling growth. Field seeding in place should be compared with nursery production of seedlings with or without use of containers and transplanting into the production fields. Comparison of bareroot plantings vs. container grown plants should also be made.

Type of Container for Transplants

Transplanting most probably will be employed in any system of multiplication and propagation of jojoba. A comparison of shallow vs. deep type containers, and their relationship to plant adaptability under natural rainfall and irrigation, will need to be investigated. Frequently plants with a taproot will develop a whorled root system at the tip as a result of growing in a container. New root growth and root regeneration on plants with a knotted or whorled root is frequently inhibited after transplanting. This generally results in poor establishment and less than adequate growth of the plants. Means of controlling this problem and the effect of plant establishment under arid and irrigated conditions will need investigation.

Conditioning Plants for Transplanting

It is anticipated that plants grown for transplanting will need to be conditioned before removal to the field. "Hardening" plants prior to transplanting can be accomplished by several means such as restricting or withholding moisture, restricting nutrient supply, exposure to direct sunlight, and exposure to cool temperatures. Research is needed to compare hardened and nonhardened jojoba plants under arid and irrigated conditions for rate of survival and to determine the most efficient method of hardening the plants.

Planting and Establishment of Plants in the Field

Methods of planting will vary depending upon the availability of water for irrigation, soil type, terrain, and location of the planting site. The use of various types of mulches including paper and plastic should be tested for their efficacy in conserving moisture, weed control, and assistance in establishment of transplants and seedlings. The usage of the new hydrophylic polymer--hydrogel, which can hold up to 25 times its weight in water, should be tested to determine if it can assist in the establishment of plants under arid conditions. Greenhouse experiments have indicated that the material can be mixed with soil or sand and is effective in providing a water reservoir for plants. The hydrogel reduces loss of water through drainage to strata below the roots and through evaporation from the soil surface.

METHODS OF CULTURE

Soils and Water Studies

Jojoba appears to have some specificity with regard to soil type. Most observations indicate that jojoba plants are usually restricted to well drained and aerated, coarse desert soils, and coarse mixtures of gravels and clays. According to Gentry, jojoba soils are generally neutral to alkaline, have an abundance of phosphorus and are subject to annual drying. Plants are generally lacking upon bottomland soils of clay and silt throughout their range which may indicate the sensitivity to higher soil moisture levels and reduced soil aeration, and cooler soil and air temperatures during the winter months. It is clearly apparent that one of the most important areas of research to be conducted initially is a study of the soil and nutritional requirements of the jojoba plant. An equally important consideration is the salt tolerance of the plants. Genetic variability may well exist for this character. Water requirements of the plant and effects of water quality must also be investigated in conjunction with research on soil and fertility requirements.

Methods of Irrigation

Research on methods of applying irrigation water must be conducted in cooperation with other soil and water studies. In certain areas, due to lack of available water for irrigation, production may need to be conducted under rain-fed conditions. Plant survival, growth and yield under natural rainfall should be compared with plots receiving supplemental moisture during periods of extreme water stress. These in turn should be compared with conventional border or furrow irrigation, sprinklers, and the various forms of trickle or drip irrigation. Special emphasis should be placed on methods of minimizing water usage and on techniques of water harvesting and conservation. The effects of irrigation and soil moisture on the yield of oil on a per plant basis as well as on an area basis will need investigation.

Plant Populations, Planting Arrangements and Distances

Research is needed to determine optimum plant population within a given area. Population can be varied by various planting arrangements and distances. The plant population or carrying capacity of a given site, undoubtedly, will vary depending upon soil type, topography, elevation and availability of water for irrigation. Since jojoba is dioecious, another consideration is the ratio of pistillate to staminate plants in the population and their distribution to facilitate optimum pollination and maximum production.

Pruning Procedures

Information is needed in regard to the response of jojoba to pruning practices. Various pruning practices will need to be employed at different stages of growth and at different times of the year to determine the relationship to nut production and vegetative growth. Mechanical pruning vs. hand pruning, severity of pruning and recovery of plants, longevity of plants pruned compared to those unpruned will need observation and study. Methods of pruning to facilitate both hand and mechanical harvesting will need to be investigated.

Mechanical Harvesting

Consideration will need to be given to ways and means of mechanically harvesting the mature nuts. Some existing equipment such as the raspberry fruit harvester may be applicable. Catching frames or vacuum pickups may be employed advantageously in this regard. Assistance from the Agricultural Engineers will be needed to develop systems that are efficient and compatible with the necessary methods of culture.

Pest Control

A survey of present and potentially destructive insects and diseases on jojoba should be made. Methods of control should be sought for those problems judged to be of economic significance before they reach the point of creating serious economic loss.

Economic Information

Reliable information needs to be generated on the costs of production and marketing, the market potential and the comparative advantage of production for the crop. Due regard must be given to the utilization and disposal of the residual seed meal as well as the expressed oil.

CONCLUSION

From this long list of research needs one might conclude that too much needs to be done in order to initiate the culture of jojoba. I believe that a coordinated, interdisciplinary effort can achieve enough useful information within a span of five to eight years to provide a firm basis for a profitable industry based upon the culture of jojoba. Certainly much valuable information can be obtained in less time developing methodology for propagation and culture, and by utilizing native stands of the plants for other observations and experiments. However, it is unrealistic to expect much reliable information on yield and production of first cycle selections of plant materials by this time. The perennial nature of the plant precludes the foreshortening of this time period. The time lag from propagation and planting of selections to first fruiting is estimated to be from three to five years. A minimum of another three to five years will be needed to properly evaluate and assess the initial improvements of the selection program.

The time frame should be viewed optimistically. The developmental period for most new crops is considerably longer than this. Accomplishment of this goal will require a realistic budget of both Scientific Man Years as well as money. The possibilities and potential of this new crop appear to be great. We in Horticulture are very much interested in becoming more heavily involved in research with this species if adequate funding is forthcoming. We are also interested in the plant for usage in landscaping, and consider it to be one of the finest of our native plants for this purpose. We have the competence to provide the research leadership in the propagation, culture and breeding of jojoba in cooperation with the other needed areas of expertise. We believe that such a coordinated effort would provide a valuable new crop for the arid Southwest and would be a valuable contribution to the economic and social improvement of the Indian populations in the area.

RESEARCH NEEDS FOR NATIVE PLANTS

Edward F. Haase
Office of Arid Lands Studies
University of Arizona
Tucson, Arizona

Native stands of jojoba are found in areas of considerable geographic, topographic, climatic, and other environmental variation. The variation in plant habitat is reflected in significant morphological and physiological differences found among the plants themselves.

The desirable goal of developing jojoba as a cultivated plant requires considerable information on the course of its ecological life history in different native habitats. Native jojoba, with its great variability, has excellent genetic source potential for cultivated stock, but may only be of limited value unless the full range of plant variability is known and is available for planting experimentation. Thus, there appears to be a great need for a comprehensive field-oriented research program to investigate, monitor, and document aspects of genetic and environmental variability in native jojoba. This resulting information would have valuable practical application in determining the best available genetic stock and the optimum environmental factors for high growth and productivity in a particular location where jojoba cultivation is proposed.

Repeated observations over a period of months or years should reveal important information on plant characteristics which could not be obtained by one-time or short-term observation. The location of desirable genetic prototypes could save plant breeders many years by providing stock which already exhibits some of the characteristics which might otherwise take years to develop. This is particularly significant because several years occur between succeeding generations of jojoba plants.

The best available insight into the variability which characterizes native populations is the excellent paper by Gentry (1958) on the natural history of jojoba. It has provided valuable background information for this presentation. Another interesting paper which documents variation in the physiological ecology of jojoba was recently published by Hikmat *et al.*, (1972).

A thesis by Burden (1969) considered the ecology of jojoba at its lower elevational limits. Although limited in geographic scope, valuable data were presented on jojoba germination, distribution, microclimatic habitat variation, and plant water stress.

Three general goals are suggested for a comprehensive field research program on native plants:

1. The first goal is to identify, monitor, and document phenological (climatic) related phenomena in jojoba throughout its distribution range. Research methods should also provide for the measurement or estimation of environmental factors which affect the regional climate, the microclimate, and the local habitat. These factors include moisture and temperature of the atmosphere, of the plant, and of the soil; latitude, elevation, topographic relief, soil physics, soil chemistry, soil parent material, associations with other plants, or associations with insects, browsing mammals and disease-causing organisms.

Although it may often be difficult to distinguish between genetic and environmental plant variables in native habitats, an attempt should be made to discriminate between them, e.g., Gentry (1958) pointed out that a widely ranging growth habit occurring at random in the same locality is indicative of a genetic-based difference. Separating out many genetic and environmental factors may require research in a transplant garden where experimental control is possible.

Information on phenological or related phenomena should include observation and measurement of differences in growth habit. Jojoba may mature as a low bush less than 0.5 meters high ranging to a large shrub more than 3 meters high. Short internodes, considerable branching, and frequent dieback may occur in some plants, particularly in dry environments; long internodes with little lateral branching may occur in other plants or under more favorable moisture conditions. Perhaps tree ring analysis would help provide insight into age/maturity/growth habit relationships.

Variation occurs in growth and development of vegetative plant parts both in time of initiation and extent of growth. The extent of seasonal growth may vary from year to year in a given location and from place to place in a given year. Specific morphological growth phenomena include leaf bud swelling, twig elongation, and leaf drop or dieback. Leaves may vary in shape, size, thickness, color, and pubescence. Root system growth would be more difficult to observe or measure.

Native jojoba is found from about 23° to 34° N latitude and ranges from sea level in Baja California to about 5000 feet in elevation in the mountains of Arizona. Winter precipitation predominates in California whereas it is biseasonal at the eastern end of the distribution range in Arizona. Late fall, winter, and spring rains appear to be the most significant for growth and seed production.

Jojoba often occurs on slopes, along washes, on alluvial fans, and on coarse soils in general. Plant vigor varies with habitat as well as sex, staminate plants often being larger with more luxuriant foliage than pistillate plants. In a dry year such as 1971-72, plants on north-facing slopes are generally in better vegetative condition than plants on other slopes, particularly those facing south.

A program to monitor the phenology of jojoba should emphasize flowering, fruiting, and seed production. Variation occurs in initiation time and duration of flowering, the total flowers per shrub, and the number of nodes producing flowers. The number of staminate plants may be nearly equal to the number of pistillate plants in some habitats, but may vary to more than 5 male plants to one female plant in other areas.

Fruiting varies in time of initiation and duration of both fruit development and dehiscence, in the numbers of fruits per shrub, in numbers of fruits per branchlet, in numbers of fruits per flower stalk (peduncle), in length of flower stalk, and in percent of aborted fruits during development. The capsules may vary in size, color, and shape.

Seed variation occurs in size, shape, weight, and oil content. Seeds may also vary in number per capsule and number per shrub. Production of seeds is erratic in native jojoba and may vary from nothing in exceptionally dry years to 6 pounds or more per bush under favorable conditions.

Germination of native jojoba occurs only when conditions of moisture, temperature, and light are favorable and the establishment of a plant is a relatively rare occurrence. Careful field observations and measurements as well as controlled laboratory experiments could indicate optimum moisture, temperature, light, and seed age requirements for germination of plants from different locations. Germination experiments might also be combined with chromosome studies.

Jojoba may occur as essentially the only woody perennial in some areas, but it is often found associated with a variety of other perennials. Plant density may range from widely scattered plants to dense populations of over 200 shrubs per acre.

Animal utilization of native jojoba may vary with geographic location, time of year, intensity, plant organ affected, and animal agent. Insects may damage twigs, ovules and seeds; rodents and birds may gather seeds; deer or cattle may browse foliage and fruit.

Desirable variants in native plants of jojoba which would have useful application for certain types of cultivated stock were delineated by Gentry (1958) and include the following: a large even-crowned shrub; shedding of leaves before maturity for ease of picking; fruit dehiscence concentrated over a short time period for ease of harvest; late season flowering or plants from high elevations to avoid frost damage; staminate and pistillate flowers on the same plant to facilitate certain genetic studies; long flower stalks to avoid fruit damage from exposure to the sun; multiple fruits per flower stalk; large and heavy seeds; high seed oil content; many seeds per shrub; multiple seeds per capsule; and large capsules. It is interesting to note that the Desert Botanical Garden in Phoenix has offered \$50 to the first person showing them a jojoba bush with capsules greater than 2 inches long.

2. The second suggested goal is to establish a jojoba plant material and plant information bank with input from representative native populations throughout the jojoba distribution range. A jojoba plant material bank would probably best be located near sites where jojoba cultivation projects would utilize the material. A jojoba plant information bank would probably best be located where access to pertinent documents is available and where appropriate facilities for information dissemination already exist or could be readily developed.

3. The third suggested goal is to manipulate native plants and their environments to enhance jojoba seed productivity. Possible manipulations include seasonal irrigation in areas with ease of access and the timely pruning of plants to increase and concentrate fruit yield or to facilitate seed collection.

Although cultivation of jojoba undoubtedly offers the best long-term productivity potential, large scale seed collection will depend on native populations for several years to come if a demand for seed develops. Harvesting of native jojoba populations might continue if it is economically feasible, even after a significant number of cultivated areas come into production, particularly if the periodic years of heavy fruiting could be predicted ahead of time.

RUNOFF FARMING FOR INCREASED JOJOBA YIELDS

C. Brent Cluff

Water Resources Research Center
University of Arizona
Tucson, Arizona

INTRODUCTION

The jojoba plant is found in a climatic zone with a mean annual rainfall of 4 to 18 inches. In the lower rainfall zone it has been observed that the plants are limited to sites where the rainfall is concentrated, such as by sandy arroyos or on alluvial fans at the mouth of canyons (Gentry, 1958). Gentry has also observed, in a 4.3 inch rainfall zone in the Joshua Tree National Monument, a tremendous difference between two jojoba plants, one growing near and therefore watered by runoff from road pavement and the other growing away from the road, dry and nearly leafless. Thus it may be concluded that runoff farming techniques applied to the jojoba plant will increase the growth of the plant.

According to Gentry (1958), the low intensity, deep penetrating winter and spring rains are more important to its survival and seed production than are the higher intensity, summer convectional rains. As the last two years in the Southwest have indicated, in general there is more variability at a given station in winter rain totals than there is in summer rain totals (Sellers, 1960). The chances are greater for a dry winter than for a dry summer.

Through runoff farming techniques it may be possible to capture the summer rains, concentrate the water, and give it a chance to penetrate to the deep rooted jojoba plants. As will be indicated, it may be possible to also catch and store excess summer rains to be fed back to the jojoba plant during winter and spring to maximize production of seed.

Additional research is needed to determine the full extent of the possible improvements and the economics involved, to determine if the improvement in yields will justify the cost. In the remainder of this paper, the various methods of runoff farming which may be applied to the jojoba plant will be discussed.

RUNOFF FARMING ON THE NEGEV DESERT

One of the classic examples of runoff farming extends back to 1000 B.C. in the Negev Desert. There, in a 100 millimeter annual rainfall regime without any source of additional water, the desert was extensively cultivated and supported a thriving civilization.

An estimated 300,000 hectares of the Negev Desert was utilized at one time for runoff farming. Israeli scientists (Evenari *et al.*, 1971) have reconstructed some of the ancient runoff farms and have shown that they can work. These farms consisted of a cultivated area and a catchment basin. Each cultivated area was situated in a relatively narrow valley bottom on loess soil 2-3 meters deep and terraced by low stone walls. The catchment basin (20 to 30 hectares in size) was on surrounding slopes. Some of these slopes were smoothed and cleared of rock to increase the amount of precipitation that they would catch. The water harvest from the catchments averaged from 150 to 200 cubic meters per hectare per year or about 15 to 20 percent of the annual rainfall. The ratio of cultivated land to catchment area was 1:20 to 1:30. Thus, one hectare of cultivated land collected runoff from 20 to 30 hectares of hillside catchment and received an average of 4,500 cubic meters or a depth of 45 centimeters of water. This water enabled the farmers to successfully grow wheat, barley, legumes, almonds and grapes as reported in documents of the time (Kraemer, 1958).

Three important features were present at Negev, which allowed cultivation of crops in an area receiving only 45 centimeters of applied water. These were: (1) The relatively deep loess soil which allowed deep storage of moisture in the soil profile; (2) The low evaporation rate of the wetted soil because of a crust which formed immediately after the soil was wetted by floods. This crust reduced soil water evaporation from eight to eleven millimeters per year; (3) A relatively high runoff rate which was also a result of the tendency of the soil to crust upon being wetted. This crusting tendency was enhanced by the presence of sodium with the combination of natural sodium and raindrop energy causing the crusting which was the controlling factor in infiltration rate.

The Israelis have determined that the smaller the catchment area the larger the percentage of runoff. Thus, for a 100 millimeter rainfall a 350 hectare catchment produced 2.5 millimeters of runoff, a 10 hectare catchment produced 13 millimeters and a "microcatchment" of one tenth hectare produced 50 millimeters. These findings indicate substantial losses in overland flow on the larger catchments.

Following these observations the Israelis planted trees, each in its own small catchment. The catchments are constructed by forming an earth border in a rectangular pattern on slight slopes. The borders help collect and concentrate the runoff around the planted areas. Construction costs for the microcatchments is estimated to be between five and ten dollars per hectare. Maintenance would be minimal, with weed control the greatest expense. Control of weeds is vital since they would transpire moisture into the atmosphere which could otherwise be used beneficially by the cultivated plant.

RUNOFF FARMING IN OTHER SEMIARID AREAS

Runoff farming has also been practiced in other areas of the Middle East and Northern Africa (Shannon *et al.*, 1969). In North America there is evidence of agricultural practices which divert infrequent flood flows onto the land for irrigation. The development of groundwater resources near Safford, Arizona, has reduced the dependence of the agriculture on flood flows to the extent that it cannot be classified as runoff farming. In Mexico, in the state of Coahuila, as well as in other states, large bottom land areas are flooded using local runoff from adjacent catchment areas. This practice differs from that in the Negev only to the extent that the catchments are not modified to increase runoff.

The University of Coahuila is also conducting experiments in the raising of peaches in micro-catchments (Martinez, 1970) and in 1968-1969, over 200 trees were established. The smallest catchment was 172 square meters and had a cropped to catchment area ratio of 1:7. Ratios of 1:9 and 1:13 are also being tested. These plantings were observed by the author in the fall of 1971. In general the peach trees appeared to be doing quite well in spite of the fact that the area had encountered one of the lowest rainfall years on record in 1970. In addition, the surfaces of the microcatchments were not kept free of weeds which reduced water yield.

RUNOFF FARMING EXPERIMENTS AT THE UNIVERSITY OF ARIZONA

For the last three years the Department of Agricultural Engineering (now included in the Department of Soils, Water and Engineering) has been conducting runoff farming experiments at Atterbury Experimental Watershed. A one-half acre cropped area has been established and is watered from precipitation falling on a natural hillside catchment area. Two crops of sorghum have been raised during the past two summer seasons on this area.

Beginning in 1963, the Water Resources Research Center in cooperation with the Department of Agricultural Chemistry and Soils (now included in the Department of Soils, Water and Engineering) has conducted research in developing water harvesting techniques which would reduce the costs of harvesting and storing precipitation runoff. Various treatments were tested ranging in cost from the sodium treated, but otherwise natural, catchment at five to ten dollars per acre to the use of butyl rubber at a cost of over \$10,000 per acre. The sodium treated catchment was effective when initially treated, but the effects were temporary and could not be duplicated even with additional treatment. This was apparently caused by the sodium induced clay migration in the light desert soils on which the tests were conducted (Cluff *et al.*, 1971).

An acre plot at Atterbury Experimental Watershed was treated by shaping with a grader, smoothing, and compacting. The compaction was done following a natural rainstorm in the spring of 1970. In the two years following this treatment over 200,000 gallons of water have been collected for a catchment efficiency of 33 percent. The treatment is still effective and it should last indefinitely providing it is recompacted every three to four years. The terminal infiltration rate was found to be 1.8 millimeters per hour. Under these assumptions the cost of the water on a large catchment would be less than \$.10 per 1,000 gallons. This treatment is similar to that used in Western Australia since 1948. The Australians refer to these catchments as "Roaded Catchments" (Carder, 1970). More than 3,000 acres of these catchments have been installed in Western Australia.

Tests at The University of Arizona have indicated that a treatment of sodium chloride mixed into the surface of the soil prior to compaction will increase the efficiency of the compacted earth catchment and will also tend to eliminate weed growth. This type of treatment has been established on an acre of land at Page Experimental Ranch located north of Tucson in a 16-inch rainfall area. The catchment was constructed to be multipurpose to the extent that it would be used for growing horticultural crops and producing water (Figure 1). The cost of this system is approximately \$100-\$200 per acre and the efficiency of the treatment has been approximately 50 percent. The terminal infiltration rate is essentially zero and the total rainfall required to prime the watershed is less than five millimeters. The excess runoff generated in this scheme would be stored and pumped back on the horticultural crop during periods of drought (Figure 1). These treatments could also be combined with a gravel or plastic mulch, as shown in Figure 2, in order to prevent evaporation loss in the wetted area.

The efficiency of the catchment can be increased by paving with asphalt (Myers, 1967) or water repellants such as silicones (Myers, 1969). Diesel oil has been tested by Hillel (1967) as another economic way of increasing the efficiency of the smoothed compacted catchment. These treatments are effective in soils that are stable and do not shrink or swell.

Treatments which are independent of soil type are the gravel-covered plastic or the asphalt-plastic-chip treatment (Figure 3). The graveled plastic catchment has been under test at the University of Arizona since 1965. Our research results indicate that a properly constructed graveled plastic catchment in a rainfall regime similar to Tucson should harvest 70 percent of the total precipitation over a 20-year period. The cost of treatment of a graveled plastic catchment depends on the method of installation and the availability of gravel (Cluff, 1971). For imported gravel, a self-propelled chip spreader modified to dispense both gravel and plastic would be recommended. In areas where there is gravel in the soil profile, a gravel extracting soil sifter was constructed and tested to install graveled plastic catchments. A properly constructed and maintained graveled plastic catchment should last at least 20 years. The cost of water produced from a graveled plastic catchment in a 12 inch rainfall zone using a five percent interest rate would be \$.60 per thousand gallons where gravel is imported and \$.30 per thousand gallons where there is gravel in the soil profile.

Since the spring of 1971, an asphalt-plastic-chip treatment has been tested at the Water Resources Research Center. The major disadvantage in using the asphalt is that it requires expensive additional treatment before the water can be used for domestic use. However, this would not be a handicap if the treatment was used in conjunction with runoff farming. The treatment consists of spraying the smoothed soil with asphalt and immediately covering with a layer of plastic. The top of the plastic is then sprayed with asphalt and immediately covered with chips. Both polyethylene and polypropylene plastic have been tested for use as reinforcement in the asphalt. The polypropylene is more compatible with the asphalt and is more resistant to mechanical drainage than is the polyethylene. The polyethylene's chief advantages are that it costs approximately one fifth as much as the polypropylene, and is more readily available. The amount of gravel required for this treatment is approximately one third that of the graveled plastic treatment and the water yield efficiency should be greater than 90 percent since most of the gravel chips in this instance are bonded to the plastic with asphalt. The system should be easier to retreat than the graveled plastic system but firm cost estimates are not available since this system has been under test for only one year. However, if the asphalt-plastic-chip treatment lasts for 20 years, the cost per thousand gallons of water should be less than \$1.00.

RUNOFF FARMING TECHNIQUES AS APPLIED TO THE JOJOBA PLANT

The runoff farming technique most easily applicable to existing jojoba plants is the microcatchment system. In areas with favorable soil and topography, earth borders could be placed around existing jojoba plants in such a way as to concentrate the available runoff around the plant. Competing vegetation and grasses could be removed to further enhance the growth of the plant.

The shaped runoff farming technique as indicated in Figure 1 would require a plantation of new jojoba plants. The number of plants that could be supported per acre would be dependent on the amount of rainfall and type of treatment applied to the shaped catchment. For instance, more plants could be supported if the catchment area were surfaced with an asphalt-plastic-chip treatment than if the catchment were only compacted.

DISCUSSION AND CONCLUSIONS

Runoff farming experience in the Negev Desert indicates that three factors are important in order for this system of farming to be successful:

1. Inexpensive method of concentrating precipitation.
2. Good soil moisture holding capacity in the cropped area.
3. Some method of reducing evaporation loss from the surface of the soil in the cropped area.

In the Negev Desert, the above requirements can be met rather economically making the runoff farming practical in a 100 millimeter rainfall zone.

In the natural habitat of the jojoba on the North American Continent some of these factors are not present. However, a compensating feature is that rainfall in excess of 100 millimeters occurs in most of the natural habitat of jojoba. With this higher rainfall it may be possible to compensate in those areas with sub-marginal soil moisture holding capacity by storing excess flood flows in surface reservoirs to serve as supplemental water to be used on the plants during long periods of drought. Evaporation loss from the surface of the soil can be reduced by artificial means.

The cost of water produced by water harvesting methods may be higher than that normally used in irrigated agriculture, but the value of the water when used as a supplemental source may justify the expense. Questions, such as what is the value of one thousand gallons of supplemental water to a jojoba plant, need to be answered. Jojoba is an ideal plant to use in runoff farming because it is a native of semiarid deserts and can survive extended droughts. Using runoff farming techniques, this plant could be grown on lands which are presently pump-irrigated in the Southwest and which are being forced out of production because of rapidly declining groundwater tables. The jojoba plantation depicted in Figure 1 would be much more esthetically pleasing than the fields of tumbleweeds that are presently growing on abandoned farms. The potential is there, but additional research is needed before management decisions concerning increased jojoba yields with runoff farming techniques can be made.

ACKNOWLEDGEMENT

Special acknowledgement is extended to Gordon Dutt, of the Department of Soils, Water and Engineering of the University of Arizona, who has been a cooperator in the research investigating the use of sodium chloride to increase runoff.

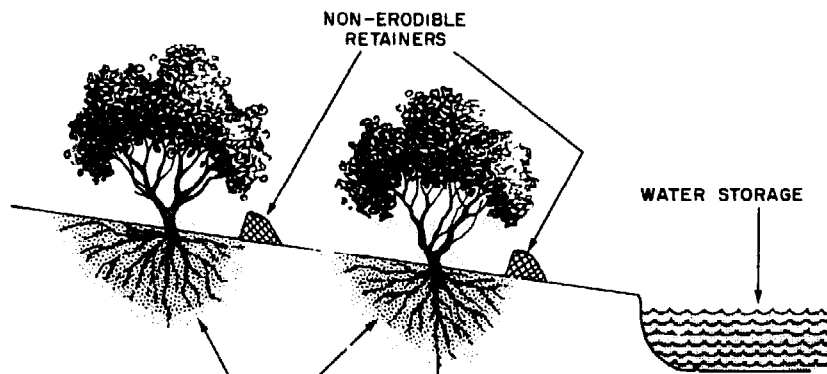
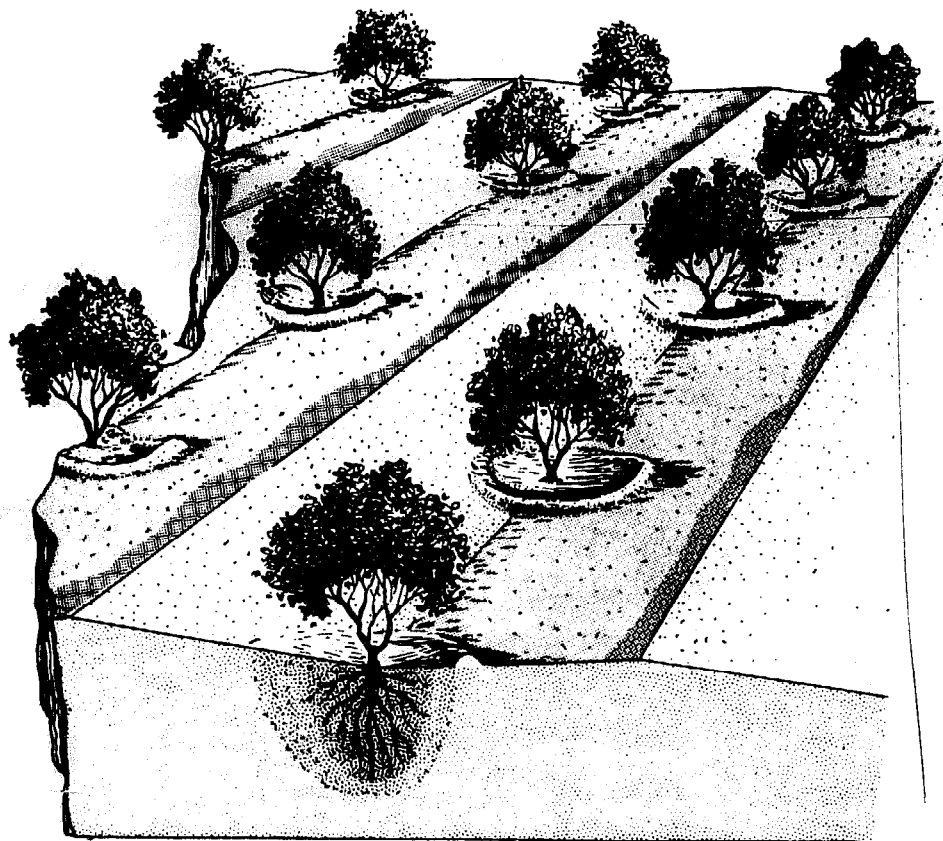

FIGURE 1 -

WETTED AREA

SCHMATIC OF SHAPED MULTIPURPOSE CATCHMENTS
FOR GROWING OF CROPS AND HARVESTING OF WATER.

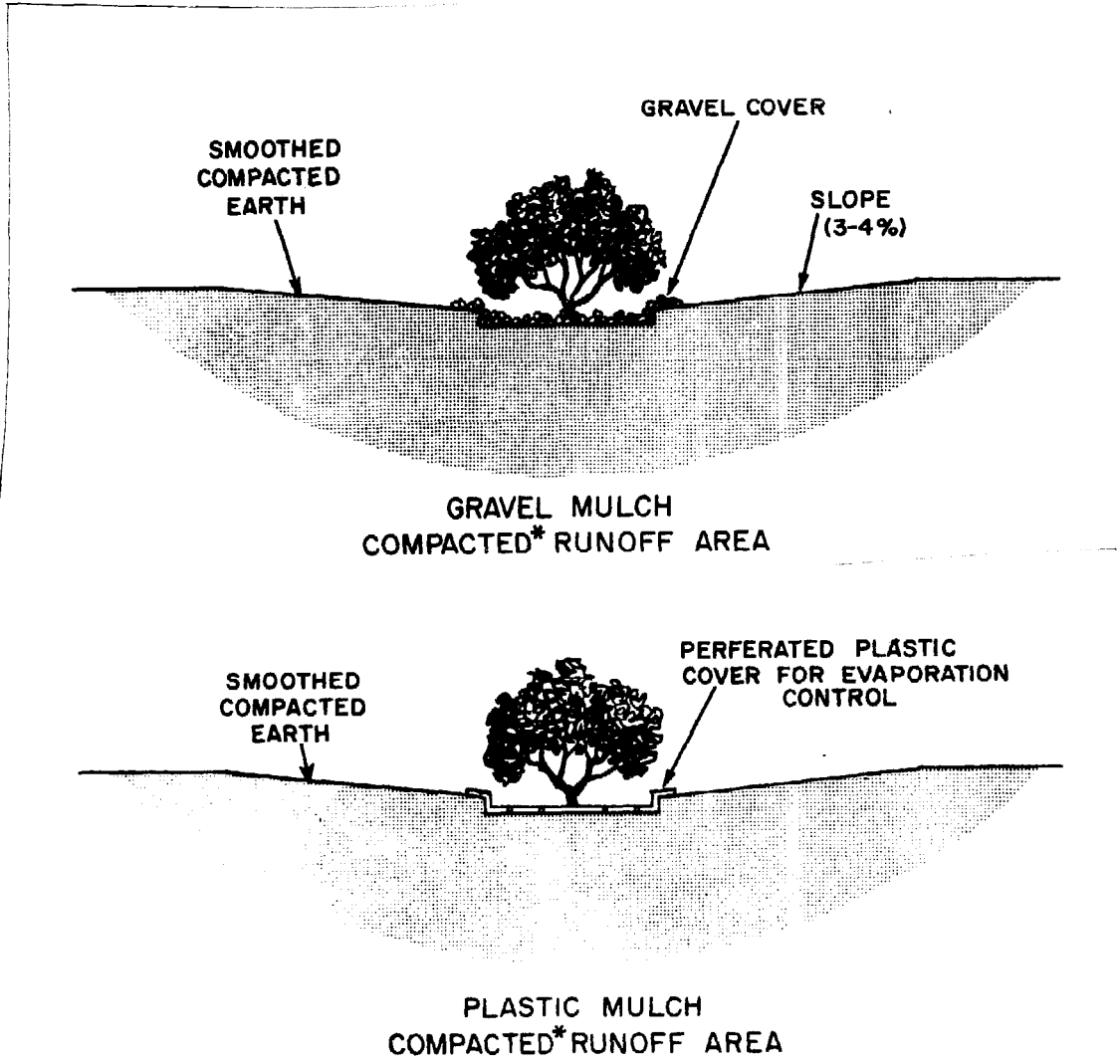
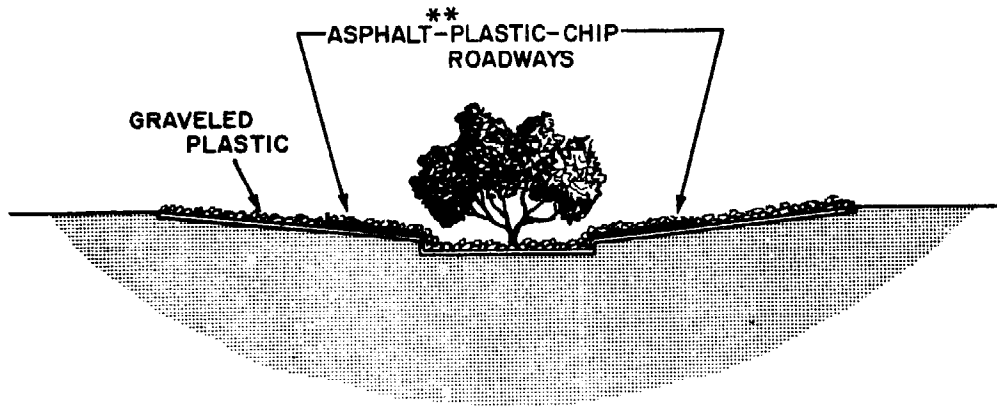
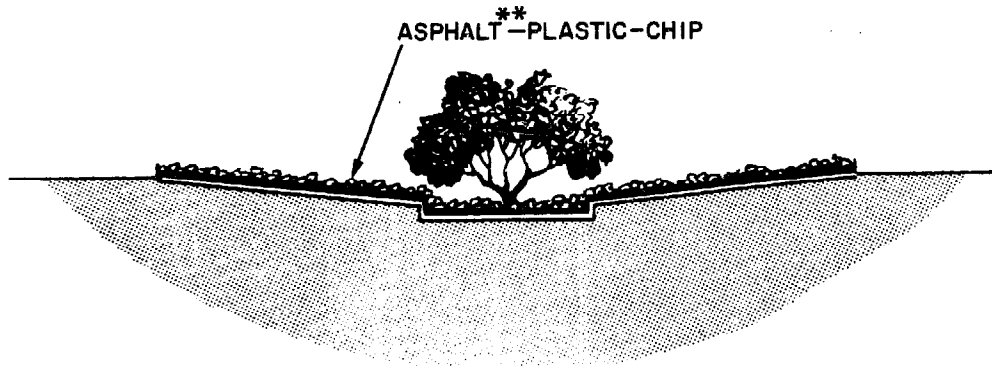

FIGURE 2 - PROPOSED RUNOFF FARMING TECHNIQUES

*CAN USE SODIUM CHLORIDE IN CONJUNCTION WITH COMPACTION



GRAVELED PLASTIC MULCH
GRAVELED PLASTIC RUNOFF AREA



ASPHALT-PLASTIC-CHIP MULCH
ASPHALT-PLASTIC-CHIP RUNOFF AREA

FIGURE 3 - PROPOSED RUNOFF FARMING TECHNIQUES

** CAN USE EITHER POLYETHYLENE OR POLYPROPYLENE

PREPARATION OF JOJOBA PRODUCTS AND THEIR POTENTIAL USES

J.J. Spadaro and M.G. Lambou
Southern Regional Research Laboratory
Agricultural Research Service
U.S. Department of Agriculture
New Orleans, Louisiana

INTRODUCTION

You are already aware of the background for this work so my presentation will be confined to the research contributions of the Southern Marketing and Nutrition Research Division of USDA in New Orleans.

Research on jojoba seed was undertaken at the Southern Division during the latter part of the 1950's. Results of this research were published in 8 technical articles. One of the first things SMN did was to survey the research potential of jojoba seed and its products. Based on the literature search, a decision was made to investigate processing methods to produce various jojoba products and to evaluate the potential uses of these products.

Under processing I will discuss subjects such as extraction of the liquid wax, a sodium reduction method for the preparation of alcohols, and touch on hydrogenation, epoxidation and polymerization. In most of our work, we applied processing methods and chemical reactions normally used for processing edible oilseeds that contain a glyceride oil and not a wax. We have had many years of experience with oilseeds.

PROCESSING AND PRODUCTS

The jojoba seed used was obtained from the Boyce Thompson Arboretum, Superior, Arizona. Seeds were stored at 35° F. until used. The seed contained 4.2% moisture, 2.5% nitrogen and 44% liquid wax.

Mechanical Extraction

One hundred thirty pounds of seed were prepared for mechanical extraction (cold hydraulic pressing) by heating to 100° F. for 20 minutes, cracking into 6 to 10 pieces by passing the seed through corrugated rolls spaced 0.050 inches apart, and then flaking the cracked meats through smooth rolls set at 0.018-inch clearance. The flakes produced had an average thickness of 0.025 inches. For the pressing operation, flaked meats were charged to a six-stack, pilot-plant model hydraulic press and pressed for 50 minutes at 4400 pounds ram pressure. The liquid wax was then filtered and about 40 pounds of liquid wax were recovered from 130 pounds of seed.

Figures 1 and 2 show the hydraulic oil-mill press used in this work, the characteristics of the flakes prior to pressing, and the characteristics of the resulting press cake.

The liquid wax had an iodine value of 84, free fatty acids of 0.15%, saponification No. of 94 and specific gravity of 0.8638. This product was used as the control since it was believed that this method of extraction would have the least undesirable effects on the liquid wax product. It was recognized that cold-pressing was inefficient in that residual liquid wax was about 11%.

Solvent-Extraction

Six solvents were evaluated on a laboratory scale for extraction of the liquid wax: carbon tetrachloride, benzene, isopropyl alcohol, heptane, hexane and tetrachloroethylene. Results of only three of these, those that appear to have the most potential, will be reported.

Seed were equilibrated to room temperature in a sealed container (after removal from cold storage), cracked by passing through two-high corrugated rolls (0.040 inch clearance between rolls, rate 250 pounds/hour) and then flaked by passing the cracked meats through a pair of smooth rolls (0.004 inch clearance between rolls, rate 150 pounds/hour). Extraction of the flakes was accomplished in Soxhlet extractors under conditions outlined in Figure 3. A total of 20 to 24 solvent passes was used. Extraction temperatures ranged from 65° C. for hexane to 84° C. for isopropyl alcohol and 86° C. for heptane. Meals were desolventized in air at ambient temperature for 72 hours. Miscellae (solvent plus liquid wax) were desolventized under vacuum at 3-6 millimeters mercury for 2 hours. Temperatures were mostly under 110° C. using (water-pumped) nitrogen as the sparging agent. Thereafter, stripped liquid was dried in a vacuum oven at 105° C. for 2 hours.

Wax characteristics of the extracts compared to the cold-pressed extract are outlined in Figure 4. All solvents listed seemed to be adequate although each extracted a small quantity of a white crystalline

precipitate which appeared on desolventization. However, the precipitate had no apparent effect upon the melting point or hardness of the resulting hydrogenated wax.

Isopropyl alcohol extracted a considerable quantity of sugars which were removed as formed to prevent the wax product from becoming brown-colored by caramelization. Based on this study, heptane and hexane appear to be satisfactory solvents for extracting wax from jojoba seed. Isopropyl alcohol was not recommended because of the additional handling required.

Pilot plant extractions were then carried out applying the filtration-extraction procedure developed at the Southern Division for oilseeds. Hexane and heptane were used. Equipment used included Allis-Chalmers pilot-plant single-pass cracking and flaking rolls, a bench-scale cooker, and a bench-scale filtration-extraction unit. With these units, conditions similar to those used in commercial plants can be studied with relatively small quantities of material. The cooker, shown in Figure 5, was designed to make possible accurate maintenance of desired cooking temperatures and to permit quantitative addition and recovery of all materials.

Filtration-Extraction

Seed was flaked to a thickness of 0.004 inches, cooked, crisped in open trays for about 20 minutes, stirred with solvent, and filtration-extracted. For the cooking operation the flakes were heated to 180° F., sprayed with 10-15% water in a two-minute period, and the temperature then increased to and maintained at 210-220° F. for 30 minutes. Moisture content of the flakes was kept constant by refluxing for the first 15 minutes, then reduced gradually to a predetermined level during the last 15 minutes. The cooked flakes were made crisp by evaporative cooling at ambient temperature. This decreases by 1-2% the moisture content of the cooked flakes. To evaluate filtration-extraction characteristics of the cooked flakes, a bench-scale apparatus such as shown in Figure 6 was used. The prepared, cooked flakes were slurried in hexane at 120° F or in heptane at 140° F. and filtration-extracted. Mass velocities were above 4500 pounds/hour/square foot resulting in extraction efficiencies of 98.0%. When optimum seed preparation and extraction conditions are used both hexane and heptane are suitable solvents for commercial extraction of jojoba. Hexane, however, is preferred because it is readily available, lower in cost and has a lower boiling point which makes it easier to remove from the products.

Filtration-extraction data are outlined in Figure 7. Note that the high extraction efficiency did not vary with the decrease in mass velocity.

The next two figures (8 and 9) show the effects of moisture and extraction temperature on extraction efficiency and mass velocity.

Liquid Wax

As you have already heard, approximately 50% of the seed is a liquid wax which has many potential uses. It can be extracted in a remarkably pure state. Some potential uses are outlined in Figure 10. This wax can be used as a replacement for imported vegetable waxes and sperm whale oil. A recent anonymous press release reported Russian researchers had determined that jojoba oil is nonfattening when used as a salad oil.

The earliest article (Calavijero 1789) ascribed remarkable medicinal properties to the seeds and their liquid wax. Research done in more recent times in South America claims that the liquid wax has some value in treatment of the tubercle bacillus and a U.S. patent was issued for its use as a stabilizer for penicillin (Hinds, 1949; Kester, 1949; Mirov, 1952). One man told me yesterday that he has eaten the roasted seeds. The use of liquid wax for cooking and medicinal purposes has also been reported.

The natural wax can also be converted into plasticizers and lubricants. The wax may be used as a lubricant for high speed machinery and equipment operating at high temperatures and pressures and as cutting and grinding oils. If approved by FDA, the liquid wax or its products would likely solve many lubrication problems in food industries because the wax resists oxidation even at elevated temperatures.

A high dielectric constant may make this liquid wax suitable for use as a transformer oil. Other possibilities include use as an ingredient in manufacture of carbon paper, stencils, pharmaceuticals and cosmetics.

Meal

Meal remaining after extraction of the wax is reported to contain 30-35% protein and could be used as feed for livestock. This idea is supported by observations of deer and other wildlife indigenous to the growing region feeding on the jojoba plant and its nuts and lends credence to use of the liquid wax as a salad oil for humans.

Conversion of Wax to Alcohols

The sodium reduction method has been used commercially to produce high yields of alcohols from glycerol esters. The Southern Division undertook application of this method for the preparation of long chain unsaturated alcohols from jojoba, even though no glycerol esters are present in this seed. Sodium reduction was conducted on both a laboratory and pilot-plant scale. Stainless steel pilot-plant reduction and hydrolysis units are shown in Figure 11. The top jacketed, reduction vessel with a capacity of 15 gallons is equipped with an auxiliary stainless-steel stopper which fits flush to the bottom outlet to prevent unreacted metallic sodium from settling in the drain line. The 20-gallon hydrolysis unit is equipped with a condenser and steam-sparging tube for heating water used in the hydrolysis step.

One mole of moisture-free jojoba liquid wax and two moles of a reducing alcohol, methyl isobutyl carbinol, were reacted with 4 atoms of sodium dispersed in toluene, an inert medium. Reduction and hydrolysis take place as shown in the following equations:

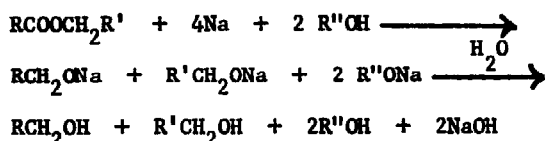

The hot reaction mixture from the reduction unit was transferred slowly to the steam-heated water in the hydrolysis unit giving rise to an emulsion of long-chain alcohols, water, toluene and sodium hydroxide. Addition time was approximately 40 minutes. Hydrolysis was continued for an additional 45 minutes. The emulsion was washed with distilled water three times, breaking the emulsion and removing most of the sodium hydroxide. Additional reducing alcohol was added to change the existing ratio of alcohol to toluene. The mixture was then heated to 100° C. and the aqueous layer was drawn off. Long-chain jojoba alcohols were recovered, without affecting the ethylenic bonds from the alcohol layer by distillation (boiling range 155-161° C. at 1 millimeter absolute pressure).

Figure 12 shows the infrared spectrum of the product alcohols from jojoba oil by sodium reduction compared with the spectrum of a pure sample of erucyl alcohol (13-docosene-1-OL). The two spectra are essentially identical, confirming that the products from sodium reduction are highly purified long-chain unsaturated alcohols. Yields of about 91% were obtained in lab-scale experiments and 82-86% for pilot-plant experiments. Unsaponifiables were as high as 98%; free fatty acids were low, ranging from 0.03 to 0.07% and the products were essentially free of soaps.

Hydrogenation

You will remember, I reported a little earlier that all six solvents extracted a small quantity of a white crystalline precipitate. Each of the six products were divided into two portions, one of the clear upper portion and the other containing the precipitate was further divided into two portions, one of which was freed of precipitate. All were hydrogenated except that fraction containing the precipitate extracted by isopropyl alcohol. No significant differences were noted in the characteristics of the resulting hard waxes as shown in the following table.

	Melting Points, °C.	Hardness ^{1/}	I.V.
Clear fractions	65-68	90	0.26-0.46 ^{2/}
Precipitate-containing fractions			
With ppt.	64-67	80-90	1
Freed of ppt. by acid-washing	65-66	90	0.8
Cold-hydraulic pressed wax	66-67	92	0.6

^{1/} Measured by the trionic gauge.

^{2/} Extracted with hexane, heptane and carbon tetrachloride.

All the products were hard white crystalline waxes and had iodine numbers less than 1, melting points ranging between 65-68° C., and hardness values of 90 on the trionic gauge.

and docosenol) may be used alone or as intermediates in preparing dibasic acids, long-chain ethers, hydroxyethers, esters and sulfated products, as bases for creams and ointments, and in lubricants, emulsifiers, antifoamers and other products.

While this talk presents a highly condensed version of the information contributed by the Southern Marketing and Nutrition Research Division, I feel certain it indicates that consideration should be given to additional organized study and evaluation in depth of the products that can be made from jojoba nuts.

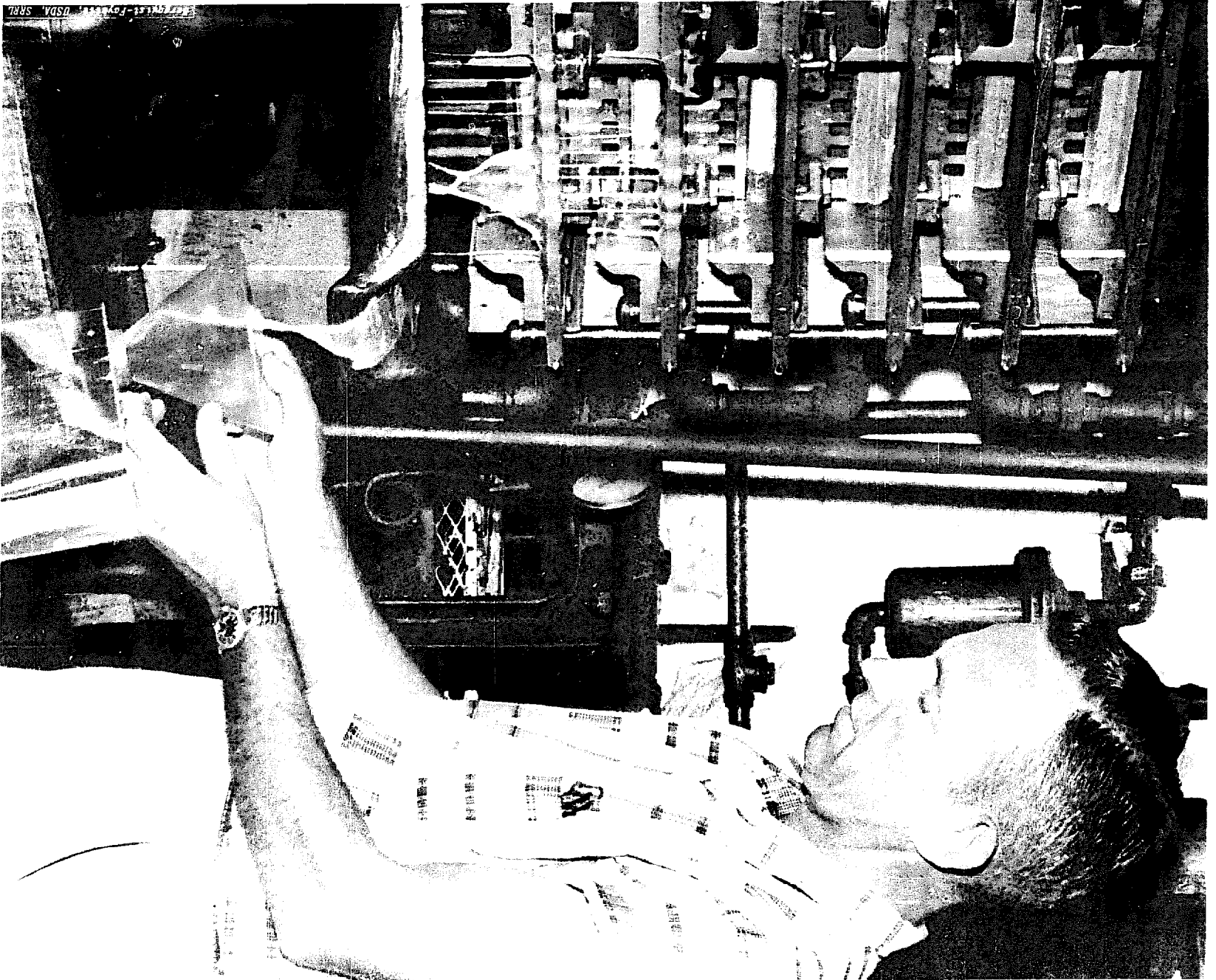

FIGURE 1

FIGURE 2

Characteristics of Meals and Flakes

Sample	H ₂ O, %	Nitrogen, %	Nitrogen Solubility, %	Lipides, %
	Experiment 1			
Flaked nuts	7.2	2.41	...	46.2
Press cake	9.1	4.11	...	12.0
	Experiment 2			
Flaked nuts	3.7	2.47	87.5	44.0
Press cake	6.3	4.09	94.5	11.3

FIGURE 3

Extraction and Desolventization Conditions

Solvent	Extraction		Desolventization		% Wax
	Temp. °C	Passes No.	Temp. °C	Pressure mm Hg.	
Hexane	65	20	97	4	48.8
Heptane	86	21	105	6	48.1
Isopropyl Alcohol	84	24	99	3	36.1

FIGURE 4
Wax Characteristics

Solvent	Index of Refraction N _D ²⁵	Density (20°C)	I.V.	P. %	Unsaponifi- ables %	Oil Color
Hexane	1.46642	0.8631	83.3	0.001	49.8	Bright Yellow
Heptane	1.46649	0.8641	83.2	0.006	50.2	Dull Yellow
Isopropyl Alcohol	1.46676	0.8649	84.3	0.001	49.9	Dull Yellow
Cold- Pressed	1.46440	0.8646	83.2	--	50.3	Bright Yellow

FIGURE 5

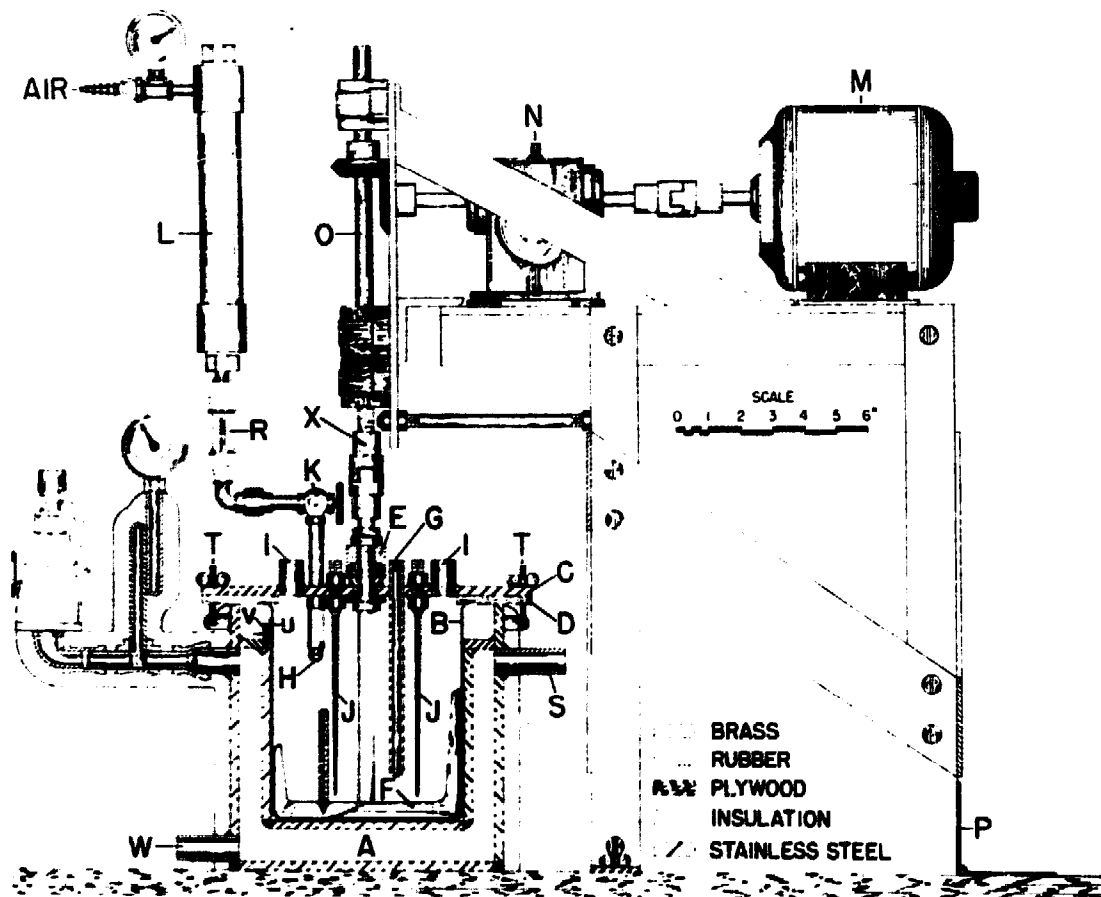

BENCH SCALE REACTION VESSEL AND COOKER.

FIGURE 6

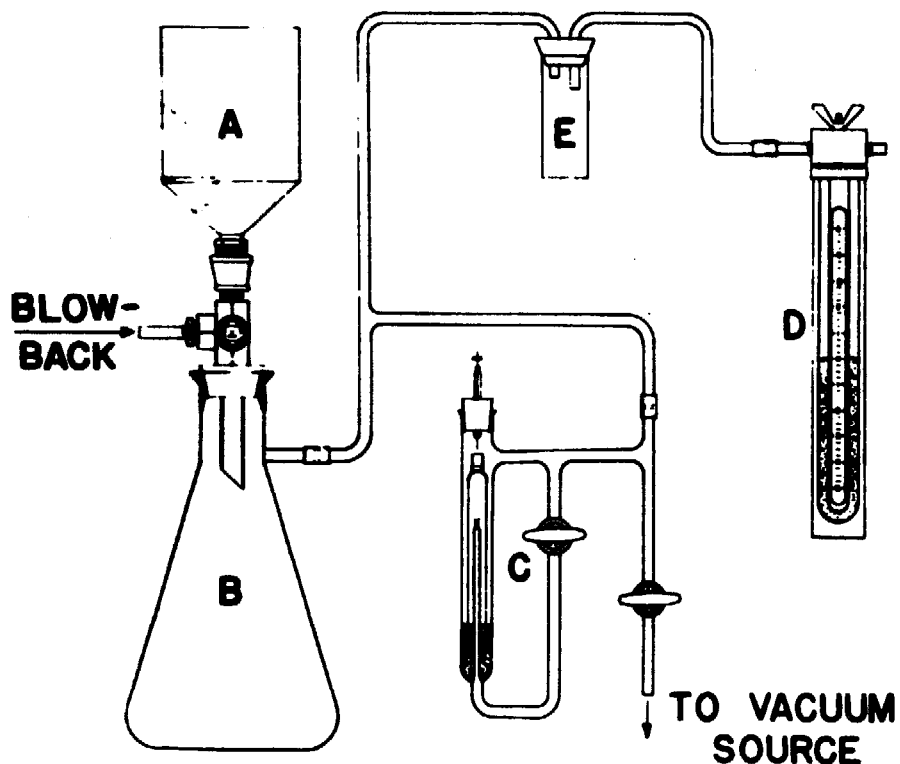

Bench-scale test unit for filtration-extraction.

FIGURE 7

Filtration-Extraction Data.^a Extraction Solvent--Hexane

Raw flake thickness, inches	0.004		
Experiment No.	1	2	3
Maximum moisture during cooking, %	10.0	15.0	15.0
Moisture of flakes to extractor, %	6.7	6.2	6.8
Extracting temperature, °F	120	120	120
Mass velocity, lbs./hr./sq.ft. ^b	6,170	4,520	2,710 ^b
Extracted meal (solvent-free)			
Moisture, %	5.6	5.8	5.8
Residual lipids, %	1.78	1.96	1.58
Extraction efficiency, %	98.0	98.0	98.3

^a Test conditions: material wt., 450 g.; solvents-to-meats ratio, 1.5 to 1; slurring time, 30 min.; washes, three; cake thickness, 2 in.; and filter screen, 60 mesh.

^b Mass velocity reduced by reducing vacuum.

FIGURE 8

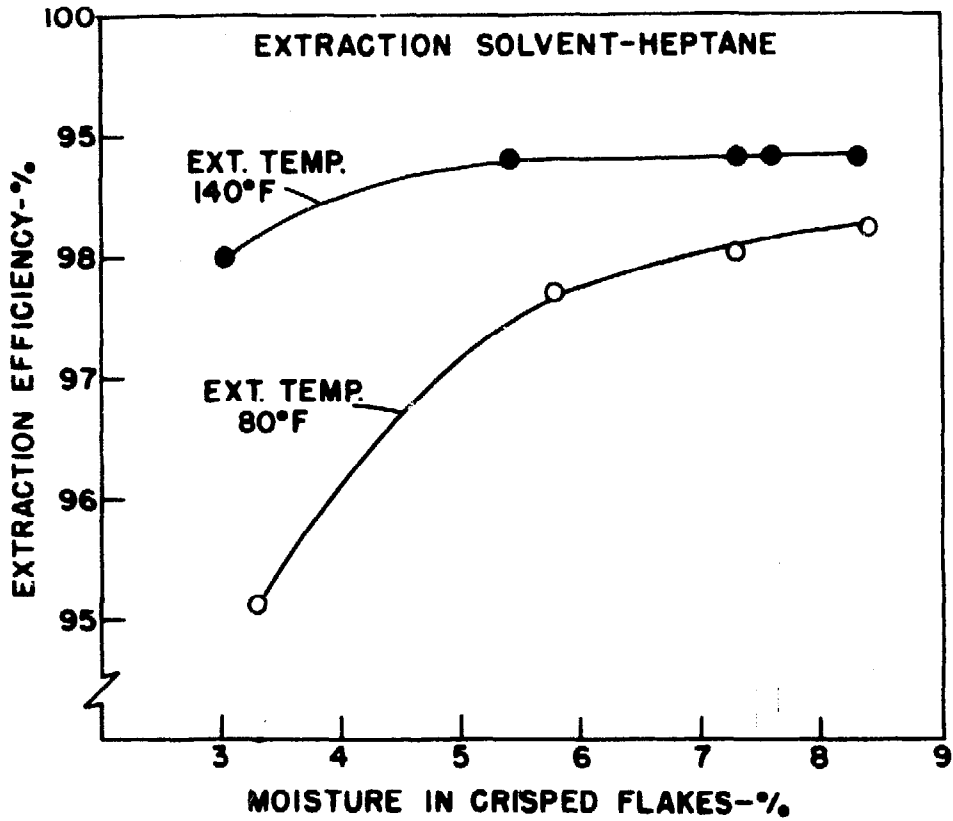

Effect of moisture in prepared flakes on extraction efficiency.

FIGURE 9

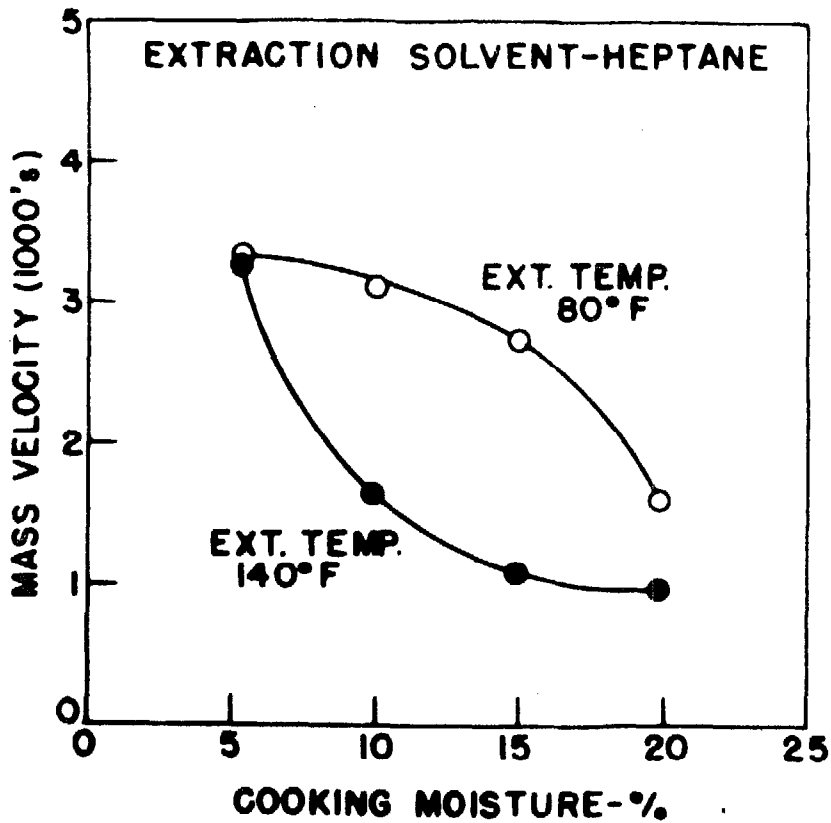

Effect of moisture in meats while cooking on the filtration rate of slurry.

FIGURE 10

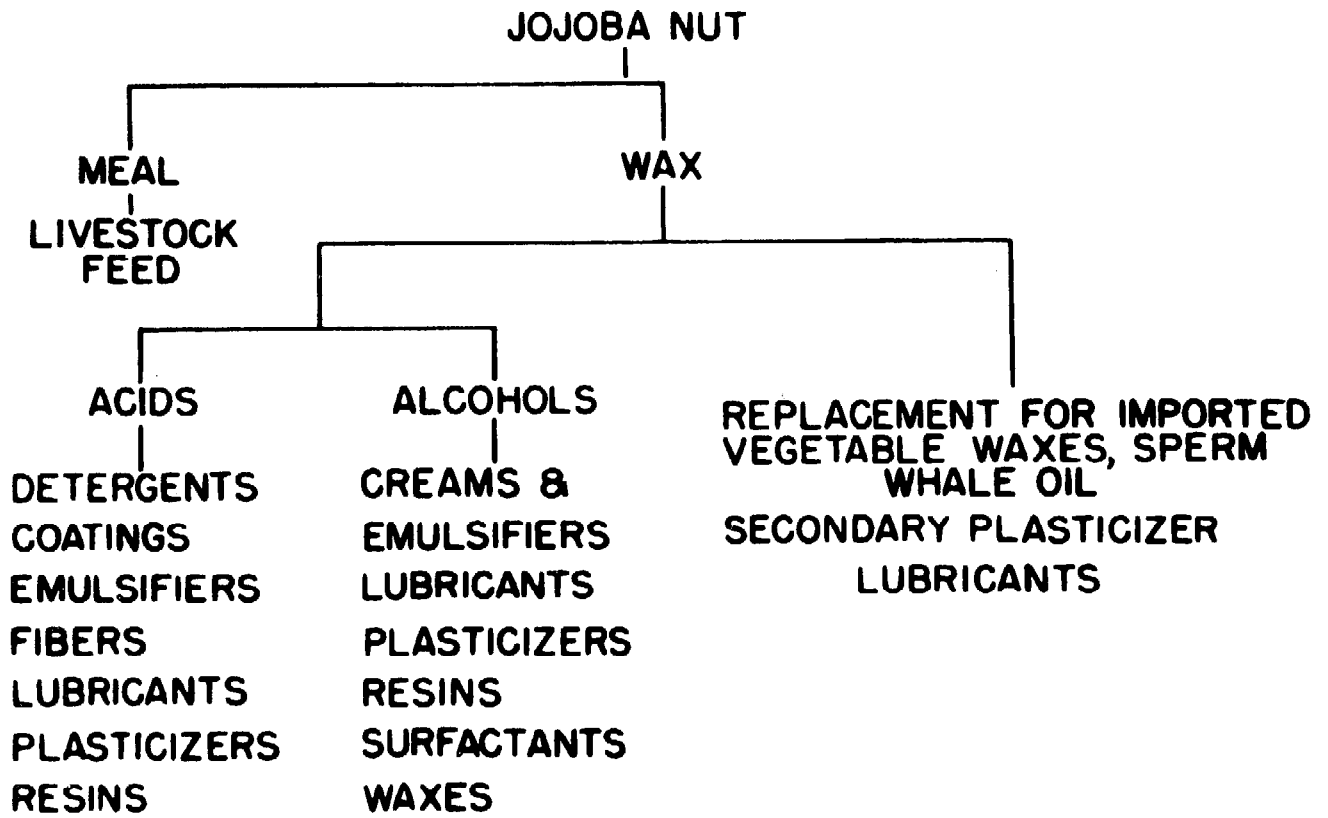
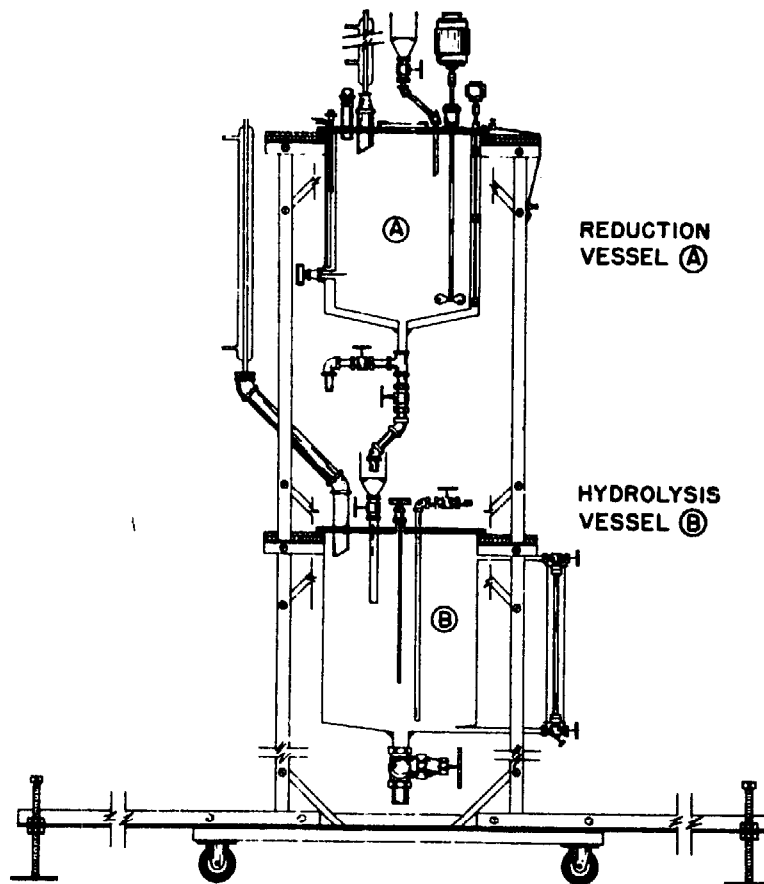
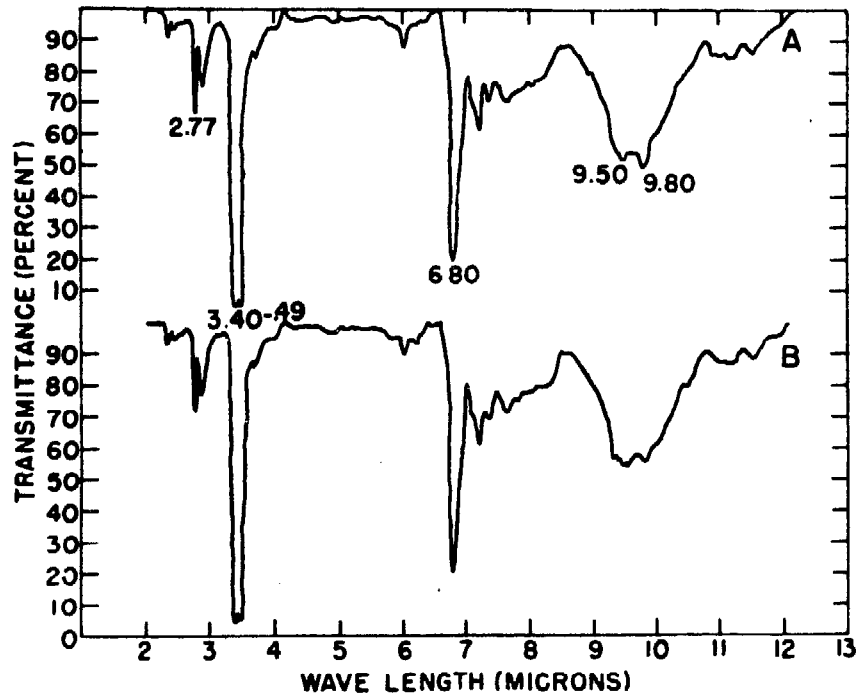

FIGURE 11



Pilot plant sodium reduction and hydrolysis units.

FIGURE 12



Infrared absorption spectra
 A. product alcohols produced by sodium reduction of jojoba oil
 B. pure erucyl alcohol (13-docosene-1-OL).

FIGURE 13

The over-all formulation used was:

Resin (Vinylite VYDR) ²	63.5%
Plasticizer or plasticizer-stabilizer combination	35.0%
Stearic acid	0.5%
Basic lead carbonate.....	1.0%

FIGURE 14

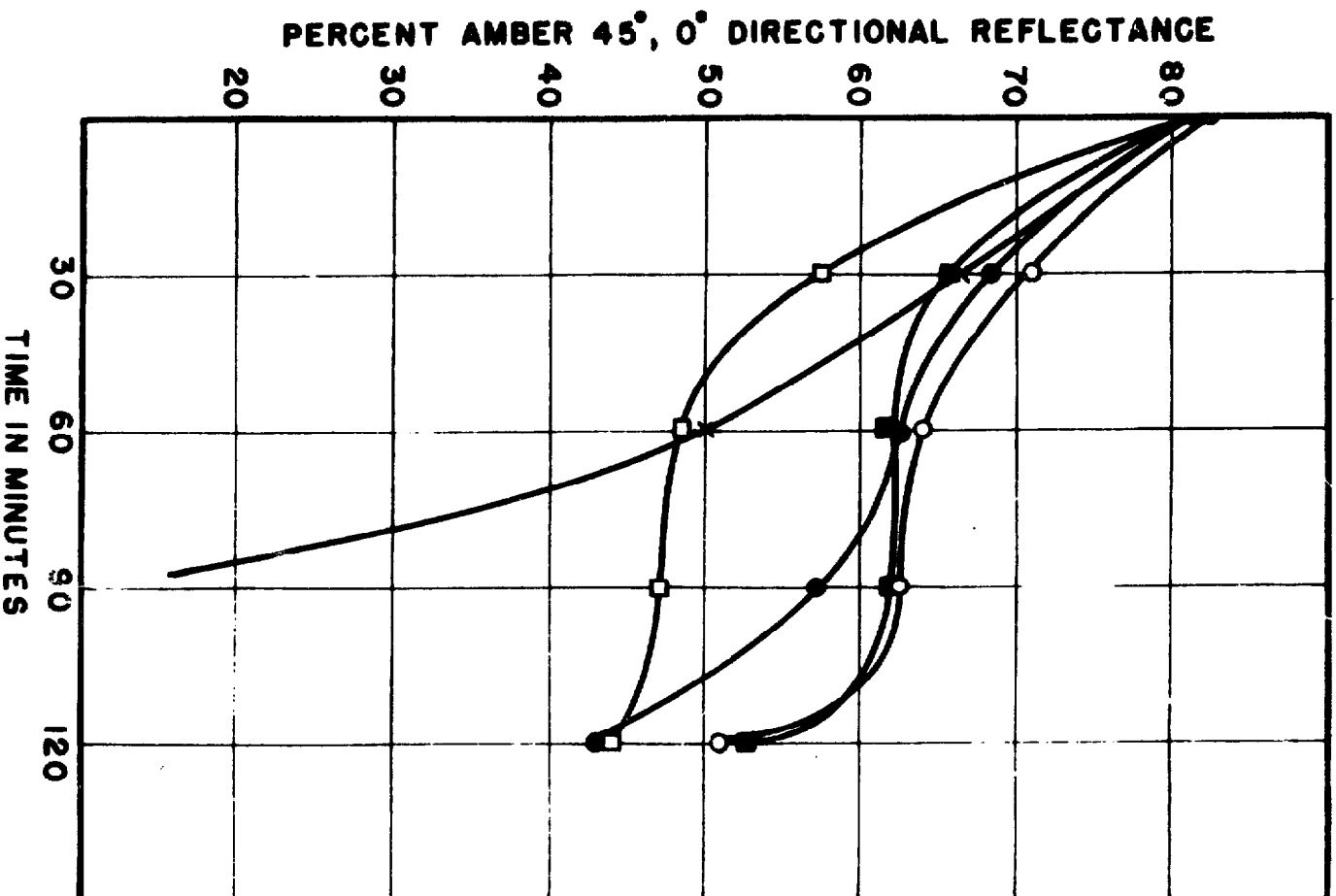

Reflectance values of DOPP formulations I containing 5 parts of (○) epoxidized jojoba oil, (●) epoxidized glycol dioleate, (□) butyl epoxystearate, (■) epoxidized soybean oil, (x) control vs. exposure to 350 °F.

FIGURE 15

Properties of Vinyl Copolymer (VYDR) Plasticized with Jojoba Esters

Plasticizer	Tensile strength, p.s.i.	Ultimate elongation, %	100% Modulus, p.s.i.	Hardness shore A 10 sec.
Maleinated acetylated jojoba alcohols Methyl esters + DOP (50-50).....	2160	350	1990	47
Hydrogenated maleinated acetylated jojoba alcohols Methyl esters + DOP (50-50).....	3120	340	1880	47
Maleinated jojoba oil Methyl esters.....	2890	280	1910	48
Methyl esters + DOP (50-50).....	3190	360	1750	42
Butyl esters + DOP (50-50).....	3070	360	1830	47
Maleinated jojoba acids Methyl esters.....	2810	280	1560	40
Butyl esters.....	2460	210	1720	46
Butyl esters + DOP (50-50).....	3090	360	1610	44
Hydrogenated maleinated jojoba acids Methyl esters.....	2810	290	1670	41
Butyl esters + DOP (50-50).....	3050	360	1630	43
DOP (Di-2-ethylhexyl phthalate) control.....	2850	300	1590	42

FIGURE 16

Nitrile rubber (Hycar 1042-33% acrylonitrile).....	100.0
SRF Black.....	60.0
Zinc oxide.....	5.0
Stearic acid.....	1.5
Sulfur.....	1.5
Benzothiazyl disulfide.....	1.5
Softener.....	20.0
Cure: 30 min. at 310° F.	

SAPONIFICATION AND GAS CHROMATOGRAPHIC ANALYSIS OF JOJOBA WAX ESTERS

Thomas K. Miwa

Northern Regional Research Laboratory
Agricultural Research Service
U.S. Department of Agriculture
Peoria, Illinois

INTRODUCTION

Seven years ago, when I first came to Tucson to learn how to make vinyl plastics under Professor Marvel, I hadn't dreamed that I would be back here to attend a conference on jojoba as a crop. Well, 7 years from now I hope to return to Tucson to see cultivated jojoba growing in its full splendor.

My first contact with jojoba came about 12 years ago when I was assigned the task of converting high-erucic vegetable oils into some useful industrial product. At that time, jojoba was assigned to the Southern Regional Research Laboratory; so no research on jojoba was done at our Northern Laboratory. However, because of the unique nature of the oil, synthetic wax ester oils that resembled jojoba were prepared at our Laboratory from the high-erucic seed oils. After the jojoba project was discontinued by the Southern Laboratory, I decided to put the finishing touches to some of the analyses that I had started on jojoba and its synthetic substitutes. Two years ago, the chemical analysis of jojoba oil was reported at the Chicago Meeting of the American Oil Chemists' Society. The compositions of jojoba acids and alcohols determined by newer methods were different enough from the earlier compositions reported by McKinney and Jamieson (1936) to warrant an updating of jojoba's composition. Furthermore, no report had ever been made on the composition of the unsaponified oil. The main portion of my presentation today will be on techniques of saponification of the oil and the gas chromatographic analyses of jojoba wax esters. The presentation is being expanded from the original plan of 15 minutes to 45 minutes, and this will now allow time for some detailed discussions on methodology which were not included in last year's publication. There is some little-known information on saponification of jojoba oil that will be very helpful, especially in the prevention of emulsification and the complete separation of acids from alcohols. In addition to saponification and gas chromatography, mention will be made of the use of jojoba oil as a possible therapeutic cosmetic, as reported in a research bulletin by an industrial firm.

ALCOHOLYSIS AND SAPONIFICATION

I have always considered jojoba oil a precious uncut diamond. If one learns how to cut it, he can surely bring out its superb glitter and brilliance. I have also looked at it as a noble oil, like liquid gold. It is very resistant to oxidation and rancidification, and this quality in turn provides the resistance to normal chemical changes that are brought upon the oil. When the oil is subjected to conventional saponification, only a small fraction is affected, and analysis of this fraction by gas chromatography reveals a predominance of C_{18} fatty acids. Obviously, the higher molecular weight wax esters are very resistant to saponification. Remembering that alcoholysis of a triglyceride oil with an acid catalyst is much easier than saponification of the oil and that saponification of esters of simple alcohols is quite facile, I transesterified jojoba oil with ethanol and hydrochloric acid and then saponified it with ethanoic KOH. In the transesterification step, ethanol was chosen instead of the cheaper methanol because ethanol is relatively nontoxic, and the gas chromatographic analysis of the mixture of alcohols and fatty esters is much simpler to interpret when ethyl esters are present in place of methyl esters. The alcohols and ethyl esters are separated at the baseline even when saturation slows down the movement of the alcohols and unsaturation speeds up the acid esters. This will be illustrated in one of the later slides.

In the first slide, the transesterification and saponification steps are outlined briefly. About half a gram of jojoba oil is placed in a reaction tube with 10 grams of dry ethanol containing 5% HCl (this is prepared by bubbling gaseous HCl into dry ethanol until a 5% increase in weight is obtained) and 1 milliliter of dry benzene is added to increase the solubility of the oil in ethanol. Jojoba oil remains insoluble as suspended globules during the first 15 minutes of reflux, but in the next few minutes it quickly goes into solution as alcohols and ethyl esters start to form. Although the reaction appears to be finished within an hour, it is allowed to reflux for 8 hours to ensure total conversion to the ethyl esters and the fatty alcohols. Then ethyl ether is added to form a clear homogeneous phase. Water is added slowly and without shaking until two phases are formed. The water phase will be mostly ethanol/water with no entrainment of ethyl esters or fatty alcohols. Excessive shaking is avoided because the ethanol in the water may extract fatty alcohols into the aqueous phase. The organic layer is washed free of mineral acid and ethanol and dried in a vacuum oven. The sample is weighed and analyzed by gas chromatography for ethyl ester and fatty alcohol compositions and also

WAX ESTER ANALYSIS

In the analysis of jojoba oil by gas chromatography, there are many little items that should not be neglected in order to obtain good chromatograms. Six items are listed on Slide 7, of which the most important is the transport of emerging components from the outlet of the column to the sensing element of the detector. Because the boiling points of the wax esters are higher than the temperatures of the column, transfer line, and detector, the volume of the transfer line should be minimized in order to prevent condensation. This is normally accomplished by designing a short transfer line, by narrowing the internal diameter of the tubing, and by packing the column outlet connection with glass wool. The detector temperature should be kept as high as possible, at least as high as the upper limit of the programmed column temperature. The flame ionization detector of our unit is kept at 385° C for wax ester analysis. This will prevent any high-boiling component or volatilized liquid phase from condensing at the base of the detector. Such condensates move to the flame tip as ripples and spikes. A critical separation performed by the column can be undone by a lack of proficiency in transporting the emerging components to the detector.

The second important item is the depositing of the injected sample deep into the column where the heat from the programmed oven can effectively move the components along the column. Even with on-column injection, if the flashing temperature were not high enough or if the oil cannot be flashed because of its high boiling point, the sample may become deposited at a region just beyond the flashing port but still out of reach of the heat from the column oven. A flashing solvent such as toluene is very handy for jojoba oil. If the neat oil sample were to be injected directly into the oven region, bypassing any injection port, then the carrier gas must be preheated to the temperature of the oven. Frequently, the failure of on-column injection processes is traced to the lack of preheating of the carrier gas.

The next item is the cleanliness of the stainless-steel tubing. Most stainless-steel tubing is extruded and drawn out with a lubricant of some sort, and this has most likely been pyrolyzed or oxidized. If not soluble in the washing solvent, the oxidized lubricant will behave as a polar liquid phase when heated by the chromatographic oven. To clean the tubing, a piece of string with several knots, soaked with acetone, is pulled through the tubing back and forth. This scrubbing process will remove the dark greasy material which had not been removed by the acetone rinse. In some cases, the difference in chromatographic behavior between a glass column and a stainless-steel column is due merely to the difference in cleanliness of the inner walls of the tubings. Because of the narrowness of the tubings, the walls account for a significant percentage of the partitioning surface area.

When packing the gas chromatographic column, the stationary phase should be passed through a sieve or visually inspected by spreading it over a sheet of paper to remove any clumps that may interfere with the packing process. Even a properly coated commercial stationary phase can form tiny clumps by standing on the shelf for several months.

In gas chromatography, it is important for the operator to decide upon the level of accuracy and precision that would be necessary for his analysis. The sample size to be injected is varied so that no overloading of the major component nor loss of the minor constituents is seen. As in the case of jojoba oil, high-temperature GLC usually shows a loss of a finite quantity, rather than a percentage, of each component. If illustrated with numbers, this would mean that a microgram of each component is lost, whether one component consists of 1,000 micrograms and another only 2 micrograms of the injected sample. The loss in the first component is only one out of a thousand but for the second it is 50%. If the sample size is cut to half, then the second component cannot be detected. Therefore, it would be wise to purposely overload the runs at least once to be sure that all of the high-molecular-weight minor components are properly detected. For a given sensitivity of the chromatograph, one must be sure that the results to be reported were not influenced erroneously by the size of the analyzed sample.

The last item listed is the fast sweep-out of undesirables immediately before injection of the sample. Unlike isothermal GLC, the cooling down process in programmed-temperature GLC will trap, at the head of the column, undesirable decomposition products from the injection port septum and from the liquid phase within the flashing block. When the oven temperature is held at 250° C or cooler for more than 15 minutes, an appreciable amount of contaminants will collect as zones and later emerge as peaks. These should be swept out in a fast programmed run before injecting a sample. During a succession of runs, the chromatograph should be left at "final hold" while a new sample is prepared for injection, and the sample should be injected as soon as the oven is stabilized at starting temperature.

The ideal programming rate for wax esters is 2° C per minute, starting at 250° C. For the first 10 minutes, even though the temperature is rising at 2 degrees per minute, the process is essentially isothermal in nature. This is illustrated in Slide 8, as a plot of retention times for three homologous series of hydrocarbons, methyl esters, and wax esters. This type of plot has never been reported before, but it shows how lower molecular-weight compounds emerge immediately after injection in a manner identical to isothermal processes; and in about 10 minutes the system is converted into a linear programmed elution process. The first 10 minutes of the programmed plot is shown as an insert at the

top. The plots also show that the differences in retention times between paraffins and methyl esters, having the same number of carbon atoms in their molecules, are all convertible to 1.7 methylene units. The differences between paraffins and wax esters are equivalent to 1.3 methylene units. The ester linkages help to promote intermolecular attraction and this in turn cuts down the movement in the gaseous phase, because the intermolecular attraction keeps the molecules in the condensed liquid form. Gas chromatography is a technique that depends on how easily gaseous molecules can be produced by the heat excitation of condensed molecules. Intermolecular attraction, and consequently condensation, is greater when the partial electronic charges in the ester linkages can find each other easily. Methyl esters, with their charges dangling at the end of the molecules, have stronger intermolecular attraction than wax esters, which have their charges buried in the middle of their molecules.

Slide 9 is a reproduction of a chromatogram that was run specifically to show the relative proportions of the components. The values on the peaks are the area-percentages. Prior to this run, the percentages of the minor constituents were verified by injections of much larger samples. The wide separations between peaks are not necessary unless other constituents are present. If unmodified jojoba oil were to be analyzed, conditions may be altered to hurry the emergence of the components, as seen in the top half of Slide 10. Instead of a 40-minute run, the analysis time is cut to 25 minutes by doubling the programming rate to 4 degrees per minute. However, if jojoba oil is modified to any degree and the relative amounts of modified and original components were to be determined, then maximum resolution is needed. The bottom curve in Slide 10 shows hydrogenated solid jojoba mixed with natural jojoba oil in a ratio of 3 to 2. Even under this high resolution condition, the saturates and unsaturates are not completely separable.

NONRANDOMNESS IN ACID-ALCOHOL COMBINATIONS

As reported last year in the Journal of the American Oil Chemists' Society, jojoba oil does not have a composition that equals the random combination calculated from constituent fatty acids and fatty alcohols. Docosenol is predominantly bound to eicosenoic acid. Slide 11 shows the compositions in mole-percent, as obtained by GLC, as calculated from the random recombination of acids and alcohols, and as calculated from a partially specific biosynthetic pattern. Ignoring the last column for a while, if one were to take 75% of the C₂₂ docosenol and specifically assign them to eicosenoic acid and then take all of the remaining fatty acids and fatty alcohols and randomly combine them, a composition as listed in the second to the last column will result. The implication is that during the most active stages of seed oil production, docosenol eicosenoate is biosynthesized almost exclusively. The last column shows how the composition changes toward random combination when jojoba oil is boiled under nitrogen at 420° C for several minutes. The main constituent, C₄₂, has dropped from 49 mole-percent to 39 mole-percent, which is close to the value for calculated random.

GEOGRAPHIC AND GENETIC INFLUENCES

Slide 12 shows the variability of jojoba oil depending on regional and phenotypical changes. The Arizona desert sample was received about 15 years ago, and the source is Boyce Thompson Institute. The seeds were stored at room temperature, but the oil is a fresh extraction. Another sample of oil from this same collection, which was extracted 12 years ago and left in a vial at room temperature, was chromatographed and found to have the identical composition as the freshly extracted oil. The second sample, labeled "Tucson suburbs," was obtained 7 years ago from Professor Muramoto of the University of Arizona. The composition of oil from this sample is nearly identical to that labeled "Arizona deserts." Professor Yermanos of University of California at Riverside provided the samples labeled "California deserts" and "California oceanside." The plants of the former are identical in growth pattern to the Arizona plants, but the oceanside variety has been described as prostrate in growth habit and as having smaller leaves and seeds than the desert type. The oil composition of the desert type is similar to the Arizona types, but the oceanside sample from the different phenotype has a tendency toward higher molecular weights.

The hydrolyzed fatty acids reflect the same pattern, as seen in Slide 13. The oceanside sample contains less C₁₈ oleic acid and more C₂₂ erucic acid than the Arizona type. The constituent fatty alcohols again reflect the same pattern, as seen in Slide 14. Additionally, a marked increase in saturated alcohols is observed for the oceanside sample. Such tendencies toward higher molecular size and greater saturation is normally coincident with increase in "topical" conditions. If the oceanside phenotype is found genetically different from the Arizona phenotype, the information given in these slides may provide chemotaxonomical support for establishing such varietal forms.

THERAPEUTIC COSMETIC FOR ACNE

In 1965 the Research and Development Division of Purex Corporation, Limited, released a bulletin entitled "A Different Approach to the Treatment of Acne Vulgaris," in which it was suggested that

jojoba oil be used as a therapeutic agent for excessive excretions from the sebaceous gland. This study had followed earlier observations that sebum excretion sets in rapidly when the skin's surface is defatted and that the rate gradually declines and finally drops to a minimum when the layer of sebum fat reaches a certain thickness. Rapid excretion resumes when the fat layer is removed again. Instead of directing all effort toward removing the self-limiting sebum layer as quickly as it forms and thereby encouraging its unending replacement, the investigators at Purex reasoned that the purposeful application of a fat layer chemically resembling sebum might aid in developing a critical thickness which would limit replacement flow.

The clinical tests had been very encouraging, so the corporation contacted Dr. Gentry for information on the supply of jojoba oil. Dr. Gentry, in turn, referred them to Dr. I.A. Wolff, who was then at our Northern Laboratory, for information on possible substitution of jojoba oil with the synthetic Limnanthes douglasii wax esters that we had patented. At that time we were not able to provide any help, and it seems that the whole program was dropped by the corporation.

POTENTIAL WATER EVAPORATION RETARDANT

On the subject of the need for utilization research on jojoba oil, which Dr. Jones had pointed out earlier, several years ago, when asked to evaluate the problem of water evaporation losses in the 17 western states, I became aware of the need for an inexpensive yet very efficient water-evaporation retardant. The retardant must be capable of respreading itself after a windy spell had caused its agglomeration. Saturated straight chain alcohols would need emulsification before spreading, and they would most likely form an insoluble scum after a windy spell. If jojoba oil were to become available in large quantities at a reasonable price, the simple process of acid-catalyzed interesterification of jojoba oil with inexpensive ethylene glycol would yield a mixture of ethylene glycol fatty acid esters and fatty alcohols, both of which are surface-active types of compounds. The unsaturation in the chain may be an asset when considering such factors as self-spreading, biodegradability, breathability, and toxicity to wildlife. (Arizona is fortunate to have Dr. Myers of Phoenix, who is one of the few world authorities on water-evaporation retardants.) If this jojoba product should prove to be effective, rafts used for evaporation retardation would be unnecessary; and this western region might benefit, twofold, by using an evaporation retardant produced from its own field crop for the conservation of its precious water.

SLIDE 1

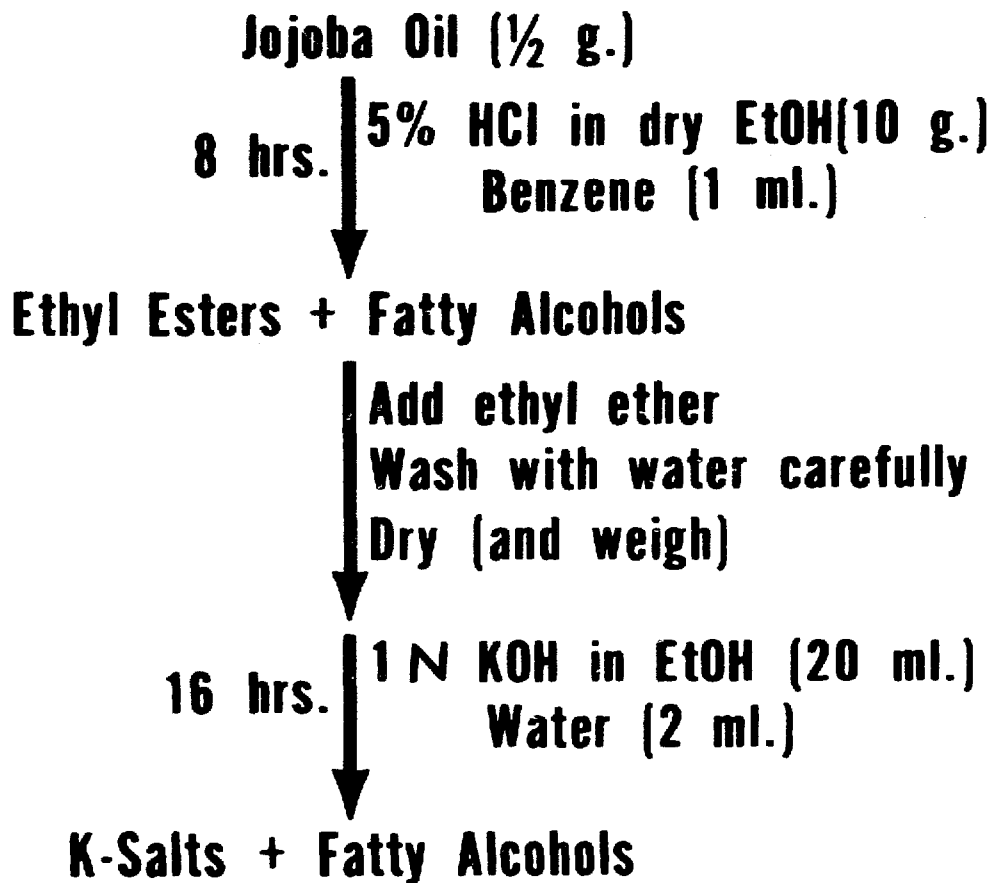

96

SLIDE 2

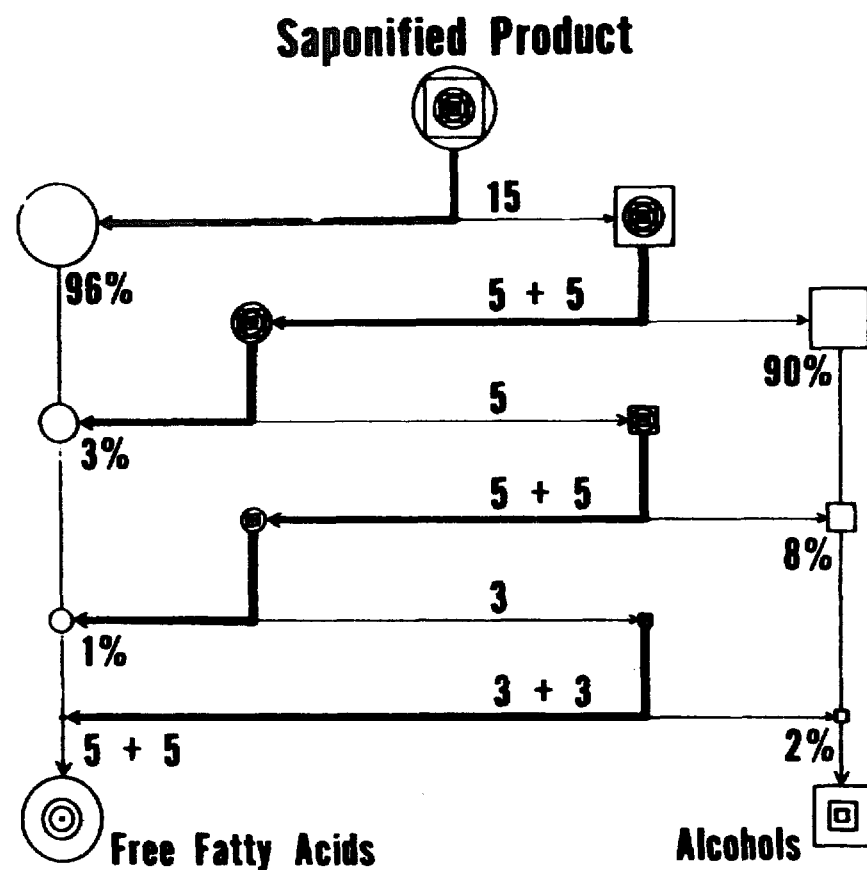

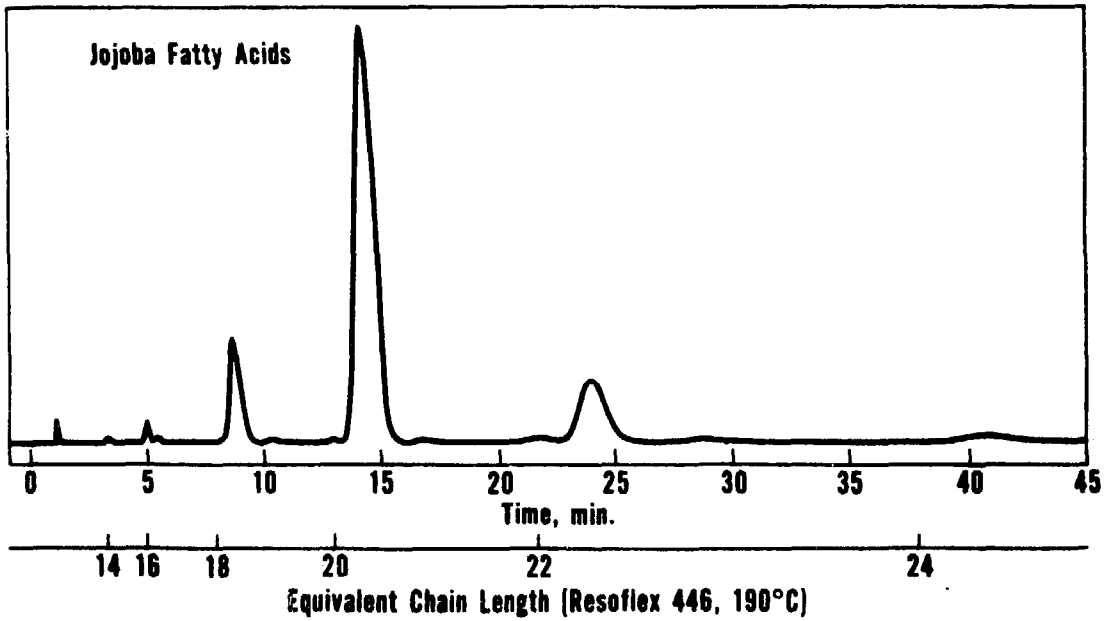
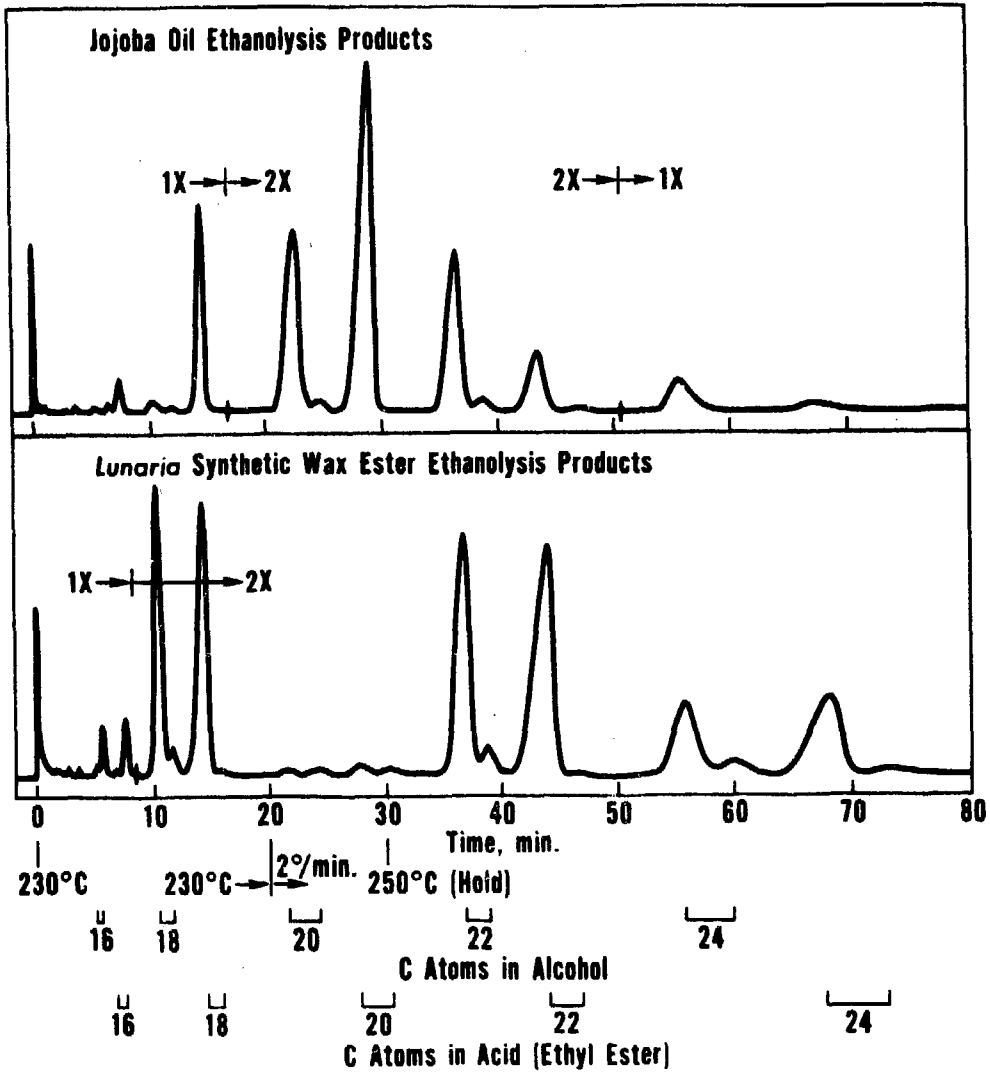

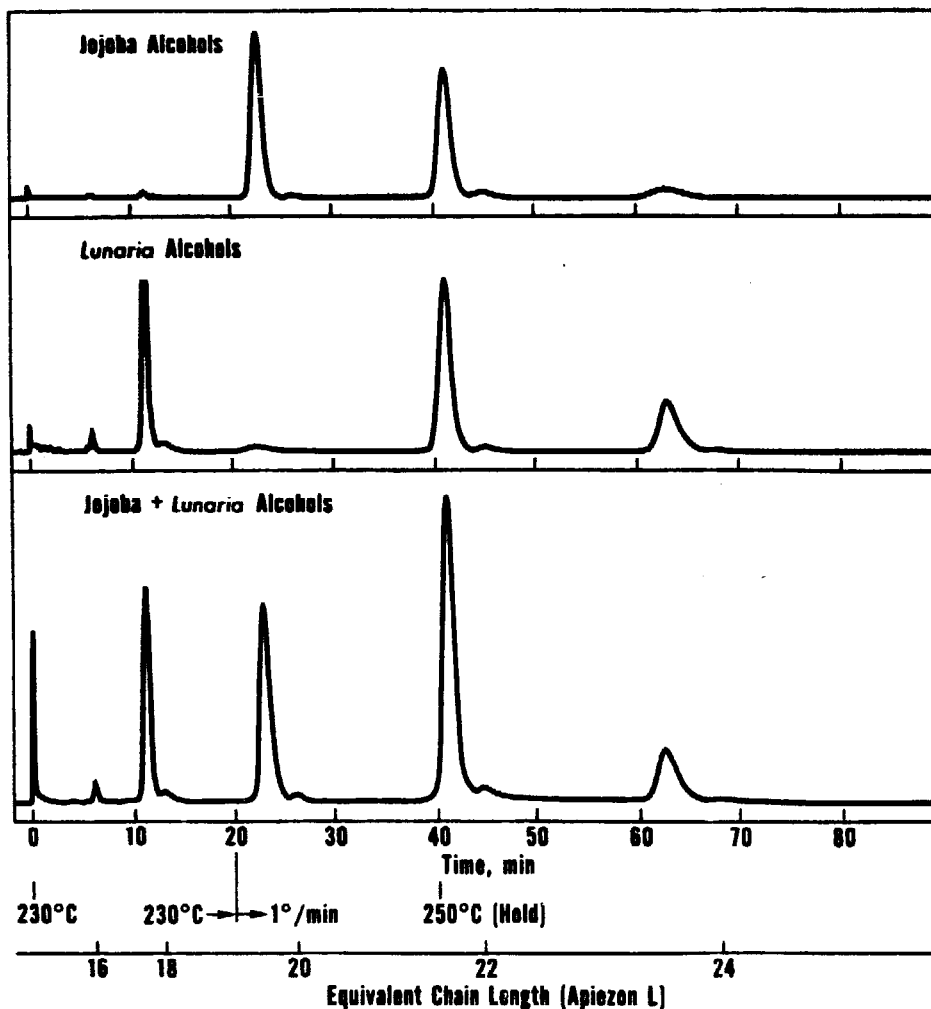

Jojoba Acids and Alcohols

Carbons & double bonds	Ethanolysis		Isolation	
	Acids	Alcohols	Acids	Alcohols
14:0	0.1	0.0	0.1	0.0
16:0	.8	.2	.8	.1
16:1	.2	.0	.2	.0
18:1	6	.6	6	.5
18:2	.1	.0	.1	.0
20:0	.1	1	.0	.4
20:1	35	22	35	23
20:2	.1	.0	.1	.0
22:0	.2	1	.0	.5
22:1	7	21	7	21
22:2	.1	.0	.1	.0
24:0	.0	.0	.0	.1
24:1	.5	4	1	4
Total.....	50.2	49.8	50.4	49.6

Gas Chromatography of Jojoba Wax Esters

◎ Transport of emerging components to detector.

○ Flashing sample with toluene deep into oven.

Cleanliness of SS tubing.

Removal of clumps from packing material.

Injection of ample quantity of sample.

Fast sweep-out when standing long at "Ready".

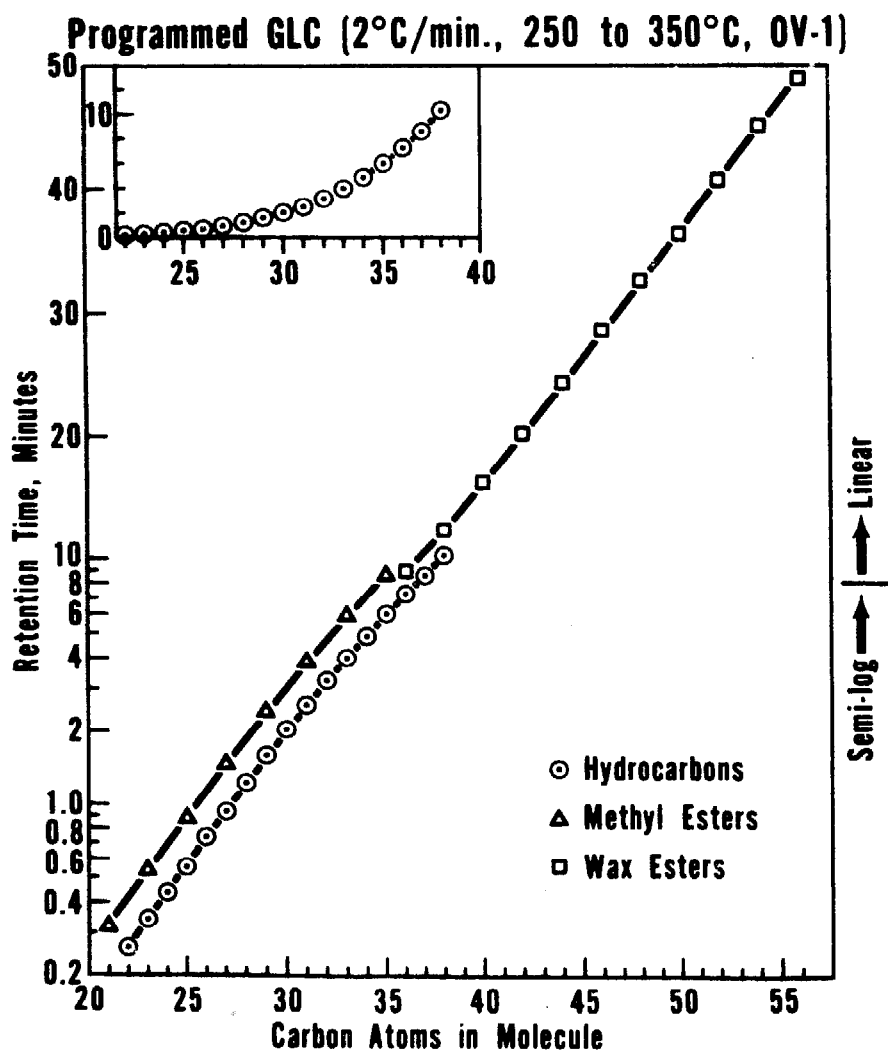

GLC of Jojoba Wax Esters

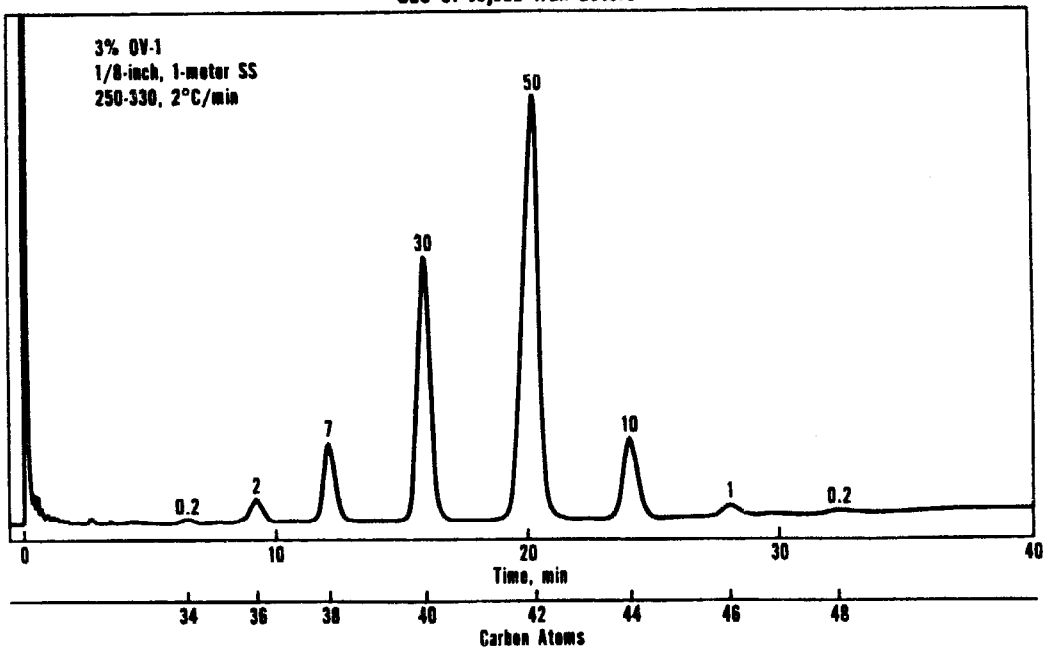

SLIDE 10

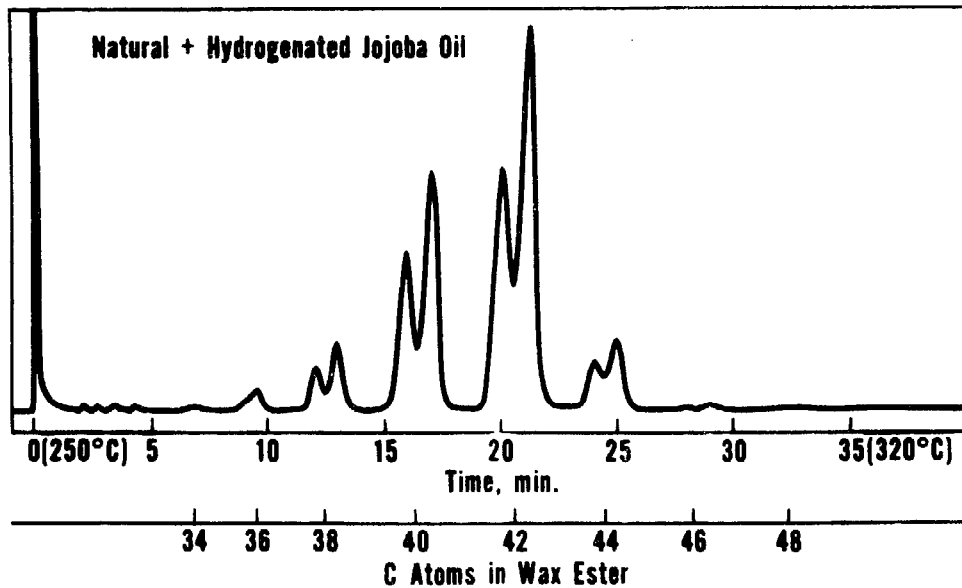
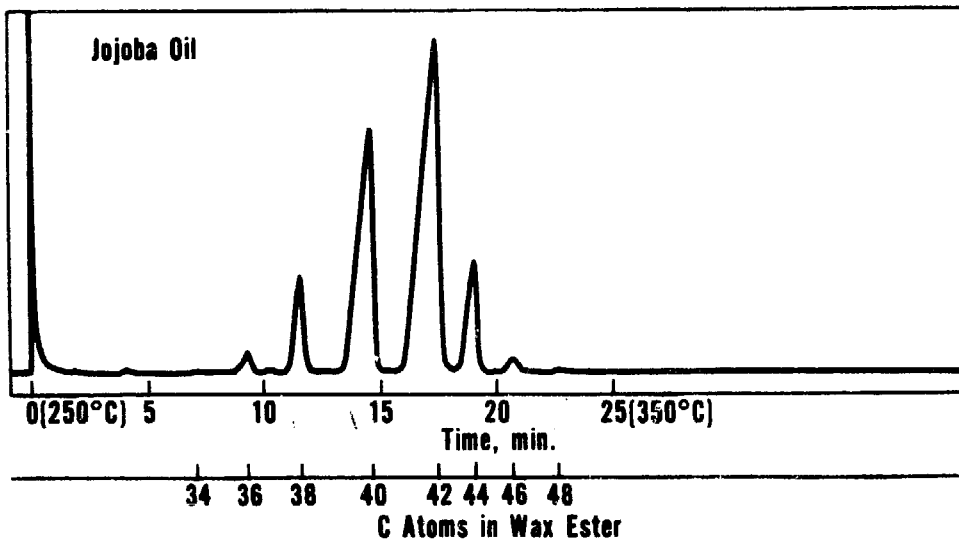

Nonrandomness of Jojoba Oil (Mole Percent)

Carbons in wax ester	G L C	Calculated random	Calculated 75% nonrand. for doco-eico.	Boiled to 420°C
34	0.2	0.1	0.1	0.3
36	2	2	2	4
38	8	8	10	9
40	30	40	31	33
42	49	37	48	39
44	10	11	7	10
46	1	2	2	4
48	0.2	0.1	0.2	0.5
Total	100.4	100.2	100.3	99.8

Variability of Jojoba Oil (GLC %)

Wax esters	Arizona deserts	Tucson suburbs	California deserts	California oceanside
C ₃₄	0.2	0.2	0.2	0.1
C ₃₆	2	2	2	2
C ₃₈	7	7	6	4
C ₄₀	30	30	28	21
C ₄₂	50	48	51	55
C ₄₄	10	11	11	15
C ₄₆	1	2	2	3
C ₄₈	0.2	0.3	0.3	0.4

SLIDE 13

Variability of Jojoba Acids (GLC %)

Methyl esters	Arizona deserts	Tucson suburbs	California deserts	California oceanside
18:1	11	11	10	7
20:1	70	71	70	69
22:1	13	13	15	17
24:1	2	2	2	3

SLIDE 14

Variability of Jojoba Alcohols (GLC %)

Alcohols	Arizona deserts	Tucson suburbs	California deserts	California oceanside
20:0	0.8	0.6	0.5	2.1
20:1	46	46	42	30
22:0	2	2	2	6
22:1	42	41	47	47
24:0	0.2	0.2	0.1	0.4
24:1	7	8	8	13

JOJOBA OIL AND MEAL SUBACUTE TOXICITY STUDY WITH RATS

A.N. Booth
Western Regional Research Laboratory
Agricultural Research Service
U.S. Department of Agriculture
Albany, California

An important aspect of the utilization of jojoba seed, to which we should address ourselves, is concerned with the potential value of the press cake or meal as a feed for livestock. As you know, when oils are removed from oilseeds such as peanuts, cottonseed, soybeans, sunflower and sesame seeds, the residual meals are sold primarily as protein feed supplements. On the assumption the same situation would also apply to jojoba, the question to be considered is the suitability of jojoba meal as a feed for livestock. Previous speakers have indicated that animals such as deer and cattle will consume the vegetative portions of the jojoba shrub, but not clearly established is the extent to which these and other animals will also ingest the oil-bearing seeds, and if so whether any adverse effects are produced.

Judging by past experience, many of the commonly known oilseed meals have posed problems for use as feedstuffs. Cottonseed meal, for example, contains gossypol, a yellow pigment which restricts the use of cottonseed meal as feed for monogastric animals. The development of a glandless variety of cottonseed may hopefully solve this toxicity problem. Soybean and peanut meals contain trypsin inhibitors which are easily inactivated by heat processing. Crambe and rapeseed meals contain goitrogens which are difficult to eliminate in a practical manner. The meal from castor beans is unsuitable as a feed due to the presence of a heat-labile toxic protein called ricin and a toxic alkaloid ricinine. The meal also contains allergens which pose health hazards for man.

More than 10 years ago we conducted some preliminary feeding trials in which laboratory rats were fed a meal (which was produced at the Southern Regional Research Laboratory in New Orleans) by hexane extraction to remove the oil from the crushed jojoba beans. Surprisingly, all rats died within 2 weeks when offered a diet containing either 22% of the whole beans or 30% of the meal. The probable cause of death was due to starvation, since very little of the diet was consumed. Rats also failed to survive when fed a diet containing 15% jojoba meal. Finally, when dietary levels of the meal were reduced to 10% or lower, there were no deaths, but growth inhibition was observed even when the dietary level was reduced to 1.5%.

Heating the meal in an autoclave appeared to decrease somewhat the growth inhibiting effect. Various organs and tissues from male rats fed the 10% level of jojoba meal for a period of 35 days were preserved in formaldehyde and after staining, were examined for histopathological effects. According to the veterinary pathologist, three distinct lesions were recognized:

1. Severe testicular atrophy with cessation of spermatogenesis
2. Large cytoplasmic vacuoles in the acinar cells of the pancreas
3. Fatty infiltration of the liver

From these results it was concluded that toxic constituents were present in the jojoba meal.

One other experiment was attempted with the jojoba meal which involved successive extraction with ether, followed by acetone, followed by methyl alcohol. The material extracted by each of the three solvents as well as the residual meal were then fed to rats. A growth inhibition was observed in the group of rats fed the acetone extractives, with a slight effect being exerted on growth by the ether extractives. Both the methyl alcohol extractives and the residual meal, on the other hand, showed no activity as gaged by growth. From these preliminary effects in rats, the possibility must be considered that jojoba meal could also be toxic when fed to swine and poultry. As for sheep and cattle, however, it is possible that the ingested meal might be detoxified in the rumen.

Concurrent with the jojoba meal feeding trials, we also investigated the effects of feeding jojoba oil to rats. Here again poor growth was observed when a diet containing 10% jojoba oil was fed to male rats for a period of 90 days. Since jojoba oil is a liquid wax rather than a glycerol ester, the digestibility of the oil was investigated by quantitative estimation of the weight of the rat feces. The results indicated that more than 80% of the ingested jojoba oil fed in the diet could be accounted for in the feces. In other words, the digestibility of the oil by rats was less than 20%. This, of course, could explain the slower growth rate of rats fed jojoba oil. A more serious finding, however, was a massive edema of the testes when the tissues of rats fed jojoba oil were examined microscopically. Whether the toxic factors in the oil and in the meal are the same can only be answered by actual chemical isolation and identification of the compounds involved.

The nutritional value of the protein in jojoba meal is another unanswered question which must be considered in evaluating the meal as a feedstuff. Determination of the amino acid composition of the

jojoba protein would be the initial approach, but the biological value of the protein when fed to animals must also be evaluated. One such test is known as the PER value (protein efficiency ratio) but this cannot be determined on the jojoba meal until it is known to be free of toxic factors.

Also pertinent to the question of the acceptability of jojoba meal as a feed for livestock are the requirements of the Food and Drug Administration before approval for use can be granted. The answers to at least 3 basic questions would be anticipated. First, does the material cause any adverse effects when fed to livestock such as cattle, swine or poultry? Second, is it safe for man to consume the meat, milk or eggs from animals fed the meal? In other words, are any hazardous compounds transmitted into the meat, milk or eggs? Third, is a reliable method available to assay detoxified meal for assurance of the absence of toxic factors?

In summary, attempts have been made in this brief discourse to point out the need to investigate any problems which might arise in conjunction with the utilization of jojoba meal as a feed for livestock. This aspect of the development of a new crop such as jojoba should be given enough priority so that if necessary, ample time and effort can be expended on the development of adequate and practical detoxication processes.

SUMMARIZING REMARKS

Noel D. Vietmeyer

National Academy of Sciences
Washington, D.C.

To summarize the meeting and our current knowledge, I believe:

1. The meeting's overall spirit is a positive one, supportive of the thesis that jojoba is important and it has future potential.
2. We have seen that jojoba has had a checkered history but that it has never yet failed because of its own inherent technical characteristics.
3. We have seen that there are some negative features to a jojoba development program; mainly a lack of sound basic scientific knowledge and the need for time-consuming research and development, plus the nagging question of toxicity which is worrisome, but in my opinion, not at all likely to completely jeopardize jojoba's development.
4. We have seen that the path ahead is not a simple one, that it is fraught with many difficulties, and it is clear that coordination, good will and a spirit of cooperation between all parties involved in jojoba development is needed.

Yesterday our knowledge of jojoba's biology took a quantum leap:

Dr. Forti mentioned his plants that bear fruit in three years after transplanting (not 5 or 7 or 10 year previously a bug-a-boo in the literature). He described indications that jojoba under irrigation may yield two crops per year.

Dr. Crosswhite set the record straight regarding Dr. Gibson and the Boyce Thompson Arboretum's role in jojoba development. Without them we might not have been here today.

We learned that jojoba contains a proven (by the National Institutes of Health) antitumor agent and that though it is in small quantity it might be an economically supportive by-product.

We learned that the chemical composition of the oil produced by the upright standing plants does not vary with location and that the composition is now known with extreme accuracy.

We learned that jojoba oil can be processed and recovered using standard equipment, that enough data is now available to scale up to full size, and that the oil and alcohols come out very pure.

We learned that cold-hardiness is an important genetic trait that may have caused the downfall of several previous plantings.

We learned that Dr. Forti has developed during the past 10 years in Israel what are probably the most productive and genetically consistent strains in the world. I believe that future work in this country should include extensive plantings of his stock and he has agreed to supply material to permit this.

We now know that three criteria for a commercial crop are favorable for jojoba. The criteria are:

1. must be productive
2. must be responsive to the artificial environments of man
3. must have a genetic versatility

It was reported yesterday that jojoba adequately meets these three criteria, at least at this incipient stage of its development.

This knowledge and much more presented at this conference was hardly dreamed of in all the years since jojoba's last quantum leap in 1958. Now let's look to the future.

ORGANIZATION

Problem A. This is an historic meeting and we must ensure that the wisdom and knowledge of jojoba presented and represented here is made available to all those who would wish to join the effort to develop this plant. I believe this can best be done with a very carefully edited monograph covering

all the aspects of jojoba from the botanical sciences to the lubrication sciences. I hope that the next step will be to produce such a book. This will focus outside readers' attention on the importance of jojoba and will lay before them, as a challenge, the scope and magnitude of the tasks ahead. This book should be very carefully edited and should build the case (realistically though) for jojoba so that readers not indoctrinated with the jojoba spirit become so. It will take time.

Problem B. To develop plants or existing stands that can yield oil economically in the shortest possible period I believe that all approaches and innovations must be explored. The latest in plant genetic technology, the latest in horticulture technology, the latest in water harvesting and the best mechanical technology for harvesting wild plants should all be considered and brought to bear in a coordinated, objective research and development effort between all the specialists needed.

I believe that the three-pronged approach described for the conference by Dr. Jones to be a very sound planning model to begin with.

Problem C. To keep the research and development moving in the most efficient and effective manner is still most important. Jojoba even now could repeat the cycles of the past and decline into obscurity for another decade. I propose that here and now be established a Task Group for National and International Cooperation in the Research and Development of Jojoba; that the Task Group include Dr. McGinnies (representing Arizona) and Dr. Yermanos (representing California) and that between them they choose a multidisciplinary panel of some 10 or so members. Dr. Perry (Australia) and Dr. Forti (Israel) should be foreign corresponding members.

The Panel's task will be:

1. To communicate research and development efforts so as to avoid unnecessary duplication
2. To improve communication and cross-fertilization between all of the disciplines involved (botany, agronomy, soil science, hydrology, oilseed processing, industrial utilization)
3. To produce a mimeographed newsletter to keep all outside interested parties aware of advances in jojoba research and development
4. To convene an informal jojoba meeting to maintain communication between the disciplines
5. To help ensure that research grant requests are not duplicative
6. To immediately write a brief state-of-the-art position paper written in nondetailed language for a nontechnical audience such as the press and the Arizona and California Congressional Delegations and for use in making research grant proposals
7. To petition for standardization of the botanical name of jojoba
8. To produce a few pages of guidance on the planting and nurturing of jojoba seeds
9. To consider a plant material bank and a jojoba information bank

This suggestion to establish the Task Group was approved by the conference. Dr. William McGinnies was nominated chairman for the first year.

RESEARCH AND DEVELOPMENT

Some of you may think we have talked a lot about research. This should not scare you. Jojoba research has a long way to go but as results come out, jojoba cultivation can continue; there is no law that says commercialization must wait until all the research is complete. As an example, man is only just beginning to understand the chemistry of cement and concrete and to understand why concrete is so strong, and yet we have been using it in construction since 1830.

With this clearly in mind, I would like to point out how this conference has brought to light principles and areas for jojoba research and development.

Two general principles that are important are:

1. One-shot experiments usually do more harm than good. There are multiple ways for processing jojoba oil into end products, multiple ways of using the end products; first choices are uneducated choices and run a very high risk of producing an unjustified negative result. Research and development efforts must be well founded, well funded and well supplied with material. They must be competently conducted without haste. Furthermore, the results must be public knowledge and open for refereeing and

scrutiny by the technical community. We can see some mistakes in this area in the older work where tons of oil were shipped from Superior to industrial users, yet we still know little of their results.

2. Jojoba development will be spurred if a unique product can be found--one that has no substitute. The uniqueness of jojoba as a sperm oil substitute may no longer be enough.

The solid, hydrogenated wax may actually be the jojoba product to begin with!

Some research topics that have been suggested

1. Agronomy

- a. Field studies to analyze, as Dr. Jones said, "the results of experiments that have been under way for thousands of years." To find germ plasm and environmental relations in the desert
- b. To get plants with high productivity (Dr. Forti believes they are still not productive enough to be a cultivate)
- c. To get more uniform genetic material
- d. To manipulate natural stands to make them more productive
- e. To develop plants that consistently produce seed clusters
- f. To develop jojoba strains suitable for ornamental purposes
- g. To identify the sex of a seed before it is planted
- h. To further develop hermaphroditic plants and to incorporate this genetic trait into existing high yielding strains
- i. To further develop the grafting of male stems to female bushes and to determine if their pollen remains viable
- j. Response of jojoba to fertilization and herbicides
- k. Harvesting the seed economically
- l. Pruning

2. Utilization

- a. Use as a cosmetic especially a therapeutic cosmetic for acne
- b. To finalize questions of oil and meal toxicity to nonruminants and ruminants
- c. To obtain FDA approval for using jojoba in animal feeds, cosmetics, and foods
- d. Extensive, long term research and development into the multitude of industrial uses for jojoba
- e. Reinvestigation of the effects of jojoba on Tubercle bacillus, Bacillus leprae and the Brucellosis bacilli
- f. The use of jojoba oil for water evaporation control

What will happen as a result of this meeting? A continuing dialogue and collaboration between jojoba scientists in many disciplines will continue. OEO and other agencies will gain even more confidence in the plant, its potential and its product. More and very extensive funds are already being discussed. Many more of us will become "Johnny Mirov Appleseeds" and with a renewed sense of dedication. A book of the realities and promise of jojoba will be produced. Many researchers have and will be stimulated to renewed efforts.

It is impossible to determine precisely the effects of a meeting such as this but I very firmly believe that a decade from now we will look back on this meeting as the catalyzing force that projected jojoba along the pathway leading to commercialization.

LITERATURE CITED

- Burden, J.D.
1970 Ecology of Simmondsia chinensis (Link) Schneider at its lower elevational limits. M.S. Thesis, Arizona State University.
- Calavijero, F.T.
1789 Storia Della California. M. Fenzo, Venezia (Venice).
- Carder, D.J.
1970 Road Catchments--A method of increasing runoff into dams and reservoirs. Western Australian Department of Agriculture Technical Bulletin No. 5.
- Cluff, C.B.
1971 Plastic catchments for economical harvesting of rainfall. Proceedings of Tenth National Agricultural Plastics Conference, Chicago, Illinois. Edited by J.W. Courter, University of Illinois.
- Coit, J.E.
1962 Horticultural aspects of jojoba. *Fruit Varieties* 16:32-34.
- Daugherty, P.M., H.H. Sineath, and T.A. Wastler
1953 Industrial raw materials of plant origin IV. A Survey of Simmondsia chinensis (Jojoba). Georgia Institute Technology Bulletin 17:1-36.
- Evenari, M., L. Shannon, and N.H. Tadmor
1971 Runoff agriculture in the Negev Desert of Israel. Food, Fiber and the Arid Lands, The University of Arizona Press, Tucson, Arizona.
- Fore, S.P., F.C. Magne, and W.G. Bickford
1958 Epoxidized jojoba oil as a stabilizer for vinyl chloride containing plastics. *Journal of American Oil Chemists' Society* 35(9):469-472.
- Fore, S.P., H.P. Pastor, J.P. Hughes, and W.G. Bickford
1960 Derivatives of jojoba oil as plasticizers for vinyl polymers and bung-N rubber. *Journal of American Oil Chemists' Society* 37(8):387-390.
- Frick, C.
1939 The horned ruminants of North America. American Museum of Natural History.
- Gentry, H.S.
1958 The natural history of jojoba Simmondsia chinensis and its cultural aspects. *Economic Botany* 12:261-294.
- 1965 A desert boxwood still in the desert. *Boxwood Bulletin* 5:32-36.
- Gibson, F.
1938 Simmondsia californica Nuttall is dioecious. Boyce Thompson Institute, Contributions 10:45-46.
- Gindel, I.
1956 Acclimatization of plants (Hebrew). Am Oved Publishing House, Tel Aviv, 355 pp.
- Greene, R.A. and E.O. Foster
1933 The liquid wax of seeds of Simmondsia californica. Botanical Gazette 94(4):826-28.
- Hikmat, A. Al-Ani, B.R. Strain, and H.A. Mooney
1972 The physiological ecology of diverse populations of the desert shrub Simmondsia chinensis. *Journal of Ecology* 60(1):41-57.
- Hillel, Daniel
1967 Runoff inducement in arid lands. Final Technical Report submitted to the United States Department of Agriculture, Volcani Institute of Agricultural Research, Rehovot, Israel.

- Hinds, W.E.
1949 Penicillin Product. United States Patent Office #2,487,336.
- Jones, M.A. and N.B. Knoepfler
1957 Wax uses of desert shrub, jojoba, subject of promising study. Chemurgic Digest 16(1):5-6, 11.
- Katznelson, Y.
1967 Climatic regions of Israel (Hebrew). Israel Meteorological Service, Series A, No. 23.
- Kester, E.B.
1949 Minor oil-producing crops of the United States. Journal of American Oil Chemists' Society 26:65-83.
- Knoepfler, N.B. and H.L.E. Vix
1958 Review of chemistry and research potential of Simmondsia chinensis (Jojoba) oil. Agricultural and Food Chemistry 6(2):118-121.
- Knoepfler, N.B., E.J. McCourtney, L.J. Molaison, and J.J. Spadaro
1959 A comparison of six solvents for the extraction of jojoba seed. Journal of American Oil Chemists' Society 36(12):644-648.
- Kraemer, C.J., Jr.
1958 Excavations at Nessana III: Non-literary papyri. Princeton University Press, Princeton, New Jersey.
- Martinez, Lorenzo and Sergio Cepeda Voldes
1970 Aprovechamiento De Aguas De Escurrimiento y Produccion De Cosechas en Suelos De Laderas Aluviales de la Zona Arida del Municipio de Saltillo. Boletin Tecnico de la Escuela Superior de Agricultura "Antonio Narro" Universidad de Coahuila.
- Marvel, C.S., D.M. Paisley, G.M.A. Khattab, W.G. Bickford, and S.P. Fore
1960 Polymerization reactions of the acrylate and methacrylate esters of alcohols from jojoba oil. Journal of Polymer Science 44:289-294.
- McGinnies, W.G. and J.F. Arnold
1939 Relative water requirement of Arizona range plants. University of Arizona Agriculture Experiment Station Technical Bulletin 80.
- McKinney, R.S. and G.S. Jamieson
1936 A non-fatty oil from jojoba seed. Oil and Soap 13:289-292.
- Meteorological Service
1961 Climatological Normals. Part I. B. Temperature and relative humidity (2nd Edition) Israel Meteorological Service, Series A, No. 3B.
-
- 1970 Annual Rainfall Summary 1968-69. Israel Meteorological Service, Series B, No. 22/R.
-
- 1970 Monthly Weather Report, January-March 1970. Israel Meteorological Service, Series B. No. 277-279, W.
-
- 1970 Monthly Weather Report, September-December 1969. Israel Meteorological Service, Series B, No. 272-275, W.
-
- 1971 Monthly Weather Report, April-May 1970. Israel Meteorological Service, Series B, No. 280-281, W.
- Mirov, N.T.
1950 Simmondsia. Chemurgic Digest 9(7):7-9.
-
- 1952 Simmondsia or jojoba, a problem in economic botany. Economic Botany 6(1):41-47.
- Molaison, L.J., R.T. O'Connor, and J.J. Spadaro
1959 Long-chain unsaturated alcohols from jojoba oil by sodium reduction. Journal of American Oil Chemists' Society 36(9):379-382.

- Myers, L.E., G.W. Frasier, and J.R. Griggs
 1967 Sprayed asphalt pavements for water harvesting. *Journal of the Irrigation and Drainage Division, Proceedings of the American Society of Civil Engineers.*
- Myers, L.E. and G.W. Frasier
 1969 Creating hydrophobic soil for water harvesting. *Journal of Irrigation and Drainage Division, Proceedings of the American Society of Civil Engineers.*
- Raven, P.H. and D.W. Kyhos
 1965 Chromosome numbers of spermatophytes, mostly Californian. *Aliso* 6:105-113.
- Scott, W.B.
 1937 *A history of land mammals of the Western Hemisphere.* MacMillan Co., New York.
- Sellers, W.D.
 1960 Precipitation trends in Arizona. *Proceedings of the 20th Annual Western Snow Conference, Santa Fe, New Mexico.*
- Shannon, L., M. Evenari, and N.H. Tadmor
 1969 Ancient technology and modern science applied to desert agriculture. *Chronica Horticulturae*, Vol. 9, No. 3.
- Spadaro, J.J., P.H. Eaves, and E.A. Gastrock
 1960 Direct extraction of jojoba seed. *Journal of American Oil Chemists' Society* 37(3):121-124.
- Stebbins, G.L. and J. Major
 1965 Endemism and speciation in the California flora. *Ecological Monographs* 35:1-35.
- Yermanos, D.M., L.E. Francois, and T. Tammadoni
 1967 Effects of soil salinity on the development of jojoba. *Economic Botany* 21:69-80.