

**AT** MICROFICHE  
REFERENCE  
LIBRARY

A project of Volunteers in Asia

Liklik Buk: A Rural Development Handbook/Catalogue  
for Papua New Guinea

by: P. R. Hale and B. D. Williams

Published by:

Liklik Buk Information Center  
P.O. Box 1920  
Lae  
Papua New Guinea

Paper copies are \$ 5.95.

Available from:

Volunteers in Technical Assistance  
1815 North Lynn Street Suite 200  
P.O. Box 12438  
Arlington, VA 22209 USA

Reproduced by permission of the Melanesian Council  
of Churches.

Reproduction of this microfiche document in any  
form is subject to the same restrictions as those  
of the original document.

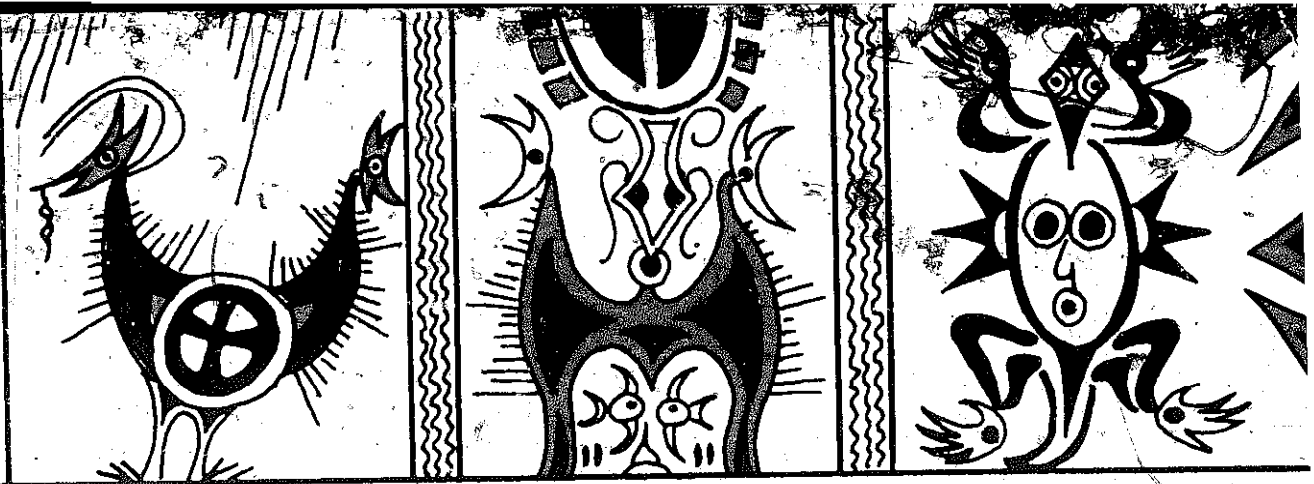

# LIKLIK BUK

A Rural Development Handbook Catalogue  
For Papua New Guinea

English Edition 1977

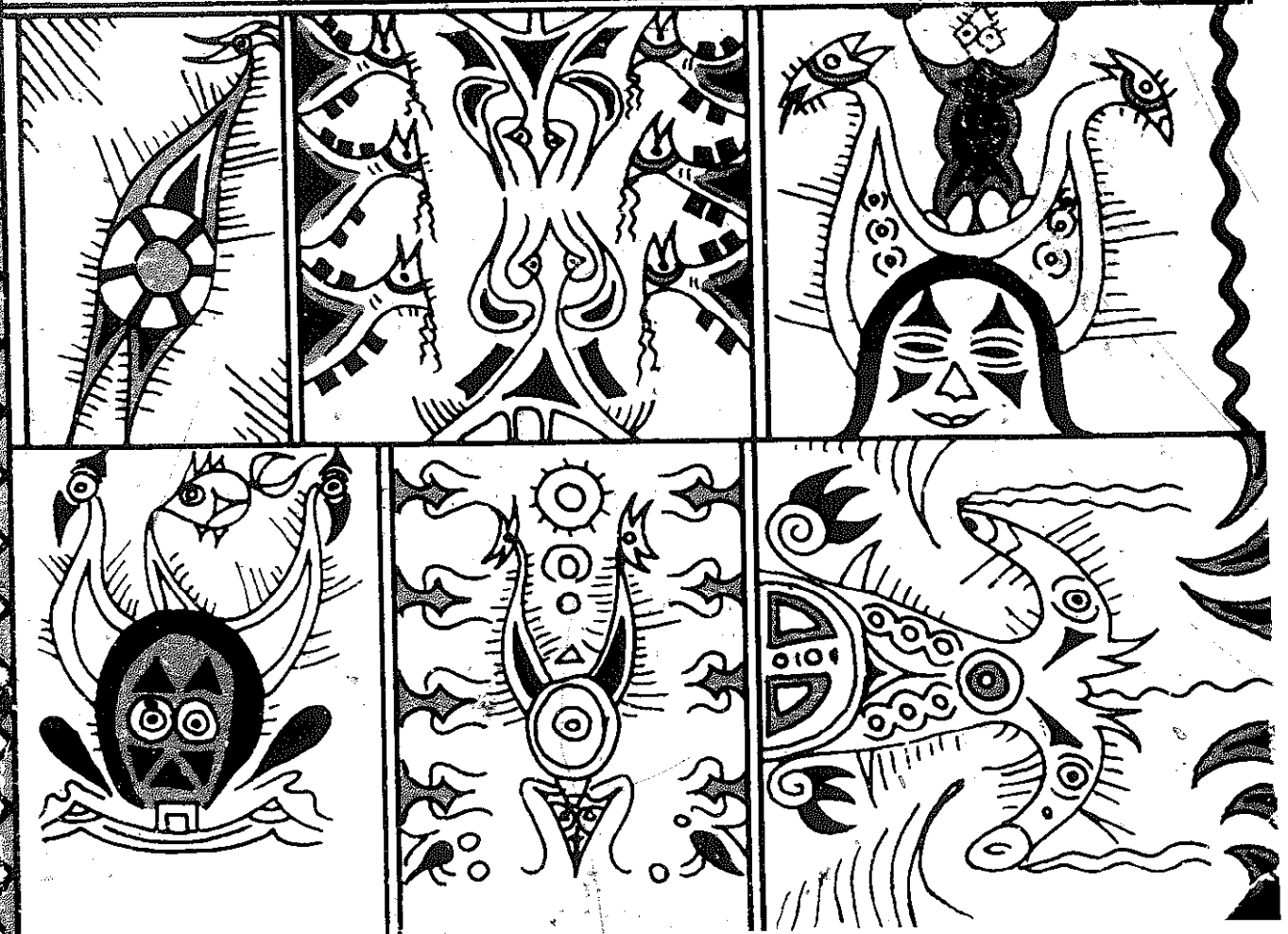

**CAUTION \$7**

Supply of this technology except  
on consideration of social and  
cultural factors is inappropriate.

# LIKLIK BUK

## A Rural Development Handbook Catalogue For Papua New Guinea

Leaders/Rural School Teachers/Didimen  
Business Development Officers/Priests  
Adult Education Officers / Politicians  
Rural Development Officers / Pastors  
Trainers / Student Volunteers / Leaders  
Good deed Doers / Nutrition Workers  
Vocational Training Centres / Leaders  
Volunteers / Bisnismen / Missionaries  
Community Leaders / Welfare Workers  
Health Workers / High School Leavers  
Communicators / Animators / Trainers

Liklik Buk gives community level leaders and trainers in Papua New Guinea better access to rural development information sources, with the goal of village self-help action. Short, rich articles on crops, animals, processes, designs, health, animating rural development; lists of books, pamphlets and organizations; plus comments and editorials from a broad range of contributors. Information given on particular topics is not complete, but it is basic, technically sound, and helps the reader define an interest and find further information.

If you take away from the midst  
of you the yoke,  
the pointing of the finger, and  
speaking wickedness,  
If you pour yourself out for the  
hungry  
and satisfy the desire of the  
afflicted,  
Then shall your light rise in the  
darkness  
and your gloom be as the  
noonday.  
  
And the Lord will guide you  
continually,  
and satisfy your desire with good  
things,  
and make your bones strong;  
and you shall be like a watered  
garden,  
like a spring of water,  
whose waters fail not.

Isaiah 58:9b-11

© The Melanesian Council of Churches  
ISBN: 0-86935-0244

THE MELANESIAN COUNCIL OF CHURCHES:

The Anglican Church  
The Evangelical Lutheran Church  
The Roman Catholic Church  
The Salvation Army  
The Wabag Lutheran Church  
The Western Highlands Baptist Church  
The United Church.

Published by: Liklik Buk Information Centre,  
P. O. Box 1920  
Lae, Papua New Guinea

Edited by: P.R. Hale and B.D. Williams

The Cover by: Nelson Aigua, Marili Village, Siassi.

Printed by: WIRUI PRESS  
P. O. BOX 107  
WEWAK, PNG.

Distributor: WANTOK PUBLICATIONS  
P. O. BOX 1982  
BOROKO, PNG.

Liklik Buk welcomes the reproduction of portions  
of this material for non-commercial purposes.  
Credits and copies of articles would be appreciated.

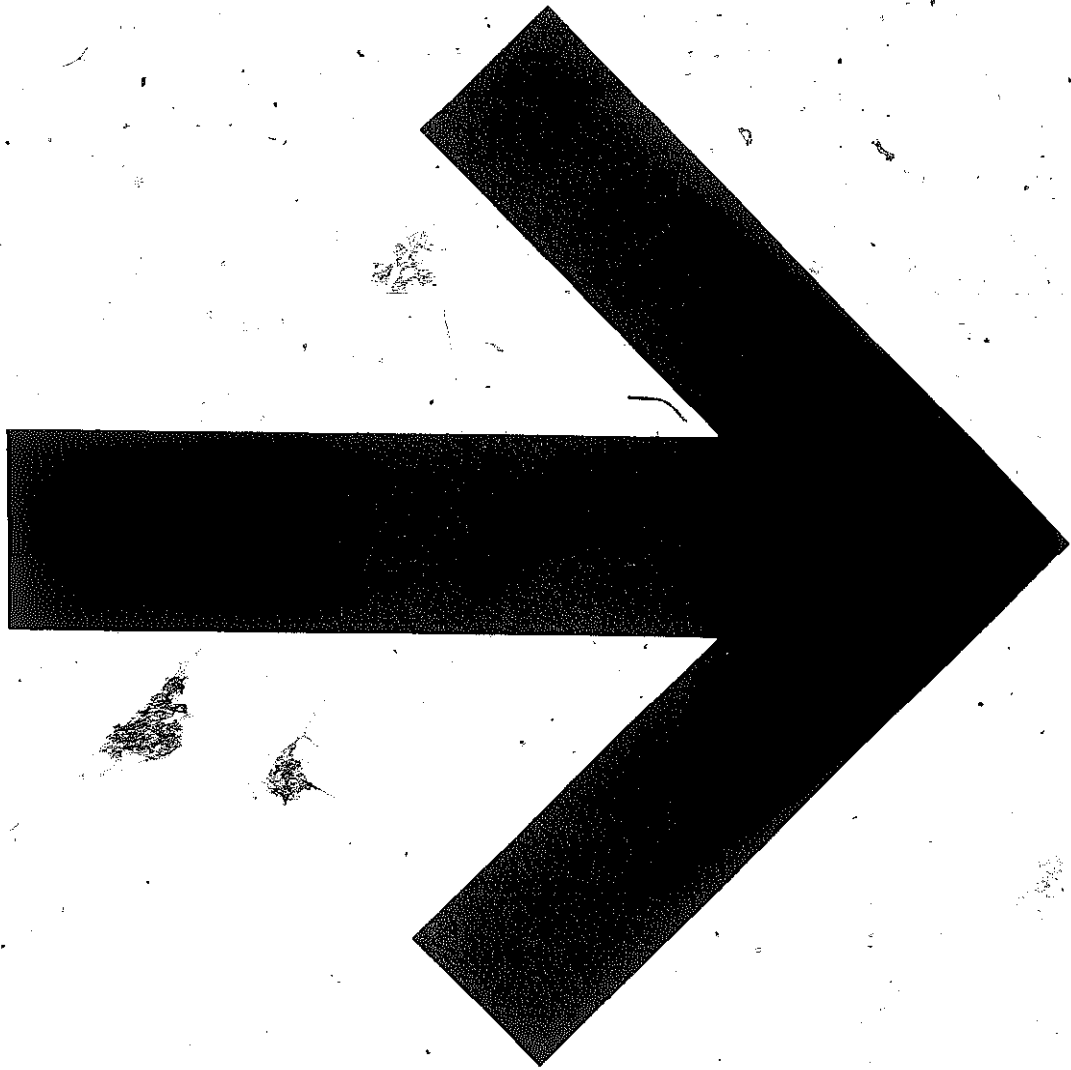



## FORWORD

Appropriate technology, intermediate technology, self-help technology are becoming common terms in Papua New Guinea. Even though we do have considerable advanced technology, there is a growing appreciation for technology which our people in the villages can initiate, maintain, and control - technology which uses locally available resources, and which fits better with our way of doing things.

Papua New Guinea has a rich and varied treasure of basic technology as an integral part of her culture. So appropriate technology is not new - only the name is new. The challenge is to encourage our people to continually rediscover themselves and their capability to create and innovate.

Liklik Buk is an invaluable tool for those who work at this task. We commend it for widespread use, and congratulate all who participated in producing it.

A handwritten signature in cursive script, reading "M. T. Somare". The signature is written in dark ink on a light background.

M. T. Somare  
Prime Minister

# GENERAL INDEX

## CROPS

page

### Primary Energy Crops

Banana	1
Buckwheat (No Article)	
Cassava	2
Corn	2
Oats (No Article)	
Potato (English or Irish Potato)	3
Rice	4
Sago	5
Sorghum	6
Sugar Cane	6
Sweet Potato	7
Taro	8
Chinese Taro	8
Giant Taro	9
Swamp Taro	9
Wild Taro	10
Elephant Yam	10
Yam	10

### Legumes

Cowpeas	11
Mung Beans	12
Peanuts	13
Snake Bean	13
Yard Long Bean	13
Soybean	13
Winged Bean	14
Cover Crops (No Article)	
Rhizobium Supply Service	15

### Oil Plants

Coconuts	16
Oil Palm	17
Editorial- Appropriate Technology	18

## Vegetables

Traditional Vegetables	19
Aibika	19
Amaranthus	19
Aupa (No Article)	
Ferns	20
Kagua	20
Karakap	20
Oenanthe	20
Pitpit	20
Pitpit Moi	21
Rorippa	21
Rungia	21
Taro Leaves	22
Tulip	22
Valangur	22
Introduced Vegetables	
Ceylon Spinach	22
Comfrey	23
Okra	23
Planting Distances for Vegetables	24
Vegetable Nursery	24
Planting Guide	26
Vegetable Seed Supply	26
Transplanting	27
Special Requirements for Tomatoes	28
General References	29
Supply of Planting Material	30

## Fruits and Nuts

Avocado	31
Breadfruit	31
Carambola	32
Five Corner	32
Citrus Fruit	32
Granadilla	33
Guava	33
Jak Fruit	34
Macademia Nut	34
Giant Malay Apple	35
Mango	35
Mangosteen	35
Passion Fruit	36

Pawpaw	36
Pineapple	37
Rambutan	38
Marcotting Layering	38
A Lesson in Budding	39

## Tree Crops

Bamboo	41
Kapok	42
Rubber	42
Rollers for Rubber	43
Trees: Timber, Posts, Firewood	44
Casuarina	44
Hoop Pine	44
Kamarere	44
Klinkii Pine	45
Giant Leucaena	45
Pine Tree	46
Teak	46
Table of Common Woods	48
Planting Forest Trees	49
Living Fence Posts	49

## Beverages

Cocoa	51
Coffee (Robusta)	52
Tea	53

## Spices

Birdseye Chillies (No Article)	54
Cardamom	54
Ginger	55
Nutmeg	55
Pepper	55
Rosella	56
Tumeric	56
Vanilla	56

## Soil Management

Food Crop Farming Systems	57
Soil Erosion Control	58
Soil and Fertilizers	59
Soil and Leaf Analysis	60
Composition of Fertilizers	61

## Soil Tillage

Small Machines	62
----------------	----

## Pests and Diseases

Editorial - Agricultural Poisons	62
Controlling Pests with Chemicals	63
Products Available	63
Editorial - Rats or Cats?	64
Notes on the Use of Chemicals	65
Sprayers	65

Home-made Insect Repellent	66
Insect Identification	66
Disease Identification	67
Nematodes	67
Rats	67
Snails	68
Pest Control	69

## General Articles

Food Storage	70
Editorial - Grain Policy	70
Publications from DPI	71
Books on Crops	71
Locally Grown Planting Materials	72
Plant Identification	72
Hand Seeders	72
Essay - Nutrition from Farming	73
Essay - A Step at a Time	74

# LIVESTOCK

## Poultry

Chickens	75
Ducks	76
Geese	77
Guinea Fowl	77
Pigeons	78
Turkeys	78

## Animals

Pigs	79
Beef Cattle	80
Dairy Cattle	81
Water Buffalo	81
Training Water Buffalo	82
Notes on Piercing a Buffalo's Nose	82
Goats	83
Sheep	84
Reproduction of Farm Animals	84
Pasture	85
Editorial - Self-Reliance	86
Rabbits	86

## Fish Culture

Tilapia	88
Carp (No Article)	
Oysters (No Article)	
Shrimp (No Article)	

## Insects

Butterflies (No Article)	
Honey Bees	89
Silkworm Rearing	89



## Wildlife

Crocodiles	90
Wildlife	90
Cassowary (No Article)	

## PROCESSES

### Crop Processing and Utilisation

Dried Bananas	91
Breadfruit	91
Cassava Starch	91
Coconut - Fresh	92
Coconut Oil	92
Ginger	92
Grain Processing	93
Corn	93
Rice	93
Drying Kaukau	93
Kaukau Flour	94
Further Notes on Kaukau	94
Nutmeg and Mace Processing	94
Oil Palm Oil	95
Pepper Processing	95
Sago Processing	95
Full Brown Sugar	96
Uses for Village Sugar	97
Commercial Village Sugar	97
Tapioca-Sago	99
Processing Tea	99
Preparation of Tumeric	99
Vanilla Processing	100
Yam Processing	100

### Livestock Processing and Utilisation

Pasteurization of Milk and Cream	101
Butter and Buttermilk	101
Buttermilk Pancakes	101
Cheeses	101
Preserving Meat and Fish	103

### Food Preparation

Dried Legumes	106
Infant Feeding	106
Recipes for Families and Institutions	108
Notes for Use of Green Soybeans	109
Bean Sprouts	110
Peanuts	110
Jams and Marmalades	112
Fruitjuice Processing	113

Bread, Biscuits and Cakes	114
Breadfruit Biscuits	114
Buckwheat Recipes	114
Corn Recipes	115
Kaukau Biscuits	115
Peanut Cakes	116
Wheatmeal Bread	116
Bread Making	117
Coconut Recipes	118
Coconut Icecream	118
Mango Chutney	119
Mango Pickles	119
Pickled Eggs	119
Salted Eggs	119
Sausages	120
How to Use Salted or Smoked Fish	120
Baked Cured Fish	121

### Building and Road Construction

Brick Making	122
Adobe Blocks	122
Earth Building Blocks	123
Concrete Making in PNG	124
Roofing Shingles	125
Make Your Buildings Last Longer	126
Earth Moving with Water	127
Principles of Drainage	127
Surveying and Map Making	128
Local Government Advisory Service	128
Forest Products Research Centre	128

### Village Industry - Arts and Crafts

Bottle Cutting	129
Basket Weaving	130
More Basket Weaving	131
Blacksmithing	132
Charcoal Manufacture	132
Dyeing Wool	134
Natural Dyes for Silks	135
Small Engine Trouble Shooting	136
Home-made Degreaser	137
Fishing	
Making a Net	137
Basic Knots for Fish Nets	139
Derris for Fish	139
Sinkers from Old Batteries	140
Leather Tanning	140
Rawhide	141
Metal Casting (No Article)	
Pottery	142
Frangipani Perfume	143
Sawmilling	143
Black Marking Ink	144
Silk Screen Printing	144
Soap	145
Inkle Loom	146
Welding with Electric Arc	147
How to Sharpen Tools (No Article)	

References	148
Handcraft Marketing	148
Miscellaneous	148
Care and Operation of Lamps	148
Care of Primus Stoves	149
Care and Operation of Kerosene Refrigerators	150

## DESIGNS

### Energy

Water	
Hydroelectricity	151
Water Wheel	151
Wind	153
Windmills	153
Windmill Pumps	154
Solar Energy	155
Hand and Pedal Power (No Article)	
Biogas Digestors	156
Compost	158
Firewood and Other Fuels (No Article)	
General References	158

### Water Resource Development and Use

Springs, Wells and Filters	
Sand Filters	159
Pumps	
Hydraulic Rams	160
Water Pump	161
Foot Operated Water Pump	162
Malaysian Water Lifter	162
Transporting Water	163

### Crop Production

Hand Planter	163
Two Man Shovel	163
Insect Trap	164
Hand Weeder	164
Dust Applicator	165
Thresher	165

### Livestock Production

Poultry	
Creep Feeder	167
Chicken Feeders	167
Chicken House	168
Pigs	
Concrete Pig Trough	168
Feed Tray for Pigs	168
Pig Housing	169
Pig House	170
Concrete Pig Floor	170

### Hunting and Fishing

Noose Trap for Wild Pigs	171
Rat and Bird Trap	172
River Fish Trap	172
Bamboo Fish Trap	173

### Crop Processing, Food Preparation and Preservation

Coconut Scraper	173
Coffee Pulper	174
Coffee Roaster	174
Fish Smoker	175
Treaty of Lancaster	175
Grain Grinder or Mill	176
Oil Press	178
Peanut Sheller	178
Peanut Roaster	178
Sugar Crusher	178
Stoves and Ovens	179
Meat Cooler	181

### Building and Road Construction

Bamboo Splitter	182
Wood Preservation	182
Pole Building Construction	182
Building Materials and Designs	182
Ferro-cement	183
Rubbish Glass in Concrete	183
Sago Loom	184
Self-help Roads	184
Inclinometer	185

### Transports

Motorized Canoe	187
Propelling Ferrie	189

### Village Industry Arts and Crafts

Clothing: Sewing and Mending	190
Neckfacing a Garment	194
Patterns	
Easy Shift	195
Butterfly Dress	196
Easy Shift	197
Sleeveless Shift	198
Easy Pants	199
Average Shift	200
Caftan	200
Meri Blouse	201
Shirt for Boys	202
Afro Shirt	203
Child's Sleeveless Top	204
Little Girl's Dress	205
African Girl's Dress	206

Shorts for a Child	206
Child's-Sleeveless Blouse	207
Teenager's African Tunic	208
Wrap-around Skirt	209
Woven Cold Shirt	209
Easy Decorations	210
How to Crochet	211
Furniture	
Student's Chair	212
Student's Desk	212
Bench	213
Stool	213
Grinding Wheel	213
Potter's Wheel	214
Old Tyres	215
Old Inner Tubes	215
Old 200 Litre Drums	216

## ANIMATING VILLAGE DEVELOPMENT

Animation	217
Modern and Traditional	221
Guidelines for Development Projects	222
Cooperatives and Development	223
Women in Rural Development	223
Visual Aids	224
Visual Aids for Community Education	225
Rural Youth Organizations	225
Church and Development	226
Church and Peoples' Movements	226
Business Group Incorporation Act	226
Telephones	227
Postal Services	228

## HEALTH

<b>Nutrition</b>	229
Baby and Child Care	229
Breast Feeding	231
Bottle Feeding	231
Supplementary Feeding	231
Editorial - What Makes Children Grow	232
<b>Food Composition Tables</b>	233
<b>Family Planning</b>	236
<b>Healing</b>	
Bush Medicines	240
Medicinal Plants	240
Dental Health	241
<b>References</b>	242

VIII

## GENERAL REFERENCES

### Literature, South Pacific

Department of Primary Industry, PNG	244
Department of Business Development	244
Educational Research Unit	245
Village Development Office	245
Editorial - Government Publications	245
SPC Publications	245
Resource Books	245
Publishers	245

### Literature, Overseas

Intermediate Technology Publications,	247
General	247
Agriculture	247
Health	247
Rural Workshop	247
Water	247
Stichting Tool	248
Tropical Products Institute	248
United Nations Publications	248
U.S. Government Publications	249
University of the Philippines	249
VITA	250
Sourcebooks	251
Books for Stimulation and Reference	251

### Book Suppliers

PNG	253
Overseas	253

### Periodicals

### Succour and Comfort

PNG Development Bank	255
Engineering, Architectural and Mechanical Advisory Service	255
Village Development Office	256
Rural Improvement Programme	256
Village Economic Development Fund	256
Others	257
VITA	259

### Suppliers

PNG	260
Overseas	263
How to Order by Mail	265
How to Place an Overseas Order	266
PNG Maps	266
Metric Conversion	266
Notes for Contributors	268
Wompom	269
Acknowledgements	270

## HOW LIKLIK BUK HAPPENED

In April 1975 about one hundred church-related grass roots level rural development workers met in a seminar in Lae to share their experience. We heard again and again, "But where do I find out about this?" or "Where do I find out about that?" Discussing ways to help the workers get the information they need became a very important part of that seminar. There was strong agreement that a printed handbook catalogue of information should be developed to support the activities of village workers all over Papua New Guinea.

The objective was a readily available and reasonably up-to-date reference that would give workers access to the information that they need.

We have been delighted at the response to this effort shown by a broad range of contributors. We have found many new friends and allies of village development among church, government, academic and business groups, and have been pleased at the continuing response from the rural development workers themselves.

The 1976 edition of 5,000 copies sold out in less than two months. This time we have twice as many pages, three times as many contributors, and 12,000 have been printed. A modest office has been set up as a three-year special project to handle production of Liklik Buk and to respond to information requests. A pidgin version of the Buk is in progress, and portions of the Buk are being translated and reprinted by Lotu Pasifika Productions for use in the South Pacific.

## THE PURPOSE OF LIKLIK BUK

Finding and evaluating answers to specific questions is a difficult, sometimes hopeless task for a person (even a competent person) who has no library, no telephone, few everyday professional associates, and very irregular mail service.

At the same time, many of those persons in PNG who have the greatest wealth of technical information and experience in rural development have been "promoted" out of rural life into desk-bound administrative jobs.

Liklik Buk is a way to give easier access to information sources and to stimulate more dissemination of the expertise available. It is patterned somewhat after the approach used by The Whole Earth Catalogue in the United States, though the finished book is of course quite different.

A key part of this concept is that the materials are to be updated more or less continuously through the written responses of the readers. It is a big job, of course, but basically, Liklik Buk is designed to be self-supporting, self-revising, self-updating (just as Rural Development ought to be).



## LIKLIK BUK IS NOT FINISHED

We have only "scratched the surface." As you will see, there are many areas of information which must be improved, and many good things happening in Papua New Guinea which have been left out. With your help the next issue will be better.

The Buk is printed on newsprint because we don't think you'll need to keep it for more than a year or so. When the next Buk comes out it will contain the good things from this one, plus the new things you have sent us. When you get your new one, throw this one away! (but don't use it for smoking!)

## HOW YOU CAN HELP US

1. If you know how to do something that isn't already in Liklik Buk, and you think that someone else might like to try it, write to us and tell us about it. Tell us as much as you can, so that we can tell others in the next Buk.
2. If you see something in the Buk that you can tell us something more about, tell us so that we can add it to the next Buk. We will write your name next to that information.
3. If you see something that is wrong in the Buk, write and tell us about it so that we can change it in the next Buk.

So - the next Buk will be much better!

To encourage you to write something for the next Buk, we will give you a free copy if you send us something that is printed in it.

cont'd

## HOW TO USE LIKLIK BUK

For Heaven's sake DON'T READ THIS BUK! It is a book for browsing a little bit at a time. Hide it in the bottom of your "in" basket as encouragement to empty it. Put it in the box where you hide your bank pass-book - (You'll be a rich man if you read the Buk each time you plan to withdraw money). Keep it next to your Bible for reading when the Bible doesn't have the solution for your particular problem. But please don't be like the didiman we know who left his unopened copy at home while he spent three months researching the following problems for council projects: an easily built fish smoking unit for village use, a source of supply for coffee pulpers, and a recipe for rat-bait - which were all in the LIKLIK BUK!

Look at the index in the front of the Buk if you are trying to solve a particular problem. You will see that the materials are divided into:

- CROPS
- LIVESTOCK
- PROCESSES
- DESIGNS
- ANIMATING VILLAGE DEVELOPMENT
- HEALTH
- GENERAL REFERENCES

Some basic information for your question will be found (we hope) in one of the major sections. But since many problems have several parts to a solution, extra information will be found in other sections, too. The page numbers in the margins give you the place to find this information.

There are some topics that we still don't have contributions for. We have put these headings in to encourage you to fill the blank in the next edition (and receive a free copy of that edition if your contribution is accepted).

If you find that the information in the Liklik Buk is not enough for what you want to do, write to the person who contributed the article OR get the books or pamphlets that are mentioned OR write OR visit the people and places that have had experience with the matter. Or do all three! If all these fail, write to the Editors, Liklik Buk, Box 1920, Lae, and we'll try to help.

Be sure to slip through the pages from time to time. It will put new ideas into your head, and someday you may find a use for them.

It takes time and money to do many of the things in the Liklik Buk, but more importantly, knowledge and ability. Liklik Buk will give you an idea of how much time and money you will need, and some hints on where to find a little knowledge. But the Buk can not give you the ability. This you will get only from trying and practicing.

## VILLAGE SELF-HELP ACTION IS OUR GOAL

We will not pretend that Liklik Buk is for the direct use of village people - though it is meant to be for their benefit. It is primarily a support for those who have dedicated themselves to working with village people: didiman, teachers, business development officers, pastors, university students, overseas volunteers, or village leaders. May it give inspiration, new ideas, helpful information, and may it lead to action!

We hope that even those with limited ability in English can make some sense out of the names, addresses, and suggestions.

PNG may well have more available technical expertise than any country of its size anywhere in the world. When we read of the publications available, the research and study going on, the different organizations ready to give information and assistance, we must come to the conclusion that in PNG availability of technology is not the problem. It's effective application is a problem, though. On balance, PNG seems to be strong on research, study, discussion, publicity, and weak on dissemination of information, coordination, field action, critical evaluation. We tend to be strong on tools and machines, technical innovations, and weak on the all-important question of how to "animate" the process of total human development.

We dedicate Liklik Buk to PNG village self-help ACTION.

Peter R. Hale

B. David Williams, Jr.

### MEMBERS OF THE LIKLIK BUK COMMITTEE:

- Pedi Anis  
Central Planning Office
- Haru Bekker  
Yangpela Didiman
- Ulrich Bergmann  
Evangelical Lutheran Church
- Jean Kekedo  
Village Development Office
- Seri Pitoi  
Village Representation
- Department of Primary Industry  
(1977 Edition: Alan Abala, Lynn Harris, Ian Reardon)
- Unitech Community Development Committee  
(1977 Edition: Helen Bates)
- WANTOK Publications  
(1977 Edition: Kevin Walcot)

# CROPS

## Primary Energy Crops

### BANANAS

### BANANAS

Botanical name: Musa sp.

Height: 3 - 6m.

Age to first production: 8-12 months

Normal life span: Diploids: 2 yrs.

Triploids: several years

Insect pests and control: Scab moth (Nacoleia octasema) only in NG Islands, not NG mainland and Papua. A very serious pest, makes a scab on the fruit. Some control with DDT dust and spray, but not very effective. Banana Weevil Borer (Cosmopolites sordidus). Control by getting rid of old corms and butts on top of the ground, or use Solgar Banana Fruit Fly (Strumeta musae). Place polythene bags around bunch. Bags also protect from fruit bats. Nematodes may also be a problem in the roots.

Diseases and control: Sigatoka Leaf Spot (Cercospora musae). This attacks the leaves and reduces the yield a lot. Use resistant varieties (ABB group) or plant only a few of the susceptible ones in one area.

Indication of maturity: The fruit become full and somewhat rounded, leaves begin to dry out.

Planting information: Spacing depends on variety but for large varieties plant at about 2.5m on the square. Dig a deep hole. Use the suckers with the narrow leaves.

Useful products at village level: Fresh fruit (certain varieties) and cooked fruit. Thinly sliced cooking bananas fried in oil or fat make

Bunch of triploid bananas.



popular snacks, and are especially good for children on low-fat diets. The large, coarse varieties are, when cooked, a good source of energy foods for pigs. Thinly sliced bananas may be dried and stored.

Further reading: D.P. Heenan (1976). <sup>(p 244)</sup> <sup>(p 245)</sup> Methods for Commercial Banana Growing. Harvest 3 (2): 42-47. Preliminary Observations on the Growth and Production of Bananas in the Northern District of Papua New Guinea. PNG Agric. J. 24 (4): 145-155 (1973). Bunch Covers for Bananas in the Northern District. PNG Agric. J. 24 (4): 156-161 (1973). Bourke, R.M. (1976). Know Your Bananas. Harvest 3 (2): 48-54. Lambert, M. (1970) Banana Production in the South Pacific. SPC Handbook No 5. Feakin, S.D. (1966). Pest Control in Bananas, Pans Manual No 1 or LAES Information Bulletin No 6 Know Your Bananas. English and Pidgin.

Industrial use: Banana starch or flour.

Sources of supply of planting materials: local.

Remarks: Research work is done at DPI, Kerevat, ENB. Bananas are found everywhere in PNG and are the staple food in very dry areas such as the Markham Valley, and Cape Vogel, the Papuan coast, also in areas where land is short like the Gazelle Peninsula. There are very many varieties in PNG. Diploids are the traditional low yielding ones. Triploids are the higher yielding introduced varieties. There are groups of bananas that are drought resistant and very tough. See article by Bourke. (Know Your Bananas)

Initial contributor: R.M. Bourke, LAES, Kerevat, ENBP.

Bunch of diploid bananas



## CASSAVA

## TAPIOK

Description: A longlived shrub, with enlarged tuberous roots. The leaves are large and palmate with 5 to 9 or more lobes.

Botanical name: Manihot esculenta

Height: 3 - 4 metres

Age to first production: 9 - 12 months

Normal life span: 15 - 24 months, but tubers will tend to become woody.

Pests and control: Rats, bandicoots and pigs are a minor problem. Baits and traps are set up to control rats and bandicoots; build fences to keep pigs out. No known evidence of major insect pest infestation in PNG as yet.

Diseases and control: No evidence or presence of major cassava diseases occurrence as yet in PNG. Occasional occurrence of Leaf Spot (Cercospora spp.) on plant leaves; a minor problem. Use of resistant varieties as a control measure.

Indication of maturity: When the leaves begin to yellow and fall, dig up a few tubers and try.

Planting information: The best results are usually obtained using sticks with at least 3 buds 20 to 30cm long, 2.5 to 4cm thick, selected from lower or midsection wood of plants at least 10 months old. Planting distances of 80-140cm. Closer spacing leads to lodging of plants. Cassava stems planted close together in line with bamboo strips interwoven make a reasonably good fence. (Though pigs might try to root under it.)

Useful products at village level: The tubers are good for human consumption and for stock feed. The leaves make good green feed for chickens. The tubers may be sliced thinly and dried for storage. Flour may be made.

Industrial uses: Starch Source. Flour from Cassava used in bread-making, useful as a partial substitute for wheat flour; chips pellets, flour from dried crushed leaves for livestock feed. Stalks used in manufacture of particle boards.

Sources of supply of planting materials; local. A number of varieties are available at LAES, Kerevat, ENBP.

Further reference: Kay, D.E.(1973). Root Crops, TPI Crop and Product Digest No 2. Free from TPI, 56/62 Gray's Inn Road, London WC1X 8LU, England.

Phillips, T.R., Cassava Utilization and Potential

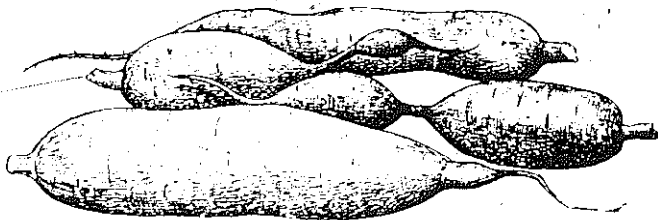

Markets, IDRC-020e, Ottawa, Canada.

Purseglove, J.W.T. Tropical Crops: Dicotyledons Longmans.

Remarks: Very little has been done about this crop in PNG. It yields 30t/ha or more. Good famine reserve crop, since certain varieties can be left in the ground for long periods without the food value being reduced. Will not grow well in cold highland areas and can be killed by frost. Certain bitter varieties contain cyanogenetic glucosides which may lead to poisoning if they are eaten raw. To make them safe the roots should be cut into pieces and steeped in water for a day before cooking - this water is poisonous and should be carefully thrown away. Tubers contain Hydrocyanic acid which can be harmful to humans if eaten in large quantity. Could lead to Goitre in humans. Some Cassava varieties are sweet and others bitter. Bitter ones are due to presence of Hydrocyanic acid and can be destroyed by normal cooking or boiling and roasting. A suitable crop to grow in areas where environmental conditions of low and uneven rainfall and poor soil are not suitable for growing crops like potato or taro.

Initial contributor: A. Opu, LAES, Kerevat, ENBP.

## CORN (MAIZE)

## KON

Botanical name: Zea mays

Height: about 1.5 - 3 metres

Age to first production: about 9 weeks (fresh)

Normal life span: 15 weeks

Insect pests and control: Stem borer (Ostrinia furnicalis). The grubs eat into the stem. It can be controlled with lindane granules, but the



attack would have to be very bad to justify this. Another insect: *Heliothis amigera* gets into the cob. Weekly sprayings with 0.1% Carbaryl solution suggested.

Diseases and control: Leaf rusts (*Puccinia* spp.) Use resistant varieties from Kerevat or Buba (DPI). Leaf blight, downy mildew, and blister smut.

Indication of maturity: For selling fresh to Europeans: Tassel on the cob goes brown. For Papua New Guineans: A few weeks after this. For stockfeed or seed: Wait until the plant is dead.

Planting information: Use improved seed from DPI spacing 90cm x 20cm. Plant 1 or 2 seeds per hole only. Get seed for planting from many cobs, not just a few cobs. This is important.

Useful products at village level: Fresh food for people, or dry grain for stockfeed. The dried corn may be used in limited amounts in baking when mixed with wheat flour. (p 115)

Industrial uses: Cooking oil from germ of seed; flour from the seed for some kinds of bread.

Sources of supply of planting materials and cost: LAES, Kerevat, ENB; Regional Office, DPI Box 348, Lae; Regional Office, DPI Box 6639, Boroko; DPI, Aiyura via Kainantu, EHP; high yielding seed available free in small amounts.

Related tools or equipment: Hand-operated corn huller @ K80, from Agquip, Box 1121, Rabaul, or Plantation Supply and Services, Box 92, Goroka.

Further references: Free publications: Superior Corn Varieties Now Available (Nupela Pikinini Kon Bilong Planim) LAES. Information Bulletin 3, DPI Buba Information Bulletins 5, 11, 22; Corn DPI Port Moresby. Rural Development Series Handbook 8. (price 50t)

Remarks: Corn is becoming an important crop in the Markham Valley and is found everywhere in subsistence gardens. Local varieties produce about 1-2tonne/ha. Improved ones produce about 5-6tonne/ha. Corn is probably a more suitable stockfeed for PNG generally than sorghum. It is good to have some corn in your garden because it grows quickly if there is drought or frost that kills the garden. Corn must have good drainage, is not resistant to flooding.

Initial contributor: R.M. Bourke, LAES, Kerevat, ENB

## POTATO (IRISH OR ENGLISH POTATO)

Description: A soft-stemmed plant sometimes regarded as a perennial, because of its ability to reproduce vegetatively by means of tubers left in the ground from one season to the next, although normally cultivated as an annual. There are a great many different varieties. The highest yields are

found in areas with a moderate climate, but they may also be grown in the tropics in the cool highlands areas.

Botanical name: *Solanum tuberosum* L.

Mature Height: 30 - 60cm

Age at maturity: early varieties 3 - 3 1/2 months; medium varieties at 4 - 5 months, and late ones up to 7 months. Normal 3 to 4 months in the tropics.

Indication of maturity: when the skins have set.

Temperature: a rainfall of 50 - 75cm evenly distributed throughout the growing period is considered essential. Not below 500 m.

Soil: Potatoes can be grown on all soil types, except heavy waterlogged clays, but for optimum yields, a deep well-drained loam or sandy loam relatively free from stones and with a pH of 5.5 to 6.0 is needed. (p 93) (p 106) (p 176)

Altitude: Late-maturing varieties from temperate regions can usually be grown successfully in the tropics at altitudes of approx. 390 to 2,100m. Some of the indigenous So. American varieties can be grown at altitudes higher than 2,100m.

Planting: Tubers, either whole or cut, are planted. Whole tubers are preferred, as they save labour and are less liable to develop rots in the soil. The planting material should weigh at least 40 - 55g. Good healthy planting material is essential. Potato tubers enter into a period of rest after harvesting and under normal conditions will not sprout until this period has ended (usually about 8 weeks.) Before planting the field should be ploughed to a depth of 25 - 30cm at least twice and harrowed so as to produce a fine deep tilth. Plant seed potatoes in ridges, 5-15cm deep, every 20-30cm, with 75-120cm between the ridges. The very best spacing depends upon the variety used and local conditions.

Pests and diseases: Potatoes are subject to a large number of pests and diseases, and prompt identification and control is essential if

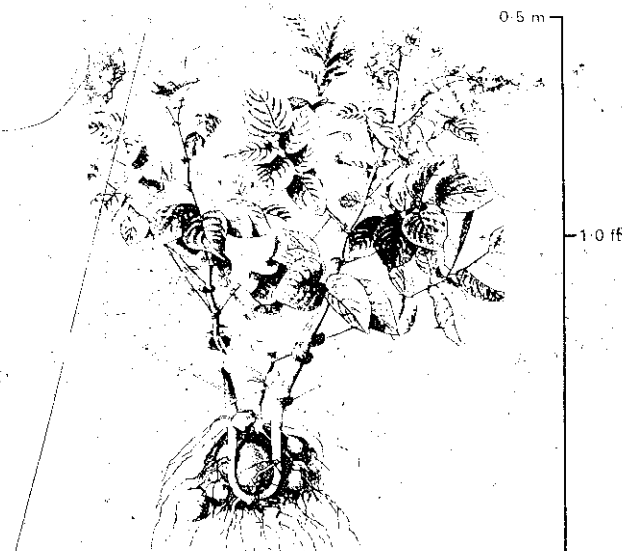



planting is to be economic. Aphids, potato tuber moth, root eating ants, flea beetles, fungal diseases, blights, bacterial diseases, and virus diseases can all cause serious losses. Seek expert advice on control methods.

Uses: Eaten boiled, roasted, baked or fried. Processed into a variety of products such as canned whole potatoes, frozen french fries or chips, dehydrated flakes, powder or granules, potato salad.

Secondary uses: Stockfeed, starch, flour, alcohol.

By-products: Potato pulp for livestock, potato peels for livestock, potato sprouts for vegetable, citric acid.

PNG Experience: SAMU LTD., a new potato growers' cooperative related to WASO LTD., probably has the most solid experience in the country. Address: Samu Ltd., Wapenamanda, Enga Province.

References: Root Crops, D.E. Kay, Tropical Products Institute.

## RICE

## RAIS

Description: A short-lived grass able to grow in flooded conditions.

Botanical Name: Oryza sativa

Height: 90cm to 110cm

Crop life: 4 to 5 months depending on variety

Harvest at maturity, when 9/10 of the rice is yellow.

Insect pests and control:

1. Pink Stemborer: use Diazinon spray
2. Brown planthopper: Diazinon or Orthene
3. Chinch bugs: Lindane seed treatment
4. Mole crickets: Diazinon
5. Rice bugs (Leptocoryza): Actellic or light traps.
6. Whorl maggots, leafhoppers, army worms, nymphalids, green vegetable bugs do not generally present a problem. If they do Orthene, Diazinon, or Malathion will control.

(p 164)

Diseases and Control: No virus diseases have been noted in PNG; Bacterial leaf blight in some areas, minor; Helminthosporium brown spot, and Cercospora leaf spot are caused by fungi. Occasionally Helminthosporium will cause seeds to turn brown and not develop, no control. Zinc deficiency in some soils causes leaf tip to appear burned, but this should not be confused with a burned tip that shows after the plant has recovered from drought. Phosphorous deficiency causes uneven maturity of rice.

Indication of maturity is when 80% of the grains are yellow, firm and clear, but 20% of the grain are firm but still green. In almost all cases this will occur thirty days after the flowers appear.

Planting of dry rice (Rainfed, not flooded fields): Two methods of planting are recommended:

1. With a pointed stick make a planting hole 3-4cm deep and drop 5-10 seeds in each hole, cover hole. Holes should be about 25cm from each other in a line.
2. Plant seed in a continuous line. Lines should be about 23cm apart, and the seed planted 2-3cm deep.

In both cases, after three to four weeks transplant any missing places where the rice didn't grow, by taking seedlings from places where there are many.

50-150kg of Nitrogen per hectare will improve yields in all parts of PNG.

Planting paddy rice (flooded fields): Those interested should contact: Manager, Gabmazung Rice Farm, Box 80, Lae. It is not difficult, but involves a different technology best learned through a field experience.

Useful products at village level: <sup>93)</sup> Rice to eat, using mortar and pestle or simple concrete mill. Rice hulls make very good litter for chickens; Rice hulls can be placed between two walls to make very good insulation for cold storage; Rice hulls mixed with clay soils will improve soil by being a mulch (very slow to decompose); Rice bran and polish is a good feed for pigs and chickens; ash from burning rice hulls makes excellent scouring powder for the kitchen.

Industrial uses: The polish is used in baby foods and health foods; hulls are mixed in feeds, fertilizers to prevent caking; hulls are mixed in concrete to make lightweight bricks; ground hulls are used for making polishing abrasives; oil is expelled from the bran to make rice oil; hulls are burned to make ash for cement, and as a dust to help sweep up spilled oil; broken grains are made into flour to mix with wheat flour.

Rice seed is available from DPI in all provinces, or direct from the Agriculture Experiment Station at Bubia, Lae, for special varieties.

No special tools are required to grow rice, but there are many tools that help to make it easier: seeders, drum threshers: Tutt Bryant, Badili; rice knives, winnowers: OIC, DPI, Bainyik, ESP

(p 165)  
(p 166)

-cont'd



Further references (also see bibliography):

Tietze, R., Planim Rajs, Buk 7, Yangpela Didiman bilong Niugini, 20t, Kristen Pres, Madang;

Rice Production Manual (p 250)  
Field Problems of Tropical Rice, by K.E. Mueller, IRRI, PO Box 1300 MCC, Makati D-708, Philippines.

Information Bulletin 16, Rice, anon, DPI Bubia, 1975; Farming note 6, Rice, DPI Konedobu, 30toea.

PNG Experience: Rice is grown in the Markham, East Sepik, West Sepik and New Ireland Provinces, and the Mekeo. Agriculture Officers in these areas are familiar with rice. Interesting experiences with dry rice: contact Manager, Puas Vocational Centre, PMB, Kavieng, NIP.

Remarks: Rice should only be grown where temperatures are above 21°C and where there is a minimum rainfall of 250mm per month. Some areas have shorter rainfall seasons than others and the proper variety is one which will flower before the end of the rainy season. Dry weather at flowering will cause the seeds to be empty. Sometimes, by chance, rice is grown when there is a drier period. Usually this will make the rice take longer to mature and the rice will be shorter in height than normal. Many things that happen to rice are thought to be burn caused by the sun, but unless you see the leaves rolling up in a tube during the sunny period it is something else like insects or disease.

Brown rice and white rice come from the same plant and can be made from the same seed. The seed is the part that is planted and is harvested. It has a yellow skin and this is called the hull. Rice with the hull on is called "paddy" or "padi". When the hull is removed in a hulling machine, brown rice comes up. This is the most nutritious rice. White rice is made from brown rice by scraping the brown part off in a machine called a "whitener". The brown part is called "bran", and is very good pig food and chicken food.

When rice is harvested it should be dried so it will be milled well and will keep well in storage. You know that rice is dry enough for storage if you can bite a seed with your front teeth and hear a snap when it breaks. Do not mill rice until it has stored for three weeks after drying, or you will have many broken grains.

Initial contributor: J.T.Hale, Box 215, Wewak, ESP

MAMI (No Article)

## SAGO

## SAKSAK

Sago is seldom cultivated, but usually grows wild. It provides the staple food of many marsh-dwelling Papua New Guineans.

Botanical name: Metroxylon rumphii (thorned stem)  
Metroxylon aagu (smooth stem)

Height: 10 - 15 metres  
Age to first production: 12-15 years  
Normal life span: 12-15 years

Insects pests and control: Palm Weevil (Rhynchophorus sp.) The grubs enter injuries on the stem or crown of the palm. Chemicals for control are very dangerous in inexperienced hands. Control of breeding sites, often by eating the grub, is common biological control.

Indication of maturity: Highest level of starch is accumulated when flower begins to appear at about 12-15 years. Palm dies shortly after.

Planting information: Suckers growing from the base of older trees are planted in fresh water swamps at 5m x 5m. Under most conditions replanting of an existing swamp is not necessary, but it is necessary to cut out extra suckers when trees grow too close together. Smooth stem varieties yield better than thorned stem ones.

Useful products village level: Starch is used for food as a pure starch or mixed with shredded coconut or pieces of meat or fish. Leaves are used as a thatch for roofs when folded over sticks and sewn with bush twine.

The mid-rib of the leaf (pangal) is split and used as a wall cladding. When split very fine it is woven by hand or a simple loom into blinds for wall coverings. Loom plans are available from the Forests Products Research Centre.

Industrial products: Sago is a source of commercial starch.

Source of planting material: local.

Location and result of PNG experience: Sago is a traditional crop of coastal and lowland people. Yields range from 100 to 350kg per tree depending on variety and soil, and requires the effort of a family for 3-4 days to process the starch.

Remarks: Although sago is low in protein and vitamins it is a widely used starch form in coastal lowland and islands PNG. The low protein level is compensated by the custom in most areas of mixing coconut, vegetables and pieces of meat before eating.

Sago ferments and spoils very quickly.

Initial contributor: E. Cox, Bagi Agr. Centre, Box 65, Angoram, ESP.

## SORGHUM

Botanical name: *Sorghum bicolor*  
Height: 100-130cm dwarf varieties  
Crop life: 100-135 days

(p 244)

This is a drought-resistant crop which is often grown in regions where other cereals do not thrive. The grain-type sorghum is an excellent animal feed. It is not only more drought-resistant, but more flood-resistant than maize.

Many productive hybrid varieties are available from Australian seed companies. A popular open-pollinated variety is "Alpha", available from DPI Experiment Station, Bubia, Lae.

Sorghum may be threshed when mature and dry, or the whole heads may be cut and given to chickens or pigs anytime after the hard dough stage. Sorghum is usually about 9% protein, a little under maize.

Recommended population per hectare is 180,000 or plant in rows 36cm apart, about 15cm between plants. It is better to overplant a little and then thin out later. Most varieties take around 100 days to mature.

Remarks: After harvest many Sorghum varieties will grow a second and third crop from the base if there is enough water. Yields will be much less than first crop.

which take about the same period to mature as the original crop. The yield declines slowly with each ratoon, and after two or three ratoon crops have been harvested replanting is usually done.

Indication of maturity: In commercial production harvesting operations are carefully timed so as to get maximum sugar content, and sampling laboratories are used for testing. In the village the stems are taken when they appear woody.

Planting information: The planting material is usually stem cuttings (setts) which have 2 or 3 nodes each, planted around 1 metre apart in 1.5m rows. Weeding is important. Since sugar cane is a heavily soil-depleting crop, fertilization is important if it is grown continuously. It is understood that in order to build up a large concentration of sugar in the stems, a natural period of stress is required, usually a dry period. Timing of planting should be done with this in mind.

Harvesting information: Sugar cane should be squeezed within 48 hours after cutting, as the sugar content drops rapidly after that time.

Useful products at village level: People chew on the fresh, mature cane; fresh juice for drinking; dark brown sugar (gur or jaggery, or muscovado) which can be used for jams, candies, cooking, coffee or tea. The crushed stems can, after drying in the sun, be used for fuel. (p 96)

Industrial products: White refined sugar, (p 97) molasses, residue (press cake) for cattle feed, bagasse (crushed stems) is used for building materials (fibreboards) and for fuel. (p 178)

Sources of supply of planting materials: local; Many varieties available at DPI Experiment Station at Bubia, Lae.

PNG Experience: Agronomist-in-Charge, DPI Experiment Station, Bubia, Lae.

Remarks: In chewing sugar cane, always start from the top end. If one starts from the bottom end, he is known as "one who does not know much about growing sugarcane."



## SUGAR CANE

Botanical name: *Saccharum officinarum*  
Height: 2 - 3 metres  
Age to first production: 12 to 14 months, may take 18 months to 2 years.  
Normal life span: After the first cutting the plants throw up successive stems called "ratoons",

SWEET POTATO

KAIKAU

Description: A soft stemmed perennial vine cultivated as an annual.

Botanical name: Ipomoea batatas

Height: Vine, lays on the ground.

Age to first production: 2 months

Normal life span: 4 - 5 months, lowlands.

5-6 months and up to 8 months at high altitudes.

Insect pests and control: Sweet potato weevil (Cylas formicarius) can be very severe, especially in dry weather. Control is by crop rotation, but this is not always effective. Dipping of planting material may be needed. See Harvest article for further information.

Sweet Potato Hawkmoth (Herse convolvuli) eat the leaves. Spraying with carbaryl may be justified if damage is very severe. (See Harvest) Leaf miner: (Bedellia somulentella), (See Harvest)

Diseases and control: Little Leaf occurs on the Gazelle Peninsula and in the Central Province and New Ireland Province. Do not take planting material from these areas to other areas.

A scab disease caused by the fungus (Elcinoe batatas) occurs. Most varieties are resistant.

Indication of maturity: In some varieties the leaves turn yellow.

Planting information: Plant at about 50,000 cuttings from the youngest part of the vines per hectare. Planting density is not too important. At very close spacings it gives about the same total weight, but the tubers are larger and fewer. Use cuttings 30-40cm long. Mounds give better yields than ridges, which in turn are very much better than planting on the flat or heavy (clay) soils. Mounding or ridging is not so important on light (sandy) soils. There are hundreds, perhaps thousands, of varieties in PNG, with big differences in taste and yield. You must choose the variety that suits you best. (p 93)

Useful products at village level: Tubers: human and stock feed. Leaves: a green vegetable. (p 94)

Industrial products: Starch source. Flour made from sweet potatoes can partially replace wheat flour in bread making. (p 115)

Sources of planting materials: local. (p 116)

Further references: Kimber, A.J. (1972), Sweet Potato in Subsistence Agriculture. Papua New Guinea Agriculture Journal 23, (3 and 4): 90-95. (p 244)

Kimber, A.J. (1971). Cultivation Practices with Sweet Potato. Harvest 1 (1): 31-33.

Kimber, A.J. (1972). Widespread Damage by Insect Pests in Highlands Sweet Potato Gardens. Harvest 2 (4): 117 - 121

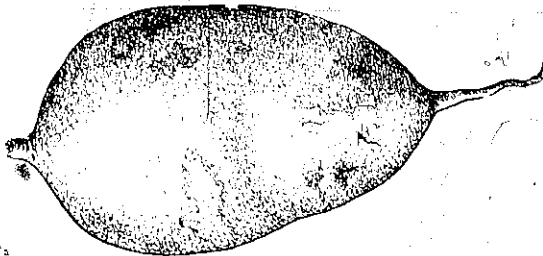

Kay, D.E. (1973) Root crops. TPI Crop and Product Digest No 2. Available free from Publications Section, TPI, 56/62 Gray's Inn Road, London WC1X 8LU, England.

PNG Experience: Sweet potato is the most important crop in PNG. It is grown almost everywhere, and is especially important in the highlands. It yields about 14 tonnes of edible tubers per ha. in the highlands and 18-20 tonnes per ha. in the lowlands. A lot of research has been done on the crop at DPI, Aiyura via Kainantu, EHP and at LAES, Kerevat, ENB.

Remarks: Sweet potato is very responsive to fertilisers, and if used properly their use can give very good returns. N and K are the main nutrients needed.

Initial contributor: R.M. Bourke, LAES, Kerevat. ENR



TARO

TARO TRU

Description: A long lived, cormous plant with large heart-shaped leaves.  
 Botanical name: Colocasia esculenta  
 Height: 50cm - 200cm, usually 100cm.  
 Age to first production: 7 months.  
 Normal life span: 7-10 months.

Insect pest and control: Taro beetle (Papuana spp) Often a serious pest. Can be controlled with lindane granules. For 6% granules apply 1.5gm of chemical in each planting hole before planting. Sweet potato hawk-moth: Damage would have to be very severe before spraying is worthwhile. Use a 0.1% solution of carbaryl (Septene 80; Resistox; Sevin) if spraying is necessary.

Diseases and control: Virus diseases can be very destructive. Use resistant varieties. Leaf blight can be bad in wet weather. Use resistant varieties. Separate new plantings from old ones. Avoid pure stands of taro. (See paper by Putter).

Indication of maturity: The leaves become smaller.

Planting information: Large setts give a quicker ground cover, produce bigger plants, and give a higher yield. There are thousands of varieties in PNG which differ in yield, disease resistance and taste. You must choose the variety that is best for you.

Useful products at village level: Corms - food (p 94) for people, leaves are a good vegetable; Cormels (suckers) are good food for pigs or for people.

Sources of supply of planting materials: local.

Further reading: Massal, Emile and Barrau, Jacques (1955). Pacific Subsistence Crops, Taros, SPC Quarterly Bulletin 5 (2): 17-21. (p 246)  
 Plucknett, D.L., de la Pena, R.S. and Obero, F. (1970) Taro (Colocasia esculenta). Field Crop Abstracts 23 (4): 413-426. (A review paper).  
 Putter, C.A.J. (1975). Disease Resistance in Plants and its Role in Crop Protection Strategy and Tactics in Papua New Guinea. Proc. PNG Crop Conference, Lae. April-May 1975.

PNG Experience: Taro is a most important staple in the lowlands. It yields about 7 tonnes per ha. usually, but up to 17 tonnes per ha. Research is being conducted on the agronomy and pests and diseases at LAES, Kerevat and Vudal ENB. For other information: The Agronomist-in-Charge, LAES, Kerevat ENB.

Remarks: Taro production is declining in PNG but it remains a most important crop and has great spiritual significance for many villagers.

Initial contributor: R.M. Bourke, LAES, Kerevat, ENB.

## CHINESE TARO

## TARO KONG KONG

(Known as "Tinauna" in Gazelle, "Karavela" in SDA Mission)

Description: A long-lived cormous plant with large coarse heart-shaped leaves. It looks similar to taro tru (Colocasia esculenta) but the veins are more prominent, the leaves larger and the V of the leaf extends as far as the petiole. The suckers (cormels) are usually



eaten rather than the mother sucker (corm).

Botanical name: Xanthosoma sagittifolium

Height: 2 metres

Age to first production: 9 - 12 months

Normal life span: A perennial

Insect pests and control: Taro beetle (Papuanna spp.) attacks the corm and cormlets. 6% Lindane granules applied at 1.5g of chemical per plant in the planting hole gives some control.

Diseases and control: A virus (?) disease attacks the crop and makes it short. The trunk becomes very large compared with the leaves.

Indication of maturity: The edges of the older leaves turn yellow and die.

Planting information: Use large setts. Space at about 1.5m square.

Useful products at village level: Corms as pig feed. Cormlets as food for people.

Sources of planting material: local.

Further references: Kay, D.E. (1973). Root Crops, TPI Crop and Product Digest No 2. Available free from Publications Section, Tropical Products Institute, 56/62 Gray's Inn Road, London, WC1X 8LU, England.

Remarks: Chinese taro is a new crop to PNG. It is now important on the Gazelle Peninsula and in the Finschhafen area, but can be found throughout PNG.

Further information from the Agronomist-in-Charge, LAES, Keravat, ENB. Chinese taro is increasing in importance. It is tolerant of shade and is often grown under bananas or coconuts. It yields about 20 tonnes of edible cormlets/ha.

Initial contributor: R.M. Bourke, LAES, Keravat, ENB.



*Paragum taro in a garden in Southern New Ireland*

Remarks: Tastes similar to taro tru (colocasia esculenta). It is locally important in a few areas, but a fairly minor crop generally. Paragum is useful because it can be left in the ground for many years, so it is a useful emergency food. There are many wild varieties as well as edible ones. Some of these may cause irritation of the mouth, but apparently are not harmful.

Initial contributor: R.M. Bourke, LAES, Keravat, ENB.

## GIANT TARO

## PARAGUM

Description: Leaves are long, arrow shaped and have rounded lobes. The stem (corm) forms a trunk and is the part of the plant eaten.

Botanical name: Alocasia macrorrhiza

Height: 2 metres

Age to first production: 1 year (?)

Normal life span: Several years

Planting information: The mother plant or sucker is used.

Sources of planting materials: local.

Further references: Kay, D.E., Root Crops; TPI Crop and Product Digest No 2. Available free (for official bodies) from Publications Section, TPI 56/62 Gray's Inn Road, London, WC1X 8LU, England.

## SWAMP TARO

Description: A giant herbaceous perennial. Leaves are arrow-shaped with long lobes.

Botanical name: Cyrtosperma chamissonis

Height: 2 metres or more

Age to first production: 2 years

Normal life span: Up to 9 years before harvesting

Insect pests and control: Little problem. Rats have been a problem in the Mortlock Islands.

Planting information: Grown from suckers or setts from harvested plants. Planted in pits in the Mortlock Islands.

Useful products: The corms are used as food, mainly for animals, but some people eat them.



Swamp taro, Vudal

The leaves and flowers can be used as a vegetable.  
 Sources of supply of planting materials: local.

Further References: Kay, D.E. (1973). Root Crops, TPI Crop and Product Digest No 2; Boag, A.D. and Curtis, R.E. (1969), Agriculture and Population in the Mortlock Islands, PNG Agricultural Journal 12 (1): 20-27.

Remarks: Found in swampy areas around the coast. It is the main food on coral atolls such as the Mortlock Islands off Bougainville. It will grow on swampy, salty soils that are useless for most other crops. Yields about 10 tonne/ha.

Initial contributor: R M Bourke  
 LAES, Kerevat ENB

WILD TARO ELEPHANT YAM

Description: A herbaceous plant bearing a single three part leaf, each part of which is divided into a number of segments.

Botanical name: Amorphophallus campanulatus  
 Height: 1 to 2.5 metres  
 Age to first production: 1 year  
 Normal life span: 4 - 6 years

Indication of maturity: The leaves begin to wither and die.

Planting information: It is grown from small corms, or pieces of 3-4 year old corms. There is a resting period of 2-3 months for planting material.



Wild taro plants-grow in grassland in Bogia area

Uses at village level: The corms are used as food, and the young petioles may be eaten as a vegetable.

Sources of planting materials: local.

Further references: Kay, D.E. (1973). Root Crops. TPI Crop and Product Digest No 2. (Available free from Publications Section, TPI, 56/62 Gray's Inn Road, London WC1X 8LU, England.)

This taro is sometimes seen growing wild and is sometimes cultivated. It is common in grassland areas such as Markham Valley, Bogia area, and Central Province. Because the crop takes about 4 years to mature it is not particularly important, but it can act as a useful food reserve.

Initial contributor: R.M. Bourke, LAES, Kerevat, ENB.

YAM

Description: Includes over 600 species of tuberous plants, usually with short fibrous roots and long vines that grow up poles.

Botanical name: Dioscorea spp.  
D.alata: greater yam  
D.esculenta: lesser yam  
D.bulbifera: aerial yam

Height: A vine, long or short, depending upon variety.

Age to first production: 8 - 11 months

Indication of maturity: Harvest when the leafy material is completely dead.

Insect pests and control: Yam beetles, mealy bugs. Control with 6% lindane granules, 1.5g of chemical in each planting hole. Do not apply unless damage is severe.

Diseases and control: Leaf spot, certain virus diseases. Plant on new ground.

Planting information: Plant just before the rainy season with small whole tubers, the little bulbs, or pieces of big tubers that have been kept

# Legumes

## COWPEAS

Cowpeas can be a useful source of protein at the village level in many areas. The following information is for grain cowpeas.

Botanical name: Vigna unguiculata (L.)  
Height: About 2m, highly variable, some varieties are tall climbers  
Age to first production: about 70 days  
Normal life span: 4 months  
Indication of maturity: 90% of pods are golden brown

Insect pests and control: black bean aphids, spray with Malathion; pod borers, spray Orthene.

Planting information: Plant at high density (50cm x 10cm apart) for maximum grain yield. Many varieties give no response to fertiliser. Avoid both very high rainfall times and very high soil fertility. Both promote leaf growth at the expense of pods and turn the crop into a green manure and fodder crop rather than a grain crop.

Sources of supply of planting materials and further information: small quantities from Agr. Faculty, UPNG, Waigani, or LLB, Box 1920, Lae.

Remarks: The pods can be threshed after harvesting and drying by putting them in copra bags and bashing the bag against the ground. See recipes for grain legumes.

Initial contributor: W. Erskine, UPNG, Waigani

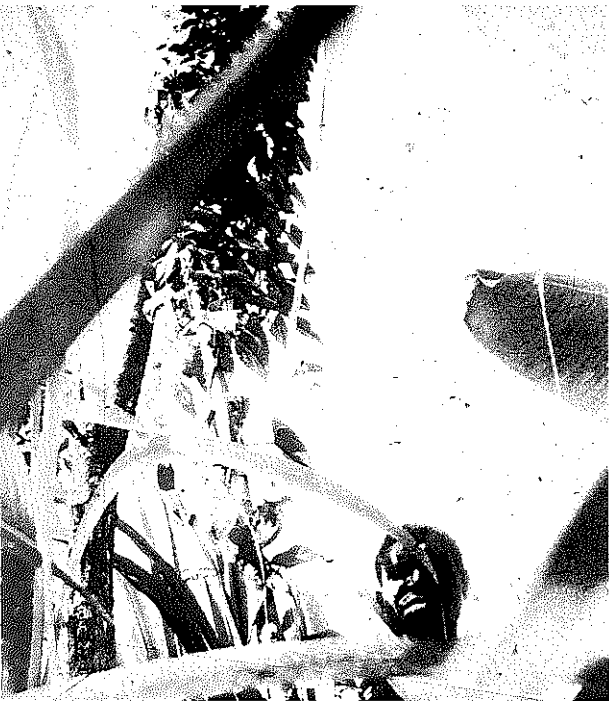

for some months. Plant in rich well-drained soil, if possible, where the new gardens are made. Spacing varies from 1-2 metres. Keep free of weeds for at least three months. A 3 - 4 m post is planted next to each yam for the vine to grow on.

Harvesting and storing: It is sometimes wise to leave the tubers in the ground until they are needed, as they keep quite well there. Most varieties may be successfully stored for many months if they have adequate ventilation and protection from flooding, rats, and insect attacks.

Uses at village level: Tubers for human food can be boiled, baked or fried. Sometimes dried and made into flour. It is good to use the peelings and waste for feeding livestock.

Sources of planting material: local.

Further reference: Root Crops, D.E. Kay, Tropical Products Institute.

Remarks: It is said that some varieties contain toxic substances and must be cooked well. Check local customs.







Gathering mung beans in the garden.

## MUNG BEAN

The mung bean is easily cooked, has about 24% protein, is popular at village level in Indonesia, the Philippines and India. It is generally easier to grow in the tropics than soybeans. It is high in the vitamin thiamine.(B<sub>1</sub>)

Botanical name: Phaseolus aureus  
 Height: 40 - 60cm  
 Age to first production: approx 65 days  
 Normal life span: approx 80 days

Insect pests and control: Mung beans are commonly attacked by a broad range of insects from the time after germination up to near harvest, but the most destructive infestations occur during flowering to pod-formation stage. Spraying with Orthene might be advisable at that time. Other foliar sprays will work. Otherwise, a moderate level of insect damage is acceptable to avoid spraying costs.

Diseases: an occasional rust, but usually not worth treating. Dithane will control.

Planting information: Avoid the wettest times. Mung beans make an excellent secondary crop. Row spacing 50cm. Sow 40-50 seeds per linear metre. Cover with fine moist soil about 2-3cm deep. No inoculant is necessary. 5-7 days after planting, thin to 30-40 plants per linear metre. Retain the most vigorous plants. Weed as early as possible. Cultivation is necessary only for weed control. Harvest when the pods are mature (dark brown).

Uses at village level: Good food! See recipes for grain legumes. Makes excellent bean sprouts.

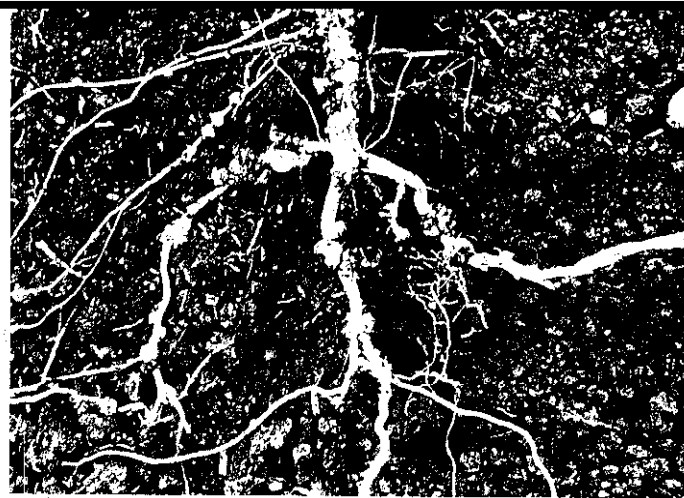

Bumps on these roots are nodules. The nodules contain bacteria that convert nitrogen from the air to nitrogen that can be used by the bean.

Sources of planting materials: Liklik Buk, Box 1920, Lae; OIC, DPI Exp. Station, Bubia, Lae. Try to get Variety NG 7272, which is newly introduced from the Philippines.

PNG Experience: Some mung beans have been grown in the Markham Valley on a commercial basis, for stock feed, with mediocre results. I suspect that a mediocre variety was used. This bean is labour intensive and is much more suitable at village level, for human food. My own garden produced a computed yield of 950kg/ha of dried beans during the wet season, and yields should be better during the drier time. Apparently mung beans have not yet been promoted as a village-level crop in PNG. They should be better at lower elevations, but are worth a try at any location below 1,500m.

Remarks: The beans are most easily prepared for eating by boiling for 30 to 60 minutes, depending upon hardness. Soaking overnight greatly shortens cooking time. After cooking separately, mung bean goes well with other vegetables. A small amount of vegetable or animal fat (try coconut cream!) improves palatability, and other seasonings should be added according to taste. Some like it with curry. See recipes.

(P 108)

Mung beans in the pod being threshed.



PEANUTS  
(GROUNDNUTS)

GALIP PINAT

SNAKE BEAN YARDLONG BEAN

If we consider the energy yield per unit area of land, peanuts probably offer the greatest potential of all the legumes. They are a familiar village crop in most areas of PNG, but are definitely under-used.

Botanical name: Arachis hypogaea  
Height: 40 - 60cm  
Age at harvest: 100-140 days, depending upon variety and location

Major pests and diseases and control: In many places peanuts are quite free from pests and diseases, but rust and certain soilborne fungi can cause problems. The DPI Station at Bubia recommends the use of fungicide seed dressing (for example, captan and PCNB). In the village situation crop rotations may be sufficient to control these.

Indication of maturity: yellowing and wilting of the leaves.

Planting information: plant in light soil, if possible, or on ridges. Spacing may be variable, but 60-80cm rows are typical, with about 10cm between plants. White Spanish peanut variety (grown widely in the Markham Valley) is recommended. Inoculation is not necessary.

Used at village level: Eat boiled, roasted, fried (p 178) as peanut butter, chopped. See recipes. (p 111) (p 251) (p 110)

Commercial uses: oil for cooking, margarine, soap-making, printing ink. Residual oil-cake is used for stock feed.

Sources of planting material: easily found in most localities.

Further references: Peanuts, DPI Exp. Station, Bubia, Lae. (p 244)

Remarks: Peanuts can easily be dried and stored by hanging them in the shell, and usually still on the stalks, over the kitchen fire. Peanuts are much more digestible when cooked, though many in PNG eat them raw. Only mature peanuts which have been freshly harvested and/or free from moulds should be used for cooking, as a toxic substance called aflatoxin can be generated on mouldy peanuts.



Description: A soft-stemmed climbing vine grown for pods and leaves.

Botanical name: Vigna unguiculata var. sesquipedalis  
Height: to 3 metres  
Age to first production: 60 days  
Normal life span: 120 days

Insect pests and control: Common pests are aphids and pod borers. A spray with malathion or Orthene will control most species.

Indication of maturity: Village tastes for snake beans require that the bean become quite fat, but Westerners prefer harvesting when still thin. Vitamin content is highest at the more immature stage. Should be cooked only for a short time, or may be eaten raw.

Planting information: Plant in ridges or hills 60 to 90cm apart and 20-25cm in the row. Place stakes at each seedling for climbing.

Initial contributor: E. Cox, Box 65, Angoram ESP.

SOYBEAN  
(SOYA)

Under favourable conditions, soybeans are the plant with the highest potential protein yield per unit area of land, and are also very high in fat. The



LAES Station at Kerevat reports yields as high as 2,500kg per ha.

Botanical name: Glycine max  
Height: 60-100cm  
Age to production: about 12 weeks

Insect pests and control: Some green vegetable bugs, small pink root scale; control with Orthene. Rusts, control with fungicide (Dithane M45).

Indication of maturity: Pods turn brown.

Planting information: Typical spacing is 60cm rows, 10cm apart in the row. Soybeans grow better in temperate or sub-tropical climates than in the tropics, so in PNG do better at higher altitudes than at sea level. In many situations you will need to inoculate the seeds to initiate the growth of nodules on the roots (see government inoculum service below). (P 15)

Uses at village level: (P 107) Good food: Soak, cook, and make into various soups, and stews (see recipes for grain legumes); Soybean high protein flour for soy milk and baking; beansprouts. (P 110)

Commercial uses: Oil for cooking, margarine, soaps, plastics, high protein flour, soysauce, bean curds (tofu); soybean oil meal (residue from oil extraction) is high-protein stock feed concentrate.

Sources of planting materials: Small quantities from DPI, Buba, LAES Kerevat; CLTC, Banz c/- Box 382, Mt. Hagen, WHP. Order large quantities from the seed companies. Order inoculant (state amount of seed to be treated) from Rhizobium Supply Service, DPI, Box 2417, Konedobu.

Remarks: Success in soybean growing in PNG is quite mixed. Some are highly successful, and others quite unsuccessful. Be sure you can do it yourself before promoting these. It is definitely worth a try, whatever your situation, because of the high potential yields and high food value.

Unfortunately, soybeans are not widely acceptable as a food without special methods of preparation. Most varieties have a somewhat bitter taste and a hard, indigestible cellulose seedcoat. Soak the seeds overnight, throw away soak water, and remove the seedcoats by hand, before cooking. Another problem with soybeans is the presence of an inhibitor called "trypsin" in the raw beans. This inhibitor probably interferes with the intestinal digestion of protein. Boiling the beans for an hour or pressure-cooking for 10 minutes destroys the trypsin. This is important to know if you are planning to grind or mill the dried beans for a more direct use.

Initial contributor: B. Heyward  
Bayer River, WHP

## WINGED BEAN

The winged bean, popularly known as "arsebean", or "bin", has been causing a great deal of interest in recent years because: it is a traditional crop in the PNG highlands; it is high in protein (as high as 37% in the dried grains); and it produces tubers, which are also popular and relatively high in protein (up to 11% of the wet wt., as compared with yam and potato, which are about 2%).

Almost all parts of the plant are eaten: flowers, leaves, green beans, seeds and tubers. In the highlands, however, the tubers are preferred. Winged beans are grown for both home consumption and cash. It is rarely used for animal feed.

Botanical name: Psophocarpus tetragonolobus  
Height: A long vine which grows on stakes  
Age to first production: Flowers, leaves, green pods, 3 months; Tubers after 5-6 months.  
Normal life span: 6 months

Climate: Winged bean can be grown in almost any part of PNG. However, it is generally not grown at altitudes above 1,800m. In both the highlands and lowlands drier weather is better (less disease).

Varieties: Many varieties of winged bean are found in PNG. There are basically two types: roots and pods. A collection of different varieties is maintained at UPNG, and particular types of varieties can be obtained on request.

Ground preparation and planting: Winged bean can be grown in almost any type of soil, as long as it is well-drained. In the highlands, beds or mounds are used. Seeds are planted 2-3cm deep at 20cm distance in rectangular or triangular patterns. Planting on ridges can also be done, although this method is not very common. Ridges are made 50cm apart and about 40-50cm high. Seeds are planted at a distance of 10cm on these ridges. Sometimes winged beans are also grown mixed with other crops such as Maize or Soybeans. Planting is done generally at the onset of the dry season, but - if pests and diseases can be controlled - winged beans should grow equally well in the wet season. An abundant moisture supply is necessary if winged beans are being grown to obtain roots.

Nodulation: Winged bean roots form abundant pea-sized nodules which fix atmospheric Nitrogen. This makes the soil more fertile for the crops that follow. In most soils the nodules grow freely. However, if this does not happen, the inoculation is necessary.

Fertilizer: No fertilizer is needed in recently cleared areas. In poor soils NPK, each at the rate of 25kg per hectare is recommended.

Weeding and staking: In the first six weeks after planting, weeds should be removed to encourage healthy growth. Weeding is usually not necessary after that, especially during the dry season. When the crop is 6-8 weeks old, stakes (such as pit pit or other cane) should be provided, one stake per 2-3 plants. The stakes should be 2-3m high for a grain crop; 1-1.5m high for a tuber crop. If staking



materials are scarce, improvise with vines or string between stakes. It is often grown along garden fences.

**Pruning:** Pruning is not necessary if the crop is grown for green pods. However, if roots are wanted, the young shoots, flowers and pods are periodically removed.

**Diseases:** These diseases are of major importance:-

1. Leaf spot - which is destructive in wet season. It can be controlled with regular spraying with Benlate (50 ml / 100 litres twice a week)
2. False rust - is also of importance under wet conditions. This disease is difficult to control.
3. Root-Knot Nematodes - is one of the most widely distributed diseases. Its attack reduces yield, and it also reduces the quality of the tubers. The only control method is prevention, or growing winged bean on new ground or soil that is free of the Nematode problem.

**Pests:** Insect pests that attack under dry conditions are not usually serious. However, a number of pests, including Aphis, Pod borers, and leaf miners can cause considerable damage under lowland conditions. Spray.

**Harvesting:** The harvesting of flowers, leaves and green pods for eating may start from 3 months after planting. Roots are harvested after 5-6 months. In the highlands the general maturity time is higher than in the lowlands.

**Yields:** The seed yield varies from 800 - 1000kg per hectare. The yield of Green pods and other vegetative parts may vary considerably. Tuber yield varies between 5,000 - 10,000kg per hectare.

**Marketing:** At present local markets are the only places to sell winged bean. Flowers, leaves and young pods are sold in small bunches at 10t each. Cooked green beans sell for 10-15t per kg. Cooked tubers sell at 25-30t per kg. Cooked beans and tubers may be stored for 2-3 days.

**Useful references:** The Winged Bean - A High Protein Crop for the Tropics by National Academy of Science, Washington, DC, USA, 1975.

"Cultivation of the Winged Bean in the Papua New Guinea Highlands" by T.N. Khan, J.C. Bohn and R.A. Stephenson, World Crops, 1976.

"Papua New Guinea: A Centre of Genetic Diversity in Winged Bean", by T.N. Khan, Euphytica, 1976.

"Psophocarpus tetragonolobus, a Crop with a Future?" by G.B. Masefield. Field Crop Abstract 24(4): 157-160, 1973.

"Investigations of Winged Bean in Ghana" by F. Pospisil, S.K. Karikari and E. Boamah-Mensah, World Crops 23(5):260-264, 1971.

"Traditional Legumes of the Papua New Guinea Highlands" by Jocelyn M. Powell. Science in New Guinea 2. 48-63, 1974.

"Diseases of the Winged Bean in Papua New Guinea", by T.V. Price Aust. Plant Pathology Society Newsletter Vol 5(2).

**Technical information and planting materials:**  
Winged Bean Research Group, Faculty of Agriculture, UPNG, University.

Initial contributor: T. Khan, UPNG, University.

## COVER CROPS (No Article)

## RHIZOBIUM SUPPLY SERVICE

Most legumes need bacteria called Rhizobium to use nitrogen from the air for growing. There are many different types of Rhizobium and these are called strains. Different species of legumes need different Rhizobium strains. For most legumes, the right strain is already in the soil, but some need a Rhizobium strain that is not in the soil. Centro, soybean and leucaena are some of the legumes that need inoculating with the correct Rhizobium if they are being grown in an area for the first time, and improved strains are also available for other legumes.

You can obtain the correct Rhizobium for your crop by writing to the Rhizobium Supply Service, DPI, Box 2417, Konedobu. There is no charge for this, but you will be asked to examine the roots of the inoculated legume for nodules and to send a form back to Konedobu. Instructions on how to use the Rhizobium are given when it is sent to you.

**Reading:** Shaw, D.E. and others (1972) "The Rhizobium Supply Service in Papua New Guinea." Papua New Guinea Agricultural Journal 23 (1 and 2) 12-26.

# Oil Plants

## COCONUT

Botanical name: Cocos nucifera  
 Height: Tall variety - up to 26m  
 Dwarf variety - up to 14m  
 Commencement of bearing: Tall variety,  
 4.5 to 10 years; dwarf variety  
 4 to 6 years, depending on  
 management.  
 Life span: 80 to 100 years  
 Potential yield depending on good nutrition,  
 2½ tonne copra/ha, but varies with varieties.

### Pests

Rhinoceros beetle  
 (Scapanes australis)  
 (Oryctes rhinoceros)

### Control

Young palms: Lindane granules placed in frond axils and regular hand picking. Mature palms: no simple effective control

Palm weevil  
 (Rhinchophorus  
bilineatus)

Prevent wounds which act as entry sites for the weevil.

Treehoppers  
 (Segestidea sp.)  
 (Segestes sp.)  
 (Sexava sp.)

No simple control applicable to small holders. Banding of palms with 'Osticon' may be partially effective.

Coconut leafminer  
 (Promecotheca papuana)

Natural biological control may occur.

Coconut flower bug  
 (Axiagastus cambelli)

Biological control in some areas. Trunk injections with systemic insecticides possible.

Seedling leafminer  
 (Brontispa longissima)

Application to young fronds of Lindane and Gammexane type sprays.

Amblypelta bug  
 (Amblypelta sp.)

Biological control using 'kurakum' ants.

Coconut spathe moth  
 (Tirathaba rufivena)

Usually not necessary

### Rats

Poison baits, trapping, protective barriers.

### Diseases

### Control

Chlorosis, wilt and other deficiency diseases.

Application of the deficient nutrient as fertilizer.

Seedling leaf spot  
 (Drechslera incurvata)

Regular application of "Duter" fungicide. Potassium fertilizers used to increase the palm resistance.

Lightning strike

No effective control

Finschafen disease

Control of the vector insect.

White thread blight  
 (Corticium  
penicillatum)

In areas subject to this leaf disease palms should be planted on a 9m triangle rather than at closer spacing.

Planting information: In planting coconuts for profit the following should be heeded: select good nuts from good palms; some varieties in PNG are better than others and seed of these can be obtained for planting. Proper nursery construction and adequate maintenance - polybag nurseries have many advantages over field nurseries; transplant into the field during moist soil conditions and at a suitable depth in a planting hole; select only the best seedlings from the nursery; correct spacing (an 8.2m triangular spacing is good for most areas); good and regular maintenance; regular pest control.

Uses at village level: Coconut meat from mature nuts is dried for copra production, is grated for milk used in cooking, is grated for oil extraction, is used fresh for pig and chicken feed. Immature nuts are used for food and drink. Fronds, leaves are used for thatching, basket work and fuel. Timber is used for house construction, fences, bridges, but rots quickly.

Industrial uses: Copra is used for oil production. The oil is used in soaps, detergents, margarine and confectionaries. The residues are used as stock feed. The meat is often processed as desiccated coconut for confectionaries. The husk can be made into coir (for ropes, brushes, mats, okum, and other uses).

Sources of planting material: Usually available locally. Seed of the better varieties, such as Karkar, are available through DPI, Madang. Usual price (not including shipping) is 5t per nut. DPI intends to produce high yielding hybrid seed near Madang. This will not be available for several years.

Materials: Polybags for nursery, from ICI, Lae. Insecticides from ICI New Guinea Pty. Ltd., Box 1105, Lae; Elvee Trading Pty. Ltd., Box 151, Rabaul; Nufarm Rural Products, Reynolds St., Mareeba, Qld., 4880, Australia. ('Duter' - K4/k)

References: Various articles in PNG Agricultural Journal Vol. 17 (2) April, 1965. Also,

Management: Vol. 21 (3 & 4) 93-101 (1970)  
 22 (2) 77-86 (1971)  
 22 (3) 167-173 (1971)  
 23 (3 & 4) 73-79 (1972)

Pests and Diseases: Vol. 22 (1) 1-5 (1970)  
 23 (1 & 2) 27-40 (1972)  
 24 (3) 79-86 (1973)

Annual Reports of DASF up to 1969, and Agronomy Research Report, Section 11 - Coconut, 1969-1972. All of these are published by DPI, Konedobu.

cont'd

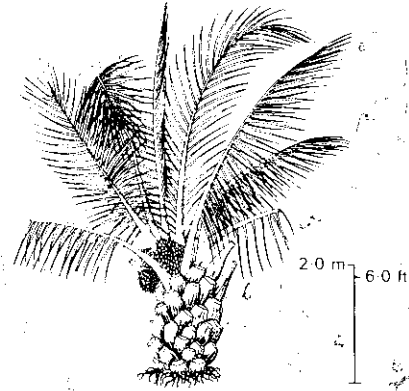

## OIL PALM.

Botanical name: Elaeis guineensis Jacq.  
 Height: Up to 20metres depending on age and growing conditions.

First production: At 2½ years, but usually the flowers are removed until 3 years, so the bearing commences about 3½ years.

Life span: Palms may continue bearing 50 years or more. However, these palms would be very tall and difficult to harvest. 25 years may be the economic life of a palm in PNG.

Potential production: In the region of 25-30 tonnes fresh fruit bunches per hectare from fertilized palms.

### Pests

Rhinoceros beetles  
 (Oryctes rhinoceros)  
 (Scapanes australis)

Bagworms  
 (Plutorectis sp.)  
 (Clania sp.)

### Rats

### Diseases

Leaf streak, spotting and chlorosis  
 (Physiological origin)

Bud rot:  
 (cause unknown)

Gradual decline  
 (cause unknown)

Leaf blight  
 (Curvularia sp.)

### Control

Plantation hygiene. Insecticide (lindane granules) in leaf axils. Hand collecting of beetles.

Usually biological control is sufficient.

Warfarin baits applied when damage significant.

### Control

Determine the nutrient deficiency and apply appropriate fertilizer.

Recovery may occur naturally. No control known.

No control known.

Spraying of seedlings with Captan or Thiram fungicides.

Planting information: Use only specially bred seed; seedlings are raised in a centrally administered nursery, in poly bags; seedlings are ready for planting out at about 9-12 months of age; usually seedlings are planted on a 9.8 or 8.8m triangle; seedlings are given an initial fertilization and a cover crop maintained between the young palms; castration of flowers is carried out until the palm

General references: The Coconut Palm - a Monograph by Menon and Pandai, Indian Central Coconut Committee, 1958; Coconuts by R. Child, Longmans; Coconut Growing by C.J. Piggatt, Oxford U.P.; Pacific Islands Planters Handbook, Imperial Chemical Industries (New Guinea) Pty. Ltd. Insect Pests of Coconuts in the Pacific Region by J.H. Stapley, reprint from Outlook on Agr. Vol 7 No 5 1973, pp 211-217.

PNG experience is found in most PNG coastal areas. H: Gallasch, LAES, Kerevat; J. Sumbak, Bubia Experiment Station, via Lae; C. Perry, Entomologist LAES, Kerevat; The Entomologist, DPI, Konedobu; The Chief Pathologist, DPI, Konedobu.

Miscellaneous: Pests and diseases are usually recognized but soil deficiencies may be greatly lowering yields without being recognized. Deficiencies in sulphur and potassium and to a lesser degree nitrogen are very widespread in PNG. An indication of the presence or not of a nutrient deficiency can be gained from chemical analyses of leaf and coconut water, samples submitted to the Chief Chemist, DPI, Konedobu or to the Chief Chemist, Analysis Laboratory PNG University of Technology, Box 793, Lae. Charges can be advised by the University.

Initial contributor: H.E. Gallasch, LAES, Kerevat, ENB.

is considered large enough for bearing - usually at about 3 years; hand pollination of female flowers is necessary in the early years to ensure good fruit set and production. Once commercial production has begun, harvesting must be done regularly to be sure of good quality fruit. Given suitable economic conditions, fertilizers are regularly applied to the bearing palms.

(P 95) (P 187)

Uses at village level: No processing is done at present at village level, although the extraction of oil is widely done in parts of Africa, and could be adapted to conditions here. Oil is good for cooking, for lamps, and the fruit or the residue from extracting oil may be fed to pigs.

Industrial uses: The fruit is crushed and palm oil is extracted from the fleshy skin at the factory. The nut is broken and palm kernel oil extracted from the kernel. The residues of bunches and fruits are burned and ash used as fertilizer. The heat generated may be used for firing boilers. Residues may also be used for road surfacing. The palm oil is an edible oil used in shortening and margarine manufacture and in soap making. The palm kernel oil is used in margarine, cooking oils, cosmetics, confectionary (uses similar to those of coconut oil).

Planting materials: Improved planting material may be supplied at a nominal cost by the central estates. For non commercial purposes seed is obtainable from many DPI Extension Centres.

Materials and equipment may be obtained through commercial or co-operative enterprises in the areas of oil palm projects or from DPI, Kimbe, WNB.

References: The Papua New Guinea Agricultural Journal, Vol 18 No 4 (1976), Vol 22 No 4 (1971); The Oil Palm, by C.W.S. Hartley, Pub by Longmans, Green and Co., London, (1967); The Oil Palm in Malaya, Pub by Ministry of Agr. and Co-operatives, Kuala Lumpur, Malaysia (1968); Oil Palm Developments in Malaysia and Their Control, by B.J. Wood, The Incorporated Society of Planters, Kuala Lumpur (1968); Diseases and Disorders of the Oil Palm in Malaysia, by P.D. Turner and R.A. Bull, The Incorporated Society of Planters, Kuala Lumpur (1967)

PNG Experience: H. Gallasch, Agronomist, LAES, Kerevat, ENB; OIC, Dami Oil Palm Exp. Station, via Kimbe; The Entomologist, LAES, Kerevat, ENB; The Chief Pathologist, DPI, Konedobu.

Remarks: In PNG oil palm is only grown commercially adjacent to or in conjunction with large estates which provide joint processing facilities. The only producing area at present is centered on Mosa Plantation and factory at Kimbe, WNB. A second area will centre on the oil palm project commencing at Biialla, while a third project is planned for the Popondetta region of the Northern Province.

Due to the high yields obtained in PNG it is advisable to fertilize the palms regularly. Chemical analysis of foliar samples can indicate which fertilizers should be applied.

Initial contributor: H.E. Gallasch, LAES, Kerevat, ENB

#### THE APPROPRIATE TECHNOLOGY GAME

EVERY TIME AN INTERNATIONAL FLIGHT LANDS IN PORT MORESBY, WE GET AT LEAST ONE MORE APPROPRIATE TECHNOLOGY EXPERT. PNG HAS MORE APPROPRIATE TECHNOLOGY EXPERTS PER CAPITA THAN ANY OTHER COUNTRY IN THE DEVELOPING WORLD, MOST OF THEM FOREIGNERS.

THE TROUBLE WITH APPROPRIATE TECHNOLOGY EXPERTS IS THAT MOST ARE EXPERTS AT LITTLE EXCEPT CONVINCING THEMSELVES THAT THEY HAVE SOMETHING TO TEACH. PERHAPS LIKLIK BUK IS NO EXCEPTION!

IT IS VERY PLEASANT TO SIT AROUND THE YARD OF A HIGH COVENANT HOUSE SIPPING BEER AND DRAWING PLANS FOR DEHYDRATED KAUKAU FACTORIES. IT IS EVEN SATISFYING LIVING IN A BUSH HOUSE AND BUILDING AN EVAPORATIVE COOLER FROM POLES AND MOSQUITO NETS.

THE TROUBLE IS THAT MUCH OF THE "APPROPRIATE" TECHNOLOGY IS WHAT SOMEBODY THINKS IS APPROPRIATE FOR SOMEONE ELSE.

WE HAVE EVEN HEARD IT SAID THAT "APPROPRIATE TECHNOLOGY" IS SIMPLY A CONSPIRACY TO FORCE DEVELOPING COUNTRIES TO ACCEPT TECHNOLOGIES OF LOW PRODUCTIVITY.

OR COULD APPROPRIATE TECHNOLOGY BE AN "EGO TRIP" FOR EXPATRIATES WHO CAN'T MAKE IT IN THEIR OWN COUNTRY?

THESE QUESTIONS MAY BE UNFAIR, BUT UNTIL MORE OF WHAT IS CALLED APPROPRIATE TECHNOLOGY IS INVENTED, MADE, AND ADOPTED BY PAPUA NEW GUINEANS, THE APPROPRIATE TECHNOLOGY "EXPERT" SHOULD EXAMINE HIS MOTIVES VERY CRITICALLY.



# Vegetables

## TRADITIONAL VEGETABLES

(p 229)

There are two food groups that form the basis for meals in PNG. One group consist of energy foods such as sweet potato, taro, yams, bananas or sago. The other group is the vegetables. The vegetables are very important in the village diet. For many people they provide much of the protein, vitamins and minerals that people eat. Very little has been written about them and most of the information is in the heads of experienced gardeners. There is a danger that some of the vegetables will be lost as they are replaced by introduced ones.

It would be a great pity if the traditional vegetables are replaced by introduced ones, as many of the traditional species are superior in food value to introduced ones. (A good indication of food value is the colour of the vegetable: dark green ones are usually richer than lighter coloured ones). Also pest and disease problems are generally less serious on the traditional species. And finally PNG's vegetables, some of which are only eaten here, are part of the country's cultural heritage.

Some introduced vegetables will find a place in the gardens, of course. Their spread should be encouraged if they are easy to grow and are nutritious. Successful introductions include kangkong (*Ipomoea aquatica* or aquatic sweet potato) and pumpkins which are grown for both tips and fruit. More recent introductions such as bašella (*Basella rubra*) and Russian comfrey (*Symphytum* spp) may also become common.

Notes on some of the traditional vegetables are given below. There are very many more species than these eaten and you would find it an interesting project to gather information on traditional vegetables in your area.



Aibika - one of the world's most nutritious leafy vegetables.

**AIBIKA** (*Abelmoschus manihot*). This well known crop is a shrub 1 to 1.5m high. It is grown in many areas. It is propagated from stem cuttings. There are a great number of varieties which show big differences in leaf shape, colour and production. The young leaves are picked and are cooked in coconut cream or water in a saucepan or banana leaves. They can also be fried. It is a very rich food and has a high protein content. Harvesting can commence 2-3 months after planting and production continues for 1-2 years.

Insect damage is fairly common. The most common pest is a beetle (*Nisotra* spp) which makes "shot holes" on the leaves. A moth (*Sylepta corogata*), army worms (*Spodoptera* spp), and a stem borer also damage it. The stem borer can reduce production greatly. It is sometimes attacked by nematodes on the roots.

*Amaranthus* or pigweed: a weed in the temperate zone but a useful green vegetable in the tropics.



**AMARANTHUS** (*Amaranthus*, spp) *Amaranthus* is a traditional crop usually grown on cultivated lands. It is usually started by scattering the seeds on moist soil. It prefers wet weather, should be planted at the beginning of rainy season. It doesn't require drainage.

The first harvest is when thinning. You pull the whole plant and then discard the roots and keep the leaves. The second harvest is the main harvest when the plant is about 6-8cm high, and the tops are plucked. The third harvest would be the time when the side branches are plucked. After that the shrub gets old and dries up.

There is some insect damage by grubs chewing the leaves of the young plant. However, there is no disease damage.



It is cooked and eaten immediately after it has been harvested. If stored in a shady place it can last a day or two, but no more than that.

AUPA (no article)

FERNS. Shoots and young leaves of various ferns are commonly gathered and eaten.

KAGUA. (*Ficus* spp). Kagua is a Tolai name given to a tree that produces a thick edible leaf. The surface of the leaf is coarse, like sandpaper. Kalakala is the Tolai name of a similar tree which also produces an edible leaf.

KARAKAP (*Solanum nigrum*). This self-sown green is very commonly found in gardens. It is a small herb that grows to about 40cm in height. The black fruits are also edible. It can be propagated from seed.

OENANTHE (*Oenanthe javanica*) is a traditional highlands vegetable domesticated from bush varieties which are abundant in the area. The wild varieties are eaten in times of hunger and by hungry children, but they are not so tasty as are the cultivated varieties. Varieties range in colour from yellowish green to purplish green. Once they grow in an area they are hard to get rid of. Because of their vigorous growth, they are sometimes planted in coffee gardens to keep the weeds down.

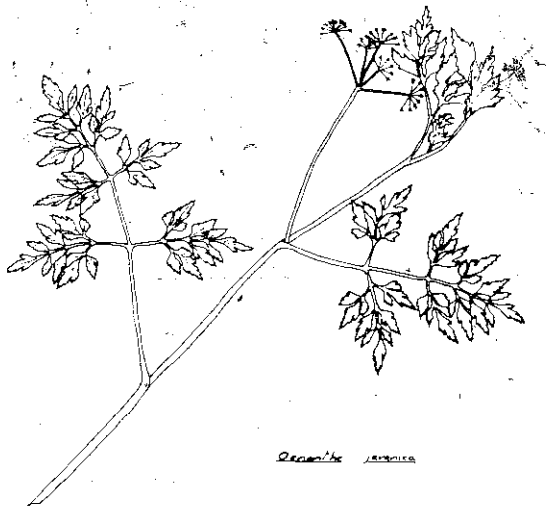

The plant is grown by cuttings with both midstems and tops used. Planting is done with a digging stick and usually 5-6 cuttings are planted in one hole. It grows in both wet and dry soils.

This vegetable cannot be stored, as it loses its flavour and becomes bitter. Large quantities are eaten both raw or cooked. Cooking is usually done in pits or in small wooden drums together with *Rungia klossii* and *Setaria palmaefolia*. These days it is boiled, but doesn't taste as good as when roasted.

Besides being a food, the hollow stems are used by children to make small trumpet-like noises.



Tall pitpit, Morobe Province.

PITPIT (*Sacclarum edule*) is a cane of unknown origin with an edible inflorescence. There are no wild forms known and if gardens are neglected the pitpit soon seems to die out. Traditionally pitpit has no special value as does sweet potato or yams, but is simply an interplanted extra.

Pitpit is planted mainly into virgin soils on dry ground. It has no specific climatic requirements and can be planted at any time of the year. It is grown from cuttings 30-50cm long. Each cutting contains three to four nodes, and is taken from the mature part of the plant. The cuttings are planted at random in the garden by making holes at a slant with a digging stick and then planting 3-4 cuttings in one hole. The planting material is planted so that 15-20cm of the cuttings are underground. If too many plants result, some are removed at weeding.

There are a number of varieties, some of them more popular than others.

The crop takes 7-9 months to come into bearing, depending on the variety. The unopened flower on top is the portion of the plant eaten. Generally it is considered to be ripe when most of the leaves on the stalk are brownish coloured and the leaf sheaths lose their hair. Harvesting is done by cutting the stem a few nodes away from the base of the inflorescence. The tender stem just below the inflorescence is also eaten. If the inflorescence is not harvested when mature it gets attacked by a fungal disease which starts at the top end. After several harvests, or in 3 to 4 years the edible portions become smaller in size and are usually abandoned.

It can be eaten raw, but is usually cooked over the open flames. The inflorescence and leaf sheath

coverings are put on the fire for a few minutes. When cooked the outer leaf sheath is removed leaving the hot, inner tender leaves and inflorescence for consumption.

This tall pitpit (*Saccharum edule*) is significantly more nutritious than the short (*Setaria palmaefolia*).

PITPIT ("MOI") (*Setaria palmaefolia*) is thought to be one of the original crops of the people in the Mt. Hagen area. It seems to have been domesticated and improved through selection and continuous growing. Wild forms grow in the bush and along river banks. These wild forms are often used in times of famine and by hunting parties.



It is a hardy plant and can be grown in dry or damp soils. In very wet soils, drainage is required. It can be planted at any time of the year, but is usually planted before the rains with a digging stick, two cuttings per hole. Shoots are taken from older plants, which are usually left to dry for a day or so, they then tend to root quicker. There are a number of varieties grown.

The crop takes 4-5 months to mature and then the big shoots are harvested. Harvesting consists of breaking the shoot off 2-3 nodes below the first unopened leaf sheath. Shoots may be harvested from a single plant for about two years prior to plants being left. *Setaria* is an important famine food as the plant survives in fallow gardens for many years.

*Setaria* is a much favoured food by the women and children. It can be eaten raw, but it is usually cooked, as too much raw *Setaria* can cause stomach aches. To eat raw, the hard outer parts are removed, and the soft inner shoot is eaten, usually with "Kenkaba" (*Rungia klossii*). Traditionally, *Setaria* was cooked either in the ashes or in "mumus" with other greens.

RORIPPA ("Kund") (*Rorippa* spp.) *Rorippa* is a traditional highland vegetable of unknown origin. No wild forms of it are known. It is planted mainly by the women in mixed gardens when the rains start. It grows well in wet soils but can also be planted in drier garden sites, and is grown by seeds broadcast over the garden site when the soil is wet.

"Kund" is thinned at an early stage so that other plants can grow better. The plants that are removed are eaten. The tops are cooked while the roots are cut off and discarded. For eating only the younger plant portions are used. "Kund" can be roasted with meat or by itself.

RUNGIA ("Kenkaba") (*Rungia klossii*) is considered to be a very old traditional highlands plant. Wild forms still grow in the bush and are consumed by hunting parties or in times of famine.

It is a small herb which is eaten raw or cooked. It is grown in mixed gardens together with short pitpit (*Setaria palmaefolia*). It has no special climatic requirements and so can be planted at any time of the year.

It is grown by cuttings. A hole is made with a digging stick and then a number of cuttings are put in the hole. The growing plant is seldom attacked by pests or diseases. The plant is considered to be mature when it is about 30cm high, and this may take 3-4 months. Two or three leaves are all that are picked. If plucked too far down the stem it becomes quite hard.

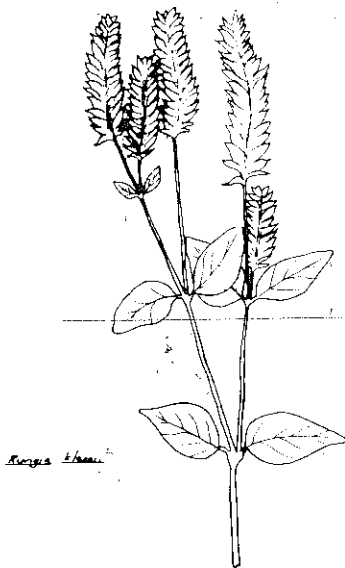

## TARO LEAVES.

Taro is most important for its edible corm but the leaves are often an important vegetable as well. The young leaves or petioles are used. Taro leaf blight (caused by *Phytophthora colocasiae*) and insect larvae that eat the leaves can make the leaf unsuitable as a vegetable.

## TULIP (*Gnetum gnemon*)

The name of this tree comes from the English words "two leaf" and it should not be confused with the West African Tulip (*Spathodia campanulata*) which is an introduced tree common in secondary regrowth



in some areas. Tulip is a long lived tree. The young leaves are eaten as are the seeds, which have a nice nutty flavour. It is especially common in the Sepik area.

*Valangur* - a common shrub in the Gazelle used for flavoured greens. Much wider use of local vegetables is possible.



*VALANGUR* (*Polyscias grandifolia*) is a shrub that normally grows 1 to 1.5m. In the Gazelle and New Ireland it is grown as a fence near houses. The leaves have a pleasant odour, and the young leaves are picked for a vegetable and flavouring in stews.

Planting material all of the above: Find local sources.

Reading: Barrau, J. 1958). *Subsistence Agriculture in Melanesia*. B.P. Bishop Museum Bulletin 219. (US\$9 from the Museum Bookshop).  
Martin, F.W. & Ruberte, R.M. (1975). *Edible Leaves of the Tropics*. Antillian College Press, Mayaguez, Puerto Rico.

Initial contributor: R.M. Bourke, LAES, Kerevat, with notes from Nicholas Kuman and Cecelia Poniq, UPNG Agriculture Students.



*Kangkong* - also called aquatic sweet potato

## INTRODUCED VEGETABLES

### CEYLON SPINACH BASELLA

Description: A dark green soft stemmed vine with juicy leaves. Good as a cooked green.

Botanical name: *Basella rubra*

Height: Vine up to 10 metres long

Age to first production: 4-6 weeks

Normal life span: 4-6 months

No insect pests observed.

Planting information: This is a useful green vegetable that will grow almost anywhere, including slightly swampy ground. It can be grown from cuttings or from seed. Plant cuttings 20-25cm long or seeds on a square 20x20cm. Seeds may take 3 weeks to germinate. During the rainy season vines should be trellised to prevent disease and increase output. Begin picking when the vines have covered



the trellis. Early picking stunts later growth. Harvest one leaf in three.

Uses at village level: As a cooked green. A few drops of muli juice can improve flavour. Soak seeds and boil them in a small amount of water to make ink.

Sources of planting material: Seeds only, Manggai High School, PMB, Kavieng.

Further references: Vegetable Production in Southeast Asia by J.E. Knott and Jose R. Deanon, University of the Philippines 1967 p. 273-276.

PNG experience: Manggai High School, PMB Kavieng.

Remarks: The useful life of the planting can be increased by picking flowers as they develop. Also production can be increased by harvesting the entire last 15-30cm of the vine. This will promote branching. Ceylon Spinach is resistant to snails. Leaf growth responds well to nitrogen fertilizer, especially urea and compost.

Initial contributors: W. Kitchen, W. Gabara, Manggai High School, PMB, Kavieng, NIP.

PEOPLE are not the problem.  
 PEOPLE are what it's all about.  
 PEOPLE are the answer.

## COMFREY

Botanical name: Symphytum asperrimum  
S. peregrinum

Though there are many types of Comfrey, the one most commonly eaten by people is Russian Comfrey (S. peregrinum). The dried leaves can be ground and used as a coarse flour in bread, biscuits etc.

It is a high-yielding perennial of the Boraga family, and the greens make a good cooked vegetable.

According to the Energy Primer, Portola Institute, 1974, p112 Comfrey has one of the highest protein contents (21% of dry matter) of any plant known. It is also one of the few plants that concentrates Vitamin-B-12. Its flowers are an important source of nectar and its leaves can be used to help wounds to heal. (Crush the leaves and apply to the wound or make a strong tea and soak wound in tea. Especially good for tropical ulcers.) The name "Symphytum" means "to grow together", a reference to these healing qualities.

The DPI Experiment Stations at Kerevat and Aiyura are familiar with Russian Comfrey. St. Paul's Lutheran High School, in Wapenamanda, EP, grows it, and it grows like a weed around Mt. Hagen.

Reference: Comfrey - An Ancient Medicinal Remedy, Henry Doubleday Research Assn., 20 Convent Lane, Bocking, Braintree, Essex, UK. 36p.

Initial contributor: H. Bekker.

## OKRA

Okra is an extremely easily grown tropical and subtropical vegetable, sometimes called "Lady's Finger"



or "Gumbo". Nutritionally, it is not very special, but it compares favourably with other green vegetables. It grows best at the lower elevations, but has a wide adaptability to a variety of soil and climate conditions.

Botanical name: Hibiscus esculentus  
 Height: 80cm - 150cm  
 Age to first production: 60 - 70 days  
 Normal life span: Will bear edible fruits for 2 to 3 months, especially if pruned from time to time.

Insect pests and control: Usually it is not economic to spray, but if infestations are serious, Orthene is effective. This is not a cash crop.

Indication of maturity: Harvest when the fruits are about the size of a "lady's thumb", well before they start to become fibrous and woody. Regular harvest of the fruits when they are young and tender prolongs the fruit-bearing.

Planting information: Plant seed in a well-tilled soil about 1 to 1½ cm deep, in rows 80-90cm apart, with about 30cm between each plant in the row. Planting rates can be thicker, with thinning done later. Regular weeding is necessary. Periodic plantings of smaller plots will give a steady supply of fruits.

Use at village level: A useful green vegetable. Some people like okra because it is slightly "slimy" when boiled, and others dislike it for the same reason. It is often used in tropical cooking to thicken soups and stews. Frying small slices of okra or the use of a small quantity of vinegar or muli juice will take away the slimy characteristic. Fried okra tastes surprisingly like oysters.

Sources of planting materials: Liklik Buk, Box 1920, Lae; Vudal Agr. College, ENB; Manggai H.S., PMB, Kavieng, NIP; Agricultural College, UPNG, Waigani; Yates Seeds.

Remarks: Food value per 100g raw foodstuff, edible portion: 32 calories; 1.8g protein; .2g fat; 7.4g total carbohydrates; 82mg calcium; .7mg iron; 740 I.U. pro-vitamin A; 440mcg carotene; .08mg thiamine; .07mg riboflavin; 1.1mg niacin; and 30mg ascorbic acid. (Food tables, WHO, Western Pacific).

## PLANTING DISTANCES FOR VARIOUS VEGETABLES

### TRANSPLANTING SEEDLINGS

Lettuce	25-30cm apart in rows. Rows 30-50cm apart.
Cabbage	"
Cauliflower	"
Chinese Cabbage	"
Tomatoes	45cm apart in rows. Rows 60cm apart.
Egg plant	"

### DIRECT PLANTING OF SEEDS

Carrots	In 1-2cm deep drills 30cm apart, water well on planting. Weakest seedlings removed until a space of 5cm between seedlings obtained. May also be planted by broadcast method.
Radish	"
Silver Beet	"
Parsley	As above, but requires plenty of watering until seedlings emerge.
Capsicums	50-60cm apart in rows. Rows 40-45cm apart.
Oak Dwarf French Beans	24cm apart in rows. Rows 40cm apart. Seed planted 2cm deep and watered.
Cucumbers	In mounds 90cm apart, 4 seeds/mound, planted 2cm deep and watered.

Initial contributor: C. Benjamin, DPI, Box 351, Kimbe, WNB.

### VEGETABLE NURSERY NERSERI

Description: A nursery is a small house where delicate young seedlings are grown to protect them from too much sun and rain. Vegetables like lettuce, cabbage, cauliflower, tomato, chinese cabbage, and eggplant are very weak when they are young. In a few weeks the seedlings are strong enough for transplanting on their own in the garden.

Materials: 4 corner posts 1.5 - 2.0 metres (bush material) 5 poles for frame of the roof (bush mat) bush twine, leaves or kunai for the roof.

Order of work:

Mark the corner posts so that the nursery runs from north to south.

Construct nursery, but be sure the roof is high enough so that early morning and late afternoon sun gets to plants.

Place good topsoil with much organic matter under the nursery, and make the surface smooth with no lumps of soil, so that small seeds will germinate easily.

Sources of supply of materials: All are available locally.

Further references: C. Kemp, 1976, Proceedings of the 1975 Papua New Guinea Food Crops Conference, "Trial Work with Introduced Vegetables in West New Britain", p. 238-259.

PNG experience: K. Brewer, AIC, Dami Oil Palm Research Station, Dami, via Kimbe WNB; Kimbe

Community School; Mai Community School, via Kimbe;  
 Buvussi Community School, via Kimbe; Sarakolok  
 Community School, via Kimbe.

Remarks: Plant posts solidly in ground so the building will not fall on the seedlings. Make sure that the long sides face east-west so that the seedlings get the gentle morning and afternoon sun, but are protected from the hot noon-day sun. The high side of the nursery should be to the east, so that the ground will warm up quickly in the morning. Water plants in nursery twice a day, early morning and late afternoon. Pull out weak seedlings as they appear so only strong healthy plants will be transplanted.

Initial contributor: C. Benjamin, DPI, Box 351,  
 Kimbe, WNB.

# AGRICULTURE IS THE BASIS OF INDEPENDENT DEVELOPMENT

## VEGETABLE NURSERY

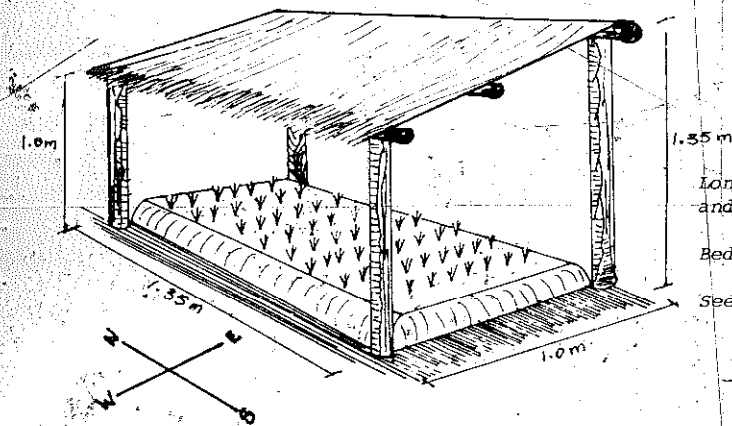

Long sides face east and west to catch the morning and evening sun.

Bed is made of mounded topsoil rich in organic matter.

Seeds are sown either in drills or broadcast.

## VEGETABLE BED

Soil in beds is turned well and all clods broken up to give a fine tilth.

Beds are constructed by mounding organic matter.

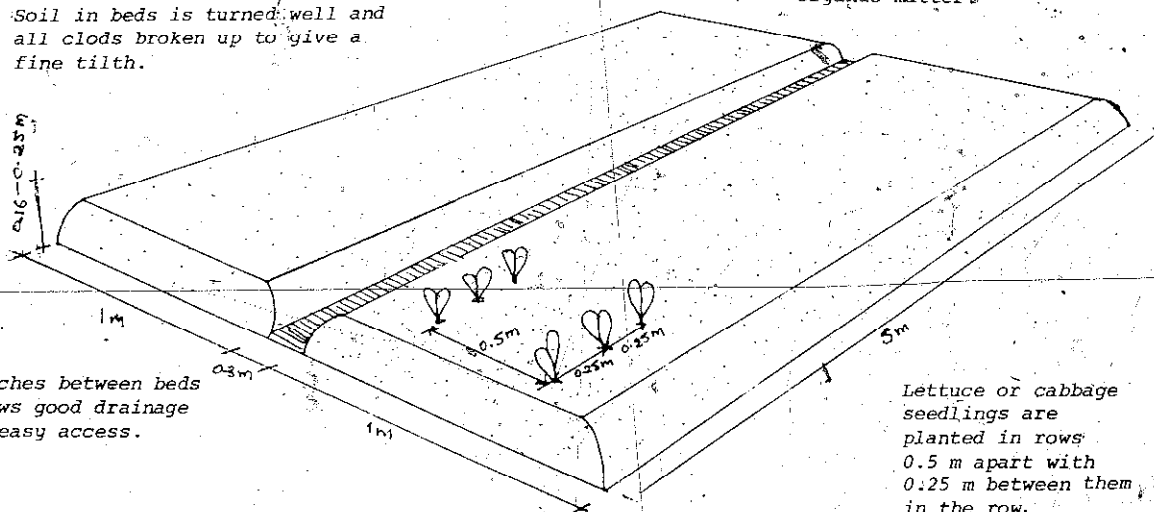

Trenches between beds allows good drainage and easy access.

Lettuce or cabbage seedlings are planted in rows 0.5 m apart with 0.25 m between them in the row.

## PLANTING GUIDE

	How planted*	Amount to sow per 30m row	Distance between rows (cm)	Space betw. plants in rows (cm)	Time to maturity (weeks)
Beans, climbing	direct	50-70g	100-130	15-25	
Beans, dwarf	direct	60-80g	60-100	5-10	
Beetroot	direct	50g	45-60	6-10	9-12
Broccoli	transpl	50 plants	50-90	30-60	10-16
Brussels sprouts	transpl	50 plants	50-90	45-60	18-25
Cabbage	transpl	50-80 plants	60-90	35-70	8-16
Capsicum	transpl	50-70 plants	45-60	30-60	12-16
Carrots	direct	25g	40-50	5-10	10-15
Cauliflower	transpl	40-50 plants	50-60	50-60	12-26
Celery	transpl	200 plants	40-90	15-20	20-24
Cucumber	direct	25g	120-180	30	9-12
Egg plant	transpl	50-70 plants	60-120	60-90	14-18
Kohlrabi	direct	50g	45-60	20-30	10-12
Leek	direct	50g	30-75	5-15	20-24
Lettuce	transpl	25g	45-60	20-30	9-12
Zucchini	direct	50g	90-120	70-100	5-7
Water melon	direct	50g	180-240	60-75	12-14
Onion	direct or transpl	50g	30-50	5-12	18-30
Parsley	direct	25g	30-60	10-30	10-12
Parsnip	direct	50g	45-75	7-12	18-25
Pumpkin	direct	50g	220-330	90-140	14-22
Radish	direct	50g	30-40	1.5-3	4-5
Silver beet	direct	50g	30-45	20-30	8-12
Spinaach	direct	50g	30-65	8-20	7-10
Sweet corn	direct	250g	100-120	20-35	10-12
Squash	direct	50g	100-200	70-100	8-14
Tomato	transpl	40-50 plants	90-160	50-90	14-18

\* "Direct" means that the seed is planted straight into the garden.

"Transplant" means the seed is first planted in a seedbox or seedbed, then transplanted to the garden.

Adapted from Introduced Vegetables, DPI Handbook #9.

## VEGETABLE SEED SUPPLY

The regular supply of good quality vegetable seed has always been a most unsatisfactory matter in P.N.G. The type of seed and the range of seed presented to the largely uninformed public has been confusing and the ordering of seed has quite often been completely haphazard with little expertise on requirements involved. Generally, Australian or New Zealand temperate vegetable varieties prove to be satisfactory in the Highlands areas but many of these varieties are not suited to the high temperatures and high humidity of the coast. By personal contact with the firms involved, DPI has made an effort to rationalise the supply of vegetable seed.

The Taki Seed Company of Japan has an impressive range of vegetable varieties that are well suited to tropical conditions. A great deal of seed has been obtained from that company as well as Farmer's Seed in Taiwan for experimentation over the

past year. Most of the Yates seed evaluated in 1974 was from Yates New Zealand. The Yates companies in Australia and New Zealand are completely separate and although many of their vegetable varieties are similar some varieties listed are available from one company only. Both Rumsley's Seeds and New World seeds have almost identical variety lists to Yates Australia, but again with a few differences.

In Port Moresby, vegetable seed can be obtained from the following sources:

1. Steamships Trading Co. Ltd.  
Hardware and Paint Division  
Ela Beach  
Manager - Mr. Ron Hancock. Steamships is agents for Yates New Zealand "Longlife" seed. They have quantities of small packet and bulk seed in stock and will arrange large orders of bulk seed.
2. Tutt Bryant Pacific Ltd.  
Hubert Murray Highway  
Badili  
Manager - Agricultural Division,

cont'd

## TRANSPLANTING

Mr. Bevan Holden. Tutt Bryant markets vegetable seed from Yates New Zealand, Yates Australia, New World, Rumsley's and from Takii Seed Company of Japan. They will also be supplying seed from Farmer's Seed, Taiwan very shortly.

3. Makana Vocational Training Centre  
P.O. Box 5664  
Boroko  
Manager - Mr. Cliff Curant. Makana Supplies Yates New Zealand seed and has provided a good mail order service for seed.
4. Burns Philp (N.G.) Ltd.  
Builders Hardware  
Boroko  
Agents for Yates Australia seed.
5. Exmark Stock and Produce  
P.O. Box 6060  
Boroko  
Manager - Mrs. S. Mudge. Exmark will supply Yates Australia seed in bulk quantities.
6. Mr. Ron Burness  
Agencies Pacific Pty. Ltd.  
P.O. Box 5044  
Boroko  
will supply seed from Takii Seed of Japan and Farmers Seed of Taiwan in commercial quantities.
7. Carpenters Hardware  
Boroko  
P.O. Box 3043  
Port Moresby  
Supplies Yates Australia seed.

Readers should note that importation of seeds from overseas is restricted under P.N.G. Plant Quarantine regulations, which aim to protect vegetable growers against the introduction of new diseases. Vegetable seed from Australia and New Zealand is admitted freely, but a permit is required for import of seed from other countries. Certain types, where the danger of disease introduction is greater, are more closely restricted. These include tomato, lettuce, beans and peas. Where local agents are listed as supplying Japanese or Taiwanese seed, the agent has imported this seed under permit.

Many of the firms listed above also carry good stocks of other requisites such as fertilisers, fungicides, insecticides, spraying equipment and nursery supplies.

(Excerpts from Information Bulletin No. 1, DPI Plant Introduction Station, Laloki)

Plants which are grown as seedlings in a nursery must be transplanted to the final bed. This is usually done when the seedling is three weeks old. It is very hard on the seedling when it is pulled up by the roots, because many small bits of the root are broken, no matter how carefully you up-root it. There are steps for transplanting so that the young seedling will recover well from the damage of being up-rooted.

Follow these steps for all kinds of plants that are planted by transplanting, such as lettuce, cabbage, paw paw, onion, and small trees. The nursery makes it easy to look after many young plants at one time.

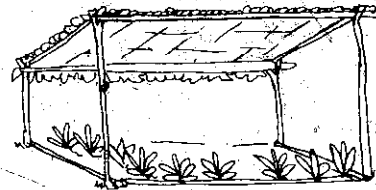

1. Seedlings are ready to transplant when three weeks old. The best time is in the late afternoon.

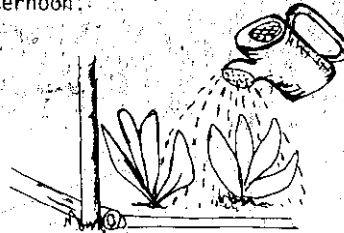

2. Water seedling before uprooting.

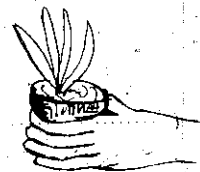

3. Remove seedling with damp soil around the roots.



4. Make holes in garden where each plant will grow.

cont'd



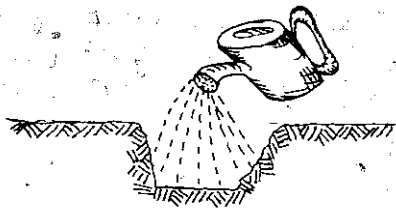

5. Water each hole well before transplanting.



6. Place seedling in hole and pack the soil.

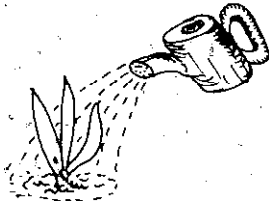

7. Water the planted seedling well.

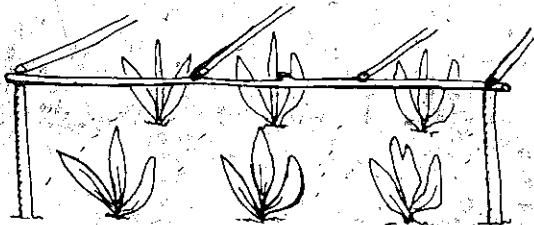

8. Build a shade frame over the garden, until seedlings are growing well.

If you have a large garden and it is hard to make shade houses for all of it, any large leaf is good. Kapiak leaves are best because they harden when dry.

### SPECIAL REQUIREMENTS FOR TOMATOES

The soil must be well-cultivated.

The plant must be watered twice a day.

The top of the soil should be covered with dead grass or weeds to keep the soil cool and to stop water from evaporating. This is called mulching.

### PLANTING TOMATO SEEDLINGS

RIGHT

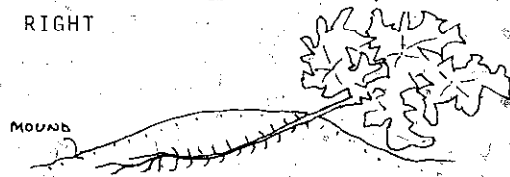

1/3 of tomato seedling is planted above the ground.  
2/3 of tomato seedling is planted below the ground.

More stem planted under the ground causes more roots to grow. These roots give more food and a greater support to the plant.

WRONG

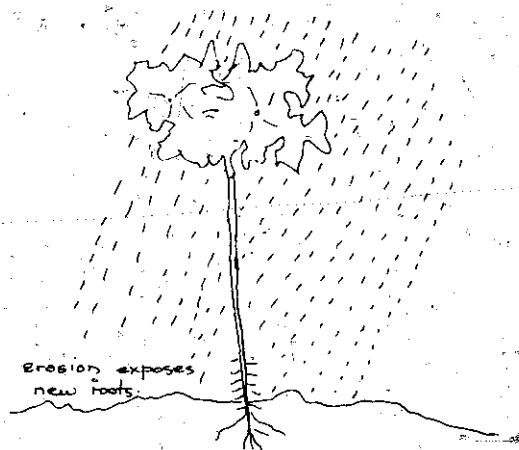
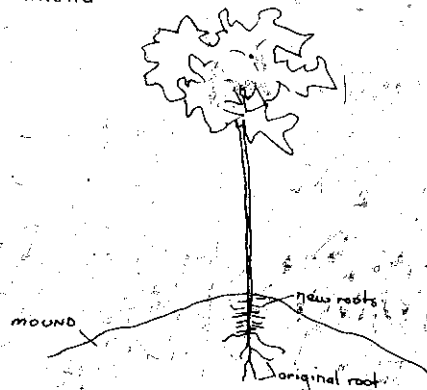

If the tomato is planted like this any heavy rainfall will wash the mound away, exposing the new roots.

C. Benjamin, DPI, Box 351  
Kimbe, WNBP

## GENERAL REFERENCES

Commercial Vegetable Growing, H.D. Tindall, Oxford University Press, London, 1968 Pounds 1.50 (pb).

Despite the title this book is for smallscale gardening in the tropics, written primarily for Africa, The Caribbean and Asia, it is still useful for PNG. The first quarter of the book deals with general considerations of good gardening practices, to permit continuous cropping on tropical soils. It also has some very useful advice on marketing and simple business considerations for the market gardener.

The remainder of the book is an excellent series of short descriptions of the wide variety of vegetables most of which are grown in PNG, together with brief suggestions for planting practices and other considerations.

Level simple.

Vegetable Growing in Southeast Asia, by James E. Knott and Jose R. Deanon, Jr., University of the Philippines Press, 1967.

This is a very detailed book on the growing of a wide range of common vegetables in humid tropics. Each of the crops is discussed with reference to history, important uses, varieties, soil and climatic requirements, harvesting, handling and control of insects and diseases. This book has broad application to extension and management for fresh food production in this country. A bonus is the most complete list of the wild vegetables and fruits used in many parts of Asia as food, most of which are recognizable in PNG diets.

Level intermediate/advanced.

EDIBLE LEAVES OF THE TROPICS, by Franklin W. Martin and Ruth M. Ruberte, Mayaguez Institute of Tropical Agriculture, Mayaguez, Puerto Rico, 1975, Agricultural Research Service, Southern Region, US Department of Agriculture, Printed by the Antillian College Press, Mayaguez, Puerto Rico.

Seems to be reasonably comprehensive. Includes tables for nutritional and chemical composition for a wide range of plants having edible leaves. Illustrated with 56 black and white plates.

Initial contributor: R. Stephensen, Faculty of Agriculture, UPNG, Port Moresby.

INTRODUCED VEGETABLES, DPI Handbook #9, edited by C.A. Fowler, 33pp. Is supposed to be distributed through your DPI Office.

A useful summary of basic information for those who want to grow vegetables to sell. Includes raising of seedlings, planting and packing, insects and diseases, organizing production and marketing. Special advice for particular crops, planting guide.

HIGHLANDS FOOD CROPS NEWSLETTER,  
Box 339,  
Mt. Hagan, WHP.

Short timely bulletins from KUK RESEARCH STATION, monthly; includes a variety of recommendations, advice on problems, planting and management practices, all on vegetables.

A. Jacob and H. Von Uexkull, Fertiliser Use, Nutrition and Manuring of Tropical Crops, Translated by C.I. Whittles, Verlagsgesellschaft fur Ackerbau, Hanover.

Discussion of the principles of nutrition followed by a review of fertilizer recommendations for the most important crops. Tables of composition of fertilizers, manures, and crops.

Initial Contributor: Ken Willson  
PNG Univ. of Tech.  
Box 793, Lae

Oxford Book of Food Plants, by S.G. Harrison, Masfield and Wallis, Oxford U. Press, London, 1969, Pounds 3.50.

A beautifully illustrated (colour) book of the major food crops of the world, including oil crops, mushrooms, seaweeds, spices, root crops, and fruits. Temperate zone crops are included, but exotic foods not. Detailed illustrations. An excellent teaching aid for agriculture or botany in upper primary or high school.

No. 2 Root Crops, by Mrs. D.E. Kay, Tropical Products Institute, 1973, 56/62 Gray's Inn Rd., London WC1X 8LU, England.  
1 pound 50 plus postage

250 pages of very helpful information on tropical root crops. Highly recommended.

Soils of The Humid Tropics, by The Committee on Tropical Soils, Agricultural Board, National Research Council, National Academy of Sciences, Washington D.C., 1972, 217 pp.

Technical papers on all aspects of tropical soils by leaders in the respective fields. This is a response to the recognition that the transfer of technology from temperate to tropical regions is greatly hampered by the great differences between the soils of the two. An effort is made to distinguish the specific problems of tropical soils from the commonly held generalizations. An important book for teachers of agricultural science.

level/advanced

Technical Manual for Fertilizers, Fungicides, Weed Killers, Insecticides, Veterinary Products, Home Products, - free from Amalgamated Chemicals (NSW) Northam Ave., Bankstown, N.S.W. 2200.

A wide range of products is listed with their uses, rates, available sizes. Very useful for those directly involved in agricultural production.

J.W. Pursglove, Tropical Crops, Dicotyledons, Vol I and II; J.W. Pursglove, Tropical Crops, Monocotyledons, Vol. I and II; both published by Longmans.

These four volumes (the first two are now available in one book, paperback) include annual and perennial crops, and describe cultural practices in many parts of the world.

This is a most valuable reference work for all of the most important crops.

## SUPPLY OF PLANTING MATERIAL

IT IS OFTEN HARD FOR PEOPLE TO GET NEW KINDS OF SEED. THERE ARE WAYS, IF YOU CAN BE PATIENT AND PERSISTENT, BUT THERE ARE GOOD REASONS WHY YOU MAY HAVE A SLOW RESPONSE.

REQUESTS FOR SEED AND PLANTING MATERIAL ARE IRREGULAR, AND IT IS VERY EXPENSIVE TO STORE THEM WITHOUT LOSS. AGRICULTURE PEOPLE ARE DISCOURAGED, TOO, THAT REQUESTS FOR FREE SEED IN LARGE QUANTITIES HAVE BECOME ANNUAL EVENTS FROM FARMERS AND SCHOOLS THAT MAKE LITTLE OR NO EFFORT TO MAINTAIN THEIR OWN SEED SUPPLIES.

LAES KEREVAT IS A GOOD EXAMPLE OF A SINCERE ATTEMPT TO STORE AND SUPPLY SMALL QUANTITIES OF SEED FOR MULTIPLICATION. THEY ARE QUICK TO RESPOND, BUT IT IS UNFAIR TO EXPECT THEM OR ANY OTHER DPI STATION TO SUPPLY LARGE QUANTITIES ON A RECURRING BASIS.

PNG HAS AN EXCEPTIONALLY GOOD STOCK OF PLANTING MATERIALS TESTED AND ADAPTED TO PNG CONDITIONS. ONLY IN RARE CIRCUMSTANCES IS IT NECESSARY TO GO OVERSEAS FOR NEW VARIETIES, AND THEN IT IS ESSENTIAL TO PROTECT THE COUNTRY BY HAVING THEM GROWN OUT IN QUARANTINE.

BUT THE PUBLIC NEEDS BETTER ACCESS TO NEW OR IMPROVED PLANTING MATERIAL. THIS WOULD BE A MOST USEFUL BUT SOMEWHAT EXPENSIVE AND DIFFICULT SERVICE FOR SOMEONE TO RENDER ON A NATIONAL BASIS.

HIGH SCHOOLS, VOCATIONAL CENTRES, COLLEGES AND THE UNIVERSITY, PLUS THE MANY INFORMAL AGRICULTURAL PROGRAMMES OF THE CHURCHES AND OTHER ORGANIZATIONS COULD PLAY A VERY HELPFUL LOCAL ROLE IN RURAL DEVELOPMENT BY MAINTAINING SMALL SEED GARDENS AND SHARING SEEDS PARTICULARLY FOR NUTRITIOUS CROPS.

Companion Plants (And How to Use Them) by Helen Philbrick and Richard B. Gregg. 1.50 Watkins, London, 93 pp, Mostly about temperate crops, but might be useful in a library. Some samples:-

"Corn does well with beans and peas, which help the soil by putting back nitrogen which the corn uses up. Beans benefit from the slight shade given by the corn plants." "Other plants which appreciate the sheltering shade of corn are melons, squash, pumpkins, and cucumbers."

"Garlic, onions and shallots inhibit the growth of peas and beans. European peasants used to put pieces of garlic into their grain for protection against weevils"

"The guava tree (Psidium guajava) protects nearby citrus trees."

"Spearmint is a plant antagonist against ants, aphids, black flea beetles, cabbage butterfly caterpillar; Garlic against aphids, weevils;"

"Potatoes and sunflower stunt each other."

"Root excretions from potatoes somewhat inhibit growth of tomatoes".

"Peas and radishes are mutually helpful."

"Soybeans will loosen heavy soil and make it pliable.

"Toads (Bufo) are very useful in the garden, eating many insects and other pests which attack our plants. They exude a slime distasteful to enemies but not poisonous to man. Their skins contain adrenalin and have been used medicinally. Toads do not cause warts."

"Tobacco, like the tomato, likes to grow in the same place year after year, and like tomato prefers compost made of its own leaves and stalks". (readers may like to react to that one!)

Level Simple

ASIAN VEGETABLE RESEARCH AND DEVELOPMENT CENTRE  
Box 42,  
Shanhua, Tainan 741  
Taiwan, R.O.C.

Coordinated effort by highly qualified plant scientists and economists to improve the quality and quantity of vegetable production in the tropics. Emphasize Soybean, Mungbean, Tomato, Chinese Cabbage, Sweet Potato and White Potato. Research, training, technical advisory service, seed samples.

# Fruits and Nuts

## AVOCADO

## BATA

Description: An evergreen tree which grows in flushes.

Botanical name: Persea gratissima or Persea americana

Height: 15 - 20 metres

Age to first production: 5 - 6 years (seedlings)

Normal life span: 50 years

Insect pests and control: None of importance

Diseases and control: Root rot (Phytophthora cinnamomi) Don't plant orchard in poorly drained soil.

Indications of maturity: Stem breaks easily from the fruit. Poke a little stick into the skin and if it goes in easily, it is ripe. Also, when cut in half, the seed should draw easily from the flesh. Allow to ripen 1-3 days until soft to touch.

Planting information: Easily grown from seed but quality varies. Should be grown vegetatively. Seeds planted in plastic bags should not be covered with more than 1cm soil. Seedlings can be budded after 2-4 months. In PNG current recommendations are to produce seedlings and transplant at 6-9 months to orchard, planting 7-15m apart depending on the vigour of the variety. Plant in well-drained soil. A pueraria cover crop under the trees is good. Cultivation should not be done as the tree roots are surface feeders. Weeds can be controlled by very shallow cultivation, cover crops, or herbicides.

Useful products at village level: Edible fruit (very high food value), especially good for infant diets, a nutritious, marketable fruit.

Industrial use: Oil is extracted for edible oil and as a cosmetic base.

Sources of supply of planting materials and cost: LAES, Kerevat, small amounts free. Large amounts 2t per seed, plus freight costs.

Further references: LAES Information Bulletin No 5, free; Dicotyledons, by Purseglove, Longmans, K8.50

PNG experience: Yield trials, LAES, Kerevat.

Remarks: Fruits rich in Vitamin B, A, & E, highly digestible oil. Highest energy value of any fruit - 1% sugar, 4% protein, 30% oil, 65% water.

Initial contributor: D.W. Loh, LAES, Kerevat, ENBP.

## BREADFRUIT

## KAPIAK

Botanical name: Artocarpus altilis

Height: 20 metres

Age to first production: 3-6 years

Normal life span: 50 years

Rarely attacked by serious diseases or pests.

Indication of maturity: Fruits start to yellow slightly and can easily be picked.

Planting information: Breadfruit can be planted by seed or by root cuttings. In the nursery root suckers can also be used. Seedless varieties from Polynesia must be planted by cuttings which are 2cm in diameter and 20cm long, laid in a shaded nursery bed either flat or at a slight angle. The seeded varieties commonly found in PNG can be grown from fresh seeds or cuttings. Seeded varieties are also known as bread nuts. (p 91) (p 114)

Uses on the village level: Although it is a staple food of many Polynesian societies it is not so important in Melanesia. It is usually cooked as a vegetable, baked, roasted, fried or in soups. Coconut cream or grated coconut are often added. Polynesians generally cook the breadfruit after peeling, but Melanesians usually peel after baking.

The seeds may be eaten after boiling or roasting. Rope fibre can be made from the bark, and the white sap is used to seal canoes. The sap can also be spread on sticks and can be used as a bird trap since it remains tacky for several days. Leaves are suitable livestock food, and the wood is good for furniture and making canoes.

Breadfruit can also be preserved for up to a year. There are no formal trials in PNG, but it is grown widely in tropical lowlands.

Sources of supply: Villages and markets in lowlands for seeded varieties, and varieties with few seeds. There is no identifiable seedless stock in PNG.

Further references: Dicotyledons by Purseglove, Longmans, K8.50

Remarks: Although there is no known seedless stock in PNG, it is anticipated that seedless varieties will be introduced in the near future. Most work on breadfruit is in Fiji.

Initial contributor: D.W. Loh, LAES, Kerevat, ENBP.

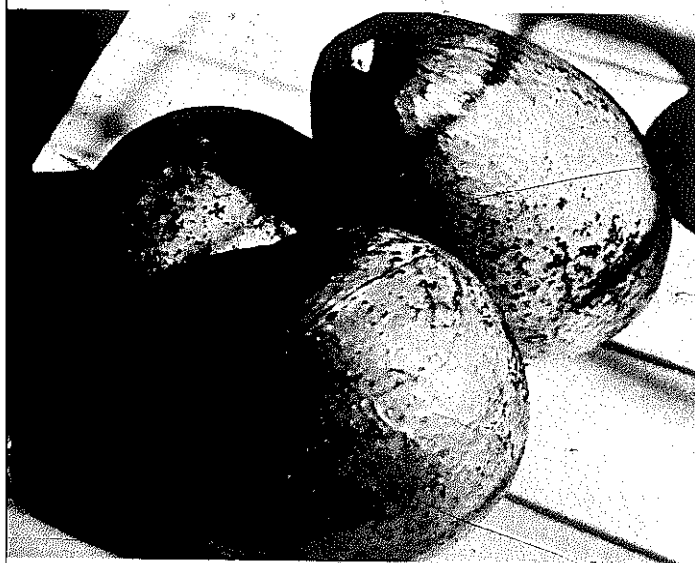

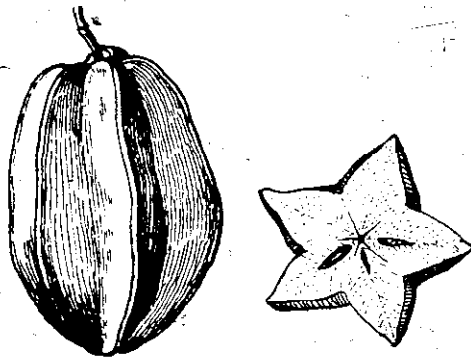

## CARAMBOLA FIVE CORNER

Description: An attractive small tree flowering with clusters of pink flowers.

Botanical name: *Averrhoa carambola*

Height: 5 - 12 metres

Age to first production: 2 years

Normal life span: 20 years

Insect pests and control: Fruit fly - Malathion 1% spray.

Indications of maturity: Yellowing of fruit.

Planting information: Seed planted in seedbed is planted out when 15-20cm high. Planted 10-15m apart in field.

Useful products at village level: Edible and marketable fruit. Fruit drink - grate fruit, add sugar and water to taste. The juice removes stains from linen and can be used for cleaning and toning brassware.

Sources of supply of planting materials and cost: LAES, Kerevat, no charge, freight costs only.

Further references: LAES Information Bulletin No 5, free; *Dicotyledons* by Purseglove, Longmans K8.50

Remarks: "Hawaiian Sweet" is the most popular variety.

Initial contributor: D.W. Loh, LAES, Kerevat, ENBP,

## CITRUS FRUIT MULI

Botanical name: *Citrus* spp.

The commercially important fruits of this genus may be classified as follows:

Sweet orange	<i>Citrus sinensis</i>
Sour orange	<i>C. aurantium</i>
Pummelo, shaddock	<i>C. grandis</i>
Mandarin, tangerine	<i>C. reticulata</i>
Lemon	<i>C. limon</i>
Lime	<i>C. aurantifolia</i>
Citron	<i>C. medica</i>
Grapefruit	<i>C. paradisi</i>
Calamondin	<i>C. mitis</i>

Height, age to first production, and normal life span are all highly variable, depending upon

species, manner of propagation, and pruning. With some exceptions, most citrus trees have an economic life of about 40 years.

Pests and diseases: A wide range of insects and mites attack some or all species of citrus. The most serious are scales, mites, aphids, thrips, several species of fruit flies, moth borer, trunk and bark borers, ants and termites. Among diseases, viruses such as psorosis, tristeza, and xyloporosis, bacterial diseases such as canker, and fungal diseases such as *Phytophthora* root rot, various foot rots, sour orange scab, and melanose, as well as burrowing and citrus nematodes, may be serious. Control of most insects and mites, sour orange scab, and melanose may be controlled with standard insecticides and fungicides. For fruit fly control, use Malathion plus poison bait. Certain virus diseases like psorosis or xyloporosis can be avoided by use of healthy budwood. The only feasible control for citrus canker is to plant resistant varieties. Root rot can be kept in check even with susceptible varieties by planting the trees high, providing for good air circulation around the base of the trunk, and treating of lesions with copper paste as they are found. Trees suffering from root rot should be destroyed.

Cultural information: Citrus can be grown on almost any type of soil, provided it is well drained.

To prepare site, clean out underbrush, trees and large roots or rocks that might hinder growth. If possible grow a cover crop for a year before planting.

Most varieties can be grown from seed, but take much longer to bear, and will not grow true to type. If possible, bud on locally adapted stocks. Seeds for root stocks should be sown fresh, lightly covered in well-prepared beds with sterilized soil. Germination is 2-4 weeks. Collect as needed - use mature, well-rounded wood with plump buds. Bud on root stocks 5-8mm in diameter. (p 39)

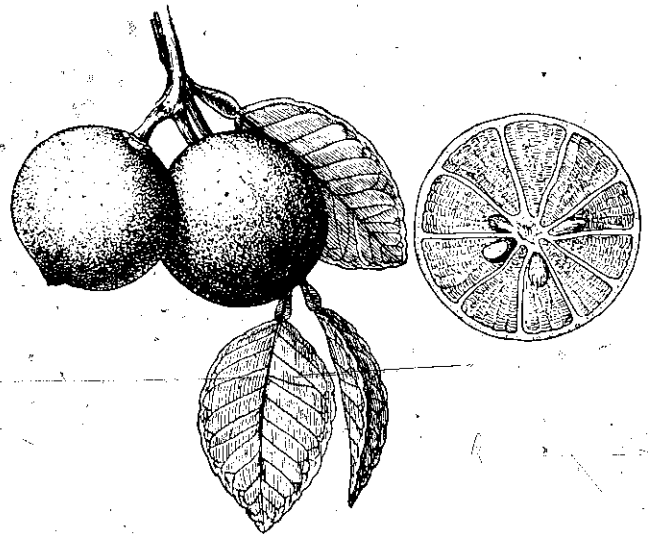

Set out young year-old trees in field just before rainy season begins, or provide for watering. Spacing will vary from 4.5m for limes up to 12.0m for pummelos. Better results will come if trees are not crowded. Holes should be big enough that roots will not be crowded. Fill holes with good soil. Initial care consists of watering, applying fertilizer after about 6 weeks (50-100g per tree), periodic removal of unwanted sprouts, and selection of 4-6 good branches with wide crotches. Newly set trees should be mulched heavily, with a cover crop between the trees.

Citrus trees seldom need pruning except to form a good branch framework and to remove diseased, dead, or tangled branches. Excessive pruning merely reduces yields.

Lemons, limes and calamondins flower and bear fruit more or less continuously, though they may have a main bloom. Citrus fruits do not contain starch, so they must be fully mature before they are picked. Some varieties do not lose their green colour when they are mature; others must be fully coloured. Periodic sampling and tasting will give an indication of when fruit are ready.

Uses: Citrus fruits are eaten fresh, and are processed into numerous products, including juice, juice blends, sections, salads. Fruit contain 20 to 60mg Vitamin C per 100g and also have amounts of provitamin A. Fruits unfit for human consumption are well-liked by cattle and other animals. (p 112)

Sources of supply of planting materials: Various varieties are found throughout PNG. You might have to grow your own seedlings. Consult your Provincial Rural Development Officer for sources of budwood. The DPI experiment stations and the agricultural schools often have some varieties available in small quantities.

References: Reither, Batchelor, and Webber (Eds.), The Citrus Industry, Vol 1 History, World Distribution, botany and Varieties; Vol 11 Anatomy, Physiology, Genetics, and Reproduction; Univ. of California.

Remarks: Many Citrus give added flavour to green vegetables, okra and fish. A "cheese" can be made with milk and muli. (p 101)

(Excerpts from "Tropical and Subtropical Fruit Crops," James Soule, Univ. of Florida, USA.)

LLB

## GRANADILLA

Botanical name: Passiflora quadrangularis L.  
Height: 10 - 15 metres

Age to first production:

Description: A strong, long-lived climber with fleshy tuberous roots and square stem.

Pests: Rats, bats and birds. May be protected by covering the fruit.



Indication of maturity: Fruits are 10-15cm x 20-30cm and change from dark green to yellow-green.

Planting information: May be planted from seed or cuttings at 3 metre spacings and trained to overhead trellises made of posts and wire or bamboo so that the fruit hang down.

Useful products at the village level: Fresh fruit. The ripe fruit, peeled, then cut in little pieces, mixed with the seeds, a little milk and a little sugar, makes a very refreshing snack. The seed is crunchy, the flesh around the seed is tart, and the pulp is smooth and gives body -- a nice combination. The ripe fruit can be steamed with sugar and cloves to make imitation "apple" pie. The green unripe fruit can be boiled or baked and eaten as a vegetable like pumpkin or marrow.

Industrial uses: Flavour for ice cream, soft drink or jams, but not usually grown commercially.

No PNG trials, but widely grown in wet lowlands. Does not do well at higher altitudes.

Initial contributor: D.H. Loh, LAES, Kerevat; ENBP.

## GUAVA

Description: A shallow-rooted shrub or small tree producing suckers from roots near the base of trunk. Smooth greenish to reddish brown bark.

Botanical name: Psidium guajava

Height: 3 - 10 metres

Age to first production: 1 to 2 years

Normal life span: 30 years

Insect and disease: none of importance

Indication of maturity: Fruit turns from green to light green or yellow and becomes soft.

Planting information: Sown in plastic bags 1 to 1.5cm deep and transplanted to field at 15-20cm in height. Planted out at 6-8 metres apart.

Useful products at village level: Edible and

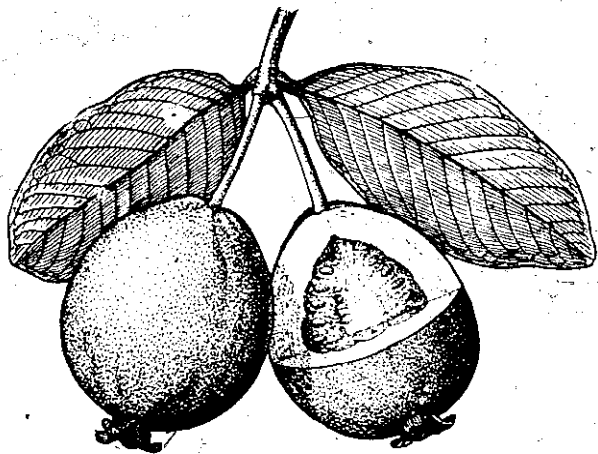

marketable fruit. High in pectin, makes good jellies or jams. Mature wood of guava tree makes good handles for tools, as it is very hard and resilient. The ripe fruit is a valuable source of Vitamin C with 2 to 5 times that of an orange (300mg or more Vit C per 100g). It is also high in Vit A, iron, calcium, and phosphorus. Dehydrated guava jelly powder is a rich source of Vit C and was used to fortify rations of Allied troops during WW2.

The leaves are sometimes used medicinally for diarrhoea, and for dyeing and canning.

Sources of supply of planting materials and cost: LAES Kerevat; Rabaul market, many other local markets. Most varieties can be grown from seed, but take much longer to bear, and will not grow true to type. If possible, bud or graft on locally adapted stocks, or propagate by cuttings. Seeds for root stocks are best obtained from select trees. Seeds remain viable for about one year, and germination takes place in 2-3 weeks.

Remarks: Relished in the village as an immature fruit especially by children. Guava may be declared a noxious weed in certain areas. The problem is that the seeds remain viable so long and the birds scatter them about. This would mean that it would be a legal offence to grow them on your property.

Further references: LAES Information Bulletin No 5. Free: Dicotyledons, by Purseglove, Longmans K8.50

PNG experience: Widely found throughout PNG.

Initial contributor: D.W. Loh, LAES, Kerevat, ENBP.

## JAK FRUIT

Description: An evergreen tree with white resinous latex in all parts, similar to bread fruit.

Botanical name: Artocarpus integrifolia

Height: 20 metres

Age to first production: 3 - 8 years

Normal life span: 50 years

Insects and diseases: Not seriously encountered.

Indication of maturity: Strong odour from fruit when ripe. Fruit becomes soft.

Planting information: Seed must be fresh. Preferably planted in final location or in large

plastic bags. Few seedlings survive transplanting due to extremely delicate taproot.

Useful products at village level: Edible and marketable fruit. Seeds may be boiled and eaten like large nuts. The yellow heartwood is a valuable timber (especially valued for making guitars in the Philippines).

Sources of supply of planting materials and cost: LAES; Kerevat, free, freight charges only; DPI, Kavieng.

Further references: LAES Information Bulletin No 5 free; Dicotyledons, by Purseglove, Longmans K8.50.

PNG experience: Orchard trials LAES, Kerevat.

Remarks: Important food with the poorer people of the eastern tropics. The capsule around the seed is eaten raw, not the outside pulp. Fruits can weigh up to 30kg each. Related to Breadfruit.

Initial contributor: D.W. Loh, LAES, Kerevat, ENBP.

## MACADEMIA NUT

Description: A large tree with nuts which are round, hard and have thick shells.

Botanical name: Macadamia integrifolia

Height: 10 metres plus

Age to first production: 7 years

Normal life span:

Bears fruit in Kudjip, WHP and Kainantu, EHP.

Nuts are very nutritious. Oil content is 73% at maturity and the kernels are a good source of calcium, phosphorus, iron and vitamin B<sub>1</sub>.

The kernel contains 9% each of protein and carbohydrate.

Seeds are planted 2.5cm deep in sand in full sun and germinate in 1-4 months. Germination is often very difficult. After 18 months, the seedlings are ready to graft with side or veneer grafts. They also may be cleft-grafted or whip-grafted. Cuttings from mature branches with the leaves intact may be rooted in sand with high humidity. Wood for grafting should be ring barked well in advance of the time of use. The entire graft is covered with grafting tape to avoid drying. Transplanting needs to be done carefully and preferably in the cool season.

Difficulty in propagating, slowness in coming into bearing and the limited areas in which it produces well are factors in preventing any rapid expansion of production. In PNG best success above 1500 m.

Source of planting material: L. Schulz, SIL, Ukarumpa, via Lae.

Information taken from: Handbook of Tropical and Subtropical Horticulture, Dept of State, Agency for International Development, Washington, DC. Free.

Initial contributor: H. Bekker.

## GIANT MALAY APPLE LAULAU

Description: A tall erect evergreen tree flowering profusely with scarlet blooms.

Botanical name: Eugenia megacarpa

Height: 20 - 25 metres

Age to first production: 6 - 8 years

Normal life span: 40 years

Insects and Diseases: None of importance

Indication of maturity: Pink to red colouring on fruit.

Planting information: Seeds planted in plastic bags in shaded nursery and transplanted to the field at 10-15cm height. Usual field spacing 5-10 metres.

Useful products at village level: Large edible and marketable fruit.

Sources of supply of planting materials and cost: LAES, Kerevat, free, freight charges only.

Further references: LAES Information Bulletin No 5 free; Dicotyledons, by Purseglove, Longmans, K8.50.

PNG experience: LAES; Kerevat.

Remarks: Larger than the common village Laulau. A very tall, erect tree.

Initial contributor: D.W. Loh, LAES, Kerevat, ENBP.

## MANGO

Description: An erect branched evergreen tree living for 100 years or more, with a dense dome-shaped canopy.

Botanical name: Mangifera indica

Height: 10 - 40 metres

Age to first production: 6 years

Normal life span: 40 years (commercial life)

Insects and diseases: none of importance

Indication of maturity: slight yellow to pink colour of fruits.

Planting information: Raised in special seedbeds to restrict development of tap roots - 20cm deep with iron or concrete floor. Seeds must be fresh, not dried. Plant in seedbed 15cm apart with light shade 1m above. Plant out after second leaf flush has matured. Planted 10-12m apart.

Useful products at village level: Edible and marketable fruit; jams and preserves; makes excellent dried fruit when dried in sun in halves. (p 112) (p 119)

Sources of supply of planting materials and cost: Villages in Gazelle Peninsula, 10-20t each.

Further references: LAES Information Bulletin No 5, free. Dicotyledons, by Purseglove, Longmans.

Remarks: Has a caustic sap. Related to Cashew nuts. Try to avoid the poorer turpentine-flavoured fruits and the fibrous varieties. The large elongated

varieties are the best. Fruiting is usually more successful where there is a distinct dry season. Smudging (with heavy smoke), and more recently, chemical sprays, are used commercially to induce fruiting. Preserve good stock by budding.

Initial contributor: D.W. Loh, LAES, Kerevat, ENBP.

## MANGOSTEEN

Description: A slow growing, smooth leaved, evergreen tree with yellow latex in all its parts.

Botanical name: Garcinia mangostana

Height: 15 metres

Age to first production: 10 to 15 years

Normal life span: 50 years

Insect pests and control: Fruit fly-miner, control usually uneconomic. Malathion 1%.

Diseases: None of note.

Indication of maturity: Red to purple colouring on fruit.

Planting information: Seeds planted in large bags containing good rich soil - germinate 6 to 8 weeks. Planted out in field at 18 to 24 months, at 7-10m spacing.

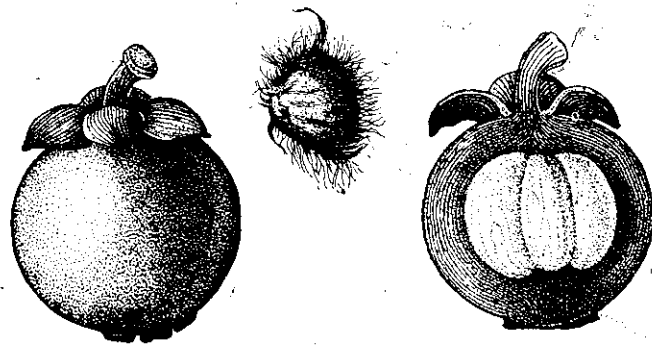

Useful products at village level: Quality edible and marketable fruit.

Sources of supply of planting materials and cost: LAES, Kerevat, small amounts available at no charge.

Further references: LAES Information Bulletin No 5, free; Dicotyledons, by Purseglove, Longmans, K8.50.

PNG experience: Kerevat. No formal trials.

Remarks: Often acclaimed as the most delicious of all tropical fruits.

Initial contributor: D.W. Loh, LAES, Kerevat, ENBP.



## PASSIONFRUIT

Description: A vigorous woody, long-lived climber up to 15m long, with tendrils. The purple fruit variety has egg shaped fruits 4-5cm in diameter and is adapted to altitudes of about 1500m. The yellow fruit variety has fruit 5-6cm in diameter and is more acid. It is adapted to the tropical lowlands.

The flowers of the purple variety open at dawn and close at noon, while those of the yellow variety open at noon and close at dusk.

Pollination is mainly by carpenter bees (*Xylocopa* spp) but occasionally by honey bees and wasps. If the flowers are pollinated by hand the fruit are larger. Most varieties are self incompatible, that is, they will not bear fruit unless there are enough vines for cross pollination.

Flowers will not pollinate during periods of rainfall.

Botanical name: *Passiflora edulis* f. *edulis* - Purple  
*Passiflora edulis* f. *flavicarpa* - Yellow

Age to first production:

Diseases and insect pests: None of importance.

Indication of maturity: *F. edulis* - green to deep purple

*F. flavicarpa* - green to bright yellow

Planting information: Plant seeds from ripe fruit without removing the pulp. They take 2-4 weeks to germinate. Seeds planted into plastic bags can be planted into the field after 3-4 months or when they are 25cm tall.

Good varieties can be maintained vegetatively by cuttings of 2-3 internodes taken from reasonably mature wood of pencil thickness.

Plant seedlings 3-7cm apart and provide trellises of posts and wire. Most soils are satisfactory except heavy, poorly drained soils.

Useful products at village level: Good quality edible and marketable fruit.

Sources of supply of planting materials: Yellow variety seed is available in small quantities at no cost from LAES, Kerevat. Purple varieties from Goroka market.

PNG experience: No formal trials on yellow varieties but widely grown in lowlands on plantations and villages. Purple varieties are widespread in Eastern Highlands Province. During 1960's DAS and Cottees established a processing plant for fruit juice. Further information on purple varieties from J.J. Nitsche, DPI, Goroka.

Remarks: A delicious tropical fruit, easily grown and with a very high content of Vitamin C. May be eaten directly from the shell or used as a fruit salad. The yellow pulp around the seed may be used for jams and jellies.

The name "passionflower" was given by early missionaries in South America who believed that the flower represented the crucifixion.

Initial contributor: D.W. Loh, LAES, Kerevat, ENBP.

## PAWPAW

Botanical name: *Carica papaya*

Height: 5 - 7 metres

Age to first production: 6 - 10 months

Normal life span: 4 - 5 years

Insect pests: Nematodes may stunt growth, so plant only in new ground or in places where there have not been gardens for several years.

Indication of maturity: Pick when the fruit begins to turn yellow on the underside. Let ripen naturally.



Planting information: 2.5m x 2.5m for plantation. Seed direct or transplant seedlings grown in nursery. Pawpaw trees do not like wet feet. They must be on well-drained soil. They do like wood ashes, so you might mix in a few when you prepare the places for the tree.

Village level uses: Fresh edible fruit; fresh fruit juice; meat tenderizer (wrap meat in pawpaw leaf, or rub with pawpaw fruit and poke holes in meat with a fork); relief from insect bites (place pawpaw rind on insect bites); clearing of dead tissue in tropical ulcers (place pawpaw rind on

wound, change frequently).

Industrial uses: Meat tenderizer, green fruit is tapped for white latex from which is made papain. It is an important ingredient in many medical preparations, as it is an enzyme.

Sources of supply: local.

Further references: A Handbook of Tropical Agriculture, G.B. Masfield, Oxford Univ. Press.

Remarks: Pawpaw trees may be (1) male, (2) female or (3) both male and female. The best pawpaw are the red pawpaw sometimes called "pawpaw melon" in pidgin. The reason that the seeds of red pawpaw don't always grow into red pawpaw trees is that the mother flower might have been fertilized by pollen from another kind of pawpaw.

## PINEAPPLE

## ANANAS

Botanical name: Ananas comosus

Height about 1 metre

Age to first production: Up to 3 years if no hormone applied. Usually 1-2 years, depending upon what planting materials are used.

Normal life span: Perennial, but yields decline with time if not replanted.

Insect pests and control: Mealy bug is sometimes a serious problem. Dip planting material in Malathion solution.

Diseases and control: Pineapple wilt disease (a fungal disease) can be serious. Treated by the preplanting dip used for mealy bug. Nematodes can be a problem.

Indication of maturity: Fruit turns yellow or orange.

Planting information: Aerial suckers (suckers that grow from the stem above the ground) are the best planting material as they produce a fruit quickly and give better yields than other planting materials. Ground suckers (from under the ground), slips (on the fruit stalk below the fruit) and tops are also satisfactory planting material. Strip the lower leaves off the suckers and allow them to dry for a week before planting. Spacing: Double rows 1.8m apart, 30cm between plants within rows if cultivated mechanically.

Useful products at village level: Fresh fruit, or fresh fruit juice for people. Makes excellent jams, especially when mixed with pawpaw, with sugar being processed at the village level.

Sources of supply of planting materials and cost: local rough variety has many more suckers than the smooth variety.

Related supplies: Phymone to cause early and controlled flowering is available from Elvee Trading Co., Box 151, Rabaul; N.G. Pastoral Supplies, Box 83, Lae. Cost is about K1.90 for 227ml bottle.



Pineapple plant. Note slips at base of fruit and suckers at base of plant. Plant these, and not the top of the fruit.

Further references: R.M. Bourke; Pineapples, DPI Rural Development Series, 50t; J.L. Collins, Pineapple, Leonard Hill, London; R.M. Bourke, Making Pineapples Fruit/Mekim Painap i Karim Prut, LAES, (1976) Information Bulletin No.9; M.N. Hunter and Sickey, B., Pineapple Production in the Markham Valley. Harvest 2(1). (p 244)

PNG experience: Pineapples are widespread in village gardens and are a good source of vitamins



Applying flowering hormone to a pineapple plant

(p 112)  
(p 114)

in the village diet. The rough leaf variety yields only about 8 t/ha. Research has been done on them at LAES, Kerevat; DPI, Bubia, near Lae; and DPI near Madang; at the University of Technology, Lae (Dr. Ken Willson).

Remarks: There is a chemical called Phymone that makes the plants carry fruit quickly and all year round. It is very cheap. You place 4 drops in a fish tin of water and put the solution onto the plant. A fish tin will do 7 plants. 5 months after you put the chemical on, the plant carries a fruit. Phymone does not work well on smooth leaved varieties. Use a calcium carbide solution for these varieties instead. More information from LAES, Kerevat, ENBP. Pineapples grow well in shade and yields are almost as good as in full sunlight, but there is much less weeding and nitrogen deficiency does not occur. They do well under coconuts, bananas, pawpaw, buai, pigeon pea, etc.

Initial contributor: R.M. Bourke, LAES, Kerevat, ENBP.

## RAMBUTAN

An evergreen, bushy tree with male and female flowers on separate trees.

Botanical name: *Nephelium lappaceum*

Height: 20 metres

Age to first production: 5 - 6 years

Normal life span: 50 years

Insect pests and control: Minor fruit fly attacks.

Diseases and control: None noted.

Indications of maturity: Fruit changes from green to red or yellow; birds feed on ripe fruit.

Planting information: Planted into field when 15cm high. Initial growth fast, subsequent growth very slow.

Useful products at village level: Edible and marketable fruit.

Sources of supply of planting materials and cost: LAES, Kerevat, free, freight charges only.

Further references: LAES Information Bulletin NO 5, free; *Dicotyledons*, by Purseglove, Longmans, K8.50

PNG experience: Kerevat orchard, LAES, Kerevat.

Remarks: A sweet slip stone variety is available. Good flavour varieties should be propagated from marcotts (cuttings).

Initial contributor: D.W. Loh, LAES, Kerevat, ENBP.

## MARCOTTING LAYERING

These are ways of getting new plants by making roots grow on old plants.

"Marcotting" is when the branch is left on the tree and soil is put around the branch. Roots are produced where the soil is. "Layering" is putting the branch into the soil. These methods are easy and usually work. The plants will be exactly the same as the parent plant. The marcotted tree produces fruit up to two years earlier than a seedling.

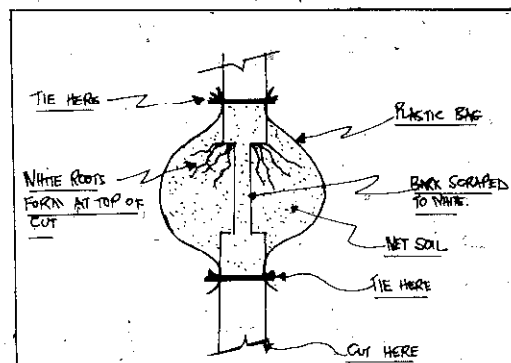

### HOW TO MARCOTT

1. Select the tree you want. The tree must be healthy, well grown, and the best of its kind (citrus are most suitable).
2. Choose a tree that is already producing fruit.
3. Select a fruiting branch that is as thick as your finger.
4. With a sharp knife cut away the bark in a ring around the stem. Remove bark only, do not cut too deep as this will cut the sap and the plant will die.
5. Scrape away all green fibres so bark will not grow again.
6. Place plastic bag, tying below the cut (scraped bark). Add very wet soil and tie the top so that the soil will not dry out.
7. After 2 to 4 months roots will appear (seen 'white through the plastic) and the branch is removed and planted.
8. Choose a time when trees are growing fast.

Contributed by: R. Fisher, Navota Farm, Santo, New Hebrides.

## A LESSON IN BUDDING

It is often very advantageous to bud a tree. It will ensure that you get the same kind of fruit as that of the tree from which the bud is taken; and often the new tree bears fruit much earlier than one which is not budded. Trees commonly budded are: Citrus, Mango, Rambutan, Durian, Avocado, and Rubber. There are many others. Budding is easier than grafting.

### SOME GENERAL NOTES:

#### Preparing the root stocks:

1. Plant seeds from a vigorous kind of tree of the same species as your bud. When the seedling is pencil size or slightly larger is a good time for budding.
2. Give this root stock some nitrogen fertilizer, either chemical or organic - about 30 days before budding. A new flash of growth indicates readiness for budding.

3. The root stock should have ample moisture before and after budding.
4. Clean the stem of the root stock with a dry rag.
5. Keep the root stocks in the sun. The buds will sprout faster, and the leaves of the root stock will shade the bud during the 3 week waiting period.

#### Preparing the bud wood:

1. The guidelines are very similar to those for the root stocks, with regards to size of branch, fertilizer, moisture, and cleanliness.
2. The selected bud eye must be dormant (alive, but not sprouting). It should come from a recent flash of growth that is becoming mature - the green colour turning to brown.
3. Do not bud in the rain, as it will be very difficult to keep the work clean. Cleanliness is very important.

Your Tool: Use a small razor-sharp knife with a nice point, as shown. If your knife is too big or dull you might mutilate the bud eye.

1.



2.



3.



4.

See photo captions on next page.

5.





6. 7.



8.



9. 10.



11.



Photo-Captions:

1. Cut two lines up and down on a clean place of the root stock, about 3cm long; a little farther apart than the bud is wide, and as deep as the bark.
2. Cut across at the bottom and then lift that whole portion, starting from the bottom.
3. Cut off about 2cm of the bark.
4. Cut two lines on the bud wood, one on either side of the selected bud eye, also about 3cm long; with the bud in the centre. Lift the bud along with the bark and some wood by cutting under the bud with the knife.
5. Pull the wood away from the bud, using care that the clean part on the back of the bud is not touched.
6. Insert the bud under the 1cm flap of the root stock.
7. Trim the bud to the exact length of the open space on the root stock.
8. Wrap plastic tape around the bud. Make your own tapes out of clean and dry plastic bags,

preferably clear. Start down and wrap upwards (so that water will run off).

9. Twist the end of the tape and tie with a simple slip knot on the last turn. Leave the plastic tape on for three weeks. If it is clear plastic you can see the bud eye taking life from the root stock. Sometimes the bud dies. After three weeks open the tape. Wait one more week with the bud exposed. Cut the root stock clear off about 4cm above the new bud, using a sharp pruning tool.
10. The bud will sprout. In some cases the other natural buds of the root stock will also sprout. Cut these off. This shows a mango bud several months after it sprouted.
11. This is a budded rubber seedling after about six months. Note that the old trunk above the bud is already quite small compared to the lower trunk. Later it will dry up and drop off, and the whole trunk will become straight.

Cut off a small branch of a tree and practice this until you feel confident. Then try the real thing.

Initial contributor: Camilo Toledo, Box 80, Lae.

# Tree Crops

## BAMBOO

## MAMBU

Botanical name: The most common genera are:-

Phyllostachys  
Arundinaria  
Bambusa  
Dendrocalamus

There are about 500 species.

People eat it (the tender shoots) while sitting in a chair made of it, live in houses made of it, bake things in it, cook things with it as a fuel, carry water in it (as a vessel or as a pipe), and sleep in a bed made from it.

The farmer keeps his animals in cages or pens made from it, castrates his pigs with a sterile blade made from it, makes the yoke for his beast of burden from it, and ties the beast with a rope made from it.

The fisherman patrols his bamboo fish traps on a raft made of it, or a canoe outfitted with it.

Their wives carry food from the market in a bamboo basket, sift, sieve, stir their cooking with it. They comb their hair with it, and afterwards put in an ornament made from it.

Their naughty little boys shoot a bamboo/kerosene cannon to make a big noise at New Year's.

A unique and outstanding example of the use of bamboo is the great bamboo pipe organ, found in Las Pinas, Rizal, Philippines.

The Japanese are famous for their countless objects of utility and beauty made of bamboo.

### PLANT SOME!

Unfortunately, some of the most useful varieties of bamboo are not widely found in PNG. It is easy to propagate, and in almost any region some planting materials may be found. Quite a number of types are found in the Botanical Gardens, Lae.

The following are common practices for propagating bamboo in the Philippines: Take 4 nodes from a stem about a year old (this means not mature, but already a bit woody). Plant near a creek or a stream, or in a place that will usually have plenty of moisture. Put into the ground at a 45 degree angle, with 2 nodes under the ground and 2 nodes above the ground. You might plant several sticks in one hill. But put the hills somewhat far apart, say 10m or more.

Following is an excerpt from a book BAMBOO, by Robert Austin, Dana Levy, Koichiro Ueda, 1970, 215 pp, US\$15.00, postpaid, from John Weatherhill, Inc., 720 Fifth Ave., N.Y., NY 10019, USA:-

"Bamboo is one of the most extraordinary plants



that exists. It flowers perhaps once in a hundred years, and then it dies. It grows faster than anything in the world. In fact, it is sometimes possible to see it growing, just as one can see the hands of a large clock moving: there are recorded instances of bamboo's growing four feet in a single day. In a grove in spring the vitality of the surrounding green pillars is almost palpable. While the stem is growing above ground, the root stops: when the stem has finished, then comes the turn of the other. Bamboo also possesses the characteristic of making its complete growth in about two months only. Thereafter it remains the same size as long as it lives.

"But bamboo is interesting for much more than this: it is the most universally useful plant known to man. For over half the human race, life would be completely different without it. The East and all its peoples can hardly be discussed without bamboo being taken into account. Accepted as a mere fact of life or prized for aesthetic reasons, it touches daily existence at a thousand points which vary as widely as its employment in literary metaphor and its use in the walls of houses. It serves the most mundane purposes, and the most refined: dwellings are constructed from bamboo; it is widely used for eating and drinking utensils and for countless other household implements. Ubiquitous, it provides food, raw materials, shelter, even medicine for the greater part of the world's population. The interlocked roots of a bamboo grove restrain the river in flood and during earthquakes support the insubstantial dwellings of country villages.

"Regarded as a material to work, bamboo shows itself "grateful" - to use the artisan's term. It is flexible, yet tough, light but very strong. It can be split with ease, in one direction only, never in the other; it may be pliant or rigid as

the occasion demands; it can be compressed enough to keep its place in holes; after heating, it can be bent to take and retain a new shape. It is straight and possessed of great tensile strength.

"Praise God for bamboo!"

## KAPOK

Description: A lowland tree which can make living fence-posts, and at the same time produce firewood, charcoal, and material for pillows. Not a crop to plant in groves.

Botanical name: Ceiba pentandra

Height: Up to 30 metres

Age to first production: 3-5 years

Normal life span: 20-30 years

Disease and Insect pests: None of importance

Indication of maturity: Pods should be harvested before they open. The dry pod is ready for harvest when a light tap with a stick or shaking the branch makes the pod fall.

Planting information: It is easiest to plant cuttings. Seeds or seedlings can also be planted. A 6m distance is suitable, but you can plant Kapok fence posts closer if you will cut off the sprouts from time to time for firewood.

Source of supply of planting materials: Local.

Remarks: A mature tree will produce 3-5kg of Kapok a year, which is a lot of pillows. To separate the floss from the seed, allow the pods to dry in the sun for 2-3 days. Break open the pod and place seeds and floss in a large deep box to 1/3rd full. Take a very straight pole 3-5cm thick and 1.5m long.

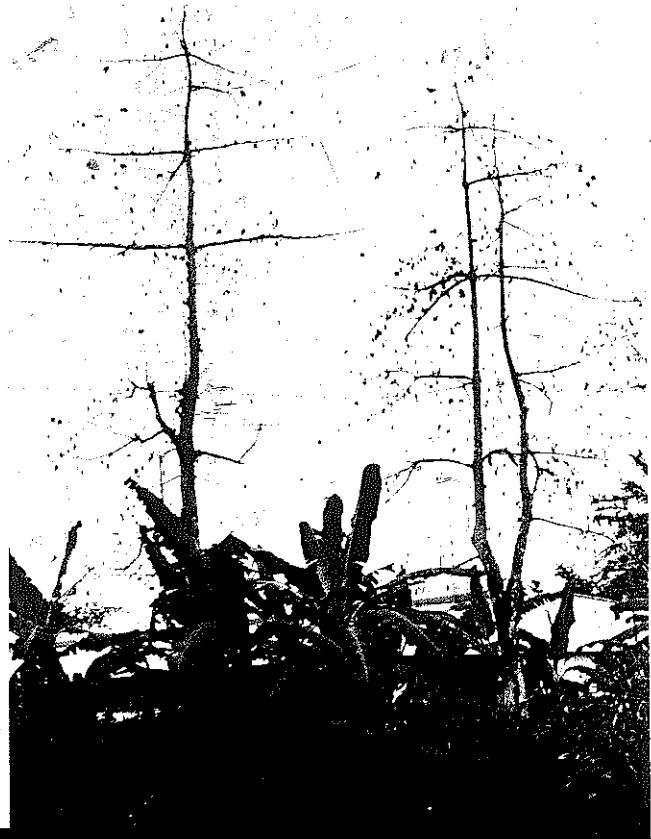

The stick should be very smooth but the tip at the bottom can have very short branch studs. Place the stick tip down into the box of kapok and spin rapidly between your hands. The spinning motion causes the kapok to fluff up to the top of the box and the seeds to settle to the bottom.

Initial contributor: E. Cox, Bagi Agr. Centre, Box 65, Angoram, ESP.

## RUBBER

## RUBA GUMI

The PNG Government has indicated its intention to promote wider planting of natural rubber (NR) on a small holder basis, and will be asking for UN/FAO expertise. Rubber is an excellent crop for small-holders because it is labour intensive and could provide many jobs. It can utilize hilly land unsuitable for other types of cash cropping. Hopefully, those planting rubber will keep a realistic perspective (since you can not eat rubber!) Plant only after your food requirements are assured, and retain your best land for food production.

Botanical name: Hevea brasiliensis

Height: 10 - 15 metres

Age to first production: 4½ years to 7 years, depending upon climate and management.

Normal economic life: 30-40 years, depending upon prices, labour costs, and other factors.

Insect pests: minimal.

Diseases: The most difficult are the fungus diseases of the fast-growing soft tissues of the forks of branches; of the tapping panel; and of the roots. These are all readily controllable with various standard fungicides. Other diseases exist, but are not a major problem.

Indication of maturity: Trees approximately 50cm in girth (circumference). Usually tapping is not begun until about 60% of the trees are of this size or larger.

Planting information: NR can only be grown economically within 15 degrees of the equator, generally, and lower than 450 metres above sea level, due to temperature considerations. (Rate of growth is all-important). NR can not withstand regular strong winds or typhoons. It is not economical where there are prolonged dry seasons. 2000mm of rain annually, well-distributed, would be an absolute minimum. 3000mm would be optimum, and somewhat more than that should not be a problem, if modern techniques (plastic bags) for gathering latex in the case of frequent morning rains, and modern fungicides. NR requires an acidic, well-drained soil. Never plant on poorly drained low-lying areas.

The most commonly found pamphlets available in PNG are the DPI (5) booklets "Grow Good Rubber". These do not show the most modern and effective techniques for NR propagation. Be sure to seek expert advice if you want to plant. NR root stocks are propagated from seeds in a nursery, preferably

in plastic bags. When they are about the size of a pencil they are budded with a high-yielding variety (this is a modern technique called "green-budding".) After the young bud sprouts, the tree is placed in the field 3m apart in 9m-rows. (p 39)

Management up to tapping is relatively simple, consisting mainly of removing weeds immediately around the trees ("ring-weeding") for about 3 years; establishing a leguminous cover crop (such as *Pueraria phaesolides*), and protecting against grass fires. Animals should not be allowed within the plantation, as they might damage the trees.

Inter-cropping can be practiced for 2 or 3 years, but it is not highly economical in the long run, as the time to reach tappable size might be extended.

Uniformity of tree size is very important, as trees greatly retarded will be shaded out once the canopy forms.

Some rough economic guidelines: 400 to 600 trees per hectare (or 167 per acre minimum); conservative production estimate, 5kg of dry rubber per tree per year; approximate value (usually higher) of dry rubber per kg is K0.50. Based on these figures, one ha. will produce dry rubber each year worth about K750.00. Greater production is quite possible with good management.

Useful products at village level: This is mainly a cash crop. NR requires processing. It is easily marketable as ribbed smoked sheets, or if you are near a large rubber mill, as coagulum or "cup lump" (coagulated in the collection cup.)

Sources of planting material: RRIM variety 600 is recommended. Popondetta Agr. Training Institute, Popondetta, NP. has a ployclonal seed garden with the following varieties: RRIM 623, 605, 600, 501, and PB551; a budwood garden for RRIM 600 has been started at the Lutheran Rice farm c/- Box 80, Lae; for additional sources write the Chief Agronomist, DPI, Konedobu.

Further references: For information on propagation, including budding, write Rev. Camilo Toledo, Gabmazung Rice Project, Box 80, Lae. Camilo is an expert rubber budder, and has had much experience with all phases of rubber-growing. The most competent organization for answering specific technical questions is the Rubber Research Institute of Malaya, Box 150, Kuala Lumpur, Malaysia. Good publications are also available from RRIM. (p 244)

PNG experience: You can see rubber growing in Northern Province around Popondetta; Milne Bay; at Sogeri (though these trees are not very good, and the conditions hardly economical); New Ireland at various places. Your provincial DPI office can tell you the nearest place to see it growing.

Remarks:- The labour of rubber production is generally of a pleasant nature, mainly in the morning, and practically all in the cool shade of the trees. Long term market prospects are very good, as world and PNG consumption are expected to rise steadily,



Tapping a tree about 10 years old. Note scars where tapping was improperly done.

and its main competitor, synthetic rubber, is increasingly more expensive to produce due to the rising cost of petroleum. A number of simple small industries can be based on NR, such as manufacturing rubber shoes, rubber products for the home.

ROLLERS FOR MAKING RIBBED SMOKED SHEETS OF RUBBER

These are important for farmers with small areas who want to process their own rubber for maximum control over their marketing. Most of the world's natural rubber is marketed in "ribbed smoked sheet" form (RSS).

Kian Lee SMR Factory (PTE) Ltd.,  
527-528 Fifth Floor,  
Plaza Singapura,  
Orchard Rd.,  
Singapore 9.

Their Model "T" No 5 is especially good, as it is for either hand or motor operation. Ruggedly built, it comes with a fly-wheel/crank, which may be removed and replaced with a pulley.

Other sources:

Klang Motors,  
244, Jalan Meru  
Klang, Selangor State, N. Malaysia

Kwang Cheong Engineering,  
312 Jalan Sungei Besi,  
Kuala Lumpur, Malaysia

Wong Chian and Son,  
9D, Jalan Dua, off Sungei Besi Rd.,  
Kuala Lumpur, Selangor, Malaysia.



TREES GROWN FOR TIMBER, POSTS AND FIREWOOD

CASUARINA (*Casuarina* spp) is a fast growing tree which has an important place in highlands agricultural systems because of its ability to fix nitrogen, pull nutrients up from deep in the soil, and to compete with Kunai grass. It is an important shade tree and source of firewood.

When planted around a garden within the last year of gardening it can get ahead of the Kunai and slow its growth, and can be strong enough to withstand the damage of the pigs when they enter the area.

The demand for fuel and the fact that many highlands areas have gone to Kunai make it very advisable to plant more *Casuarina*.

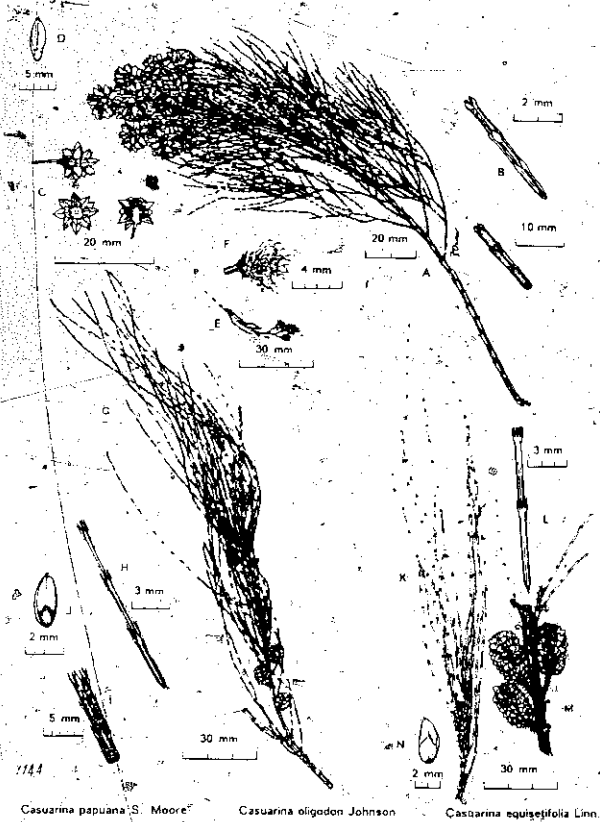

HOOP PINE (*Araucaria cunninghamii*) is an indigenous *Araucaria* of great economic value. The species gives high class lumber and plywood, and due to the long fibre length gives a superior paper.

Hoop is located in a wide range of conditions. In PNG it ranges from near sea level (Southern Morobe Coast) to approximately 2,400m. It is common in the central cordilla and is also found on the islands of the east of Papua. It is fire sensitive and remnants of many stands reduced by shifting cultivation and burning off show its once wider occupation of forest areas. Extensive hoop pine area remains in the Bulolo/Wau Valley where the pine forest is being harvested and will be replaced by hoop and klinkii plantations.

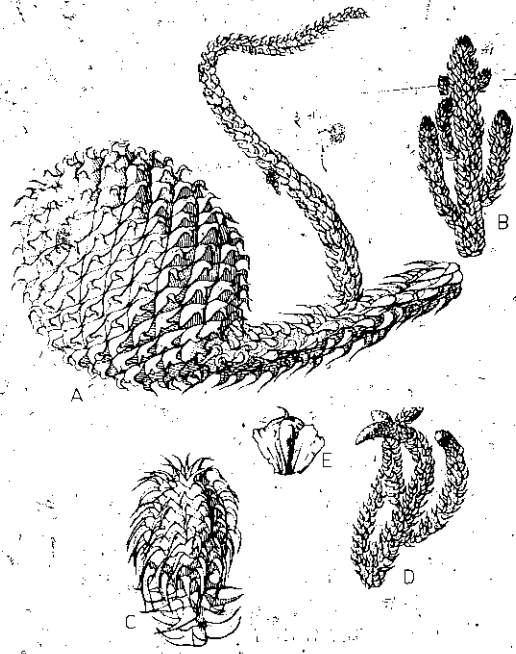

ARAUCHARIA CUNNINGHAMII

The species has proved easy to handle in the nursery and plantation establishment.

Timber strength: Group 6: the timber is readily converted and is easy to work with both machine and hand tools.

Timber durability: Class 4.

Timber uses: for plywood, flooring, moulding, lining and poles.

At village level the wood can be used for fence and house posts and more commonly as firewood and shade.

Booklets are available at Forest Stations. For further reference contact closest Forest Station. (p. 50)

KAMARERE (*Eucalyptus deglupta* Blume) is a large tree reaching 72 m high and 2.5m in diameter. Gross volumes to 60 cubic metres volume per tree have been measured, and very high volumes per hectare have been recorded.

Seedlings of Kamarere demand full overhead light for development, and stands are restricted to natural clearings (river, pumice or gravel beds, landslides, volcanic blast areas) or the garden areas which are established in the traditional shifting cultivation procedures of the lowlands. In these areas it forms pure stands but is soon provided with an understory of more tolerant species. Later the Kamarere will be eliminated from the site as it is unable to regenerate under these conditions. Then the typical lowland rain forest will remain.

The naturally occurring stands are within the 250-500cm of rainfall per year range, with perhaps

See drawing, page 47

the mean near 300cm, and without a prolonged seasonal drought. A temperature range between 25<sup>o</sup> and 30<sup>o</sup>C and a relative humidity 78% to 90% is common in the lowland stands. The highland climates may range 12-26<sup>o</sup>C for temperatures and 60% to 80% for relative humidity.

Kamarere occurs on a variety of soils. It requires a good supply of available minerals and though often associated with creek and river beds it will not stand water-logged conditions. The optimum condition will appear to be a deep, rich, well drained soil with a non-seasonal rainfall of approximately 300cm per year.

The species is not frost tolerant.

Timber Strength: Group 4.

Durability: Class 3.

Timber uses: It is readily milled and works well with both machine and hand tools. It is suitable for heavy construction, flooring, furniture and boat building.

Use in village level: Posts, poles and fire wood. More detailed publications are available at Forest Station. (P 50)

KLINKII PINE (*Araucaria hunsteinii*) is an indigenous Araucaria of great economic value to PNG - not only because of the large virgin stands but also in its adaptability to plantation techniques. The species gives high lumber and plywood, and due to the long fibre length gives a superior quality paper. The tree form is generally excellent and superior to that of *A. Cunninghamii* with which it is associated in its PNG distribution.

Klinkii is located 600-1500m above sea level in a belt stretching from the Milne Bay hills to the slopes of the Didana Range (140<sup>o</sup> east, 32km inland

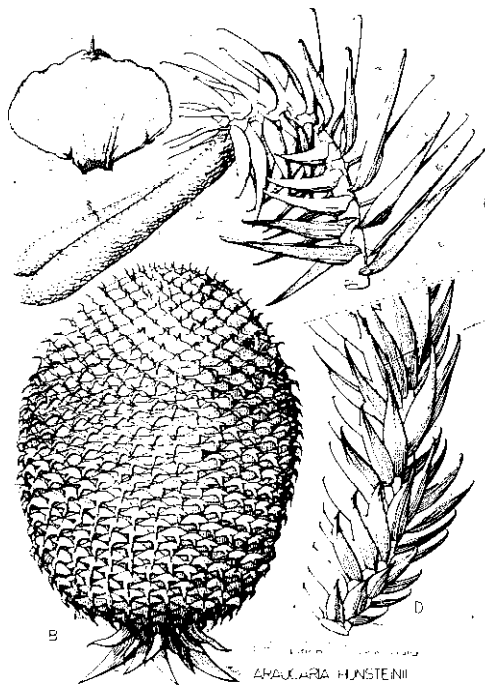

from Collingwood Bay) scattered on the Owen Stanley slopes through to Bulolo/Wau and to the Jimi River Valley (145<sup>o</sup>E) and in the ranges behind Finschhafen.

Both species of Araucaria tend to grow together, but with one species or the other predominating. In the Jimi Valley, while Klinkii is widespread, Hoop Pine is rare, if present at all. However, Hoop Pine has a much wider range extending from south of New South Wales/Queensland border, to Irian Djaya.

Klinkii is one of the large trees of the world, and heights to 87m have been recorded. Trees of 3.6m girth are common and it is thought these are between 300 and 400 years old.

There were initial difficulties in establishing Klinkii in plantations due to nursery and early field problems:

Timber strength: Group 6.

Durability: Class 4.

Timber uses: Timber is easy to work with both machine and hand tools. It dresses well to a smooth finish used widely for all interior work including panelling and moulding. May be used for fence posts, poles and as firewood. For further reference contact nearest Forest Station. Publications are available. (P 50)

#### GIANT LEUCAENA

An extremely fast-growing leguminous tree useful for forage, shade, erosion control, firewood, living fence posts, poles, timber, charcoal, and pulpwood. It is different than the well-known *Leucaena glauca*.

Botanical name: *Leucaena leucocephala*

High performance varieties are being promoted in the Philippines, and seeds will soon be available in PNG. The major uses:

Forage: Produces up to twice the amount of high protein highly digestible forage as ordinary *Leucaena*. Amounts of 77.8 met. tonnes per hectare per year with an average of 4.6 cuttings (back to 10cm) have been reported. Converted dry weight yield was about 20 metric tonnes per hectare. In these tests it was grown in rows 50cm apart.

Fertilizer: Research at the University of Hawaii indicates that as a green manure crop the fertilizer equivalent of a year's harvested hectare of *Leucaena leucocephala* is estimated to have exceeded 550kg N, 225kg P<sub>2</sub>O, and 550kg K<sub>2</sub>O.

Wood production: Even ordinary *Leucaena* is considered to be a moderately high volume wood producing species. It is claimed that the Giant *Leucaena* will exceed the ordinary *Leucaena* by 100-200%. Variety K-8 (Hawaiian Giant) has reached heights of over 15 metres in 6 years. Firewood yield is very high as well. The wood also makes excellent quality charcoal.

Pests, diseases, problems: Few known enemies except animals which browse and humans who cut it down or eradicate it. The main problem seems to be weevils that attack the seeds which are not as waxy and hard as those of the ordinary *Leucaena*.

Planting information: Plant seeds in seedbeds or plastic bags, or for forage directly in the field. To improve germination it is recommended that the seeds be scarified (seed coat weakened). The easiest way is to heat water to boiling, let it cool just slightly, then put the seeds in an equal volume of that water to soak for 12 hours. For maximum nitrogen fixation a suitable rhizobium should be used (DPI Rhizobium Service, Box 2417, Konedobu.) In seedbeds plant seeds no more than 4cm apart in rows 25cm apart. Transplant to permanent location at 2-4 months. If seedlings are transplanted bare-root, prune top stem back to a point where the bark has turned brown. Seed trees may be planted at a spacing of 2 x 5m. For hillside planting (erosion control and intercropping) drill in paired contour rows 40cm apart and 2-5cm apart in the row. The paired rows should be about 2m apart, centre to centre. For timber production plant at 10 x 2m with a later thinning of less vigorous trees to a spacing of 10 x 4m or 10 x 6m. For firewood plant 1 x 2m with a later thinning to desired density. Can also be planted from cuttings. (p 15)

Sources of supply of planting material: Variety K-67 El Salvador is already present in PNG, but not



LEUCAENA LEUCOCEPHALA (Lam.) de Wit

yet in large quantities. Small quantities of seed are known to be in the hands of Division of Botany, Lae; Wesley High School, Salamo MBP; and Liklik Buk, Box 1920, Lae. Varieties K-8 and K-28 are presently being cleared through DPI Plant Quarantine in Port Moresby. Note that the most common variety in PNG is "Peruvian", which is not as good as the above.

References: "Bayani - Leucaena leucocephala, A Source of Fertilizer, Feed, and Energy for the Philippines", by Michael Benje 1976, 21pp. available from Agricultural Development Section, USAID, Magsaysay Centre, Roxas Blvd., Manila, Philippines.

PINE TREE (*Pinus* spp) is an important fast-growing timber product tree. It provides good pulpwood and wood for construction, furniture, posts and poles, and firewood.

*Pinus* grows well in both fertile and infertile soils, in grasslands, in both highland and lowland areas. The tropical species which can germinate well here in PNG are *P. caribaea*, *P. merkussi*, *P. patual*, and *P. strobus*.

Viable seeds are usually produced by *Pinus* within 8 years, but larger amounts are not available until later.

*Pinus* seedlings need well-prepared seed beds, so advice from an experienced forest officer is important.

See "Silviculture of *Pinus* in PNG" Forestry Bulletin No 5, available from Forest Offices.

TEAK (*Tectona grandis*) has been widely planted throughout the tropics and was introduced to New Guinea at the beginning of this century.

It is a large deciduous tree with a long clear cylindrical stem. It is sometimes fluted (has grooves) and is often buttressed at the base, (well-braced by highly developed roots).

It grows from sea level up to 1220m but does not thrive at higher altitudes. An average rainfall of 125-250cm per year with a marked dry season of 3-5 months and a temperature range of 5°C to 44°C appears to be optimum. The species is not frost tolerant except at the northern limit of its range.

Teak requires a deep well drained soil of moderate fertility. Sub soil clay pans or massive laterites or deep sands are not good. Teak will not stand water-logging.

Many of the lowland areas of PNG are excellent for the growth of teak, particularly on the Papuan side of the island where a marked dry season occurs.

The wood is hard and can be used for fence and house posts, or can be used for firewood.

It can be planted with seeds or by cutting, and may grow very fast. (p 50)

For further details references contact closest Forest Station.

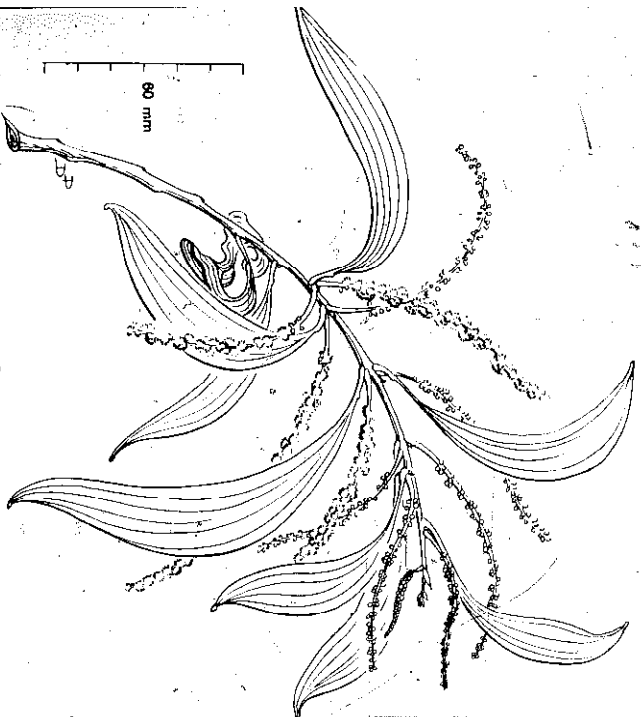

Rattle

*Acacia aureculiformis* A. Cunn.

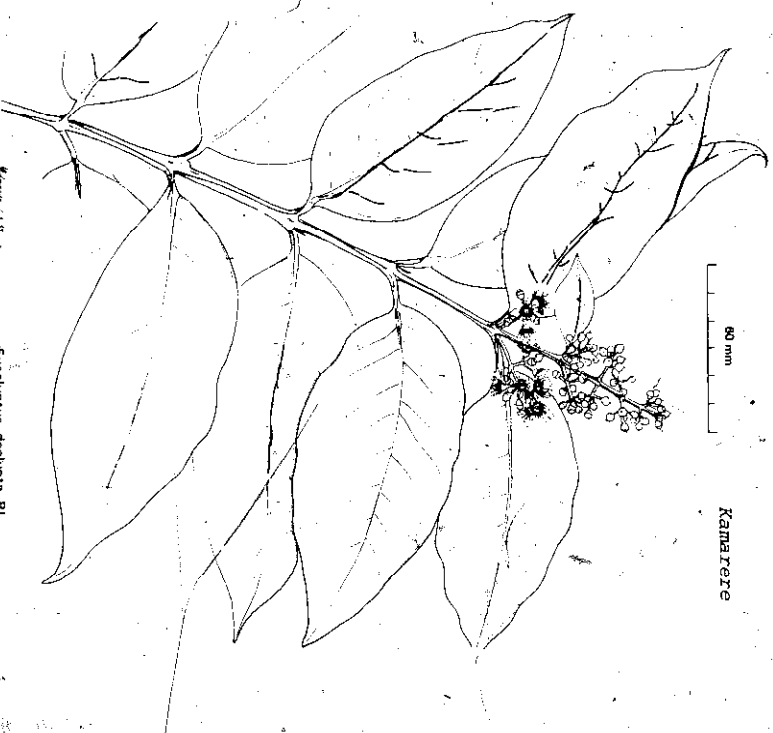

80 mm

Kamarete

*Eucalyptus deglupta* Bl.

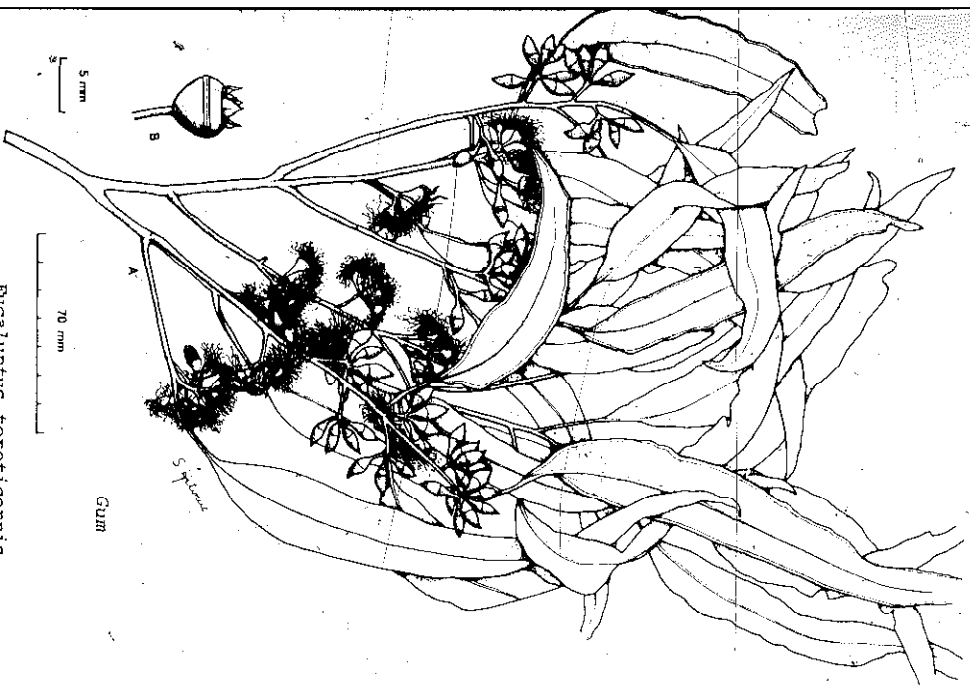

5 mm

70 mm

Gum

*Eucalyptus tereticornis*

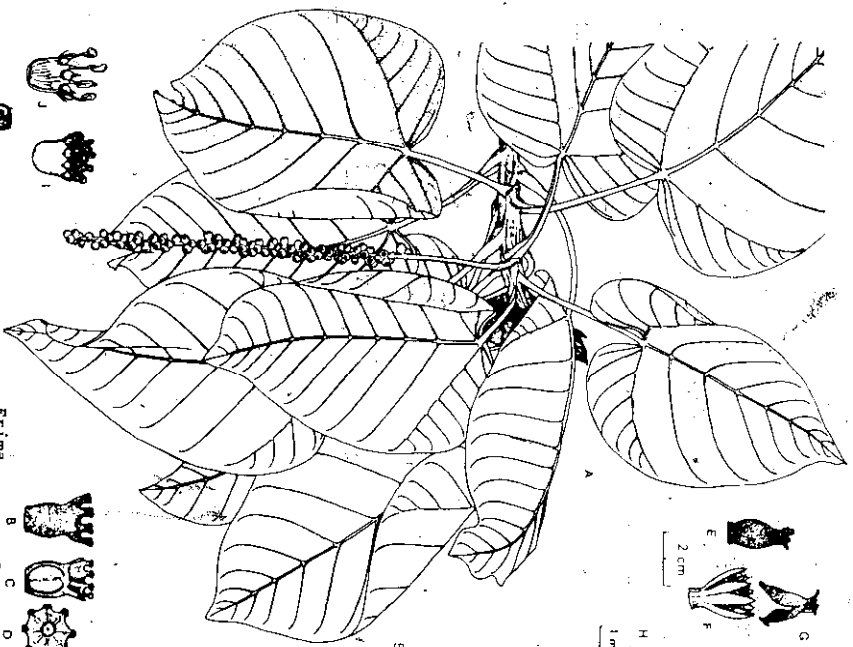

2 cm

1 mm

5 cm

2 cm

2 cm

*Ocimum sanctum* Linn.

COMMON NAME	BOTANICAL NAME	WHERE IT GROWS	WHAT WOOD IS LIKE	CHARACTERISTICS OF TREE	PLANTING MATLS SOURCE	PAPERS AVAILABLE
Kamarere	<i>Eucalyptus decupita</i>	Highlands and Coastal zones	S 4, D 3, red-brown, straight, used for posts, firewood, shade, heavy construction.	Very fast growing, heavy branches, smooth bark, grows 72m tall and 2.5m in diameter.	Forest Station	Yes
Gum Trees	<i>Eucalyptus</i>	Highlands and Coastal zones	S 3-4, D 2-3, red-brown, used for posts, firewood, general construction.	Very fast growing, double stem may occur, grows 18m tall and 0.6m in diameter.	Forest Station	Yes
Teak	<i>Tectona grandis</i>	Lowlands, Morobe, Central, N.P.	S 4, D 1, yellow to golden brown, used for posts, firewood.	Fast growing, heavy branches, bad form, grows 58m tall and 7.6m in diameter.	Forest Station	Yes
Rattle	<i>Acacia</i> spp	Highland and Coastal zones	S 4, D 2-3, hard & heavy, used in boat building, heavy construction, furniture.	Fast growing, light branches, straight spurred trunk, grows 40m tall and 80cm in diameter.	Forest Station	Yes
Hoop	<i>Aracaria humboldtii</i>	Bulolo/Wau Highlands	S 6, D 4, straw colour, uniform texture. Used for sawn timber, plywood, veneer.	Fast growing, straight form, dark brown bark, grows 66m tall and 2m in diameter.	Forest Station	Yes
Klinkii	<i>Araucaria cunninghamii</i>	Bulolo/Wau Highlands	S 6, D 4, straw colour, light. Used for plywood, veneer, sawn timber.	Fast growing, reddish brown rough bark, needle-like leaves, straight form, grows 93m tall 2m diameter.	Forest Station	Yes
Pine Trees	<i>Pinus</i> spp	Highlands and Lowlands	Light, straight grain. Used for posts, firewood.	Very fast growing, straight, needle-like leaves, grows 25m tall, and 0.5m in diameter.	Forest Station	Yes
Casuarina	<i>Casuarina</i> spp	Highlands and Lowlands	S 2, D 2-3, hard, heavy. Used for posts, firewood, general construction.	Average growing, needle-like leaves, bad form, grows 40m tall and 1m in diameter.	Forest Station	Yes
Erina	<i>Octomeles</i>	Central, N.P. New Britain	S 7, D 4, light brown to grey-yellow. Used for Canoes, firewood, sawn timber.	Fast growing, buttressed, flat crown, straight trunk, grows 60m tall, 2m in diameter.	Natural stand & Nursery	No
Anisoptera	<i>Anisoptera polyandra</i>	Morobe	S 5, D 3, pale yellow or yellow brown. Used for general construction.	Average growing, buttressed and straight, grows 50m tall and 1.2m in diameter.	Natural stand	No
Vitex	<i>Vitex cofassus</i>	New Britain	S 3, D 2, yellow to grey-brown. Used for boat and house construction.	Average growing, buttressed, heavy branches, 35m tall 0.5m in diameter.	Natural stand	No
Terminalia	<i>Terminalia</i> spp	General, not Highlands	S 6, D 3, pale yellow to yellow. Used for flooring, posts, firewood, poles.	Very fast growing, very straight, no taper, grows 50m tall and 2m in diameter.	Forest station	Yes
Rosewood	<i>Pterocarpus indicus</i>	General, not Highlands	S 4, D 1, white to pale yellow. Used for boat building, posts, general constr.	Average growing, fairly straight, leaning heavy branches, grows 35m tall and 1m in diameter.	Natural stand	No
Taun	<i>Pometia</i> spp	General	S 4, D 3, pink to pinkish brown. Used for domestic flooring, furniture.	Average growing buttressed, straight, grows 45, tall and 1.2m in diameter.	Natural stand	No
Pencil Cedar	<i>Palaquium</i>	General, not Highlands	S 6, D 4, hard, heavy, pale pink to brown. Used for light const. flooring, furniture.	Average growing, buttressed, straight, grows 40m tall and 1.2m in diameter.	Natural stand	No
Hopea	<i>Hopea</i> spp	General, not Highlands	S 3-1, D 2, pale straw yellow brown. Used for heavy construction, wharf and bridge.	Fast growing, straight, heavy branches, grows 40m tall and 1m in diameter.	Natural stand	No
Kwila	<i>Intsia bijuga</i>	Sepik, Madang, most Coastal Reg.	S 2, D 1, heavy, brown to dark brown. Used heavy constr. posts & carvings.	Average growing, crooked, weakly buttressed, broad crown, grows 38m tall and 1.2m diameter.	Natural stand	No
Brown Albizia	<i>Albizia procera</i>	General	S 6, D 4, light, yellow to brown. Used for furniture, canoes, form work.	Very fast growing, straight, heavy branches, grows 20m tall and 50cm in diameter.	Natural stand	Yes
Mango	<i>Mangifera</i>	General, not Highlands	S 5, D 4, rays narrow, straw to pale brown. Used for light construction, flooring.	Fast growing, broad crown, straight, grows 36m tall and 1.5m in diameter.	Natural stand	No
Canarium	<i>Canarium</i>	Sepik, Morobe, C.P., N.B.P.	S 4, D 4, pale brown to pink brown, smooth. Used for light const. flooring, boxes.	Average growing, buttressed and fluted, grows 50m tall and 1m in diameter	Natural stand	No

S = Strength; D = Durability.

## AVERAGE STRENGTH OF WOODS

Strength Group	Density in lbs/cu ft at 12% MC	Modulus of rupture in pounds per cubic inch	Modulus of Elasticity in millions of pounds per cubic inch	Maximum crushing strength in lbs per cubic inch	Maximum shear strength in lbs per cubic inch
1.	56.0	23,000	2.72	11,800	2,720
2.	47.5	19,500	2.36	10,300	2,430
3.	40.0	16,500	2.06	9,000	2,180
4.	33.5	13,600	1.80	7,750	1,900
5.	28.0	11,500	1.55	6,700	1,700
6.	23.5	9,750	1.32	5,800	1,500
7.	20.0	8,250	1.15	5,000	1,320

## AVERAGE DURABILITY OF WOODS

- Class 1. Very durable, suitable for long term use in contact with the ground.
- Class 2. Durable, suitable for use in the ground and for unprotected exterior use.
- Class 3. Moderately durable, suitable for protected exterior work and for interior use.
- Class 4. Non-durable, not suitable for exterior use unless treated.

## GENERAL PLANTING PROCEDURES FOR FOREST TREES:

1. If possible, plant when the soil is moist.
2. Remove tubes.
3. Plant firmly up straight.
4. Avoid stones and logs.
5. Approximately 3m x 3m distance.

## SOME COMMON PEST AND DISEASE PROBLEMS WITH TREES GROWN FOR TIMBER.

Insects: Termites, Hyblace Puera, various seed larvae, white grubs, moths, hemiptera beetles, and white ants. Vanapa attack Hoop Pine that have already been damaged. No cure. Haylurdrectonus: prune affected parts.

Control: Chemical control is not generally recommended. Vanapa (prune and completely remove the infected parts) and white ants (destroy nests) are of most concern.

Diseases: Damping Off (a root fungus at seedling stage), prevent by heat sterilizing soil; Chlorosis a nutrient deficiency corrected with the corresponding plant food (usually NPK is given).

Others: Snails, rodents (rats & other small animals with strong teeth), weeds and fire.

## FOREST NURSERIES

Starting an artificial grove of trees, as well as regenerating a previous forest, usually depends on the production of good seedlings. These can be better grown in nurseries.

The object of the nursery is to produce good seedlings at low cost.

Temporary nurseries are those used for only a few years. They supply small numbers of plants for a particular area. They are usually built close to planting area, usually in previously forested areas where soil fertility is high. Advantages are:- low cost since they require no permanent installations; because they are close to the planting site they produce plants that are better adapted; and transport costs are low.

Some disadvantages are:- low production; harder to supervise; higher per plant cost; and it is restricted to kinds of trees that do not require many special nursery aids.

Temporary nurseries should be located on flat ground, near water source, where suitable soil exists.

Village groups will seldom need a permanent nursery, but if one is needed you may get detailed information from your closest Forest Station. Publications and booklets are available at Forest Stations.

Prepared by Office of Forests, Lae.

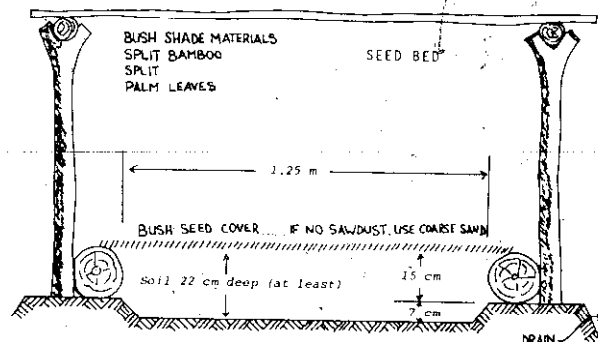

## LIVING FENCE POSTS

There are sometimes big advantages in using living fence posts, if you have the materials for planting them. Leucaena or Kapok are good species, and there are others. They don't rot, they produce firewood, give shade, and in the case of legumes are good for the soil. Living Kapok fenceposts give materials for pillows and mattresses.

Plant fresh cuttings 5cm to 20cm in diameter depending upon your needs in the same way that you would put a fence post. They will sprout and grow. If possible let them get established before putting the fence wire. If some die, replace them. If you live where the rain is uncertain, you might start the posts to sprout by putting them in a .5 m



deep hole, filling the hole with soil, and keeping the soil moist. This hole should be near a source of water.

Some possible disadvantages: This might not be good for the sun side of a garden where you want plenty of sunshine. The posts will tend to grow around your fence wire, and you can't re-use it. If you don't want them to grow into large trees you must cut them back regularly.



FORESTS DEPARTMENT - REGIONAL OPERATING STATIONS

CENTRAL PROVINCE

Port Moresby - Regional Forest Office,  
Box 1754, Boroko  
Phone 257138  
Forest Station, Brown River, Phone VHF 240117

NORTHERN PROVINCE

Popondetta Department of Forests,  
Phone 297016

MOROBE PROVINCE

Lae - Regional Forest Office, Box 638, Lae.  
Phone 422022  
Forest Station, Bulolo, Box 87.  
Phone 445202  
Wau, Box 42 Phone 446370.

WESTERN HIGHLANDS PROVINCE

Regional Forest Office, Box 267, MT. Hagen  
Phone 521333  
Forest Station, Kagamuqa, Phone 551353

SOUTHERN HIGHLANDS PROVINCE

Box 29, Mendi. Phone 591172

MADANG PROVINCE

Box 2116, Yomba. Phone 822127  
Box 43, Wewak. Phone 871004  
Forest Station, Vanimo. Phone 871004

EASTERN HIGHLANDS PROVINCE

Forest Officer. Phone 721737  
Forest Station, Lapeigu. Phone 721072  
Box 338, Goroka.  
Kainantu. Phone 771163

NEW GUINEA ISLANDS

Box 172, Kavieng. Phone 941548.  
Rabaul - Regional Forest Office, Box 406,  
Rabaul. Phone 922188  
Forest Station, Kerevat. Phone 926215

THAT LAST IDEA WAS SIMPLE, WASN'T IT?  
WE BET YOU HAVE AN IDEA THAT'S AS GOOD.

WE'RE SO CERTAIN THAT YOUR IDEA IS GOOD  
ENOUGH FOR THE NEXT EDITION OF THE  
LIKLIK BUK THAT WE'LL BET YOU A FREE COPY  
OF THE BUK THAT YOUR IDEA WILL GET IN.  
SEE NOTES FOR CONTRIBUTORS - PAGE 268.

# Beverages

## COCOA

## KAKAO

### Description:

Botanical name: Theobroma cacao

Height: 5-8 metres

Age to first production: 2-3 years

Normal life span: 25 years

Insect pests and control:

1. Cacao Weevil (Pantorhytes) - introduce "crazy ants".
2. Cacao Web Worm (Panseptia) - in young trees brush off the rubbish and paint the mouth of the channel underneath with 0.3% dimethoate. In old trees, control is probably uneconomical. Ensure a good cocoa canopy and enough overhead shade.
3. Pod-suckers ("capsids") - spray twice, 2-3 weeks apart, with 150-200g of lindane active ingredient per hectare.
4. Termites ("White ants") - open the channels in the tree and pour in a small quantity of 0.2% chlordane. Prune so that there are no dead stubs.
5. Longicorns (bark borers) - avoid too much shade and keep grass cut. Treat channels with 0.5% active ingredient Lebaycid (ICI) or Vapona (Shell).
6. Caterpillars - usually controlled after a short time by their parasites and predators. 0.2% carbaryl is effective.

### Diseases and control:

1. Black Pod - harvest ripe pods frequently. Hook off black pods at separate harvests. Fungicidal sprays are sometimes economic.
2. Dieback (vascular-streak dieback) - use resistant planting material. Check young plantings at least monthly and prune out any infections found. (Not found in New Ireland or Bougainville).
3. Canker - cut off the affected bark to allow the canker to dry out.
4. Root rot - remove all of the root system of an infected tree. Carefully cart away and destroy by burning.
5. Pink disease - prune off and burn infected branches.
6. White threadblight - prune off and burn infected branches.

Indication of maturity: Pod changes colour (green to yellow, red to orange).

Planting information: First establish overhead shade (Leucaena, coconuts, Gliricidia). Cocoa



seed or cuttings may be planted straight into the field, seed on a 3 metre triangle and cuttings on a 3.5 metre square. However, seed is best planted into a nursery first. Use polythene bags 35cm x 18cm, plant one seed per bag, and plant out the best plants at age 4 months during favourable weather. Discard the slow-growing plants. Weed the young plants regularly by hand (not by knife or spade) to remove competitive grass and weeds.

Useful products at village level: Fresh beans are pleasant to suck. Industrial level: Fermented dried beans are processed into chocolate for eating or cocoa powder for drinking purposes.

Sources of supply of planting materials and cost: Pods and cuttings are available, free of charge at present, from the Lejo Station in the N.P. and Kerevat. Cuttings cannot be shipped to New Ireland or Bougainville.

Sources of supply of related tools or equipment and cost: Suppliers - Burns Philp & Co.; Steamships Trad. Co.; Elvee Trad. Co.; Theo Thomas & Co.

Materials and cost: Lindane 16% K10.20, 4 litres; dimethoate 30% K37.00, 4 litres; copper oxychloride 50% K94.00, 25kg; 2, 4, 5-T 80% (for shade thinning) K22.20, 4 litres; urea fertilizer K175.00 tonne; cocoa hooks K2.50 each; bush knives K1.70 each; planting bags K7.00 for 1000; spades K3.00 each; knapsack sprayers K94.00 each.

Further references: PNG Agricultural Journal Vol. 13 (1) 41-42, 13 (4) 127-147, 14 (1) 1-15, 15(3/4) 79-90, 16 (1) 1-19. (p 246)  
Harvest Vol 1 (4) 129-138.  
Annual Reports of DPI (formerly DASf) up to 1969.

General: Cocoa, by G.A.R. Wood, published by the Longman Group, London; Cocoa Manual, by T. Hardy, Inter-American Institute of Agricultural Sciences, Turrialba, Costa Rica; Tropical Crops, Dicotyledons 2, by J.W. Purseglove, pp 571-598 Longmans.

Location and result of PNG experience with this crop: Cocoa has been grown for about 75 years in the lowlands of PNG and 80,000 hectares are currently grown in 13 provinces. For the majority of growers the crop has been a profitable one, while others have experienced serious pest and disease problems. Control methods are now available for



these pests and diseases. Contact - J.B. O'Donohue, LAES, Kerevat.

Remarks: Careful management of the young cocoa is repaid by higher production and fewer problems in later years. The development and maintenance of a complete cocoa canopy should be a primary aim.

Initial contributor: J.B. O'Donohue, LAES, Kerevat, ENBP.

## ROBUSTA COFFEE KOPI

Botanical name: Coffea canephora

Height: 8m or more or may adopt a bush habit. Constant pruning is necessary to restrict the height to about 2.5m for easy picking of the fruit.

Age to first production: 20-24 months after field planting of the seedlings. Bearing is usually seasonal.

Indication of maturity: Berry turns pink or red.

Potential yield: Dependent on the following factors: Density of planting, pruning system, level of shade, level of management, variety or clone planted. Up to 5000kg coffee cherry per ha. per year or up to 1000kg parchment per ha.

Life span: Dependent on pruning system and management factors. Useful life up to 25-30 years.

### PESTS

Coffee Stem Borer  
(Zeuzera coffeee)

Longicorn Beetles  
(various species)

Armyworm Caterpillars  
(Tiracola sp)  
(Ectropis sp)

### DISEASES

Pink Disease  
(Corticium salmonicolor)

Root Rot  
(various fungi)

Brown Thread Blight  
(Pellicularia koleroga)

White Thread Blight  
(Corticium marasmium  
spp)

Chlorosis and dieback  
(Physiological disorder)

### CONTROL

Low incidence of damage usually makes control unnecessary

High or low volume insecticide spraying or shade management.

### CONTROL

Pruning and burning of infected branches.

Tree isolated by trenching. The tree and roots removed and burnt.

Correct shade management and removal of infected branches.

Correct shade management and removal of infected branches.

Caused by insufficient shade or lack of nutrients and moisture.

Planting information: Seeds are germinated in a small nursery bed and good seedlings selected for planting in polythene bags. Suitable shade, such as Leucaena trees, are established through the area to be planted. At about the 6 leaf-pair stage the seedlings are transplanted to the field. The spacing depends on the pruning system used, but will usually be a 2m triangle or a 1.5 x 2.5m hedge. Good management is necessary for the seedlings to come into bearing quickly. As the trees mature the level of shade can gradually be reduced.

Fertilizing Coffee: Chemical fertilizers may help your coffee to earn more. Some points to consider: The major nutrients are not all needed in the same amounts, and in order to get the best yields they should be available in the right quantity and balance at the right time; each farm, with its own particular soil and other conditions should have its own individual fertilizer programme.

In order to get the full benefit from chemical fertilizers, the trees should be protected from weeds, pests, and diseases, drainage should be adequate, and pruning done properly.

Village level harvesting and processing: When ripe the berries are picked (harvesting), berries are passed through a hand machine to remove the skin (pulping). The slimy seeds are placed in a wooden or concrete trough and just covered with water (fermentation). After several days the seeds are washed and placed in the sun (drying). The dry seeds (parchment coffee) are bagged and sold to buyers. (p 174) (p 262)

Industrial usage: Coffee berries are converted to parchment coffee using machine-operated pulpers and hot air driers in conjunction with sun drying. The coffee parchment is hulled to remove the parchment skin. The green coffee bean remaining is bagged for export. Green coffee may be roasted, ground, and used for making coffee beverage, or may be converted to instant coffee powder.

Planting material: Clonal seed of robusta coffee is available, on request, from LAES, Kerevat.

Related materials or equipment: Polythene planting bags: ICT(NG) Pty. Ltd., Box 1105, Lae or their agents throughout PNG. Pulping machinery, etc: Plantation Supply and Services Co. Pty. Ltd., Box 92, Goroka. Tru-Cast Foundry Pty. Ltd., Box 160, Lae. Major trading companies in coffee areas. (p 262)

References: Articles applicable to Robusta coffee are to be found in the following numbers of the PNG Agricultural Journal: Vol 12 No 1, 9-12 (1959); Vol 19 No 3, 115-124 (1967); Vol 15, No 1&2, 1-6 (1962). Modern Coffee Production, by A.E. Haarer, Leonard Hill Books Ltd, London, 1962. An information letter "Coffee and its Nutritional Requirements in the Highlands of New Guinea", is available from Plantation Supply and Service Co. Pty. Ltd., Box 92, Goroka, EHP.

PNG experience: H. Gallasch, LAES, Kerevat; Chief Pathologist, DPI, Konedobu, Chief Agronomist, DPI, Konedobu.

Coffee seeds live for only a few weeks and should be planted as soon as they are received. Coffee is a fairly hardy crop and can survive under poor management although it only yields well given good management and conditions. Robusta coffee will grow in almost all lowland regions of PNG, that is, below 800m above sea level. At higher altitudes (up to 1800m) Arabica coffee is grown.

Information on Arabica coffee is available from The Agronomist-in-charge, HAES, Aiyura, EHP, or Chief Agronomist, DPI, Konedobu.

Remarks: Shortage of certain elements in the soil may reduce yield even if management is good. It is possible to learn which elements are needed by testing leaf samples. Information on selecting samples and getting them analysed by the Chief Chemist, DPI, Box 2417, Konedobu.

Initial contributor: H.E. Gallasch,  
LAES, Kerevat, ENBP.

## TEA

## TI

Description: A small tree growing to 6-7 metres unless pruned regularly.

Botanical name: *Camellia sinensis* L.

Height: 1½ - 2 metres

Age to first production: 2½-3 years, depending on management.

Normal life span: 40-50 years

No pests and diseases of importance.

Planting information: Tea is grown from selected cuttings at 60cm x 60cm in fertile loam soils with a high organic matter and tending toward acid (pH 4.0 - 6.5). Soil must be well drained. Nitrogen and Sulphur (ammonium sulfate fertilizer) are important. Tea grows well from the coast to over 2700 metres. At higher altitudes production is low and growth slow, while on the coast quality of tea is reduced. Yield 1-6 tonnes/ha/year.

MARKETS FOR COMMERCIAL PLOTS OF TEA: These exist only in WHP. Small holders on Wurup, Nogoba, Avi, Kindeng, Kondepina and some small tenure conversion schemes near Banz sell green leaf to DPI officers on the roadside for spot cash. DPI transports green leaf to tea factories (W.R. Carpenters Estates, ANG Developments, Pioneer Concrete Industries and Mt. Hagen Teagrowers). These large Tea Plantations were established on drained peat swamps in the Wahgi Valley. The smallholder Tea was developed on similar drained swamp country close to these "Nucleus" Estates. Tea smallholders also raise vegetables and livestock. Limited development of Tea growing could be expected in the SHP in the future. For the small holder Tea requires regular attention as good tea can only be made from fresh tips, that is, two leaves and a bud. One person working steadily for 8 hours should pick 45kg of leaf which can be sold for approximately 7t/kg.

Useful products at village level: Cash crops, (99)  
home-made tea. (P)

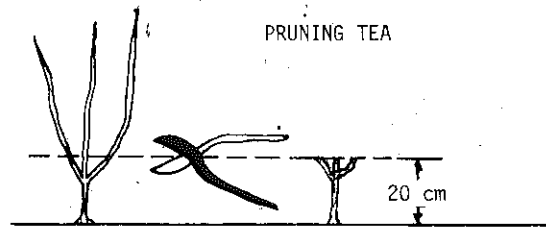

FIRST YEAR

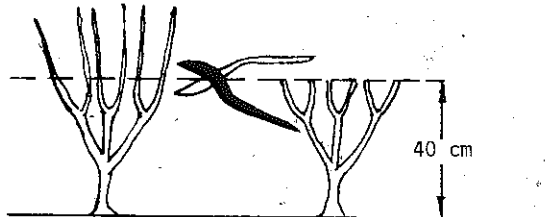

SECOND YEAR

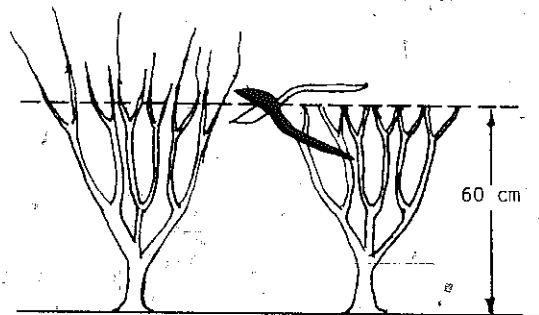

THIRD YEAR

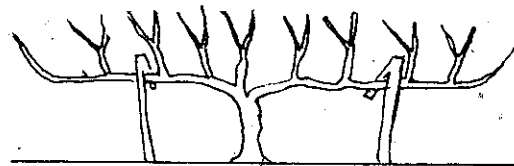

ANOTHER WAY: Hold the main branches down with pegs. They should be level on both sides, or else the new shoots will not grow nicely. Prune year by year as shown above.

Further references: "Tea" Eden, 2nd edition Tropical Agriculture Series, Longmans. "Tea Manufacture" Harler, Oxford Tropical Handbooks. Kuk Tea Research Centre, J.G. Morgan, Harvest Vol. 2, No 4, 1972.

Contributed by: D.W. Kidd, Box 312, Mt. Hagen WHP.

# Spices

BIRDSEYE CHILLIES (No article) (p 244)

## CARDAMOM

Description: A tall herbaceous perennial, with branched underground rhizomes, from which arise several erect leafy shoots and erect panicles.

Botanical name: Elettaria cardamomum

Height: 2 - 5 metres tall.

Age to first production: Three years after field planting.

Normal life span: 1 - 15 years

Insect pests and control: Myrids (a pod sucker), controlled by spraying or dusting the young foliage of individual plants with lindane. Rats control can be done with rat poisons or traps. Wasps lay eggs in pods, letting weevils in.

Diseases and control: Soil-borne fungal rot diseases observed in nurseries. It can be controlled by drenching or dusting.

Indications of maturity: When they are just changing from yellow to green.

Planting information: Cardamoms are propagated either vegetatively by division of rhizomes or by seed. Land is lined using 1.5m to 3m triangle spacing and holes 60 x 60cm and 45cm deep are dug.

Useful products at village level: Dried cardamom fruits are marketed, or used with betel nut.

Industrial uses: They are used for flavouring curries, cakes, bread and other kinds of food and drink.

Sources of supply of planting materials and cost: LAES, Kerevat, ENBP. Free, freight charge only.

Further references: Tropical Crops: Monocotyledons, Purselove K8.50; Cardamom Handbook, Rural Dev. Handbook No 3, A.W. Grant, free, DPI, Box 2417, Konedobu.

PNG experience: LAES, Kerevat.

Initial contributor: F. Aia, LAES, Kerevat, ENBP.

## GINGER

## KAWAWAR

Description: Slender long-lived herb, with branched rhizomes born horizontally near surface of soil, bearing leafy shoots close together.

Botanical name: Zingiber officinale

Height: 30 - 100cm

Age to first production: 8 - 9 months

Normal life span: 8 - 9 months

Insect pests and control: Larvae of a dipterous insect (unidentified) bore through the leafy shoots. Natural enemies often give some degree of control.

Diseases and control: Some diseases are leaf spot and dieback. The most common rhizome diseases are soft rots caused by Pythium spp. Planting material should be carefully selected and drenched in fungicide such as ceresan and hot water treatment before planting.

Indication of maturity: The shoots have turned brown and begin to fall over, usually in the driest part of the year.

Planting information: Carefully select planting material. Cut rhizomes into small pieces each weighing 30-40 gram pieces, plant in a small hole 5-10cm deep and cover with loose soil. Spacing within ridges is 15-30 x 30-45cm. Spread sawdust evenly on the surface of the ridges to the depth of 5-10cm.

Useful products at village level: (p 92) As a vegetable with meals. Wash and sell in market.



Industrial uses: The dried rhizomes, which may be scraped or peeled before drying, are the spice. In western countries it is used for cooking in ginger bread, biscuits, cakes, puddings, soups and pickles. It is often used in curry powder, and is very important in Chinese cooking. It is used in making ginger beer, ginger cola and ginger wine.

Sources of supply of planting materials and cost: LAES, Kerevat, free. Freight charge only.

Further references: Tropical Crops: Monocotyledons Purselove, K8.50.

PNG experience with this crop: Yield trials, (p 244) LAES, Kerevat, ENBP.

Initial contributor: F. Aia, LAES, Kerevat, ENBP.

## NUTMEG

Description: A spreading evergreen tree with male and female flowers on separate trees. 5-13 metres high, sometimes attaining 20m. Root system superficial. The fruits yield two spices: Mace and Nutmeg.

Botanical name: Myristica fragrans

Height: Up to 20 metres high

Age to first production: 5 - 8 years

Normal life span: 30 -40 years

Diseases and control: Observation at Kerevat show that nutmeg trees are relatively free from major pests and diseases.

Indications of maturity: When the outside skin splits open to expose the seed.

Planting information: Plants are normally raised from seeds. Seeds should be put into soil immediately after harvest as they die very quickly. Plant out under established shade after they are 15-30cm tall; planted at distance of 8m x 4m or 9m x 4.5m.

Useful products at village level: Nutmeg (the nut) and Mace (the red skin) are both dried and marketed. Fresh mace in soups is a good spice. (p 94)

Industrial uses: Nutmeg fruits are used for flavouring milk dishes, cakes, drinks and other foods, while mace is preferred in meat dishes, pickles and sauces.

Sources of supply of planting materials and cost: LAES, Kerevat, free. Freight charge only.

Further references: Tropical Crops: Dicotyledons 2, Purselove, K5.94.

PNG experience: LAES, Kerevat, ENBP.

Initial contributor: F. Aia, LAES, Kerevat, ENBP.

Ripe Nutmeg fruit.

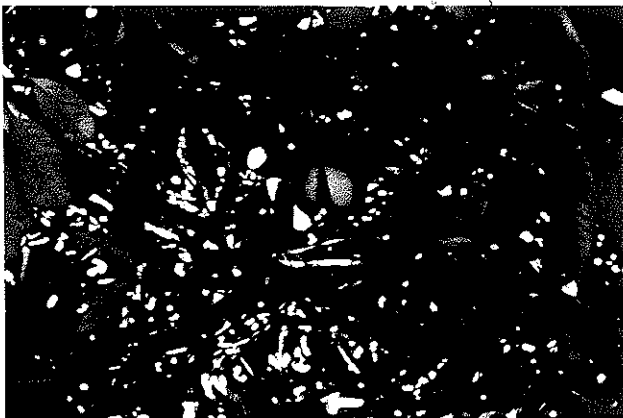

## PEPPER

Description: A long-lived, smooth-stemmed woody climber to 10 m in height, but under cultivation the mature vine has a bushy appearance 2-4m high and 1.5m in diameter.

Botanical name: Piper nigrum

Height: 10 metres

Age to first production: 18 months after planting

Normal life span: Temporary gardens, 3-4 years; semi-permanent 10-12 years; permanent 30-50 years.

Insect pests and control: A small pepper bug eats the underside of leaves causing small yellow/brown spots. Control with 0.1% Lindane spray.

Diseases and control: Black leaf disease: chemical control involves regular spraying with 0.5% copper oxychloride or Captan; Pink Disease: chemical control involves spraying with 0.5% copper oxychloride and prune 15cm below the point of infection and destroy prunings; Thread Blight: this can be controlled with 0.5% copper oxychloride sprayed at regular intervals until there is no sign of the disease spreading.

Indication of maturity: White pepper: To make white pepper harvest spikes with 50-90% of berries red in colour; Black Pepper: To make black pepper harvest when one or two red berries are noticed on the spike. (photo p 57)

Planting information: Primary vines raised in nursery. These are then planted out on the field after 6 months under shade supports at the spacing of 3m x 3m.

Useful products at village level: (p 95) Pepper marketed in two forms: Black and White.

Industrial uses: Pepper fruit is dried and used as a spice to flavour meat dishes and in making pickles, sauces, ketchups, sausages and other meat products.

Sources of supply of planting materials and cost: LAES, Kerevat, free. Freight charge only.

Further references: Tropical Crops: Dicotyledons 2 by Purselove; Aburu, Kana, Pepa, Free from LAES, Kerevat, ENBP (in Pidgin). (p 24A)

cont'd

PNG experience with this crop: LAES, Kerevat.

Remarks: White pepper is not as pungent as black pepper.

Initial contributor: F. Aia, LAES, Kerevat, ENBP.

## ROSELLA

Description: A short lived perennial shrub cultivated as an ornament and for its red flowers and leaves.

Botanical name: Hibiscus sabdariffa

Height: 1-2 metres

Age to first production: 4 months or more.

Begins flowering in February.

Normal life span: 18 months to 2 years

Insect pests: Leaf chewing insects.

Diseases: Nematodes attack roots.

Indication of maturity: The flowers close and become deep red. Harvest before flowers become woody. Snap stem at base of flower.

Planting information: Plant seeds 60cm apart in 90cm wide rows. If planted for a single hedge, closer planting is alright.

Useful products at village level: Leaves may be eaten as a kumu. The flower can be used to make lolly water, jelly or jam.

Industrial products: Calyces (the fleshy red part) are high in pectin, which is used in making jams, jellies and custards. Potential exists for an industry when demand for commercial pectin exists in the tropics, and when apples cannot be grown. Bast fibres of stem can be used for making paper, but only 30% recovery is possible.

Sources of planting material: Yates seeds at seed stores, and locally in many places.

Further references: Knott J.E. and J.R. Deanon (1967) Vegetable Production in South East Asia p. 268-9.

Remarks: The flower is a very attractive decorative plant, and is a useful replacement for lolly water and jams in village and in town.

## TUMERIC

Description: A perennial herb to 1 metre tall with a sheet stem and tufted leaves.

Botanical name: Curcuma longa

Height: 1-2 metres

Age to first production: 10 - 11 months before harvesting.

Normal life span: 10 - 11 months

Insect pests and control: The larvae of lepidoptera (unidentified) bore the shoots but damage is little. Grasshoppers feed on the leaves.

Diseases and control: Large water-soaked spots of the leaves caused by the fungus Phyllosticeta spp. Spray the plants with 0.5% copper oxochloride when early symptoms are seen.

Indication of maturity: Lower leaves turn yellow; or shoots dry and fall over.

Planting information: The land should be thoroughly prepared. Best planted in September/October (Kerevat). Is often planted on ridges, usually about 30-45cm apart and with 15-30cm between plants. Recommended spacing is 30 x 15cm. The crop is propagated by setts (finger or rhizomes) with one or two buds, planted 5-7cm deep. Approximately 1,700kg of setts are required to one hectare.

Useful products at village level: May be used as a spice in food. Note: after harvest the primary rhizomes are separated from the side rhizomes, washed and dried. They may be boiled in water and dried in the sun for 7-8 days.

Industrial use: Used mainly to make curry powder. The yellow colour of tumeric is what gives curry its colour.

Sources of supply of planting materials and cost: LAES, Kerevat, free. Freight charge only.

Further references: Tropical Crops: Monocotyledons, Purselove, K8.50.

Yield trials have been conducted at LAES. For information contact Agronomist-in-charge, LAES, Kerevat, ENBP.

Notes: Indian tumeric has the following approximate composition: Water 13.1%; protein 6.3%; fat 5.1%; carbohydrates 69.4%; ash 3.5%; fibre 2.6%. On distillation it yields 1.3 to 5.5% volatile, aromatic orange red and slightly fluorescent oil.

Initial contributor: F. Aia, LAES, Kerevat, ENBP.

## VANILLA

Description: A long-lived fleshy herbaceous vine climbing by means of aerial roots up trees or other supports to a height of 1 - 15m. In cultivation it is trained to a height which will allow easy hand pollination and harvesting.

Botanical name: Vanilla fragrans or Vanilla planifolia

Height: 10 - 15 metres

Age to first production: 3 years

Normal life span: 15 - 20 years

Insect pests and control: The larvae of two insects of the order lepidoptera damage the flowers and young capsules by feeding on them. They are kept in check by predators and parasites.

cont'd

Diseases and control: Collar rot: to reduce chance of this infection loop the vines a few centimetres above the ground.

Indications of maturity: When the dark green colour of the pod begins to yellow or is yellow in colour.

Planting information: Commercial vanilla is always propagated by stem cuttings. These should be taken from healthy vigorous plants, and may be cut from any part of the vine. The length of cutting is usually determined by the amount of planting material available. Cuttings 90-100cm in length are usually preferable. With short cuttings at least 2 nodes should be left above ground. The portion above ground should be tied to the support until the aerial roots have obtained a firm grasp. Spacing used: 2.75m between rows and 1.37m within rows.

Useful products at village level: The beans or capsules are dried and cured. After curing they are packed and marketed. (p 100)

Industrial uses: Vanilla is used in the manufacture of ice cream, chocolate, sweets, perfumes.

Source of supply of planting materials and cost: LAES, Kerevat, free. Freight charge only.

Further references: Tropical Crops: Monocotyledons by Purseglove, K8.50.

Location and result of PNG experience with this crop: Vanilla trials: LAES, Kerevat; Suma Pltn., Box 6, Kavieng, NIP; Dalum Plantation, Poliamba Estates, Box 6, Kavieng, NIP.



*Vanilla trained on Leucaena glauca at LAES, Kerevat. Pepper may be trained on Leucaena glauca in the same manner.*

Initial contributors: F. Aia, LAES, Kerevat, ENBP.

## Soil Management

### FOOD CROP FARMING SYSTEMS

The farming system that a farmer uses is made up of the different crops he grows, how the crops are grown together or follow each other, the type and length of fallow and the use of animals and tools and irrigation. It is everything the farmer does in his farming work. A good example of a PNG farming system is the long forest fallow or shifting cultivation system. This is based on a short garden period followed by a long forest fallow.



*New systems are evolving. A Tolai farmer plants cocoa and Leucaena under diploid bananas and Chinese Taro.*

There are very many farming systems in PNG and generally they are used because they are the most suitable for the environment. However, in some places changing conditions require new systems, for example, where land is short or where mechanization becomes possible. The new systems are being found both by the farmers themselves and with the assistance of agriculturalists. But it is important to keep in mind that traditional practices, such as mixed cropping of different species and varieties, are often more productive than introduced ones.

cont'd

Some ideas on farming systems for institutions in the lowlands and systems for farmers short of land are given below.

#### FARMING SYSTEMS FOR INSTITUTIONS

Given the present prices for foods, institutions should seek self-sufficiency first in fruits and vegetables (protective foods), and coconuts (high energy food). If land and time permit, grow staples, and finally protein crops.

There are a large number of suitable vegetable crops, but the emphasis should be on traditional ones like aibika, tulip, pumpkin tips or karakap rather than temperate climate crops like tomato, cabbage and cucumbers, which are less productive and often of lower food value.

Institutions should place greater emphasis on fruit and nut crops, especially trees, both traditional species (like galip, talis, aila and taun) and introduced species (such as guava, avocado, citrus and pineapples).

Sweet potato is the main staple food grown by institutions, but cassava and banana give more food for the work and could be used more. Other energy crops that could be used are swamp taro in swampy areas and sugar cane for garden snacks.

Peanuts, cowpea and soybean are probably the most suitable protein species, but mung bean should be considered as well.

Land should be allotted for the following uses:

1. Main gardens devoted to staples, vegetables, grain legumes and fallows.
2. Blocks of perennial crops such as coconuts, bananas, fruit and nut trees.
3. Additional vegetable gardens.
4. Near buildings plant fruit trees and other perennials.
5. Wet areas for water tolerant crops such as kangkong and swamp taro.
6. Trail climbing species on fences.

For the main gardens choose a series of crop and fallow rotations. It is suggested that a relatively intensive system using fertilizers and a planted pigeon pea fallow is suitable for institutions prepared to use inorganic fertilizers. For those that do not wish to use chemical fertilizers, a combination of a short pigeon pea fallow and a long forest fallow is suggested.

#### FARMING SYSTEMS FOR FARMERS IN THE LOWLANDS WHO ARE SHORT OF LAND.

The traditional long forest fallow farming system is a very efficient system, but alternatives are needed where population pressure is high. There is no "magic" alternative, however, such as using a legume fallow instead of a forest fallow. All of the modifications or alternatives to the long forest fallow are already used by some people in PNG. Some of the possible modifications and

alternatives are:

1. Shorter fallow period. Yield per crop and the food return for labour input is decreased, but total food production over a long term period is increased.
2. Use of higher yielding varieties of existing crops.
3. Change of staples from lower yielding traditional crops to higher yielding ones, eg. from taro and diploid bananas to sweet potato and triploid bananas.
4. Greater use of long lived crops such as triploid bananas.
5. Interculture of feed crops with plantation crops. Coconuts offer the greatest possibility, but other plantation crops such as cocoa, rubber and coffee can share space with food crops when they are young.

As well, there are non-agricultural alternatives such as migration and cash employment.

Further reading: Fuller discussions on these subjects are contained in the following two papers which may be obtained from the author:

Bourke, R.M. (1976). Food Crop Farming Systems for Institutions in the Lowlands. Paper presented to Tenth Waigani Seminar, Lae, May 1976.

Bourke, R.M. (1976). Some Alternatives to the Long Fallow System in the Lowlands. Unpub. paper.

Initial contributor: R.M. Bourke, LAES, Kerevat, ENBP.

#### SOIL EROSION CONTROL

CONTOUR MOUNDING - An effective Erosion Control in the Enga Province.

Erosion of rocks and soils by water is a normal happening. It is responsible for the leveling of our mountains, the breakdown of rocks, the development of valleys.

But uncontrolled water can take away our precious topsoil, carry away the food of our plants, and even cause big parts of a hill to break away.

In some countries of the world water has been so controlled and soils so managed, that even with over 300 years of continuous farming, they are reported to be better than ever.

We should all recognize the seriousness of the problem of soil erosion in PNG and take positive steps to control it. Unfortunately, many communities fail to realize this problem until it is too late.

The contour mound outlined here is a scheme developed over a period of four years through St. Paul's Lutheran High School at Pausa, Wapenamanda, E.P. Students from a wide area of Enga provided the village contacts for actual tests of the scheme.

cont'd

On a slope of 20% or less, a continuous mound 2.1m in width with a minimum height of 40cm will effectively control soil erosion.

For a 20-40% slope the width of the mound must be increased to 2.5m with the depth of the mound increased proportionately.

Slopes over 40% have not been tried.

### CONSTRUCTING A CONTOUR MOUND - END VIEW

Start at the top and work down.  
Use green, not dry, compost.  
This tends to suit deep rooting crops best.

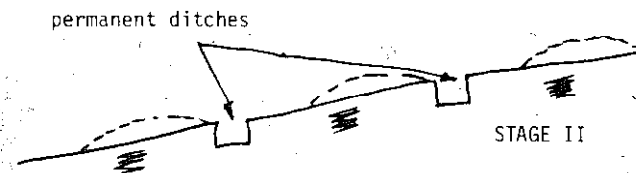
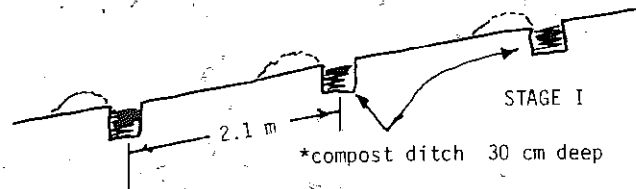

\*compost means green fresh kaukau vines, grass, etc.

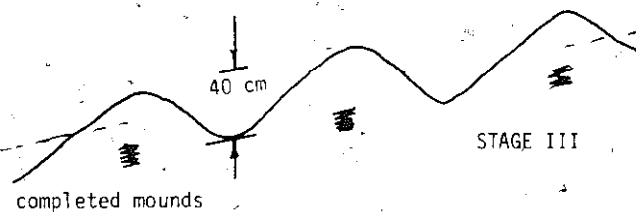

Contributed by M.L. Herman, St. Paul's High School, Pausa, Wapenamanda, EP.

Soils of the Humid Tropics, Committee on Tropical Soils, Agricultural Board, NRC, National Academy of Sciences, Washington, D.C. 1972, 217 pp.

Technical papers on all aspects of tropical soils. Specifically written to emphasize the difference between tropical and temperate soils, so that technology transfers can be made more appropriate. A particular effort is made to distinguish between the specific problems of tropical soils and commonly held generalizations. An important book for teachers of agriculture sciences.

Advanced.

## SOIL AND FERTILIZERS

(p 244)

All plants take from the soil water and some essential foods (nutrients).

The important foods are minerals. They can be divided into two classes.

Plants need a large amount of the first class, which are known as Major nutrients. These are:-

NAME	SYMBOLS
Nitrogen	N
Phosphate (Phosphorus)	P, P <sub>2</sub> O <sub>5</sub>
Potash (Potassium)	K, K <sub>2</sub> O
Lime (Calcium)	Ca, CaO
Magnesia (Magnesium)	Mg, MgO
Sulphur	S

Very small amounts of the second class are required. These are known as Minor nutrients or micronutrients. There is a very large number of these; the most important are:-

Zinc	Zn
Copper	Cu
Boron	B
Manganese	Mn
Iron	Fe

Each species of plant requires different amounts of each nutrient. The amount of one nutrient required, compared with the amounts of other nutrients, must be such that it suits the particular crop being grown.

If a plant has too much of one or more nutrients, or not enough of one or more nutrients, the plant will not grow properly. The crop will be small. When there is not enough of one or more nutrients, we say there is a deficiency.

Too much or not enough of one or more nutrients may make the plants look sick. The leaves may change colour or lose their colour and scorch. Leaves may be very small, twisted, or fall off. Sometimes the inside of the plants rots. Some of these symptoms can be confused with the effects of diseases and insect pests. If you see such signs, consult a Didiman.

Chemical analysis of the soil, or of leaves from plants, can often tell us whether there is too much or too little of various nutrients. DPI may be able to do this analysis. The University of Technology at Lae will do it, but they charge prices which may be beyond a small farmer. If you believe that it would be helpful to have analysis done, consult DPI, or Mr. A. Gerard, Analysis Laboratory, at the University of Technology, Lae, or Dr. K.C. Willson of the Agriculture Faculty of the University of Papua New Guinea at Lae.

The more fertile soils will have plenty of nutrients available and bad effects from deficiencies may occur. Organic material in soil usually has large



amounts of nutrients available. Natural topsoil is usually more fertile than subsoil. It is therefore important to retain topsoil and to add organic material such as mulch, compost, animal manure and so on to soil to maintain fertility and avoid problems from deficiencies.

Very often the soil cannot provide enough nutrients and there is not enough organic material available to provide the nutrients required. When this happens nutrients must be provided by buying and applying fertilisers, which are chemicals containing the nutrients.

Those who sell fertilisers must be able to tell you the amount of each nutrient in the fertiliser. For example:-

Single superphosphate contains 20%  $P_2O_5$  and 11.9% S

Triple superphosphate contains 43%  $P_2O_5$  but no S

Buy the right fertiliser to give the nutrients you need. Calculate the amount of fertiliser to give the amount of nutrient. For example, you will need over twice as much single superphosphate as you will need triple superphosphate to give the same amount of the phosphate nutrient,  $P_2O_5$ . However, if you buy single superphosphate you also get sulphur. This nutrient is often required in PNG.

Some fertilisers contain only one nutrient. Others contain two or more. The latter is convenient when more than one nutrient is required. Sometimes you can buy individual fertilisers to provide the nutrients you need, and mix them together on the farm so that you have only the one mixture to apply. Before doing this, make sure that the fertilisers can be mixed safely and without harming each other. DPI or the main suppliers will be able to advise you.

Recommendations for the fertiliser applications to particular crops are given in the sections on each crop. Start by using the recommended applications. However, soils vary, and you may find by experience that the application rates need altering to suit local conditions. If you think that some alteration of application rates is needed, consult DPI. Analysis of soil or leaf samples may be helpful.

Soil fertility can be improved and thus the amounts of nutrients available in the soil can be increased, by growing a different crop. This crop may only be natural regrowth after a garden is abandoned. This traditional method of shifting cultivation is quite effective, provided the area is left undisturbed for a sufficiently long period of time. Six to ten years is desirable. If gardens are reused after a shorter period, the soil fertility will not be fully restored, and the crop yields will be low unless fertiliser is used.

The period for restoration of soil fertility can be reduced if a special crop is planted. Legumes, for example *Pueraria phaseolides* or one of the beans, are very good for this purpose as they take nitrogen from the air and put it into the soil. Tall but shallow-rooted grasses, for example Guatemala Grass, can be used but for the best

results the grass must be fertilised. Another alternative is to plant a pasture and graze animals for two or three years. At the end of the period of the special crop, all the plants must be ploughed into the soil. An important example of this is sugarcane; when this is grown on a plantation scale, two crops of cane must be followed by growing a legume for six to nine months. Similarly, if pyrethrum is grown by itself, it must be followed by another crop after two to three years; pasture for cattle makes a very good system.

Books for further reading: *Tropical Agriculture*, pub by Angus and Robertson, written by A. Jacob & H. von Vexkull, Chapters 3, 4 & 5, a good elementary discussion with simple diagrams.

Fertiliser use. *Nutrition and Manuring of Tropical Crops*. Verlagsgesellschaft für Ackerbau, Hamburg.

Initial contributor: Dr. K.C. Willson, PNG University of Technology, Box 793, Lae.

## SOIL AND LEAF ANALYSIS

The Chemical Analysis Laboratory at the PNG University of Technology, (Box 793, Lae) can provide the following analyses:

Classical analysis of ores and metallurgical products.

Soil and leaf analysis.

Bacteriological examination of waters.

However the service is not free and commercial rates are charged. For example, analysis of one soil sample for major elements costs K26.00. Write to them for charges before you send a sample.

Initial contributor: R.M. Bourke, LAES, Kerevat, ENBP.

HOW TO MAKE COMPOST page 158

THE IDEA OF "USING" THE LAND IN THE WESTERN SENSE, THE THOUGHT OF WEARING IT OUT, NEVER OCCURRED TO THE TRADITIONAL MELANESIAN COMMUNITY, WHICH WAS "ALIVE IN THE LAND."

COMPOSITION OF FERTILISER MATERIALS (1)

MATERIAL	NITROGEN %	PHOSPHORUS AS AVAILABLE P <sub>2</sub> O <sub>5</sub> %	POTASSIUM AS SOLUBLE K <sub>2</sub> O %	CALCIUM %	MAGNESIUM %	SULFUR %	CHLORINE %	COPPER %	MANGANESE %	ZINC %	BORON %	APPROX. CALCIUM CARBONATE EQUIVALENT (2) LBS/TON
Ammonia anhydrous	82											-2,960
Ammonia, aqua	16-25											-720 to -1,080
Ammonium nitrate	33.5									.01		-1,200
Ammonium nitrate- limestone mixtures	20.5			7.3	4.4	.4	.4					0
Ammonium phosphate (mono)	11	48	.2	1.1	.3	2.2	.1	.02	.03	.03	.02	-1,300
Ammonium phosphate (am. phosphate-sulfate)	13-16	20-39	.2	.3	.1	15.4	.1	.02	.2	.02	.03	-1,520 to -2,260
Ammonium phosphate (di)	16-21	48-53		.3		23.7	.5	.03		.01		-2,240
Ammonium sulfate	20.5-21.0											-2,200
Ammonium sulfate- nitrate	26.0					15.1						-1,700
Ammoniated super- phosphate	3-6	18-20		17.2		12					.02	- 140
Basic slag, Open- hearth		(3) 8-12		29	3.4	.3			2.2			+1,000
Bone meal	2-4.5	(4) 22-28	.2	22-25	.4	.1	.2			.02		+500
Borax											11.6	+1,260
Calcium cyanamide	21			38.5	.06	.3	.2	.02	.04			+1,245
Calcium nitrate	15			19.4	1.5	.02	.2					+320
Castor pomace	5.2	1.8	1.1	.4	.3	.04	.3		.04	.05	.01	-100
Copper oxide								.75				
Copper sulfate						12.8		24.9		.55		
Fish scrap	6-10	7	.8	6.0	.2	.2	.4					-100
Gypsum (land plaster)			.5	22.5	.4	16.8	.3					+4,600
Magnesium oxide				1.1	56.1	.2	.5					
Manganese sulfate				6.6	1.9	14.5		.05	25.1	.08	.3	

MATERIAL	NITROGEN %	PHOSPHORUS AS AVAILABLE P <sub>2</sub> O <sub>5</sub> %	POTASSIUM AS SOLUBLE K <sub>2</sub> O %	CALCIUM %	MAGNESIUM %	SULFUR %	CHLORINE %	COPPER %	MANGANESE %	ZINC %	BORON %	APPROX. CALCIUM CARBONATE EQUIVALENT LBS/TON
Nitric phosphates	14-22	10-22	.1-16	8-10	.1	2-3.6	0.1-12.0	.02	.2	.02	.03	-300 to -580
Nitrogen solutions	21-49											
Phosphoric acid (liquid)		52-54										-1,000 to -1,400
Potassium chloride (muriate of potash)			60-62		.1	.1	47.0				.03	0
Potassium-magnesium sulfate			22 44-46	.4	11.2 .2	22.7 .3	1.5 1.1				.09	+520
Potassium nitrate	14		50-53	.5	.7	17.6	2.1					0
Potassium sulfate		(5)		33.2	.2	.3	.1		.03			+200
Rock phosphate												
Sewage sludge, Activated	5-6	2.9	.6	1.3	.7	.5	.6	.07	.07	.1		
Sewage sludge, Digested	2	1.4	.8	2.1	.5	.1	.2	.3	.3	.4		
Sodium nitrate	16		.2	.1	.05	.07	.4	.07			.01	+585
Superphosphate, Normal		18-20	.2	20.4	.2	11.9	.3				.01	0
Superphosphate, Concentrated		42-50	.4	13.6	.3	1.4		.01	.01		.01	0
Tankage, Animal	6-9	6-15	.4	8-11	.2	.5	.8			.02		+240
Tankage, Process	7-9	1	.1	.8	.01	.9	.8				.03	-320
Urea	42-46			0-1.5	.7	.02	.2			.02		-1,500
Urea-formaldehyde	36-40									77.2		
Zinc oxide										27.8		
Zinc sulfate					.06	13.6		.02				

- 1.) Most of the percentages larger than one of N, P<sub>2</sub>O<sub>5</sub> and K<sub>2</sub>O are the usual guarantees. Where more than one grade is commonly sold, the range is indicated by two numbers separated by a dash. The rest of the percentages are averages compiled by A.L. Mehring, USDA chemist, from many published analyses.
- 2.) Ind. Eng. Chem., Anal. Ed. 5, 229-34 and other sources. A minus sign indicates the number of pounds of calcium carbonate needed to neutralize acid formed when one ton of the material is applied to the soil. A plus sign indicates basic materials, and a zero physiologically neutral materials.
- 3.) By the 2-% citric acid method.
- 4.) Total P<sub>2</sub>O<sub>5</sub>. All of the phosphorus in natural organics is considered available.
- 5.) 30 - 36% total P<sub>2</sub>O<sub>5</sub>, which is relatively unavailable in many soils.

FROM: "OUR LAND AND ITS CARE", NATIONAL PLANT FOOD INSTITUTE, U.S.A.

# Soil Tillage

## SMALL MACHINES

### ROTARY HOES

Many people in PNG today are using a small machine to help them in their gardens to grow more food. One kind of machine is the rotary hoe.

The rotary hoe is usually made so that the man walks behind it and steers it. The engine turns many hoes and also makes the machine go forward. The driver only has to steer it.

In PNG you can buy three kinds of small rotary hoes: The first kind is the Troy-bilt, available from Kamscoinc, Kavieng, New Ireland. The price is about K800. Another kind is the Howard 350 rotary hoe. It costs about K1,000. Both machines use the same brand of engine and do the same kind of work. These have big wheels with tires like tractors and the wheels pull the machine. Behind the machine are the turning hoes which dig the ground. The hoes can be set to dig deep or shallow, for ploughing or for weeding. With attachments you can make ridges for planting other kinds of crops. These machines are strong enough to dig new ground.

The third kind of machine is the Masport Rota-hoe. This machine is the cheapest, and it costs only K425 from South Pacific Machinery in Boroko. It can also use many attachments for special work in the garden. It is different from the other two rotary hoes because the hoes are in the front of the machine and the wheels are not powered. The turning hoes dig the ground and pull the machine at the same time. This machine is not strong enough to dig new ground. It is very good for weeding and digging old ground.

These machines are very useful for a man who wants to make business growing food to sell, but who does not have enough money to buy a big tractor. These can easily be put into a utility and driven to another place to do work, and they can also be put on canoes.

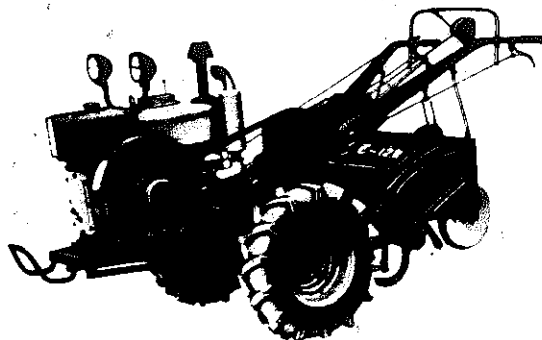

Dongfeng 12 h.p. two-wheel tractor

See page 263



CeCoCo Agricultural Equipment

See page 263



A rotary hoe - "masin baira"

### AGRICULTURAL POISONS:

THE INCREASING SOPHISTICATION OF BOTH RURAL AND URBAN PEOPLE IN PNG HAS LED TO AN INCREASED USE OF HOUSEHOLD AND GARDEN INSECTICIDES AS WELL AS POISONS FOR OTHER PEST CONTROL.

MANY OF THE PRODUCTS THAT ARE SOLD WITHOUT RESTRICTIONS ARE EXCEEDINGLY DANGEROUS, INCORPORATING CHEMICALS SUCH AS CHLORDANE, PARATHION, DIELDRIN, AND AZODRIN. ASIDE FROM THE CARE TAKEN BY THE SELLER IN INSTRUCTING THE BUYER IN THE PROPER USE OF CHEMICALS, THERE IS NO REAL CONTROL OF THE SALE OF THESE CHEMICALS.

WE ARE LUCKY THAT THERE ARE VERY FEW RECORDED DEATHS FROM THE MISUSE OF AGRICULTURAL CHEMICALS IN PNG, BUT THE GREATER USE BY MORE PEOPLE TODAY REQUIRES GREATER CARE IN THE DISTRIBUTION OF THESE CHEMICALS.

MOST COUNTRIES HAVE CONTROLS ON THE SALE AND USE OF DANGEROUS CHEMICALS, BUT TODAY IN PNG ONE TRADING COMPANY STILL SELLS 20 LITRE DRUMS OF 75% CHLORDANE CONCENTRATE.

ISN'T IT TIME FOR LEGISLATION RESTRICTING THE CATEGORIES OF PESTICIDES AVAILABLE TO THE PUBLIC WITHOUT PERMIT IN THE SAME MANNER THAT PRESCRIPTIONS ARE REQUIRED FOR MEDICINES? WHAT ABOUT A PESTICIDE REGISTRATION LAW?

# Pest Control

## CONTROLLING INSECT PESTS WITH CHEMICALS

The two fundamental laws of ecology are, we are told:

"1. Everything affects everything else. 2. There is no such thing as a free lunch."

Using Agricultural Chemicals is no exception. We might increase production, but so often there are long-term hidden costs in using them.

The Companies making and selling Agricultural Chemicals are more sensitive than ever before to the dangers of their products, and due to political realities are doing careful and expensive research just to ensure their own survival. So there are good products available.

But the best approach to chemicals is under-use them. Direct them towards very specific problems, and only when the problem cannot be solved by other economic means.

We would like to be able to give more systematic, helpful information about the common chemical insecticides available in PNG, but it is not easy. As you will notice, even the names of the pests are not uniformly presented, so you'll have to feel your own way.

Any one insect pest may be controlled by several insecticides. Your choice will depend upon a number of factors. These are probably the most important:

1. Cost - you will want the most economical, other factors being equal. But the most effective and safest ones are often the most expensive.
2. Availability - you may not always be able to get just what you want.
3. Local experience - local advisers can often recommend something that works.
4. Time of application - some Chemicals must be avoided at certain times in the crops' life.
5. Safety - some chemicals are dangerous. Don't use them if the recommended safety precautions cannot be carried out.

Ed. note: LD<sub>50</sub> is a way of measuring the danger of poisons. Each number here is a measure of how much poison is needed to kill male rats. The smaller numbers are more poisonous than large numbers. "a.i." means "active ingredient."



### SOME OF THE PRODUCTS AVAILABLE IN PNG:

KLORFON (ICI) - Controls a wide range of insects, is quick-acting, and easy to use. Recommended for Army Worm, Barley Grub, and Webworm in pasture and field crops; Cabbage White Butterfly, Cabbage Moth, Cabbage Looper, and Green Vegetable Bug; flies in households, public buildings, stock and poultry buildings; Pantophrytes Weevil Borers in Cacao.

a.i: trichlorphon LD<sub>50</sub>:630

ACTELLIC (ICI) - A new relatively safe organo-phosphate general purpose insecticide which can be used on practically every agricultural crop. Controls the following:-

Acarina - Red spider and other mites.  
Homoptera - Aphids, White Fly, Scale Insects, Mealy Bugs, Jassids.  
Heteroptera - Plant bugs.  
Coleoptera - Beetles and Weevils.  
Lepidoptera - Caterpillars, Moths, Borers.  
Thysanoptera - Thrips.  
Diptera - Flies, Cereal Flies & Midges.  
Orthoptera - Locusts & Grasshoppers.

a.i: pirimiphos methyl LD<sub>50</sub>:2050

ORTHENE (ICI) - An organo-phosphate insecticide of moderate persistence with residual activity for 5-10 days at suggested use rates. Reasonably safe. Has been shown effective against some insects which are tolerant to other organic phosphates. Controls:-

Homoptera - Potato Leafhopper, Potato Aphid, Pea Aphid, Cabbage Aphid, Green Bug, Greenhouse White Fly

cont'd

Hemiptera - Lygus Bug, Southern Green Stink Bug, Brown Stink Bug, Harliquin Bug.  
Coleoptera - Spotted Cucumber Beetle, Bean Leaf Beetle, Bean Beetle, Potato Flea Beetle.  
Lepidoptera - Cabbage Looper, Soybean Looper, Diamond Back Moth, European Corn Borer, various Army Worms, various Cut Worms, Velvet Bean Caterpillar, Potato Tuber Worm, Coddling Moth, Corn Earworm.  
Thysanoptera - Citrus Thrips.

a.i: acephate LD<sub>50</sub>:1494

GAMMAPHEX (ICI) - An emulsifiable concentrate of BHC based on Lindane. Toxicity about the same as DDT. Highly inflammable. Suitable for control of Aphids, Thrips and most leaf-eating pests of vegetables.

a.i: gamma benzene hexachloride LD<sub>50</sub>:88

SOLGAR (ICI) - An emulsifiable concentrate, for soil-pests. Recommended for the long term control of Banana Borers and vegetable soil pests.

a.i: pirimiphos ethyl LD<sub>50</sub>:>1500

GAMMEXANE 7 MISCIBLE OIL (ICI) - An emulsifiable concentrate of BHC based on Lindane. Recommended for:- Rhinoceros Beetle and Black Palm Weevils in Coconuts, Curli Grubs & Wire Worms in Cacao, Shot-hole and Ambrosia Beetles in rubber, Leaf-eating Beetles in Oil Palms, soil pests in vegetables crops, house-flies and mosquitos, Pin-hole Borers in timber and Termites.

a.i: gamma benzene hexachloride LD<sub>50</sub>:88

DIELDREX 30 (SHELL) - An economical but rather toxic chemical for a wide range of insects including Amblypelta, Ants, Banana Weevil, Borers, Banana Rust Thrips, Beetles, Centipedes, Cockroaches, Coconut Leaf Hopper, Coffee Ring Borer, Crickets, Cut Worm, Ear Wigs, Grass-hoppers, Leaf Hopper, Locust, Longicorn Beetles, Palm Weevil, Ryparid Beetle, Sandflies, Sexava, Spiders, Sweet Potato Weevil, Taro Beetle, Termites, Thrips, Timber Borers, Tip Wilt Bug, Tortise Shell Beetle, Weevils, White Ants, Wire Worms, White Curl Grubs.

a.i: dieldrin LD<sub>50</sub>:46

MALATHION 50 - A well-known standard insecticide available from many companies recommended for Aphids, Cabbage Moths, Cabbage White Butterfly, Citrus Scale, Climbing Cutworm, Corn Ear Worm, Diamond Backed Cabbage Moth, Fleas, Green Shield Bug, Leaf Hopper (not all types), Lice, Mealy Bugs, Mites, Mosquito Pumpkin Beetle, Scale insects, stored grain pests, Ticks.

a.i: malathion LD<sub>50</sub>:2800

D.D.T. (25% MISCIBLE OIL) - An emulsifiable concentrate is widely used, but is already banned in some countries because it tends to accumulate in toxic amounts. It kills a wide range of insects, it is cheap, but we hope that you can find something else.

a.i: D.D.T. LD<sub>50</sub>:114

## RATS OR CATS?

ONE OF THE REASONS THAT MANY PEOPLE FIND RATS TO BE A PROBLEM AROUND THE HOUSE IN THE VILLAGE IS THAT THERE ARE NOT AS MANY CATS AS THERE USED TO BE BEFORE THE MALARIA CONTROL BRANCH OF THE PUBLIC HEALTH BEGAN SPRAYING WITH DDT TO KILL MOSQUITOES.

THE PUBLIC HEALTH DEPARTMENT ADVISES THAT CATS SHOULD BE SAFE IF THEY ARE KEPT OUT OF A HOUSE FOR THREE DAYS AFTER SPRAYING, BUT HAVE YOU EVER TRIED TO TIE UP A CAT FOR THREE DAYS?

EACH HOUSE RECEIVES MORE THAN 300 GRAMS OF ACTUAL DDT DURING EACH SPRAYING, BUT IT TAKES LESS THAN 3 GRAMS OF DDT TO KILL A 2KG CAT. CATS GET DDT BY LICKING THEIR FUR AFTER RUBBING AGAINST THE WALLS OF A SPRAYED HOUSE AND BY EATING COCKROACHES AND GECKOS THAT HAVE PICKED UP DDT ON THEIR FEET WHILE WALKING AROUND A HOUSE.

THE PUBLIC HEALTH DEPARTMENT DOESN'T CONSIDER THAT THE LOSS OF CATS IS TOO HIGH A PRICE TO PAY FOR MALARIA CONTROL AND THEY DO NOT THINK THAT RATS ARE A PUBLIC HEALTH PROBLEM.

DDT SPRAYING IS CONSIDERED THE CHEAPEST FORM OF CONTROL AVAILABLE FOR MOSQUITOES THAT CARRY MALARIA, AND NO ONE SERIOUSLY QUESTIONS THAT IT WORKS. IF YOU WORRY MORE ABOUT YOUR CAT THAN YOU DO ABOUT GETTING MALARIA YOU HAVE THE RIGHT TO TELL THE MALARIA CONTROL SPRAYERS NOT TO SPRAY.

ONE OTHER THING ON CATS. A LOT OF PEOPLE USE CHLORDANE DUST TO KILL COCKROACHES IN THE HOUSE. ASIDE FROM BEING A DANGEROUS CHEMICAL TO MAN, CHLORDANE WILL ALSO KILL CATS EVEN FASTER THAN DDT.

IF YOUR CAT IS VERY LISTLESS AND SHAKES A LOT ASK YOURSELF IF YOU HAVE USED CHLORDANE OR DDT IN THE HOUSE RECENTLY.

ALWAYS REMEMBER TO READ INSTRUCTIONS BEFORE USING.

SAFETY SUGGESTIONS: Store sprays and dusts in labeled containers; keep pesticides out of reach of children, pets, and irresponsible people; keep storage areas locked; avoid smoking while spraying or dusting; avoid inhaling sprays or dusts, and wear protective clothing and masks when exposed to them; avoid spilling materials on your skin, and if you do, wash immediately; wash your hands thoroughly after spraying or dusting before eating or smoking; cover food and water containers when

spraying around livestock areas; dispose of empty chemical containers so they will not be a danger; wash contaminated clothes before re-use, if the label tells you to; check equipment before spraying or dusting; clean equipment after each use; avoid spraying in high wind; don't allow your spray to drift to neighbouring crops; be sure that you're using the right chemical for the job you want to do.

## IMPORTANT NOTES ON USING CHEMICALS

**WARNING:** Many chemicals are dangerous. They are transported in concentrated form and then diluted with a large amount of water before spraying. In the concentrated form they are quite strong enough to kill a man. In the diluted form they can kill insects and can certainly make people sick although the diluted form would not normally kill a person.

### 1. DANGER TO THE SPRAYMAN

When using sprays there are some very important rules to follow:

- a) Use only the sprays that are recommended.
- b) Read the label carefully, and follow the instructions.
- c) Don't get the chemical on your skin.
- d) Change spray clothes as soon as possible after spraying, and wash them.
- e) After spraying, wash yourself with soap & water.
- f) Do not smoke or eat while spraying.
- g) Keep the spray away from water or food that people or animals will be eating.
- h) Store all chemicals in a safe place away from food and children.
- i) When a chemical container is empty it should be destroyed, not washed out or re-used.
- j) Do not expose yourself needlessly to the spray liquid.
- k) Wash the spray machine completely when spraying is finished.

### 2. DANGER TO THE CONSUMER

There is another danger. If the insecticide is sprayed onto a vegetable just before the vegetable is picked and sold, then the person who eats the vegetable will eat the insecticide too. He will probably get sick, and he might even die. So growers must not spray their vegetables for insects just before they pick them to sell them. The label of the insecticide bottle will tell him when he should not spray his vegetables. If he sees "WITHHOLDING PERIOD - 14 DAYS" (sometimes "HARVEST DELAY - 14 DAYS") that means that he should not spray the vegetable 14 days (or less) before he picks them. It is not easy to tell in advance exactly when the vegetables will be ready for picking. That is something that people learn by experience.

#### Method of Spraying

Read the instructions on the insecticide container, and follow them carefully. If you don't understand them, ask someone to help you, otherwise you may kill your vegetables, or even kill yourself. The insecticide will need to be diluted with water before spraying.

The usual machine for spraying is a 12-14 l knapsack sprayer which is carried on the sprayman's back. He holds the hose in one hand while he pumps with the other hand.

A detergent (such as Teepol made by Shell Company, or Lissapol made by I.C.I.) helps to spread the spray liquid over the leaves. Add 30ml of detergent to a 12-14 l knapsack sprayer.

Shake the liquid in the knapsack sprayer just before you start to spray. Some of the chemicals will sink to the bottom and will not be sprayed out unless you shake well.

When filling up the knapsack sprayer, always put the water in first, then add the detergent and the insecticide. Shake well and start using immediately. If there is any delay after you have made up the spray mixture, shake it again before you start spraying.

Each plant should be sprayed to "run-off" point - that is until the liquid starts dripping from the tips of the leaves. The spray must be directed to completely cover the underside of leaves and the inner parts of the plant as well.

Suggested by: J. Greve, from DPI Rural Development Handbook No. 9.



A low cost bucket pump sprayer

## SPRAYERS FOR AGRICULTURAL CHEMICALS

When using a sprayer for applying insecticide, be sure to read the instruction book, and don't lose the book that gives you the numbers for ordering spare parts.

**Use of the sprayer:** The operation of the sprayer is different for the different kinds of sprayers, but the sprayers all work much the same way: the pump builds up pressure and forces the liquid through the small hole at the tip. This causes the liquid to become a spray. Be careful not to lose the part with the hole or the sprayer will not work. If the water is dirty the hole might be

plugged. Then you will have to remove the part with the hole and take out the rubbish.

When you fill the sprayer you will be putting a small amount of chemical in with a large amount of water. How much chemical depends on the chemical, and you should read the instructions for the chemical. Usually this is on the tin. These instructions are for putting the right amount of the chemical on the leaf. (Unfortunately, these instructions are not always clear for the beginner).

When you spray you should hold the sprayer long enough for the liquid to begin to make drops that will run off the leaf. This is called the "run-off point". When this point is reached, the right amount of chemical is on the plant to be able to do the job that you want it to do.

There are many kinds of sprayers available in New Guinea. Some use motors to pump the spray, and they cost about K250. Another type is the knapsack sprayer. We know of three brands sold in PNG.

Rega: Lead coated brass, holds 15 litres, cost: K90 to K100, available from many agricultural supply firms.

Solo: Plastic, 16 litres, cost K55., distributed by Plantation Supply and Service Co., high pressure.

CP3: Plastic, 18 litres (3.3/4 gallons) cost K60., distributed by Mt. Hagen Technical Services Co., medium pressure. By all accounts this is the most durable sprayer available in PNG and represents good value for money.

Smaller sprayers are also available for the home gardener at a cost of K16 to K25. Check on spare parts before you buy.

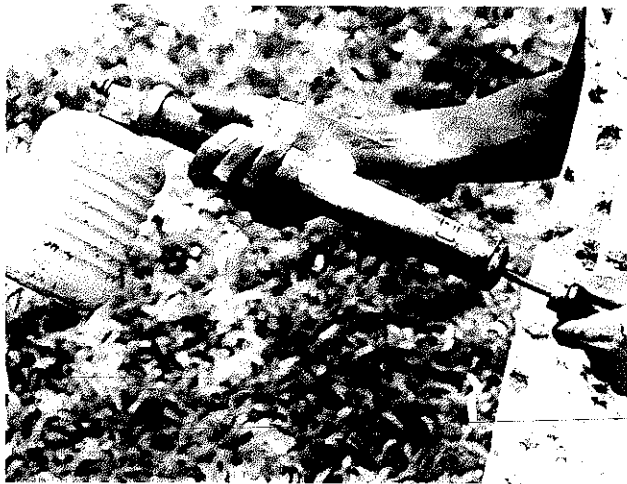

A low cost hand sprayer

## HOME-MADE INSECT REPELLANT

A home made repellent for keeping insects away from leafy vegetables can be made from small red chilli peppers (lambo) and soapy water. The insects are not killed, they just stay away from the leaves that are sprayed.

Take a large amount of small red chillies and grind them. Add enough water to cover the chillies and a little soap powder or liquid soap. Mix this well. The soap is important because it helps the chillie water stick to the leaves.

The liquid can be sprayed directly or you can sprinkle it by pouring it through a tin that has had several small holes punched in the bottom.

This is good for all kinds of cabbage and for other green leaf vegetables.

Initial contributor: Sr. K. Murphy, Pangia Voc. Centre, Pangia, SHP.

## INSECT IDENTIFICATION

A dead insect will fall to pieces quickly, so it is necessary to send any specimens of insects, eggs, larvae or pupae in preservative. The preservative usually used is methylated spirits.

The insect to be identified should be placed in a small bottle or tube, then methylated spirits is poured in to fill the bottle completely. The bottle should be securely sealed, placed in a plastic bag, and then packed in a box which is much larger than the bottle. The space in the box should be filled with cotton wool or crushed up newspaper so that the bottle is not broken in transit.

Address parcel to: Senior Entomologist,  
Dept. of Primary Industry,  
Box 2417,  
Konedobu.

Write (or type) three copies of an information sheet. Put one copy in the parcel with the specimen, and send another copy separately to the Senior Entomologist. Keep the third copy in your files. The information sheet should contain the following details:

Name of vegetable on which insect was found.  
Place where insects were found - name of village and name of nearest town, and name of owner of land where insects were found.  
Details of damage done by insect.  
State whether all plants are affected or only a few.  
Date specimens sent.  
Name and address of person sending specimens (and designation if DPI staff).

## DISEASE IDENTIFICATION

If you want to find out the name of a disease on a crop, you can send specimens to the Chief Plant Pathologist, DPI, Box 2417, Konedobu. Leaves or parts of the plant with the disease should be sent so as to arrive in Moresby on a week day, preferably early in the week.

For identification, the plant pathologist needs to know which plant the disease is on; the symptoms on the plant; how bad it is; where the specimen was collected; who collected it; and on what date.

It is not always easy to identify the disease, especially by the time the plant gets to Moresby. However, you will always receive a quick reply to your letter, even if the pathologist is not able to identify the disease.

## NEMATODES

Nematodes, sometimes called eel worms, are a common pest in many parts of PNG. Most nematodes attack the roots, and because they are so small and are underground people do not notice them.

Usually the sign of nematodes is that the leaves die. Many people think that leaves die because the sun is too strong, and they do not want to dig up the plant to check it because they know that uprooting will kill most plants. If there are nematodes you will see that parts of the roots have swollen up.

The nematode is too small to see. The swelling is due to a family of nematodes feeding and causing the roots to grow too fast in the place they are feeding. The swelling chokes the roots, and water and food does not reach the leaves.

Other insects also attack roots, and you should not be afraid to pull up sick plants to check the roots for insects if they are very sick.

## RATS

Rats are a common pest in towns and rural areas. The biggest problem is in the house and storehouse, where they eat food, and at night nibble on peoples feet. They have sometimes seriously injured small children. Occasionally they are serious pests in plantations and gardens but only rarely are they of economic importance. They are most likely to be a problem on small islands with well developed plantations, because the development deprives them of bush, and kills off many of the natural predators like snakes, birds and lizards.

The rat traps are the cheapest and most effective means of controlling rats in houses and storehouses, but they are a labour intensive method. For best results change the bait every day, change the location of the trap once a week, and change the type of bait every two or three weeks. Good baits are small bits of fresh coconut, pumpkin or water-

melon seeds, or hard cheese, but they must be fresh. Trade stores and Trading companies sell traps for 25-40t each.

Biological control of rats is the simplest means and for long term control is the best. Generally the natural predators such as snakes, birds and lizards, are hunted by people for food and from fear and this gives the advantage to the rat in the garden, the plantation and the bush.

Cats are an excellent natural control near houses and warehouses. A difficulty with cats is that they die quickly in villages where DDT is sprayed to control the mosquitoes that give malaria. Because cats like to rub themselves on walls, and eat geckos and cockroaches in the house, they are poisoned by the DDT. A very small amount of DDT less than 3g for a 2kg cat - is likely to kill a cat. The shaking and drunken behaviour of a cat before it dies is a sign of DDT poisoning. Although you can tell the Malaria Control not to spray your house, you run a much higher risk of malaria. It means you must choose between cats and malaria.

Man is another biological control. There is nothing wrong with eating rats from rural areas, and roast rat is a little like chicken. But the idea is not to everyone's taste.

Rats do not like clean places. Burying rubbish, covering food, cleaning weeds, and building ratproof warehouses on stilts will make rats leave. You can also poison rats. Many people like this idea, because they think it will kill all the rats. Poisons for rats work by causing the rat to bleed to death in the stomach and since the rat cannot throwup, it must drown in its blood.

The oldest poison of this kind is called Warfarin. It comes as a powder that is mixed with bait. When the bait is eaten over a period of several days, the rat dies. One trouble with warfarin is that it will also kill dogs and pigs who eat a lot of it, so you must hide the bait where only the rat will find it. A very simple rat bait is made from putting 10g of Warfarin with 5kg of rice or wheat meal. Mix this very well and put small portions inside a piece of bamboo, where only the rat can get it. Every few days you will have to add some more bait as the rat eats a little bit.

If you need a longer lasting bait you can make 50kg from:

20kg paraffin wax  
25kg wheatmeal  
5kg sugar  
4 tins fish  
70g Warfarin  
120g Busan fungicide

The process:

1. Melt the wax in a large pot.
2. Mix the warfarin with a little wheatmeal and then mix it altogether with the rest of the wheatmeal, the sugar, and the Busan fungicide.
3. Add the fish to the wheatmeal and sugar and mix well.

cont'd





A bamboo rat bait station to protect bait from weather and domestic animals.

4. Take the melted paraffin from the fire, and add all the other ingredients to the wax. Stir well.
5. Pour the mixture onto corrugated iron and let cool in the shade.
6. When the mixture is hard, break it into small pieces. This is the bait that you put in places where rats will find it. It is better to hide the bait from other animals and from the rain. Bamboo or old tins are good.

Source of ingredients: Warfarin can be bought from Elvee Trading, Box 151, Rabaul. K20.00 plus freight for a 454g tin. Paraffin wax can be purchased from the same source (approximately K14.00 per 25kg box). Total cost of materials @ 50t per kg.

Paraffin wax rat bait has one problem. The heat of the cooking can reduce the effectiveness of the warfarin, also the paraffin reduces the effectiveness of the warfarin.

Warfarin also has the problem that pigs and dogs can die from eating it. You can buy other kinds of rat poison as well. Ratak is a ready made poison that kills rats but does not kill pigs. It does not spoil or get eaten by insects. It is available from ICI, Box 1105, Lae, or stores that sell plantation supplies. It comes in 500g packets or 40kg drums and costs about K2.00 per kg.

Remarks: Rats are very intelligent animals. They quickly learn to avoid traps and some poisons. They only eat things that they think taste good. Rats will always be with us, but they can be controlled. Rat control is not a responsibility of government; it is the responsibility of each man or community who is affected, because it is the man and the community that make the conditions that the rats like.

## SNAILS DEM DEM

The African Giant Snail

Scientific name: Achatina fulica

This pest is also useful for pig food (cooked), chicken food (cooked and dried), duck food (cracked and raw), and human food (cooked & spiced).

Originally introduced to the New Guinea Islands during the war by the occupying Japanese army, the snail has spread to almost all parts of PNG. Many areas are not yet affected, but with the extension of roads it is inevitable that in time all coastal areas will be invaded.

Most introductions of the snail are by accident, such as when a person brings cuttings from one area to another and the small snails are on the cuttings. A resting snail may hide from the sun on a muddy part of a car during the day and then drop off in another area the next night. Cold kills the snail, so the highlands will not be affected. Once introduced into an area the snail is virtually impossible to get rid of, but there are several ways that it can be controlled and even exploited.

### ACHATINA FULICA

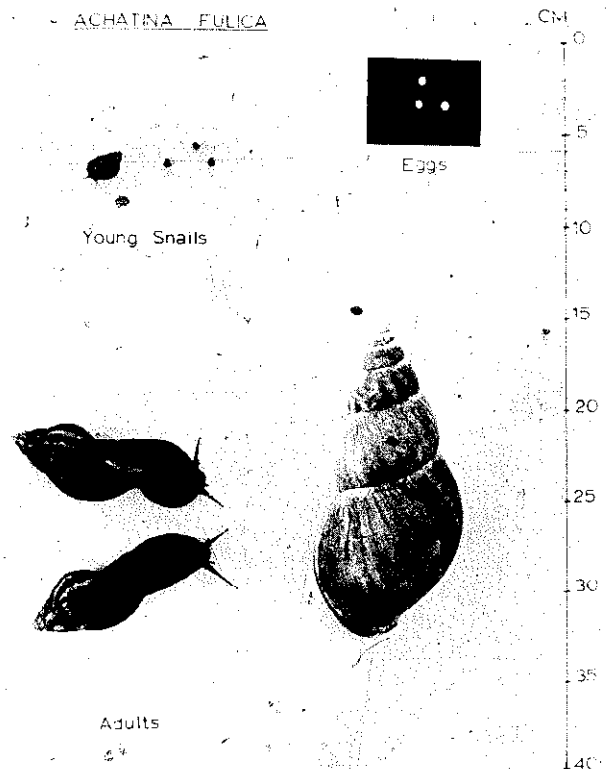

1. The cannibal snail, Euclandria rosea attacks only the African snail. The South Pacific Commission has financed the introduction of this biological control in the New Hebrides and in New Caledonia, and it has been introduced into some parts of PNG. It does not seem to be effectively established here.

2. Another predator snail, Gonaxis quadrilateralis, eats the eggs of the Giant African Snail. It eats only the eggs of this snail. The fleshy body of this snail is orange yellow. If you introduce this predator to your area you must put two or

three of them with each pile of Giant Snail eggs that you find in the ground. This should be done during the wet season when the Giant Snail lays its eggs. Gonaxis introductions are not always successful.

3. Baiting: The use of methaldehyde bait is a cheap and successful means of local control of the snail. You can buy small quantities in garden supply and trading company stores all made up or you can make your own.

The best recipe for making your own bait is 1kg of sawdust, 1½kg cement and 10 g of methaldehyde mixed together with enough water to make a mortar (plaster that hardens). Form the mortar in to balls or blocks 2-4cm in diameter and let dry in the shade. The bait is placed every 2-4 metres around the garden or it can be easily crumbled and spread evenly around the garden. See the piles of dead snails the next morning near the bait.

4. Collect live snails and feed to animals. It is an excellent protein equivalent to many grades of fish meal. For ducks, break the shell and feed raw. For chickens, break the shell, cook the snail, and sun-dry before feeding. For pigs, cook the snails (since pigs can get disease from the parasites of the snail).

The pigs will soon learn to crack the shells with their teeth. Recipes for humans can be found in some cookbooks (Joy of Cooking), but the basis for all recipes is to place the snails in covered buckets without food for 5 to 10 days before cooking. Each day the shells should be washed in clean water.

Further references: Giant African Snail, A Problem in Economic Malacology, A.R. Mead, Univ. of Chicago Press, 256pp. 1961.

The African Giant Snail, Achatina fulica in the Pacific Islands, M. Lambert, South Pacific Bulletin, 4th Quarter 1974, Vol 24 No 4, pp35-40; "The Giant Snail", G.S. Dun, PNG Agricultural Journal, Vol 18, No 4, March 1967.

Note: Methaldehyde is available from the Planter's Association, Box 14, Rabaul. Cost about K3.50 per kg in 35kg drums.

Additional note: Biological predators have probably been introduced to your province already. If you want to try them in your village, check with the didiman before you write to Kerevat for help. Kerevat can collect snails from its own area and ship them, but it's easier to get them from places closer to you.

Remarks: Once the Giant African Snail is introduced to an area, there is no hope of getting rid of it. All the methods of control recommended here only keep the populations low enough so the damage is not too serious. Of all the methods, the one that gives the best control is to collect all available snails every day in the area close to your gardens and eat them.

Initial contributor: P.G. Hicks, LAES, Kerevat, ENBP.

PEST CONTROL - for technical assistance - the addresses of the DPI insect experts (entomologists) are:-

1. The Entomologist, Plant Industry Station Buba, DPI., Lae.
2. Entomologist, DPI., Popondetta NP.
3. Entomologist, Lowlands Experiment Station, DPI., Kerevat, ENBP.
4. The Chief Entomologist, DPI., Box 2417, Konedobu, CP.
5. Entomologist, Kuk Research Station, Box 339, Mt. Hagen, WHP.
6. Entomologist, Highlands Agr. Experiment Station, P.O. Kainantu, EHP.

G. Frohlich and W. Rodewald, Pests and Diseases of Tropical Crops and Their Control

Covers most pests and diseases of all important crops, detailed description and colour photographs of the most important pathogens and affected plants.

HANDLE WITH CARE

This book is loaded with technology, which, when applied without sensitivity, can do more harm than good.

## NEEDED: A PNG GRAIN POLICY.

IN 1972-73 PNG IMPORTED 22,930 TONNES OF WHEAT PRODUCTS WORTH 2.29 MILLION KINA, 61,656 TONNES OF RICE PRODUCTS WORTH 7.81 MILLION KINA, AND 6481 TONNES OF OTHER CEREAL PRODUCTS WORTH 2.68 MILLION KINA. ALTOGETHER MORE THAN 91067 TONNES OF CEREAL PRODUCTS COSTING NEARLY 13 MILLION KINA WAS IMPORTED. DURING THE SAME PERIOD PNG PRODUCED 909 TONNES OF RICE. THIS IS A CONSUMPTION OF MORE THAN 37KG OF CEREAL PRODUCTS FOR EACH MAN, WOMAN AND CHILD OF THE ESTIMATED 2.5 MILLION PEOPLE IN THE COUNTRY. IT ALSO REPRESENTS TEN PERCENT OF THE CARBOHYDRATE INTAKE OF THE COUNTRY.

NATURALLY, THE PEOPLE EATING MOST OF THE CEREAL PRODUCTS ARE URBAN PEOPLE OR PERSONS LIVING IN URBAN-TYPE ENVIRONMENTS SUCH AS INSTITUTIONS AND BOARDING SCHOOLS. EACH YEAR MORE PEOPLE ARE EATING MORE CEREAL PRODUCTS AND PAYING MORE FOR THEM: BREAD, RICE, TWISTIES, BISCUITS, AND BEER.

DESPITE HOPES THAT ROOT CROPS CAN ULTIMATELY FILL A GREATER PROPORTION OF THE FOOD REQUIREMENTS OF THESE PEOPLE, THE COUNTRY GREATLY DEPENDS ON IMPORTED CEREAL GRAINS. THE PRICES PAID AND THE AVAILABILITY OF THE CEREALS DEPEND ON WEATHER, WAR, POLITICS AND THE PRICE OF FUEL AND FERTILIZER IN THE PRODUCING COUNTRIES. PNG IS POWERLESS TO CONTROL ITS DESTINY IN THESE MATTERS.

THE STEADY INCREASE IN THE PROPORTION OF PAPUA NEW GUINEANS LIVING IN TOWNS AND CITIES WILL CAUSE A CORRESPONDING INCREASE IN DEPENDENCY UPON EASILY STORED, EASILY TRANSPORTED FOOD. IT IS IMPORTANT ALSO TO ASK WHETHER PEOPLE ARE MOVING TO CITIES IN ORDER TO BECOME DEPENDENT ON THESE STORED FOODS OR WHETHER THEY ARE DEPENDENT ON STORED FOODS BECAUSE THEY HAVE MOVED TO THE CITY. URBAN POPULATIONS IN PNG ARE INCREASING AT 8.5% PER YEAR AS COMPARED WITH THE POPULATION AS A WHOLE, WHICH IS GROWING ABOUT 3% PER YEAR. IF THIS CONTINUES, ONE FOURTH OF THE POPULATION WILL LIVE IN TOWNS AND CITIES BY 1986.

SINCE 1972-73 THE PRICE OF MOST CEREAL PRODUCTS HAS NEARLY DOUBLED. FOR URBAN FAMILIES AND INSTITUTIONS WITH A VERY HIGH PROPORTIONAL CONSUMPTION OF CEREAL PRODUCTS EVEN SMALL RISES IN THE PRICES CAUSE SEVERE HARDSHIP.

ISN'T IT TIME THAT WE THOUGHT ABOUT WHERE THIS DEPENDENCY ON IMPORTED GRAINS IS TAKING US? GRAINS SUCH AS MAIZE, RICE, MILLET, SORGHUM, AND OATS CAN ALL BE GROWN HERE AND MIGHT ALL PLAY A PART IN AN INTERGRATED APPROACH TO THIS PROBLEM. ISN'T IT TIME THAT WE DEVELOPED A NATIONAL CEREAL GRAIN POLICY TO LIMIT OUR DEPENDENCE?

## FOOD STORAGE

Farm products often have to be held for a while on their way from the producer to the consumer. Storage losses can be very great, so it is important to keep them in the best possible condition.

Insect damage is one of the main causes of loss. Reduce or prevent it by:

1. Drying the food or commodity properly;
2. Using suitable chemical insecticides strictly in the recommended manner;
3. Keeping the store house clean and dry;
4. Keeping the food or commodity in neat stacks away from the parts of the building;
5. Selling or disposing first of those goods that were first taken in;
6. Keeping old bags away from the stored goods;
7. Inspecting regularly and taking immediate action when problems arise.

Further notes on preparing and maintaining the store house:

1. The building should be waterproof and well drained.
2. The structure and floor should be swept clean.
3. Pallets on which the goods are stacked should be at least 15cm high.
4. After cleaning and every 2 months thereafter the building should be sprayed with 2.5% Malathion plus 1% Lindane. (This is made by putting 680ml of Malathion 50% together with 850ml of Lindane 16% in 14litres of water). Do not allow the spray to contact the stored products. Cover the stored products with a waterproof cloth or sheet when spraying. Apply 5 litres of this spray mixture per 9 sq metres of surface.
5. No machines, crates, or other objects should touch the building on the outside, and vegetation should be kept cut back to ground level for at least 3 m or 10ft all around.
6. The food or commodity should be stacked neatly on pallets, with a metre between each stack, never against the walls, and no closer than 1m to the roof trusses.
7. Sweep the storehouse daily; re-bag or get rid of any spilled goods; repair broken bags in the stacks as soon as they are noticed.

The Entomology Section, DPI, Konedobu can give further advice on materials and methods for controlling insects. BE CAREFUL! Some insecticides can make food unfit for people.

Initial contributor: J. Greve, DPI, Konedobu.

## INFORMATION BULLETINS ON CROPS

(P 244)  
DPI,  
AGRICULTURE RESEARCH CENTRE BUBIA,  
BOX 348,  
LAE.

Information Bulletins available free:

1. Soybeans (*Glycine max*)
2. Observations on Sunflower, Sesame, Safflower
3. Responses of Coconuts to Potash Fertilizer in Coastal Papua
4. Peanuts in the Markham Valley
5. Maize in the Markham Valley
6. Grain Sorghum in the Markham Valley
7. Soybean
8. Control of Dinitaria and Devil's Fia
9. Economics of Fertilizer Use in Coconuts
10. Sugar Cane
11. Maize in the Markham Valley
12. Sovahean
13. Grain Sorghum in the Markham Valley
14. Peanuts in the Markham Valley
15. The Locust Outbreak in the Markham and Ramu Valleys 1973 - 75.
16. Rice
17. Stored Products
18. Important Pasture Weeds particularly in the Markham/Ramu Valleys
19. Hybrid Coconuts
20. Grain Sorghum in the Morobe and C.P.
21. Peanuts in the Markham Valley
22. Maize
23. Soyabean

Lowlands Agricultural Experiment Station,  
Kerevat, ENB.

The following Information Bulletins are available free from the Agronomist-in-Charge, LAES, Kerevat.

Available in both English and Pidgin.

- No 1 Tok save long wok long Didiman long Kerevat. (The Lowlands Agr. Experiment Station)
- No 2 Marasin bilong kilim dai ol Demdem. (Baits for Giant African Snails)
- No 3 Nupela Pikinini kon bilong planim. (Superior Corn Varieties now Available)
- No 4 Han Kakao. (Cacao Cuttings)

- No 5 Rot bilong kisim ol kain pulbul na pikinini prut na kaikai belong planim I kam long didiman long Kerevat. (Planting material available from LAES)
- No 6 Save long ol banana bilong yumi. (Know Your Bananas)
- No 7 Nupela pasin bilong kirapim kokonas - planim long bek plastik. (Coconuts, Polybag Nursery)
- No 8 Wokim bilak pepa tasol. (Make Black Pepper, Not White)
- No 9 Mekim painap I karim prut. (Making Pine-apples Fruit)
- No 10 Tok save long ol kainkain marasin. (Pesticide Labels)
- No 11 Kilim dai dilakpela binatang I save bakarapim ol kokonas. (Control of the Indigenous Rhinoscerous Beetle in Coconuts).

HIGHLANDS AGRICULTURAL EXPERIMENT STATION,  
AIYURA, VIA KAIMANTU, EHP.

Bulletins available:

1. "Tok Save Long Arabika Kopi", van Horch, Kimber, and Teke, 18pp. 1975.
2. "Tok Save Long Stroberi", by W. Teke, 10pp. 1976.
3. "Prospects for Grain Sorghum, Maize and Soybean in the Highlands", A.J. Kimber 5pp.
4. "The Development and Utilization of Root Crops in PNG" by A.J. Kimber, 8pp.

OTHER BULLETINS ON CROPS ARE LISTED IN THE "GENERAL REFERENCES" SECTION UNDER THE VARIOUS ORGANISATIONS PRODUCING LITERATURE.

(P 244) (P 246)

## SOME BOOKS ON CROPS

East African Crops, by J.D. Acland, Longmans 252 pp. K2.40 at the University Book Shop, Port Moresby.

A Manual of plantation and field crops with good illustrations, simple English, and details for management. Suitable for High School Teachers and advanced Didimen.

Guide for Field Crops in the Tropics and the Sub-Tropics USAID. Free.

This well illustrated but abbreviated guide to growing cereals, beans, oil plants and root crops should be considered an introduction only and recommendations should be tested for PNG conditions. It is free from the Office of Agriculture, Technical Assistance Bureau, USAID, Washington, DC 20523, USA.

> Root Crops, Digest No 2, by Tropical Products Institute, 56/62 Gray's Inn Road, London WC1X 8LU.

A well-organized manual on production and utilization of nearly fifty root crops. Gives clear instructions for processing many crops so that the starch can be stored. Good for libraries. Of limited use for fieldworkers.

Underexploited Tropical Plants with Promising Economic Value, National Academy of Sciences, Washington DC, 1975, 188pp, free on request.

Of marginal value for community-level workers, as it simply outlines areas where further research is needed. It tends to speak in relation to commercial scale production. Though suggested by some readers, we cannot recommend it for village oriented people.

LOCALLY GROWN PLANTING MATERIALS MUST BE THE FOUNDATION FOR VILLAGE GARDENING.

THE LOCAL WORKER SHOULD NOT EXPECT THAT A REGULAR SUPPLY OF SEEDS CAN BE PROVIDED TO THE VILLAGES FROM OUTSIDE. EVEN LARGE GOVERNMENT OR COOPERATIVE-SPONSORED PROGRAMMES FOR FRESH VEGETABLES HAVE PROBLEMS SUPPLYING PLANTING MATERIALS.

EVERY VILLAGE WILL HAVE AN INVENTORY OF ECONOMIC PLANTS WHICH CAN BE READILY IDENTIFIED BY SOMEONE WHO WILL ASK ABOUT IT. MY EXPERIENCE INDICATES THAT THIS INVENTORY MAY INVOLVE FROM 50 TO 100 ITEMS IN THE TYPICAL PNG VILLAGE. IN MOROBE PROVINCE WHERE I LIVE IT IS PROBABLY AROUND 75.

THIS INVENTORY IS NOT FIXED; BUT IT IS SLOW TO CHANGE. IT INVOLVES CONTINUOUS PLANT PROPAGATION. FOR A PLANT TO BECOME NUTRITIONALLY SIGNIFICANT AT THIS TIME AT THE VILLAGE LEVEL, IT SHOULD REALLY BECOME A PART OF THIS BASIC LOCAL INVENTORY. THIS WOULD EXCLUDE IMPORTED HYBRID SEEDS, AND PLANTS WHICH ARE VERY DIFFICULT TO PROPAGATE TRUE TO TYPE. IT WILL EXCLUDE PLANTS WITH SEEDS OF LIMITED VIABILITY.

NEW "FINDS" THAT ARE REASONABLY EASY TO PROPAGATE AND THAT ARE OF CLEAR VALUE WILL BE GROWN AND SAVED. NEW PLANT OPTIONS SHOULD BE PRESENTED CLEARLY, WITH DEMONSTRATIONS NOT ONLY AS TO HOW THEY ARE GROWN, BUT ALSO HOW THEY ARE EASILY AND ADVANTAGEOUSLY USED.

## PLANT IDENTIFICATION

The Division of Botany, Office of Forestry, Department of Primary Industry, (Box 314, Lae) has a plant identification service. If you want to find out the name of a certain plant, you can send part of that plant to Lae and the Division of Botany will write back with scientific and common name. The reply is usually quite quick. They can identify food crops, weeds, pastures, poisonous and wild plants or whatever you send.

For grasses and small plants, send leaves, stems and flowers. For shrubs and trees, send a twig

with leaves and flowers or fruit on it. All specimens must be dried between newspapers before sending them.

You must tell them; who collected it; the exact place of collection; when it was collected; the sort of plant it is; and what you want to know about the plant. Do not ask for all the information they have on a plant, but just what you need to know, such as, is this a good pasture plant? Is it poisonous?

They will also tell you where you can find out more about the plant if such things have been published.

*Esmay low cost seeder for planting. Available from Tutt Bryant Port Moresby for K40.*



## HAND SEEDERS

Planting large areas of ground by hand is very expensive if you have to hire labour. If you don't have tractor-driven planters to hire, here are two kinds of hand seeders that can plant very large areas of ground. They are useful for rice, sorghum, corn, peanuts and beans, as well as vegetable crops.

The first is called the Planet Jr. type. It is a rugged design that has been used for more than a hundred years. As the tool is pushed, like a wheel barrow, the seed falls through a hole in the bottom of the box. The hole can be made bigger or smaller depending on the kind of seed. As the big wheel turns it causes a door to open and close so that the seed is spaced at the right distance. In the ground one part of the tool opens a furrow, the seed falls into the furrow, and then another part covers the seed. The back wheel packs the ground for good germination. It will work even on rough, trashy soil.

The Esmay seeder is a lightweight aluminium and plastic tool, and does the same work as the Planet Jr. It isn't quite so rugged, but it is easier to use. The drive wheel turns a plate that picks up the seed from the hopper and drops it into the soil. For different sized seeds use a different plate - six come with the machine. There are no metal parts to rust and the seed is not damaged by the opening and closing door.

Tutt Bryant sells both kinds. The Planet Jr. costs about K150 and the Esmay about K40.

## MORE NUTRITION FROM OUR FARMING

How may we maximize the nutritional returns from our efforts in agricultural improvement? Some activities clearly have a far bigger nutritional payoff than others, and some are largely irrelevant to immediate village nutritional needs.

In dealing with the problem of insufficient food intake, with children especially in mind, we might recognize the following aspects of the problem:

(1) Many villages are simply not producing enough food. They may or may not recognize this, as (2) the traditional low fat staples are extremely bulky foods. Persons, children, especially, may feel full without really getting enough food; and (3) cultural factors may be a significant contributing cause in the problem, as, for example, in many groups the men eat first, the women and children last, with the smaller children often having the very last choice.

In spite of their bulk, traditional staples such as kaukau, taro, bananas and yams still have the greatest potential for supplying carbohydrates at the village level on a regular basis. Even a proportionately small improvement in the production and/or utilisation of these would result in the availability of thousands of tons more food across the country. Conversely, activities which might distract attention from production of staples for family use could have serious negative effect. Some persons now claim that producing fresh foods or non-foods such as coffee or tea for cash may in some areas actually decrease the size of the nutrition package available to the family. It is not easy in PNG to demonstrate that access to cash brings better nutrition. A multi-level long-term educational effort should obviously be coupled with technical and economic promotion.

Hopefully, we will see some gradual shift in local customs in favour of the better nutrition of children. Education efforts among women should be given highest priority.

Vitamins are generally not deficient in PNG diets at the village level, so strong emphasis on green leafy vegetables does not need to be made, especially for introduced varieties. A broad range of native leaves and fruits rich in various vitamins can be found in most villages.

Due to cultural factors and the usual manner in which they are utilized, growing more pigs or cattle at the village level might have little effect on the regular diet of the average villager. This doesn't mean that we would discourage the promotion of pigs or cattle, but that these should be put into their proper perspective. The nutritional payoff of these will vary greatly from place to place, depending upon local customs, availability of government inspectors, access to abattoirs, access to markets.

Growing more chickens or ducks for either eggs or meat might bring positive direct nutritional results. Though they produce fewer eggs, native hens are a better risk if the farmer insists on "self-support". Introducing an improved-breed rooster may have beneficial effect on egg production. The regular practice of scattering a few seeds (such as sorghum,



sunflower, maize) near the house in the early morning or late afternoon will help their diet and remind them where "home" is. Farmers who are obviously more progressive and who have access to baby chicks and good feeds might be encouraged to start a small poultry unit on a business-like basis with the birds confined.

In coastal and swamp areas where fish and other sea-foods are plentiful, insufficient protein may only be an occasional or seasonal problem. Simple preservation techniques like salting and smoking might have significant effect in making these foods more widely available, both geographically and seasonally. Though this is not "agricultural", it is related to agricultural strategy.

Legumes in the form of dried beans offer one of the greatest opportunity areas in PNG nutrition, and more attention is now being paid to them. They especially lend themselves to recipes for infants and children. Based on experience in other countries in the Western Pacific, on World Health Organization papers, and on my own experience elsewhere under similar agro/economic conditions, we might best focus on three: peanuts (*Arachis hypogaea*), soybeans (*Glycine max*); and mung beans (*Phaseolus aureus*). Every rural worker should try these and evaluate them locally. Some workers would put winged beans and cowpeas ahead of the mung bean for PNG, but it is really an open question. (p 229)

In addition to the "big three" mentioned, depending upon local conditions, the following might be very useful in PNG: winged beans (*Psophocarpus tetragonolobus*) cowpeas (*Vigna unguiculata* spp.), kidney beans (*Phaseolus vulgaris*), Lima beans (*Phaseolus lunatus*), peas (*Pisum sativum*), and field beans (*Dolichos lablab*). All of these can fit very nicely into crop rotations, and can have beneficial side effects for the other crops.



## A STEP AT A TIME

If the farm and the farmer do not develop together then there will be trouble. We can compare the development of a farm with a man climbing stairs. If the man takes one step at a time he will climb the stairs safely. If he tries to run up the stairs or to jump two or three stairs he is likely to trip and fall over. It is like this with farmers. The problem is that extension advice often encourages farmers to jump a number of stairs. We often tell farmers about starting intensive piggeries with expensive housing before they are able to understand the basic simple improvements, especially better feeding. Field experience shows that farmers who adopt higher practices before they experience and master the bottom steps usually fail and waste a lot of money.

For example, here are some stages in the development of a pig project:-

1. Traditional - Sweet potato supplement, night housing.
2. Semi-intensive - Protein supplement, pig-proof fencing, legume grazing crops, rotational grazing, rotational cropping, controlled breeding, culling, "Nilverm" for parasites, boar paddock, Anthrax vaccination.

3. Intensive - Intensive housing, permanent water, protein concentrate, planned food crops for pigs, pen hygiene, balanced diet, waste disposal, culling of breeding stock.
4. Intensive (commercial) - Breeding records, grade boar, two litters per year, financial records, purchased feed, feed mixing machinery, feed storage, permanent material housing, piped water, marketing arrangements, separation of stock classes, weighing equipment.
5. Advanced - Modern scientific farming. Detailed performance records. Artificial insemination; employed geneticist, large scale, air conditioned buildings etc.

Some of the practices that can be introduced to improve pig husbandry are more important than others. We call these KEY Practices. Some key practices are:

- a. Protein Concentrate Supplement: an adequate protein intake is very important for improving pig husbandry. It is no use going on to introduce more complex practices if the protein content of the diet is not high enough.
- b. Pen Hygiene: as you get more and more pigs living closely together disease becomes a problem. Permanent water supply, concrete pens, and regular additions of litter to keep litter systems are required. These key practices are difficult to introduce: Farmers are often interested in introducing things which will give them status, such as an impressive pig house;

It is difficult to demonstrate that these key practices are in fact necessary (for example, the farmers may really believe that sweet potato is the best feed;) and

Extension officers might not see the importance of these key practices themselves. When they demonstrate "better" pig husbandry they usually think of a "model piggery." This model is usually an intensive piggery with expensive housing. When the farmer looks at the demonstration the most obvious thing he can see is the housing, not the feeding. The demonstration is not really showing the key practices to the farmer.

- c. Records: Many of the practices which can be introduced to improve breeding and nutrition are dependent on having records of what is happening on the farm. These include performance records (such as breeding records, weight gains) and financial records.

(from "Pig Handbook", D.A.S.F. Rural Development Series Handbook No. 5.)

# LIVESTOCK

## Poultry

### CHICKENS

### KAKARUK

Scientific name: Gallus domesticus

Nature of products: Eggs, meat

Size or age at maturity: Broilers for meat are usually killed at 9-10 weeks at about 1600g.

These are improved breeds. Layers usually start giving eggs at 24-26 weeks of age (improved breeds).

Normal productive life: Layers usually give economic production for about 12 months after they begin laying, or up to 18 months of age. (improved breeds).

Breeds available: Rhode Island Red, Australorp, Sussex, White leg horn.

Chickens most readily available at present are a "Hyline" meat bird and "Hyline" layer from Ilimo Farm Products, Pty. Ltd., Box 1885, Boroko. The Australorp, a relatively hardy, all purpose breed, are available from the Poultry Research Centre, Lae.

Feeding: Commercially, day-old chickens require a 20-21% protein feed. (up to 6 weeks). Then from 6 weeks to 24 weeks 15% protein ("grower" feed). The laying hen requires a well-balanced feed containing about 16% protein. (P 167)

In the village, the birds usually find much of their own food, and production is usually much lower. Feeding a little sorghum or corn, or better still some dried legumes or sunflower seeds, will help to increase their productivity.

Breeding, hatching, handling of young: roosters are not necessary for hens to lay eggs. But roosters must run with the hens if you want the eggs to hatch into baby chicks. If you want a commercial poultry project you should probably buy your chicks direct from a hatchery. For village poultry keeping, allow the hen to sit on her own eggs, and provide a secure place for her. Eggs require 21 days of incubation to hatch.

Baby chicks need a uniform mild temperature until they are 6 weeks old. In nature their mother's body heat provides warmth. When chickens are raised "artificially" an electric bulb or kerosene lamp is good. In this case provide an enclosure to conserve the heat and a guard around the lamp to prevent burning of the young birds.

Housing: In a semi-commercial system only about .25 sq.m per bird are needed, and may be made of bush materials. (For 10-12 hens and a rooster, for example, a house 1.5m x 1.5 or 2.0m will do). Have a nest for every 3 birds, some roosting space, a feed trough, and a water trough. (P 168)



For commercial broiler production housing allow .1 sq.m per bird. Allow 56cm of feeding space per 10 birds and 28cm watering space per 10 birds.

At village level "colony" type housing is of interest. A small bush materials house is provided, such as a small "A" frame house with bamboo slats on the ends. The birds are kept inside all morning, when they lay some eggs; are released at noon so that they are able to hunt for food; and are fed some grain or seeds in the house at late afternoon, then locked up for the night. (P 168)

"Deep litter" is a popular management of the poultry house in PNG: The house must be kept dry; must not be over-crowded; and the litter (any dry materials such as coffee hulls, rice hulls, sawdust, chopped dry grass) must be turned about once a week. Advantages: it is cooler in hot weather, warmer in cool weather; birds like to scratch in it; droppings combine with the litter for less smell, less flies; deep litter is valuable fertilizer.

Most common diseases: Coccidiosis - prevent by using medicated feed or water; Leucosis - prevent and cure with feed medicated with aureomycin; Vitamin and mineral deficiencies: Fowl Pox - vaccinate, as there is no cure.

Sources of supply for breeding stock: Australorp from Poultry Research Centre, Box 348, Lae. Order these through your Provincial Livestock Officer with DPI in your province.

Ilimo Farms supply only hybrid birds which are excellent for production, but which should not be used for breeding. If you are near an agricultural school you might obtain improved breed chickens in small quantities. In the Western Highlands try the Lutheran Agricultural School and CLTC both in Banz.

References: Pigs and Poultry in the South Pacific, Watt and Michelle, may be purchased at leading PNG Bookstores.

cont'd



Poultry Handbook. DPI Rural Development Series Handbook No 4, 1974, 73 pp. order from Coordinator, Rural Development Series, Publications Section, DPI, Box 2417 Konedobu (prepared for DPI Field Officers).

Poultry and Pigs compiled by Dale Busse, 1975, Balob Teachers' College, Box 80, Lae. Prepared for training teachers, may be made available upon special arrangement. Write direct.

Important terms: Layer: an adult female bird  
Rooster: an adult male bird  
Pullet: an immature hen, 6-24 weeks of age  
Chicken: bird up to 6 weeks age  
Nest: a box where a hen lays her eggs  
Brooder: a source of heat for young chickens  
Broiler: a kind of bird especially bred and grown for meat production  
Roost or perch: a piece of wood where the bird sleeps.

## DUCKS

## PATO

Scientific name: Mallard: Anas platyrhynchos  
Muscovy: Cairina moschata

Product: Meat, eggs, feathers, down

Size: Males 4 - 5.5kg; females 2 - 4.5kg

Age to breeding: Ducks 6.5 months

- Muscovies: 7.5 months

Normal life span: 3 years

Breeds available: for meat - Muscovy, Pekin, Aylsbury, Rouen, for eggs - Indian Runner, Khaki Campbell

Description: Ducks are web-footed birds that like to live near water. They can move quickly in water, but their legs make it difficult for them to move on land. They have large heads, slender necks and broad-bills with tiny saw-like teeth on the edges, that helps them to pull weeds and grass. They have an oil gland above the tail to waterproof the feathers. Domestic ducks have lost the ability to fly. They are often easier to look after than fowl but they still require good feed and management.

Muscovies are not true ducks, but are probably a cross between a swan and a duck. They are better parents than true ducks and are slightly hardier.

Most ducks in villages are Muscovies. They are easily recognized by the enlarged hairless skin on the face of older birds.

Feeding: Ducks do well eating grasses like paspalum, panicum, setaria or soqeri with legumes, and eat insects, snails, frogs and fish. Some flocks of Muscovies have learned to break the shell of dem-dems on their own. Ducks do well on chicken feed but should also have greens or kaukau. While ducks will grow well without added feed, regular feeding each evening will keep them near the house, and chicken feed will help them to lay many eggs. Ducks are messy feeders and it is necessary to take special care in a duck house.

Breeding: Muscovy eggs take 35 days to hatch. True duck eggs take only 28 days to hatch. Muscovies will breed with true ducks but only a few of the eggs will hatch. Ducks from those eggs can not have offspring. One male (the drake) for each 5 females is enough. Muscovies are very good setters, and will hatch the eggs of other birds that are forgetful. A duck will raise more young if the newly hatched ducklings are raised artificially like baby chickens.

Housing: A simple house like those for chickens is enough, but special care is necessary to see that they cannot spill the water on the litter. Ducks lay their eggs in the morning and should be kept in the house until about 9am. Young ducklings should be kept in the house until they are four weeks old and large enough to avoid being eaten by crows and eagles. Although ducks like water for swimming, they do not need it. They should have water troughs deep enough to put their heads under water since they need to wash their eyes regularly.

Diseases: Ducks are more resistant to coccidiosis than chickens, which is one reason that they are hardier. They can get food poisoning, so special care is needed to keep food and water containers clean.

Sources of supply for breeding stock: Many missions and schools keep ducks. Both ducks and Muscovies can be got from Vudal and PATI, as well as from Ilimo Farms, Box 1885, Boroko; Bible College, Evangelical Brotherhood Church, Box 324, Lae; DPI Poultry Research Centre, Box 348, Lae, but order through your own provincial livestock officer.

Remarks: When catching ducks or Muscovies hold them by the wings, not by the legs. Muscovies are ready for eating at 14-16 weeks when they should weight about 4kg. Well managed ducks (not Muscovies) can produce more eggs a year than chickens, but good management is difficult. Muscovies seldom give more than 60-90 eggs depending on their age.

Initial contributor: D. Busse, Balob, Box 80, Lae.  
Updated by: R. Weber, PATI, Box 131, Popondetta, NP.



## GEESE

Scientific name: *Anser anser* (except Chinese goose)  
Product: Meat, feathers, down  
Size: 6-8kg  
Age to breeding: 1 year  
Normal life span: 20-30 years

Description: Geese are larger than ducks, have longer necks, make a loud honking noise and are good "watch dogs". They have heavy down feathers under the big feathers which can be plucked for soft pillows and mattresses. Like ducks they have oil glands near their tail for oiling the feathers. They are cautious, not "silly". They are very intelligent. They are able to protect themselves very well, with their wings and bill used as weapons. They have lost their ability to fly long distances.

Breeds: Although there are many breeds of domestic goose, the best for the tropics is the Chinese goose since they breed easily in the tropics and lay eggs all year round. Other domestic geese need a cold period before breeding.

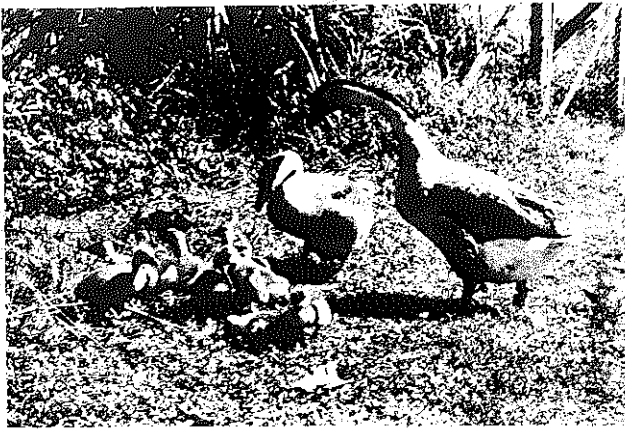

Male and female Chinese Geese with their babies (goslings).

Uses: Geese are usually raised for meat. The offspring of a pair of geese will provide 45-70 kilograms of fatty meat a year. The down feathers may be plucked from both the live geese (carefully!) and dead geese to be used for pillows and blankets. Since they eat mostly grass, some farmers use them for weeding crops, if the crop is not attractive to the geese.

Habits: Geese need free access to grass and other edible leaves. They will also eat insects, small water animals, vegetables and grain. The grass eating habit makes them a good lawnmower. They eat little bits all day. Geese like water but do not need it for breeding. The female lays 3-6 eggs at a time, and will raise as many as 6 families a year. One male (called a gander) is needed for every 2 or 3 females. Usually geese mate for life.

Housing: Is not required for geese in small numbers.

Sources of supply for breeding stock: Some mission stations and high schools have geese, and they can

be purchased for breeding purposes from HATI, PATI, and Vudal and the DPI Poultry Research Centre Box 348 Lae.

References: *Ducks and Geese in the Tropics* by A.G. Wancn, *The Complete Poultry Book*, by W. Powell - Owen, Cassell, London.

Initial contributor: D. Busse, Balob, Box 80, Lae.  
Updated by: R. Weber, PATI, Box 131, Popondetta, NP.

## GUINEA FOWL

Scientific name: *Numida meleagris*  
Products: Meat and eggs  
Size: 1 - 1.5kg  
Age to breeding: 12 months  
Normal life span: 6-8 years  
Breeds available: Peal Guinea

Description: Guinea fowl are from Africa, and are wilder than most domestic fowls. They have dark grey feathers with small white spots and a bare head and neck. The small head has a bony ridge called a casque on top. The short tail usually points down. The eggs are smaller than chicken eggs and are pointed at one end. They will lay 40-60 eggs a season, but as many as 100 under good management. They like to hide their eggs in a corner with bushes. The chicks are brown with red beaks and legs. White guinea fowls are all white from hatching. Males are difficult to tell from females but normally has a cry sound like "chee-chee", the female sounds like "buckhead-buckhead". The male often walks on tip-toes.

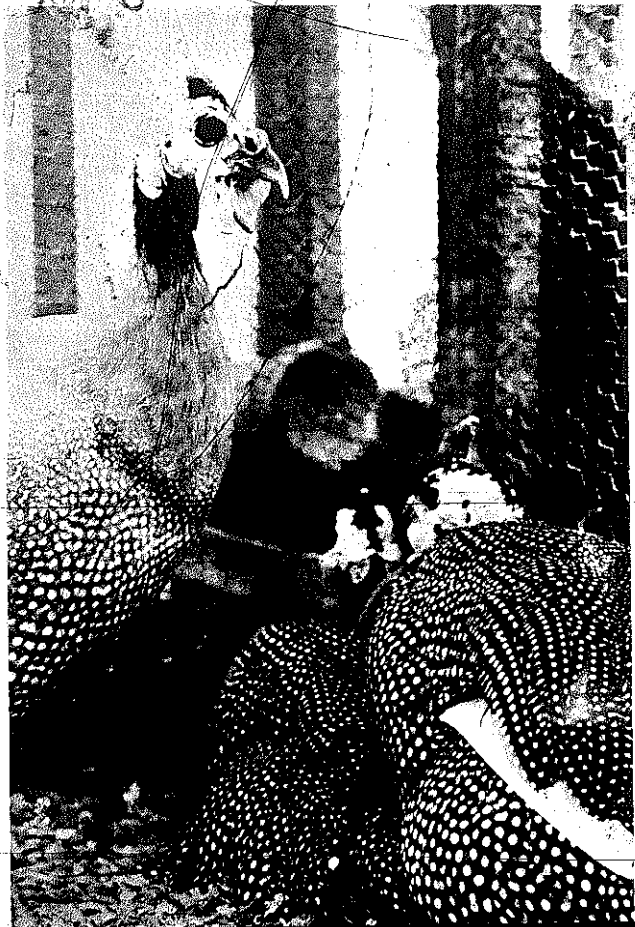

**Habits:** Guinea fowl are often hard to manage. They like to fight with themselves and with other birds, and they are very brave, and will attack animals that are dangerous to them. They like to follow a leader and will play, fight or run as a group. Guinea fowl can fly, although even in the wild they do not fly far. They like to roost on high branches and are hard to catch during the day. Chicks are able to get to high perches at 8 weeks.

**Management:** Adults are very strong and do not get sick often. Chicken feed or kaukau in addition to foraging will help them to grow faster or lay more eggs. They should be fenced or they may go wild. The best way to keep them in a fence is to clip the feathers of one wing so that they can't fly over a fence. Chicks should stay inside a house until they are 3-4 weeks to protect them from hawks and wet weather.

**Sources of supply of breeding stock:** DPI Poultry Research Centre, Box 348, Lae, and PATI, Box 131, Popondetta. (only small flocks are available at this time).

**Initial contributor:** D. Busse, Balob, Box 80, Lae.

## PIGEONS

**Scientific name:** *Columba livia*  
**Age to first breeding:** 5-6 months  
**Age to maturity:** 5-6 weeks  
**Expected life span:** 12 years and up  
**Weight at maturity:** 700g  
**Breeds available:** King Pigeon (meat)

**Description:** The pigeon is raised both in temperate and tropical zones as a meat bird, because it likes to stay close to its home and therefore requires no fencing. Specially trained pigeons are used by military and postal services for delivering messages, - and regularly fly over distances of more than 1500km back to their home.

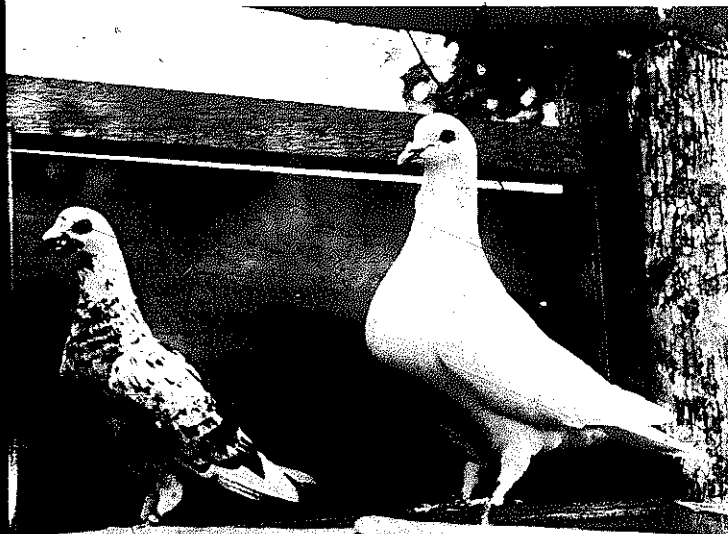

Female homing pigeon (left) and male King Pigeon. Note the great size and high forehead of the male.

## BREEDING:

**Housing:** Any waterproof house that is cool and easy to clean is suitable. Nesting shelves should be placed in dark corners about 20cm by 20cm with short walls on three sides to keep eggs falling off.

To keep the cats, dogs and snakes out of the pigeons it is better if the house is on-leqs.

**Feeding:** Like all poultry, pigeons in houses require a balanced diet. Poultry feed is suitable.

**Diseases:** There are few diseases of pigeons in PNG. Worms, lice and coccidiosis (diarrhoea) can be expected, and the treatment for chickens is suitable for pigeons.

**Sources of Breeding Stock:** PATI and private breeders in Lae, Rahaul and Port Moresby.

**PNG Experience:** Snr. Livestock Lecturer, PATI, Box 131, Popondetta, but very little has been done so far.

**References:** *Keep Your Pigeons Flying* by L.F. Whitney, Faber, London; *Pigeon Racing*, F.W.S. Hall, Arco Mayflower, London; *Pigeon* B. Thornton, EP Group of companies, London.

**Remarks:** Indigenous wild pigeons of the *Ducula* species are a popular meat bird. On Tench Island, New Ireland Province, wild pigeons are fed on coconut and other scraps in the village area, and the pigeons quickly lose their fear of man. In time they become too fat to fly and shortly afterwards they are invited to a sinasing.

Pigeon raising has not yet become widespread in PNG, but it is popular in many developing countries as a meat source because it requires very little effort.

A Goura pigeon on the New Guinea mainland is protected under PNG law. This means that only Papua New Guineans may hunt them, and they can hunt only with traditional weapons and only for traditional purposes (not for selling).

**Initial contributor:** R. Weber, PATI, Box 131, Popondetta, NP.

## TURKEYS

**Scientific name:** *Meleagris gallopavo* (for domestic turkeys descended from North American wild turkeys)

**Products:** Meat, feathers, eggs.  
**Size:** Hen to 7kg; Tom to 12kg, 1.2m long  
**Age to first production:** 8 months - laying  
 6 months - meat  
**Normal productive life:** 4 years  
**Breeds available:** Bronze Wing and White

**Feeding:** Poultry ration is too low in protein for young turkeys (poults) and too low in vitamin A, D, R<sub>2</sub>, Calcium and Phosphorous as well. For raising in houses special feeds or feed supplements are required.

**Breeding:** One gobbler needed for each 10 hens. The hen will lay 22-28 eggs before nesting. Incubation is 26-28 days. Keep gobbler away from eggs as he will try to break them.

cont'd

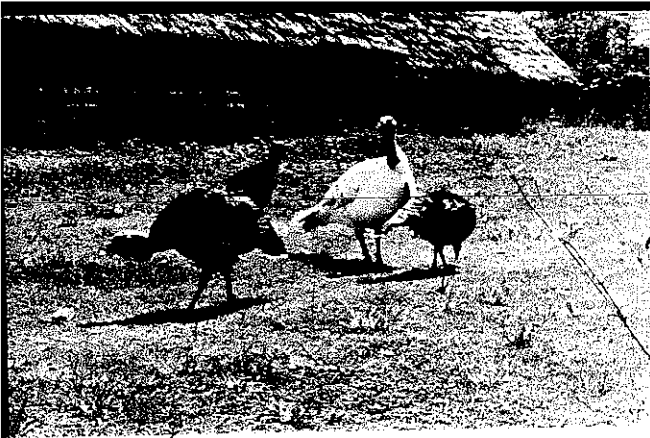

White and Brownwing turkeys

**Housing:** The difficulty of providing a balanced food for turkeys in PNG means birds should be allowed to run about to supplement any feeding. Dry housing is necessary to protect turkey from wet weather.

**Diseases:** Turkeys catch cold very easily, and are generally more susceptible to disease than chickens.

**Sources of breeding stock:** PATI, Box 131, Popondetta; and scattered flocks in the highlands and NP.

**PNG Experience:** PATI, various missions, schools.

**Further reference:**

**Remarks:** Turkeys are not considered intelligent birds, and will get excited very easily. Turkey eggs are larger than duck eggs, and a hen will lay year round in the tropics and produce up to 80 eggs per year.

**Initial contributor:** D. Busse, Balob, Box 80, Lae, MP. Updated by R. Weber, PATI, Box 131, Popondetta, NP.

## Animals

### PIGS

### PIK

**Scientific Name:** *Sus scrofa* (The European Hog, from which domestic hogs are largely descended). The PNG native pig is probably a descendent of *Sus vittatus*.

**Nature of Products:** Meat; leather for shoes, hand bags, gloves, and other leather goods, hair for brushes; glue, soap; medicines.

**Size when mature:** A native pig will usually reach about 50kg under village conditions, 75kg under intensive feeding; an improved breed pig will weigh at least twice that in 9 months. An improved breed female may be mated at about 9 months or at least 120kg weight. 55 to 70kg is a typical weight range for a town meat market.

**Normal productive life:** Meat animals should be sold or slaughtered when the feed consumed no longer produces at least an equivalent gain in value of the animal. Breeding animals may be used for 4 to 5 years, after which time they should be replaced.

**Breeds available:** Bush native pigs, Berkshire, Tanworth, Large White, Landrace, Crossbreds.

**Feeding:** Feeding is the most important factor in pig production. Quality and quantity of protein is the major challenge confronting the farmer.

Weight range	Class	Protein required
3-30 k	sucker	22%
30-60	weaner	18%
60-140	porker	16%
140-180	baconer	14%

(p 169)  
(p 68)

**Sows that are pregnant or giving milk to their piglets need as much protein as baby pigs.** Access to green feeds and soil will help to ensure that the pigs will get minerals and vitamins. Plenty of fresh clean water is necessary.

**Breeding:** Use the best animals for breeding. Breeding animals must not get too fat. Mate gilts at 9 months or older, 120kg in weight or more. The heat period (oestrous) lasts 3-4 days. Breed on 2nd day. The cycle is 21 days. One boar can service 15-20 sows. The period of gestation is 114 days (3 months, 3 weeks, 3 days). A sow will come into heat about a week after her litter has been weaned. 7 or 8 piglets raised successfully to weaning is considered a good sized litter. Do not use a boar before 9 months of age. Two litters a year is considered normal.

**Farrowing:** Keep sow separated from other animals. Piglets occasionally require assistance in clearing membranes away from face, otherwise sows usually have little difficulty and should be left alone. Provide young piglets with solid food after 3-4 weeks, and if sow is not a good milk-producer, after one week.

**Housing:** A pen 9 square metres in size is adequate for: a sow and her litter; or up to ten porker pigs; or 2-3 sows. A boar's pen should be at least 5sq m. if the sow is brought to him. There is much flexibility in how the housing is designed. The best floors are concrete with plastic vapor barrier below, or deep litter. (p 169)

**Most common diseases:** Parasites (prevent through cleanliness and by using pig "wormers"); Pneumonia (provide warm, sheltered housing, protect against parasites); Anthrax (prevent by vaccination, cure with antibiotics).

cont'd.

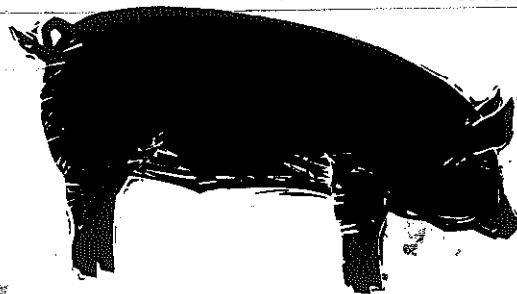

Sources of supply of breeding stock: Consult your nearest DPI Office.

Further references: Books - Pigs and Poultry in the South Pacific, Watt and Michelle, available in leading PNG bookstores.

Pig Handbook DPI Rural Development Series, Handbook No. 5, 100 pp. 1975, order from Publications Section, DPI, Box 2417, Konedobu.

For specific technical questions, write: Mr. Ian Watt, DPI, Pig Breeding and Research Centre, Goroka, EHP.

Terms:

Baconer: a pig suitable for curing ham or bacon  
Balanced ration: a good ration which contains all that the pig needs

Barrow: a castrated male pig

Boar: a male pig

Creep area: an area of the house only for piglets, with small entrances so that only piglets may enter

Farrow: to give birth to piglets

Gilt: a female pig before she is ever mated

Oestrus or heat: the time when a female is ready to be mated

Piglet: a pig still sucking milk

Porker: a pig suitable for fresh meat

Sow: a female pig

Wean: to separate piglets from the sow

Weaner: a weaned pig

Related housing and equipment (p. 168 - 170)

Remarks: If you use snails for protein supplement, be sure to cook before feeding to pigs.

A herd of Brahman beef cattle

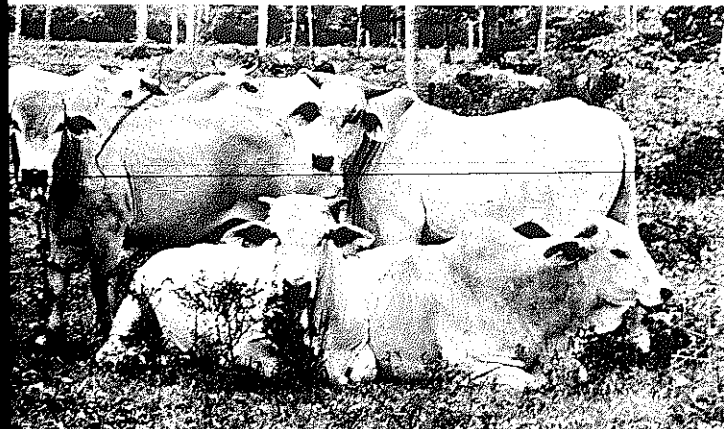

## BEEF CATTLE

## BULAMAKAU

Scientific name: *Bos taurus*, *Bos indicus*  
Products: Fresh meat, dried/salted meat, leather  
Size: Males 550-800kg at maturity; females 325-500kg at maturity.

Age at breeding: Males, two years, 350kg; Females, 1½ - 2 years, 225kg. Do not use for breeding at low weights or the animals will not bear as many calves.

Normal productive life of cattle is ten years.

Breeds available: Brahma, Droughtmaster, Javanese, and Brahman crosses with Angus, Hereford, etc.

Feeding: Graze animals on kunai at a rate of one beast to two hectares, on kangaroo grass at the rate of one beast to 4 hectares. Improved pastures with better grasses and legumes can be stocked at 1 beast per hectare. For feeding animals kept in a pen you will need 50 to 75 kilograms of grass and 50 litres of water a day. Salt blocks or mineralized salt blocks should be provided.

Breeding: A cow is able to conceive (oestrus cycle) every 18 to 21 days, and it takes 280-290 days until birth (gestation). Brahman cattle take longer. Birth takes 3 hours from the beginning of hard labour, and one hour from the appearance of the feet of the calf. If the calf is not born in this time help will be needed. Treat the navel of the calf with screw worm smear daily until well-healed. One bull is needed for every 20 to 30 cows.

Housing is not needed for cattle but there must be shade.

Diseases and pests: (1) Screw worm enters cuts and sores. Apply smear daily to all cuts until healed. Check cattle every few days for new cuts. All parts of PNG. (2) Liver flukes: Use 'Zanil' drench (ICI) every eight weeks in the highlands where flukes are found. (3) Round worms: use 'Nilverm' (ICI) drench every eight weeks in the highlands.

Buying and moving cattle: To get cattle you should either contact the Provincial Livestock Officer at DPI or purchase from other cattle raisers. You must have a permit from the Provincial Livestock Officer to move cattle. Bulls cost about K400, cows about K120-K150, and heifers about K90-K150. The higher prices would be for pregnant animals.

Further references: Keeping Cattle in PNG, DPI, 5 vol. Free, English & Pidgin, 16-20 pages each booklet; Beef and Dairy Cattle in the Tropics

Training: Farmer Training Schools at Erap, Urimo, and Baiyer River. For information contact Provincial Livestock Officer.

PNG experience: Cattle raising has been successful in nearly all districts in PNG. Cattle have been

raised in the country since the end of the nineteenth century.

The New Guinea Graziers Association is the society for people who raise cattle, Box 1671, Lae.

Remarks: Do not breed cattle too early or they will not do so well. Be sure to get a stock movement permit from the Provincial Livestock Officer when you want to move cattle. He will inspect the cattle for diseases or flies so you know the cattle are healthy. You cannot butcher meat except for rations or your own personal food unless the animal is killed in an abattoir and is inspected for healthy meat.

Initial contributor: J. Holmes, DPI Erap, Box 348, Lae.

## DAIRY CATTLE

Scientific name: Bos taurus  
Products: Fresh milk, cheese, yogurt (primary) and meat and leather (secondary)  
Size: as for beef cattle  
Normal productive life: 6-8 years  
Breeds available: Freasian, Seride, Sahiwal (all scarce)

Feeding: Dairy cow feeding is the most complex of all animals. Native grasses are not good enough. Very good improved pastures and supplementary feeding are needed. For a specific situation, consult OIC, Beef Cattle Research Centre, Erap, Box 348, Lae.

Breeding: As for beef

Housing: Shade is very important for dairy cattle in the tropics. Also a milking shed is required for commercial business of selling milk and must meet Dept. of Health specifications.

Diseases and pests: As for beef

Breeding stock is very limited: Wanaru Dairy and Malahang Dairy, in Lae; CLTC, Banz; and Tanuabadai Dairy in Port Moresby. Also Lutheran Agricultural School, Banz, and Lutheran Dairy, Wabao.

PNG experience: above dairies

Remarks: Throughout the tropical world dairy cattle raising is the most difficult form of animal technology. It is not a good business for beginners, particularly because of the very high cost of building safe milking sheds.

Initial contributor: J. Holmes, DPI Erap, Box 348, Lae.

Cattle Production in the Tropics, by W.J.A. Payne Vol 1 (Breeds and Breeding), Longmans, Great Britain, 1970, 336 p.

## WATER BUFFALO

Scientific name: Bubalus bubalis  
Products: Meat, leather, milk and work  
Mature size: Males: 500-700kg  
Females: 350-500kg

Productive life: It is not uncommon for buffaloes to produce and rear a calf at 20 years of age. However, in a breeding herd cows would normally be culled no later than 12-15 years of age. Meat animals should be slaughtered no later than 3-4 years.

Breeds: There are two main breeds of domestic water buffalo. They are the riverine breeds such as the Murrah used for milk production, and the swamp breeds used mainly for meat and work. Only the swamp breed is present in PNG and it may be either white or grey in colour.

Feeding: Water buffaloes are ruminants (animals with 4 parts to their stomach) with the ability to convert grasses into meat. They are most suited to wet swampy areas and generally outperform cattle in these environments. They should be provided with ample water, forage and mineral supplements. The area of land required for one water buffalo will vary according to the type of pasture, rainfall and class of animal.

Breeding: The average age at first calving is about 3 years. Buffalo bulls can be used for service from 2 years onwards. The proportion of bulls to females should be about 1 to 20. Oestrus occurs every 21 days and the duration is 1½ days. The gestation period for the swamp breed is 310-320 days, but varies slightly depending upon the age of the cow and the sex of the calf. Buffalo do not usually have difficulty giving birth to their calves. Water buffalo will not cross breed with cattle. Selection of buffaloes should be based on productive characteristics such as liveweight gain and reproductive performance.



Housing: A wallow and/or shade are required, otherwise the buffalo would suffer extreme discomfort during the day.

Diseases and Pests: Buffaloes are not as susceptible to external parasites as cattle. However, calves are susceptible to screw worm, strike and wounds should be treated with a suitable smear. Internal parasites:

- (i) Neoscaris vitulorum, a roundworm, can be a problem in young calves - Drench with Piperazine at a rate of 200mg per kilogram body weight, shortly after birth and again one month later;
- (ii) Strongyloides spp. - Drench with "Nilverm";
- (iii) Liver fluke - Zanil.

Source of breeding stock: Sepik - DPI, Urimo; Madang - Catholic Mission, Alexisshafen; Morobe & highlands - DPI, Erap; Islands - Selapui Plantation via Kavieng and Catholic Mission, Rabaul; Papua - DPI, Launakalana

Because of the limited number of buffaloes, stock may not be available from the sources listed. Prices are in line for comparable cattle types, except where buffaloes have been trained for work. A movement permit must be obtained from a stock inspector prior to movement.

Remarks: Buffaloes were introduced into PNG around the turn of the century, and have been utilized for both meat and work. DPI commenced evaluation of the buffaloes in 1971 on the Sepik Plains. In this area they are far superior to cattle. Limited observation suggests that they will perform very well in wetter areas.

The present population of buffaloes is about 1350 (July '76) and supplies will be limited for the foreseeable future.

Initial contributor: J. Stutter, DPI, Erap, Box 348, Lae.

The Husbandry and Health of the Domestic Buffalo, F.A.O., Rome 1974, 993 pp., US\$8.00 Very thorough. A compilation of papers on all aspects of the domestic buffalo.

#### NOTES ON TRAINING AND CARING FOR WATER BUFFALO

Camilo Toledo, a Filipino rice technician and water buffalo-trainer for the Lutheran Gabmazung Rice Farm at Lae, gives a few basic pointers for training:

1. One of the first lessons the animal learns is to untangle itself from its own rope. This usually takes only a week or so. Tie the rope around the horns or neck at first, through the nose later.
2. It is helpful to have someone handling the animal every day, sometimes gently patting and stroking the various parts of its body. Preferably it is the same person, who becomes a "friend".
3. It is tempting to get the animal to do work very early by having a man lead from the front. Do not do it, as the animal must learn to work with the man behind. Be patient and do it right.

4. For directional training (go right, or go left), the man who trains should always be on the left and at the rear. The usual signal is a steady pull on the rope to go left, and a gentle jerking to go right.

5. After some directional training the animal also learns to carry a man on its back.

6. Usually you hitch the animal first to a sled, then to a harrow, then a plough, and finally a cart. The sled is the easiest. Gradually the animal will get used to pulling, and its skin will get tougher under the yoke.

7. Incentives are very important: let untrained or difficult animals train around or move toward other familiar buffalo, especially during directional training; train the animals when they are "partially" hungry, then after their work give them a bath, some salt, and good grass.

8. The animal will always try to be rebellious at first, but the man has the control, and the animal must learn to accept it.

9. Water buffalo need shade when it is very hot, as well as plenty of water for drinking and bathing.

#### NOTES ON PIERCING A BUFFALO'S NOSE

The ideal age to pierce the nose of a water buffalo is one year. A nylon rope through a hole in the nose is better than a brass ring, not only because it is cheaper, but also because the animal feels the direction of the pull more clearly. With a brass ring the feeling is distributed to all sides of the nose and the animal may be confused.

Prepare a nylon rope about 8 mm thick and 1m long. Also prepare a sharp bamboo stick about 30cm long. The wood should be mature, the tip very sharp, and the other end broad enough to hold very firmly. The stick should taper from the point to a thickness greater than that of a rope.

Tie the animal securely between two rails, locked in both front and rear, with head held firmly against a vertical pole. (See photo)

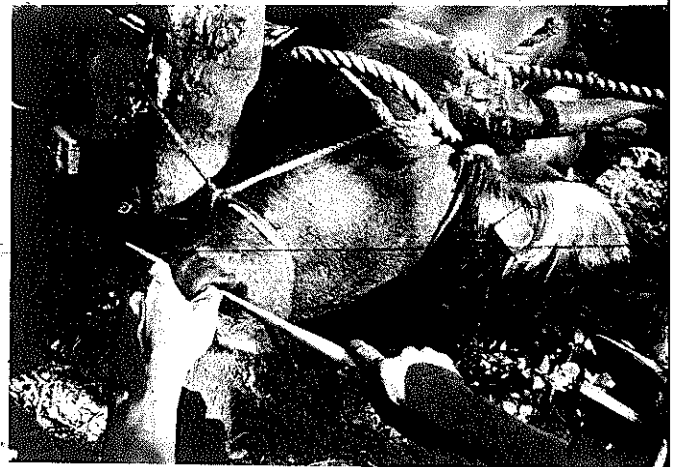

1. Place thumb and finger in nose as shown. Locate the thinnest place in the cartilage.

It is very easy to find. Put the bamboo point through, quickly working it in until the hole is big enough for the rope. Leave the stick in place for 1-2 minutes.

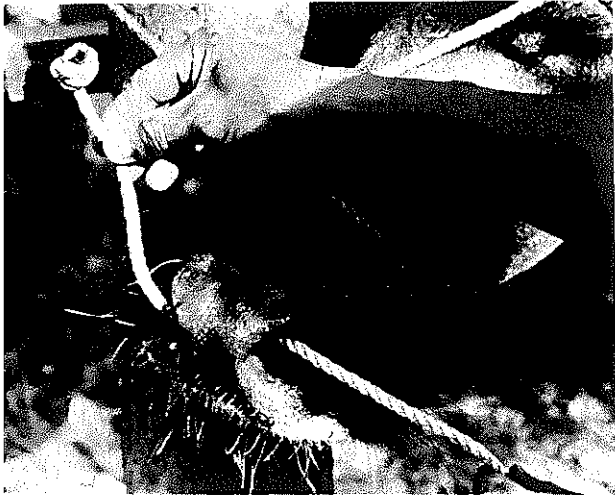

2. Insert the rope. Tie as shown.

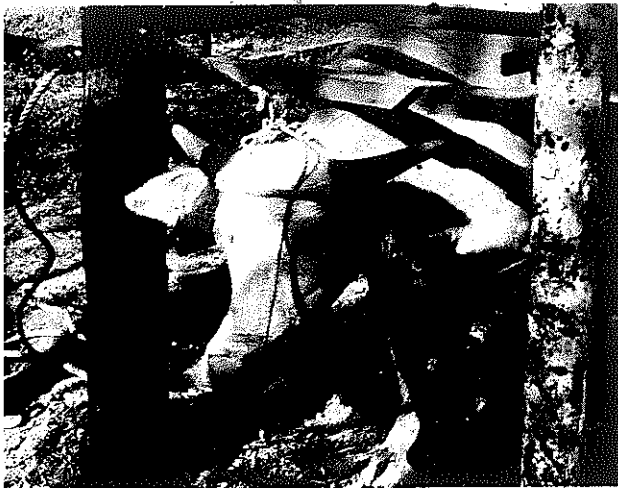

3. Attach the loose end of the nose rope to the rope around the horns for at least one week, allowing the nose wound to heal. After a week you can tie the nose rope to a longer rope, for handling.

**AGRICULTURE IS  
THE BASIS OF  
INDEPENDENT  
DEVELOPMENT**

## GOATS

## MEME

Scientific name: Bovidae capra  
Nature of products: Fresh meat, high quality leather possibly milk (though not very common in the tropics)

Size when fully grown: Native tropical goats are around 25-30 kg.

Normal productive life: Goats live to an age of 7 to 10 years, generally.

Breeds available: Pure-bred goats of the European milking breeds are usually not recommended in the tropics, as they have a rather high mortality from disease. The ordinary native tropical goat is recommended for PNG.

Feeding: Goats are "notoriously" able to feed themselves, being voracious foragers. Masfield gives the following figures for feeding a 25-30kg native tropical goat, per day: starch equivalent, 0.4kg; protein equivalent, 0.02kg; dry matter capacity 1.1kg. Being a ruminant, the goat does well on ordinary grasses, and will survive even when the food supply is small. Clean water supply is important.

Breeding: The gestation period of a goat averages 155 days. The first heat or oestrus after birth of young is 1 to 3 months, with recurrences every 18-21 days, and a duration of 1-3 days. The lactation period is indefinite, and depends largely on the treatment given. Multiple births are less common in native tropical goats than in the improved breeds.

Housing: Simple shelter is sufficient, though tying or fencing is important if you wish to protect your gardens and/or for practicing selective breeding. Some arrangement for supplementary feeding of pregnant and suckling females is advantageous.

Diseases and pests: Native tropical goats are quite resistant to disease. The usual sanitation practices for handling farm animals should be ample protection against disease.

Sources of supply for breeding stock: Goats are not easy to buy at this time, but it is possible if you are persistent and want only small quantities. For more information you might try one or more of the following: Mr. A. Quartermain, PNG Univ. of Technology, Box 793, Lae (Unitech has around 20 goats); Sub-provincial Rural Development Officer, DPI Finschhafen (several herds are found in Finsch area); The Principal, PATI, Popondetta, NP (PATI has around 10 goats); The Director, Seventh Day Adventist College, Kabiufa, EHP (They are supposed to have a small herd); Talidig Vocational Centre, Box 2070, Yomba, Madang (K45 per breeding pair),

Further references: See items on goats in book review: "Lukautim Meme", Yangpela Didiman, 13pp, Pidgin, Box 39, Banz, WHP. Farming notes "Goats", DPI Publication; Introd. to Tropical Agriculture, 1971, section on goats.

(P 252)

cont'd



Remarks: Large numbers of goats can cause serious deforestation if not systematically managed.

Goats in the tropics should have:

(1) Some rocky ground or rough concrete to wear down and keep their hoof nails healthy, should be drenched with Nilverm regularly to prevent loss of condition from internal parasites.

(2) Be closely controlled by wire chain or small boys.

(3) Be castrated and or dehorned where appropriate to prevent deaths through mating rivalries.

References: Goat Production in The Tropics, by Devendra and Burns, Commonwealth Agriculture Bureau, England, 1970. Argues for increased use of goats in the tropics, where 2/3 of the world's goats live. Many of the current criticisms are shown to be exaggerated. Tropical breeds are studied.

Observations on The Goat, by M H French, FAO Agricultural Studies No. 80, Rome, 1970. Includes origins and history of the goat. Weighs advantages and disadvantages of the goat in subsistence economy. More than 400 references in the bibliography make this book a first step for further study.

## SHEEP

## SIP SIP

Scientific name: *Ovis aries*

Products: Fresh meat, dried meat, wool

Productive life: Not yet known under PNG conditions.

Feeding: Short and fine grasses such as Kikuyu and Kangaroo grasses in the highlands and Kangaroo, and Buffel in coastal areas.

Age at Maturity: Males 18 months, females 12-18 mos.

Gestation: 150 days, oestrus cycle 17 days, multiple births common but not usual.

Housing: Dog-proof housing is important, and they must be penned at night where wild dogs roam. Men, dogs, and pigs attack sheep.

Disease: Liver fluke controlled with Zaniil Nilverm, or Thiobenzole; Screw worm controlled by

Preangan sheep from Erap at Bugandi H.S.



inspection and use of smear.

Supply: None will be released by DPI until 1978 when numbers have been increased. Earlier trials in the mid-50's failed for reasons not understood. No releases are planned until we know more about them.

No PNG references known.

PNG experience: Dr. T. Leche, DPI N.Z. sheep project, Box 766 Goroka (wool and feed); Lloyd Hurrell, Wau; Graeme Murray, Valley View Farm, Lae.

Remarks: There are less than 2000 sheep in PNG. 800 of these are three breeds recently imported from New Zealand. There are others on some DPI stations, mission stations, and farms. Sheep are not yet recommended until proper management in PNG is understood. Some very good farmers have succeeded, but others equally good have failed.

Initial contributor: J. Holmes, DPI, Box 348, Lae.

### REPRODUCTION OF FARM ANIMALS

#### A. Gestation Periods, in days

Animal	Shortest Period	Average	Longest Period
Horse	305	340	400
Cow	210	283	353
Donkey	365	374	385
Buffalo	290	310	330
Sheep	140	147	160
Goat	148	155	165
Pig	109	112	130
Rabbit	25	32	35

#### B. Incubation Periods

Bird	Average time to hatch
------	-----------------------

Chicken	21
Duck	28
Guinea-fowl	28
Turkey	28
Goose	30
Pigeon	20

#### C. Periods of Oestrus (Heat periods)

Animal	Duration of heat	First Heat after birth	Recurrences
Horse	3-9 days	7-11 days	2-4 weeks
Cow	1-2 days	1-2 months +	16-24 days
Buffalo	1-3 days	2-3 months +	3-4 weeks
Sheep	1 day	2-6 months	2-3 weeks
Goat	1-3 days	1-3 months	18-21 days
Pig	3-4 days	5-6 days fr.	15-30 days weaning

FROM: Handbook of Tropical Agriculture by Masfield

## PASTURE

A pasture is an area of ground on which one or more crops is grown as food for animals. Pasture must be managed in such a way that there is always sufficient food for the animals. The food must supply all the requirements of the animals for different types of nutrients. If the pasture does not do this, either the animals will not grow well or food will have to be bought, which is expensive.

Pasture for cattle and sheep requires the highest standard of management because these animals will eat only a limited number of crops. Pigs, goats, chickens and ducks will eat a much wider range of plants.

### PASTURE PLANTS

The basis of all pasture for sheep and cattle is grass. A species of legume is often added to the grass so that the grass and the legume grow together. The legume brings two benefits. First it will take nitrogen from the air and put it into the soil; this nitrogen will help to make the grass grow better. Second the legume will contain more of the important foods called proteins; the presence of these proteins will make the animals grow faster.

A good pasture grass must produce a high yield of leaf which is attractive to the animals and is nutritious. Finally, the grass must be able to regrow quickly after the animals have eaten it. The most palatable and nutritious growth of most grasses is the young regrowth which follows cutting, grazing or burning.

There are several species of legume which are used in pasture. There is little difference between these as food for animals; a legume must be chosen which grows well in the situation of each particular farm.

Pastures can be classified into three types:-

1. Unimproved pastures grow only the local grass.
2. Semi-improved pastures grow a legume in addition to the local grass.
3. Improved pastures grow selected grass species which yields higher than a local grass and also grow a legume.

Your nearest Agricultural Office should be able to suggest plant species suitable for your area and where you can get them.

### PASTURE MANAGEMENT

The most important part of management of pasture is the 'stocking rate', that is the number of animals feeding on the pasture. This is generally written as number of beasts per hectare (one beast equals one mature cow). If the stocking rate is too high, the animals will eat the grass more quickly than it will grow. This will eventually kill the grass plants so that the food available will become less and less. Weeds will grow where the grass plants die; some of these are harmful to cattle.

### RULES FOR PASTURE MANAGEMENT

1. Animals should start grazing when the pasture produces the rush of green growth ('blaze of growth') which will follow grazing, cutting or burning. There will be a delay of several weeks between grazing and the 'blaze of growth'.
2. Each plant in the paddock should be cut by a grazing animal once only. The animals should be moved to another paddock before they need to return to a grazed area for a second time.
3. Animals with the highest nutritional needs (milking cows, cows in calf) should be put into the paddock first. Animals with lower requirements (dry cows, beef animals) can be put into the paddock after the others have had the best of the grass. The first group should be removed before all the foliage is eaten - rule 2 still applies.

### PASTURE IMPROVEMENT

The better the pasture the more beasts that can be stocked. Growing a legume with local grasses will improve a pasture. Legumes are usually grown from seed. The seed can be sown among the grass. Legume seeds must be inoculated; the inoculum can be obtained free from DPI, Konedobu. In many cases the seed needs scarifying also. This can be done conveniently by boiling some water in a suitable container, taking the fire away, dropping the seed into the water and allowing it to remain while the water cools down. Alternatively put the seed into a cement mixer and run the mixer for ten minutes.

For the best pasture, the area should be ploughed to remove all existing plants. However, the ground need not be worked to a fine tilth. The new grass should be sown as soon as possible. Some grasses are grown from seed, others by planting vegetative pieces. A legume should be sown at the same time or shortly afterwards.

### PASTURE MAINTENANCE

Other methods can also be used to keep a pasture in good condition.

Cutting after the animals are removed from a paddock removes uneaten growth which has grown old or is of poor quality. New regrowth will come over all of the pasture.

Rolling will break or damage weeds. Where the grass spreads vegetatively, rolling will force additional pieces of stem into the ground where they will root and thicken the grass cover. Vegetatively spread weeds like blue rattail will also be spread.

Chemicals can be used to kill weeds.

Fertilisers can improve growth. Nitrogen fertiliser can be beneficial when the pasture consists only of grass. When a legume is present, nitrogen fertiliser is of little value. Phosphate fertiliser will benefit a legume. Potash fertiliser may be

necessary in some places. Fertiliser use should be discussed with an advisory officer beforehand.

Contributed by: K.C. Willson, Unitech, Box 793, Lae.

A Guide to Better Pastures for the Tropics and Sub-Tropics, Wright Stephenson and Co, Ltd., 330 St. Kilda Road, Melbourne 3004, Australia.

This was distributed free, may be out of print now, but is very very good, and worth trying to find.

An Introduction to Tropical Grasslands Husbandry, by R.J. McIlroy, Oxford U. Press, London, 1964.

This book is already a classic field reference, is found in most DPI offices throughout PNG. Tropical pasture management and improvement are the focus of the book. Grasses and legumes suitable for the tropics are identified and discussed by each species. Level: simple

SELF RELIANCE MAY BE THE FAVOURITE TERM IN PNG THESE DAYS. BUT SO MANY OF US STILL CALL FOR HELP BEFORE WE HAVE MADE GOOD USE OF THE RESOURCES ALREADY AT HAND.

SELF RELIANCE MAY BE THE ABILITY TO DO THINGS WITHOUT HELP, BUT EVEN MORE THAN THAT, IT'S A WAY OF THINKING, A WILL TO SOLVE ONE'S OWN PROBLEMS.

THERE'S NOTHING WRONG IN ASKING FOR HELP WHEN YOU REALLY NEED IT. THE PROBLEM IS THAT SOME KINDS OF HELP LOCK US INTO PERMANENT ONGOING DEPENDENCY UPON HELP.

SOME OF THE ACTIVITIES FOR IMPORT REPLACEMENT FOR EXAMPLE, MAY OR MAY NOT MAKE US MORE SELF RELIANT. THEY MIGHT MAKE US SELF-SUFFICIENT BUT NOT SELF-RELIANT. THERE'S A DIFFERENCE.

SELF RELIANCE IS THE DEGREE TO WHICH YOU ARE ABLE TO CONTROL YOUR OWN DESTINY. NOBODY IS TOTALLY SELF-RELIANT. WE CAN LIVE WITH INTER-DEPENDENCE. BUT NO NORMAL PERSON OR COMMUNITY WANTS TO BE CONTROLLED BY OR DEPENDENT UPON OUTSIDE FORCES.

IF YOU WANT HELP, BE SURE THAT YOU UNDERSTAND JUST WHAT KIND OF HELP YOU NEED AND CAN CONTROL. THAT'S STILL BEING SELF-RELIANT.

THIS BUK IN YOUR POSSESSION IS NOW ONE OF YOUR RESOURCES, JUST AS YOUR MONEY IN THE BANK, YOUR SKILLS AND KNOWLEDGE, YOUR GROUND AND GROWING GARDENS, YOUR COUNCIL AND YOUR GOVERNMENT. HOW YOU USE ALL OF THESE TO GET WHAT YOU NEED OR WANT IS YOUR MARK OF SELF-RELIANCE.

More and more often I have the horrible thought that all our spending, instead of building up the community, is destroying the community by teaching it to sit on its backside and put out its hands.

Julius Chan  
Post Courier 27/8/75

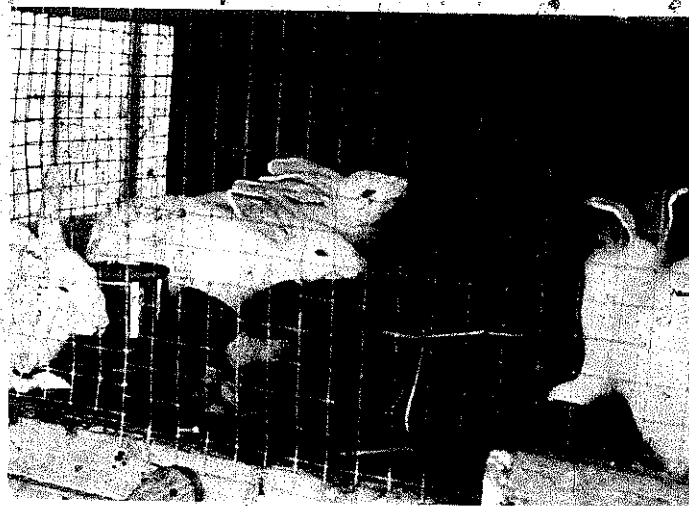

## DOMESTIC RABBIT

Editor's note: Rabbits are illegal in PNG. This article has been included because it contributes accurate, helpful information to this continuing debate. We urge our readers to respect the present law, and at the same time we advocate improving restrictive government policies.

Scientific name: *Oryctolagus cuniculus*  
Description: Domestic rabbits provide meat and the skins can be made into useful pelts. At full growth a Domestic rabbit weighs 4-5kg, giving 2-4kg of meat, depending on the breed. Domestic rabbits may be bred at age 5-6 months and will breed well up to 3 years, occasionally to 6 years. Breeds that do well in the tropics are "New Zealand Whites" and "Californian Whites."

Feeding: It is a common misconception that Domestic rabbits can survive on a diet of leaves only. Caged rabbits need grain as well.

Breeding: At maturity (5-6 months), Domestic rabbits may be bred. They take 31-32 days for gestation, and may be rebred six weeks after the litter is born. 6 to 8 babies are usually born. Up to four litters a year are possible with good feed.

Housing: This can range from a minimal packing crate that has a few holes for ventilation and a place for food and water to more sophisticated houses especially designed for rabbits. A water-tight roof is necessary.

cont'd

Common pests or diseases: Domestic rabbits get a number of sores and mites that result from dirty or wet cages, and also ringworm. Coccidiosis and diarrhoea are sometimes a problem. Nearly all diseases of Domestic rabbits can be prevented with clean dry housing. And if you don't have secure housing, dogs or cats will get them.

Sources of breeding stock: There are no known supplies of breeding stock in PNG at this time.

Further references: Rabbit Raising for Fun and Profit, Farm Bulletin 19, Dept. Development Communications, College of Agriculture, College, Laguna, Philippines, 1967, P1.50; Domestic Rabbit Production George S. Templeton, Interstate Printers, Danville, Illinois 61832, USA. US\$6.75; American Rabbit Breeders Assoc. 4323 Murray Ave., Pittsburg, Pa. 15217, USA. US\$0.25

It is believed that there has been no experience with rabbits in PNG. But domestic rabbit production is a feature of tropical countries such as Philippines, Indonesia, Mauritius, Nigeria, Vietnam, and Jamaica.

The following is reproduced in whole without comment from The South Pacific Bulletin Vol 24, No 4, pp 19-20, "Rabbits for Meat", by W.P. Bewg, Animal Production Officer, South Pacific Commission:

"Meat is becoming more expensive and demand is increasing. At the same time, attempts are being made to reduce levels of imports to save dollars. Under these circumstances, there is a move in some countries to try and produce more beef, and to become self-supporting, however, many people are not in a position to keep cattle. Almost anyone can keep rabbits. The purpose of this article is to give a general idea of what is involved in domestic rabbit-keeping for anyone who is interested.

"One way in which the Government of Nigeria in West Africa is trying to increase protein consumption in peoples' diets is by encouraging a rabbit industry. Farmers can obtain rabbits from 18 Government breeding-centres which produce thousands of rabbits each year.

"Another country, Mauritius, off the coast of Africa, has a similar programme.

"West Germany produces twenty thousand tons a year of domestic rabbit meat. This is equivalent to about half the total recorded meat consumption of the 19 countries in the SPC area.

"Tame rabbits are more efficient converters of food into meat than the usual farm animals like pigs, poultry and cattle. They need less food to produce the same amount of meat as the other animals mentioned.

"Tame rabbits, as they are sometimes called, are quite different from the wild rabbits which are such a pest in Australia and New Zealand. They are much less able to look after themselves outside a cage and their life is not likely to be very long should they escape. They are often white in colour, which

makes them easy to see, not very fast runners, and unlike their wild cousins they live on top of the ground instead of in the protection of underground holes.

"Researchers in Australia found that domestic rabbits reared in cages and then released did not reproduce and succumbed to injury, disease and predation.

"The basis of rabbit-keeping is to have one or more females (does), each in a separate cage, and to fatten and eat their offspring. These are usually killed while still young, and are sometimes referred to as "Fryers" because they are suitable for cooking by frying. They are normally ready for killing at eight weeks of age.

"A doe produces her litter 28-30 days after mating, but the young do not come out of the nest until they are about three weeks old. Where the animals are well managed, it is quite possible to mate the doe four times each year and produce four lots of rabbits for killing. All being well, she can produce between 30 and 40 young annually. These will weigh about 40kg alive, representing about 20kg of meat. Slightly more than half (55%) of the animal is carcass meat.

"Old packing cases make good rabbit cages. About 1/2 sq m of floor space is sufficient for one rabbit, but since the doe and her young will be together about 1 sq m is recommended for each doe.

"One of the advantages of rabbits is that they eat grass. The better the food, the better they will produce, but green grass, green leaves or legumes and vegetable kitchen scraps will do quite well. Commercially concentrated foods rather like chicken mash or pellets can be fed, of course, this adds to the expense.

"Five minutes spent cutting some green material is often the main work of the day for the domestic rabbit keeper.

"Strong and sometimes emotional views are held by some people on the advisability of keeping domestic rabbits. This is connected with the experience with wild rabbits, particularly in New Zealand and Australia. However tame rabbits are not quite the same animal, and if they escape, they are not so well equipped to survive.

"It is also worth noting that even in Australia, rabbits have not spread into the subtropical and tropical parts of the country and, of course, most Pacific Islands lie in this climatic area.

"For the average householder, rabbits offer an opportunity to produce meat for home consumption without the need to buy expensive feed."

GUINEA PIGS (No Article) (do you know what a baby one of these is called? a new guinea pig! Bah!)

# Fish Culture

## TILAPIA

## MAKAO

Scientific name: Tilapia mossambica

This article will not tell you how to grow tilapia, but it may help you to decide whether or not you should try.

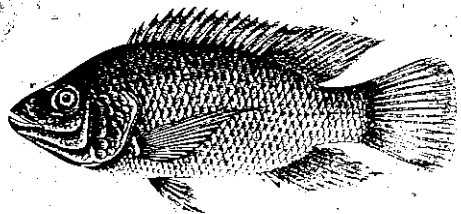

Tilapia was first introduced to the Sepik in 1959. Since then it has spread to all parts of the river and has now become the protein staple for the river people, and a vital part of their economy.

The estimated possible total production is 30,000 tonnes per annum. (Inland Fisheries Research Unit, Angoram) 22,000 tonnes would be utilized for commercial exploitation developed by villages at Angoram, Amboin, Chambri lakes and Ambunti. Production is steadily increasing and has reached 4,000kg per month for marketing.

Work involved in producing salted fish is as follows:

1. Catching: Most of the fish are caught in gill nets set overnight and picked up about 5 o'clock in the morning.
2. Cleaning: Fish are beheaded, de-scaled and cut down the back, leaving the belly skin intact. Guts are removed and the fish is washed carefully.
3. Salting: Fish are laid flat in a plastic bucket between layers of salt, and left for a period of two days.
4. Drying: After removal from the brine, the fish are dried on limbu beds in the sun for 3 or 4 days. Hot air dryers can be used.
5. Packing: Fishermen take the fish to Angoram where it is repacked into 20kg lots for shipment or airfreight.

Initial capital investment required by the people to commence salting operations is K3.00 for purchase of 25kg of salt. It is ideal for low income villagers to start. The price paid to the fishermen is 25t per kilo for their catch.

Fisheries Officers concentrating on a continual supply of this product have now overcome the two major problems of marketing of the fish: transportation and storage. Salted tilapia has proved to keep for a period of months without refrigeration. Tilapia is now economically transported by boat and highway trucks throughout the country.

Fresh Food Markets handle most of the wholesaling, while government institutions can also get Tilapia through their government stores account.

Tilapia has become a popular part of the diet in many PNG villages. The salt is a very valuable component when the tilapia is steamed or mumu'd with kaukau or rice. The tilapia exhibits a 30% to 40% increase in weight when soaked. There is no wastage of tilapia if it is ground or hammered into a fine meal, which can be used as a paste or cake.

Nutritionally tilapia compares favourably with tinned mackerel, but has a lower amount of energy per gram of fish. Tilapia is actually less expensive for the consumer than mackerel for protein. However, mackerel still provides an extra measure of energy in the form of oil. Nutritionists say either type of fish is worthwhile to include in the village diet. Roughly, three tilapia are equal nutritionally to one tin of mackerel.

Trade stores will be interested to know that there is just as much profit per bag of tilapia as per case of imported tinned fish. Wholesale purchase of 48 cans @ 26t per tin and retailing at 30t, leaves K1.92 margin per case. A 10kg bag of tilapia holds approximately 100 fish, wholesaling at 60t per kilo and retails at 10t per fish (k1.00/kg). This leaves between 2.5 to 4t mark-up per fish or K2.50 to K4.00 for storage, handling and profit.

Tilapia is a PNG product, and its promotion will help decrease food imports. It is however, illegal to introduce tilapia to waters where it is not presently established.

For more information approach your business development officer. See book, p 88

Initial contributor: C.T. Kelley, Box 179, Mt. Hagen, WHP.

The Fishes of New Guinea, by Ian Munroe, DPI, Port Moresby, 1967.

This is the definitive book identifying the fishes of the New Guinea waters, if you need such a book. Many colour plates and drawings. Names are the common English names and the scientific names, but no local names are included. Level: advanced.

CARR (No article)  
OYSTER (No article)  
SHRIMP (No article)

# Insects

## HONEY BEES

Scientific name: *Apis mellifera*  
Products: Bulk honey or comb honey

Age to first production: A colony will begin production within 6-12 months.

Normal productive life: Under proper management a colony will produce indefinitely. Honey may be extracted every few months for a total of 50kg per colony per year.

Breeds available: Italian strain

Feeding: It should never be necessary to feed colonies in tropics as bees feed from flowers.

Breeding: It is important to have a high quality queen for domestic colonies or for upgrading wild colonies. Under good management a good queen will maintain a strong colony with plenty of foragers.



Housing: Specially constructed wooden hives are required. Plans available from DPI, Box 766, Goroka. Woodware is available from Kubinja High School, Goroka. Other equipment (smokers veils, foundations etc.) from PNG Beekeeping Supplies, Box 319, Goroka.

There are no recorded diseases of bees in PNG. The wax moth, a pest of hives is no problem under good management.

Sources of supply of breeding stock: Wild colonies or hobbyists in PNG. Stock will be available from DPI in late 1977 when research phase is completed. Wild colonies can be upgraded with DPI supplied queens.



Further references: The Australian Beekeeper Magazine, Box 20, Maitland, NSW 2320. A\$7.20 per year. Lists articles, suppliers, references. Bee Keeping in the Philippines, Morse & Laigo, 56pp 1968 P4.10. Dept. of Development Communication, UPCA College, Laguna, 3720, Philippines.

Location and result of PNG experience: J. Swincer, DPI, Box 766, Goroka. Research still underway but looks promising. Best recorded 12 month production 90kg, average 50kg.

Remarks: The initial costs of a hive are about K30 and the smoker and veil cost K18. Other equipment as desired for protection.

Throughout this article good management is stressed, because it is so important for successful beekeeping. A potential bee keeper should arrange to visit a colony and work with it before investing. Some people have a natural aptitude for bee keeping, and if you are not one of these, bee keeping is probably not for you. Bees need continued proper management to produce well, and if you feel it is too hard you will not have success. If you naturally like looking after bees, your first reward will be pleasure, and the honey will be a bonus.

There are many difficulties with bee keeping. The most discouraging is that even with the best of care, a colony may swarm - that is it will decide to move to another place - and you will have lost the colony.

Initial contributor: J.C. Swincer, DPI,  
Box 766, Goroka EHP.

Photos from ONWARD magazine

INSECT REARING (No Article)  
INSECT MARKETING (No Article)

## SILKWORM REARING

The silk industry in PNG is presently centered at a breeding/experimental station at Kagamuga. A number of village mulberry plantations have been established at various locations in the Southern Highlands, but production has been very low.

Proper temperature and cleanliness are critical for successful silk breeding. A number of mulberry strains have proven suitable for the highlands,

and bombyx worms are the best for these conditions.

Fungus diseases have been a problem, but these can be controlled through strict hygiene. Spore-borne viral diseases are also dangerous and effective preventative methods are being worked on.

Rearing of cocoons has proven successful at Kagamuga, with a high quality silk being produced. Processing is still in the experimental stage.

Growth in this field will only take place if production stabilizes at a high enough level to warrant the necessary capital investment, and if detailed studies prove silk rearing to be an attractive economic activity. Silk cannot be recommended as a viable village activity, at this stage.

Initial contributor: C.T. Kelley, Box 179,  
Mt. Hagen, WHP.

## Wildlife

### CROCODILES

Scientific name: Crocodylus spp.

There has been considerable talk in the past year about rearing crocodiles for their skins in village pens. Here are some excerpts from the DPI Bulletin "Raising Crocodiles in Village Pens", by D.F. Puffett:

Some typical prices (subject to change); Fresh water 45 x 10cm belly width, 20-50t; 90 x 20cm, K4.00; belly width 25cm, up to K14.00; belly width 30cm up to K21.00.

A strong pen is essential, either wire or strong poles imbedded in the ground. The height above ground should be at least the length of the longest crocodile you intend to keep.

A pond is needed inside the pen, if possible, lined with wood, as crocodiles can dig into the side of a pond.

Crocodiles 45cm long are good for starting, as they are easy to handle.

It is better not to mix large and small crocodiles as the big ones might eat the small ones. But fresh water crocodiles and salt water crocodiles can be mixed.

The skin of salt water crocodiles is more valuable than that of fresh water crocodiles, because the scales are smaller. But most skins sold in PNG are from fresh water crocodiles.

Crocodiles eat meat from animals, birds and fish. They will live without regular feeding, but do not grow as quickly.

Crocodile meat may be fed back to crocodiles.

People can also eat crocodile meat.

It is normal for some of the crocodiles in the pens to die. But if the skins are recovered quickly, they are marketable.

The easiest way to keep the water in the pond clean is to channel water in from a stream to flush it out.

Shade is necessary.

Another helpful publication: "Crocodile Industry Training Manual" by John Lever, March 1975. - Free.

For more complete information, write:

Wild Life Branch  
Dept. of Natural Resources  
Box 2585  
Konedobu.

### WILDLIFE

The Wildlife Branch of the Department of Natural Resources has the best record in PNG for sharing information regarding its work. A large number of practical pamphlets on wildlife raising and protection are available. Some of the most interesting are:

- 69/5 A Guide to Dangerous Snakes in PNG.
- 71/3 The Preservation of the Garu Wildfowl Egg Grounds
- 71/6 A National Project for the Conservation of Birds of Paradise in PNG
- 72/2 Raising Crocodiles in Village Pens
- 75/2 Wildlife Laws in PNG
- 75/8 A Deer and Wallaby Farm in PNG
- 75/9 Wildplant Utilization in PNG
- 75/19 Proposed Organization of Crocodile Farms in Western Province
- 75/27 Endangered Animals of PNG
- 76/4 Collection Export, Research and Filming Involving Wildlife in PNG

There are also two Crocodile Farming Manuals:

- Book 1 Low Cost Pen
- Book 2 Caring for Crocodiles

There is also a manual on raising Cassowaries

You'll get a complete list of the pamphlets by asking for 75/17 List of Wildlife Leaflets from Wildlife Branch, Box 2585, Konedobu.

CASSOWARY (No Article)  
BUTTERFLIES (No Article)



# PROCESSES

## Crop Processing and Utilisation



in the sun

For storage the breadfruit is wrapped in pandanas leaves which have had the thornes removed. They are wrapped tight enough to be sealed from air. In a smoky kitchen or a cool dry place the preserved breadfruit will keep for several years.

Initial contributor: Q.G. Tapisuwe, Vudal, PO Kerevat, ENBP.

### DRIED BANANAS

In Uganda green bananas (probably plantain varieties) are split and sun dried. The dried bananas are then crushed in a mortar and pestle. The product, a type of flour, is used for porridge or similar recipes.

J. Greve

### RESERVATION OF BREADFRUIT

In the New Hebrides breadfruits are dried and stored for later use.

You will need: Breadfruit  
firewood or coconut shells  
stone  
a portable bed 60cm high made of split bamboo  
Pandanas leaves  
clean salt water

A large pit is dug 30cm deep and a table big enough to cover it is made from bamboo. The pit is filled with stones and a large fire is built on the stones. The breadfruit are put in the fire to cook just long enough to loose their green colour:

Then the breadfruit are cooked they are removed from the fire to cool. When cool the skin is peeled and the breadfruit is cut in half. The part in the middle of the breadfruit is taken out until the wall of the breadfruit is 5cm thick. The breadfruit is washed carefully in fresh seawater, and then placed on the bamboo bed like an upside-down cup



over the hot stones

All the unburnt wood is removed from the fire, and the bed of breadfruit is placed over the hot stones. Each day for four days the breadfruit is dried over hot stones after a big fire has been made to heat the stones.

After four days the breadfruit is dry enough to finish drying in the sun, but first the breadfruits are turned the other side up. After three more days the breadfruit is harder than a dry biscuit.

### CASSAVA (TAPIOCA) STARCH

Starch Production:

(a) The mature roots are first washed to remove dirt and loose soil.

(b) In small-scale operations the roots are then peeled by hand to remove the skin and cortex; on a factory scale only the outer skin is removed, since when processing large quantities of roots it becomes economic to recover the starch from the cortex although it only contains about 50% of that in the core of the root.

(c) The roots are next sliced and put through a rasping or grating machine to produce a slurry or pulp.

(d) The slurry is then sieved to separate the fibrous tissue from the starch milk. Considerable quantities of clean water are used at this stage in order to ensure efficient separation of the starch granules from the slurry.

(e) The starch milk is collected and left in settling tanks for at least six hours, when the starch sinks to the bottom and the liquid is drained away.

(f) The surface layer of the starch mass is usually a yellowish-green colour and contains impurities and is therefore scraped off, leaving a creamy white mass below, which is stirred vigorously with water and then left to settle. This washing and settling process is repeated once or twice more until the starch is judged to be sufficiently pure.

(g) The starch cake is dried, either by spreading it out in trays in the sun or in factories in hot air driers.

(h) Finally, the hard lumps of starch are crushed into a powder and sieved.

It should be pointed out that because the cells of cassava roots are relatively tough, the grinding process must be efficient in order to liberate all the starch granules and to obtain an extraction rate of approximately 20-25% commercially.



## USE OF FRESH COCONUTS

Use of coconut cream and coconut milk is basic. It is added to taro, yams, kaukau, pumpkin, green leaves, cooking bananas, sago, and pit-pit. It is also excellent with fish, meat, and fowl.

**Coconut cream:** Grate the coconut. Add  $\frac{1}{2}$  cup of the coconut water or other hot water. Allow this to stand a few minutes. Squeeze with the hands and then put the grated coconut in a piece of cheesecloth or a strainer, and wring or press out the coconut cream.

**Coconut milk:** Use about 1 cup of water to every 2 cups of scraped coconut. Follow the same procedure as above with the same coconut you have already squeezed the cream from. Or you can skip the first process and do this directly. If the milk stands in the fridge, the cream will come to the top and harden, and it can easily be removed for using in special ways.

**Drying:** Put the grated or shredded coconut in a shallow pan and dry in the sun, or place in the oven, but stir frequently to keep it from turning brown, in the case of an oven. The sun method may take several days, but takes little effort. The oven is faster, but constant attention is required. Store in tightly covered containers.

**Freezing:** The grated coconut (not squeezed) can be frozen in plastic bags or containers for use when needed.

**Chips for use with dips:** As above, the coconut is dried in the oven. However, instead of shredding, it is cut into fine strips.

**Baking:** This coconut can be used in place of desiccated coconut, even without drying it, if you reduce the amount of liquid in the recipe. This is because there is so much milk in the fleshly grated coconut. For using on top of meringues or cakes, just toss together lightly the freshly grated coconut meat and a bit of sugar. Sprinkle it on the top of the meringue before baking - the sugared coconut turns a nice brown and becomes slightly crispy.

Initial contributor: Lae YMCA, Box 1463, Lae.

## OIL FROM COCONUT

This is a traditional method for extracting oil from coconuts. The usual use of such oil has been for oiling the hair and body, especially for feasts. In Tonga you can see plenty of such coconut oil in small bottles being sold in the markets for this purpose.

Coconut oil is also good for cooking, and for making soap. In the Philippines many people in the rural areas used it for fuel during World War II to run their small diesel engines for rice and corn mills when no other fuel was available.

Ingredients needed: mature fresh coconuts

Equipment needed: Large cooking pan  
Coconut scraper  
Optional - oil press  
or optional - cloth bag for squeezing grated coconut.

The Process:

1. Grate the mature fresh coconuts as you would for most cooking purposes.
2. Squeeze out the cream, either with your hands, or with a cotton sack, or better still, with a small press.
3. Rinse out the grated coconut with the water, and squeeze that, too.
4. Cook the combined cream and the rinsed (coconut milk) gently over a fire. The oil will gradually rise to the surface and become somewhat clear. (A small amount of salt, about 3-4% will speed the settling of the solids.
5. Separate oil from water by pouring off the oil.

Note: This oil will not keep for a long time, and it can make people very sick if they eat it when it is too old.

The residue from squeezing the grated coconut is useful for cooking purposes or for animal feed.

## PROCESSING GINGER

Utensils: Plastic basins, knives, ladle, plastic film bags, colander (a perforated utensil for draining food).

Raw materials: Ginger, sodium benzoate (or benzoic acid)

The Process: A. For sliced Ginger:

1. Wash fresh whole ginger
2. Peel by scraping off the skin with a knife
3. Slice 25mm thick
4. Dip in 4% sodium benzoate (or benzoic acid) solution (2 to 3 tbsp. per litre of water) for 5-10 minutes. Sodium benzoate may be purchased from ICI or from drug companies. Drain off liquid. Spread on wire trays lined with nylon mesh or woven bamboo.
5. Dry in a forced draft drier or any suitable drier at 63-66°C to 5-7% final moisture content or until slices are crisp and feel dry to the fingers. If possible, dry under the sun.
7. Pack in insect-proof containers.

B. For whole Ginger:

1. Wash whole fresh ginger
2. Peel by scraping off the skin with a knife
3. Soak in 4% sodium benzoate solution (one week or longer) in a covered container
4. Spread on wire or bamboo trays
5. Dry in a forced draft drier or any suitable drier at 66-67°C to a final moisture of 9-11% or until the ginger feels dry to the fingers. If possible, dry under the sun.
6. Pack in insect-proof containers.

Initial contributor: A. Hepworth, Box 793, Lae.

## GRAIN PROCESSING

### RICE PROCESSING

Rice hulls are not tasty, so there are a number of ways to remove them. The cheapest method is to use a mortar and pestle. Cut or burn a dish-shaped hollow in a tree stump and pound a kilogram of paddy with a long post 10 - 15cm in diameter. You will break many grains, and you must later blow away the husks, but all can be done with bush materials. (p 107)

A more advanced method is a hand-operated mill that is like a coffee huller. (below) Properly adjusted it will produce brown or white rice with mostly whole grains. Cost is about K100, but it will last many years. With a large pulley it can be motorized. Order through Plantation Supply and Services.

A larger mill using the same principal is installed at Gabmazung near Lae. Mills of this design produce a lot of bran, polish and broken, so you should have pigs or chickens nearby to eat the waste. For a larger mill initial cost and maintenance are low.

Most rice mills in PNG use rubber rollers. From the smallest village mill to the big mill at Bainyik rubber rollers are used to separate the hulls from the paddy rice. With rubber rollers there is very little damage to the grain.

Rubber roller mills are more expensive to buy and to maintain because the rollers wear out in 5-20 tonnes of rice, but they are easier to run.

The Gordon rice mill. This mill operates on the same principal as a coffee huller, and is developed from the Engleburg huller. It will easily meet the needs of two or three families.

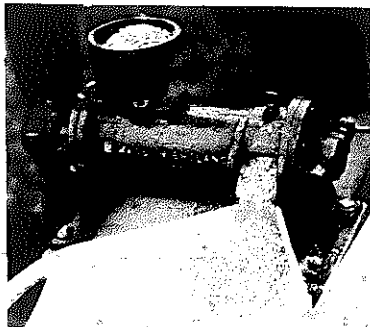

A rubber roller rice huller. The two "wheels" roll toward each other at the top, but one wheel turns a third faster than the other. There is a small space between the two rollers so that the husk is wiped off but the grain is not broken. (below)

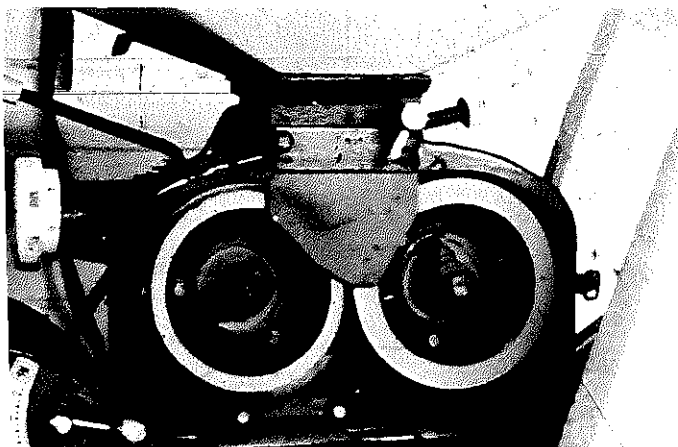

### CORN PROCESSING - GRINDING

Many people in PNG eat fresh corn after boiling it or roasting it, but corn can also be kept for a long time until you are ready to eat it if you dry it properly.

Dry corn must usually be processed before eating. It is best to grind it, unless you make it into hominy, but there is no recipe for hominy yet in the Liklik Buk. (p 176)

Grind the corn, either by breaking it fine in a mortar and pestle, or by using a grinder. You can use a metal grain mill (p 106) or a concrete one.

Do not grind more grain than you can eat in 2 or 3 days. The embryo of the grain will be broken during the grinding, and the oil in the embryo will turn rancid quickly in storage.

To get a fine meal from corn you may have to pass it through the grinder several times. Save time by screening the meal through a piece of flywire, and only regrind what does not pass the screen.

You cannot make ordinary bread from corn meal because it is low in gluten protein. There are good recipes to use for cakes and porridge from corn. (p 115)

### DRYING KAUKAU (Sweet potato)

Equipment needed: Plastic film sheets, knives or cutting machine for slicing.

Ingredients required: only kaukau.

The Process: Cutting:

- Select only sound, strong tubers, both large and small
- Wash. Do not remove skins.
- Cut with a sharp knife into slices no more than .5cm in thickness (or use slicing device).
- Put out on clean plastic
- Use the rubbish kaukau and cut pieces as pig food immediately.

Drying: (1 to 3 days under average conditions)

- Plastic should lay up and down a slope, so that water has no opportunity to lay in pockets either on or under the plastic.
- Keep the grass under the plastic cut short. Long wet grass slows down drying considerably.
- Lay the cut kaukau out in a thin layer. No double layers!
- When opening plastic in the morning -
  - Do it early and every day.
  - Spread the kaukau out so that it covers the whole plastic.
  - Anchor the edge of the plastic with enough stones to prevent the wind from blowing the plastic shut.
  - Watch for tends developing, such as leaky plastic, water pockets, etc. and correct them immediately.

- e) Black plastic is superior to other colours. It absorbs heat rather than reflecting and therefore dries the kaukau faster.
- f) When closing plastic before a rain or in the evening:
1. Cover properly so that no rain will enter during the night.
  2. Use older, broken plastic as a double-layer on top of other plastic to give extra protection.
  3. Use your newest plastic during the rainy days, and the older, cracked plastic during the dry times.
  4. Use stones to help hold down edges.
  5. Roll the bundle half turn, so that the open edge is down.
  6. When the kaukau is dry, get it off quickly and into clean bags.

Storage: Dry kaukau is not hard to store.

1. When dried enough, the kaukau slice will snap, and not bend.
2. Put into a dry house, not on a dirt floor.
3. Weevils do not bother dry kaukau.

Sources of supply of materials: Plastic film found in most builders supply stores.

PNG experience: Dried kaukau has been successfully stored with the above method in the Wapenamanda area for up to one year with no noticeable deterioration.

Initial contributor: M.L. Herman, St. Paul's H.S., Wapenamanda, EP.

## KAUKAU FLOUR

### Production:

1. Use fresh kaukau. Wash and clean it well. It is not necessary to peel it.
2. Slice this kaukau thinly across the grain into slices about 2-3mm thick.
3. Spread the sliced kaukau out in the sun to dry, if possible on something which will allow air to circulate around it. Dry for 2-3 days, or until slices are quite brittle. Take it in at night and during rainy or damp weather.
4. Grind it. (p 106)

### Uses:

1. As long as the flour is kept dry it can be stored for quite a long time.
2. It is possible to mumu it using just the kaukau flour, and also to mix it with other ingredients such as peanuts.
3. It can be mixed into a batter and fried in a pan.
4. It has been mixed with wheat flour and used for bread-making.
5. It can be used in soups and stews.
6. Hard or softer biscuits may be made from it. You may like to try some other ways!

Note: Taro and tapiok flour may also be produced by this method. The tapiok must be peeled.

Initial contributors: J.P. Powell, J.S. Tomkins.

## FURTHER NOTES ON PROCESSING KAUKAU

1. Remember - processing kaukau can be considerable work. In many situations it will not be worth the trouble. It will be quite difficult during rainy or damp weather without special drying facilities.
2. Dried kaukau is not easy to grind into flour - it tends to be tough.
3. Kaukau flour does not have the desirable properties of wheat flour. It can be substituted for wheat flour up to only about 20% in baking. It is very low in protein. Its taste is not particularly "special".
4. Shredded kaukau dries very nicely and is an attractive form, if dipped momentarily in boiling water (blanching) immediately after shredding. This is a good form for human consumption, and it stores well. All things considered, it probably costs about as much to make as rice costs to buy. If you have the kaukau and the time, it may be worth doing.
5. When re-constituted with water, dried kaukau is less bulky than fresh kaukau, which is good.
6. Dried kaukau may be effectively pulverized and mixed with other materials for animal consumption in an ordinary hammer mill.

## NUTMEG AND MACE PROCESSING

Drying can be done on trays in the sun if the sun shines all day for three or four days.

Drying of nutmeg and mace is a very simple operation. After harvest the mace is separated from the seed. The seed or nutmeg is spread evenly on wooden trays and allowed to dry slowly indoors until the seed rattles in the shell. The shell is removed by a tap on the end with a wooden mallet. The nuts are graded according to size and packed for export. Sometimes the nuts are exported in the shells.

The mace is flattened out and spread flatwise on wooden trays and dried in the sun until the colour changes from bright red to yellow. This takes up to six months.

Initial contributor: F.Aia, LAES, Kerevat, ENB.

## OIL FROM OIL PALM

Not many people realize that the oil may be extracted from oil palm nuts very easily at the village level. This is widely practiced in West Africa. Doug Franklin, former principal of PATI, has impressively demonstrated the following process.

Village level uses for palm oil: High quality cooking oil, oil for making soap, oil for lamps. Palm oil is rich in Vitamin A.

Ingredients needed: Oil palm nuts.

Equipment needed: Large ~~oil~~ for boiling nuts  
Simple oil press  
Fine mesh sieve or screen  
Containers

#### The Process:

1. Harvest mature nuts in bunches. A sort of chisel with long handle might be helpful in cutting the main stem of the bunch.
2. Break nuts off the cluster and wash them.
3. Boil the nuts for 30 minutes.
4. Squeeze them in a simple screw-type press. A juice will come out that is mostly water but also containing considerable oil. Some small bits of pulp will also be present.
5. The oil will rise to the top. Pour it off, separating it from the water.
6. Filter the oil by pouring it through a sieve. The small bits of pulp will be removed. If you want to use the oil immediately, no further treatment is required.
7. If you want to store the oil for weeks or months, heat it briefly to sterilize it. (We do not know the time and temperature, but presume that this is not critical. Make it quite hot but do not allow it to burn).

Palm kernels can be fed to pigs, which quickly learn to crack the shell. Too many palm kernels causes a very yellow fat, and the high fibre slows growth. S.P. Hale says they are a good snack for people.

NOTES: There are quite a number of oil palm trees found around PNG, but many of them were planted simply for ornamental purposes. Extracting oil from these may or may not be worthwhile. The high-yielding hybrid varieties are very worthwhile through this process. Remember that you can not plant a seed from a hybrid tree and get the same kind of tree. Get good seeds from a reliable source.

It is common in West Africa also to extract palm oil by cooking the nuts in a drum, and as oil rises to the surface of the water, to skim it off. We understand that this method is less efficient than using an oil press.

Below: Removing the inner pith of the sago.



## PEPPER PROCESSING

Drying can be done on trays in the sun if the sun shines all day for three or four days.

We only recommend black pepper to be processed. To make black pepper harvest when one or two red berries are noticed on the spike. Fruits may be given the following treatment:

- a) Dry direct in the sun for 4-6 days.
- b) Scald in hot water then sun dry for 3-5 days. To scald the fruits heat the water to 82°C then place the pepper in a wire basket and immerse the contents in the hot water for two minutes. The fruit is properly scalded when the colour changes from green to greyish or when a thin silver skin splits.

When properly dried, the dry berries still attached to the spikes or stalks are either rubbed between the hands or heaped and beaten with a wooden stick until the berries separate from the stalks. The stalks are separated by screening and winnowing. Further screening using a 4.8mm wire mesh removes dust and small foreign objects and immature berries. After screening the berries are floated in water to remove imperfect or immature berries and other foreign objects which float to the top and are washed off. The berries are redried in the sun for 38-48 hours; then packed in either burlap bags or small 2 kilogram plastic bags and stored in a cool airy room.

Drying may also be done in hot air driers when unfavourable weather prevails.

Initial contributor: F.Aia, LAES, Kerevat, ENB.

## SAGO PROCESSING

When mature the sago palm is cut down and then cut into 1-2 metre lengths. After the bark is removed the inner pith is scraped out using an adze-like tool with hollowed tips. The pith is beaten and washed in a water trough made from the midrib of an old sago leaf. The fibre is separated from the starch by filters made from sago leaves. The starch and water suspension is allowed to flow to another trough when the starch settles to the bottom and the water flows into the river.

The sago is wrapped in leaves, allowed to drain for a day, and while still in leaves is placed in a very hot fire for one minute. This parcel is rewrapped in leaves for storage or marketing.

For eating the sago meal can be cooked by pouring boiling water over the crushed meal and stirring quickly until it makes a starchy paste. The meal can be fried, with or without grease, and with or without added coconut, meat pieces or fish. It can be baked in leaves and used for snacks or hard rations. It is also used as the starch filler in mums.

Since sago has only 0.5% protein, a straight diet of sago will result in malnutrition. It is part-

icularly serious if spoiled children eat nothing but sago without supplement. The great value of the sago is that it produces large quantities of storable energy food with relatively little effort. For a balanced diet vegetables and protein must be added.

Sago is not popular in all areas where it is eaten. Where alternative foods are available, sago is considered to be food for taim hangri.

Initial contributor: E. Cox, Baqi Aqf. Centre, Box 65, Angoram ESP.

#### PRODUCTION OF FULL BROWN SUGAR

(p 178) (p 179)

There are basically three stages in this process: the extraction of juice from sugar cane, the purification of this juice, and then its crystallization into a full brown sugar.

#### Extraction from cane:

The juice can be extracted from the cane by means of some roller-type crushing mechanism. We have used old hand-operated clothes wringers to crush the sliced cane. With these the cane must be put through a number of times to extract almost all the juice. If you do not have a strong set of rollers, try (a) splitting the cane in half, or (b) pounding it first with a hammer. Sugar crushers are becoming more and more common in PNG, especially home-made ones (see designs).

(p 178)

Editors note: Don't waste your time trying to use a clothes wringer to squeeze sugar cane. The springs aren't strong enough, and if they were the rollers might break.

#### Purification of juice:

Strain the freshly crushed juice into a container using a piece of cloth. Then heat the juice to boiling point and continue boiling while carrying out the following steps.

1. Remove scum from the surface using a wire gauze strainer.
2. Obtain a few aibika leaves and stems, or okra, crush with water, and mix a small quantity of the sticky water obtained into the boiling juice. This causes dissolved impurities to form a thick surface scum which can be removed as before. (If the aibika water is quite concentrated, use about 10mls for 2-3kg of juice).
3. Next, the natural acidity of the juice must be neutralized. This can be done by placing some pieces of limestone (either previously heated or not) or some clean wood ash contained in a cloth bag into the boiling juice for quite some time. Remove these before the syrup becomes too concentrated. Or, if you have lime available for chewing betelnut, use about one tablespoon for each 6 litres of juice - just stir it into the juice. Also remove any more dark scum and the waxy material which sticks to the sides of the pot.

cont'd



Crushing sugar cane at Bugandi High School, Lae.



Boiling the sugar juice



Stirring during the final stages, when the sugar is cooling and turning into crystals

## Concentration of clear juice into full brown sugar:

As the boiling process is continued, frothing of the syrup will take place. Because of this the container must be fairly deep.

Once the syrup has become quite thick, and it moves easily in the pot, and the bubbles are large and burst noisily, there are two possible methods of continuing the process:

1. Soon after this if there are signs of sugar crystallizing on the sides of the container, this must be stirred in but the heating may be continued. Then crystallization starts to occur in the main mass. This should be poured out and stirred as it cools to break it up.

2. If a short time has elapsed at the above stage without signs of crystallization, it would be wiser to pour it out into another container and stir considerably as it cools. Crystallization should then take place as this cooling and stirring process is continued. This is done because some sugars, generally those with a higher molasses content, do not reach an obvious point of crystallization while being heated, but if taken too far, tend to be darker and have a richer flavour than the ones first mentioned.

The variation between varieties of sugar can only be discovered by actual experience. At present we have produced sugar in the manner described from about 12 cane varieties in the Kagua and Hagen areas which have generally been of very good quality.

Initial contributors: J.P. Powell, J.S. Tomkins.

## SOME USES FOR VILLAGE SUGAR

We doubt that production of dark brown sugar at the village level will be a good money earner. But it is fun, especially if done on a social basis, and the concentrated sweets are very good for children who are on a bulky low-fat diet. This type of activity also helps people to realize what nice things they can "create" with materials right at hand. Here are some suggestions:

Uses for raw sugar juice: Filter through a clean cloth, add water and muli (citrus) juice for a refreshing drink. Other juices and pulps from ripe fruit may be added. Much better for you than Coca Cola!

In the final stages of boiling: You can cook kaukau and banana "chips" (thin slices) in it. They will not be crisp, but sweet and "mealy". Or fry the slices in oil first, until crispy, then dip briefly in syrup. Or make small balls of flavoured biscuit dough and cook in the boiling syrup.

Use the dark brown sugar: For fruit jams (see recipes or for coconut-candy: 2 cups fresh grated coconut  
1 cup dark brown sugar (p 112)

Cook gently for about 20 minutes, stirring constantly. Spread on waxed paper or banana leaves. If you want it to stick together more, for candy bars, add 1/4 cup of wheat flour before cooking. A little vanilla flavour is nice.

## MAKING SUGAR COMMERCIALLY AT THE VILLAGE LEVEL

In India, the dark brown sugar made at the village level is called "Gur" or "Jaggery". Gur making is a traditional cottage industry of India and is one of the major agro-industries of the country. Ordinarily the gur-makers are those who cultivate sugar cane and are self-employed. These notes will help you to understand how it is done.

The process of manufacture is divided into the following stages: 1) crushing, 2) boiling (clarification and concentration), and 3) moulding.

### 1. Crushing

The extraction efficiency of juice from cane varies with different crushers, ranging from 60 to 65%. Both bullock driven crushers and power driven crushers are available.

The quality of cane is one of the principal factors responsible for the quality of gur. Hence it should be ensured that dried, damaged, diseased, fallen, over-ripe or unripe, over-manured, water-logged, stale, unclean, or improperly cut (many roots and long tops) are not used for quality gur. In case these have to be used, they should be used separately and not mixed with the good cane. For these the process of clarification is more critical.

Accurate weighing of the cane is necessary, as the various checks and calculations are based on the weight of the cane crushed.

Deterioration of the cane starts soon after it is harvested, so it should be crushed as soon as possible.

The fresh juice should go into concrete or steel tanks for measurement and to be readied for the boiling pans.

### 2. Boiling

#### a) Clarification of the Juice.

Different types of juice boiling furnaces have been designed according to individual requirements and to suit local conditions. A single pan furnace using 1.25m diameter standard pans is able to boil 75kg of juice per hour, and suits a cane grower working with the bullock driven crusher. To handle the juice obtained from power driven crushers, a furnace having two or more pans is necessary. The pans usually have bottoms 1/2cm thick or more. The fire is usually in a pan that can be moved from under the sugar juice pan when the syrup reaches the desired stage.

The clarificants in use are either vegetable or chemical. The vegetable clarificants commonly found in PNG would be aibika, okra, castor seed, or peanuts. Ordinarily chemical clarificants are not advisable.

To prepare the vegetable clarificants, the green stems and the roots of the plants are first crushed and then steeped in water. After some time the crushed material is rubbed vigorously in water till a thick mucilagenous liquid is produced in sufficient quantity. The crushed material is again steep-

ed in water and rubbed as above to yield more mucilage. The process is repeated again and again in order to obtain maximum extract which is used in clarification. About 2kg of the plant is sufficient to clarify 45 l of juice.

Peanut kernels or castor seeds are crushed in a mortar or grinder, with water. The resultant milky liquid is then strained through fine cloth and collected in a vessel. The process is repeated while the seeds continue to yield milky fluid, which is used for clarification. Extract of about 1½ kg of peanuts or 3kg of castor seed would be enough to clarify 45 l of juice.

Chemical clarificants are helpful when the juice obtained from abnormal quality of cane has to be processed. The commonly used chemical clarificants are lime water, sodium carbonate, sodium bicarbonate, super phosphate, sodium hydrosulphite. The juice of abnormal cane always contains a higher percentage of reducing sugar and the acidity is also high. While the chemicals do improve the clarification, yielding gur of lighter colour, their use involves risk. The acidic chemicals cause inversions of sugar into invert sugar and the alkaline ones make the colour of gur. Moreover, the effect of chemical clarificants is not lasting and the product is not fit for long storage. Therefore the use of chemicals should be made sparingly. When necessary the chemical clarificants are applied after the clarification with vegetable extracts is completed.

Sodium hydrosulphite is a bleaching agent. It is used by some producers because it makes the colour of gur whiter. But this effect is only temporary, as the original colour returns after a few days. An overdose of the chemical also imparts a bad taste to the product.

The clarification of juice plays an important part in the production of a quality product. The main object of clarification is to remove the maximum of impurities and colouring matter at the earliest stage. The cane juice is a liquid which varies in colour from grey to dark green according to the colour of the cane itself. It contains all of the soluble constituents of cane, such as sucrose, reducing sugars, salt, organic acids, and carries in suspension gums, fine fibres, wax, clay, colouring matter, and albumin.

The juice as received from the crusher is filtered into the first pan on the furnace through a coarse cloth or wire gauze strainer to remove trash and fibre particles. When the quantity of juice is sufficient, it is heated slowly to boiling. In the course of this process the scum appears on the surface of the juice and accumulates to the sides of the pan. At this time a hissing sound is heard from the heated juice in the pan. This should gradually become less and less as the temperature rises. Before the sound stops, the specified quantity of the extract of vegetable clarificants is added to the juice. This is the stage when the temperature of the juice is supposed to have risen to boiling point, and the cracking of the scum layer on the top is well advanced.

The vegetable clarificants have no chemical reaction on the juice. The extract contains vegetable albumins, which coagulate on heating, entangle the suspended and colloidal impurities and bring them up to the surface, where they are skimmed off by means of a perforated ladle.

During the skimming process, care should be taken to see that the juice does not boil vigorously. Otherwise the layer of scum would be disturbed and get mixed up with the juice, causing difficulty in the removal of impurities. In order to reduce vigorous boiling while skimming, cold water is occasionally sprinkled on the juice. The boiling subsides briefly, and the clarification is also helped to a certain extent.

The scums are dark green in the beginning. But towards the completion of clarification these are like white froth. If the scums appear to be still dirty, a further dose of clarificant is given till the froth rising to the surface is perfectly white.

Sometimes it may be found that even repeated additions of vegetable mucilage does not remove the impurities completely, which is indicated by the persistence of the dirty scums. In such cases, a dose of diluted milk (one part milk with 4 parts of water) is very helpful. The milk may be replaced by the milky fluid from crushed peanuts, which is used in the same manner.

The scums removed during clarification contain some juice, which can be filtered out and collected in a container. This juice should be fed back into the pan, as it is liable to deteriorate.

#### b) Concentration of the juice

In single pan furnaces the clarification and concentration to final stage is carried out in the same pan, while in furnaces having two or more pans the clarified juice is forwarded to consecutive pans in stages. When the clarification of the juice is completed the boiling is accelerated and the concentration of juice into a thick syrup is taken on to "striking point" (the gur stage). There is a lot of frothing in this last stage. To prevent overflowing, an aqueous extract of castor seeds is sprinkled over the surface and the froth subsides immediately. The concentrated juice reaches the striking point at a temperature of 115-117°C. Experienced workmen judge the time for stopping the boiling by the shape and size of the bubbles formed on the surface of the concentrated syrup and from the sound produced from the bursting of the bubbles. Constant stirring is done at this stage so that the heating may be uniform and charring does not take place.

At this stage if a drop of thick syrup is taken out with the help of a wooden rod and dipped in cold water, a hard ball is formed. Or, the hot liquid is taken out with the help of a wooden rod and allowed to trickle down from one end to form a thread which immediately breaks on cooling. Or, if the syrup is stirred, it appears as if it is leaving the bottom of the pan and is not sticky.

### 3. Moulding

As soon as the juice is concentrated to this stage the pan is removed from the fire and the boiled mass is poured into a shallow cooling pan. The cooling pan for solidifying gur may be of clay, wood, or iron. The mass transferred to the cooling pan is allowed to cool for some time and then stirred and mixed up thoroughly with the help of wooden spoons, and then allowed to cool until it begins to solidify.

It may then be placed in moulds of desired shapes and sizes and kept aside for a few hours for hardening. When ready the blocks are taken out of the moulds, packed in clean containers and stored for disposal.

Initial contributor: A. Hepworth, Box 793, Lae.

(Note: this is a heavily edited version of a paper from India, probably from the Planning and Action Research Institute, Lucknow, India.)

### TAPIOCA SAGO MADE FROM CASSAVA STARCH

Tapioca/Sago consists of pieces of partly gelatinized cassava starch and can be prepared in the form of flakes, seeds and pearls. In the preparation of tapioca flakes, the moist starch, (see page 91) is rubbed through a sieve of about 20 mesh/in. to give a coarse ground moist flour and partially gelatinized by cooking for about 2 minutes in iron pans previously smeared with oil. The flakes of tapioca are then dried at about 112°F (50°C) to a moisture content of approximately 12%. In the preparation of tapioca seeds or pearls, the sieved damp starch is made into globules by shaking in cloth bags or by the use of mechanically operated granulators. The globules are then graded according to size and gelatinized by roasting them for about 15 minutes on hot pans, smeared with coconut oil. They are finally dried in a hot-air drier at 104°-112°F (40-50°C) for about 1.2 - 2 hours; the yield of tapioca from fresh tubers is usually about 25%.

from Root Crops, TPI.

### PROCESSING TEA

Although the machinery and processing at a tea factory looks complicated, the steps are simple and easy to duplicate.

Process:

1. Pick only 2 leaves and a bud from the tea bushes
2. Allow the leaves to wither and become soft and limp. This takes about 24 hours if the leaf is spread out thinly (1kg of green leaf covering 2.7 sq metres of stretched jute or lap lap). Tea should lose nearly half its original weight during this period.
3. Rub the withered leaves firmly between the palms of the hand. This is necessary to bruise the cells of the leaves and to spread the juices over the entire leaf surface.

4. Cover a bulk of the leaves. A "fermentation" now occurs. (Do not let the leaf mass over-heat). Maximum allowable temperatures 27-33°C. During this time the leaf turns dark and a tea aroma develops. This should take less than 4 hours. Over-fermented teas are less soluble and therefore weaker when brewed.

5. To kill the fermentation: The fermented mass should be (a) Dried in an oven, preferably with the oven door partly open to prevent "stewing", using temperatures of 54-66°C.  
(b) Spread very thinly on a sheet of clean flat iron and dry in the sun until brittle dry.
6. Tea will pick up moisture from the air and go mouldy, therefore store it in a airtight container.

7. 1kg of Green Leaf should make 200g of tea. Altogether in 1976 PNG had approximately 3800 ha of tea planted and produced 6000 tonnes of made tea. Production per hectare is still rising.

Experience in PNG: DPI carries out clonal selection, testing, and multiplication at Kuk Tea Research Station near Mt. Hagen, WHP.

Contributed by: D.W. Kidd, Box 312, Mt. Hagen, WHP

### THE PREPARATION OF TURMERIC

Tumeric is one of the chief ingredients of curry powders, giving a yellow colour as well as a spicy flavour to the curry. It consists of the dried, boiled rhizomes of *Curcuma longa* L., a plant cultivated extensively in India, Sri Lanka, and Indonesia. It is usually propagated by means of setts or small portions of the rhizome. Its cultural requirements are similar to those of ginger, to which it is closely related. The rhizomes are harvested during dry weather, after the leaves and stems have withered. The whole clumps are lifted carefully, adherent earth removed, and the fibrous roots cut off. The rhizomes are then broken up, the secondary lateral rhizomes being known as "fingers" (on account of their shape), and the main stem producing rhizomes, which are shorter and thicker, as "bulbs". These bulbs may be cured separately, either whole or cut in halves or quarters. These are known as "splits".

Curing consists of 1) boiling the rhizomes in water, 2) drying in the sun, and 3) "polishing".

The rhizomes are placed in a large iron pan or earthenware pot, and sufficient water is added to cover them to a depth of 5 to 8 cm, and the rhizomes boiled over a slow fire until they are soft; this may require from two to four hours. They are tested for completion of cooking in the same way as potatoes, with a thin pointed stick. When they are sufficiently cooked, the stick will penetrate easily. Overcooking and undercooking should both be avoided, as this yields an inferior



product.

The rhizomes are then removed from the boiler, spread out in a thin layer in the sun and dried. They should be turned over from time to time, and at night they should be heaped and covered over. Drying requires up to 10 days.

When thoroughly dry, the rhizomes are "peeled" or "polished". This was formerly done by rubbing with the hands or feet, but it is now done either by shaking the rhizomes, mixed with stones, in a long narrow gunny bag, or in a bamboo basket, or by rotating them in a polishing drum.

A polishing drum may be made from wooden cask or barrel, closed at both ends. It is provided with a small door 15-20cm in the side, and is perforated all round with holes about 1/2cm in diameter and 10-15cm apart. The barrel is fitted with a central axle, in the form of an iron rod long enough to project horizontally on two wooden posts. It is turned by means of a handle fixed to one end of the axle.

After tumeric is polished, it is ready for export. For use it is either ground, or pounded, or grated.

Initial contributor: A. Hepworth, Box 793, Lae.

## VANILLA PROCESSING

Vanilla is a flavouring material and comes from the Capsules (pods) of the vanilla plant, which is an orchid.

1. The pods are harvested when slightly yellow. These are placed indoors for 10 days to wilt (become brown).
2. After wilting the pods are exposed to the sun for three hours each day for 10-20 days till oily in appearance.
3. Exposure to sun is reduced to one hour after 10-20 days until the pods reach correct moisture (30%).
4. The dried pods are sorted, graded into different lengths then tied into 200 g bundles.
5. The bundles are placed in air tight containers and conditioned for 3-4 months.
6. After conditioning, the bundles are packed in cartons for export.

Initial contributor: F. Aia, LAES, Kerevat, ENBP.

## YAM PROCESSING

(a) Yam dough - the yams are peeled and any inedible parts removed, then are then cut into small pieces and boiled in water until soft. After this they are pounded in a mortar until a glutinous dough is formed, which is usually sufficiently firm to be cut into slices.

(b) Yam flour - traditionally the tubers are sliced to a thickness of approximately 1cm, peeled and dried in the sun. After drying, the hard pieces of yam are ground or milled to give a coarse flour. Recently the following improved method has been developed for use in W. Africa. After washing thoroughly under running water, the tubers are cut into slices approximately 5cm thick and cooked for 20-25 minutes or until soft, after which they are peeled and mashed into a pulp, which is spread out to a depth of about 2cm and dried for 6-8 hours at a temperature of 122-158°F (50-70°C), until the moisture content is 10% or less. The dried product is next finely ground and passed through a sieve before being packed into polyethylene sacks.

from Root Crops, TPI.

Our objective is not to be "well-liked", but to support people in their process of growth, whether they like it at the moment or not. In the short run many persons would rather be dependent than alive and growing. So we can't just do whatever people say they want us to do. In the long run, persons appreciate the ones who help them to grow, not the ones upon whom they have become dependent.

THAT LAST IDEA SOUNDED EASY, DIDN'T IT?  
YOU THINK THAT YOU COULD WRITE SOMETHING  
LIKE THAT, TOO, DON'T YOU?

WE'LL BET YOU A COPY OF THE NEXT EDITION  
OF THE LIKLIK BUK THAT YOU CAN WRITE AN  
ARTICLE THAT WILL BE ACCERTED.

LOOK ON PAGE 268 FOR INSTRUCTIONS ON HOW  
TO SUBMIT A CONTRIBUTION.

## SELF-HELP

# Livestock Processing and Utilisation

## PASTEURIZATION OF MILK AND CREAM

Pasteurization is a mild, carefully controlled heating process which effectively halts many dreaded milk-borne diseases.

Raw milk or cream may be pasteurized at home in one of the three following ways. The first two require the use of a dairy thermometer and all demand a quick cooling of the processing water or pan so that the milk does not take on a "cooked" taste.

1. This is the preferred method: Arrange empty, sterile, glass, heatproof jars on a rack, in a deep kettle. Allow 2.5cm - 5cm of headroom when you pour the raw milk or cream into the jars. Fill the kettle with water until it comes above the fill line of the milk in the jars. Put the thermometer in one of the jars. Heat the water, and when the thermometer registers 72°C hold the heat at that temperature for 15-30 minutes. Cool the water rapidly to about 10°C. Refrigerate, covered, at once.
- \*2. This method is more apt to leave a cooked taste, as the heat is harder to control than in 1. Heat milk or cream slowly over direct heat to 60°C and keep it there for 30 minutes. Plunge the pan at once into ice water and reduce the heat to about 10°C. Refrigerate, covered, at once, in sterile jars.
3. This method should be used only in emergencies, as the milk flavor is definitely altered. Place the milk to a 2.5cm depth in a wide pan and bring it quickly to a rolling boil, stirring constantly. As soon as the boiling reaches its full peak, reduce the heat by plunging the pan into ice water. When the bottom of the pan is cool enough to touch, refrigerate the milk at once in covered sterile jars.  
(From the Joy of Cooking, by Rombauer & Beckler) (p 121)

## BUTTER AND BUTTERMILK

**Butter:** Let cream sit in a litre jar until slightly sour (or use a buttermilk starter). Leave ½ air space. When sour, shake jar. Release the gas from time to time by loosening the lid. When the fat has separated from the liquid, the butter is made. Gather the fat globules with a fork into a bowl and rinse well, pressing the butter to get all the buttermilk out (if left in, it sours). Salt if desired.

**Buttermilk:** Use in baking instead of whole milk. Substitute 1 tsp. baking soda for 3 tsp baking powder when using buttermilk, and no lemon.

## Buttermilk pancakes:

2 cups whole wheat flour 1 egg  
½ tsp salt 1 tsp baking soda  
2 tbs fat 2 cups buttermilk

Mix well and drop from a spoon into small cakes into a hot, greased skillet. Turn when bubbles appear on one side. Brown on other side.

H. Bekker.

## Ghee

1. Boil the butter gently until the milk fat is clarified and all water evaporated.
2. Filter.
3. Pack in bottles or tins. Stock in a cool place.

## CHEESE

Because milk in the tropics spoils rapidly, many people are interested in making cheese to preserve the food value of milk. There are nearly as many recipes as there are people who make it. Here are a few that have been tried in PNG.

### Definitions:-

**Curd:** the nearly solid portion of soured milk

**Whey:** the liquid part of soured milk. It can be substituted for milk in all baking.

**Rennet:** an enzyme derived from the largest stomach (omasum) of unweaned ruminant animals (goats, cattle, sheep, buffaloes)

Rennet is available in tablets in the supermarket as Junket Tablets or you can make your own. When a 2-4 week old calf or goat is killed the largest of the four stomachs, the omasum, is saved to extract the enzyme rennin. The omasum can be identified also by the pleats inside and the usual presence of curds.

Fill a litre jar with brine. Make brine by dissolving as much salt as possible in warm water, and then add a little more for the omasum to absorb. When the brine has cooled add the clean omasum and then store in a cool place. The omasum from a young goat will provide rennet for up to 60kg of cheese.

Fresh milk to make cheese should first be strained through a sterile cloth, then pasteurized by heat quickly to a boil, then allowing to cool. Full fat milk powder when dissolved according to the manufacturer's instructions can be used directly.

### ONE SIMPLE METHOD OF MAKING CREAM CHEESE

Warm the milk to body temperature and add 1 teaspoon of lemon juice per litre of milk. Pour the milk into a clean container, cover with a clean cloth and allow it to ripen in a warm place for one day. (At this stage the milk should smell sour but should be thrown away if it smells putrid).

After the milk has ripened, warm again to blood

temperature and add rennet (junket tablets from Supermarkets) in half the quantity that is used for making junket. Stir and leave to coagulate for 8-12 hours (overnight).

Sterilize some muslin, cheesecloth or thin laplap by boiling in water. Stir the coagulated milk, scoop it into the cloth and hang the cloth by the corners to drain out the whey. Let the curds drain for 2 days stirring the curds twice a day to help the whey drain out.

Remove the new cheese from the muslin and mix with salt to taste. This is a type of cream cheese that will keep for a few weeks in the refrigerator. Interesting ways of eating this cheese are to mix it with finely chopped herbs, onions or fruits such as pineapple and then to spread on bread.

To make a cheese which keeps longer, more of the moisture should be removed. Turn the salted cream cheese into a mould with a sterile cloth and press for about 3 days with a weighted board, turning the cheese daily. A cake tin with a removable bottom may be used as a mould. This is a type of white cheese. The addition of 1 teaspoon of commercial yoghurt per litre to the milk before ripening will give cheese another flavour.

Initial contributor: A. Hepworth, Box 793, Lae.

#### MULI CHEESE

Materials and equipment needed:

4.5 litres (1 quart) milk  
2 tablespoons vinegar or juice of  
two large lemons  
One cloth

Optional: 2 tablespoons butter  
½ teaspoon salt

Process:

Boil the milk (even powdered milk can be used) Remove from the heat and immediately add the vinegar or muli juice.

Stir this mixture until well mixed and then let the solid portion coagulate out from the whey (liquid portion).

Pour everything into a cloth; tie the cloth up and squeeze the cloth until most of the liquid is extracted. This liquid can be fed to animals.

Three days later you have cheese which can be eaten as it is or can be further processed.

To further process the cheese, cook the cheese with the butter and salt; cool the mixture and press into the desired shape. The cheese can be refrigerated or tied in banana leaves. Flavour improves with age, but never entirely loses muli taste.

Initial contributor: J.T. Hale, Box 215, Wewak, ESP.

COTTAGE CHEESE: Put 8 litres of milk into an enamel pan. Slowly heat until it is lukewarm. Remove it from the heat. Add 2-3 teaspoons of rennet solution. Stir once or twice. Let sit in a warm place until set. Test by inserting a finger and lifting it. If the whey floats in the space made by the finger and the space is clear, it is ready.

Stir with hands until the curds are small and evenly broken.

Put a cheese cloth on a bucket and use clothespins to hold the cloth in place. Strain the whey off the curds. After all the whey has dripped through, salt the curds and hang the cheesecloth with a looped string with a container underneath to catch the last drops. Use when dry.

CHEESE CURD: Same as for cottage cheese, but do not break the curds. Pour into cloth and drain. Allow to stand for 12-24 hours. Cut the solid cheese into small squares or use in slices.

FRENCH GOAT CHEESE: To 8 litres of still warm goat's milk, add 2-3 teaspoons of rennet solution. Let stand in warm room for 12-30 hours. When whey is yellow liquid and the curd is floating in a chunk, it is ready. Pour off whey and spoon curds into moulds. (Tuna or lard cans with both ends cut off). Let drain approximately 12 hours and turn and drain another 6-12 hours. Salt sides as cheese is turned. Can be eaten fresh or old as desired. Pack in oil to keep. Cheese is soft, mild and tasty.

RICOTTA CHEESE WITH WHEY: Bring whey to near boil. Skim off curds, salt and hang for a day.

NORWEGIAN WHEY CHEESE (best with goat whey): Boil whey down (takes a day) stirring occasionally. When thick and brown, stir more often. Add some cream, lower heat and let thicken. Pour into buttered dish. Use as spread on biscuits.

#### CULTURES FOR MAKING CHEESE

Rennet and Cultures from:

Australian Rennet Manufacturing Co. Ltd.,  
23 Fuller Street,  
Walkerville, S.A.

Phone Adelaide M.L. 2491  
Cables: "RENNETCO WALKERVILLE"

Prices work out at about .1¢ per gallon of milk for cottage cheese. Other cultures are from \$2.00 to \$3.00 for starter. Of course once you get your own starter you can continue propagating it if you're careful.

PRESERVING MEAT AND FISH: We have received a great many contributions for the Liklik Buk on how to preserve meat and fish. In general they fall into two ways: salting and smoking. There are so many different variations that we cannot give them all.

Traditional preservation allowed excess meat and fish to be stored only a few weeks at the most, and generally required constant attention during the storage period. Today the traditional methods remain popular in the face of tinned meat and fish largely because of the special taste, but not because they facilitate trade or long term storage.

TRADITIONAL SMOKING: The meat or cleaned fish is cut into convenient sizes and placed on a rack about 60cm over a fire. Various techniques are used to direct the smoke to the meat. Most "smoking" processes are basically dry cooking and a medium amount of preservation by the smoke occurs. The meat will sometimes keep for up to a month, but only if it is kept in the smoke of a fire.

TRADITIONAL SALTING: Some traditional salting methods for meat and fish will keep indefinitely, and their basic techniques are similar to long term preservation methods. The short term preservation by salting is to drain the meat or fish of all blood remove all scales from the fish and proceed to rub salt on all surfaces until it is fully absorbed into the flesh and any more that is added remains on the surface. Meat should be cut to slices 2-3cm thick. Meat salted in this fashion is left on a rack in the sun during the day, and in a bag of salt at night until it is required for use. As with all salted meat or fish a long soak in fresh water is needed before eating.

Thanks to P. Amamagi & B. Awagem of Vudal; and T. Nohoro, I. Kaipo. G. Bevan, W. Ruki, A. Sumunda, K. Sumunda and J. Down of PATI.

#### DRIED SALTED MEAT (SIMPLE PROCESS) "JERKY"

You can use any cut of meat to make "Jerky". Cut the meat with the grain into strips 2.5cm wide and 1cm thick. Make them any length you can. Prepare a brine of 7 litres of water to 1kg of salt (the brine should be salty enough to float an egg in its shell). Soak the strips for 2 days in the brine. Remove and wipe dry. Hang the strips of meat in the sun to dry; they may be pinned to the clothesline with spring clips. When they are dry they may be smoked or simply stored as is in an airy place well protected with netting.

(From The Last Whole Earth Catalogue)

JERKY or BILTONG (as it is called in South Africa):

I make it by cutting the meat into strips as described above, but I do not prepare a brine - I simply salt the meat liberally and leave in a container overnight - drain off the liquor - resalt with a mixture of salt and curry powder and hang up to dry as described. It is important to keep the flies off the meat until the outside of the meat is no longer

wet - otherwise blow flies will lay their eggs in it and make it rot. Cover with fly wire or mosquito net.

Contributed by: J. Greve, DPI., Konedobu.

BRINE CURING: As well as salting, meat and fish can be preserved in brine, which is made from salt, sugar, potassium nitrate (saltpetre), and water.

You will need:  
4kg salt,  
1kg sugar  
60gm saltpetre (from a chemist)  
22 litres of clean fresh water  
a large plastic container

1. Mix the ingredients in the water to make the brine. You can do this directly in the plastic container, but be sure that everything is dissolved.
2. Cut the meat into convenient sizes, after the blood is all drained from the meat. Long thin pieces cure more quickly than thick pieces. You should weigh all the meat at this time, so you will know how long to keep the meat in the brine. The meat should remain in the brine for 6-8 days for each kilogram of meat, or longer if the pieces are thick.
3. Place the meat in the container of brine, as much as you have, but don't let any meat stick above the brine. Use a stone to stop the meat from floating.
4. Put the container in a cool place. If it is not cool, you may see a green slime beginning to grow on the top of the brine. If this happens you will have to throw out the brine and make new brine or the meat will spoil.
5. Once a week take the meat out of the brine and then repack it in the container. You can use the same brine, if it is not slimy. The repacking ensures even curing of the meat.
6. The meat should stay in the brine 6-8 days for each kilogram of meat. That is, for 1 kg it should stay 6-8 days, but for 4kg it will need 24-30 days, and for 10kg it will need 60-80 days.
7. After curing take the meat out and let it drain before you smoke it. Of course at any time you like you can take the meat out if you are going to eat it.

Contributed by: R. Bassett, HATI, Box 312,  
Mt. Hagen.

#### DRY SALT PRESERVATION OF MEAT AND FISH:

You will need:  
1kg salt for each kg meat or fish  
a large container - a plastic rubbish bin, a clay pot or a good wood box.

1. The meat should be hung for one day to allow all blood to drain from it. All bones should be removed because the salt will not enter the marrow of the bone and the marrow will spoil. Cut the meat into strips no wider than 30cm and no thicker than 10cm, but as long as you like. Make sure there is no fat on the meat.

cont'd

2. Rub plenty of salt into all sides of each piece of meat.
3. Then put the meat into a container that has first had about 5cm of salt placed in the bottom. Make the first layer and be sure no piece is touching its neighbour. Cover the first layer of meat completely with salt, then put another layer of meat, continue until the meat is finished, and put a final layer of salt on top. Put a cover on top and a heavy stone on the cover to act as a press.
4. After 2-3 weeks the meat can be removed for smoking, but it can be left in the salt without spoiling for as long as you like.

Remarks: When the meat is finished, you can use the salt for the next batch of meat.

If the meat is not well drained you will see blood in the salt after some time. This will not keep well, and the meat should be repacked.

Initial contributor: R. Basset, HATI, Box 312, Mt. Hagen.

**SMOKING MEAT:** You cannot store smoked meat very long unless you have salted it or cured it in brine first. Smoking serves a number of purposes.

1. It improves the flavour of the meat.
2. It will dry the meat if the smoke is warm.
3. It protects the meat while it is in the smoke by keeping the flies away that carry the bacteria that start spoilage.
4. The smoke that stays in the meat will help the meat keep longer.

The idea of smoking meat is to dry the meat only slightly, but not to cook it while the smoke is getting into it. This improves the flavour. Here is a simple smoking house built from a drum, but you can use a tightly built box as well.

Cover the trench with roofing iron or plants or bush timber and leaves and cover it all with soil to keep the smoke in. Hang the meat with wire from rods or sticks poked through the sides of the drum or box. You don't want to lay the meat on wire mesh or it will not smoke evenly.

Build a fire in the fire pit and when it is burning well cover the pit so the smoke will have to go out past the meat. If you are smoking brine cured meat you must have a cold smoke or the meat will begin to cook. A cold smoke is from a very slow burning fire, and one of the best ways is to burn dry hardwood sawdust.

Initial contributor: R. Basset, HATI, Box 312, Mt. Hagen.

**FISH: CURING AT HOME:** The best way to keep fish is to keep them alive, but that's not always possible. If you have no ice or refrigeration then smoking or salting are practical ways to preserve fish at village level. These are simple methods which do not require much equipment. It should be understood, though, that these methods do not preserve fish for a very long time, like tinned fish.

There are several methods which are called "curing". Dry salting, salting with water/salt solution, hot smoking, and cold smoking. Do not try to air-dry fish when you have rainy or damp weather. (p 121)

It is important to know the basic principles and rules, so send for this helpful pamphlet before you try: "Home Curing Fish", A Guide for Extension and Village Workers, Department of Primary Industry, Kanudi Fisheries Station, Box 2417, Konedobu.

Another booklet is available which tells about cutting various types of fish, with many good photographs:

"An Illustrated Guide to Fish Preparation", Rogers, Cole, and Smith, 73pp. Tropical Products Institute, 56/62 Gray's Inn Road, London WC1X 8LV, England. Price: Pounds 1.40 including postage.

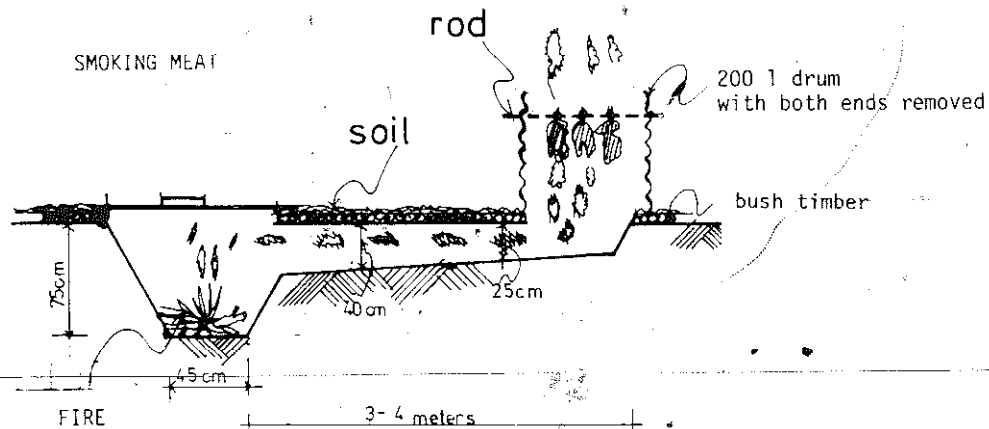

Some new Fisheries Research and Development items which technically oriented readers may want to follow. (Through Tropical Products Institute, 56-62 Gray's Inn Road, London WC1X 8LU, England):

(a) Storage in Ice:

It has been discovered that tropical fish stay fresh longer in ice than temperate or cold water fish, probably because spoilage bacteria and the fishes' own enzymes are adapted to the high temperatures of the tropics. This could mean that simpler and less expensive small scale fishing enterprises may be possible than it was earlier thought.

(b) Smoking Kilns:

Overheating of fish during smoking can cause significant losses of certain amino acids (protein). Design of smoking kilns is being studied carefully.

(c) Fish Silage:

Sometimes the daily catch of fish is so much more than usual that fish goes to waste. But usually the amounts are too small to justify making fish meal. Minced or chopped fish is acidified to pH 3.0 and allowed to hydrolyse to form fish silage. A carbohydrate filter is then added to absorb moisture. Afterwards the product is sun-dried and powdered for use as an animal feed. Feeding trials indicate that it may be used as an ingredient, but not as a complete feed.

(d) Shark/Salt Cake:

Low-value fish may be stored for a long time in the form of a simple fish/salt cake. Initial taste trials are encouraging and further research is being done.

Suggested by: J. Gluckman, DPI Fisheries  
Box 2417, Konedobu.

Processing and Utilization of Animal By-products,  
by I. Mann. FAO Agricultural Development Paper,  
No. 175. 2nd printing 1967, 246pp, US\$3.00.

One of the best FAO Technical Papers around. It has excellent diagrams and pictures that show how to build the tools for processing animal by-products. Very appropriate technology, particularly where slaughtering is a small scale operation.

Gives processes for meat meal, blood meal, bone meal, hide preservation, glue manufacture and the utilization of horns, hooves, glands, casings, and compost, as well as the generation of methane gas from any remaining waste. Designs are low cost; more sophisticated designs are briefly described.

An excellent manual for designs appropriate to village economies. It is clear, simple, and complete. It is probable that PNG Public Health regulations would forbid many of the designs.

Niugini Table Birds Pty. Ltd.,  
Box 1152, Lae. Telephone No 422229.

Pricelist available only.  
Buys: Produce Poultry Products

Niugini Table Birds Pty. Ltd., is primarily a poultry abattoir and processor. Through extensions and management officers they are affiliated with breeder farms and broiler growers. The company owns its own abattoir producing fresh broilers. They are supported in production by over 120 independent local farmers who produce all of their unprocessed birds.

Agents for Niugini Table Birds, Pty. Ltd., Ross  
Michael, Managing Director, Michael PNG Pty Ltd.

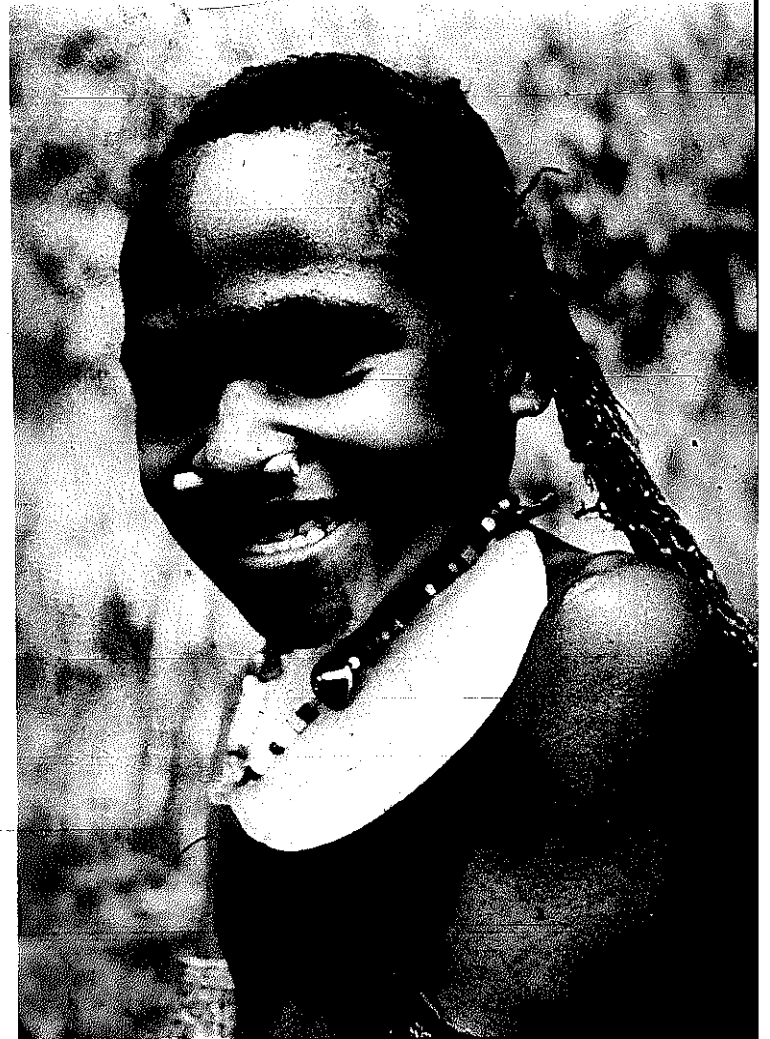

# Food Preparation

## DRIED LEGUMES

SOYBEANS, PEANUTS, COMPEAS, MUNG BEANS, WINGED BEANS, AND OTHER SMALL DRIED BEANS MAY ALL BE USED WITH THE FOLLOWING RECIPES.

### SAMPLE RECIPES FOR DRIED LEGUMES

Selected from The Health Aspects of Food and Nutrition, World Health Organization, Western Pacific Regional Office, Manila, 1969.

These recipes are intended only as guides and samples. They should be adjusted, revised, and flavoured according to local tastes and available foods.

Some useful equivalents for these recipes:

1 tsp. = 5 grams water; 1 tbsp = 15 grams water  
or 10 grams dried beans

3 level tsps make 1 level tbsp  
8 level tbsp make ½ breakfast cup (approx 120 cc)  
1 cup = 240 cc.  
2 cups make 1 pint (approx 500 cc)  
2 pints make approx 1 liter (1000 cc)  
8 pints or 4 liters make 1 gallon  
4 cups make approx 1 liter  
1 liter of water weighs 1 kg = 2.2 pounds

1 large breakfast cup holds about 200 cc water, (as drunk)  
1 large breakfast cup brimful holds 250 cc water  
1 large breakfast cup brimful holds 170 gr dried beans

### INFANT FEEDING RECIPES

(for infants 4 - 12 months)

Notes on preparation of infant foods in general:

- Grinding- Fine pounding or grinding or mashing and sieving is often necessary. For home use, a mortar and pestle may be used. (p 93) (p 176)  
For quantity preparation of dried beans and cereals, a grinder made of stone (traditional style) or iron (commercial) is convenient.
- Mashing and sieving- For older infants (7 - 12 months) many foods can be thoroughly mashed with a fork. For younger infants (4-6 months) they should be mashed and then sieved or strained.
- Pulping- For soft-cooked vegetables, cheap lightweight vegetable mills or grinders are available and very effective.

The left-hand column gives the quantity for one serving (Home use). The right hand column gives the quantity for ten servings (feeding stations).

### 1. DRIED BEANS-RICE PORRIDGE

	For one	For ten
Dried beans	2 tbsp.	1½ cups
Rice	2 tbsp.	1½ cups
Water	1 cup	8 cups
*Milk powder (*if available)	1 tbsp	2/3 cup
Brown sugar	1 tbsp	2/3 cup

- Prepare dried bean flour and rice flour from well-dried beans and rice by pounding or grinding. If thorough drying in sunlight is not possible, heating gently over a low fire helps to yield a fine flour.  
(Flour of dried beans or rice may keep for one month in an airtight container, if the grains are first slowly toasted for fifteen minutes until golden brown, then ground or pounded and quickly stored in the air-tight container.)

A flour which is more readily soluble in water can be made by boiling the beans for 30 minutes, then drying thoroughly and finally pounding or grinding.

- Blend dried bean flour and rice flour in small amount of cold water.
- Boil remaining water and add mixture, stirring constantly to prevent scorching.
- Add sugar and milk, or fish flour\* (\*if available).
- Cook for fifteen minutes more to a soft custard consistency, adding more water if necessary.

*This simple type of hand driven grain mill is very useful in preparing ground-legume recipes.*

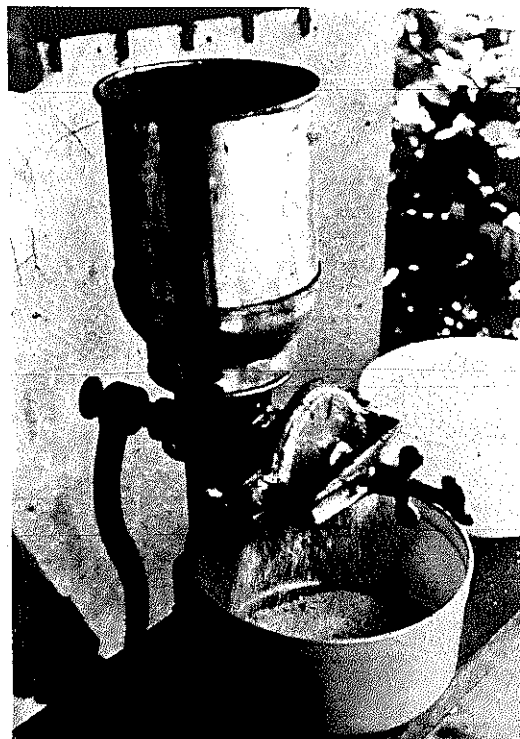

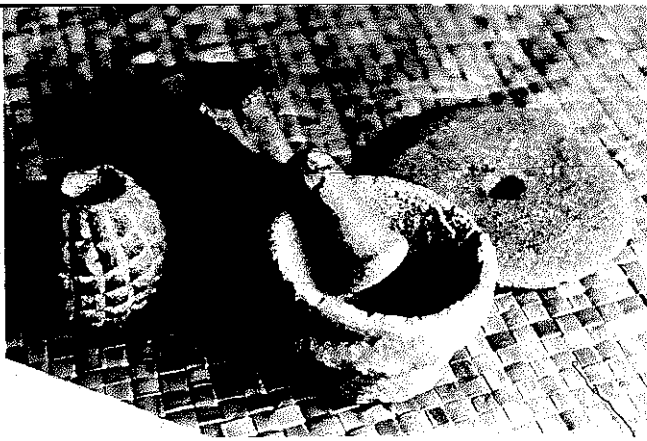

The traditional mortar and pestle may be used for crushing grain legumes.

- f. Serve warm to infants four months of age and over\*\* (The stool may be more bulky and softer than usual but this is not harmful).

\*\*Although this mixture is in general recommended to begin only after 4 months, in circumstances where no breast milk or artificial milk is available, it is known that it can be tolerated by infants even in the first months of life, if begun initially in small quantities.

## 2. MIXED VEGETABLE/DRIED BEANS PUREE

	For one	For ten
Sweet potato (yellow), mashed	2 tbsp	1½ cups
Dark leafy greens	¼ cup	2½ cups
Dried beans (any type)	2½ tbsp	1½ cups
Water	1½ cups	12 cups
Salt	½ tsp	1 tbsp
Milk powder* (or any milk available), or fish flour		

- Boil dried beans until soft (½ - 1 hour); mash.
- Boil sweet potato until soft (10-20 minutes); remove skin and mash.
- Boil the dark leafy greens with a little water and salt for 5 minutes. Mash.
- Mix all these ingredients and pass through a sieve (for infants 4 - 6 months.)
- Add the milk (dissolved in one-half cup water) and cook for another 5 minutes, stirring constantly.
- Serve warm to infants four months and over.

\* if available

## 3. SOYBEAN SOUP

Soybeans	2 tbsp	1½ cups
Salt	¼ tsp	1 tbsp
Water	1 cup	8 cups
Any dark leafy greens	¼ cup	2½ cups

- Put soybeans in excess water. Remove the imperfect beans (which float). Soak overnight or about twelve hours. Drain. (The water used for soaking may have a slight bitter and beany taste, therefore change the water before cooking.)
- Boil in clean water until tender (1-2 hours).

- Boil the dark leafy greens in a small amount of water for three minutes.
- Pass cooked soybeans and leaves through a grinder (either stone or metal).
- Cook for five minutes more.
- Serve warm to infants six months and above.

## 4. SOYBEAN PUREE WITH COCONUT MILK

Soybeans	2 tbsp	1½ cups
Coconut milk	¼ cup	2½ cups
Salt	¼ tsp	1 tbsp

- Prepare soybeans as in recipe 3 steps a and b.
- Pound or pass soybeans through a grinder. Boil again for five minutes.
- Add coconut milk to soybeans (coconut milk is the diluted coconut cream, or the product obtained by repeated washing of the residue after first expressing the cream).
- Cook for five minutes. Add salt.
- Serve warm to infants six months and above.

## 5. GROUND PEANUT BALL

Peanuts, shelled	¼ cup	2½ cups
------------------	-------	---------

- Slowly bake or toast selected mature well dried peanuts (without moulds) until golden brown (at least half hour). Do not allow to burn.
- Remove the skin (optional)
- Pound or grind finely, using pestle and mortar or corn grinder. Wash hands and form ground peanut into balls.
- Feed one whole ball daily to infants over six months, or toddlers, along with any other food. (Divide into 2 or 3 portions, if not all consumed at once.)

Note: Ground peanuts should be stored in clean, tightly covered containers, when preparation is not consumed in one serving. Commercial peanut butter is not recommended for infants because the ingredients (coconut oil, etc.) and the quality can not be controlled.

Working for the people.

Working for thank you.

These are two different things, and there is often goal conflict between them.



6. PEANUT/BANANA MASH\*\*

Peanuts shelled ¼ cup 2½ cups  
 Bananas, ripe\* 1 piece 10 pieces

- Prepare ground peanuts as in Recipe 5.
- Peel the bananas and mash smoothly with fork.
- Blend with the finely ground peanuts.
- Serve to infants five months and above in divided portions if necessary. (for infants below five months, add a little boiled water to make a creamy consistency).

\* Preferably a variety with yellow core (containing Vitamin A) if available.

\*\* Although this mixture is in general recommended to begin only after 4 months, in circumstances where no breast milk or artificial milk is available, it is known that it can be tolerated by infants even in the first months of life, if begun initially in small quantities.

SINCE RECIPES INVOLVE A DELICATE BALANCE BETWEEN INGREDIENTS, WE KEEP THE OLD IMPERIAL SYSTEM FOR OUR RECIPES UNTIL TESTED METRIC RECIPES ARE AVAILABLE. IF YOU MAKE A GOOD CONVERSION, LET US KNOW FOR THE NEXT EDITION.

RECIPES FOR SCHOOL CHILDREN (AND PRESCHOOL)  
 ALSO SUITABLE FOR ADULTS  
 (Quantities to serve 100 or 10 persons)

1. DRIED BEANS WITH LEAFY VEGETABLE  
 (1 cup portions)

	For 100	For 10
Dried beans	20 cups	2 cups
Rice (or substitute sweet potato)	20 cups	2 cups
Dark leafy greens (cleaned)	30 cups	3 cups
Water (or rice washing)	5 gallons	10 cups
Dried fish (10 cm long or other seafood or meat)*	100 pcs	10 pcs
Ginger or other seasonings	season to taste	
Powdered milk* dissolved in a little water	2 kilo packet	

- Clean and wash the dried beans and rice.
- Heat the water, add washed dried beans and cook until nearly soft.
- Add rice (or sweet potatoes), seasonings, and meat. Cook 20 minutes longer (or longer in the case of sweet potatoes).
- Add dark leafy greens and milk\* Cook five minutes more.

\*If Available.

2. DRIED BEAN SOUP (1 cup portions)

Dried beans	20 cups	2 cups
Rice (or substitute sweet potato)	20 cups	2 cups
Mixed vegetables (diced) such as yellow sweet potato, squash, okra, scratched corn,		
onions.	10 cups	1 cup
Dark leafy greens	20 cups	2 cups
Water	5 gallons	10 cups
Oil or fat	600 gr.	5 tbsps

- Wash the dried beans, cover with cold water and bring to a boil
- When tender, add the oil, salt, rice, and diced vegetables.
- Continue cooking until the mixture becomes pulpy.
- Add the leaves three minutes before removing from fire. If desired, pass through sieve or grinder to obtain creamy consistency.

3. DRIED BEAN STEW (1 cup portions)

Dried beans	20 cups	2 cups
Water	4 gallons	8 cups
Banana (cooking Variety)	50 pcs	appr. 5 pcs
Sweet potato yellow	50 pcs	5 pcs
		(5 kg each)
Rolled wheat or wheat flour*	10 cups	1 cup
Salt	1 cup	3 tbsps
Meat	1 kg.	1 cup
		(150 gr)

- Toast the dried beans lightly and grind finely.
- Put this and the meat into water and bring it to boil.
- Add the diced banana and yellow sweet potato, rolled wheat and salt. Boil for 15-20 minutes.

\*If Available

DRIED BEANS AND EGG SOUP (1 cup portions)

Ingredients as for Recipe 2

Eggs	20 pcs	2 pcs
------	--------	-------

- Prepare the dried bean soup as in Recipe 2
- Beat the raw eggs. Add into the soup by pouring down a 30 cm chopstick held nearly vertically and passed in spiral fashion over the mixture so that the egg is thinly distributed throughout the whole.
- Mix and simmer for one minute.

5. SOYBEAN SOUP (3/4 cup portions)

Soybeans dried	20 cups	2 cups
Water	5 gallons	12 cups
Oil	600 cc	5 tbsp
Tomato (chopped)	10 cups (1 kg.)	1 cup
Salt	1/2 cup	2 tbsp
Yellow sweet potato or squash, diced, or carrots*	10 cups	1 cup
Any leafy greens	20 cups	2 cups
Garlic or other seasonings	20 cloves	2 cloves
	or to taste	
Flour*	1 cup	3 tbsp
Onion (chopped)	20 pcs	2 pcs
Milk powder* dissolved in water; or fish flour or small dried fish or shrimps	10 cups	1 cup

- Soak soybeans in water overnight
- Wash and cook 1 - 2 hours
- Dissolve milk in warm water. Set aside
- Saute the garlic, onions and vegetables. Add the soybeans, salt and flour
- Make thick or thin soup according to one's taste. Add the milk or fish\* and leafy greens five minutes before removing from fire.
- Serve hot.

6. SOYBEAN STEW (with milk) 3/4 cup portions)

Soybeans	20 cups	1 cup
Meat, or fish, or snails	1 kg	1 cup
Salt	1/2 cup	2* tbsp
Water	4 gallons	10 cups
Milk powder*	10 cups	1 cup
dissolved in water	5 gallons	10 cups

- Boil the soaked soybeans for 1-2 hours, then add meat or fish and boil until tender.
- Season with salt.
- Add the leafy vegetables five minutes before removing from fire.
- Serve hot with 1 cup of milk\* for each person

7. FRIED SOYBEANS (with milk\*) (3/4 cup portions)

Soybeans	20 cups	2 cups
Water	5 gallons	10 cups
Oil (Cooking)	900 cc	1/2 cup
Salt	1/2 cup	2 tbsp
Milk powder* dissolved in water (warm)	10 cups	1 cup
	5 gallons	10 cups

- Soak soybeans overnight, and boil 1-2 hours. Drain water
- Add salt.
- Fry in vegetable oil until soybeans are light yellow and crispy.
- Eat fried soybeans with milk\*.

\*if available.

8. SAVORY SOYBEANS (with milk\*) (3/4 cup portions)

Soybeans	10 cups	1 cup
Onions, minced	2 cups	1/2 cup
Tomato sauce*	10 cups	1 cup
Sweet pepper (red)	10 pcs	1 pc
Cooking oil	600 cc	5 tbsp.
Water	5 gallons	10 cups
Salt	1/2 cup	2 tbsp
Milk powder* dissolved in water	10 cups	1 cup
	5 gallons	10 cups

- Soak soybeans overnight, add salt and boil 1 - 2 hours.
- Heat the oil and add the onion and pepper. Cook for five minutes.
- Add the boiled soybeans and tomato sauce. Allow to simmer over the low fire until thoroughly heated. Serve warm or hot.

9. SOYBEANS WITH COCONUT (3/4 cup portions)

Soybeans, dried	20 cups	2 cups
Coconut, grated	20 cups	2 cups
	5 coconuts	
Salt	1/2 cup	2 tbsp
Sugar (white)	5 cups	1/2 cup
	(3/4 kg.)	
Water	5 gallons	10 cups
Milk powder* dissolved in water	10 cups	1 cup
	5 gallons	10 cups

- Soak beans overnight. Drain and cook in boiling water until tender.
- Add the salt. When done remove from fire, drain and set aside to cool.
- Place in a platter. Make a ring around the soybeans with grated coconut.
- Serve with one cup milk\*

\*If available.

10. SPROUTED BEAN STEW (with milk\*) (1 cup portions)

Soybeans or mung beans, dried	20 cups	2 cups
Shrimps*, or fish* or meat*	5 cups	1/2 cup
Fat (Oil)	600 cc	5 tbsp
Water	5 gallons	10 cups
Onions, diced	10 pcs	1 pc
Garlic, minced (or other seasonings)	10 pcs	1 pc
Powdered milk* dissolved in water	10 cups	1 cup
	5 gallons	10 cups

- Soak the beans overnight. Drain off water and place in a container with holes. Cover the soybeans with a cloth to keep warm. (p 110)
- Sprinkle water on the beans twice a day until they have a sprout of 2 - 3 cms. long (2 or 3 days.).
- Saute garlic, onions, shrimps or meat in oil. Add five gallons/10 cups water. When water boils add the bean sprouts and cook until tender.
- Serve with milk\* (1 cup)

NOTE: Bean sprouts could also be cooked for soup.

## NOTES FOR USE OF GREEN SOYBEANS

1. Pick soybean pods before they are mature (just turning yellow). Clean them.
2. Mumu; or steam in pot, adding salt.
3. Eat straight out of shell.  
This is a method of eating soybeans that the Japanese use. Special varieties are grown for this, but almost any other varieties will do, except the black soybeans. It is a good way because it is similar to peanuts, and because the protein content is not much different from dry beans. Also, it is an easier way - none of the mess of drying, shelling, etc.

Initial contributor: H. Bekker

**CRISP SOYBEANS:** Put cooked soybeans into the sun to dry. When dry, roast them in an oven until crisp and slightly browned. Keep in sealed container. Excellent snack.

**SOYBEAN CASSEROLE:** Soak the soybeans. When swollen grind in a mill. Mix the ground beans with garlic, onions, tomatoes, salt and pepper. Bake in slow oven until done.

Initial contributor: H. Bekker

## BEAN SPROUTS

Especially good where fresh food is not readily available. Seeds of Soybean, Mung bean, Cowpea, Wing bean, Sunflower seed, and Corn seeds can be sprouted, but the traditional Asian bean sprout is from Mung beans.

Put mature seeds into a container with water. Let sit one or two days in the water, changing the water at least three times a day. After beans have started to sprout, drain the water and let sit in a dark place (to keep the sprouts blanched and from getting bitter). Rinse frequently, but do not let the sprouts sit in any water (tends to rot them). Sprout until the roots are thick.

Another way to do them is to put the sprouts, after they have been soaked, between two hessian sacks (or terry cloth towels) on a screen and to pour water over them, keeping them moist and dark.

To cook: Fry in quick fry Chinese dishes (with thinly sliced capsicum, green beans, carrots, onions, peas, or any other suitable vegetable). Or fry with onions and oil, then add cooked egg noodles, salt and pepper.

Initial contributor: H. Bekker

## PEANUTS, USES

### BOILED PEANUTS IN SHELL (with milk, if available) (½ cup portions)

Peanuts in shell (dried)	7½ kg	3/4 kg.
Salt	1 cup	2 tbsp
Water	10 gallons	1 gallon
Milk powder* dissolved in	10 cups	1 cup
Water	5 gallons	10 cups

- a) Boil washed peanuts in water (plus salt) for about an hour, adding more water as necessary.
- b) Remove from fire and drain off the water. Serve warm with 1 cup of milk per person\*

\*If available.

### FRIED PEANUTS (½ cup portion)

Peanuts, shelled <sup>1</sup>	3.3 kg	2 cups
Cooking oil	1 gallon	1½ cups
Garlic*	10 cloves	1 clove
Salt	1 cup	2 tbsp

- a) Soak the shelled peanuts overnight. Remove the skins and dry the peanuts under the sun for an hour.
- b) Heat the cooking oil, add the garlic and peanuts.
- c) Stir constantly to prevent scoring. Add salt.
- d) Remove from the fire when the peanuts are golden brown.

1. One kg of peanuts in shell yields 670 grams of shelled peanuts (5 cups)
2. Most of this can be recovered and used again.

\* If available

### PEANUT SOUP (1 cup portions)

Peanuts shelled	3.3 kg	2 cups
Dried shrimps*	10 cups (1 kg)	1 cup
Sweet pepper, sliced	10 pcs	1 pc
Onions	10 pcs	1 pc
Salt	1 cup	2 tbsp
Water	3 gallons	5 cups
Dark Leafy greens	20 cups	2 cups

- (a) Boil the peanuts until soft (20-26 minutes).
- (b) Add washed shrimps and prepared vegetables. Simmer for five minutes.
- (c) Serve warm.

Note: If fine consistency is desired, pass all ingredients through grinder and simmer again.

\*if available

## ROASTED IN SHELL PEANUTS

The peanuts are cleaned, dried in the sun and then roasted. Roasting may be carried out on a sheet of iron over a fire, in a hand roaster (see design) or on a large scale in an electrically driven rotating cylindrical screen using LP gas or oil burners as a heat source.

Roasting takes between 45 minutes to 1 hour and temperatures at 150°C to 200°C are commonly used.

Roasting is complete when the kernels have a golden-brown colour. The peanuts are then taken out of the roaster and cooled.

To retain the texture and taste of fresh roasted peanuts the peanuts are stored in airtight containers.

Initial contributor: A. Hepworth, Box 793, Lae.

## SALTED ROASTED PEANUTS

Shelled peanuts are fried in oil at 138-143°C for approximately 10 minutes, cooled, sprinkled with salt and stored in airtight containers or sealed into cellophane bags. The thin skin is sometimes removed before frying.

Alternatively the peanuts may be dry roasted, as for roasted inshell peanuts, mixed with 1.5 to 2.0% oil and salted.

## PEANUT BUTTER

Peanuts are shelled, dry roasted and cooled. The thin skins are removed and the peanuts are then finely ground usually in two stages. During grinding 2% salt, up to 5½% vegetable oil and sometimes 1-2% sugar are fed into the grinder with the peanuts. The peanut butter is then packaged in airtight containers.

Initial contributor: A. Hepworth, Box 793, Lae.

## PEANUT BUTTER

Smooth and delicious as commercial peanut butters may be, they are often made without the germ of the nut. This valuable portion - as in grains - contains minerals, vitamins and proteins and is literally fed to the birds. The commercial objection to the germ is twofold: 1. that the flavour of the butter is made somewhat bitter, 2. that, as grains, the heat of processing and the heat in storage may cause the finished product to grow rancid. If you are smart make your own full-bodied peanut butter in an electric blender (substitute small hand-operated mill).

Use: Fresh roasted or salted peanuts. Remove skins from peanuts. It is wise to start with a bland oil: Safflower or vegetable oil. Allow 1½ - 3 tbs to 1 cup peanuts. If nuts are unsalted, add salt to taste. (about 2 teasp salt per cup).

From: Joy of Cooking, by Rombauer and Becker

## CURRIED PEANUTS

1. Melt a tablespoon of oil or fat in a pan.
2. Add a teaspoon of curry powder and a chopped chilli to the oil.
3. Cook the raw peanuts slowly in the pan.

## PEANUT CAKES

You will need: 2 cups of cooked sweet potato  
1 cup grated coconut  
2 teaspoons salt  
1 beaten egg, or 2 tbs of flour (to bind the mixture)  
2 cups of ground roasted peanuts

1. Mix all of the ingredients thoroughly, add a little water, milk, or coconut cream if necessary to moisten the mixture.
2. Make into flat cakes.
3. Fry in fat or bake in an oven.

This mixture makes about 20 small cakes.

## PEANUT BUTTER CANDY

You will need: 2 cups sugar  
½ cup milk  
2 tablespoons peanut butter

1. Put in a pot and mix well together; boil for 5 minutes.
2. Remove from the fire and beat steadily till cool.
3. Pour into soup plate or cake tin. When set cut into squares.

## PEANUT BARS

You will need: 2 cups flour  
1 cup coarsely chopped peanuts  
1 tsp. baking powder  
½ cup milk  
1 egg  
½ cup sugar  
2 tbs butter  
a pinch of salt

1. Sift flour, salt, and baking powder into a bowl; rub in the butter, nuts, and sugar.
2. Mix to a rather stiff dough with the egg and milk.
3. Turn on to a floured board and roll out almost an inch thick.
4. Cut into bars of convenient size and fry in a pan with fat until golden brown.

From: "12 Things to Do with Peanuts", South Pacific Commission Literature Bureau

ALSO TRY GRINDING SHELLLED, ROASTED PEANUTS TO COARSE PASTE AND COOKING WITH VEGETABLES.

## JAMS AND MARMALADES

We give these considerable space because there are so many fine fruits available during certain seasons, and because these might help to get more calories into the diets of children.

How will you eat jams if you don't have bread? The heavy sea biscuits (strongpela basket) are found in trade stores throughout the country, and you can also eat jams with kaukau and taro. Jams are commonly eaten as a sauce with rice in some parts of Southeast Asia.

### GENERAL INSTRUCTIONS FOR MAKING JAMS

Peel the ripe fruit and mash until it is reduced to very fine pieces or pulp; add from 50-100% of its weight of sugar and cook until thick. Transfer to sterilized jars while boiling hot and seal tightly.

### CITRUS FRUIT JAM MAKING

Ingredients: Citrus fruit, sugar  
Utensils required: Cooking pan, coarse sieve, kitchen knife.

Summary: Citrus jams or marmalade is prepared by cooking the fruit material to a pulp, then adding sugar and boiling again until the setting point is reached. At this stage the jam is packed in jars. (Setting point is when it becomes thick).

#### Ingredients

1. For Marmalade (yields about 5kg.)  
1½k oranges, juice of 2 lemons  
3 litres water  
2½kg sugar
2. For three fruit (yields about 5kg)  
2 grapefruit }  
4 lemons } total weight about 1½-2kg  
2 oranges }  
2½ litres water  
2½k sugar
3. For Tangerine  
Tangerines }  
1 grape fruit } total weight about 1-1½kg  
1 lemon }  
juice of 2 lemons  
2 litres water  
1kg sugar

#### The Process:

1. Clean the fruit
2. Dip in boiling water for 1-2 minutes
3. Peel as for eating
4. Cut the peel into fine shreds. Put the shredded peel and lemon juice and half of the water in a pan, and boil until the peel is tender.
5. Cut up the rest of the fruit and simmer in a closed pan for 1½ hours.

6. Rub the pulp through a sieve.
7. Add the strained pulp to the peel.
8. Add the sugar - stir until dissolved.
9. Boil rapidly until the setting point is reached (about 15 minutes).
10. Allow to cool slightly, then pour into hot sterilized jars and put on the lids.

Note: Jars and lids are sterilized by boiling in water for 10 minutes.

If recipe 3 is followed the following modifications should be made to the method:

- step 4: Cut the peel of the grapefruit and lemon, and boil together with the fruit and water for two hours.
- step 5: The tangerine peel should be cut into shreds and tied in a cotton bag. Put the bag in with the boiling fruit but remove after 30 minutes.

Initial contributor: J.H. Hepworth, Box 793, Lae.

### CUMQUAT MARMALADE

Materials or equipment needed: Knife, two bowls, cumquat fruit, sugar, cooking pot, glass bottles with lids.

One cup of sugar is required for each cup of reduced cooked cumquat pulp.

Description of the process: Slice cumquats thinly and remove seeds. Put seeds into bowl, cover with water and leave overnight. Put sliced cumquats into another bowl, cover with water and leave overnight. Next morning put cumquat slices and water into saucepan, add strained water from cumquat seeds. Bring to boil, then simmer until fruit is soft and liquid is reduced to half.

Measure and allow one cup sugar for each cup cumquat mixture. Bring cumquat mixture to boil. Add sugar and stir until dissolved. Simmer for 2-3 hours on low heat until it jells. Pour into sterilized jars (boil jars in water for 20 minutes).

This process has been used in Kavieng, New Ireland with excellent results.

Initial contributor: J. Hale, Box 122, Kavieng NIP.

### MANGO JAM

Utensils required: Blender or coarse sieve or masher, kitchen knife, mixing bowls measuring cup, wooden spoon.

Ingredients required: Ripe mangoes, sugar, citric acid (food grade).

Packaging materials: Sterilized glass jars with caps that can be sealed.

#### The process:

1. Wash mangoes to remove surface dirt.
2. Slice and scoop out flesh. Pass through blender or coarse sieve or mash.
3. Mix the pulp with an equivalent amount of sugar.

cont'd

4. Heat over low fire with constant stirring. When almost thick, add 0.3% citric acid based on the weight of the pulp used.
5. Continue heating until temperature is 105°C (211°F) or until the mixture can be spooned out.
6. Fill into sterilized jars and seal.
7. Air cool, label and store.

Initial contributor: A. Hepworth, Box 793, Lae.

#### PAWPAP -PINEAPPLE JAM

Utensils: Kitchen knife, chopping board, measuring cup, aluminium saucepan, wooden spoon, jars.

Raw materials: pawpaw, pineapple, sugar.

The process:

1. Select fully ripe, sound pawpaw. Remove seeds and scoop out pulp with a spoon. Mash with a fork.
2. Peel pineapple, remove eyes and chop till fine.
3. Mix equal parts of mashed pawpaw and chopped pineapple.
4. Add 1½ cups sugar to every 2 cups fruit mixture.
5. Boil briskly in an aluminium pan until thick. Stir constantly to avoid scorching.
6. Pour immediately in hot sterile jars and seal tightly.
7. Cool and store.

Initial contributor: A. Hepworth, Box 793, Lae.

#### ROSELLA JELLY

Ingredients: Rosellas, sugar, water.

Utensils: 2 cooking pots, white cloth, any measuring container, bottles with caps.

Process: Wash the rosellas that you have picked including seeds, tips and calyces, and place in pot.\*

2. Add enough water to cover everything.
3. Boil over the fire for one hour.
4. Pour the juice into another pot through the cloth to remove all the bits.
5. Measure the number of cups of juice.
6. Add this many cups of sugar to the juice.
7. Boil juice and sugar gently, stirring frequently for 20 minutes.
8. Pour into bottles and seal. This will be jelly when it is cool.

Initial contributor: M. Cockburn, 125 Prince Albert Parade, Newport, NSW. 2106

#### ROSELLA JAM

Ingredients: Rosellas, sugar, water, muli rinds (if desired).

Utensils: 2 cooking pots, scales, measuring cup, white cloth, and storage jars.

Process: Separate calyces (the red part) from seeds and tails.

2. Weigh out 1kg of calyces\*

\*The calyces are the thick outside flower petals.

3. Put in one pot and add 625ml. water (1.1 pint)
4. In another pot put 670g of seeds and tails and add 625ml. water. Boil this rapidly for exactly five minutes.
5. Strain the seeds and tails from step 4, through the cloth and put this liquid into the pan with water and calyces.
6. Boil the combined liquids for about 20 minutes until colour of liquid is a deep red. Add chopped up skin of lemon muli to taste at this time if desired.
7. Remove saucepan from fire and measure the amount into the other pot. Add this many cups of sugar.
8. Boil combined sugar and fruit and juice as quickly as possible for 10 to 15 minutes. After 10 minutes spoon out a little onto a plate to see if it jellies. Keep cooking until sample jellies.
9. When jellied, remove from fire, pour into bottles and seal. Serve when cool.

Initial contributor: M. Cockburn, 125 Prince Alfred Parade, Newport, NSW. 2106

### FRUITJUICE PROCESSING

Equipment required: Sharp knife, juice extractor, sieve, large pan, bottles or jars with screw top lids, thermometer, scales, measuring jug.

Raw materials required: Citrus fruit, sugar, sodium benzoate (or benzoic acid)-available from ICI or New Guinea Wholesale Drugs, or other drug companies.

Summary: Fruit juices are prepared by extracting the juice from the fruit, filtering, adding sugar and preservative, pasteurising, and bottling.

The Process:-

1. Sterilise bottles and lids by boiling in water for 10 minutes.
2. Clean the fruit in cold water.
3. Remove any over-ripe fruit and cut out any damaged or rotten parts.
4. Cut the fruit in halves.
5. Extract the juice and filter the juice through a sieve.
6. For every 1 litre of juice add ½ kg of sugar.
7. Pasteurise the juice by raising the temperature to 85 degrees C and holding at that temperature for 10 minutes.
8. Allow to cool slightly and then stir in sodium benzoate (or benzoic acid) 0.6 gr. per litre of juice. (This chemical will make the juice keep well for a long time.)
9. Fill while still hot into the sterilised bottles and close immediately with the lid.
10. Dilute juice to taste with cold water for drinking.

cont'd

## CROWN SEALS FOR BOTTLING FRUIT JUICES

Mr. K. Beutel  
Plaza Health Foods  
K - Mart Plaza  
Cannon Hill, Brisbane, 4170  
Queensland  
Australia

Note: crown tops and simple hand-operated crowners are sometimes available at reasonable prices at Burns Philp stores.

## PINEAPPLE CORDIAL

(using the trimmings from a fresh pineapple)

Ingredients: 1 pineapple  
                  ½ cup sugar (more or less to taste)  
                  1 pint water

Equipment: 1 saucepan  
                  1 screw top bottle  
                  stove or fire

### Method:

Cut off green top of pineapple and bottom stalk and throw these away.  
Wash pineapple skin well.  
Peel and core pineapple.  
Cut up the core.  
Put the peel and core pieces in the saucepan. Add sugar and water.  
(The actual eatable part of the pineapple is not used in the cordial)  
Boil for 5 minutes.  
If you keep boiling for too long (over 10 mins) the cordial will go bitter.  
Cool liquid.  
Drain and bottle.  
To serve: dilute with water to taste.

S. Tracy

## ROSELLA DRINK

Materials and equipment needed: Cooking pot; mature rosella plants.

To make 14 cups of rosella drink: remove red sepals (these look like flower petals and enclose the large seed case) and put into a large saucepan with 8 cups water and ½ cups sugar. Boil for 45 minutes or until such time as the red sepals turn white and the water becomes a deep red colour.

Remove sepals and let rosella water cool until you can easily pour it into clean containers. Mix one part water to one part rosella or dilute the rosella water according to taste.

Source of supply for rosella: Yates Seed Co.

PNG Experience: Puas, New Hanover.

Initial contributor: J. Hale, Box 215, Wewak, ESP.

## BREAD, BISCUITS AND CAKES

### USES OF GRAIN

#### BREADFRUIT BISCUITS

Here is a way that my people preserve a seasonal fruit using a simple technique:

#### Materials needed:

4-5 fruits from a favoured variety, preferably the seedless one  
2 new baskets made of coconut leaves  
firewood  
a wire net above the fireplace  
knife

#### Method:

Build fire. Place the fruits on the fire and turn them from time to time as they cook.

When they are cooked peel them with a knife. Remove the inside core, and let the fruit cool.

Cut into thin slices and place them evenly in the baskets. Put the baskets above the fireplace on a wired net.

When the slices are dry and hard they are finished, and will keep for months.

Contributed by: M. Kemp, Vudal, Kerévat, ENBR.

#### BUCKWHEAT

Buckwheat flour: Grind buckwheat into flour, and use in bread, about 1 part buckwheat flour to 3 parts wheat flour.

#### Buckwheat Pancakes:

2 cups buckwheat flour    1 egg  
1 tsp salt                    2 tbsp fat  
1 tsp baking soda         2 cups milk  
juice of 1 lemon

Mix batter well. Spoon into a hot, greased skillet, making patties. When bubbles appear on one side, turn and cook the other side.

Groats: Crack the buckwheat. Cook the same way as rice: Use plenty of water, bring to a boil; when boiling, turn down heat a little. When all the water is evaporated and bubbles stop (and groats are almost cooked), turn down heat and do not open cover. After 15 minutes, remove from heat and let sit for another 15 minutes without lifting the cover. Take a flat paddle and remove (can be made from large diameter bamboo).

H. Bekker

## CORN

Cornmeal: Husk the corn, leaving the inner husks attached. Dry with the husks on for a day, then braid the husks and hang to dry. When dry, remove the kernels from the ears and grind in a flour mill. Use the flour in bread with wheat or as follows:

### Cornbread:

Mix 2 cups cornmeal	1 tsp baking soda
1 cup wheat flour	juice of 1 lemon
1 egg	2tbs butter, oil or lard
1 tsp salt	milk to mix (stiff dough)

Bake in a low greased pan in a moderate oven until bread draws from the sides and a knife comes out clean. If all cornmeal is used, use 3 cups cornmeal and 3 eggs.

### Hush Puppies:

2 cups cornmeal	1 tsp baking soda
1 cup wheat flour	juice of 1 lemon
1 tsp salt	dash of pepper
1 small onion, chopped fine	milk to mix (stiff dough)

Make into little balls and fry in shallow, hot fat, turning to brown evenly.

### Scones: (cooked on top of stove or flat grill)

1 cup cornmeal	1 tsp salt
1 cup wheat flour	2 tbsp fat
1 tsp baking soda	milk to mix (stiff dough)
juice of 1 lemon	

Mix and form into small disks 2cm thick. Fry in dry skillet with a cover on it, over low heat. When one side is cooked, turn over. Variations: Use all whole wheat flour and/or add honey, sugar, fruit for a sweet cake.

Porridge: Let 1 cup cornmeal sit in 4 cups water to reconstitute. Add salt. Bring mixture to a boil and let simmer at least 15 minutes. Cook until thick and meal soft.

Variations: 1. Add ground peanuts to mixture.  
2. Add ground soybeans to mixture.  
3. Use milk instead of water.

Chapatis: Use half cornmeal and half wheatmeal, adding salt and water to make a dough. If desired, add some fat. Make little balls and roll out into flat disks, as thin as possible. (Wine bottles make good rollers). Fry in a dry skillet or on a flat grill. Also can be fried in some fat. Fry until one side is puffed up and turn to cook on other side. Soft without fat; crisp with fat. Also can be made with all whole wheat flour.

### Masa: (cornmeal for making Mexican tortillas)

1 kg corn kernels
60gm lime
3 litres water

Wash the corn, add the lime and water and put on to boil. Let boil until the kernel skins loosen. Remove from flame and let cool. Rub handfuls of kernels between the palms until all skins are loosened and removed. Wash the skinned kernels thoroughly in cold water. Grind very fine and make tortillas by rolling out or by patting between the hands to a very flat disk. Cook dry or with fat in a skillet or on a grill.

Enchiladas: Take an uncooked tortilla or chapati and fill with chopped cooked pork, tomatoes and onions. Line in a pan and pour over it a sauce of tomatoes, capsicum, onions, garlic, chiles, salt and pepper. Bake until cooked, or steam in a heavy, covered skillet.

Tamales: Take fresh sweet corn. Remove husks carefully. Remove the kernels with a grater (can be made by punching holes in bottom of a fish can) or grind in a food mill. Add rendered pork fat to ground corn and some salt.

Make a filling: Brown some chiles in pork fat, add finely chopped pork, tomatoes, salt and pepper. Simmer until thick.

Put a thin layer of corn mixture on each husk. Put some filling in and cover with more corn mixture. Put another husk around it so that the mixture is completely wrapped. Tie together with husks. Place in steamer or a mumu. Tamales are done when the corn draws away from the husk (about 1 hour).

May be made plain with just fat added to corn with salt and/or sugar. The chiles may be too hot for children. Make plain ones for young children - an easy way for them to eat corn.

Initial contributor: H. Bekker.

THE FOLLOWING RECIPES WERE SENT BY C. KELLEY,  
BUSINESS DEVELOPMENT OFFICE, MT. HAGEN

### KAUKAU BISCUITS

8oz sweet potato flour	2 tsp baking powder
1/2oz margarine	milk to mix

Method: Rub margarine into the flour and baking powder. Mix to a stiff dough with the milk. Roll out on a floured board to 2-3cm thick. Cut into rounds with a scone cutter. Bake at 400°F for 15-20 minutes.

### BANANA CAKES

1 banana	6 tbsps milk
1/2 cup sweet potato flour	

Method: Mash the banana. Stir banana, milk and flour together to make a stiff dough. Form into a slab cake on greased foil or banana leaf. Bake at 350°F for 30 minutes.



### KAUKAU CAKE

2 cups sweet potato flour 2-3 cups milk  
1/4 cup margarine 2 tsp baking powder  
1 cup sugar pinch salt  
1 egg

Method: Beat sugar and margarine together. Beat in egg. Sift flour, baking powder and salt together. Add flour mixture and milk alternately, a little at a time to beat in egg mixture. Stir gently. Place in cake tin and bake in hot oven 30 minutes.

### FRIED SCONES

1 cup wheatmeal flour 1 tsp salt  
1 cup sweet potato flour water to mix

Method: Mix all ingredients together to form a stiff dough. Form into large flat scones. Deep fry in boiling fat until golden brown.

Note: Pieces of chopped meat, fish or peanuts can be added to the mixture before frying.

### PEANUT CAKES (makes about 20 small cakes)

2 cups cooked sweet potato 1 beaten egg  
2 tsp salt 2 cups peanut flour

Method: Mix all ingredients thoroughly. Add some water or milk if mixture is too stiff. Form into small flat cakes. Fry in fat or bake in hot oven for 10-15 minutes.

### PLAIN SCONES

2 cups plain flour 4 tsp baking powder  
1 tsp salt 3/4 cup milk  
2 tbsp fat

Method: Sift flour, baking powder and salt into a bowl. Rub in fat. Add enough milk to make a soft dough. Turn out onto floured board and knead slightly. Roll out to about 1cm thick. Cut into even pieces with knife or small tin or scone cutter. Place on greased flat tin. Bake hot oven (400°F) for 10-15 minutes.

### Variations for Scones

Add 2 tbsp milk powder to flour and mix with water instead.

Add 2 tbsp sugar to make sweet scones.

Add 3/4 cup mashed pawpaw & 2 tbsp sugar. Use less milk.

Add 2 mashed bananas and 2 tbsp sugar.

Add 1/2 cup peanut flour.

Add 1 cup mashed cooked pumpkin.

Add 1 cup cooked corn (scrape from cob).

Add 1 cup fish or 1 cup chopped meat.

Add 1 cup grated cheese (use tinned cheese - cheaper)

Add 1 egg and use less milk to mix.

### SAVORY FLOUR CAKE

1 cup wheatmeal salt, water  
1/2 tin fish oil or dripping

Method: Mix wheatmeal and salt. Mash the fish and mix into the wheatmeal. Add water and mix to stiff dough. Make into flat cake. Fry in hot fat or wrap in softened leaf and bake in oven.



### SWEET FLOUR CAKES

1 cup wheat meal  
2 mashed bananas water or milk  
2 tbsp sugar oil

Method: Mash bananas and mix into the wheatmeal and sugar. Add water or milk and mix to a stiff dough. Make into flat cakes and cook as for savory flour cakes.

### WHEATMEAL BREAD (1 x 4lb loaf or 2 x 2lb loaves)

8 cups (4lb) wheatmeal 4 tsp (2oz) dried yeast  
8 1/2 tbsp (4oz) margarine 1 pint liquid (1/2 water  
and 1/2 milk)

Method: Sift wheatmeal into bowl. Warm liquid slightly. Dissolve yeast in half the liquid. Make a hole in the wheatmeal and pour in yeast liquid. Sprinkle with a little wheatmeal. Cover with a cloth and leave in warm place until yeast starts to bubble. Add rest of liquid, margarine and salt. Knead until smooth and not sticky. Put dough back in basin, cover with a cloth and leave in a warm place until double size (proving). Knead again. Place in floured baking tin and cover with cloth. Prove in warm place until double size. Bake in hot oven (400°F) for 25 minutes.

### BREAD

3 cups plain flour 1 tsp sugar  
1 tbsp dried yeast 1 cup water  
1-2 oz margarine 1 tsp salt

Method: Sift flour and salt into bowl. Half fill cup with warm water, add sugar and yeast. Rub margarine into flour. Fill the cup with the yeast i.e. to the top, with cold water. Pour yeast mixture into centre of flour. Mix into a dough. Turn onto a board and knead for 5-10 minutes. Shape into bread and put in greased tins. Cover with plastic bag or damp cloth and leave to rise until dough has doubled in size. Remove bag or cloth. Bake in hot oven (400°F) for 30-45 minutes. When cooked bread should be golden brown and sound hollow when bottom knocked with knuckles. Turn out of tin and cool on wire rack.

### Variations:

Use 2 1/2 cups plain flour and 1/2 cup peanut flour.

Add 1 tin chopped meat to the dough.

Sift 3 heaped tbsp milk powder with the flour.

## YEAST (Root vegetable or potato yeast)

3 tbsp flour  
1½ tbsp sugar  
1 cup water

Clean peelings from -  
potato, yam, taro, or  
tapioca.

Method: Mix all together. Put in a bottle. Cork it and tie on firmly. Leave overnight. Next day empty the bottle but do not wash it. Make a new mixture (as above), put in bottle and leave overnight. Next day empty the bottle but do not wash it. Make a third mixture and put in bottle. Leave until ready to use - it bubbles when ready. Do not wash the bottle - next time you will only need to make 1 mixture. Make up mixture 12 hours before you need it.

## LEMON YEAST

Same as potato yeast, but use 8 drops of lemon juice instead of peelings.

## USE OF THESE YEASTS

In any recipe requiring yeast use 1 cup of lemon or potato yeast instead of dried yeast. Use less water to mix the dough.

THE PRECEDING RECIPES WERE SENT BY C. KELLEY,  
BUSINESS DEVELOPMENT OFFICE, MT. HAGEN

## BASIC BREAD RECIPE

Ingredients: 1 kg. of wheat flour  
10 gr. salt  
15 gr. sugar (1 tbsp)  
30 gr. oil (2 tbsp)  
15 gr. dried yeast (1 tbsp)  
650 c.c. water at 37 degrees C.

Baking temperature: 220 degrees C.

Baking time: 25 - 35 minutes

Loaf size: 500 gr.

Method: Dissolve yeast in some water. Leave for 10 minutes. Mix yeast solution, water, sugar, salt. Sift in the flour, Knead well.

Leave for rising until double size. Form loaves. Allow to rise again (prove). Bake.

Initial contributor: A. Hepworth, Box 793, Lae.

## BREADMAKING

The following recipe was found to be a successful one at the Balimo Vocational Training Centre:

### Ingredients:

4 tsp yeast  
3 tbsp sugar  
24 cups flour  
8 tsp salt

### Utensils:

8 bread tins  
2 large aluminium basins  
2 bowls for yeast  
flat working surface  
round bottle for rolling

### The Process:

1. Put 4 teaspoons of yeast in 8 cups of warm water, add 2 large table-spoons of flour, 3 tablespoons of sugar. Stir and leave for one hour.
2. Put 14 cups of flour in a dish, add the yeast ferment liquid, and mix. Leave in a warm place for one hour.
3. Mix 1½ cups of warm water and 3 cups of flour into the risen dough.
4. Put 7 cups of flour on a table and sprinkle on 8 teaspoons of salt.
5. Place the dough in the middle of the flour on the table and knead until all the dry flour has gone into the wet dough.
6. Roll the dough flat with a bottle and cut into 8 equal parts and shape these into loaves.
7. Put the rolls into tins and place in a warm place for one hour, then without bumping the tins place them into the hot oven (temp. 380-400) F and cook for about one hour.

By using 16 bread tins, 4 large aluminium basins, 4 bowls for yeast ferment liquid, and having a large warm-cupboard on top of the oven it is possible to cook 32 loaves of bread in one day.

A note on difficulties: No problem has been experienced at Balimo with either mould or rope in the bread. ROPE, which is caused by an organism similar to yeast, causes the bread to become putrid in about 24 hours. A repulsive odour is present. This organism is very difficult to kill. Boiling water will not destroy it. Vinegar can be used to wash all items used in the bakery to destroy rope. Vinegar should then be used in every loaf of bread until all traces of rope disappear. - 1½ pints of vinegar to 100 lbs. of bread is recommended.

Reference: Bread and Breadmaking, A.J. Edwards, Mauri Bros. and Thompson, 812 Bourke St., Waterloo, Sydney, Australia.

Suggested by: C. Hemmes, Box 2148, Konedobu

## WHITE BREAD

- ½ pint milk or milk-water or water
- 1 level tbsp sugar
- 1 lb plain flour
- 1 dessertspoon salt
- 1 tbsp margarine
- 1 level tbsp yeast

1. Scald milk, add sugar. Cool to lukewarm. Add yeast, cover, and leave for a few minutes until yeast starts to work.
2. Sift flour and salt
3. Rub in margarine
4. Make a well in the centre of the flour and add yeast mixture.
5. Mix to a soft dough.
6. Knead on a floured board until smooth (10 mins)
7. Cover with a cloth and stand in warm place for 10 minutes.
8. Shape into loaves or rolls.
9. Place on greased trays. Cover with cloth and leave in warm place until dough has doubled in bulk.
10. Bake loaves in hot oven 400° for 15 minutes and 350° for 20 minutes. Rolls for 425° for 15 minutes.

Initial contributor: R. Beasley, Wesley High School, Salamo, MBP.

## BREADS:

**Yeast muffins:** Add 1 tablespoon yeast to ½ cups lukewarm water (or whey). Let dissolve. Add about 3 cups wholewheat flour and 1 tsp salt. Let rise. Punch down and form into flat disks. Let rise. When risen, fry or dry grill on both sides until done.

**Scones:** 2 cups wholewheat flour  
1 tsp baking soda  
1 tsp salt  
2 tbsp fat  
1 cup buttermilk

Mix well. Form into small disks 2cm thick. Fry in dry skillet with a cover, over low heat.

H. Bekker.

The Tassajara Bread Book, by Edward Espe Brown, 1970, 146 pp., US \$2.95 postpaid.

Available from: Shambala Publications, Inc.  
1409 5th St.  
Berkeley, California 94710 U.S.A.

"Here's a breadmaking guide that stands on profound respect for simple, wholesome ingredients and a ripening, maturing, baking, blossoming process that turns a glob of dough into a fragrant food fit for any man's meal. Good bread is always magically more than the sum of its ingredients. There are recipes for breads yeasted and unyeasted, fruit-filled loaves, sourdough, pancakes, pastries, muffins, and various favourite snacks

from the Tassajara Kitchen. This Zen cook knows the true nature of bread."

- Hal Hershey, from The Whole Earth Catalogue

## COCONUT

**Coconut Candy:** See recipe, p 97, "Uses for sugar."

**Coconut chips:** Remove the meat from the dry coconut, keeping the pieces as large as possible. Slice thinly & salt. Spread on flat sheet and place in oven on low heat, or fry on top of stove in heavy skillet. Roast until crisp and slightly browned. Keep in sealed container to retain crispness.

**Coconut pudding:** 3 cups grated coconut  
½ cup cornstarch (tapioca flour)  
½ cup sugar  
¼ tsp salt

Add boiling water to grated coconut until the coconut is just covered. Let sit for 15 minutes then strain. Measure coconut milk into the pan. Add sugar, cornstarch and salt. Stir until the cornstarch is dissolved. Cook on slow heat, stirring constantly until it boils. Let boil a few minutes on low heat. Pour into a shallow pan and let cool. Cut into pieces and serve.

**Breakfast cereal:** Take the grated coconut from the pudding, sprinkle with salt and toast until browned. Add toasted rolled oats, fresh fruit, lemon juice, milk, honey, chopped peanuts.

Initial contributor: H. Bekker

## COCONUT ICECREAM

**Ingredients:** 2 pints thick coconut cream from two or three coconuts  
juice of 1 coconut  
chopped vanilla pod (remove seed)  
or vanilla essence  
2 cups sugar  
2 heaped tablespoons cornflour

**Equipment:** saucepan  
stirring spoons  
small bowl  
stove or fire  
storage container  
freezer

## Method:

Boil coconut cream, vanilla-pod and sugar for 10 minutes.  
In small bowl stir cornflour and coconut juice into a smooth paste.  
Add paste to coconut cream.  
Boil till thick, stirring all the time.  
Cool to room temperature, stirring occasionally.  
Freeze for about 12 hours before serving.  
Stir once an hour for the first three hours.

Contributed by: S. Tracy.

## MANGO CHUTNEY

Utensils: Kitchen knife, paring knife, cutting board, measuring cup, saucepan, wooden spoon.

Ingredients:

4 cups diced green mango	1 small box raisins
½ piece large ginger root	2 cups vinegar
1 clove garlic	3 cups brown sugar
8 pieces small onions	4 tbsp coarse salt
2 pieces hot pepper	

The process:

1. Salt the sliced green mango and allow it to stand overnight.
2. Drain the salted mangoes.
3. Boil vinegar, sugar and spices. Simmer for 5 minutes.
4. Add sliced mangoes and cook until thick.
5. Pack in sterilized jars. Seal.
6. Air-cool. Label and store.

Initial contributor: A. Hepworth, Box 793, Lae.

## MANGO PICKLES

Utensils: Stainless steel knife, pickling jars, bowls.

Ingredients: Fresh immature green mangoes  
10% brine (approx, 1½ tbsp coarse salt for every cup water; boil & cool)

Packaging materials: Sterilized glass jars with tops that will seal.

The process:

1. Wash mangoes to remove surface dirt.
2. Peel mangoes, remove seeds, and slice into longitudinal pieces of ½ cm thick. (if desired, the fruits may be used unpeeled.)
3. Place in pickling jars and immerse in 10% brine solution.
4. Let stand for at least a week until the mixture has a pleasant fermented odour. Stir mixture daily.
5. Boil the brine and remove scum if there is any formed.
6. Rinse mango slices with boiling hot water and pack in jars.
7. Fill jars with boiled brine, cap, seal and cool immediately.

Initial contributor: A. Hepworth, Box 793, Lae.

## PICKLED EGGS

Utensils: Saucepan, utility bowl, cheese cloth, utility plate, glass jars.

Raw materials: chicken eggs or quail eggs  
vinegar  
sweet pepper (red)  
1½ tsp. whole mixed spices (black pepper, bay leaf, cinnamon, cloves)  
salt, garlic, sugar.

The process:

1. Have eggs at room temperature to prevent cracking during cooking.

2. Start in cold or boiling water. For a cold start, completely cover eggs in saucepan with cold water. Heat until water boils. Remove from heat. Cover pan. Let stand 2-3 minutes off the heat. For a boiling water start, bring water to boil in a saucepan. With a spoon carefully lower eggs into the water to prevent cracking the shell. Reduce heat. Keep water simmering until eggs are cooked, about 18-20 minutes for chicken eggs, 5-10 minutes for quail eggs. To keep yolks centered, turn eggs several times during the cooking.

3. Immediately cool eggs under cold water.

4. Remove shells and pack carefully in a jar.

5. Mix vinegar, sugar (1:1), salt, red pepper cut into slices, and garlic. Immerse mixed spices tied in a spice bag. Simmer for about 10 minutes.

6. Pour hot pickling into the jars to cover the eggs completely.

7. Let stand for at least 2 weeks before serving.

8. Keep in a cool place.

Initial contributor: A. Hepworth, Box 793, Lae.

## SALTED EGGS

Utensils: Kettle, glass jars, measuring cups.

Raw materials: chicken eggs with shell  
course salt  
plastic bag  
muslin cloth

The process:

1. Wash eggs very clean.
2. Prepare brine solution by boiling enough water to cover the eggs. Add salt by the handful and stir to dissolve it. Continue adding salt until the last addition will no longer dissolve. Saturation point is reached by adding about 2 cups salt to 1 cup water. Allow brine to cool.
3. Carefully pack eggs in wide-mouthed glass jar or ceramic container.
4. Pour cold brine solution over eggs. Weigh down with plate or cup to keep eggs from floating or use a sealed plastic bag filled with the brine solution.
5. Cover mouth of container with 2 or 3 layers of muslin cloth or any suitable cover.
6. Keep in a cool, dry place.
7. After 12 days, boil an egg and taste. If not salty enough for your taste, keep remaining eggs in the solution for one week longer.

Initial contributor: A. Hepworth, Box 793, Lae.

## SAUSAGES

Sausages are made from minced meat. It is sometimes mixed with a filler and seasonings, and is filled into prepared animal intestines or casings. (It may or may not be cured) Fresh sausages do not keep any longer than fresh meat, but sausages which are cured and then dried or smoked have good keeping qualities.

**Preparing casing:** The intestines are removed from the animal and the fat is separated. The intestines are stripped by squeezing to remove any remaining contents and then placed in a bucket of warm, clean water. After soaking, the outer and inner linings of the intestines are stripped off. Beef intestines are then turned inside out and stripped of lining material. The prepared casings are then packed in salt until needed. Only casings free from parasites and holes should be used, and the type of intestine used determines the shape of the sausage.

**Sausage fillings:** Minced meat is mixed with fillings such as bread crumbs or cooked mashed sweet potatoes, salt and seasonings until the mixture binds together. The mix is then forced into the prepared casings through a nozzle or funnel and links formed at intervals by twisting. For cured sausages  $\frac{1}{4}$  level teaspoon of sodium nitrate is added for each 1kg of meat. After mixing thoroughly the mix is spread out approximately 2 - 2.5cm deep on trays, covered with a clean cloth and stored in a cool place for 24 hours before filling into casings. The sausages are then hung to cure in a cool place for 2-3 days and then dried or smoked slowly.

Sausages are an easy way of preserving meat and can be made from cheap, but still good, pieces of meat and a filling to your own taste.

Initial contributor: A. Hepworth, Box 793, Lae.

*Selling Tilapia in a Highlands trade store*



*Tilapia cooking demonstration, Western Highlands*

## HOW TO USE SALTED OR SMOKED FISH

**TALAPIA SALTED FISH:** Office of Business Development is trying to promote the sale of salted fish, especially in the highlands, through the Fresh Foods Depots. It is available at 60t per Kilogram, which is relatively cheap, and the salt component is desirable when the fish is cooked with Kaukau or rice.

Apparently there is a problem of acceptance, due to the preference for tinned fish. Business Development says, however, that pending price increases on imported fish will make salted fish more attractive. It is being pushed for institutions, fast food outlets and trade stores.

Cured fish needs to be "freshened" before it is used. Soak the fish in cold water overnight or as long as 48 hours. Change the water several times. Freshening may also be done by breaking the fish into large flakes, putting it in cold water and heating it very slowly, but not boiling it, for 30 minutes to 1 hour. This is called simmering. Fish that are very salty and very dry may need to be soaked in cold water and then simmered.

Be sure to cook all cured fish before eating it. Cured fish can be cooked and served in many different ways. Some general suggestions are given here but, most people have their own favourite way of cooking, seasoning and serving cured fish.

**FISH SOUPS AND STEWS:** You can make a good-tasting soup or stew by cooking dried cured fish in liquid with many different kinds of vegetables. Use water the fish was simmered in when you freshened it. Some of the vegetables most commonly used for soups and stews are yams, rice, tomatoes, and potatoes. You can also use okra, peppers, spinach, or other green leaves, groundnuts, and pimento. Season soup and stews to suit your own family's tastes.

**BROILED CURED FISH:** Wash and freshen the fish. Drain, dry, and sprinkle it with cooking fat or oil. Place the fish on a metal rack, flesh side up. Place the rack 10 or more cm depending on heat, above hot coals. Cook the fish for 3-4 minutes, then turn it over and cook it about 4 minutes more. How long it will take to cook

all the way through depends upon the size of the fish. Thick pieces take longer.

**BAKED CURED FISH:** Freshen the fish, then wash and dry it. Place it, flesh side up, in a greased pan. Sprinkle it with cooking fat or oil. Cover it with milk or a combination of milk and the water you simmered the fish in when you freshened it. You may add cut up vegetables and seasonings if you want to. Place the pan in a Mumu oven and bake the fish for 20 minutes to 1 hour, depending on the thickness of the fish. Add more liquid as the liquid in the pan evaporates. Take the fish out of the pan and place it on a serving dish. Melt some butter in the liquid that is left and pour it over the fish. Serve the fish while it is hot.

**PLAIN COOKED FISH:** Wash and soak the fish in cold water overnight or longer. Change the water occasionally. Put the fish in a deep pan or skillet. Cover it with cold water and heat it very slowly until it is almost boiling. Do not let it boil. Boiled fish tends to fall apart. Simmer the fish until it is tender. This may take an hour or more. Skim off the scum. Lift the fish onto a hot platter. Put oil or melted butter and pepper over the fish and serve. You can also use this cooked fish in many other ways. Be sure to take the bones out before using the fish.

**CREAMED FISH:** You can make creamed fish by adding flaked, cooked fish to a sauce. Make the sauce by cooking fat, flour, and liquid such as the water the fish was cooked in, milk or plain water together. Add some flaked boiled fish and seasonings, mix well, and heat. Serve the creamed fish with bread, potatoes or rice.

**FISH CAKES:** You can make fish cakes with Kaukau or Yams. Peel the yams or kaukau. Cut them into small pieces and cook them until they are tender. Drain the yam or kaukau and mash it. Add flaked boiled fish, a lightly beaten egg, and seasonings. Shape the mixture into cakes and roll them in meal or flour. Brown them lightly in a little hot fat or fry them in deep fat until they are golden brown. Drain the fish cakes and serve them hot.

**SCALLOPED FISH:** You can mix flaked fish with cooked rice, and then add some milk and well-beaten egg. Pour the mixture in a pan and bake it in an oven. This makes a very tasty food called scalloped fish. You can add seasonings to please yourself and your family.

**SEASON TO YOUR TASTE:** However you cook cured fish, the kind and amount of seasoning you use will depend on the way you and your family like your food to taste. Vegetables and cooking fats and oils add flavour to fish. People in most countries also add other seasonings. Some seasonings that go well with dried cured fish are hot pepper, dried ground pepper, curry, paprika, locust bean. Be careful if you add salt. You may not have soaked out all the salt used in curing the fish. If you add more salt when you cook it, it may be too salty.

Sent by C. Kelley, Box 179, Mt. Hagen

Kukbuk Bilong Hilans, by H. Bekker, pamphlet in Pidgin, 25t from Yangpela Didiman, Box 39, Banz, WHP

International Food Information Service  
Farnham House  
Farnham Royal, Slough, U.K.

Provides information in all fields of food science and technology; monthly abstracts on topics ranging from basic food science, food economics, hygiene, toxicology and packaging for specific food groups; annotated bibliographies on a wide range of subjects.

The Joy of Cooking, by Rombauer and Becker, 1931-1967, 849 pp, US\$6.95. Available from Bobbs Merrill Co., Inc., 4300 W. 62nd St., Indianapolis, Ind 46206, USA.

A classic. It is a whole school, and anyone teaching home economics should have one.

Brown & Kidd Pty. Ltd.,  
147 New Canterbury Road, Petersham NSW 2049 Australia  
Phone 560 3444 T/graph code BROWNKIDD  
A free catalogue is available.

Sells: Special orders, food processing, bakery equipment, custom manufacturing, metal products. Advisory services: Planning for bakery and food factories.

"Brown & Kidd Pty. Ltd., have been established as a manufacturer of food processing equipment for bakeries and allied foods for over 50 years and, in fact, have supplied quite a number of pieces of equipment to PNG."



# Building and Road Construction

## BRICK MAKING

Permanent buildings with low maintenance are often built of bricks or blocks. Many parts of PNG are earthquake areas, and steel or wire reinforcement is necessary for brick load bearing walls.

A brick is smaller than a block. When building with bricks or blocks a 10mm layer of mortar is used between each row.

Bricks or blocks can be made of the following materials:-

1. Stabilized earth:-
  - (a) Soil and cement or
  - (b) Soil and lime or
  - (c) Soil and cement and lime
2. Coronous bricks:-
  - (a) Coronous and sand and cement
  - (b) Coronous and cement(You have to crush or screen coronous before using)
3. Sand Cement Bricks - river or beach sand and cement.
4. Sand Gravel Cement Bricks.

In 1969 Public Works developed a rugged brick machine that was supposed to be available through the government stores. If it ever was available it isn't any more. But there is a Technical Bulletin No 6 from the Local Government Engineers that gives details, and Local Government Engineers will advise on where to purchase such machines. (Box 1108, Boroko).

Bricks can also be manufactured from clay, and burned to make them long lasting. The Building Research Station of PWD has done some work on clay brick making and there are two Technical Research Bulletins: No 7, Selection of Materials for Burnt Clay Brick Manufacture; No 12, Capacity Brick Kiln.

*Making clay bricks in China with simple wood forms. These will be dried and then burned.*



*Setting clay bricks out to dry*

PWD doesn't want to give general recommendations in the Liklik Buk, because a lot depends on the different kinds of soil or coronous that you have. They have a Soils Laboratory (Box 1108, Boroko) that will test soil samples (they need 2-4kg of each soil being considered), but the Technical Bulletins give you a simple field test for your own trials.

M. Simpson, Local Govt. Engineer, Box 1108, Boroko.

## ADOBE BLOCKS

Description: Building blocks made from garden soil and reinforced by chopped straw or grass.

Materials: Garden soil, fresh water, chopped grass stalks.

Tools: Several spades, or shovels, a block mould, (see diagram) a ramming implement, bush knife.

Description of work: Select soil for block making that does not have a lot of sand (or coronous) or large amounts of clay. Garden soil free from obvious vegetable matter and stones is best.

It is best to make the block close to the place where they will be used for building, to save transport costs. If good soil is available in the same place, this is better.

It is desirable to dig a large amount of soil, and clean the rubbish the day before blocks are going to be made.

Kunai grass chopped to 10cm lengths is added to the soil with water and the mass turned until it is evenly mixed. Other types of grass, especially runner grasses are suitable.

The damp soil is covered with banana leaves or copra sacks and allowed to mature over night. The soil should never be allowed to become muddy. An even dampness is needed. You will have to learn by experience.

before making blocks the soil should be turned again and checked for proper dampness.

Block Making: Soil is shovelled into the mould and rammed firmly down and into the corners. Keep topping up until the upper surface is level with the edge of the mould. When you lift the handles on the

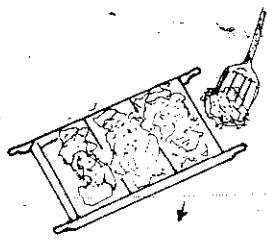

soil shoveled into the mould.

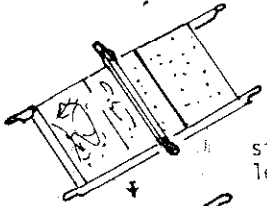

strickle used to level surface.

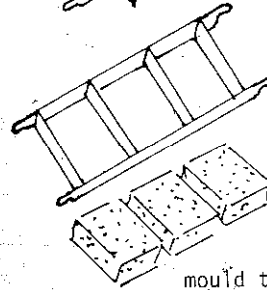

mould taken off and stack blocks.

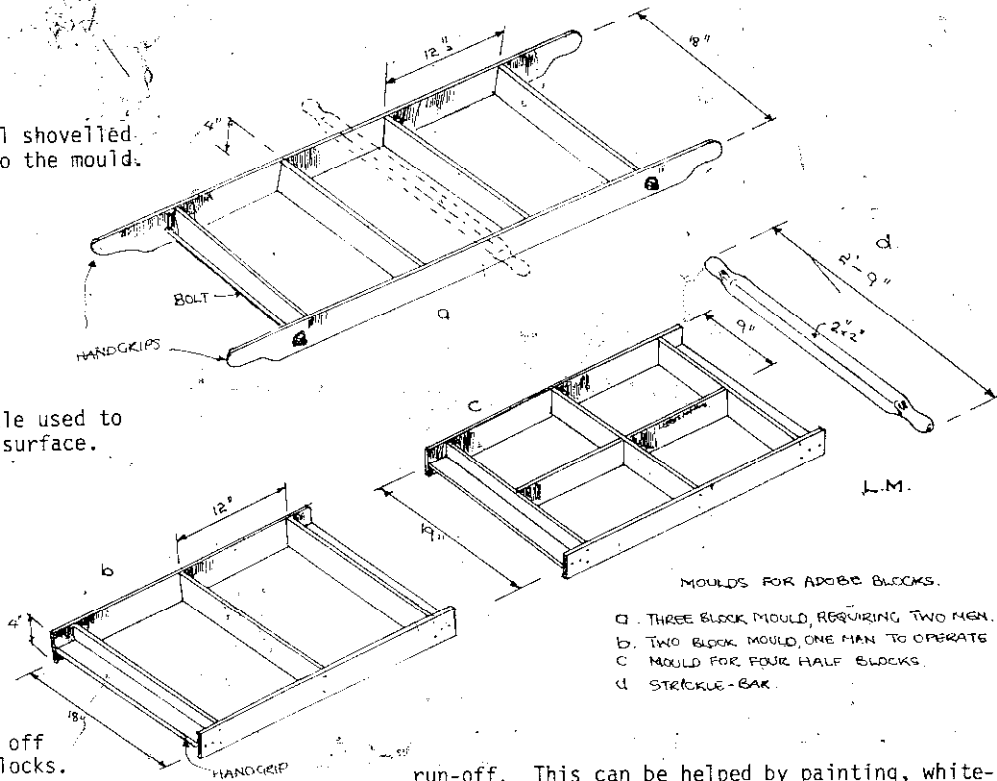

- MOULDS FOR ADOBE BLOCKS.
- a. THREE BLOCK MOULD, REQUIRING TWO MEN.
  - b. TWO BLOCK MOULD, ONE MAN TO OPERATE
  - c. MOULD FOR FOUR HALF BLOCKS.
  - d. STRICKLE-BAR.

mould the block should stay in position, as the mould comes away. Greasing the inside of the mould with sump oil is helpful in getting release. Some block makers like to construct a mould that is slightly bigger at the bottom than at the top. This also helps to break the suction more quickly, and release the mould.

The completed block(s) can be lifted carefully and stacked. Never stack in direct sun because sun tends to dry the blocks unevenly. Stack with space between blocks to allow air flow, and in a shady place. Protect from rain.

Reference: "Build Your House of Earth" G.F. Middleton, Compendium, Centreway 259 Collins St., Melbourne 3000. Aust. (Paperback)

Experience in PNG etc: There is very little experience with adobe in PNG. There is a lot of tropical experience with adobe in Africa and South America, where it is very good. An experimental adobe building at Madina High School NIP was successful.

Remarks: Adobe blocks uses a resource in plentiful supply. It is very cheap because the only expense is for labour and basic tools.

Adobe buildings have thick dense walls which are very cool in hot areas and keep heat in where built in cooler climates.

Adobe does not allow termites, and if correctly made is as permanent as cement bricks are. It is very important that the outer surface of a wall is protected from rain, and splashing from roof

run-off. This can be helped by painting, white-washing, plastering, coating with sump oil etc. Adobe walls will support the heaviest types of roofing structures.

Excellent blocks of uniform density can be made with a CINVA-RAM brick machine.

Adobe block walls combined with shingle roofing, gives a high quality, permanent building.

Initial contributor: L. Wilson, Kerevat National High School, Rabaul.

## EARTH BUILDING BLOCKS

CINVA-RAM  
Marac Exports Ltd.  
P.O. 366  
Auckland, New Zealand

This firm markets the well-known Cinva-Ram brick-making machine, cost around K125.00. They give excellent service, and a catalogue is available.

Initial contributor: Jack Ruth  
S.I.L.  
Ukarumpa via Lae

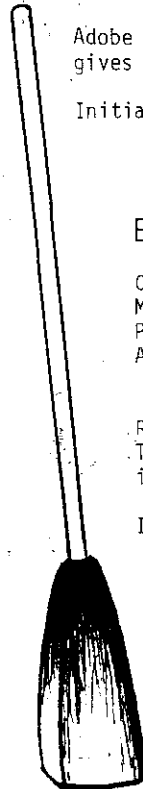

RAMMER



Stamford Bros.  
18 Woodfield Boulevard  
Caringbah 2229  
Australia

Simple aluminium moulds for ordinary and decorative bricks, flower pots, paving stones.

Chicago Co. Pty. Ltd.  
3 Short St.,  
Chatswood, N.S.W. 2067, Australia

"Specialised equipment, technical advice, and marketing assistance for the concrete and allied industries." Block-making machines and structural moulds.

## CONCRETE MAKING IN PNG

(p 129) (p 183)

Concrete is a basic, universal building material that will last a long time when properly made. With the rising cost of cement it is especially important to make it the proper way, so that it will last a long time.

Strong concrete requires a few simple tools to make it well.

### A. Materials and facilities required:

- Shovel or spade
- Bucket to carry water (size to hold 4-5 litres)
- Measuring box (300mm x 300mm x 300mm) or about 0.03 cu metres
- Wire mesh (copra or cocoa wire)
- Mixing surface: a concrete floor, plywood, metal or other hard surface.
- Cement: This is the manufactured material that comes in 40kg bags. It holds approximately 0.03 cu. m.
- Fine aggregate: Normally sand is the fine aggregate. Dry sand runs easily in the hand. Sand from rivers or the beach can be used but it must be clean or the concrete will be weakened.
- Course aggregate: This is known as gravel. The individual particles are from 5mm to 20mm. You can use river stones, crushed rock, coronos or similar materials.
- Water: Clean water without mud or leaves should be used. Dirty water will give weaker concrete.

- B. For each 0.2cu m of concrete you will need 0.03 cu m cement - (1 measuring box)  
0.06cu m fine aggregate (sand) - two measuring boxes  
0.12cu m course aggregate (gravel) - four measuring boxes  
3.0 litres water. Be sure to use clean water, clean enough for drinking.

### C. Method.

1. Choose a hard surface that is flat near where you will put the concrete.
2. Make the box for measuring the materials from wood and be sure it has handles to make it easier to carry.

*Friendship is the cement that holds the world together.*

3. Screen all the gravel that you will be using on the wire mesh by throwing the gravel on the mesh. The big pieces will not pass through the screen. Use only the gravel that passes through the mesh.

4. Measure out the materials for the first batch of concrete this way:

Put one box of cement on the mixing surface. Add two boxes of sand to the cement. Add four boxes gravel to cement and sand. This will give a mix of 1:2:4.

5. Mix this material together with the shovel or spade by turning it again and again until it is all mixed and the texture and colour is even.

6. Form the mixed materials into a mound and make a hollow in the centre. Pour 1 litre of water into the hollow.

7. Mix the dry material with the wet by taking dry material from the edges and turning it into the water in the centre. Don't let the water run away. Mix well.

8. When all is mixed make a new mound, add one more litre of water, and mix as before.

9. Reform the mound again, add the last litre of water, and mix until it is even in texture and colour.

10. The concrete is ready to use. DO NOT ADD EXTRA WATER if the concrete is damp enough to be formed. Extra water will make the concrete weaker.

11. After the concrete is put in its place and has become firm in an hour or two, begin to keep it wet for the next three days to get strong concrete. This step is as important as all the other steps. Either pour water so that the surface never dries out, or cover the surface with old copra sacks or banana leaves, to hold the water in place. This will make the concrete as strong as possible and will prevent it from cracking while it sets.

- D. Sources of supply: Cement is available from many trade stores and from all major trading companies. Gravel, sand, and water are where you find them.

Remarks: If fresh water is not available you can use seawater, but the cement will not be so strong with the salt in it.

Contributed by: L. Sukap, Technical Officer, Local Government Advisory Service, Dept. of Transport, Box 1108, Boroko.

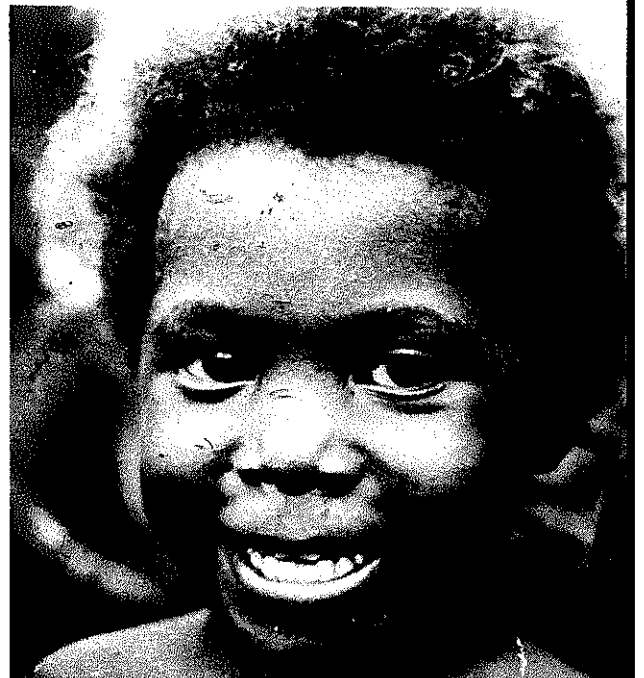

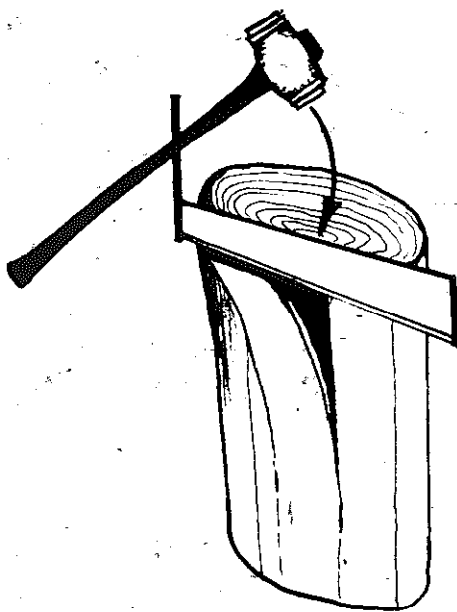

**— SHINGLE KNIFE —**

13 MM. STEEL PLATE, BEVELLED ONE EDGE. 25 MM. ROD WELDED TO ONE END, TO SERVE AS HANDLE.

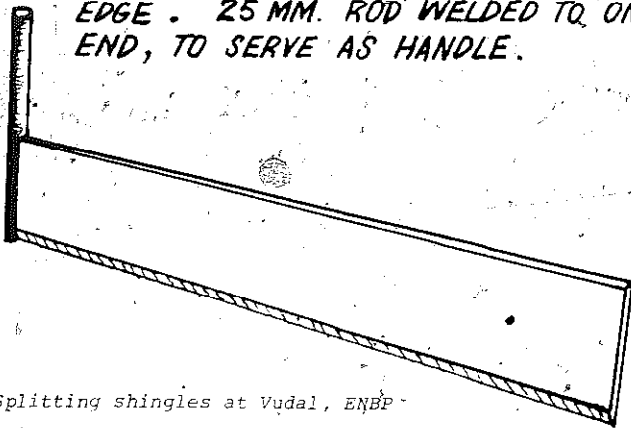

Splitting shingles at Vudal, ENBP

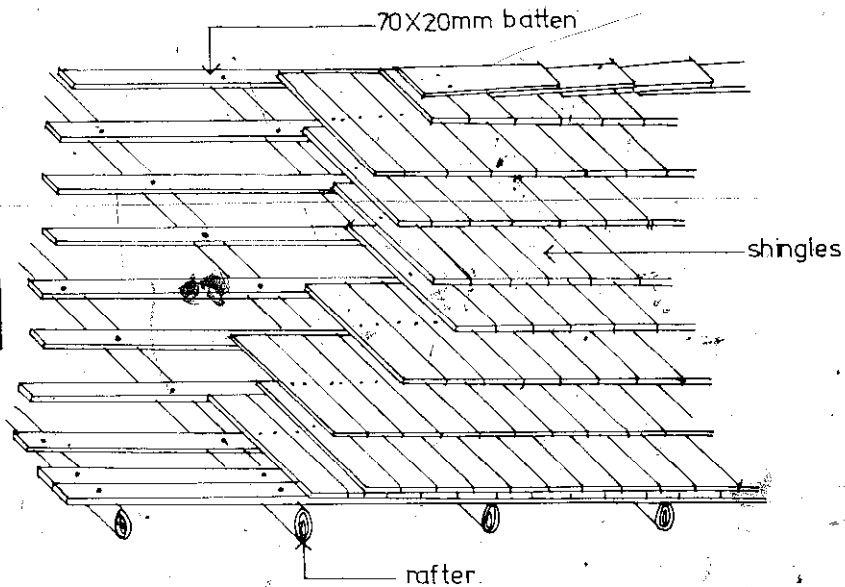

**SHINGLE ROOF CONSTRUCTION**

**ROOFING SHINGLES:**

Description: Thin boards or tiles, hand-made from wood, used to cover a roof. They are an alternative to kunai grass, saqa leaf, corrugated iron etc.

Materials and Tools: A log (or more, depending on size of building) of a clean splitting, straight-grained timber such as Taun. A shingle knife, a heavy wooden mallet, a tomahawk. Use a cross-cut or chain saw to cut log into even cross-sections.

Order of Work: The two basic tools, a shingle knife and mallet, must first be made (see diagram).

A sound log of Taun (or other suitable straight grain timber) should be cut into 70cm cross-sections using a chainsaw. Each section is stripped of bark and the sapwood, with an axe.

A cross section is placed on end and the knife placed about 2cm in from the edge in an upright position. While it is held in this position, the top edge is struck a heavy blow with the mallet. A shingle of wood should separate from the block, perhaps needing another blow to continue the split to the bottom. The knife is then placed in a similar position adjacent to the area split and another shingle struck off. The process is continued around the circumference of the block, the block getting smaller as shingles are struck off it. The core is thrown away.

Rough shingles can be trimmed with a tomahawk, to ensure a uniform thickness of a little under 2cm. Width of the shingles will vary, but this is acceptable and does not affect their use in roofing.

**Laying a Roof:** The principal is like kunai and sago leaf roofs. Light timber battens are fixed at regular intervals across the rafters, instead of bamboo or cane. The shingles are laid from the bottom, moving towards the ridge. Each shingle is fixed to the batten by a single nail and should touch the shingle next to it, if possible.

When overlapping starts on the second row (and above rows) keep in mind that at least half of the row below should be covered by the over lap. This ensures a watertight roof. Care is taken to cover the spaces between shingles in the lower row, when laid.

**Sources of Supply:** Timber from a logging company or cut on site if available. Taun is a common timber in many parts of PNG. The shingle knife must be made by a competent welding shop. The mallet can be easily made in a village situation.

**References:** The Shingle Roofing Manual is available from the Forest Products Research Centre, Box 1358, Boroko. "Earth Garden" (Box 378, Epping NSW) No 10, September 1974 carries an article on shingle making and laying.

**Results of use in PNG:** Taun shingles have been extensively used in the Northern Province by the Anglican Mission. They are both durable and economical. There are other buildings which have employed them with similar success in Madang and New Ireland.

**Remarks:** Shingles have big advantages over traditional roofing materials because they are more permanent. Experience in PNG does not permit an accurate estimate of their life span, but a well laid roof should last 10 years or more with normal maintenance.

Shingles do not provide a place for rats and insects as may be found in grass roofs.

A shingle roof, after an initial bleaching period, is very good for catching rainwater.

Shingle roofing is most attractive throughout its life span.

Shingle roofing combined with adobe brick walls is a good building combination for PNG conditions using local materials.

Treating wood shingles with preservative will make them last longer, but this is not good if you drink water from your roof.

**Initial contributor:** L. Wilson, Kerevat National High School, Rabaul.

THE ESSENCE OF KNOWLEDGE IS,  
HAVING IT,  
TO APPLY IT.

Chinese proverb

## MAKE YOUR BUILDINGS LAST LONGER (p 182)

There are many ways to make a building last longer. Wood preservative will help a lot and it is also important to make the building last longer by good building practice. One of the most important parts of this is to keep the wood in the finished building as dry as possible. Some of the ways of doing this are:-

**USE WIDE EAVES (ROOF OVER HANGS):** The wider the roof overhangs the more it will protect the walls from getting wet. It will also keep the sun off the walls so that the house will be cooler. An overhang should never be less than 60cm (2ft) and is much better if it is 1 metre (3ft) or 1.3 metres (4ft).

**PROTECT PROJECTING ENDS:** Water gets into the end of a piece of wood much more easily than the side, so ends of bearers, joints, rafters or other pieces of wood that are exposed to the rain and sun should be protected. You can do this by using a fascia of large board nailed onto all of the ends, or you can simply project the roofing iron out over the ends of the rafters, or bring the wall siding down over joints. You can also make little caps of galvanised iron and nail them over the end of the pieces of wood. A final method is to paint the ends with paint or tar.

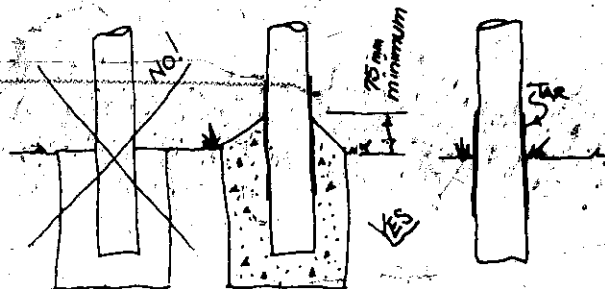

**PROTECT POLE ENDS IN THE GROUND:** When you put a pole into wet ground it also becomes wet. Chemical treatment will help the wood resist rotting, but if you can keep the wood dry, it is even better. The best way to do this is to paint the end that is going into the ground with tar or bitumen. Use the same stuff that is used on the road. Just melt some and paint it on. You should do this to all poles going into the ground.

**KEEP WALL LINING OR SIDING CLEAR OF THE GROUND:** Because lining is usually made of thin material like bamboo, pit pit or thin weather boards, it rots more quickly than large pieces of wood. Keep it away from the ground so that when it does get wet it can dry off easily. If you are building a house on a concrete slab or with an earth floor, it is a good idea to build a wall of bricks or stone around the edge up to a height of 60cm (2ft). You can also lay a large log that has been treated by "sap replacement" on the ground. Then start the bamboo, pit pit or weather board above this. This way the siding will not get as wet and can dry off better.

cont'd

**CAP FENCE POSTS AND OUTSIDE POLES:** The top end of a pole that is exposed to the rain usually will let water into the wood. This is because there are small splits or cracks running in from the end. It is a good idea to sharpen it to a point at the top. If you want to protect it even better, you can paint the end with tar, or nail a galvanised iron cap over it.

**CHOOSING THE RIGHT WOOD:** PNG has many different kinds of trees with different kinds of wood. Some will last a long time and some will not. If you are using wood that lasts a long time, then don't bother treating it. If you don't have any long-lasting wood, then you should. Some treatment method information may be obtained from the closest Forest Station. Some methods will treat all kinds of wood, others will only treat some kinds. It is important to choose the right wood. (p 48)

**SPACE FLOORING:** One of the main causes of rot is water. If a floor is going to get wet often, leave a small space between the boards to let the water run out. A space 5mm ( $\frac{1}{8}$ " ) wide will do very well. You should do this on all verandahs. It is also a good idea in shower rooms. If you want to wash the floor in the rest of your house often, then you can do this everywhere in the house. When you put spaces between the boards, do not use tongue and groove flooring.

**REFERENCE:** Manual of Rural Wood Preservation by PNG Forest Products Research Centre, Hohola. (p 182)

Prepared by Office of Forests, Lae.

## EARTH MOVING WITH WATER

Hap Skinner, Bernie Crozier, and Ray Hocking of SIL have successfully used running water to move tonnes of earth in building airstrips. The same way can be used in some places to build roads, terrace gardens, level village sites and sports fields.

An excellent booklet "Principle of Hydraulic Mining" has been written about it, available from Office of Village Development, Box 6937, Boroko. Or write to these men, c/- SIL, Box 5359, Boroko.

## PRINCIPLES OF DRAINAGE

All land drainage problems are different. They differ because of:

- Different soil types
- Different drainage requirements for crops
- Topographic changes
- Size

However in spite of these differences there are four basic principles which should be applied to all drainage work. These are:-

### 1. DIVERTING WATER FROM OUTSIDE THE AREA TO BE DRAINED.

It is unusual to find an area completely isolated from outside drainage water. This outside drainage water must be disposed of before you can lower the watertable of the land you are trying to drain.

The control of this "outside" water can be done in two ways:

- by diverting it before it gets onto your block.
- by providing a big enough drain to carry it through your block without having it get on the area.

### 2. SELECTING A SAFE AND RELIABLE OUTLET

The outlet must provide reliable drainage even through the wettest parts of the year. If you are draining into a creek or watercourse you must be sure that if the water in the creek rises it will not "back up" along the drain lines.

As well as being reliable at all times of the year the drainage outlet must also be safe from erosion. This means making sure that the outlet is not too steep or does not drop into an unprotected gully. Using a naturally grassed depression overcomes this problem.

### 3. ADAPTING DRAINAGE SCHEME TO FIT SOIL, SLOPE AND CROP CONDITIONS:

The drainage system must be adapted to suit changes in soil and slope conditions.

On deep porous soils, drains can be spaced further apart than on shallow clay soils. On steep slopes it is desirable to have drainage across the slope. Different crops have different drainage needs. Highlands tree crops such as Tea or Coffee need at least 75cm (2'6") of well drained soil. Shallow rooting crops such as vegetables or pastures can get by with a much higher watertable.

### 4. MAKING PROVISION FOR ACCESS:

You must think about road access for cultivating implements such as tractors and ploughs when designing a drainage scheme. Usually with a bit of planning, it is possible to run roads and drains together - giving a maximum return for your drain digging work and providing best use of land.

The "top end" of drains should also be left open to provide access for cultivating equipment.

Further reading: "Comments on Drainage in the Highlands of Papua New Guinea" by A. McGrigor. This can be obtained from Publication Section, Dept. of Primary Industry, Konedobu.

Initial contributor: A. McGrigor, HATI, Box 312, Mt. Hagen, WHP.

## SURVEYING AND MAP MAKING

Surveying is a useful skill for people involved in the development of Rural Areas. It can be used to:-

- (a) Measure distances;
- (b) Mark land boundaries;
- (c) Calculate the area of a piece of ground; and
- (d) It is a useful tool for Farm Planning - to define and calculate areas of different soils, land use, vegetation and to record features such as creek, fence lines etc.

### SURVEYING

The basic equipment required for simple land surveying is:-

- (a) Prismatic Compass - for measuring direction or bearing.
- (b) 100 metre steel band - for measuring distance.
- (c) Field Book, Pencils and Eraser - for recording bearing and distances taken during the survey.
- (d) Bamboo poles or straight sticks - for marking lines.

Surveying equipment is available from the following sources:-

Brian Bell & Co.,                      Theodist,  
Box 1228,                                      or Box 3437,  
Boroko.    Port Moresby.

Prismatic Compasses range from K47.00 to K87.00 depending on the make or model.

100 metre chains in canvas covered spools are K50 - K60.

### MAP MAKING

Surveying usually involves producing a map or plan of the surveyed area. To do this you will need:-

- (a) A rule marked in centimetres
- (b) Metric Graph paper
- (c) A circular protractor
- (d) Pencils and erasers

These can be obtained from most Stationery stores.

For further information and advice on surveying and mapping contact the Dept. of Lands, who have offices in all major centres. The Prime Minister's Dept. at your District Headquarters usually has an officer who is experienced in surveying.

You can also write to the Highlands Agricultural College, Box 312, Mt. Hagen for a copy of their Surveying and Mapping notes.

Note: Department of Lands sometimes accepts people for on-the-job training in surveying on a voluntary basis.

Initial contributor: A. McGrigor, HATI, Box 312, Mt. Hagen, WHP.

THE LOCAL GOVERNMENT ADVISORY SERVICE is part of the Department of Transport, Works and Supply. Engineers and architects in this service, work only with rural design and engineering problems, on projects such as schools, aid posts, roads, bridges, markets, etc. There is also a mechanical section to advise on cost, purchase and maintenance of machinery and vehicles.

Normally the service is only available to councils and Area Authorities on their projects, but if your council supports your project and approves it, you can get assistance for a mission, school, or total self-help project in the village.

Further information: The Secretary, (P 255)  
Department of Transport Works and Supply,  
Local Government Advisory Service,  
Box 1108,  
Boroko.

### BULLETINS AVAILABLE FROM THE ABOVE

- No 5 Selection of materials for Stabilized Brick Manufacture.
- No 9 Construction of a Brick Hot Air Copra Drier. (This is a permanent but costly design)
- No 11 Moving of Burnt Clay
- No 13 Shaft Lime Kiln

### BULLETINS ON WOOD

- No 10 Manufacture of Charcoal by Retorts.
- No 14 Low Cost Housing Prefabricated Panel System both from Local Government Advisory Service Box 1108, Boroko.

Self-Help and Rural Development Roads Construction Manual. From Local Government Engineer, Box 1108 Boroko. You don't need a bulldozer to build a road, though it can help. This book is a little technical, but it is the best for its size available anywhere. Free.

Suggested by: M. Simpson, Local Government Architect, Box 1108, Boroko.

### FOREST PRODUCTS RESEARCH CENTRE

Forest Products Research Centre  
P.O. Box 1358  
Boroko.

The Research Centre has a number of very helpful publications. Perhaps the most useful for rural development workers is the "Manual of Rural Wood Preservation". Here are the main items:

1. "Manual of Rural Wood Preservation", 2nd edition, June, 1975, 25 pages. Tells about wood-destroying insects and fungi, building practices, treatment methods for rural areas. Includes poles, bamboo shingles, weather-boards. Simple and practical. A very important publication.

2. "Preservative Treatment of Tropical Building Timbers by a Dip Diffusion Process", by Tamblin, Colwell, and Vickers, 8 pp., 1972. A test report. Rather technical. Might be helpful for builders and teachers of building construction.

3. "Pole Buildings in Papua New Guinea", a review of the work of Peter Lattey of the Forest Products Research Centre. Aug. 1974, 41 pages. Peter Lattey was a C.U.S.O. volunteer in P.N.G. This interesting booklet containing many photos and drawings reviews some of his creative work. Lots of ideas for those with ambitious ideas about using local materials.

4. "The Introduction of Wood Preservation into P.N.G. and its effect on the Rural Economy," by C.R. Levy. Feb. 1975, 16 pp. Because of unstable soils and frequent earthquakes, pole construction is an ideal building technique for P.N.G. It is only truly effective, however, when the poles and other woody materials are adequately protected against insects and decay. Wood preservation can significantly reduce the non-productive work involved in maintaining private and community buildings.

5. "The Jalousie", an All Wood Louvre Window, by Sequerra and Levy, March, 1975. 4 pp. A popular Philippine design is explained.

Department of Architecture  
University of Queensland  
St. Lucia Australia

Designs for low-cost housing for the tropics with special emphasis on designs using indigenous technology.

Ministry of Technology  
Forest Products Research Laboratory  
Prince's Risborough  
Aylesbury, Bucks, U.K.

Various publications on Forest products research. Write for list and prices.

New Zealand Portland Cement Association  
11th Fl. Securities House  
126 The Terrace  
P.O. Box 2792, Wellington, N.Z.

Technical Bulletins, articles on the use of cement including a home and farm series. Write for lists and prices.

## Village Industry/Arts and Crafts

### BOTTLE CUTTING

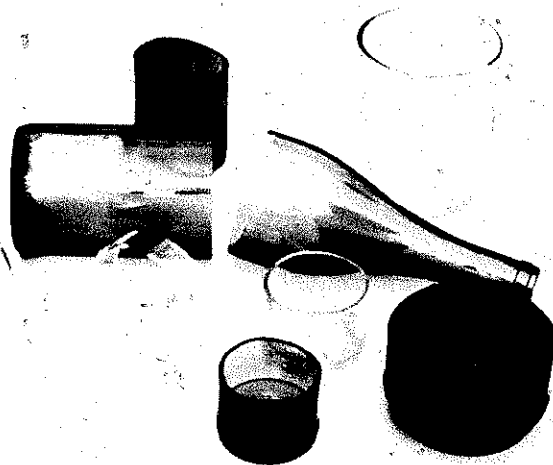

According to one informed source there are 14.37 zillion empty bottles lying around PNG. Most of them belong to the Moresby Bottling Company as each of the bottles tells you. They spend a lot of money on legal fees to stop people from using the bottles a second time and on advertising the fact, but they don't spend much time picking up the bottles that are lying all over the countryside. (Question: If the bottles belong to them, why aren't they responsible for picking up the bottles and paying the medical costs of people who step on their broken bottles?)

For some time now there has been a popular cult overseas of people who cut bottles to make glasses and candle holders. You can buy fancy kits for K10 - K15, so we haven't included the way in Liklik Buk before. Here is one way that works using only materials found next to an empty bottle.

Equipment needed: Metal file or freshly broken quartz pebble; candle or kerosene burner, or string wick alcohol burner; newspaper; empty round bottles any size.

Method:

1. Cut a short deep scratch on the bottle at the level you want to cut it with the edge of a metal file or quartz.
2. Tear four strips of newspaper 3cm wide and as long as a double page of the Post Courier, and soak in water. You will need more strips for larger bottles or bottles with thicker walls.
3. Carefully wrap two wet strips around the bottle on each side of the scratch so that the strips on one side of the scratch are almost one cm from the strips on the other side. The scratch should be exactly in

the middle. It is very important that the strips are wrapped so that the edge closest the scratch is straight, if you want to have a straight cut in the glass.

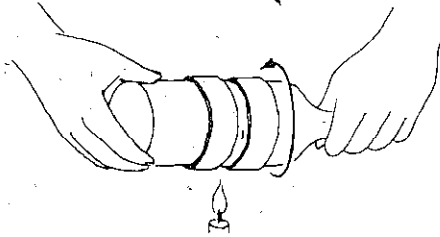

4. Slowly rotate the bottle a few times over the flame so that the glass between the two strips is just heated by the tip of the flame. If too much carbon on the bottle makes it difficult to crack, metholated spirits or alcohol flame may be necessary. Then turn the bottle a short distance each way with the scratch over the flame until you hear a slight cracking sound. Turn the bottle more and more each way as the crack grows longer. When the two cracks nearly meet, gently pull the two halves of the bottle apart until they separate. This whole step should take one to three minutes only.

5. Rub the cut edge with sandpaper, emery cloth or a smooth stone to remove the sharp edge.

Remarks: With a little practice it is very easy to make an even cut. If the bottle does not crack before the newspaper dried, it means the bottle wall is:- (1) too thick and you need more newspaper, or (2) you have placed the strips too close to the scratch mark, or (3) you have not made the scratch deep enough to begin.

If you find that the cut is not even, it means that (1) you did not give enough heating when you rotated the bottle in the beginning, or (2) the strips of newspaper were too far apart.

Initial contributor: A. Inversin,  
Box 4981, Unitech, Lae

## BASKET WEAVING

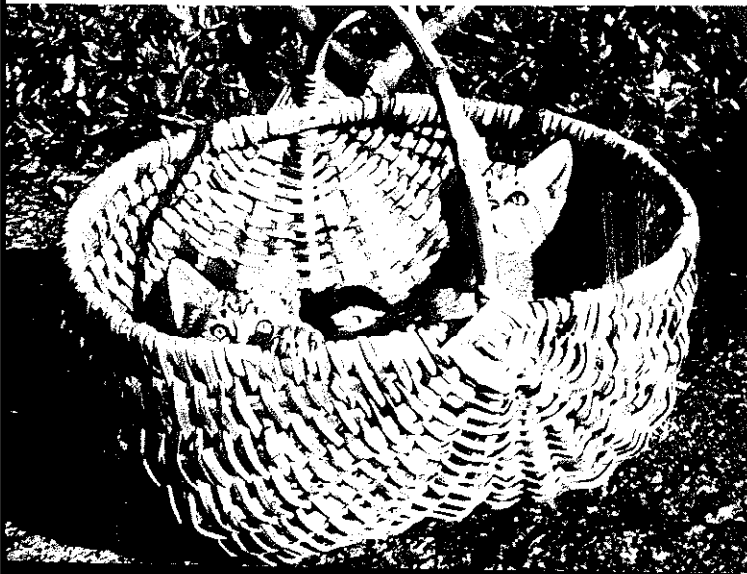

This traditional German design is one of the easiest to do, and the baskets are very practical. Use strips of cane or bamboo.

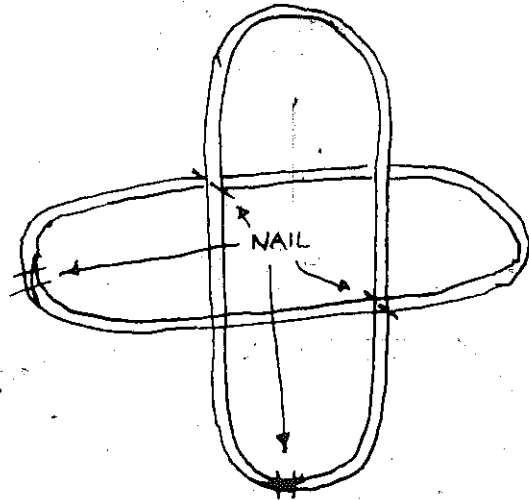

Make two circles, preferably with round cane. Fasten with small nails or wire.

To make bamboo or cane strips: Cut 5 or 6 wide strips around outside wall, then cut into narrower strips and clean them. You want the durable hard outer layers. Dispose of soft inner layers. Use mature but fresh materials.

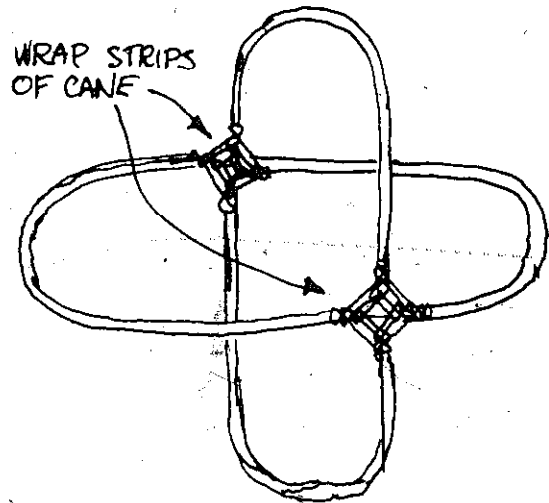
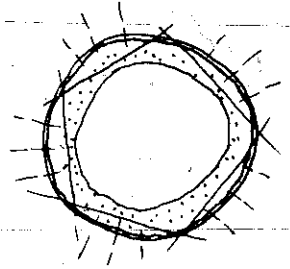

Wrap strips of cane where they cross. See photo.

cont'd

## MORE BASKET WEAVING

The Base - Cut 10 stakes about 40cm long. Split 5 of them in the middle and slip the other 5 through to form a cross.

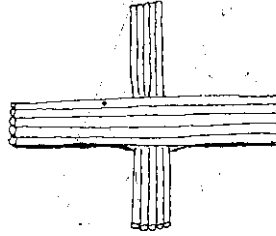

Weave the base with a weaving cane doubled. This is called pairing. First weave around the 5 stakes as a group, going around twice. Then divide 2 - 1 - 2 going around twice again.

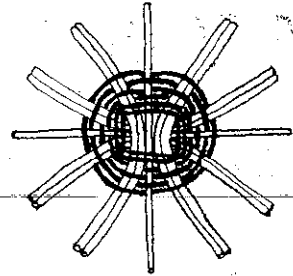
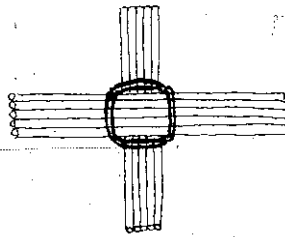

Then separate the stakes and weave individually keeping them the same distance apart.

As you weave bend the ends of the stakes down a bit so the center of the base will be raised up a bit. This will permit the basket to sit more steady and not be wobbly.

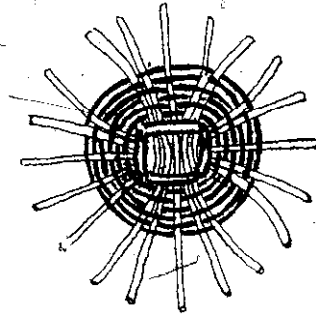

Keep weaving until the base is the size you want. Make sure as you weave the cane is pulled very tight against the round before it. It helps to hammer it with a length of cane after each round.

The Sides - Cut 39 stakes for the sides of the basket. The length of the stakes should be about 30cm longer than you want the height of the sides. This will allow for the part that is pushed into the bottom and the part that is used for finishing the sides off.

cont'd

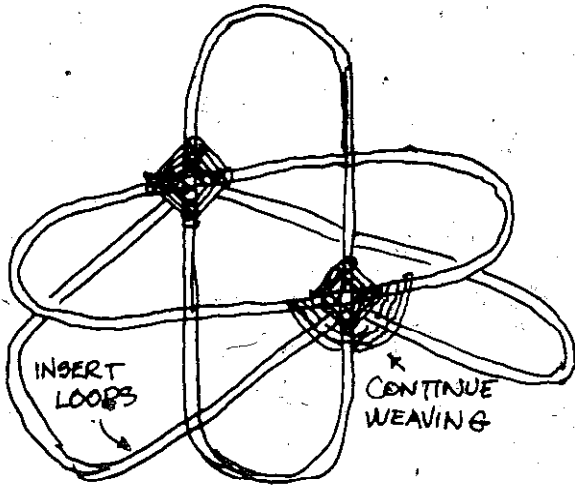

Insert the two loops which form the bottom outside corners of basket. Make a nice point on the ends of the loops for easy insertion. Continue weaving a little bit.

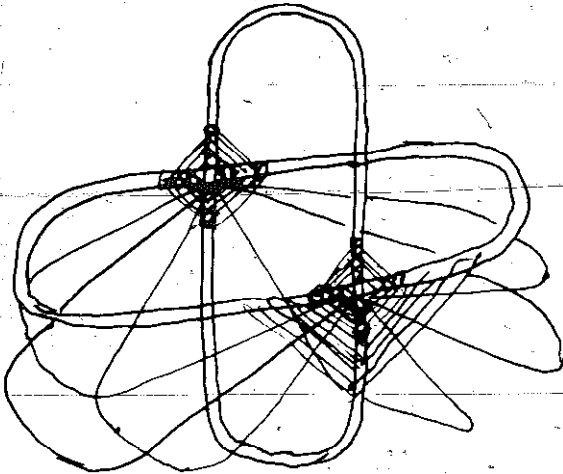

Now insert more loops, as many as you need. You will have at least 5 loops on each side in addition to the two basic circles. You can add more loops later if you need to. When the weaving becomes too wide or uneven in one place, turn around before reaching that place, to make it even.

With a little practice you will teach yourself how to make it look nice. There are several variations on this design. See photo of poultry nests on page 167.

Suggested by G. Bergmann, Boana, M.P.

THAT LAST IDEA SOUNDED EASY, DIDN'T IT?  
YOU THINK THAT YOU COULD WRITE SOMETHING  
LIKE THAT, TOO, DON'T YOU?

WE'LL BET YOU A COPY OF THE NEXT EDITION  
OF LIKLIK BUK THAT YOU CAN WRITE AN  
ARTICLE THAT WILL BE ACCEPTED.

LOOK ON PAGE 268 FOR INSTRUCTIONS ON HOW  
TO SUBMIT A CONTRIBUTION.



Sharpen the side stakes on one end so they are pointed like a pencil. Insert the stakes one on each side of the base stakes. One stake will only have one since there needs to be an odd number of stakes for the sides. After sticking the side stakes in the bottom so they all extend the same amount, squeeze them all tight at the end of the base where they will be bent up.

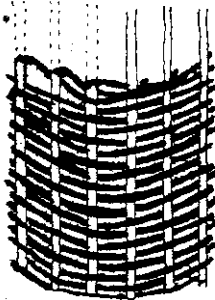

When the side stakes are bent up, it's easier to use four weaving canes. Start each weaving cane one stake to the right of the one before it going in the direction of right. After going around once with the four weaving canes, cut off three and continue with one the rest of the time. This is called randing.

Finishing off - When about 15cm of the stakes remain, stop weaving and soak the stakes, squeeze and start turning down to make the border. One stake is bent inside the stake to the right of it, outside the next one and inside the third one and finishes there. The next one is bent over the first one and inside the stake to the right of it and outside the second one and inside the third stake and finishes there.

Initial Contributor: Dale Busse, Box 80, Lae

## BLACKSMITHING

The Making of Tools, 93 pp, 1973, and The Modern Blacksmith, 96 pp, 1974, Both by Weygers, published by Van Nostrand Reinhold Co., N.Y., Toronto, London, Melbourne, Price: Canadian \$4.95 each.

Both books are profusely illustrated by the author and deal with the basic techniques of old fashioned blacksmithing. Detailed description of the manufacture of tools, such as hammers, chisels, tongs, shears, augers, wrenches (spanners), shovels, etc. It even deals with the making of an anvil from a piece of railroad rail.

For raw material, Weygers does not use store-bought stock. Instead he recommends the use of waste iron such as drilling rod, car springs, axles, bumpers, power hacksaw blades, old files, etc. These are two books well worth investing in especially if one is in an isolated area where gas welding equipment is either not available or expensive. Intermediate level.

J. Bekker

BLACKSMITH TRAINING: The office of Business Development has brought an IVS volunteer from Sri Lanka to help set up some small pilot blacksmith shops. If you want someone to be trained at the 2 to 3 month blacksmithing course in Rabaul, write: Nick Grato, Business Development Office, Box 385, Rabaul.

## CHARCOAL MANUFACTURE

(p 128)

In Africa and Asia wood charcoal is a widely used cooking fuel. It has five important advantages. 1. It is a concentrated energy source, with 3-4 times the heat value of green wood and twice the heat value of dry wood. Thus it is more practical for high temperature work like blacksmithing. 2. It is easier to transport long distances. 3. It does not make smoke when it burns. 4. It preserves wood that would otherwise rot before burning, and can be stored indefinitely in all kinds of weather because it will not rot. 5. It adds no taste to food which is cooked over it, and there are no residues in smoke to damage the cooking pots.

Although charcoal can be used in confined spaces, since there is no smoke, you must have ventilation to prevent the buildup of poisonous carbon monoxide gas.

Charcoal is made by heating wood in a limited supply of air. When the wood temperature is heated to about 300°C, there is a heat generating reaction that comes from the tars in the wood breaking down. This heat causes the water, acids, tars and oils - which are about 70% of the weight of the wood - to be driven off as gasses. The unburned carbon and ash which remains is called charcoal.

Commercial plants made of brick and steel are used to produce large quantities. Often the gasses in these plants are recovered and made into useful products like acetic acid, methanol, acetone and various tars.

Small quantities of charcoal can be manufactured very easily in a 200 litre (44 gal) drum. One drum will produce about 20kg of charcoal a day. Two men with a minimum of training can handle 6-8 drums at a time. Charcoal can be made from any debarked wood, green or dry, hardwood or softwood, timber off-cuts or branches. Coconut shells can be used and will produce a very fine grade of charcoal. Pieces should not be more than 15cm in diameter nor more than 85cm long so they will fit in the drum.

To prepare the drum first cut out the bottom. Cut two small holes about 15cm x 15cm each in the top in addition to the two bung holes that come with the drum. (photo)

Place the drum over two logs or pipes so that a little air can enter the bottom through the holes when the fire is started. Stack the wood vertically upright and pack it as tightly as possible. Leave an empty space in the centre of the drum to

fill with twigs and leaves when the fire is started.

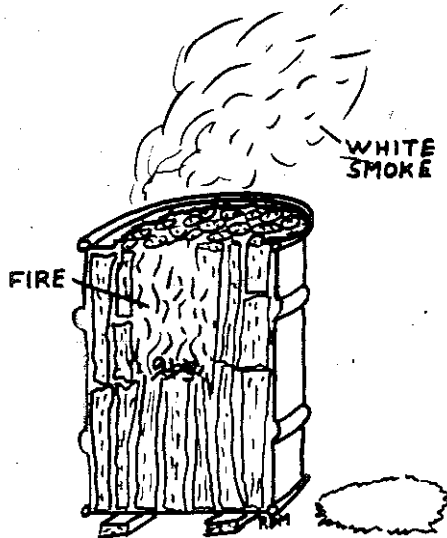
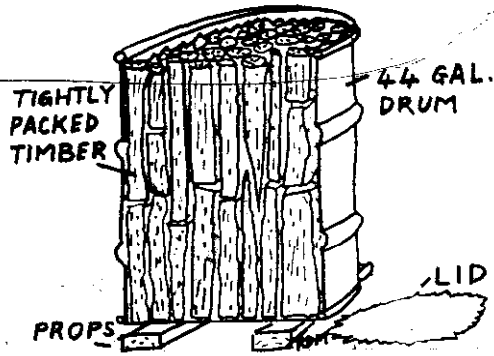

It is important to control the fire so that the wood will not burn but will become charcoal instead. The air supply must be adjusted so that only white smoke comes out. If black smoke or no smoke is visible, the air supply is incorrect.

There are four steps to control the air:

1. Use the cutout from the bottom of the drum to close the opening enough to keep a steady flow of thick white smoke.

2. When the use of the cutout is not enough, rock the drum to reposition the logs or shells inside. (The drum will be hot, so use tools or heavy gloves to protect your hands.) Usually the drum should be rocked every 15-30 minutes during the burn.

3. After the drum is heating well, about 30-60 minutes after the start, remove the drum from the logs or pipes. This will cut the flow of air through the bottom. The timing for lowering the drum is when neither steps 1 or 2 are enough to keep the thick white smoke coming out.

4. After 90 minutes, begin adding short pieces of wood to the drum. You should refill the drum 2-3 times during the run, so that at the end of the run you will have a full drum of charcoal. The extra wood also cuts down the amount of air available as the charcoal settles. If steps 1, 2, and 3 are not enough to keep a steady white smoke coming out, you know it is time to add more wood.

After about 5½ hours of white smoke you should have a drum filled with red hot charcoal. Now you must seal the large opening at the top of the drum to put out the fire and let the charcoal cool. This is the most difficult part, and has the greatest risk of injury to the beginner.

Fit the cover back in the opening. One person should hold this in place with a long pole, so that when the drum is tipped over, the charcoal will not fall out. Carefully tip the drum, using poles or pipes and heavy gloves to prevent burns. Tip the drum to its side, and then completely over.

When the drum is vertical again, seal the base with mud around the edges, and plug the four holes at the top. Left overnight, the drum will cool enough to empty it the next day.

Ed. note: The obvious danger to operators from potential burns if they are not careful concerns us. In other countries, the run is closed down simply by sealing the base and covering the open top with a piece of flat iron that is weighted. With this method it is necessary to have a straight edge to the drum opening so that there will be a good airtight seal.

With a little practice it is possible to make charcoal free from ash and unconverted wood. Of course any pieces of unconverted wood can be used in later batches. Charcoal is different from charred wood because it is totally black throughout and can be broken up by hand.

Use the charcoal for household cooking, blacksmithing, or other times when you need high heat in a confined space. It is an economical fuel when the only alternative is firewood which must be carried a long distance.

Initial contributor: N. Grato, Box 385, Rabaul.

## DYEING WOOL WITH MORDANTS

Mordant: A substance which makes dyes permanent. Different dyes and different materials may require different mordants for a desired effect. Different mordants are used at different times in the dyeing process. Follow instructions for each mordant.

General directions: Quantities here are for 0.5kg of wool and 20 litres of water.

1. Use clean wool.
2. Wet wool in warm water before dyeing or using mordant.
3. Add ½ teaspoon acetic acid to 4 litres of water to all dye baths. This helps swell fibres and makes them absorb dye more readily, colourfast.
4. Boil wool and dye subjects together, moving them frequently to prevent uneven dyeing. Boil gently until required shade obtained. Add

salt, boil longer.

5. Lichens that are dry should be soaked 24 hours in water before dyeing. Bark or dried berries, put in muslin bag and soak overnight.
6. Iron and copper pots affect the colour (darkens it); tinned or stainless steel pots are better (neutral).

Mordants used before dyeing:

Alum: 90g alum  
30g cream of tartar

1. Dissolve alum and cream of tartar in boiling water.
2. Put wool in mixture and raise temperature slowly. Keep just to boil for 1 hour. Keep cover on.

cont'd

## NATURAL DYE PLANTS FOR WOOL

PLANT	PART USED	MORDANT	COLOUR
Bamboo	Leaves	Alum	Pale green
Bracken fern	New brown fronds	Alum	Golden fawn
Bracken fern	Roots		Red to black
Carrots	Leaves	Alum	Yellow
Chrysanthemums	Flowers	Alum	Shades of green
Dahlia	All shades/flowers	Alum	Red/orange shades
Elderberry	Ripe Berries	Alum	Lilac blue
Elderberry (Sambucus)	Ripe Berries	Chrome	Violet purple
Elderberry (Nigra)	Leaves		Yellow
Eucalyptus (varies with species)	Leaves	Alum	Yellow-green
"	"	Tin	Yellow
"	"	Copper	Light brown
"	"	Iron	Brown
"	"	Iron & copper	Dark grey
"	"	Tin & Iron	Green
Hibiscus (red)	Flowers	Tin	Brown
"	"	Iron	Lavender-grey
"	"	Chrome & Alum	Yellow
"	Flowers/caly/stalk	Tin	Olive green
Horsetail (Equisetum)	Stalks	Alum	Warm grey
"	Green tips	Alum	Greenish-yellow
Indian Mulberry (Morinda citrifolia)	Bark		Red
"	Roots		Yellow
Marigold	Flowers	Alum	Deep yellow-green
"	"	Aluminum & Soda	Old gold
New Zealand Spinach	Leaves	Alum & Soda	Primrose yellow
Onion (round)	Skins	Alum	Yellow to brown
Passion Fruit	Skins	Chrome & Iron	Brown
Spagnum moss		Alum	Lemon yellow
"		Chrome	Yellow
Sweet potato	Leaves	Iron	Yellowish blue
"			Brown
Tamarilles tree tomato	Red fruit	Cream of tartar/tin	Mauve blue
Tankets	Roots		Brown
Tobacco & Comfrey	Leaves & stems	Ammonium sulphate, Ferrous sulphate	
Tumeric	Root	Alum	Grey
			Bright yellow, gold

- Then either (a) let wool cool, squeeze, store in damp condition for 2-3 days (wrap in towel) or (b) allow to steep in liquor overnight, squeeze and start dyeing colour.

Potassium Di-chromate (chrome): Chrome 15g

- Dissolve chrome in cold water.
- Immerse damp wool, cover container, heat to boiling point, agitate, simmer for 1 hour.
- Cool and allow wool to stay in mordant overnight. Can be used immediately, but better to leave several days in damp towel in cool, dark place.
- Rinse out mordant well, then put in dye bath.

Mordants used during dyeing:

15g Ferrous Sulphate (Sulphate of iron)  
30g cream of tartar

- Dissolve iron and cream of tartar in hot water and stir very thoroughly when adding to the dye bath (tends to dye unevenly).
- Enter wool and keep gently moving for 15-20 minutes, stirring all the time.
- Rinse thoroughly - mordant weakens fibres. (Keep separate vessel for iron - difficult to clean).

Potassium Bitartrate (cream of tartar):

20g stannous chloride (tin crystals)  
80g cream of tartar

- Boil dye subject until good dye extracted. Lift from dye bath.
- Add cream of tartar and tin and simmer a few minutes, then leave to cool.
- Wet wool and add to cooled dye bath.
- Boil gently until shade desired obtained.

No Mordants needed: Lichens.

Parmelia lichens: found lying flat on trees or rocks. Shaded fawn, grey or black and white. Often have spores. Colours obtained - fawn to rich brown.

Usnea: Old Man's Beard - stringy greenish yellow, hangs from trees. Colours obtained - yellow to fawn, rust and brown.

Xanthoria parietina: bright orange lichen on walls or rock. Colour obtained - yellow.

## NATURAL DYES FOR SILKS

Silk in skeins must be handled carefully to prevent its matting; dip the skeins in and out of the dye instead of stirring them. In both mordanting and dyeing, the bath should not be over 70°C. Otherwise proceed as wool. Bracken fern use shoots, Iron mordant, grey colour.

Boil 500g of fern shoots 30 minutes and strain

liquid into warm dye bath. Enter washed, wet silk and steep one hour. Remove silk; cool dye bath and add 30g ferrous sulphate and 60g cream of tartar. Mix well; return silk to bath, heat gradually to 70°C and steep half an hour longer. Dry silk before rinsing.

Dyemaking with Australian Flora, The Handweavers and Spinner's Guild of Victoria, 31-33 Victoria St., Melbourne, 1974 A\$4.50

Dyes from Plants of Australia and New Zealand, Joyce Lloyd, AH & AW Reed, 182 Wakefield St., Wellington, or 51 Whiting St., Artarmon, NSW. 1971 A\$3.95

"Cloth Dyes from Natural Sources", K. Robinson in Appropriate Technology Vol 2, No 4 (Feb 1976). An excellent reference if you are serious about making your own dyes.

Dye Plants and Dyeing by E.J. Schety, editor, Pub. by Brooklyn Botanical Garden, 1000 Washington Ave., Brooklyn, N.Y. 11225, USA. US\$1.50 plus postage. Gives description and recipes of different natural dyes from around the world with instructions for a beginner. Illustrated. A very handy intermediate level book for those interested in dyeing.

Nature Plant Dyeing by Palmy Weigle, editor, Pub. by Brooklyn Botanical Garden, 1000 Washington Ave., Brooklyn, N.Y. 11225 USA. US\$1.50 plus postage.

More on natural dyeing with different mordants, instruction on preparation of wool, a supplement to Dye Plants and Dyeing. Advanced level, useful for those teaching dyeing.

H. Bekker

The Use of Vegetable Dyes by V. Thurston, Dryad Press, Bristol, England.

Though listing mostly British plants this pamphlet is very good for more details on tricks of dyeing and the use of mordants.



## SMALL ENGINE TROUBLE SHOOTING

### A. PROBLEM: ENGINE DOES NOT START:

#### Possible causes:

1. Fuel tank empty, fuel tap not turned on.  
Check fuel level - check fuel tap.
2. Fuel flow obstructed.  
Remove fuel line at carburettor to check flow. If restricted, check fuel line; breather hole in cap; filter in tap.
3. Spark plug failed or dirty.  
Remove spark plug, clean and reset to .025 - .028 (about the thickness of wood of a matchbox cover). Reconnect high tension lead and lay spark plug on engine. Operate starter mechanism. If no spark between the electrodes, replace the spark plug with a new one of the same type.
4. Ignition points faulty.  
Clean, reset gap to about 0.38 mm (.015")
5. Faulty condenser or coil.  
Replace condenser (can cause badly pitted points). Have mechanic check coil.
6. High tension lead fault or suppressor cap failure.  
Remove suppressor from the end of the spark plug lead, and hold end of wire about 1/2 cm from the engine while operating the starter. A spark should jump the gap; if not inspect the lead for any cracks. If damaged, replace the lead, or suppressor cap.
7. Incorrect mixture of oil/benzine.  
If in doubt as to the fuel mixture, drain and replace. (2 stroke only)
8. Blocked air filter.  
Clean foam type filters in benzine, dry, add oil, squeeze dry, replace. Replace paper-type with a new one.
9. Carburettor faulty.  
Clean carburettor, jets, and needle valves.
10. Worn or broken piston rings, crankcase seals leaking, or cylinder head gasket failure.  
Switch off fuel. Remove spark plug lead. Turn engine by hand in the normal direction of rotation. Each complete turn should have two distinct compression periods - one strong and one weak. If compression weak, overhaul engine (2 stroke only).  
  
Switch off fuel. Remove spark plug lead. Turn engine by hand in the normal direction

of rotation. Each complete turn should have one distinct compression period. If compression is weak, overhaul the engine (4 stroke only).

### B. PROBLEM: ENGINE STARTS BUT RUNS POORLY OR LACKS POWER:

#### Possible causes:

1. Spark plug dirty or not set at correct gap.  
Remove-clean-reset gap at .64-.71 mm (.025-.028")
2. Ignition points binding, or set at wrong gap.  
Check that they move freely. Check gap. Check that there is no oil on point's surfaces.
3. Coil or condenser breaking down.  
Replace condenser. Have coil checked.
4. Ignition timing slipped.  
Check that the flywheel key has not broken on the crankshaft.
5. Incorrect mixture of oil/benzine.  
Drain and replace with correct mixture (2 stroke only).
6. Small quantity of water in fuel.  
See B-5 also drain carburettor.
7. Intermittant fuel obstruction.  
Check fuel flow at carburettor, clean needle valves, check breather hole in fuel cap.
8. Carburettor faulty.  
Dismantle - clean jets, float chamber and needle valves.
9. Air filter dirty.  
See A-8.
10. Excessive carbon build up.  
If the muffler is heavily coated with oily deposits, decarbonise the engine.
11. Burned valves, seats, or sticking valves.  
Remove cylinder head, and turn the engine. If valves remain open, or if valve seats are pitted or burnt, overhaul the engine (4 stroke only)
12. Loss of compression.  
Check as in A-10

### C. PROBLEM: ENGINE STOPS DURING USE:

#### Possible causes:

1. Out of fuel  
Refill the tank.
2. Spark plug failure or dirty spark plug.  
Check as in A-3
3. Contact points gap incorrect or jammed.  
Check gap - reset if necessary.

4. Condenser, coil or suppressor cap failure.  
Replace condenser, have coil checked, replace suppressor cap.
5. Restricted fuel supply  
Check as in B-7
6. Governor linkage broken or badly adjusted.  
If broken replace. Get mechanic to adjust (4 stroke only).
7. Vapour lock in fuel.  
If engine and thus carburettor are very hot, allow to cool.
8. Dirt in carburettor.  
Dismantle, clean all jets, needle valves, and float chamber.
9. Excessive carbon build up.  
Check as in B-10
10. No oil in crankcase.  
Check oil level, refill as necessary. If engine is noisy when restarted, overhaul.
11. Mechanical failure.  
Check as in A-10. Also, if the engine will not turn, allow it to cool, and then check the compression. If it still will not turn, or if the compression is weak, overhaul the engine. Check as in A-10. Read the above note also.

Contributed by: R.G. Haeusler, Kurum Plantation, Karkar, via Madang.

### HOME-MADE DEGREASER

For cleaning up engines or machinery before working on them: Mix 1 part liquid detergent to 6 parts diesel fuel or kerosene. Brush on, loosen dirt, then rinse off with water

The Shell Book of How Cars Work, by Gordon Walmsley, John Baker Publishers Ltd., 4 Soho Square, London W1V 6AD, 1966. Pounds 1.80.

This is a very nice little book full of drawings and diagrams to explain the mysteries of the internal combustion engine and the running gear of an automobile. The ability to visualize the actual engine is required, but the explanations are clear, straightforward and brief. The book is available from the Technical Education Library, Dept. of Education, Konedobu, and is very suitable for class work in motor mechanics courses. An added bonus - it explains how various fuels and lubricants are extracted from petroleum.

Level simple/intermediate J.T. Hale  
Box 215, Wewak, ESP.

### Automotive Operation and Maintenance, VITA, 1973

A specialised handbook giving hundreds of pieces of appropriate information for more effectively operating a car or truck in places with bad roads, a weak servicing infrastructure, and a difficult climate.

It deals with problems seldom encountered in an industrialised country and which a driver usually learns about through great costs and bitter experience.

Cost: US\$6.50. Available from VITA, 3706 Rhode Island Ave, Mt. Rainier, MD 20822 USA.

### FISHING

#### MAKING A NET

Only a few tools are needed in net making and mending: a needle, a small knife for cutting twine, and a mesh gauge which measures the size of the mesh (see Fig. 1). The process of making a simple cast net involves almost all the fundamental skills which you will need to know.

FIGURE 1

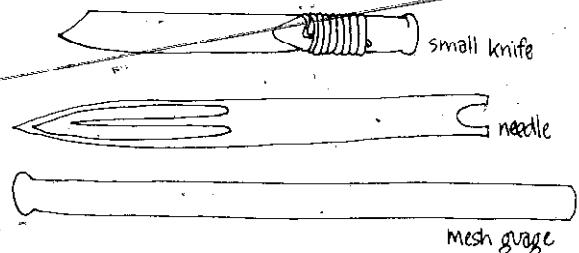
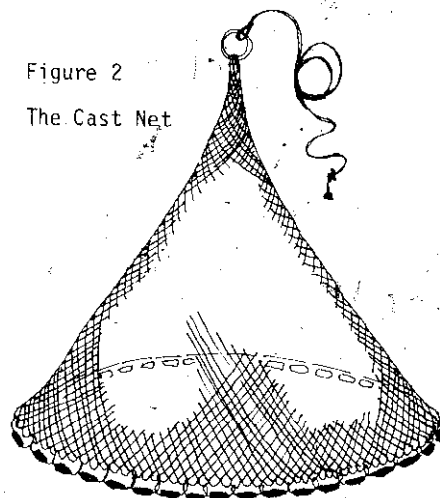
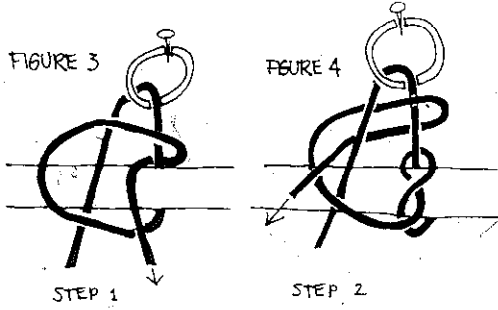
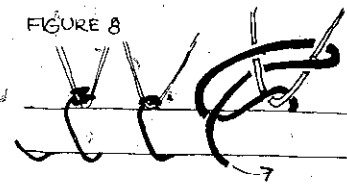
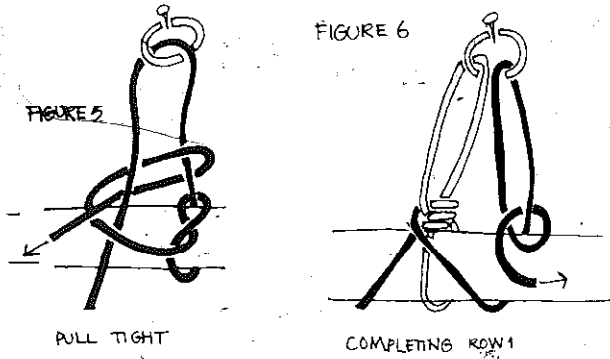

Figure 2  
The Cast Net





First, make the foundation mesh. Make a loop of rope or twine hooked on a nail. Pass the needle through the loop. Hold the mesh gauge in the left hand and with the left thumb press the end of the standing part of the twine against the mesh gauge, spacing the gauge about the width of the needle away from the rope. Slip the needle behind the first bar or strand, cut through the loop (Fig. 3), and pull the twine down. Make another loop to the left and over the gauge. Pass the needle behind the two bars and cut through the loop (Fig. 4). Pull the twine down and tighten the knot as in (Fig. 5). Pass the twine below the gauge and up through the loop of rope and repeat the first operation shown in (Figs. 5 - 6) until you have made about 30 or 40 meshes.



After the third row of mesh, begin increasing the number of meshes. This should be done every other knot. Variations may be done by increasing the meshes with every knot depending on the type of net being made. (Fig. 9).

Make three rows of meshes and start again to increase the number of meshes by making extra loops just in line with the first. Increasing the loops should be done after completing every three rows of meshes until you have made the desired length of net. The last row of mesh may be doubled to make it stronger.

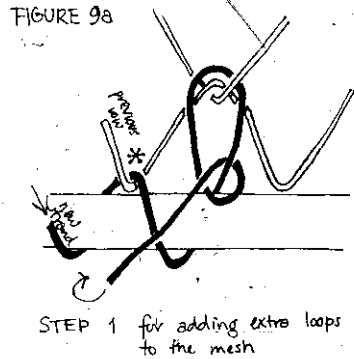

\* NOTE ON FIGS 9a-c: Step described in fig. 8 omitted for clarity.

Second, join the last mesh with the first mesh. Start the second row of mesh. Slip the needle through the first mesh pulling the twine over the mesh gauge until the loop of the mesh reaches the top edge of the gauge (Fig. 7). With the left thumb clamped over the mesh, form a loop to the left and up through the thumb. Pass the needle behind the mesh and through the loop forming a knot (Fig. 8). Repeat until the second row of meshes is made.

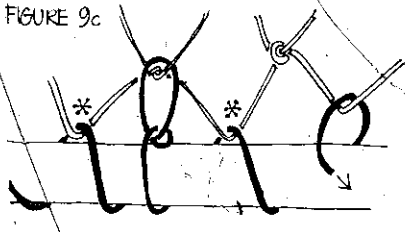
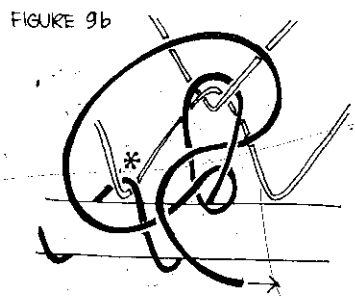
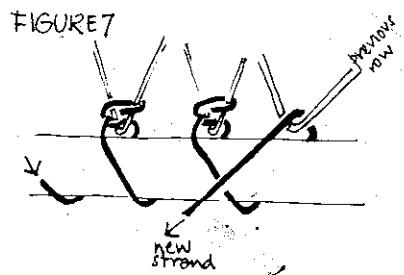
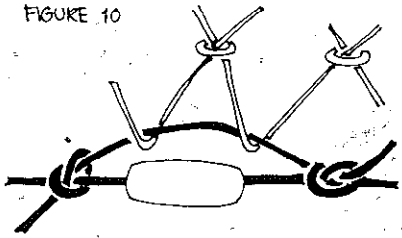

FIGURE 10



Attach the lead sinkers. They should be tied together with a piece of twine and a rope where the lead pieces are hooked. Fig. 10 illustrates how lead sinkers are tied together.

To make the netting more durable, count about 30 meshes from the lead sinkers upwards. At the thirtieth mesh reinforce the meshes by doubling the thread or twine. This should be done for every twenty-five meshes.

Initial contributor: V. Estillore  
Magarida Voc. Ctr  
Amazon Bay, C.P.

BASIC KNOTS FOR FISH NETS

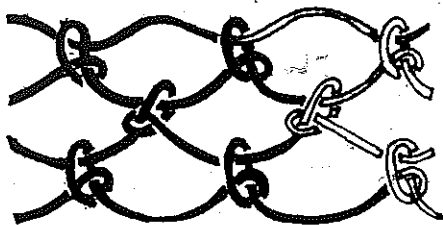

The "Lake Dwelling" knot: first found in European lakes, now also Pacific and Congo. Will not slip if coarse fibre is used, and the mesh remains constant.

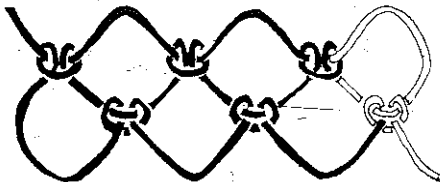

The "Peruvian" knot: will slip unless hand-twisted. Irregular fibres are used.

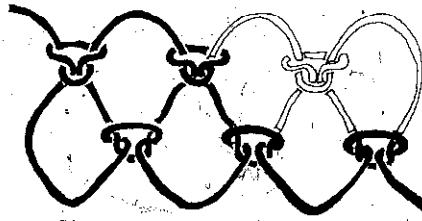

The "Reef" knot: An improvement on the Peruvian, slips only if synthetic fibres are used. Common in Asia.

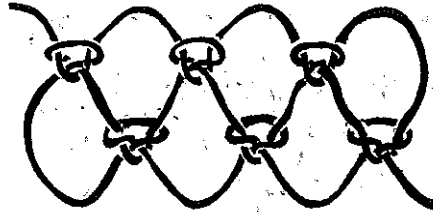

The basic "Weaver" knot: Complicated. Nowadays found worldwide. Suitable for natural and synthetic fibres, and for machine weaving.

References:

Fish Catching Methods of The World, A. von Brandt, 1972; and How to Make and Mend Nets, by J. Garner, 1962, a useful instruction manual; both published by Fishing News (Books) Ltd, 110 Fleet St., London EC4, UK.

Initial contributor: J. Lowson  
Box 793, Lae

DERRIS FOR CATCHING FISH

Throughout PNG people use one of the derris root legumes to stun fish. Although poisonous even to humans in large amounts, in small amounts it is widely used as a safe insecticide called rotenone. In very small quantities it stuns fish so that they float to the top of the water. If not harvested quickly they will recover when fresh water mixes with the treated water.

In the Western Province during the dry season, people watch for schools of fish swimming in from the sea up small rivers. It is the custom then to fence the mouth of the river by driving stakes in the mouth of rivers that are no deeper than a man's chest. Then they weave or tie finely split bamboo to the stakes to act as a fence so the fish cannot go back to the sea.

Derris roots are then crushed between stones or any other suitable way and the liquid collected. When the fish come close to the fence the liquid is poured in the water. The unconscious fish are collected when they rise to the top. Any fish not collected will recover in time and survive as fresh water comes down the river.

cont'd



Derris juice can also be used in salt water pools on the reef where water movement is not rapid.

There is very little danger to people using this method and the effect of the poison does not last long. It is safe to eat fish caught this way.

Initial contributor: J. Wapi, Wudai, PO. Keravat, ENBP.

#### LEAD FISHING SINKERS FROM OLD BATTERIES

Melt the lead plates in a steel container over a fire. Pour the HOT molten lead into moulds. Moulds are sometimes available from sports stores. Or you can use small pieces of bamboo, or even paw paw stem for moulds. For the centre hole use a piece of round grass or something similar. Or make moulds right in the ground. The product will be crude, but they are easy to make.

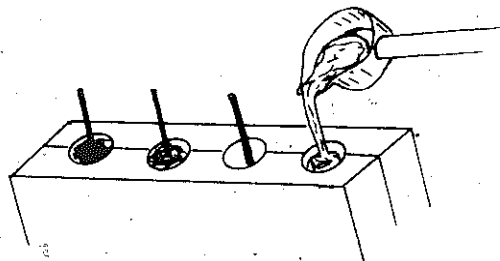

#### LEATHER TANNING

With the PNG cattle population rapidly increasing, and with more and more animals being killed at local levels, we would expect considerable interest to develop in the production of leather.

Facilities required: Three tanning tanks 240 x 100cm deep with gradations of 250 litres marked every 6.5cm from the bottom: One drying rack as large as the biggest skin; two 200 litre drums.

Materials needed for 100kg of dry skins:

50kg lime or kambang	from Trading companies
2kg sodium sulfide	" Shell Chemical
2kg boric acid	" Chemists
200kg mangrove bark, oak, casuarina, or wattle	" local trees
10 litres vinegar	" Trading companies
40 litres coconut oil	" Coconut Products Ltd Rabaul or pressed at home.
Fleshing knife	" Stockman's supply, firms or make your own
Hose for siphon	" junk heap
10 Copra sacks	" local sources

The process:

1. Put 100kg chopped mangrove bark, five litres vinegar, and 1000 litres of clean water in Tank No 3. Stir daily for a week.

2. After one week put 500 litres of liquid from Tank No 3 in Tank No 2 using siphon and add 500 litres of clean water to it. Put 250 litres of liquid from Tank No 2 into Tank No 1 using siphon, and add 750 litres of clean water to it. Then refill Tank No 3 to the 1000 litre mark.

Note: to keep tanning liquid strong after each 100kg of hides is tanned add 40kg of mangrove bark to Tank No 3 and fill to the 1000 litres mark with clean water. Continue after each tanning until Tank No 3 is full of bark, then throw out the bark (but keep the liquid), continue adding 40kg of bark after each tanning.

3. Each time you add 40kg of bark to Tank No 3 take 250 litres of liquid from Tank No 3 and add to Tank No 2. Then take 250 litres from Tank No 3 and add to Tank No 1. Refill all tanks to the 1000 litre mark. When the tanks are ready you can begin tanning.

Note: if you have to wait more than 12 hours after skinning an animal before you begin tanning, you should salt it by first scraping all the meat and fat carefully from the skin. Rub salt in the skin, roll up skin for one day, then dry it. When you are ready to tan, wash the salt out by soaking in clean water for half a day until hide is soft. When hide is soft again or if the hide is fresh, go to step 4.



4. Paint the inside of the skin with a solution of 50 parts kambang or lime, 50 parts water and 5 parts sodium sulfide. Then fold the skin in half with the insides together and leave for 12 hours. Scrape the hair off with a long curved knife. When hair is off, wash out the lime by soaking the skin for two hours in a drum with 250g of boric acid in 50 litres of water. Then wash and drain.

4a. If you want to keep hair on the skin do not use lime but you must wash the skins very well overnight in a strong mixture of detergent, bleach and water or else the grease in the skin will make the leather rot.

Now you can begin tanning.

5a. Put skin in Tank No 1 for 3 days, but turn the skin every day.

- b. On the 4th day put the skin in Tank No 2 for four days but turn every day.
  - c. On the 8th day put the skin in Tank No 3 for 4 days but turn every day.
  - d. On the 12th day take the skin from Tank No 3 and hang on a rack to drain. The rack should be level so that the hides lie flat. Cover with copra sacks so the hides won't dry out. Leave for 3 days.
  - e. After 3 days of draining wash the skins in clean water and take off any bits that stick to the hide. Then drain for 3 more days, but keep covered with copra sacks so they won't dry out.
  - f. Rub copra oil or neatsfoot oil into the skin then pile in a stack for a day. Do this again the next day and one more time the 3rd day.
  - g. Now hang the skins in the shade where there is lots of wind and no sun so that the hides can dry slowly.
6. Softening: This is done by wirebrushing the inside of skin and then sanding well with a coarse sandpaper. It can then be pummelled and worked to make pliable. The leather is ready for using then. Furs can be done in the same manner but take only a few days to tan if small i.e. cuscus.

Further references: File 10-310, 18 November 1974, Business Development Office, Box 385, Rabaul.

Equipment for the Tanning of Hides and Skins, by L.R. Ray & E. Backman, 1951, 18pp. US\$0.25. FAO Agriculture Development Paper #13.

#### Home Tanning and Leather Making Guide

Best information on tanning we've seen. If you're eating deer or calf or dog or whatever and throwing the skin away, you don't need this book. Meathead.

-SB



#### Home Tanning and Leather Making Guide

A. B. Farnham  
1950; 176 pp.

\$1.50 postpaid

from:  
Harding's Books  
2878 East Main Street  
Columbus, Ohio 43209  
or WHOLE EARTH CATALOG



#### PROPER RIPPING OPEN CUTS FOR A CORRECT PATTERN

The dotted lines show the path of the knife, and the solid lines show the appearance of the hide when spread out.

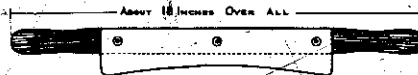

TWO HANDED SCUDDING KNIFE

Used like Shicker, curved to fit beam. Brass, copper or slate edge, to avoid rust.

I.D. Clarke and J.S. Rogers. Home Tanning of Leather and Small Fur Skins. U.S.D.A. Farmers Bulletin No. 1334, Superintendent of Documents, U.S. Government Printing Office, Washington, DC 20402, USA. 15¢.

In 25 pages this booklet gives the most complete introduction to tanning for use in village industries. Many alternative methods are described including a salt/battery acid method for making belting leather.

PNG Experience: This has apparently been tried in ENB., but no report of results has been received, also at Kelabovia, SHP. (Photo opposite)

Remarks: Note that while the process for one hide takes nearly three weeks, the amount of time each day is very little. Those working in cooler climates will find it easier than those in very warm areas.

For a trial, use smaller scale - in the proportions outlined above. A copper laundry kettle or a 200 litre drum is good.

Neatsfoot oil can be made by putting fresh hooves and shin bones of beast in a sugar bag and boiling well. The oil will float. Skim and bottle when cool.

Updated by: B. Telford, CMLL, Kelabovia, via Wewak, ESP.

#### RAWHIDE

Making Rawhide from cattle leather is simpler than tanning, and the product is really quite good. Some of the Vudal students made rawhide successfully last year, and the product was so popular that we couldn't get any ourselves to try making handcraft articles.

Basically the process is just removing the moisture from the skin and replacing it with a non-mineral oil or fat, over a period of about three weeks. The students used a mixture of neatsfoot oil and beef tallow, heated in tins.

It is best to do this when the humidity is not high, as the skin must dry, and cannot be put in the sun. A slow steady drying process is what you want.

The thoroughly cleaned skin is placed in some sort of frame, and regularly, preferably every day or two, more oil is worked into it. This doesn't take much time. When it is well-dried it may be taken out of the frame. During the three weeks time the colour changes from reddish brown to brownish white.

The skin will still have the hair on it, which is nice for some purposes. The hair can be shaved off

with a sharp tool if desired. We have heard that the hair can be removed by placing the skin in the ground for a while, but we don't know how.

The rawhide is only slightly stiff when finished, unlike certain types of tanned leather. It may be loosened by pulling it back and forth over a smooth round pole or pipe.

Rawhide makes good boot laces, belts, handbags, woven straps for a bed frame, and even water-tight containers.

Contributed by: J. Tyler, Vudal, Kerevat ENBP.

Let us know of your experiences and ideas about rawhide.

#### Leather Making Tools

Available from C.S. Osborne and Co.  
125 Jersey St.  
Harrison, New Jersey 07029  
U.S.A.

Catalogue available.

#### METAL CASTING (No Article)

#### LIME-KAMBANG

In all coastal areas of PNG people make lime from coral for adding to the mixture of betel nut. High quality edible lime is made from live coral which is collected from the reef and allowed to dry for 2-3 months before it is cooked.

The traditional way to cook the lime is to dig a deep hole much larger than is needed for the coral collected. Firewood is placed in the hole to fill it, the coral is placed on top of the firewood and then more firewood is placed on top of the coral until as much firewood is on top of the coral as is in the hole. It is important to choose firewood that will burn very hot and leave little ash. In many places leucaena (landro) is used.

The fire is set and allowed to burn fiercely until all the wood is burned. The lime remaining in the whole is covered as soon as possible with the leaves of the ADUI plant (Kuanua), and on top of the ADUI leaves a mat of coconut leaves covers everything. Earth is then put back in the hole to cover the leaves, and the lime is left until the next day.

The following day the earth and protecting leaves are removed and the lime is carefully taken out of the hole so that it does not get dirty. Immediately it is sieved on a piece of fly wire over leaves or a basket to collect only the fine lime powder. The rest is thrown away.

Remarks: Commercial quality of lime for building and agricultural purposes can be made from limestone. To test a sample pour a little dilute hydrochloric acid over the sample and look for bubbling in the liquid. If it bubbles it is worth doing further tests. Limestone can be burned in a hot fire. To learn more about making lime, get

Technical Bulletin No 13 from Local Government Engineers, Box 1108, Boroko.

Note: Limestone and coronous are not the same, but limestone is often found near areas where coronous is.

Initial contributor: Serry Loamin, Vudal,  
PO Kerevat, ENBP.

#### POTTERY



(p 214)



To make clay pots to modern standards is a very technical business requiring specially blended clays, wheels for throwing pots and sophisticated ovens. Yet for many thousands of years pots have served men in PNG and they were made only with the materials at hand. The drying was very simple.

You need clay, and the choice of clay is important. Generally the good clays are grey in colour, but some red clays are suitable. It is important that the clays don't crack when dry, and you should test the clay by drying a small piece.

The clay should be made wet evenly through the pile and any rubbish or hard pieces should be taken out. It should be soft enough to work easily, but not so soft that it will not hold its shape. Add enough water a little at a time and work it with your hands so it is all the same consistency.

There are many ways for making pots. One is to form the pot a bit at a time from handfuls of clay. The clay is wet on the surface so it is slippery and will not stick to your hand. As the pot takes shape it is tapped smooth and finished with a light-weight, smooth paddle.

t'd

cont'd



Another way is to wet the clay a little on the surface and roll it into ribbons or "snakes" about 2cm in diameter. These are coiled around and around, the desired pot. The ends and edges are then worked by hand to join each other.

Whenever you are working with clay have enough water close by so that you can keep your hands wet, then they will not stick to the clay.

The pot must be dried slowly so that it dries evenly through the whole thickness. This is usually done by placing the pot in the shade and letting it dry for at least a week. The pots can also be placed on a shelf or in a basket over a very small fire so that the pot dries slowly. When it is hard the pot is fired, or baked to give it strength. The pot is placed on a fire of hardwood or coconut shells and then the pot is covered with more and more wood. The pot should be baked until the colour changes to a red brown. If it is another colour it will not be a good pot.

**References:**

Discovering Pottery, by H. Mammott, Paul Hamlyn Pty Ltd, Dee Why West, NSW 2099, 1972, 136 pp, K1.95 in many PNG bookshops. A good introduction to pottery making, with lots of clear pictures. Don't start until you have read a book like this. If you have already started, buy something else.

Ceramics, by G. C. Nelson, Holt Reinhart and Winston. This is the something else. A comprehensive studio guide, with more than 150 step-by-step photos and examples, by one of America's outstanding contemporary potters.

Initial contributor: Damien Naiyaleva, Jack Wokipim, Salome Masina, Vudal, PO Kerévat, ENBP.

**FRANGIPANI PERFUME**

Long ago in the olden days the Namatanai people in New Ireland Province used to make a scented oil from frangipani flowers.

They used coconuts, frangipani flowers collected from beneath the tree, and betel nut leaf.

They broke up the flowers and placed the small pieces into a container made from the base of a betel palm leaf. The base was cut from the rest of the leaf and each end tied tight to give a curve like a toy boat.

The coconuts were scraped and the liquid was squeezed directly on top of the pieces of the flower.

Each morning for a week the container was put in the sun to dry, but in the afternoon it was put in a cool place so it would not dry too quickly. By the end of the week the oil would be shiney on the surface and have a sweet smell.

Men would use this oil to rub in their hair or on their skin to make themselves attractive. The oil would keep for 4-6 weeks. Some people still do it once in a while, but I must admit that it's no longer as exciting - maybe because we're now civilized.

Initial contributor: E.A. Wesley, Vudal, PO Kerévat, ENBP.

**SAWMILLING**

You can use a pitsaw, but just try to buy one in PNG! Very difficult.

**MINI -MILL** Lumber-making Chain Saw Attachment.  
Granberg Industries, Inc., Richmond, Ca 94804 USA.

Here is something I've been looking for for years, and now I've found it! I have one, and it really works. An attachment to be used with your own Chain Saw.

Available from: Morgan Equip. Pty. Ltd.,  
Box 1729, Lae  
Box 252, Arawa  
Box 5423, Boroko  
Box 1234, Rabaul

**This is how the MINI-MILL works:**

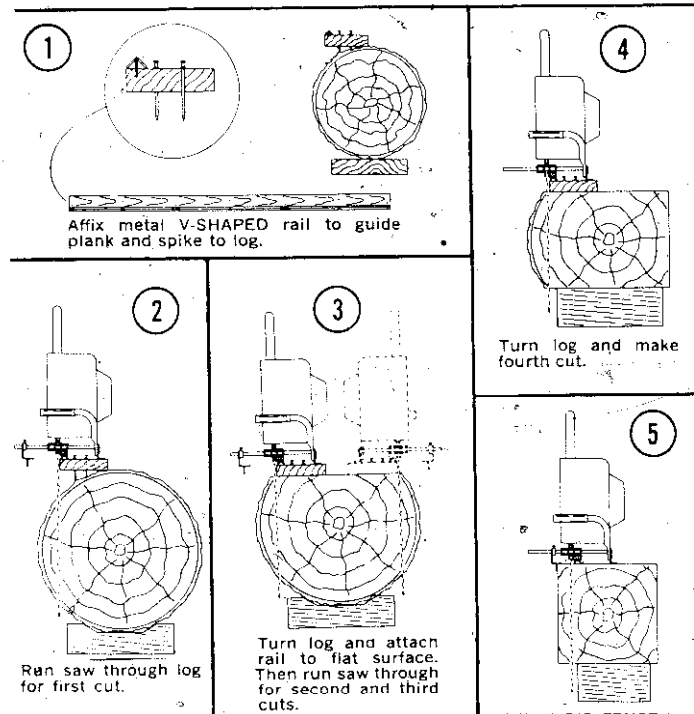

This little compact attachment combined with a chain saw converts the two tools into a single precision lumber-making mill. With this MINI-MILL anyone can make smooth ready-to-use dimensioned lumber from logs; no special talents are necessary. Lumber can be milled in any desired thickness. From these boards one-by-sixes, two-by-fours, or any size can be made. A handy lumber-making tool for anyone who enjoys building and repairing all sorts of things made of wood. Comes complete with 12-feet of metal V-shaped guide rail in three 4-foot lengths.

Adjust RIP FENCE to size thickness required and make lumber.

Contributed by: U. Bergman, Wantoat, via Lae

Mobile Mfg. Co.  
6810 N.E. Cornfoot Drive  
Portland, Oregon 97218  
U.S.A.

"Mobile Dimension Saw", three models priced between US\$3,000 and US\$4,500, with capacities of 1500 to 3500 board feet per hour. Simple, rugged, choice of engines. One man can operate. Runs on track, with large vertical blade and small horizontal blade. Comes as a complete sawmill ready to operate, with blades, engine and track, plus trailer, trailer hitch, tooth grinder, tooth wrench, lag bolts, lag bolt ratchet wrench, was wrench, and jack. Equipped with spark arrestors. Beginners are supposed to be able to learn operation easily. Cuts any size lumber from  $\frac{1}{2}$ " X 1  $\frac{3}{4}$ " to 4  $\frac{1}{2}$ " X 12  $\frac{1}{2}$ ".

International Enterprises of America, Inc.  
4000 N.E. Columbia Blvd.  
Box 20066  
Portland, Oregon 97220  
U.S.A.

"Mighty Mite" transportable sawmill, two models, each with choice of gasoline, diesel, or electric power. Horizontal main saw, vertical edger saws. Runs on track. Cuts any size lumber from 1" X 2" to 8" X 12".

Portable Electric Sawmills Pty. Ltd.,  
68 High Street,  
Box 199, Wodonga, Vic. 3690. Aust.

Two sizes available. A Lister aircooled generating unit powers electric saws mounted on a portable frame to cut high quality timber right where the logs are.

## BLACK MARKING INK FOR LOGGERS

Ingredients required: Old torch batteries and old motor oil.

How it is done: Take the carbonstick of the old battery, pulverise, and mix with oil.

This is being done in Morobe Province.

Initial contributor: U. Bergmann  
Wantoat, via Lae

## SILK SCREEN PRINTING

(P. 195)

Preparing Screen: Stretch silk or tetoron over frame of desired size and attach with either drawing pins or stapler.

Preparing Design: Method 1 - PAPER STENCIL:  
Simple - allows many designs with one screen, but is not permanent. Suitable for use at village level.

1. Cut out design on cartridge paper. Paper which has been painted with linseed oil or shellac would be more lasting, but is not necessary.
2. Attach to screen with small pieces of masking tape. If design is to be printed with a squeegee (see below) edges will have to be masked.

Method 2 - PROFILM OR LACQUER PAPER: Permanent, but allows only one design per screen.

1. Use blue lacquer paper. Cut out design, being careful not to cut backing paper.
2. Place lacquer paper on top of newspaper, and silked frame on top of lacquer paper.
3. Fuse paper to silk, exerting pressure all around frame to ensure good contact between silk and lacquer.
  - (a) Blue stencil paper (oiled). Fuse to silk by using a rag dipped in DUCO THINNER. Rub thinner over a small area, rub this area quickly with a dry rag. Repeat until all lacquer paper is attached.
  - (b) Brown iron-on paper: fuse to silk by ironing with iron at a low temperature.  
Note: not recommended, as it does not last long, and as silk must be used (Nylon stretches when ironed). Silk is expensive.
4. Remove backing paper gently.
5. Use masking tape to cover all of the back of the screen not masked by the stencil paper. Apply tape all around the edge of the inside of the frame.
6. The frame can be shellacked or varnished if liked. Mix shellac flakes with methylated spirits. The liquid should not be too thick. Spread over the design: quickly remove any from the open areas by rubbing it with dry rags till silk is clean. If shellac is not removed immediately from open areas, screen will remain clogged, and will be ruined.

### Sources of Dyes

PERMASET: R. Collie & Co. Pty. Ltd.,  
GPO Box 829L  
Brisbane 4001 Qld.

THERMOFIX: Edman Wilson,  
18-20 Whiting Street,  
Artarman, NSW. 2064. Aust.

### Printing of Material

Method I - SPONGE: Edges do not need to be masked. A smaller amount of dye is required, and as many colours as you like can be used. Takes more time,

so screen must be washed more often (so that ink won't set on screen).

1. If not using a permanent screen, place paper stencil on back of screen. Stick, using small strips of masking paper.
2. Applying pressure to screen, take a dry piece of sponge, dip in dye and rub over the areas not covered by the stencil.
3. You may use as many colours as you like. Use a dry sponge for each colour.
4. Remove paper stencil (if paper stencil method is used) and wash screen immediately.
5. Iron the design to set the colours.

**Method II- SQUEEGEE:** This requires edges of screen to be masked, as a pool of dye is needed. This method is much faster, and gives a professional finish. It uses more dye. If more than one colour is desired, more than one stencil has to be cut. Different colours may be placed along the end of the screen, in sequence, to obtain a multihued effect.

1. Pour a little dye into one end of the screen.
2. Applying pressure to the screen, pull squeegee across the screen and back again.
3. Lift screen and place in the next position.
4. Repeat until the printing has been completed.
5. If using a paper stencil, remove it immediately and place it on a newspaper.
6. Wash the screen immediately, using a bucket of water and a cloth. If dye is allowed to dry, it will clog screen and cannot be removed later.
7. Iron design to set colours.
8. Note: If overprinting, place newspaper over each print, or dye from the first print will get on the underside of the frame and smudge the next print.

#### Setting the Print

Heat is required to set Permaset or Thermofix. Permaset requires 5-6 minutes at 350°F; Thermofix requires 1½ minutes. If no iron is available, place work in the sun for an hour, if possible on the top of a tank.

It is possible to design a setting cupboard in which materials reach this heat, and this greatly increases production levels. This is necessary only when a large volume of work is to be done.

#### Useful Hints

Only print on flat fabrics. Most synthetics do not print satisfactorily. Resin-coated materials do not print.

Fabrics must be printed on a padded, calico covered table to absorb excess dye.

Always have sufficient dye in your screen when printing all-over designs.

Use at least two pulls of the squeegee. The first pull prints, the second pull levels off the colour concentration and gives an even finish.

Firmly close all tins and jars when not in use. Always stir thoroughly with rotary beater or stick before use.

#### Popular Silk-Screened Items

(p 195)  
Afro shirts, adult and child  
Caftans  
Shifts, with printed yoke and pockets  
Placemats and serviettes  
Tablecloths  
T-Shirts  
Wall-Hangings  
Dress Length material (3½ yds)  
Shirt Length material (2 yds)  
Tea towels  
Ties  
Bags  
Laplaps

Contributed by: Lae Vocational Training Centre  
for Girls

#### SOAP

(p 248)  
Equipment needed: 2 large bowls, buckets, or pails, made of iron, enamelled steel, clay or plastic. DO NOT USE ALUMINIUM.

A mould for making soap - a wooden form or a plastic container will do, but must be water tight. If the mould is not flexible, line it with cloth or paper to make it possible to remove the soap. Split bamboo halves or plastic lollipop cups are good too.

Ingredients required for 4kg of soap:  
13 cups vegetable oil or animal fat  
2 2/3 cups of caustic soda crystals  
5 cups of rainwater

The process:

1. Add all the caustic soda to the rainwater (NEVER ADD WATER TO CAUSTIC SODA CRYSTALS, as it may splatter and burn). This is now called lye water. It will begin to get very warm. Stir it with a wooden stick until all the crystals are dissolved, then let the liquid cool until the temperature of the outside of the pot is the same as your hand. DO NOT PUT YOUR FINGER IN THE LYE WATER. It can burn your skin. The temperature must be right or the soap will not be good. If you have a thermometer, the temperature should be 37°C.

2. Place all the oil in another pail, and slowly, in a steady thin stream add the lye water. While pouring the lye water, slowly stir the mixture all the time. Stir steadily and in one direction for up to one hour. You will begin to see small milky white particles beginning to follow the path of the stirring stick. If this does not happen within one hour, stop and wait fifteen minutes, then stir again for five minutes. Do this until you see the track.

3. When you have tracks, carefully pour the mixture into the mould, and leave for two days in a dry place where it will not be disturbed. If it is shaken or moved the soap will not set.

4. After two days remove the mould and cut it

into bars using a thin wire stretched tight between your hands. Pile the bars so that the air will circulate on all sides for two to four weeks. When the soap is cured at the end of this time, it will be better than soap purchased in the store.

You will never have "spoiled" soap, if you use the right materials. If it doesn't work out the first time, you can rework it. Sometimes the soap will not be good if:

- (a) the oil is rancid or salty; or
- (b) the lye water is too hot or too cold; or
- (c) you stir it too fast or not long enough.

If you think that the soap is not strong enough, cut it into small pieces and put it into a container with five pints of water. Melt the soap on a low heat and stir occasionally. When it is all melted, raise the heat until the mixture boils. Keep on boiling until the mixture becomes syrupy and drops in sheets from a spoon. Pour it into a mould and let stand for two days. Then take it out of the mould and cut it into bars as before.

Sources of materials: Any cheap vegetable oil or fat will do. In large quantities coconut oil can be purchased from CPL in Rabaul, but they mean tonnes not barrels. Palm oil sludge can be purchased from the factory in Kimbe, and at other Palm oil projects. Grease and fat from cattle or pigs can be used.

If you have no other source you can make your own oil from coconuts or oil palm in the village. Caustic Soda is sold at Trading Companies and other stores in one pound tins for about K1.00 per pound. It is also called sodium hydroxide.

Further references: "How to make soap using Coconut Oil", Division of Technical Education, Department of Education, Konedobu.

PNG experience: Process was developed at Puas Vocational Centre where it was done frequently, and at other schools.

Remarks: Coconut oil makes softer soap than other oils, because it is low in stearic acid. It tends to be a little greasy, but it is a very good soap. It is the only soap that will make lather in sea-water.

Potassium hydroxide can also be used to make soap from all oils and fats except coconut oil. It is cheaper than sodium hydroxide. DO NOT TOUCH any of the liquid remaining in the mould after the soap hardens, as it can cause serious burns. Sr. Veronica of CM Lavongai, Kavieng, reports that girls in a training school used the liquid in the pot left over after pouring the mould as a shampoo. Their hair fell out. (It grew back.)

Important: If you ever get lye water on your skin, you must remove it carefully and quickly. If it is not removed it will burn your skin. Vinegar or muli juice can be used to neutralize the lye, and you should have some near when you are making soap.

Initial contributor: P.R. Hale, Box 215, Wewak, ESP

## INKLE LOOM

Description: A simple framework made from sawn timber, bamboo, tree forks or round poles with which braids, belts and straps can be woven. Size can be varied from a table model, to one which stands on the ground.

Materials for Manufacture: Use materials that are most easily available. Bamboo, sawn timber and darning, round timber from de-barked tree branches. Fasten joints with rope lashings (see photograph). If using sawn timber, use screws and glue or dowels and glue. Bolts make the most solid assembly if sawn timber is used. Quantities depend on size of loom required.

How to use the loom: Select materials according to type of braid, and purpose for which it is to be used. Woolen yarn, synthetic yarn, cotton, linen, banana fibre (Natural colour or dyed), pandanus root fibre, sisal, abaca. Warp strings should be strong as tension is considerable. Warps should be chosen for colour as the warp shows most in the finished braid. (Warps are the lengthwise threads.)

1. Cut about 20 fine heddle loops in a strong thread, each sufficient to reach from X to Y on your loom. All are exactly the same size.
2. Take a warp string, beginning at Peg A, pass it round C, D, E & F then back to A. Continue on with the second round, over Peg B then through a Heddle Loop and over C, D, E, F & again back to A. This method is repeated with each alternate string passing through a Heddle Loop. Change colour by putting a different coloured string at A when wanted. When the warp strings are wide enough, the loom is ready for weaving.
3. Weaving is done between Y and C. A thread is passed in Zig Zag fashion across the warp first, pressing down the A to B threads, then A to C threads. A ruler or thin piece of bamboo is used to "beat down" the weft threads after each row.

After a few centimetres have been woven, remove the Peg D to release tension, and move the whole strip downwards. This places the part being woven in a comfortable position again. Replace Peg D and continue weaving.

Sources of Supply for Materials: Large stores such as Burns Philp and Steamships sell woolen and synthetic yarn in various colours. These can be used with natural fibres used in the village. Sisal, abaca, pandanus, banana, even young coconut leaf and pandanus leaf can be used.

String can be made the same as it is made for string bags and dyed or used in natural colours.

Remarks: There are many uses of Inkle braids such as headbands, belts, decorative bands on clothing, straps for bags and baskets. They are very strong, and can be made easily up to 15cm wide. They may be joined by the edge to make mats, clothing or decorative panels.

cont'd

## The Inkle Loom

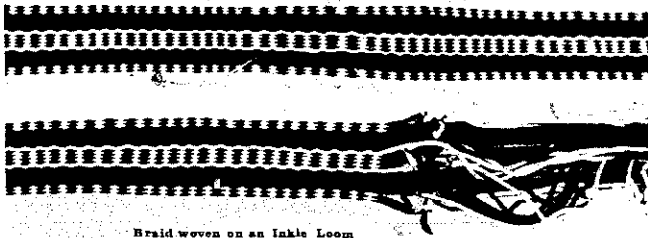
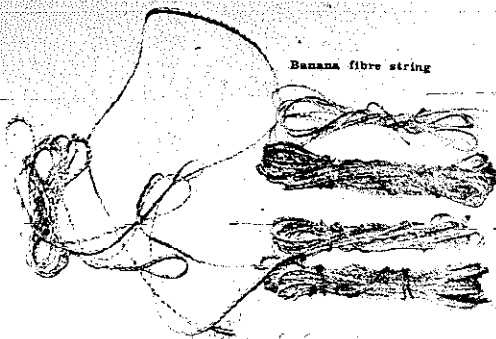
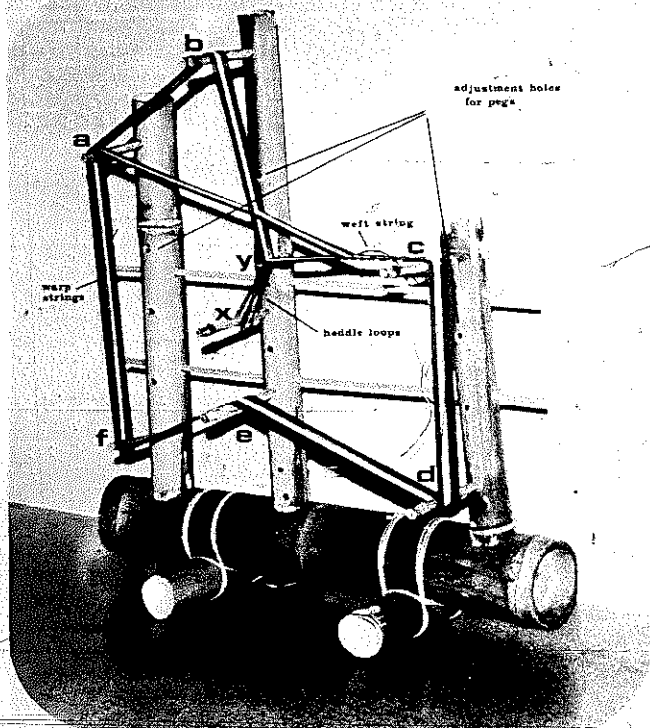

Braid woven on an Inkle Loom

The Inkle Loom is one of the simplest forms of loom, but makes a very pretty braid. It does not need any purchased parts.

Further references: "Golden Hands" Encyclopedia of Crafts. Part 60, at most newsagents 90c.  
"Band Weaving", Tacker, Studio Vista.  
"Weaving", Znamierowski. Pan Craft Books.

Initial contributor: M. Tyler, Kerevat National High School, Rabaul.

## WELDING WITH ELECTRIC ARC

Arc welding is a process of joining metals by means of the heat created in an electric arc. The many jobs that arc welding does are all around us. It is said that there is not a single industry or business which does not depend in some way upon arc welding. It is also said that an arc welder is one of the few tools in existence which can pay for itself in only one job!

Arc welding has great potential for stimulating employment, and particularly self-employment. As hydro-electric power becomes more widely available in P.N.G., especially in the town, arc welding will be quite feasible and practical for persons who want to make a small business.

There are many schools and vocational training centres in P.N.G. that teach arc welding. You might be able to find a friend who can teach you.

Arc welding lessons for school and farmshop: James F. Lincoln Welding Foundation, obtained from Lincoln Electrical Co., Aust. Pty. Ltd., 36 Bryant St., Padstow NSW 2211, Australia.

The companies selling arc welding equipment are usually willing to provide basic information. Try C.I.G. New Guinea Pty. Ltd., P.O. Box 93, Lae.

## WOODCARVING

### WOODCARVING TOOLS

1. Ashley Iles, Ltd.  
Fenside  
East Kirkby  
Spilsby, Lincs.  
England
2. Woodcraft Supply Corp.  
313 Montvale Ave.  
Woburn, Mass. 01801 U.S.A.
3. Craftsman Wood Service Co.  
2127 Mary St.  
Chicago, Ill. 60608 U.S.A.
4. Carl Heidtmann  
563 Remscheid - Hasten  
Unterholterfelder Str. 46  
West Germany

HOW TO SHARPEN TOOLS (No Article)



## REFERENCES

**HANDCRAFTS:** The Office of Business Development has a Handcrafts section in its Small Industries Division. This section performs three main functions:

1. **Advisory:** aid to would-be entrepreneurs in the retailing or exporting of handcrafts. It also advises on what handcrafts are available in PNG and encourages the introduction of new handcrafts for particular areas.
2. **Marketing:** promotion of PNG handcrafts overseas, selling of handcrafts, assisting local handcraft dealers in marketing and assisting producers to get their products to market.
3. **Production:** assisting local producers in what to produce, what finish to give (quality control) how to pack and freight for local and overseas markets. It includes technical advice to producers on equipment and maintenance.

We have Headquarters staff as well as field staff but it is a very small section at present and all Provinces cannot be given full service.

**HANDCRAFTS RESEARCH AND TRAINING:** We have trained many people now engaged in Weaving and Pottery as a business and we are researching the possibilities of people working in handcrafts associated with the orchid/plant growing industry such as wire baskets, wooden slat baskets, rope pot hangers (macrame work). Other handcrafts being investigated are stone and shell jewellery making (at Rabaul), traditional and introduced wood carving, bamboo ornaments and utensils (now being done with students at Kerema), and leatherwork.

Much work has been done in encouraging production of quality carvings based on traditional designs and colours and in establishing markets. We have also helped local artifact firms in the technicalities of packing and shipping overseas.

**CONTACTS:** We have the names and addresses for equipment, raw materials, retailing and overseas markets. For further information contact:

Handcrafts Office,  
Office of Business Development,  
Post Office,  
WARD STRIP,  
WAIGANI, PNG

Council for Small Industries in Rural Areas  
Box 717  
35 Camp Rd.  
Wimbledon Common, London S.W. 19, England

British government-sponsored. Publishes a large selection of both technical and general booklets and leaflets, such as "The Blacksmith's Craft", "Fabricating Simple Structures", "The Thatcher's Craft", "Design for Mobile Shelter", "Motorising of Hand Screwing Machine." Write for lists and prices.

## ARTS AND CRAFTS OF HAWAII

by Te Rangi Hiroa, Bishop Museum Press, 1964, Honolulu, Hawaii, US\$16 plus 50¢ shipping.

There are 14 volumes: I - Food; II - Houses; III - Plaiting; IV - Twined Baskets; V - Clothing; VI - Canoes; VII Fishing; VIII Games and Recreation; IX Musical Instruments; X - War and Weapons; XI - Religion; XII - Ornaments and Personal Adornment; XIII Death and Burial; XIV Index. These describe in detail: designs, construction, materials used, uses, etc. A useful resource set; many items applicable in PNG. May be ordered separately. Not all volumes are the same price.

Intermediate level

H. Bekker

## MISCELLANEOUS

### CARE AND OPERATION OF HURRICANE AND PRESSURE LAMP

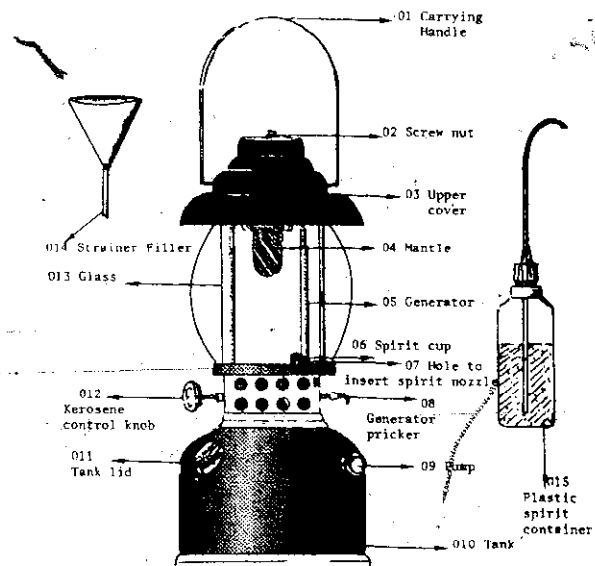

In all my experience with pressure lamps, I have found people quite happy to operate a primus stove, but when it comes to a pressure lamp many people are scared. But there is no need to be afraid of them if you follow the given instruction for operating them. Pressure lamps are not dangerous if handled and cared for properly.

A pressure lamp is a good friend and gives a good bright light and will last a long time if cared for properly.

1. Always use the best kerosene, which has been strained.
2. Always preheat the generator with spirit and not kerosene.

cont'd

3. Always see that the glass is kept clean.
4. If you wash the glass, make sure it is thoroughly dry before you light the lamp. If not, the glass will break.
5. Always handle the lamp gently. Handling the lamp roughly can break the mantle or the needle in the generator, or the glass.
6. Remember all these parts are expensive to buy and sometimes they are not available.

#### DIRECTIONS FOR USE:

1. Fill tank three quarters full with clean kerosene and replace cover tightly.
2. Fill the spirit cup with spirit nearly full. Light with a match.
3. While the spirit is heating the generator, check that the kerosene control knob is closed.
4. Just before the spirit is burnt out, turn the generator pricker a few times and open the pump by turning it anti-clockwise. Give a few full pumps and then close it turning it clockwise and open the kerosene control knob a little.

(Note:- on some models the pump is always open) When the spirit has completely burned out and the lamp is burning properly, fully open the kerosene control knob and give the pump a few more full pumps as before. Now you should have a nice bright light. You may need to pump the lamp from time to time.

5. While the lamp is burning and not being carried, turn handle to the side so it does not get hot. This will prevent a burnt hand if you wish to carry the lamp.
6. To turn the flame out, firmly close the kerosene control knob and the flame will die. Open the tank lid slightly and gently release the air pressure in the tank. If you leave air in the tank it might leak fuel.

#### GENERAL NOTES.

1. To replace a broken mantle, remove the carrying handle, then the screw nut on top, then lift off the upper cover and the glass. (Some models may be slightly different.) Remove the broken mantle and tie on the new mantle. Now replace the glass and upper cover. A new mantle is covered with a protective covering, which has to be burnt off with a lighted match. Take care as once this protective covering has been burnt off the mantle can easily be broken.
2. If the flame shoots up very high when you turn on the kerosene control knob, turn it off quickly and let the flame go out. Usually this happens when the generator has not been preheated enough.
3. There are different makes of pressure lamps. The most commonly used in PNG are the Coleman 300, Coleman 500, the Tilley and the new Chinese 'Light' brand pressure lamps. All four lamps operate on the same principle but with a few variations.
4. The Tilley lamp's mantle is fitted around the generator and is preheated with a special clamp that is soaked in spirit and clamped on to the generator below the glass. The clamp is lit with a lighted match and when the generator is heated sufficiently the lamp is lit in the usual way and the spirit clamp removed.

5. The 'Light' brand Chinese pressure lamp has a special knob for releasing the air. This knob must be closed before pumping the lamp and opened when the kerosene is turned off.
6. Each brand of lamp has its own brand of mantle and generator.

A Note for teachers:- When using these notes for instruction - have a pressure lamp, the three kinds mentioned if possible, for practical demonstration.

#### CARE AND OPERATION OF PRIMUS STOVE

A primus stove can be very useful where there is no electricity or gas for heating or cooking purposes, where firewood is scarce, or when the electricity and gas fail. But like all things it must be cared for well.

1. It likes to be kept clean
2. It needs clean kerosene
3. It must be preheated with spirit, and not kerosene

If you carry out these instructions your primus stove will perform well. If not, it will give you plenty of headaches and black saucepans.

WORKING PRINCIPLE: In the primus stove the kerosene turns into a gas while circulating through the burner. The burner is heated with spirit first, and the kerosene passes through the brass nipple, mixes with air, and develops an intensely hot, blue flame. If the primus stove is not kept clean it will not produce a nice clean blue flame.

#### DIRECTIONS FOR USE:

1. Fill tank not more than three quarters full with clean Kerosene. Use a strainer. Open the air release screw.

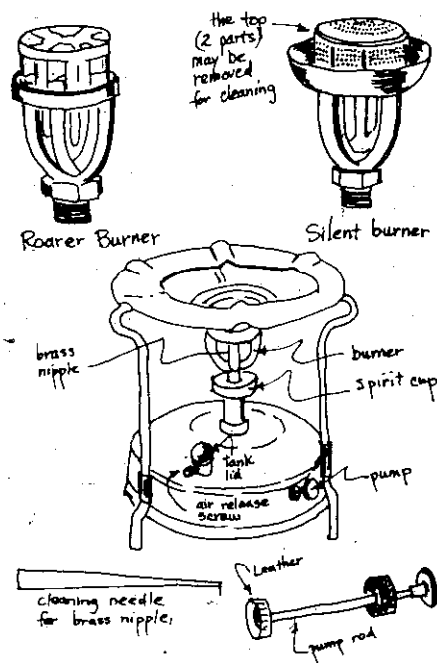

2. Fill the spirit cup with spirit and light the spirit. Care should be taken that the flame is out of the wind.
3. When the spirit in the cup has almost burned out, firmly tighten the air release screw. Give pump several full pumps and the stove will start burning. If, however, the spirit should burn out before the stove starts burning, apply a lighted match to the top of the burner to set it alight. As soon as the burner is well heated, the flame may be increased by further pumping.
4. To reduce the flame, open the air release screw slightly, and tighten it immediately when the flame is sufficiently reduced.
5. To turn the flame out, open the air release screw. Always leave the air release screw open when the stove is not in use.

#### GENERAL INSTRUCTIONS:

1. If the flame does not increase after pumping, or if the flame is not even or not blue, clean the hole in the brass nipple by inserting the cleaning needle.
2. Clean the nipple while the stove is burning and always have a lighted match at hand to light it at the top of the burner, should the flame go out. Always keep the brass nipple very clean to obtain the best results.
3. If after long use, the stove does not burn properly in spite of cleaning the nipple with the needle, the burner is probably clogged and a new burner will be needed.
4. If, while pumping, the flame shoots up and turns yellowish white, open the air release screw at once. This usually happens when the burner has not been preheated enough - either not enough spirit has been put into the spirit cup, or the wind causes the flame not to burn properly, or the flame from the spirit goes out before pumping the stove. If this occurs repeat (2) & (3) listed under Directions for Use.

Empty the tank occasionally and rinse with kerosene, to remove any foreign matter that may have accumulated in the tank and which is likely to block up the burner and the nipple hole.

If the pump does not work properly unscrew the pump and pull out the pump rod. Put some grease on the dry pump leather and flatten the leather out a little. When replacing the pump rod, fit the leather of the pump carefully. The leather should face downwards into the barrel of the pump.

Contributed by: B. Dolling, Braun Health Centre, Butaweng, Finschhafen, via Lae.

#### CARE AND OPERATION OF KEROSENE REFRIGERATOR - FREEZERS.

These general principles apply to all blue flame and white flame refrigerators or deep freezers.

For the refrigerator to work efficiently, it needs care and routine maintenance.

#### SOME PROBLEMS AND HOW TO DEAL WITH THEM

Refrigerator defrosting unintentionally: Sometimes you may find the refrigerator or freezer defrosting itself when you don't want it to.

First check the flame - has it gone out? If the flame is out, see if the kerosene tank has run dry. If you fill twice a week, this should not happen, unless the tank is leaking.

If the refrigerator is placed in a strong draught, the wind can blow out the flame. Find a corner out of the wind. Also if there is too much carbon in the flue or on the wick, the flame will go out.

Remedy: Remove the tank, check the wick, clean it and the flue of all carbon; replace and adjust the flame. It is easier to replace the tank when it is only half full, and then top it up when it is in position. **FILL THE TANK BEFORE LEAVING IT.**

Flame may be too low: If this is the case, adjust the flame so that it is as high as possible without smoking or making a noise.

Smoking: If black smoke is coming from the chimney, it could be that the flame is too high, or there is carbon on the wick. Whenever a freezer smokes you must clean the burner, wick, flue, etc. If it still smokes after cleaning everything and adjusting the flame, it could be that the burner is not fitting exactly into the bottom of the chimney, or that dirt has got into the kerosene tank. If this is so, clean out the tank by washing in kerosene only. Pour a small amount of clean kerosene in and tip it out into a separate container. Do this until the kerosene comes out clean. Don't throw away the dirty kerosene as it can be filtered and used again.

Other Points: It is a good rule to open a freezer or refrigerator as seldom as possible. Frequent opening will prevent them from getting cold. The wick may have burned down and be in need of replacement. Read the instructions on the box of the new wick carefully, and do exactly what they say. Different kinds of wicks fit differently. Be sure that you have the right type and size wick for your burner.

Blue flame burners can be difficult if not treated carefully: If your freezer is defrosting the rules above apply in the same way. The flame must be blue all around and burning evenly. If it is white it is either too high or has carbon on it or carbon in the flue; also the burner may not be fitting exactly into the bottom of the chimney. Carefully adjust the tank to a better position. The wick may have to be turned up and down a few times before the flame is right. There should be only blue flame and not white (or yellow) flame. If the flame is higher on one side than the other, then trim the wick even.

Contributed by: M. Bradbrook, Anglican Church, Dogura, MBP.

# DESIGNS

## Energy

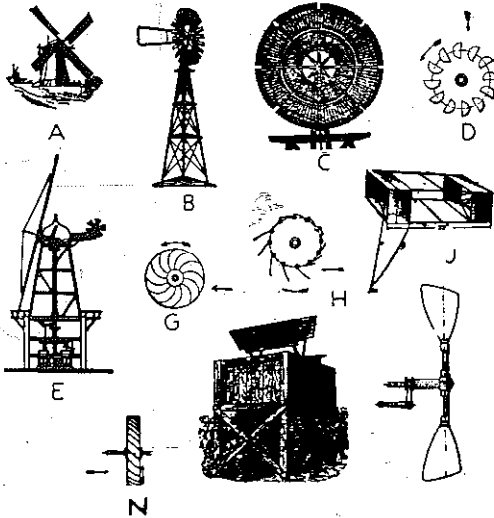

### WATER WHEEL

The use of water power has wide potential in many mountain communities. The initial difficulty is to build the wheel to convert the energy of the falling water to work that is useful to man.

The overshot water wheel is most efficient, but it requires damming a river so that the water will be able to flow on top of the water wheel.

More than a year ago an overshot water wheel was installed at Zafillo village, near Finschhafen, to drive a No 2½ Bentall coffee pulper. The total cost of all materials was K100.

#### Materials required:

- 2 x 2m length of 100 x 100mm hard wood post
- 1 x 1.25m length of 1" pipe
- 30 metres of 75 x 25mm dressed hardwood
- 4 sheets 900 x 1800mm (3' x 6') flat iron
- 1 sheet 900 x 1800mm (3' x 6') ¼" marine ply
- glue, nails, screws, paint and solder or rivets
- 2 Vee pulleys of about 250mm diameter
- 1 Vee belt to suit pulleys
- 2 flanges to attach shaft to wheel.

Dimensions in the drawing are given in Imperial measurements because the ratios in the original design are simple numbers.

There are 24 buckets in the design, all made of flat iron. This will make a well balanced wheel by having three buckets per section.

## WATER

### HYDROELECTRICITY

If you are considering building a small hydroelectric unit, these two publications will be very helpful:

1. "Micro-hydro: Civil Engineering Aspects", by D.S. Mansell, G.P. Atkins, S.N. Kiek, 11 pp, available free from Civil Engineering, Box 793, Lae.
2. "Low Cost Development of Small Water-Power Sites", by H.W. Ham, 43 pp., available from VITA, 3706 Rhode Island Ave., Mt. Rainier, Md. 20822, U.S.A., US.\$3.60 airmail postpaid, US\$2.00 surface mail postpaid.

### MANUFACTURED TURBINES AND REGULATORS FOR HYDROELECTRIC PLANTS

1. James Leffel and Co.  
Springfield Ohio 45501  
U.S.A.
2. Ossberger Turbinenfabrik  
Weissenburg  
Bavaria, Germany
3. Officine Buehler  
Taverne, Canton Ticino  
Switzerland

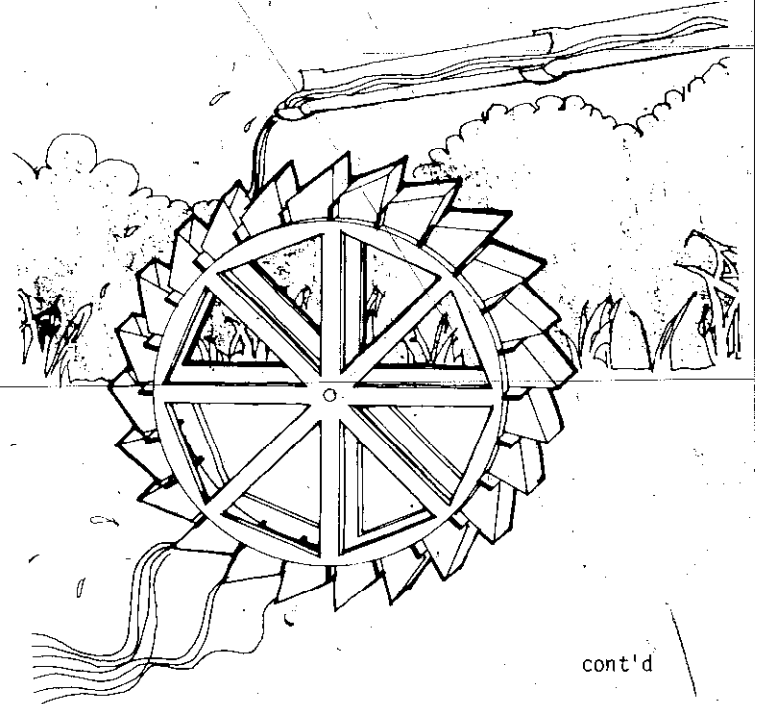

cont'd

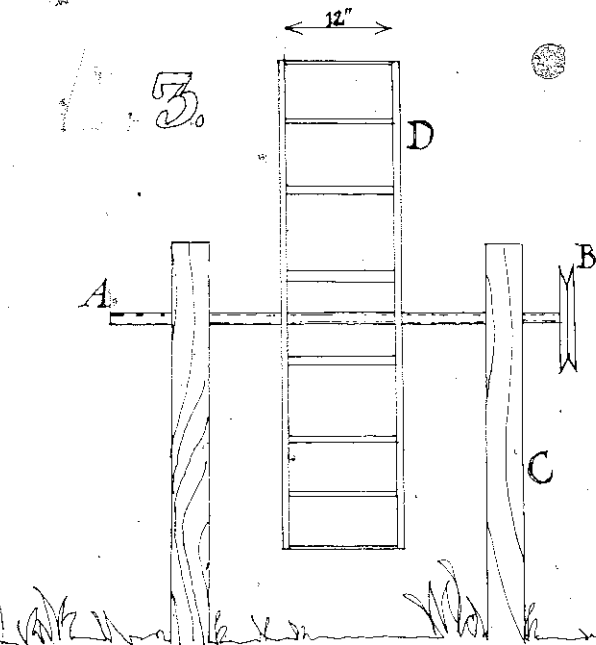
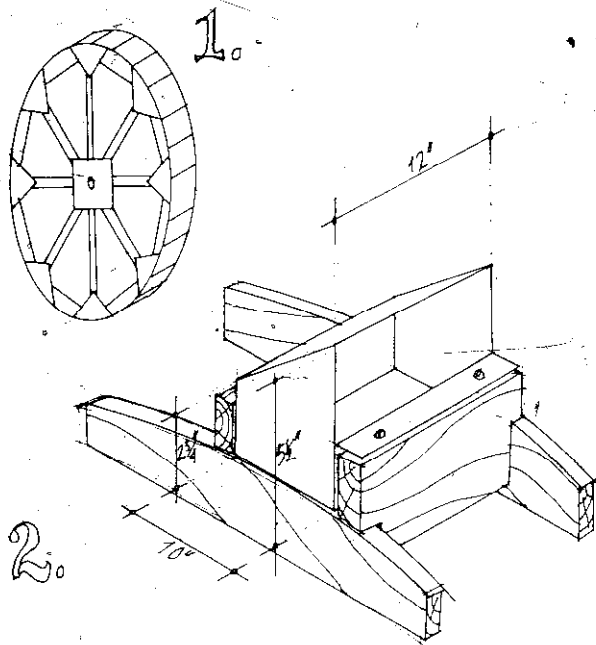

Figure 1: shows glued ply wood cleats fixing together wheel frames of 3" x 1" dressed hardwood used throughout.

Figure 2: shows bucket construction of soldered flat iron screwed or nailed to frame.

Figure 3: A. 1" galvanized water pipe  
 B. 250 mm vee pulley  
 C. 100 x 100 mm kwila hardwood posts  
 D. Water wheel on its mounting

NOT TO SCALE

An alternative design is to make the buckets out of dressed 150 x 25mm (6" x 1") hardwood, using the same dimensions of height but slightly narrower buckets. On a five foot wheel 27 wooden buckets are required.

The design is built to operate at 40rpm on a flow of water of 250 litres (50gal) per minute. If the wheel is made very much smaller, it will not be big enough to do very much work; if it is bigger, these materials will not be strong enough.

The life expectancy of the wheel in constant use is about 3 years without maintenance if well built and painted.

After boring the hole in the hardwood posts for the shaft, place the end of the posts with the hole in a bucket of warm engine oil for several days, so the shaft will turn easily.

Editors note: There are many details missing here. The critical point of this design is the way in which the wheel and the pulley are attached to the shaft. Welding is an easy solution if available, but it may not be available to most of our readers. If you use a bolt through the shaft, don't use one larger than 6 mm (1/2"), as it will weaken the shaft.

Initial contributor: I.M. Bean, DPI Rural Development Centre, Pindip, MP.



Overshot water wheel (above) and generator (below) at the Swiss Mission near Minj, WHP. Power is transmitted through a counter shaft in order to increase the rpms.

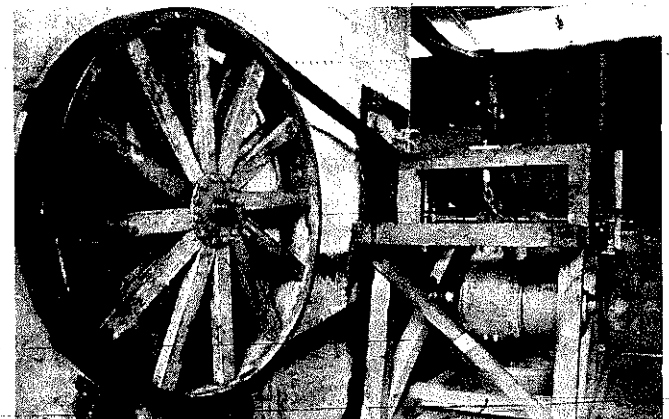

WIND

WINCO  
DYNATECH, INC.  
P.O. Box 3263  
Sioux City, Iowa 51102

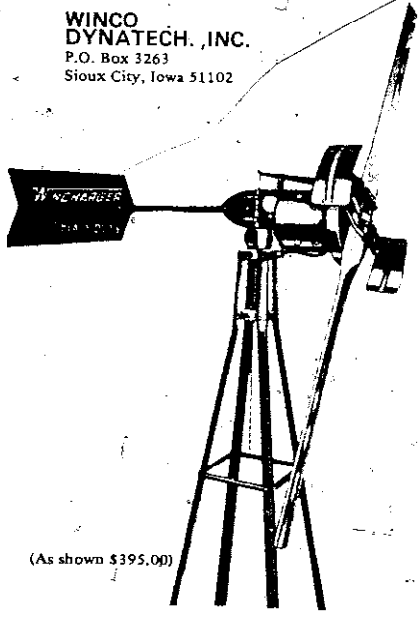

(As shown \$395.00)

WIND GENERATORS

F.W. Davey and Co. Pty. Ltd.,  
Box 120 Oakleigh, Victoria 3166  
Australia

(Quirk's Windlite). They need detailed information on your wind situation and your power needs before they can quote prices.

COMMERCIAL WINDMILLS AND PUMPS

1. Southern Cross Dealers throughout Papua New Guinea.  
Representative: Ken Parker  
P.O. Box 498  
Port Moresby

WATER PUMPING WINDMILLS

DEMPSTER INDUSTRIES INC.

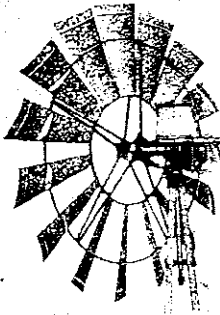

from:  
Dempster Industries Inc.,  
P.O. Box 848  
Beatrice, Nebraska 68310

HELLER-ALLER COMPANY:  
BAKER WINDMILLS

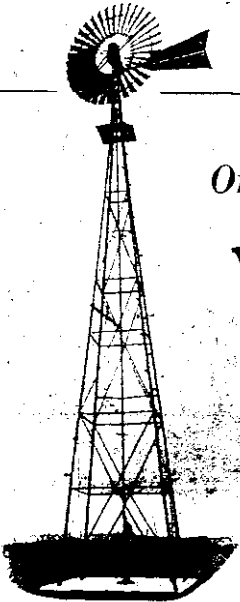

The Original **BAKER**  
RUN-IN-OIL  
**WINDMILL**

from:  
The Heller-Aller Co.  
Corner Perry & Oakwood  
Napoleon, Ohio 43545

Distributor:  
O'Brock Windmill Sales  
Rt. 1- 12th Street  
North Benton, Ohio 44449

AERMOTOR WATER SYSTEMS

AERMOTOR PUMPING CAPACITY								
Diameter of Cylinder (inches)	15 MPH Capacity per Hour, Gallons		Total Elevation, In Feet					
	SIZE OF AERMOTOR							
	6 Ft	8-16 Ft	6 Ft	8 Ft	10 Ft	12 Ft	14 Ft	16 Ft
1 3/4	105	150	130	185	280	420	600	1,000
1 7/8	125	180	120	175	260	390	560	920
2	130	190	95	140	215	320	460	750
2 1/4	180	260	77	112	170	250	360	590
2 1/2	225	325	65	94	140	210	300	490
2 3/4	265	385	56	80	120	180	260	425
3	320	470	47	68	100	155	220	360
3 1/4		550			88	130	185	305
3 1/2	440	640	35	50	76	115	160	265
3 3/4		730			65	98	143	230
4	570	830	27	39	58	86	125	200
4 1/4		940			51	76	110	180
4 1/2	725	1,050	21	30	46	68	98	160
4 3/4		1,170						
5	900	1,300	17	25	37	55	80	130
5 1/4		1,700				40	60	100
6		1,875		17	25	38	55	85
7		2,550			19	28	41	65
8		3,300			14	22	31	50



from:  
Aermotor Water Systems  
Broken Arrow, Oklahoma 74012

## HOW THE SAVONIUS ROTOR WINDMILL WORKS

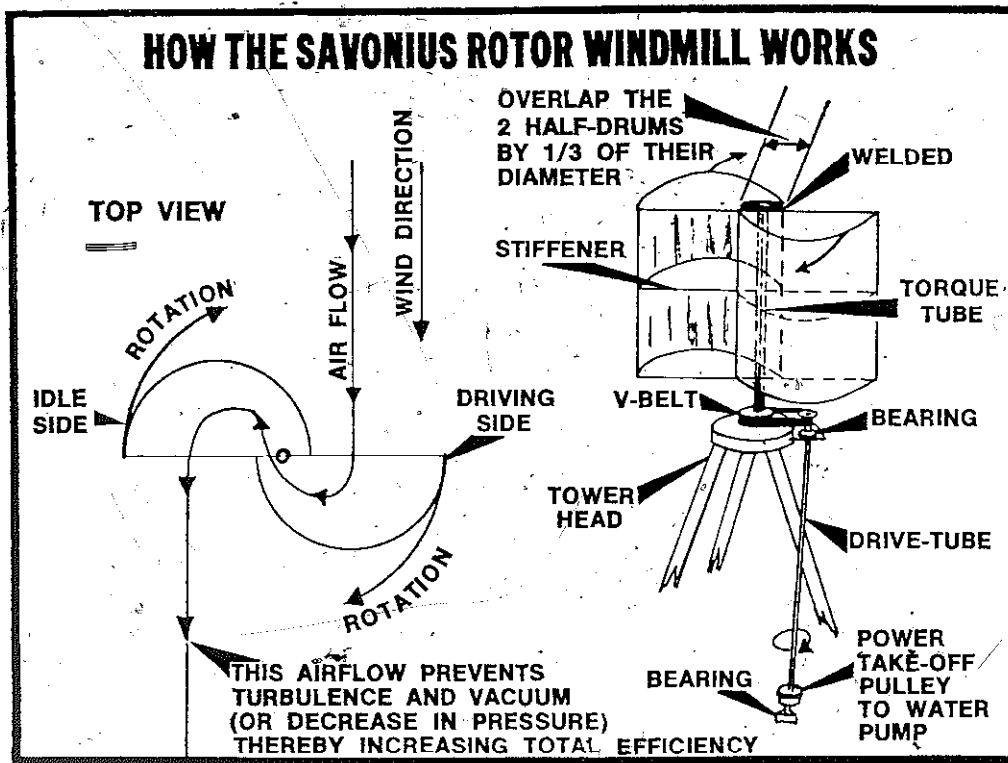

It will be easy to predict how Papua New Guinea will develop once we know why coastal people eat tinned fish.

### WINDMILLS, "HOW-TO" INFORMATION

"How to Construct a Cheap Wind Machine for Pumping Water", by A. Bodek, 12 pp., Feb. 1965 U.S. \$0.75, from Brace Research Institute, McGill Univ., Montreal, P.Q., Canada.

"Low Cost Windmill for Developing Nations" (1970) US\$2.00 surface mail postpaid, or US\$3.60 airmail postpaid to P.N.G. from VITA, 3706 Rhode Island Ave., Mt. Rainier Md., 20822 U.S.A.

### WINDMILL PUMP

A reliable, simple windmill/pump mounted on a pole with 4 wire stays, built of basic materials like wood, canvas, and leather. The wind turns canvas sails, which are self-governing, being held by bands made of rubber. Detailed construction and installation plans are available in an 80 page booklet for Swiss Francs 16 from World Council of Churches CCPD Technical Unit, 150 route de ferney, Box 66, 1211 Geneva 20, Switzerland.

See article, The Cretan Sail Windmill, Appropriate Technology, Vol 2 No. 3 p.4

IS THE CHEAPEST, MOST RELIABLE WINDMILL YOU KNOW LISTED HERE? IF NOT, THE REASON IS PROBABLY THAT YOU HAVEN'T TOLD US ABOUT IT. SO DO IT NOW. TODAY. BOX 1920, LAE.

(p 268)

SOME DAY, AFTER WE HAVE MASTERED THE WINDS, THE WAVES, THE TIDES, AND GRAVITY, WE WILL HARNESS FOR GOD THE ENERGIES OF LOVE: AND THEN FOR THE SECOND TIME IN THE HISTORY OF THE WORLD MAN WILL HAVE DISCOVERED FIRE!

Teilhard de Chardin

(p248)

## SOLAR ENERGY

In many parts of PNG solar energy is used to heat water for homes. Solar water heaters are cheap to install, and easy to construct - if you need hot water. Many people think that hot water is a waste of time and an unnecessary luxury, but in some cases it is very important. Hospitals and restaurants need hot water for cleaning, and most hospitals have water heaters that use a great deal of fuel or electricity. Properly designed solar water heaters are long-lasting and can store hot water during the night. Some will even make hot water on cloudy days.

The heat energy from the sun which is called "infra red" light, and which is different from the light energy from the sun that lets us see, can heat water which is inside a closed container. Infra red energy is the same as that used in special globes in hospitals for treating sore muscles. Infra red is the same energy that makes a cement floor so hot in the sun, or makes the roofing iron so hot. A simple water heater for small amounts of water can be made by filling a plastic bag with water, tying off the open end, and leaving it in the sun for a few hours. Solar water heater designs are readily available.

Another use of solar energy is to make electricity. This is very expensive way, even though the sun is free because the collector is very expensive to make. But it is definitely economic for some uses. One example is out-station radios that work on batteries. If you have to charge the battery and have no other use for the electricity, a small engine-powered charger is very expensive. If the benzine runs out of the motor breaks the battery will run down. With a solar collector the sun is always charging the battery, and even on cloudy days the charger works at half power. A four watt by 12 volt sun charger will keep a full charge on the battery of a typical out-station transmitter that is used for two "skeds" a day. Such a unit will cost about K160 including installation - far cheaper than the smallest generator. Such sunchargers are available from AGQUIP, Box 1121, Rabaul.

To make electricity from sunshine, special materials such as selenium and silicon are used to catch the energy. When they are hit by energy from the sun, a small electric current is started. This current can be stored in a battery until it is needed.

The selenium material is able to see visible light, the same as that light which lets us see. The silicon material works on heat energy. This means that battery chargers made from selenium will work well on cloudy days too, because the heat energy of the sun is able to pass through clouds better than the energy that makes it possible for us to see.

The major use of solar battery chargers used to be providing electricity for satellites. Now the cost of these chargers is low enough that they can be used more widely. A village radio transmitter on Tench Island in NIP. is powered by this charger and it never wears out.

Brace Research Institute,  
Macdonald Collège of McGill University,  
Ste. Anne de Bellevue,  
Quebec, H9X 3M1,  
Canada.

(P 251)  
(P 257)

List of available publications from the Institute.

- L. 1 How to Make a Solar Still (plastic covered), by A. Whillier and G.T. Ward, 9 pp., January 1965. Revised February 1973, Price X\$1.25
- L. 2 How to Make a Solar Steam Cooker, by A Whillier, 6 pp. January 1965. Revised October 1972. Price C\$1.25
- L. 4 How to Build a Solar Water Heater, by D.A. Sinson and T. Hoad, 10 pp., February 1965. Revised February 1973. Price C\$1.25
- L. 5 How to Construct a Cheap Wind Machine for Pumping Water, by A. Bodek, 12pp., February 1965. Revised February, 1973. Price C\$1.25
- L. 6 How to Make a Solar Cabinet Dryer for Agricultural Produce, by T.A. Lawand, 9 pp., March 1973. Price C\$1.25
- T.10 Performance Test of a Savonius Rotor, by M.H. Simonds and A. Bodek, 20pp., January 1964 Price C\$2.00
- T.17 Instructions for Constructing a Simple 8sq. ft. Solar Still for Domestic use and Gas Stations, by T.A. Lawand, 6 pp., Revised September 1967. Price C\$1.25
- T.58 Plans for a Glass and Concrete Solar Still, by T.A. Lawand and R. Alward, 9 pp., December 1968. Revised October, 1972. Price C\$4.50
- T.85 Production Drawing for Solar Dryer by O. Goldstein, June 1973, Price C\$2.50
- T.99 Survey of Solar Agricultural Dryers, by Brace Research Institute, 144 pages plus photos, January 1976. Price C\$7.00

Please send a postal money order or if you send a cheque please add C\$0.25 for handling charges.

If you order just one leaflet, please add an additional C\$0.25. Please mail to the attention of The Publication Department.

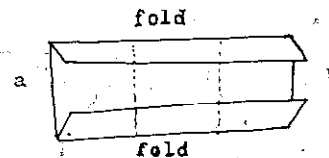

### SAVE AN ENVELOPE

Many letters which are written only on one side can be mailed without an envelope.

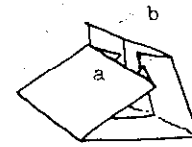

Fold as shown. Tuck "a" into "b". Put a stamp to seal it.



H. Bekker



LAND AND PEDAL POWER (No Article)

BIOGAS DIGESTORS

Thus far in PNG these have generated a lot more heat than light! Popularised by George Chan, who was a lecturer in Environmental Health at the Univ. of P.N.G., the "Digester" is a system for producing high quality organic fertilizer plus methane gas from organic wastes in an air-tight container. Minimal projects, algae ponds, ducks, and vegetable gardens form a balanced integrated production unit, according to the concept.

Without a doubt these have potential for high-density population areas among highly motivated groups, probably more for the organic fertiliser than for the gas. Attempts should continue to make these succeed. One might wonder, though, if the emphasis which has been given is realistic at this stage - time will tell.

At present practically all of the digester units in PNG are found at a school of one sort or another. This is exactly where they belong, as this is probably where we presently find the management capability required, and the money and interest for experimentation - surely in PNG situation these must still be considered quite experimental. Practically all of those in PNG with which I am acquainted were "donated" and were initiated by expatriates. When Papua New Guineans show a readiness to start building them with their own money then perhaps we can get excited.

This is definitely not meant to criticise the Digester as a concept, but a plea for us to stay in touch with PNG realities, and to build Digesters right when we do them. If you want to build one, here are some suggestions:

a). Visit an existing unit - there are already a number of them around - talk to those who built and manage them;

- b) Try a small system on a pilot basis - perhaps using an old oil drum. Build the "real" unit when you are confident that you have mastered the technology;
- c) Design the digester to a scale compatible with your available waste and water resources - if you're counting on enough methane to cook with or to run some lights, you'll need a lot of waste and water, continuously;
- d) Seek competent technical help;
- e) If you have difficulty producing methane, and the rest of the system is working, be patient - the benefits from the organic fertiliser (both the liquids and the solids) should be the primary concern;
- f) If you succeed - let us know about it so that we can tell others. We're eager for a success story!

The following are available from Intermediate Technology Publications, Ltd., 9 King Street, Covent Garden, London WC2E 8HN, U.K. (P 247) (P 258)

Methane Digesters - For Fuel, Gas and Fertiliser, by John Fry and Richard Merrill. Includes designs for a small and an intermediate scale system. 47pp. 1973 US\$3.90 surface mail, US\$4.95 airmail.  
Methane: Fuel for the Future, by Bell Boulter, Dunlop and Keiller. Surveys current use and future possibilities. Prism Press, Dorchester. 86pp. 1975; \$2.90 net; US\$3.45 surface, US\$4.85 airmail.  
Methane Production by Anaerobic Fermentation, proceedings of a recent ITDG seminar. 12 papers, discussion, references. Illustrated. 1975, price not known.  
Practical Building of Methane Power Plants, by John Fry, pioneer of the first displacement digester. Pub. by Know, Andover, 97pp. 1974; US\$9.20 net; US\$10.15 surface, US\$12.80 airmail.

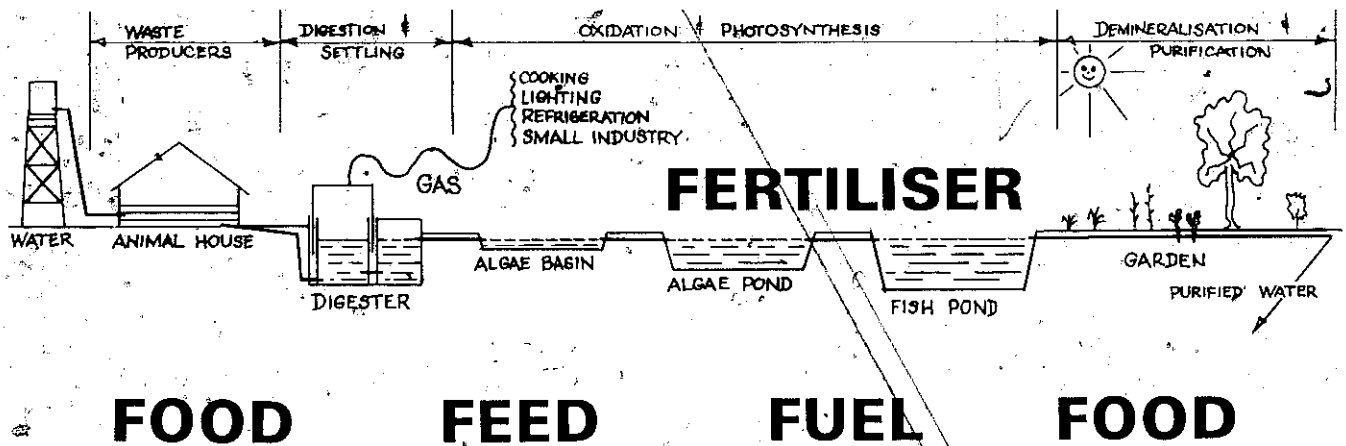

# TWO WAYS OF INCREASING FERTILISER PRODUCTION

Target: 230,000 tonnes of nitrogen fertiliser per year

Western Technology

Appropriate Technology

One large coal based fertiliser plant (eg the city)	26,150 small village level bio gas fertiliser plants
TOTAL COST	
<b>\$140</b> MILLION	<b>\$125</b> MILLION
FOREIGN EXCHANGE COST	
<b>\$70</b> MILLION	<b>NIL</b>
JOBS CREATED	
1000	130,750
ENERGY CONSUMED	
<b>0.1</b> MILLION MWH per year consumed	<b>6.35</b> MILLION MWH per year generated

Diagram by a company feature - To Choose a Future

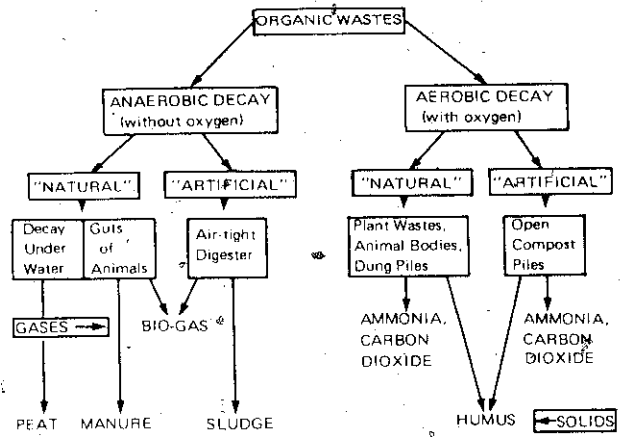

END PRODUCTS OF ORGANIC DECAY.



Digester at Pakana Vocational Training Centre, Port Moresby under construction (top), and 1975

## VILLAGE AGRICULTURE

### FROM TRADITIONAL SYSTEMS TO NEW SYSTEMS

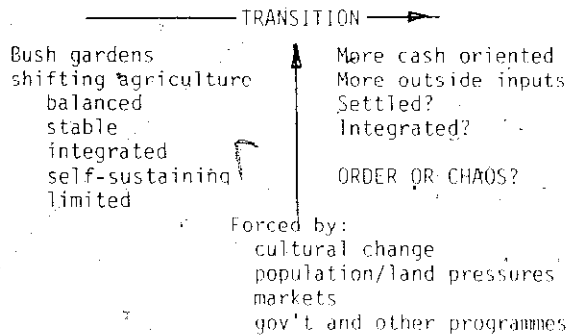

Are the people in your village aware of this process?  
Are they critically aware of it?  
Do they talk about it?

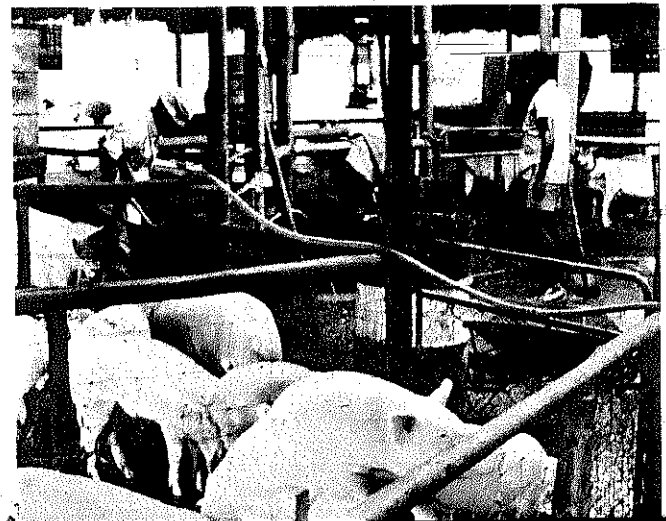

## COMPOST

Plant and animal wastes give us a practical way of adding nitrogen and other important elements to our gardens. When organic matter is well-rotted and becomes a part of the soil, it helps the soil to hold the mineral plant foods in a readily available form for the plants. Organic matter also helps the soil to hold water. When it is wet, organic matter swells up like a sponge, gently holding the water and making it less likely to evaporate.

On the other hand, coarse, woody organic matter may temporarily make less nitrogen available to plants, as nitrogen is taken up rapidly by the bacteria that are breaking down these materials. Such materials are best left in a compost heap until they are well-rotted. Dried leaves are somewhat slow to break down and sawdust very slow. Succulent green materials break down fast.

Many different kinds of plant and animal materials may be used to produce compost: leaves, grass, weeds, garden refuse, kitchen wastes, animal manure, and fish scraps are all suitable.

While composting may be too hard to practise for general use, it is often very practical for gardens where there are plenty of composting materials available and where a high level of fertility is especially important.

Ordinarily it is good to supply nitrogen to the compost heap in addition to the wastes to help the micro-organisms break down the wastes. Animal manure will help. Other forms of nitrogen like ammonium sulfate may be used, but they leave an acid residue which should be neutralized by adding a small amount of lime.

The compost heap should be a convenient size for the amount of materials you have on hand, usually a meter wide, at least a meter long, and around a meter high. The top should be left flat or with a slight depression in the centre to catch and hold rain. (The compost should be kept moist). If you get a lot of rain, though, you might even want to cover your compost a bit.

The pile of waste will heat and rot. If it is kept moist, and depending upon how much coarse material and nitrogen is added, it will rot enough in 3 or 4 months for you to use. If you add no nitrogen you might want to leave it for as long as 6-8 months.

If the compost is ready, but you don't need it yet, put it under shelter so that the nutrients will not be lost when it rains. On vegetable seedbeds compost should be applied at the rate of one to two kg per square metre and thoroughly mixed with the soil.

## FIREWOOD AND OTHER FUELS (No Article)

## GENERAL REFERENCES

Energy Primer, Portola Institute, 1974. 200pp US\$6.50 postpaid. Make payment and order to:  
Whole Earth Truck Store,  
558 Santa Cruz Ave.,  
Menloe Park, CA 94025 USA.

It is the best available single resource on energy: solar, water, wind, and biofuels. Absolutely loaded with further references. "A comprehensive fairly technical book about renewable forms of energy. The biofuels section covers biomass energy (energy that is released from plant materials when they are eaten, burned, or converted into fuels), agriculture, alcohol, methane, and wood. The focus is on small-scale systems for individuals, small groups, or community. More than 1/4 of the book is devoted to reviews of books and hardware sources. Hundreds of illustrations and a dozen original articles are used to describe the working of solar water heaters, space heaters and dryers, waterwheels, windmills, wind generators, wood-burning heaters, alcohol stills and methane digesters. The final section of the book focuses on the need for energy conservation and some of the problems and potentials of integrated energy systems."

Level: intermediate/advanced.

Alternate Sources of Energy,  
Rt 2 Box 90,  
Milaca Mn 56353 USA.

A newsletter emphasizing alternate technologies of energy for agriculture, architecture, transportation, and communication. US \$5.00 for 6 issues. Also publishes "Coming Around", an introductory source list on Appropriate Technology, 11 duplicated pages, US \$1.00.

Conservation Tools and Technology Limited,  
143 Maple Road, Surbiton, Surrey KT6 4BH. U.K.

This firm sells books, equipment and plans for people needing to use their own resources to provide energy. This includes windpower, solar heating, water turbines for electricity, hydraulic ram water pumps, and methane gas production. (They don't sell solar powered electrical products) A catalogue is available for Pounds 1.00. The firm also has a CTT Association with membership Pounds 5.00 per year. Members receive a quarterly newsletter, and a 5-10% discount on purchases.

They don't sound cheap, and UK is a long way for shipping, but their books, materials and equipment are of first rate quality. The advantage is that almost everything is under one roof.

Suggested by: B.A. McLennan, 56 Fitjohns Ct No 8,  
Hampstead, London NW3 U.K.

SPECTRUM, Alternative Sources of Energy Rt 2, Box 90A, Milaca MN 56353 USA. US\$2.00

Catalogue of tools (mostly US) and processes for small scale use of solar, wind, water, and other forms of energy.

# Water Resource Development and Use

## SPRINGS, WELLS AND FILTERS

(p 245)

Fig. 33. PROPERLY PROTECTED SPRING (I)

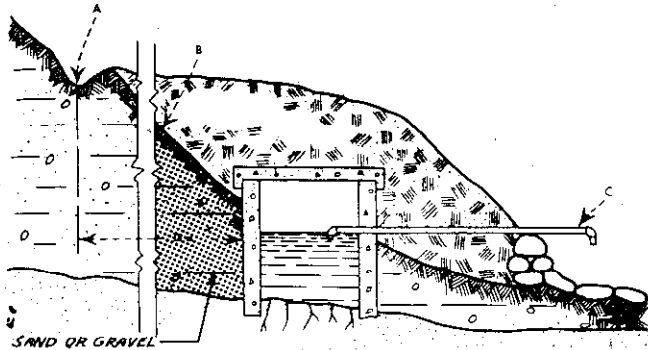

- A Protective drainage ditch to keep drainage water a safe distance from spring
- B Original slope and ground line
- C Screened outlet pipe: can discharge freely or be piped to village or residence

Springs can offer an economical and safe source of water. A thorough search should be made for signs of ground-water outcropping. Springs that can be piped to the user by gravity offer an excellent solution. Rainfall variation may influence the yield, so dry-weather flow should be checked.

Fig. 34. PROPERLY PROTECTED SPRING (II)

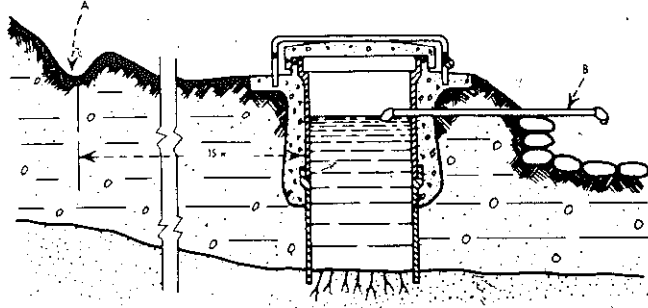

- A Protective drainage ditch to keep drainage water a safe distance from spring
- B Screened outlet pipe: to discharge freely or be piped to village or residence

RURAL WATER SUPPLY AND SANITATION IN LESS DEVELOPED COUNTRIES - A SELECTED ANNOTATED BIBLIOGRAPHY, by White and C. Seviour, 82pp. Price C\$1.00 from IDRC, Box 8500, Ottawa, Canada K1G 3H9.

The broad view given here will help planners, administrators, engineers and community leaders to locate literature describing experiences and problems similar to the ones they face.

## SAND FILTER

There are many areas in PNG where only muddy river water and cloudy brackish water are available if there is no rain for more than two weeks.

Sand filtration does not make all polluted water safe for drinking, but if properly built and kept will remove most of the undissolved impurities, and the water will be much easier to boil or treat.

It is important to note that the filter must be cleaned periodically, and the water must be boiled or treated with Chlorine to be truly safe. If not operated correctly, the sand filter can actually add bacteria to the water.

But the advantages of the filter are that it removes the larger worm eggs, cysts, and things hardest to kill with Chlorine; you can use smaller doses of Chlorine - better taste; the water looks cleaner; re-contamination is less likely, because you have reduced the amount of organic matter.

This unit gives about 1 litre of water per minute. It is important to use clean, fine sand, but not too fine. It should be able to pass through ordinary fly wire, and it is best to wash it.

NOTES: Do not allow the sand to dry out, or the microorganisms that form on the surface layer will die. Do not let the water flow too fast, or they

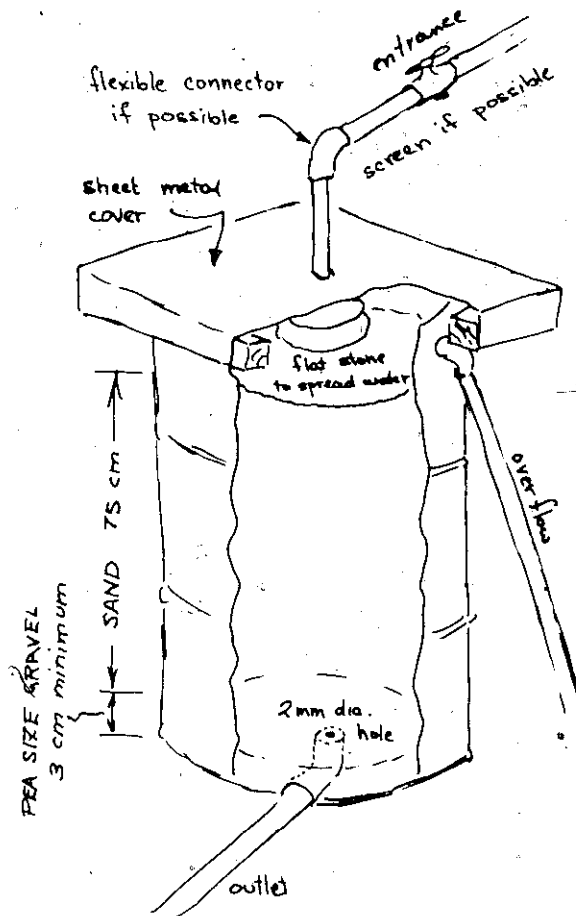

will be washed away. Fix the water intake so that there is always a small overflow. Screen the intake and provide a settling basin to help keep pipes from becoming plugged.

Keep light from the sand surface but allow air to circulate. This will prevent the growth of green plant matter on the surface but help the growth of microorganisms that aid the filtering action.

When the flow becomes too slow, clean the filter by scraping off and discarding the top centimetre of sand and lightly raking or scratching the surface. After several cleanings, scrape the old sand down to a clean level and add clean sand. Cleaning should not be more often than every several weeks or even months.

Material from: WHO Monograph #42, Water Supply for Rural Areas and Small Communities, E.G. Wagner and J.N. Lanoix (1959).

Suggested by: A.A. Gerard, Box 793, Lae.



## PUMPS

(P 248)  
(P 250)

### HYDRAULIC RAM (See photo, lower left)

The hydraulic ram is a simple device which uses the power from falling water to force a small portion of the water to a height greater than the source.

It is without a doubt the cheapest method of raising water, and there is no other device which needs so little attention after installation. It has no engine, and functions with only two working parts. The only maintenance required is to clear rubbish away from the strainer on the intake and to replace the valve rubbers when they wear.

But it must be suited to its job. If your conditions are not right, or if the pump is wrongly designed, it will be little better than nothing.

Between 7 and 14 times as much water is required to

cont'd

### Performance Graph for a 50mm Hydraulic Ram Pump Employing a 7.7m Drive Head

Height  
in  
Metres

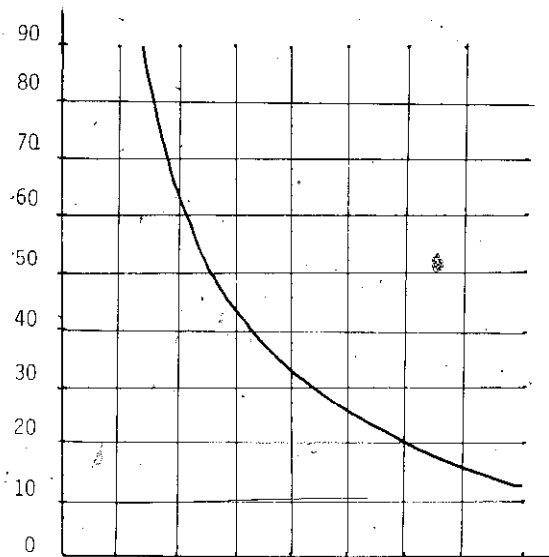

0 10 20 30 40 50 60 70 80  
Litres delivered x 1000 per day

Recommended (Galvanized Iron) Drive Pipe: 50mm diameter, 18.5m length. Recommended (Plastic) Delivery Pipe: 25mm diameter. Minimum water supply required, 90 litres per minute. Ratio of waste water to delivered water = 6.56/1 @ 77m Delivery Head. Kinetic Energy conversion efficiency = 15.24% (Atmospheric vent). Optimum pump operational speed = 60 strokes per minute.

Supplied by Fred Keating, Goroka

work the pump than will be raised. A small amount of water with plenty of fall will pump as much water as a greater amount with only a little fall.

The drivepipe should be metal, unless it is encased in concrete. It should be as straight as possible without elbows, and normally the same pipe size as the intake end of the ram. It should be watertight and rigidly anchored, with a strainer at the top to keep out rubbish. For 50mm rams one length of pipe is suitable (about 6.1m); for 100mm rams, two lengths.

Always locate the ram as near the source of supply and the delivery point as is possible while maintaining the lowest elevation. This will ensure the minimum expense for the pipe. Digging a deeper ram pit and digging out for drive and wasteline might improve the installation at a saving.

Further Information in PNG: Write Fred Keating, Goroka Technical College, Box 556, Goroka. Fred has helped form 6 school leavers to start an enterprise to make hydraulic rams for sale. His design is an improvement over the VITA hydraulic ram, which he says has "low efficiency, too many screw threads, and unworkable dimensions". The model they are making with 50mm drive pipe connector has the following specifications:

- a) All-welded steel pump body assembly.
- b) Easily removed base plate for access to check valve assembly.
- c) Delivers up to 11,000 litres daily at 36.5 metres, but variable according to drive and delivery head.
- d) Can be operated in battery formation or with larger models for higher performance up to heights of 150 metres.
- e) Supplied with drive pipe filter and instructions for installation and operation.

You may also write to Mr. D. Burton, PNG University of Technology, Box 793, Lae. He has had experience with these.

Further information, Overseas sources:

1. Hydraulic Ram for Village Use (1970), US\$1.00 plus .80 airmail postage to PNG. Complete plans, c/- VITA, 3706 Rhode Island Ave., Mt. Rainier, Md. 20822 (A very clear condensation of this material is found in Appropriate Technology, Vol 1, No 4, Winter 1974-75).
2. If you want to go "first class", buy one from RIFE RAMS, Box 367, Millburn, N.J. 07041, USA. Ask for descriptive material and prices. A 2 inch (drive pipe size) model costs about US\$400, including crating.
3. "CECOCO" motorless Hydro-hi-lift pump, 6 different models (1½ inch, 2", 3", 4", 6" & 12" drive pipes). For description and prices write to CECOCO, Box 8, Ibaraki City, Osaka, Japan.
4. China Agricultural Machinery Co. Ltd., 11 Tung Hsing St., Taipei 105, Taiwan, R.O.C. (probably the cheapest available outside PNG).

#### WATER PUMP

A hand operated water pump for deep wells built of readily available materials was built by LUKIS RAMASO, a 5th year Mechanical Engineering student at Unitech in Lae.

Imported pumps can be bought at relatively low cost, but rising prices may make it increasingly advantageous to make them in PNG.

Lukis used 50mm (2") steel pipe with a 35cm section at the bottom honed (made smooth) on the inside for the pump cylinder. The rod to move the piston was 7mm (½") round bar.

A standard foot valve was used. The photos show the manner of assembling the piston with leather cups and the top arrangement of the pump.

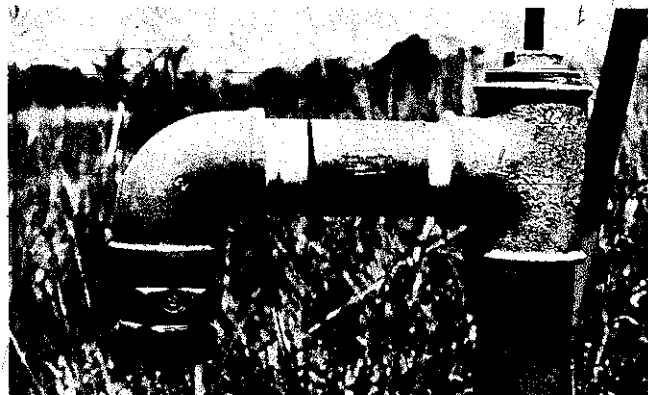

Most of the parts are from ordinary pipe fittings.



This shows what the parts down inside the pump look like.

cont'd

**FOOT-OPERATED PUMP** for a submerged deep-well cylinder.

"With this simple design, a person can pump 3 times as much water with his legs as he could with his arms." For details write:

Technical Services CCPD  
World Council of Churches,  
150, route de Ferney, Box 66,  
1221 Geneva 20, Switzerland.

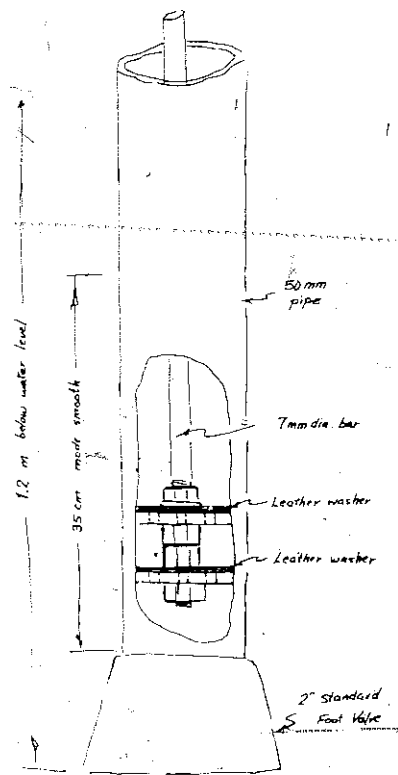

FOOT OF PUMP, CUTAWAY VIEW

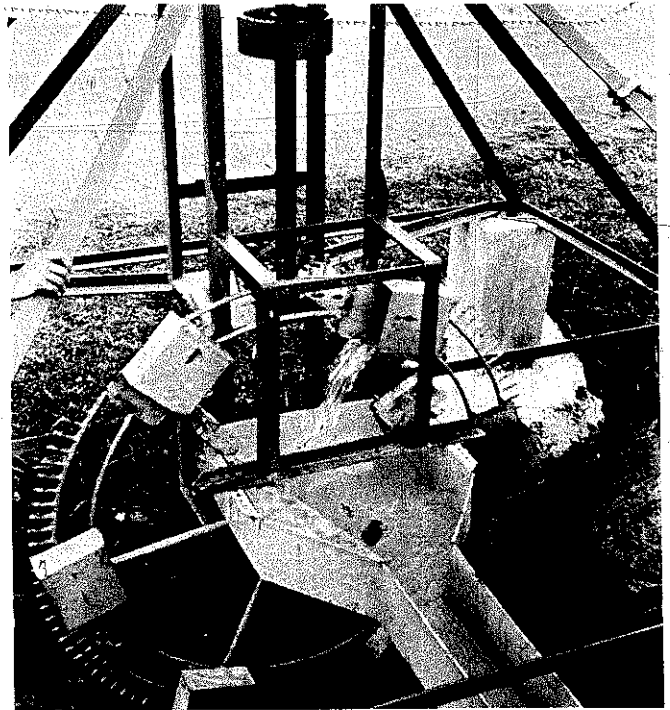

**A MALAY-INDONESIAN WATER LIFTER**

Above: Wheel for lifting water one metre, driven by a small Savonius windmill. Note "peg gears" welded from round bar.

Water lifted up by paddles

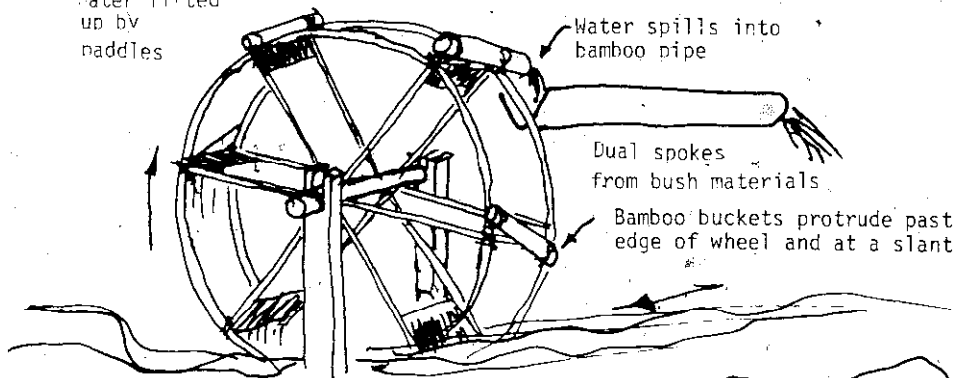

Wheel of any height. As little as 2-3 m, or up to 10 or 15 m.

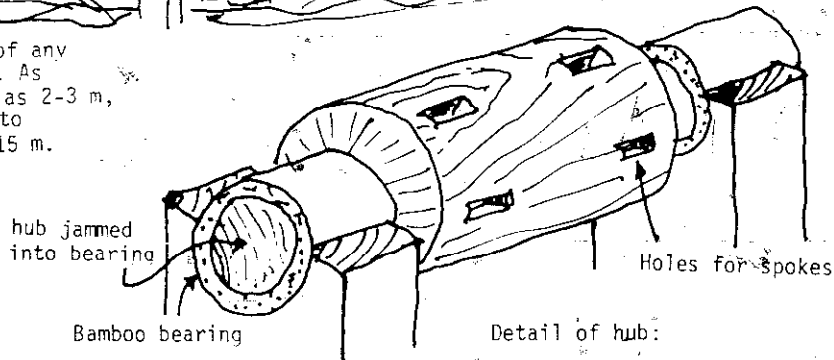

## TRANSPORTING WATER



*This bamboo tube carries water for over two kilometres to village Kandumin, Wantoat, Morobe Province.*

## TWO MAN SHOVEL

This widely used tool serves to prepare alternating ridges and furrows, to form bounds for irrigated crops, and for other shovel work. It consists of a large, slightly concave, flat sided blade with two rings on the inside. The rings hold the ends of a rope. In use, one man pushes and directs the shovel with the long handle, while a second man facing the first, pulls on the rope. When the proper rhythm is maintained, work is generally faster than two men using two shovels. It is widely used in Arabia, the U.S.S.R., central and northern Iraq, Iran, Afghanistan, Turkestan, China, and Korea.

Reference: H.J. Hopfen, *Farm Implements for Arid and Tropical Regions*, FAO, Agricultural Development Paper No 67, Rome, 1960.

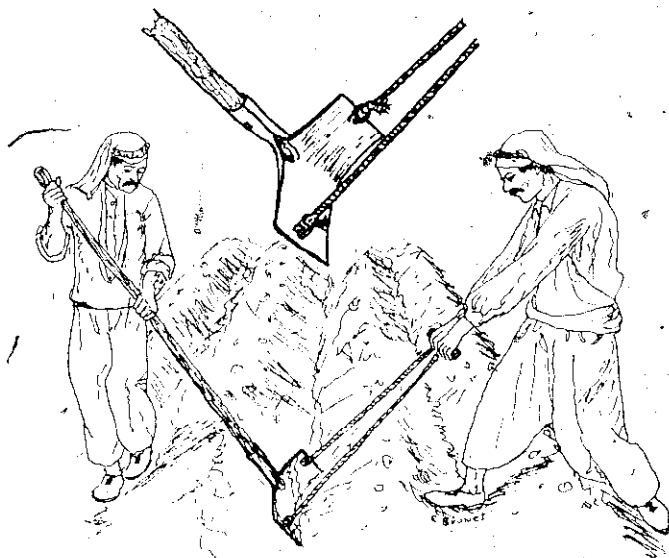

Suggested by: J. Greve, DPI., Box 2417, Konedobu.

## Crop Production

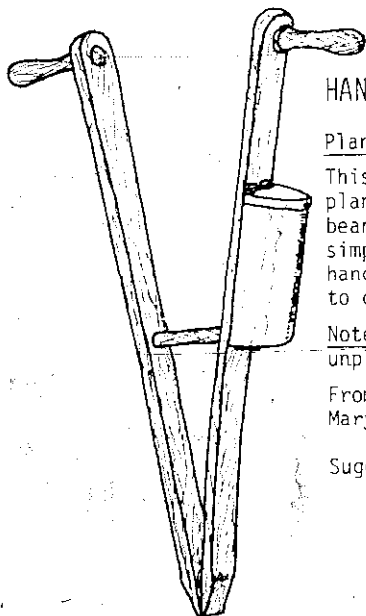

### HAND-PLANTER

Planter, hand-operated jab type

This hand-operated tool is a simple automatic planter which can be used to plant corn, peas, beans and seeds of similar size. To operate, simply jab the point into the soil and push the handles together. The seed plant is adjustable to control the number of seeds planted.

Note: This corn planter cannot be used in unplowed soil.

From: VITA., 3706 Rhode Island Ave. Mt. Rainier, Maryland 20822, USA.

Suggested by: J. Greve, DPI., Box 2417, Konedobu.

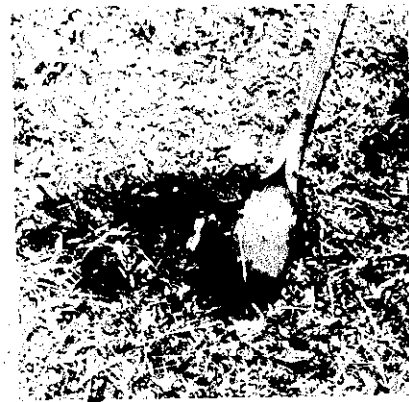

*This useful digging tool was made from a piece of pipe. After heating, split along the weld line with a point or wedge. Insert wood handle and sharpen.*

A. Inversin, Box 4981, Unitech, Lae.



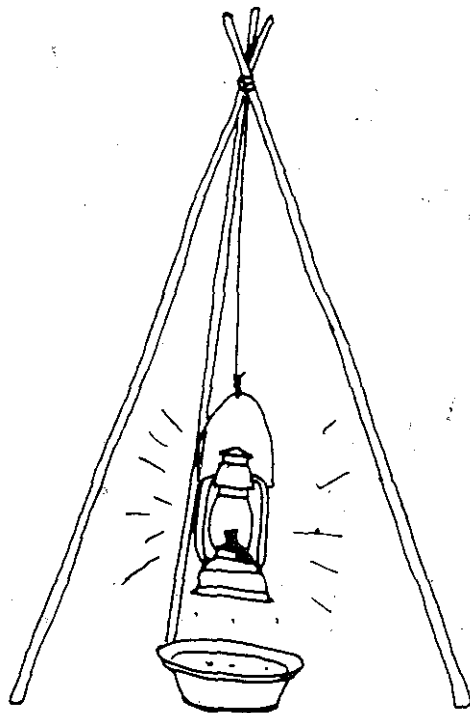

## INSECT TRAP

This catches insects that like to fly at night to a light. You catch many insects that feed in the daytime and are fooled to think it is daytime. It is good for many rice pests.

Materials needed: 1 kero lamp (about K2.00) 3 bush sticks, a little twine, and 1 basin. These may be bought at most trade stores, or perhaps you already have them.

Tie the three sticks at one end to make a tripod and hang the lamp, and fill the basin with water. Let the lamp burn during the night. Insects fly against the lamp and fall in the water. A little kerosene in the water will insure that they will die quickly and not get away, and the glow of the kerosene attracts the insects.

Use a lamp big enough to burn the whole night. Don't let anyone steal your lamp!

## HAND WEEDER

This simple and highly effective weeding tool can help to eliminate a lot of stoop labour and kneeling.

It can be made from a 46 cm (18") section of certain sariff materials or other metal. It is important to select stock that can be bent sharply without heat and without breaking. Discarded heavy duty banding material and 1½" wide galvanized hoop iron will work.

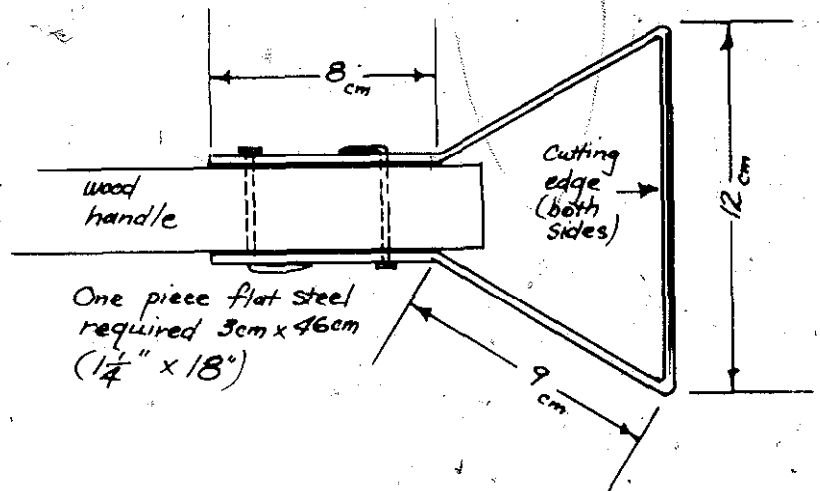

Mild steel works, since the triangular shape gives the weeder rigidity.

Bend and punch holes as shown.

After bending the tool and punching the holes, a strong wood handle about 3 cm in diameter is attached with flat head 2" nails, bent over.

Finally, both sides of the cutting edge are sharpened.

The tool is operated with either a pushing or a pulling stroke, or a push-pull stroke. A light pressure is applied to hold it to the ground. It is especially suitable for dry rice, vegetables, corn, peanuts, and pineapples. It is most effective when used on young weeds which can be cut without chopping.

B. Pulpulis, Box 49, Kavieng, NIP.



## DUST APPLICATOR

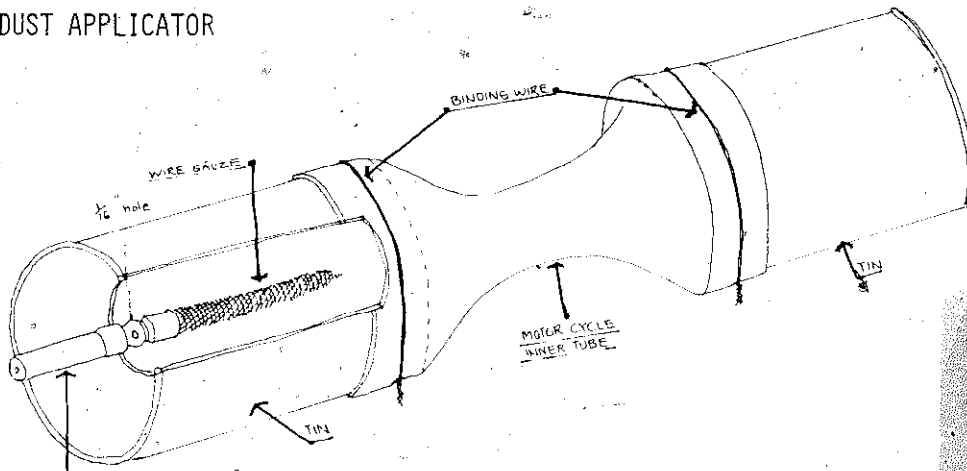

metal tube  
with 2 mm hole

Description: A homemade tool for applying agricultural dusts to control fungus and insects.

### Materials:

- 2 empty small milo tins
- 15-20cm length of motorcycle inner tube
- 5cm piece of copper brake fluid tubing
- tie wire
- scrap fly wire (wire gauze)
- solder or Araldite

### Order of work:

1. Cut out the bottom of one of the milo tins.
2. Drill or punch hole in bottom of remaining tin.
3. Drill small (1/16") holes in one half of the copper tube, as in picture.
4. Attach with wire a flywire (wire Gauze) filter to the end of the tube with the holes. A short piece of wire gauze rolled and wired to the copper tube and twisted tight at the end is sufficient.
5. Solder or Araldite the tube into the hole at the bottom of the tin.
6. Wire one end of the length of motorcycle inner tube around the mouth of the tin, and the other end around the cut out portion of the other tin. Do not lose the tin lid.
7. Place dust to be used inside the tin and close lid tightly. Operate by short push-pull strokes of the tins.

Further references PANS, Vol 21 No 4, Dec 1975.  
p.-418 - 19.

PNG Experience: Not yet used in PNG except for a working model at Tigak Agriculture Station, NIP. The design is by P.C. Mercer, Box 215, Lilongwe, Malawi, and is used for control of peanut fungus.

Remarks: The use of dusts for fungus and insect control, has limited use during rainy seasons, since rain washes the dust off. However locally formulated dusts for agriculture are very cheap, and are generally much safer for unskilled workers to use. Examples of available insect dusts: Gamma B.H.C. and D.D.T. powder; fungicides: Bordeaux mixture, and copper oxychloride.

## THRESHER

A simple frame  
for threshing  
rice.



The plans for this foot operated thresher for rice and other small grains may be ordered from Village Development Office, Box 6937, Boroko.



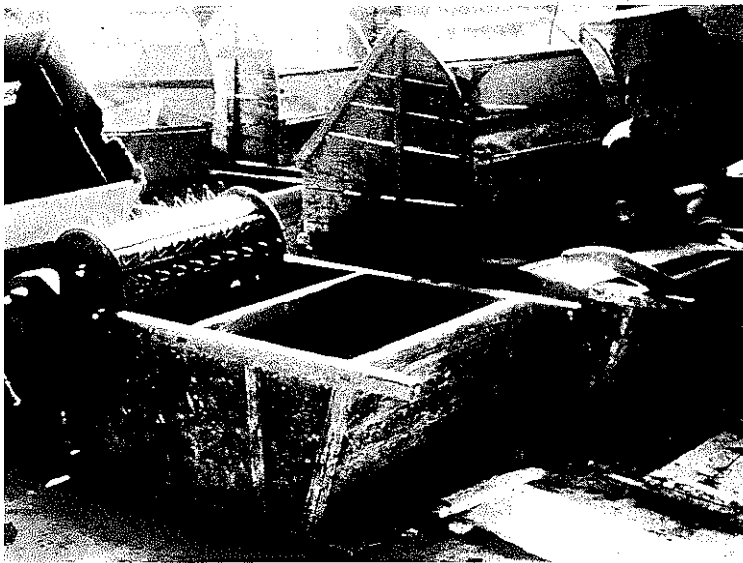

These pedal driven rice threshers are found by the thousands in South China. Interesting features are the barge-shaped box to catch the grain, and the removable hood. These are kept near the rice harvesters to minimize carrying.

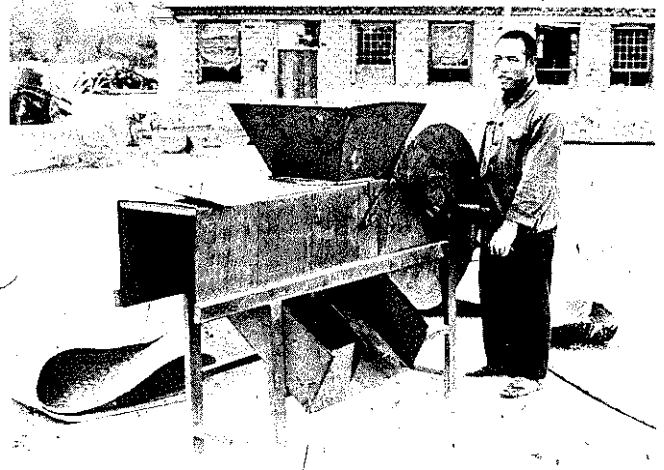

Chinese winnowing machine made of steel. The shape of these is not critical provided you have adjustable partitions inside.

Tradition Central Luzon Philippines model winnowing machine, plans available from International Rice Research Institute, Box 933, Manila, Philippines.

(p 248)



Drying rice in trays. These may be made using old pieces of iron for the bottoms, and may be stacked one upon the other in the case of rain, or at night. Pwas Vocational Training Ctr., PMB Kavieng.

# Livestock Production

## POULTRY

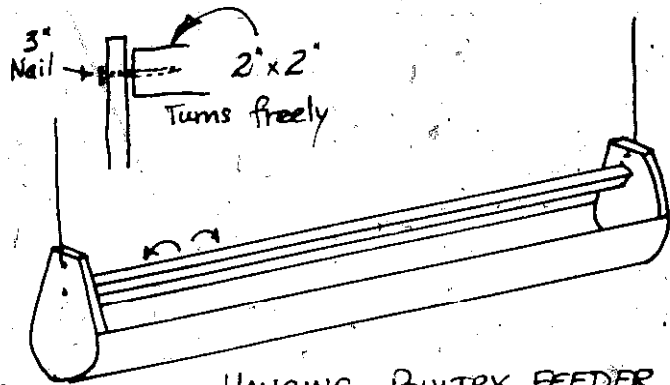

HANGING POULTRY FEEDER  
prevents chickens from standing  
in feed.

Suggested by  
Tony Watts  
Box 126, Popondetta

from Ulrich Bergman  
Wantoot, via Lae

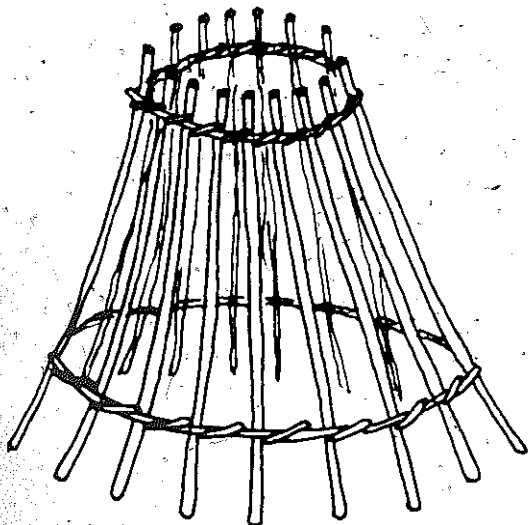

Pitpit or Bamboo

### POULTRY FEEDER

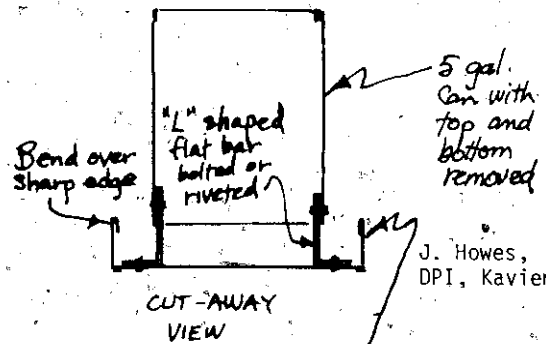

J. Howes,  
DPI, Kavieng, NIP

end of  
13 gal. oil  
drum

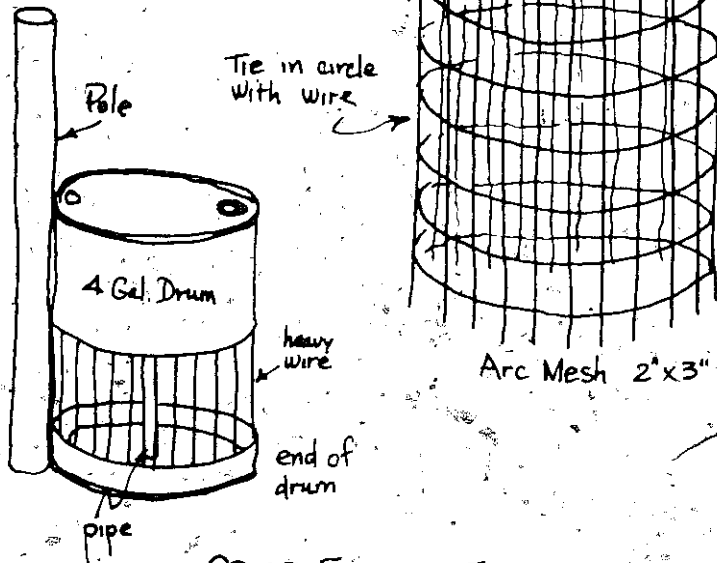

CREEP FEEDERS FOR  
BABY CHICKS

KEEP THE BIG  
CHICKENS OUT

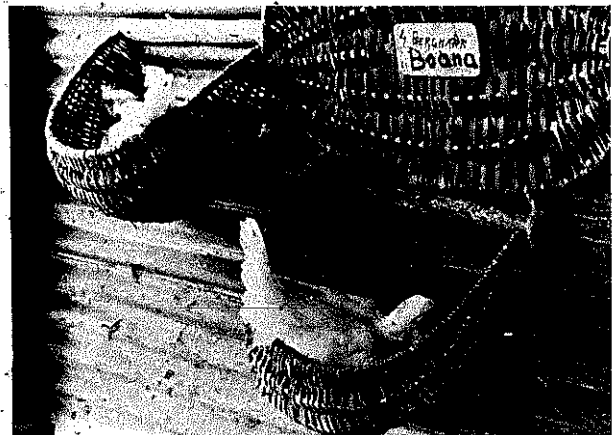

"basket" nests. See basket weaving, (p 130)

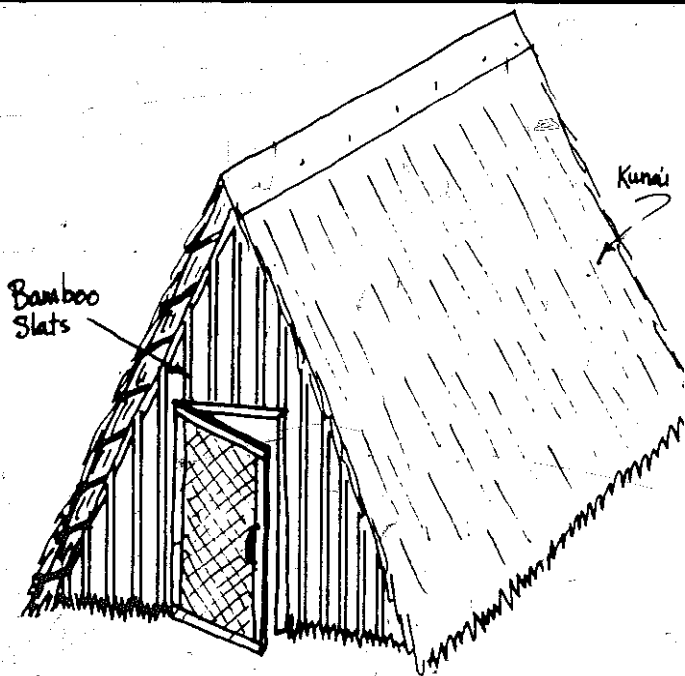

"COLONY" TYPE HOUSE FOR POULTRY  
Made of bush materials

### PIGS

#### CONCRETE PIG TROUGH

Description: A heavy feed or water trough that holds 35 litres. It is very stable, and cannot be turned by the pig, but with the handle, can be moved and cleaned by the person.

#### Materials list:

- 4 x 10 litre buckets sand
- 2 x 10 " " gravel
- 1 x 10 " " cement @ K1.00
- 1 piece chicken wire 45 x 42cm
- 2 pieces chicken wire cut into a half circle 40cm on base and 22cm radius.
- 2 pieces  $\frac{1}{2}$ " reinforcing iron 60cm long @ 50¢
- timber to form
- 13 gal drum split lengthwise
- waste oil (sump oil)

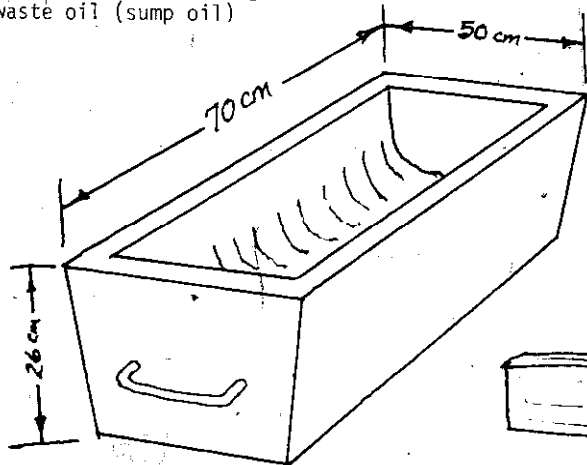

#### Order of work:

1. Construct the framework for the form following drawing. There is a floor to the frame which is not nailed to the sides. Leave heads of nails protruding slightly so form can be removed easily and used again.
2. Fit split drum inside wooden battens on floor, but do not nail in place.
3. Coat outer surface of drum with oil to prevent concrete sticking.
4. Place upper form over floor.
5. Mix concrete, and add a little extra water so it will pour well. (p 124)
6. Install reinforcing wire and a handle if desired. Leave a slot in the end form so that it will slip off.
7. Pour concrete into form, allow to set 24 hours before removing the form. The trough may be used in 7 days. Cure it in the shade.

#### FORM CUTAWAY END VIEW

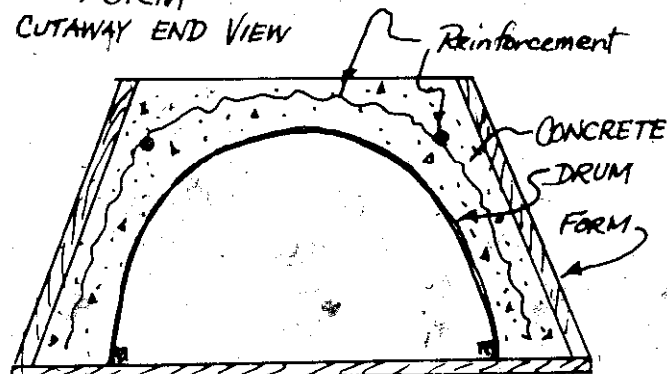

PNG. Experience: Manggai High School, PMB Kavieng, since March 1976.

Remarks: One form is sufficient to make one trough a day. Leave the heads of nails loose so the form can be dismantled easily and avoid damage. To clean trough the person can easily tip the trough with the handle.

Initial contributor: Manggai High School, Kavieng.

#### FEED TRAY FOR PIGS

This feeding tray for pigs, made of wood and flat iron or a piece of 13 gal. drum has no corners for food to stick in, is

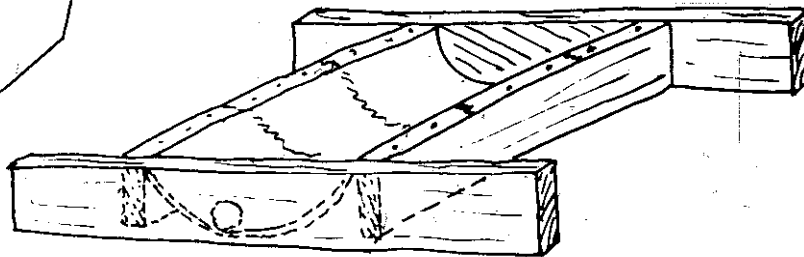

durable, and it fits under the side wall of the pighouse so that you can pour in the food from outside. It has been tried at Dosambago Skul Bilong Kirapim Ples, Wantoat, Morobe Province. In 6 months of use it has been very satisfactory. You can make different sizes for different ages of pigs. Long timbers on sides give weight and stability.

Initial contributor: U. Bergmann  
 Wantoat via Lae

**PIG HOUSING**

**TAKE NOTE!**

A DPI experiment in Goroka by Malynicz showed that FEED could be 4 times as important as breed and 39 times as important as housing.

Breed was 8 times more important than housing.

Are you sure you need better housing?

PIG HOUSE MADE OF BUSH MATERIALS GOOD FOR FATTENING TWO PIGS. 2 m x 4 m

- Note:
1. A little sunshine in the morning;
  2. A little green grass each day, in addition to the other food;
  3. Plenty of clean drinking water;
  4. Good drainage: Splash floor daily to wash manure through cracks in the floor; and
  5. Durable posts and floor, ordinary materials for roof.

This timber pighouse keeps pigs off the ground and out of the gardens. Make provision for getting pigs in and out easily. Feeding tray fits in under side of wall and food can be poured in from outside. A disadvantage - sunlight has difficulty getting in if not properly oriented or designed.

PNG experience: Dosambago Skul Bilong Kirapim Ples, Wantoat, and many Wantoat villages. Original information provided by David Williams, here presented with minor alterations by Ulrich Bergman, Wantoat, via Lae.

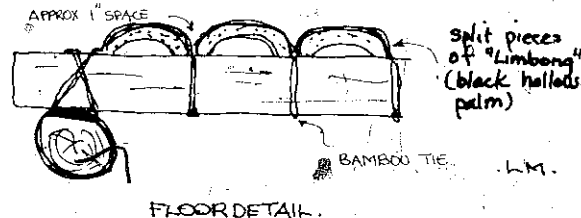
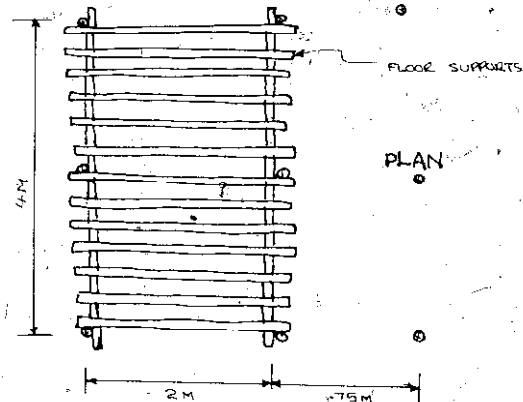
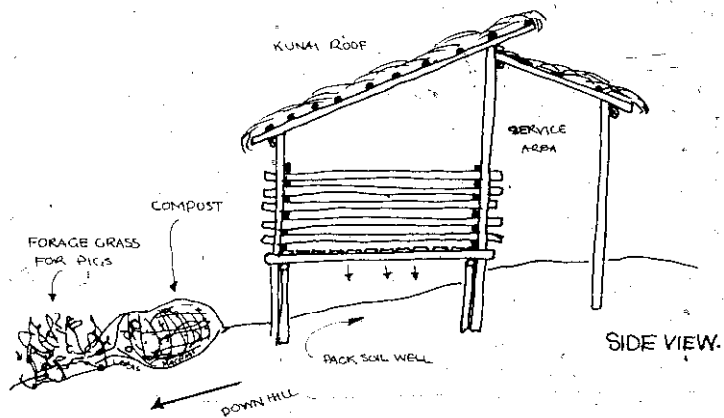

Pig house built of bush materials, Martyrs' High School, NP

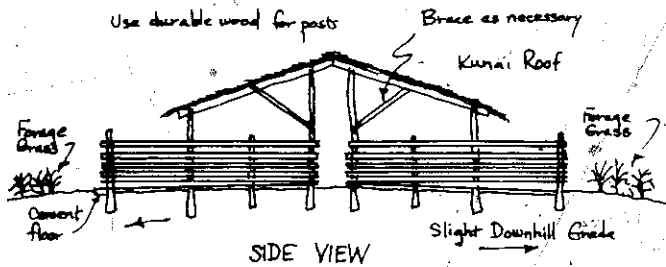

Note: You may start with one, or both sides, one or more sections.

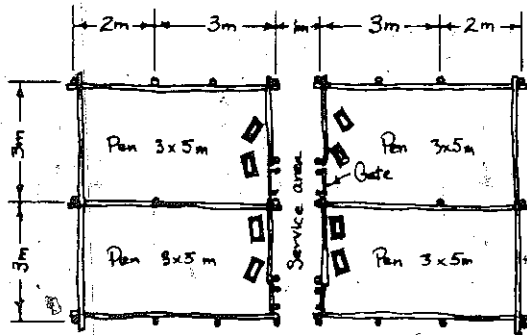

TOP VIEW

**PIG HOUSE**

This type of piggery (initial construction, one side) has been successful at the Doſambago Skul Bilong Kirapim Ples, Wantoat, Morobe Province. It is built in a place where the manure can drain off into an area which produces plenty of forage grass for the pigs.

**NOTES:**

1. Except for cement floor, it is all made of bush materials. (If the soil is well-packed, even a very thin cement floor will suffice.)
2. It can be expanded as much as you like simply by adding similar sections.
3. It's very easy to move pigs from one section to another (especially good for mating purposes).
4. One section is large enough for a sow and her piglets, or for 2 or 3 fattening pigs, or for one fully grown boar.
5. The caretaker can usually put the feed and water without going inside.
6. It is easy to clean. Just wash the manure out the back.
7. At the back, the manure will support a beautiful forage grass garden which can be used to feed the pigs. The green feeds help them to stay healthy and to have a good appetite.
8. If you start with "clean" pigs and never

move them from this unit, worms should not become a serious problem.

9. If you want to use rainwater from the roof, put gutters and catch the water in a tank.
10. If you need a "guard", a sleeping place can be built up high in the center.

Recommended by U. Bergmann, Wantoat via. Lae. Original design D. Williams, Box 80, Lae.

Cross-section of an insulated concrete floor

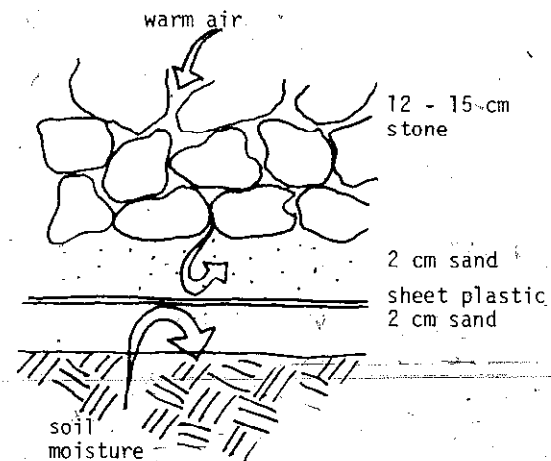
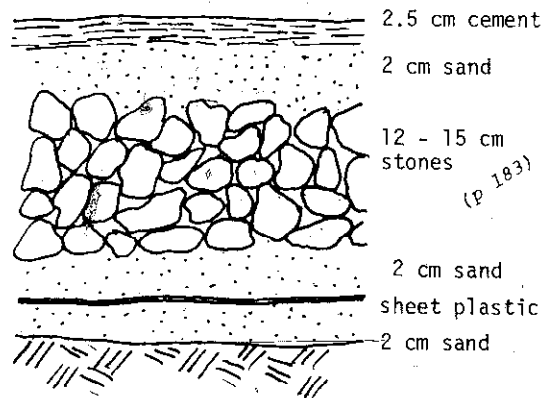

The effect of sheet plastic in the insulated floor.

from Pigs and Poultry in the South Pacific

# Hunting and Fishing

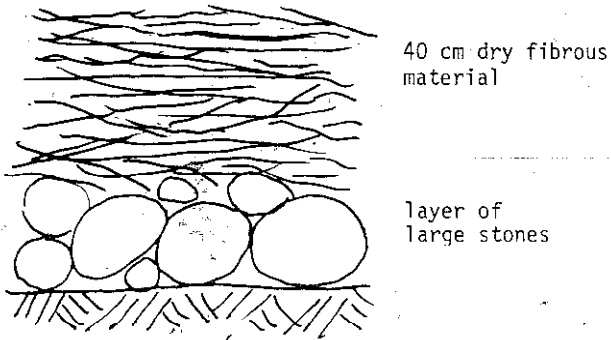

Cross-section of a deep litter floor

from Pigs and Poultry in the South Pacific

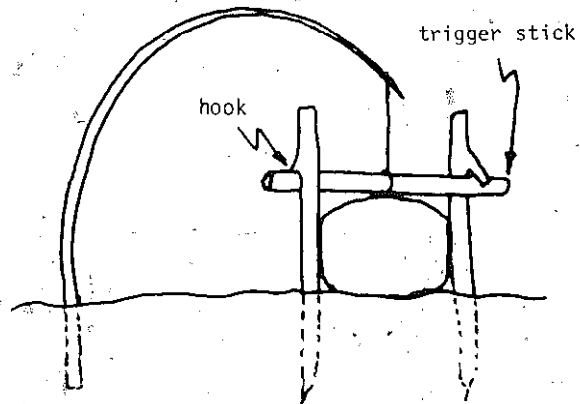

## NOOSE TRAP FOR WILD PIGS

Pigs are often trapped in many parts of PNG using a noose trap. While there are many variations in details this is a common one.

A very strong stick that will bend without breaking is planted in the ground and a noose of rope or cane is hung over the trail used by a pig. Brush and barriers are placed around the trail to keep the pig going along the trail. Often a young tree growing next to a pig trail is used, by just cutting branches. To set the noose, the cane or rope is tied just above the noose to a branch. The noose is pulled tight until it reaches the ground. Two sticks with parts of a branch like hooks are driven into the ground. The hooks face in opposite directions and the stick attached to the noose is caught under the branch parts so that a small movement lets the noose loose.

When the pig rubs its back walking under the trigger stick the trap is sprung and the pig is caught by the noose.

Check the trap daily or more often in case a pig is caught so that dogs or another person will not steal a pig that is caught in your trap.

There are many other ways of making such traps, and some use very sensitive and complicated triggers made of bamboo balanced in a certain way, but this is the easiest trap for a beginner.

Initial contributor: B. Levi, Vudal, PO Kerevat, ENB

## PORTABLE CONFINEMENT FOR PIGS AND OTHER SMALL ANIMALS

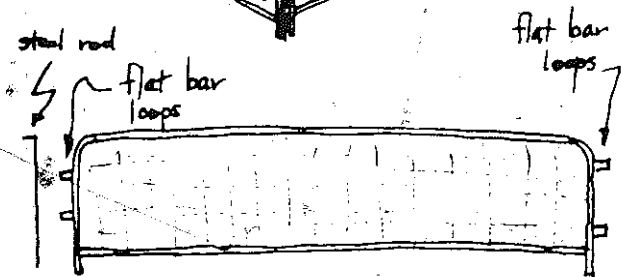
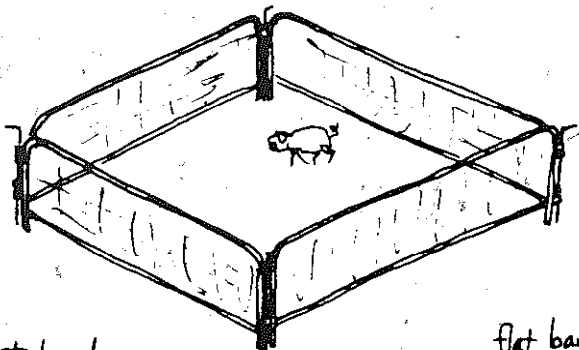

Panels made of pipes and hog wire. Use 3 or more.

Or make similar panels out of hardwood and hog wire.

Or try arc mesh circles.

Pigs under control in a garden can provide tillage plus fertilizer.

Yes, you have a role in DEVELOPMENT, leader, but: is your role DEVELOPMENTAL?



ANIMAL TRAP

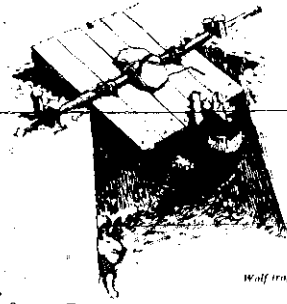

from Frontier Living

RAT AND BIRD TRAP

This rat and bird trap made from bamboo is very effective. It is tied together with bits of inner tube and string, and an inner tube spring activates it and holds the "catch".

The bottom part of the vertical piece can be tied to a fence post, or the pointed left end of the horizontal part can be stuck into a banana stalk. Or the trap can be mounted inside a house.

The stick on top of the "catch" (a small plastic bottle is shown here), held down by the strong rubber band, is the trap. The small stick under the "catch" is the trigger. The bait is tied to the trigger. When the "catch" pushes down the trigger, it lets go of the trap release stick, and the trap snaps down.

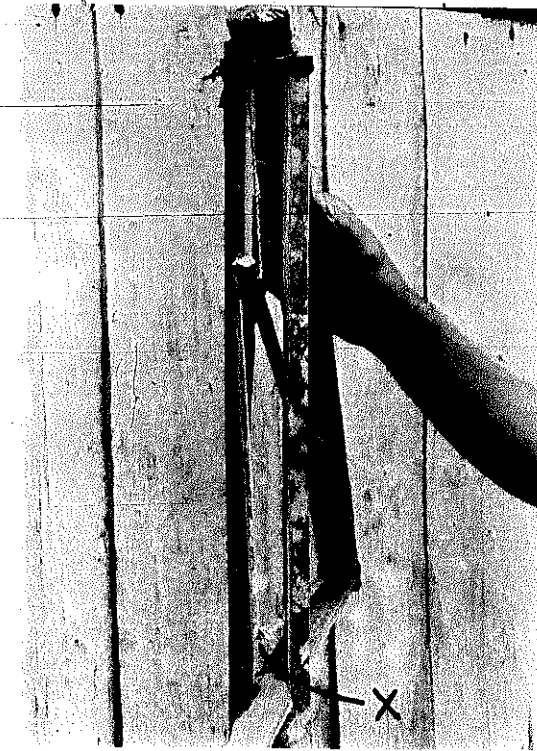

This shows the trap in a loaded condition, ready to go off. The trap release stick is held precariously by the trigger stick at point X.

from Orestus Martin, MARA, c/ UCCP Church, Butuan City, Philippines



RIVER FISH TRAP (NOT FOR SALT WATER)

Use: 3 circles made of heavy wire, or even old wheel rims from a bicycle.  
 Chicken wire netting.  
 8 gauge fencing wire.  
 Copper or soft iron tie wire.

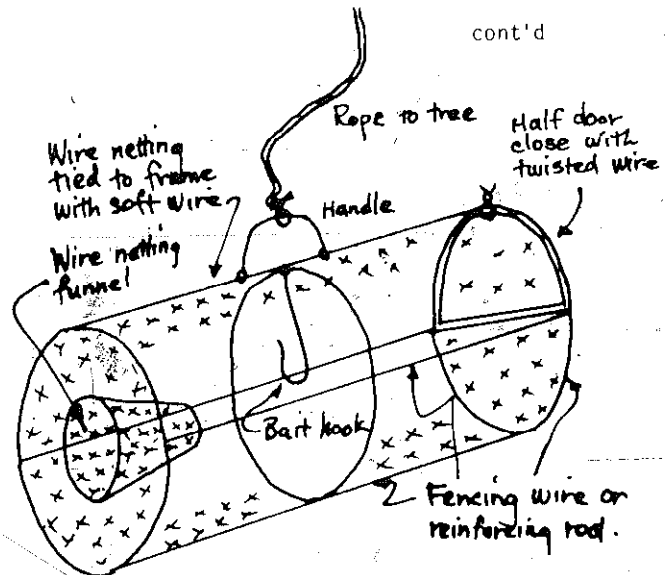

Although the people of P.N.G. make many varieties of fish trap, the above trap is strong and will last many years in fresh water.

Bait the hook with meat, old bones, or a bag of kaukau, etc. Leave the trap near the river bank well below the surface of the water. Tie the rope to a tree. Check the trap for fish every three or four days.

Initial contributor: M.J. O'Riley  
Dep't of Education, Madang

### BAMBOO FISH TRAP

A simple bamboo fish trap using the white ants found at the base of trees as a bait is used in the West Sepik.

Very large bamboo is cut into one metre lengths. All but the node at one end is removed, and in that node a small hole is bored with a piece of pointed steel that has been made very hot.

Masses of the white ants are broken into pieces just small enough to fit inside the bamboo. The trap with bait is placed in slow moving streams where fish feed during the night. Place the length of the bamboo crosswise to the flow of the stream so that the ants will not be washed away, and anchor the bamboo with a rock.

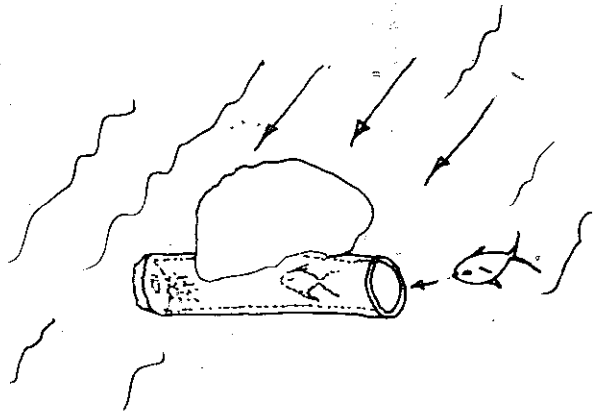

During the night the feeding fish enter the bamboo to get the ants, and remain there during the next day since the bamboo is a good hiding place.

On the morning after when you check your trap be sure to quickly place your hand over the open end of the bamboo, then pour out the fish, prawns or crabs into a bucket on dry ground. Be sure to put fresh ants each time you check the trap.

Initial contributor: R. Seki, Vudal, PO,  
Kerevat, ENBP.

## Crop Processing Food Preparation and Preservation

### COCONUT SCRAPER

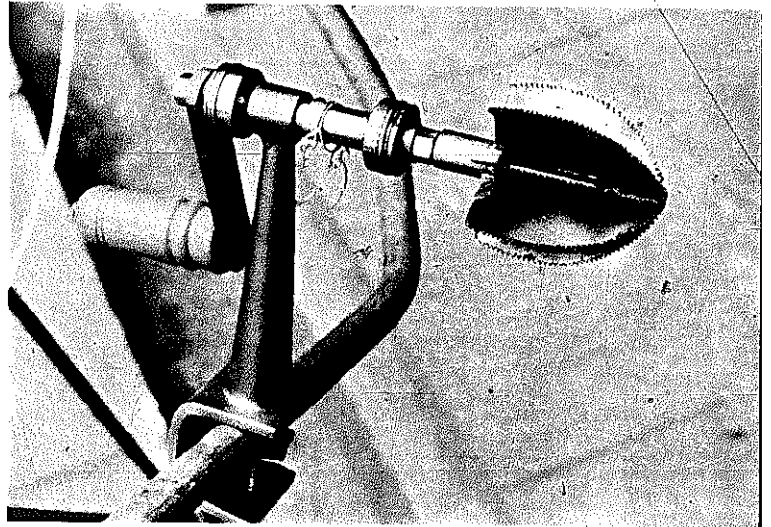

*"Lucky Meri Super Scraper" coconut scraper, using front axle and bearing of bicycle wheel from New Britain Engineering, P.O. Box 163 Rabaul. Price K7.50 plus shipping.*

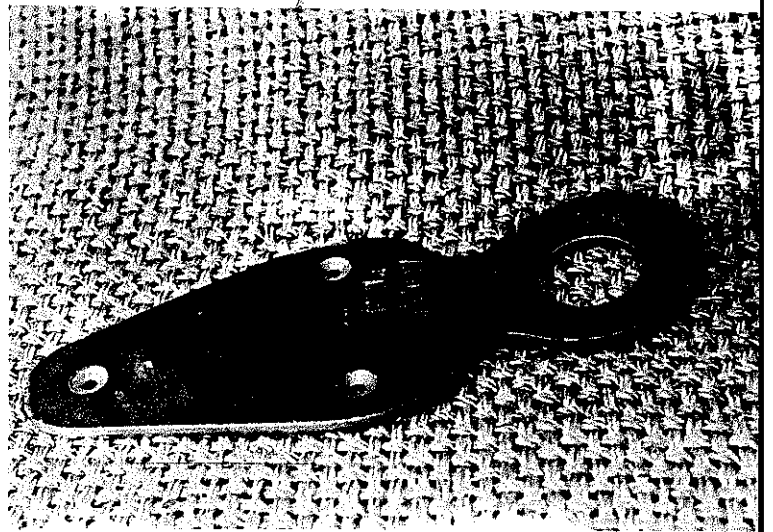

*Coconut scraper made at St. Joseph's Vocational Training Centre, Lae*

The level and basis upon which persons can turn outwards to seek solidarity with other human beings reflects or even defines the measure of their security and their maturity.

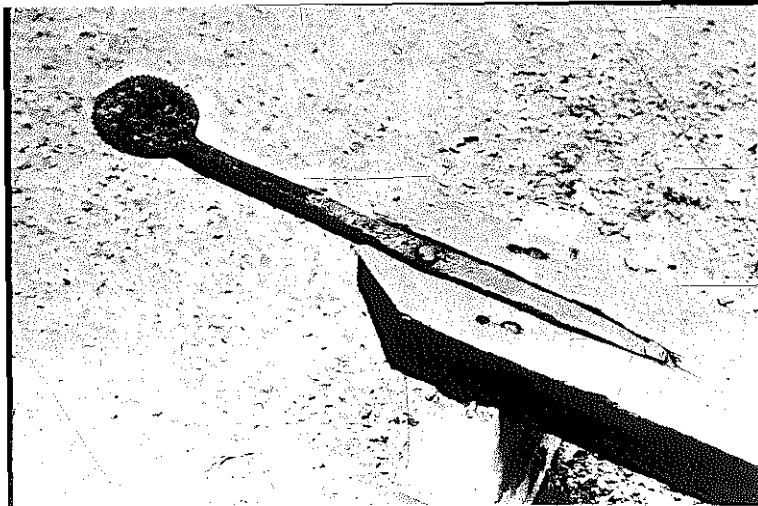

Very common type of coconut scraper found in the Philippines. Made from 12 mm (1/2") round bar.

### COCONUT SCRAPER

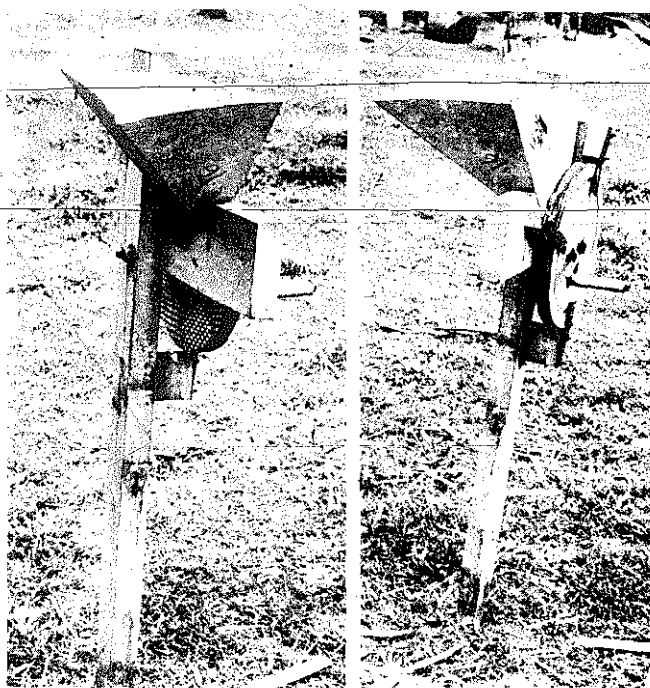

Home made coffee pulper made of wood, tin, and a few odds and ends. More information from Village Development Office, Box 6937, Boroko.

### COFFEE PULPER

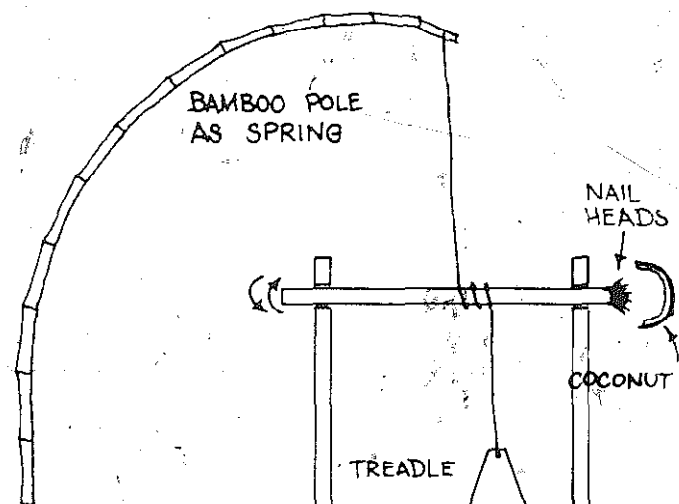

MR BISNISMAN/ MR VOCATIONAL CENTRE MANAGER! DO YOU MAKE OR SELL SOMETHING THAT WOULD HELP THE READER OF THIS BUK? WRITE AND TELL US WHAT IT IS AND WE'LL PUT IT IN THE NEXT EDITION. IF YOU LIKE, A CONTRIBUTION TO HELP KEEP THE COSTS OF THE BUK DOWN WILL WIN YOU AN HONOURED POSITION IN THE ACKNOWLEDGEMENTS SECTION AT THE END OF THE BUK. EVEN IF YOU DON'T LIKE, WE'LL STILL INCLUDE YOUR PRODUCT OR SERVICE, IF IT WILL HELP THE READER.

### COFFEE ROASTER

Coffee roaster made at Kundiawa Vocational Training Centre.

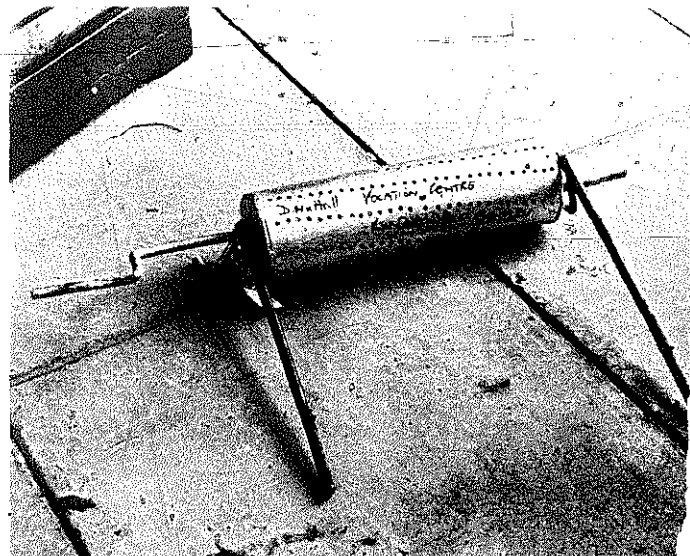

This is a simple treadle-operated scraper for extracting coconut, common in some parts of Indonesia, unknown in others. This appeared in *Appropriate Technology*, August 1975, where it was reported that the scraper was used successfully by BUTSI, the Indonesian Board for Volunteer Service, through a newly created village Technology unit. For more information on BUTSI write: Dr. W.P. Napitupulu, BUTSI Secretary, Tromol Pos 3290, Jakarta, Indonesia.



At the treaty of Lancaster, in Pennsylvania, anno 1744, between the Government of Virginia and the Six nations, the commissioners from Virginia acquainted the Indians by a speech, that there was in Williamsburg a college with a fund for educating Indian youth; and that if the chiefs of the Six nations would send down half a dozen of their sons to that college, the government would take care that they be well provided for and instructed in the learning of the white people.

The Indians' spokesman replied:

"We know that you highly esteem the kind of learning taught in those colleges, and that the maintenance of our young men, while with you, would be very expensive to you. We are convinced, therefore, that you mean to do us good by your proposal and we thank you heartily.

"But you, who are wise, must know that different nations have different conceptions of things; and you will not therefore take it amiss, if our ideas of this kind of education happen not to be the same with yours. We have had some experience of it; several of our young people were formerly brought up at the colleges of the northern provinces; they were instructed in all your sciences; but, when they came back to us, they were bad runners, ignorant of every means of living in the woods, unable to bear either cold or hunger, knew neither how to build a cabin, take a deer, nor kill an enemy," spoke our language imperfectly, were therefore neither fit for hunters, warriors, nor counsellors; they were totally good for nothing.

"We are however not the less obligated by your kind offer, though we decline accepting it; and to show our grateful sense of it, if the gentlemen of Virginia will send us a dozen of their sons, we will take care of their education, instruct them in all we know, and make men of them."

Initial contributor: B. Franklin, Philadelphia, PA USA.

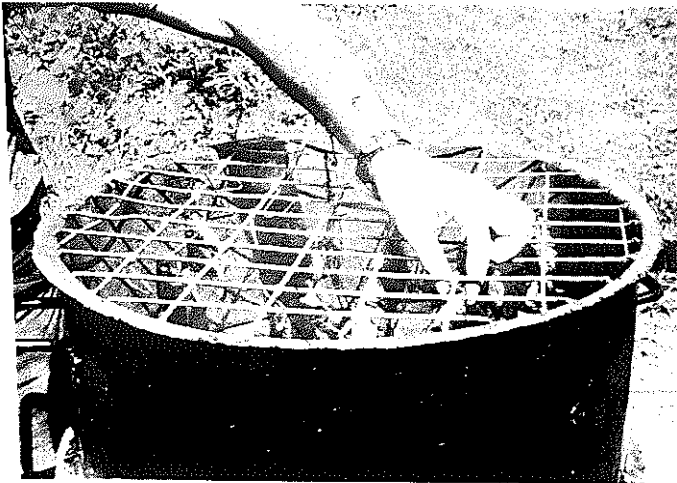

## FISH SMOKER

Smoking fish, Bugandi High School, Lae. This unit was designed by Howard Hepworth, Dept. of Business Development, Box 568, Lae. Note burner at bottom. Top sections were each made of 1/3 of an oil drum, each having a security wire grid for hanging the fish tail down, and they may be stacked up to ten units high. A cover or wet copra sack is placed on top. As the units on the bottom are sufficiently smoked they are removed, and the next unit is brought closer to the burner. A slow smoky fire is desired. Depending upon the size of the fish and the heat of the fire, smoking takes anywhere from 8 to 12 hours. Big fish should be split and the fillets slashed.

Be careful with this design. The heat from the fire can cook the fish, and can seal the surface so that the smoke does not enter the fish. Keep a cool, cool fire going.

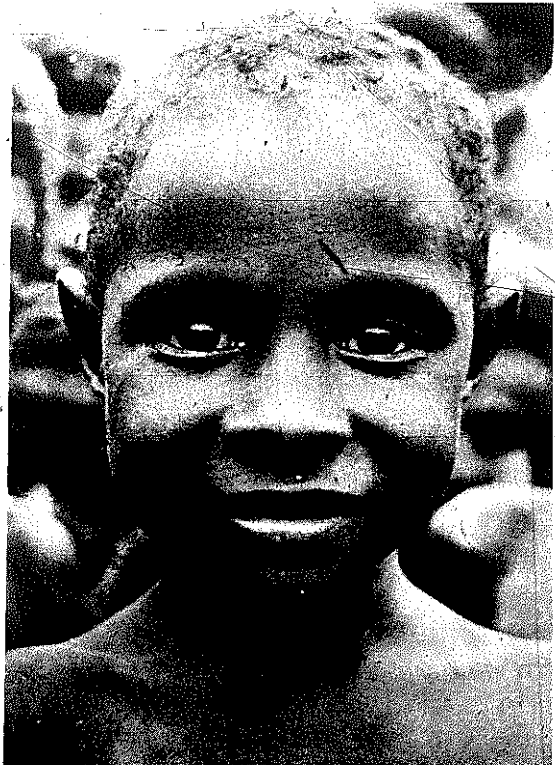

# GRAIN GRINDER OR MILL

This small concrete grain grinder works like the millstones used in many parts of the world over the centuries. It is especially good for cracking corn and grain legumes. You can make fine corn meal with it if you run the corn through several times and then screen it through fly wire. This type of mill will remove the hulls from rice kernels, but this particular size, which is good for cracking corn, is a bit heavy and breaks the rice grains excessively. Of course, such a rice mill does not separate the hulls from the grains, which has to be done in another operation (winnowing and screening).

(p 166)

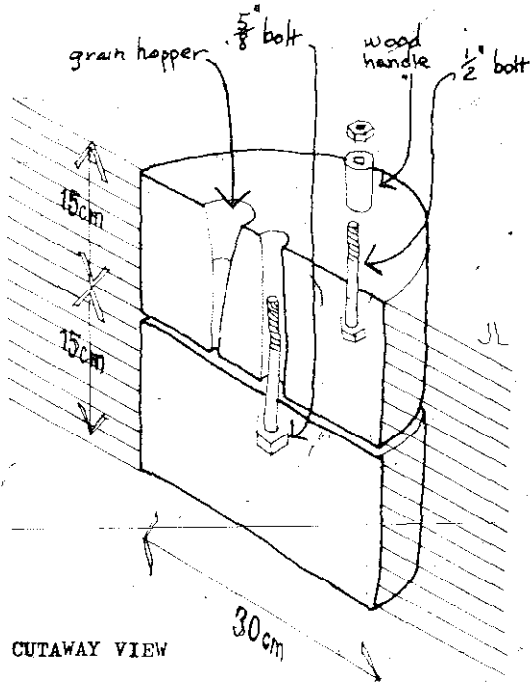
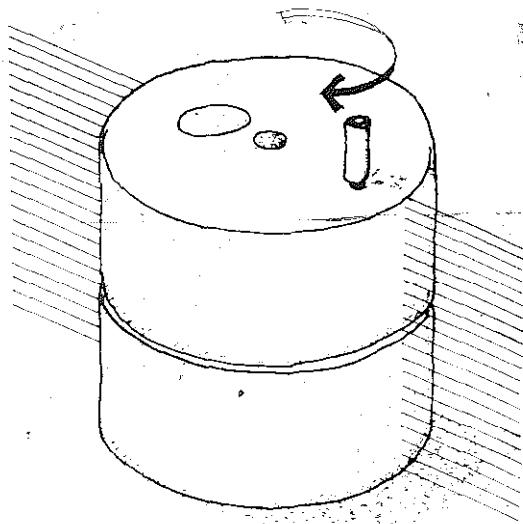

CUTAWAY VIEW

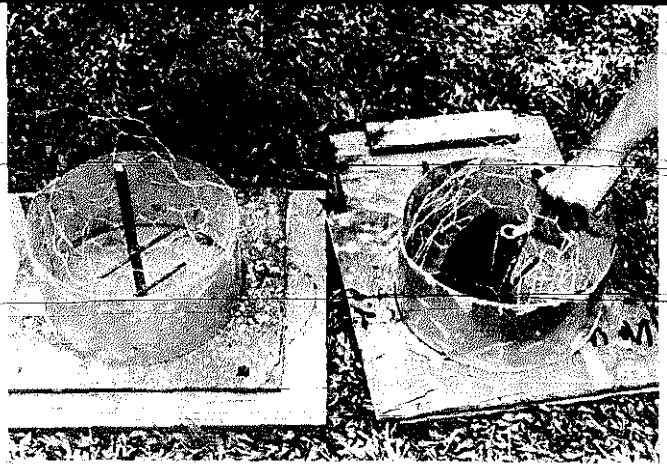

The forms can be made from scrap pieces of iron, or from pieces of 20 litre round tins. Any old bolt will do for the pin. The piece of pipe for the bearing (top) is not really necessary, if you don't have it. Poultry wire reinforcing is advisable, but not absolutely necessary. The hole for the grain (top piece) should be like the drawing or like the wood grinder shown. →

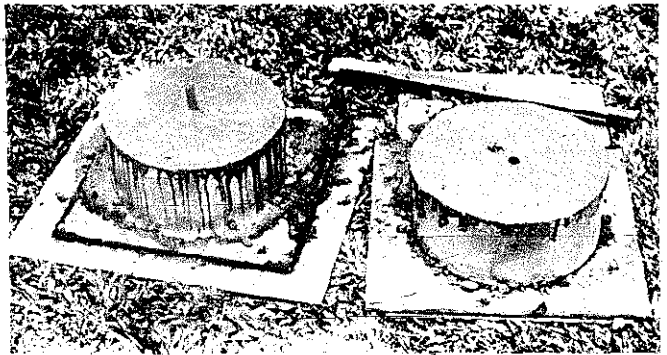

The freshly poured concrete.

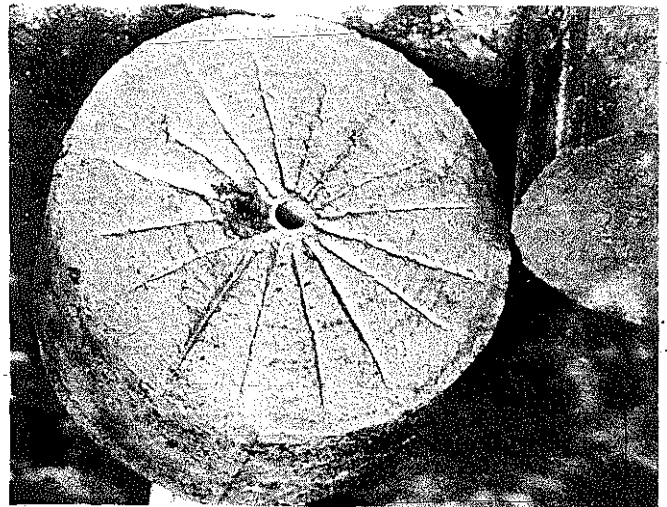

Marks like this are made in both faces with the corner of a small board. On the second day you can fit them together and turn the top enough to seat them nicely. The concrete will be well cured in 3 to 4 weeks.

cont'd

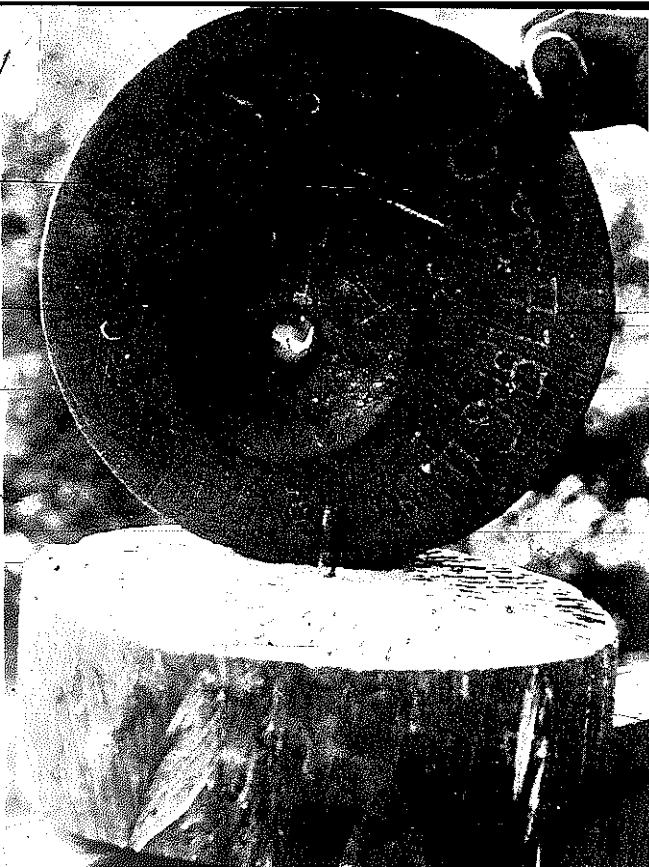

Here is a similar grinder, but made with hardwood and with small pieces of cast iron (from an old Chinese frying pan) driven into both faces.

When using such a grinder, put it in a shallow box or on a mat or piece of plastic to catch the grain.

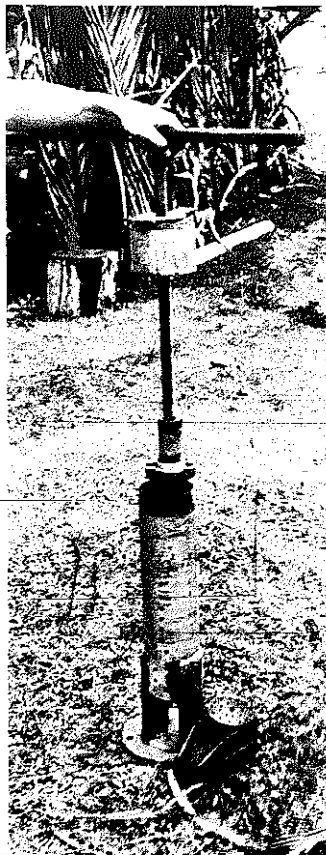

Oil press similar to one at right, but with differences in some details. The bottom can easily be removed for loading and unloading.

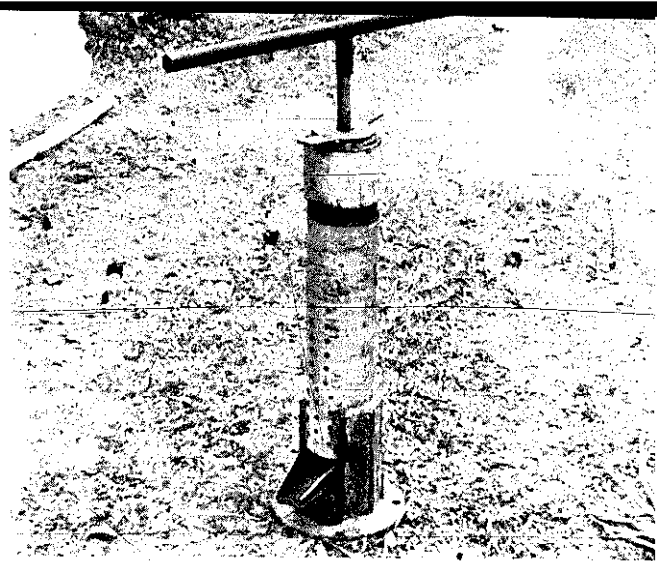

The press shown at lower left looks like this when it is assembled.

### OIL PRESS

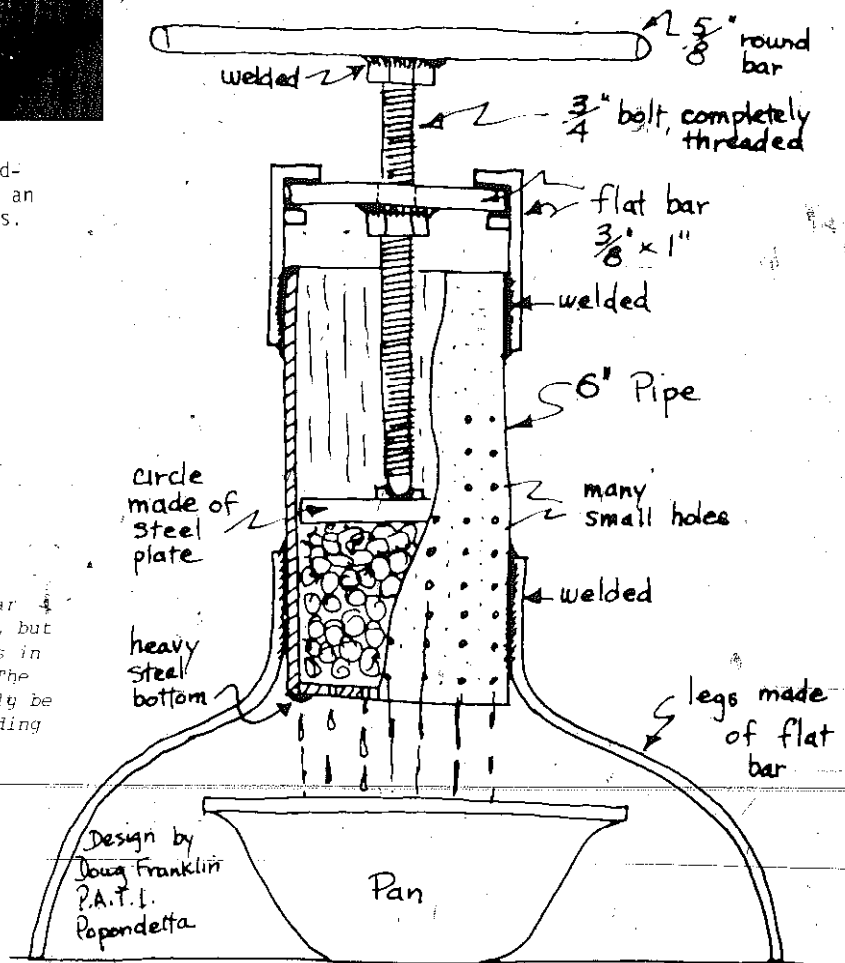

SIMPLE OIL PRESS  
(cutaway view)

## PEANUT SHELLER

(P 250)

This type of peanut sheller has proved itself in many countries and can be quite efficient as long as the right size screen is used. The degree of efficiency will depend very much on both the moisture content of the peanuts and the type of nut being shelled. These machines are easy to operate, provided that only about 5 cm of nuts are placed in the sheller at any one time. To have an ideal set-up one would put a number of machines using different sizes of screen. The nuts are first placed in the machine with the largest size screen. Any nuts not shelled would then be passed through the second size, and so on. Winnowing has to be carried out as a separate operation.

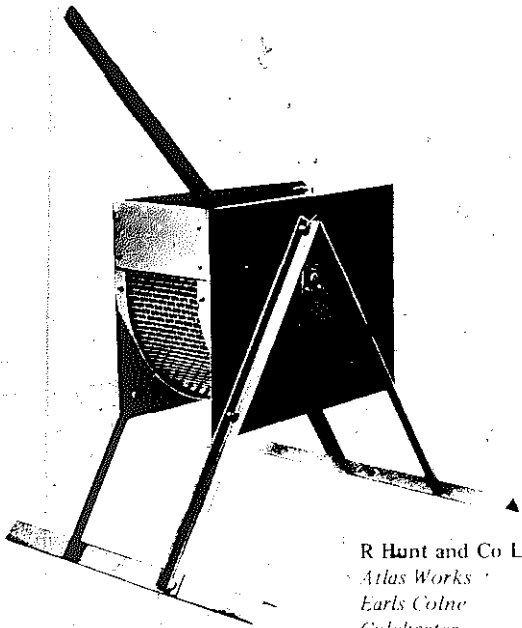

R Hunt and Co Ltd  
Atlas Works  
Earls Colne  
Colchester  
Essex  
England

Make your own, or buy from:

# AGRICULTURE IS THE BASIS OF INDEPENDENT DEVELOPMENT

## PEANUT ROASTER

This is constructed from a wire mesh cylinder supported on a frame, as shown in the diagram, or from a round 20 litre tin with the lid securely fastened and holes punched in it. In the cylinder or tin, provision is made for loading and unloading by a trap door or sliding door. The roaster is mounted so that it can be slowly rotated over a fire or heat source. (See notes on roasting peanuts)

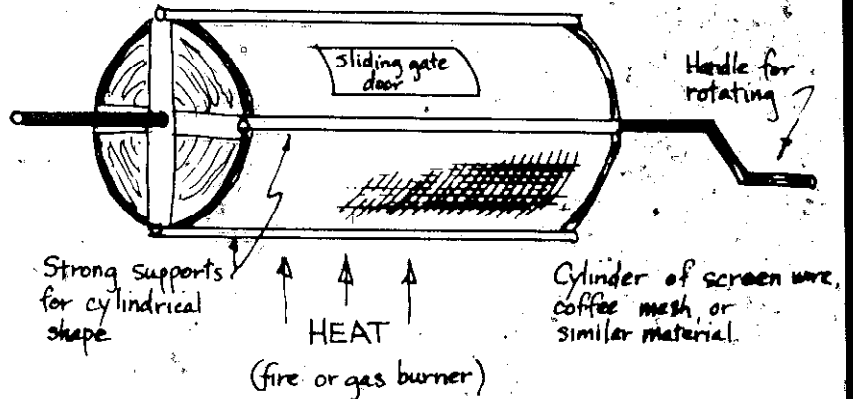

## SUGAR CRUSHERS

IF YOU THINK YOU CAN CRUSH SUGAR CANE EFFECTIVELY WITH AN OLD CLOTHES MANGLE OR WRINGER, YOU'RE WRONG. SAVE YOURSELF THE BOTHER.

This powerful sugar cane crusher (left) was built at PATI, Popondetta from available junk with welding equipment. A man can easily drive the crusher with 5 canes loaded at a time.

Rollers are pre-set and spring-loaded, so that no further adjustment is made. The rollers are 21 cm (8") x 60 cm (24"), mounted on 38 mm (1½") steel shafting, with ball bearings. A Toyota 3R flywheel gear and a 12 tooth pinion gear drive the unit. The crank handle radius is 30 cm (12").



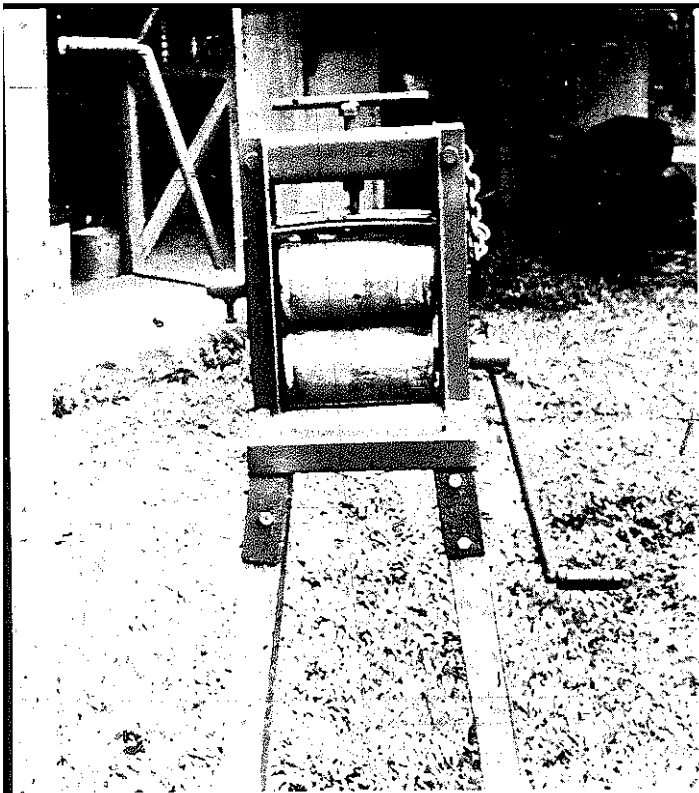

### SUGAR CRUSHER

This is a simple 2-man sugar crusher without gears. It can easily be fabricated if you have access to a welder and cutting torch.

Sugar cane is passed 3 or 4 times, with adjustment screw on the top tighter each time.

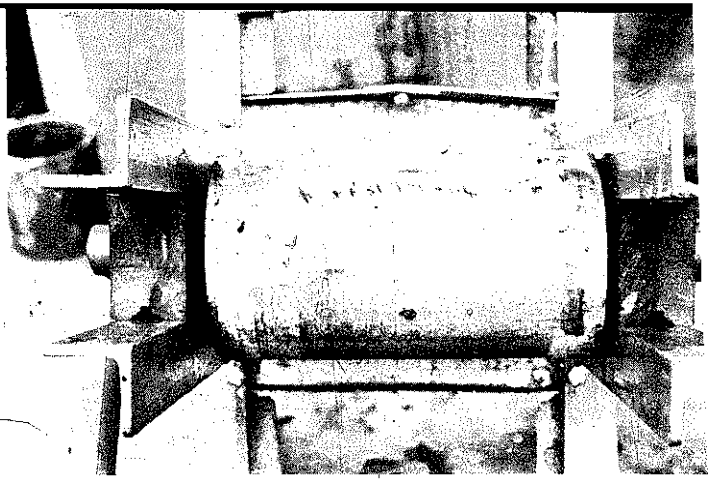

Rollers are pieces of 4" galvanised pipe, 8" long. Shafts are 1" mild steel. Bearings are hardwood, and the top pair slide up and down depending upon the thickness of the cane. The angle iron is 1½" X 1½" X 3/16". The pan to catch juice slants downward and to the centre of one side. The chain is simply to keep the spring from getting lost.

### DRUM STOVE

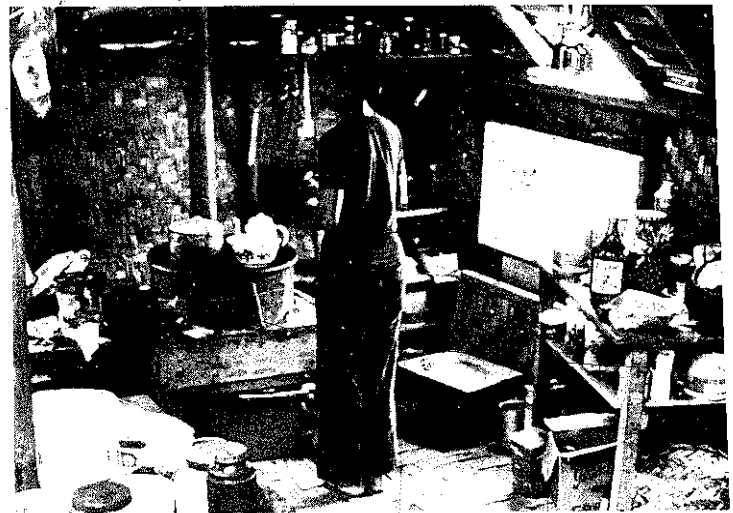

Note movable door to control burning.

H. Bekker

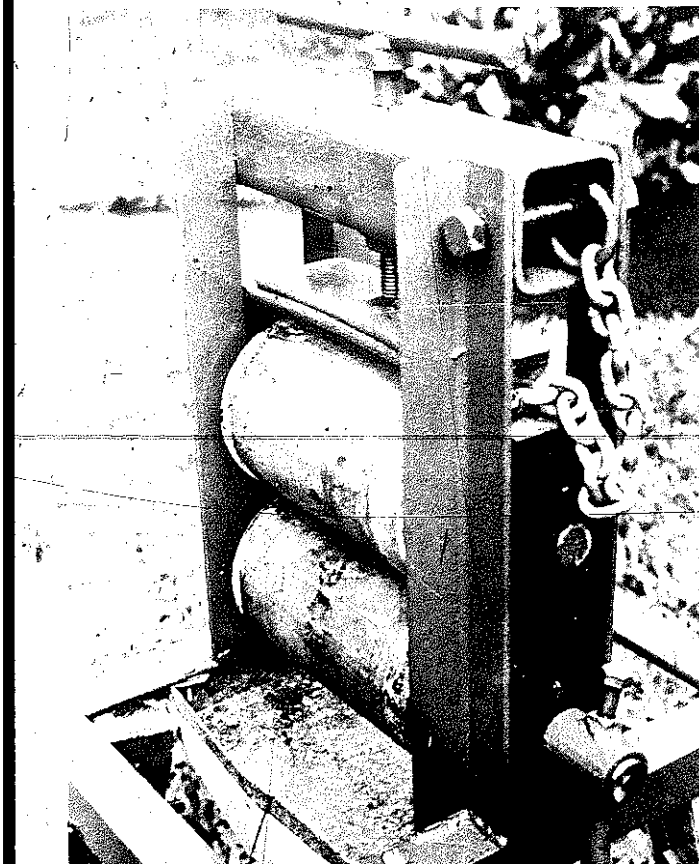
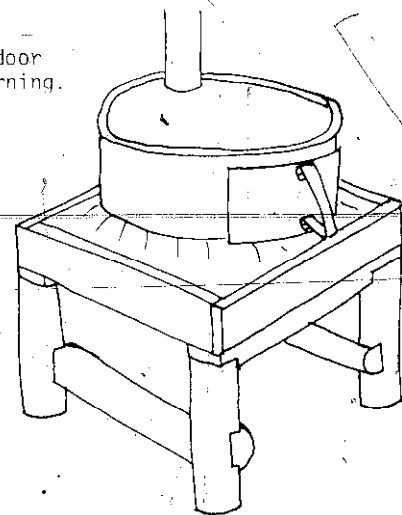





## STOVE

Smokeless cooker shown at Vudal Appropriate Technology Workshop, October, 1976. It is made of clay, and has a bamboo chimney. The clay should be allowed to dry out slowly and evenly, if possible, to avoid cracks. A metal chimney would be safer.

A similar plan is found in VITA Village Technology Handbook, p. 335.

(p 250)

## BREAD OVEN FROM BALIMO VOCATIONAL CENTRE

### Materials List:

- 1 good quality 200 litre drum (no holes)
- 1 old 200 litre drum
- 2 pieces flat iron (for door and tray of oven)
- scrap pieces corrugated iron for fire box
- 10 pieces  $\frac{3}{4}$ " water pipe 3" long.
- short pieces fencing wire to tie them
- 2 1" hinges for oven door.
- 2 pieces 4" diameter chimney pipe.
- 1 piece of fibro cement, for front of oven door.
- 1 thermometer from old stove (optional).

### How to Make the Oven:

1. Take the good drum and cut the top for the door.
2. Rivet two rails inside this drum, for the tray to slide on.
3. Take the old drum and cut all of the top and bottom out of it. Cut it from top to bottom. Mark every 1" around the top and bottom. Use your hacksaw and cut in 1" at every mark. Now bend all these edges in at right angles. Make small holes in this drum to put wire through, to hold the 10 pieces of  $\frac{3}{4}$ " pipe. These small pieces are to hold this outside drum from touching the inside drum. Cut a hole to fit the chimney into.

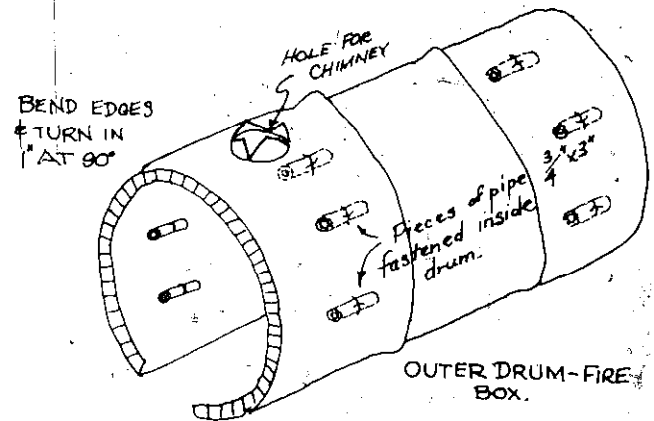
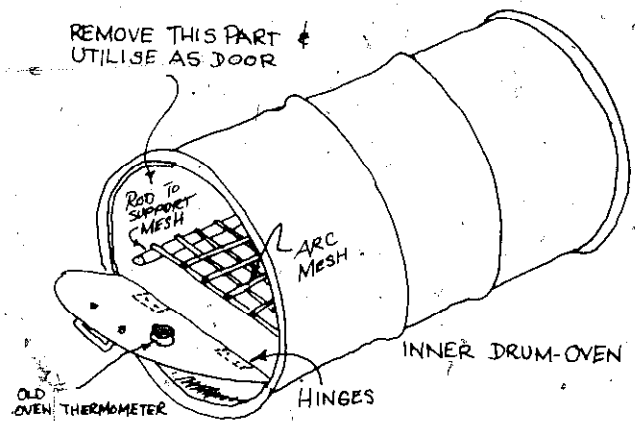

See Bread Recipes p114-118.

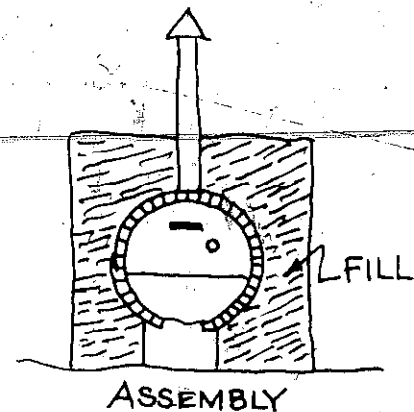
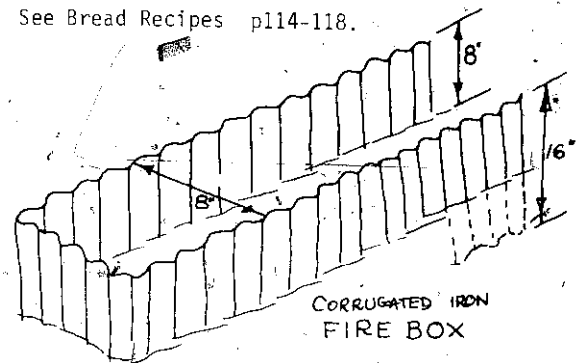

4. Make the oven door from a sheet of flat iron. If you have some fibro, bolt it on the outside of this door. Put a thermometer from an old stove in the door. Make a handle for the door.
5. Push the good drum inside the old drum.
6. Now make the fire-box. It will need to be about 8" high, and about 5 feet long. One end will be closed. The top and one end must be left open until you set the oven on it. After you put the oven on the fire-box, then cover the remaining openings of the fire-box with pieces of corrugated iron.
7. Put the chimney into the hole cut in the old drum, and hold it straight up with some timber. Cut the bottom of the chimney and bend out some tags, before you put it in the hole. These tags will stop the chimney from going inside too far.
8. Build a box around the oven. Fill the box with dirt. Now you will only see the oven door at the front of the box, a hole for making the fire at the back, and a chimney coming out the top.

Submitted by Case Hermes, Box 2148, Konedobu.



A similar design, but covered with rocks and cement.

## MEAT COOLER

Where there are cold running streams, people can use them for refrigerating meat for extended periods of time. The method is time consuming for small amounts of meat, but is suitable for storing large amounts.

Choose a small stream that runs continuously, but is capable of being dammed or temporarily diverted. In the centre of the stream bed below the dam, dig a hole about 0.6m deep. The hole is lined on the sides and bottom with 10cm of clay to seal it. Then line the clay with several layers of banana leaves (or a sheet of plastic). Wrap the cut meat in banana leaves or plastic bags and lay this in the hole in a single layer. Then cover the packaged meat with banana leaves or plastic, and a 10cm layer of clay before putting back the gravel from the river bed. Place a few large rocks on top of the "refrigerator" so the water will not wash it away, and then let the stream run again. It is only necessary to dam the stream again for a short time to get the meat back again.

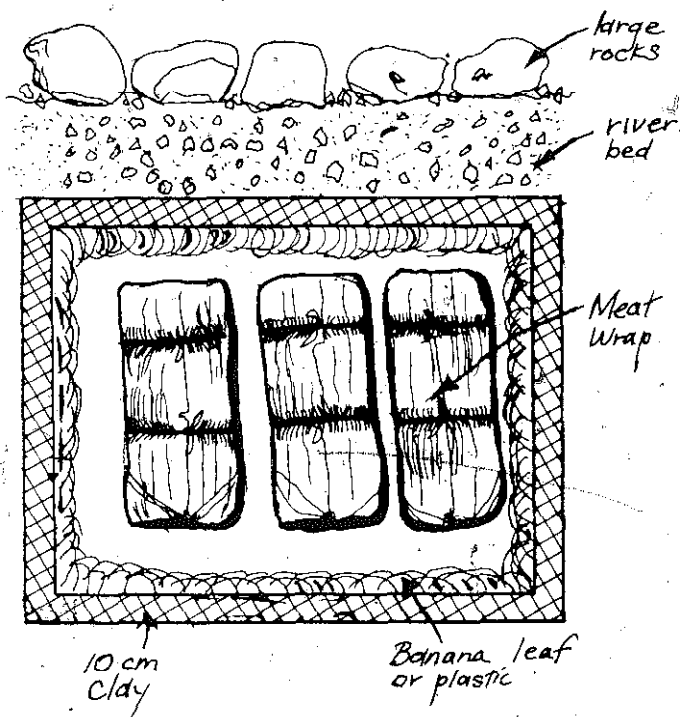

This method is used by people near Waghu, WHP.

Initial contributor: M.W. Mare, Vudal, P.O. Kerevat.

KNOWLEDGE IS OF TWO KINDS. WE KNOW A SUBJECT OURSELVES, OR WE KNOW WHERE WE CAN FIND INFORMATION UPON IT.

Samuel Johnson

# Building and Road Construction

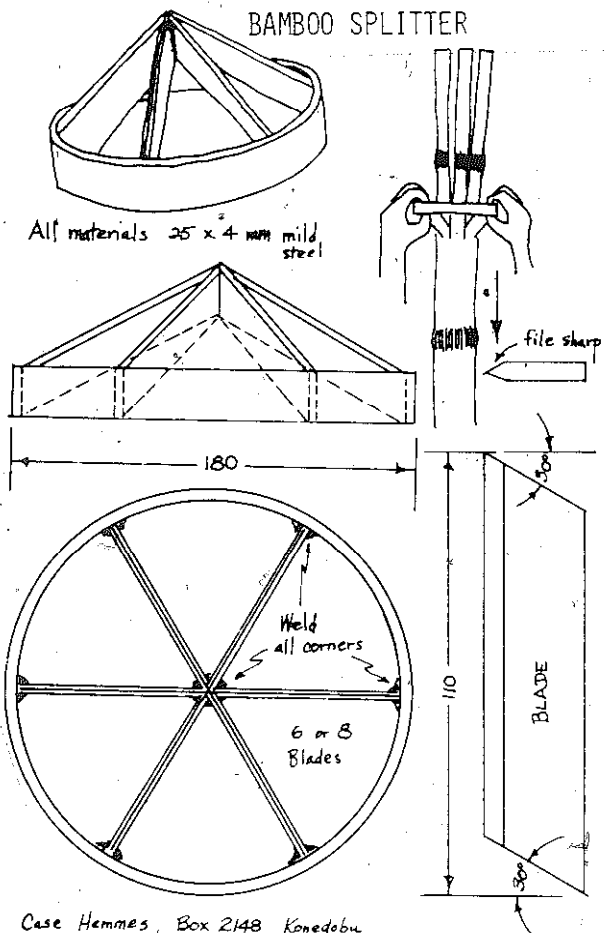
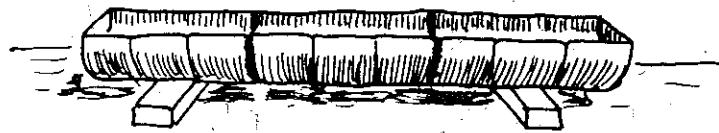

## WOOD PRESERVATION

This long tank made of 3 half drums welded together makes a good container for treating your wood building materials.

## POLE BUILDING CONSTRUCTION

No one building material is the ultimate answer for building problems in P.N.G. Each material has its advantages and disadvantages.

If sawn timber is available at reasonable prices, it has many advantages over poles.

However, in many places poles are readily available, and sawn timber is not. In such a case it should be seen that functional, durable, attractive buildings can be made using poles.

Even though pole construction is the ages-old technique throughout P.N.G., strong prejudices have developed in favour of "European" designs and imported materials, and against the use of bush materials. We need to point out continuously that locally available materials have major advantages, and that proven, scientifically determined ways exist for using them.

See "Manual of Rural Wood Preservation", and "Pole Buildings in P.N.G.", both from Forest Products Research Centre, P.O. Box 1358, Boroko.

(P 126)

(P 50)

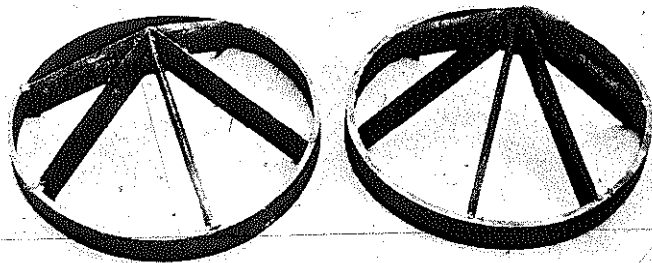

## BUILDING MATERIALS AND DESIGNS

The Local Government Architect, Box 1108, Boroko will send you the Technical Information Handbook that they wrote. In many ways it is like the Liklik Buk, except that it is free. Each Council should request one, and it is available to others who write. It is a collection of plans for housing and engineering projects for rural areas. Each page gives the description of a plan that you can order from the office that drew it. Lots of pictures, material lists and references to other publications. A good example of interdepartmental cooperation, especially with the Forestry. English.

DON'T YOU THINK YOU COULD SHARE YOUR KNOWLEDGE WITH SOMEONE ELSE? SHARE IT IN THE LIKLIK BUK, THIRD EDITION. DO IT BEFORE 15 AUGUST 1977. DO IT NOW, BEFORE YOU FORGET YOU KNOW IT, MAIL IT TO BOX 1920, LAE.

## FERRO-CEMENT

Ferro-cement as a building material is not new. It was invented before conventional reinforced concrete, and is a descendant of the family of construction materials which includes straw and mud bricks, wattle and daub, bamboo and clay.

It has its widest application in thin walled shell structures such as boats, barges, roofs, grain bins. It consists of sand and cement mortar densely reinforced by fine wire mesh, and is a high performance, high strength material.

One of its main attractions is its forgiving nature- it can be made up by unskilled workers, and survives poor workmanship. It is uniquely suited to the tropics, where rust, decay and insect damage are serious problems.

An excellent 90 page booklet, "Ferro-cement: Applications in Developing Countries" may be obtained free of charge from:

Board on Science and Technology for  
International Development  
Office of the Foreign Secretary,  
National Academy of Sciences  
1201 Constitution Avenue  
Washington D.C. 20418 U.S.A.

## RUBBISH GLASS IN CONCRETE

Empty non-returnable bottles are excellent building materials. Glass is very strong material and can be used for floors and walls, to save on the expense of cement.

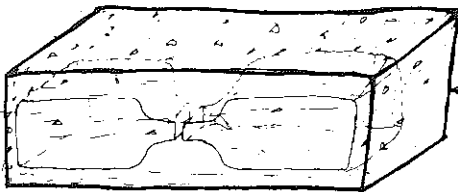

1. In building solid concrete blocks, two empty bottles in the centre of the block will save 15% in materials.

(p 124)

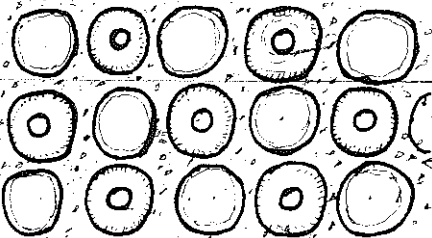

2. A permanent wall can be made of bottles using mortar between each bottle.

1 CM LAYER OF CEMENT

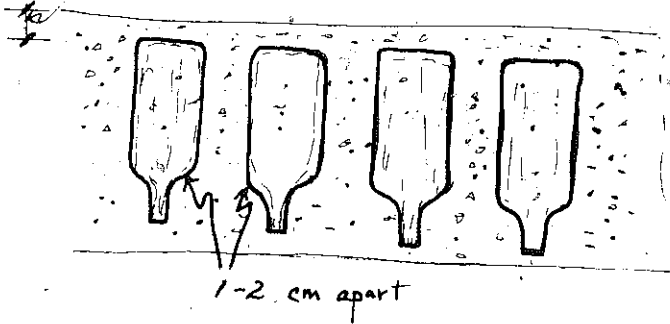

3. In pouring a concrete floor, you can place bottles neck down with a 1-2 cm space between each bottle and 1cm layer of cement on the top.

Suggested by I.M. Bean, DPI., Pindiu, MP.

## USE OF OLD TYRES AS ROOFING

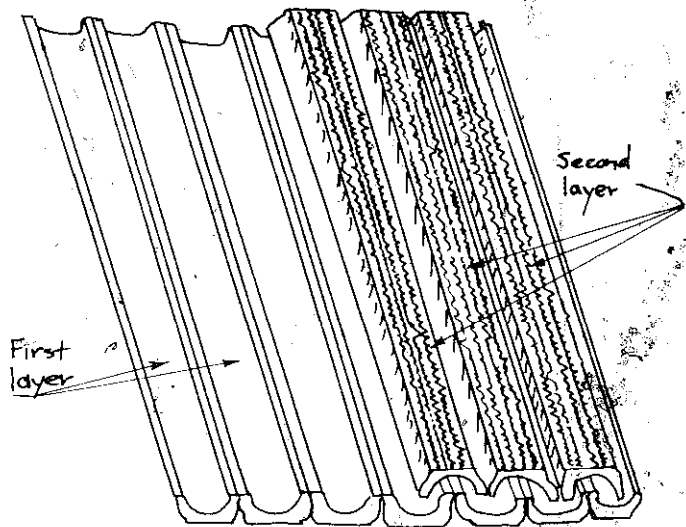

Reference: Australasian Post, May 1976

Suggested by C. Hemmes, Box 2148, Konedobu

Shelter, edited by Lloyd Kahn, Random House, 1973  
176pp. US\$6.00 from Random House Inc., Westminster,  
Maryland 21157, USA.

A beautiful, fun book with hundreds of pictures and much text about simple homes, natural materials, and human resourcefulness. The book is concerned about discovery, hardwork, the joys of self-sufficiency, and freedom. It is about Shelter, which is more than a roof overhead.

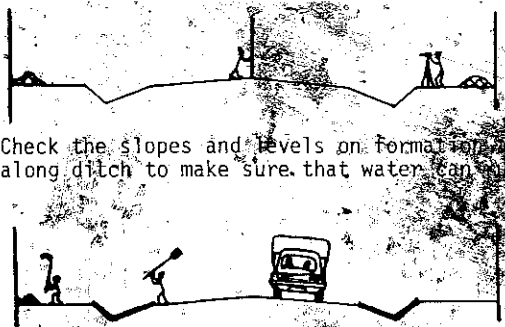

5. Check the slopes and levels on formation along ditch to make sure that water can flow.

6. Lay the topsoil on the ditch slopes to encourage grass to grow again.

NOW MAINTAIN IT - keep drains clear - fill in holes - maintain slopes.

Suggested by C. Hemmes, Box 2148, Konedobu

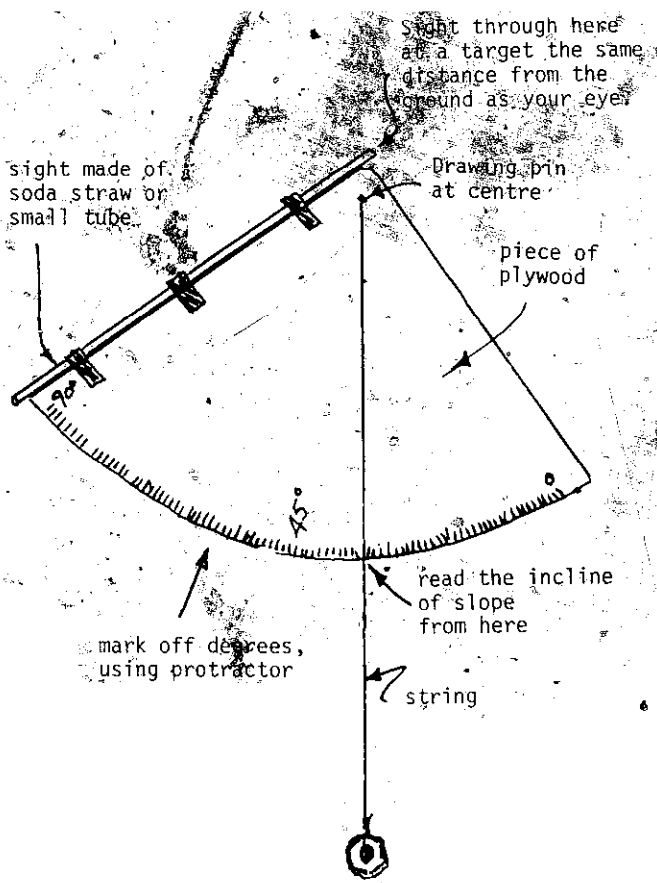

### INCLINOMETER

A simple inclinometer can be most useful in making approximate measurements in difficult situations when more precise instruments are not available.

- Determine:
- slopes of hills for classifying land
  - road grades
  - heights of trees
  - widths of rivers
  - falls for water systems
  - contours for terracing or planting

To find the approximate elevation of a place above a pump site when you have no surveying instrument:

1. Measure the distance along the slope.
2. Measure the incline or slope of the hill using the home-made inclinometer.

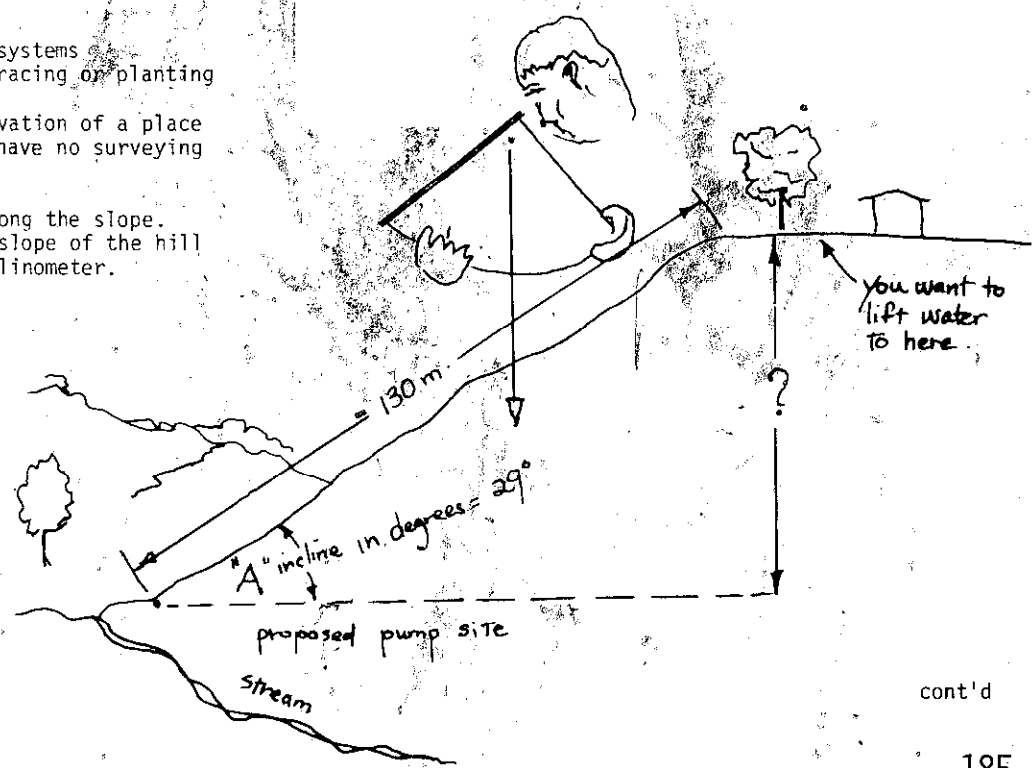

cont'd

3. Compute the height, using a table "Natural Values of Trigonometric Functions". From trigonometry we have the following formula:

The Sin of any angle "A" =  $\frac{\text{opposite (perpendicular)}}{\text{hypotenuse (distance)}}$

$$\sin 29^\circ = \frac{?}{130 \text{ m}}$$

In the table at the back of a math book we find that the Sin of  $29^\circ = .4848$ .

$$.4848 = \frac{?}{130 \text{ m}}$$

$$\text{or } ? = .4848 \times 130 \\ = 63.02 \text{ m}$$

4. If the hill is irregular, do it in two or more stages.

Suggested by F. Keating, Goroka.

NOTE: degrees slope and percent slope are not the same. 10 percent slope means 10 metres rise in 100 metres. If you don't know Trigonometry, plot your case on a piece of paper with a ruler and protractor.  
Or, a rough guide:  
Angle in degrees = % slope x .6

## TRANSPORT

### BICYCLES

"TECHNOLOGY OF BICYCLES" S.S. Wilson, SCIENTIFIC AMERICAN, March 1973 - A good discussion on the mechanics and efficiencies of bicycles.

BICYCLE TRANSPORTATION, N. Dougherty and W. Lawrence, Environmental Protection Agency, 1974 (US Govt Printing Office. Washington DC 20402 USA. US\$0.94)

Bicycles and Bicycle parts supplier:

Mr. Y.S. Pai  
Cycle Division  
Ace Cycle Int'l. Inc.  
P.O. Box 117  
Taipei, Taiwan

Messrs. Feliz Corporation  
P.O. Box 68 - 382  
Taipei  
Taiwan

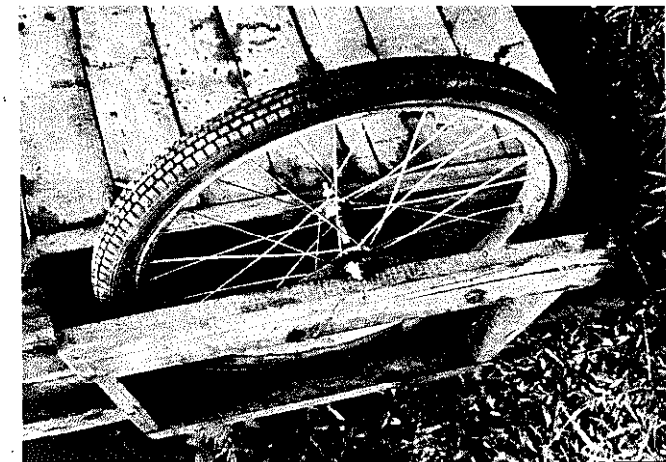
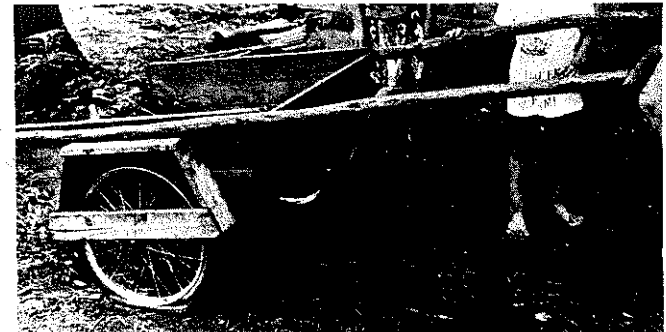
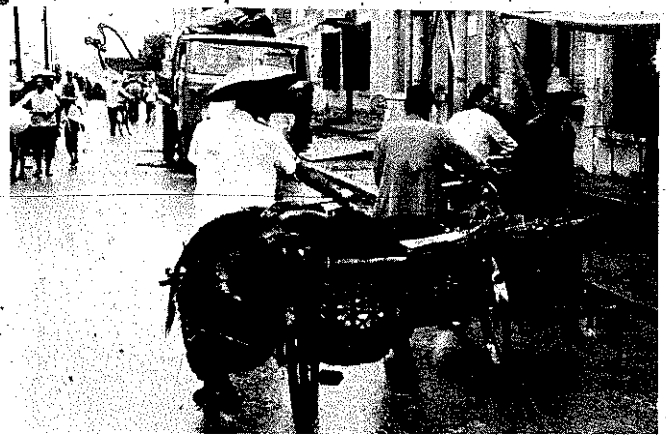

A MOTORIZED CANOE

We have had several requests for information on how to put a small gasoline engine in a canoe. This is basically how small fishermen in the Philippines do it - a simple, economical, time-tested and refined design. There are probably good PNG ways to make such a canoe, using techniques already found here.

This canoe is used for fishing, for transporting people, and for light hauling. It is more maneuverable than an outboard motor, is relatively fast, and handles well in heavy seas. The engine can easily be removed for other uses or for safe keeping.

A key part of the design is how the shaft goes through the dugout bottom. The 16mm (5/8") shaft (cont'd on p 189)

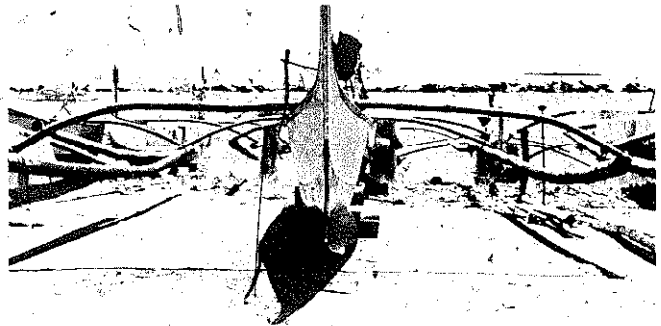
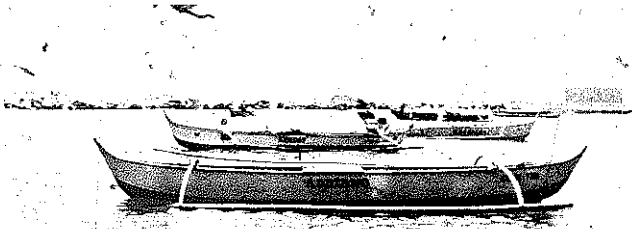

1. The engine is mounted roughly in the centre.

2. The distance between the outriggers is about 3/4 the length of the canoe. 2 or 3 arms may be used. The bamboo is bent permanently over a fire.

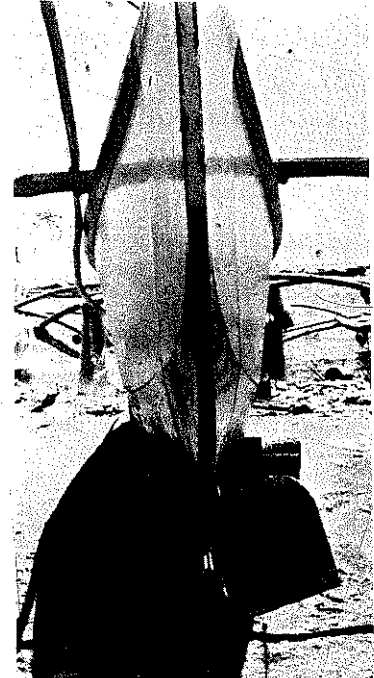
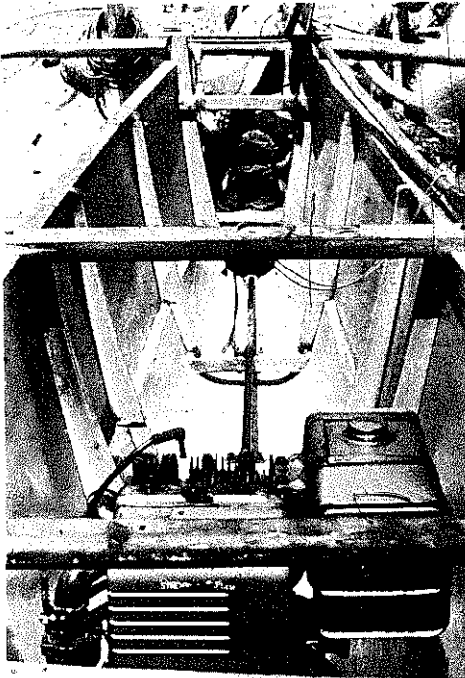
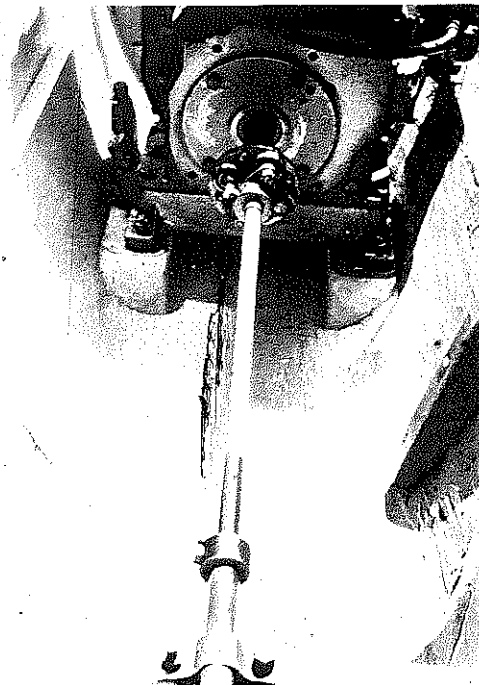

3.—The shaft is connected to the engine with a flexible joint.\* The Engine shaft is aligned with the propeller shaft. Note at bottom of photo where shaft enters tube. The round collar with set screw is not really needed, except to keep the shaft from sliding downwards when the engine is removed.

4. Looking aft from engine. Note how the marine plywood sides are attached to the dugout hull.

5. Outside view from the rear of the canoe.

\*See flexible joint in figure 7, made with pieces of pipe, flat bar, tyre sidewall, and small bolts.

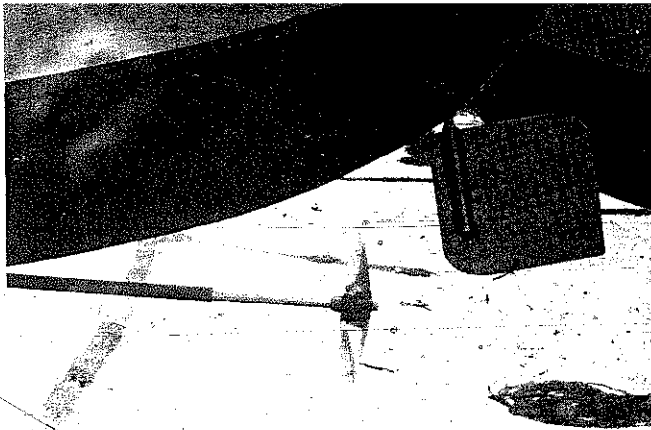

6. Side view of propeller and rudder. The rudder can be made of brass, but many simply weld them out of steel and keep them painted. The rudder shaft also goes through a tube.

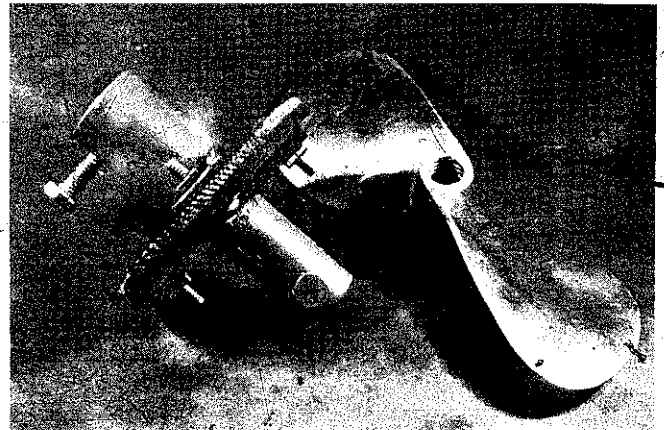

7. These parts you will not find in PNG hardware stores. If you are really clever, you can make both of these, but you may want to buy your first set ...

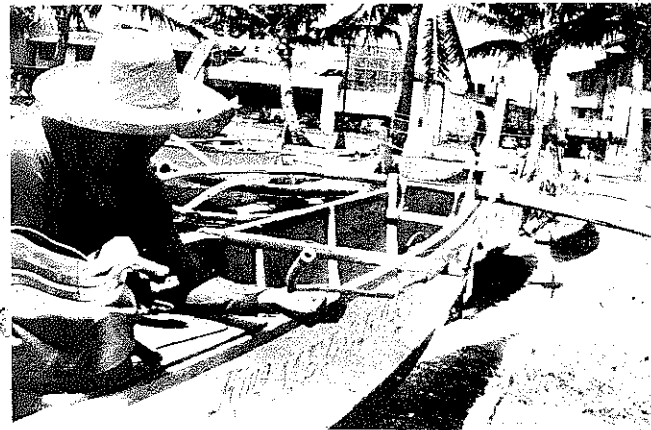

8. The rudder is controlled with a bamboo stick.

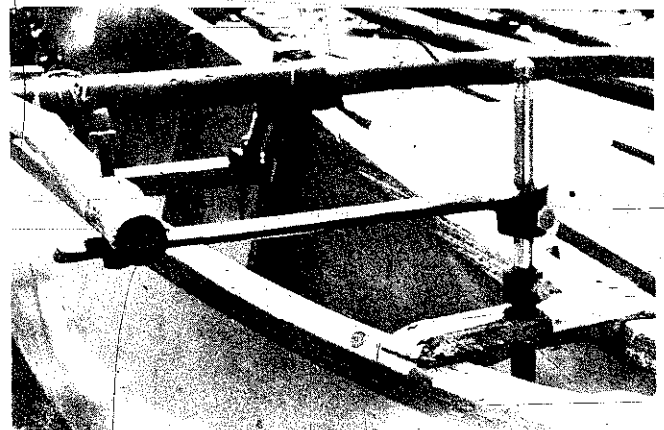

9. This rudder assembly is very fancy. A much simpler one will do.

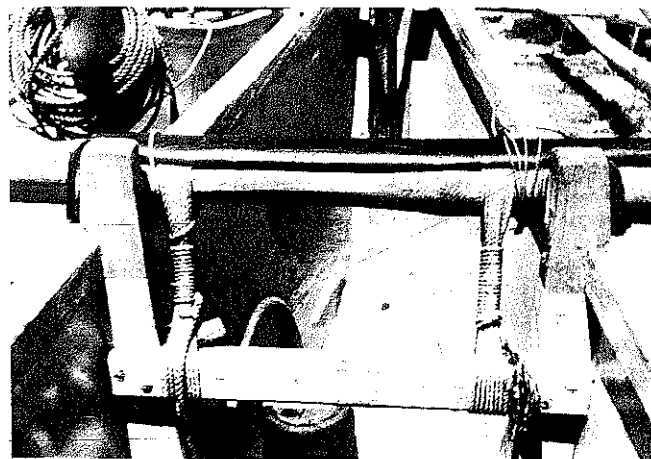

10. The outrigger arms are attached with nylon ropes. Often a narrow platform is attached on top of the outrigger arms at either side of hull. In such a case three arms are used.

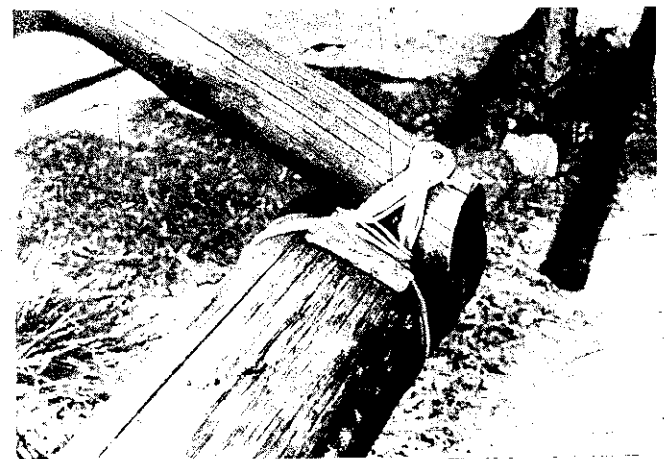

11. The bamboo runners are attached to the arms with heavy nylon fishing line. Note brass nail in top of bamboo arm and piece of old slipper between two bamboos. A thick-walled durable kind of bamboo is used.



(which must be stainless steel or brass) goes through a 19 mm (3/4") galvanized steel water pipe (or brass pipe) which is sealed into the wood. The long tube is packed with heavy grease, and serves as both bearing and water seal. Even if the water rises in the tube it seldom leaks into the hull because the tube comes up close to the engine, higher than the water line when the boat is unloaded. The hull should be curved enough so that the propeller won't hit bottom.

Typical specifications:

- Length of hull: 7 metres
- Size of engine: 8-12 hp.
- Size of shaft: 16 mm (5/8")
- Size of propeller: 8" (20cm)

Where do you get the parts?

Make your own from locally available hardware. Two parts you will not find, and these are available one per customer from LIKLIK BUK, the propeller for K4.00, and the flexible joint for K3.00. Or order from Seaside Trading, 117 Union Civic St., Galas, Quezon City, Philippines.

PROPELLING FERRIE

To change the direction move the tow cable to the other end of the horse:

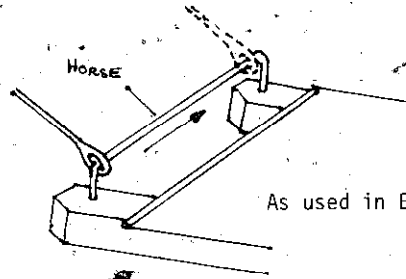

As used in East New Britain



Plywood work boats being built by the Technical Department, United Church, Salamo, MBP.

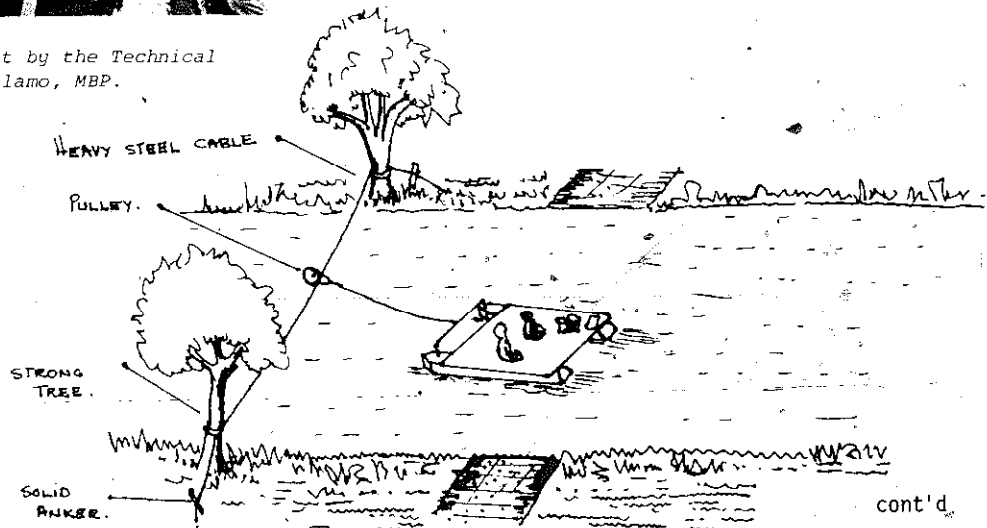
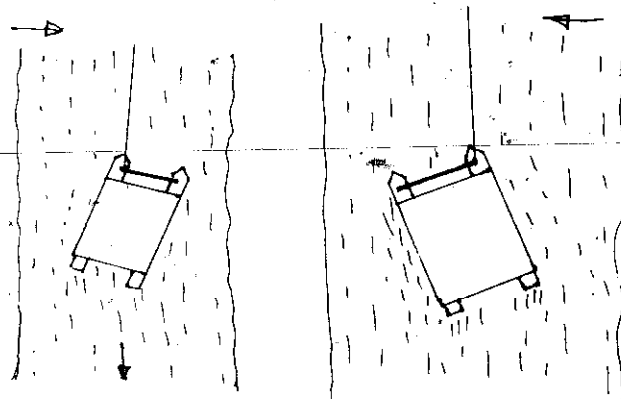

cont'd.

# Village Industry Arts and Crafts

## CLOTHING

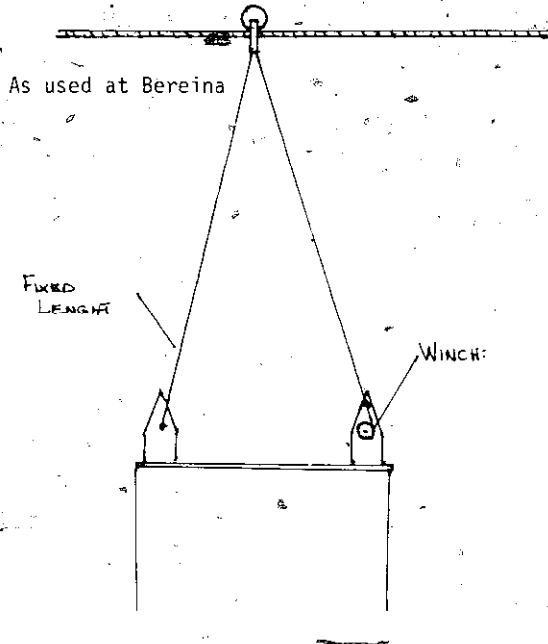

An alternative design: Use two tow cables, one with a fixed length, and one with a winch. To change direction or speed of travel, shorten or lengthen the second tow cable by using the winch.

Suggested by C. Hemmes, Box 2148, Konedobu

We included a few items on clothing in the 1976 edition with the advice that more patterns and ideas could be obtained from the Lae YWCA. They have had so many letters that they are not able to cope with them!

So we have expanded this section - don't write to the Lae YWCA.

We have drawn on two major sources: "Sewing Children's Clothes", a kit from FAO United Nations; and patterns of the Lae Vocational Centre for Girls.

The FAO item "Sewing Children's Clothes" is a very popular kit which includes cards giving instructions for clothes and other useful items, life-size plastic patterns, and a basic sewing course guide. It has been especially designed by a Home Economics expert for women with no experience in cutting or sewing. Though it was developed in Africa, it is quite suitable for PNG. Each kit costs US\$5.00. You may order by sending the equivalent amount in Kina (approx. K3.85) to the United Nations Information Centre, Box 472, Port Moresby, and they will get it for you.



## SAMPLE SEWING LESSONS FOR UNSKILLED ADULTS

### 1. THE MATERIAL

Threads of the material run in two directions:

- a) The WARP or LENGTH. The threads forming the warp are the first to be set up on the loom and are all parallel.
- b) The WEFT or WIDTH. This is woven from a continuous thread running to and fro across the warp, under and over the warp threads. It makes a firm edge on either side, called the selvage.

Fabrics come in different widths. Most of them are 80, 90, 100, 130 or 140cm wide (37, 36, 39 or 55").

The warp and the weft run at right angles.

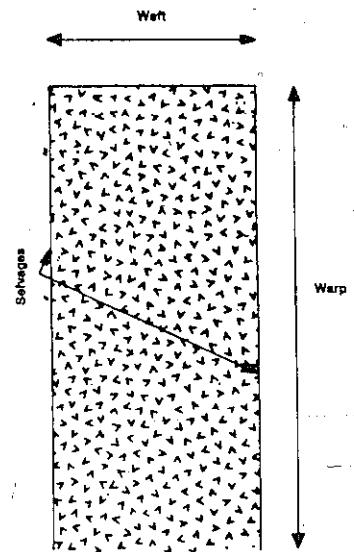

cont'd

They are the two STRAIGHT ways of the fabric. If you hold up a piece of material, gripping it between the thumb and forefinger of each hand, and pull it lightly, you find that:

- in the direction of the WARP the fabric will not stretch;
- in the direction of the WEFT it will stretch slightly;
- in the other direction, ON THE BIAS, it will stretch quite readily.

## 2. PATTERNS AND CUTTING

Where a seamless part of a garment is to be cut out (eg the front of the child's dress), the edge of the pattern is placed along the fold of the material.

The material must be folded absolutely straight and preferably lengthwise to ensure that the garment does not lose its shape.

The edge of the pattern to be placed along the fold is marked with a dotted line.

Cutting should be done on a large table, so that the material can be spread out flat. Pin the pattern to the folded material, making sure that the material stays flat. Cut along the very edge of the pattern. Seams and hems are included in each pattern piece.

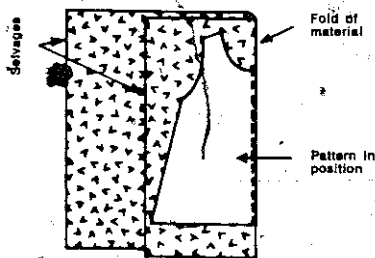

Avoid wasting material in cutting: leave no waste spaces between the pattern pieces and, before you start, arrange the pieces on the material to make sure you make the most of it. This is particularly important if you are using the pattern to cut a batch of garments out of one piece of material.

## 3. NEEDLE AND THREAD.

A working length of thread should not be longer than about 50cm (18"). Learners often tend to make the working length too long. The first stitch is secured by a knot. The knot should be small, placed on the very end of the thread and tucked into the seam so that it does not show. The last stitch is fastened by making two small stitches one over the other. Stitching is always done on the wrong side of the material.

## 4. TACKING.

Tacking is done in large running stitches to hold the work together temporarily until the permanent stitching is completed.

Tacking stitches should be 3mm long, at intervals of about 1 - 1.5cm. This will hold the seam

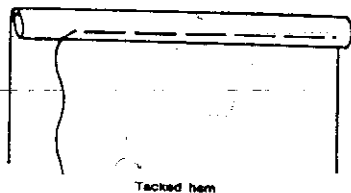

firmly together.

## 5. HEMMING.

The first, narrow turn-in is marked with the finger-nail. Then the second turn-in is tacked and stitched. Hemming should be done with small, oblique stitches, which should hardly show on the right side of the material.

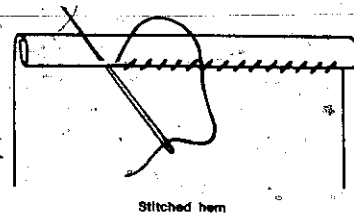

## 6. RUNNING STITCH.

The stitches and the spaces between them are of equal length.

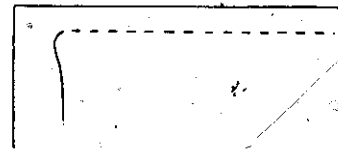

## 7. BACK STITCH.

This is similar to running stitch, except that at each stitch the needle is put back in the last hole of the previous stitch and brought out twice the distance beyond.

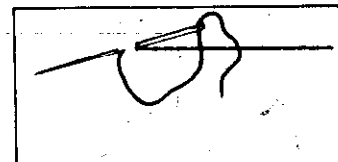

The stitches are end to end, forming a continuous line.

Back stitching is used instead of running stitch where a strong seam is required and also as ornamental stitching on the right side of a garment.

## 8. OVERCASTING.

This is used to hold the raw edges of any material that may fray.

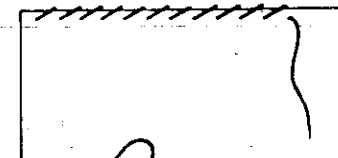

## 9. WHIP STITCH.

This is used to join two selvages or two turned-in edges. Use small stitches, holding the two pieces of material edge to edge.

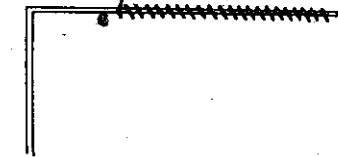

## 10. OVERCAST FLAT SEAM

This is the easiest seam for joining two pieces. The pieces are held edge to edge and joined with running stitch. Each of the raw edges is then overcast, and the edges are opened out and flattened down with the finger-nail. Alternatively, the raw edges may be overcast together.

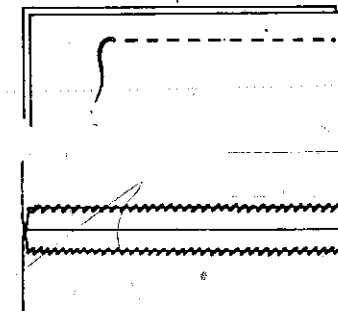

### 11. FELL SEAM

A fell seam is worked in two stages:

a) Use running stitch to join the two pieces of material, which should be so placed that the edge of the piece underneath shows by 0.5 cm.

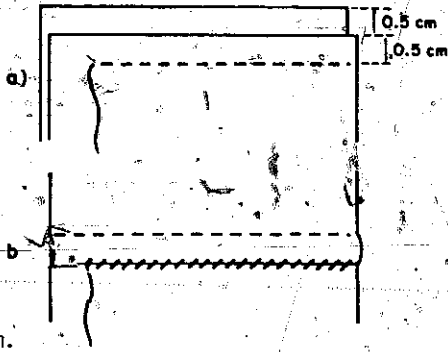

b) Smooth down the seam. Then turn in the wider edge and stitch it down like a hem over the other.

### 12. STEM STITCH

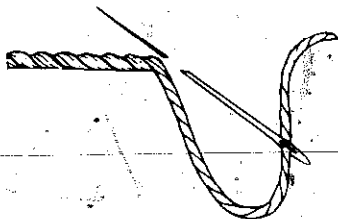

### 13. HERRINGBONE STITCH.

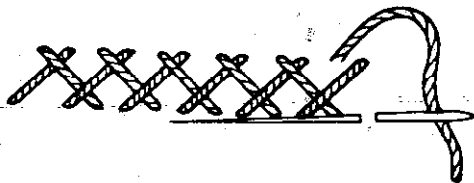

### 14. SCALLOP STITCH.

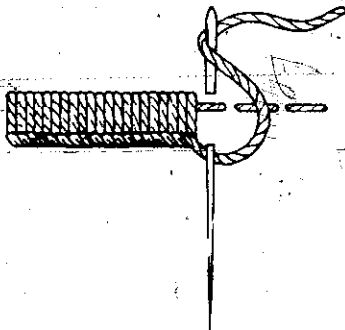

### 15. BUTTON LOOPS

a) On the edge of the hem, make a few long stitches, loose enough to form a loop as wide as the button.

b) Cover the loop with closely placed scallop stitches (or better still, buttonhole stitch).

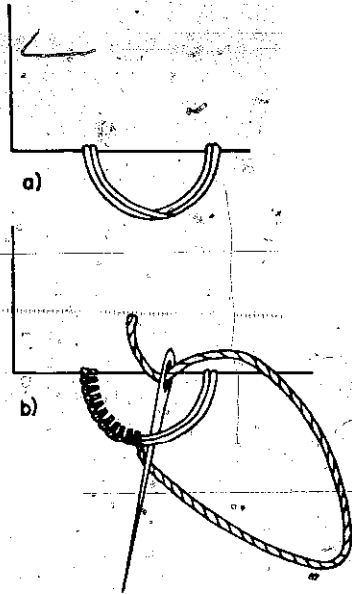

### 16. BUTTONHOLES

a) Working carefully on the straight, cut a slit as long as the button is wide.

b) Work the edges of the slit with buttonhole stitch.

c) Secure the ends of the buttonhole by worked bars.

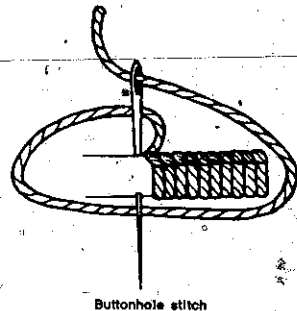

Buttonhole stitch



Finished buttonhole

### 17. SEWING ON A BUTTON.

a) Secure the thread with a knot and make one stitch where the button is to be.

b) Pass the thread 4 or 5 times through each hole in the button, taking care not to pull it too tight, so that there are 2mm or so (a fraction of an inch) between the button and the material.

c) Wind the thread several times round the threads holding the button, and secure with two stitches on the wrong side.

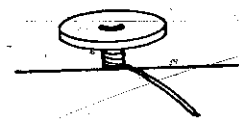
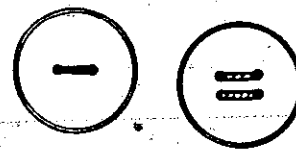

## 18. POCKETS.

- Cut out the pocket as shown.
- Along the top edge, make a 1cm hem. Use either of these two methods:
  - hem stitch, on wrong side,
  - back stitch, on right side.
- Tack a 1cm turn-in all the way round.
- Tack the pocket onto the garment where required, ensuring that it is straight.
- Stitch on with a row of back stitch 2mm from the edge. Strengthen the corners of the pocket by working a triangle at the top of each side seam.

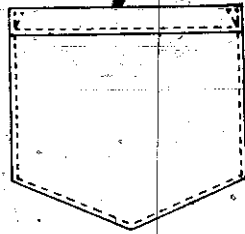

Patch pocket

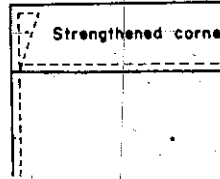

Strengthened corner

## MENDING

Mending sometimes requires special skills such as darning and patching, but most mending needs only those skills which are used in sewing. This is so for mending hems and seams, sewing on buttons and turning worn collars.

The lesson in mending will consist in showing learners how to neatly repair their own clothes and other items they may bring from home.

It may, however, include a piece of practice work in darning to help learners master a skill which is frequently used.

As whip stitch or fell seam patching is difficult for beginners, this kind of mending will be adequately dealt with by showing learners how to set on a hem-stitched patch where required.

### DARNING.

Darning is done with so-called "darning cotton" or, failing this, with thread. Either should match the garment in colour and thickness. A darn is made up of parallel rows of running stitches. The stitches in each row correspond to the spaces between the stitches in the previous row. No knot is used at the beginning, and the last stitch is not secured with extra stitches. At the beginning of each row the thread should form a tiny loop so that the darn is not pulled tight.

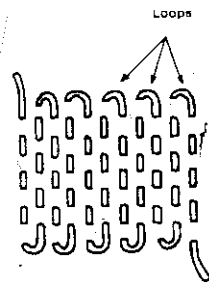

Strengthening darn

### STRENGTHENING DARN.

This is a darn made on a part of the garment which has worn thin without wearing through.

### DARNING A SPLIT.

Darning stitches are made on the straight, at right angles to the split. A single stitch should never cross both edges of the split. Broken threads on the raw edges of the split are laid along the edges and held down while the work proceeds. The darn begins and ends with a strengthening darn over a centimetre or so at either end of the split. It should cover 1cm on either side of the split.

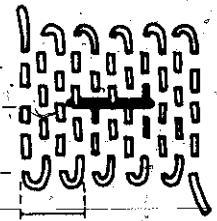

1 cm

### DARNING AN L-SHAPED TEAR.

Each portion of the L is darned in the same way as a split, and the two darns overlap at the angle.

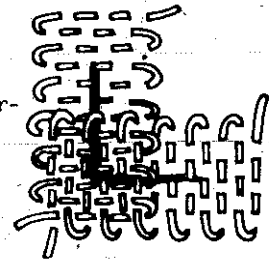

### DARNING A HOLE.

The first part of the darn is done so that the hole is covered by parallel threads. The second part is worked at right angles to the first, the needle being passed alternately over and under each of the parallel threads, so that a kind of weave results.

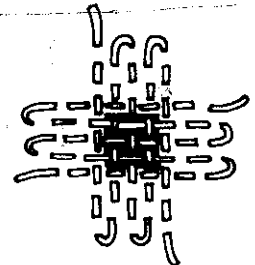

NOTE: To mend a split whose edges are clean or a tear in a little-worn garment, work a simplified darn, passing the needle alternately over and under each of the edges, with a single row of stitches along each edge of the tear.

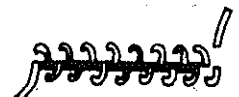

## HOW TO PUT A NECK FACING IN A GARMENT



1. Put slightly oversize material in position, the two right sides together. Mark the desired neck opening. If you are putting a slit for the front or for a zipper, allow at least 1 cm between the two lines. Now sew on your mark.



2. Cut out the circle, 1.5 cm inside from stitching. Also cut down centre of slit.

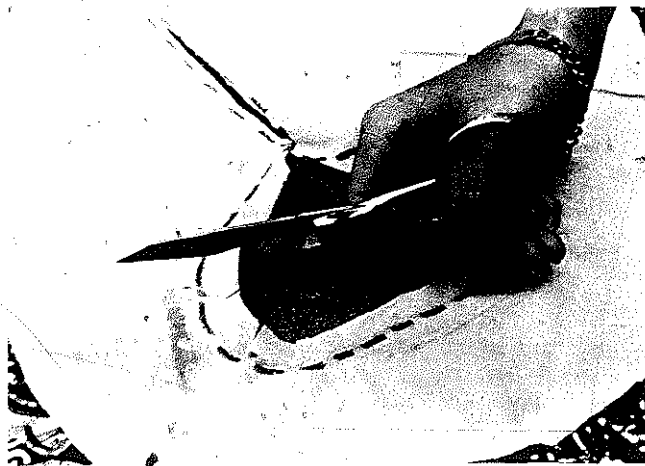

3. Snip around curved areas. Don't get too close to stitching. Trim corners where slit meets circle.

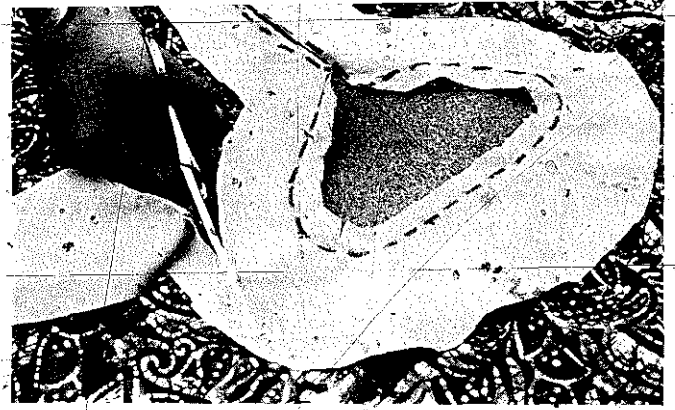

4. Trim excess facing material.

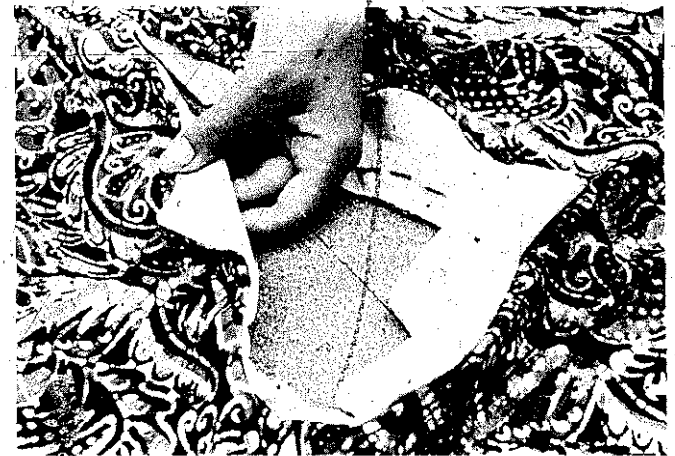

5. Turn facing under, exposing the right side. If you like, hem-stitch the edge of the facing inside.

Suggested by L. Williams, Box 80, Lae

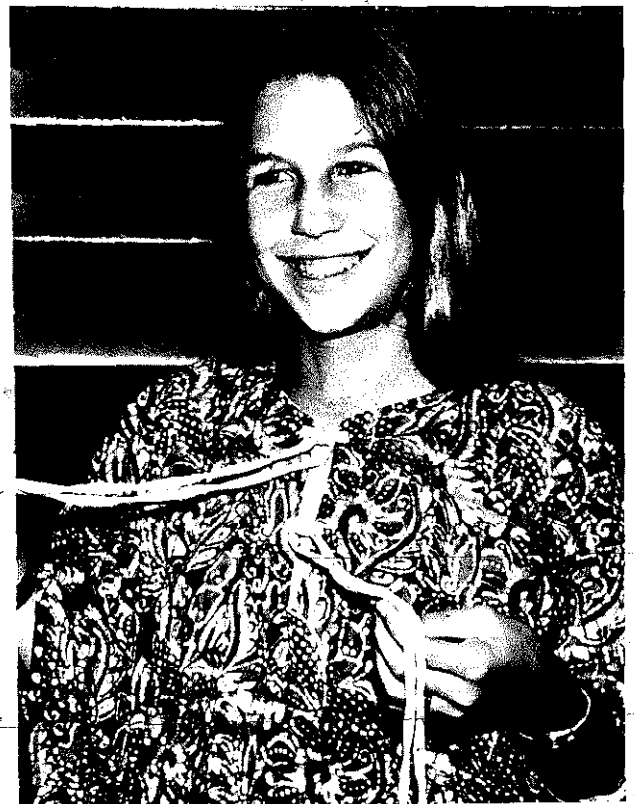



To Sew Dress:

1. Running stitch - edges of dress (4 - 7 - 10) using small stitches, turning under a little bit of material ( $\frac{1}{2}$ " )
2. Slip hem sleeves (4-3-4).
3. Running stitch outside edge of facing, turning material under as you sew.
4. Place facing on dress with right side of facing. Back stitch around neck using very small stitches. Slip hem facing down onto wrong side of dress.
5. Join sides of dresses (4-7). Back stitch - place a piece of material (4" X 1") around curve of side seam. Sew. Clip (short cuts with scissors) curves of side seams.
6. Hem bottom of dress.

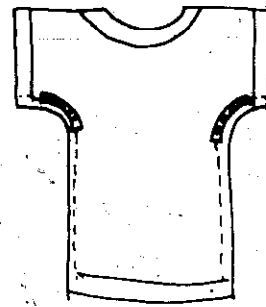
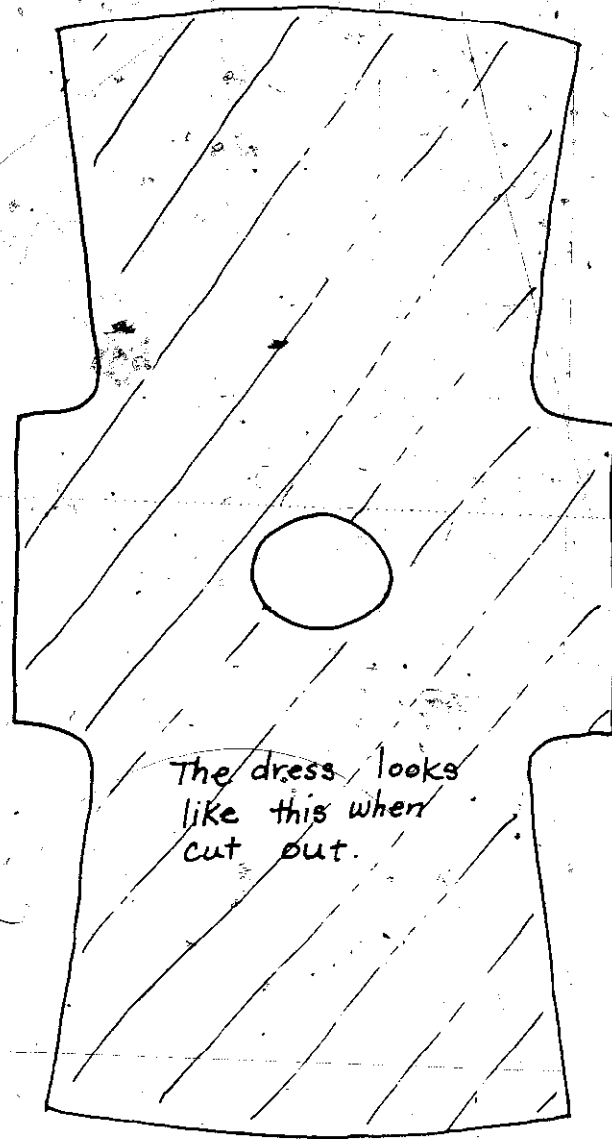
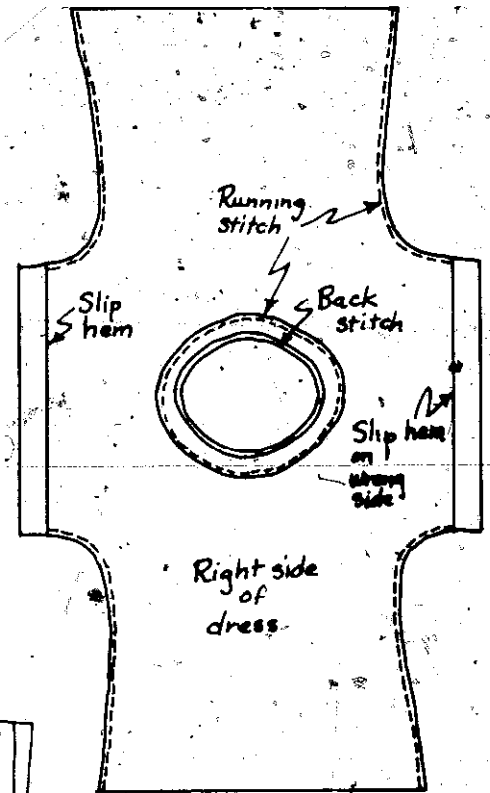

BUTTERFLY DRESS

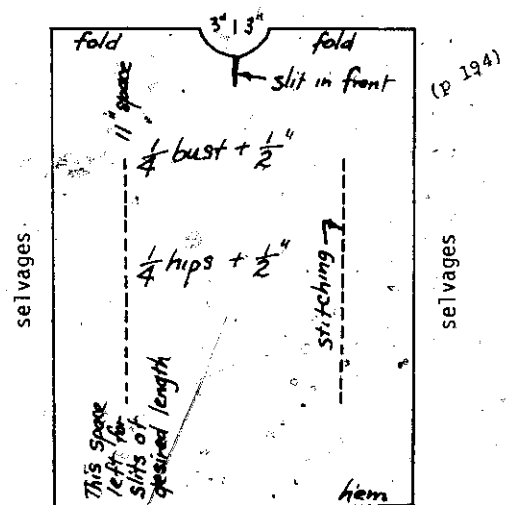

ALL DIMENSIONS IN THIS SECTION ARE IN INCHES



EASY SHIFT

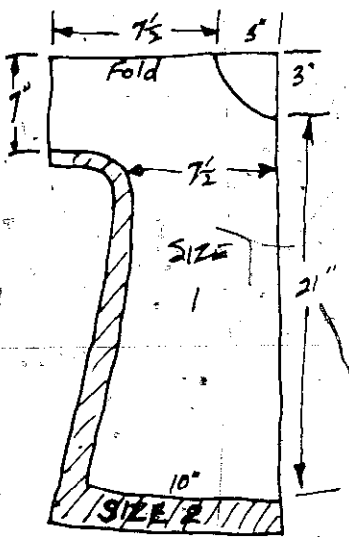

SIZE 2 - add  $\frac{1}{2}$ " to side seam  
1" to hem

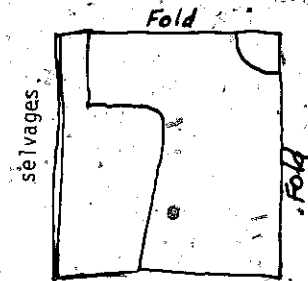
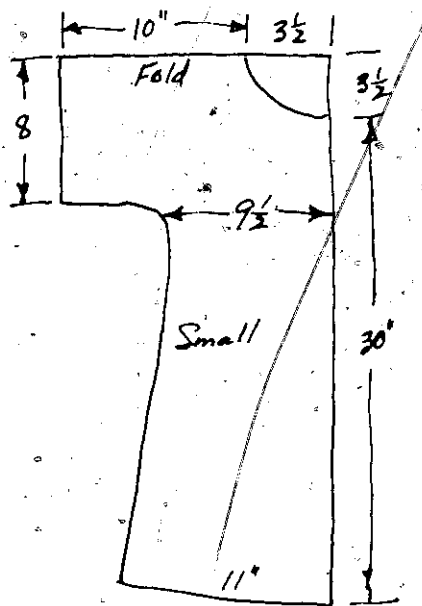

TO PLACE PATTERN ON MATERIAL

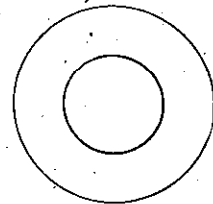

(p. 194)

FACING

Complete circle 2 1/2" wide

Sewing:

1. Neaten edges of side seams and facings.
2. Sew hems of sleeves.
3. Sew facing on shirt, then turn facing inside. Then on the outside sew a line of stitching  $\frac{1}{8}$ " from edge, around the neck.

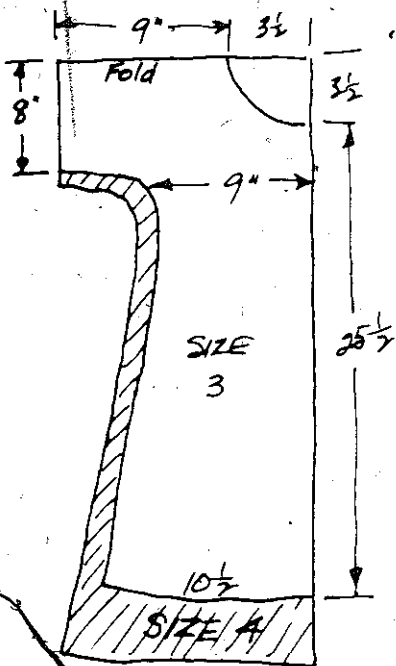

SIZE 4 Add 5" to hem  
1" to side seam

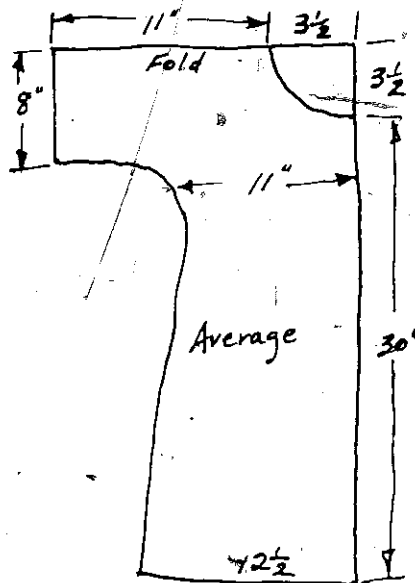

ALL DIMENSIONS IN THIS SECTION ARE IN INCHES

Alas! Most patterns we have were originally in Imperial measurements. We'd like to change, but we're afraid to make convenient conversions until the metric measurements are tested. Please send us your tested measurements for these (and any other) designs.

ALL DIMENSIONS IN THIS SECTION ARE IN INCHES.

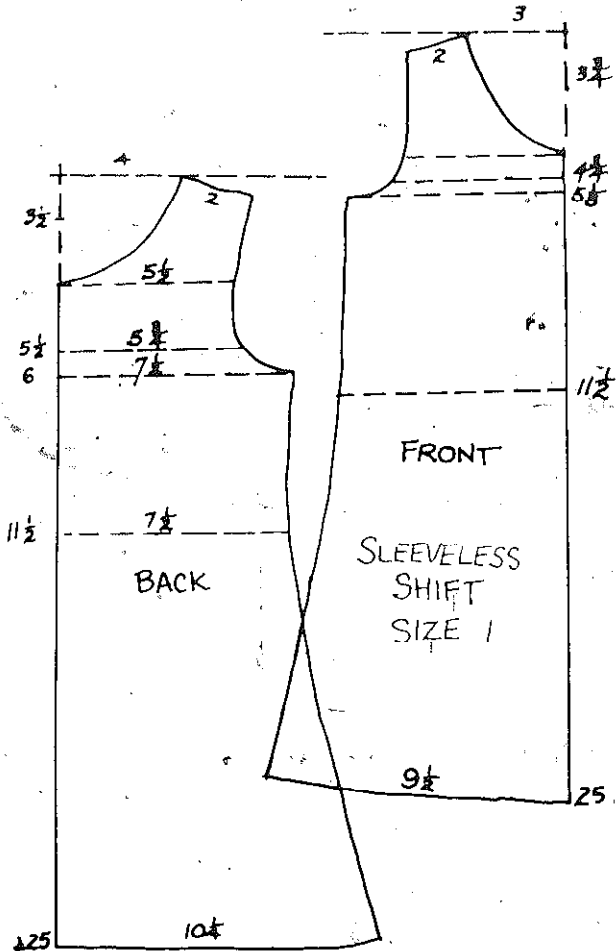

all measurements in this column are from top corner in all shift patterns.

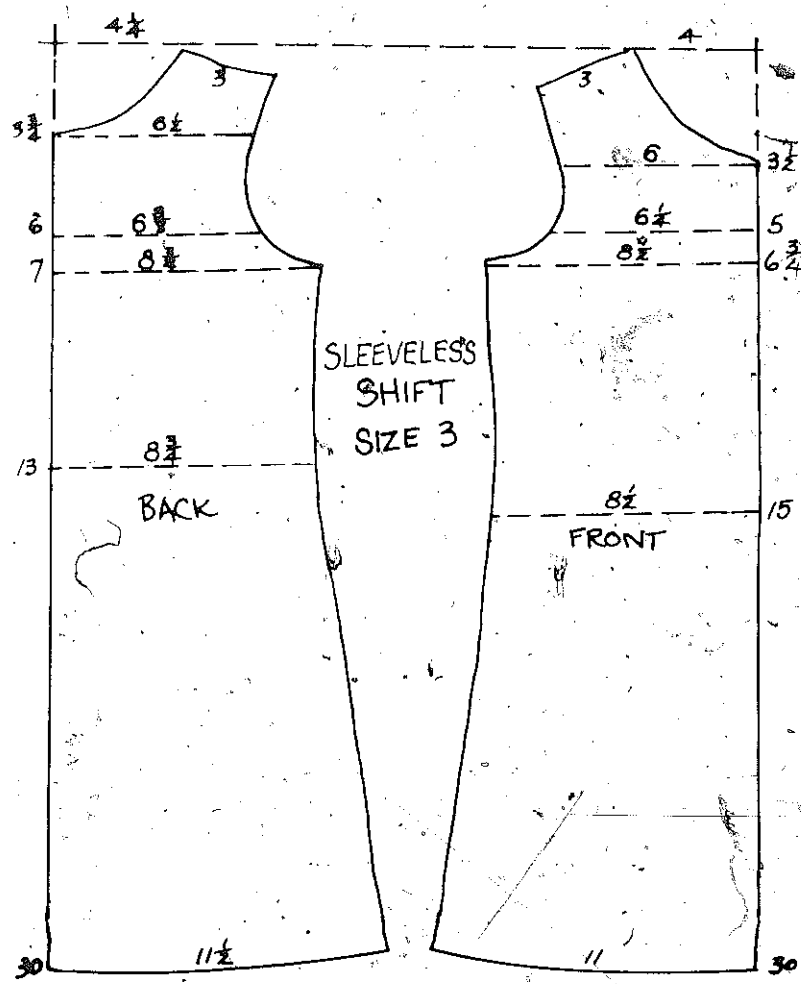

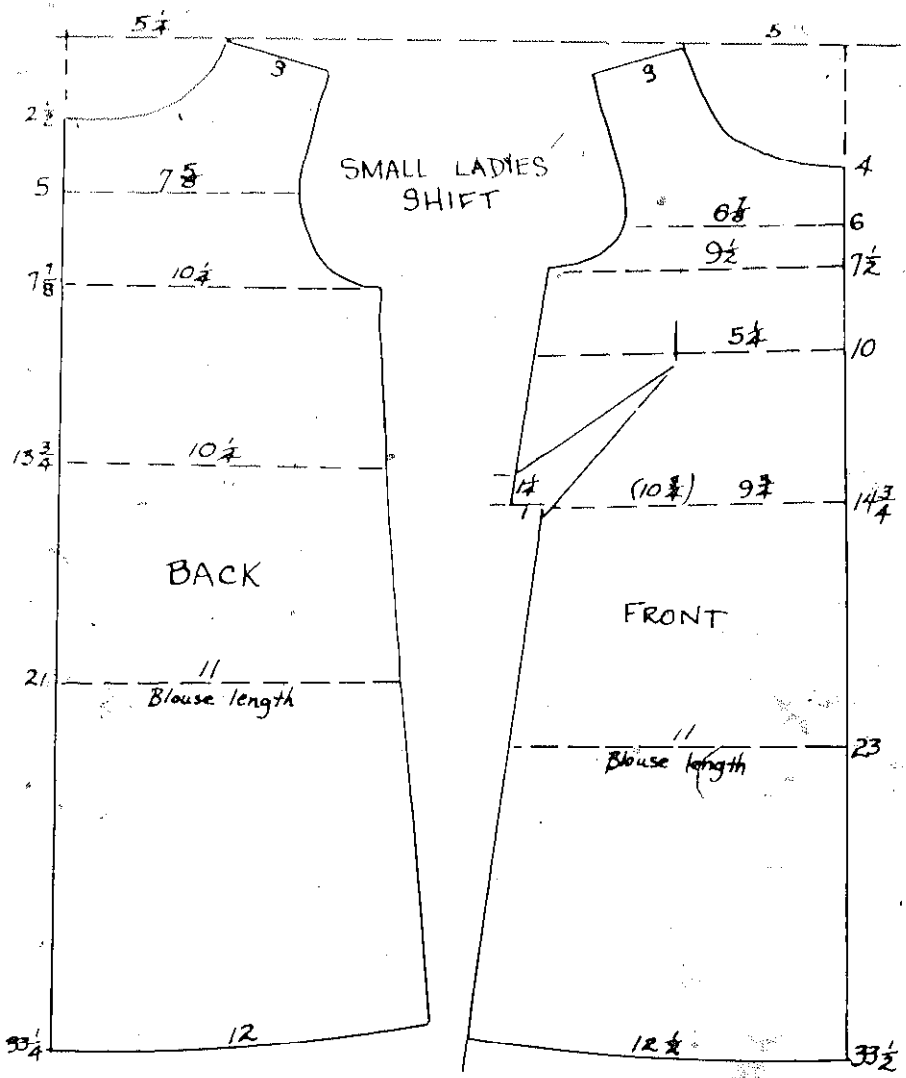

### EASY PANTS

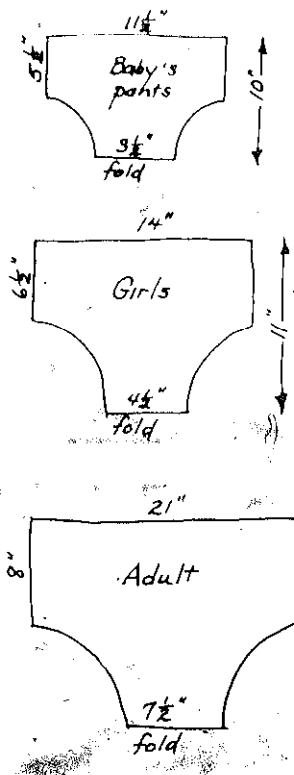

SEWING  
 1. Hem legs first by hand or machine, turning a small hem (1/4").

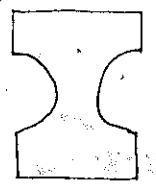

2. Join side seams together. Overcast edge.



3. Turn hem at top wide enough for elastic.

ALL DIMENSIONS IN THIS SECTION ARE IN INCHES.

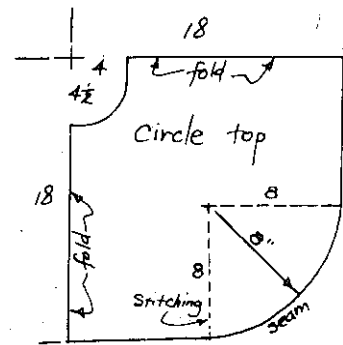
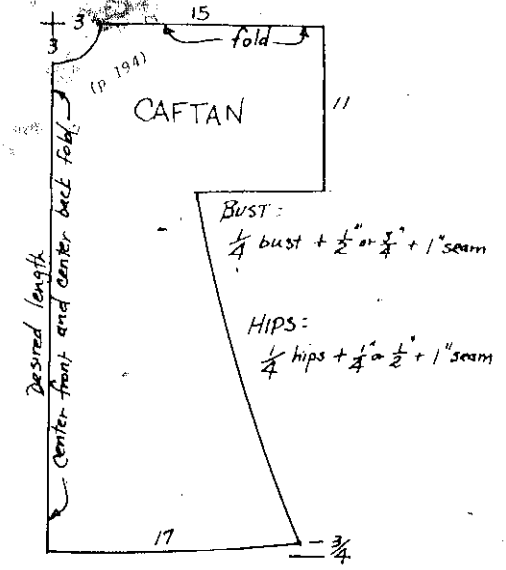
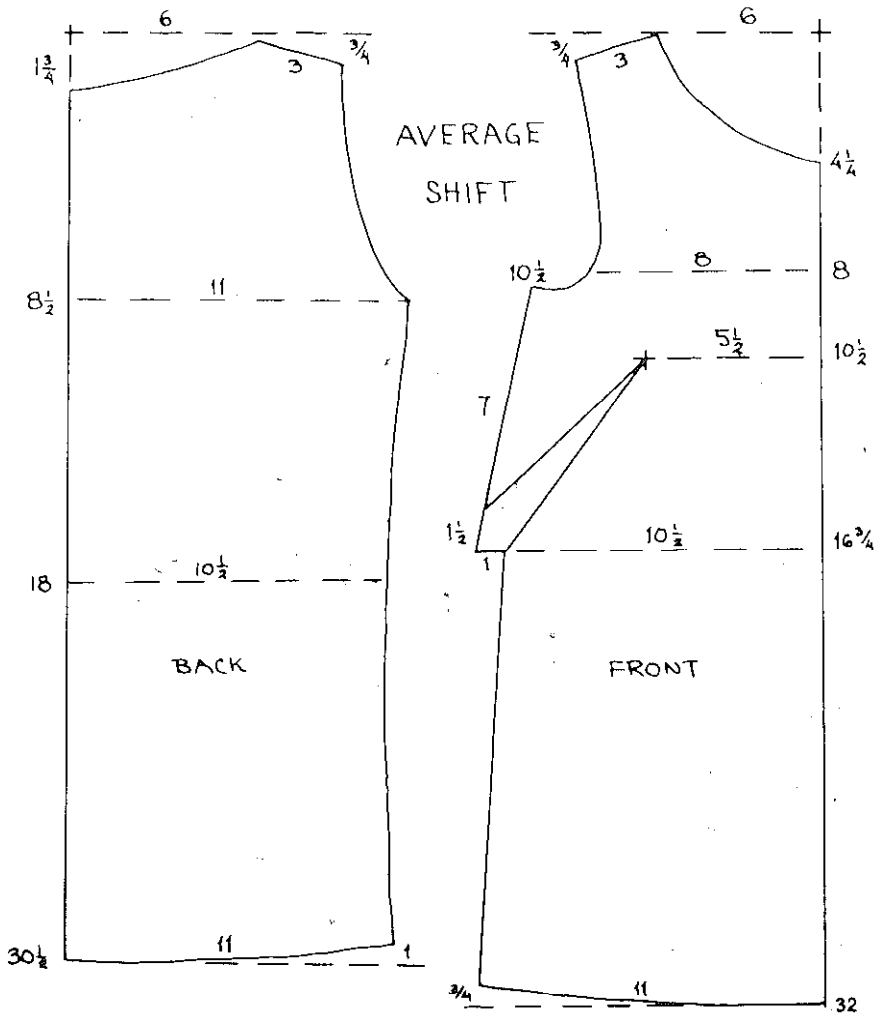

ALL DIMENSIONS IN THIS SECTION ARE IN INCHES.

# MERI BLOUSE

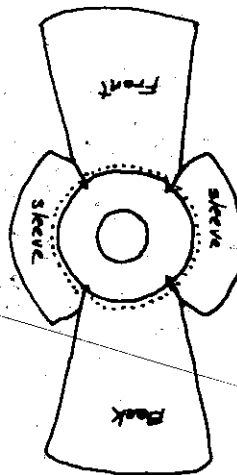
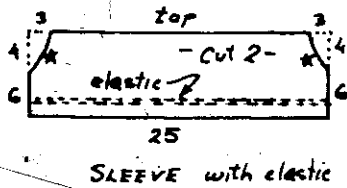
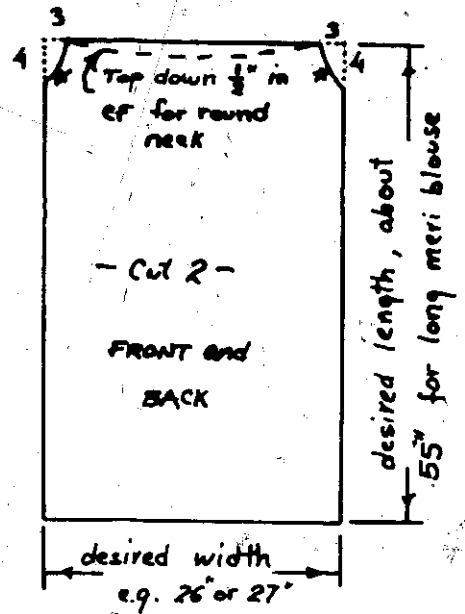
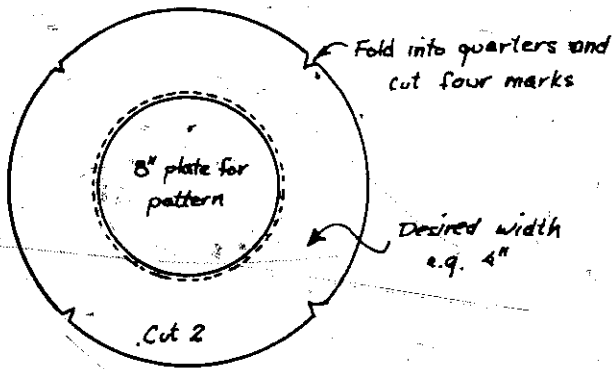

## ROUND NECK

1. Sew neck pieces together, right sides together. Clip and turn.
2. Gather top of front, back, and 2 sleeves.
3. Sew armholes (marked \*) together. Attach to neck, matching marks cut in round neck with armhole seams.
4. Sew elastic hem or armbands. If you want a sleeve with armband rather than an elastic, make the sleeve 7" wide (not 10") and make sleeve band 11½" x 5"-or to fit.
5. Join side seams

## SQUARE NECK

Instead of round neck make front and back yokes and shoulder straps.

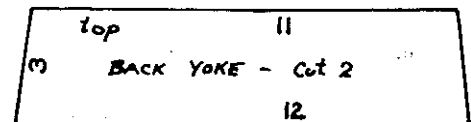
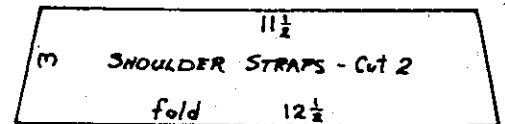
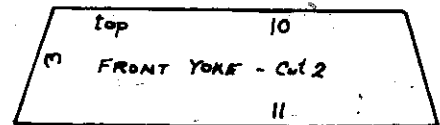

ALL DIMENSIONS IN THIS SECTION ARE IN INCHES

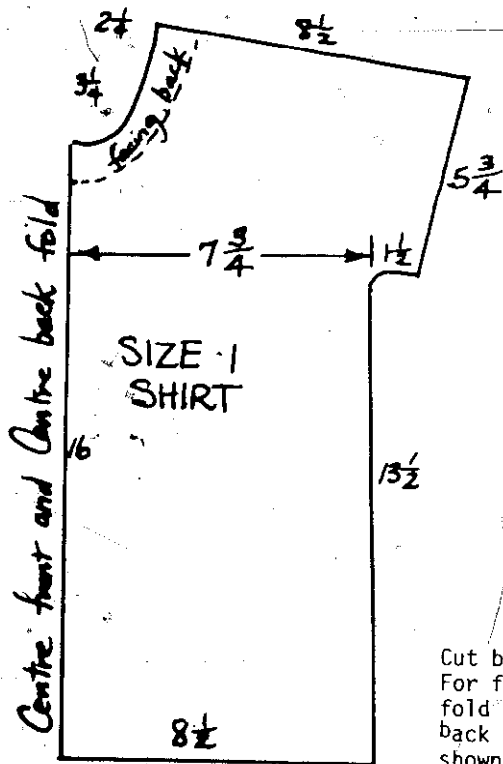

SHIRTS FOR BOYS

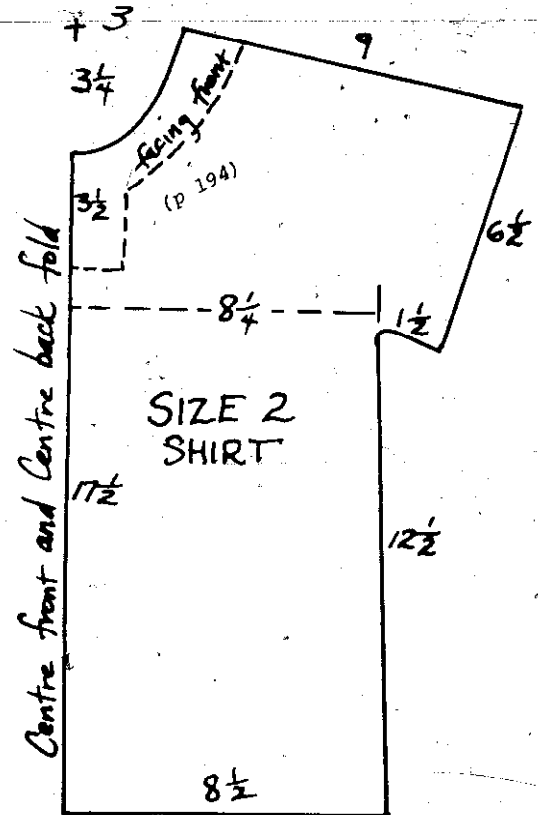

FOR ALL SHIRTS:

Cut both front and back on fold. For front cut facing, also on fold as shown on size 2. For back cut facing on fold as shown on size 1.

ALL DIMENSIONS IN THIS SECTION ARE IN INCHES

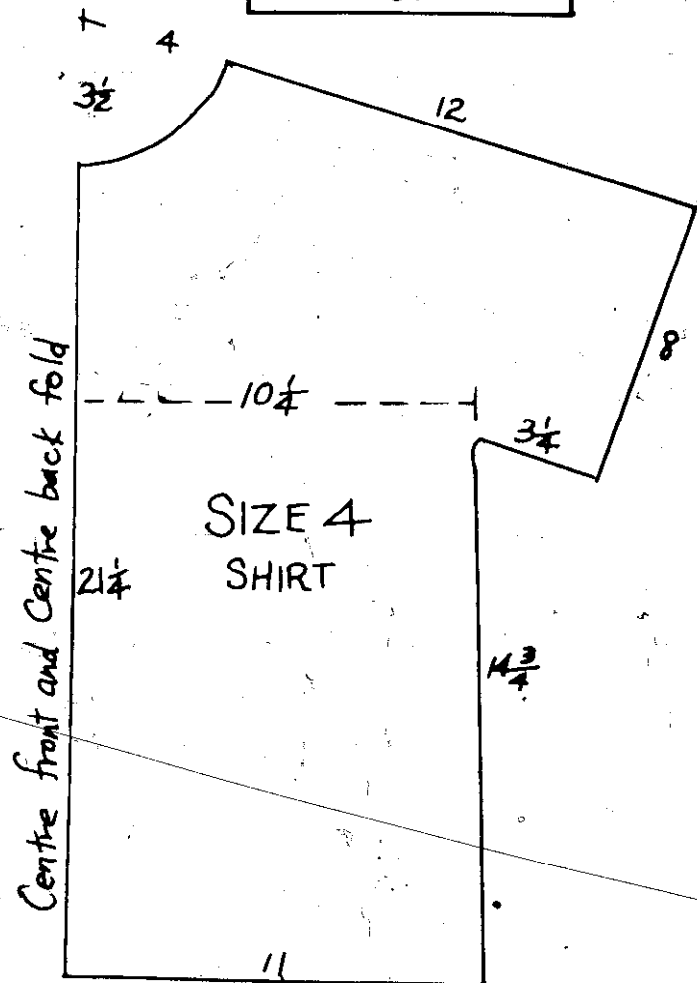
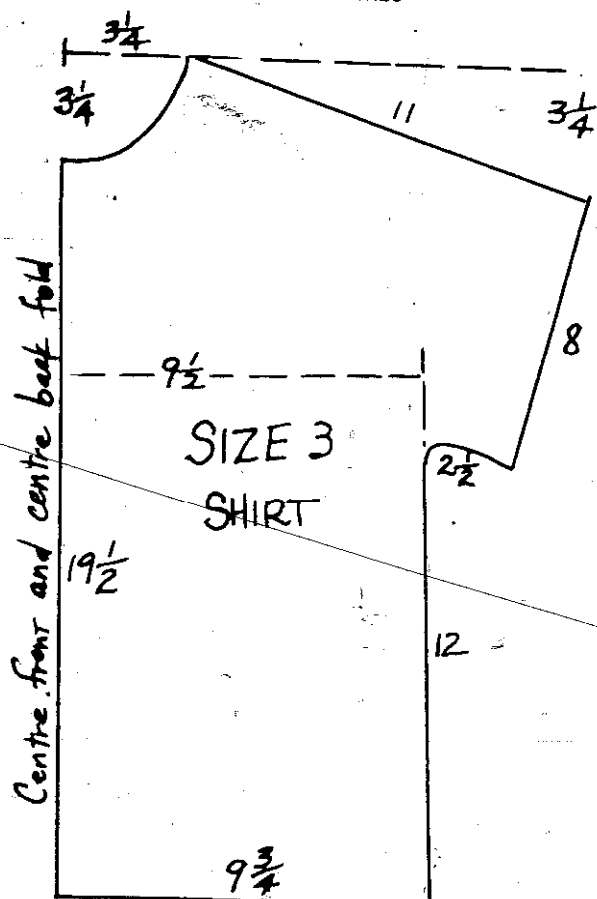

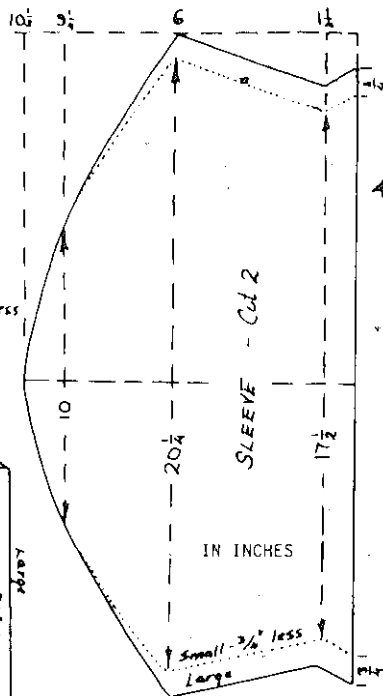
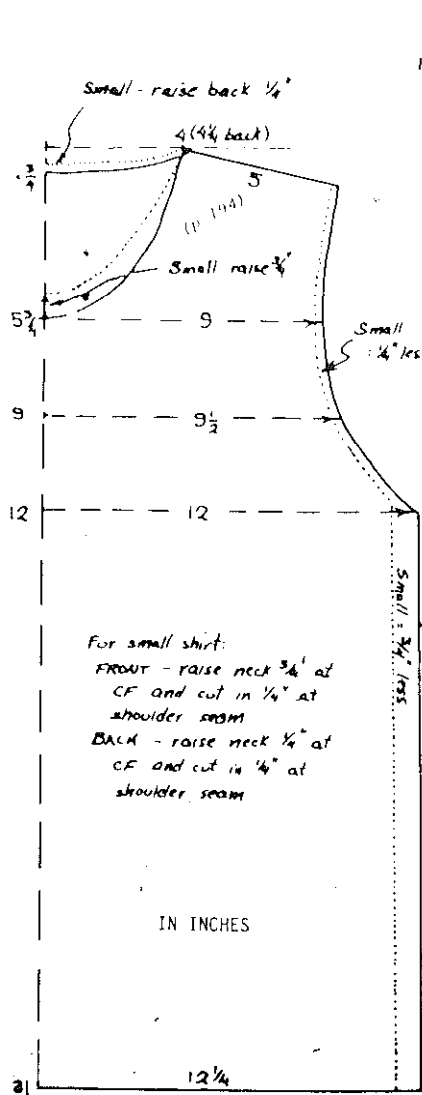

AFRO SHIRT WITH SLEEVES

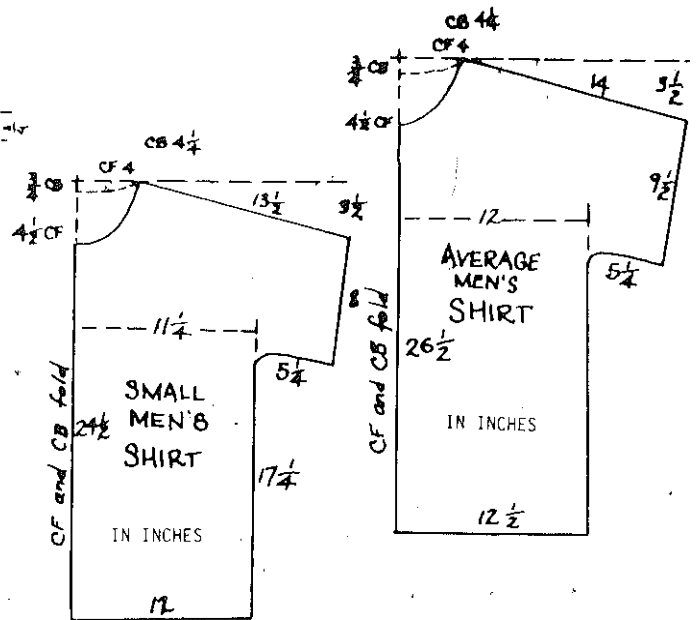

EASY AFRO SHIRT

FOR AVERAGE SIZE MAN; MAKE YOUR OWN ADJUSTMENTS.

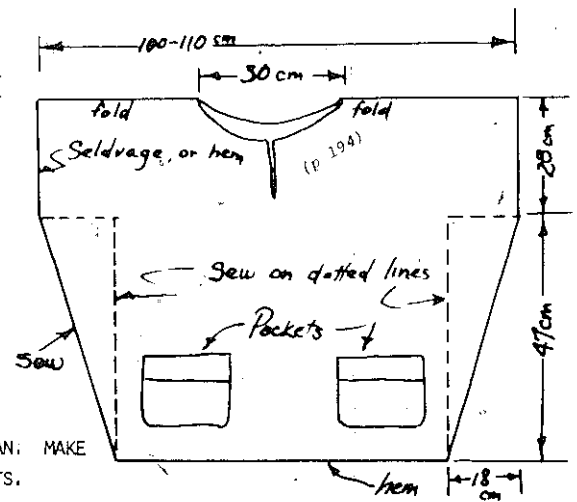

THE FOLLOWING SERIES OF PATTERNS IS FROM "SEWING CHILDREN'S CLOTHES", A POPULAR KIT PREPARED BY FAO, UNITED NATIONS.

(P 190)

### SLEEVELESS TOP FOR A CHILD

6 - 12 months

The top will be made from a thin material, plain, checked or striped. It may be made to match the pants.

Materials: Sewing materials. Fabric 25 x 70 cm wide. Four tops can be made from 75 cm in a width of 90 or 100 cm. 2 fasteners.

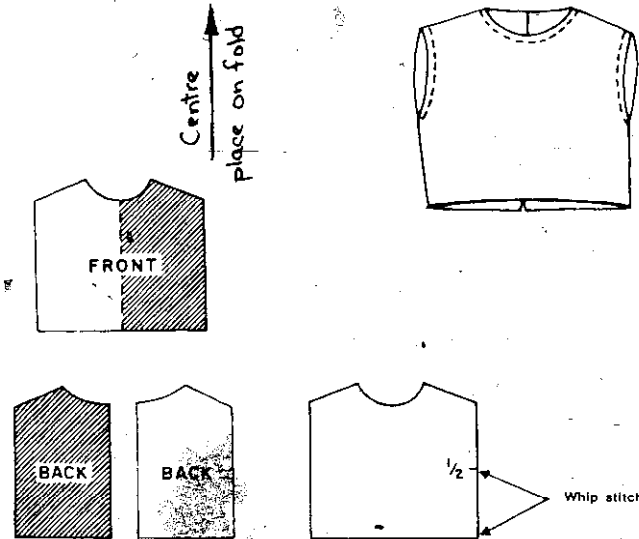
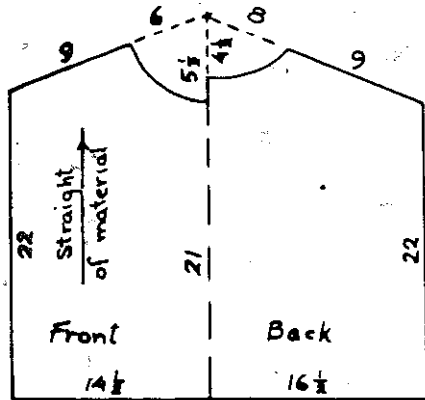

Cutting: The front is cut in one piece. The back is in two halves and has a 1 cm overlap. The bottom edge and sides are cut on the straight.

Sewing:

1. Hem sides and bottom edge of front and back pieces. Width of hem: 0.6 cm.
2. Work narrow hems round the neckline, front and back.

3. Work a 1 cm hem down the centre edge of each half of the back.
4. Fell seam the shoulders.
5. Whip stitch the sides together to half way up their length.
6. Decorate the neckline with a row of herring-bone stitch about 0.6 cm from the edge.
7. Sew the two fasteners to the hems of the back pieces, one in the top corner and the other 8 cm lower down. Buttons and buttonholes may be used instead of fasteners.

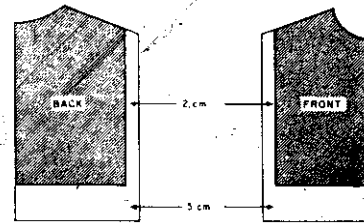

NOTE

To adjust the pattern to fit a 2 - 3 year-old child, add 2.5 cm to the side of each pattern piece, and about 5 cm at the bottom.

### SIMPLE DRESS FOR A LITTLE GIRL

1 - 2 years

This dress requires very little material and is easy to make. Use a bright-coloured cotton fabric.

Fabric: 35 x 70 cm

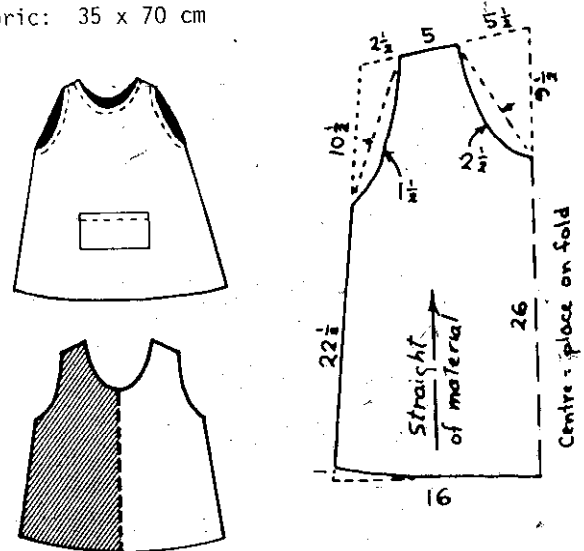

Cutting: The dress is made of two identical pieces, front and back, joined by side and shoulder seams. The dress has a slightly rounded hem.

cont'd

ALL DIMENSIONS IN THIS SECTION ARE IN CENTIMETRES



### Sewing:

1. Fell seam the shoulders.
2. Fell seam the sides.
3. Work facings for the neck and armholes, or work narrow hems.
4. Make a 2 cm bottom hem.

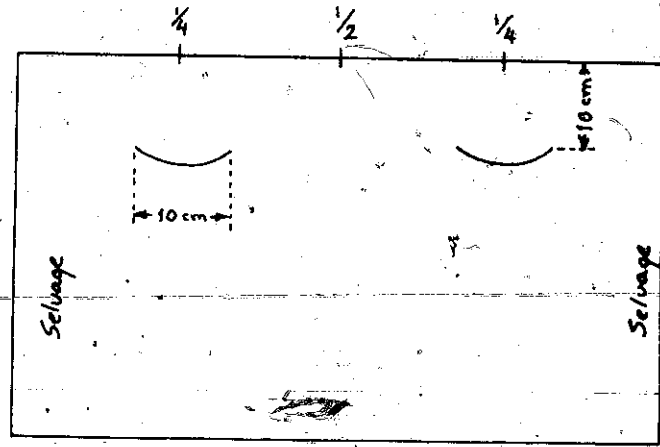
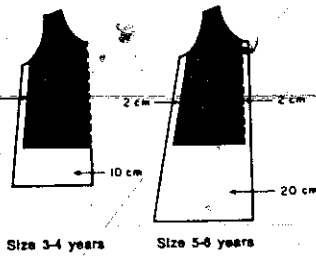

### Notes:

A sleeveless shirt to fit a 1 to 2 year-old boy will be obtained from this pattern, shortened by 10 cm.

A rectangular piece 12 x 8 cm may be added to front to form a pocket. The pocket as well as the neck and armholes may be decorated with embroidery.

### Sewing:

1. Tack a single turn-in not more than 3 mm wide all round the arm slits.
2. Cover the turn-in all round with buttonhole stitch, using embroidering cotton.



## GATHERED DRESS FOR A LITTLE GIRL

1 - 4 years

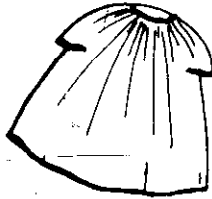

This is an attractive little dress, which can be worn for several years if a wide hem is allowed at the bottom. Use a thin cotton fabric. The dress is extremely easy to cut and to sew, although edging the armholes may be slightly difficult for beginners.

### Fabric:

- a.) To fit age 1 - 2 years: 40 x 70 cm.
- b.) To fit age 3 - 4 years: 55 x 80 or 90 cm.

Elastic: 25 cm

**Cutting:** The dress consists simply of a rectangular piece of material with a seam down the back and an elastic to gather it round the neck. Two curved slits make up the armholes.

Cut the rectangle to the size required, leaving the selvages intact. Mark out with a pencil first the half and then each quarter of the total length of the top edge.

Ten cm below each quarter-mark, pencil the arm slits on the fabric. Cut neat slits along the pencilled lines.

3. Flat-seam together the two short sides of the rectangle (the selvages).
4. Make a 2 cm hem at the bottom.
5. Hem the top, allowing 1 cm clear inside the hem for the elastic to pass through.
6. Pass the elastic through this hem with a safety pin. Overlap the ends of the elastic and join them by overcasting.

### Notes:

1. This pattern may be used to make a child's top opening at the back (size to fit age 1 - 2 years). The top requires 30 cm of fabric 70 cm wide, and 80 cm of tape. The tape (or ribbon) is used instead of elastic to gather the neck and is tied at the back.
2. The dress or top can have a front pocket (rectangular piece 14 x 8 cm). The pocket may be embroidered to match the edging round the arm slits.

ALL DIMENSIONS IN THIS SECTION ARE IN CENTIMETRES

## AFRICAN TUNIC FOR A LITTLE GIRL

2 - 4 years

The tunic is made from bright-coloured cotton fabric.

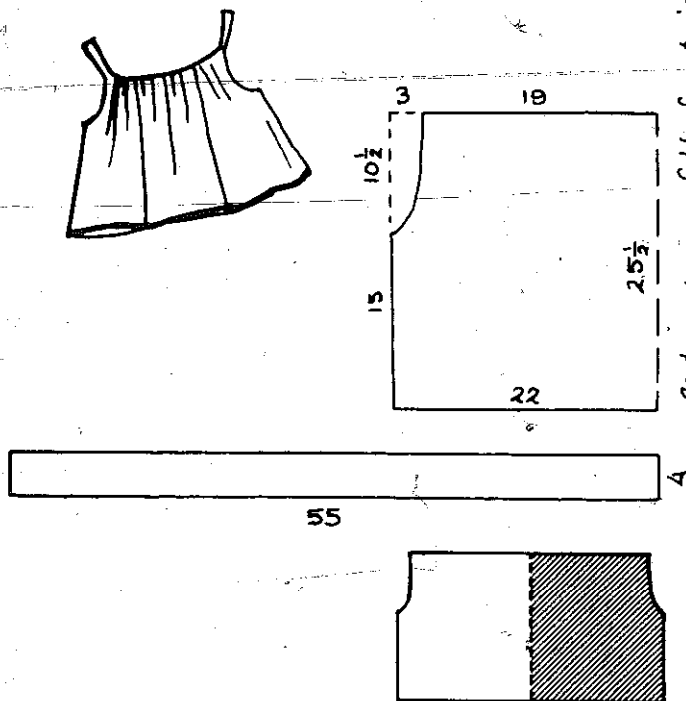

Fabric: 30 x 90 cm

Cutting: Back and front are the same. Both are gathered at the top by means of a strap passed through the hem. The strap is made from a strip of material 55 x 4 cm.

Sewing:

1. Work narrow hems round armholes.
2. Work 2 cm hems at top of front and back.
3. Join sides with fell seams.
4. Make a 1 cm hem at bottom.
5. To make a strap, tack a 1 cm turn-in along the edges and whip stitch together.
6. Pass strap through both hems at top and sew the two ends together.

Notes:

1. To adjust the pattern to size 5 - 7 years, add 5 cm at the bottom and make the strap 65 cm long.
2. A little dress may be obtained from the same pattern. Simply add 10 to 20 cm at the bottom, according to age.

ALL DIMENSIONS IN THIS SECTION  
ARE IN CENTIMETRES

## TUNIC (SINGLET) FOR A LITTLE GIRL

5 - 7 years

Fabric: 40 x 80 cm wide.

Cutting: Back and front are identical.

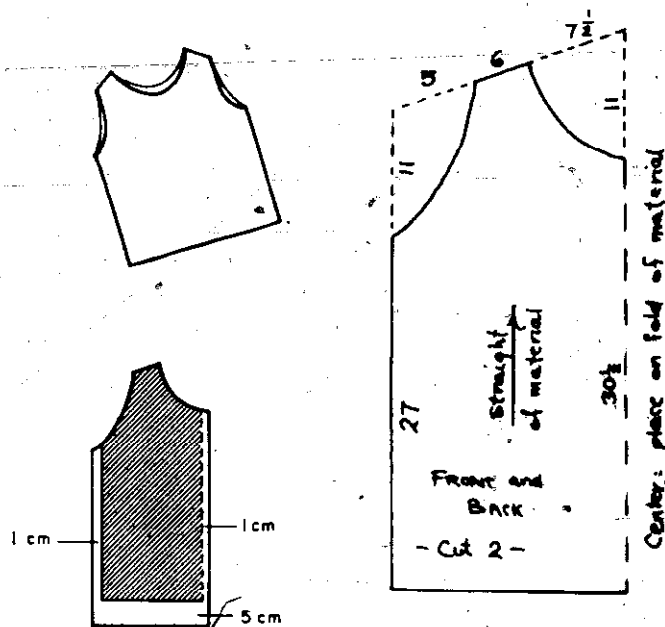

Sewing:

1. Fell seam shoulders.
2. Fell seam sides.
3. Work narrow hems round neck and armholes;
4. Make a 2 cm bottom hem.

Note: To adjust the pattern to size 8 - 10 years, add 1 cm to the side and to the centre edge of the front piece and 5 cm at the bottom.

## SHORTS FOR A CHILD

6 - 10 years

Use a plain, tough, nonsoiling cotton fabric. The shorts have an elastic waistband and are slightly gathered. They are easily run up and make a practical garment, just right for little boys at school.

Fabric: 30 x 100 cm

Elastic: 40 cm

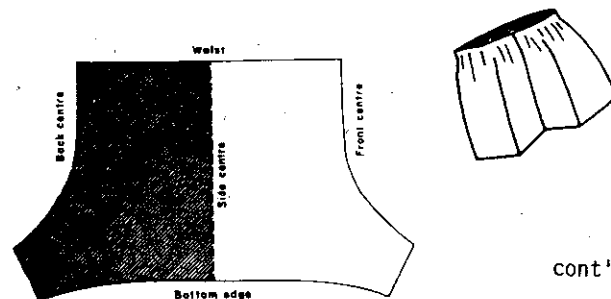

cont'd

Cutting: Front and back are the same. Cut out twice, with the material folded double. There are no seams down the sides. The garment has only centre seams, front and back.

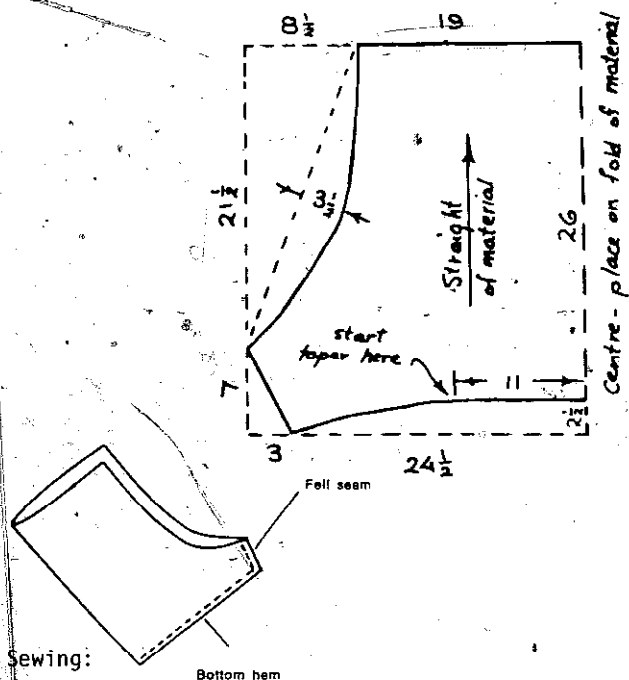

Sewing:

1. Fell seam each leg to form leg openings.
2. Make a hem 0.4 cm wide round each leg opening.
3. Join the two halves of the garment with a fell seam, making sure that the two inside leg seams fit together accurately.
4. Make a hem a little wider than 1 cm round the waist, and pass the elastic through it with a safety pin. Overlap the ends of the elastic and join by overcasting.

Note: The shorts may be provided with a pocket. Place a square piece of material 12 x 12 cm on the back of the right-hand half of the garment.

### SLEEVELESS BLOUSE FOR A CHILD

6 - 10 years

The garment is cut out in one piece and requires 90 cm wide fabric. The collar and pocket are cut out separately.

Fabric: 55 x 90 cm

Cutting: Fold the material selvage on selvage. Apply the pattern so that the centre line of the back (dotted line) lies exactly on fold of material.

Mark the centre line of the front on the fabric with pencil.

Cut out so that the selvages at the edge of the facing are left intact. (The facing is the inside turn-in of the garment.) If the fabric is

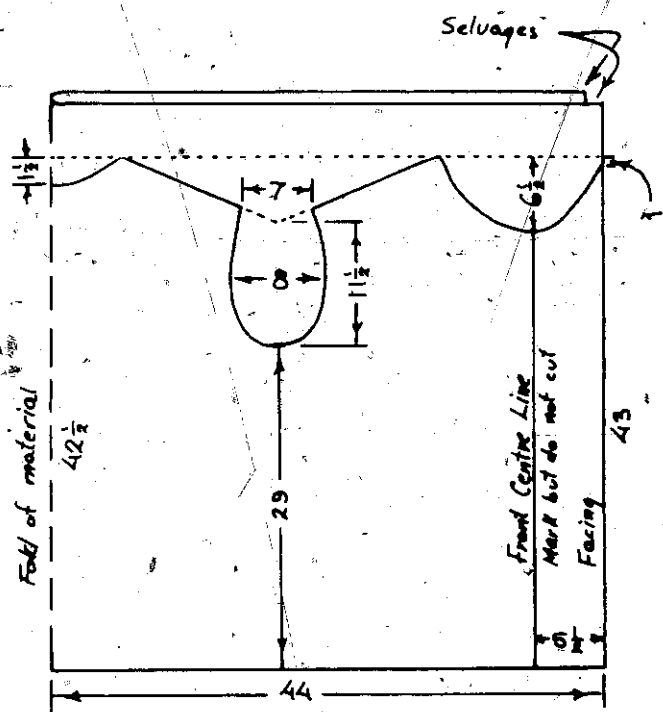
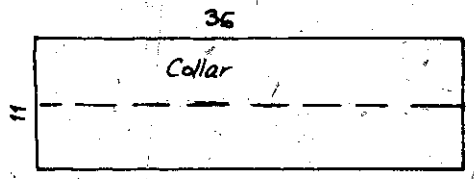

exactly 90 cm wide, the edge of the facing will coincide with the selvages. If the width of the material is slightly more or less than this figure, the facing will be made that much wider or narrower, but do not change the front centre line or cut away the selvages.

The collar is made from a rectangular piece of material, measuring 36 x 11 cm which will be folded in half lengthwise.

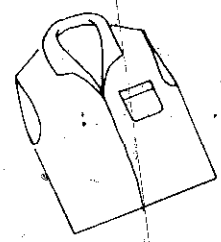

Sewing:

1. Make a narrow hem around armholes.
2. Fell seam shoulders.
3. Make a 1 cm hem at bottom.
4. Turn in facings as pencil-marked, tack them down and whip stitch at bottom.
5. Fold collar piece lengthwise and seam the ends 1 cm from edge. Turn inside out. Smooth down seams.
6. Fit collar. To do this, first pin the ends and centre of the collar to front corners and centre of opening, on the inside. Then tack inside portion of collar to neckline from the inside and back.

stitch, 0.5 cm from the edge. Finally, working from the outside, hem stitch the outer portion of the collar over this seam.

- Whip stitch the front of the garment up to 13 cm from the collar.

Note: A pocket made from a square piece of material 12 x 12 cm may be added on the left side of the front. The pocket may be embroidered with a design or with the child's initials.

## AFRICAN TUNIC FOR A TEENAGER

Bust 80 - 90 cm

Fabric: 50 cm x 100 cm wide

Mark material as shown, or make pattern first, if desired.

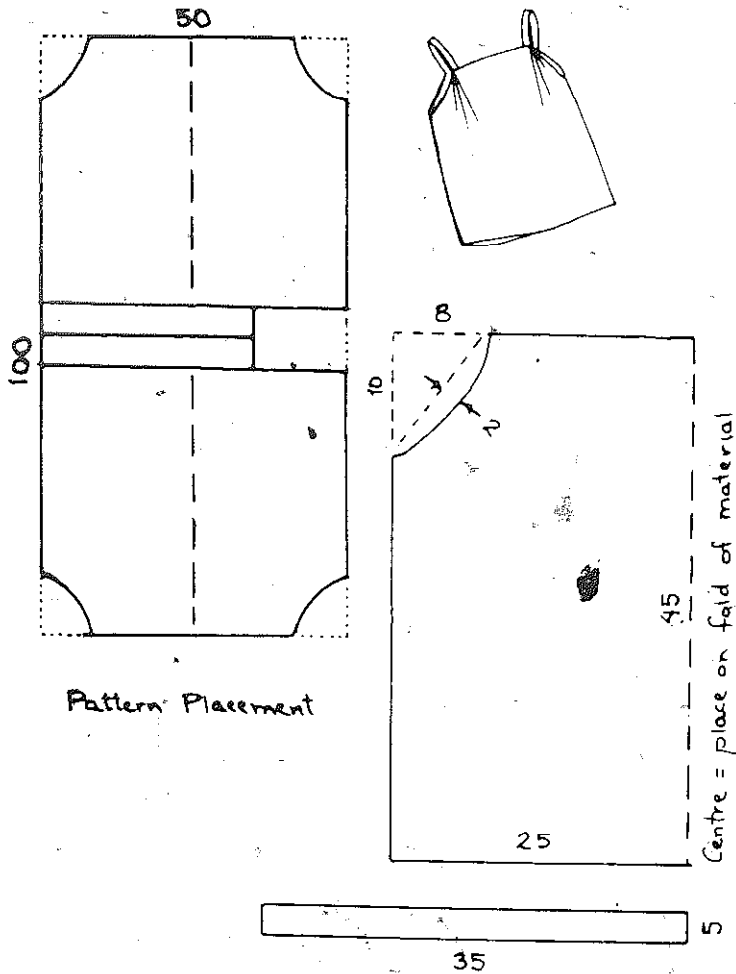

### Sewing:

- Make a narrow hem around each armhole.
- Make a fold 2 cm wide at each top angle of the front and back piece, and secure the fold with a few stitches. See that on the outside the fold is laid toward the armhole.
- Work 1 cm hems along the top of the front and back.
- Fell seam the sides together.

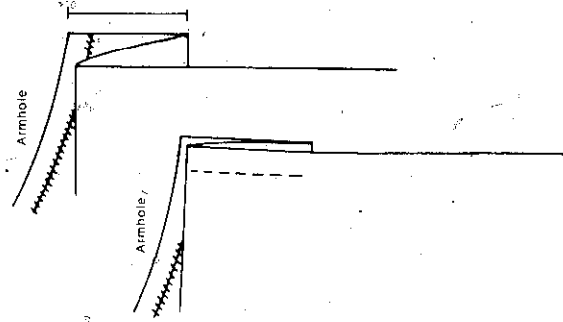

- Make a 1 cm hem at the bottom.
- Make the straps by tacking a turn-in, just over 0.8 cm wide, along the edges and then whip stitch the edges together.

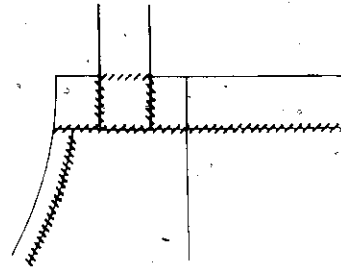

- To attach the straps, fasten their ends to the centre of each fold on the inside, and hem stitch down.



WRAP AROUND SKIRT

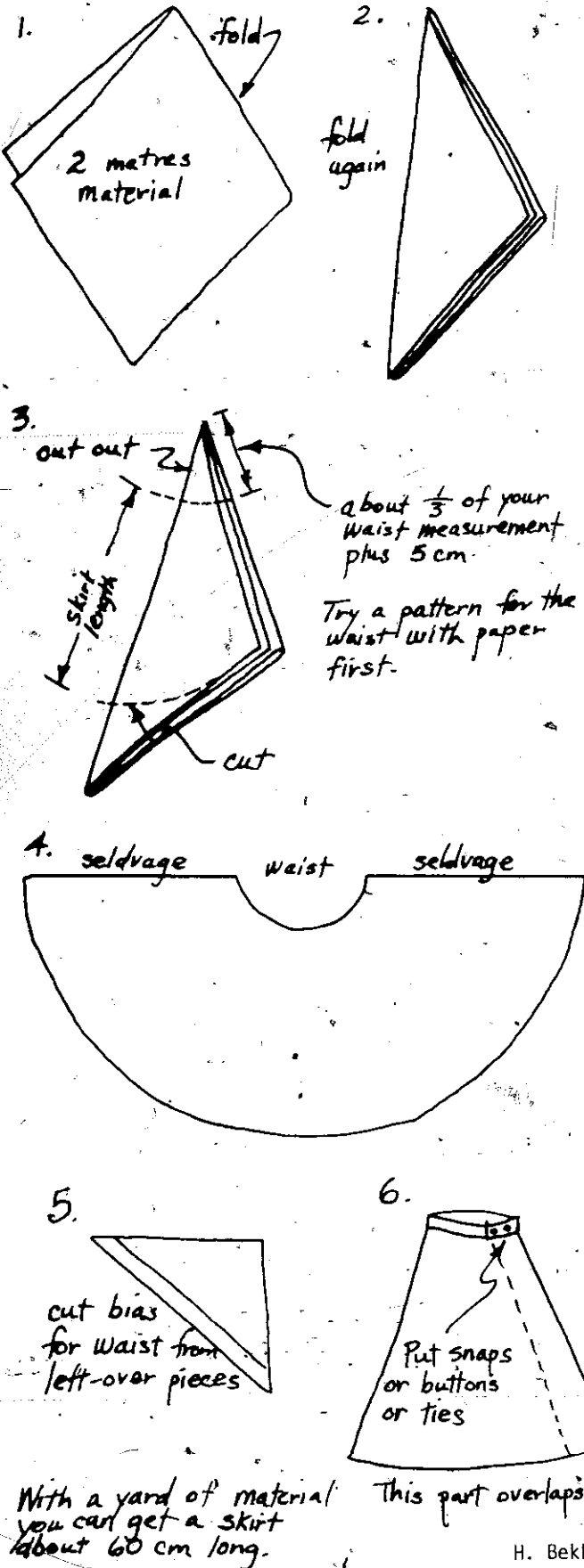

With a yard of material you can get a skirt about 60 cm long.

H. Bekker

WOVEN COLD SHIRT

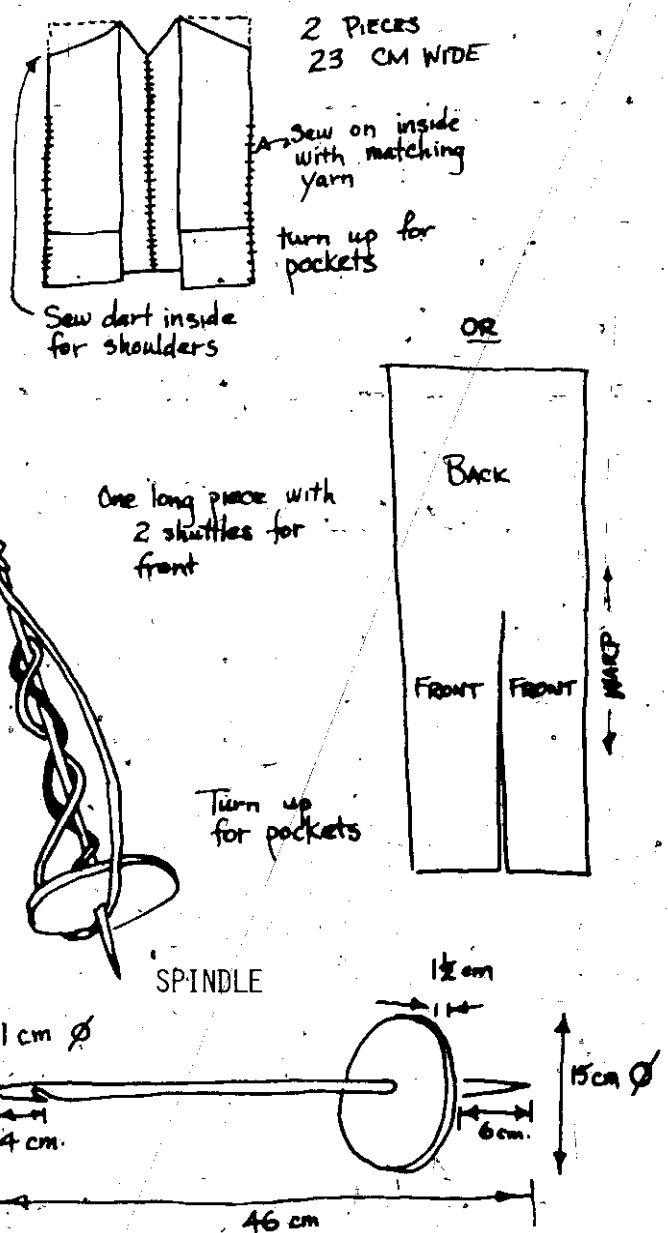

Crochet hook made from hard wood or bamboo  
Used for

Cold Shirts\*  
Ponchos  
Blankets  
Caps

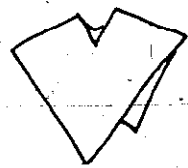

\*Same as long piece woven. Crochet sides; add sleeves if desired. Spin wool or silk on spindle loosely, crochet, or knit, make needles from bamboo.

H. Bekker

# EASY DECORATIONS

(p. 146)

Easily done embroidery on rik-rak braid can brighten plain clothes.



Pin rik-rak braid on material.



Tack rik-rak in place.



Sew anchoring stitch in embroidery cotton.



Sew holding stitch in embroidery cotton across rik-rak.



Remove tacking stitch.

Use 3 strands at a time out of 6 strand embroidery cotton.

Also try multiple rows at different spacings, or add a pattern of simple stitches between or around the rows of rik-rak.

Initial contributor: S. Holzknecht  
Box 5854, Boroko



# HOW TO CROCHET

\*See footnote

1. To begin: Hold wool or string between thumb and index finger of the left hand, with the thread extended between the other fingers. Hold the hook by the flange between the thumb and index finger of the right hand. Use the second finger of the right hand to control the stitches on the stem of the hook. Take the hook under and over the extended thread, forming a loop over the hook as shown in diagram (a). Take the hook under and over the thread again as shown in (b). Draw the wound thread through the initial loop to form the first stitch on the hook as shown in diagram (c). Pull the end of the wool to draw up the slip knot below the stitch. Hold this knot (or the base, as work proceeds) between the thumb and index finger of the left hand.

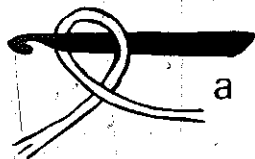

a

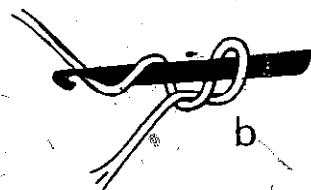

b

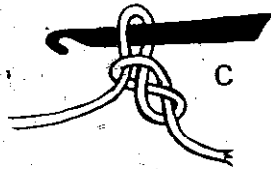

c

2. Chain: This forms the basis of all crochet stitches and it should be practised until it is worked to perfection. Each stitch should slip easily over the hook and must be even throughout. With the first loop on the hook, take the hook under and over the extended thread as

shown in diagram (a): Draw the wound thread through the loop on the hook, forming a chain stitch as shown in diagram (b). Continue working chain stitches as required. See diagram (c).

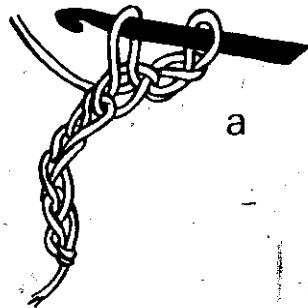

a

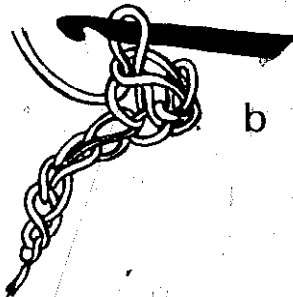

b

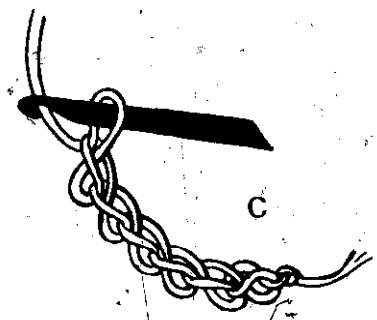

c

3. Double Crochet: Work through both loops of stitch unless otherwise stated in the pattern. Miss 1 ch., \*draw loop through next ch. as shown in diagram (a). Draw loop through the 2 loops on hook, completing 1 double crochet stitch (1 d.c.) as in diagram (b). Repeat from \*, working 1 d.c. in each successive ch. to end. To turn, work 1 ch.

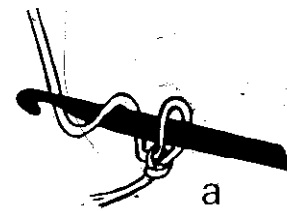

a

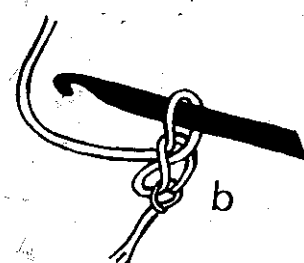

b

4. Half Treble: Miss 2 ch., \* wool over hook, insert hook through next ch. as shown in diagram (a). Draw loop through 3 loops on hook as shown in diagram (b). Wool over hook and draw through 3 loops, completing half treble stitch as shown in (c). Repeat from \* for number of stitches required. To turn, work 2 ch.

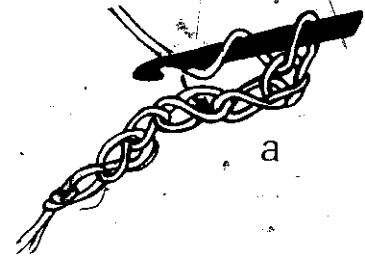

a

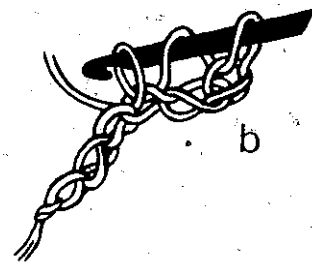

b

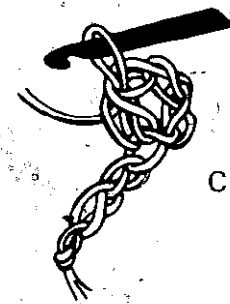

c

\*means "repeat until the next\*"

cont'd

5. Treble: Miss 3 ch., \*wool over hook, draw loop through next ch. -3 loops on hook as shown in diagram (a). Wool over hook and draw through 2 loops as shown in (b), wool over hook and draw through remaining 2 loops, completing one treble stitch as shown in (c). To turn, work 3 ch.

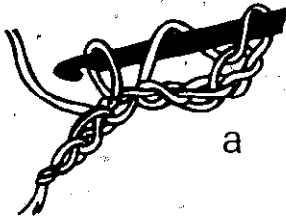

a

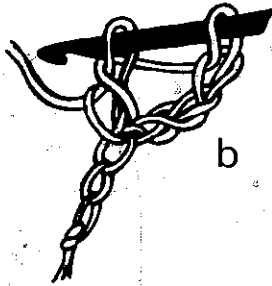

b

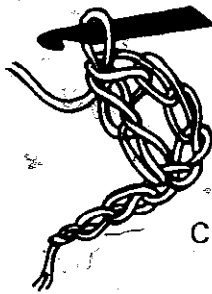

c

6. Double Treble: Miss 4 ch., \*(wool over hook) twice, draw loop through next ch., 4 loops on hook as shown in (a). (Wool over hook and draw through 2 loops) 3 times, completing 1 double treble stitch as shown in (b). To turn, work 4 ch.

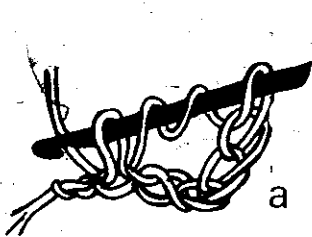

a



b

FURNITURE

(p 251)

STUDENTS CHAIR TYPE C

age group 9-12

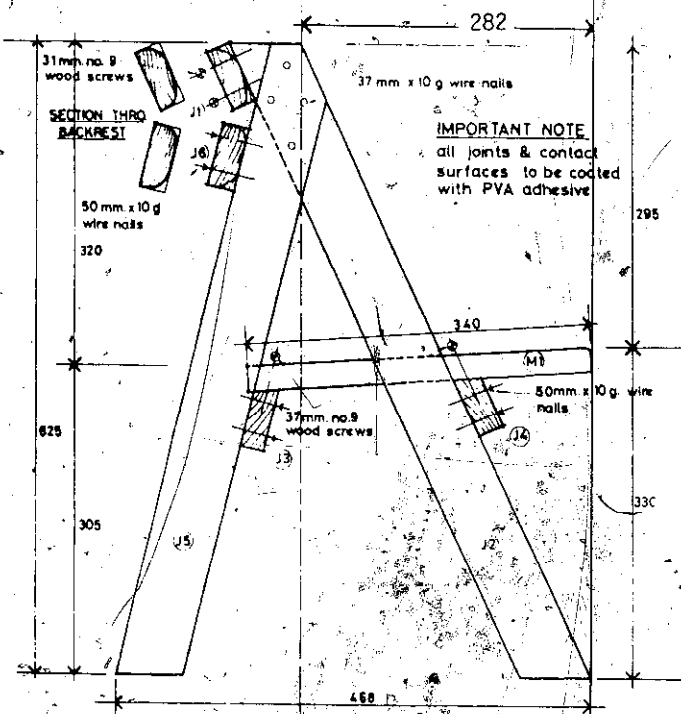
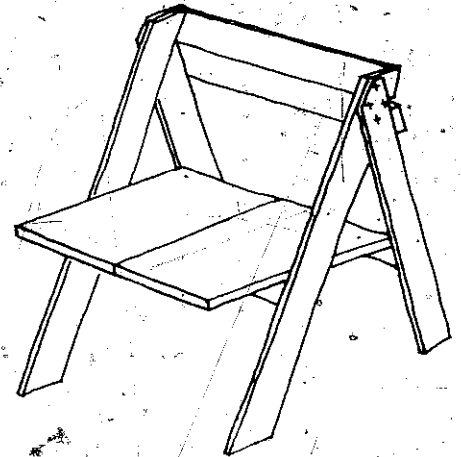

STUDENT DESK

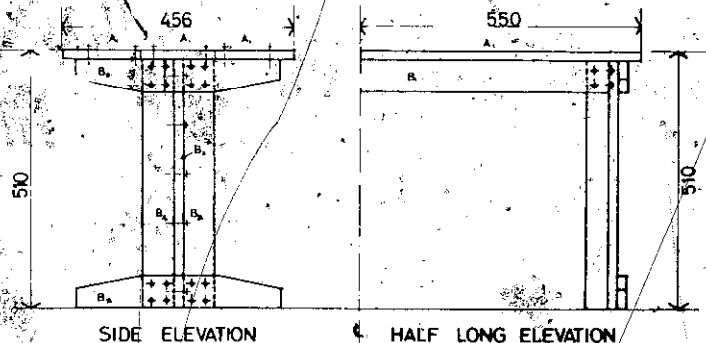
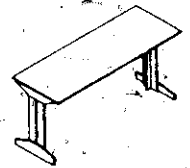

Contributed by Sr. Godelief, Box 3, Lae



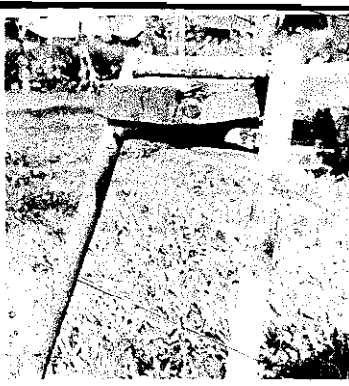

Legs for a portable bench are made of pieces of pipe. Let legs angle outward and they become stronger with a load.

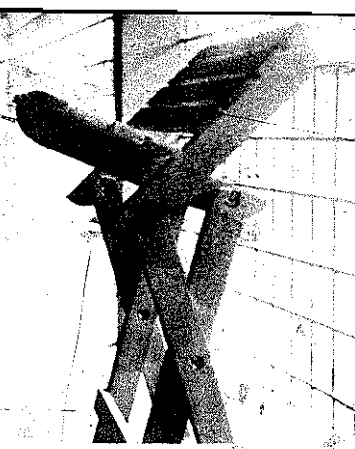

Stool made at Baitabag Vocational Centre, Madang, folds into a compact flat package. Joints are held with split rivets (made from nails) and washers.

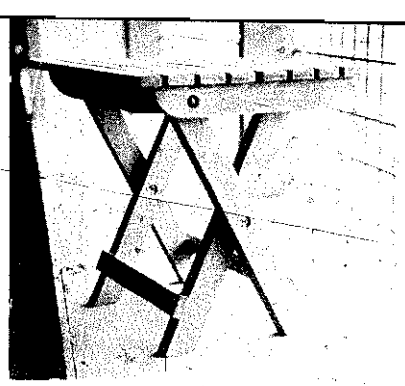

\*split rivets made from large nail (cut with hacksaw).

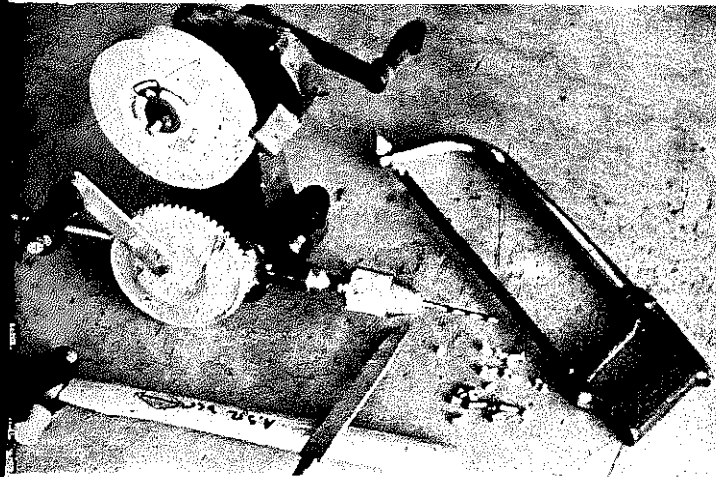
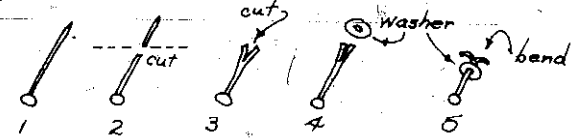

### GRINDING WHEEL

With just these tools and rivets you can do a surprising amount of metalwork in the village without electricity or a forge. The crank grinder (made in China) is available from Steamships Hardware, Lae, for K13. w/o stone.



A home-made grinding wheel at SIL, Ukarumpa, EHP. The stone is made from sharp-cornered sand with just enough cement to bind it together. It has a square hole.

The shaft is made from a square board carefully fit into the hole. It is rounded where it turns in its "U" shaped bearing. A piece of galvanized iron holds it in.

The piece of tyre has water in it.

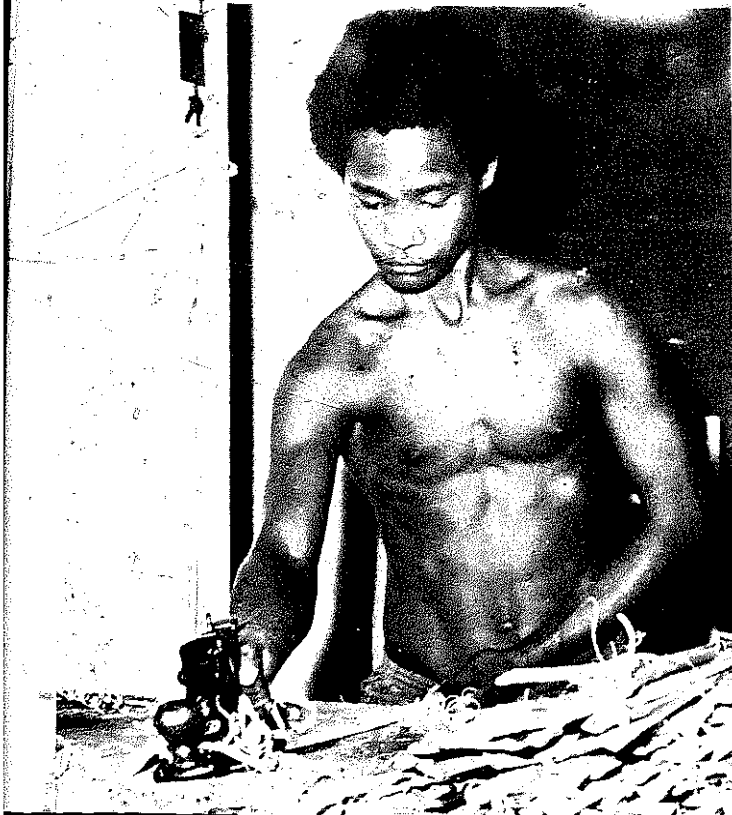

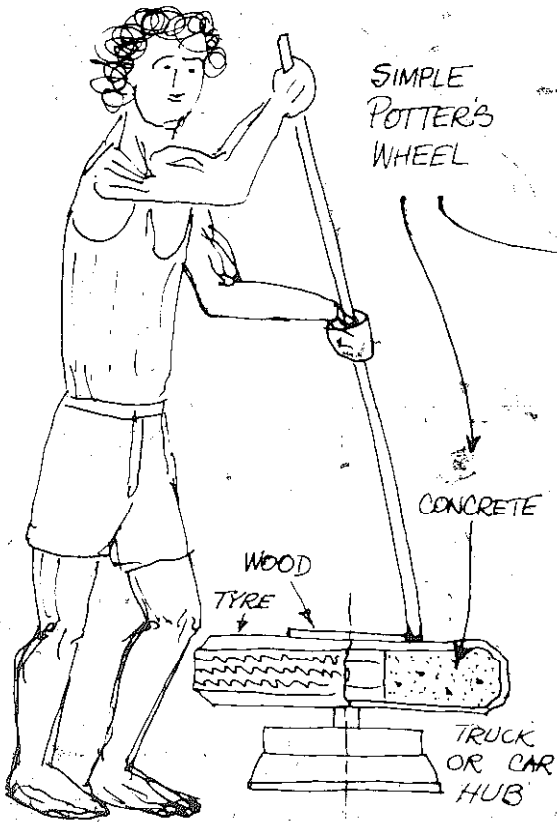

POTTER'S WHEEL. Make it spin fast by turning it with a pointed stick in a small hole in the concrete. The wheel is heavy enough that with practice you can throw a pot with each spin.

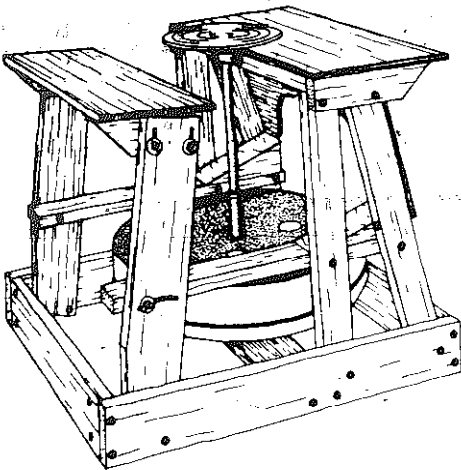

Another design: A simple kickwheel



Father Kingsley Gegoyo, Executive Officer of the Melanesian Council of Churches, and Bud Larson of SIL examine a knife and saw frame made by villagers in Sui Village, Northern Province.



Trays for many uses



## OLD TYRES

1. Boat bumpers at piers - or on boats.
2. Tread for wooden or steel wheels - cut tread of tyre into bands of desired width, nail to wood, or "sew" with wire to the steel wheel.
3. Harness for work animals - cut side walls (in a spiral) into strips, rivet (or sew with wire) according to your own harness design.
4. Shock absorber for towing vehicles with rope, or on front bumper when pushing vehicles.
5. Cushion for portable generator - lay appropriate size tyre on ground, set generator frame on top, - very smooth!
6. Feed troughs - cut in half around tread.
7. Temporary engine mounts - cut pieces of tread to size - this can keep your vehicle going until you get the right part.
8. Hinges for heavy gates or doors. Two or more rectangular pieces of side wall nailed well to post and to gate or door.
9. Playground equipment - swings of various types, crawl-through obstacles.
10. Flower pots:
  - a) cut tyre in half around tread.
  - b) cut off inner bead; bend in a circle, with the tread part up and outside to try for size.
  - c) cut off at desired point.
  - d) sew ends together with wire.
  - e) sew rubber circle into bottom with wire.
11. Sandals - these are difficult, but with practice some attractive soles can be made with treads and straps made of leather or inner tube. (be careful - they mark floors!)
12. Stop soil erosion on steep hillsides - join the tyre circles with wire or cable, flat on the ground. Plant bushes or shrubs in the centre of the tyres. The soil will be held and the plants will grow.
13. Smoke screen - burning tyres will keep birds from raiding the crops you're growing. (but also kills trees and shrubs in the vicinity.)

14. The wire left from burnt tyres is sometimes useful, although it rusts very fast.

15. Make your roof!

(p 183)

16. Now you add some - write us a letter!

How can we cut old tyres? The hardest part is getting the first cut through the tyre. Use a pointed knife or a pointed chisel and hammer. It helps to have two persons - one to hold the tyre. Once you get started, a sharp bush knife will do the job, with the person holding the tyre spreading the rubber so that the knife will not "stick". Pouring a small trickle of water as you cut will make it easier. For a big tyre, pound the back side of the bush knife with a hammer, "steering" the knife as you go. But start with a small tyre, and when you know how, move to larger ones.

How can we put holes in old tyres? We can drill them with a steel bit, or burn through with a red hot iron rod. Make 2 or 3 pointed rods with handles. Heat over red hot coals. Use in rotation.

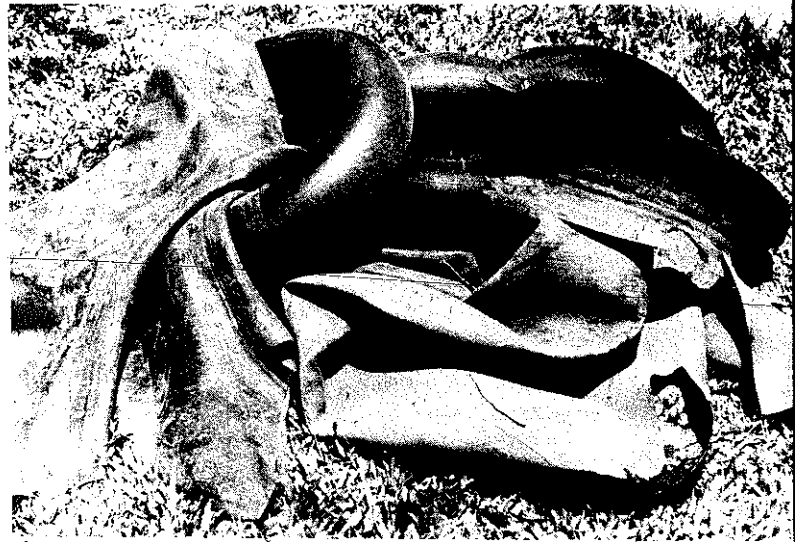

## OLD INNER TUBES

1. Cut into strips and tie your things on the back of a bicycle or motorcycle.
2. Bind up a broken car or truck leaf spring as an emergency repair.
3. When glueing, clamp two pieces of wood together with strips of inner tube.
4. A door spring or other kind of stretch spring.
5. Nail a rubber flap to a door, just above the padlock, to protect it from rain.
6. Wrap thin strips around a bundle of coconut leaf mid-ribs to make an out-door broom.
7. Tie bamboo scaffolding with strong rubber strips to paint a building.
8. Assemble a small building or shelter of local materials by tying with rubber strips.

cont'd

9. Wrap inner tube strips around leaky pipes as a temporary repair. It might last for years!
10. Inner tube squares will make hinges for animal cages or small cabinets. Fasten with tacks.
11. Sling shots - mustn't forget those!
12. Faucet washers or other types of rubber gaskets.
13. "Flap" valves for air billows for a forge.
14. Diaphragm for small water pumps.
15. A model bio-gas digester was made from an inner tube and shown at a recent workshop in Port Moresby.
16. Whole inner tubes can be used to float things in water. Many inner tubes used together in a frame can be used to float heavy things.
17. A round canvas cover tied to an inflated inner tube can turn it into a trampoline, or inverted, into a play boat or a life raft.
18. Weave straps on a bed frame for a comfortable bed.
19. Insecticide duster. (p 165)
20. Bookstrap - cut a complete circle like a big rubber band.
21. Elastic for a fish spear gun.

How do we cut old inner tubes? Heavy duty scissors are the best tool, but a sharp knife will do, if only a rough cut is needed.

When wrapping something with rubber strips, the top layers of rubber usually exert enough pressure to hold the starting end secure. The finishing end can usually be tucked under a tight earlier wrap.



#### BEDDING FROM INNER TUBE STRIPS

Construct a rectangular bed frame with wood poles or boards, support it on wooden legs.

Cut inner tubes into lengths approx 6-7cm wide.

Half the strips must be a bit wider than the bed, the other half must be a bit longer than the bed.

Weave the strips. It need not be tightly woven - you can allow gaps.

Nail the ends to the frame.

#### FLOWER POT FROM TYRE

Cut tyre in half across tread using knife and hacksaw.

Put a hole at both ends of each half, and one at the bottom for drainage.

Tie rope through the holes of each half and hang.

Contributed by: S. Tracy, Box 1539, Lae.

#### TOOL FOR CUTTING OIL DRUMS

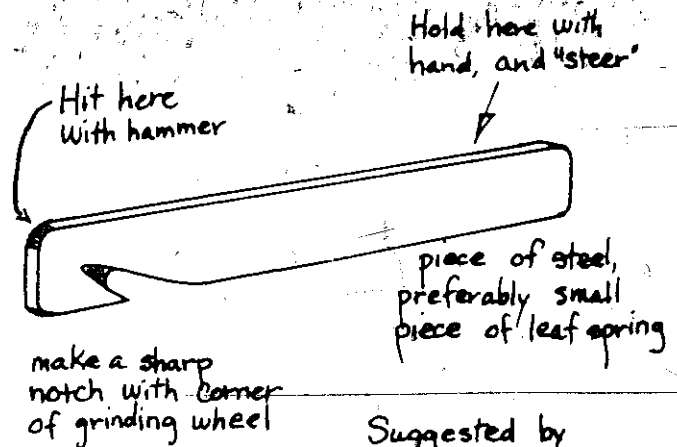

Suggested by  
Bob Jamieson  
Box 571  
Goroka

#### OLD 200 LITRE DRUMS

1. Drains under roads.
2. Fill with cement and stones to stop erosion near wharves.
3. Hot air pipes for copra driers.
4. 101 different kinds of ovens and stoves.
5. Forms for concrete bridge and pier pilings.

# ANIMATING VILLAGE DEVELOPMENT

"Animate" - "To breathe life into; enliven; inspire; inspire; actuate" ...

"Animate" is a good word because its meaning speaks of life. It carries with it the suggestion that somebody is doing something to someone else. But what? In this case, it is action that makes others alive, obviously not in the flesh and blood sense but in the bodily sense of being more wholly alive. It is action that helps others to move forward, to decide and to create. That movement, decision and creation is not for personal advance but for the people as a community. The "people" may be any group whose life we share - a village, a town community, a trade union, a club.

The difficult thing about animation is that it is an action different in nature from actions which we usually make for communication or education. The key to animation is to live in dialogue. But the fact is that most work with people is a process of telling, teaching, or at best, extending to them some special knowledge.

Real dialogue (or deep mutual speaking and listening) turns this approach inside out. Because it is not just telling ... it is listening. It is not just teaching ... it is learning with. It is not extending knowledge ... it is discovering the richness of knowledge already present in the life of the people - knowledge which they themselves may have come to believe does not exist.

Dialogue means discussing the life we share - the world in our midst - so that together we can discover the things we want to change. (Dialogue is not the action of an I, nor is it the action of a small powerful group.) The animator can think of himself or herself as entering a different world - the world as it is experienced by the people he/she is working with. It is a loving act, which does not say "no" to the known world of the animator but says a clear "yes" to the life and experience of the people.

As the animator listens and shares in the life of the community, he/she will become aware of the discontents, the worries, the deep and nagging questions of the people, such questions can be profound because they have to do with a people's sense of human dignity. These questions can also be so difficult to take hold of that even the people themselves may not know what is concerning them. These questions have to do with the relationships of men and women to their natural environment, their relationships with their ancestors, their relationships with each other and their relationships with the land and the produce of the land. These are the matters of basic human dignity. In scientific language we call them social, economic and political affairs.



As the animator begins to see and understand, then his/her role becomes more concrete because now the animator can help the people to see. This can be done by re-presenting to the people the life situations which they are having difficulty seeing. Their condition is like being inside a box and therefore not being able to see the box. A representation can help the people to get out of the box to see it.

Paulo Freire, who explored this process of animation with peasants of northeastern Brazil, used slides and drawings to objectify or show in a real form the life of the people. In this way their life

"The development issue is not the amount of money and expertise we can hand out but the prophetic fire and depth we can communicate to ask new questions and summon people to take their destiny in their own hands together as co-workers with God."

Phillip Potter

became for them an object - something concrete which they could talk about, criticize and act upon. The idea of re-presenting is a reverse approach from that of presenting, which is the common method of teaching and communicating. In the act of re-presenting the animator tries to make simple, clear and concrete for the people what they already know. It is a process of "making alive" because it reverses the process of presenting. Over the years, "presenting" has convinced the people that they do not know.

But what kind of picture will accomplish this re-presentation? The picture must express the basic question which the animator has perceived. Freire uses the example of labourers constructing beautiful buildings of Brasilia, their capital city. He explains that the workers were building beautiful houses, "but they did not have houses". A picture of men with bricks, trowels and mortar working on a building helped the people to clarify the nature of their true situation, one of enslavement. A picture might be of wharf workers or road labourers or market women or provincial officers. A picture of a man in grass clothing standing in an outrigger canoe holding to the rope of an administration vessel has proved effective in helping people to see themselves, and to voice their sense of injustice about economic and political arrangements.

A development worker reported hearing a man declare "These politicians are trying to sell us like a basket of kumala". The words reveal an awareness of the inhumanity present in the political structures of which that man is a part. As long as he was sunk in these structures unable to control them, he was unaware. He could not see the box. Once he sees, and once he knows he sees, then he is motivated to begin to shape structures that restore to him his human rights and dignity.

Sometimes these questions about the meaning of life or the injustices that oppress us are called "themes". The themes in the life of people are the dilemmas which, in a sense, give the people energy. The themes stir them, motivate them, get them going. To the extent that the theme can be clarified by the people, they are capable of choosing an action to overcome the obstacle and improve their own quality of life.

Or the re-presentation may not be a picture. In PNG today there are many artists of the contemporary struggle. Poets and playwrights are expressing the dilemmas, the sorrows, the confusions in the life

We must find ways to stimulate our people to ask themselves basic questions about where they are going, what forces are taking control over their lives:

"What is happening to our young people?" / "What is happening to our ground?" / "What is happening to our customs & values?" / "What is happening to our money?"

of today's people, all of whom are caught in some way in the whirlpool of change. Any of these expressions of the deeper reality of life - where we play out the drama of winning our human dignity and our cultural identity - can be used to re-present to the people their own specific themes.

In this use of pictures, poetry, plays and even some radio programmes and newspaper quotations as re-presentation, a totally different understanding of media emerges. The media are no longer aids to the communicator but become instead the medium or means through which people dialogue about their world. The picture or drama or poem stands in the midst of people - re-presenting to them their own life, which is the true medium for their dialogue. In this way men and women can begin to fashion and refashion their world; they can create and recreate their culture in their own time.

The need to live in dialogue never ceases in this process. The animator does not tell the people their themes. He/she represents them in such a way that the people can discover and speak clearly about them. The role that follows may be in planning a strategy and finding the necessary resources, but this stage too is one of saying "yes" to the strengths and knowledge that the people already possess.

(For pictures, search the files of a government information office. Collect the pictures in magazines or newspapers. Borrow pictures of people engaged in their everyday life from the social studies files of the education department. Calendars may also yield thematic representations. Photographers can make their own slides and prints.)

Some examples of the way this approach has worked in communities may help to encourage leaders who deeply trust the people and who seek to stimulate and organize them. But some warnings are needed.

Animation is a long process. People are not empowered to act overnight. A few sessions using techniques of animation will not prove to be magical solutions. Ideas used by other people in other settings cannot be transferred to another community. Every community has its own life, its own themes, which give the people a unique destiny. Some communities may share common themes, or a nation may have its themes, but it is important for the animator to realize that he or she will need to invent the media that will help a particular community to see its own life. Also through the animation process, some people may begin to change their behavior, but for most people to live differently is a very risky struggle, demanding patience and understanding.

The following examples use Biblical quotations together with pictures to open up the life situation. These are often a good starting point because most Papua New Guineans respect the Bible. However, other written materials which express the basic ideas of justice, truth and human dignity - national constitution, human rights declarations, Eight Point Plan - or written statements by trusted leaders - can serve as well, providing they have a place in the life of the people.

cont'd

JAMES CHAPTER 2

My brothers! In your life as believers in our Lord Jesus Christ, the Lord of glory, you must never treat people in different ways because of their outward appearance.

Suppose a rich man wearing a gold ring and fine cloths comes in to your meeting, and a poor man in ragged cloths also comes in.

If you show more respect to the well-dressed man and say to him, "Have this best seat here," but say to the poor man, "Stand, or sit down here on the floor by my seat," then you are guilty of creating distinctions among yourselves and making judgments based on evil motives.

Here is a picture that was used to help people face the discomfort they felt in relationship to traders.



These questions guided the discussion:

- What is happening in this picture?
- What are the thoughts of the man?
- How do you think he feels?

Share stories about ships coming to your village or your island. Think about these things:

- Why did the ships come?
- Why do they come today?
- Ships bring much to the islands. What do they take away?
- Is the man richer or poorer because of the ship?
- What will happen to him?

Through this discussion a group found that their romantic ideas about ships, part of the stories of the past, do not fit the real life situation.



This picture helped a group of mothers to rediscover their role as teachers of their children. Most parents and other relatives today have given away responsibility to formal schools and no longer have confidence in their knowledge, skills or ability to teach.

The picture shows a boy who used the materials of nature to change his environment. His bow and arrow is a fundamental tool, created by him or the people who teach him. He represents to a community the reality that they are creators of culture. In today's society, where people feel that culture is pouring in upon them, requiring their adaptation, they can begin to rediscover their creativity and traditional self-reliance. The animator read the Biblical passage from Genesis (1:27-28) and used these questions to keep the discussion moving:

- What does it mean to "subdue the earth?"
- How has this boy subdued the earth?
- In what ways are we master over "the fish .. the birds .. and every living thing?"

- Who taught this boy to make a bow and arrow?
- Who taught him where to look for fish?
- What are some other things he has learned from the people of his village?

Man's religious understanding of himself can affect his power to create or to believe that he is capable of changing the conditions in which he lives. This picture has helped a community to think about their confusion around the idea, "what is man?"

cont'd



What are we saying about ourselves and who we are as human beings?

What are your thoughts as you look at this picture? Share them with others. Does this man remind you of someone you know? Tell a story about him? Read Psalm 8:3-9. Through Biblical revelations we come to see man as he truly is. How would you describe this man? You may choose words such as the following or think of others:

slave ruler creator free man liberator  
master servant imitator prisoner sinner

powerful small intelligent alone  
weak mighty ignorant together with others

cont'd

This picture helped a group that was troubled by the fact that their work was no longer related to their community life. The animator asked, "Who are these people working for?" and then later read some statements about socialism from the writings of Julius Nyerere, the president of Tanzania in East Africa. The people were able to distinguish between work which they do (1) for money, (2) for self-advancement, (3) for community, (4) for businessmen who live outside the community. They were able to see how patterns of work often conflict with their basic beliefs about the purpose of work.

A good source of pictures is the CAVA Calendar - The National Catholic Calendar, available in many bookshops, or from CAVA Studio, Box 133, Goroka.

Contributed by: R. Coop, Box 90, Rabaul.

# CHANGE

rarely takes place when people are "comfortable" or think that they are comfortable. A tension must develop before persons or groups can have meaningful change. These tensions are often expressed as a felt need, and are finally articulated in one way or another.

Community development workers who merely help people to become "comfortable", who simply do things for people - identifying and analyzing their problems for them, and "doling out" answers, are part of the problem, not part of the long-term answer.

## INFORMATION ON SOUTH PACIFIC ISSUES

### POVAI

People's Action Front, Suva, Fiji. F\$3.00

POVAI aims to provide information and views on the various struggles of people in the Pacific to determine their own lives. Contains material not usually found in the regular news media. Six issues per year.

SURELY YOU CAN HELP US IMPROVE LIKLIK BUK!  
SHARE YOUR EXPERIENCES IN THE IMPORTANT WORK OF  
BRINGING ABOUT MORE SOCIAL AND POLITICAL AWARENESS.  
SEND AN ARTICLE TO LIKLIK BUK, BOX 1920, LAE.



# Modern and Traditional

## THE CONFLICT BETWEEN TRADITIONAL MELANESIAN AND MODERN WESTERN VALUES AND GOALS IN DEVELOPMENT.

### SOME TYPICAL TRADITIONAL MELANESIAN CHARACTERISTICS OR GOALS

The traditional Melanesian societies sought to preserve a state of stability, balance, harmony. Above all, the leaders struggled to keep their group intact as a society, to survive as a people. This usually meant guarding against change. The strong communal bonds were emphasized. Individualism was considered threatening, and was frowned upon.

Children were educated informally, and practically right in the village to take clearly defined roles which reinforced the bonds of kinship and interdependence.

Leaders, or "big men" emerged through a complex informal process, usually an unspoken process, to defend the group, organise the people, settle disputes, and manifest personally the wealth, dignity, and strength of the group.

Relationships with outside persons and groups were entered into very cautiously over a long period of time.

Objective concepts of right or wrong did not really thrive. Behaviour was promoted which supported kinship obligations and customs more than any particular moral code. Enforcement was carried out through social pressures. Conflict within the group was minimized, but conflict with outsiders was quite common. Identifying with a side of "right" was not nearly so important as identifying with wantoks. Handling of conflict within the group was more concerned with reconciliation than with punishment.

The ground was not only a place on which to live and produce. It was the seat of cultural ties, the focal point for human relationships, cultural values, language, ambitions. A specific geographical place where a person has his physical and spiritual roots was the place of one's ancestors, the location of the familiar myths handed down from one generation to the next. It could not be owned by any one individual, and "sale" or lease of land meant something far different and less absolute than in the western sense of the word.

### SOME TYPICAL WESTERN SOCIAL CHARACTERISTICS OR GOALS

Most modern western societies prefer an open society with capacity to change. Individualism is encouraged. There is great mobility, with persons free to find "community" on their own terms. Privacy is valued. Bonds of kinship are often very weak. Security is often based on a job or on the nuclear family.

Children are educated formally in classrooms, often rather theoretically, often away from the immediate community, with a great diversity of roles, opportunities for specializations.

Politics are highly developed, formal. Leaders are elected through a clearly defined process, with leadership centered more on intellectual rather than physical qualities. The leaders don't carry the great range of functions, as in Melanesian societies. A great deal of "delegating" takes place.

Relationships with other persons and groups tend to be entered into easily, but are less personal, more superficial, more easily broken.

Most western societies tend to be rather moralistic (at least most of them have rather highly developed laws and moral codes, even if they're not closely followed in practice!) Enforcement is quite formal with more emphasis on punishment than on reconciliation.

Land is primarily a place on which to live, a place from which you can do business, or a resource for production. It is seen for its usefulness, not for its sentimental value or religious significance. Individuals can often own land and do almost anything they want with it - divide it, sell it to anyone, destroy its usefulness if they please. It's interesting that in very densely populated countries such as The Netherlands, Israel, Japan, however, we see land laws coming back to tribal-type controls.

The primary economic goals were subsistence and prestige. Through communal enterprise food was grown and collected. There was much sharing, little storing. Capital was accumulated in the form of food (usually pigs) or money (such as shell money) which could buy food, and in a highly ritualistic fashion was directed in most complicated ways to achieve situations which might return maximum prestige. Prestige was often visibly measured in terms of pigs and women.

Exchange was not mainly for the purpose of obtaining consumer goods - it served to maintain balance, to bring about sharing, to play out "one-upmanship".

The economy as a system was not dynamic, but was rather static or changeless.

Division of labor was mainly between men and women. There was otherwise very little specialization or division.

Religious and secular goals were highly integrated. Religious knowledge gave power for economic and other forms of success. Religion was a community matter, not just an individual matter. Sharing, rather than obedience to a religious code, was stressed. Fulfillment was seen in terms of this worldly life, not in another unseen life.

Economic goals of most western societies, as in Melanesian societies, might be seen in terms of subsistence and prestige. However, they are usually more simple and direct: earning money to improve physical comfort, convenience, security, prestige. Wealth is defined differently. The house, the clothing, the car, the electrical appliances are all visible signs or criteria of success or failure. Pursuit of success is carried out in highly individualistic manner. Sharing is limited usually to nuclear family, there is much saving, much accumulation of wealth by individuals. Capital is often accumulated for the purpose of enhancing earning capacity.

Exchange is very practical, not ceremonial, usually based on cash, and is seldom subject to group control.

The economic system is highly dynamic, very subject to change and fluctuation.

A high degree of specialization is found.

In most western societies there is a clear separation of the sacred and the secular. Religious knowledge is irrelevant to economic success. Religion is a private, individual matter, often, with even the family avoiding interference with individual religious preferences. Religion often aims at fulfillment in some other life, rather than this one.

Prepared from various papers of the Melanesian Institute

## SOME GUIDELINES FOR DEVELOPMENT PROJECTS

These guidelines indicate the kinds of activities which the Melanesian Council of Churches would like to encourage:

1. Community-oriented activities which
  - a) Serve human needs in the context of the whole community;
  - b) Have incentives and vested interest for success resting with the community served, and not with outside leadership;
  - c) Foster group cooperation and community spirit.
2. Indigenous-led activities which
  - a) Represent indigenous initiative, use indigenous leadership, and which "release" the energies of the people.
  - b) Emphasize indigenous participation in decision-making, and tend to build indigenous responsibility and initiative.

3. Activities which produce self-reliance rather than dependency (especially in relation to things like leadership, running expense, expertise, supplies of essential materials).
4. Activities which aim for long-range, basic effect, rather than short-term amelioration.
5. Activities which
  - a) Promote reconciliation and understanding between persons, clans, groups, and larger communities.
  - b) Enhance cooperation, coordination, and utilisation of existing resources.
6. Creative activities which lead the way in trying or demonstrating potentially useful techniques.
7. Activities which help to make the churches' resources of manpower, expertise, and organizational network available to the larger community.

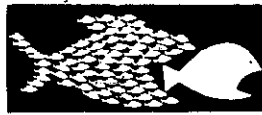

## COOPERATIVES AND DEVELOPMENT

The key to successful cooperatives is EDUCATION IN BASIC HUMAN DEVELOPMENT. The process of creating awareness is the most vital need in Melanesia today: awareness for and participation in what is happening. Then secondly, and only secondly can come the training in economic development.

The second aim of development education should be to devise economic models based on our culture, social needs, and environmental patterns. We consider many of the imported economic models to be irrelevant or harmful.

Of all the imported economic models, the community and communal aspect of the cooperative model is the nearest to Melanesian life traditions. However, in many cases cooperatives have been wrongly led to develop as big companies, dependent upon foreign expertise, and overly concerned with profit-making.

(Edited portions of a report from the Tubiana, North Solomons, Seminar on Cooperatives, June 1976.) For further information write:

Church and Society Programme  
Pacific Conference of Churches  
Box 5768  
Boroko, PNG

## WOMEN IN RURAL DEVELOPMENT

"INTERNATIONAL WOMEN'S YEAR WILL BE A SNARE AND A DELUSION UNLESS IT INCLUDES MOBILIZATION OF APPROPRIATE TECHNOLOGY TO HELP THE OVERBURDENED PEASANT WOMAN EASE THE BURDENS OF HER TASKS, BECOME MORE SELF-RELIANT, AND ACHIEVE GREATER DIGNITY AND EQUITABLE STATUS. OVER THE YEARS, VERY LITTLE ATTENTION HAS BEEN GIVEN TO HELPING HER FIND THE SKILLS AND TOOLS SHE NEEDS TO BECOME A BETTER FOOD PRODUCER AND PREPARER, WITH BETTER CONSERVATION OF HER ENERGY, AND BETTER NUTRITION FOR HER FAMILY. THE LONG NEGLECT OF HER NEEDS AND CLAIMS IS, TO MY MIND, THE MOST OUTRAGEOUS SIN OF BOTH NATIONAL AND INTERNATIONAL STRATEGIES FOR DEVELOPMENT AND FOR THE EXTENSION OF BASIC HUMAN RIGHTS. THE TIME IS OVER-DUE TO OVERCOME THIS NEGLECT."

*From a World Council of Churches staff report.*

A FEMALE BODY COUNT IS NOT A GOOD MEASURE OF THE MEANINGFULNESS OF WOMEN'S INVOLVEMENT OR THE HELPFULNESS OF A PROGRAMME. WOMEN SHOULD PARTICIPATE IN EVERY ASPECT OF AN INSTITUTION PROVIDING SERVICES TO WOMEN AND CHILDREN NOT ONLY AS RECIPIENTS OF SERVICES BUT IN DESIGNING PROGRAMMES, CARRYING THEM OUT, SERVING ON GOVERNING BOARDS AND IN EXECUTIVE LEADERSHIP.

"RURAL WOMEN HAVE BORNE ON THEIR BACKS THE ECONOMIES OF WHOLE NATIONS, THE WELL-BEING OF MILLIONS. THEY HAVE DONE THE WORK, WITHOUT WHICH THEIR FAMILIES, THEIR COMMUNITIES, THE WORLD, WOULD FALTER AND COLLAPSE INTO CHAOS. THEY ARE AS STRONG AS THE LAND, AND AS THEY FREE THEMSELVES, THEY BECOME STILL STRONGER, AND ALL THE WORLD WITH THEM."

*From the filmstrip "As Strong As The Land"*

### ARE YOU CONSIDERING A PROJECT FOR WOMEN?

1. To what extent are the women who are the project's beneficiaries involved in its initiation, formulation, direction and evaluation?
2. How does the project empower women to affect their own situation, enabling them to be self-reliant and self-determining? What opportunities does it offer for retraining or upgrading skills which enhance opportunities for self-reliance?
3. How does the project help develop economic, political and family life patterns and models that are liberating?
4. To what extent does the project include women from the poorest or most dependent sectors of their society?
5. In what ways does the project increase political consciousness about social and political status, enabling women to speak out about their concerns to government, church, farmers' or labour organizations, and other institutions that affect their lives?
6. How does the project strengthen supportive links among women, and help to reduce the sense of isolation so often experienced by rural women?
7. How does the project integrate rural communities into processes of national and regional development?
8. How does the project encourage development of national and local institutions, enabling them to identify problems, plan solutions, organize work and carry out operations all on an integrated/comprehensive basis? Could it serve as a model for other projects?

cont'd

9. What provision does the project have for monitoring its affect on girls and women at every age level?

10. How does the project contribute toward a more positive self-image for women, especially in perceptions of themselves as important members of the rural labour force?

From: Women in Rural Development  
The Women's Division  
Board of Global Ministries  
United Methodist Church.

#### RURAL DEVELOPMENT TRAINING FOR WOMEN

South Pacific Commission,  
Community Education Training Centre,  
Box 5082,  
Raiwaga PO.  
Suva, Fiji.

Gives a 10 month course in home economics for leaders and trainers, mainly for women. Programme includes practical skills in meal planning, use of foods, home gardens, health, first aid in the home, sewing/clothing, use of family resources, handcrafts, techniques and methods of teaching.

## Communication

### VISUAL AIDS

THIS DOES NOT SIMPLY MEAN MOVIES AND EXPENSIVE OVERHEAD PROJECTORS! You can make many of your own visual aids.

Visual (sight) aids help teachers and leaders to create and maintain interest, increase retention, develop greater understanding, provide variety, simplify complicated ideas, create realistic impressions, motivate, and can help us to reduce the number of words we use.

Some examples:

MODELS: are three-dimensional. They can reduce large objects, enlarge small objects, provide interior views, accent important features, and may be assembled or taken apart. They can emphasize fundamentals and remove non-essentials. You can make your own models.

PHOTOGRAPHS AND SLIDES: can be very real. They can reduce large subjects, enlarge small subjects, can take us to other times and places. They can stop action, can be easily kept up to date. They can spotlight a problem or issue. We can easily collect pictures from magazines, newspapers, pamphlets. Slides can be made at a relatively low cost, if we already have a camera, and the pictures can easily be arranged and re-arranged. Slide projectors are much cheaper than movie projectors.

CHALKBOARDS: are perhaps the most widely available visual aid, familiar to us all. But few teachers have really developed their techniques for using a chalkboard. Here are some ideas:

- a) Start with a clean board
- b) Use large pieces of chalk, if possible, and soft chalk, if possible.
- c) Use coloured chalk as well as white.
- d) Print wherever possible.
- e) Use straight lines. Keep material neat, orderly, and uncrowded.
- f) Use templates or patterns if you have to repeat a basic form many times.
- g) Use a good eraser.
- h) Use a stick for pointing.
- i) Put materials on the board step by step as you present your idea.
- j) Plan ahead what you will put on the chalkboard and when you will put it.

Other notes: Try to use a glare-free board. A green-coloured board is restful to the eyes. Don't wash the board with water very often - it will fill the surfaces. If you want to make semi-permanent marks, moisten the board before writing.

FLANNEL BOARDS OR FELTBOARDS can be attractive, colourful, inexpensive, versatile, and make rapid presentation of your ideas very easy.

As you know, flannel is a soft, fuzzy cloth. A flannelboard may be just as big as the cloth you can buy. You stick things on it - letters and words, pictures and shapes. You can stick the following things to flannel: flannel, styrofoam, blotter paper, sponges, sandpaper, yarn, suede paper, "flocked" paper.

You can make nice charts and graphs on a flannelboard using yarn. Black flannel makes a striking background. Flannel may be attached to a piece of plywood with a light coating of glue.

CHARTS are a sort of stylized picture. Some types: time lines, streams (showing relationships between parts and the whole), trees (showing relations of whole to parts), flow charts (showing routing or process), issues (pro and con), timetables, organisational structures.

Charts may be simple, pin up, flip charts, hinged, hidden, plastic or acetate overlay, in the form of a thermometer or a clock.

POSTERS can teach a process, remind viewers of something, motivate people, advertise events or campaigns. They can be made in any local situation.

Attract attention by using colour, contrast, motion, shape, textures, size, mystery, titles, repetition, unusual elements, white space. Produce outstanding posters through competitions.

Letters should be large and simple. 1 cm letters can be read about 5 m away; 2 cm letters can be read about 10 m away; 5 cm letters can be read about 20 m away.

OVERHEAD PROJECTORS are expensive, but if available can be very useful. You can stand in front of the group and see your listeners' faces. You can write or draw beforehand, or "on the spot".

cont'd

MOVIES are very popular, and have advantages, especially with large groups. But often we overlook the disadvantages. They are expensive. Because they are expensive there are only a limited number of view points on a given subject; especially if produced by a business firm or a government information agency there may be biases.

Because movies are also entertainment they cannot be stopped for questions. When the film is over the question has lost its urgency or is forgotten.

Because movies are passive learning experiences knowledge, ideas, and viewpoints are often learned without realizing it, and so too the biases and distortions.

Some suggestions if you want to use movies. Preview your film. Make sure that the film is directly related to your objective. - and if it isn't, be ready to stop the film or make comments. Prepare the group, prepare the room, prepare the machine so it is ready to go. When the film is finished, go back to the subject quickly, relate the film to the subject, and correct any errors in the film immediately. Discuss the film.

ALWAYS ASK - ARE MY VISUAL AIDS WORTH THE TIME, EXPENSE AND EFFORT INVOLVED?

(p 249)  
(p 243)

## VISUAL AIDS FOR COMMUNITY EDUCATION

Most people who work with rural communities are interested in finding more effective ways of communicating information or of starting a discussion. Sometimes just sitting down and listening and talking to people is the best way. There may be other times when you are not able to be with them, or you may feel that talking with them is not the most interesting way of communicating, or of helping them to understand and remember something important. You may want to try a more dramatic way to encourage people to gather to think about a problem.

Students at the University of PNG have been experimenting with different forms of communication for rural communities, working with the University's Educational Research Unit. Here are some examples of what can be done. All (except film) are cheap and not too difficult.

**Short Plays:** Act out stories that are entertaining and educational, through clubs, youth groups, school groups.

**Slide-tape sets:** Combining cassette tape and colour slides, are particularly useful.

**Cassette tapes:** An entertaining play or a cassette tape may convey much information and can be used many times. It can even be used on the radio.

**Movie films:** If you have the money and expertise for making them, they are almost always enjoyed and can help to start discussions.

**Literacy sheets:** Simple one-page pidgin literacy sheets with line drawings can enable people to read things related to their own village projects.

**Demonstrations:** Instead of talking about a good diet and new ways of cooking food, the better way is to have people actually watch and cook and taste.

For more information on any of these forms of communication, write the Educational Research Unit, UPNG, Box 4820, University.

Initial contributor: G. Kemelfield, ERU, Box 4820, University.

VISUALLY  
SPEAKING THIS  
SECTION VIOLATES NEARLY  
EVERY PRINCIPAL OF EFFECTIVE  
VISUAL COMMUNICATION, DOESN'T IT? HELP  
US BETTER COMMUNICATE VISUALLY THE USES OF  
VISUAL AIDS NEXT YEAR. CONTRIBUTIONS  
TO LIKLIK BUK, BOX 1420, LAE  
BY 15 AUGUST, 1977!  
DO IT NOW, OR  
SOONER.



Preparing Instructional Objectives, by R. Mager, Fearon Publishers, Inc, Palo Alto, California, 1962, US\$1.75.

A very helpful, unconventional presentation with discussion of techniques for getting feedback from trainees. The moral of the book: "If you're not sure where you're going, you're liable to end up someplace else - and not even know it!" Intermediate level.

## RURAL YOUTH ORGANIZATIONS

**BOUGAINVILLE FAMAS KLAP:**  
c/- St. Patrick's Agricultural School,  
Mabiri, Box 106, Kieta, Bougainville.

Bougainville Famas Klap is an entirely indigenous self-help association of farmers, founded in 1971, and fully directed by Bougainvilleans. Emphases are to foster dignity of rural life, fellowship and unity, self-help, and greater security for members. Provides a forum for discussion. There is an annual fee of K10.00, and a distinctive badge.

An annual meeting is held, always in conjunction with a field day or agricultural show. There are also monthly area meetings and field days on members' farms.

Agricultural text books have been produced in Pidgin. A bimonthly farm newspaper "Bougainville Fama" is issued.

Members also help with agricultural projects at primary and secondary schools, help members teaching agriculture on home or village farms, assist with agricultural correspondence courses.

There is a very close association with the St. Patrick's Agricultural School, due to the fact that the organizers were graduates, and due to the outstanding work of Brother Patrick there.

YANGPELA DIDIMAN,  
Rural Youth Movement,  
Box. 30,  
Banz. WHP.

Yangpela Didiman is a rural self-help and self-reliance movement which is sponsored by the Lutheran Economic Service, the development branch of the Evangelical Lutheran Church. Its aim is to assist group self-help action at the village level.

Village clubs, school clubs, and other interested bodies may ask for teaching aids, literature, and information. Groups of clubs organize meetings and courses which are conducted by Yangpela Didiman staff.

A monthly newsletter is issued in Pidgin.

A new group is accepted into the movement only if the leaders provide a programme which is accepted by the members of the group. Membership fee is not compulsory, but most clubs charge 50t per year, which is used for sporting equipment, musical instruments, kerosene lamps, or other selected local needs.

Typical local projects: food production projects, cash projects, community projects (such as building a community centre, literacy classes, sports, community gardens for experiment or seed production, road and bridge-building), exhibitions, competitions, field days, demonstrations. For most of these activities there are booklets, pamphlets, and other materials available at the headquarters.

The Yangpela Didiman organisation seems to be going through a period of difficulty. Maybe they've expanded their funding and staff too fast and too much.

## CHURCH AND DEVELOPMENT

In order to give validity and consistency to its development message the Church must be prepared to bring about changes in its own life. It should strive to become in a local sense the self-actualized, self-propelled, self-propagating people of God.

As much as possible the Church should recognize and work with the local leadership which has emerged naturally, and should avoid imposing its own leadership. Special encouragement might be given to those, especially young persons, showing leadership potential. By example the Church should seek to promote Servanthood as the appropriate leadership style.

The Church should avoid overlapping or competing with government or other agencies, and should strive to consult and coordinate as widely as possible.

The Church should make its resources of manpower, expertise, organisational network, and wherever possible, finance, freely and unselfishly available for overall development effort.

(Edited excerpts from a statement of The Melanesian Council of Churches)

## CHURCH AND PEOPLES' MOVEMENTS

One seminar has said: "Development is not an idea. It is people participating in planning their own future."

Romans 8:22 expresses the fact that the creation of the world surrounding us is not at rest. It is "groaning", or in constant struggle. Human beings are in the centre of this groaning or struggle. Man is at the centre of his environment, which he is called to "subdue", or take care of.

Human development is social, and total human development embraces everything that affects the life and growth in a society: political, economic; social, cultural; religious. These parts of the total are inter-related and cannot be separated.

We ask ourselves: "How are we involved together in serving and supporting the process of total human development in PNG?" The various groups to which we belong are an expression of our "togetherness in fellowship". This togetherness or solidarity is an important part of the concept of total human development.

At the same time this poses challenges to our perspectives and vision. In the North Solomons, The Gazelle Peninsula, Papua, The Highlands, regional united action has thrown people from various groups, various Churches, together. In many cases the Churches have identified with these peoples' movements, in some cases not. Sometimes these movements have created sharp divisions within the Churches.

If the Churches are really concerned about people, then peoples' movements must concern the Churches. Church leaders cannot simply sit back and watch as the people insist on participating, insist on having the kind of development that they really want.

It is interesting, and perhaps inevitable in these peoples' movements that there are new forms of unity cutting across old denominational divisions, old tribal divisions, and at the same time, new divisions created. We must be prepared to accept this if these movements are truly of the people.

Peoples' movements are at the very grass roots of development and whether or not we agree with them in every detail, they convey the aspirations of the people for total human development.

Contributed by: D. Avi, United Church, Waigani.

## BUSINESS GROUP INCORPORATION ACT OF 1974

This law says that if three or more people from the same clan or tribe wish to set up a business they may register the business as a Business Group, and except for dealings with people outside the group they may run the business according to their

traditional laws and customs.

There are good reasons for registering a business, and a Business Development Officer can explain these to you. It will make it easier to deal with a bank, for example.

Before this law was made, registering businesses was not always suitable for village businesses. This new law was designed especially for PNG conditions.

A successful village group chairman in the highlands says, "Because we are registered, it is much easier to talk to banks, and some kinds of grants are available only to registered groups ... A business group is easier to run than a company ... It has given our clan a sense of pride ... The Development Bank recognizes our labour in building up capital, because we are registered."

Some important points in this law:-

1. Only Papua New Guineans may form Business Groups or receive any of the profits of a Business Group.
2. There must be at least three members of a Business Group and all members must be bound by the traditional laws of their customary group.
3. Any disputes between the Business Group and a member of the Group, or between members of the Group, are settled by the Dispute Settlement Authority who has been named by the members of the Group. He will judge the dispute according to the traditional laws followed by the Group.
4. Written records of the Group's activities do not usually have to be kept, although the Registrar may direct that certain records are kept.
5. Receipts for contributions must be issued.
6. A statement of assets and liabilities must be prepared once a year and presented to the Registrar of Business Groups.
7. The liability of members is limited.
8. The liability of committee members is unlimited for actions incurred while they are committee members.
9. It is possible for a co-operative society, a company, an association or a savings and loan society to convert to Business Group status.
10. When an application for Registration as a Business Group is lodged, a fee of K10.00 must be paid. If the application is refused the fee is not refunded.

If you wish to form a Business Group you should contact a Business Development Officer in plenty of time because the application process can be very slow in some provinces.

Initial contributor: BDO, Mt. Hagen.

SKUL BILONG STUAKIPA, Box 330, Wewak, provides practical training for a minimum of one year in all aspects of retail store management. Because of limited facilities, the Skul is open only to people from the Sepik.



## TELEPHONES

The telephone service in PNG is one of the best in any developing country. It is useful for the ordinary citizen as well as the businessman and the government.

If you want a telephone in your house or business you should write or visit:

The Manager  
Customer Service  
Postal and Telecommunications Service  
Port Moresby, or Lae, or Rabaul, or Mt. Hagen.

He will want to know:

1. The name of your village or town.
2. If your place is near a road.
3. If your place is on a hill, valley or flat land.
4. If there are tall trees all around.
5. If you have electric power.
6. How many telephones you need.
7. If there are other villages close by that want phones.
8. If you want a public telephone as a business.

He will help you to decide the best service for your area. There are many kinds of service. Some are:-

1. An ordinary telephone, connected by wire on posts or underground.
2. A manual VHF radio, good for a distance of up to 40 kilometres to the nearest base station, if there are no big hills between the radio and the base station.
3. An automatic VHF, so that you can dial the numbers yourself without waiting for the operator.
4. A coin operated public telephone.
5. An outstation (SSB) radio. Although not as good as VHF it will operate anywhere in PNG. You can only get one if there is not another service within 10 kilometres.

You will need power for radio equipment, but if you don't have electricity you will need a battery charger using a petrol engine, water, wind, or

sunshine.

Outstation radios require a licence which you get by applying to: The Manager, Radio Branch, Department of Public Utilities, Port Moresby.

The cost of an outstation radio is K2000-3000 for all the equipment, and you still have to pay for each call or telegram.

Outstation radios are a public service and you must send messages for anyone who asks, although he must pay the cost. Anyone who feels an outstation radio is not doing its job properly can complain to the Manager, Radio Branch.

Telephone or outstation service requires planning. For new locations it may take 2 years to install a telephone or radio service. Post and Telecommunications owns the equipment and charges rent each month. First it must find the money to buy the equipment and install it, but you can speed things by loaning P & T the money and helping to dig trenches or install posts. You will need to plan ahead.

Because the equipment is expensive there must be someone to take responsibility for the radio or telephones.

### POSTAL SERVICES

Many places that have a lot of mail still do not have Post Offices. An agency post office can be a good business and a help to the community.

Write to the Assistant Secretary  
Postal Services  
Postal and Telecommunications Dept.,  
Port Moresby,  
and ask about what you must do to start an agency.

Contributed by Posts and Telegraphs, Public Relations Office.



**AGRICULTURE IS  
THE BASIS OF  
INDEPENDENT  
DEVELOPMENT**

READ READ READ READ READ READ READ

#### LITERACY

READ, The Adult Literacy Magazine, Quarterly, published and printed by Summer Institute for Linguistics, Ukarumpa, via Lae. 25t per issue

Write S.I.L. for literacy info.





# HEALTH

## Nutrition

Nutrition is the study of food and how the body uses the food which is eaten. Good nutrition means that the body is getting enough of the right kinds of food so it can grow, work and stay healthy. Malnutrition, or bad nutrition, means that the body is not getting enough of the right kinds of food. People who are malnourished do not grow as well as they should, they do not have enough energy to work as hard as they might, and they are sick more often than people who are eating properly.

All people of all ages need to be concerned about the food they eat. We must choose food that will give us energy to work and that will protect our bodies from disease. Children need plenty of good food so that they will grow properly. Pregnant women and women who are breast feeding need extra food for the fetus to grow properly and so the mother can produce plenty of good milk without getting weak and malnourished herself.

In order to be well-nourished, a person must eat a variety of foods. The most common way to stress the importance of eating a variety of foods is to talk about the three food groups.

**GROWTH FOODS** are protein foods such as fish, meat, eggs, milk, beans, and peanuts. These foods supply more amounts of protein per unit of measure than foods such as leafy greens and sweet potatoes, although these foods provide some protein, too. Protein is essential for growth and body repair, so we should eat foods high in protein each day. It is especially important for children to eat protein foods, such as peanuts and tinned fish. Breast milk is the most important source of protein for babies.

**PROTECTIVE FOODS** provide us with the vitamins and minerals that our bodies need to function properly. Vitamin A is found in dark green and orange coloured foods. Children who are not given these foods may go blind. Iron, calcium and iodine are important minerals in our foods. Iron is important as part of the hemoglobin in the blood. Calcium is necessary for formation of strong bones and teeth. Lack of iodine can cause goitre. All the salt sold in stores is iodized, and should be used to prepare the family's food.

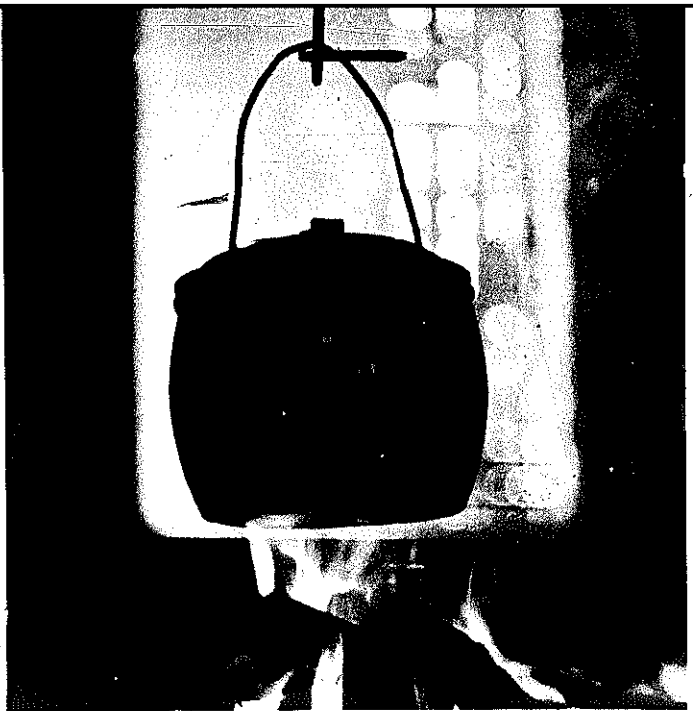

Traditional varieties of vegetables are better sources of vitamins and minerals than the newly introduced ones. In Tables 1-4 the vitamin A, vitamin C, calcium and iron content of three traditional foods are compared with three "European" vegetables. The amaranthus, aibika, taro leaf and pumpkin tips are better sources of these nutrients than are cabbage, cucumbers and lettuce.

Dark green leaves have much more iron, calcium and vitamin A in them than light green leaves do. Most of the local greens also contain more protein than imported varieties. Plants such as aibika, pumpkin tips and amaranthus, which are already being grown and eaten in most areas, should not be replaced by the less nutritious imported plants.

cont'd

Tables 1 - 4: Comparison of vitamins and minerals in traditional and introduced green vegetables.

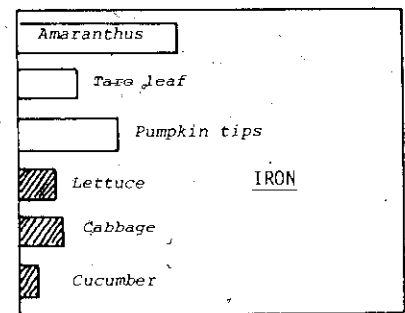
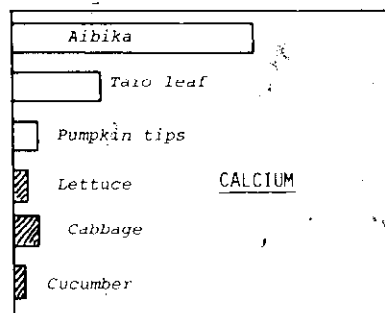
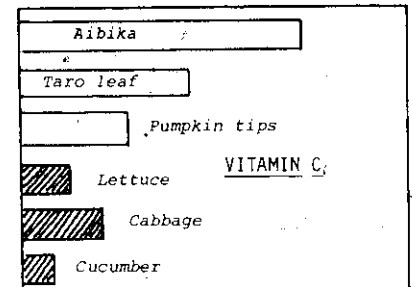
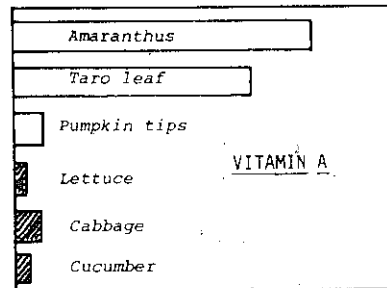

□ Traditional

▨ Introduced

Stable foods, such as sweet potatoes, saço, taro, bananas, English potatoes and rice, are ENERGY FOODS, which is the third group. While these foods may provide some protein and vitamins, they are mostly valued for the calories they supply so we have enough energy to work. Fats are more concentrated sources of energy than the staple foods. Peanuts, pandanus and other nuts, coconut cream, drippings, butter and margarine are good sources of fat. Fat should be included in cooking, if possible, to add extra calories for extra energy. Most Papua New Guinean diets are low in fat.

Energy foods, such as sweet potatoes, taro and saço should always be eaten with protective and protein foods. Mixed foods provide better nutrition and are stronger foods. We should eat a staple food, plus other food, such as peanuts and greens with sweet potatoes, to make a good mixed food.

Good nutrition means eating enough of the right kinds of food. Children have small stomachs and it is impossible for them to eat enough in two meals a day to get enough food to grow properly. This is especially true when their main food is a bulky, high volume food, such as sweet potatoes. Children must eat 3 or 4 times a day. This means school children must have a noon-time meal so they will be more alert and able to learn better. Concentrated, low-volume foods, such as peanuts, tinned fish, beans, nuts, fats and meat should be fed to children as well as adults. These foods supply lots of energy as well as protein for growth.

Simply knowing about good nutrition is not enough. People must practice good nutrition, too. In nutrition, as in every other aspect of our lives, our actions demonstrate our real beliefs. We can show our belief in good nutrition by planting a variety of foods in our gardens, by eating a mixed diet, and by choosing nutritious snacks, such as peanuts and fruit juices instead of cheese pops and lolly water. This is a very important part of nutrition education.

Initial contributor: M. Cast, Nutritionist, Provincial Health Office, Box 458, Lae, (with excerpts from an article by J. Eng, Area Nutritionist for the highlands).

BOOKS

Nutrition for Papua New Guinea. Nutrition Section, Department of Health, Konedobu, 1975 182pp. Based in part on "Nutrition for Developing Countries" by King, King, Mosley, Burgess, it is a must for field workers in PNG who are involved in Community Education activities. Cost K1.60 from UPNG Bookshop, Box 4820, University.

Papua New Guinea Cook Book. Louise Shelly, Wirui Press, 1977, 105pp. Written by a former CUSO worker the book gives descriptions of local foods and traditional and modern recipes for PNG, as well as a collection of international recipes using local foods. This would be a good book for foreigners living in PNG who want to use more local foods in their cooking and also good for Papua New Guineans who want to try foreign recipes or recipes from

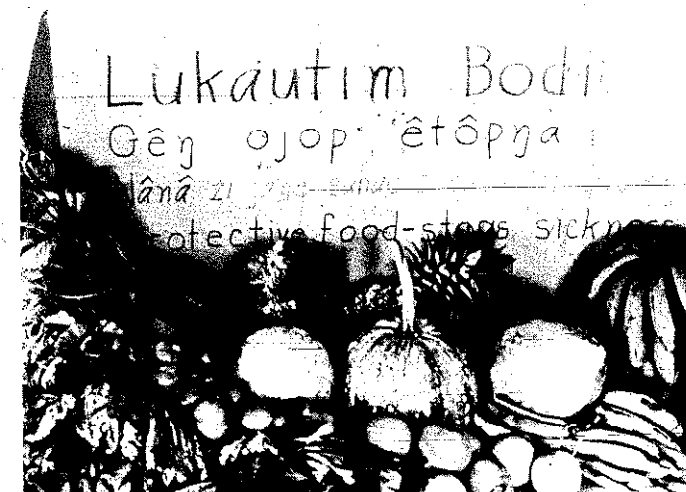
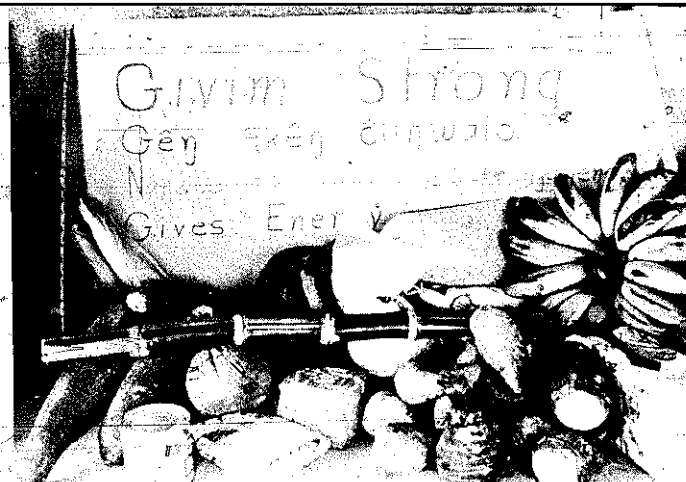

another region of the country. For sale in local bookshops.

The following posters may be ordered from: Health Education Section, Department of Health, Box 2084, Konedobu.

Pictures of Food suitable for use on a flannelgraph:

- Food Series (2) Blood #51
- Food Series (2) Body Building #52
- Food Series (2) Protection #53
- Food Series (2) Work #54

Kaikai bilong Man #124

Good Food Makes us Strong and Healthy #6  
(shows the 3 food groups)

School Lunches #112

Child Care #66

Child Care - Good Food No 1 #62

Child Care - Attend Clinic No 3 #64

Good Food for Baby #59

The following teaching and visual aids can be ordered from: Nutrition Section, Department of Health, Box 2084, Konedobu.

Booklets:

- Good Food for Your Baby
- Gutpela Kaikai bilong Bebi belong Yu
- Food for School
- Kaikai bilong Skul
- Recipes for Papua New Guinea

Posters:

- Good Food - Healthy Baby
- Peanuts are Good for all the Family
- Breast Feeding is Best
- Food for a Baby at 6 months.

Journal: Nutrition & Development

Published periodically by the Nutrition Section, Department of Health. It contains articles pertaining to nutrition teaching and research of interest to teachers, health workers and other field workers.

Flipchart: A Happy Baby is a Healthy Baby.

A series of pictures, each accompanied by a short script in English, Pidgin and Motu, tells the story of 2 mothers and their new babies. It emphasizes supplementary feeding.

## BABY AND CHILD CARE

### Breastfeeding

All mothers should breastfeed their children until they are two years old. Breast milk is the best food for a baby because it is natural. It contains all the nutrients needed for the baby. There are other reasons why it is so good for the baby.

1. Breast milk is always ready whenever the baby is hungry.
2. It is safe because it is made and kept inside the breast.
3. The harmful bacteria which can get into drinking water and dirty feeding bottles never get

4. Breast milk has antibodies which help the baby to fight disease.
5. Breast milk never goes sour or bad, even when a mother is pregnant.
6. It is always the right temperature for the baby.
7. It does not cost anything and it does not give the mother extra work.
8. Breast-feeding makes mother and child happy.

Breast-feeding is the natural way to feed a baby. Any other way of feeding is called artificial feeding.

### Bottle feeding - The Baby Killer ?

(p 243)

"Third World babies are dying because their mothers bottle feed them with western style infant milk. Many that do not die are drawn into a vicious cycle of malnutrition and disease that will leave them physically and intellectually stunted for life."

"The frightening fact is that this suffering is avoidable. The remedy is available to all but the small minority of mothers who cannot breast feed, because mothers' milk is accepted by all to be the best food for a baby under six months old."

"Although even the baby food industry agrees that this is correct, more and more Third World mothers are turning to artificial foods during the first few months of their babies' lives. In the squalor and poverty of the new cities of Africa, Asia, and Latin America this decision is often fatal."

Why is bottle feeding dangerous for the PNG child? The risk of death or severe malnutrition is greatly increased in the child who is bottle fed.

1. PNG homes do not generally have functioning refrigerators for storing prepared milk. It quickly becomes contaminated and causes disease in the child.
2. Milk bottles and teats are difficult to sterilize. They quickly become contaminated unless boiled or soaked in sterilizing solution.
3. Milk products are expensive. They are often over-diluted to make them last longer. The child then starves.

What can be done? PNG women are extremely good with breast feeding their children, despite the fact that they themselves often suffer from malnutrition. They should all be encouraged to continue. For the more sophisticated there is the temptation to follow "European" patterns. They should be told of the risks and without exception encouraged to breastfeed their children.

In certain cases of illness in the mother, artificial feeding may be necessary. This will usually be commenced in a hospital using a cup and a spoon for the first 2 months of life and after that the baby is continued on a mainly solid diet.

Diarrhoea is a very serious disease in children. Always take the sick child to an aid post or health centre. When a child gets diarrhoea the mother must;

1. Give him water from a clean cup or with a cup and spoon. A child with diarrhoea should drink four or more cups of water every day.
2. The mother must also put a little salt and sugar in the water.
3. Do not stop feeding a child with diarrhoea. Feed him three times everyday and snacks 2-3 times everyday. Food gives the child strength.
4. Bananas are very good for children with diarrhoea.

Remember that diarrhoea is a very serious disease in young children and will happen many times when a child is malnourished. Not feeding a child that has diarrhoea makes the child very weak so he has little strength to fight the diarrhoea or any other infection.

Contributed by: M. Cast, adapted from Information written by C.M. Binns and Holst, Wapenamanda, EP. Quotes from "War on Want" publication.

## WHAT MAKES CHILDREN GROW?

THE COMPLEXITY OF THE PNG NUTRITION PROBLEM IS REALIZED WHEN YOU ASK PEOPLE, "WHAT MAKES CHILDREN GROW?" (OR WHAT PREVENTS THEM FROM GROWING?) THE IMPORTANCE OF SUFFICIENT FOOD OF THE RIGHT KIND IS OFTEN NOT FULLY REALIZED.

SOME EXAMPLES OF THE DIFFICULTY: MANY CHILDREN ARE TOLD THAT IF THEY MISBEHAVE, THEY WON'T GROW. IN SOME GROUPS GIRLS ARE TOLD NOT TO PLAY WITH BOYS, OR THEY WON'T GROW. SOME THINK THAT TO EAT THE EGGS OF WILD BIRDS WHEN YOU ARE A CHILD WILL RETARD YOUR GROWTH. MORE THAN ONE GROUP, WE'RE TOLD, BELIEVE THAT PUTTING A CHILD'S BABY TEETH, AS THEY COME OUT, INTO A YOUNG GROWING BANANA STALK, WILL HELP THE CHILD TO GROW. AT LEAST ONE GROUP BELIEVES THAT FRIGHTENING A BABY WHILE HE OR SHE SLEEPS CAUSES HIM TO STRETCH, AND MAKES HIM GROW FASTER.

SO IMPROVING NUTRITION AT THE VILLAGE LEVEL IS NOT SIMPLY AN AGRICULTURAL OR MEDICAL QUESTION, BUT A COMPLEX MIX OF FACTORS. WE CANNOT HOPE TO MAKE MUCH PROGRESS IF WE TAKE A PURELY AGRICULTURAL OR MEDICAL APPROACH. AN INTEGRATED APPROACH WITHIN THE SPECIFIC CULTURAL FRAMEWORK IS THE ONLY ANSWER. WORKERS FROM THE VARIOUS DEPARTMENTS AND ORGANISATIONS MUST WORK OUT A VIABLE PATTERN OF COOPERATION AT THE LOCAL LEVEL.

## SUPPLEMENTARY FEEDING

### 1. SUPPLEMENTARY FEEDING STARTING AT 4 MONTHS:

Breast milk is the best food for a young baby. However, it is important that the mother start feeding her child solid foods when it is 4 months old (before the baby gets its first tooth). Supplementary feeding this early in life is important because when the baby is 6 months old, milk alone will not keep the fast-growing child well fed. Mother's milk is still the most important food for the baby.

A baby 4 mos. old can begin eating soft ripe fruits such as banana or pawpaw. Kaukau and pumpkin that has been well cooked is also very good for a small baby. Make it soft with breast milk and feed the baby with a spoon or with your fingers. Make sure you always wash your hands before feeding the baby.

As the baby gets a little older try giving new foods such as greens, tinned fish, beans, peas, peanut butter. Always make the foods soft and mash them into very small pieces. The baby will not like these new foods at first. Give him a little bit every day. When he is 6 mos. old he will enjoy eating.

When the baby is one year old it will want to start eating by itself. Give the baby its own plate and spoon. He will want to play with his food. It is important that the mother helps him put the food in his mouth.

2. WEANING A YOUNG CHILD: A child needs its mother's milk until it is old enough to get all the nourishment it needs from food; therefore it is important for a family to space its children.

End breast feeding slowly. Taking a child away from the breast suddenly may upset it so much that it will not eat. It is also painful for the mother because her breasts will swell up with milk.

When the child is weaned the mother must watch closely to see that the child is eating enough food. All young children must eat three meals every day and have snacks between meals too.

A young child's stomach is very small so it must eat many times every day to grow strong and healthy. Many children become malnourished when they have been weaned because the mother spends more time with the new baby. The older child may feel that it is no longer loved and stop eating. A child that has been weaned slowly and still gets attention from his mother will not do this.

3. DIARRHOEA IN THE HOME: When a child has diarrhoea often it may be caused by two things: lack of cleanliness, or malnutrition. A malnourished child gets sick much easier and more often than a healthy child.

Keeping our bodies and our clothes clean and being careful when we are handling food will do much to stop diarrhoea.

# FOOD COMPOSITION TABLES

(WORLD HEALTH ORGANISATION, WESTERN PACIFIC REGIONAL OFFICE)

**TABLE A.1.4**  
**SOURCES OF ENERGY**  
(Rich in carbohydrates or fats)  
Composition per 100g of raw foodstuff, edible portion (E.P.)

	E.P. as % of A.P.	MOISTURE	CALORIES (per 100 g)	PROTEIN				FAT		CARBOHYDRATE		CALCIUM (mg per 100 g)	IRON (mg per 100 g)	PRO-VITAMIN A (I.U. per 100 g)	β-CAROTENE (mcg per 100 g)	THIAMINE (mg per 100 g)	RIBOFLAVIN (mg per 100 g)	NIACIN (mg per 100 g)	ASCORBIC ACID (mg per 100 g)	Source	REMARKS	
				g per 100 g	% cal. fr. prot.	Protein score	NPU	NDP Cal. %	g per 100 g	Total (g/100 g) (incl. fibre)	Fibre (g/100 g)											
1. RICE - "brown" (under-milled or home pounded) ( <i>Oryza sativa</i> )	100	13	359	7.1	6.7	76, 57	70.2	5.0, 4.0	1.1	78.0	0.7	14	1.0	(0)	(0)	0.16	0.04	0.5	(0)	a	70-74% extraction	
"white" (highly-milled)	100	13	360	6.7	7.1	77, 56	57.2	5.2, 4.2	0.7	78.9	0.4	10	0.9	(0)	(0)	0.08	0.03	1.6	(0)	a	70% extraction	
2. MAIZE (grain or whole meal) ( <i>Zea mays</i> ) (fresh)	100	12	356	9.5	9.6	55, 41	51.1	5.0, 4.0	4.3	72.9	-2.1	7	2.3	450*	270	0.45	0.11	2.0	(0)	a	97-100% extraction	
3. SORGHUM ( <i>Sorghum vulgare</i> )	100	11	343	10.1	11.9	42, 31	—	—	—	1.2	20.7	1.0	5	0.6	350**	210**	0.15	0.09	1.7	14	a	80-100% extraction
4. MILLET (Ragi eleusine)	100	11	332	6.5	7.9	59, 45	—	5.0, 4.0	1.7	78.0	2.6	350	4.0	(100)	60	0.35	0.05	1.5	(0)	a	80-100% extraction	
5. WHEAT (grain or whole meal) ( <i>Triticum vulgare</i> ) (white flour)	100	12	333	10.5	11.9	68, 43	40.3	7.0, 4.7	1.9	73.9	2.1	36	4.0	(0)	40	0.41	0.10	(4.6)	(0)	a	94-100% extraction	
6. BREAD, loaf, brown (50/50) — loaf, white — roll (pan de sal)	100	37	245	7.2	11.2	—	—	—	—	1.8	51.3	0.4	20	1.7	0	0	0.19	0.05	1.9	0	b	half white, half brown flour
7. BISCUITS (wheat meal) (50/50) — plain, sweet — crackers	100	2.7	420	7.3	6.6	—	—	—	—	10.5	77.0	—	45	2.7	0	0	0.16	0.12	1.5	0	b	half white, half brown flour
8. BARLEY (whole except hulls and groats) ( <i>Hordeum vulgare</i> )	100	12	332	11.0	11.9	78, 54	64.6	8.1, 5.9	1.8	73.4	3.4	33	3.6	(0)	(0)	0.46	0.12	5.5	(0)	a	60-70% extraction	
9. OATMEAL (rolled oats) ( <i>Avena sativa</i> )	100	10	385	13.0	12.1	79, 57	65.7	8.2, 6.2	7.5	67.8	1.9	56	3.8	(0)	(0)	0.63	0.14	0.9	(0)	a	40-55% extraction	
10. SWEET POTATO ( <i>Ipomoea batatas</i> )	87	70	117	1.3	3.0	64, 38	—	2.0, 1.2	0.4	27.3	0.8	34	1.0	500**	300**	0.10	0.05	0.6	23	b	white	
	68.0	120	0.8	1.8	—	—	—	—	0.1	29.1	0.6	30	0.6	60	36	0.07	0.05	0.24	65	b	yellow	
	68.0	127	0.6	1.3	—	—	—	—	0.1	30.8	0.8	30	0.6	1670	1000	0.07	0.05	0.7	65	b	yellow	
	85	70	119	2.8	6.4	—	—	—	0.3	27	1.0	25	1.0	0-4000	0-2400	0.1	0.04	0.7	30	e		
11. TARO ( <i>Colocasia spp.</i> ) ( <i>C. esculenta</i> )	82	72.5	104	1.9	5.0	69, 53	—	3.8, 2.7	0.2	24.2	0.9	22	1.1	β	β	0.15	0.03	0.9	5	a		
	53.5	165	1.4	2.3	—	—	—	—	0.5	39.0	3.0	22	—	5	3	0.27	0.04	0.20	5	b		
12. YAM ( <i>Dioscorea spp.</i> ) ( <i>D. alata</i> , white)	86	72.4	105	2.4	6.3	75, 50	—	4.5, 3.0	0.2	24.1	0.9	22	0.8	4	2	0.09	0.03	0.5	10	a		
	54.5	161	1.4	3.6	—	—	—	—	0.1	38.7	0.5	23	0.5	0	0	0.14	—	0.19	0.8	b		
	85	73	106	2.0	5.2	—	—	—	0.2	24.5	0.5	10	1.2	20	12	0.1	0.03	0.4	10	e		
13. POTATO, Irish ( <i>Solanum tuberosum</i> )	85	78	82	2.0	6.7	53, 34	59.6	4.8, 2.3	0.1	18.9	0.4	8	0.7	β	β	0.10	0.03	1.4	10	a		
14. CASSAVA ( <i>Manihot utilisima</i> ) fresh Meal and flour	75	62.5	146	1.2	2.2	—	—	—	0.3	34.7	1.3	33	0.7	β	β	0.06	0.03	0.6	36	a		
	100	14	1.5	2.8	84, 41	—	—	2.2, 1.3	0.6	81.5	—	12	1.0	β	β	(0)	(0)	(1.0)	0	a		
15. STARCHES (Cornstarch, tapioca, arrowroot, sago)	100	12	362	0.5	0.55	—	—	—	0.3	86.9	0.2	0	0	0	0	0	0	0	0	a		
16. PLANTAINS ( <i>Musa paradisiaca</i> )	66	68.2	113	1.2	3.6	—	—	—	0.5	29.2	0.4	7	0.8	320**	190	0.06	0.04	0.6	16	a		
17. BANANA ( <i>Musa sapientum</i> )	71	73.5	94	1.3	4.6	71, 44	—	—	—	—	—	—	—	200**	120	0.04	0.05	0.7	11	a		

	E.P. as % of A.P.	MOISTURE	CALORIES (per 100 g)	PROTEIN				FAT		CARBOHYDRATE		CALCIUM (mg per 100 g)	IRON (mg per 100 g)	PRO-VITAMIN A (I.U. per 100 g)	β-CAROTENE (mcg per 100 g)	THIAMINE (mg per 100 g)	RIBOFLAVIN (mg per 100 g)	NIACIN (mg per 100 g)	ASCORBIC ACID (mg per 100 g)	Source	REMARKS	
				g per 100 g	% cal. fr. prot.	Protein score	NPU	NDP Cal. %	g per 100 g	Total (g/100 g) (incl. fibre)	Fibre (g/100 g)											
18. SUGARCANE JUICE ( <i>Saccharum robustum</i> )	100	81	71	0.3	1.7	—	—	—	β	18	β	6	2.0	β	β	0.02	0.1	0	β	e		
19. SUGAR, refined	100	—	387	—	—	—	—	—	—	—	β	β	0	0	0	0	0	0	0	a		
20. SUGAR, crude (from cane, palm, coconut)	100	7	351	1.0	1.1	—	—	—	—	90	—	78	5.0	β	β	β	β	β	β	a		
21. MOLASSES	100	24	232	—	—	—	—	—	—	(60)	—	273	6.7	0	0	0.06	0.11	2.8	0	a		
22. COCONUT meat, fresh, mature ( <i>Cocos nucifera</i> )	46	48	351	4.2	4.1	82, 55	55.0	3.5, 2.4	34.0	12.8	3.3	9	1.7	0	0	0.06	0.03	0.6	2	a	AP means in shell; FR means shell removed	
meat, fresh, immature	34	70	180	4.0	7.7	—	—	—	15	10	3	8	1.3	10	6	0.05	0.03	0.7	4	a		
milk (from mature nut)	100	58.5	311	2.5	2.8	—	—	—	34	6	0	15	1.0	De	De	0.04	0.025	3.5	5.3	m		
water (mature nut)	100	94.3	22	0.3	4.7	—	—	—	0.4	5.0	0	20	0	—	—	0	0	0	—	f		
water (immature nut)	100	94.8	17	0.2	4.1	—	—	—	0.4	3.6	—	30	0	—	—	0	0	0	—	f		
23. BREADFRUIT ( <i>Artocarpus altilis</i> )	77	80	106	0.9	2.8	—	—	—	1.5	25.2	1.2	35	0.5	19	11	0.08	0.06	0.8	72	b		
24. JACKFRUIT ( <i>Artocarpus heterophyllus</i> ) seeds	28	72.0	98	1.3	4.5	—	—	—	0.3	26.2	1.2	33	1.2	40	24	0.11	0.03	0.9	29	d		
25. VEGETABLE OILS	100	0	884	0	—	—	—	—	100	0	0	0	0	0	0	0	0	0	0	a		
26. MARGARINE	100	15.5	720	0.6	—	—	—	—	81	0.4	—	(15)	β	0	0	0	0	0	0	a		
27. BUTTER	100	15.5	716	0.6	—	—	—	—	81	0.4	—	15	β	**	**	β	β	β	β	a		
28. PORK FAT	100	0	816	3	—	—	—	—	89	0	0	0	0	0	0	0	0	0	0	a		
29. ALCOHOL & OTHER BEVERAGES																						
a. Beer, brown ale, bottled (30% alcohol)	100	97	35	0.3	—	—	—	—	β	3	0	8	0.1	0*	0	β	0.05	1.0	0	e		
b. Palm wine (1/2-1 day fermentation) (15% alcohol)	100	99.5	17	0.2	—	—	—	—	0	3	—	—	0.32	—	—	0.02	0.01	0.38	145	e		
c. Spirits, 70% proof (31.5% alcohol) (mean of brandy, gin, rum, whisky)	100	68.5	222	0.2	—	—	—	—	β	β	β	β	β	β	β	β	β	β	β	k		
d. Coffee, extracted from 100 g ground coffee by boiling 5 minutes	100	92	48	6.8	49.1	—	—	—	β	6	0	30	1.0	β	β	β	0.01	270	0	e		
e. Tea, extracted from 100 g leaves with hot water (5-10 minutes)	100	90	24	10.0	100	—	—	—	—	—	0	30	β	0	0	0	0.9	6.0	0	e		

β means "trace"  
— means "no data available," not necessarily "0"

\*\* Total Vitamin A activity: (Summer) 4000 I.U. (1200 mcg retinol) per 100 g. This includes the provitamin A (β-carotene) activity.  
(Winter) 2400 I.U. (720 mcg retinol) per 100 g.

TABLE A.1.5 SOME ANIMAL SOURCES OF PROTEIN Composition per 100g of raw foodstuff, edible portion (E.P.)

	E.P. as % of A.P.	MOISTURE	CALORIES (per 100g)	PROTEIN					FAT (g per 100g)	CARBOHYDRATE		CALCIUM (mg per 100g)	IRON (mg per 100g)	VITAMIN A (I.U. per 100g)	β-CAROTENE (mcg per 100g)	THIAMINE (mg per 100g)	RIBOFLAVIN (mg per 100g)	NIACIN (mg per 100g)	ASCORBIC ACID (mg per 100g)	REMARKS
				g per 100g	% cal. fr. prot.	Protein score	NPU	NDo Cal. %		Total (g/100g)	Fiber (g/100g)									
30. HUMAN MILK (Mature, i.e. after 30 days of lactation)			60	1.2	8.0	(100)		8.0	3.8	7.0	0	33	0.15	177	53	01-02	02-04	0.17	4.3	Ref. 32,136
31. COW'S MILK (fresh, whole (3.5% fat))	100	87.3	65	3.5	22.9	66, 60	81.6	9.8, 9.2	3.5	5.0	0	119	0.1	140	42	0.04	0.18	0.1	1	a
Evaporated whole	100	73.7	138	7.0	21.7				7.9	9.9	0	240	0.2	320	100	0.05	0.35	0.2	1	a
Sweetened condensed	100	27	320	8.1	10.8				8.4	54.8	0	293	0.2	330	100	0.05	0.43	0.2	1	a
Powdered whole	100	4	506	26	21.9	69, 64		6.8, 6.4	30	34	0	897	0.7	1,080	320	0.24	1.31	0.7	4	a
Powdered (skimmed)	100	4	360	36	42.7				1	51	0	1,235	0.9	40	12	0.35	1.80	1.0	6	a
32. GOAT'S MILK	100	86.4	73	3.8	22.2				4.5	4.5	0	141	0.1	160	48	0.05	0.11	0.3	1	a
33. CARABAO MILK (Water buffalo)	100	80	121	5.8	20.5				9	4.4	0	(120)	(0.2)	(90)	(27)	(0.05)	(0.10)	0.1	1	a
34. PORK—medium fat	100	52	364	12.0	13.2	81, 69		9.0, 7.8	35.0	0		6	6.5	0	0	0.58	0.14	3.1	0	h
35. BEEF—lean	100	69	183	17.5	38.2	80, 69	66.9	9.5, 8.5	12.5	0		10	2.6	0	0	0.08	0.16	4.2	0	h
36. BEEF—corned, canned	100	60	224	18.6	33.2				16.5	0		20	4.3	0	0	0.02	0.24	3.4	0	h
37. LIVER—beef	100	69.7	136	19.7	57.9		65.0		3.2	6.0	0	7	6.6	43,900	13,170	0.26	3.33	13.7	31	d
fresh pork	100	72.3	134	19.7	58.6				4.8	1.7	0	10	18.0	14,200	4,260	0.40	2.98	16.7	23	d
38. POULTRY	61	66	200	20.2	40.4	79, 64	70.7	8.8, 7.3	12.6	0		12	1.5	400	120	0.10	0.16	8.1	(0)	a
39. EGG, fresh hen	89	74	163	12.4	33.2	100	93.5	33.5	11.7	0.9		50	2.5	1,000	300	0.10	0.30	0.1	0	a
fresh duck	87	71	189	13.0	29.4				14.5	0.5	0	57	2.8	1,200	360	0.15	0.30	0.1	0	a
40. FISH, fresh, fatty (sea)	50	68.6	176	20	45.4	80, 70	79.5	74.5	10	0		38	1.2	(100)	(30)	0.08	0.21	2.7	0	a
fresh, other (sea)	45	77.2	104	19	76.1				2.5	0		28	0.8	0	0	0.06	0.08	2.2	0	a
fresh, (sitapia)	39	77.3	107	17.5	65.4				4.1	0		77	0.1	100	50	0.03	0.10	4.2	0	a
fresh, (anchovies)	75	78	82	17.9	87.3	72, 67		4.5	1.1	0		469	0.7			0.01	0.08	3.7	0	a
41. FISH, preserved:																				
canned in oil	100	51	314	22	28.0				24	1	0	44	1.3	(100)	(30)	0.06	0.20	2.6	0	a
canned, not in oil (fatty)	100	65	188	20	42.5				11	1	0	40	1.2	(100)	(30)	0.03	0.20	4.0	0	a
canned, not in oil (other)	100	75	108	21	77.8				2	0	0	32	0.8	0	0	0.03	0.06	1.9	0	a
medium-cured (fatty)	69	41	261	40	63.3	75, 66		74.5	10	0	0	80	2.4	(100)	(33)	0.10	0.36	4.4	0	a
medium-cured (other)																				
anchovies, dried and powdered	55	37	223	46	82.5				3	0	0	69	1.8	0	0	0.09	0.18	4.6	0	a
	100	5.2	351	82.0	93.4				2.6	0	0	2,296	31.3	320	100	0.05	0.16	9.4	0	a
42. TURTLE	30	80	82	16.0	78.0				1.0	2		100	1.0			0.2	0.5	3.0		e
43. MOLLUSCS (oysters, mussels, clams, etc.)	25	83	71	10.0	56.3	81, 71		74.5	2.0	3		150	10.0	200	60	0.05	0.15	1.8	0	e
44. CRUSTACEANS (lobster, crab)	37	77	94	18.0	76.6	78, 66		74.5	3.5	2		100	5.0	0	0	0.05	0.10	2.5	0	e
45. SHRIMP (large, fresh)	63	75.6	96	19.6	81.7				0.8	2.5		146	1.1	250	75	0.07	0.04	3.6		e
46. SHRIMP (small, fresh) (acetes shrimp)	100	79.1	78	16.6	85.1				1.3	0		699	3.0			0.07	0.15	2.4		e
47. SHRIMP (small, dried)	100	21.6	286	52.4	73.5				3.6	10.2		2,306	21.4	115	34	0.06	0.19	5.5		e
48. FERMENTED SHRIMP PASTE	100	63.3	69	14.9	86.4				1.0	0.2		469	5.4			0.01	0.10	1.6		e
49. FERMENTED FISH PASTE (Anchovies)	100	49.0	129	26.7	82.8				2.5	0		280	8.3			0	0.27	5.0		e
50. SMAIL (river, pond)	100	78	83	12.0	57.8				2.0	4		1,500	8.3			0	0.05	1.3		e
51. SEA SLUG (Beche de mer)	100	76	92	22.0	95.6				0	1		120	1.4			0				e
52. CATERPILLAR	100	80	81	12.0	59.3				3.0	1.5	2.0	61	6.3			0.08	0.43	2.4		e
53. TERMITE	100	75	148	10.0	27.0				12.0	0	1.2	12	1.0							e
54. LOCUST	100	75	134	20.0	59.7				6.0	0	4.0	30	1.0							e
55. SAGO GRUB	100	70.5	181	6.1	13.5				13.1	9		461	4.3			0.08	0.43	2.4		i

β means "trace" — means "no data available", not necessarily "0"  
 \* These figures represent total vitamin A activity (including provitamin A portion). The percentage of this total vitamin A activity which is actually derived from β-carotene is estimated (WHO 232A, Appendix 6) as follows:  
 milk poultry, eggs — 30%; fish — 10%  
 \*\* Breastmilk contains on average, in addition, 27 mcg carotenoids per 100 g of which about 6 mcg is β-carotene, so that total provitamin A activity is about  $(\frac{6}{21} + \frac{21}{6}) = 28$  I.U.  
 \*\*\* These values are artificially low. The percentage of calories derived from protein is so high that, when fish alone is eaten, much of the protein is used for energy production. The percentage of calories derived from protein indicates better the real protein value.

TABLE A.1.6 SOME VEGETABLE SOURCES OF PROTEIN Composition per 100g of raw foodstuff, edible portion (E.P.)

	E.P. as % of A.P.	MOISTURE	CALORIES (per 100g)	PROTEIN					FAT (g per 100g)	CARBOHYDRATE		CALCIUM (mg per 100g)	IRON (mg per 100g)	PRO-VITAMIN A (I.U. per 100g)	β-CAROTENE (mcg per 100g)	THIAMINE (mg per 100g)	RIBOFLAVIN (mg per 100g)	NIACIN (mg per 100g)	ASCORBIC ACID (mg per 100g)	REMARKS
				g per 100g	% cal. fr. prot.	Protein score	NPU	NDo Cal. %		Total (g/100g)	Fiber (g/100g)									
56. SOYBEANS (Glycine max) whole	100	8	335	38.5	46.0	62, 47	61.4	5.0, 4.9	18	31.3	4.8	208	6.5	140	84	0.3	0.30	2.1	0	a
full-fat flour (seedcoat removed)	100	8	357	39	37.9				21	27.4	2.4	197	6.2	160	96	0.77	0.28	2.0	(0)	a
low-fat flour, grits, etc.	100	8	261	46	61.2				5	35.2	2.3	247	7.6	110	66	0.70	0.30	2.0	(0)	a
curd (tofu)	100	87.4	58	6.3	37.7				3.1	2.5	0.1	46	1.1	20	12	0.05	0.04	0.4	(0)	a
fermented (natto)	100	61	153	17	38.6				9	11	3	100	3.7	(40)	24	0.09	0.20	(1.0)	(0)	a
fermented (shiung)	100	65	153	17	38.6				10	6	3	100	3.7	40	12	(0.05)	(0.20)	(1.0)	(0)	a
sprouts	100	86.3	46	6.2	46.8				1.4	5.3	0.8	48	1.0	180	108	0.23	0.20	0.8	13	d
57. PEANUTS (Groundnuts) (Arachis hypogaea)	71	5.2	546	25.6	16.3	69, 43	42.7	8.8, 6.0	43.3	23.4	3.3	52	1.9	30	18	0.84	0.12	16.0	0	a
58. GREEN GRAM (MUNG BEANS) with coat (Phaseolus aureus) sprouts	100	12	336	22.0	22.7	32, 22	48.5	5.5, 4.3	1.0	61.7	4.7	100	8.0	40	24	0.45	0.2	2.0	0	e
59. KIDNEY BEANS (Phaseolus vulgaris) dried mature, moist, fresh	100	12.2	336	23.1	23.9	47, 34	43.7	7.5, 5.8	1.7	59.4	3.5	163	6.9	(0)	(0)	0.57	0.22	2.5	2	d
60. LIMA BEANS (Phaseolus lunatus) dried	100	12	338	20.0	20.5	50, 41	51.5	7.4, 6.4	1.5	63	5.0	90	6.0	0	0	0.5	0.14	1.5	0	e
61. HYACINTH BEANS (Field Beans) dried (Dolichos lablab) (Lablab niger)	100	11.8	338	22.2	22.8	37, 27	59.9	6.2, 4.8	1.5	61.0	6.8	88	3.5			0.62	0.20	2.3		d
62. WINGED BEANS, dried (Psophocarpus tetragonolobus)	100	14	399	33.0	28.7				16.0	37	5.0					0.08				e
63. BROAD BEANS, dried (Vicia faba)	100	12.2	338	25.4	26.1	41, 28	47.8	6.9, 5.1	1.7	57.8	7.8	95	6.5	130	78	0.60	0.26	2.5	5	d
64. PEAS (whole) dried (Pisum sativum)	100	11.6	339	23.8	24.4	50, 37	47.9	7.9, 6.2	1.4	60.2	5.4	57	4.7	140	84	0.77	0.28	3.1	2	d
65. CHICK PEAS, dried (Cicer arietinum)	100	10.6	359	20.8	20.1	53, 40	52	7.7, 6.3	4.7	60.9	5.3	162	8.4	90	54	0.49	0.18	1.6	0	d
66. COW PEAS (whole) dried (Vigna sinensis)	100	10.6	342	22.9	23.2	57, 41	45.1	8.7, 6.6	1.4	61.6	4.2	77	6.5	30	18	0.92	0.16	2.2	2	d
67. PIGEON PEAS (husked) dried (Cajanus cajan)	100	13.1	333	21.9	22.8	39, 27		6.4, 4.8	1.6	59.9	1.5	92	4.5	140	84	0.47	0.18	2.0		

**TABLE A.17**  
**SOME OTHER VEGETABLES**  
Composition per 100g of raw foodstuff, edible portion (E.P.)

	E.P. as % of A.P.	MOISTURE	CALORIES (per 100 g)	PROTEIN			NPU	NDP Cal. %	FAT (g per 100 g)	CARBOHYDRATE		CALCIUM (mg per 100 g)	IRON (mg per 100 g)	PRO-VITAMIN A (I.U. per 100 g)	B-CAROTENE (mcg per 100 g)	THIAMINE (mg per 100 g)	RIBOFLAVIN (mg per 100 g)	NIACIN (mg per 100 g)	ASCORBIC ACID (mg per 100 g)	Source	REMARKS
				%	% cals. fr. prot.	Protein score				Total (g/100 g)	Fibre (g/100 g)										
<b>A. LEAVES</b>																					
75. LEAVES, (a) dark green (b) medium (c) light green	80 80 80	85 91 03	41 25 23	5.0 2.0 1.5	29.8 19.5 15.9	57, 53	—	8.8, 8.2	0.7 0.3 0.2	6.5 4.8 4.8	3.5 0.8 0.8	250 80 40	4.0 2.5 0.5	3 000 1 000 30	1 800 600 18	0.1 0.08 0.05	0.3 0.02 0.05	1.5 0.5 0.3	100 50 40	c e e	
76. ABELOSCHUS MANIHOT (Atibika, New Guinea)		82.7	47	5.7	29.6	—	—	—	0.3	8.6	1.8	580	—	—	—	—	—	—	—	—	
77. AMARANTHUS spp. (Brassica oleracea capitata)	71	86.9	36	3.5	23.7	88, 62	—	13.0, 9.5	0.5	6.5	1.3	267	3.9	6 090	3 600	0.08	0.16	1.4	80	d	
78. CABBAGE, common (Brassica oleracea capitata)	69	91.8	25	1.6	15.6	65, 39	35.2	8.1, 5.3	0.1	5.7	1.0	50	0.4	100	60	0.06	0.05	0.3	50	a	
79. CABBAGE, Chinese (Brassica sinensis)	79	95	14	1.4	24.4	—	—	—	0.1	2.6	0.6	100	2.0	3 500	2 100	0.06	0.03	0.4	25	a	dark green
80. CASSAVA leaves (Manihot dulcis)		82.0	55	7.2	31.9	59, 51	—	8.8, 7.7	1.9	6.1	2.4	175	2.0	2 000	1 200	0.33	1.07	1.7	275	b	
81. HORSE RADISH-TREE leaves (Moringa oleifera, Malunggay, Philippines)	61	77.4	75	5.9	19.2	—	—	—	1.8	12.8	1.8	353	3.5	12 450	8 470	0.20	0.73	3.7	232	g	
82. KALE (Brassica oleracea acephala)	63	85.9	42	3.9	22.7	60, 23	54.3	9.1, 4.4	0.6	7.8	1.3	230	2.3	7 600	4 560	0.11	0.25	1.6	120	a	
83. MUSTARD greens (Brassica juncea)	83	92.2	23	2.2	23.3	—	—	—	0.3	4.1	0.8	188	3.0	5 670	3 400	0.09	0.25	0.7	100	a	
84. SAUROPIUS ANDROGYMIUS (Sayur manis, Malaysia)		92.1	22	2.2	24.4	71, 68	—	10.7, 10.3	0.3	3.9	0.7	81	3.0	9 420	5 650	0.11	0.20	0.7	59	a	
85. SPINACH (Spinacia oleracea)	81	92.1	22	2.2	24.4	71, 68	—	10.7, 10.3	0.3	3.9	0.7	81	3.0	9 420	5 650	0.11	0.20	0.7	59	a	
86. SPINACH, Philippine (Talinum triangulare)	67	92.5	22	1.7	18.8	—	—	—	0.4	4.2	0.7	79	5.5	5 255	3 150	0.11	0.17	0.5	58	g	
87. SWAMP CABBAGE/SPINACH (Ipomoea aquatica) (Kampkong)	60	89.7	30	3.9	31.7	73, 44	—	10.5, 6.9	0.6	4.4	1.0	71	3.2	4 825	3 000	0.09	0.24	1.3	49	g	
88. SWEET POTATO leaves (Ipomoea batatas)		85	47	3.5	18.2	—	—	—	0.5	9.5	1.5	70	8.0	6 000	3 600	0.10	0.20	0.9	25	c	
89. TARO leaves (Colocasia spp.)		85	57	5.0	24.4	—	—	—	2.5	6.6	2.3	—	—	—	—	—	—	—	—	b	
<b>B. ROOTS, Bulbs, etc.</b>																					
90. CARROT (Daucus carota)	92	88.6	40	1.1	6.7	79, 40	—	5.1, 2.8	0.2	9.1	1.0	34	0.8	2 000 (-10 000)	1 200 (-6 000)	0.06	0.04	0.7	6	a	
91. CHAYOTE (Sechium edule)	85	91.5	29	0.6	5.0	—	—	—	0.1	7.4	0.6	12	0.5	20	12	0.02	0.04	0.5	19	d	
92. LEEKS and green onions (Allium porrum, odorum, cepa)	47	87.8	43	1.8	10.2	—	—	—	0.2	9.4	1.2	80	1.0	50	30	0.06	0.04	0.5	18	a	
93. ONIONS, mature (Allium cepa)	93	88.8	40	1.4	8.5	—	—	—	0.2	9.0	0.8	32	0.5	50	30	0.03	0.04	0.2	9	a	
94. RADISH	56	93.7	20	1.1	13.4	—	—	—	0.1	4.2	0.7	37	1.0	30	18	0.03	0.02	0.3	24	a	

g means "trace"  
— means "no data available"; not necessarily "0"

\*\* Pumpkin leaves  
\*\*\* Turnip (Brassica rapa) leaves

**TABLE A.17 (continued)**  
**SOME OTHER VEGETABLES**  
Composition per 100g of raw foodstuff, edible portion (E.P.)

	E.P. as % of A.P.	MOISTURE	CALORIES (per 100 g)	PROTEIN			NPU	NDP Cal. %	FAT (g per 100 g)	CARBOHYDRATE		CALCIUM (mg per 100 g)	IRON (mg per 100 g)	PRO-VITAMIN A (I.U. per 100 g)	B-CAROTENE (mcg per 100 g)	THIAMINE (mg per 100 g)	RIBOFLAVIN (mg per 100 g)	NIACIN (mg per 100 g)	ASCORBIC ACID (mg per 100 g)	Source	REMARKS
				%	% cals. fr. prot.	Protein score				Total (g/100 g)	Fibre (g/100 g)										
<b>C. VEGETABLE FRUITS:</b>																					
95. BEANS snap, fresh, young, in pod (Phaseolus vulgaris)	91	89.1	35	2.4	16.7	56, 39	—	7.4, 5.5	0.2	7.6	1.5	57	.8	400	240	0.08	0.12	0.5	17	a	
96. CUCUMBER (Cucumis sativus)	75	95.6	13	0.8	15.0	—	—	—	0.1	3.0	0.6	10	0.3**	0**	0.03	0.04	0.2	8	a		
97. EGGPLANT (Solanum melongena)	82	92.7	24	1.2	12.2	—	—	—	0.2	5.4	0.9	15	.4	30	18	0.04	0.05	0.6	5	a	
98. MARROW (White) or immature pumpkin (Cucurbita spp.)	83	95	15	0.8	13.0	—	—	—	0.1	3.5	0.6	18	.6	100	60	0.06	0.04	0.5	20	a	
99. MELON, bitter (Momordica charantia)	82	93.4	22	0.9	10.0	—	—	—	0.4	4.6	0.9	32	0.9	335	200	0.06	0.03	0.03	55	g	
100. OKRA (Hibiscus esculentus)	88	89.8	32	1.8	13.7	85, 56	—	9.5, 4.8	0.2	7.4	1.0	82	0.7	740	440	0.08	0.07	1.1	30	d	
101. PEPPER, sweet, large, green (Capsicum annuum)	82	92.8	24	1.2	12.2	—	—	—	0.2	5.3	1.4	-6	0.8	290	170	0.04	0.05	0.9	103	a	
102. PEPPER, chili, small, red (Capsicum frutescens)	87	72.2	62	4.8	18.9	—	—	—	2.2	9.0	1.4	65	2.3	7 010	1 200	0.31	0.25	1.8	69	g	
103. PUMPKIN (YELLOW SQUASH) (Cucurbita spp.) (mature)	68	89.9	33	1.3	9.6	—	—	—	0.3	7.7	1.2	18	0.6	400 (-4 000)	240 (-2 400)	0.06	0.03	0.4	11	a	
104. TOMATO (Lycopersicon esculentum)	80	93.8	20	1.1	18.5	66, 21	—	8.4, 4.1	0.3	4.2	0.6	11	0.6	700	420	0.04	0.04	0.5	24	a	
105. TREE TOMATO (Cythomandra betacea)	73	85.9	48	1.5	10.5	—	—	—	0.3	11.3	2.2	13	0.8	—	—	0.04	0.04	1.0	17	d	
<b>D. STALKS &amp; STEMS:</b>																					
106. BAMBOO SHOOT (Bambusa spp.)	29	91.0	27	2.6	23.5	—	—	—	0.3	5.2	0.7	13	0.5	20	12	0.15	0.07	0.6	4	d	
107. SETARIA PALMAEFOLIA, hearts (Pilipit, New Guinea highlands)		92.4	27	0.5	4.5	—	—	—	0.2	6.8	1.1	21	—	—	—	—	—	—	—	j	
108. TARO, stalk (Colocasia esculenta)	93	21	0.5	5.8	—	—	—	—	0	5.5	1.6	218	—	—	—	—	—	—	214	j	
<b>E. FLOWERS:</b>																					
109. BANANA heart	54	88.9	36	1.6	10.8	—	—	—	0.4	8.0	1.1	56	1.1	440	260	0.02	0.02	0.5	13	g	
110. PUMPKIN flowers	59	89.8	29	2.0	16.8	—	—	—	0.5	5.6	0.7	74	3.1	910	550	0.05	0.11	0.9	24	g	
111. SACCHARUM EDULE (efflorescence) (Pilipit, New Guinea lowlands)	89	37	4.1	27.0	—	—	—	—	0	7.6	0.7	10	—	—	—	—	—	—	—	i	
<b>F. MISCELLANEOUS:</b>																					
112. MUSHROOM (Agaricus spp.)	91	91.1	23	2.4	25.5	42, 18	72.4	7.0, 4.2	0.3	4.0	0.9	9	1.0	0	0	0.10	0.44	4.9	5	d	
113. "FUNGUS"	85	51	2.4	11.5	—	—	—	—	3.5	4.3	0.3	—	—	—	—	—	—	—	—	b	
114. SEAWEEDS:																					
(a) Agar (Gelidium spp.)	100	17.8	2	(0)	(0)	—	—	—	0.2	(0)	—	—	—	—	—	—	—	—	—	d	
(b) Kelp (Laminaria spp.)	100	23.6	9	(0)	(0)	—	—	—	1.1	(0)	—	—	—	—	—	—	—	—	—	d	
(c) Laver (Porphyra laciniata)	100	16.9	5	(0)	(0)	—	—	—	0.6	(0)	—	—	—	—	—	—	—	—	—	d	

g means "trace"  
— means "no data available"; not necessarily "0"  
\*\* paired cucumbers

SOME FRUITS TABLE A.1.8

Composition per 100g of raw foodstuff, edible portion (E.P.)

	E.P. as % of A.P.	MOISTURE	PROTEIN				FAT	CARBOHYDRATE			CALCIUM	IRON	PRO-VITAMIN A	CAROTENE	THIAMINE	RIBOFLAVIN	NICOTIN	ASCORBIC ACID	REMARKS	
			g per 100 g	% cal.	Protein score	NPU		Total (g/100 g)	Fibres (g/100 g)	(mg per 100 g)										(mg per 100 g)
115. APPLE ( <i>Malus sylvestris</i> )	84	84.0	58	0.3	-1.7	65, 38		1.0, 0.5	0.4	15.0	0.9	6	.3	90	54	0.04	0.03	0.2	5	a
116. APPLE "Malay" or "rose" ( <i>Eugenia malaccensis</i> )	77	85	51	0.6	3.3				0.7	13.7	0.7	10	.5	0	0	0.03	0.03	0.3	15	e
117. APPLE "Star" ( <i>Chrysophyllum caimito</i> )	87	80	80	1.0	4.2				2.0	16.5	1.5	15	0.5	10	6	0.03	0.02	1.0	8	e
118. AVOCADO—low fat (Persia)—high fat	67 70	82.9 67.1	98 225	1.4 1.8	4.8 2.7				8.3 23.4	6.5 6.3	1.5 1.7	10 15	.6 .9	180 340	110 200	0.06 0.10	0.12 0.44	1.5 1.5	10 10	a a
119. CITRUS: Orange ( <i>C. sinensis</i> ) —Mandarin ( <i>C. reticulata</i> ) —Lemon ( <i>C. limonia</i> ) —Lime, small ( <i>C. microcarpa</i> ) —Pomelo ( <i>C. grandis</i> osbeckii)	72 71 62 38 56	87.1 87.3 88.7 89.8 83.4	45 44 41 40 59	0.9 0.8 0.8 0.4 0.5	6.7 6.1 6.6 3.6 2.8	57, 28		4.0, 1.9	0.2 0.3 0.5 1.0 0.3	11.3 10.9 9.5 8.3 15.3	0.8 1.0 0.9 0.7 0.6	34 (33) 40 18 30	.4 (0.4) 6 0 0.7	170 (420)	100 250	0.08 0.07	0.03 (0.03)	0.2 (0.2)	50 31 50 45 42	a a a a a
120. DURIAN ( <i>Durio zibethinus</i> )	24	62.9	144	2.5	5.8				3.1	30.4	1.7	9	0.9	30	18	0.24	0.20	0.7	24	d
121. FIG ( <i>Ficus carica</i> )	97	81.7	65	1.2	6.0	80, 44		4.8, 2.8	0.4	16.1	1.4	54	.6	80	48	0.06	0.05	0.5	2	a
122. GUAVA ( <i>Psidium</i> spp.)	78	80.6	69	1.0	4.9				0.4	17.3	6.2	18	.9	180	110	0.03	0.04	1.2	160	a
123. MANGO (a) ripe ( <i>Mangifera indica</i> ) (b) green	62 72	81.7 85.1	65 53	0.7 0.5	3.6 3.2				0.2 0.2	17.0 13.8	0.8 0.4	11 16	.4	1 900 135	1 140 80	0.05 0.08	0.06 0.04	0.6 0.2	48 73	a a
124. MANGOSTEEN ( <i>Garcinia mangostana</i> )	29	83.0	63	0.6	3.2				0.6	15.6	5.1	8	0.8	—	—	0.03	—	—	2	d
125. MELON, musk (Cantaloupe) ( <i>Cucumis melo</i> )	56	92.6	26	0.7	9.0				0.2	6.0	0.5	20	.4	1 200	720	0.05	0.03	0.6	30	a
126. MELON-water ( <i>Citrullus vulgaris</i> )	53	92.9	25	0.5	6.3				0.2	6.1	0.2	6	.3	170	100	0.04	0.04	0.2	6	a
127. PAPAYA (a) ripe ( <i>Carica papaya</i> ) (b) green	66 64	88.6 93.2	39 23	0.6 1.0	5.2 14.6				0.1 0.1	10.1 5.2	0.9 0.8	24 59	0.4 0.3	1 000 0	600 0	0.03 0.03	0.04 0.02	0.4 0.2	64 22	a a
128. PASSIONFRUIT ( <i>Granadilla</i> ) ( <i>Passiflora</i> spp.)	33	80.0	70	0.6	2.9				(0)	18.9	(0)	11	1.1	10	6	0	0.10	1.3	16	a
129. PERSIMMON, Japanese ( <i>Diospyros kaki</i> )	80	79.6	73	0.8	3.7	80, 60		3.0, 2.2	0.3	18.7	1.2	7	0.4	1 900	1 140	0.05	0.05	0	9	a
130. PINEAPPLE ( <i>Ananas sativus</i> )	64	86.7	47	0.5	3.9				0.2	12.2	0.5	18	0.5	90	54	0.08	0.03	0.2	40	a
131. PLUMS ( <i>Prunus</i> spp.)	94	82.0	64	0.8	4.2				0.2	16.5	0.5	17	0.5	350	210	0.06	0.04	0.5	5	a
132. POMEGRANATE ( <i>Punica granatum</i> )	48	81.3	66	0.6	3.0				0.3	17.2	0.3	3	0.4	0	0	0.02	0.02	0.2	8	a
133. SOURSOP ( <i>Annona muricata</i> )	66	80.2	71	0.8	3.8				0.4	18.0	1.0	20	0.5	20	12	0.06	0.06	1.0	19	a
134. TAMARIND	48	31.4	239	2.8	3.9				0.6	62.5	5.1	74	0.6	30	18	0.34	0.14	1.2	2	a
135. TIEBA ( <i>Lucuma peruviana</i> )	73	57.2	154	2.5	5.4				0.6	39.1	7.5	40	1.1	2 060	1 240	0.02	0.03	2.5	43	a

0 means "trace" — means "no data available"; not necessarily "0"

## Family Planning

Family planning is concerned with improving the life situation of families, through:

- Spacing of childbirth;
- Helping couples to limit their family to the size they really want and can support;
- Helping couples who find it difficult to have children; and
- Providing information and counselling on matters related to parenthood.

Human beings have the capability of producing many children during their lifetime. This capability must be used carefully, responsibly. It is the parent's responsibility to make sure that every child they cause to be born is wanted, loved, and can be properly cared for.

Papua New Guineans are quite used to the idea of preventing births, as they have traditionally used various means of preventing births and causing abortions. However, few of these traditional methods are reliable, and some are dangerous.

The most reliable and safe methods have been developed only in the last 20 years. More and more people are now realising that family planning is vitally important for the well-being of families, and the nation as a whole.

There is sincere disagreement over the use of some of the methods of family planning, but general agreement about the need for married couples themselves to take the responsibility for their own family planning decision-making.

It is important that every rural development worker be able to tell families where they can get family planning information, if they want it. The basic source of medical information is the Dept. of Public Health, through its hospitals, health workers, clinics, and aid posts.

It is also important that the rural development worker understand and be able to explain the process of human reproduction.

### How a Baby is Made

At the time of sexual intercourse the husband's semen, which contains millions of sperm, or seed, is left in the upper part of the woman's vagina. These sperm swim through the cervix, through the uterus, and into the tubes to "look for" the egg.

At ovulation time, usually about every 28 days, a ripe egg bursts out of the woman's ovary, and is "sucked up" into the end of the pipe. It will live for only one day if it is not fertilized with a



## The Main Parts of The Female Reproductive System

1. The Uterus - the house or basket for the baby. It is the place where the baby lives and grows for 9 months before it is born.
2. The Ovaries - these are two "egg baskets". There are thousands of eggs inside each basket. But only one egg (or two for twins) gets ripe at one time each month.
3. Fallopian Tubes - these are the passage ways for the egg and the sperm. The end of each tube is open and has "fingers" which catch the ripe egg when it bursts out of the egg basket. The other end opens into the uterus.
4. Cervix - this is the bottom part of the uterus where the mucus is made. This mucus looks like the white of a raw egg, and it is a clear, slippery, stretchy water. This mucus comes through the vagina each month at the same time that the egg begins to get ripe. It tells the woman: "This is the time you can become pregnant."

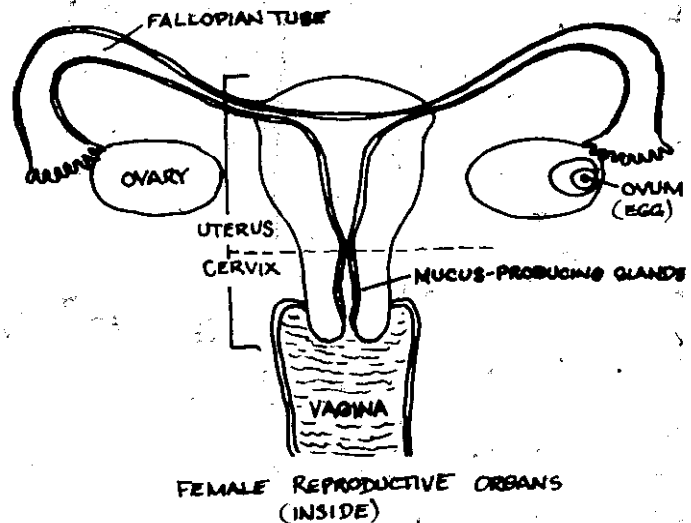

sperm. If it is fertilized, only one male sperm will go inside the ripe egg, and at that time the baby begins to grow. That moment is called "conception".

This new life grows into a "ball" of cells which moves slowly inside the tube to the uterus. At 2 weeks this new life is about 1 centimetre in size, and it will settle in the uterus, which has formed a thick soft lining, making a good bed for a new baby. (This is the substance which is released with each monthly period, if there is no baby to begin.)

As the little baby grows, it gets its food at first from the mother's uterus, and then later, through her blood, through the placenta, which is attached to the baby's belly.

After nine months the baby is born. The mother will not have her menstrual period during this time.

### The Menstrual Cycle

The menstrual cycle begins when a girl is about 12 to 14 years old, and can continue every month until she is 45 to 50 years old.

For the purposes of family planning the thing we are interested to know is the exact time of ovulation. This is when it is not safe to have intercourse (if we want to avoid having a baby) if we are using no other methods to prevent conception.

### METHODS OF FAMILY PLANNING

There are several methods of Family Planning.

One method may be best for one family, another method better for another family. Each family should carefully choose one they feel is best for them. They may want to talk to a Health worker. When a man and woman use family planning, they

can have sexual intercourse as usual, but a baby does not start to grow as long as they are properly using the method.

### THE OVULATION METHOD

The "Ovulation Method" of family planning helps us to determine rather closely when ovulation takes place. Understanding it will enable us to use any other method more effectively, and to select another method more wisely.

Below is a picture of a typical menstrual cycle. However, each woman is different, and she should make her own chart. Furthermore, her chart might be different from one month to the next.

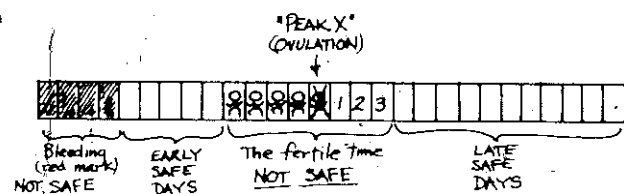

Here are the rules for following the Ovulation Method of family planning to avoid pregnancy.

1. Begin to chart at once: every night before you go to bed put only one mark on your chart for that day:
  - a) Bleeding - put a red mark
  - b) Dry for the whole day - put a pencil mark
  - c) Wet, slippery, mucus - draw a baby
2. Abstain from intercourse for one cycle so you will know the mucus days.

3. In the next cycle avoid intercourse during the days of the period. These days are NOT SAFE: in short cycles ovulation can happen during the period.
4. If there are dry days after the period, these are safe days to have intercourse.
5. As soon as mucus comes, avoid intercourse. Fertile mucus days are NOT SAFE.
6. Mark the last day of clear slippery stretchy mucus with an X. This is the most fertile time, the "PEAK X".
7. Avoid intercourse for the next 3 dry days after the Peak X. These days are NOT SAFE.
8. The dry days from the 4th day after the PEAK until the next period are SAFE DAYS.
9. If intercourse takes place on an early safe day and the first time you have intercourse after the PEAK X, mark the day with a line. Then your teacher will be able to see if you make a mistake.
10. When a new period begins, start a new line.
11. If someone is teaching you this method, try to see them at least once each month until you learn the method well.

These points are emphasized:

Watch for mucus as the period is finishing; if mucus is seen avoid 3 dry days after it stops.

In short cycles there may be no early safe days.

In long cycles there may be many early safe days.

Fertile mucus feels slippery. It is clear, smooth, and stretchy, like the white of a raw egg.

Infertile mucus is cloudy, sticky, not stretchy, not slippery.

Until you know the difference between fertile and infertile mucus, avoid analysing the mucus the day after intercourse when using the early safe days. It may be wet from the man's semen. Just put a baby mark for that day.

If your next period does not come 2 weeks after the PEAK X watch for mucus and avoid all mucus days and 3 dry days after.

Each cycle, each month might be different.

Do not copy from the previous cycle.

Following this method to avoid pregnancy while breastfeeding:

1. Begin to chart soon after the baby is born. Every night before you go to bed put a mark on your chart for that day.
  - a) Bleeding - put a red mark
  - b) Dry for the whole day - put a pencil mark
  - c) Wet, slippery, mucus - draw a baby
2. Avoid intercourse on all fertile mucus days (clear, smooth, slippery, stretchy mucus) and for 3 more days after it stops. You can become pregnant on these days.
3. All other dry days and infertile mucus days

(thick, sticky, non-stretchy mucus) are safe. There may be many months of only dry days. These days are "safe". You cannot become pregnant.

4. Avoid any days of bleeding or spotting of blood and 3 days after. This may be ovulation.
5. When it is close to your having your period again, after 3, 6, 12 months or more, you may have many days of mucus. Be careful at this time.
6. When your period (bleeding) starts again, the first few months (cycles) can be very irregular. Therefore, be careful to avoid all mucus days and 3 days after.

Note: While the baby is taking only breast milk you will be dry nearly every day. When you start to give food to the baby you will notice mucus days. This means the egg inside your body is trying to get ripe (ovulate) and you can get pregnant again. This is how some women get pregnant without having a period between babies.

For more information about the Ovulation Method, write to: The Health Secretary, the Catholic Church, Box 1306, Boroko.

THE PLASTIC LOOP (for women) is one of the most common methods used in PNG. It is a small piece of plastic which is placed inside the women's uterus.

The best time to have a loop put inside is six weeks or more after the baby is born. If menstrual periods have started again, the best time is when the bleeding is finishing, or during the next few days.

The loop is straightened out inside a thin tube, and then inserted. A Sister or Doctor can put it into the uterus in a few minutes. The woman may not feel it, or may just have slight discomfort.

While the loop is inside, she can have sexual intercourse and she is unlikely to become pregnant. The man does not feel the loop when they have sexual intercourse because it is right inside the uterus.

A few women may have some questions first, such as heavier menstrual periods, but usually after a month or two the body gets used to the loop and the woman does not know it is there. She can do hard work or carry heavy loads. The loop does not make any difference. Many women have loops in for many years without any problems.

In a few women the loop comes out by itself. If so she should go back to the clinic as soon as possible, and another can be put in.

If a man and woman want to have another baby, the Sister can easily remove the loop by pulling on the threads. Then another baby can start to grow. After the birth of the next baby, another plastic loop can be put inside.

This is an easy method because the man and woman do not have to do anything else to prevent pregnancy while the loop is in place.

THE PILL - is another very common method. While a woman takes one pill every day she will not become pregnant. Her body does not make an egg each month while she is taking the pills, so a baby cannot start to grow.

A health worker can teach women how to take the pills, and can check them first. There are just a few women who should not take pills due to medical conditions.

The Health Department gives 3 kinds of pills. The woman must go to the clinic for these, and should be told and understand clearly about how to use the kind she gets. Microlut (Blue Packet) is for women who are breastfeeding a baby less than 12 months old; Neogynon ED Fe (red and yellow packet) is for women who can read with babies over 12 months old; Eugynon ED Fe (Red spot packet) is easier for women who do not read to understand and who have babies over 12 months old.

THE INJECTION (for women) is called Depoprovera.

If a woman uses this method, she has an injection in her arm every 12 weeks until she wants to have another baby. Her body does not make an egg while she is having injections.

Most women who have these injections lose very little blood each month. Some have no menstrual periods at all while they are having the injections. This does not mean a baby has started. It means the medicine is working.

In some women there are days of blood spotting in the middle of the month. If this is a trouble or if it is heavy she should go back to the clinic for treatment.

When the woman wants to have another baby she can stop having injections. Then she can get pregnant again, but it may take several months or even a year or two because the medicine is still affecting the body. So the Health Department only gives this method to women with two children or more.

It is also expensive and not as available as other methods. It is only used when other methods are not suitable.

THE CONDOM (for men) is a bag of thin rubber which is used by a man when he has sexual intercourse. He puts the bag over his penis before it touches the woman. There is a little space left at the end of the bag to catch his fluid and seeds. They cannot get out to the woman's egg and start a baby.

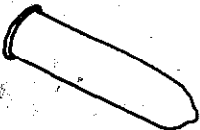

After sexual intercourse the man has to be careful not to spill any of the fluid inside the woman. If he puts his finger on the rubber ring, it will not come off inside the woman.

The man takes off the condom and puts it in the rubbish tin or in a hole in the ground. Condoms

are usually only used once.

This is a safe and easy method with no medical side effects, so the man does not have to go to a health worker. It is a useful method for people in rural areas who are not close to a health worker.

Condoms can be bought at Chemist shops or trade stores. The man should keep several so that a condom is used every time he has sexual intercourse.

OPERATIONS (for men and women). If a man and woman are sure that they have enough children, and do not want any more babies later, either the man or the woman can have a little operation.

A doctor performs the operation after the husband and wife both sign a paper to say that they want to have the operation and understand its effects.

If the woman has the operation (called a tubal ligation), the doctor ties her tubes on each side so that the egg and the sperm cannot join. If the man has the operation (called a vasectomy), small tubes are tied just under the skin so that the man's fluid has no sperm in it.

The easiest time to do the woman's operation is straight after the birth of a baby. She can discuss it with the sister at the Antenatal Clinic.

Many men and women like the little operation, because there are no side effects afterwards, and they do not have to do anything more to prevent pregnancy. It is the most reliable way to prevent pregnancy, so it is a good method for a man or woman with a large family, or if the wife has a condition which would make it dangerous to have another baby.

After the little operation, a man or woman feels just as strong as before, and sometimes women even feel stronger.

#### WHERE TO GET THESE METHODS:

Loops, injections - at health centers and hospitals.  
Pills, condom samples - at aid posts, health centers and hospitals.

Condoms - sold at Chemist shops and trade stores.  
Ovulation method - taught by specially trained teachers.

Tubal ligation, Vasectomy, investigation of infertility - by doctors at hospitals and some health centers.

All health workers can give information and refer people to where the methods are available.

For general information and training materials write: The Family Planning Section,  
Department of Health,  
PO Box 2084,  
Konedobu.

Thanks to Dr. N. Muirden, Dept. of Health, for her help in updating this item.

Pregnancy, Childbirth and the Newborn, a Manual for Rural Midwives, Leo Eloesser, Edith Galt, Isabel Hemingway. 1959. 150 pp. \$2 (Am.) from Ninos Heroes

139, Mexico 7, D.F., Mexico. Teacher's Guide, 43 pp. 50 cents. 25 cents postage and handling.

The manual was based on the ideas of the Canadian surgeon, Bethune, and was first printed in China in 1950. Since then, it has been used in Mexico and South America. As the title says, it is "a manual for rural midwives", and deals with normal births in rural areas. The illustrations are helpful in understanding the development of the mother and foetus and the position of the baby to be born. Suggestions for improving the diet include eating whole grains, growing a bigger garden, getting some extra hens for protein, etc. A very practical and sensible teaching guide.

Level: intermediate.

Reviewed by: H. Bekker.

## Healing

### BUSH MEDICINES

We have found very little material on "bush medicines". However, the following letter from Dr. Des A. Scholz, Yagaum Lutheran Health Centre, Box 107, Madang, gives some insights:

"There are a number of bush medicines in use, but most of these are concerned with pain-relief, e.g. rheumatic aches, headaches, abdominal pains. Most of the things used for relief are in the nature of counterirritants, like 'salat', which is related to the stinging nettle. They are about as effective as most of our liniments and rubs, and in general do no harm.

"The second category of medications are those with a known beneficial effect, e.g. Pawpaw. If this is applied to sores and tropical ulcers, it does quite effectively dissolve the old and necrotic tissue in the ulcers, and will result in a clean wound. Its beneficial effect is related to an enzyme in the pawpaw, which will help dissolve dead tissue. It seems likely that some of the bark and sap of certain trees does help to stop diarrhoea, and this could be of use.

"The third category of medications are those with a powerful effect e.g. 'Koniak', which is the same, or similar to Kava, and I think has a cocaine-like effect. This is given in some areas for relief of a chronic, severe pain in old people, and is very effective. It would also be addictive. In this category are the poisons found in certain roots, used to poison fish. This is, or has been, used, in at least one place to treat hookworm, and apparently is effective.

"The fourth category are those remedies which would be similar to some of our traditional remedies, and equally useless, e.g. putting spit or urine in infected eyes, etc.

"The fifth category are the magical remedies, in which the active agent is seen to be the ritual,

which in most cases is accompanied by some application of leaves, chewing ginger, etc. This latter is reserved for the 'saveman' only, while all of the former tend to be more the property of the whole tribe."

### MEDICINAL PLANTS

#### ALOE VERA



Different species of Aloe have been used in Africa and Asia for various purposes, but Aloe vera is best known to me as a burn plant. When our 2 year old son had a second degree burn (blistered skin), we applied the sap from Aloe vera and his crying ceased. We kept the dressing clean, he was never again bothered by the pain and there is no scar.

Because it is useful and convenient to use, we would like to see it propagated and distributed throughout PNG, especially to villages distant from hospitals. At home in Hawaii as a child, we always had a Aloe in the yard, and the local Plant & Transport there had a Aloe next to their welding torches.

The Aloe vera is in the family Liliaceae, of African origin. The leaves are 30-60cm long, erect, thick, light green with white markings, and very juicy. The spines do not prick. The sap is thick, yellow and bitter, with a penetrating odour.

Burkill, in A Dictionary of the Economic Products of the Malay Peninsula, 1966 describes the preparation of the drug: "The plant is very succulent and mucilaginous, the greater part of the leaf-tissue containing none of the medically active substance; but deep in along the courses of the fibro-vascular bundles are strands of large cells full of a yellow juice, which is the aloetic juice and source of the drug. To get it, the leaves are cut off and placed so that the juice may bleed into a collecting vessel. The rest of the leaf scarcely bleeds, and being inactive, is not wanted to do so. It remains only to concentrate the extract, either by the sun's heat, or artificially. If concentrated by evaporation quickly and completely, followed by sudden cooling, the extract becomes vitreous in fracture; if not cooled suddenly, it becomes opaque.

This preparation is Bitter Aloes or Jadam."

From Burkill and other sources, we found that in Malaysia, the sap is put on wounds, daubed on the fever, and used on swellings and skin diseases; that the sap of the heated leaves may be squeezed out, mixed with sugar and taken for asthma, and that a similar preparation is used in Java for coughs; that in Malaya, the mucilaginous flesh and sap are used to poultice burns: in India, it is used internally for various complaints of the intestinal tract and for poulticing burns; in the West Indies, it is made into a watery extract and applied to the head to destroy lice. It is used as a laxative, and in larger dosages, used to stimulate menstrual flow. Known as Bitter Aloes, it is sold as a tonic. Also commercially it is an ingredient for sun tan lotion and burn ointment.

The Aloe likes sun and suffers from too much water; it does not need rich soil. It is propagated like a pineapple.

Editor's note: Aloe is also well known in the Philippines for its medicinal qualities. Many there believe that regular application of the slimy juice will help to cure baldness in many cases.

Aloe vera is available through the Division of Botany, Office of Forests, Box 314, Lae, MP.

Initial contributor: H. Bekker.

## DENTAL HEALTH

The most common health problem in our country is dental disease! When the teachers of the Port Moresby Dental College looked at the teeth of the people in a typical Highlands village they found many people with:

Holes in their teeth (cavities),  
Infected gums that were red, sore and swollen,  
Loose teeth caused by infected gums and bone,  
Many missing teeth.

Strong healthy bodies include good teeth. Good teeth are:

Clean (no dirt, pipia, stain, debris, or food on them); Have no holes (cavities); and Have a firm pink skin (gum) around them.

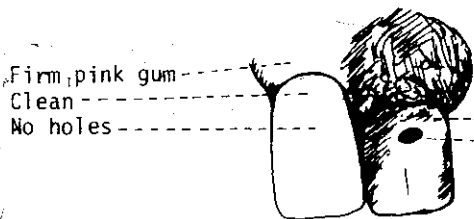

Firm, pink gum  
Clean  
No holes

Sick skin (swollen gums, sore, bleed when touched)  
Dirt (stain, debris, food)  
Hole (cavity)

Good

Bad

There are two steps to good strong teeth:

1. Keep the teeth clean.
2. Do not eat too much sugar.

Let us look at each of these. All of us have seen a post (stump) in the ground that has been eaten by ants until it is soft and rotten. Something like this happens to teeth. If we leave dirt on teeth, the bacteria (which are like very very small ants) in the mouth eat it and give off an acid which makes a hole in the tooth. This same dirt near the skin of the tooth (gum) causes the skin to be sore (inflamed) and the bone becomes sore and the tooth becomes loose. To prevent both holes in teeth and loose teeth, clean the teeth every day. How? With a tooth brush or with a brush you make. Make your brush by taking a small piece of bamboo as long as your little finger and half as thick. Chew one end of the bamboo to make a brush that looks like this:



Now use this brush and brush around the tooth; both on the lip side and tongue side next to the skin. Do a very careful job and brush between each tooth as far as you can. When you first start brushing your skin (gums) may bleed a bit but keep up the brushing every day and the skin (gums) will soon become strong.

A good brush can also be made from the husk of the beetle nut. Take a small piece of the husk and remove the green outer layer. Chew the wide end and you will now have a good brush that looks like this:



The curve of this brush makes it good for reaching and cleaning the tongue side of the teeth.

cont'd

You should also eat good strong food for strong teeth. Read these two lists carefully:

#### GOOD FOODS FOR TEETH

Milk	Peanuts	Cucumber
Sweet Potatoes (Kau kau)	Fruits	
Beans	Nuts	Pineapples
Peas	Cabbage	Papaya
Maize (corn)	Carrots	Fats
Bananas	Pumpkin	Seeds
Meat	Tomatoes	Coconut
Fish	Spinach	

#### POOR FOODS FOR TEETH

Lolly water  
Sweet biscuits  
Cheese pops  
Candy  
Gum.

## References

Barefoot Doctor's Manual, U.S. Dept of Health, Education & Welfare, Public Health Service Publication No 45-695 (NIH) \$9.75 from: U.S. Government Printing Office, Washington, DC 20402 USA.

Field Workers Medical Manual, by Summer Institute of Linguistics Staff, Summer Institute of Linguistics, Inc., Huntington Beach, California 92648, USA, 1973.

This book is intended for persons with little medical training to help them develop a pattern of thinking about illness and its treatment. The manual was developed for use of workers in isolated areas where professional medical help is not readily accessible. The material of the volume is organized under both symptoms of the common diseases and under their medical categories and the descriptions, treatments and preventive measures are given in clear, laymen's language. This book is excellent source material for all areas of PNG, especially those that are isolated. Price K10.00. Order from SIL, Ukarumpa, via Lae, PNG.

Level: intermediate.

Reviewed by: Dr. J. Patto, Nazarene Hospital, Box 70, Banz.

Medical Care in Developing Countries, by M. King, Oxford U. Press, 1966. Available from University Book Shop, Port Moresby. May come out in paperback. This is the basic reference and textbook for the provision of appropriate health care in the developing world. Intermediate level.

Women and Child Care in China, Ruth Sidel, 1972, \$1.25 from: Penguin Books, Inc. 7110 Ambassador Road, Baltimore, MD 21207 USA.

Teaching Aids at Low Cost (TALC)  
30 Guilford Street,  
London WC1N 1EH, England.

TALC is a teaching activity of the Institute of Child Health, University of London, to provide teaching aids at or below cost price for health workers, particularly in developing countries.

#### Books and Pamphlets Available.

##### Health Care in China.

An introductory study of what China has achieved in revolutionizing health care in 25 years. We believe that all health workers in developing countries should know something about how this has been achieved, and study whether similar changes can be brought about in their own community. Price 60p.

##### Medicine in China

5 articles by Dr. E.M. Adey & Dr. A.J. Smith, published in the British Medical Journal and reprinted specially for TALC. This gives further information on health care in China. Price 40p.

#### BOOKS FOR AUXILIARIES

Nutrition in Developing Countries, by King, Morley and Burgess.

One of the few books for health workers written in simple English, with practical exercises which school children and others can undertake in the community. Price Pounds 2.20

Paediatric Out-Patient Manual, by Pauline Dean, Paediatrician.

An excellent little book, locally produced from St. Luke's Hospital, Anua, Nigeria. It is very well suited for medical assistants and nurses in out-patients. Price 25p.

Symptom-Treatment Manual, from Shanta Bhawan Hospital, Nepal.

A simple statement of the care of common conditions. Price 35p.

Care of the Newborn Baby in Tanzania, by Hamza and Segall.

A well-written booklet suitable for use in many countries other than Tanzania.

Simple Dental Care for Rural Hospitals, by D.J. Halestrap.

Gives the basic knowledge required by a medical worker who has to take responsibility for dental conditions. Price 40p.

Nutrition Rehabilitation Village, by Joan Koppert

Describes nutrition rehabilitation in an urban setting. Price 20p.

Health Care of Children Under Five.

Outcome of a conference on child care in India.  
Price 35p.

Visual Communication Handbook, by D.J. Saunders

Written for the person who wishes to become more effective in communication at village level.  
Price Pounds 1.00

Memorandum on Tuberculosis in Developing Countries, by Oxfam.

Describes methods of tackling tuberculosis with limited resources.

Memorandum on Leprosy Control, by Oxfam, Leprosy and The Leprosy Mission.

Available in English, French, German and Spanish, this sets out the basis of management. Price 15p.

Paediatric Priorities in the Developing World, by D. Morley.

A book of 450 pages which sets out possible alternative priorities to those suggested by traditional western paediatrics.

The 'Baby Killer' by M. Muller, produced by War On Want (2nd edition)

Highlights the problems produced by unrestricted advertising of bottle-feeding in the developing countries. Price 40p.

The Care of Babies and Young Children in the Tropics, by D. Morley.

A leaflet written for European mothers taking their children to hot climates for the first time. Price 15p.

OTHER MATERIAL AVAILABLE FOR THE COST OF PACKING AND POSTAGE ONLY.

Measuring Malnutrition - The Shakir Strip

School children evaluating under-fives clinics. A method that can be tried where three-quarters of the children in the village have home-based weight charts.

Reading list; and a list of sources of teaching material in maternal and child health for developing countries.

Patterns of Mortality in Childhood, by Puffer.

This is a summary of the PAHO study of infant mortality in the Americas.

COLOURED SLIDES W/Cassette Tapes for Teaching: List available upon request.

Charge for administration, packing, and post, 30p.

For orders over Pounds 3.00 add 10% for postage.

If paying by cheque or money order in currency other than sterling, add 50p. Cheques should be made out to "TALC".

Moresby Wholesale Drug Supply Pty. Ltd.  
P.O. Box 1066  
Boroko

Phone 25 3633

25 3185

Cables "WHOLIDRUG"

Pharmaceuticals, chemical supplies, veterinary lines, medical goods, special orders. Of particular interest:-

- a. First aid kits- various types designed in consultation with U.P.N.G. Medical School.
- b. Mail order service for those with regular sizeable orders.
- c. Trade store supply. An attempt is being made to help trade stores to stock simple medicines, toiletries, and family planning items.

For further information, write Mr. P.M. Hayden, above address.



WE ALL WANT LESS TALK AND MORE ACTION. BUT UNCOORDINATED, POORLY PLANNED ACTION CAN GET PRETTY MESSY. THE FUTURE IS IN THE HANDS OF THE PEOPLE WHO ARE WILLING TO SIT THROUGH MEETINGS, MORE MEETINGS, MORE MEETINGS. THE RIGHT MEETINGS, OF COURSE: MEETINGS WHICH LEAD TO ACTION.

# GENERAL REFERENCES

## Literature, South Pacific

### DEPARTMENT OF PRIMARY INDUSTRY, PNG

DPI Publications,  
Box 2417,  
Konedobu.

Publications available August, 1976:

PNG Agricultural Journal, K1.00 per issue. Research  
Bulletin, K2.00 per volume. Harvest, 50t per issue.

#### Farming Notes:

- 1 Looking after the soil
- 2 Sorghum
- 3 Corn (Maize)
- 4 Goats
- 5 Passionfruit
- 6 Rice
- 7 Peanuts
- 8 Pineapples
- 9 Sweet potato
- 10 Vegetables
- 11 Rubber
- 12 Bananas
- 13 Coconuts
- 14 Pyrethrum
- 15 Wildlife
- 16 Pepper

All approximately 30t.

#### Rural Development Series Handbooks:

- |                                |       |
|--------------------------------|-------|
| 1 Basic Extension Skills       | K2.00 |
| 2 Rural Broadcaster's Handbook | K1.50 |
| 3 Cardamom Handbook            | "     |
| 4 Poultry Handbook             | "     |
| 5 Pig Handbook                 | "     |
| 6 Chillies                     | 50t   |
| 7 Pepper                       | "     |
| 8 Corn                         | "     |
| 9 Introduced Vegetables        | 75t   |

#### Keeping Cattle in PNG - 20t per book

- 1 Introduction
- 2 Choosing land for a cattle farm, finding money for a cattle farm
- 3 Fence, yards and crush
- 4 Looking after cattle
- 5 Pastures for cattle
- 6 Sickness in cattle

#### Raise good pigs - 20t per book

- 1 Housing - coastal
- 2 Housing - highlands
- 3 Feeding and management
- 4 Breeds
- 5 Marketing

Some new publications will be coming soon:

#### Extension Bulletins:

History of Agriculture in PNG  
Study in Subsistence Agriculture

#### Farming Notes:

Cardamom  
Chillies  
Winged Beans  
Fruits and Nuts  
Coffee  
Food Crops  
Rice

Send your order without payment. You will receive a bill with the publications with instructions as to how to pay.

NOTE: If you are a farmer or a politician you are entitled to one free copy of each of the ones you need. You may get these through your Agricultural Officer, or through the Provincial Rural Development Office.

### DEPARTMENT OF BUSINESS DEVELOPMENT

Department of Business Development  
Post Office, Wards Strip

Has a number of booklets for people to help their businesses. They are beginners books, but everyone has to start somewhere. Some booklets have a small charge. You can get these booklets from your nearest Business Development Office, or if they are out, from the Publications Officer, above address.

1. Trade Stores in Papua New Guinea is three separate books. The first is called Starting a Store, the second, Managing a Store, and the third is Bookkeeping for Small Trade Stores. They are free. They are in English.

2. Making a Profit from your Truck is also three books, called How to Start your Truck Business, How to Manage your Truck, and Truck Accounting. Books two and three together cost 50t, but the first one is free. They are in English and also in Pidgin.

3. Lukautim Autbot Mota Bilong Yu, is a Pidgin book on care and operation of outboards. It won't tell you about Seagull outboards, but it's a good reminder of proper care of your new outboard.

4. A Guide to Setting up an Urban Trade Store was written by The PNG Chinese Association of Port Moresby, and is very good for help with the kinds of goods to stock. It's free.



5. Basic Commercial Forms shows a number of common forms a new business man may be sent, and describes their purpose and what he must do if he gets them or needs to use them. Free.

6. Business Group Incorporation Act - 1974. In English, Pidgin and Motu. Tells the requirements for registering under this new act to legalize traditional forms of organization to do modern business. Free. (p 277)

7. Business Terms Dictionary in Simple English and also in Pidgin. Clears up a lot of the difficult words in doing modern business. Free.

## EDUCATIONAL RESEARCH UNIT

Box 4820, University P.O.,  
Port Moresby.

### ERU Research Reports Related to Rural Development

G. Kemelfield & P. Palmer, Education and Village Life  
S.G. Weeks, How Tertiary Students Use Their Vacations  
S.G. Weeks, National Service and Community Involvement as Seen by Tertiary Students in Papua New Guinea

### ERU Occasional Papers

S.G. Weeks, Ed. Education and Independence, 1975:  
A Resource Book on Documents and Issues in Education

### ERU Working Papers

S.G. Weeks, Nuigini: Hailans I Go Ahet (A Tok Pisin Literacy Game)

The price of each research report is 70 toea for up to fifty pages.

Please make your cheque payable to the University Bookshop (PNG).

### ERU Reports:

G. Kemelfield, A Community-Based Education System: A Proposal.

S.G. Weeks, Community School in Africa: Is There a Lesson for PNG?

50 toea each from University Bookshop (PNG).

VILLAGE DEVELOPMENT OFFICE has the following books:

The Village Blacksmith: by Ray Dubert (pidgin text) a simple booklet detailing the construction of a village forge, blacksmith shop and working metals. (p 132)

Foot Operated Thresher: by K. Hemmes and D. Williams (English text). How to construct a simple thresher for stripping the grain from crops such as wheat, rice and barley. (p 163)

Gravity Feed Waters System: by Neil Anderson (Pidgin text) How to construct, level and install a simple reticulated village water system with gravity feed.

The Principles of Hydraulic Mining: by B. Crozier, H. Skinner & R. Hocking (English text). A process for excavating, transporting and filling ground without the use of heavy equipment, providing there

is an ample supply of water above the excavating site.

Publications may be obtained from:

The Director,  
Village Development Office,  
PO Box 6937,  
BOROKO. (p 256)

## GOVERNMENT PUBLICATIONS

THE DEPARTMENTS OF PRIMARY INDUSTRY, BUSINESS DEVELOPMENT, PUBLIC HEALTH, EDUCATION, AND PUBLIC WORKS REGULARLY PUBLISH HANDBOOKS, MANUALS, PLANS, AND REFERENCES USEFUL FOR RURAL DEVELOPMENT. BUT ONLY RARELY CAN ONE GET A COPY OF THESE AT THE PROVINCIAL LEVEL OFFICE.

IT IS UNDERSTANDABLE THAT WE DON'T FIND A PUBLICATIONS OFFICER FOR EVERY DEPARTMENT FOR EVERY PROVINCE. PNG CAN'T AFFORD IT.

BUT THERE IS IN EACH PROVINCE AN INFORMATION OFFICER IN THE DEPT OF PROVINCIAL AFFAIRS. THERE IS MUCH TALK ABOUT INTER-DEPARTMENTAL COOPERATION AND COORDINATION - HERE IS A REAL TEST FOR IT! WHY NOT LET THE PROVINCIAL INFORMATION OFFICER MAINTAIN AN UP-TO-DATE SUPPLY OF PUBLICATIONS FOR ALL DEPARTMENTS FOR DISTRIBUTION AND SALE TO THE PUBLIC?

OR IS THERE A "DANGER" THAT IF SUCH A PROGRAMME WERE SUCCESSFUL THE DEPARTMENTS MIGHT TEND TO COOPERATE ON OTHER MATTERS AS WELL?

Yangpela Didiman Booklets in Pidgin  
Box 39  
Banz, WHP

A variety of items available in both printed and ink duplicated form. Write for list. Nominal prices.

## SPC PUBLICATIONS

SOUTH PACIFIC COMMISSION, Noumea, New Caledonia  
Handbooks/ 1968.

1. Rat Control in the South Pacific, by F.P. Rowe 1968.
2. Cocoa Production in the South Pacific, by K. Newton, 1968.
3. Improving Land Tenure, by R.G. Crocombe, 1968. Rev. ed. 1973.
5. Banana Production in the South Pacific, by M. Lambert, 1970.
6. Coconut Production in the South Pacific, by M. Lambert, 1970.

3. Vegetable Production in the South Pacific, by M. Lambert, 1971.
9. Handbook of Practical Bacteriology, by J. Saugrain, 1973.
10. Weed Control in the South Pacific, by M. Lambert, 1973.
12. Handbook of Hospital and Health Service Administration, by D. Horne, V. Williams, 1975.

#### Information Circulars

- 34 Taro/Taro, by M. Lambert. August 1971.
- 52 Fruit Cultivation, by M. Lambert. June 1973.
- 55 Special Project-Vegetable Production in the South Pacific, by M. Lambert, January 1974.
- 56 Comments on Experiments Recently Undertaken in some Pacific Islands on Certain Varieties of Vegetables, by M. Lambert, March 1974.
- 58 Some Aspects of Pasture Research and Development, by P. Bewg. April 1974.
- 59 Something New in Sewage, by C. Richard, Sept 1974.
- 60 Solar Energy, by C. Richard. November 1974.
- 65 The Marketing of Fresh Vegetables, by J. Ishida. May 1975.
- 66 Special project on Vegetable Production, by M. Lambert. June 1975.
- 68 Evaluation of Broiler Meat Chicken Performance, by D. Armstrong, September 1975.

#### Information Documents.

- 8 Processing of Banana Products, by D.E. Kay 1967
- 24 A Manual of Introductory Soil Science and Simple Soil Analysis Methods. S.G. Reynolds. 1971.
- 33 Rat Control Without Rat Destruction, by E.J. Wilson 1974.

Notes: Prices are shown only for those publications of which the free distribution is very limited. Charges may also be made for Handbooks, Technical Papers and for postage costs. When making requests, please say whether sea or airmail postage is required but do not send payment in advance.

Requests may be made to:

The Secretary-General,  
South Pacific Commission,  
Box D5, Noumea, New Caledonia.  
or  
The Director, S.P.C. Publications Bureau,  
Box 306, Haymarket NSW 2000. Aust.

#### RESOURCE BOOKS

The P.N.G. Telephone Directory  
Available at P.N.G. local post offices at 50t each.

The "pink pages" contain a host of helpful addresses and ideas for those trying to find goods and services. Even if you don't have a telephone you'll find these well worth the investment.

Papua New Guinea Handbook, 7th edition, 1974, Ed. by J. Tudor, Pacific Publications, Sydney A\$5.50 plus A\$1.50 for mailing. The most complete handbook on PNG suitable for the desk. Many references are out of date, but the Handbook is still very useful for its maps and data on areas and their resources. Particularly helpful for newcomers. Level: simple.

The Pacific Way: An Emerging Identity, by Ron Crocombe, 56pp. Lotu Pasifica Productions, Box 208 Suva, Fiji Price F\$1.20 postpaid.

Assessments, criticisms, hope for the future by a well known and highly respected Pacific Studies Authority. Nine full pages of photos. Liberal discounts for bulk orders.

Level: intermediate

#### PUBLISHERS

Christian Publisher's & Booksellers Association, Box 111, Wabag, EP.

The South West Pacific Book List gives basic information about a selection of publications and cassette tapes produced in this area. Most items are religious in nature, but Community Development, Literacy work, Social Issues, are also categories included. Lists of publishers and suppliers to bookshops, bookshops, and publications by title and category.

#### WANTOK PUBLICATIONS, INC

Main office: Box 1982, Boroko.

Other offices: Box 396, Wewak  
Box 749, Madang  
c/- Box 90, Rabaul  
c/- Box 1920, Lae.

Publishers of WANTOK, a weekly newspaper in Melanesian Pidgin with particular emphasis on rural development issues. Subscription K5.00 per year.

Distributors of LIKLIK BUK (in PNG and overseas), THE NEW INTERNATIONALIST (third world development issues) K14.00 per year (by arrangement with Community Aid Abroad, Fitzroy, Victoria, Aust.) WIRUI PRESS CALENDARS (Port Moresby area only)

#### BOOKSELLERS

See section on Book Suppliers p 253.

# Literature, Overseas

PUBLICATIONS AVAILABLE FROM

## INTERMEDIATE TECHNOLOGY PUBLICATIONS

9 King St.  
London WC2E 8HN, England

Unless otherwise stated, all books and leaflets are Intermediate Technology publications. PRICES ARE SURFACE AND AIRMAIL OVERSEAS, in Pound Sterling and US \$.

### GENERAL:

**Appropriate Technology** A quarterly journal (annual subscription). A forum for the exchange of ideas amongst those directly involved in development work; includes technical articles, book reviews, readers' contributions. 3.00 (\$7.00); 4.50 (\$10.50).

**Aid and Self-Help** by Elizabeth O'Kelly. Distills a good part of the new wisdom in the field of developing aid. Published by Charles Knight and Co., London. 140 pp. 1973. 4.50 (\$10.35), 5.75 (\$13.25).

**Disaster Technology: An Annotated Bibliography** by Diana Manning. Aimed at supplying relief agencies with information on the published and unpublished literature available concerning technical aspects of disaster relief and prevention, with special emphasis on developing countries. Published by the London Technical Group. 331 pp. 1974. 6.25 (\$14.40), 9.75 (\$22.45).

**Small is Beautiful: A Study of Economics as if People Mattered** Dr. E.F. Schumacher, Founder-Chairman of Intermediate Technology, shows how fragmentation of specialised competence, particularly that of economists, scientists and technologists; has led to confusion of the means and ends of modern life; he stresses the need for a return to wisdom in planning for the future. Published by Blond and Briggs, London, 288 pp. 1973, Paperback 1.10 (\$2.55), 2.05 (\$4.70) Hardback 3.95 (\$9.10), 5.20 (\$12.00).

Also by Dr. E.F. Schumacher - three booklets; **The Age of Plenty - A Christian View** Published by The Saint Andrew Press, Edinburgh, 23 pp. 1974. .45 (\$1.05), .70 (\$1.60); **People's Power** published by National Council of Social Service, 16 pp. 1975. .30 (\$0.70), .50 (\$1.15); **Thinking About Land**; Published by Catholic Housing Aid Society, 10 pp. 1973. .20 (\$0.45), .40 (\$0.95).

### AGRICULTURE

**Complete Technical Drawings** for eight farm implements designed for local construction. 1973. (print size varies up to 30" X 30")

18. Manual broadcast sower (UK) 3.85 (\$8.85), 4.80 (\$11.05)
19. Welding jigs, three designs (UK) 1.65 (\$3.80), 1.95 (\$4.50)
20. Treadle-operated peanut thresher (Malaya), 2.85 (\$6.55), 3.60 (\$8.30)
21. "Wananchi" ox-cart (Tanzania) .70 (\$1.60), 1.05 (\$2.40)

22. Donkey cart (Tanzania) 1.20 (\$2.75), 1.80 (\$4.15)
23. Polyrow peristaltic-pump sprayer (UK) 1.70 (\$3.90), 2.15 (\$4.95)
24. Hand-pushed sod seeder (UK) 1.20 (\$2.75), 1.65 (\$3.80)
34. "SATEC" multi-crop seeder (France) 2.85 (\$6.55), 3.60 (\$8.30)

**Dimensional Drawings/Photoprints with text; Agriculture Green Leaflets.** 1973. .35 (\$0.80), .50 (\$1.15) for each leaflet.

1. "Wananchi" ox-cart (Tanzania)
2. Cart for one draught animal (Tanzania)
3. Ox-cart using old car wheels (Malawi)
4. "Kabanyolo" toolbar (Uganda)
5. Chitedze ridgemaster toolbar (Malawi)
6. Prototype multi-purpose ox-drawn tool (Nigeria)
7. Five-tine sweep cultivator (India) and high clearance peg-tooth harrow.
8. Triangular spike-tooth harrow (India)
9. Flexible peg-tooth harrow (Iran) and rigid frame Japanese harrow
10. Two clod crushers (Malawi)
11. Ox-drawn tie-ridger/weeder implement (Nigeria)
12. IDC weeding attachment for Emcot plough
13. Adjustable width drag ditcher/bund former (USA)
14. Sled-type corrugator/irrigation furrow former (USA)
15. Single-row and 3-row rice seeders (Zambia); (photoprints)
16. Rotary weeder for row-planted rice (Zambia) (photoprints)
17. Multi-action paddy field puddling tool (Zambia) (photoprints)
27. Cassava Grinder (Nigeria)
28. Rotary corn thresher (Nigeria)
29. IDC-BORU groundnut lifter for Emcot plough; IT groundnut lifter (Nigeria)
30. IT granule applicator (Nigeria)
31. IT expandable cultivator (Nigeria)
32. Hand-operated seed dressing drum (Malawi)
33. IT high-clearance rotary hoe (Nigeria)

**Technical Report with Constructional Drawings on a Hand-operated Winnower** produced by the IT Working Group at Technische Hogeschool, Eindhoven, Holland, 1974. 1.90 (\$2.05), 1.55 (\$3.55).

### HEALTH

**Health Manpower and the Medical Auxiliary** Three articles twelve case studies, and an annotated bibliography of 134 references. 65 pp. 1971. 1.70 (\$3.90), 2.20 (\$5.10)

**Intermediate Techniques** booklet of sketches of specialised hospital furniture and equipment for the physically handicapped, for local construction. 23 pp. 1973.

**Paediatric Priorities in the Developing World** by Dr. David Morley. A valuable addition to the medical literature on child care in developing countries. Published by Butterworths 470 pp. 1973 1.65 (\$3.80), 2.60 (\$6.45)

### The Training of Auxiliaries in Health Care

An annotated bibliography listing a wide variety of material used in training auxiliaries at different levels; includes text-books, course descriptions, and visual aids. 100 pp, 1975, 1.85 (\$4.25), 2.80 (\$6.45)

### Simple Designs for Hospital Equipment.

The following leaflets are available in booklet form, 1973, for each booklet .35 (\$0.80), .60 (\$1.40):

1. Invalid carriage with chain drive and brake
2. Hospital bedside table and locker
3. Hospital ward screen
4. Dressing and instrument trolley
5. Hospital wheelchair
6. Bush wheelchair
7. Bush ambulance
8. Hospital blood transfusion drip stand
9. Folding bed (wire spring)
10. Paraplegic turning frame
11. Hospital folding bed (metal plate spring)
12. Hospital patient's trolley

### RURAL WORKSHOP

**How to Make a Metal-Bending Machine** Technical specifications with plans and drawings for a hand-operated metal-bending machine, with photographs. 1973. 1.20 (\$2.80), 1.70 (\$3.90)

**Oil Drum Forges** Full technical specifications for making a simple forge from an oil drum with (a) foot-operated bellows pump or (b) hand-operated fan. Revised edition. 1975 .95 (\$2.20), 1.75 (\$4.00).

### WATER

**A Bibliography of Low-Cost Water Technologies.** Third edition (1974) of G.H. Bateman's 1971 appraisal of the information assembled by the ITDG Research Project on low-cost, low-skill water technologies. 39 pages, includes sources and references on water supply storage, transport, lifting and use. 1.20 (\$2.75), 1.75 (\$4.00).

**A Manual on the Automatic Hydraulic Ram Pump** contains details of how to make and maintain a small hydraulic ram on a suitable site. The second part takes a more technical look at the ram performances and design considerations and contains a useful annotated bibliography. 37 pp. 1975. 1.20 (\$2.75), 1.70 (\$3.90).

OTHER ITEMS AVAILABLE ON "BUILDING", "CHEMISTRY", "CO-OPERATIVE ACCOUNTING", "ENERGY" (See Digesters), "INDUSTRIAL", "REPORTS ON RECENT INTERMEDIATE TECHNOLOGY PROJECTS."

(p 160)

## STICHTING TOOL

MauritsKade 61a, Amsterdam, Netherlands.

A non-profit foundation representing cooperating groups mostly from university-science departments or technical colleges. "Seeks to form a bridge between the scientific knowledge in developed countries and the practical problems in developing countries." Technical advice, documentation, some publications.

Publications list - February 1976.

Blackboardtips, an illustrated guide for the effective use of the school blackboard. 12pp US\$1.00

Grain Silo, construction manual for a silo made of clay bricks, with a concreted upperplate. 6pp US\$1.00

Lectures on Socially Appropriate Technology. Reviews of 12 aspects of technology, such as building, small workshops, farming tools, energy, and their relation to third world development. 235pp. US\$6.00

The Salawepump, construction manual for a hand-operated piston pump. 6pp US\$1.25 (p 161)

Soap Preparation, How to prepare soap at home 6pp US\$1.00

Windmill bibliography (2 vols) (p 154)  
part 1: Alphabetical index  
part 2: Keyword index, with abstracts US\$10.00

Winnower, Construction manual for a handoperated winnower. 35pp US\$2.00 (p 166)

## TROPICAL PRODUCTS INSTITUTE

56/62 Gray's Inn Rd.  
London WC1X 8LU England

Complete lists and a newsletter are available. Some samples:

CONFERENCE PROCEEDINGS : Proceedings of the Conference on Animal Feeds of Tropical and Subtropical Origin.

Tropical Products Institute Conference held in London 1-5 April 1974, 347pp. Price including postage, Pounds4.45 in UK and surface mail; Pounds7.50 airmail.

Proceedings of the Conference on Tropical and Subtropical Fruits.

Tropical Products Institute Conference held in London 15-19 September 1969, 307pp. Price including postage Pounds2.10 in UK surface mail; Pounds4.12 airmail.

### CROP AND PRODUCT DIGESTS

No 1 Oils and Oilseeds, 1971, .x + 170 + xxii pp. Price including postage Pounds0.95 in UK surface mail; Pounds1.55 airmail.

No 2 Root Crops, 1973, 245 + xxxv pp. Price, including postage, Pounds1.75 in UK; Pounds1.85 surface mail, Pounds3.05 airmail.

No 3 Grain Legumes to be released soon, price not available (We look forward to this one with great interest)

cont'd

## INDUSTRIAL TECHNOLOGY

Industrial Technology: a guide to sources of information in Britain available to developing countries. 1971, 29pp.

The Guide has entries on 57 different organisations in the industrial technology field and gives details of the work they do and the information they can provide, together with their full address, telephone number and telegram or telex code.

To enable the Guide to be given widespread free circulation, its size has been restricted and its entries have been kept concise.

COMMODITY/PROCESS REPORT TITLES: Many are available. Here are samples. Write for complete list.

The Small-scale Manufacture of Soluble Coffee. Price 60p. 1973. G82

An Illustrated Guide to Fish Preparation. Price Pounds 1.40. 1975. G83

The Market for Tuna. Price Pounds 1.15. 1973. G80

The Improvement of Hand-operated Groundnut Decorticating Machines. Price 25p. 1971 G68

The Use of Protein-rich Foods for the Relief of Malnutrition in Developing Countries: An Analysis of Experience. Price 90p. 1972. G73

The Market for Natural Rubber with particular reference to the competitive status of Synthetic Rubber. Price 65p. 1970. G47

## UNITED NATIONS PUBLICATIONS

There are so many UN publications available that we couldn't possibly list them, and have merely placed selected references under various topics. If you want a particular UN publication the UN Information Centre can get it for you at a great savings of time and money, but you have to know exactly what you want.

UN Information Centre,  
Box 472, Port Moresby.

Focus, An ink-duplicated monthly newsletter on international social, political, and economic issues. Good for high school and college libraries. Free.

FAO periodicals: Order through above UN Information Centre.

Ceres, FAO Review on Development; Issued bi-monthly in separate English, French and Spanish editions. Annual subscription rate US\$8.00. Reports on the multiple aspects of agriculture and socio-economic progress in developing countries, and deals with aspects of trade, technology, foreign aid, international finance legislation, education and training, the protection of the world from pollution, world affairs, and food production.

cont'd

Food and Nutrition, A review devoted to world developments in food policy and nutrition - issued quarterly in separate English, French and Spanish editions. Annual subscription rate US \$8.00.

World Animal Review, A quarterly journal devoted to world development in animal production - animal health and animal products - issued in separate English, French and Spanish editions. Annual Subscription rate - US\$5.00. Includes reports on new methods, techniques, equipment, machines, news, notes, book reviews. Profusely illustrated.

Plant Protection Bulletin, issued bi-monthly in separate English, French and Spanish editions. Annual subscription rate - US\$5.00. Promotes mutual understanding between countries concerning current situation and control of plant pests and diseases, and plant protection organizations and activities of individual countries. Makes available much information not generally contained in other publications.

AGRINDEX, Monthly bibliography of the latest agricultural literature. Issued in English, giving also titles in original language when available. Annual subscription rate - US\$60.00. Comprehensive current awareness service in all fields of agriculture.

Films and Filmstrips available from UN Information Centre. (p 224)

One week loan for borrowers in Port Moresby and one month for those in rural areas. The Centre pays forwarding costs and borrower pays for return. Two to three films may be borrowed at a time. A report form must be filled each time. Films must be shown free of charge to the public.

## U.S. GOVERNMENT PUBLICATIONS

United States Government Publications  
Superintendent of Documents  
US Government Printing Office  
Washington D.C. 20402 USA

While most of the materials produced by this office are for American consumption, some are helpful for PNG. Various lists of publications are issued for different categories of information. Since they handle approximately 25,000 different publications, no single catalogue could list all of these. There are no free items, although the lists are free. Remittances from countries outside the U.S. should be by bankers draft, payable to the Supt. of Documents. Here are a few of the lists:

- No. 21 Fish and Wildlife
- 38 Animal Industry
- 42 Irrigation, Drainage, and Water Power.

- 44 Plants
- 46 Soils and Fertilizers
- 68 Farm Management

The monthly catalogue, which costs US\$4.50 for a year's subscription, is a comprehensive current listing, and might be useful for the larger libraries.

## UNIVERSITY OF THE PHILIPPINES

Department of Development Communication  
College of Agriculture,  
College, Laguna, 3720, Philippines.

### LEAFLETS: (PARTIAL LIST)

- 3 Methods of Seeding and Planting Garden Crops, C.L. Madrazo. Price P0.25
- 8 Disease Control Guide for Vegetable Growers, F.C. Quebral & R.G. Davide Price P0.25

### CIRCULARS:

- 6 A Guide to Broiler Production, E.C. Coligado Price P0.60
- 10 Get the Best Effects From Herbicides, M.R. Vega Price P0.30
- 11 Home Preservation of Mangoes and Papayas, Onate et. al. Price P1.65
- 12 How to Make Compost, B.C. Felizardo, S.M. Tilo & E.C. Elefano P1.05
- 15 Management of Soybean Production, I.C. Gagampang, R.M. Lantican & S.N. Tilo P0.50

### FARM BULLETINS:

- 1 New Ways With Rice (cookbook), A.M. del Mundo & N.R. Bustrillos Price P1.50
- 5 Landscape Your Garden, E. de la Cruz Price P1.25
- 6 Egg Farming for Beginners, A.C. Campos & M.M. Labadan Price P1.75
- 7 Increase Profit Through Culling and Selection, M.M. Labadan Price P1.65
- 8 How to Propagate Fruit Plants, R.V. Valmayor & R.E. Coronel Price P1.25
- 14 Care of Baby Pigs from Birth to Eight Weeks, R.B. Puyaoan, M.G. Supnet & J.A. Eusebio P1.00
- 15 Crop Production Goals for Vocational Agriculture A.O. Gagni & G.F. Saguiguit Price P1.25
- 16 Successful Brooding of Chicks, M.M. Labadan & A.S. Adejar Price P1.15
- 17 Corn in Meals and Snacks (cookbook), L.U. Onate, A.M. del Mundo & S.M. Novero Price P1.25
- 19 Rabbit Raising for Fun and Profit, L.L. Clamohoy Price P1.50
- 20 Better Meals with Root Crops, A.M. Del Mundo & L.U. Onate Price P1.15
- 22 Goat Raising in Your Backyard, L.L. Clamohoy Price P3.60
- 23 Preserving Fruits (cookbook), L.U. Onate P1.80
- 24 Cassava - A Guide to Its Culture, C.D. Molinyawe Price P1.50
- 27 Beekeeping in the Philippines, R.A. Morse & F.M. Laigo Price P4.10
- 28 Black Pepper, I.S. Anunciado Price P1.50
- 29 How to Grow Grain Sorghum, A.A. Gomez & A.C. Mercado, Jr. Price P1.25
- 30 How to Grow and Store Ginger, T. Cadiz Price P0.75

- 32 Peanut Production, I.C. Gagampang & R.M. Lantican Price P3.70
- 33 How to Make a Farm Plan for Rice Farming, E.P. Abarientos Price P0.60
- 34 Growing Mungo (Mung Bean), I.C. Gagampang & R.M. Lantican Price P1.20
- 36 36 Ways of Cooking Soybeans, L.I. Onate, A.R. Aguinaldo & J.A. Eusebio P2.50
- 39 Easy Recipes for Sorghum, L.U. Onate & N. Lantican Price P1.50

#### TECHNICAL BULLETINS:

- 6 Swine Raising for Beginners, J.A. Eusebio Price P2.15
- 7 Rambutan, R.V. Valmayor, H.L. Valmayor & L.G. Gonzalés Price P4.30
- 22 Beef Cattle Selection and Culling, M.G. Supnet, L.L. Clamohoy & J.C. Madamba P1.80
- 24 A Handbook of Citrus Diseases in the Philippines Ma. Salome E. del Rasario Price P2.50
- 25 Insect Pests of Vegetables, N.M. Esguerra & B.P. Gabriel Price P9.00
- 27 Beef Cattle Health and Sanitation Manual, O.C. Martin & F.P. Vergara Price P4.50
- 28 Harvesting Handling and Storage of Leading Philippine Fruits, D.B. Mendoza Jr., Er.B. Pantastico & J.C. Hapitan Jr. Price P2.50
- 29 Handling and Storing Perishable Foods for Home Use, Er. B. Pantastico Price P1.85
- 30 The Principles and Practice of Plant Disease Control, O.E. Schultz & F.C. Quebral Price P4.80
- 35 Common Rice Diseases and Their Control, D. Lapiz & O.S. Opina Price P3.60

#### MANUALS AND SYLLABI

- Rice Production Manual 1970- Revised Edition, Price P16.00 postage fee P1.70
- Vegetable Training Manual P10.00 postage P1.20
- Rural Broadcasting (Syllabus on Radio) P.B. Bueno, P.M. dela Paz & F. Librero Price P8.00 postage fee P1.20
- Irrigation and Drainage Principles and Practices A.O. Gagni, W.P. David, V.A. Sahagun & M.R. de Vera Price P7.50 postage fee P1.20
- Principles of Soil Science (Laboratory Manual) Price P7.50 postage P1.20
- Swine Production and Management (Laboratory Manual) Price P7.50 postage fee P1.20
- Corn Production in the Philippines Price P6.00 and postage fee P1.20
- Coconut Production in the Philippines, Price P3.90 postage P0.90
- Poultry Production in the Philippines, Price P5.60 postage P0.90
- Rice Production in the Philippines, Price P5.50 postage P1.20

Please address all letters and cheques to the;

Department of Development Communication,  
College of Agriculture,  
U.P. at Los Banos,  
College, Laguna 3720, Philippines.

Postage listed is Philippine domestic postage; for surface mail to PNG send twice the amount for the domestic postage. Be sure to send a bank cheque in Philippine Pesos. (K1.00 = approximately P8.90) Allow 4 months for seamaile delivery.

VITA (Volunteers in Technical Assistance)  
3706 Rhode Island Ave.  
Mt. Rainier, Md, 20822 USA

(P 259)

(Note: The VITA Field Representative, Box 4981, Unitech, Lae, has a limited supply of VITA publications.)

#### LIST OF PUBLICATIONS:

Village Technology Handbook, revised edition, 1975, 387 pages, US \$9.00 postpaid (add US \$7.20 for airmail)

A popular "Old Standard" which has been around since 1963. 37 well-prepared articles on a variety of topics. 143 pages on water resource development and use. About 30 pages on toilets. Good article on earthmoving for irrigation and road-building. Excellent article on soap-making. But it cannot be considered comprehensive, most references cited are rather old and are not available for readers in developing countries to buy, and it is much too expensive. Invest your money in VITA's shorter papers. Level: Simple

2E Automotive Operation & Maintenance (1975) 202 pages. A manual for drivers using pioneer roads and for novice mechanics in areas without extensive service facilities. Price US\$6.50

#### Agriculture and Food Processing

- 5E Smoking Fish in a Cardboard Smokehouse (1966) Price US\$0.50
- 6E How to Salt Fish (1966) Price US\$0.50
- 9E Solar Cooker Construction Manual (1967) US\$2.00
- 12E Fresh Produce Handling & Distribution (1969) Price US\$0.50
- 15E Groundnut Huller (1970) Price US\$0.50
- 24E How to Perform an Agricultural Experiment (1971) Price US\$1.50

#### Construction

- 7E Making Building Blocks with the Cinva-Ram Block Press (1966) Price US\$1.50
- 10E Small Scale Manufacture of Burned Building Brick (1968) Price US\$1.00
- 25E Waterproofing Soil Construction (1973) US\$1.00

#### Health

- 22E Health Records System (1971) Price US\$1.50
- 23E Bandages Impregnated with Plaster of Paris (1971) Price US\$1.50

#### Power and Water Resources

- 8E Low Cost Development of Small Water Power Sites (1967) Price US\$2.00
- 18E Hydraulic Ram for Village Use (1970) US\$1.00
- 20E Low Cost Windmill for Developing Nations (1970) US\$2.00
- 27E Design Manual for Water Wheels (1975) US\$4.00
- 28E Handpumps for Village Wells (1975) US\$1.50

### Other Helpful Manuals

- 3E Bat Control (1963) Price US\$0.50
- 13E Chalk Stick Making (1969) US\$1.50
- 14E Playground Manual (1969) US\$2.00
- 30E Simple Furniture Design (1975) US\$0.50

Price includes cost of surface mail. For airmail, add 80% to the total price of the order.

## Sourcebooks

### SOURCEBOOKS

Appropriate Technology Sourcebook, 2nd edition. US\$2.00 from The Appropriate Technol. Project, Box 4543, Stanford, California 94305, USA.

This is a 304 page booklet of reviews of a wide range of books and pamphlets about appropriate technology. Like the Liklik Buk it does not tell you how to do something. It tells you where to go to find out how. There are general books and how-to pamphlets published by a number of groups throughout the world from Nigeria to the Philippines and from South Africa to Canada.

There are many books or pamphlets on different free energy sources, as well as on housing, public health, agriculture tools, agriculture product processing, and even books on how to make tools to make other tools.

Where there are reviews of technical plans the reviews are based on the construction of the item and lists the materials required, the cost of the materials, and the tools needed to build. Of particular interest to PNG are plans for pedal powered peanut threshers, a hand powered peanut huller from automobile wheels, and an excellent book on the construction of methane digesters. The Sourcebook says that the Energy Primer, which is also reviewed elsewhere in the Liklik Buk, is the most valuable book they have reviewed. (p 158)

Next to the Liklik Buk, the Sourcebook is probably the most useful list of references available.

Level: intermediate.

## Books

A HANDBOOK ON APPROPRIATE TECHNOLOGY, Brace Research Institute and Canadian Hunger Foundation, from CHF, 75 Sparks Street, Ottawa, Ontario, Canada K1P 5A5. 280 pp. Formerly loose-leaf, now paperback. Papers on Appropriate Technology, its philosophy, techniques. Case studies are shown with pictures and diagrams. Contains a glossary, a catalogue of tools and implements, bibliography, and lists of groups around the world involved in Appropriate Technology. Price C\$6.00 not including postage. Airmail and handling C\$7.85. We don't know the Surficemail rate.

The Cumberland General Store Wish and Want Book (Being a Comprehensive Selection of Down to Earth Tools for Living the Good Life). Price US\$3.00 incl. surface post.

Available from The Cumberland General Store, Rt. 3, Box 479, Crossville, Tennessee 38555.

It is, as it indicates, comprehensive. Virtually all of the tools are hand powered: canners, forges, windmills; pumps, plows, traps, grinding mills, pruning tools, washing machines, and animal pulled farm equipment.

These things are expensive in this catalogue, but all of the tools can be made in PNG, just as they used to be made in small factories in American rural areas. Every item is illustrated, and usually clearly enough that you could make your own from the drawing. These are the tools that made early America "self-reliant."

Radical Technology, Godfrey Boyle and Peter Harper, Ed., 1976 \$5.95 from: Pantheon Books  
201 E. 50th St.  
New York, NY 10022

An impressive collection of essays, reports, access to information and counterculture philosophy. Interesting essays on tree farming, textile making, biological chemicals, metal working and paper making. An introduction to appropriate Technology from a counterculture perspective. By the editors of Undercurrents.

WHOLE EARTH CATALOGUE (US\$6.00)  
WHOLE EARTH EPILOGUE (US\$4.00)  
CQ-EVOLUTION QUARTERLY (US\$8/yr)

Box 428, Sausalito, California 94965 USA.

Continual update by the "original" access catalogue (inspiration for Liklik Buk). Various "appropriate" tools, books, philosophy, and comments, mixed with gossip.

### BOOKS FOR STIMULATION AND REFERENCE

Appropriate Technology - Problems and Promises, ed. by N. Jequier, Development Centre, OECD, Paris, 1976, 344p. From OECD Publications, 2, Rue Andre-Pascal, 75775 Paris, Cedex 16, France.

An interesting treatment of the philosophical and policy issues of Appropriate Technology, with 19 papers from practitioners in the field. Helpful for those sorting out priorities and formulating policies.

Level: Intermediate/advanced.

African Food Production Systems, Cases and Theory, by P. McLaughlin, Johns Hopkins Press, Baltimore, USA US\$12.50.

A collection of seven studies by anthropologists which emphasize seven African societies' responses to innovations in food production technology. The editor's introduction is a cry for greater under-

standing and investigation into the constraints on food productivity instead of just talking about it. It is also an outline of the areas where greater research is needed if the tide of reduced productivity is to be turned.

This series is particularly interesting in that it shows how many African societies reflect PNG. The introduction that lists the constraints on productivity, with social aspects listed in great detail, make the book valuable for anyone concerned with planning or implementing development projects on any level. Level: intermediate.

---

Agricultural Development: An International Perspective, by Yujiro Hayami and V.W. Ruttan, Johns Hopkins Press, Baltimore, USA, 1971, US \$12.00.

A study of the potential for technology transfer and growth in agriculture. It emphasizes studies of U.S. in comparison to Japan and her former colonies of Korea and Taiwan. Comprises a significant amount of general data on farm productivity and production in these and other countries. Considerable economic theory and formulae. Basically a university text in agricultural development and of interest to planners and policy makers. Level: advanced.

---

Experiences With Agricultural Development in Tropical Africa, (2 vols), by J.C. de Wilde et al, Johns Hopkins Press, Baltimore, USA, 1967, US\$17.50

Published for World Bank, this two volume study focuses on development schemes financed by the Bank in six African countries. The volume dealing with the case studies is descriptive of the economic aspects of the projects, but some insight is shown as to social, political, and cultural factors that have effected the schemes. The other volume attempts to draw general conclusions about changes in the societies, land tenure, technology, agricultural education, credit and marketing and cooperative structures as a result of the impact of the projects.

Although a bit heavy and filled with data the volume of synthesis is very useful background for people who think that their own development problems are unique - they aren't. A failing of the books is the perfection of their 20/20 hindsight, and the few solutions to the problems they identify. Level: intermediate/advanced.

---

A Handbook of Tropical Agriculture, by G.B. Masfield, Oxford Univ. Press, 1970, 196 pp.

As the name indicates it is a handbook of brief statements on tropical soils and environment, crops of all major types, livestock, pests and diseases. Not for the specialist, but helpful in a school library. Level: simple.

Rural Reconstruction and Development, a Manual for Field Workers, by Yen, Feliciano, et al, International Institute of Rural Reconstruction, Silang, Cavite, Philippines, 1967, 456-pp, Order direct, approx US\$4.00.

This is a manual for the fieldworkers of the Rural Reconstruction movements, with basic guides in areas of livelihood, education, health, and village self-government. Written primarily for Philippine conditions, it has useful materials for those working with rural youth movements and people's organizations at village level in PNG. Level: simple/intermediate.

---

We Don't Know How, by William and Elizabeth Paddock, Iowa State Univ. Press, Ames, US\$4.50.

Long experience with some keen disillusionment of the development process qualify the authors for this controversial book. They have investigated projects supported by charitable and government organizations in several South American countries which the organizations had identified as being very successful. The Paddocks had hoped to learn what makes a successful project. The problem they found was that there were none among the various health, educational, agricultural, and economic projects. Just why the projects were not successful is the meat of the book. Since many of the projects have similarities in means of financing and focus with many projects in PNG, the warnings are useful. Level: intermediate.

---

China: Science Walks on Two Legs, Science for the People, Avon Books, 1974, \$1.75 from: Hearst Corporation, 959 Eighth Ave, New York, NY 10019 USA.

---

First Steps in Village Mechanization by George A. McPherson, Tanzania Publishing House, Box 2138, Dar es Salaam, 1975. No price given.

This is a how-to-do-it book for peasant farmers in Tanzania, and so many of the needs are different from PNG. Village carpentry suggestions are primitive by PNG standards, and agriculture equipment for animal power is not yet relevant, but there is a very good section on village forges and tools that can be made from scrap. One agriculture tool which might be useful in the Markham Valley, is a corn sheller made from wood and staples. There are many useful suggestions on the use of old rubber tyres, including knife and chisel handles, animal harnesses, and solid rubber tyred wooden wheels. All drawings are clear and photographs of the finished product are shown.

The instructions are a little sophisticated for village technicians, but would be very useful in vocational centres and more sophisticated workshops.

Level: simple.



Modern Agriculture for Tropical Schools, Oxford University Press, Kuala Lumpur, 1970. Price Singapore \$5.50.

This is the best school book for High School agriculture, for students learning in English as a second language. It is a rare book because it assumes that the High School students are capable of thinking. It actually teaches something about agriculture beyond the how-to level.

Available from: Marican and Marican Booksellers G57 Katong Shopping Centre, Singapore 15, Republic of Singapore.

Level: simple/intermediate.

#### THE SAMAKA GUIDE TO HOMESITE FARMING

"Samaka" is an abbreviation which means approximately "A united effort of a group to have more plentiful food for their families". And this is what it's all about.

A good book, a useful book, but somewhat uneven in its treatment of subjects. No school should be without one and group leaders, missionaries and private individuals engaged in mixed farming would find it extremely useful. It is a particularly useful idea book for people changing from subsistence bush gardens to home lot gardens.

If you're looking for quickly obtained yet useful advice, then this book will help you. If you are looking for commercial advice, or a lot of detail about a subject, then you will need to find a more specialized book.

About 30 subjects are covered: the sections on Goats; Vegetables; and Chickens, being particularly useful

The book was written in 1954 and suffers from this to a degree. A revision has been made, but it could have been better. There are bad examples of mixing Metric and Imperial measurements.

Some of the measurements, and many of the names, will be unfamiliar to people in PNG; but most of these become clear after reading on for a few pages.

Available from UPNG Bookshop.

Level: simple

Reviewed by: F. Robinson, Konedobu.

We're as unhappy as you with the quality of this section. Too few contributors have shared with us useful books on Development and Technology. Let us know the best references and books by sending us a review for the third edition. (see p 268/269)

## Book Suppliers

PNG

Christian Book Store  
Box 78, Mt. Hagen WHP

The Book Depot.  
Box 90, Rabaul ENBP

Menduli Book Depot  
Box 35, Mendi SHP

Christian Book Centre  
Box 122, Madang MP

Christian Bookstore  
Box 91, Goroka EHP

Christian Book Shop  
Box 169, Wewak ESP

Attic Book Shop  
Box 802, Lae

Christian Book Centre  
Box 718, Lae

Madang Bookshop, Pty. Ltd  
Box 484, Madang

New Guinea Book Depot  
Box 5495, Borokó

Goroka Book Shop  
Box 621, Goroka

University Bookstore  
Box 4820, University

## OVERSEAS

Blackwells  
Broad Street  
Oxford OX 1 3BQ England

A major bookseller that specializes in mail order and special order. Catalogues of books are available by subject matter to regular purchasers without charges. Very good service, prices are net plus postage and insurance. Expect 4 to 5 months delivery wait. Books published in Britain are cheapest this way.

Compendium, Pty. Ltd.  
Books for Self Sufficiency  
Centreway  
259 Collins St., Melbourne, Australia 3000

This is a bookstore that specializes in ecology-oriented, self-sufficiency and handi-craft books, generally of the "how to" nature. Despite high cost of catalogue and the supplements, it is the best available in the South Pacific. Remember, though, that the store caters primarily to Australian needs. Catalogue and three supplements A\$2.70/year.

# Periodicals

Countryside and Small Stock Journal  
Countryside Publications Ltd, Route 1 Box 239  
Waterloo, Wisconsin 55594, USA, Jerome  
Belanger, Editor. One year US\$6.20, 2 yrs  
US\$10.40, 3 yrs \$15.60.

A monthly magazine for the homesteader who is relearning self-reliance. Much of what is written is not for PNG, but there are many ideas that are suitable. The magazine is reader-oriented, and this means that many of the readers share their own bits of traditional knowledge. Many of the designs assume that the reader can scavenge in an American dump for pieces, but only the Lae dump seems to be in the same category of conspicuous consumption. There is great emphasis on energy conservation, non-mechanical farming and organic gardening. An editorial bias in favour of small farms, goats, and rabbits.

Development Forum, by Centre for Economic and Social Information, United Nations, Palais des Nations, CH1211, Geneva 10 Switzerland. Monthly, Free, but specify language desired (English, French, Spanish, German, Italian.)

This is airmailed monthly on newsprint. The reporting is journalistic and deals with current issues and controversies on the development scene. Also lists films, pamphlets, display materials that are available through the various U.N. agencies. DF is designed not to offend. Level: simple/intermediate.

Development News Digest,  
Box 1562,  
Canberra, ACT 2601.

A\$6.50 per year for a news digest concerned with third world issues. Published by the Educational unit of the Australian Council for Overseas Aid. Directed at voluntary aid agencies, members of parliament, the media, education institutions, and community groups, it aims to encourage a critical and questioning approach to activities in the Third World.

Earth Garden  
P.O. Box 111  
Balmain, N.S.W. 2041  
Australia

Comes out approx 4 times a year, A\$1.00 per issue. Presents a range of so-called "natural" life styles. It is intended as a key to sources, practical ideas, alternatives, self-sufficiency.

Grass Roots "The Craft and Lifestyle Magazine"  
Box 900  
Shepparton 3630  
Australia

Subscription A\$4.40 for 4 issues, back copies \$1.20. "Produced for those who wish to regain control over their lifestyle by exploring the alternatives to modern mass consumption." Many articles on simple agriculture and intermediate level technology.

Ideas and Action Bulletin  
C/- Freedom From Hunger Campaign/Action for Development, Via delle Terme di Caracalla,  
00100 Rome, Italy.

Issued approximately every six weeks, free. Lots of "preaching", lots of "jargon", from an organization which means well, but which is largely a "paper" committee. Not for those working at village level. Will provide some stimulation for those working at regional and national level.

Mother's Bookshelf,  
Box 70, Hendersonville, NC 28739, USA.

The books listed can tell you how to produce energy from the wind and sun, build a low-cost comfortable home, garden organically, make money at home (legally), raise food in a cupboard, find underground water, use natural pest controls, raise rabbits and chickens, make soap, can and dry home-grown fruit and vegetables, sell handicrafts, keep bees, build walls fences and gates, store a year's supply of food ... and do a thousand and one other useful things.

Reviewed by: J. Dash; Gerehu.

The New Internationalist,  
Wantok Publications,  
Box 1982,  
Boroko.

K14.00 Airmail per year. Reports on the issues of world poverty; focuses attention on unjust relationship between rich and poor worlds; debates and campaigns for radical change for meeting basic human needs; and seeks to mobilize people, ideas, and action for world development. Sponsored by Christian Aid, OXFAM, and Third World First. Articles and opinions do not necessarily represent the views of the sponsoring organisations. Editorial Offices: 62a High Street, Wallingford, Oxon. OX10 0EE. U.K.

The New Technologist,  
c/- Voluntary Committee on Overseas Aid and Dev't,  
International Development Centre,  
25 Wilton Road,  
London SW14 1JS U.K.

Free. Published by the Academics Against Poverty programme, with the purpose of encouraging workers in science and technology in institutions of higher learning to adapt their teaching and research to the expressed needs of communities. Basic articles, bibliography, further contacts.

---

Power Farming Magazine  
29 Alberta St.  
Box 3408  
Sydney, 2001

Subscription A\$10.00 for P.N.G. Generally advanced level agricultural technology, but with occasional articles on intermediate technology.

---

RAIN/Environment Education Centre,  
Portland State University, Portland, OR 97221 USA.

Publishes RAIN, an environment/intermediate technology oriented periodical with various ideas, book reviews, briefs on who is doing what and where.  
Subscription US\$5.00

---

Rural Life  
C/ Institute of Rural Life  
27 Northumberland Rd.  
New Barnet, Herts, U.K.

Three pounds annually. A quarterly review of the Institute, which promotes lectures, conferences, and courses of study on Rural Life and home and overseas. It is in contact with more than 200 societies throughout the world; over 100 registered correspondents in some thirty countries.

---

Small Industry Development Network,  
Quarterly Newsletter,  
Engineering Experiment Station,  
Georgia Institute of Technology,  
Atlanta, Georgia 30332, USA.

Subscriptions free. News, Comments, Contacts, Book and other publications lists, oriented towards appropriate technology. When writing give your name, title, organization, address.

---

World Farming  
1014 Wyandotte St.  
Kansas City, Missouri, 64105 U.S.A.

Free subscriptions for "agriculturists" living outside of continental United States, US\$5.00/yr for others. Lots of advertising, some good articles.

## Succour and Comfort

It is claimed that PNG receives from all sources more foreign aid per capita than any other developing nation. It is true that the per capita aid is greater than the per capita Gross National Product of the eighteen least developed nations. We urge readers to keep this in mind before seeking development funds from outside resources.

### PNG DEVELOPMENT BANK

How is the Development Bank different from other Banks?

1. You cannot open a passbook, a cheque account, or deposit and withdraw as you do with other banks.
2. The Development Bank gets most of its money from the Government and from organizations like World Bank and Asian Development Bank. This money is then loaned to Papua New Guineans to establish businesses to help develop the country.
3. Interest rates are usually lower than those charged by other banks. (Interest is what you pay the bank for its service in giving the loan).
4. The Development Bank does not ask that the borrower give as much "Deposit" (The borrower's contribution to the project) as other banks.
5. The Development Bank often lends money for longer periods than other banks.
6. The Development Bank does not always require as much "security" (something of value given by the borrower to support the loan) as other banks.

The Story of the Papua New Guinea Development Bank is available from their branches and offices. The booklet tells a person who wants to borrow from the bank how he should go about getting a loan, and how the bank works once the loan is approved. It doesn't tell about the delays that are involved in getting a loan, due to the paper work that is necessary, but most people know about that already.

The PNG Development Bank tends to make regular changes in its policy, so it is a bit difficult to keep up. For up-to-date information, write:  
Publicity Office  
PNG Development Bank  
Box 6310  
Boroko

### ENGINEERING, ARCHITECTURAL AND MECHANICAL ADVISORY SERVICE

Within the Department of Transport, Works and Supply there is a branch called the Local Government Advisory Service. Its function is to provide technical and professional advice to all Local Government Councils and Area Authorities, within Papua New Guinea.

The Engineering section mainly assists with design

for roads, bridges, wharves, causeways and village water supplies. The Architectural section undertakes design of such things as offices, meeting halls, markets, aid posts, theatres, class rooms, houses, museums, and guest houses. The Mechanical section offers advice on the costs, purchase and maintenance of machinery and vehicles.

It is possible for village groups and associations to make use of this advisory service provided their Local Government Council or Area Authority supports their enquiry with a letter approving the proposed project.

For further information write to:

The Secretary,  
Department of Transport, Works & Supply,  
Local Government Advisory Service,  
PO Box 1108,  
Boroko.

(p 128)

### VILLAGE DEVELOPMENT OFFICE

Box 6937, Boroko. Phone No 25-9999.

(p 245)

This office in the Department of the Prime Minister has advised us that they have four basic functions:

1. There is a fellowship scheme that pays  $\frac{1}{2}$  the salary of a public servant or K50 per month for a private individual who wants to use his skills to help his village, for a period of 6-12 months, if his leave is approved. Details of the project must be made with application.

2. The office conducts appropriate technology workshops to assist villages with technical ideas for improving village life. (Ukarumpa & Vudal last year)

3. The office, together with the South Pacific Appropriate Technology Foundation, helps people get in touch with the proper department for assistance with projects. The office also makes sure that you have enough information about your project to be able to get action from the department that is to help you. If you feel that some department is not helping you enough write or visit the Village Development Office to get their assistance.

4. The office also publishes information sheets and technical books on new ideas for village level technology.

For more information on any of this work write to the above address.

**SELF-HELP**

RURAL IMPROVEMENT PROGRAMME is a source of money for Area Authorities and Councils to supplement funds raised through taxes and fees for carrying out projects in rural areas.

Villages and groups can ask for assistance on their projects by making a proposal through their council or for money if they have made a self-help contribution. If the council approves the application it is forwarded to the Area Authority for evaluation. You should have your application made by November if you want to be considered for money for the next financial year. You will have a much better chance of getting approval if you check out your application with officers of any departments concerned before you submit the application. They will often be able to help with technical details to make your application stronger.

One problem with RIP grants is that approval is politically motivated in some areas.

**THE MAN WHO LIBERATED MAN WORKS WITH OTHERS TO DEFEAT THE EVILS OF POVERTY, DISEASE AND IGNORANCE. HE WILL USE THE RESOURCES OF HIS OWN KNOWLEDGE, THE KNOWLEDGE OF OTHERS, THE LAND, THE WATER, OR SIMPLY HIS OWN SWEAT**

Graffiti on a Wesley High School wall.

### VILLAGE ECONOMIC DEVELOPMENT FUND

The Village Economic Development Fund is a way of getting money for business projects. In each Province a Committee outside the Area Authority administers the fund on the advice of the PNG Development Bank and the Department of Business Development. A project can get a grant of up to 40% of the total needed for the project, but it must raise the rest of the money from its own resources or from bank loans.

For more details see the Development Bank or the Business Development Office near you.

Here again politics play a part in some decisions. One Area Authority passed a resolution that the name be changed to the "Ministers Development Fund" as a protest against what they felt was political favouritism in approving a grant. (Post Courier, 5 Oct, 1976). But don't despair. Good projects are approved too, but sometimes the bureaucratic delays are frustrating.

Wau Ecology Institute  
P.O. Box 77  
Wau

The Wau Ecology Institute is an organization dedicated to the study of the plants, animals, and ecology of Papua New Guinea, and to conservation and education in relation to these. A small but competent staff plus visiting students and consultants study a variety of specific interests. This is a good example of solid accomplishment on a very limited budget. If you ever go to Wau, you'll find this a most interesting and worthwhile place to visit. If you have questions about P.N.G. ecology, these people may be able to help you.

Community Development Committee  
University of Technology  
Box 793, Lae

Your technical questions requiring expertise will be referred to appropriate persons. Civil, agricultural, mechanical, and electrical engineering, plus chemical and food technology are especially active areas at Unitech.

*If you give a man a fish, you feed him for a day. If you teach him to fish, you feed him for a lifetime.*

*-ancient proverb.*

## OTHERS

Action Library  
1717 H. Street, N.W. Rm T 345,  
Washington D.C. 20525 U.S.A.

Specialised technical information on agriculture, housing and teaching, bibliographical data, and advice on where to find information.

Agricultural Missions, Inc.  
475 Riverside Drive  
New York, N.Y. 10027 USA

"Agricultural Missions, Inc. serves churches (Protestant and Catholic) in their work among rural people in the Third World. It provides technical information and assistance to rural development projects; orients and trains personnel and missionaries for rural programmes and development; provides leadership and support for seminars and short courses; helps create, strengthen and prepare leadership for overseas church-related rural development organizations; builds and strengthens rural programme-planning capabilities of churches in the Third World; supplements and cooperates with the efforts of government and other agencies to achieve a world without hunger."

Anti-Poverty Ltd.  
c/Mr. Paul Sherlock  
Oxford College of Further Education  
Oxford, England

Projects in intermediate technology research are being carried out, including development of a mechanical tablet-counting machine for rural dispensaries; simple pumps which can be made from spare pieces of drain-pipe; a small machine for knitting chicken-wire; a low-cost lathe; a small aluminium crucible made from an oil drum; various applications of solar energy. Detailed drawings available.

Brace Research Institute  
Agricultural Engineering Building  
MacDonald College  
McGill University  
Montreal, P.Q., Canada

(p 155)  
(p 251)

Plans, publications on intermediate technology. Especially active in seeking practical uses for solar energy.

Canadian Hunger Foundation,  
75 Sparks St.,  
Ottawa, Ontario K1P 5A5  
Canada

Handbook, publications and referral service on appropriate technology.

Christian Relief and Development Association,  
Appropriate Technology Unit,  
Box 5674,  
Addis Ababa  
Ethiopia.

Assists community improvement projects by providing information. Publications or reports are available on wind power for pumps, well drilling, getting rid of porcupines, bamboo pipes, termites, soap-making, handbook for agronomy crops, handbook for soil and water conservation, manual on rural leather tanning, hand dug wells, handcraft production in Ethiopia. A small fee plus postage is charged. We do not have a price list.

Gandhian Institute of Studies  
A.T. Development Unit,  
P.O. Box 116, Rajghat,  
Varanasi 221001, Uttar Pradesh, India.

Recently published a Directory of Appropriate Technology which includes information on appropriate technologies being successfully practiced in India.

Small Industries Development Organization  
Box 2476; Dar es Salaam, Tanzania.

Has done a lot in beekeeping, crafts, methane gas from cow dung, lime-burning, and others.

The Institute of Development Studies UK  
University of Sussex  
Brighton BN1 9RE, UK

Mainly oriented to teachers and planners. Offers courses and maintains a publications service for various development related topics and issues. Current lists and prices available upon request.

Intermediate Technology Development Group Ltd  
Parnell House  
25 Wilton Rd.  
London SW1V 1JS, UK (P 247)

Its main aims are: to compile inventories of existing technologies which can be used within the concept of low-cost, labour-intensive production; to identify gaps in the range of existing technologies; to research into and develop by invention or modification new or more appropriate processes; to test and demonstrate in the field the results of its investigations; and to publish and make known the results of its work as widely as possible so as to facilitate the transfer and use of appropriate technology.

Missions Liaison Group  
91 Darebin St.  
Heidelberg 3084 Australia, Phone 45 5325

"Under the auspices of the Methodist Departments of Home and Overseas Missions, endeavors to provide assistance to the needs of mission areas in developing countries and at the local level by purchasing goods, materials and equipment; endeavoring to match the needs of some with the availability of surplus or obsolete goods of others; obtaining specialized advice and guidance; by organising work parties both large and small to assist in meeting needs. Assistance is not restricted to any particular country, denomination, or religion."

National Institute of Agricultural Engineering  
Restpark  
Silso, Bedfordshire, England

Plans for small devices and technical information.

Overseas Development Council  
1717 Massachusetts Ave. N.W.  
Suite 501  
Washington D.C. 20036 USA

"An independent non-profit organization seeking to ensure wise decisions affecting the process of development of the poorer nations. Functions: to provide a national centre serving as a clearing house, coordinator and catalyst with respect to

the manifold activities related to overseas development; to conduct studies of its own on current and emerging problems; to serve as a forum for those directly concerned with development."

Seminars, conferences, information distribution. Generally the Council publishes 14-16 titles a year in its Monograph, Development Paper, Occasional Paper, and Communique series. Write direct for current lists and prices.

Society for International Development  
1346 Connecticut Avenue, N.W.  
Washington, D.C. 20036 USA

Promotes discussion of development issues; publishes International Development Review (quarterly) and Survey of International Development (10 issues yearly); reference service on development information, directing individual inquiries on any development matter to appropriate sources. Annual membership dues for those in developing countries at local salary levels is US\$6.00, and which entitles members to the two publications.

READERS: WE WOULD APPRECIATE KNOWING YOUR EXPERIENCES IN OBTAINING THE SERVICES OF SOME OF THESE GROUPS, ESPECIALLY THOSE WITH THE "POSH" ADDRESSES. ARE THEY DOING WHAT THEY CLAIM?

Technical Assistance Information Clearing House,  
200 Park Avenue South  
New York, N.Y. 10023, USA

"Serves as a centre of information on the socio-economic development programs abroad of U.S. Voluntary agencies, missions, and foundations and other non-profit organisations." Free newsletter (irregular) includes new publications and conference announcements.

Seatec International (Southeast Asia Technology)  
Consulting Engineers Design, Research & Planning,  
131 Townsend Street, San Francisco,  
California 94107 USA.

An engineering consulting firm specializing in the fields of environmental and water resources engineering and applications of intermediate technology in the developing countries of South East Asia. Has carried out work for United Nations, US Agency for International Development, and international lending agencies. Contacts throughout Asia.

International Rice Research Institute,  
Box 933,  
Manila, Philippines.

IRRI Engineering Department has developed a number of simple and economical designs for Agriculture, mainly rice, and is willing to make these available free along with expert technical assistance to manufacturing firms (both small and large) willing to produce them. Some examples: foot-operated irrigation pump, various types of grain threshers, grain cleaners, grain driers, power tillers, lug wheels for tractors which go into rice paddies.

NEW ZEALAND AID PROGRAMME includes a special High Commissioners Fund administered from the High Commissioner's Office in Boroko. It is a form of direct assistance to the village, for projects with a significant portion of self-help that are unable to get further assistance through existing channels. A well documented submission will get a very rapid response, often resulting in the assistance arriving in six weeks. Only non-business projects are eligible, and the maximum assistance is K1,000. Further information from High Commissioner's Fund New Zealand High Commission, Box 1144, Boroko.

VITA - Volunteers in Technical Assistance  
3706 Rhode Island Avenue  
Mt. Rainier, MD 20822 USA

or

P.O. Box 4981, Unitech, Lae,

Through correspondence with individuals and organizations in developing countries, VITA Volunteers provide personalized assistance in areas such as ...

- agriculture and animal husbandry
- food processing and preservation
- small scale rural industries
- equipment design
- housing and construction
- crafts production
- medicine and health
- alternative energy sources
- water and sanitation

VITA provides its services free of charge to development organizations, small businessmen, extension agents, missionaries, and others who are engaged in serious development-related activities but who cannot afford the cost of conventional consultants.

When you need help in solving a problem or implementing a project, VITA provides ...

- by-mail technical assistance by volunteer consultants
- over two dozen low-cost manuals on village-level technology
- cooperative projects with local development organizations
- short-term consulting on-site by a volunteer consultant when requestors can provide travel and other expenses.

cont'd

#### HOW TO MAKE A REQUEST:

1. Define the problem, giving all pertinent details, such as measurements, amount of rainfall, symptoms of disease, kind of soil, vegetation, etc.
2. Comment on the development of the project, idea or study and mention all previous attempts to solve the problem.
3. Indicate local resources, both funding and raw materials, naming those previously contacted or used.
4. Spell out any difficulties that could affect the solution - location, short growing season, lack of fuel, local customs.
5. If a group project, identify the organization and its purpose.
6. Allow 6-8 weeks for a response from VITA.

Allen Inversin has recently arrived in Lae where in addition to working at the Appropriate Technology Unit of the University of Technology, he is the VITA Field Representative for PNG. His concern will be to improve the quality of VITA services for requestors in the country. Any requests to VITA may be sent through him and he will try to ensure that you get the assistance you require. In pursuing his work, he will do some traveling to meet as many requestors as possible. If you have any questions on how VITA can help you with a specific technical problem, feel free to get in touch with him: Box 4981, Unitech, Lae.

Also let him know if you would like to receive the free VITA quarterly newsletter which gives you both an idea of some of the work VITA is doing in appropriate technology and some useful addresses.

Voluntary Service Overseas,  
Field Office, Box 5685, Boroko, PNG.

An independent charitable organisation concerned with the recruitment of professionally qualified volunteers in Britain and their placement in appropriate development projects in the developing countries. VSO has been involved in supplying volunteers for work in PNG since 1961. Volunteers work for both Government and Non-Government organizations and projects, and are particularly interested in supporting projects in rural development through such bodies as Local Government Councils, or Non-Government organizations such as Local Co-operative Societies etc. VSO is able to recruit volunteers to work in agriculture, education, engineering, medicine, social work, and other development activities but always try to ensure that there is a training element incorporated into the volunteer's job so that in due course the need for a volunteer is removed as national personnel take over. Projects are normally asked to provide a volunteer with accommodation and living allowance but costs such as travel from the UK to PNG are borne by VSO.

World Council of Churches  
Technical Services Unit  
Commission on The Churches' Participation in Dev't  
150, route de Ferney P.O. Box 66  
1211 Geneva 20  
Switzerland

Responds to requests for documentation on various technological problems. Write for lists of publications and prices.

## SELF-HELP

World Neighbors  
5116 N. Portland Ave.  
Oklahoma City, Okla 73112  
U.S.A.

A non-profit agency engaged in village-level self-help development projects in 26 countries. Has printed information and filmstrips.

## Suppliers

PNG

THE FOLLOWING FIRMS RESPONDED TO OUR INVITATION TO LIST GOODS AND SERVICES OF INTEREST TO PNG VILLAGE PEOPLE:

Agquip New Guinea,  
Box 1121, Rabaul.

Phone: 921470

Distributors for Holder Tractors and Spraying Equipment; Bosch Power Tools; Stahlville Handtools, Agricultural Chemicals and Machinery.

Agquip is one of the few firms in PNG which can find you a spare part for almost anything. They have a telex and use it to get quick service. This service costs a bit, but it gets results.

Angco Pty. Ltd.,  
Box 175,  
Rabaul.

Telephone 921413/921233

Branches at Goroka, Lae, Kavieng, Kieta, Mt. Hagen.

Buys: Coffee, Cocoa, Tea.

Angco Pty. Ltd., are the premier purchasers of PNG cocoa, coffee and tea, handling in the vicinity of 60% of both the PNG coffee and cocoa crops respectively.

## BOOK BINDING

Bookbinding is an art. Make your copy of LIKLIK BUK a permanent reference. The chairman of the Port Moresby Sheltered Workshop, c/ Port Moresby General Hospital, says that many of the physically disabled people there can bind books. Write for details.

Coffee Marketing Board  
Goroka

Sells small coffee roasters to village people at a subsidized price of K2.00. Made by the students at Goroka Technical College.

Elvee Trading Pty. Ltd.,  
Box 151, Rabaul. Phone 922175  
T/graph code ELVEE RABAU

A free price list is available.

Sells: Supplies, special orders, agricultural equipment, agricultural supplies, hardware, marine equipment.

"Elvee Trading Pty. Ltd., has been in business for the past 15 years and specialises in importing and reselling the most suitable and economical range of agricultural chemicals, poultry and pig feed, veterinary chemicals, seed, sprayers, pruning equipment, domestic and industrial pest control, Epiglass marine protection and boat building products and Wormald fire extinguishers".

Exmark Stock and Produce (PNG),  
Box 6060, Boroko. Phone 253560  
T/graph code "EXMARK" Boroko.

Sells: Supplies, special orders, agricultural equipment, agricultural supplies.

Advisory services on stockfeed, mineral & vitamin supplements.

"Exmark is located in Hohola, Port Moresby, and retails all forms of stockfeed, mineral/vitamin supplements and protein concentrates for domestic animals. In addition we specialize in saddlery, horse care products, and some veterinary lines. Enquiries regarding retail, wholesale prices, product availability and supplies to outstations are welcome."

Harry Heath and Company,  
Box 1028, Boroko. Phone 255216/256505.

Buys: Scrap and salvage.

Sells: Bicycles, services, special orders, marine hardware, marine equipment, custom manufacturing.

Advisory services, diving and salvage work, underwater repairs, marine engineering, aqualung/skin diving sales and service, boat chandlery, bicycle sales and service, scrap metal dealers, sales and service Kawasaki generators.

Agents for: Gardner Marine, Industrial and Automotive Engines, Epiglass Marine and Industrial Paints, Gamlen Marine and Industrial Chemicals.



C. Logan Machinery - Gleason Cranes - Australia,  
203 Grant Street, South Melbourne 3205.

Phone 692331 / 693666 Telex 34474  
T/graph code "LOGMAC"

Buys: Used machinery  
Sells: Services, marine equipment, food processing  
equipment, metal products.

"Supplies of new and used machinery in the mining  
field construction and heavy industry. Specializing  
in cranes (all types), generating sets, petrol/  
diesel/turbine, contractors' plant, mining equipment,  
road making equipment."

---

Lohberger Engineering Pty. Ltd.,  
Box 810, Port Moresby, Phone 243185 / 243063  
T/graph code HONTOM

Branches: Port Moresby only.

Sells: Supplies, services, special orders, agricul-  
tural equipment, agricultural supplies, some hard-  
ware, custom manufacturing, metal products.  
Advisory services: Water supply and electric power  
supply.

"We can advise and supply equipment on all types of  
water supply systems. We can advise and supply  
equipment for all your electric power supply needs".

---

Morobe Newsagencies Pty. Ltd.,  
Box 960, Lae. Phone No 421830

Sells: Supplies wholesale, retail magazines, books  
and newspapers, comics, parker pens, greeting cards,  
postcards, paperbacks, toys of all sorts.

---

New Guinea Book Depot,  
Okari Street, Box 5495, Boroko. Phone 254611.

Price list available upon request.

Sells: Books, stationary, special orders.  
Other services: Mail orders to Government  
Departments, schools, and private persons.

---

New Guinea Pastoral Supplies Pty Ltd  
Stock and Station Agents  
Box 83, Lae, Phone 42 2635  
42 3919  
Cables "PASTSUP" Lae

Agricultural and veterinary chemicals, veterinary  
instruments, fencing materials, saddlery, feeds  
and seeds, cattle equipment, agricultural machin-  
ery, catalogue available.

---

New Guinea Wholesale Drug Co. Pty. Ltd.,  
Box-349, Lae. Phone No. 424133

Free catalogue available. Branches: Madang.

Sells: Supplies, special orders, agricultural  
supplies.

"We manufacture & wholesale veterinary medicine for

pigs, horses and cattle. Also syringes, scalpels,  
special screwworm medicine. We also manufacture  
and wholesale medicines for humans."

---

Plantation Supply & Service Co. Pty. Ltd.,  
Box 92, Goroka.

Phone 721069, Telex 72566. Free catalogue  
available. Branches at Lae and Mt. Hagen.

Buys: Birdseye chillies, peppercorns, cardamoms  
and vanilla, (vast quantities needed). Also croc-  
odile skins, basketware, pottery, wood manufactures,  
trochus shells and any other exportable products.

Sells: supplies, services, special orders, agricul-  
tural equipment, agricultural supplies, hardware,  
marine equipment, food processing equipment.

Advisory services in the use of agrochemicals,  
application of village level food or crop processing  
equipment.

PSS's new slogan is 'Serving Rural Industry', and  
its product lines cover every possible need in the  
rural sector - plantation or village level. From  
fertiliser to fencing or seeds to soil cultivation  
equipment PSS can supply the product and back-up  
service. Full details are available from PSS Lae,  
Goroka, or Mt. Hagen.

---

Ross Engineering,  
Box 10, Rabaul. Phone 922009 T/graph code ROSSENG

A free information sheet is available. Branch at  
Rabaul only.

Sells: Marine Equipment and Custom Manufacturing

Advisory Services: "Lister" agents and general  
marine and Engineering supplies.

---

Sohi Gilseman Pty. Ltd.,  
Box 25, Mendi. Phone 591030.

Branches at Mt. Hagen.

Sells: Supplies, services, special orders, hardware,  
Custom Manufacturing, Metal products.

"We retail Builders and General Hardware in Mendi.  
Also gift lines, mens, womens and childrens clothing  
and footwear, stationery etc. We do building, new  
and renovations etc, plumbing and miscellaneous  
small jobs.

In Mt. Hagen we have a Sheet Metal Factory and  
manufacture all Sheet Metal products including  
custom made duct work etc."

---

South Pacific Machinery Pty. Ltd.,  
Box 6115, Boroko.

Phone 253184 Telex NE22222 T/graph code PACMAX

A free newsletter will be available shortly.  
Branches: Lae, Agents at Rabaul & Mt. Hagen.

Sells: Supplies, agricultural equipment,  
agricultural supplies, marine equipment, food  
processing equipment, custom manufacturing,  
metal products.

Advisory services: General application of farm

machinery and irrigation technique in PNG.

Imports and manufactures a wide range of farm implements, engineering woodworking and marine supplies.

Stockmans Pty. Ltd.,  
Box 684, Lae. Phone 423936/422880  
T/graph code STOCKMANS LAE

A free catalogue is available. Branches: Mt. Hagen.

Types of services offered: Auctioneering, Insurance, livestock buyers, meat wholesalers, meat retailers, rural merchandise, and General Stock & Station Agents.

Buys: Cattle, pigs, eggs, dressed chickens, sheep, horses, goats, vegetables as required.

Sells: Full range rural equipment including ploughs, tractors, chemicals, stockfeed, butchers supplies, abattoir equipment, veterinary equipment and livestock requirements. Auctioneering services, Insurance agents services, special orders, hardware, and food processing equipment

Tru-Cast Foundry Pty. Ltd.,  
Box 160,  
Lae.

Make cast iron wood-burning stoves and coffee-pulpers which are sold through Steamships, Burns Philp, and New Guinea Co. Hardware departments. Also make iron and non-iron castings to order. Buy scrap cast iron

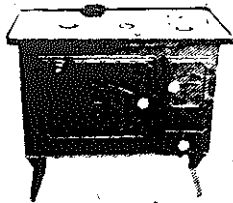

No. 3 K100.



Copper Stand 1.2 Gal  
K30. without copper



No: 1 K53.

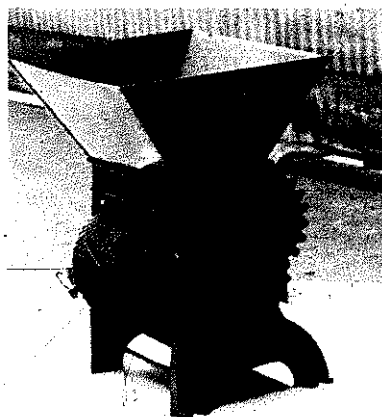

Coffee Pulper K124

### OUTBOARD MOTORS

The survey by the Committee on Standardization of Selected Imports showed that at any given time nearly half the outboard motors in PNG are not working. Why?

1. Operator abuse.
2. Spare parts hard to find.
3. There are few service facilities and they are expensive.

This means a big loss to the nation and to the people who use outboards. But there is one make of outboard called SEAGULL. It has such a good reputation that in the Solomon Islands the Pidgin word for Outboard is Sigul. It is extremely reliable.

### WHAT IS WRONG WITH SEAGULLS.

They are noisy and have an ugly appearance. They are slow. They use a special sparkplug. They use a special fuel mixture (10:1). They have no reverse gear. The biggest model is only 4.5.HP. The maximum speed is 8 km per hour.

### WHAT IS RIGHT WITH SEAGULLS.

They are very rugged and have a better chance of surviving operator abuse. They will run forever if cared for. They start easily and use very little fuel. There are few parts to break, and they are easy to replace.

cont'd

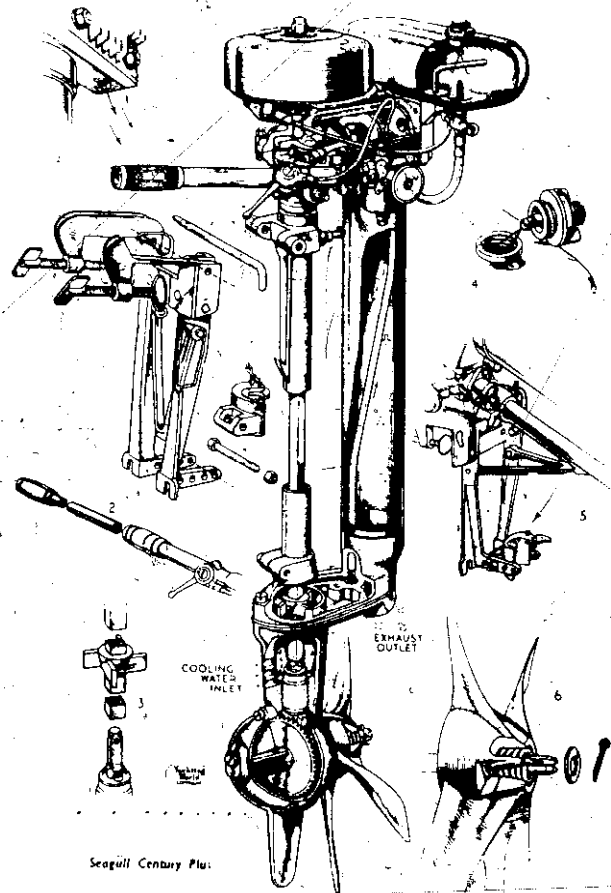

SEAGULL outboards are cheap. The most expensive model is only a little over K300.00. They will push a heavy load as fast as a small one.

The manufacturers call the SEAGULL 'The Best Outboard for the World'. The same design has been used for more than thirty-five years.

Therefore - Advantages of SEAGULL are:

1. Require no skill or mechanical ability to run.
2. There is no running in period.
3. Require minimum maintenance.

The SEAGULL is sold in PNG by:-

Auto Outboard Engineering, Box 349, Madang.  
Bougainville Marine, Box 277, Arawa.  
Diver Services, Box 1049, Rabaul.  
Marua Traders, Box 22, Kerema.  
Musa Agencies Pty. Ltd., Box 143, Popondetta.  
Needham & Co., Box 67, Lae.  
Needham & Co., Box 63, Madang.  
New Ireland Tyre Supply, Box 157, Kavieng.  
Oil Company Services Pty. Ltd., Box 582, Wewak.  
Ross Engineering, Box 10, Rabaul.  
United Church Technical Department, Salamo, MBP.

Initial contributor: R.A. Lachall, Box 103, Kavieng.

## OVERSEAS

### Australian Telephone Directories

Australian Capital City alphabetical and business ("Pink Pages") telephone directories give addresses and brief indications of almost every business in Australia. They are published annually, and until 1973, promptly. More recently the system has become a little unwieldy, and some directories are a year late. Strong suggestions have been made to change the directories system for the larger cities.

A most important aspect: the 1965 to 1973 directories were only 30¢ (30t) each. These are available at post offices in Australia, and may be available in some P.N.G. post offices. For postage considerations, the largest directories weigh about 1 kg.

CeCoCo (Chuo Boeki Goshi Kaisha)  
Box 8, Ibaraki City  
Osaka, Japan

Distributors of a broad range of simple tools and machines for farming, village-level and small industrial processing, and manufacturing. A 158 page catalogue is available for US\$10. airmail postpaid. Somewhat high prices but excellent service.

China Agricultural Machinery Co., Ltd.  
11 Tung Hsing St.  
Taipei 105, Taiwan, ROC

Tillers, various kinds of simple agricultural machinery and tools. Wide range of hand tools. Information on request.

China National Machinery Import and Export Corporation.  
C/- China Resources Company,  
Bank of China Building,  
Hong Kong.

Head Office: Erh Li Kou, Hsi Chiao, Peking, China.

An interesting range of basic tools and equipment at low prices, but must be ordered in large quantities. Information available on request. Some sample items:



Hand-driven Maize Sheller, Model 5TYR-0.1

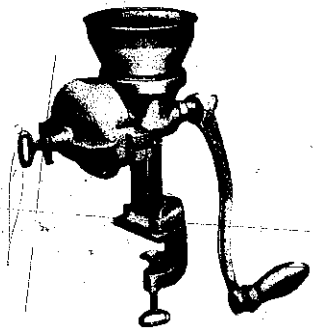

Hand Operated Grinder, No. 201

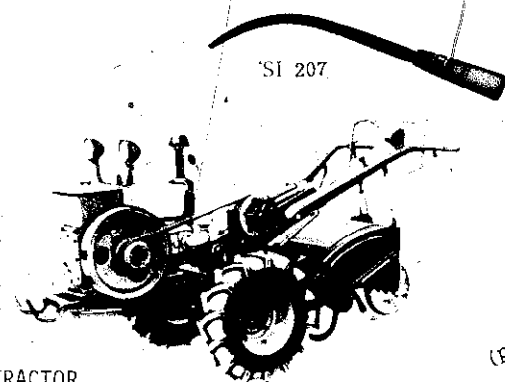

### DONGFENG TRACTOR

The Chinese standard 'workhorse' is the 12 HP Model Dong Feng. It is used throughout China in many different applications - rotary tiller, water pump, bench-sawing, transport and ploughing.

There are many 'Rotary hoes' available in PNG, and several of them have features which this machine does not have. None are built so solidly, however, and none are so simply constructed and easily serviced. From the financial point of view, none are as cheap for the power offered.

It costs K1,380 at any of the main ports and comes complete with spare PTO, two sets of tines, and a

cont'd

complete - (I mean complete!) range of tools and the sort of spare parts that one really needs. Its nearest rival in this horsepower range is nearly K1,000 more, and needs more skilled adjustments more often.

My machine came from: Kimbe Bay Shipping Agencies  
Box 27,  
Kimbe, WNPB.

With some of the equipment you can ride while you guide the tractor. At other times you must walk. It is harder work than operating a four-wheel tractor, but a lot easier than working by hand.



*This Dong Feng has a trailer on the back and powers a wood saw at the front (in Sha Shi Yu Commune, China).*

Some persons are buying Dong Feng Tractors with the help of Development Bank loans, but it is up to the buyer to arrange this. Not all persons or groups will be qualified.

Some of these tractors are being stocked in Lae, but most are held at Kimbe. Delivery is quick, usually only a week or two.

Service is still limited, but this should not be a great problem, as most mechanics will understand how to work on them.

Suggested by: F. Robinson, DPI, Box 2417, Konedobu.  
Konedobu.

Cossul and Co. Private, Ltd.  
123/367 Industrial Area  
Kanpur India

Cable: "Implements"  
Kanpur

Manufacturers of hand and animal powered tools for agriculture. Some products may be suitable for PNG. Reasonable prices but long wait. We know of one firm that has been waiting nearly a year for equipment to be delivered - and the payment was sent with the order!

## SELF-HELP

Glascraft Marine (Qld) Pty. Ltd.,  
499 Adelaide Street, Brisbane. Phone 221 4022.

Two catalogues available, price 50¢ + postage  
Branches at Brisbane, Adelaide, S.A.

Sells: Supplies, special orders, hardware (stainless steel nuts, bolts, screws, wood screws, washers), marine equipment, metal products (sail & power boat fittings) and most marine requirements.

Agents for: Arrow sailboats, Mirror sailboats, Mariner Craft, Hook N.Z. Sails, "Blue Streak" Battens, Canoe Distributors, Champion Spars, Fico Marine, Ronstan Marine, Riley Marine, "Sapphire", Aquameter Instruments, VDO Instruments, Jabscó Pumps, Lawco Conversions, Rolco Conversions, Weatherall Lifejackets, Kopsens - Sydney, Inglis Smith Melb., Epicraft Paints, Dynel Cloth & Tapes, Selleys.

ISEKI Agricultural Machinery Mfg. Co. Ltd.  
1 - 3 Nihonbashi 2 - chome, Chuo-ku  
Tokyo 103, Japan

Tractors 12 - 28 hp., Power Tillers 2-11 h.p., Combine Harvester, Reaper Binder, Rice Polisher, Rice Huller, Thresher, Rice Transplanter, Grain Drier, Grass and Bush cutter, others. Write direct for info.

Kirloskar Brothers Ltd.,  
Export Division,  
Udyog Bhavan, Tilak Rd., Poona 411002, India.

Cable: KIRLOSKAR POONA. Telex No 014-247 KB, PN.

Manufactures pumps and accessories mainly, but also some agricultural machines, including sugar crushers, hand-operated peanut shellers.

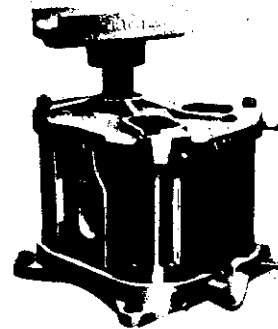

*KUMAR animal-driven sugar crusher. Three vertical rollers, crushes 130 - 150 kgs cane per hour.*

Ransomes, Nacton Works,  
Ipswich, England. IP3 9QG. UK.

A wide range of well-designed agricultural equipment much of it rather specialized or sophisticated, but some items suitable for village use.



Seaside Trading  
117 Union Civica  
Galas, Quezon City, Philippines

This firm is willing to make purchases and arrange shipping to PNG on a commission basis. They have access to Philippine made small tools and equipment such as bush knives, rice harvet-ing knives, water buffalo implements, rice mills, threshers, seeders.

## HOW TO ORDER BY MAIL

Ordering by mail is often the easiest way to get things. Often the companies outside Port Moresby don't have many requests for certain kinds of things and they don't keep them in stock. If you wait for them to order for you it may take a very long time, and will probably cost you more money, too. Your business is losing money if you can't get the things you need for you to be earning money. Ordering by mail is often the best way to get going again. It certainly might save you a long expensive trip.

There are two kinds of mail orders:

(a) The first is when you order by catalogue. Popular catalogues for ordering clothing in PNG are Australian catalogues such as Wynn's and David Jones. Many times though people also want to order from advertisements they see in magazines.

If there is an order blank or a form for sending your order, USE IT! The company has a system to handle the orders it receives. If you use another paper, it can be lost.

Read the order form carefully and give all of the information that they ask for.

They want to know your name. Give them your usual name for receiving mail.

They want to know your address. Give them your full address for receiving mail. Don't forget on an overseas order to include

'Papua New Guinea' as part of your address.

For each item that you want to order from a cata-  
logue there will be a code number. Usually this is on the line right next to the price. For each item you order you must write the order number. Also you should write the name of the article you want to buy. There is a space in the order blank.

Next there is a space for how many you want to buy. Write the number even if it is only 1.

If you have a choice of colour or size, be sure to write the proper size or colour you want. Let them know your second choice, too. If the company is out of the one colour that you want, then they can send

you another one that you will like almost as much. Write the price in the space provided and the weight of the thing you are buying.

All of these things are important, because people who work in these companies processing your order are not very smart. They only go by what you write in the proper spaces and they won't guess what you want.

The hardest part is to add all the weights of the items you want to buy and then figure how much extra money for postage you must send. Sea mail from Australia takes 6-8 weeks, and sometimes more if there is an industrial action somewhere (these are very common in Australia, you know). Air mail is quickest, but is much more expensive. You must choose how much you are willing to spend for having the item quickly.

Send your money with the order. It is best to send a bank draft, a cheque, or a money order. Don't forget that now that PNG is independent, other countries will prefer a bank draft in their own currency from one of the banks in PNG.

Send this with the order. There are no dinaus or credits in mail order business unless you make arrangements first.

If your arithmetic isn't as good as it used to be, ask a friend who can do arithmetic well to check your numbers. It is very hard to wait a long time for a thing you have ordered and then have a letter come to say that they won't send it unless you send ten cents more!

(b) The other kind of ordering is for things that you don't know the price of, like spare parts, books, materials for building, etc.

Unless you have an account with a company, ALWAYS write to them first to ask the cost of the item and for them to tell you the cost of postage or freight to have it sent to you.

Give them complete information about what you want to buy. For example, if you are buying a book, give the name of the book, the author, the company that published the book and the year it was published. This way you will get the right book!

If you are ordering spare parts ALWAYS give the serial number and the name of the machine you are getting the parts for. Then get the part number and the name of the part. For example, if you want a head gasket for your utility, write the name of the utility, for example "Toyota Stout 2000." AND BE SURE TO GIVE THE SERIAL NUMBER. Even though the name of the machine may be the same the company may have made some changes. If you give the serial number, the parts man in the company can give you the right part for your machine by checking the serial number.

When you know the price, send your order with the money required. Be sure to send the money safely: use a cheque, a money order, or registered mail to send cash. If the letter is lost or stolen, then you won't lose your money.

## HOW TO PLACE AN OVERSEAS ORDER

Many of the books and plans listed in the Liklik Buk are not easily available in PNG, except as reference books in libraries or homes. It is often difficult to get a copy for yourself. The Liklik Buk Information Centre can duplicate copies in its own files for the cost of the duplicating.

For books, you can place an order with one of the book stores in PNG, but they will not handle orders for small pamphlets because of the high clerical costs.

It is often very hard to order from foreign countries and sometimes very expensive. It seems that the present system in PNG is designed to prevent the little man from making a small international purchase.

Now that PNG is independent and has its own money you cannot send PNG money or cheques overseas. You cannot buy a money order for overseas the way it was once possible.

The only approved way is to buy a bank draft in a foreign currency from a Bank in a major centre, but not at an agency or a branch. The cost of these drafts is prohibitive for a small order. The charge for each draft is K1.00 plus 6 toea duty stamp. For a small book or a pamphlet, this can be many times the cost of the book itself.

It is illegal to use another way under the current exchange controls. Only authorized Banks can change foreign currency. But sometimes a friend who has a cheque account in his own country will write a small foreign currency cheque to pay for the order and you can make him a gift of the equivalent in Kina & Toea. United States Dollar cheques are the most useful since they are widely accepted in many countries.

There really ought to be another way for making small foreign currency transactions to get books and magazines and pamphlets. International money orders can be bought in other countries but not in PNG. For small amounts there should be a simpler and cheaper way, so that this kind of information can reach as many people as possible.

## PNG MAPS

The only source for maps of all types in PNG is the National Mapping Bureau. All maps which are on file are available to the public at a charge. Aerial photographs of many areas are also available.

If you wish copies of maps of particular areas, write to: Superintendent of Mapping,  
National Mapping Bureau,  
Box 5665,  
Boroko Telephone 271463.

In your request for maps tell the place of major

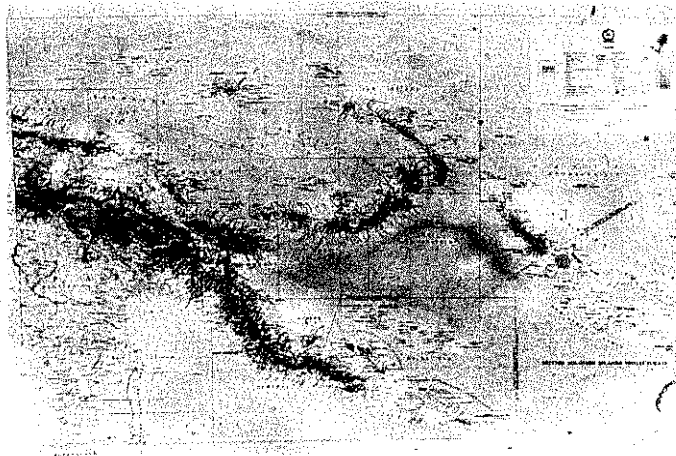

interest, how much surrounding area is important to you, and the scale of the map that you want.

Scales available are generally 1:25,000, 1:50,000, and 1:100,000. The most detailed maps are the 1:25,000.

These maps cost 50t a copy, but it may take two or three maps to cover the area that interests you. The Superintendent will tell you how many maps you will require.

Maps of townships are available in 1:10,000 at a cost of 80t, and aerial photographs at a scale of 1:30,000 are also available at a cost of K1.50 per photo.

Unfortunately there is no catalogue or register of maps available, but there is one in preparation.

Initial contributor: J. Van Af, Box 5665, Boroko.

PNG Bureau of Statistics, P.O. Wards Strip,  
Port Moresby.

A Catalogue is available listing publications containing statistics on PNG: Serials; Irregular publications; and Monographs. A helpful index is included with a broad range of subject headings. A charge is made for publications.

## METRIC CONVERSION

Papua New Guinea uses the International System of Units, and this is the only legal system of measure in the country. Many people still are used to the Imperial System and find it hard to change.

Centimetres (cm) are not listed as a unit of measure in the International System of Units. You are supposed to use millimetres (mm). A piece of wood is no longer a 3 x 1 but is now a 75 x 25. In agriculture, lengths commonly used would be in very big numbers if we used millimetres. So, we often use centimetres (for example, 90cm instead of 900mm);

## MAKING THE CHANGE EASY

Learn to "think metric". If you continue to work by using conversion factors you will need a pencil and pad as a permanent companion. Better to banish the concept of imperial measurements and substitute metric concepts. The following will help:

10 millimetres	(equal to 1 centimetre)
10 centimetres	about four inches
1 metre	a long pace (a little more than a yard)
1 kilometre	1000 metres (a little more than half a mile)
10 square metres	about 12 square yards
1 hectare	= 10 000 square metres (about two-and-a-half acres)
50 grams	a little less than two ounces
500 grams	a little more than one pound
1 tonne	= 1000 kilograms (a little less than one ton)
500 millilitres	a little less than one pint
1 litre	about one-and-three-quarter pints
200 litres	the volume of a 44-gallon drum.



### MEASUREMENTS (USING THE BODY) AND OTHER COMMON REFERENCES.

Often when you want to measure something you find that you have left your ruler behind. One ruler that you can't lose is yourself. Different parts of your body can be conveniently used as a ruler. These measurements may be a little different for different people. Here are some typical measurements for one person. You can check your own. If you don't need to be exact these will give you a close measurement.

3-4 cm	The distance from the tip of your thumb to first knuckle.
8 cm	The distance across your hand at the widest part of four fingers.
10 cm	The distance across a flat hand including the thumb.
20-22cm	The distance from your thumb tip to the tip of your little finger when stretched as far apart as possible.
25 cm	The length of a bare foot, heel to big toe.
45 cm	The distance from elbow to tip of longest finger. Often you can estimate this as half a metre (50cm)
1 metre	The distance of a long pace. This distance is slightly longer than a step when walking comfortably. Measure out metre lengths for about 20 metres with chalk on concrete. Practice walking so that your toe always hits the metre mark. Soon your body will learn the feel of a metre step. This is particularly useful if you need to measure the side of a garden, or the length of a fence.

Properly used these measurements will give you within 10% of the actual distance. This is close enough for most agricultural requirements.

1 fish tin holds about  $\frac{1}{2}$ kg (500 g) of fertilizer, salt, sugar.

1 bottle cap holds 3 cc when level.

The wood of a matchbox cover is approx. .50mm (Suitable to check the gap for spark plugs or contact points in an emergency. (A hacksaw blade is approx. 0.030", or 0.76 mm.)

We declare our first goal to be for every person to be dynamically involved in the process of freeing himself or herself from every form of domination or oppression so that each man or woman will have the opportunity to develop as a whole person in relationship with others.

We accordingly call for:

1. Everyone to be involved in our endeavours to achieve integral human development of the whole person for every person and to seek fulfilment through his or her contribution to the common good; and
2. education to be based on mutual respect and dialogue, and to promote awareness of our human potential and motivation to achieve our National Goals through self-reliant effort; and
3. all forms of beneficial creativity, including sciences and cultures, to be actively encouraged; and
4. improvement in the level of nutrition and the standard of public health to enable our people to attain self fulfilment; and
5. the family unit to be recognized as the fundamental basis of our society, and for every step to be taken to promote the moral, cultural, economic and social standing of the Melanesian family; and
6. development to take place primarily through the use of Papua New Guinean forms of social and political organization.

from the Preamble of the P.N.G. Constitution

ORDER FORM

WANTOK PUBLICATIONS  
BOX 1982  
BOROKO

The LIKLIK BUK is just what I need. I can't get it at my nearest bookstore. Please send me \_\_\_\_\_ copies.

NAME \_\_\_\_\_  
ADDRESS \_\_\_\_\_  
CITY/TOWN \_\_\_\_\_  
STATE/PROV. \_\_\_\_\_  
COUNTRY \_\_\_\_\_ POSTCODE \_\_\_\_\_

ORDER FORM

WANTOK PUBLICATIONS  
BOX 1982  
BOROKO

The LIKLIK BUK is just what I need. I can't get it at my nearest bookstore. Please send me \_\_\_\_\_ copies.

NAME \_\_\_\_\_  
ADDRESS \_\_\_\_\_  
CITY/TOWN \_\_\_\_\_  
STATE/PROV. \_\_\_\_\_  
COUNTRY \_\_\_\_\_ POSTCODE \_\_\_\_\_

NOTES FOR CONTRIBUTORS

We invite readers to send us articles for the next edition of LIKLIK BUK. If your article is accepted or makes a substantial change in an existing article you will receive a free copy of the edition in which your contribution first appears. However, if you submit more than one article you will receive only a single copy.

We don't try to tell everything about everything, although for very short or very important subjects we will be somewhat complete. It is the purpose of the LIKLIK BUK to tell enough about something to help a person decide if it is suitable for him. For further information he should seek out the references and contacts listed in the article.

We want articles about things that have been tried in PNG, and we do accept articles about things that have been tried, but don't work. Failure is useful information too, to warn the person who comes behind. If you make a contribution we expect that you have tried it, or at least have participated in a trial. Don't think that we want only "new" technology;

POSTPAID PRICES FOR 1977 LIKLIK BUK

Papua New Guinea

Orders of 1 - 15 copies K3.00 each  
16 - 119 copies 2.50 each  
120 or more copies 2.20 each

Overseas single copy price

	Surface mail	Airmail
Asia and Oceania	K4.00	K6.00
Rest of the world	5.50	9.00

Please make payment by bank draft in PNG Kina.  
Overseas Bulk Orders  
Special rates. Write for more information.

ORDER FORM

WANTOK PUBLICATIONS  
BOX 1982  
BOROKO

The LIKLIK BUK is just what I need. I can't get it at my nearest bookstore. Please send me \_\_\_\_\_ copies.

NAME \_\_\_\_\_  
ADDRESS \_\_\_\_\_  
CITY/TOWN \_\_\_\_\_  
STATE/PROV. \_\_\_\_\_  
COUNTRY \_\_\_\_\_ POSTCODE \_\_\_\_\_

traditional methods that are not generally known in PNG are also wanted.

Untried items that are simply pulled out of someone's fertile imagination or from some foreign publication will be excluded.

**BE BRIEF.** Use an outline given below. The outlines will help you to remember the important points to help the person who reads your article. Sometimes subjects can't be expressed in just the outline. We know that. Add what you feel is important. But try to include the minimum. We find that nearly every article in LIKLIK BUK will fit one of these outlines.

We also welcome essays or editorials on matters of nationwide importance about the use of technology and resources. The social and cultural as well as technical aspects of technology must not be forgotten. Again, please try to be brief.

Here are some outlines. When you have completed your contribution send it to the Editor, LIKLIK BUK, Box 1920, Lae, PNG.



OPS - Use this outline for trees, vegetables, (traditional & introduced) and cash crops.

name: English/Pidgin/Motu

Description:

- 1 Botanical name
- 2 Height
- 3 Age to first production
- 4 Normal life span
- 5 Major pests and control
- 6 Major diseases and control.
- 7 Indication of maturity
- 8 Altitude limits in PNG

Planting Information & spacing  
Useful Products

- 1 Village level
- 2 Industrial level

Sources of supply of planting material & costs

Sources of supply of related tools or equipment & cost

Further references (include publisher, price, place to order)

Locations and results of PNG experience (include names & addresses of contacts)

Remarks: any extra information that you think will help the reader, or that doesn't fit this outline

Your name and address

IVESTOCK - Use this outline for animals, birds or insects.

name: English/Pidgin/Motu

Description:

- 1 Scientific name
- 2 Weight at full growth
- 3 Age at first production
- 4 Normal life span
- 5 Major pests and control
- 6 Major diseases & control
- 7 Breeds available in PNG
- 8 Altitude limits in PNG

Feeding

Housing, if required

Breeding, birth & handling of young (include mating cycle & period of gestation)

Useful products

- 1 Village level
- 2 Industrial level

F. Sources of supply of breeding stock and cost.

G. Sources of supply of related tools and equipment and cost

H. Further references (include publisher, price and place to order)

I. Locations and results of PNG experience (include name and addresses of contacts)

J. Remarks: any extra information that you think will help the reader, or that doesn't fit this outline

K. Your name and address

PROCESS - Use this outline for how-to-do things such as recipes, crop processing, or product utilization. Can also be used for techniques.

Name: English/Pidgin/Motu

A. List materials or facilities required

B. List ingredients required and amount of each

C. Description of process (Give quantitative measurements such as times, temperatures, frequencies etc)

D. Sources of supply of materials and ingredients and cost

E. Further references (include publisher, price and place to order)

F. Locations and results of PNG experience (include names and addresses of contacts)

G. Remarks: any extra information that you think will help the reader or that doesn't fit this outline

H. Your name and address

DESIGN - Use this outline for tools equipment, patterns and plans.

Name: English/Pidgin/Motu

A. Brief description of item and its purpose

B. Material list, including quantities, & approximate total cost

C. Simple design drawing and/or photo

D. Description of order of work

E. Sources of supply of materials

F. Further references (include publisher, price and place to order) Source of detailed plans if available

G. Locations & results of PNG experience (include names and addresses of contacts)

H. Remarks: any extra information that you think will help the reader, or that doesn't fit this outline

I. Your name and address

SUPPLIERS - Use this outline for information about organizations and companies to get things.

A. Name of Company/Organization

B. Address

C. Telephone

D. Cable address

E. List of materials, services or supplies

F. Is a catalogue available? Price?

G. Quality of service

H. Your name and address

BOOKS - Use this outline for books, pamphlets, or magazines you recommend.

A. Title

B. Author

C. Publisher

D. City

E. Price

F. Is it available in PNG? Where?

G. Statement of subject of publication

H. Evaluation: Good? Bad? Relevant?

I. Level: Simple, intermediate, or advanced

J. Your name and address

Please send us a copy of any photographs that you have to illustrate your contribution. We would like to keep the photo for the permanent files of the LIKLIK BUK CENTRE.

Below is an example of an ideal article for a contribution. As an illustration, we use a fictitious tree crop.

## WOMPOM

KARUK (Pidgin) PLAT (Motu)

The Wompom Fruit (*Hysopia sagittarius* L.) is a viney shrub that grows to 90 metres. It is grown in village gardens and as a shade tree for dodad trees.

Planting Guide: 20 metres by 20 metres, grown from seedlings and planted out at 6 months.

Useful products: The fruit can be eaten raw, or can be cooked to prepare a nutritious meat substitute "Wompom Steak". The skin of the Wompom can be processed into belting leather. Leaves contain resins suitable for water-resistant glues. The wood of the trunk is very hard and can be used to manufacture wood products requiring flexibility, such as bows, whips for caning children, and wireless antennas. Industrial uses: petrol additives (from the bark) printing ink (leaf), grinding polish (fruit pits) and all forms of shrink-proofing of haplon cloth (sawdust extraction).

Botany: The tree begins to produce 8 months to 40 years after planting and will live for 2 to 98 years. Fruit harvests are about 8 kg to 7 tonnes per tree. Ripe fruit is indicated by 5/6 of the fruit turning bright black and separating from the stem with a gentle tug. The tree will ratoon when cut. Minimum temperature for growth is 78°C.

Diseases: Wompom is susceptible to polio and malaria, but can only be controlled by severe pruning of infected parts.

Pests: Whales and gold bugs are pests recorded in the literature. Whales should be carefully picked off the tree and the gold bug, which eats leaves, is usually controlled by lighting a large bon fire under the tree to burn the bugs. People in the coast of Chungu Province know how to work magic to get rid of the bug.

Sources of supply: Seeds are available from Toot Bryan and Seashipps, packed in special tropical packs. Clonal cuttings are available from the Coastal Agricultural Experiment Station in Goroka.

Further information: Grow Good Wompom (pidgin and motu) DOSF free; Botany and Agronomy of the Wompom, Hutchins, Old Delhi University Press, US\$125.00

Remarks: Mr. Dinggaan Molekila at Dingle PTS in Lip Province says he has used the small branches to reinforce cement for a 110 foot clear span pre-stressed concrete bridge. Fr. Henry Sharp at Able Seminary says that when he first came to New Guinea in 1928 an old German Priest told him that he saw people using the leaf buds on sores to cure tropical ulcers, and Henry Tulili of Kaugere says he was able to make a replacement ktingpin for his 1927 Holden when spares were unobtainable.

Initial contributor: Simon Peter Rock, Kavieng.

EDITOR'S NOTE: We're not sure how this got in here. Please use your own careful judgment about some of the strange information included in Liklik Buk.



The irresponsible use of new technologies is an ever present danger in any society.

Treat technology and societies with the respect that they deserve.

*Tanget and kawawar are traditional warnings of prohibition. The use of kawawar warns of magical or extremely powerful forces behind the warning.*

## THANK YOU!

To our families, not only for patient acceptance of several months of chaos and confusion, but also for helpful criticism, articles, photos, advice.

To the Liklik Buk Committee, for sound direction and enthusiastic cooperation.

To the contributors of articles and references, whose names are listed under their items. Their increased participation has made it possible to double the size of Liklik Buk.

To Heather Gerard, who patiently typed practically everything in the Buk - most of it twice!

To WANTOK Publications, especially Fr. Kevin Walcott and Fr. Francis Mihalic, for encouragement, advice, photos, materials.

To friends who have given more than the usual interest and support: Mike Bourke and colleagues at LAES Kerevat, Jean Kekedo and the Village Development Office, the Forests Office, Lae, and the Division of Botany, Lae.

To Alan Inversin for giving many hours in proof-reading, and for helpful criticism and comments.

To Jack Lowson and his architecture students at Unitech for substantial help in preparing illustrations.

To the Catholic Church community, Wewak, for making us a part of the family while we were in our final, long days of editing, and to Brother Bernhard and Wirui Press for being so patient and pleasant to work with.

To Christian Aid of England for the grant which makes possible a Liklik Buk Information Centre.

To those firms which have contributed towards the production costs of this edition of the Liklik Buk: Angco Pty Ltd, Agquip, Harry Heath and Co, Sohi Gil-senan Pty Ltd, John Lysaght (PNG) Pty Ltd, New Guinea Pastoral Supplies Pty Ltd, Plantation Supply and Service Co Pty Ltd, Ross Engineering.

The Editors

## PHOTO CREDITS

J. BEKKER: 152; R.M. BOURKE: 1 (lower l), 9, 20, 19 (lower l); 22 (r), 37 (lower r);  
 D. ELLINGSON: 65, 68 (upper l); 165 (upper r);  
 J. ENG: 120; J. HALE: 62, 72; A. INVERSIN: 129, 163 (lower r); LAES, KEREVAT: 57 (l), 68 (r);  
 D. MORGAN: 84; ONWARD MAGAZINE: 89, 140;  
 PATI: 76, 77 (l), 78, 79, 178 (lower l); POST & TELEGRAPHS: 227; R. RAMASO: 161; WANTOK PUBLICATIONS: 50, 74, 90, 95, 105, 121, 124, 135, 175 (lower r), 190, 208, 210, 213 (lower l), 267;  
 P. WILLIAMS: 73, 217. All others by Liklik Buk

## METRIC UNITS FOR EVERYDAY USE

Quantity	Metric unit and symbol	Conversion Factors (Approximate)	
		Imperial to Metric Units	Metric to Imperial Units
<b>Length</b>	millimetre (mm)	1 in = 25.4 mm	1 mm = 0.0394 in
	centimetre (cm, 10 mm)	1 in = 2.54 cm	1 cm = 0.394 in
	metre (m, 100 cm)	1 ft = 30.5 cm	1 m = 3.28 ft
	kilometre (km, 1000 m)	1 yd = 0.914 m 1 mile = 1.61 km	1 km = 0.62 mile
<b>Mass (commonly called "weight")</b>	gram (g)	1 oz = 28.3 g	1 g = 0.0353 oz
	kilogram (kg, 1000 g)	1 lb = 454 g	1 kg = 2.2 lb
	tonne (t, 1000 kg)	1 stone = 6.35 kg	1 kg = 0.157 stone
		1 ton = 1.02 t	1 t = 0.98 ton
<b>Area</b>	square centimetre (cm <sup>2</sup> )	1 in <sup>2</sup> = 6.45 cm <sup>2</sup>	1 cm <sup>2</sup> = 0.155 in <sup>2</sup>
	square metre (m <sup>2</sup> , 10 000 cm <sup>2</sup> )	1 ft <sup>2</sup> = 929 cm <sup>2</sup>	1 m <sup>2</sup> = 10.8 ft <sup>2</sup>
		1 yd <sup>2</sup> = 0.836 m <sup>2</sup>	1 m <sup>2</sup> = 1.2 yd <sup>2</sup>
		1 perch = 25.3 m <sup>2</sup>	1 ha = 9.88 roods
	hectare (ha, 10 000 m <sup>2</sup> )	1 acre = 0.405 ha	1 ha = 2.47 acres
	square kilometre (km <sup>2</sup> , 1 000 000 m <sup>2</sup> , 100 ha)	1 mile <sup>2</sup> = 2.59 km <sup>2</sup>	1 km <sup>2</sup> = 0.386 mile <sup>2</sup> = 247 acres
<b>Volume</b>	cubic centimetre (cm <sup>3</sup> )	1 in <sup>3</sup> = 16.4 cm <sup>3</sup>	1 cm <sup>3</sup> = 0.061 in <sup>3</sup>
	cubic metre (m <sup>3</sup> , 1 000 000 cm <sup>3</sup> )	1 ft <sup>3</sup> = 28 300 cm <sup>3</sup>	1 m <sup>3</sup> = 35.3 ft <sup>3</sup>
		1 yd <sup>3</sup> = 0.765 m <sup>3</sup>	1 m <sup>3</sup> = 1.31 yd <sup>3</sup>
		1 bushel = 0.0364 m <sup>3</sup>	1 m <sup>3</sup> = 27.5 bushels
<b>Volume (liquids and gases)</b>	millilitre (ml)	1 fl oz = 28.4 ml	1 ml = 0.0352 fl oz
	litre (l, 1000 ml)	1 pint = 568 ml	1 litre = 1.76 pints
	kilolitre (kl, 1000 l, 1 m <sup>3</sup> )	1 gal = 4.55 litres	1 kl = 220 gal
<b>Time interval</b>	second (s)		
	minute (min, 60 s)		
	hour (h, 60 min)		
<b>Speed</b>	kilometre per hour (km/h)	1 mph = 1.61 km/h	1 km/h = 0.621 mph
<b>Pressure</b>	kilopascal (kPa)	1 psi = 6.89 kPa	1 kPa = 0.145 psi
<b>Pressure (for meteorology)</b>	millibar (mb, 0.1 kPa)	inch of mercury = 33.9 mb	1000 mb = 29.5 inches of mercury
<b>Energy</b>	kilojoule (kJ)	1 Btu = 1.06 kJ	1 kJ = 0.948 Btu
		1 kilocalorie* = 4.19 kJ	1 kJ = 0.239 kilocalorie
	megajoule (MJ, 1000 kJ)	1 therm = 106 MJ	1 MJ = 0.009 48 therm
		1 therm = 29.3 kWh	1 kWh = 0.034 therm
		1 "gas unit" (1 kWh) = 3.6 MJ	1 MJ = 0.278 kWh = 0.278 "gas unit"
<b>Power</b>	kilowatt (kW)	1 hp = 0.746 kW	1 kW = 1.34 hp
<b>Temperature</b>	degree Celsius (°C)	$^{\circ}\text{C} = \frac{5}{9} (^{\circ}\text{F} - 32)$ $^{\circ}\text{F} = \frac{9}{5} ^{\circ}\text{C} + 32$	

\* kilocalorie, commonly called "Calorie" is a non-SI metric unit

See Article "Metric Conversion" (p 266)  
and "Measurements" (p 267)

CENTIMETRES



