

Warsaw Pact Ground Forces



GORDON L. ROTTMAN
Colour plates by RON VOLSTAD

Published in 1987 by
Osprey Publishing Ltd
Member company of the George Philip Group
12-14 Long Acre, London WC2E 9LP
© Copyright 1987 Osprey Publishing Ltd

This book is copyrighted under the Berne Convention. All rights reserved. Apart from any fair dealing for the purpose of private study, research, criticism or review, as permitted under the Copyright Act, 1956, no part of this publication may be reproduced, stored in a retrieval system, or transmitted in any form or by any means, electronic, electrical, chemical, mechanical, optical, photocopying, recording or otherwise, without the prior permission of the copyright owner. Enquiries should be addressed to the Publishers.

British Library Cataloguing in Publication Data

Rottman, Gordon L.
Warsaw Pact Ground Forces.—(Elite series: 10)
1. Europe, Eastern—Armed Forces
I. Title II. Series
355'.00947 UA646.8

ISBN 0-85045-730-0

Filmset in Great Britain
Printed through Bookbuilders Ltd, Hong Kong

Artist's Note

Readers may care to note that the original paintings from which the colour plates in this book were prepared are available for private sale. All reproduction copyright whatsoever is retained by the publisher. All enquiries should be addressed to:

Ronald B. Volstad
P.O. Box 1577
Main Post Office
Edmonton
Alberta
Canada T5J 2N9

The publishers regret that they can enter into no correspondence upon this matter.

Acknowledgements

The author gratefully acknowledges the invaluable assistance of many individuals and organisations during the preparation of this book. Special thanks go to Steven J. Zaloga for his assistance in providing information and photographs. The efforts of Beryl Barnett Jr. in providing photograph sources and many of the more interesting colour plate insignia and equipment details, and Ken Atkin's photographic reproduction work, are greatly appreciated. He would also like to thank the US Army Forces Command Opposing Force Training Detachment; the Recognition Division of the International Long Range Reconnaissance Patrol School, West Germany; and his friends in the Danish Army *Jaegerkorpset*. Above all this book would not have been possible without the editorial and supportive abilities of the author's wife, Enriqueta.

Photo/illustration credit codes:

AR = *Armeerundschau* (Army Review—East German Army magazine)
DIA = US Defense Intelligence Agency
GPO = US Government Printing Office
ILRRPS = International Long Range Reconnaissance Patrol School
JGK = Danish Army *Jaegerkorpset*
KAW = *Krajowa Agencja Wydawnicza* (Home Publishing Agency, Poland)
MVDDR = *Militarverlag der Deutschen Demokratic Republic* (Military Publisher of East Germany)
OPFOR = US Army Forces Command Opposing Force Training Detachment
UBKWPS = *Uniformen der Bewaffneten Kraft der Warschauer-Pakt-Staaten und Jugoslawiens* (West German)
VA = *Volksarmee* (People's Army—East German Army newspaper)
ZAP = *Zapismik* (Czechoslovak Army magazine)

Warsaw Pact Ground Forces

Introduction

While much has been published on the armed forces of the Union of Soviet Socialist Republics (USSR), little is available on the forces provided by the other member nations of the Warsaw Pact (WP). These forces should not be taken lightly, as they represent a substantial military potential. The combined ground forces of the six non-Soviet Warsaw Pact (NSWP) countries total over 775,000 active troops, rivalling the United States' 781,000-man Active Army. They also maintain almost two million ground forces reserves. These figures do not include the air forces, naval forces, and the many internal security and border forces.

In recent years there has been much conjecture on the military potential and reliability (in the eyes of the Soviets) of the NSWP forces, but little information is available about the troops and units. This book will attempt to provide information on the historical background, origins, strength, organisation, order of battle, terms of service, reserves and mobilisation, internal security forces, and possible combat effectiveness of the forces of each of these nations. A study of WP special operations forces (airborne, diversionary, mountain, naval infantry) can be found in *Elite 5, Soviet Bloc Elite Forces*.

The Rôle of the Warsaw Pact

The official designation of what is commonly referred to in both the East and West as the Warsaw Pact is the 'Agreement on Friendship, Co-ordination, and Mutual Assistance'. The agreement was signed on 14 May 1955 in Warsaw by the USSR, Albania, Bulgaria, Czechoslovakia, German Democratic Republic (East Germany—DDR), Hungary, Poland, and Romania¹. Shortly thereafter it was given the additional title of the

'Warsaw Pact' for sake of brevity. A period then took place where each of the signators made bilateral treaties with each other and concluded in 1957. The DDR, Hungary, Poland, and Romania each made additional agreements with the USSR permitting the stationing of Soviet troops in their countries. Even without the existence of the WP the Soviet forces would remain in these countries and would be unimpaired by its dissolution due to the 1945 Potsdam Agreement signed by the Allies (US, UK, USSR, France).

The signing of the Warsaw Pact treaty was, in effect, the Soviet Bloc's reply to the admission of the Federal Republic of Germany (West Germany—BRD) into the North Atlantic Treaty Organisation (NATO) ten days before the formal signing of the Warsaw Pact treaty. The actual purpose of the WP, which had been planned well in advance, was to act as a counter to NATO, in existence since August 1949. It was also to provide the machinery by which the USSR could formally control the Eastern



Some idea of the size of the area covered by the Warsaw Pact may be gained from the distances of the various capitals from Moscow. (GPO)

¹Yugoslavia is not a member of the WP even though it is a Communist state and its forces primarily equipped with WP material. It maintains a neutral status, and has trade ties with both East and West.



A typical posed photo portraying the brotherhood of the WP states. The five soldiers in the foreground are (left to right) an East German, a Hungarian, a Czechoslovak paratrooper, a Bulgarian, and another Hungarian. (OPFOR)

European armed forces, transmit its foreign policy, and exercise political control. Economic, transportation, and energy control is provided through another Soviet-dominated organisation, the Council of Mutual Economic Aid (COMECON), of which all WP countries are members.

The Pact was to remain in effect for 20 years. It would automatically be extended for another ten years if no member state announced its intent to withdraw within the one year required prior to the twentieth anniversary. The 20-year period ended in 1975 with no such intent being declared. The ten-year period ended in May 1985, and the Warsaw Pact agreement was extended another 20 years.

The WP has not been without its problems, with most being provided by the 'brother' states. In 1956 the Hungarian Revolt broke out when the government demanded that the USSR withdraw its troops from Hungarian soil, and stated that it would withdraw from the WP to become a neutral country. The USSR brutally crushed the revolt and installed a new government, all the while using the Warsaw Pact as 'legal' justification. In 1958 Romania withdrew from its agreement to permit the stationing of Soviet troops on its soil, and ceased to take part in WP exercises. Beginning in 1960, Albania ceased to take part in any WP activities, becoming formally inactive in 1962, and at that time beginning to adopt the ideology of Communist China. In 1965 the USSR attempted to establish a non-aggression pact between the WP and NATO, looking toward the dissolution of both organisations. (The former WP countries would, of

course, have remained under Soviet control, while the Western European countries would have been without central organisation. The United States armed forces would certainly have been withdrawn, leaving the front door to the West wide open.) This effort failed. Czechoslovakia attempted in 1968 to form a 'socialist democracy' which was counter to the aims of the WP and COMECON. Soviet and other WP forces invaded the country later in the year in order to restore a pro-Soviet government and 'return an errant brother state to the fold'. Albania, inactive in the WP for the past eight years, formally withdrew from the treaty in protest at the invasion.

The WP has since had no major upheavals, and its 30th anniversary saw the ratification of the treaty for another twenty years; but the Pact is not without its internal political and economic problems. Pact forces have been used as surrogates of the USSR in many parts of the world to advance its political and military goals. Not only is the WP a military force with its efforts directed towards NATO and other nations, but it is used by the USSR to maintain its domination over those same member states. For discussion's sake, the NSWP forces are divided into the Northern Tier with the more modernly equipped forces of the DDR, Czechoslovakia, and Poland; and the Southern Tier of Bulgaria, Hungary, and Romania.

Organisation of the Warsaw Pact

The WP is totally dominated and controlled by the USSR at all levels. Its organisation is complex, as it serves to integrate the member states' forces into the overall Soviet Armed Forces. There is no combined standing WP army. The USSR has twice attempted to achieve this goal, in 1956–57 and 1967–68, but both efforts failed due to opposition from the NSWP states. They feared that their troops might be deployed in support of purely Soviet adventures, e.g. on the Chinese border or in Afghanistan. The Soviets do maintain 'advisers' to varying degrees in all the NSWP armed forces, with the exception of Romania.

The highest level control organ of the WP is the

There is also a small Committee for Training, which administers and standardises some aspects of training.

Unit organisation

Within the WP all armed forces subordinate to the ministry of national defence (MoND) are referred to collectively as the 'army'. The 'army' consists of the 'ground forces' (or what in the West is traditionally thought of as the 'army'); the 'naval forces' (not possessed by Czechoslovakia or Hungary); and the 'air force/air defence force'. The latter 'branch' contains both the air force in the normal sense (including helicopter units intended to support the ground forces), and ground-based air defence forces (SA-2 and -3 surface-to-air missiles, anti-aircraft guns, and air warning radar) dedicated to national air defence, as opposed to 'army' air defence units assigned to troop formations.

Divisions and most other units subordinate to higher headquarters are referred to as military districts. These are organised on a regional basis, with each country having two or three. They may be numbered or bear a regional name. In time of war these headquarters will in most cases provide combined-arms army headquarters under Soviet *Front* level command rather than national control. There is much speculation and argument as to whether these national armies will be permitted to remain 'pure'—that is, made up of solely national units—or if they will be integrated with Soviet formations. WP forces do not use the corps as an intermediate level of command between divisions and an army. A WP army consists of from three to

five divisions plus numerous combat support and service support brigades/regiments and battalions.

Outwardly the organisation of NSWP divisions and other major units generally parallels those of the Soviet Ground Forces. Command echelons above division, divisional subordinate units, and non-divisional units will often be found with slightly different internal organisation. Major differences will also be found in the type and density of weapons, vehicles, and equipment. This is particularly true among the Southern Tier forces, with older model tanks, towed artillery rather than self-propelled, more anti-aircraft guns than missiles, and limited numbers of armoured personnel carriers (APC), with many motorised rifle units relying on truck transport.

The motorised rifle (MR) and tank (referred to as 'armour' in DDR and Poland) divisions are the principal combat or operational formations within the WP. The two are similarly organised, the major difference being the mix of types of combat regiments. The NSWP divisions have not undergone the reorganisation recently undertaken by the forward-deployed Soviet divisions.

Within the WP the MR division is the most common type, and is primarily intended to accomplish a breakthrough of enemy lines. The organisation chart on an accompanying page portrays a typical example of an NSWP MR division. The tank division's role is to exploit the breakthrough accomplished by the MR divisions and to attack enemy headquarters, support elements, and reserves in his rear areas. Its organisation is similar to that of the MR division, except that there are three tank regiments, one MR regiment, and no anti-tank battalion. Divisional combat regiments (MR and tank) are likewise similarly organised and contain scaled-down combat support and service support sub-units¹, in effect making them small divisions. A typical NSWP MR regiment organisation chart is also shown herewith. A tank regiment has the same organisation, but with three tank battalions and no MR or anti-tank sub-units.

Divisional combat support units are intended to

An example of the organisation of a typical WP motorised rifle division. A tank division is similarly organised, but has three tank regiments, only one motorised rifles regiment, and no anti-tank battalion. (DIA)

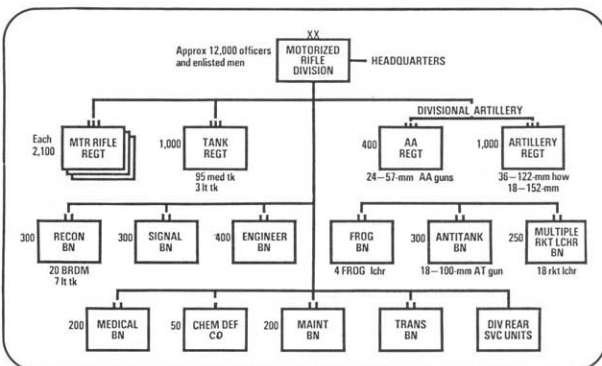

¹Within the WP, sub-units are elements subordinate to larger units, i.e. separate battalions, regiments, and brigades. It includes battalions organic to regiments/brigades, companies/batteries, platoons, sections, and squads.

provide immediate support to the division's combat regiments conducting the main attack. Additional combat support elements may be allocated from army level troop units. WP divisional service support units are rather lean, providing only limited essential support. The burden of service support is born primarily by army level units, thus allowing the divisional staff to concern itself with fighting the division.

The only other types of NSWP divisions are the small Polish air assault and naval assault divisions, and possible wartime-mobilisation Czechoslovak and Romanian artillery divisions. The Bulgarians have tank brigades rather than divisions.

Army level combat support units are plentiful. They are normally of brigade or regimental size. Either term may be used depending on a given country's practice, and they are of similar size, containing two to four battalions depending upon type. Most air defence regiments have five firing batteries, with no intermediate battalions, and some types of brigades may contain regiments. Each country's ground forces contain a varied number of artillery, rocket (SCUD), air defence (surface-to-air missile, anti-aircraft gun), engineer (combat, pontoon, construction, railroad, pipeline, etc.), signal, and electronic warfare brigades/regiments and battalions. Most (but not all) non-divisional air defence missile units will be under air force/national air defence force control.

Non-divisional service support units are usually under army level and/or national ground forces control. These include maintenance, motor transport (also handles supply in most countries), medical, supply, technical, and chemical defence battalions and brigades/regiments plus various depots, which provide both supply and maintenance support. Some special combat, combat support, and service support units are normally subordinate directly to the MoND.

Combat and combat support unit organisation is rather simple, the units generally having a smaller strength and fewer combat vehicles or major weapons systems than similar NATO units. Battalions normally have three companies/batteries, although some air defence and engineer battalions have more. MR companies have three platoons each with three squads, each carried in an APC or truck—at least in theory—and an

additional vehicle in the company headquarters. Squad strengths vary from seven to ten men armed with one or two light machine guns (PK, RPK, RPD, vz.59), one RPG-7 anti-tank rocket launcher, and the remainder with assault rifles (AK-47, AKM, vz.58, or their many variants). Some forces also have a rifle grenade launcher in each squad. There is sometimes a designated sniper in lieu of one of the platoon's riflemen. Tank companies have three platoons with three tanks each (generally), and a tenth in the headquarters. Platoons may be commanded by a junior lieutenant, an ensign, or senior NCO: few WP forces employ a platoon sergeant. Artillery, multiple rocket launcher, and anti-tank batteries usually have six (occasionally four) tubes/launchers each, while air defence gun and missile batteries have varied numbers of tubes/launchers ranging from four to six systems. FROG rocket artillery batteries have two launchers, and SCUD batteries only one.

Border guard organisations are usually subordinate to their countries' MoND and occasionally to their ministry of interior. In wartime they would supplement the ground forces. Most are organised into brigades/regiments with several battalions. Various other security organisations, such as internal security, territorial defence, and 'people's militia', are usually under their ministry of interior or security, though they are often trained and equipped to some degree by the ground forces. Security forces are often neglected when considering the potential of WP ground forces. They have

Organisation of a typical WP motorised rifle regiment. A tank regiment has three tank battalions and no motorised rifles or anti-tank sub-units. (DIA)

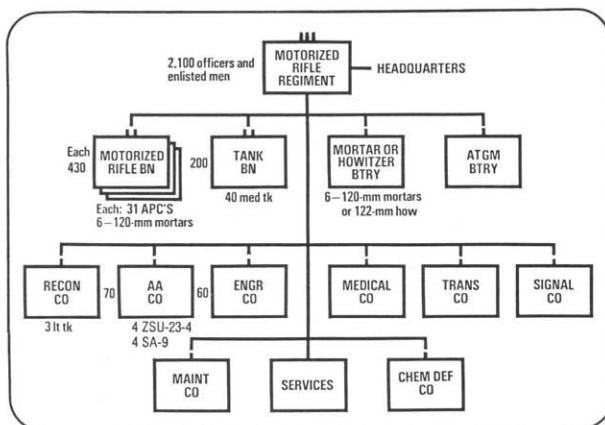

specific wartime missions, may supplement and augment the ground forces, and, if nothing else, would free combat troops from rear area security and similar duties.

Reserves and mobilisation

The almost 2,000,000 combined NSWPF ground force reserves are a substantial force—and do not include those of the air force/air defence forces, naval forces, and the many security, border, and militia forces, each of which maintains significant reserves. Additionally there are millions more who may be recalled until the age of 50 as enlisted men and 60 as officers. These reserves are not always taken into full account by some analysts and strategists. This may be because they are not organised into functional units with organic equipment, as are most Western reserve forces; they appear to be only an unwieldy manpower pool. This is not necessarily true, as their organisation and planned employment are more complex than meets the casual eye. The effectiveness of the different countries' reserve programmes varies throughout, and there are many problems in maintaining viable levels of training, especially in the more technical and leadership fields.

Recruits are conscripted into the WP armed forces twice a year, in spring and autumn, and at the same time those completing their terms of active service are released into the reserves. Other means of obtaining reservists are short-term reserve training courses of only a few months' duration.

Each country maintains two categories, Reserves I and II, based primarily on age and grade. In most cases they must serve up to 12 months on active duty, which is served at irregular intervals over a period of several years. Various training programmes are conducted to maintain the desired (although not always obtained) levels of training. These include refresher training courses, short summer duty periods with troop units, regular call-ups to take part in exercises as unit fillers (usually coinciding with large unit exercises and WP manoeuvres), mobilisation exercises, maintenance of stored equipment, voluntary training with reservists' 'collectives', and technical training and command post exercises for specialists and officers. Most countries keep individuals in the reserves until the age of 50, although officers are usually retained

until 60. Troops are usually passed to Reserve II at age 35.

There are several ways in which reservists can be absorbed into the regular forces. In order to understand this one must be familiar with the structure of active WP units. WP divisions are manned and equipped at three levels: Category A divisions are maintained to at least 90 per cent strength and fully equipped, Category B are at about 75 per cent strength with almost all equipment, and Category C are at about 30 per cent strength, with all major equipment items and the remainder in storage. Category strengths vary between countries and will change from year to year as overall manning levels change. Upon mobilisation, pre-designated reservists will be recalled to bring these divisions up to strength. Some non-divisional units are also organised at reduced strength or are 'under-organised'. As an example of how they would be brought up to strength, an army level anti-tank battalion might be expanded to a regiment by using active personnel as cadres and reservists as fillers, with pre-designated reserve officers and specialists to augment their expertise. An army level artillery regiment or brigade may have a peacetime organisation of only two full battalions, or may have three but with only two batteries each. Upon mobilisation the additional sub-units would be formed by calling up pre-designated reservists. In both examples the required equipment is maintained in storage at the units' depot.

There also exists a capability to form new divisions upon mobilisation. These are of three general types. A very small number of relatively high-quality 'second line' divisions would be formed using troop school staffs as cadre, pre-designated Reserve I personnel, and stored equipment. 'Security' divisions may be formed using reserves, border and/or security forces' personnel and equipment as well as remaining stored items. These would be used for rear area security or occupation duties. 'Third line' divisions could be formed if conflict duration demanded it. These would be formed from Reserve II personnel, territorial defence troops, people's militia, and police. These would be merely rifle divisions with limited artillery, armour, and support. They may be upgraded with some regular national troops in

leadership positions and equipment supplied by the USSR. Most mobilisation units rely heavily on the use of civilian economy trucks obtained by a system similar to the Soviet *autokolonna*. Civilian fuel and food stocks, as well as all transportation and medical facilities, would be turned over to the military. Many reserve, and in some cases militia personnel would also be used to replace battle losses.

Abbreviations used in the order of battle listings throughout this book are: Div = Division, Bde = Brigade, Rgt = Regiment, Bn = Battalion.

German Democratic Republic

The German Democratic Republic (*Deutschen Demokratischen Republik*—DDR) has the ‘youngest’ of the WP armies. The National People’s Army (*Nationale Volksarmee*—NVA) is considered by many to be the best trained and equipped NSWP army despite its small size. This is particularly true with regard to the NVA’s officer and NCO corps, the latter being of much higher quality than those of

other WP forces. Equipment is often on a par with that of the Group of Soviet Forces, Germany (GSFG). This simplifies the NVA’s logistics requirements, as some of this support is provided by the GSFG.

When Germany was placed under the control of the victorious allies after World War II it was divided into four occupation zones under US, UK, French and Soviet control. Occupied Germany was to be administered by a jointly formed Allied Control Council in Berlin. Not only was the Council concerned with the occupation and disarmament of Germany, but it was to administer the development of a democratic government and assist in rebuilding the ruined country. Almost immediately the Soviets began to ‘interpret’ the Potsdam Agreement, which had created the Council in August 1945, somewhat differently from the other Allies. The Soviet zone began to be administered separately from those of the Western Allies, and harsh war reparations were extracted. The Cold War began with the Berlin Blockade in 1948–49 and the closing of the West German border in the early 1950s, and continued

An East German motorised rifles squad machine gunner, with his IMGK (RPK), confers with his platoon leader. The squad leader, with binoculars, is to the left, and the platoon radio operator to the right with his R-126 radio. (AR)





East German artillerymen practise loading drills on a 122mm howitzer training simulator. The new chemical protective suit carrier can be seen on their shoulders. (AR)



An East German major inspects a motorised rifles squad undertaking air defence training with IMGK machine guns and an MPiKM assault rifle. They wear the winter uniform, with three-finger mittens. The helmet snow camouflage is achieved by weaving strips of paper into the netting. (MVDDR)

with the erection of the Berlin Wall in 1961. The DDR was proclaimed an independent state in 1949, although still a diffident puppet of the USSR. There are several Communist parties, but the dominant one is the Socialist Unity Party.

The beginnings of the NVA can be traced to the Soviet prisoner of war camps, where in 1943 two Soviet-instituted organisations—the ‘National Committee of Free Germans’ and the ‘German Officers’ League’—were formed. Although individuals were to serve in the Red Army, no German units were ever formed. They were, in effect, to be indoctrination and training grounds of cadres for the ‘sovietisation’ of a defeated Germany, and were to play an important rôle in the formation of the NVA. The Soviets wasted no time in forming the forerunner of the NVA, the People’s Police (*Volkspolizei*—VOPO) in October 1945. This was in violation of the Potsdam Agreement, which allowed

for civil police to be formed only on a broadly decentralised basis. The VOPO were administered by the five German states (*Länder*) making up the Soviet zone, and two months later were subordinated to the Ministry for Interior’s new Land Police Authority. VOPO Alert Units were also formed to provide a reaction force. Further militarisation of the VOPO was achieved in 1946 when an Administration for Interior was formed with even more control over the force, and the Frontier Police was established. By 1948 the two forces contained 60,000 and 10,000 troops respectively. The personnel making up these forces were former Soviet prisoner of war camp converts, former members of the Soviet-backed international brigades of the Spanish Civil War, and many former ‘re-indoctrinated’ *Wehrmacht* troops.

The period from the late 1940s to 1956 saw a number of complex reorganisations and realign-

ments, as well as the first purges of the VOPO, which became more militarised and centrally controlled. By 1952 the VOPO was organised into what were to become the three future services of the NVA and were only thinly disguised as 'police': the Barracked VOPO, Naval Police, and Air Police. The Barracked VOPO were formed in 1953 into Territorial Administrations, which were cover designations for seven divisions organised along Soviet Army lines and armed with Soviet weapons and equipment. That same year also saw the East German Uprising in which 300,000 Germans, mostly East Berliners, took part. It was put down mainly by Soviet troops with the reluctant assistance of the VOPO. In 1955 the Federal Republic of Germany (West Germany) agreed to form its own armed forces in order to share in its defence and ease the burden on the NATO nations. In reaction to this the DDR enacted the formation of the NVA and the Ministry of National Defence on 18 January 1956, and publicised it as a 'spontaneous' response—even though West Germany had not yet recruited the first 1,000 troops for the *Bundeswehr* (Federal Defence) and the DDR had an established, trained, and equipped force of 120,000 troops. Actual police-type organisations were separated from these forces and retained under the Ministries for Interior and State Security, although their subordination has occasionally changed. The Frontier Police were reorganised along military lines in 1957 and in 1961 were transferred to the MoND under the control of the NVA/Frontier Command.

In January 1962 the 'Act of Universal Conscriptio' was enacted, further establishing the NVA as a fully-fledged armed force. The Soviets had permitted more and more self-control of the NVA since its formation and even began to exhibit some 'trust' (e.g. by withdrawing many 'advisers') in their traditional enemy.

The NVA is now a well-organised, trained, and equipped force; and even though it is the second smallest of the WP armies, it would probably be the most effective man-for-man in a future conflict. The current number and mix of divisions has remained constant since 1961 when the old five rifle divisions were all converted and expanded to the current MR and armour divisions, all of which are Category A. The NVA is organised into five



Two *Grenztruppen* of the East German Border Command 'briefback' their squad leader on their patrol plan. The guards always work in pairs in order to prevent defections. (AR)

military districts (MD) of which three are not territorial districts in the usual sense, but rather administrative commands:

MD I This is the MoND and is headquartered in Strausberg-Eggersdorf. It includes the many staff and administrative organisations plus certain Land (ground) Force (*Landstreichkraft*) units directly under the MoND. Also included is the Land Forces Headquarters located in Potsdam/Geltow, which also has direct control over some units.

MD II The Air Force/Air Defence Force HQ (*Luftstreichkraft/Luftverteidigung*) co-located with MD I.

MD III Headquartered in Leipzig, it controls most Land Force formations in the southern DDR, and in time of war would act as a combined arms army headquarters, probably designated Army South or 3rd Army.

MD IV The headquarters for the People's Navy (*Volksmarine*), located in Rostock.

MD V Headquartered in Neubrandenburg, it controls most Land Force formations in the northern DDR, and in time of war would act as a combined arms army headquarters, probably designated Army North or 5th Army.

The Command of the Frontier Troops of the DDR (*Kommando der Grenztruppen der DDR*) is directly under MoND control and headquartered in Pätz.

The DDR Land Forces consist of 108,000 active troops of which 67,000 are conscripts. Not included in these totals are approximately 46,000 Frontier Troops (strength estimates vary greatly). The DDR order of battle includes:

MD I (units under MoND and Land Forces control)*:

- | | |
|--------------------------------|----------------------------|
| 1 artillery rgt | 1 signal rgt |
| 1 multiple rocket launcher bn | 1 radio relay rgt |
| 2 guard rgts | 1 radio reconnaissance rgt |
| 1 parachute inf. bn | 1 motor transport rgt |
| 5 engineer & construction rgts | |

(*Most are under the MoND and are designated '2nd' and a few are under Land Forces command—mainly training units and schools—and are designated in the '40 series'.)

An East German motorised rifles squad completes boarding its BMP infantry fighting vehicle. In the DDR army there is one BMP-equipped regiment in each motorised rifles and armoured division, the other two regiments of the MR division being equipped with BTR-60PB or -70 APCs. (JGK)

MD III:
 4th MR Div
 7th Armour Div
 11th MR Div

Both of these MDs contain one each of the following (designated '3rd' in MD III, '5th' in MD V):

Rocket bde (SCUD)	Engineer rgt
Artillery rgt	Engineer pontoon rgt
Artillery reconnaissance bn	Engineer assault crossing bn
Anti-tank bn	Signal rgt
Air defence rocket rgt	Chemical defence bn

MD V:
 1st MR Div
 8th MR Div
 9th Armour Div

The Frontier Troops of the DDR are organised into four commands:

Frontier Command North: 6 frontier rgts on the northern sector of the West German border.

Frontier Command South: 6 frontier rgts on the southern sector of the West German border.

Frontier Command Centre: 6 static, 1 crossing point, and 1 artillery rgt surrounding West Berlin.

Frontier Command Coast: Frontier Brigade Coast with 12 bns and 8 boat groups (under People's Navy control).



Two separate frontier rgts are on the Czechoslovak and Polish borders.

Pre-induction training is provided by the 'Free German Youth' and 'Sport and Technical Society' in schools. Active service for Ground Force conscripts is 18 months (24 months for Air Force and Navy). Volunteers may enlist at age 18 for three years (short service soldiers) or 12 years (career soldiers), the latter including NCOs. NCO and officer candidates are selected from secondary school graduates, and enlisted men and NCOs who have distinguished themselves in active service. The DDR was the last WP state to institute conscription and is the only one to tolerate conscientious objectors, who are, however, still inducted to serve in construction units and often face job discrimination later.

The NVA maintains one of the better reserve mobilisation structures in the WP. Much use is made of 'under-organised' units, which can be quickly expanded by pre-designated reservists provided with call-up orders (which also serve as train tickets). It is believed that two 'second-line' MR divisions can be formed from school cadres, Reserve I personnel, and stored equipment for use on the front line. Two additional 'security' MR divisions can be formed from Frontier Troops and Security Alert Police; these would probably be employed to provide rear area security for the NVA and GSFG.

Like all WP states, the DDR maintains extensive internal security forces, most of which are found under the Ministry for Interior. The People's Police (VOPO) handle all civil police functions; two other specialised forces under the VOPO are the Security Alert Police (*Bereitschaftspolizei*—BEPO), organised into 21 mobile battalions, and the Transport Police (*Transportpolizei*—TRAPO), which provide rail-road security with 80 companies. Service in these latter two organisations is considered alternative service to the NVA. The Battle Groups of the Working Class (*Kampfgruppen der Arbeiterklasse*—KG), commonly referred to as the 'Worker's Militia' in the West, are also under the Ministry for Interior, and are a voluntary force formed into over 200 battalions. Their rôle is to provide a vast rear area security force. The Ministry for State Security (*Ministerium für Staatsicherungs*—MfS) is the DDR's counterpart to the Soviet KGB. It maintains the

large MfS Guard Regiment 'Filiks Dzierzynski', which provides security for ministries, critical facilities, and high officials. MfS personnel are currently operating in Afghanistan.

The Soviets place a certain amount of trust in the NVA, with deliberately tight controls to keep their old enemy in check. An example is that the Soviets permit the DDR to manufacture only small arms, trucks, and technical equipment. A massive Soviet presence in the form of GSFG (20 divisions: ten MR, nine tank, one artillery, contained in five armies and probably used to form two wartime *Fronts*) also serves to keep the DDR in line. Regardless, the NVA will most likely be found in the forefront of a European conflict, with its armies possibly in the first operational echelon—under Soviet control. The NVA somewhat reluctantly participated in the Czechoslovakian invasion with two divisions (7th Armour and 11th MR). Its high state of readiness and up-to-date equipment testify to this, even though Soviet personnel sarcastically refer to the country as the USSR's '16th republic'. Another aspect of the NVA is its extensive employment as a Soviet surrogate in a number of African nations, especially as 'security' advisers. The NVA is expected to perform well in combat, so long as it feels its efforts are reuniting Germany—a goal not as enthusiastically supported by the USSR. If the conflict is prolonged or if they are directed to go beyond Germany's borders, it may be another story. Integration of the military into society and the economic situation are strong points for the NVA; but there is some question of how solidly the government controls the population, even though the Communist party is well ingrained into society.

Czechoslovak Socialist Republic

Czechoslovakia did not become a state until 1918, having been formed from part of the remnants of the defeated Austro-Hungarian Empire. A sense of nationalism had long existed among the ethnic groups making up the region. The Czechs, inhabiting Bohemia and Moravia, were the more politically powerful and strongly nationalistic, the

Slovaks of Slovakia to the east had just emerged from almost 1,000 years under Hungarian rule.

Czechoslovakia ceased to exist as a nation when it fell under German occupation in 1938/39, although Slovakia was established as a puppet state 'allied' to Germany. A protectorate was formed by the Germans to administer Bohemia-Moravia. Following the example of the World War I Czech legions (which had fought for France, Italy, and Russia), two separate free Czechoslovak armies were formed. The 'London Army' was established by the Czechoslovak government-in-exile, and this small force was supported by the British. The much larger 'Moscow Army' began life in April 1939 in Poland, raised from covertly organised troops who had fled the German occupation. It was not recognised by the London government until after the war began. Interned by the advancing Red Army, the Czechoslovaks were sent to the USSR. The London government persuaded the Soviets to release most of

these troops to serve under the British in the Middle East. A nucleus was retained in the USSR to form a new Czechoslovak force. In late 1941 the government-in-exile signed an agreement with the USSR allowing Czechoslovak units to be formed and controlled by the USSR. This force grew by 1944 from a battalion to the First Czechoslovak Army Corps, which saw heavy action. There was also an active Slovak resistance movement supported by the Soviets after the 1944 uprising. Bohemia-Moravia had only a limited resistance movement. It was from the 'Moscow Army' and the resistance movement's Slovak Army that the cadre of the post-war Czechoslovak Army was formed. The Potsdam Agreement for all practical purposes 'gave' Czechoslovakia to the Soviets.

The Red Army liberated most of Czechoslovakia in 1945, and occupied it until departing at the end of the year. The Czechoslovak Communist Party, strongly supported by the USSR, gained control of the government by a *coup d'etat* in 1948, and the re-emerging nation was named the People's Republic of Czechoslovakia. Both Czech and Slovak are equal official languages and are used in all

A Czechoslovak MR squad disembarks from its locally-made OT-64C APC. This is the standard APC in Czechoslovak and Polish service. (OPFOR)



government and military documents. In 1960 the constitution was revised, and a 'federal' government consisting of two republics—the Czech Bohemia-Moravia and Slovakia—was formed; the state's name was changed to the Czechoslovak Socialist Republic (*Československá Socialistická Republika—ČSSR*).

The Czechoslovak People's Army (*Československá Lidová Armáda—ČSLA*) began to be formed in 1945 and the Soviets already had their hand in it. The majority of the officers had served in the First Czechoslovak Army Corps. After the 1948 Communist takeover, those officers who had been part of the 'London Army', those who had served under the Germans, and many of those who had been in the pre-war Czechoslovak Army, were all purged. In 1948 the CSLA was reorganised following the Soviet model.

Prior to 1968 the army was considered one of the better trained and equipped among the NSWP. The 'Prague Spring' and the subsequent 'aid' rendered by fellow WP states proved to be the undoing of the army. In the spring of 1968 the Czechoslovak Communist Party announced a new 'Action Programme' which asserted that democracy, civil liberties, and equal rights were to be integrated into the socialist government. These reforms were unacceptable to the Soviets, and after firm warnings and preparatory manoeuvres (actually a rehearsal), WP forces invaded on 11 August. More than 20 Soviet divisions plus two DDR, two Polish, and one Hungarian division and a small Bulgarian force, crossed the borders. They met virtually no resistance from the CSLA, although the people staged massive demonstrations. The invasion was not without its problems, even though the Soviet command element was pre-located in Prague. Logistics soon became the paramount concern; but it was also quickly realised that many of the NSWP troops had no desire to be there (with the exception of the Bulgarians, who proved to be enthusiastic), their presence being more a forced show of 'solidarity' than anything else. They were soon withdrawn. The Czechoslovak government was rapidly replaced and 'normalised'; and five Soviet divisions (three MR and two tank) remained after the rest were withdrawn in November. This force became the Central Group of Soviet Forces, and are 'hosted'



A Czechoslovak senior private presents a political lecture to his squad, using bulletin boards set up for this purpose by the unit's political officer.

by a 'Commission for the Temporary Stationing of Soviet Forces'. Besides nudging a brother state back into line, the invasion sent an ominous signal to the other NSWP members. Albania withdrew from the Pact as a result, probably being permitted to do so only because it does not adjoin another WP state and cannot be accessed from the Black Sea.

For all practical purposes the CSLA ceased to exist as an effective force. There were the usual purges and reorganisations as the Soviet 'advisers' attempted to forge a new army that would support the regime even against a popular uprising. This has not yet been achieved, and has primarily resulted in lower quality of training (sacrificed for more political indoctrination), less modern equipment being provided (due to lack of trust), and a lower public esteem for the CSLA, which had anyway been only marginal before 1968.

Czechoslovakia is one of the most highly developed WP countries industrially, with substantial armaments production. Several lines of equipment different from the Soviets' are produced and used by other NSWP forces, especially tactical vehicles.

The CSLA is now the second largest of the NSWP even though its strength was reduced after the invasion, from nine to five MR divisions by 1972. (There had been earlier reorganisations. In 1960–61 the eight rifle, four mechanised, and two tank divisions were reorganised into 12 MR and two tank divisions. The CSLA consists of the

Ground Forces (usually referred to as the Army) and Air Force/Air Defence Force (PVOS), both under the MoND and all co-located in Prague. The Ground Forces contain 140,000 troops of which 100,000 are conscripts:

Western MD (ZVO) Headquartered in Tabor, this district encompasses all of Bohemia-Moravia¹ and contains two Czechoslovak combined arms armies, the principal operational echelons. There are also MD rocket (SCUD) and air defence rocket brigades, and signal and signal reconnaissance regiments (which may be used to form a Czechoslovak *Front* along with the MD staff in wartime). It is believed that seven of the divisions are at Category B and one at Category C strength.

1st Czechoslovak Army
(Přibram)
1st Tank Div
2nd MR Div
19th MR Div
20th MR Div

4th Czechoslovak Army
(Pisek)
3rd MR Div
4th Tank Div
9th Tank Div
15th MR Div

Both armies contain:
Rocket bde (SCUD)
Artillery bde*
Anti-tank rgt
Anti-aircraft
artillery bde
Air defence rocket rgt

Engineer bde
Engineer pontoon rgt
Signal rgt
Chemical defence rgt
Motor transport bde

Eastern MD (VVO) Headquartered in Trencin, this district contains Slovakia. Units located in it are operational reserves with the divisions at Category C strength:

13th and 14th Tank Divisions
22nd Parachute Rgt (a brigade prior to 1968)
Engineer and signal regiments

Pre-induction training is limited and what little is provided is conducted by the 'Socialist Youth Union' and 'Association for Co-operation with the Army'. Individuals are eligible for conscription at age 18, with periods of service of two years for Ground Forces, three years for Air Force/Air Defence, and 27 months for Border and Interior

Guards. With such a large number of units below strength, the Czechoslovaks maintain a good mobilisation system for their 300,000 reserves, but their training is of only limited effectiveness. It is thought that one each 'second line' MR and tank divisions, plus additional army and *Front* support units can be formed from Reserve I personnel and stored equipment in event of war. Equipment also exists for some 'security' rifle divisions formed from Reserve II personnel and probably the People's Militia.

The Border Guards (*Pohraniční Stráž—PS*) are under the control of the Ministry of Interior (as are all others described here), although they had been under MoND command from 1965-71. The PS consist of seven brigades of four battalions each and the Danube River Patrol, which is responsible for securing and patrolling the Danube on the border with Hungary and a very small portion of Austria. The Interior Guards (*Vnitřní Stráž—VS*) consist of several 'ready' regiments, and have the mission of general security and suppressing public disorders. The State Security (*Státní Bezpečnost—SB*) guard critical installations, high officials, and the uranium mines. Public Security (*Veřejná Bezpečnost—VB*) is

A border guard of the Czechoslovak Danube Patrol scans the Hungarian shore of the river. (ZAP)



¹Prior to 1969 the ZVO included only Bohemia. There was a Central MD containing Moravia, which was consolidated with the ZVO.

*May be subordinate to 7th Artillery Div (a wartime *front* unit).



the main operating arm of the National Security Corps (*Národní Bezpečnost Vojsko*—NBV), acting as civil police with the wartime mission of rear area security and guarding prison camps. Since 1970 personnel entering the NBV receive five months' basic military training and then undergo police training. This counts as equivalent military service, and they are included in the Ground Force's reserves. The People's Militia (*Lidové Milice*—LM) is under direct control of the Communist Party and is made up of volunteer workers. It is well below its desired strength.

The Soviets have little faith in the CSLA, and with good reason. There is much resentment towards the Soviets, and while the Czechoslovaks may defend themselves if attacked (though even this is open to question, as they failed to do so in 1938 and 1968), their value in a WP offensive directed at the West or even to 'assist' a brother state back onto the right track is highly doubtful. The CSLA also refused to put down the 1953 Pilsen riots. The Czechoslovak soldier is considered to be well trained and moderately well equipped, but his effectiveness against the neighbouring II West

Conducting joint training, Czechoslovak and Polish soldiers man a company command post. Note unusual display of medic's Red Cross patch on shoulder of man at upper right. (AR)

German and VII US Corps is certainly questionable. Since 1968 the new government has effectively integrated itself into society, but actual political control (and support), as well as a shaky economy, limits the overall effectiveness of the Army. The two national groups interact well, even though most Slovaks must serve away from their homeland due to the stationing of units.

People's Republic of Poland

Poland, as a nation, traces its history back over the past 1,000 years, although its territory was divided up between Prussia, Russia, and Austria between 1795 and 1918, before again becoming a sovereign state after World War I. The simultaneous German and Soviet invasions of 1939 were but a repeat of

earlier events. The German invasion of the USSR in 1941 saw the total dismemberment of Poland as a nation. Under the Germans, Poland became nothing more than an administrative region designated the *Generalgouvernement*, with its population exploited as a vast slave labour pool.

Various Polish units had served in World War I with the Russian, Austrian, and French armies, and Free Polish forces were again to be organised in World War II. After suffering a devastating defeat in 1939 at the hands of the Germans, many Polish troops escaped to Hungary and Romania and subsequently to France, where a government-in-exile was formed, and Polish units began to reform—only to suffer a second defeat with the fall of France. Large contingents were again evacuated, this time to England, where a second Free Polish Army was formed. This army's 1st Corps fought under British/Canadian command in North-West Europe.

A Polish squad goes into the assault. The left hand man is armed with an RPG-7V anti-tank rocket launcher and a holstered 9mm PM-63 machine pistol; the man in the centre has the 7.62mm PK machine gun. (KAW)



Large numbers of Polish troops were interned by the Soviets in 1939 during their backdoor invasion. When the Germans turned on the USSR in 1941 some of these troops, after disputes with the Soviets and an agreement with the government-in-exile, were allowed to move to the Middle East, where they formed the Polish Army's 2nd Corps fighting in North Africa and Italy under British command.

The Soviets began to form the Polish People's Army (*Ludowe Wojsko Polskie*—LWP) in 1941 from Polish prisoners and Poles living in the USSR. The LWP's 1st Army fought in Czechoslovakia and Poland, where 2nd and 3rd Armies were added (and later merged) by drafting Poles. They then fought alongside the Soviets into Germany.

There was also a third Polish army, the underground Home Army, which controlled most resistance movements—although the small Communist underground, the People's Guard, and the fascist NSZ remained independent.

The defeat of Germany did not mark the end of fighting for the Poles. Anti-Communist guerrilla groups were formed, and LWP units fought both them and Ukrainian guerrillas. The face of Poland



Polish political/propaganda troops receiving leaflets for distribution from a Nysa-521 van. The helmet band is believed to be sand colour.

was greatly altered in the aftermath of World War II: the state gained large portions of Germany, but even more sizeable areas in the east were ceded to the USSR. A Soviet puppet 'coalition' government had been formed in 1945 (with the government-in-exile cut off in England); but even this was brushed away in 1947, when a solidly Communist government formed by the Polish United Worker's Party was established under tight Soviet supervision. The usual purges took place in both the government and the armed forces between 1947 and 1951, which few of the pre-1945 Free Polish Army, LWP, or Home Army officers survived in place. Most of the key positions were at this time occupied by former Red Army officers, most of whom—though they may have had some Polish ancestry—were citizens of the USSR who had lived there all or most of their lives. A new constitution was adopted in 1952, when Poland was officially named the Polish People's Republic (*Polska Rzeczpospolita Ludowa*).

The LWP began its first modernisation in 1949, followed by a second in 1956. The 6th Air Assault Division was formed from an infantry division

in 1957. In 1960–61 the 11 infantry and six mechanised divisions were reorganised into nine mechanised and four armoured divisions (similar to Soviet MR and tank divisions). A fifth armoured division was added in 1965; and a mechanised division reorganised in 1967 to form the 7th Naval Assault Division (an Army unit). The LWP consists of the Ground Forces (*Wojska Ladowe*), Air Force (*Wojska Lotnicze*), National Air Defence Forces (*Wojska obrony powietrznej kraju*), and Naval Forces (*Marynarka wojenna*). The Ground Forces consist of 210,000 troops, 154,000 of whom are conscripts, giving Poland by far the largest ground forces among the NSWP. The LWP is under the MoND, which controls the Ground Forces (often referred to as the 'Army' in the usual sense) through the Military District Commands while the Air Force, Air Defence Forces, and Navy (usually referred to in those contexts) are under their own commands subordinate to the MoND. The General Staff, a branch of the MoND's Central Institute, formulates



Polish T-55 tank crewman wearing the now rarely seen black leather suit, and a Soviet winter tank crew helmet. A black cloth version of the suit has now been issued.

defence plans. Overall the Polish high command levels are organised and function somewhat differently than those of other WP forces. The Main Inspectorate of National Territorial Defence is also under the MoND and comprises security units which supplement the Ground Forces in wartime. The Ground Forces are subordinate to one of the three military districts (sometimes designated I-III): until the early 1960s there had been a fourth MD headquartered in Cracow, which merged with MD I. The two western MDs would each form a combined arms or tank army in time of war. All armoured divisions are at Category A strength:

Warsaw MD/I (WOW) Headquartered in Warsaw and containing the eastern half of the country, this district harbours the LWP's operational reserve,

with the three mechanised divisions being at Category C strength. The air assault division is Category A. It, too, may form a combined arms army with the mobilisation of additional 'second-line' divisions:

1st 'Warsaw' Mech Div	6th 'Pomeranian' Air Assault Div
3rd 'Pomeranian' Mech Div	9th 'Dresden' Mech Div

Pomeranian MD/II (POW) Headquartered in Bydgoszcz; covers the north-western quarter of the country, with all divisions at Category A strength:

7th 'Lusatian' Naval Assault Div	15th Mech Div
8th 'Dresden' Mech Div	16th 'Kashubian' Armoured Div
12th 'Szczecin' Mech Div	20th 'Kalisz' Armoured Div

Silesian MD/III (SOW) Headquartered in Wroclaw; contains the south-western quarter of the country, with the mechanised divisions at Category B strength:

2nd 'Warsaw' Mech Div	10th 'Sudeten' Armoured Div
4th 'Pomeranian' Mech Div	11th Armoured Div
5th 'Saxon' Armoured Div	

Each MD generally has the combat support units listed below. The Warsaw MD may not have all of them, and those present are probably at reduced strength. There are a few additional units directly under General Staff control.

Rocket bde (SCUD)*	Engineer pontoon rgt
Artillery bde	Signal rgt
Anti-tank rgt	Radio reconnaissance rgt
Air defence rocket rgt	Chemical defence rgt
Engineer bde	

*Two, in SOW.

Pre-induction training is provided by the 'National Defence League' and the 'Volunteer Labour Service'. Personnel for all three services are conscripted at age 19 for two years, although certain specialists and Navy sea personnel are retained for three years. Ministry of Internal Affairs troops are drafted for 27 months. Officers are obligated for 12 years once they have completed one of the many military academies. Enlisted men



A colour guard of the 7th 'Luzycka' Naval Assault Division mounted on an OT-62A APC, and wearing the Polish-made tanker's helmet instead of the more common Soviet type.

A Polish anti-tank gun crew prepare to fire an 85mm D-44 during realistic training exercises. Above the far left ammunition case can be made out a PMK-60 grenade launcher rifle and an RPG-7V, both of which are issued to all major weapons crews. (KAW)





A Polish mechanised squad's 7.65mm PK machine gun and crew, wearing the winter field uniform and the Czech-made M-10 protective mask. (KAW)

released from active duty must return to serve 12 months on active duty, and officers and NCOs 24 months, before they reach the age of 35. There are few other reserve training programmes for the 500,000 reservists, however. The Poles appear to have an effective mobilisation plan, with reservists pre-assigned to units. It is thought that one or two 'second-line' or 'security' divisions could be formed in wartime.

Within the WP, the LWP enjoys the highest esteem among its countrymen, even placing higher than the government during recent public opinion surveys. This is due to a long military tradition; to the fact that the armed forces have continued to fight the enemy even though the country was occupied; and because it has for the most part

managed to keep itself from being used to suppress the population—the government of the day has usually accepted the wisdom in this. This latter circumstance can be demonstrated by several past events. During the 1956 Poznan riots the LWP refused to disperse the demonstrators, and in a few cases even joined them. During the 1970 Gdansk riots the troops showed much restraint and made little effort to disperse the rioters. When the Minister of Defence was asked if the Army could be relied upon to put down the 1976 Warsaw and Lodz riots, he replied, 'Polish soldiers will not fire on Polish workers.' This again proved to be the case in 1981–83 during the attempted suppression of Solidarity. In order to avoid the use of the Army for the suppression of disturbances, Poland maintains extensive internal security forces.

Most of the security forces are under the control of the MoND, but nevertheless are still considered

separate from the armed forces. They are all under the command of the Main Inspectorate of Territorial Defence Forces (*Obrony Terytorialny—OT*). The Internal Defence Army (*Wojska Obrony Wewnetrznej—WOW*) is organised on the basis of one regiment per province, and is intended to provide a backup for the Ministry of Internal Affairs security organisations. A larger force is provided by the Territorial Defence Units (*OTK*), which have a similar number of regiments plus a large number of separate battalions, stationed in cities and towns. The *OTK*'s primary wartime mission is to secure lines of communication. The Border Defence Force (*Wojska Ochrony Pogranicza—WOP*) is organised into 12 border brigades and has wartime defensive missions. Another security force is the Army Internal Service (*Wojskowa Sluzba Wewnetrzna—WSW*). Subordinate to Army Counter-intelligence, it functions as a military police and to suppress uprisings in the armed forces, but has been employed against civilians during the martial law period.

One other security force is under the control of the Ministry of Internal Affairs' Internal Security Corps (*Korpus Bezpieczenstwa Wewnetrznego—KBW*), known as the Ministry of Public Security prior to 1956. (The *WOW* was under the *KBW* until it was transferred to the *MoND*'s *OT* in 1965.) The Citizens' Militia (*Milicji Obywatelskiej—MO*) was established in 1944 as the national police force. Its least popular branch, due to its activities during the martial law period, is the Motorised Units of the Citizens' Militia (*Zmotoryzowane Oddziały Milicji Obywatelskiej—ZOMO*). This force was formed in 1956 and has since undergone several re-organisations and expansions. It is organised into mobile riot brigades equipped with wheeled APCs. There is also a Volunteer Reserve of the *MO* (*Ochotnicza Rezerwa, ORM*).

The Polish soldier is considered one of the more professional in the *WP*, with the officer corps held in very high regard. The troops are well trained, but the recent economic crisis has degraded overall training standards and the acquisition of new equipment. Few doubt that the Poles would defend their country if attacked; but an effective response to an internal *WP* crisis is questionable. The Czechoslovak invasion was very unpopular in Poland, and the *LWP*'s reluctant participation in



The crew of a Polish ZSU-23-4 *Shilka* anti-aircraft gun, wearing black work suits and black artillery berets, on-load part of its 2,000-round basic load of 23mm ammunition. (KAW)

this event, plus its limited involvement in the 1970 Gdansk riots, did damage its image in Soviet eyes. The extent of its participation in a *WP* offensive directed at *NATO* would depend on many factors. The Pomeranian *MD* is intended to secure Denmark and the Baltic approaches, which is why the air and naval assault divisions exist. The Silesian *MD* may be directed towards Austria, while the Warsaw *MD* would keep the lines of communication open between the *USSR* and East Germany. Poland is the only *NSWP* state (with the minor exception of Hungary) which has provided troops in support of United Nations peacekeeping efforts. This includes Polish representation on the International Commission of Control and Supervision in South Vietnam during the 1973–75 'ceasefire', and *UN* contingents in Egypt and Syria from 1975 to the early 1980s. Poland has also sent military advisers to Cuba, North Vietnam, and some Arab countries. Poland manufactures some military equipment, and has jointly participated with Czechoslovakia in tactical vehicle development.

Not only has the *LWP* managed to remain generally aloof from internal unrest, but the Poles have rather successfully prevented Soviet intervention, a claim that few other *WP* states can make. When Wladyslaw Gomułka, ousted from power by Stalin in 1948, regained control of the Polish government in 1956, Polish-based Soviet units began to move on Warsaw. Soviet advisers had neutralised most *LWP* units, but Navy coastal defence units and Air Force formations were



Polish recon troops advance in front of their Soviet-made BRDM-2 vehicles. National insignia can be seen on the turret front, and a unit insignia to the left of the vehicle registration number. (OPFOR)

prepared to resist. KBW units also established defensive positions in the path of the Soviets, who backed down to avoid a confrontation.

The Soviets do not place much faith in the Polish armed forces due to these factors—if the armed forces do not always support the régime, how can they be trusted? It is a well-known fact that, while fiercely patriotic, the Poles do not fully support the current régime, and feel towards the Soviets an ill-concealed hatred. Such events as the Soviet execution of over 10,000 Polish officers in 1940, and the Red Army sitting idle while the Germans slaughtered the Home Army in Warsaw in 1944 (thus eliminating the non-Communist resistance movement), are far from forgotten. A small purge took place in 1968 of officers who were too open in their admiration for the Israelis during the 1967 Arab-Israeli War. Another sore point with the Soviets is the fact that the régime has made little effort to suppress religion, with most of the population still practising Catholicism; the LWP is the only WP force that maintains a chaplain corps.

Even so, the Soviets maintain only a small military presence in Poland in the form of the Northern Group of Soviet Forces' two tank divisions. It is felt that the 20 Soviet divisions in East Germany and the vast forces in the three Soviet western MDs are more than sufficient to keep the Poles in line.

People's Republic of Bulgaria

Bulgaria was under Turkish domination until 1878 (a period during which it had no military forces of its own) and became an independent monarchy in 1908, a status it maintained until 1946. The four wars in which Bulgaria took part during the monarchy all ended in defeat (1913, Second Balkan War, World Wars I and II) or in the case of the 1912 First Balkan War, an unfavourable negotiated settlement. For these reasons, Bulgaria does not nourish a strong military tradition.

Even though Bulgaria has strong ethnic ties with Russia, was liberated from Turkish rule by Russia, and speaks a language similar to Russian, the country nevertheless joined the Axis in 1941, and

ineffectively supported Germany in its war against the USSR. The USSR did not declare war on Bulgaria until late 1944—at which time Bulgaria, desiring to reverse a frustrating trend, immediately turned on the Germans, and subsequently suffered more casualties fighting their former allies than they had while supporting them. There was also an active Communist-backed partisan movement, which fought both the German and pro-Nazi Bulgarian armies.

The USSR assisted the Communist-dominated ‘Fatherland Front’ to gain control of the National Assembly during the first post-war general elections in late 1946. Less than a year later the Bulgarian Communist Party gained total control of the government, followed by the mandatory purges, and the country was named the People’s Republic of Bulgaria (*Narodna Republika Bulgariya*). The Bulgarian People’s Army (*Bulgarska Narodna Armija*—BNA) maintains the traditions of the pre-1944 army, as it had eventually fought against the Germans in support of the Red Army. It also absorbed the traditions of the Bulgarian Communist Party rebellions of 1923 (a failure) and 1944. Bulgaria is considered the most pro-Soviet member of the WP, not only because of its culture and language, but because the population strongly supports the Communist system. The Bulgarian Communist Party is almost one and the same with the government, and most BNA officers are party members. This support is of only marginal value, however, due to the somewhat limited capabilities of the BNA, and to the country’s geographic

This Bulgarian 14.5mm ZPU-4 anti-aircraft machine gun crew wear the old M-1936 helmet, which has not been entirely replaced by the M-1972. (KAW)



A Bulgarian motorised rifles squad dismounts from an MT-LB armoured personnel carrier: while not primarily intended as an APC, it is employed by some WP forces in this rôle as a low-cost alternative.

location. Even so, all has not always been well, and conspirators preparing a coup by BNA officers were uncovered in 1965. There are no Soviet units stationed in Bulgaria—both as a sign of trust, and as an indicator of the low value the USSR places on its strategic location.

The BNA consists of the Ground Forces, Air Force/Air Defence (usually referred to as the Air Force), Navy, and Border Troops, all subordinate to the MoND, headquartered in Sofia together with Ground Force and Air Force headquarters. High command organisations closely follow those of the USSR, but on a greatly reduced scale. The Ground Forces possess 105,000 troops of which 70,000 are conscripts, making it the second smallest ground force in the WP, but with the highest military to civilian ratio within the Pact. The BNA fell from a peak of 12 rifle and two tank divisions in 1955 to six rifle and one tank by 1961/62 when the rifle divisions were reorganised as MR divisions (usually in name only, however) and two more added. Tank divisions were steadily added from 1962, reaching a total of five by 1970: they were extremely small even by WP standards, and by the following year all were reorganised as tank brigades.

The Ground Forces are organised into three military districts, each of which is the base region for a small combined arms army. Each has a training MR division at Category C strength with all equipment. Their cadres are used to provide basic training to conscripts. Upon mobilisation, they would be brought up to strength with reservists. The BNA is unique in the WP in that it has no tank



Two Bulgarian Border Troop guards, clothed in the earlier pattern of camouflage uniform, conduct surveillance with a Soviet-made PDF 35mm periscope camera. (DIA)



A Bulgarian senior private T-54 tank driver wearing the two-piece tanker's suit and Soviet-made summer tank helmet. (VA)

divisions, but rather tank brigades, less than half the size of a division. The regular MR divisions and tank brigades are maintained at Category A strength. The MR divisions have few APCs and rely primarily on truck transport. The BNA uses the 'Guards' title in the same manner as the Soviet Armed Forces, i.e. as an honour title awarded to a unit for valour in combat during World War II. They even have their own equivalent to the Lenin Tomb, the Dimitroff Mausoleum in Sofia. They are the only WP state to retain a traditional ceremonial uniform: the Dimitroff Guard wears a uniform modelled after the pre-World War I Bulgarian cavalry, with a white dolman complete with 'Hungarian' knots and a lambskin cap.

MD I/1st Army Headquartered in Sofia, this is the westernmost district:

1st Guards Training	9th Tank Bde
MR Div	Mountain bn
28th MR Div	

MD II/2nd Army Headquartered in Plovdiv in the central region of the country:

2nd MR Div	5th Tank Bde
17th MR Div	11th Tank Bde
19th Training MR Div	Reconnaissance bn

MD III/3rd Army Headquartered in Sliven, this is the easternmost district, bordering the Black Sea:

3rd MR Div	Parachute rgt
7th MR Div	(probably under
18th Training MR Div	MoND control)
13th Tank Bde	Reconnaissance bn
24th Tank Bde	

Each MD/army has certain army-level troop units assigned to it:

Rocket bde (SCUD)	Engineer rgt
Artillery rgt	Signal rgt
Anti-aircraft artillery rgt	Various battalion-sized support units

The Border Troops consist of 15,000 men organised into 16 border brigades with four battalions each. They secure the frontiers with Greece, Turkey, and Yugoslavia, and are tasked with a wartime defensive mission. There is also a small Danube Flotilla which patrols the border with Romania.

An individual may enlist at age 17, but most conscripts are called up at 19. Service is for two years in the Army, Air Force, and Border Troops and three years in the Navy. There are fewer draft deferments in Bulgaria than in any other WP state. Limited value pre-induction training is provided by

the 'Dimitri Communist Youth Union' and 'Voluntary Organisation for Co-operation in National Defence'. The Bulgarians maintain the largest organisation of construction troops among the NSWP states. These individuals, those not inducted into the armed forces or physically unfit, are conscripted and their two years of service are counted as equivalent to military duty. They are not considered an armed force, and receive only construction training and political indoctrination governed by military discipline. They are employed on all national construction projects. The BNA's 200,000 reservists, besides bringing the Category C divisions up to strength, would create or bring up to strength various army level support units. If any additional divisions can be formed in wartime, they would probably be either 'security' or 'third-line' rifle types.

Bulgaria has only small internal security forces due to the fact that the government perceives no real internal threat: its controlling mechanisms are well integrated into society. There is a small Committee for State Security (*Komitet Gosudarstvennoy Bezopasnosti*—KGB), which was formed in 1965 after the attempted coup. This 'secret police' organisation was absorbed into the Ministry of Internal Affairs (*Ministerstvo Vntrennykh Del*—MVD) a few years later. The principal security force is the MVD's People's Militia (*Nadrodna Miatsiya*—NM), which performs normal police type-functions, but has a limited wartime rear area security rôle.

Bulgaria is the USSR's most trusted ally, for racial, cultural, linguistic, and political reasons, in fact it is sometimes said that even hardline Soviets are embarrassed by the dogmatic ideology of Bulgarians. Given such an ideal partner (especially considering the Soviet Union's relationships with her other satellites), it would be thought that the Bulgarians would play a major rôle within the WP—but they do not, for the simple reason that the country is located in a strategically unfavourable area. It does not adjoin the USSR, and Romania will not permit forces from other WP states to cross its borders. In order to participate in joint WP exercises Bulgarian troops must be moved to the USSR by sea or air. Bulgaria itself possesses only a limited capability to accomplish this, and must rely on the USSR to a large extent. Units do rotate to



Bulgarian crewmen, wearing the new issue camouflage suit, lounge beside their T-54 tank.

the USSR for training, using borrowed equipment. In fact, during the Czechoslovakian invasion of 1968 the limited Bulgarian contingent came from two sources, some being flown from Bulgaria to the USSR, where there was an MR regiment already in place conducting training. The only NATO countries which Bulgaria borders are Greece and Turkey and this area would see their principal wartime mission. Bulgaria would have value, however, in any Pact 'intervention' involving Romania or Yugoslavia.

The BNA is considered a marginal force of only limited combat value due to its limited training, which often takes second place to the demands of political indoctrination, and use as a labour force. Bulgaria has a weak economy with very limited industrial capability and little in the way of armaments manufacture. All weapons and equipment are obtained from the USSR and other WP countries. With such a weak economy, it surprises many that Bulgaria has been given the rôle of economic 'penetration' of various Third World countries, primarily in Africa but even including Mexico. Due to its restrictive geographic location, and taking into account the older-model equipment of the two NATO forces to the south, the Soviets supply Bulgaria with mostly outdated equipment

and then only in limited quantities. While most MR units are forced to rely on trucks rather than the few available older model APCs, it is reported that some units are still actually foot infantry. Training is considered very physically demanding, however, and the Army prides itself on its ability to operate in mountainous terrain and harsh winter conditions.

People's Republic of Hungary

In the past 500 years, Hungary has become involved in virtually every war that has presented itself—and since it has consistently lost, Hungary lacks any particularly stirring tradition on which to base its armed forces. An old kingdom, Hungary was absorbed somewhat reluctantly into the Austrian empire in 1739—the price for the latter's aid in liberating the country from 200 years of Turkish occupation. In 1867, after many revolts and much strife, a compromise was reached, and a dual government was established over 'Austria-Hungary'. The nation was still for all practical purposes ruled by Austria, however. Austria-Hungary sided with Germany in World War I, thus forcing Hungary to suffer yet another defeat. A post-war revolt made Hungary an independent republic. A Communist government (Hungarian Soviet Republic) gained control for a brief period in 1919, and fought the loss of territories demanded by the Allies. These efforts failed, and by 1920 over 70 per cent of pre-1914 Hungarian territory had been given to Romania, the new states of Czechoslovakia and Yugoslavia, and even a small portion to its former ally, Austria. No other country, not even Germany, lost so much land.

In 1941, primarily motivated by hopes of re-acquiring lost territories, Hungary allied itself with Germany and assisted in the invasion of Yugoslavia. It later declared war on the USSR and provided substantial forces¹, though fewer than Romania. Generally the Hungarian Army was of only limited value, due to their lack of modern weapons and of motivation. The army suffered several crushing defeats in 1942–43, and by the time the Red Army poured into Hungary in 1944 they were ready for a

change. The government attempted to extricate the country from the war, but German forces occupied most of the country and established a puppet government. The Soviets in the meantime established their own puppet government in the eastern region; and were later able to occupy the entire country. A few small units were formed by pro-Soviet troops, which finished the war fighting alongside the Red Army. The Soviets also formed a single Hungarian division (while promising eight) from prisoners of war and pro-Communist Hungarians residing in the USSR, but it never saw combat. The USSR permitted free elections in late 1945 when, much to their surprise, the Communists received only 17 per cent of the vote. The Communists managed to gradually gain control of the government by their usual means, and even though more 'free' elections were held, the 'ruling' democratic party was forced to merge with the Communists in 1948. By 1949 the nation was under total control of the Communist United Worker's Party, and was renamed the People's Republic of Hungary (*Magyar Népköztársaság*).

A harsh régime followed, and in 1956 the people's resentment came to a head. Demonstrations escalated to outright attacks on the hated secret police, and on the last day of October a coalition government was proclaimed. The government announced that the country would withdraw from the WP and that it desired to become a neutral state. The withdrawal of Soviet units was demanded, and assistance was requested from the United Nations. It never came; but more Soviet

A Hungarian crew mans a Soviet-made AT-4 'Spigot' anti-tank guided missile launcher. The AT-4 is replacing earlier generation anti-tank missiles and recoilless guns in battalion anti-tank platoons. (KAW)

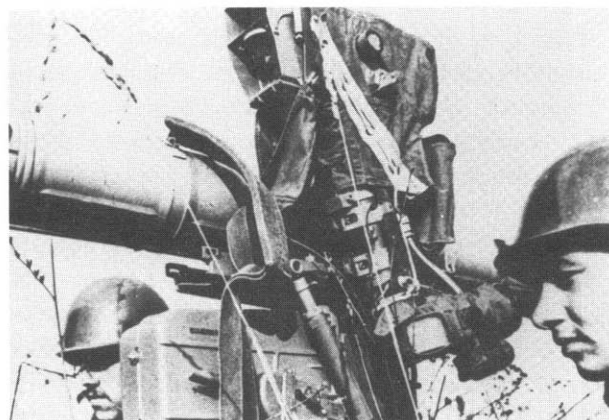

¹See MAA 131, *Germany's Eastern Front Allies 1941–45*.



Clear study of a Hungarian senior NCO wearing the traditional summer field cap, and summer shirtsleeve order. This cap replaced the earlier version with a plastic peak and folding side flaps. (AR)

troops did. The Soviet suppression of this revolt was one of its most brutal post-war episodes. Retaliation lasted into 1958. The Hungarian Army, for the most part, did nothing: most units remained in their barracks, apparently taking a wait-and-see attitude. A few honourable exceptions actually supported the revolt, but real military resistance was rare: many of the troops simply went home.

During the post-revolt period the newly installed Soviet-backed government has made many efforts to improve its image—and the lot of the people. The Communist party was renamed the Hungarian Socialist Worker's Party, and the secret police were kept more tightly in check. Hungary today has a relatively strong economy when compared to other WP states. It conducts extensive trade with the West, being one of two WP states permitted 'most-favoured-nation' trade status with the US, which provides tariff benefits.

In 1949 a new army, the Hungarian People's Army (*Magyar Néphadsereg*—MN) was formed using the assets of the old army, which had been allowed to waste away until sufficient Communist control was gained. Reorganisation and modernisation began immediately, and the MN was re-

formed along Soviet lines under their usual strict supervision. It was not long before almost all former officers of the pre-1945 army were purged. Former German equipment was used until Soviet material began to be provided in 1950. The MN grew to over 200,000 troops, the largest peacetime army in Hungary's history, and somewhat larger than the 65,000 permitted by post-war treaties. By 1956 there were nine rifle and one each mechanised, tank, and parachute divisions. What was at the time considered to be a well-trained army ceased to exist during the revolt. It was not until 1958 that new divisions began to be formed. A total of five MR divisions had been formed by 1960, and the first new tank division in 1962. The number of divisions fluctuated between four and five MR and one and two tank until 1974, when the current level of one tank and five MR divisions was established. The MN has fewer tanks and less artillery than any other in the WP. There are also only limited numbers of APCs available, but the MR divisions are at least completely outfitted with trucks. Hungary provided personnel for the UN's International Commission of Control and Supervision (ICCS) to oversee the Vietnam 'ceasefire', 1973–75: the Hungarian delegation primarily occupied itself with collecting intelligence on South Vietnamese forces and passing it to the Communist North Vietnamese.

The MN is under the MoND and consists of the Ground Forces, Air Force/Air Defence Force, and the Danube Flotilla (not a true navy, but a small riverine force), all headquartered in Budapest. The

A Hungarian firing platoon leader supervises the crew of a 152mm D-20 howitzer, the standard equipment for divisional heavy artillery battalions. The lieutenant is wearing the field version of the officer's service cap. (VA)





The command observation post of a Hungarian artillery battery, with the two officers operating a plotting board. Both wear the officer's field-version service cap, and all wear the standard camouflage suit. The far man operates a stereoscopic rangefinder.

Ground Forces consist of 72,000 troops of whom 50,000 are conscripts, making it the smallest within the WP. The parachute regiment and Guards battalion are under MoND control. The six Category B divisions are administered by two military districts (there had been four until the mid-1970s):

Western MD Headquartered in Szekesfehervar, this district covers the western two-thirds of the country and contains the elements of a combined arms army (which may or may not be designated the 1st or 2nd Army in wartime):

4th MR Div	Artillery rgt
5th Tank Div	Anti-aircraft
9th MR Div	artillery rgt
12th MR Div	Engineer rgt
17th MR Div	Engineer pontoon rgt
Rocket bde (SCUD)	Assault crossing bn

Eastern MD Headquartered in Szolnok and covering the eastern third of the country, it contains a small operational reserve consisting of the 27th MR Div and an artillery regiment.

Pre-military training programmes are provided by the 'Communist Youth League', 'Ready to Work and Fight', and 'Hungarian Sports Federation for National Defence'. Conscription is at the age of 18, followed by two years' service (all branches), though some technical personnel are

retained for three. For Ground Force non-technical personnel, the first six months of this period are often undertaken in the Labour Service. Pre-military training is usually insufficient, especially as regards physical conditioning, and the labour service helps to remedy this as well as providing an introduction to military discipline.

Hungary's 130,000 Ground Force reserves are generally of only limited value. Post-active-duty training programmes are marginal at best, and most are administered by the 'Hungarian Sports Federation for National Defence'. It is thought that one 'second-line' MR division can be formed in time of war.

All security forces are under the control of the Ministry of Interior. The Internal Security Troops (*Belso Karhatalom*—BK) are organised into regiments tasked with general security. The Security Police, usually referred to as the 'secret police', are a

Hungarian motorised rifle troops running an obstacle course in shirtsleeve order. The nearest man carries an AMD-65 assault rifle, the one behind him a 7.62mm SVD sniper rifle, and the far man an RPG-7V rocket launcher.





A Hungarian captain briefs one of his squad leaders, a sergeant. Both are in shirtsleeve order. In the background is one of the Hungarian Army's few BMP infantry fighting vehicles.

much-hated force. Created in 1949 by the merger of the Department of State Security (AVO) and the Frontier Guard, and redesignated the State Security Authority (*Allamvedelmi Hatosag*—AVH), their past excesses were one of the principal causes of the 1956 revolt. In the aftermath of the rising the Security Police and Frontier Guard were again split into separate organisations, and the former was redesignated the BACS, but they are still often referred to as the 'AVH' in a derogatory manner. The Frontier Guard (*Hatarörseg*—HÖR) is organised into 11 border districts with three or four battalions each. The most extensive frontier security arrangements are on the Austrian and Yugoslavian borders. There is also a River Guard which patrols the Danube and Drava on the borders of Czechoslovakia and Yugoslavia. The Internal Security Troops and Frontier Guard meet their manpower requirements through two-year conscription. The Government Guard Command

Three Hungarian 14.5mm ZPU-2 anti-aircraft machine guns are prepared for the ground firing rôle; the crewmen wear winter field uniform.



(*Kormanyarseg Parancsnoksag—KP*), formed in 1972, is a small organisation tasked with special guard functions. The final organisation is the Worker's Militia (*Munkas Orseg—MO*). Formed in 1957 to permit more participation by the people, it has about 70 'motorised' battalions, and is a voluntary force.

In the eyes of the Soviets, the MN is not a trustworthy army. The Hungarians have long considered Russia and Romania as their traditional enemies. Anti-Communism in general and anti-Sovietism in particular are widespread among the population: the events of 1956 have further assured this. Soviet troops have remained stationed in Hungary since World War II; the Soviet Southern Group of Forces today consists of two MR and two tank divisions. The Army itself is considered to be one of the most poorly trained and led in the WP. Bordering no NATO nation, and only the two neutral states of Austria and Yugoslavia, it would be of little value to the USSR in a general war. It could be used in an internal WP operation, especially if the target 'brother' state were to be Romania: besides being a traditional enemy, Romania has retained North Transylvania (long claimed by Hungary), and has not been forgiven for turning on her former Axis 'ally' in 1944. A Hungarian MR division took part in the Czechoslovakian invasion, but—due to morale problems, and inefficiency—it was the first WP force to be withdrawn. There is even some question of how tenaciously the MN would fight to defend itself if

Romanian motorised rifle troops take up firing positions beside their TAB-72 APC, a local copy of the BTR-60PB. They are armed with AKM assault rifles and a PK machine gun. Note the unique Romanian helmet, and its double chinstrap. (OPFOR)



attacked. This lack of Soviet trust, its low levels of training, and its unfavourable geographic location are the primary reasons that the MN is provided with only limited quantities of older equipment. Hungary does produce some of its own tactical vehicles, small arms, and other minor items.

Socialist Republic of Romania

Romania is another Balkan state which was at one time under Turkish domination, gaining its independence in 1829. She sided with the Allies during World War I and fought alongside the Russians, but withdrew from the war after the Russian revolution. Still, she was rewarded by being permitted to annexe a large and long-claimed portion of Hungary. Between the wars a fascist government gained control. The USSR occupied the border regions of Besarabia and Northern Bukovina in 1940. The Germans furthermore allowed Hungary to annexe Northern Transylvania, and the Bulgarians annexed Dobruja. In an effort to reverse this disintegration Romania sided with Germany in 1940, and German troops were moved in to secure the nation's oil producing resources.

The Romanian army participated in the invasion of the USSR alongside the Germans. Though not as well equipped as their ally, they fought well; this was also the largest army provided by Germany's Eastern European allies¹. The Soviets often concentrated their attacks on Romanian forces due to their light anti-tank weapons and limited armour. After a number of serious defeats the army's morale began to suffer, and by 1944 the country as a whole began to realise that they had allied themselves with the wrong side. In August 1944 Romania sided with the USSR and turned on the Germans and Hungarians, the latter in order to regain lost territories. The Red Army entered the capital shortly after the switch and, with Romanian help, cleared the country of Germans.

Joining the Romanian army in these efforts were

¹See MAA 131, *Germany's Eastern Front Allies 1941-45*.

- 1: Cpl., DDR Motorised Rifles; summer field service uniform
- 2: Jnr. Lt., DDR, helmet camouflage netting
- 3: Pte., DDR Motorised Rifles; winter field service uniform
- 4: Jnr. Field Sgt., DDR Commandant's Service; winter field service uniform





- 1: Snr. Seaman, DDR Coastal Frontier Command; summer field service uniform
- 2: Sgt., DDR, work suit
- 3: DDR motorcyclist's protective suit
- 4: Pte., DDR Commandant's Service; parachutist's/motorcyclist's helmet

- 1: Cpl., Czechoslovak Motorised Rifles; summer field service uniform
- 2: Czechoslovak summer field cap
- 3: Czechoslovak Motorised Rifles; winter field uniform
- 4: Jnr. Ensign, Czechoslovak Tank Troops



- 1: Jnr. Sgt., Czechoslovak Border Guard; summer service uniform
- 2: Czechoslovak Border Guard, Danube River Patrol; summer service uniform
- 3: Snr. Pte., Czechoslovak Traffic Regulator Troops; winter field uniform



- 1: Snr. Cpl., Polish Motorised Rifles; summer field uniform
- 2: Lt., Polish summer field cap
- 3: Snr. Pte., Polish Motorised Rifles; winter field uniform
- 4: Sgt., Polish Tank Troops



- 1: Cpl., Polish Army Internal Service; summer field uniform
- 2: Polish Border Defence Force; snow camouflage suit
- 3: Lt., Polish Contingent, UNEF II; desert uniform



- 1: Cpl., Bulgarian Motorised Rifles; summer field uniform
- 2: Pte., Bulgarian Motorised Rifles; winter field uniform
- 3: Jnr. Lt., Bulgarian Motorised Rifles; camouflage suit
- 4: Major, Bulgarian Motorised Rifles; officer's summer field uniform





- 1: Pte., Hungarian Motorised Rifles; summer field uniform
- 2: Snr. Sgt., Hungarian summer field cap
- 3: Snr. Pte., Hungarian Motorised Rifles; winter field uniform
- 4: Hungarian Motorised Rifleman; camouflage suit

- 1: Snr. Pte., Romanian Motorised Rifles; summer field uniform
- 2: Cpl., Romanian Combat Engineers; winter field uniform
3. Romanian Motorised Rifleman; camouflage suit



1: DDR Chemical Reconnaissance Troops; light protective suit
2: Warsaw Pact Motorised Rifleman; combined arms protective suit

3: Czechoslovak Motorised Rifleman; multi-purpose protective suit
4: Polish Artilleryman; optical protective mask





1



2



3



4



5



6



7



8



9



10



11



12



13



14



15

Warsaw Pact shoulder/sleeve insignia: see Plates commentaries for identification



1



2



3



4

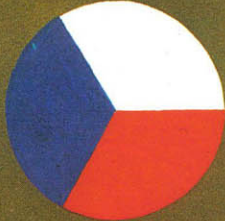

5



6



7



8



9



10



11



12



13



14



15



16



17



18

three Soviet-organised divisions of former Romanian prisoners of war. These Communist-indoctrinated troops were later to provide cadres which infiltrated the rest of the army. In further efforts to Communistise the Army, besides the 180,000 prisoners already being held by the Soviets, another 280,000 were seized *after* the Romanians had changed sides: the vast majority of these prisoners never returned. Soviet occupation troops remained in Romania after the war. The Romanian Communist Worker's Party gained control in late 1947 by forcing the king to abdicate, and the nation was proclaimed the Romanian People's Republic.

Although there were the usual purges within the Romanian Army (*Armata Romina*—AR), many of the pre-1945 officers were retained for a longer period than in other armies under Soviet control. It was not long, however, before the AR dwindled to only 90,000 troops—considerably less than the 138,000 permitted by post-war treaties. From 1947–50 the AR was reorganised on the Soviet pattern and there was additional modernisation in the early 1960s. Soviet occupation troops had been withdrawn in 1958 along with the military mission which had guided the rebuilding of the AR. It was not long before nationalistic rumblings began to be heard.

In August 1965 a new constitution was adopted, and the state was renamed the Romanian Socialist Republic (*Republica Socialistă Romina*). Since proclaiming itself a 'socialist' rather than 'Communist' state, Romania has distanced itself from the remainder of the WP. It will not allow troops from other countries to transit across the country or be stationed there. It permits no military exercises involving foreign troops on its soil, nor does it participate in WP manoeuvres other than by sending observers. The government has been critical of many Soviet policies, and strongly condemned both the Czechoslovakian intervention (at which time the AR was placed on alert to defend against a possible Soviet move into Romania) and the Afghanistan invasion. It also maintains the position that all military treaty organisations should be abolished, including the WP. Much to the further irritation of the Soviets, Romania has conducted joint defence efforts with non-WP Yugoslavia. This includes an integrated air defence warning network (though Romania's is still



Romanian T-55 tank crew studying their planned route. Their tank suits are black cloth. (KAW)

integrated with the WP's), and the joint development of a ground support fighter. Romania is also one of two WP states that enjoys 'most-favoured-nation' trade status with the US. The country has been warned that it faces a cut-off of this benefit unless its extremely repressive human rights record is improved.

While all other WP states claim that their armed forces are solely for defence from external enemies, this does not bear up under a study of their organisation and training. The AR is a purely defensive force, however, a fact that is apparent from its structure and training. In fact, the primary task assigned it by the WP High Command (which actually has little choice in the matter) is the defence of its territory from external attack. The AR consists of the Ground Forces (usually referred to as the Army), Air Force/Air Defence Force, Navy, and the Frontier Troops, all directly under the Ministry of Armed Forces (MoAF), rather than an MoND. The higher command levels of the AR display a number of internal deviations from similar organisations in other WP states.

In the early 1950s the AR reached a level of 12 rifle, one mechanised, and one tank division. Between 1960 and 1964 the rifle and mechanised divisions were converted to MR divisions; during this same period other strength reductions began, and by 1970 there were only six MR and two tank divisions. There was a gradual increase over the next six years, with three additional MR divisions being added. One was inactivated in 1977, and the AR has maintained eight MR and two tank divisions ever since. The Ground Forces now



Romanian senior lieutenant (left) and captain discuss tactics while motorised rifles squads prepare to man their TAB-72s. The officers wear red MR branch-colour collar patches, and red central stripes on their field shoulder boards; they also wear vehicle crewmans' helmets.

contain 140,000 troops of which 95,000 are conscripts.

They are administered by two MDs, each doubling as a combined arms army headquarters. There was an MD I headquartered in Jassy until 1960, when it was consolidated with MD II. Both tank and four of the MR divisions are at Category A strength, the remaining formations at Category B strength. Many of the MR units are only equipped with trucks and others are merely 'foot-mobile'. The mountain brigades each have two regiments.

MD II/2nd Army Headquartered in Bucharest, it incorporates the southern half of the country:

- | | |
|--------------|------------------|
| 1st MR Div | 10th MR Div |
| 2nd MR Div | ? MR Div |
| 4th Tank Div | 4th Mountain Bde |
| 9th MR Div | |

MD III/3rd Army Headquartered in Cluj, it contains the northern half of the country:

- | | |
|--------------|------------------|
| 6th Tank Div | 2nd Mountain Bde |
| 11th MR Div | ? Mountain Bde |
| 18th MR Div | (unconfirmed) |
| 81st MR Div | |

Each army additionally has the following units when under command:

- | | |
|-----------------------------|--|
| Rocket bde (SCUD) | Engineer rgt |
| Artillery bde | Signal rgt |
| Anti-tank rgt | Various other combat support and service support units |
| Anti-aircraft artillery rgt | |

Units directly under Ground Forces or MoAF control include the 161st Parachute Rgt, the Bucharest Garrison Bn, a signal and three artillery regiments, the latter of which may be formed into a wartime artillery division.

The Frontier Troops were administered by the Ministry of Internal Affairs until the late 1960s when they were placed under the MoAF on a status equal to the other services. Frontier regiments primarily secure the Yugoslavian and Bulgarian borders (with a Danube River Patrol), with only limited forces deployed on the Hungarian and USSR borders. They have the additional wartime mission of delaying any attacking force.

Eligible for the draft at 18, the Romanian conscript serves the shortest period of any in the WP—16 months (navy personnel serve two years). When the term of service was reduced from two years in 1964, it signalled the beginning of the strength reductions mentioned earlier. Pre-military training at a rather limited level is conducted by the 'Voluntary Sports Union for National Defence of the Fatherland' and the 'Union of Communist Youth'. Training programmes for some 350,000 Ground Force reserves are likewise limited; only small numbers of reservists are called to active duty each year for refresher training. It is estimated that up to three 'second-line' (or more probably, 'third-line') rifle divisions can be raised in time of war. Their equipment and level of training would be of distinctly low quality.

All security forces are under the control of the Ministry of Internal Affairs. Well into the 1950s the security forces received a very high priority as the government established itself. Since 1968, however, there has been a State Security Council, which maintains supervision over the various security organs in order to keep them in check. Formed in the late 1940s, the Security Troops are organised into regiments, and like similar organisations in other WP states, they are prepared to suppress any internal unrest as well as to provide wartime rear

area security. The 'Patriotic Guard', formed in 1944 and placed under the Ministry of Internal Affairs in 1949, is an all inclusive public security organisation. Its functions include normal civil police, security guards, fire-fighting services, and a very large 'people's militia' force. In wartime this element of the Patriotic Guard would provide rear area security, augment the regular Ground Forces (due to the low level of reserve training), and would be expected to operate as guerrillas after their areas were overrun by invading forces.

As can be seen, the Soviets consider Romania the most recalcitrant of WP allies. Her refusal to participate in any WP activities, and unconcealed desire to pursue her own political and economic path have guaranteed the Soviets' mistrust. Romania has even flirted with China and Israel. Of all the WP states, her armed forces have the oldest-model equipment still in general use. Romania has been forced to undertake the production of some of its own armaments including tanks. She does benefit from possessing large oil deposits and her natural gas reserves are the world's third largest. Even if Romania were an active member of the WP, her geographic location greatly lessens her strategic

value as she adjoins no NATO country. The only neighbouring non-WP nation is Yugoslavia, with which she is on friendly terms. Since Romania is bordered by the USSR and by her traditional enemies, Hungary and Bulgaria, it takes little imagination to guess against whom the AR are prepared to defend. The ability of Romania to conduct a successful defence is questionable, however, taking into account the low level of military preparedness and out-dated equipment, much of which is apparently poorly maintained. The quality of officers leaves something to be desired as well, due to a preoccupation with political reliability. In the Ground Forces much training time is spent on political indoctrination and public labour projects. Additionally the rôle of the armed forces is not well integrated into society. Even with more than usual trade with the West, Romania's economic situation appears bleak.

Members of the Romanian Patriotic Guard parade with German MG-34 machine guns and AKM assault rifles. They wear the same tan-coloured beret as the mountain troops, but can be identified by the Patriotic Guard shoulder patch, and the use of shoes rather than boots—as well as by their general deportment.



The Plates

A1: Corporal, DDR Motorised Rifles; summer field service uniform

In 1965 the 'rain-drop' camouflage pattern (*Stricheldruck*—'dashed print') uniform began to replace the older mottled camouflage uniform, adopted in 1959. The individual equipment will also be found in reed green, and formerly in the mottled pattern. His weapon is the DDR-produced MPiKMS-72 assault rifle, 7.62mm short, an improved version of the Soviet AKMS utilising a plastic forestock and pistol grip and a unique folding stock. He is emplacing a DDR-made DM-70 anti-tank mine. The DDR is the only NSWP force which still makes extensive use of the 'jackboot', for reasons of tradition, even though it often causes foot problems.

A2: Junior lieutenant, DDR, helmet camouflage net

More common than the camouflage cover worn by A1, the netting has the advantage that foliage can be attached to it. The *Stahlhelm Modell 56* was issued in 1957, replacing the standard Soviet helmet then in use. It is actually a 1944 prototype rejected by

Hitler, who did not want to give up the more traditional design even though the proposed model offered improved protection.

A3: Private, DDR Motorised Rifles squad machine gunner; winter field service uniform

The insulated winter uniform is being replaced by one similar to the type worn by A4. A stone grey pullover sweater is also provided. This squad (*Gruppe*) machine gunner is outfitted with full equipment, including an assault pack with a blanket rolled in the shelter quarter. He has the new protective mask and chemical protective cape carriers made of chemical agent resistant 'rubberised' fabric. He is armed with the PKM general purpose machine gun, 7.62mm long, used in lieu of the RPK (designated IMGK in the DDR) in some units. When mounted on a tripod it is known as the PKMS.

Warsaw Pact cap and beret badges are usually provided in full-colour enamelled versions for service and walking-out dress and in subdued versions for summer and winter field headgear. (Left to right, top row) East German enlisted; East German officers; Czechoslovak; Polish; (centre row) Hungarian; Bulgarian enlisted; Bulgarian officers, new style; Bulgarian officers, until early 1970s; (bottom) Romanian cap; Romanian parade helmet. (OPFOR)



A4: Junior field sergeant, DDR Commandant's Service; winter field service uniform

The Commandant's Service (*Kommandantendienst—KD*), usually referred to as Traffic Regulators in the West, provides traffic control and law enforcement duties as well as courier services. All of the WP forces employ similar organisations, and these are a close equivalent to NATO military police. All have some type of distinctive helmet markings. This special winter uniform is issued only to KD personnel and has an artificial fur collar. His sidearm is a *Pistol M*, a DDR copy of the Soviet PM, 9mm Makarov.

B1: Senior seaman, DDR Coastal Frontier Command; summer field service uniform

The Coastal Frontier Command is a component of

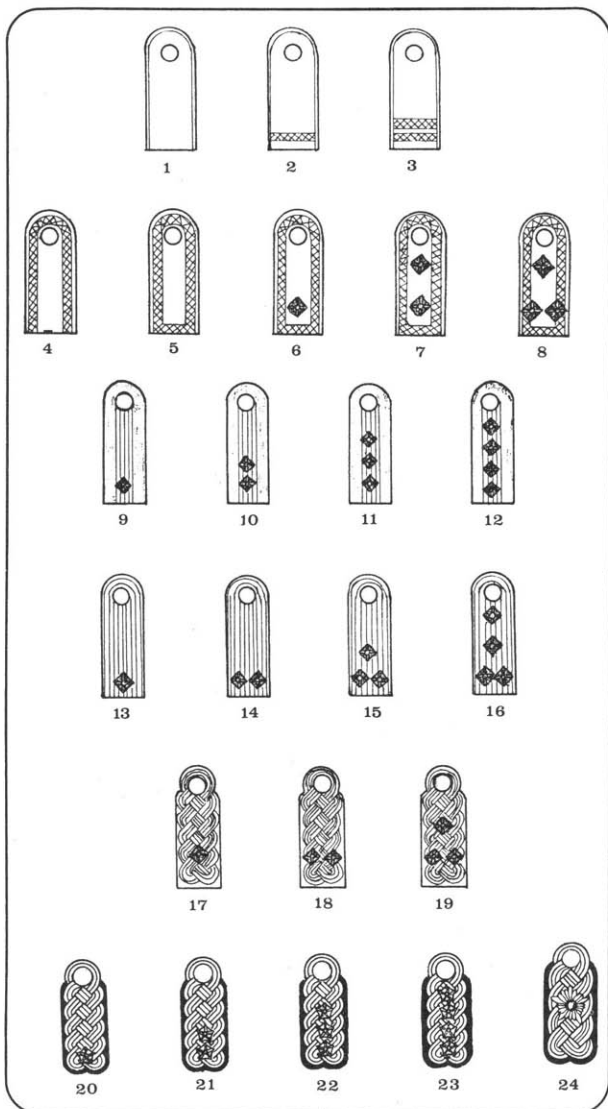

the NVA, but is subordinate to the People's Navy. This *Grenztruppe* wears a standard Navy uniform distinguished by the unfouled anchor of the frontier service skill badge on his left sleeve. The troops are also issued standard Land Force field service uniforms, but sometimes patrol in blues. His weapon is the DDR-made MPiKM assault rifle, 7.62mm short, a copy of the Soviet AKM.

B2: Sergeant, DDR, work suit

A work suit is provided to protect field uniforms when undertaking maintenance and work details. It is often worn by armoured vehicle crewmen and

East German shoulder straps. Enlisted mens' service straps are stone grey, piped in branch colours (see below). Officers' service shoulder cords are backed with a branch-colour underlay. On field straps and cords a common stone grey piping/underlay is used for low visibility and security. NCOs' and officers' braid and stars are silver on service uniform, light grey on field uniform. Ensigns' outer braid is green. Generals' braid is interwoven, one silver strand between two gold. Senior NCOs holding a position equivalent to company first sergeant are rated *Hauptfeldwebel* and wear a single braid strip on their sleeve cuffs. The rank of *Marschall der DDR*, instituted in 1984, is marked by larger shoulder cords than those of generals.

(1) Soldat (private); (2) Gefreiter (corporal); (3) Stabsgefreiter (staff corporal).

(4) Unteroffizier (sergeant); (5) Unterfeldwebel (junior field sergeant); (6) Feldwebel (field sergeant); (7) Oberfeldwebel (senior field sergeant); (8) Stabsfeldwebel (staff field sergeant).

(9) Fähnrich (ensign); (10) Oberfähnrich (senior ensign); (11) Stabsfähnrich (staff ensign); (12) Stabsoberfähnrich (staff senior ensign).

(13) Unterleutnant (junior lieutenant); (14) Leutnant (lieutenant); (15) Oberleutnant (senior lieutenant); (16) Hauptmann (captain).

(17) Major (major); (18) Oberstleutnant (lieutenant-colonel); (19) Oberst (colonel).

(20) Generalmajor (major general); (21) Generalleutnant (lieutenant-general); (22) Generaloberst (colonel-general); (23) Armeegeneral (army general); (24) Marschall der DDR (field marshal).

Branch colours. The East German Army is the only one in the WP which does not use branch of service insignia, retaining instead Germany's traditional system of *Waffenfarben*, displayed as enlisted mens' shoulder strap piping, officers' shoulder cord underlay, and parade tunic cuff patch backing:

White	... Motorised Rifles, Recce Troops
Black	... Engineers, Chemical and all Technical Services
Light grey	... Air Defence Force
Lemon yellow	... Signal Troops
Orange-red	... Parachute Infantry
Pink	... Armour Troops
Bright red	... Ground Force Generals
Crimson	... Ministry for State Security Guard Troops
Raspberry red	... Civil Defence
Brick red	... Artillery, Rocket Artillery, Rocket Weapons Tech, Service
Light blue	... Air Force
Dark blue	... People's Navy
Light Green	... Frontier Troops
Olive green	... Construction Troops
Dark green	... Rear Services (Fuel & Lubricant, Clothing & Equipment, Provisions, Medical, Military Transport), Justice, Finance.

(ILRRPS & MVDDR)

even MR troops undertaking field training. The standard field cap is worn here. He is inspecting a one-shot, throw-away 64mm RPG-18 anti-tank rocket launcher, a Soviet copy of the US M72 light anti-tank weapon (LAW). It is shown in the stored configuration, and must be extended to fire; unlike its US counterpart, however, once it has been extended it cannot be restored to the storage position.

B3: DDR, motorcyclist's protective suit

This new suit is issued to motorcyclists of the Frontier Troops and the Commandant's Service. It's made of a water- and windproof-synthetic fabric and is issued with a new protective helmet and gloves. The motorcycle here is the TS 250/1/A, standard for all NVA elements: green-painted models are used by Frontier Troops, while the Land Force's are olive drab. A saddle bag/pack with entrenching tool is normally attached to the left side, a 5-litre fuel can to the right, and a bedroll behind the double seat. The weapon is the MPiKMS, a DDR-produced copy of the Soviet AKMS.

B4: Private, DDR Commandant's Service; parachutist's/motorcyclist's helmet

This plastic helmet is worn by both motorcyclists and members of Parachute Infantry Battalion 40. Besides the cloth cover shown here, a camouflage net is also available.

C1: Corporal, Czechoslovak Motorised Rifles squad leader; summer field uniform

This 'rain-drop' pattern uniform began to replace the multi-coloured 'clown' pattern in the early 1970s, although the latter is still encountered. On

field uniforms the rank insignia is worn on a chest tab. The helmet was introduced in 1950-51. The assault rifle is the Czechoslovak-designed and produced vz.58Pi fitted with a Soviet NSP-2 infra-red night sight; while similar in appearance to the Soviet AK series rifles, the vz.58 is different internally and functionally.

C2: Czechoslovak summer field cap

The field cap has integral ear and neck protector flaps. The Czechoslovaks habitually wear the grey shirt under the field jacket.

C3: Czechoslovak Motorised Rifles squad machine gunner; winter field uniform

The insulated fur-collared winter uniform is complemented by insulated boots. Not readily

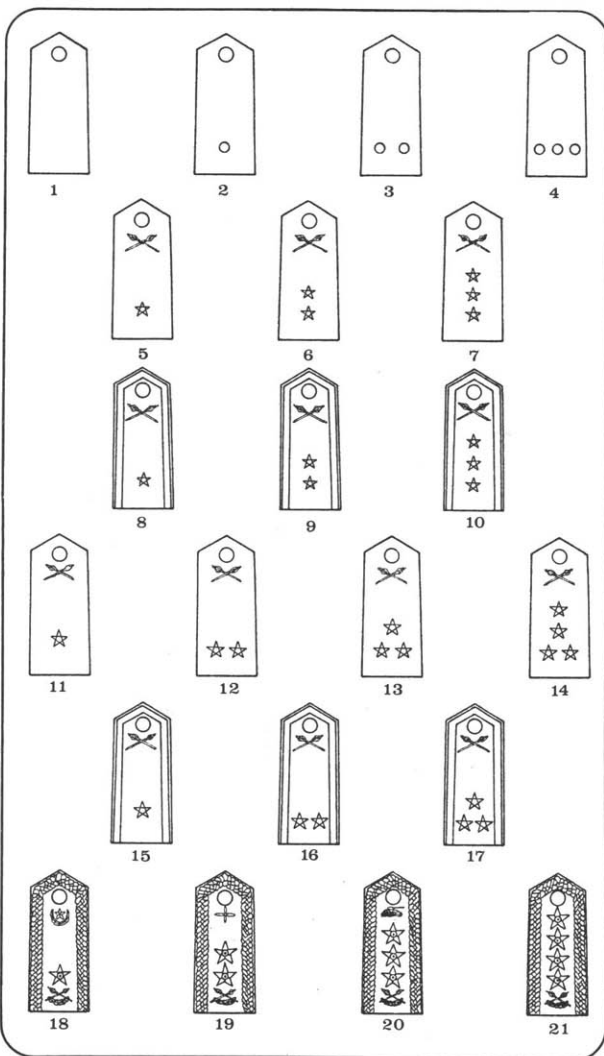

Czechoslovak shoulder straps are khaki-brown, and are worn on service but not on field uniforms. Enlisted mens', NCOs' and ensigns' pips, stars, batons and braid are silver; officers' stars, batons, and braid are gold.

(1) *Vojin* (private); (2) *Svobodník* (senior private); (3) *Desátník* (corporal); (4) *Cetar* (senior corporal).

(5) *Rotný* (junior sergeant); (6) *Rotmistr* (sergeant); (7) *Nadrotmistr* (senior sergeant).

(8) *Podpraporčík* (junior ensign); (9) *Praporčík* (ensign); (10) *Nadpraporčík* (senior ensign).

(11) *Podporučík* (junior lieutenant); (12) *Poručík* (lieutenant); (13) *Nadporučík* (senior lieutenant); (14) *Kapitan* (captain).

(15) *Major* (major); (16) *Podplukovník* (lieutenant-colonel); (17) *Plukovník* (colonel).

(18) *Generálmajor* (major-general); (19) *Generálporučík* (lieutenant-general); (20) *Generálplukovník* (colonel-general); (21) *Armádní Generál* (army general). (ILRRPS)

apparent on the Czechoslovak 'rain-drop' clothing is a very faint mottled pattern which almost appears as water stains. The vz.59L light machine gun, 7.62mm long, began replacing the vz.52/57 in the early 1960s. It can also be mounted on a tripod.

Czechoslovak field uniform ranking is displayed on the right chest on tabs made of uniform cloth. Enlisted mens', NCOs' and ensigns' pips, stars, and braid are dull silver; officers' are dull gold. The key-numbers refer to the same ranks as the previous presentation of shoulder strap ranking. (ILRRPS)

C4: Junior ensign, Czechoslovak tank platoon leader; tanker's suit

The Czechoslovaks, like many other NSW forces, are phasing out tankers' suits and using standard field uniforms in their place. He wears the Soviet-made fabric tankers' helmet, which is in almost universal use by the WP; it has integral earphones and is available in both lightweight summer and fleece-lined winter versions. The '681' on the

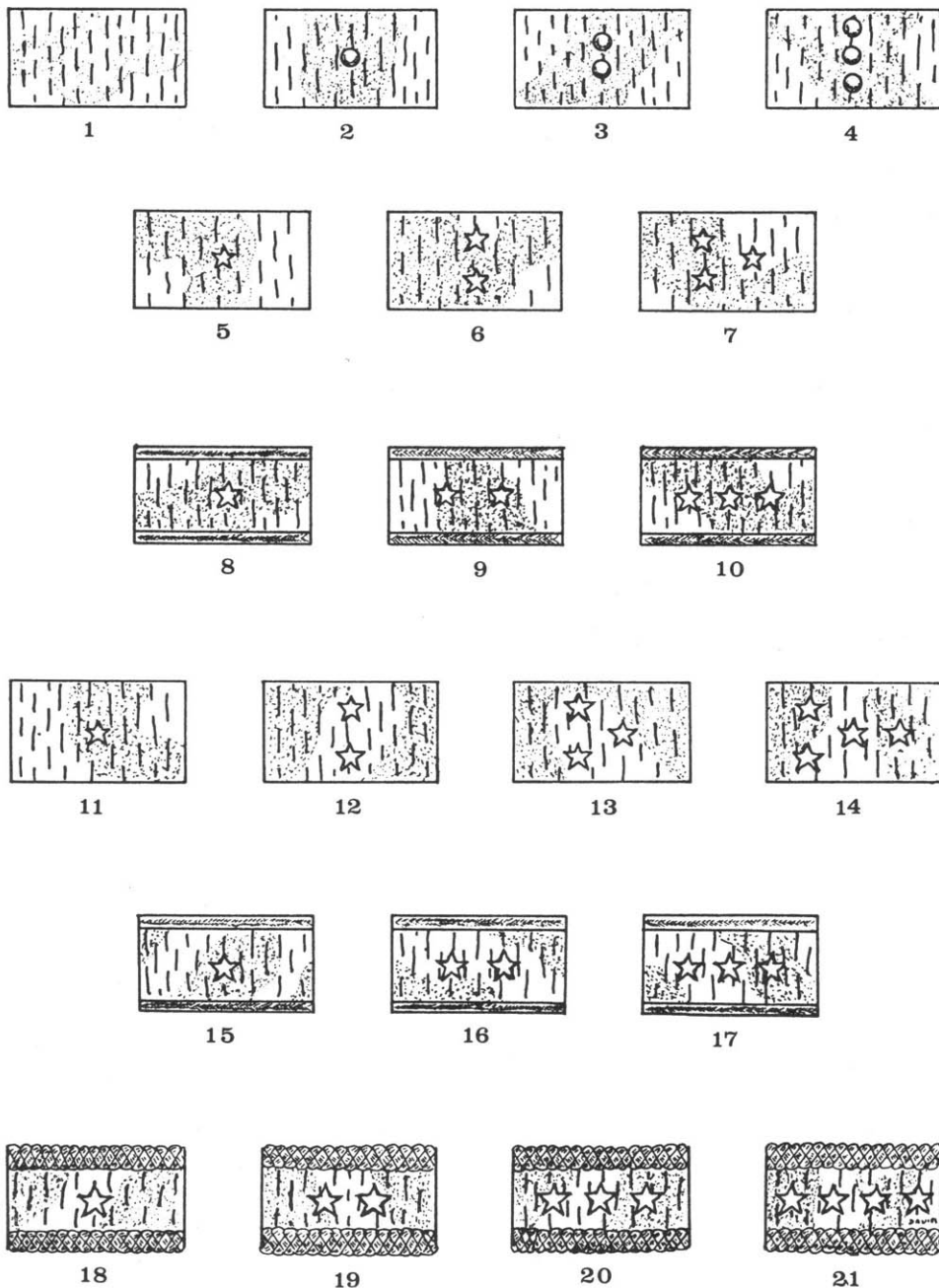



1



2

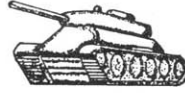

3



4



5



6

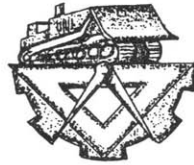

7



8



9



10



11



12



13



14



15

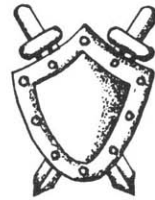

16



17



18



19



20



21



22



23

helmet's brow pad is the tank's tactical number, also displayed on its turret sides. Contrary to popular belief, there is no standard system for tactical vehicle numbering within any given WP army. Different systems are used by different units so as not to provide intelligence information to the enemy. The vz.61 'Skorpion' machine pistol, 7.65mm (.32 ACP) is issued to personnel requiring freedom of movement.

D1: Junior sergeant, Czechoslovak Border Guard; summer service uniform

The Border Guard service uniform is almost identical to that of the Army with minor insignia differences. Czechoslovak border guards usually patrol in Army field uniforms, but when their duties call for them to deal with the public, e.g. at border crossing points, they will often wear the service uniform. This guard is armed with the vz.58V folding stock assault rifle. See K2 for an explanation of the sleeve patch.

D2: Czechoslovak Border Guard, Danube River Patrol; summer service uniform

Czechoslovakia has no Navy, but the Border Guard is responsible for patrolling the Danube River. These personnel are outfitted with naval-style uniforms and employ patrol boats as well as maintaining shore security. This guard's weapon is the vz.58V assault rifle, standard issue for all troops of the Border Guard, and his binoculars are the locally made D-6 type.

D3: Senior private, Czechoslovak Traffic Regulator Troops; winter field uniform

These troops are the equivalent of the DDR's Commandant's Service. This individual is armed with the Czechoslovak-made vz.52 pistol, 7.62mm

Czechoslovak branch insignia are worn by all ranks below generals on the collars of service uniforms; by generals, on shoulder straps. Insignia are gold for all ranks.

(1) Motorised Rifles and General Service; (2) Artillery; (3) Tank Troops; (4) Airborne Troops.

(5) Air Defence and Radio Technical Troops (Air Defence Force); (6) Engineers; (7) Road Construction Troops; (8) Construction Troops.

(9) Rail Transport Troops; (10) Motor Transport Troops; (11) Chemical Troops; (12) Signals Troops.

(13) Fuel & Lubricant Supply Service; (14) Topographical Service; (15) Administration Service; (16) Justice Service.

(17) Medical Service; (18) Military Band; (19) Air Force; (20) Generals' collar insignia.

(21) 'Hradschin Guard' (conceptional); (22) Border Guard (medium green tab); (23) Interior Guard (red star). (ILRRPS)

Tokarev. He is considering the merits of the issue field ration, a colour-coded (to indicate year produced) plastic tube containing three cans of food. While the Czechoslovaks are more innovative in packaging, as with most WP rations, a bread supplement is still required to provide sufficient calories.

E1: Senior corporal, Polish Mechanised Infantry squad grenadier; summer field uniform

The Polish Army began to phase out its version of the 'rain-drop' uniform in the late 1960s; it was replaced by this unique 'worm' pattern. The M-1967 helmet replaced the similar M-1950; the helmet camouflage net has an integral face net normally kept rolled up on the helmet front. The weapon is a Polish-made PMK-60 grenade launcher rifle, a modified AKM. One is issued to each rifle squad and to the crews of major crew-served weapons (artillery, anti-tank guns, etc.). The grenadier is provided with ten-round magazines for the grenade launcher cartridges in addition to the normal 30-round ones. A KGN high explosive grenade is being fitted on the LON-1 launcher. On the crate (from left to right) are the F1/N60 anti-personnel, PGN-60 anti-tank, DGN white smoke, and CGN artillery simulator (for training exercises) rifle grenades.

E2: Lieutenant, Polish summer field cap

A field cap styled after the traditional *rogatywka* is provided to all personnel. Officers' field uniform rank insignia are displayed on slip-on cloth covers.

E3: Senior private, Polish Mechanised Infantry; winter field uniform

Outfitted in complete winter clothing, this rifleman is armed with the Polish-produced PMKM assault rifle, 7.62mm short, a copy of the Soviet AKM. He also has the Czechoslovak-made M-10 protective mask (see Plate J3).

E4: Sergeant, Polish tank commander; tanker's suit

The Polish Army has retained to some degree the tanker's suit, although black work coveralls or standard field uniforms are sometimes worn by tank and other armoured fighting vehicle crews. This cloth suit is of almost an identical design to a now little-worn black leather version. Both the standard

Soviet and a Polish-made tanker's helmet are used. Tank and artillery troops both wear a black beret, sometimes with small versions of rank insignia affixed. He is armed with the Polish P-64 pistol, 9mm Makarov.

F1: Corporal, Polish Army Internal Service; summer field uniform

The obsolete 'rain-drop' pattern uniform, occasionally still encountered, is being worn by this member of the Army Internal Service, the Polish counterpart of the DDR's Commandant's Service. The PM-63 machine pistol, 9mm Makarov, is used by tank crews and other personnel requiring a non-restrictive weapon, but something more substantial than a pistol.

F2: Polish Border Defence Force; snow camouflage suit
This is a typical example of a WP snow camouflage suit. Little ski training is conducted within the WP,

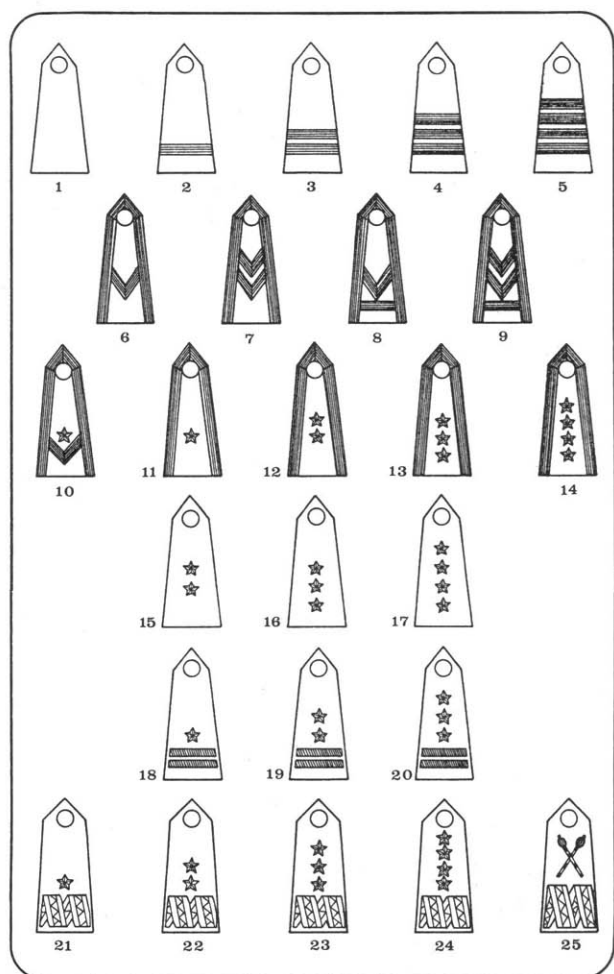

and those troops who do receive training are usually members of mountain, border, or special operations units. This member of the Border Defence Force is armed with the Polish-made PMK assault rifle.

F3: Lieutenant, Polish Contingent, United Nations Emergency Force II, desert uniform

During 1975-79 almost 1,000 Polish troops served with the UN Emergency Force in Egypt's Sinai Desert, and another 100 on the Golan Heights, in the UN Disengagement Observation Force as a buffer between the opposing forces. When first deployed they wore the standard summer field uniform until issued a lightweight desert version. The UN patch, as worn on the cap, was also worn on the left shoulder. The standard US Army helmet liner, painted sky blue with a white 'UN' on both sides and the UN insignia on the front, was also worn. A sky blue beret with the UN patch over the left eye was also used.

G1: Corporal, Bulgarian Motorised Rifles; summer field uniform

The Bulgarian Army has retained this simple uniform basically unchanged since 1936, not adopting a new one until 1970—and few of these have been issued. A national badge is displayed on the right side of the old M-1936 helmet, still very much in use. The older AK-47 assault rifle, 7.62mm short, is still in extensive use.

G2: Private, Bulgarian Motorised Rifles squad machine gunner; winter field uniform

Bulgaria is one of the few WP armies to retain the

Polish shoulder straps are khaki-brown on service uniform and of uniform cloth on field uniform. Officers' field rank insignia are worn on slip-on straps. Stars and braid for all ranks are silver on service uniform and dull white on field uniform.

(1) Szeregowiec (private); (2) Starszy szeregowiec (senior private); (3) Kapral (corporal); (4) Starszy Kapral (senior corporal); (5) Plutonowy (platoon corporal).

(6) Sierzant (sergeant); (7) Starszy Sierzant (senior sergeant); (8) Sierzant Sztabowy (staff sergeant); (9) Starszy Sierzant Sztabowy (senior staff sergeant).

(10) Młodszy Chorazy (junior ensign); (11) Chorazy (ensign); (12) Starszy Chorazy (senior ensign); (13) Chorazy Sztabowy (staff ensign); (14) Starszy Chorazy Sztabowy (senior staff ensign).

(15) Podporucznik (junior lieutenant); (16) Porucznik (lieutenant); (17) Kapitan (captain).

(18) Major (major); (19) Podpulkownik (lieutenant-colonel); (20) Pulkownik (colonel).

(21) General Brygady (general of brigade); (22) General Dywizji (general of division); (23) General Broni (general of arms); (24) General Armii (general of army); (25) Marszałek Polski (marshal of Poland). (ILRRPS)

overcoat for winter wear. The officers' version is double breasted with two rows of buttons. It is also one of the few countries that wear branch of service insignia on the field uniform. The older belt-fed RPD light machine gun, 7.62mm short, replaced by the RPK in most armies, is still used by some Bulgarian units.

Polish branch of service insignia are worn on service uniform collars in silver by all ranks.

- (1) Mechanised Infantry; (2) Artillery; (3) Armour Troops; (4) Engineers.
 (5) Signals; (6) Radio Technical Troops (Air Defence Force); (7) Chemical Troops; (8) Traffic Service.
 (9) Motor Transport Troops; (10) Administration; (11) Topographical Service; (12) Quartermasters.
 (13) Quartermasters/Construction Service; (14) Ordnance; (15) Justice Service.
 (17) Veterinary Service; (18) Army Internal Service; (19) Air Force (red/white national insignia).
 (20) Generals; (21) Marshal of Poland. (ILRRPS)



1



2



3



4



5



6



7



8



9



10



11



12



13

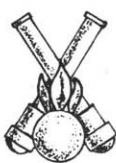

14



15



16



17



18



19



20



21

G3: Junior lieutenant, Bulgarian Motorised Rifles platoon leader; camouflage suit

It is only recently that some Bulgarian conventional units have begun to be issued camouflage suits. This example is a one-piece coverall, but one of a style similar to the standard field uniform is issued to the

Bulgarian enlisted mens' shoulder straps are the same colour as the uniform on which they are worn, and have gold braids (until recently, red). Officers' shoulder board braid is gold (until recently, silver) on service uniform and green on field uniform; stars are silver. Rank titles are transliterated from Bulgarian Cyrillic.

(1) Rednik (private); (2) Efreytor (corporal); (3) Mladshi Serzhant (junior sergeant).

(4) Serzhant (sergeant); (5) Starshi Serzhant (senior sergeant); (6) Starshina (master sergeant).

(7) Mladshi Leytenant (junior lieutenant); (8) Leytenant (lieutenant); (9) Starshi Leytenant (senior lieutenant); (10) Kapitan (captain).

(11) Mayor (major); (12) Podpolkovnik (lieutenant-colonel); (13) Polkovnik (colonel).

(14) General-Mayor (major-general); (15) General-Leytenant (lieutenant-general); (16) General-Polkovnik (colonel-general); (17) Armeyski General (army general). (ILRRPS)

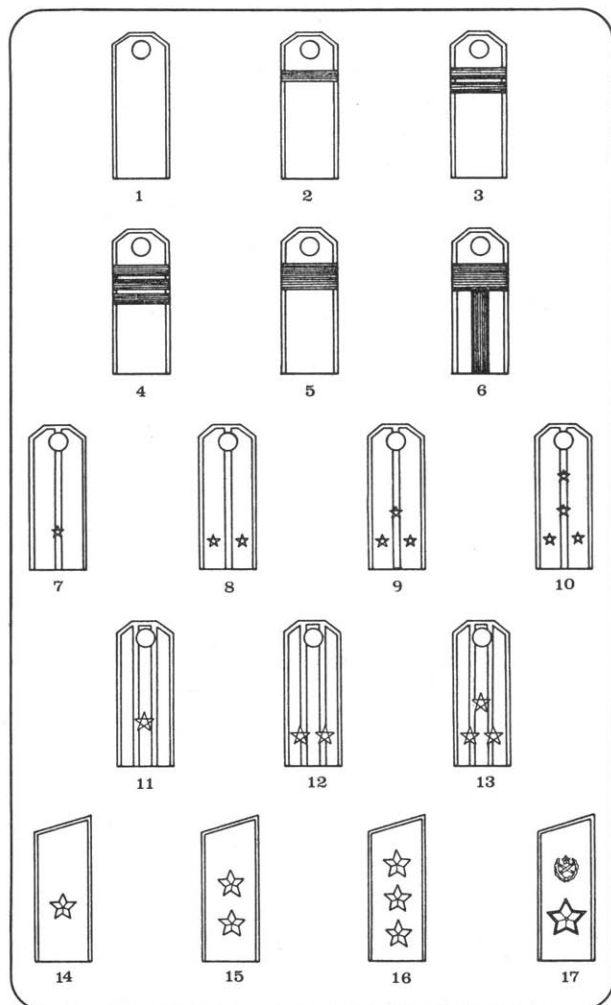

airborne regiment and border units. A new specially padded camouflage suit is also issued to the mountain battalion. Both of these suits have splinter patterns similar to the one illustrated. The field cap has integral ear and neck flaps; there is a winter version for officers, with fur-lined flaps. The Soviet-made R-126 radio is used by most WP forces for communications between platoons dismounted from their APCs and company headquarters. His assault rifle is a Polish-produced copy of the AKS.

G4: Major, Bulgarian Motorised Rifles battalion commander; officer's summer field uniform

Officers wear a summer uniform of a different style and colour than enlisted men. The tunic is a pullover type. The new M-1972 helmet, not yet in general use, is a copy of the Italian M-1933.

H1: Private, Hungarian Motorised Rifles squad grenadier; summer field uniform

The Hungarian Army uses a uniform remarkably similar to the old US Army fatigues in style and colour. Rank insignia are not often worn with this uniform. A simplified shirt is also issued, with only a single left chest pocket and lacking shoulder straps. The helmet was introduced in the early 1950s. Individual equipment is unusual in that the belt is worn through trouser loops and the equipment is suspended by shoulder straps, with smaller items merely hung from the belt. A chemical protective cape is fastened to the bottom of the mask carrier; the cape is sometimes carried attached to the back shoulders of suspenders, when worn. The new Hungarian-made AMP grenade launcher rifle is based on a modified AKM and is allocated one per MR squad; an integral launcher is permanently attached to the rifle, along with a special optical sight. Special ten-round magazines are provided for the launcher cartridges along with standard 30-round ones. He is about to fire a PGK anti-tank grenade, while a PGR anti-personnel grenade awaits its turn.

H2: Senior sergeant, Hungarian summer field cap

This cap follows a traditional pre-World War I Austro-Hungarian design. This cloth-peaked model has replaced the earlier version with a green plastic peak and folding side flaps. Special rank insignia are worn on the left side of the cap.

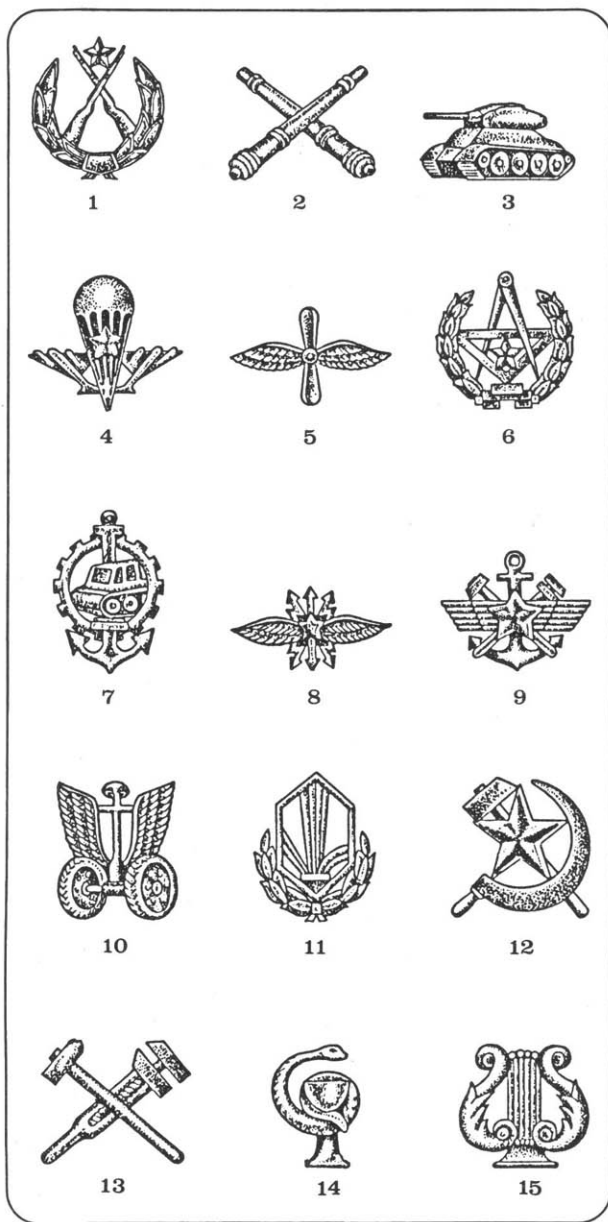

Silver branch insignia is worn on the collars of Bulgarian service uniforms and overcoats by all ranks.

- (1) Motorised Rifles; (2) Artillery; (3) Tank Troops.
 (4) Airborne Troops; (5) Air Force; (6) Construction Troops.
 (7) Engineers; (8) Signals (red star); (9) Rail and Traffic Troops (red star).
 (10) Motor Transport Troops; (11) Chemical Troops; (12) Administration Service (red star).
 (13) Engineer Technical Service; (14) Medical Service; (15) Band.

(UBKWPS)

explosive heads may be unscrewed from their handles, and several heads screwed together end-to-end with a single handle and its detonator to form a demolition charge.

H4: Hungarian Motorised Rifleman; camouflage suit

This one-piece suit is issued to some units and is worn over the standard field uniform. The new Hungarian-made protective mask is somewhat crude by today's standards. The AMD-65 assault rifle is an AMD-63 modified by the use of a shortened barrel incorporating a large flash suppressor and compensator required by the shorter barrel. Since a bayonet cannot be fitted on this weapon, a fighting knife with the same wire-cutting capability as most other AK-type bayonets is issued.

I1: Senior private, Romanian Motorised Rifles squad anti-tank gunner; summer field uniform

The Romanian Army has also retained an older style uniform. This unusual helmet was first adopted in 1938 and was copied from the Dutch M-1923/27; it was dropped from use after World War II, the Soviet SSh-40 being used until the traditional Romanian helmet was re-adopted as the M-1973. Ceremonial units wear a full-colour national badge on the front. The RPG-7V anti-tank rocket launcher is normally allocated one per rifle squad in most WP forces. It is also issued to artillery, rocket, anti-tank gun, air defence gun and missile, and recon vehicle crews, as well as unit headquarters. The backpack contains three PG-7G high explosive anti-tank rockets and their propellant charges. The carrier on the belt is for the PRO-7 optical sight and cleaning tools.

I2: Corporal, Romanian Combat Engineers; winter field uniform

A short overcoat is issued for winter wear. Branch of service is designated on the uniform in the form of coloured collar tabs, edge trimming on the rank

Shirtsleeve order is sometimes worn in the field with the olive green trousers during hot weather.

H3: Senior private, Hungarian Motorised Rifles; winter field uniform

The Hungarian winter uniform is similar in concept to those of most other WP forces. The Hungarian-made AMD-63 assault rifle is an improved version of the AKM; the plastic stock and unusual pistol grips may be found in any number of colours including sky blue, light grey, tan, and various shades of green. The 42M hand grenade, a World War II Hungarian design, is still in use. The

braid, and insignia on the shoulder straps. The flag is used to mark enemy mines. The Romanian-made version of the AKM has a forward pistol grip, and is also issued with an AKMS-type folding stock.

I3: Private, Romanian Motorised Rifles squad machine gunner; camouflage suit

This is the most common of three camouflage colours used on this two-piece suit with attached hood; the others are of the same pattern, but are medium brown and pale violet. They are often issued to MR units. The RPK light machine gun, 7.62mm short, is an off-shoot of the AKM assault rifle, and has generally replaced the RPD machine gun as the standard squad automatic weapon in most WP forces. It uses both 40-round curved box and 75-round drum magazines. Standard 30-round rifle magazines are also compatible.

J: Warsaw Pact CBR equipment:

Most WP chemical, biological, and radiological protective suits and masks and detection, survey,

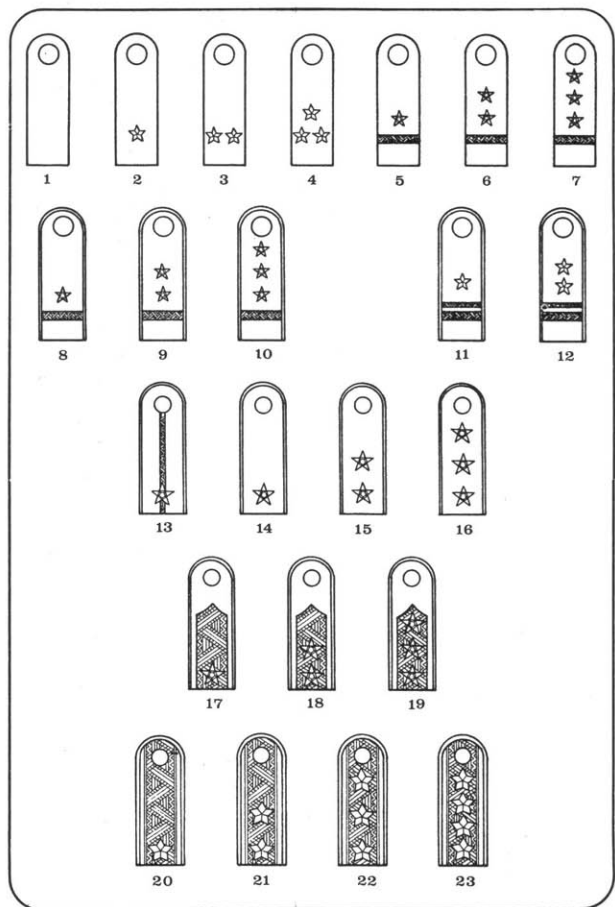

monitoring, and decontamination equipment is produced by the USSR. Over the past few years some countries, particularly the DDR and Czechoslovakia, have begun to manufacture some of their own items, however.

J1: DDR, chemical reconnaissance trooper; light protective suit

The Soviet-designed L-1 light protective suit is issued to chemical recon and decontamination troops. It is a two-piece suit with integral boots, made of rubber-coated fabric. Like all WP protective suits, it is extremely restrictive and uncomfortable during prolonged wear. The Soviet-made MM-1 protective mask is similar to the commonly-issued SchM-41M mask, but has the addition of a voicemitter to allow verbal communication. It is issued to officers, most NCOs, radio operators, and others requiring direct communication. The Soviet-made DP-63A radioactivity indicator is used to detect the presence and intensity of radiation. The contamination marker, known as the 'heavy' flag and topped with a night light, is used to mark all types of CBR contaminated areas. Most countries use flags worded in Russian; the Czechoslovaks employ one marked 'ZAMORENO'—contamination. Contamination report forms are placed in the pocket. A smaller 'light' flag, triangular in shape and without lettering, is also used. His weapon is an MPiKM assault rifle.

The shoulder straps of Hungarian service uniform and summer shirts are khaki-brown, and bear enlisted mens' and NCOs' stars, braid and edge piping in silver; ensigns' stars and piping are gold, the braids silver; lieutenants' and captains' stars and edge piping are gold, except the junior lieutenant's star, which is silver; senior officers' braid and edge piping are gold with silver stars. On field uniform, shoulder straps are olive green with dark brown stars, piping and braid. Junior enlisted ranks no longer wear collar rank insignia. English titles following the traditional Hungarian ranks are equivalent to the 'professional sergeant' grades are equivalent to ensigns.

(1) Honvéd (private); (2) Őrvezető (senior private); (3) Tizedes (corporal); (4) Szakaszvezető (senior corporal); (5) Őrmester (junior sergeant); (6) Törzsőrmester (sergeant); (7) Főtörzsőrmester (senior sergeant).

(8) Őrmester (professional junior sergeant); (9) Törzsőrmester (professional sergeant); (10) Főtörzsőrmester (professional senior sergeant); (11) Zászlós (ensign); (12) Főtörzszászlós (senior ensign).

(13) Alhadnagy (junior lieutenant); (14) Hadnagy (lieutenant); (15) Főhadnagy (senior lieutenant); (16) Százados (captain).

(17) Őrnagy (major); (18) Alezredes (lieutenant-colonel); (19) Ezredes (colonel).

(20) Vezérőrnagy (major-general); (21) Altábornagy (lieutenant-general); (22) Vezérezredes (colonel-general); (23) Hadseregátbornok (army general). (ILRRPS)

J2: Motorised Rifleman; combined arms protective suit
 The OP-1 protective suit is standard issue to most WP forces (the DDR version is the *Modell 61*). Made of the same material as the L-1 suit, it is issued with black rubber gloves, three-finger mittens and overboots made of suit material. Different types of carriers are used, most permitting attachment behind the wearer's shoulders, allowing the suit to be dropped out and donned quickly. It may be worn in a cape, overcoat, or coverall configuration. The Soviet-designed SchM-41M protective mask is by far the most commonly used by the WP, and has changed little since its adoption in World War II. Extremely uncomfortable to wear, the rubber headpiece covers the ears, restricting hearing, and there is no voicemitter. The Soviet-designed IPP decontamination kit (carried in a small pocket on the mask carrier) contains chemical agent decontaminants, nerve agent antidote syrettes, anti-smoke ampules, 'anti-radiation' tablets (which actually only provide nausea relief), scraper sticks and wiping cloths.

J3: Czechoslovak Motorised Rifleman; multi-purpose protective suit

The Czechoslovak-made protective suit is similar to its Soviet equivalent, but is made of polyamide nylon fabric. It has an inflatable waistband bladder allowing it to be used as a flotation device and, like the Soviet version, it can be used as a raincoat, shelter (when two are attached together), or raft. The Czechoslovak-made M-10 protective mask, also adopted by Poland, is an almost exact copy of the US M17 mask. The PKhR-54 chemical agent detection and identification kit is one of several models in use. He is armed with the vz.59P assault rifle.

J4: Polish artilleryman; optical protective mask

The SchMS mask is issued to personnel required to use optical weapons sights and has corrective lens inserted, as well as a voicemitter. The seldom-seen Polish 'panther' camouflage pattern was adopted in the late 1970s, but may no longer be in use.

K: Warsaw Pact shoulder sleeve insignia:

Due primarily to security reasons, few shoulder patches are employed by WP forces. Those that are usually provide nationality identification on service

uniforms, identify internal security organisations, and only rarely identify specific élite units.

K1: Czechoslovak 22nd Parachute Regiment. There are six colour variations of this insignia, introduced in 1962, worn centred on the upper left field uniform sleeve. They are thought to identify: 22nd Para Rgt/Bde (yellow); Diversionary Group (black); Tactical Recon Group (brown); Special Strategic Recon Group (green); Special Anti-tank Group (red); Parachute School (blue).

K2: Czechoslovak sleeve national insignia. This insignia is worn centred on the left upper sleeve of walking-out tunics and overcoats by enlisted men and junior

Hungarian branch insignia are worn in gold on the collars of service uniforms by all ranks.

- (1) Motorised Rifles; (2) Artillery; (3) Tank Troops.
 - (4) Air Force; (5) Engineers, Chemical Troops; (6) Air Defence Troops.
 - (7) Signals (Ground Forces); (8) Signals (Air Force); (9) Motor Transport Troops.
 - (10) Rail Transport Troops; (11) Maintenance Troops; (12) Supply Service.
 - (13) Topographical Service; (14) Justice Service; (15) Medical.
 - (16) Band; (17) Officer Students; (18) Danube Flotilla.
- (UBKWPS)

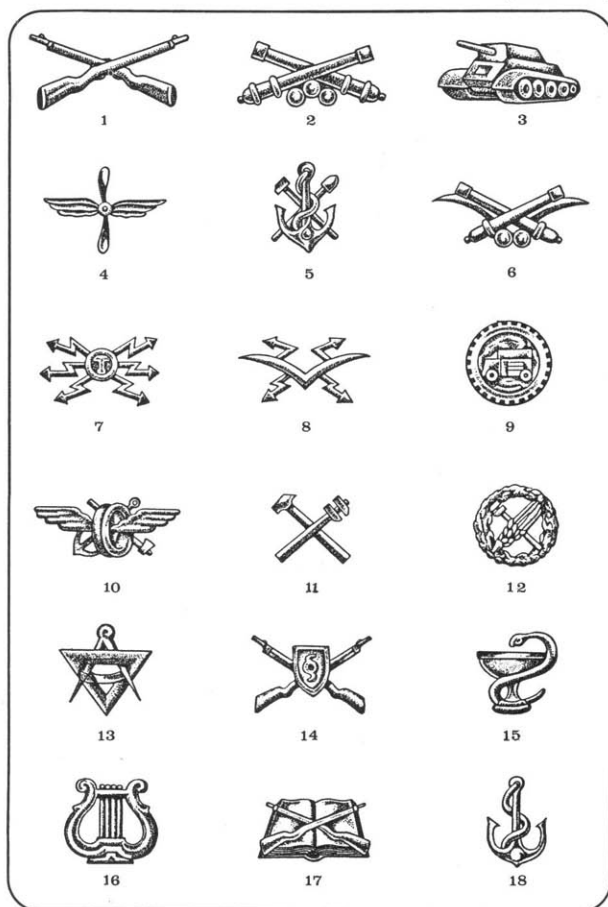

NCOs. It is not an airborne troops' insignia, as sometimes reported. The Border Guards wear the same insignia with a green background.

K3: Czechoslovak chest national insignia. This is the Border Guard version. The Ground Force (and Air Force) version has a khaki background. It is worn only over the right chest pocket of the waist-length summer service jacket by all ranks.

K4: Czechoslovak 'Hradschin Guard'. This insignia is worn centred on the left upper sleeve of service

tunics and overcoats by all except senior officers of the 'Hradschin Guard'. Prague's Hradschin Castle is the Czechoslovak seat of government. The insignia's design is derived from the guard's standard. The lion is the traditional emblem of Bohemia.

K5: Polish 6th 'Pomorska' Air Assault Division. These are but two of the 16 colour combinations of this insignia worn on the upper left shoulder of all uniforms. They identify the division's different battalions and separate companies, although actual identifications are unknown. This series of patches replaced geometrically shaped ones in the early 1960s.

K6: Polish 7th 'Luzucka' Naval Assault Division. This patch is worn by all members of the division on the upper left shoulder of all uniforms.

K7: Polish Border Defence Force Highland Brigade. The Highland, or 'Podhale' WOP Brigade wears this patch on the left shoulder of all uniforms.

K8: Polish Army Representative Company. This honour guard unit is made up of a platoon each from the Ground Force, Air Force, and Navy. The black-background patch is worn on the right shoulder of service uniforms and the brown/khaki version on

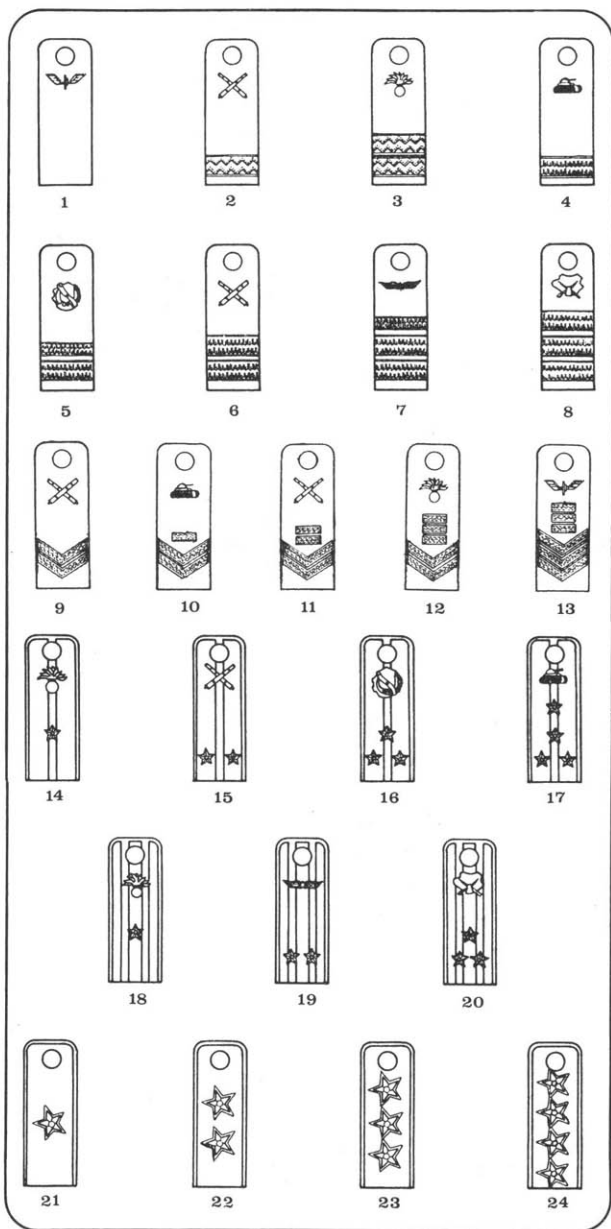

Field shoulder straps of Romanian enlisted men and military masters (i.e. warrant officer/ensign grades) are of the same colour as the uniform. Officers' straps are of the same colour as the uniform, edged and striped with branch colour. Officers' stars are silver; generals', silver edged red (Ground Forces) or medium blue (Air Force). Service uniform straps are in the branch colour, with officers' appearing as an underlay; braid is gold for enlisted and officer ranks, silver for military masters, the braids being edged with branch colour for enlisted ranks and military masters. Buttons are silver for junior enlisted ranks, gold for all others. The officers' straps shown here are the field type; service dress straps, which have braid similar to the Soviet equivalent, are often worn on field uniforms, however.

(1) Soldat (private); (2) Soldat-Fruntas (senior private); (3) Caporal (corporal); (4) Sergeant (sergeant).

(5) Sergent Major (senior sergeant); (6) Plutonier (platoon sergeant); (7) Plutonier Major (senior platoon sergeant); (8) Plutonier Adjutant (adjutant platoon sergeant).

(9)-(12) Mastru Militar Class IVA, IIIA, IIA, IA (warrant officers classes IV to I); (13) Mastru Militar Principal (chief warrant officer).

(14) Sublocotenent (junior lieutenant); (15) Locotenent (lieutenant); (16) Locotenent Major (senior lieutenant); (17) Captain.

(18) Major; (19) Locotenent Colonel (lieutenant-colonel); (20) Colonel.

(21) General Major (major-general); (22) General Locotenent (lieutenant-general); (23) General Colonel (colonel-general); (24) General de Armata (general of the army).



1



2



3



4



5



6



7



8



9



10



11



12



13



14



15



16



17

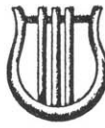

18



19



20



21



22



23

Romanian officers' and warrant officers' shoulder strap branch insignia are silver; those of enlisted ranks, gold. Collar tabs are worn by enlisted men and warrant officers in branch colour. Officers' collar oakleaves are gold, on backing of the branch colour. Ground Forces generals' gold oakleaves are backed with red, those of Air Force generals with medium blue.

Branch colours: Red (motorised rifles, quartermasters, administration, justice, military band); black (artillery, tank, engineers, technical, construction/labour, signals, radio technical, motor and rail transport, chemical); medium blue (Air Force, airborne); medium green (mountain troops); light green (frontier troops); crimson (medical).

(1) Motorised Rifles; (2) Artillery; (3) Tank Troops; (4) Engineers.

(5) Airborne Troops (medium blue canopy, red star, roundel green edged in white); (6) Technical Troops; (7) Construction/Labour Corps; (8) Signals.

(9) Radio Technical Troops (Air Defence Force); (10) Motor Transport; (11) Rail Transport; (12) Quartermasters.

(13) Administration; (14) Chemical Troops; (15) Justice; (16) Mountain Troops.

(17) Medical; (18) Band; (19) Air Force; (20) Frontier Troops.

(21) Officers' collar insignia; (22) Enlisted and warrant officers' collar tab; (23) generals' collar insignia. (UBKWPS)

field uniforms, by all ranks. It replaced a circular khaki brown patch on which was a white point-down sword, a small wreath, and similar wording.

K9: Polish Army Internal Service. The 'WSW' wears this patch centred on the left upper sleeve of service tunics and overcoats.

K10: Hungarian People's Army national insignia. This new insignia has replaced a similar one with 'MN' (*Magyar Néphadsereg*—Hungarian People's Army) in place of the sabres. It is worn by Ground Force conscripts, centred on the upper left sleeve of service tunics and overcoats.

K11: Hungarian Frontier Guard. This is worn on the upper left sleeve of conscripts' service tunics and overcoats. The 'HÖR' means *Hatarörseg*—Frontier Guard.

K12: Bulgarian People's Army national insignia. All ranks (except generals) wear this patch on the upper left sleeve of service tunics and overcoats. The Cyrillic letters transliterate to 'BNA' (*Bulgarska Narodna Armija*—Bulgarian People's Army).

K13: Czechoslovak People's Militia. These patches were introduced on 1 January 1970 replacing a red armband with dark blue letters 'LM' (*Lidové Milice*—People's Militia). The red-background patch is worn centred on the upper left sleeve of service tunics and overcoats. The subdued version is worn in the same position on field uniforms.

K14: DDR Battle Groups of the Working Class. The Battle Groups' patch was introduced in the early 1950s, and is worn centred on the left upper sleeve of field uniforms.

K15: Romanian Patriotic Guard. This patch is worn centred on the upper right field uniform sleeve by this people's militia organisation.

L: Warsaw Pact vehicle insignia:

Insignia vary in size, but most are from eight to 12 inches in height. National insignia are generally placed on the forward sides of turrets and hulls on armoured fighting vehicles. Special unit insignia, if not displayed in place of the national insignia, are

generally placed on the rear sides of the hull. On 'soft-skin' vehicles they are usually displayed on the side doors.

L1: DDR National People's Army. The Frontier Troops add a grass-green border.

L2: DDR Motorised Rifle Regiment 29 'Ernst Moritz Arndt'. This regiment, subordinate to the 8th MR Division, is trained in amphibious operations, and may display this insignia next to the national one.

L3: DDR Parachute Infantry Battalion 40 'Willi Sanger'. This is displayed on vehicle sides and is styled after the parachutist badge.

L4: Hungarian People's Army. This is the only known insignia used by this country.

L5: Czechoslovak People's Army. The relative positions of the colour segments will sometimes be found switched around.

L6: Czechoslovak Traffic Regulator Units. This fairly large insignia is displayed on vehicle hoods.

L7: Czechoslovak 22d Parachute Regiment. This is displayed on vehicle sides and is styled after the parachutist badge. The star may be solid or outlined.

L8: Czechoslovak Border Guards. Depicting the branch of service insignia, this is displayed on vehicle sides.

L9: Current Polish People's Army. This traditional insignia is referred to as the *szachownica* (pronounced 'shakofnitsa'). A square version, sitting on one corner, is also sometimes encountered.

L10: Old Polish People's Army. The 'Piaśt' eagle was replaced in the mid-1960s by L9, having been in use since 1943 by the Soviet-sponsored Polish People's Army (Free Polish units included a crown). A white outline insignia was also used to give a low-visibility alternative.

L11: Polish 6th 'Pomorska' Air Assault Division. This insignia is derived from the unit's shoulder patch.

Black details on red are also used as a subdued insignia.

L12: *Polish 7th 'Luzyczna' Naval Assault Division.* This insignia is derived from the unit's shoulder patch.

L13: *Current Bulgarian People's Army.* This insignia appeared in 1984 replacing L14.

L14: *Intermediate Bulgarian People's Army.* This was used from the late 1970s until 1984 replacing L15.

L15: *Old Bulgarian People's Army.* This was used until the late 1970s.

L16: *Current Romanian Army.* This was introduced in the early 1970s replacing L18.

L17: *Romanian 161st Parachute Regiment.* This insignia is derived from the 1952–55 parachutist badge.

L18: *Old Romanian Army.* This insignia was introduced in 1965 when that nation's name was changed to *Republica Socialistă Romina*—Romanian Socialist Republic.

Notes sur les planches en couleur

A1 Tenue de camouflage mouchetée portée entre 1959 et 1965; aujourd'hui remplacée par le motif Stricheldruck. L'armée est-allemande est la seule armée non soviétique du Pacte de Varsovie qui utilise des bottes montant jusqu'au genou. Remarquer le fusil MiPKMS-72 à monture pliable et la mine anti-chars PM-60. **A2** Le Stahlhelm M56—porté généralement avec un filet—remplacé le modèle soviétique en 1957; son utilisation avait été suggérée en 1944, mais Hitler l'avait rejetée. **A3** Cette tenue d'hiver est aujourd'hui remplacée par celle indiquée en A4. A noter l'équipement d'assaut, avec la couverture roulée dans le 'poncho', le nouveau masque à gaz, la pèlerine de protection chimique portant le harnais, et la mitrailleuse PKM. **A4** Sous-officier de contrôle du trafic portant l'uniforme d'hiver propre à ce service jusqu'à présent.

B1 Le service de patrouille côtière, ou Grenztruppen, porte des uniformes de la marine et de l'armée. **B2** Combinaison de travail souvent portée par les troupes blindées et d'autres armes lors de l'entraînement sur le terrain. Remarquer le képi de campagne de type standard et le lance-fusées anti-chars RPG-18. **B3** Nouvelle tenue délivrée aux motocyclistes des Grenztruppen et du Kommandantendienst, avec casque spécial et gants. **B4** Casque porté par les motocyclistes et les parachutistes du 40. Fallschirmjäger Btl. 'Willy Sanger'.

C1 Ce camouflage 'à gouttes de pluie' a remplacé le motif multicolore du début des années 70; cependant, le motif ancien se rencontre encore quelque fois. Les insignes de rang sont placés sur la poitrine. Le casque a été introduit à partir de 1950/51. Le fusil est le vz.58Pi. **C2** Képi de campagne tchèque pour l'été. **C3** Uniforme d'hiver rembourré et assorti d'un col de fourrure, et bottes rembourrées. Remarquer également la mitrailleuse vz.59L. **C4** De nombreuses forces du Pacte de Varsovie abandonnent peu à peu les tenues particulières à l'équipe des chars, qu'il remplacent par un uniforme de campagne standard. A noter la mitrailleuse vz.61 'Skorpion'.

D1 Les insignes des gardes frontaliers et celles du personnel de l'armée ne diffèrent guère les unes des autres. Le fusil est une arme à monture pliable vz.5V. A noter l'insigne nationale, sur la manche gauche seulement, placée sur le fond vert particulier aux gardes frontaliers. **D2** La Tchécoslovaquie ne possède pas de marine, mais la patrouille frontalière des rivières porte un uniforme de type maritime. **D3** Ce membre de la troupe de contrôle du trafic regarde un lot de rations de campagne; un tube contient trois boîtes.

E1 Depuis la fin des années 60, ce motif de camouflage vermiculé remplace la version polonaise du camouflage 'à gouttes de pluie'. A noter également le casque M1967 avec le filet, destiné à recouvrir le visage, roulé sur le devant du casque. Le fusil lance-grenades PMK-60 est équipé d'un lanceur LON-1, assorti ici d'une grenade explosive KGN. Remarquer aussi, de gauche à droite, des grenades simulatrices F1/N60 anti-personnel, PGN-60 anti-chars, DGN à fumée blanche et CGN d'artillerie. **E2** Képi de campagne d'été, de forme ragatywka traditionnelle. **E3** Fusilier en uniforme d'hiver, armé d'un fusil PMKM. A noter le masque à gaz M10 de fabrication tchèque. **E4** Cette tenue en tissu rappelle fortement l'ancien type en cuir noir, qui a aujourd'hui presque entièrement disparu. Les troupes de chars et d'artillerie portent les unes comme les autres des bérets noirs. Les premières portent parfois un casque polonais différent du type soviétique fréquent.

F1 Remarquer le camouflage 'à gouttes de pluie' aujourd'hui démodé, mais que l'on rencontre encore parfois, et la mitrailleuse PM-63. Ce service est l'équivalent du Kommandantendienst est-allemand. **F2** Tenue de neige caractéristique des

Farbtafeln

A1 Die gefleckte Tarnkleidung der Jahre zwischen 1959 und 1965 wurde jetzt durch dieses Stricheldruck-Muster ersetzt. Als einzige nicht-sovjetsische Armee der Warschauerpakt-Streitkräfte werden in der DDR kniehohe Stiefel getragen. Zu beachten das MiPKMS-72-Gewehr mit Faltschaft, und die Anti-Tankmine PM-60. **A2** Der Stahlhelm M56, meist mit diesem Netz getragen, hat 1957 den sowjetischen Helmtyp ersetzt; er war zuerst schon 1944 vorgeschlagen worden, war aber von Hitler abgelehnt worden. **A3** Diese Winteruniform wird jetzt durch die in A4 gezeigte ersetzt. Zu beachten die Sturmhausrüstung, mit einer aufgerollten Decke im 'Poncho'; eine neue Gasmaske und ein Schutzmantel gegen chemische Waffen mit Tragevorrichtung; und das PKM-Maschinengewehr. **A4** Ein Unteroffizier der Verkehrsregelung in der bisher für diesen Dienst getragenen Winteruniform.

B1 Die Grenztruppen des Küstenwachdienstes erhalten sowohl Marine- wie Infanterieuniformen. **B2** Arbeitsanzug, oft von Panzertruppen und anderen während Feldausbildung getragen; zu beachten Feldkappe und Panzerabwehr-Raketenerwerfer RPG-18. **B3** Neuer Anzug für Motorradfahrer bei Grenztruppen und Kommandantendienst, mit Spezialhelm und Handschuhen. **B4** Helm für Motorradfahrer und Fallschirmjäger des 40. Fallschirmjäger-Btl. 'Willy Sanger'.

C1 Diese 'Regentropfen'-Tarnuniform begann seit Anfang der 70er Jahre das mehrfarbige Muster zu ersetzen, das allerdings immer noch zu sehen ist. Rangabzeichen werden auf der Brust getragen. Der Helm wurde 1950/51 eingeführt. Das Gewehr ist das Modell vz.58Pi. **C2** Tschechoslowakische Sommer-Feldkappe. **C3** Isolierte Winteruniform mit Pelzkragen, und isolierte Stiefel; zu bemerken auch Maschinengewehr vz.59L. **C4** Bei vielen Warschauerpakt-Truppen werden jetzt anstatt spezieller Panzeranzüge Standarduniformen eingeführt. Zu beachten die 'Skorpion'-Maschinenpistole vz.61.

D1 Grenztruppen und Infanterie zeigen nur geringfügige Uniformunterschiede. Das Gewehr ist das Modell vz.58V mit Faltschaft. Auf dem grünen Untergrund der Grenztruppen sind antonale Abzeichen auf dem linken Ärmel zu sehen. **D2** Die Tschechoslowakei besitzt keine Kriegsmarine, aber die Flusswache der Grenztruppen tragen marineähnliche Uniformen. **D3** Dieser Verkehrsregelsoldat besieht sich eine Packung Feldrationen—eine Röhre mit drei Konservendosen.

E1 Seit Ende der 60er Jahre hat dieses 'Wurm'-Tarnmuster die polnische Version des 'Regentropfen'-Tarnmusters ersetzt; man beachte auch den M1967-Helm; das Tarnnetz ist ein Gesichtsnetz verlängert, das normalerweise aufgerollt auf der Helmvorderkante getragen wird. Das Granatwerfergewehr PMK-60 besitzt den Werfer LON-1, hier mit einer KGN-Explosivgranate geladen; man beachte ferner—von links nach rechts—die Gewehrgranaten F1/N60 (Splittergranate), PGN-60 (Panzerabwehr), DGN (weisser Rauch) und CGN (Simulierung von Artillerie). **E2** Sommer-Feldkappe in traditioneller Ragatywka-Form. **E3** Schütze in Winteruniform, mit PMKM-Gewehr; man beachte tschechische M10-Gasmaske. **E4** Dieser Stoffanzug ähnelt stark dem heute fast nicht mehr getragenen aus schwarzem Leder. Sowohl Panzer- wie Artillerietruppen tragen schwarze Kappen; und hier ist ein polnischer Panzersoldatenhelm, unterschiedlich von dem sowjetischen Typ, den man manchmal sieht.

F1 Das jetzt abgeschaffte 'Regentropfen'-Tarnmuster, das immer noch gelegentlich zu sehen ist; und die PM-63-Maschinenpistole. Diese Einheiten entsprechen dem Kommandantendienst in der DDR. **F2** Typischer Schneetarnanzug der Warschauerpakt-Streitkräfte; nur Gebirgs-, Grenz- und andere Spezialtruppen

troupes du Pacte de Varsovie. Seuls les gardes frontaliers, de montagne et certaines troupes spécialisées reçoivent généralement une formation de ski. **F3** Uniforme léger pour le contingent des Nations Unies au Moyen-Orient, avec l'insigne des Nations Unies sur le képi et l'épaule gauche. Le béret UN bleu pale et la doublure bleue du casque américain furent tous deux transmis aux troupes polonaises.

G1 Ce simple uniforme est à peu près le même qu'en 1936 et peu d'exemplaires du nouveau modèle de 1970 ont été fabriqués. Le casque de 1936, avec une insigne nationale du côté droit, est toujours fréquent. **G2** Bizarrement, la Bulgarie conserve la capote pour la tenue de campagne hivernale et appose des insignes indiquant l'arme du service sur l'uniforme de campagne. Certaines unités utilisent encore la mitraillette RPD. **G3** Uniforme de camouflage en une seule pièce, de fabrication récente; les unités frontalières ou aéroportées utilisent également cet uniforme, mais en deux pièces. A noter la copie, réalisée en Pologne, du fusil AKS et la radio de peloton R-126. **G4** Les officiers portent cet uniforme d'été différent, avec une tunique qui s'enfile par la tête. Le casque M1972, dont il n'existe encore que peu d'exemplaires, est une copie du type italien M2933.

H1 Habillé d'un uniforme très semblable aux anciens modèles de l'armée des Etats-Unis, ce soldat s'apprete à lancer une grenade PGK avec son fusil lance-grenades AMP. L'arrangement de l'équipement est inhabituel, la plupart des objets étant suspendus à des lanières retenues aux épaules et les petits objets étant placés dans le ceinturon, qui est porté dans le pantalon. A noter le masque à gaz, et la pèlerine de protection chimique. **H2** Képi de campagne d'été; modèle hongrois traditionnel, qui remplace désormais le modèle assorti d'une visière en plastique verte. Les insignes de grade sont portées sur le côté gauche. **H3** Le fusil hongrois AMD-63 a une monture en plastique et une crosse inhabituelle qui existent en plusieurs couleurs: gris, brun, vert et même bleu clair. **H4** Tenue de camouflage en une seule pièce que les soldats portent par-dessus l'uniforme de campagne normal. Remarquer le fusil raccourci AMD-65.

I1 L'uniforme roumain de style ancien est toujours utilisé. Le casque M1938, copié sur le M1923/27 néerlandais, repris du service à partir de 1973. A noter le lanceur de fusées RPG-7V et sa boîte de munitions portée sur le dos. Les visières et les outils sont portés dans un ceinturon. **I2** La courte capote d'hiver. L'arme du service est indiquée par la couleur des pattes du collet, le bord du galon de rang et l'insigne des pattes d'épaule. A noter l'AKM roumain avec crosse frontale. **I3** La plus commune des trois combinaisons de couleur remarquées pour cette tenue de deux pièces assortie d'un capuchon; les autres sont le brun et le parme.

J1 Tenue de protection L-1 de conception soviétique. Masque de protection M-1, avec un dispositif permettant au soldat de parler de manière audible; délivré aux officiers, aux sous-officiers, aux radios, etc. Indicateur de radioactivité DP-63A, et drapeau dit 'de forte contamination', avec lampe nocturne et poche destinée à renfermer le rapport de contamination. **J2** La tenue OP-1, délivrée de manière générale à toutes les armées du Pacte de Varsovie, peut faire office de pèlerine, de surtout ou de capote, selon qu'elle est arrangée ou boutonnée de telle ou telle façon. Le masque de protection standard SchM-41M a peu changé depuis la Deuxième Guerre mondiale. **J3** Cette tenue de fabrication tchécoslovaque est identique au modèle soviétique, mais réalisée dans un matériau différent. Elle comprend une bouée gonflable à la taille qui peut faire office de dispositif de flotaion. Le masque M-10 de fabrication tchécoslovaque est utilisé également par la Pologne. L'équipement de détection chimique PKhR-54 est l'un des nombreux modèles utilisés à l'heure actuelle. **J4** Le masque SchMS est assorti d'appareils d'audition et de vision de qualité pour les soldats qui emploient des visières d'arme complexes. La tenue de camouflage polonaise 'panthère', qui date de la fin des années soixante-dix, n'est peut-être plus en usage aujourd'hui.

K1 Différentes sous-unités utilisent des couleurs de fond différentes; le jaune désigne les unités de tir. **K2** Manche gauche supérieure de l'uniforme de service, pour privés et sous-officiers uniquement. Remarquer qu'il s'agit là d'une insigne nationale et non d'une insigne des troupes aéroportées. **K3** Version pour gardes frontaliers. Les troupes de l'armée la portent sur un fond kaki; portée sur la poitrine droite de la tunique de service estivale, par tous les rangs. **K4** Manche gauche supérieure de l'uniforme de service, tous rangs confondus, à l'exception des officiers supérieurs. **K5** Deux des seize combinaisons de couleur identifiant les différentes sous-unités et portées sur l'épaule gauche de tous les uniformes. **K6** Epaule gauche, tous uniformes, tous rangs. **K7** Epaule gauche, tous uniformes, tous rangs. **K8** Cette unité de garde d'honneur est composée de personnes provenant des trois services armés. L'insigne à fond noir est portée sur l'épaule droite de l'uniforme de service, et celle à fond kaki sur la tenue de campagne. **K9** Manche supérieure gauche de l'uniforme de service. **K10** Nouvelle insigne portée par les conscrits de l'armée; manche supérieure gauche de l'uniforme de service. **K11** Manche supérieure gauche de l'uniforme de service pour tous les rangs en dessous de celui de général. **K13** Insigne de 1970 portée sur la manche supérieure gauche de l'uniforme de service (fond rouge) et de l'uniforme de campagne (fond brun). **K14** Manche supérieure gauche de l'uniforme de campagne. **K15** Manche supérieure droite de l'uniforme de campagne.

L1 Les troupes frontalières ajoutent une bordure verte. **L2** Cette unité, qui fait partie de la 8^e Division de tir motorisée, est entraînée à la guerre amphibie. **L3** Figurant des deux côtés des véhicules. **L4** Seule insigne de véhicule hongroise connue. **L5** Les positions relatives des segments de couleur sont parfois inversés. **L6** Grande insigne placée sur les capots des véhicules. **L7** Insigne remarquée sur les côtés des véhicules et composée d'une étoile pleine et parfois vide. **L8** Vue sur les côtés des véhicules. **L9** Appelée szachownica, cette insigne est présentée parfois sous la forme d'un losange. **L10** L'insigne 'Piast' disparue au milieu des années soixante. **L11** Remarquée également avec des détails noirs sur fond rouge, pour une faible visibilité. **L12** Dérivée de l'insigne d'épaule de la division, de même que **L11**. **L13** Version 1984. **L14** Version de la fin des années soixante-dix. **L15** Version utilisée jusqu'à la fin des années soixante-dix. **L16** Version du début des années soixante-dix. **L17** Dérivée de l'insigne de parachutistes de 1952-55. **L18** Version utilisée entre 1965 et le début des années soixante-dix.

werden gewöhnlich als Schifahrer ausgebildet. **F3** Leichtuniform für UN-Truppen im Nahostinsatz, mit UN-Abzeichen an Kappe und linker Schulter. Hellblaue UN-Kappe und blaugestrichener amerikanischer Helm wurden an die polnischen Truppen ausgegeben.

G1 Diese schlichte Uniform blieb seit 1936 praktisch unverändert; wenige der neuen Modelle von 1970 wurden ausgegeben. Der Helm von 1936, mit Nationalabzeichen an der rechten Seite, ist immer noch viel zu sehen. **G2** In Bulgarien wird ungewöhnlicherweise im Winter immer noch der lange Mantel zur Winteruniform getragen, ebenso Truppengattungsabzeichen an der Felduniform. Das RPD-Maschinengewehr wird von einigen Einheiten noch immer benutzt. **G3** Neue einteilige Tarnuniform; Grenz- und Luftwaffeneinheiten tragen auch zweiteilige Versionen. Man beachte polnische Version des AKS-Gewehrs und das R-126-Funkgerät. **G4** Offiziere tragen diese andersartige Sommeruniform mit 'Pullover'-Bluse. Der M1972-Helm, noch nicht weithin ausgegeben, ist eine Kopie des italienischen Helms M1933.

H1 In einer früheren US-Modellen sehr ähnlichen Uniform ist er im Begriffe, mit seinem AMP-Granatwerfergewehr eine PGK-Granate abzuschießen. Üblich ist die Ausrüstungsanordnung—die meisten Gegenstände an Schulterriemen, kleinere Gegenstände am Gürtel, in den Hosentaschen getragen. Man beachte die Gasmaske mit chemischer Schutzvorrichtung. **H2** Sommer-Feldkappe in traditionellem ungarischen Design; dieses Modell hat jetzt das frühere mit grünem Plastikschirm ersetzt. Rangabzeichen werden auf der linken Seite getragen. **H3** Das ungarische Gewehr AMD-63 hat einen Kunststoffschiff und ungewöhnliche Pistolengriffe, oft in den verschiedensten Farben—grau, braun, grün und sogar hellblau. **H4** Einteiliger Tarnanzug, über der Felduniform getragen. Man beachte das verkürzte Gewehr AMD-65.

I1 Die alte rumänische Uniform wird immer noch getragen. Der Helm M1938, dem holländischen Helm M9123/27 nachgebaut, kam etwa 1973 wieder in Einsatz. Man beachte Granatwerfer RPG-7V mit der am Rücken getragenen Munitionspackung; Visier und Werkzeuge werden am Gürtel getragen. **I2** Der kurze Wintermantel. Waffengattung wird durch Farbe der Kragenaufschläge gekennzeichnet, sowie durch Einfassung der Rangabzeichen und die Insignien auf Schulterriemen. Man beachte die rumänische AKM mit vorderem Pistolengriff. **I3** Die häufigste von drei Farbkombinationen ist auf diesem zweiteiligen Anzug mit Kapuze zu sehen; die anderen sind mittelbraun und hellviolett.

J1 Von den Sowjets entworfener Schutzanzug L-1; Schutzmaske M-1 mit Vorrichtung für vernehmbares Sprechen, ausgegeben an Offiziere und Unteroffiziere, Funker usw. Radioaktivitätsanzeiger DP-63A; und die Markierungsflagge für sogenannte schwere Strahlenversuchung, mit Nachtlampe und Tasche für Versuchungsdokument. **J2** Anzug OP-1, Standardausgabe für die meisten Warschauptakt-Armeen, kann als Umhang, Overall oder 'Mantel' getragen werden, je nach Anordnung und Knöpfung. Die Standard-Schutzmaske SchM-41M ist seit dem 2. Weltkrieg kaum verändert. **J3** Dieser tschechische Anzug ähnelt dem sowjetischen, ist aber aus anderem Stoff. Er verfügt über einen aufblasbaren Teil um die Taille zur Verwendung als Schwimmweste. Die tschechische M-10-Maske wird auch in Polen verwendet. Der Detektorsatz für chemische Waffen PKhR-54 ist einer von mehreren verwendeten. **J4** Die Maske SchMS hat überlegene Sprech- und Sichtvorrichtungen für Soldaten, die komplexe Zielvorgrichtungen benutzen. Der polnische 'Panther'-Tarnanzug der späten 70er Jahre dürfte nicht mehr verwendet werden.

K1 Verschiedene Untereinheiten verwenden verschiedene Grundfarben: gelb für die Schützeneinheiten. **K2** Auf dem linken Oberarm der Dienstuniform, nur Soldaten und Unteroffiziere; man beachte, dass es sich hier nationale Insignien handelt, nicht um die von Luftwaffenpersonal. **K3** Grenztruppen-Version—Infanterieeinheiten tragen das auf Khakiuntergrund; getragen auf der rechten Brustseite der Sommer-Dienstbluse von allen Rängen. **K4** Auf dem linken Oberarm der Dienstuniform—alle Ränge ausser hohe Offiziere. **K5** Zwei von 16 Farbkombinationen, die verschiedene Untereinheiten kennzeichnen, getragen auf der linken Schulter aller Uniformen. **K6** Linke Schulter, alle Uniformen und Ränge. **K7** Linke Schulter, alle Uniformen und Ränge. **K8** Diese Ehrenwache-Einheit wird aus allen drei Waffengattungen ausgewählt; der schwarze Grundfarbenaufschlag wird auf der rechten Schulter der Dienstuniform getragen, der Khaki-Aufschlag auf der Felduniform. **K9** Linker Oberarm der Dienstuniform. **K10** Neues Abzeichen für Armeeerkuten, getragen auf dem linken Oberarm der Dienstuniform. **K11** Linker Oberarm der Rekrutenuniform. **K12** Linker Oberarm der Dienstuniform—alle Ränge unter dem General. **K13** Abzeichen von 1970, am linken Oberarm der Dienstuniformen (auf rotem Grund) sowie der Felduniformen (auf grauem Grund). **K14** Linker Oberarm der Felduniform. **K15** Rechter Oberarm der Felduniform.

L1 Für Fronttruppen kommt eine grasgrüne Umrandung hinzu. **L2** Diese Einheit der 8. Motorisierten Schützendivision, wird in amphibischer Kriegführung ausgebildet. **L3** Auf beiden Seiten des Fahrzeugs angebracht. **L4** Das einzige bekannte ungarische Fahrzeugabzeichen. **L5** Die Lage der farbigen Segmente zueinander ändert sich manchmal. **L6** Gross auf der Kühlerhaube von Fahrzeugen angebracht. **L7** An den Seiten der Fahrzeuge zu sehen, manchmal mit vollem Stern, manchmal nur dessen umrisse. **L8** An den Seiten der Fahrzeuge zu sehen. **L9** Als *Szachownica* bekannt, erscheint manchmal diamantförmig. **L10** Das 'Piast'-Abzeichen, in den 60er Jahren langsam abgeschafft. **L11** Oft auch schwarz auf rotem Grund—zwecks geringer Sichtbarkeit. **L12** Vom Schulteraufschlag der Division abgeleitet, wie **L11**. **L13** Version von 1984. **L14** Version Ende der 70er Jahre. **L15** Version bis Ende der 70er Jahre. **L16** Version Anfang der 70er Jahre. **L17** Abgeleitet vom Fallschirmjägerabzeichen 1952-55. **L18** Die von 1965 bis Anfang der 70er Jahre verwendete Version.

OSPREY · ELITE SERIES

A new series of books on the history, organisation, appearance and equipment of famous fighting men of the past and present; and on other aspects of military history which demand fuller and more flexible coverage than appropriate within our established MEN-AT-ARMS series. The ELITE titles follow the popular Men-at-Arms format, but with extended text and captions; more than 50 photographs and diagrams; and 12 full-colour plates.

Also available:

- E1 The Paras: British Airborne Forces 1940-84**
- E2 The US Marine Corps since 1945**
- E3 The Vikings**
- E4 US Army Special Forces 1952-84**
- E5 Soviet Bloc Elite Forces**
- E6 French Foreign Legion Paratroops**
- E7 The Ancient Greeks**
- E8 Israeli Defense Forces since 1973**
- E9 The Normans**

COMPANION SERIES:

MEN-AT-ARMS

An unrivalled source of authentic, detailed and attractively presented information on the history and appearance of the world's fighting men. Each 48-page book includes a concise text; some 40 photographs and diagrams; and eight pages of full-colour artwork. Acclaimed internationally for their range and good value, the books cover subjects from Ancient Egypt to the armies of the 1980s. Of more than 160 titles published since 1971, nearly 100 are still in print, representing the work of the most respected writers, researchers and artists from many countries.

VANGUARD

This series, following the same format as the Men-at-Arms books, describes key units and weapons systems of 20th century warfare, with a strong emphasis on armoured equipment and operations. Drawing upon rare documentary sources and personal testimony, VANGUARD titles concentrate upon the tactical and human aspects, rather than the drily technical. Subjects include important vehicles, unit histories, campaigns and colour schemes; and the full-colour plates are prepared with the modeller in mind. Of 42 titles published, more than 30 are in print.

GORDON L. ROTTMAN entered the US Army in 1967, volunteering for Special Forces, and completed training as a weapons specialist in 1968. He was assigned to the 7th Special Forces Group until being reassigned to the 5th Special Forces Group in Vietnam in 1969-70. He entered the Texas Army National Guard in 1974 and was the full-time Operations Sergeant in the 2nd Bn., 143rd Infantry, 36th Airborne Brigade until 1980 when he assumed a similar position

with Co. G (Ranger), 143rd Inf. where he currently serves. Sgt. First Class Rottman is a graduate of the Jumpmaster, Air/Ground Operations, Operations and Training Specialist, Advanced NCO, Winter Operations Instructor, and German International Long Range Reconnaissance Patrol Courses. He currently resides in Houston, Texas with his wife and five children.

ISBN 0-85045-730-0



9 780850 457308