

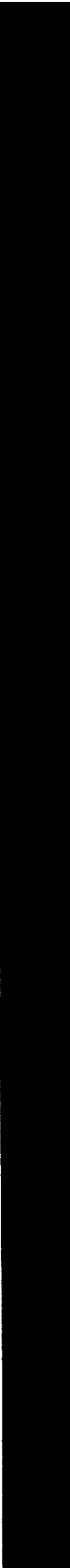

Personal System/2®
Micro Channel™ SCSI Adapter
with Cache
Technical Reference



First Edition (March 1990)

The following paragraph does not apply to the United Kingdom or any country where such provisions are inconsistent with local law: INTERNATIONAL BUSINESS MACHINES CORPORATION PROVIDES THIS PUBLICATION "AS IS" WITHOUT WARRANTY OF ANY KIND, EITHER EXPRESS OR IMPLIED, INCLUDING, BUT NOT LIMITED TO, THE IMPLIED WARRANTIES OF MERCHANTABILITY OR FITNESS FOR A PARTICULAR PURPOSE. Some states do not allow disclaimer of express or implied warranties in certain transactions, therefore, this statement may not apply to you.

This publication could include technical inaccuracies or typographical errors. Changes are periodically made to the information herein; these changes will be incorporated in new editions of the publication. IBM may make improvements and/or changes in the product(s) and/or the program(s) described in this publication at any time.

It is possible that this publication may contain reference to, or information about, IBM products (machines and programs), programming, or services that are not announced in your country. Such references or information must not be construed to mean that IBM intends to announce such IBM products, programming, or services in your country.

Requests for technical information about IBM products should be made to your IBM Authorized Dealer or your IBM Marketing Representative.

IBM may have patents or pending patent applications covering subject matter in this document. The furnishing of this document does not give you any license to these patents. You can send license inquiries, in writing, to the IBM Director of Commercial Relations, IBM Corporation, Armonk NY 10504.

IBM and Personal System/2 are registered trademarks of the International Business Machines Corporation.

Micro Channel is a trademark of the International Business Machines Corporation.

© Copyright International Business Machines Corporation 1990. All rights reserved. Note to US Government Users — Documentation related to restricted rights — Use, duplication or disclosure is subject to restrictions set forth in GSA ADP Schedule Contract with IBM Corp.

Contents

Description	1
Adapter Components	3
Disk Cache	3
Adapter Microprocessor	3
SCSI Bus Controller	3
Cache and Data Flow Controller	4
Adapter BIOS and POST	4
System Interface/Bus Master DMA Controller	4
Statement of Conformance	5
Alternatives	5
Level of Conformance	5
Implemented Options	5
Supported Devices	6
Supported SCSI Commands	6
Supported SCSI Messages	7
Device Requirements for POST Support	7
Programmable Option Select	8
POS Registers 0 and 1 (Hex 0100 and 0101)	9
POS Register 2 (Hex 0102)	9
POS Register 3 (Hex 0103)	11
POS Register 4 (Hex 0104)	12
Adapter-to-System Interface	12
Command Interface Registers (Hex 00 - 03)	13
Attention Register (Hex 04)	14
Basic Control Register (Hex 05)	16
Interrupt Status Register (Hex 06)	17
Basic Status Register (Hex 07)	19
Resetting the Adapter	20
Command Processing	21
Subsystem Control Blocks	24
System Interface	27
Abort	28
Assign	29
Device Inquiry	30
Device Inquiry Data Block	31
DMA Pacing Control	31
Feature Control	32
Format Prepare	33
Format Unit	33

Get Command Complete Status	36
Command Complete Status Block	36
Get POS and Adapter Information	42
POS and Adapter Information Status Block	42
Read Data	45
Read Device Capacity	46
Device Capacity Data Block	46
Read Prefetch	47
Read Verify	48
Reassign Block	49
Reassign Block Defect List	49
Request Sense	50
Sense Data Block	51
Extended Sense Data Block	52
Reset	54
Send Other SCSI Command	55
Write Data	56
Write with Verify	57
Error-Recovery Procedures	58
Adapter-Error Recovery	58
Data Error	58
Positioning Error	59
SCSI-Bus Parity Error	59
Operational Time-Outs	60
System-Error Recovery	60
Compatibility	65
Commands	65
Rejected Commands	65
Command Options	66
Interrupts	68
Other Differences	69
SCB Enable Word 1	69
SCB End Status Word 1	70
SCB Command Status Register	71
SCB Subsystem Control Register	72
SCB Immediate Command Format	73
Device Signals	76
Connectors	78
Index	83

Figures

1.	Adapter Block Diagram	2
2.	SCSI Commands	6
3.	SCSI Messages	7
4.	POS Register Selection	8
5.	POS Register 2 (Hex 0102)	9
6.	ROM Segment Address Select	9
7.	Adapter I/O Address Select	10
8.	POS Register 3 (Hex 0103)	11
9.	POS Register 4 (Hex 0104)	12
10.	I/O Registers	12
11.	Register Content for SCB	13
12.	Register Content for Immediate Command	13
13.	Attention Register	14
14.	Request Codes	14
15.	Basic Control Register	16
16.	Interrupt Status Register	17
17.	Interrupt ID Table	18
18.	Adapter Device Selection Defaults	18
19.	Basic Status Register	19
20.	Adapter Reset Status	21
21.	Issuing a Command	22
22.	Processing an Interrupt	23
23.	Subsystem Control Block Structure	25
24.	Enable Options	25
25.	Adapter Command List	27
26.	Abort Command	28
27.	Assign Command	29
28.	Device Inquiry Command	30
29.	Device Inquiry Data Block	31
30.	DMA Pacing Control Command	31
31.	Device Data-Transfer Rate	32
32.	Feature Control Command	32
33.	Format Prepare Command	33
34.	Format Unit Command	33
35.	Defect List Block Format	35
36.	Get Command Complete Status Command	36
37.	Command Complete Status Block	37
38.	SCB End Status	37
39.	Word 1 - Retry Counts	38

40.	Command Status Codes	39
41.	Device Status Byte	39
42.	Bits 4 - 1 Device Status Code	39
43.	Bits 15 - 8 Command Error Code	40
44.	Bits 7 - 0 Device Error Code	40
45.	Cache-Read Hit Ratio	41
46.	Bits 15 - 8 Cache Status	41
47.	Get POS and Adapter Information Command	42
48.	POS and Adapter Information Status Block	42
49.	Channel Connector Size	43
50.	Read Data Command	45
51.	Read Device Capacity Command	46
52.	Device Capacity Data Block	46
53.	Read Prefetch Command	47
54.	Read Verify Command	48
55.	Reassign Block Command	49
56.	Reassign Block Defect List	49
57.	Request Sense	50
58.	Sense Data Block	51
59.	Extended Sense Data Block	52
60.	Sense Key	52
61.	Reset Command	54
62.	Send Other SCSI Command	55
63.	Write Data Command	56
64.	Write with Verify Command	57
65.	SCSI Command ERP Table	61
66.	Adapter Command ERP Table	62
67.	SCB Enable Word 1	69
68.	SCB End Status Word 1	70
69.	SCB Command Status Register	71
70.	SCB Subsystem Control Register	72
71.	SCB Immediate Command Format	73
72.	SCSI Internal Connector Pin Assignments	78
73.	SCSI External Connector Pin Assignments	79
74.	60-Pin External Connector, Front View	80
75.	60-Pin External Connector, Side View	81

Description

The IBM® Personal System/2® Micro Channel™ SCSI Adapter with Cache serves as the interface between systems using the Micro Channel architecture and devices using Small Computer System Interface (SCSI) architecture.

The adapter supports:

- A broad range of internal and external SCSI devices.
- Up to seven SCSI physical devices. Each physical device can support eight logical devices.
- Overlapped command processing for up to 15 devices.
- Devices compatible with SCSI Common Command Set.
- A data transfer rate of up to 5 million bytes-per-second from the adapter to external devices.
- A data transfer rate of up to 16.6 million bytes-per-second from the adapter to the system (burst rate).
- A 16- or 32-bit data bus (automatically configurable).
- A 24- or 32-bit address bus (automatically configurable).

The adapter also serves as a bus master (intelligent bus controller).

Warning: In this technical reference, the term "Reserved" describes certain signals, bits, and registers that should not be changed. Use of reserved areas can cause compatibility problems, loss of data, or permanent damage to the hardware. When the contents of a register are changed, the state of the reserved bits must be preserved. When possible, read the register first and change only the bits that must be changed.

IBM and Personal System/2 are registered trademarks of the International Business Machines Corporation.

Micro Channel is a trademark of the International Business Machines Corporation.

The following is a block diagram of the adapter.

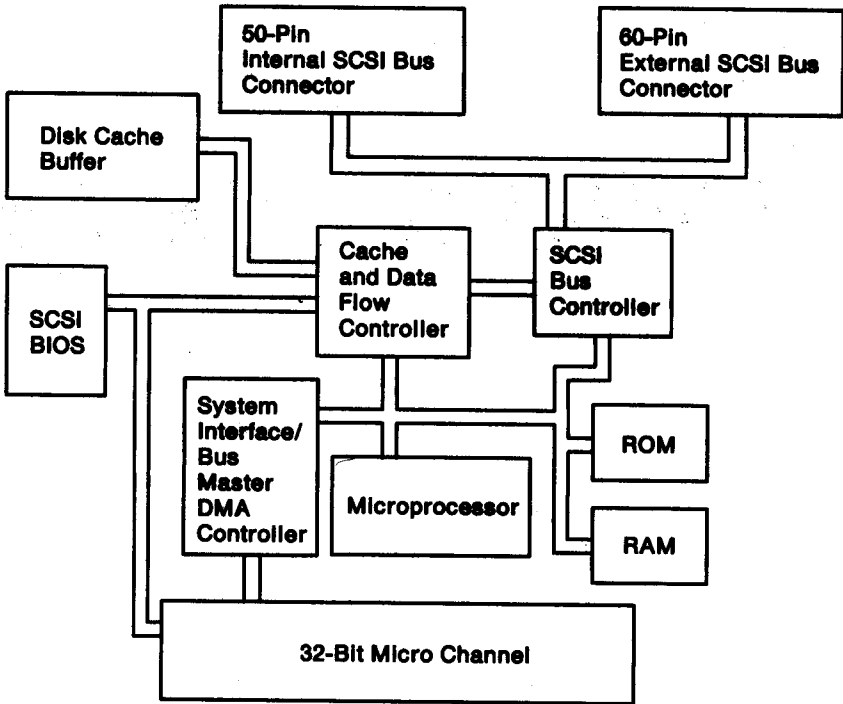

Figure 1. Adapter Block Diagram

Adapter Components

The adapter components described in this section are: disk cache, microprocessor, SCSI bus controller, cache and data flow controller, basic input/output system (BIOS), and system interface/bus master direct memory access (DMA) controller.

Disk Cache

The disk cache keeps frequently-used SCSI device data available for immediate transfer to the system. The disk cache also holds data until it can be transferred to the system by the system interface/bus master DMA controller. The disk cache is organized as 256K by 18 bits, including two parity bits, for a total of 512K bytes (K = 1024).

Adapter Microprocessor

The adapter microprocessor controls all adapter operations. It translates commands received from the system into a series of operations. For example, the adapter microprocessor manages the disk cache, controls data transfers to and from the system, and executes all necessary error detection and recovery procedures to ensure data integrity.

SCSI Bus Controller

The SCSI bus controller transmits commands, receives status, transfers data between attached SCSI devices and the adapter, and provides the following functions:

- SCSI bus arbitration
- Device selection and reselection
- SCSI phase change detection
- SCSI bus parity generation and checking.

Cache and Data Flow Controller

The cache and data flow controller manages the flow of parallel data between the cache, the SCSI bus, and the system. The controller allows concurrent data transfers between the cache and the following:

- The SCSI bus
- The Micro Channel connectors
- The adapter microprocessor random access memory (RAM).

The bus-steering and data-flow logic allows either byte, word, or doubleword transfers to the system, and performs these transfers in the burst mode.

Adapter BIOS and POST

The adapter read-only memory (ROM) contains BIOS, advanced BIOS (ABIOS), and power-on self test (POST) for fixed disk drives. Additional BIOS routines are provided to support device drivers for SCSI devices other than fixed disk. POST routines verify the SCSI subsystem configuration at power-on and after any system reset. For more information on the BIOS interfaces, refer to the *IBM Personal System/2 and Personal Computer BIOS Interface Technical Reference*. For more information on SCSI device features required for POST support, see "Device Requirements for POST Support" on page 7.

System Interface/Bus Master DMA Controller

The system interface/bus master DMA controller provides the command and interrupt registers. These registers receive commands from the system and interrupt the system when a command is completed. The transfer of data between the adapter and the system is controlled through bus master DMA. Data transfers up to 16.6 million bytes-per-second and 32-bit burst-mode operations are supported.

Statement of Conformance

The following statements are in the format specified in Appendix E of the American National Standards Institute (ANSI) SCSI Standard X3.131-1986.

Alternatives

- Single-ended receivers and drivers are used.
- + Terminal Power is supplied by the adapter.
- Parity is used on all data transfers.
- Hard reset of the SCSI bus is implemented.
- Target reservation queuing is supported.

Level of Conformance

The level of conformance is Level 2.

Implemented Options

The Synchronous Data Transfer Request message is supported. Maximum request-to-acknowledge offset is 7. Minimum transfer period implemented is 200 nanoseconds.

Supported Devices

The adapter supports devices that conform to the ANSI SCSI Standard X3.131-1986. These devices must support the mandatory commands and messages specified in Addendum 4.B, also known as the Common Command Set.

Each SCSI device connected to a single SCSI adapter must be given, at time of installation, a unique SCSI identification number (ID). The ID must be set properly, on each device, at time of installation. The ID must not be the same ID given to any other device connected to the same adapter, or given to the adapter itself. The SCSI ID is also the physical unit number (PUN).

Supported SCSI Commands

The adapter supports the following SCSI commands from the Common Command Set.

Copy *	Release
Format Unit *	Request Sense *
Inquiry *	Reserve
Mode Select	Rezero Unit
Mode Sense	Seek
Prevent/Allow Medium Removal	Send Diagnostic
Read *	Start/Stop Unit
Read Buffer	Test Unit Ready
Read Capacity *	Verify *
Read Defect Data	Write *
Read Extended *	Write and Verify *
Reassign Blocks *	Write Buffer
Receive Diagnostic Results	Write Extended *

* SCSI commands issued by the controller when translating the system interface commands (op codes hex 01 to 1E).

Note: SCSI commands shown without an asterisk can be issued only with the command Send Other SCSI Command. SCSI commands not shown are not supported.

Figure 2. SCSI Commands

Supported SCSI Messages

The following SCSI messages are supported by the adapter.

SCSI Messages	SCSI Status Messages
Abort	Busy
Bus-Device Reset	Check Condition
Command Complete	Condition Met/Good
Disconnect	Good
Identify	Immediate/Good
Initiator-Detected Error	Intermediate/Condition Met/Good
Linked Command Complete	Reservation Conflict
Linked Command Complete with Flag	
Message Parity Error	
Message Reject	
No Operation	
Restore Pointers	
Save Data-Pointer	
Note: The SCSI extended message Synchronous Data Transfer Request is also supported by the adapter.	

Figure 3. SCSI Messages

Device Requirements for POST Support

The following are the minimum requirements that SCSI devices must meet to be supported by the POST routines.

- All devices must be able to respond to the Inquiry and Request Sense commands within 3 seconds after being powered-on.
- Device type 0 must respond to the Start/Stop Unit and Test Unit Ready commands within 3 seconds after being powered-on.
- Device type 0 with non-removable media must make the drive ready for media access within 30 seconds of receiving a Start Unit command.
- Device type 0 must respond to the Read and Read Capacity commands.
- While configuring the SCSI bus, POST issues the Inquiry command to all 56 possible combinations of physical unit number/logical unit number (PUN/LUN) until 15 logical devices are assigned. Therefore, all devices must respond to each possible LUN for its SCSI ID.

Programmable Option Select

The adapter contains configurable options. These options are controlled through the programmable option select (POS) registers. These registers are accessible only when the 'card setup' signal (-CD SETUP) is active.

Warning: IBM recommends that programmable options be set only through System Configuration utilities. Directly setting the complementary metal-oxide semiconductor (CMOS) parameters or POS registers can result in multiple assignment of the same system resource, improper operation of the feature, loss of data, or possible damage to the hardware. If application programs use adapter identification (ID) information, compatibility problems between systems or options can result.

Address (Hex)	-CD SETUP	Address Line			Register
		A2	A1	A0	
0100	0	0	0	0	POS Register 0
0101	0	0	0	1	POS Register 1
0102	0	0	1	0	POS Register 2
0103	0	0	1	1	POS Register 3
0104	0	1	0	0	POS Register 4
N/A	1	x	x	x	Normal Operation

x = Don't Care

Figure 4. POS Register Selection

Note: When the system is modifying a register, the state of the reserved bits must be preserved. When possible, read the register first and change only the bits required.

POS Registers 0 and 1 (Hex 0100 and 0101)

These read-only registers contain the adapter ID (hex 8EFF). POS Register 1 is the most-significant byte of the adapter ID; POS Register 0 is the least-significant byte.

POS Register 2 (Hex 0102)

Bit	Function
7 - 4	ROM Segment Address Select
3 - 1	Adapter I/O Address Select
0	Adapter Enable

Figure 5. POS Register 2 (Hex 0102)

Bits 7 - 4 These bits determine the segment address for the adapter BIOS as shown in the following table.

Hex	Segment Address (Hex)	Hex	Segment Address (Hex)
0	C0000	8	D0000
1	C2000	9	D2000
2	C4000	A	D4000
3	C6000	B	D6000
4	C8000	C	D8000
5	CA000	D	DA000
6	CC000	E	DC000
7	CE000	F	N/A

Note: Odd numbered values are not available when 32K BIOS is enabled (Bit 7 of POS Register 4 = 1).

Figure 6. ROM Segment Address Select

Bits 3 - 1 These bits determine the I/O addresses for the adapter. Up to eight adapters can be installed in a system. However, only four adapters are supported by adapter BIOS. Each adapter must be assigned a unique I/O address range as shown in the following table.

Hex	Adapter Address (Hex)
0	3540 - 3547
1	3548 - 354F
2	3550 - 3557
3	3558 - 355F
4	3560 - 3567
5	3568 - 356F
6	3570 - 3577
7	3578 - 357F

Figure 7. Adapter I/O Address Select

Bit 0 When this bit is set to 1, the adapter is enabled. When this bit is set to 0, the adapter does not respond to any I/O or memory commands except during memory refresh operations and POS read and write operations. Adapter interrupts are disabled. This bit is set to 0 when the 'channel reset' signal on the system channel becomes active.

POS Register 3 (Hex 0103)

BIT	Function
7 - 5	SCSI ID
4	Fairness Enable
3 - 0	Arbitration Level

Figure 8. POS Register 3 (Hex 0103)

Bits 7 - 5 These bits determine the SCSI ID (0 through 7) of the adapter. Each device on the SCSI bus must have a unique SCSI ID. If the SCSI ID for the adapter is changed, an adapter-hardware reset should be performed.

Bit 4 When this bit is set to 0, fairness is disabled and priority is selected by bits 3 - 0 (arbitration level) in this register.

If the adapter is bursting data while fairness is enabled and -PREEMPT becomes active, the adapter stops channel activity and waits for -PREEMPT to become inactive before reentering arbitration.

Bits 3 - 0 These bits specify the arbitration level of the adapter when it is competing for the system channel. When competing for the channel, the adapter places this value on the arbitration lines. If no other device places a higher priority request (lower binary value) on these lines, the adapter wins the arbitration.

POS Register 4 (Hex 0104)

This 8-bit read/write register enables or disables the BIOS, selects the BIOS size, and controls BIOS memory cycles on the adapter.

Bit	Function
7	ROM BIOS Size
6 - 2	Reserved
1	ROM BIOS Enable
0	ROM BIOS Wait State Disable

Figure 9. POS Register 4 (Hex 0104)

- Bit 7** When this bit is set to 1, a 32KB (KB = 1024 bytes) ROM BIOS area is enabled. When this bit is set to 0, a 16KB ROM BIOS area is enabled.
- Bits 6 - 2** These bits are reserved.
- Bit 1** When this bit is set to 1, ROM BIOS is enabled. This bit is set to 1 at power-on time.
- Bit 0** When this bit is set to 0, one wait state is generated for operations to BIOS. When this bit is set to 1, no wait states are generated. This bit is set to 0 at power-on time.

Adapter-to-System Interface

To the system, the adapter operates as a bus master. A set of eight I/O registers issues commands and receives status from the adapter. The addresses for these registers depend on the address range selected in POS Register 2.

Register	Read/Write	Offset
Command Interface Register 1	Read/Write	00
Command Interface Register 2	Read/Write	01
Command Interface Register 3	Read/Write	02
Command Interface Register 4	Read/Write	03
Attention Register	Read/Write	04
Basic Control Register	Read/Write	05
Interrupt Status Register	Read	06
Basic Status Register	Read	07

Figure 10. I/O Registers

Command Interface Registers (Hex 00 - 03)

The system uses these four 8-bit registers to transfer either a 32-bit immediate command or the subsystem control block (SCB) address from the system to the adapter. The immediate command or the SCB specifies the operation to be performed by the adapter, and also specifies any necessary parameters.

Before the system writes an attention request code (1, 3, 4, or F) and a device number to the Attention register, it writes an immediate command or the SCB address to the command interface registers. The adapter interrupts the system when the command is completed.

The following figures show the relationship between the command interface registers and the immediate command or the SCB address.

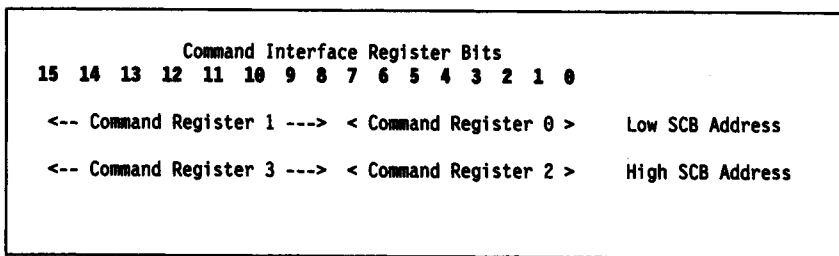

Figure 11. Register Content for SCB

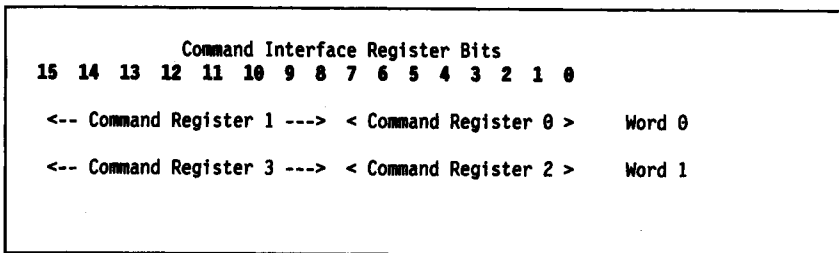

Figure 12. Register Content for Immediate Command

Attention Register (Hex 04)

The system uses this 8-bit read/write register to request an adapter operation. The value in this register specifies the operation and the device. When a value is written to the Attention register, bit 0 (busy) in the Basic Status register is set to 1. The busy bit remains set until the adapter is ready for another attention request. This bit is usually cleared within approximately 50 microseconds; however, if a Reset command to the adapter is received, the busy bit remains set until the adapter microprocessor has completed the reset sequence (up to 30 seconds).

With system interrupts disabled, the system must verify that the busy bit is set to 0 before writing to the command interface registers or the Attention register.

Bit	Name
7 - 4	Request Code
3 - 0	Device Select Code

Figure 13. Attention Register

Bits 7 - 4 The request code tells the adapter to perform a specific action for the indicated device or adapter. The following table provides additional information regarding request codes.

Hex Value	Description
1	Immediate Command
3	Start SCB
4	Start Long SCB
E	End of Interrupt
F	Start Long SCB

Figure 14. Request Codes

- 1** Requests the adapter to perform the immediate command specified in the command interface registers.
- 3** Requests the adapter to perform the command, as indicated by the SCB in system memory, at the 32-bit address contained in the command interface registers.

4 Requests the adapter to perform the command as indicated by the long SCB in system memory. This request can optionally be used to start a Send Other SCSI Command SCB. If started with this code, the entire Send Other SCSI Command SCB will be fetched at the same time. If a Send Other SCSI Command SCB is started by request code 3, two control-block fetches are required to get the entire command.

E Tells the adapter that the system has completed processing the last interrupt. The adapter can issue another interrupt to the system and reset its hardware interrupt-request latch.

The end-of-interrupt (EOI) request is not the same as the EOI instruction to the interrupt controller. The EOI instruction is in addition to the EOI request code required by the adapter to properly end an interrupt. To avoid false interrupts, issue the EOI request to the adapter before issuing the EOI to the system interrupt controller. The adapter requires 250 nanoseconds to clear the interrupt request after issuing the EOI request.

F Same as 4.

The following information refers to Figure 13 on page 14.

Bits 3 - 0 These bits specify the number of the logical device that will perform the operation. The value of hex F specifies the adapter and is used for global commands. The system can change the number assigned to a SCSI device through the Assign command. When the adapter is reset, the device assignments are set to their default values. For further information, refer to Figure 18 on page 18.

Basic Control Register (Hex 05)

This 8-bit read/write register controls various adapter functions.

Bit	Symbol
7	Hardware Reset
6 - 2	Reserved
1	DMA Enable
0	Interrupt Enable

Figure 15. Basic Control Register

Bit 7 When this bit is set to 1, the adapter hardware is reset. The adapter stays in the reset mode until this bit is reset to 0. This reset does not affect other devices on the SCSI bus. POS information is not affected. When this bit is set to 1, the system should not set this bit to 0 for at least 50 μ s. This bit must be set to 0 before setting either bit 0 or bit 1 in this register to 1.

Bits 6 - 2 These bits are reserved.

Bit 1 When set to 1, this bit enables the adapter DMA controller.

Bit 0 When set to 1, this bit enables interrupts to the system.

Interrupt Status Register (Hex 06)

The adapter uses this 8-bit read-only register to return command completion information to the system. If the adapter interrupt is enabled, a system interrupt (IRQ14) is generated when the adapter updates the Interrupt Status register.

After receiving an interrupt, the system may read the Interrupt Status register to determine the device and ID of the interrupt. The system may clear the interrupt by issuing an EOI request. This register is also updated after the adapter is reset. For more information see "Resetting the Adapter" on page 20.

The adapter clears the Interrupt Status register only after an end-of-interrupt request. This allows the program to read the Interrupt Status register as many times as necessary to determine the routine that will process the interrupt.

Bit	Symbol
7 - 4	Interrupt ID
3 - 0	Device ID Number

Figure 16. Interrupt Status Register

Bits 7 - 4 These bits identify the type of interrupt, as shown in the following table.

More information about interrupt status is available in the command status block (see "Get Command Complete Status" on page 36).

Hex	Interrupt
1	SCB Command Completed with Success
5	SCB Command Completed with Success after Retries
7	Adapter Hardware Failure
A	Immediate Command Completed
C	Command Completed with Failure
E	Command Error (Invalid Command or Parameter)
F	Software Sequencing Error

Note: All values not shown are reserved.

Figure 17. Interrupt ID Table

Bits 3 - 0 These bits identify the device reporting the interrupt.

Hex Value	Device Selected	SCSI Physical Unit Number	SCSI Logical Unit Number
0	Logical Device 0	0	0
1	Logical Device 1	1	0
2	Logical Device 2	2	0
3	Logical Device 3	3	0
4	Logical Device 4	4	0
5	Logical Device 5	5	0
6	Logical Device 6	6	0
7	Logical Device 7*	Not Assigned	Not Assigned
8	Logical Device 8	Not Assigned	Not Assigned
9	Logical Device 9	Not Assigned	Not Assigned
A	Logical Device 10	Not Assigned	Not Assigned
B	Logical Device 11	Not Assigned	Not Assigned
C	Logical Device 12	Not Assigned	Not Assigned
D	Logical Device 13	Not Assigned	Not Assigned
E	Logical Device 14	Not Assigned	Not Assigned
F	Adapter	**	**

* The device number that is equal to the SCSI ID of the adapter is not assigned after Reset. The default value for this SCSI ID is 7.

** Logical Device 15 is reserved for the adapter.

Note: These assignments may be changed by POST.

Figure 18. Adapter Device Selection Defaults

Basic Status Register (Hex 07)

This 8-bit read-only register returns adapter status information to the system.

Bit	Symbol
7 - 4	Reserved
3	Command Interface Register Full
2	Command Interface Register Empty
1	Interrupt Request
0	Busy

Figure 19. Basic Status Register

Bits 7 - 4 These bits are reserved.

Bit 3 This bit is set to 1 after all command interface registers are loaded. It is reset to 0 when any one of these registers is read by the adapter.

Bit 2 This bit is set to 1 after all command interface registers are read by the adapter. It is reset by the adapter when any one of the command interface registers is loaded.

Bit 1 This bit is set to 1 when the adapter is presenting an interrupt to the system. This bit is cleared to 0 when an EOI request code is written to the Attention register. This bit will be set if an interrupt request is active, even if the Basic Control register interrupt enable bit is set to 0. This allows the adapter to operate without presenting hardware interrupts to the system.

Bit 0 This bit is set to 1 when the Attention register is loaded or when a hardware reset occurs. It is reset by the adapter after the Attention register and command interface registers have been read or the hardware reset is completed. If a Reset command is issued to the adapter, this bit is reset after completing the reset function and before setting the command complete interrupt.

Resetting the Adapter

When the adapter is reset, diagnostic routines are run to determine if the adapter is functioning properly. The adapter can be reset by:

- CHRESET on the system channel going active.
- Setting bit 7 (hardware reset) in the Basic Control register to 1.
- Issuing the Immediate Reset command to the adapter (device 15). This command performs a soft reset of the adapter.

A soft reset occurs when the Reset command is issued to a SCSI device or to the adapter (device 15). When the command is issued to the adapter, the adapter activates the 'reset' signal on the SCSI bus, which resets all devices on the bus and clears all pending commands. When the command is issued to any other SCSI device, only that device is reset.

A hard reset occurs when the system 'reset' signal (+CHRESET) is pulsed active, or when bit 7 in the Basic Control register is set to 1. A hard reset does not reset the SCSI bus or any attached devices; it does however reset the adapter and clear the cache.

Once the reset sequence is completed, results are posted in the Interrupt Status register. After a hardware reset, bits 7 - 4 are set as shown in the following table; bits 3 - 0 are always set to hex F.

Note: After a soft reset, hex AF indicates a successful reset; hex 7F indicates a hardware failure.

Hex	Interrupt
0	No Error - Reset Completed
1	Microprocessor ROM Test Failed
2	Local RAM Test Failed
3	Power Protection Device Error
4	Microprocessor Internal Peripheral Test Failed
5	Buffer Control Chip Test Failed
6	Buffer RAM Test Failed
7	System Interface Control Chip Test Failed
8	SCSI Interface Test Failed

Note: All values not shown are reserved.

Figure 20. Adapter Reset Status

If a failure occurs during the reset sequence, the adapter will accept only a hard reset. This prevents accidental loss of data.

Command Processing

Four 8-bit command interface registers are used in conjunction with the Attention register to issue commands to the adapter. The data written to the command interface registers consists of either a 32-bit immediate command, or a 32-bit address that points to a subsystem control block stored in system memory. The data written to the Attention register specifies the device select code and a request code. The request code indicates if the command interface registers contain an immediate command or a pointer to a subsystem control block. See "System Interface" on page 27 for more information about supported commands.

One command can be specified for each of 15 SCSI logical devices, plus one global adapter command, for a maximum of 16 overlapped commands in progress. New commands can be issued even while a data transfer is in progress for a previous command. If a command is directed to a device with a command already in progress, the command in progress is ended with a command sequence error, and the new command is ignored. Before starting a command, make sure bit 0 in the Basic Status register is set to 0, and the system interrupts are disabled.

The following flowchart shows the sequence for issuing a command.

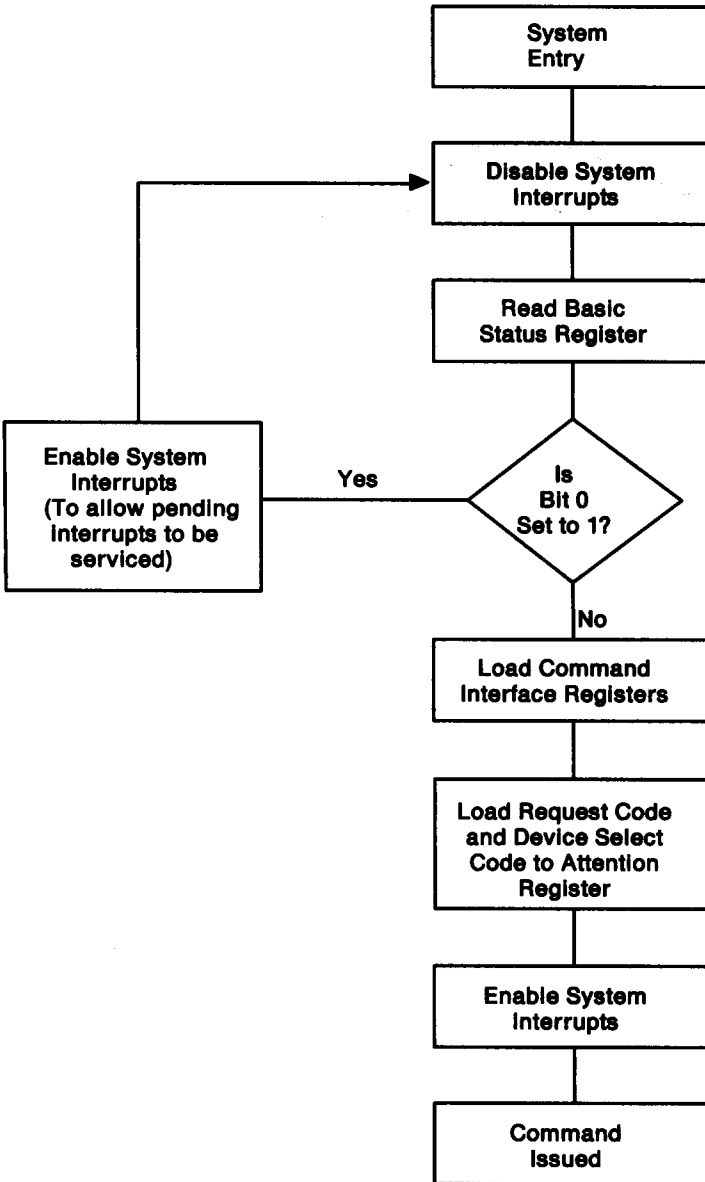

Figure 21. Issuing a Command

The following flowchart shows the sequence for processing an interrupt.

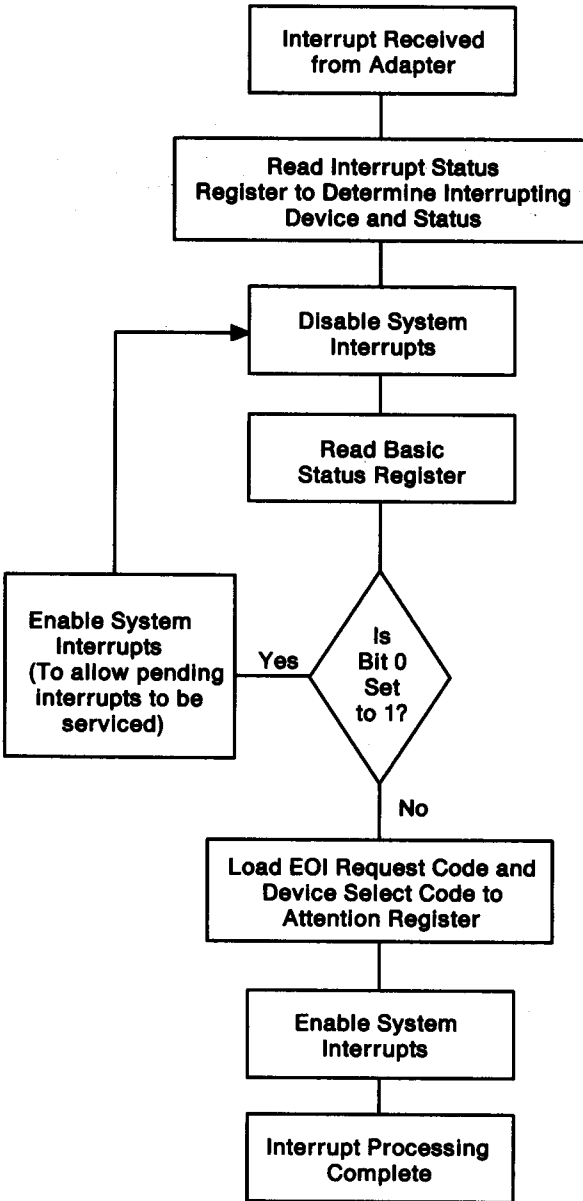

Figure 22. Processing an Interrupt

Note: If the busy bit has not cleared within 400 microseconds, the application should perform time-out procedures. When an adapter Reset command is in progress, allow up to 30 seconds for the busy bit to clear.

Once a command is completed, the adapter interrupts the system by loading the Interrupt Status register with summary status (the completing device number and an interrupt ID). The adapter waits for the EOI request before it issues another interrupt or changes the contents of the Interrupt Status register.

When the system reads the Interrupt Status register, the interrupting device number and status may be obtained. The Command Complete status block contains more status information about the completed command.

Note: To get the status block, use the Get Command Complete Status command, or inspect the termination status block, if available.

The system then loads the interrupting device number and the EOI request to the Attention register. This tells the adapter that the system has finished processing that interrupt.

Subsystem Control Blocks

The SCB commands relieve the system of transferring command blocks to the adapter through programmed input and output. The SCB specifies the desired command and associated parameters. An SCB must begin on a doubleword boundary, and any address translations, from virtual to physical, must be performed by system software before the SCB pointer is loaded into the command interface registers. If 80386 virtual page mode is being used, system software must also ensure that the SCB, data buffers, and termination status block (TSB) areas are locked into memory. The SCB specifies the desired command and associated parameters. When the SCB (or chain of SCBs) has been performed by the adapter, an interrupt request is issued to the system. The adapter presents only one interrupt request at a time to the system.

The following figure shows the format of the subsystem control block as it applies to device-related commands.

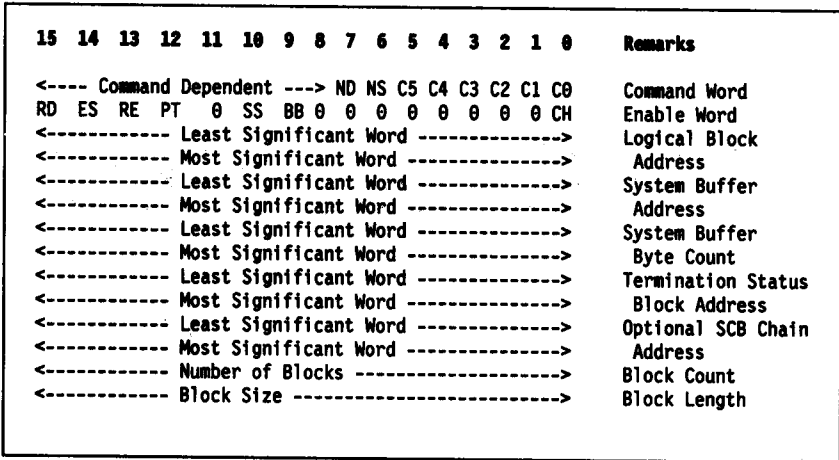

Figure 23. Subsystem Control Block Structure

A command is encoded in the first word of the SCB. The setting of bits 15 - 8 of the first word depends on the specific command identified in bits 5 - 0. If bit 7 (ND) of this word is set to 1, the adapter will not disconnect the target device during command execution. If bit 6 (NS) of this word is set to 1, the adapter will not send any Synchronous Data Transfer Request messages to the target device.

The second word of the SCB is used to enable options that are used to modify a specified command, as shown in the following table.

Bit	Symbol	Function
15	RD	Input/Output Control
14	ES	Report TSB Status Only on Error
13	RE	Retry Enable
12	PT	Pointer to List
10	SS	Suppress Exception Short
9	BB	Bypass Buffer
8 - 1		Reserved
0	CH	Chain on No Error

Figure 24. Enable Options

- Bit 15 (RD)** When this bit is set to 1, the adapter transfers data from the SCSI device or adapter into system memory (read). When this bit is set to 0, the adapter transfers data from system memory to the SCSI device or adapter (write).
- Bit 14 (ES)** When this bit is set to 1, the TSB is transferred to memory only if an error (Interrupt ID = C) is detected. When this bit is set to 0, the TSB is always transferred.
- Note:** This bit should always be set to 1, unless the command requires the TSB when no error occurs; command performance is degraded by unnecessarily writing to memory.
- Bit 13 (RE)** When this bit is set to 1, the adapter automatically retries certain operations that fail. This bit may be set to 0 by diagnostic programs to enhance fault isolation. Normally, this bit should be set to 1. See "Word 1 - Retry Counts" on page 38 for more information.
- Bit 12 (PT)** When this bit is set to 1, it allows a single command to write data to or read data from several different areas in memory (buffers) as specified in a list. This list contains up to 16 pairs of values, each pair being a 32-bit address and its related 32-bit count. In the SCB, the system buffer address field contains the address of the list, and the system buffer byte count field contains the length of the list in bytes.
- Bit 10 (SS)** When this bit is set to 1, it allows the amount of data transferred on a read operation to be shorter than the system buffer byte count, specified in the SCB, without generating an error.
- Bit 9 (BB)** When set to 1, this bit forces the adapter to transfer data directly from the SCSI device and not from a copy in the cache. Some buffer maintenance may still be performed by the adapter.
- Bits 8 - 1** These bits are reserved.
- Bit 0 (CH)** This bit selects the type of chaining condition used in command block transfers. When it is set to 0, chaining is disabled. When command blocks are chained, the SCB must contain the 32-bit address of the next SCB. When this bit is set to 1, chaining will occur if the SCB ends with no error.

System Interface

The following is a list of supported commands.

Command Type	Command	Hex Code	Supported Device Numbers (Hex)	Page Reference
Immediate	Abort	0F	0-F	28
Immediate	Assign	0E	F	29
SCB	Device Inquiry	0B	0-E	30
Immediate	DMA Pacing Control	0D	F	31
Immediate	Feature Control	0C	0-F	32
Immediate	Format Prepare	17	0-E	33
SCB	Format Unit	16	0-E	33
SCB	Get Command Complete Status	07	0-F	36
SCB	Get POS Information	0A	F	42
SCB	Read Data	01	0-E	45
SCB	Read Device Capacity	09	0-E	46
SCB	Read Prefetch	31	0-E	47
SCB	Read Verify	03	0-E	48
SCB	Reassign Block	18	0-E	49
SCB	Request Sense	08	0-E	50
Immediate	Reset	00	0-F	54
SCB	Send Other SCSI	1F	0-E	55
SCB	Write Data	02	0-E	56
SCB	Write with Verify	04	0-E	57

Note: The hex code represents bits 5 - 0 of the first command word.

Figure 25. Adapter Command List

The adapter maintains a Command Complete status block for each of the command blocks. The command blocks are updated at the completion of each command. This command status block can be obtained by using the Get Command Complete Status Block command. See "Command Complete Status Block" on page 36.

The format for each command is given following the associated command.

Abort

This immediate command causes the logical device to immediately end the command in progress and go to the bus-free state. This command sends an Identify message followed by an Abort message to the device. An Abort command to the adapter clears an active global command.

After the command is completed the system can request the status block of the cancelled command. The status block shows the state of the operation at the time it was ended.

The Abort command is issued only when the system has timed out while waiting for the adapter to complete a command. In response to this command, the adapter stops the current command and maintains command status information. This information may be used to determine where the command problem occurred. The adapter interrupts the system when it has completed the Abort command.

Command Interface Register Bits																Remarks	
15	14	13	12	11	10	9	8	7	6	5	4	3	2	1	0		
0	0	0	0	0	1	0	0	0	0	0	0	0	1	1	1	1	Abort
←-----						Reserved				-----→							

Figure 26. Abort Command

Assign

This Immediate command assigns a device number (0 to 14) to a particular SCSI device. This allows any 15 SCSI devices to have command processing active at one time. The Assign command must be directed to the adapter (device 15).

When the SCSI device is assigned a device number:

1. Adapter retries are enabled for that device number.
2. The cache buffer is cleared of any data from the device previously assigned that number.
3. The cache function is enabled for that device number.

Notes:

1. A device cannot be assigned the same SCSI physical unit number (PUN) as the adapter SCSI ID set in POS Register 3.
2. A hardware reset sets all device number assignments to the default value. See Figure 18 on page 18.
3. Device number assignments may be removed (devices 0 to 14 not assigned) by issuing the Assign command, with bit 7 (R) of the second word of the command block set to 1.
4. If the device number being assigned to a SCSI logical unit (LUN) has a command in progress when the Assign command is received, the attachment will end the command with an error, and the assignment will not be changed.
5. Only one device number can be assigned to a particular SCSI device. If an attempt is made to assign more than one device number to the same SCSI device, the command will end with an error (Interrupt ID = C).

Command Interface Register Bits															Remarks	
15	14	13	12	11	10	9	8	7	6	5	4	3	2	1		0
0	0	0	0	0	1	0	0	0	0	0	0	1	1	1	0	Assign
<--- Reserved --->					Logical <SCSI #>			R	Physical <SCSI #>			Adapter <Device #>			LUN/PUN/DEV	

Figure 27. Assign Command

Device Inquiry

Through the SCB Device Inquiry command, the system determines which SCSI devices are attached to the adapter, and specific information about those devices. When the Device Inquiry data block has been transferred, the adapter interrupts the system. Because the length of the returned data block is device-dependent, the system should specify the amount of data to be returned. If this is not known, then the system should specify the maximum value (255) and set the suppress short exception (SS) bit to 1. After the Device Inquiry data block is transferred to the specific address, the adapter interrupts the system to indicate that the command is complete.

If a SCSI device is not attached at the assigned physical SCSI address, the command-completed-with-failure interrupt will be returned in the Interrupt Status register. The Command Complete status will indicate selection time-out. If the SCSI logical unit number is not supported by an attached SCSI physical unit, the device type in the Device Inquiry data block is set to hex 7F by the SCSI physical device.

15	14	13	12	11	10	9	8	7	6	5	4	3	2	1	0	Remarks
0	0	0	1	1	1	0	0	ND	NS	0	0	1	0	1	1	Device Inquiry
1	ES	RE	0	0	SS	1	0	0	0	0	0	0	0	0	CH	Enable Word
<----- Reserved ----->																
<----- Reserved ----->																
<----- Least Significant Word ----->																
<----- Most Significant Word ----->																
<----- Least Significant Word ----->																
<----- Most Significant Word ----->																
<----- Least Significant Word ----->																
<----- Most Significant Word ----->																
<----- Least Significant Word ----->																
<----- Most Significant Word ----->																
<----- Reserved ----->																
<----- Reserved ----->																

Figure 28. Device Inquiry Command

Device Inquiry Data Block

Byte	7	6	5	4	3	2	1	0	Remarks
0	<Peripheral Device Type>								Major Type
1	RMB <- Type Qualifier ->								Removable Media Bit
2	<ISO> <-ECMA-> <-ANSI->								Standards Compliance
3	<----- Reserved ----->								
4	<- Additional Length ->								# Of Bytes (N-4)

5	<-- Additional Data --->								Additional Inquiry
N	<-- Additional Data --->								Data
ECMA - European Computer Manufacturer's Association ISO - International Standards Organization									

Figure 29. Device Inquiry Data Block

For more information about the Device Inquiry data block, refer to the American National Standards Institute SCSI Standard X3.131-1986.

DMA Pacing Control

This immediate command is issued to the adapter (device 15), and it controls the pacing of DMA transfers by the adapter. The pacing factor is specified as a percentage of the total bandwidth the adapter is allowed to use. The acceptable range is 25 to 100 percent.

The pacing value is used until a new value is specified, or until an adapter power-on or Micro Channel reset occurs. A power-on or Micro Channel reset will set pacing to 100% (no pacing).

Command Interface Register Bits										Remarks						
15	14	13	12	11	10	9	8	7	6	5	4	3	2	1	0	Remarks
0	0	0	0	0	1	0	0	0	0	0	0	1	1	0	1	Pacing Control
<----- Reserved ----->										<---Pacing Factor --->						

Figure 30. DMA Pacing Control Command

Feature Control

This Immediate command controls various features of the SCSI adapter. The command time-out limit (in seconds) can be specified through bits 12 - 0 of the second word of the command block. A value of 0 prevents the adapter from timing out. The time-out for a command defaults to 45 seconds upon an adapter hardware reset. When this command is issued to the adapter (device 15), the maximum SCSI bus synchronous-data-transfer rate allowed by the adapter can be specified through bits 15 - 13 of the second word of the command block. The following table describes the relationship between the setting of bits 15 - 13 and the maximum data-transfer rate.

Bits 15 14 13	Rate Specified (Millions of Bytes per Second)
0 0 0	5.00 (power-on default)
0 0 1	4.00
0 1 0	3.33
0 1 1	2.86
1 0 0	2.50
1 0 1	2.22
1 1 0	2.00
1 1 1	1.82

Figure 31. Device Data-Transfer Rate

When this command is issued to the adapter (device 15), the data rate and time-out value applies to all devices. When this command is issued to a device (device 0 - 14), the data rate control bits are ignored and the time-out value applies only to the device to which the command was issued.

Command Interface Register Bits																Remarks
15	14	13	12	11	10	9	8	7	6	5	4	3	2	1	0	
0	0	0	0	0	1	0	0	0	0	0	0	1	1	0	0	Feature Control
Max SCSI																
< D-Rate > <---- Command Global Time-out Value ---->																
D-Rate - Transfer Rate																

Figure 32. Feature Control Command

Format Prepare

This immediate command acts as a format interlock to prevent inadvertent data destruction. The Format Prepare command must be issued immediately prior to the Format Unit command. If another command is issued between the Format Prepare command and the Format Unit command, the format is not performed and ends in an error.

Command Interface Register Bits																Remarks
15	14	13	12	11	10	9	8	7	6	5	4	3	2	1	0	
0	0	0	0	0	1	0	0	0	0	0	1	0	1	1	1	Format Prepare
0	1	0	1	0	1	0	1	1	0	1	0	1	0	1	0	55AA

Figure 33. Format Prepare Command

Format Unit

This SCB command is used to format a storage device. Formatting the storage device destroys all data. The device performs defect management as specified in the command. Bits within the command specify the source of the defect list and the use and disposition of any defect list on the device. Because all device data is considered erased, any cache data for the device is cleared.

15	14	13	12	11	10	9	8	7	6	5	4	3	2	1	0	Remarks
0	0	0	1	1	1	0	0	ND	NS	0	1	0	1	1	0	Format Unit
0	ES	RE	0	0	0	1	0	0	0	0	0	0	0	0	CH	Enable Word
<----- Reserved ----->								0	0	0	FD	CL	0	0	0	Modifier Bits
<----- Interleave Factor ----->																Interleave
<----- Least Significant Word ----->																System Buffer
<----- Most Significant Word ----->																Address
<----- Least Significant Word ----->																Defect List
<----- Most Significant Word ----->																Byte Count
<----- Least Significant Word ----->																Termination Status
<----- Most Significant Word ----->																Block Address
<----- Least Significant Word ----->																Optional SCB Chain
<----- Most Significant Word ----->																Address
<----- Number of Blocks ----->																Block Count
<----- Block Size ----->																Block Length

Figure 34. Format Unit Command

The interleave factor used during the format operation is specified in the control block. An interleave factor of 0 selects the device default. A factor of 1 selects sequential numbering of logical blocks. All other factor values are device dependent.

Modifier bits select options to be used during formatting and are defined as follows:

FD **Format Data:** When this modifier bit is set to 1, the system supplies a defect list for the format operation. The structure of the list depends on the device being formatted. The system buffer address points to the defect list; the length is specified in the byte count. If this bit is set to 0, no defect list is transferred to the device.

Note: Not all SCSI devices support the transfer of a defect list.

CL **Complete List:** If the defect list is supplied, this bit determines whether the supplied defect list is in addition to, or replaces, the defect list already in the device. If the bit is set to 1, any previous defect list is replaced.

Note: Only a defect list in the following block format is supported by the adapter. See the ANSI SCSI Standard or specific device specification for more information.

Byte	Defect List Header								Remarks
	7	6	5	4	3	2	1	0	
0	<----- Reserved ----->								
1	<----- Reserved -BF-->								
2	<----- High Byte ----->								
3	<----- Low Byte ----->								
	Defect Descriptors								
4	<----- High Byte ----->								First Defective Block Address
5	<----->								
6	<----->								Last Defective Block Address
7	<----- Low Byte ----->								
	.								
	.								
	<----- High Byte ----->								Last Defective Block Address
	<----->								
	<----->								
N	<----- Low Byte ----->								

Figure 35. Defect List Block Format

BF **Background Format:** When this bit is set to 1, the device performs a background format. If the device supports this option, it checks the format of the command, then returns a command status indicating good status, and starts the format operation. If the device does not support the option, it may return a command status block indicating a check condition.

Commands received before completing the background format are returned with a command status block indicating a check condition. The Request Sense command returns a sense key indicating that the device is not ready and returns an additional sense code indicating that a Format operation is in progress. The Request Sense data block also shows the percentage of the format completed.

Get Command Complete Status

This SCB command requests the Command Complete status block for the last command executed on a specified device. When the status block is transferred to the system, the adapter generates an interrupt and updates the Interrupt Status register.

15	14	13	12	11	10	9	8	7	6	5	4	3	2	1	0	Remarks
0	0	0	1	1	1	0	0	0	0	0	0	0	1	1	1	Get Command Status Enable Word
1	ES	RE	0	0	0	1	0	0	0	0	0	0	0	0	0	CH
----- Reserved ----->																
<----- Reserved ----->																
----- Least Significant Word ----->																
<----- Most Significant Word ----->																
0	0	0	0	0	0	0	0	0	0	0	0	1	1	0	1	System Buffer Address
0	0	0	0	0	0	0	0	0	0	0	0	0	0	0	0	System Buffer Byte Count
----- Least Significant Word ----->																
<----- Most Significant Word ----->																
<----- Least Significant Word ----->																
<----- Most Significant Word ----->																
<----- Reserved ----->																
<----- Reserved ----->																

Figure 36. Get Command Complete Status Command

Command Complete Status Block

The command complete status block is returned to the location specified in the system buffer address field of the Get Command Complete Status command. It contains the status of the last command to a device. It is unchanged until another command is issued to that device or until a reset occurs.

An optional termination status block is returned automatically whenever an error (Interrupt ID = C) occurs. This allows command complete status to be returned for error recovery. See Figure 24 on page 25 for more information.

The command complete status block and termination status block contain the same information.

Note: A Get Command Complete Status command returns valid status information following a hardware error interrupt. For errors (Interrupt ID = 7, E, and F) caused by hardware problems, do not use the termination status block; the adapter

internally cancels a command at the point of the hardware error.

Word	15 14 13 12 11 10 9 8 7 6 5 4 3 2 1 0	Remarks
0	<----- SCB End Status Word ----->	SCB Status
1	<----- Retry Counts ----->	Retry Counts
2	<----- Least Significant Word ----->	Residual Byte Count
3	<----- Most Significant Word ----->	Count
4	<----- Least Significant Word ----->	Scatter/Gather List
5	<----- Most Significant Word ----->	Element Address
6	0 0 0 0 0 0 0 0 0 0 0 0 1 1 0 0	Device Dependent Status Length
7	<-- Command Status --><---- Device Status ---->	Command Device Status
8	<-- Command Error ---><---- Device Error ---->	Error Codes
9	<----- Reserved ----->	
A	<----- Cache Information Word ----->	
B	<----- Least Significant Word ----->	Last SCB Address Processed
C	<----- Most Significant Word ----->	

Figure 37. Command Complete Status Block

Word 0 - Subsystem Control Block End Status

Bit	Function
15 - 13	Reserved
12	Major Exception Occurred
11	Device Not Initialized
10	Reserved
9	Device Dependent Status Available
8	Additional Status Available
7	SCB Interrupt Queued
6	SCB Halted (Error/End Chain)
5	Long Record Exception
4	SCB Specification Check
3	SCB Rejected
2	Invalid Command Rejected
1	Short Record Exception
0	SCB Ended (No Error)

Note: The function indicated is true when the value of the bit is one. Reserved bits are undefined.

Figure 38. SCB End Status

Word 1 - Retry Counts

Bit	Function
15	Adapter Retry Invoked
14 - 6	Reserved
5	System Interface Check Retry
4 - 0	Reserved

Figure 39. Word 1 - Retry Counts

Words 2 and 3 - Residual Byte Count: These words contain the number of bytes that were not transferred.

Words 4 and 5 - Scatter/Gather List Element Address: These words contain the address of the scatter/gather list element being used when the command was ended.

Word 6 - Device Dependent Status Length: This word contains the number of bytes of device status information that follow. This word is set to hex 0C to indicate 12 bytes.

Word 7 - Command and Device Status

Hex	Command Status
1	SCB Command Completed with Success
5	SCB Command Completed with Success after Retries
7	Adapter Hardware Failure
A	Immediate Command Completed
C	Command Completed with Failure
E	Command Error (Invalid Command or Parameter)
F	Software Sequencing Error

Note: All values not shown are reserved.

Figure 40. Command Status Codes

Bit	Function
7	Reserved
6	Vendor Unique Bit
5	Vendor Unique Bit
4 - 1	Device Status Code
0	Vendor Unique Bit

Figure 41. Device Status Byte

Hex	Device Status
0	Good Status (No Error)
1	Check Condition (Error)
2	Condition Met/Good (No Error)
4	Busy (Error)
8	Intermediate/Good (No Error)
A	Intermediate/Condition Met/Good (No Error)
C	Reservation Conflict (Error)

Note: All values not shown are reserved.

Figure 42. Bits 4 - 1 Device Status Code

Word 8 - Command Error Code/Device Error Code

Hex	Error
00	No Error
01	Invalid Parameter in SCB
02	Reserved
03	Command Not Supported
04	Command Aborted (By System)
05	Reserved
06	Reserved
07	Format Rejected - Sequence Error
08	Assign Rejected - Command in Progress on Device
09	Assign Rejected - SCSI Device Already Assigned
0A	Command Rejected - SCSI Device Not Assigned
0B	Maximum Logical Block Address Exceeded
0C	16-Bit Card Slot Address Range Exceeded.
0D - 12	Reserved
13	Invalid Device for Command
14 - 1F	Reserved
20	Adapter Hardware Error
21	Global Command Time-out
22	DMA Error
23	Adapter Buffer Defective
24	Command Aborted by Adapter
25 - 7F	Reserved
80	Adapter Microprocessor Detected Error
81 - FF	Reserved

Figure 43. Bits 15 - 8 Command Error Code

Hex	Error
00	No Error
01	SCSI Bus Reset Occurred
02	SCSI Interface Fault
03 - 0F	Reserved
10	SCSI Selection Time-out (device not available)
11	Unexpected SCSI Bus Free
12	Reserved
13	Invalid SCSI Phase Sequence
14 - 1F	Reserved
20	Short Length Record
21 - FF	Reserved

Figure 44. Bits 7 - 0 Device Error Code

Word 9 - Reserved

Word A - Cache Information Word: Bits 7 - 0 are the cache-read hit ratio (expressed as a percentage in a binary coded decimal format).

Hex	Percent
00 - 99	00% - 99%
A0	100%

Figure 45. Cache-Read Hit Ratio

Bit	Function
15 - 12	Reserved
11	Cache Enabled
10	Cache Retry Occurred
9	Total Write Hit
8	Total Read Hit

Figure 46. Bits 15 - 8 Cache Status

Word B - Last SCB Address Processed - Low Word

Word C - Last SCB Address Processed - High Word

Get POS and Adapter Information

This SCB command requests the adapter to return POS information and adapter parameters.

15	14	13	12	11	10	9	8	7	6	5	4	3	2	1	0	Remarks
0	0	0	1	1	1	0	0	0	0	0	0	1	0	1	0	Get POS Information
1	ES	RE	0	0	0	1	0	0	0	0	0	0	0	0	CH	Enable Word
<----- Reserved ----->																
<----- Reserved ----->																
<----- Least Significant Word ----->																
<----- Most Significant Word ----->																
0	0	0	0	0	0	0	0	0	0	0	1	0	0	1	0	System Buffer
0	0	0	0	0	0	0	0	0	0	0	0	0	0	0	0	Address
<----- Least Significant Word ----->																
<----- Most Significant Word ----->																
<----- Least Significant Word ----->																
<----- Most Significant Word ----->																
<----- Least Significant Word ----->																
<----- Most Significant Word ----->																
<----- Reserved ----->																
<----- Reserved ----->																

Figure 47. Get POS and Adapter Information Command

POS and Adapter Information Status Block

Word	15	14	13	12	11	10	9	8	7	6	5	4	3	2	1	0	Remarks
0	1	0	0	0	1	1	1	0	1	1	1	1	1	1	1	1	Adapter ID
1	<--- POS Register 2 ---><--- POS Register 3 --->															POS Regs 2-3	
2	<--- POS Register 4 ---><--- Interrupt Level --->															POS Reg 4/Intr Level	
3	<- Size ---><--- Revision Level ----->															Adapter Level	
4	<# of Devices Supported><# of LUNs per Device>															# Devices/ # LUNs per Device	
5	<# of Logical Dev #'s ><--- Pacing Factor --->															# of LDNs/ Pacing Factor	
6	<--- Max Busy Time ---><--- EOI to Intro Off --->															Max Busy Time/ EOI to Int off	
7	<----- Cache Status ----->															Cache Status	
8	<----- Retry Status ----->															Retry Status	

Figure 48. POS and Adapter Information Status Block

Word 0 - Adapter POS ID - Hex 8EFF

Bits 15 - 8 These bits contain hex 8E.

Bits 7 - 0 These bits contain hex FF.

Word 1 - POS Register 2 and 3

Bits 15 - 8 These bits contain the current value for POS Register 2.

Bits 7 - 0 These bits contain the current value for POS Register 3.

Word 2 - POS Register 4/Adapter Interrupt Level

Bits 15 - 8 These bits contain the current value for POS register 4.

Bits 7 - 0 These bits contain Interrupt level, hex 0E.

Word 3 - Channel Connector Size/Adapter Revision Level

Bits 15 - 12 These bits indicate if the adapter is currently installed in a 16- or 32-bit Micro Channel connector.

Bits	Channel Connector
15 14 13 12	
0 0 0 0	32-Bit
0 0 0 1	16-Bit

Figure 49. Channel Connector Size

Bits 11 - 0 Reserved.

Word 4 - Number of Devices Supported/Number of Logical Units per SCSI Device

Bits 15 - 8 These bits contain the number of physical units supported (up to 7).

Bits 7 - 0 These bits contain the number of logical units supported (up to 8).

Word 5 - Number of Logical Device Numbers Supported/Pacing Factor

Bits 15 - 8 These bits contain the number of logical devices supported (16).

Bits 7 - 0 These bits contain the DMA Pacing factor (%) as set by the Immediate Pacing control command.

Word 6 - Maximum Adapter Busy Time/EOI to Interrupt Off Time

Bits 15 - 8 These bits specify the time (up to 30 seconds) from hardware reset to busy off.

Bits 7 - 0 These bits specify the time (one microsecond) from load of the End of Interrupt request code until the 'hardware interrupt' signal is deactivated.

Word 7 - Bit Significant Device Cache Status

Bits 15 - 0 When these bits are set to 1, the cache is disabled for the respective device.

Word 8 - Bit Significant Device Retry Enable Status

Bits 15 - 0 When these bits are set to 1, the adapter level retries are disabled for the respective device.

Read Data

This SCB command is used for devices with fixed length blocks, such as fixed disk drives. This command causes the adapter to send the SCSI Read command to the device. The blocks specified are read and the data is transferred to the system.

The Read Data command supports multiple block operations up to 65,535 blocks or 16MB minus 1 byte (MB = 1,048,576 bytes), whichever is less, of total data transferred.

For devices with variable length blocks, such as tape drives, the Send Other SCSI SCB command should be used to generate the SCSI Read command.

15	14	13	12	11	10	9	8	7	6	5	4	3	2	1	0	Remarks
0	0	0	1	1	1	0	0	ND	NS	0	0	0	0	0	1	Read Data
1	ES	RE	PT	0	0	BB	0	0	0	0	0	0	0	0	CH	Enable Word
<----- Least Significant Word -----> Logical																
<----- Most Significant Word -----> Address																
<----- Least Significant Word -----> System Buffer																
<----- Most Significant Word -----> Address																
<----- Least Significant Word -----> System Buffer																
<----- Most Significant Word -----> Byte Count																
<----- Least Significant Word -----> Termination Status Block																
<----- Most Significant Word -----> Address																
<----- Least Significant Word -----> Optional SCB Chain																
<----- Most Significant Word -----> Address																
<----- Number of Blocks -----> Block Count																
<----- Block Size -----> Block Length																

Figure 50. Read Data Command

Read Device Capacity

This SCB command is used to return the Device Capacity status block of the specific device.

15	14	13	12	11	10	9	8	7	6	5	4	3	2	1	0	Remarks
0	0	0	1	1	1	0	0	ND	NS	0	0	1	0	0	1	Read Device Capacity Enable Word
1	ES	RE	0	0	0	1	0	0	0	0	0	0	0	0	CH	
----- Reserved ----->																
<----- Reserved ----->																
<----- Least Significant Word ----->																
<----- Most Significant Word ----->																
0	0	0	0	0	0	0	0	0	0	0	0	0	1	0	0	System Buffer Address
0	0	0	0	0	0	0	0	0	0	0	0	0	0	0	0	System Buffer Byte Count
<----- Least Significant Word ----->																
<----- Most Significant Word ----->																
<----- Least Significant Word ----->																
<----- Most Significant Word ----->																
<----- Reserved ----->																
<----- Reserved ----->																
<----- Reserved ----->																

Figure 51. Read Device Capacity Command

Device Capacity Data Block

Byte	7	6	5	4	3	2	1	0	Remarks
0	<----- High Byte ----->								
1	<----->								Last Logical Block Address
2	<----->								
3	<----- Low Byte ----->								
4	<----- High Byte ----->								
5	<----->								Block Length
6	<----->								
7	<----- Low Byte ----->								

Figure 52. Device Capacity Data Block

Read Prefetch

For this SCB command, the blocks specified are read and the data is transferred into the on-card disk cache for later access by a Read Data command. The block length specified must be 512 bytes and the block count must be less than or equal to 17 for the command to transfer data into the cache. If other values are specified, the command is treated as a no-operation. This command is supported only by the cached adapter. The non-cached adapter will reject this command with a Command Error Interrupt ID. The presence of a cached adapter can be determined by bit 11 of the Cache Information word in the Command Complete Status Block. If this bit is set to 1, the adapter has a cache. Otherwise, no cache is present.

15	14	13	12	11	10	9	8	7	6	5	4	3	2	1	0	Remarks
0	0	0	1	1	1	0	0	ND	NS	1	1	0	0	0	1	Read Prefetch
1	ES	RE	0	0	0	1	0	0	0	0	0	0	0	0	CH	Enable Word
<----- Least Significant Word ----->																Logical Block
<----- Most Significant Word ----->																Address
<----- Reserved ----->																
<----- Reserved ----->																
<----- Reserved ----->																
<----- Reserved ----->																
<----- Least Significant Word ----->																Termination Status Block
<----- Most Significant Word ----->																Address
<----- Least Significant Word ----->																Optional SCB Chain
<----- Most Significant Word ----->																Address
<----- Number of Blocks ----->																Block Count
<----- Block Size ----->																Block Length

Figure 53. Read Prefetch Command

Read Verify

This SCB command reads the specified blocks of data and checks for errors. Data is not transferred by this command; it serves to verify the readability of the data and the correct operation of the device.

This command is used for devices with fixed length blocks, such as fixed disk drives. This command causes the adapter to send the SCSI Read and Verify commands to the device. The blocks specified are read and the data is transferred to the system.

The Read Verify command supports multiple block operations up to 65,535 blocks or 16MB minus 1 byte (MB = 1,048,576 bytes), whichever is less, of total data transferred.

For devices with variable length blocks, such as tape drives, the Send Other SCSI SCB command should be used to generate the SCSI Read and Verify commands.

15	14	13	12	11	10	9	8	7	6	5	4	3	2	1	0	Remarks
0	0	0	1	1	1	0	0	ND	NS	0	0	0	0	1	1	Read Verify
1	ES	RE	0	0	0	1	0	0	0	0	0	0	0	0	CH	Enable Word
<----- Least Significant Word ----->																Logical Block
<----- Most Significant Word ----->																Address
<----- Reserved ----->																
<----- Reserved ----->																
<----- Reserved ----->																
<----- Reserved ----->																
<----- Least Significant Word ----->																Termination Status Block
<----- Most Significant Word ----->																Address
<----- Least Significant Word ----->																Optional SCB Chain
<----- Most Significant Word ----->																Address
<----- Number of Blocks ----->																Block Count
<----- Block Size ----->																Block Length

Figure 54. Read Verify Command

Reassign Block

This SCB command reassigns the logical block address for a defective block to a spare block. The system supplies the reassign block defect list. The system buffer address in the command block serves as a pointer to the defect list. Because the device data is considered erased by a Reassign Block command, the cache automatically clears any data from the device having a block reassigned.

15	14	13	12	11	10	9	8	7	6	5	4	3	2	1	0	Remarks
0	0	0	1	1	1	0	0	0	0	0	1	1	0	0	0	Reassign Block Enable Word
0	ES	RE	0	0	0	1	0	0	0	0	0	0	0	0	CH	
<----- Reserved ----->																
<----- Reserved ----->																
<----- Least Significant Word ----->																
<----- Most Significant Word ----->																
<----- Least Significant Word ----->																
<----- Most Significant Word ----->																
<----- Least Significant Word ----->																
<----- Most Significant Word ----->																
<----- Least Significant Word ----->																
<----- Most Significant Word ----->																
<----- Reserved ----->																
<----- Reserved ----->																

Figure 55. Reassign Block Command

Reassign Block Defect List

Byte	Defect List Header							Remarks
	7	6	5	4	3	2	1	
0	<----- Reserved ----->							
1	<----- Reserved ----->							
2	<----- High Byte ----->							Defect List Length
3	<----- Low Byte ----->							
Defect Descriptors								
4	<----- High Byte ----->							Defective Logical Block Address
5	<----- ----->							
6	<----- ----->							
7	<----- Low Byte ----->							

Figure 56. Reassign Block Defect List

Request Sense

This SCB command is used to return the sense data for the specified device. The adapter interrupts the system when the Sense data block is transferred. The length of the data block depends on the device and can be four bytes (non-extended) or more (extended). The format of the data block for both cases is shown. The system should specify the amount of data to be returned in the SCB based on the particular device attached, or specify the maximum value (255) and set the suppress short exception (SS) bit to 1.

The sense data is valid only if a Check Condition status was returned for the previous command to the device. The sense data provides additional information on the check condition. Refer to the ANSI SCSI publication or the particular SCSI device specification for detailed information about the Request Sense data block.

15	14	13	12	11	10	9	8	7	6	5	4	3	2	1	0	Remarks
0	0	0	1	1	1	0	ND	NS	0	0	1	0	0	0	0	Request Sense
1	ES	RE	0	0	SS	1	0	0	0	0	0	0	0	0	CH	Enable Word
<----- Reserved ----->																
<----- Reserved ----->																
<----- Least Significant Word ----->																
<----- Most Significant Word ----->																
<----- Least Significant Word ----->																
<----- Most Significant Word ----->																
<----- Least Significant Word ----->																
<----- Most Significant Word ----->																
<----- Least Significant Word ----->																
<----- Most Significant Word ----->																
<----- Reserved ----->																
<----- Reserved ----->																

Figure 57. Request Sense

Sense Data Block

Byte	Sense Bits								Remarks
	7	6	5	4	3	2	1	0	
0	AV <Class> <- Code ->								Error Class/Code
1	X	X	X	< High Byte >					Logical
2	<----->								Block
3	<----- Low Byte ----->								Address

Figure 58. Sense Data Block

Byte 0 Error Class/Error Code

Bit 7 **Address Valid:** When this bit is set to 1, the logical block address field is valid.

Bits 6 - 4 **Error Class:** When the error class is 0, the sense data block is in the format shown above. When the error class is 7, the sense data block is in the extended format, shown on the following page. All other settings are device dependent.

Bits 3 - 0 **Error Code:** Errors are device dependent.

Bytes 1 - 3 **Logical Block Address:** This address is device dependent.

Note: The adapter does not examine or use device-dependent information.

Extended Sense Data Block

Byte	Sense Bits								Remarks
	7	6	5	4	3	2	1	0	
0	V	1	1	1	<-- Code -->				Error Class/Code
1	<----- Segment # ----->								Segment Number
2	FM	EM	IL	X	<-- Key -->				Sense Key
3	<- Most Significant -->								Information Bytes
4	<----->								
5	<----->								
6	<- Least Significant ->								
7	<--Additional Length-->								# of Bytes
8	<--Additional Sense -->								Additional Sense
			.						
			.						
N	<--Additional Sense--->								Bytes

Figure 59. Extended Sense Data Block

Byte 0 Error Class/Error Code

Bit 7 The Information bytes are valid only if this bit is a 1.

Bits 6 - 4 Error class 7 is for extended sense data.

Bits 3 - 0 Error code 0 is standard format. Error codes hex 1 - E are reserved. Error code hex F is device dependent.

Byte 1 Segment Number: This byte contains the current segment descriptor.

Byte 2 Extended Error Bits/Sense Key

Bit 7 A filemark (FM) has been reached on a sequential access device.

Bit 6 An end of medium (EM) has been reached on a sequential access device.

Bit 5 An Invalid Length (IL) resulted when the specified logical block length did not match the device.

Bit 4 X - This bit is reserved.

Bits 3 - 0 The coding of these bits is shown in the following table.

Hex Value	Function
0	No Sense
1	Recovered Error
2	Not Ready
3	Medium Error
4	Hardware Error
5	Illegal Request
6	Unit Attention
7	Data Protect
8	Blank Check
9	Device Dependent
A	Copy Aborted
B	Aborted Command
C	Equal
D	Volume Overflow
E	Miscompare
F	Reserved

Figure 60. Sense Key

Bytes 3 - N Device-Dependent Status: Refer to the particular device specifications for a definition of these bytes.

Note: The adapter does not examine or use device-dependent information.

Reset

This immediate command allows the system to reset a specific physical device, or globally reset the adapter and all attached devices. A Reset command issued to a SCSI device causes the adapter to send a SCSI Bus-Device Reset message to the corresponding physical device. The SCSI Bus-Device Reset message causes the physical device to immediately end all commands in progress on all logical units attached, and go to the bus-free state. The system can reset the adapter by a soft reset if, for example, the system times out while waiting to complete an Abort command.

To reset the adapter, issue a Reset command to device hex F. The adapter stops all current activity and all attached devices are reset by activating the SCSI 'reset' signal. When the Reset command is completed, the adapter sets the Interrupt Status register to indicate the results. When the Command Complete interrupt occurs, the system reads the Interrupt Status register and checks for the Immediate Command Complete interrupt (hex A). A value of hex 7F in the Interrupt Status register indicates a diagnostic routine within the adapter has detected an error and the adapter may be defective. Individual devices can be reset as required for initialization or error recovery.

Command Interface Register Bits																Remarks
15	14	13	12	11	10	9	8	7	6	5	4	3	2	1	0	
0	0	0	0	0	1	0	0	0	0	0	0	0	0	0	0	Reset
----- Reserved -----																

Figure 61. Reset Command

Send Other SCSI Command

This SCB command is used to send any SCSI command not supported by the adapter directly to a SCSI device. The command to be issued is placed at the end of the SCB. When commands are issued directly to a device using this command, messages are handled by the adapter. Data transfer direction is controlled by the read-option bit (RD) in the Enable word. When this bit is set to 1, the adapter transfers data to the system from the device. When the read-option bit is set to 0, the adapter transfers data to the device from the system. If the system-buffer byte count specified in the SCB is 0, no data is transferred. Because device data can be altered by this command, the cache is automatically cleared of any data from that device.

Notes:

1. This command should be used only when other commands cannot perform the operation; otherwise, performance of the SCSI subsystem can be impacted.
2. This command should be issued only to logical device numbers 0 to 14.

15	14	13	12	11	10	9	8	7	6	5	4	3	2	1	0	Remarks
0	0	1	0	0	1	0	0	ND	NS	0	1	1	1	1	1	Send Other SCSI Command Enable Word
RD	ES	RE	PT	0	SS	1	0	0	0	0	0	0	0	0	CH	
<----- Reserved ----->--- SCSI CMD Length --->																
<----- Reserved ----->																
<----- Least Significant Word ----->																
<----- Most Significant Word ----->																
<----- Least Significant Word ----->																
<----- Most Significant Word ----->																
<----- Least Significant Word ----->																
<----- Most Significant Word ----->																
<----- Least Significant Word ----->																
<----- Most Significant Word ----->																
<-----1----- SCSI Command -----0----->																
<-----3----- SCSI Command -----2----->																
<-----5----- SCSI Command -----4----->																
<-----7----- SCSI Command -----6----->																
<-----9----- SCSI Command -----8----->																
<-----11----- SCSI Command -----10----->																
Six Bytes or Ten Bytes or Twelve Bytes																

Figure 62. Send Other SCSI Command

Write Data

This SCB command writes data from the system to the device in consecutive blocks. This command is used for devices with fixed length blocks, such as fixed disk drives. This command causes the adapter to send the SCSI Write command to the device. The blocks specified are read and the data is transferred to the system. No verification is performed.

The Read Data command supports multiple block operations up to 65,535 blocks or 16MB minus 1 byte (MB = 1,048,576 bytes), whichever is less, of total data transferred.

For devices with variable length blocks, such as tape drives, the Send Other SCSI SCB command should be used to generate the SCSI Write command.

15	14	13	12	11	10	9	8	7	6	5	4	3	2	1	0	Remarks
0	0	0	1	1	1	0	0	ND	NS	0	0	0	0	1	0	Write Data
0	ES	RE	PT	0	0	BB	0	0	0	0	0	0	0	0	CH	Enable Word
<----- Least Significant Word ----->																Logical Block
<----- Most Significant Word ----->																Address
<----- Least Significant Word ----->																System Buffer
<----- Most Significant Word ----->																Address
<----- Least Significant Word ----->																System Buffer
<----- Most Significant Word ----->																Byte Count
<----- Least Significant Word ----->																Termination Status Block
<----- Most Significant Word ----->																Address
<----- Least Significant Word ----->																Optional SCB Chain
<----- Most Significant Word ----->																Address
<----- Number of Blocks ----->																Block Count
<----- Block Size ----->																Block Length

Figure 63. Write Data Command

Write with Verify

This SCB command is similar to Write Data, except that a Read Verify command is performed after all blocks are written. This command is used for devices with fixed length blocks, such as fixed disk drives. This command causes the adapter to send the SCSI Write and Verify commands to the device. The blocks specified are read and the data is transferred to the system.

The Write with Verify command supports multiple block operations up to 65,535 blocks or 16MB minus 1 byte (MB = 1,048,576 bytes), whichever is less, of total data transferred.

If an error occurs during a Write with Verify command, the system should retry the command. If all retries of the command fail, the system can allocate a spare block to replace the failing one through the Reassign Block command, and then reissue the command.

For devices with variable length blocks, such as tape drives, the Send Other SCSI SCB command should be used to generate the SCSI Write and Verify commands.

15	14	13	12	11	10	9	8	7	6	5	4	3	2	1	0	Remarks
0	0	0	1	1	1	0	0	ND	NS	0	0	0	1	0	0	Write Verify
0	ES	RE	PT	0	0	BB	0	0	0	0	0	0	0	0	CH	Enable Word
<----- Least Significant Word ----->																
<----- Most Significant Word ----->																
<----- Least Significant Word ----->																
<----- Most Significant Word ----->																
<----- Least Significant Word ----->																
<----- Most Significant Word ----->																
<----- Least Significant Word ----->																
<----- Most Significant Word ----->																
<----- Least Significant Word ----->																
<----- Most Significant Word ----->																
<----- Number of Blocks ----->																
<----- Block Size ----->																
Logical Block Address																
System Buffer Address																
System Buffer Byte Count																
Termination Status Block Address																
Optional SCB Chain Address																
Block Count																
Block Length																

Figure 64. Write with Verify Command

Error-Recovery Procedures

This section describes the error-recovery procedures for the adapter and the system.

Adapter-Error Recovery

The adapter performs the error-recovery procedures (ERP) as necessary to ensure data integrity and maintain system availability. Error recovery will not be performed if retries have been inhibited by setting the RE command option bit to 0 for a particular command. Adapter retry counts are maintained and can be obtained by reading the termination status block (TSB) or by using the Get Command Complete Status command.

Device level retries are device dependent and are usually disabled through the SCSI Mode Select command.

Data Error

The following section will discuss read operations, write operations, and format operations in data-error recovery.

Read Operations: The adapter can retry on certain errors. If retries are successful, the subsystem does not interrupt the command operation. The occurrence of adapter retries is indicated through interrupt ID 5. The number and type of retries are in the Command Complete status block.

Even though the adapter performs extensive retries for adapter errors, it is recommended that the subsystem retry all failed commands.

SCSI devices automatically perform read-error recovery procedures unless this function is disabled. When the adapter cache buffer is enabled and a read error is indicated by a device, the system should set the bypass buffer bit to 1 and retry the command. This prevents faulty prefetched data from causing errors.

If an error occurs while reading data already in the cache buffer (read hit), the buffer data causing the error is removed from the buffer and

the command should be retried. The retry forces the data to be read into the buffer again, directly from the device.

When a device error persists, the logical block causing the error can be reassigned to a spare block by using the Reassign Block command. The adapter does not reassign a defective block on its own.

Write Operations: Each device performs its own write-error recovery procedures unless this function is disabled. If a device returns a write error and all retries are unsuccessful, the adapter determines if the error was due to a buffer data error.

If the error was not the result of bad buffer data, the command is terminated with an error. If the error was the result of bad buffer data, the data in error is removed from the buffer and the command should be retried. This retry forces the data to be transferred into the buffer again and then sent to the device.

If a device error persists, the logical block in error can be reassigned. The adapter does not reassign defective blocks on its own.

Format Operations: Each device performs its own format-error recovery procedures unless retries have been disabled. If a device returns a format error, and all retries are unsuccessful, the adapter terminates the command with an error.

Positioning Error

Each device performs its own positioning-error-recovery procedures unless error recovery is disabled. If a device returns an error indicating a positioning error, and all retries were unsuccessful, the adapter ends the command with an error.

SCSI-Bus Parity Error

If a SCSI-bus parity error occurs, the adapter retries the failing sequence unless retries have been disabled. If the retry is unsuccessful, or if the total number of errors reaches nine, the command is terminated immediately with a nonrecoverable error.

Operational Time-Outs

The adapter ensures timely completion of commands through local and global time-outs. If a SCSI device does not respond to a selection sequence within the time-out period, a selection time-out error will be returned to the system. If a command is not completed within the time-out period, a global time-out error is returned to the adapter.

The adapter time-out values are 260 milliseconds for a selection time-out, and 45 seconds (default), which is changed through the Set Features command, for a global time-out.

System-Error Recovery

The system must process errors reported after a reset or command completion. Some types of errors are normal. For instance, a unit attention error after a device is reset, or after removable media is changed, is normal. When an error is reported that is not expected or not normal, the system should follow the error-recovery and fault-isolation procedure table. This procedure helps determine if the error is recoverable, and if it is the result of a command error, a system programming error, or a subsystem hardware failure. Recommended actions are indicated for each class of command, based on the interrupt ID returned.

The following two tables describe error-recovery procedures (ERP).

Command Class	Interrupt ID	Recommended Action
Device Reset Command	AX	ERP Complete/Retry Original Commands
	7X	ERP 19
	CX	ERP 18
	EX	ERP 11
	FX	ERP 14
	Others Time-out	ERP 18 ERP 19
Device Abort Command	AX	ERP Complete/Retry Original Commands
	7X	ERP 19
	CX	ERP 16
	EX	ERP 11
	FX	ERP 14
	Others Time-out	ERP 18 ERP 18
Request Sense Commands	1X	ERP 3
	5X	ERP 9
	7X	ERP 19
	CX	ERP 15
	EX	ERP 11
	FX	ERP 14
	Others	ERP 18
	Time-out	ERP 18
All Other Device Commands	1X	No Errors
	5X	ERP 8
	7X	ERP 19
	CX	ERP 1
	EX	ERP 11
	FX	ERP 14
	Others Time-out	ERP 18 ERP 18

Figure 65. SCSI Command ERP Table

Command Class	Interrupt ID	Recommended Action
Adapter Reset Command	AF	ERP Complete/Retry Original Commands
	7F	ERP 20
	CF	ERP 18
	EF	ERP 11
	FF	ERP 14
	Others Time-out	ERP 19 ERP 19
Adapter Abort Command	AF	ERP Complete/Retry Original Commands
	7F	ERP 20
	CF	ERP 19
	EF	ERP 11
	FF	ERP 14
	Others Time-out	ERP 19 ERP 19
All Other Adapter Commands	1F	No Errors
	5F	ERP 8
	7F	ERP 20
	EF	ERP 11
	FF	ERP 14
	Others Time-out	ERP 17 ERP 17
Hardware Reset	0F	ERP Complete/Retry Original Commands
	3F	ERP 20
	8F	ERP 21
	Others	ERP 22
	Time-out	ERP 22

Figure 66. Adapter Command ERP Table

The following error-recovery procedures assume that adapter and device retries have not been disabled.

- ERP 1** If the termination status block (TSB) or command complete status block indicates a Check condition in the device status byte, go to ERP 2. Otherwise, go to ERP 12.
- ERP 2** Issue the Request Sense command to the SCSI device. See the appropriate ERP table.
- ERP 3** If the Sense key from the request-sense data equals 6 (Unit Attention), go to ERP 6. Otherwise, go to ERP 4.
- ERP 4** If the Sense key from the request-sense data equals 2 (Not Ready), go to ERP 5. Otherwise, go to ERP 15.

- ERP 5** If the removable media bit (RMB) is set to 1 (bit 7 in the Device Inquiry data block), the program should handle media installation (for example, prompt for media insertion), then go to ERP 7. If the RMB is set to 0, go to ERP 15.
- ERP 6** If the RMB is set to 1, the program should take any action needed when the media is changed, then go to ERP 7. If the RMB is set to 0, go to ERP 7.
- ERP 7** Retry the original operation three times or more. If an error persists, go to ERP 15.
- ERP 8** Log the soft error counts from TSB or CCSB if desired. Continue normal operations.
- ERP 9** Log the soft error counts from TSB or CCSB if desired. Go to ERP 3.
- ERP 10** Retry the original operation at least three times. If an error persists, go to ERP 17.
- ERP 11** Check the command and the parameters for validity. Check the TSB or CCSB command error code for additional information.
- ERP 12** If the TSB or CCSB command error code is hex OA (device not assigned), suspect a system software initialization or configuration problem. If none is found, proceed to ERP 13.
- ERP 13** If the TSB or CCSB device error code equals hex 10 (Selection Time-Out), make sure the SCSI device is properly connected to the SCSI bus. Also, be sure that the SCSI address (ID) on the device is set properly and is not the same as any other device (including the adapter SCSI ID set in POS register 3). Otherwise, proceed to ERP 18.
- ERP 14** Check the system software command queuing/delivery code for a possible problem. If none is found, go to ERP 18.
- ERP 15** Issue an Immediate Abort command to the SCSI device. See the appropriate ERP table.
- ERP 16** Issue an Immediate Reset command to the SCSI device. See the appropriate ERP table.

- ERP 17** Issue an Immediate Abort command to the adapter. See the appropriate ERP table.
- ERP 18** Issue an Immediate Reset command to the adapter. See the appropriate ERP table.
- ERP 19** Perform a hardware reset through the Basic Control register bit 7. Set bit 7 to 1. Then, reset bit 7 to 0 to perform the reset. See the appropriate ERP table.
- ERP 20** Verify the proper connection of the SCSI bus cables and termination networks. If an error persists, proceed to ERP 21. Otherwise, replace the defective SCSI bus cable or the defective termination network.
- ERP 21** Remove the devices from the SCSI bus, one at a time, and perform a hardware reset until the error condition is removed. If all the devices and cables (except the terminators) are removed and an error persists, proceed to ERP 22. Otherwise, replace the defective SCSI device, the defective SCSI bus cable, or the defective termination network. See the appropriate ERP table.
- ERP 22** Replace the defective adapter. Restore the system to the original configuration. See the appropriate ERP table.

Compatibility

The adapter uses the SCB architecture as an interface to the system. Some differences, however, exist between the architecture definition and how the adapter implements the architecture. This section describes those differences.

Commands

The adapter does not support all commands defined by the architecture. In addition, the adapter does not support a command hierarchy. The architecture allows the Suspend and the Reset Interrupt Status commands to be accepted by a device while it is performing another command, and the adapter does not.

The following SCB commands defined by the architecture are not supported by the adapter:

- Suspend
- Resume
- Initialize Device
- Non-operation.

The Non-operation Immediate command defined by the architecture is not supported by the adapter.

Rejected Commands

The architecture defines that a subsystem indicate that a command has been rejected by setting the reject bit in a status area called the Command Status byte. Under the following conditions, the adapter generates a command-sequence interrupt:

- The device interrupt queue is full
- The attention code is not valid
- The Immediate-command operation code is not valid
- The device is busy
- The device is not available
- The device specified is not valid.

Command Options

The architecture allows optional facilities to be selected for commands sent to each device; these options are selected using Enable word (Word 1) of the control block. The Enable word also allows for subsystems, such as the adapter, to define certain bits for their specific needs.

The adapter does not use some of these options; bits selecting these options are reserved on the adapter and must be set to 0.

The following shows the differences in the options between the adapter and the architecture.

- SCB Interrupts on Command Complete
 - **Architecture:** Allows an optional interrupt on any SCB. The architecture will allow any SCB in a chain to request an SCB interrupt.
 - **Adapter:** Issues an interrupt for every SCB not in a chain. The adapter will not allow an interrupt for normal SCB completion except for the last SCB in the chain.
- SCB Interrupts on Non-SCB Command Complete
 - **Architecture:** Allows optional specification on some commands. Disallows Interrupts on other commands to avoid recursion problems with full interrupt queues.
 - **Adapter:** Issues an interrupt after every command.
- Storing End Status Word 1 on an SCB Interrupt for Normal Completion
 - **Architecture:** Compatible with the adapter when the Device Interrupt Identification register is not supported.
 - **Adapter:** Stores TSB word 0 only when requested by SCB Enable word.
- Storing of Residual Buffer Address in the TSB on Errors
 - **Architecture:** To standardize error handling, always store a Buffer address in the TSB whenever a Residual Byte count is provided.
 - **Adapter:** Stores buffer address only when Indirect list is used in SCB.

- **Suppress Exception Long in SCB Enable Word 1**
 - **Architecture:** This is an optional feature.
 - **Adapter:** The adapter does not support this option.
- **Extended SCBs and TSBs**
 - **Architecture:** This is an optional feature that allows usage of two operand-storage addresses including incrementing and decrementing.
 - **Adapter:** The adapter does not support this option.

Interrupts

The following section describes the differences between the SCB architecture definition of interrupts and the adapter implementation of the architecture.

- **Presentation of Interrupt Status in the Interrupt Status Register**
 - **Architecture:** Supports two modes of Interrupt handling. In the simple mode, all interrupts flow through the Interrupt Status register, which is compatible with the adapter implementation. In the Device Interrupt Identification register mode, SCB interrupts are not presented through the Interrupt Status register.
 - **Adapter:** All interrupts flow through a single Interrupt Status register.
- **Command to Clear the Interrupt Status Register**
 - **Architecture:** Compatible with adapter implementation when the Device Identification Interrupt register extension to the architecture is not implemented.
 - **Adapter:** Implements only a single command, and can clear only a single interrupt at a time.
- **Clearing Multiple SCB Logical Interrupts on a Single Command**
 - **Architecture:** Supported by Reset SCB interrupt command when the Device Identification Interrupt register is supported.
 - **Adapter:** This is not supported.
- **Presentation of Multiple Causes on Physical Interrupt**
 - **Architecture:** Multiple causes presented in the Device Identification Interrupt register method of interrupt handling.
 - **Adapter:** Only one cause per Physical interrupt.
- **Interrupt Code Returned for Reset Device**
 - **Architecture:** Returns Interrupt code hex 0 (reset complete) to allow a program to discard interrupt data in the Interrupt Status port for a device when a Reset Device is issued.
 - **Adapter:** Returns Interrupt code hex A (immediate command complete) no error.

Other Differences

SCB Enable Word 1

This section describes the differences between the SCB architecture definition of the SCB Enable Word 1 and how the adapter implements the architecture.

Adapter

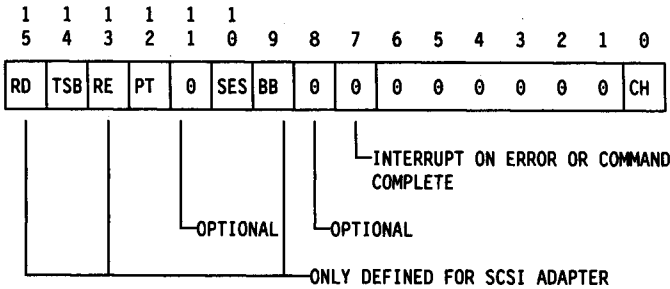

SCB Architecture

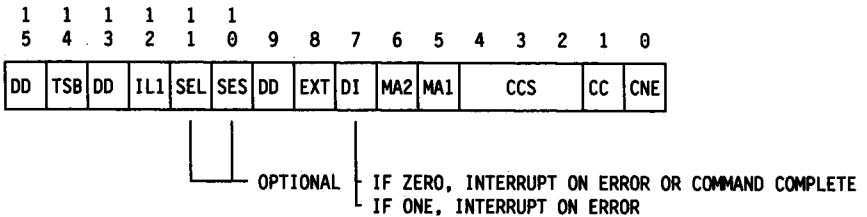

Figure 67. SCB Enable Word 1

Note: Consider the following when examining both Enable Words.

- Bits shown as 0 in the adapter are reserved and must be set to 0. These bits are upward compatible with the architecture.
- Bits CH and CNE are the same (chain no error.)
- Bits PT and IL1 are the same (indirect list specified.)
- Bits marked as DD are usable for adapter defined functions. This is compatible with the architecture.

SCB Command Status Register

This section describes the differences between the SCB architecture definition of the SCB Command Status register and how the adapter implements the architecture.

Adapter

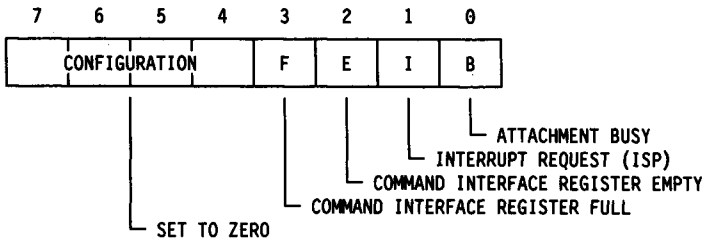

SCB Architecture

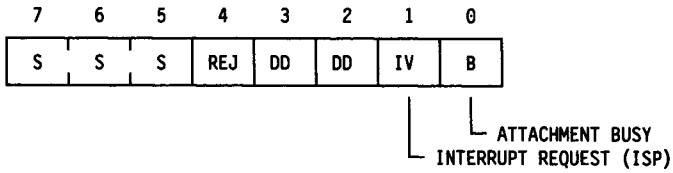

Figure 69. SCB Command Status Register

Note: Consider the following when examining the Command Status registers.

- Bits I and IV are the same. Both show that an interrupt value has been placed in the Interrupt Status register.
- Bits marked as DD are usable for adapter defined functions.

SCB Subsystem Control Register

This section describes the differences between the SCB architecture definition of the SCB Subsystem Control register and how the adapter implements the architecture.

Adapter

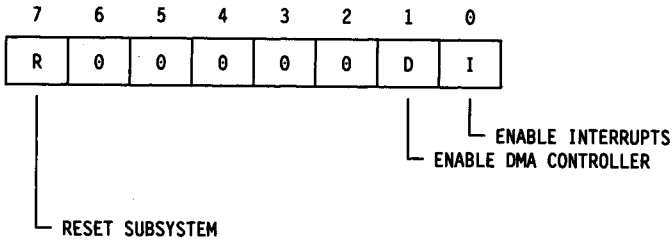

SCB Architecture

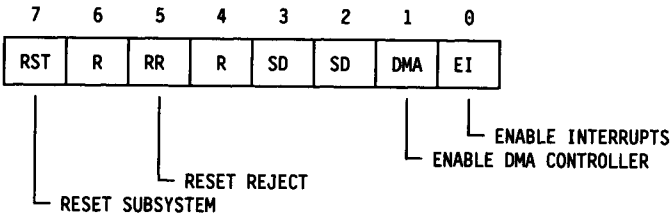

Figure 70. SCB Subsystem Control Register

Note: The following points should be considered when examining the Basic Control register and the Subsystem Control register.

- Bits shown as 0 in the adapter are reserved and must be set to 0. These bits are upward compatible with the architecture.
- Bits I and EI are the same. These bits enable the adapter to send interrupts to the system unit.
- Bits D and DMA are the same. These bits enable the adapter to continue to use DMA services.
- Bits R and RST are the same. These bits perform a hardware controlled reset of the adapter.
- Bits marked as SD are usable for adapter defined functions. This is compatible with the architecture.

SCB Immediate Command Format

This section describes the differences between the SCB architecture definition of the SCB Immediate command format and how the adapter implements the architecture.

Adapter

COMMAND INTERFACE REGISTER FORMAT 0

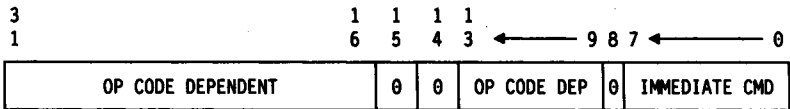

SCB Architecture

COMMAND INTERFACE REGISTER FORMAT 0

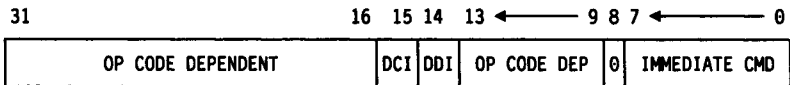

COMMAND INTERFACE REGISTER FORMAT 1

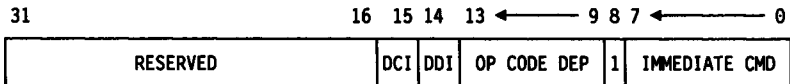

Figure 71. SCB Immediate Command Format

Note: The following points should be considered when examining immediate command format zero:

- The Immediate CMD codes assigned are compatible.
- The DDI bit is compatible with adapter implementation. When set to 0, this bit leaves the device enabled for interrupts. When set to one, this bit disables the device from sending interrupts to the system unit.
- The DCI bit is compatible with adapter implementation. When set to zero, this bit requests an interrupt on completion. When set to one, this bit does not request an interrupt on completion of an immediate command. The architecture is a superset when this bit is not ignored by the command (Reset Interrupt Status register.)

This section describes additional differences between the SCB architecture definition and how the adapter implements the architecture.

- **Specification Testing of SCBs**
 - **Architecture:** This is an optional feature.
 - **Adapter:** Compatible with architecture.
- **Device Number for Subsystem**
 - **Architecture:** Subsystem is device hex 00.
 - **Adapter:** Subsystem is device hex 0F.
- **Attention Code to Start Long SCB**
 - **Architecture:** These are device-dependent attention codes in the architecture. They are compatible with the adapter implementation.
 - **Adapter:** Uses hex 04 or hex 0F.
- **Attention Code Hex 00.**
 - **Architecture:** Uses as device reset.
 - **Adapter:** Not implemented. Does device reset under Attention Code hex 01.

- **Interrupt Status Codes are the same except for:**
 - **Architecture: Uses**
 - 0 - Reset device or subsystem complete
 - 2 - Notify event when Locate mode commands use Move mode command delivery
 - 5 - Device dependent (compatible with implementation)
 - 6 - Inform event when Locate mode commands use Move mode command
 - 8 - Hardware failure reading control block command or storing TSB status.
 - E - Command rejected when Locate mode commands use Move mode command delivery
 - D - Non-SCB command error
 - F - Device dependent
 - **Adapter: Uses**
 - 0 - Reset subsystem complete
 - 2 - Reserved
 - 5 - SCB Completed with retries
 - 6 - Reserved
 - 8 - Reserved
 - E - Invalid command
 - D - Reserved
 - F - Software sequence error
- **Disabling Device on Immediate Commands**
 - **Architecture:** Controlled by the DDI in the Immediate command format.
 - **Adapter:** Enables devices by default. The adapter does not support this option. This is a proper subset of the architecture.

Device Signals

The adapter supports single-ended drivers and receivers. All signal lines are digital, open collector transistor-transistor logic (TTL), and provide signals to the various SCSI devices. The drivers have the following electrical specifications:

Active: 0.0 Vdc to 0.5 Vdc at 48 mA (maximum)

Inactive: 2.5 Vdc to 5.25 Vdc at 250 μ A (open collector)

The following are the signal descriptions for the adapter-to-device connector.

- Acknowledge (-ACK)** This signal is driven by the adapter to acknowledge the request for data transfer.
- Attention (-ATN)** This signal is driven by the adapter to initiate the transfer of a message to a device.
- Busy (-BSY)** This signal is the OR input from all devices on the bus, including the adapter. It is driven active by a device to indicate that the bus is in use.
- Control/Data (-C/D)** This signal indicates if the data bus contains control or data information. When the signal is low, the data bus contains control information. This signal is driven by the device.
- Data Bits (-D0-7,DP)** These signals contain the eight data bits plus the one parity bit that make up the data bus. Data bit 7 is the most-significant bit and has the highest priority during arbitration. The adapter uses odd parity for all transfers except arbitration. When the signal is low, the respective bit is a logical 1.

- Input/Output (-I/O)** This signal indicates the direction of the signal flow regarding the adapter. When this signal is low, the data is either being sent to the adapter, or the 'select' signal is being driven by a device. This signal is driven by the device.
- Message (-MSG)** This signal is driven by a device to indicate that the data bus contains a message.
- Request (-REQ)** This signal is driven by a device to initiate a data transfer.
- Reset (-RST)** This signal is driven by the adapter to reset all SCSI devices. This will occur as a result of an adapter Reset command.
- Select (-SEL)** This signal is bidirectional and indicates that the data bus contains a device ID. This signal is either driven by the adapter to select a device, or driven by the device to reselect the adapter.

Connectors

The adapter has two connectors. The internal connector is a keyed 2- by 25-pin edge connector located on the top edge of the adapter. This connector supports SCSI devices mounted inside the system unit. Even-numbered pins are on the main component side of the adapter, with pin 2 at the end closest to the D-shell connector.

The following table shows the signals and pin assignments for the internal connector.

Pin	Signal	Pin	Signal
1	Ground	2	-Data Bits(0)
3	Ground	4	-Data Bits(1)
5	Ground	6	-Data Bits(2)
7	Ground	8	-Data Bits(3)
9	Ground	10	-Data Bits(4)
11	Ground	12	-Data Bits(5)
13	Ground	14	-Data Bits(6)
15	Ground	16	-Data Bits(7)
17	Ground	18	-Data Bits(P)
19	Ground	20	Ground
21	Ground	22	Ground
23	Ground	24	Ground
25	Not Connected	26	+Terminal Power
27	Ground	28	Ground
29	Ground	30	Ground
31	Ground	32	-Attention
33	Ground	34	Ground
35	Ground	36	-Busy
37	Ground	38	-Acknowledge
39	Ground	40	-Reset
41	Ground	42	-Message
43	Ground	44	-Select
45	Ground	46	-Control/Data
47	Ground	48	-Request
49	Ground	50	-Input/Output

Figure 72. SCSI Internal Connector Pin Assignments

A 60-pin external connector on the rear of the adapter allows attachment of external SCSI devices. Pins 1 through 50 correspond to pins 1 through 50 of the SCSI Standard. Pin 51 can be used as ground.

The following table shows the signals and pin assignments for the external connector. See Figure 74 on page 80 for pin location on the external connector.

Pin	Signal	Pin	Signal
1	Ground	31	Ground
2	-Data Bits(0)	32	-Attention
3	Ground	33	Ground
4	-Data Bits(1)	34	Ground
5	Ground	35	Ground
6	-Data Bits(2)	36	-Busy
7	Ground	37	Ground
8	-Data Bits(3)	38	-Acknowledge
9	Ground	39	Ground
10	-Data Bits(4)	40	-Reset
11	Ground	41	Ground
12	-Data Bits(5)	42	-Message
13	Ground	43	Ground
14	-Data Bits(6)	44	-Select
15	Ground	45	Ground
16	-Data Bits(7)	46	-Control/Data
17	Ground	47	Ground
18	-Data Bits(P)	48	-Request
19	Ground	49	Ground
20	Ground	50	-Input/Output
21	Ground	51	Ground
22	Ground	52	Reserved
23	Ground	53	Reserved
24	Ground	54	Reserved
25	Not Connected	55	Reserved
26	+ Terminal Power	56	Reserved
27	Ground	57	Reserved
28	Ground	58	Reserved
29	Ground	59	Reserved
30	Ground	60	Reserved

Figure 73. SCSI External Connector Pin Assignments

The following diagrams show the dimensions of the 60-pin external connector.

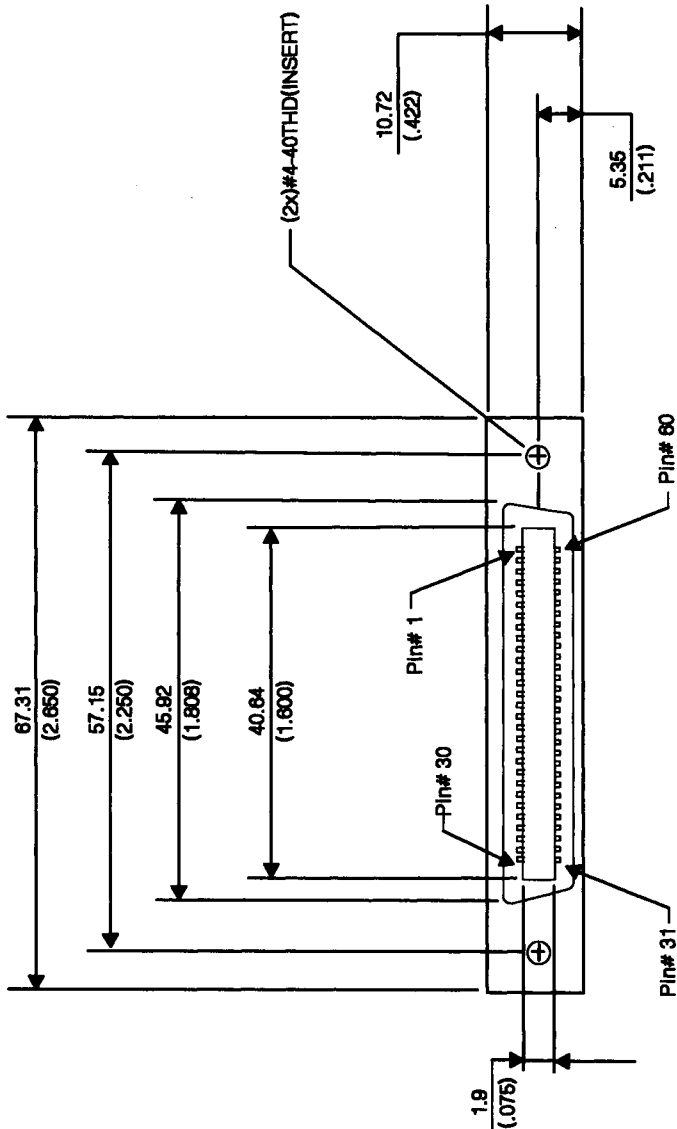

Figure 74. 60-Pin External Connector, Front View

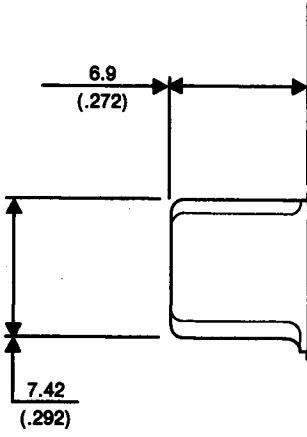

Figure 75. 60-Pin External Connector, Side View

Notes:

Index

A

ABIOS (advanced basic input/output system) 4
abort command 28, 63
adapter
 BIOS 12
 BIOS and POST 4
 block diagram 2
 command error-recovery procedures (ERP) 62
 commands 27
 components 3
 description 1
 error-recovery procedures 3, 58, 62
 ID (identification) 8, 9
 microprocessor 3, 14
 POS ID 43
 reset command 54, 77
 reset status 21
 resetting 20
 SCSI (small computer system interface) ID 63
 status 19
 time-out 60
 to system interface 12
 vs SCB architecture 65
advanced BIOS (ABIOS) 4
American National Standards Institute (ANSI) 5, 6
arbitration 11
architecture, Micro Channel 1
architecture, SCB 65
assign command 29
attention register 14, 19
attention request 14

B

basic control register 12, 16
basic status register 12, 19
BIOS (basic input/output system) 3, 4, 12
BIOS, advanced (ABIOS) 4
block diagram, adapter 2
block, logical 59
buffers 26
buffer, cache 58
burst mode 4
burst rate 1
bus
 cables, SCSI 64
 controller, SCSI 3
 data 76, 77
 master 1, 12
 master DMA 4
 SCSI 4
bus-device reset 54

C

cables, SCSI bus 64
cache
 and data flow controller 4
 buffer 58
 disk 3
 information word 41
capacity, device 46
card setup signal (-CD SETUP) 8
CCSB (command-complete status block) 63
-CD SETUP 8
chain condition 26
channel connector size 43
check condition 35, 50
CHRESET 20

CMOS (complementary metal-oxide semiconductor) 8

command

- and interrupt register 4
- common command set 1, 6
- complete status block (CCSB) 63
- descriptions 28, 32
- error code table 40
- initiation 21
- interface registers 13, 19
- list 27
- processing 21, 22
- queuing/delivery code 63
- reset 77
- sequence 21
- status codes 39

commands

- abort 28, 63
- adapter 27
- adapter reset 77
- assign 29
- command complete status block 36
- device inquiry 30
- DMA pacing control 31, 44
- feature control 32
- format prepare 33
- format unit 33
- get command complete status 36, 58
- get POS and adapter information 42
- immediate 13, 27
- read data 45
- read device capacity 46
- read prefetch 47
- read verify 48
- reassign block 49, 59
- request sense 50, 62
- reset 54, 77
- SCB (subsystem control block) 13, 18
- scb, not supported 65

commands (*continued*)

- SCSI command set 6
- SCSI mode select 58
- send other SCSI 55
- set features 60
- write data 56
- write with verify 57
- common command set 1, 6
- complementary metal-oxide semiconductor (CMOS) 8
- components, adapter 3
- configuration 63
- configuration, system 8
- conformance 5
- connectors 78
- connector, external (diagram) 80
- control blocks, subsystem (SCB) 24
- control command, immediate feature 32
- controllers
 - cache and data flow 3, 4
 - DMA 16
 - SCSI bus 3
 - system interface/bus master DMA 4
 - system interrupt 15

D

data

- buffers 24
- error recovery 58
- flow controller 3, 4
- transfer 26, 45
- transfer rate 1
- transfer rate, device 32
- data block 50, 52
- defect management 33
- description
 - adapter 1
 - command 28
- detection, SCSI phase change 3

device
 -dependent status 53
 address 11
 attached 30
 capacity data block 46
 data-transfer rate 32
 dependent status length 38
 error code 40
 error recovery 59
 external 79
 ID 17, 77
 inquiry 30
 internal 78
 level retries 58
 logical 15
 number 13, 29
 priority request 11
 requirements for POST
 support 7
 reset 54
 retries 62
 select code 14
 selection and reselection 3, 18
 signals 76
 status 39
devices supported 6
direct memory access (DMA) 4
disk cache 3
disk, fixed 4
DMA 4
DMA pacing control command 31

E

enable options 25
EOI (end-of-interrupt)
 instruction 15
 request 15, 24
error class 51
error code, command/device 40
error-recovery procedures (ERP)
 adapter 58
 adapter commands 62
 adapter microprocessor 3

error-recovery procedures (ERP)
 (*continued*)

 SCSI commands 61
 system 60
ES option bit 26
extended data block 50
extended message 7
extended sense data block 52
external connector diagram 80

F

fairness 11
fault isolation 26, 60
feature control command 32
fixed disk 4
flowchart 22, 23
format
format prepare command 33
format unit command 33

G

get command complete
 status 24, 36
get POS and adapter
 information 42
global time-out error 60

H

hard reset 5, 20
hardware error interrupt 37
hardware interrupt-request
 latch 15
hardware reset 16, 32
hit, read 58

I

ID (identification)
 adapter 8, 9
 adapter POS 43
 adapter SCSI 63

ID (identification) (*continued*)
 device 17
 interrupt 17, 58
 identification number (ID), SCSI 6
 identify message 28
 immediate commands 13, 27
 immediate pacing control
 command 44
 initialization 63
 interface, adapter-to-system 12
 interleave factor 34
 interrupt
 adapter 10, 13
 command complete 19
 device reporting 18
 enable 16
 false 15
 hardware 19
 ID 17, 60
 processing 23
 request 19, 24
 SCB architecture vs. adapter 68
 status register 12, 17, 24
 system (IRQ14) 17
 type 18
 IRQ14 17
 issuing a command 22
 I/O address 10
 I/O registers 12

L

LBA (logical block address) 49
 level, conformance 5
 logical
 block 59
 block address (LBA) 49
 device 1, 30
 unit 43
 logical unit 43
 logical unit number (LUN) 7, 29
 logic, bus-steering 4
 logic, data-flow 4

LUN (logical unit number) 7

M

mechanical specifications 80
 media, removable 63
 memory refresh operations 10
 messages, SCSI 7
 Micro Channel architecture 1
 Micro Channel connectors 4
 microprocessor, adapter 3, 14
 mode, burst 4

N

non-extended data block 50

O

operational time-outs 60
 options, enable 25

P

pacing control command, DMA 31
 page mode 24
 parity error, SCSI bus 59
 parity generation and checking,
 SCSI bus 3
 phase change 3
 physical device 1, 30
 physical unit number (PUN) 6, 7,
 29
 pin assignments, connectors 78,
 79
 POS (programmable option
 select) 8
 adapter ID 43
 and adapter information status
 block 42
 read and write operations 10
 registers 8, 9, 43
 warning 8

positioning-error recovery 59
POST (power-on self test) 4, 7
-PREEMPT 11
prefetched data 58
procedures, error-recovery 58, 62
PT option bit 26
PUN (physical unit number) 6, 7

Q

queuing/delivery code 63

R

RAM (random access memory),
 adapter microprocessor 4, 21
rate, burst 1
rate, transfer 1
RD option bit 26
RE option bit 26
read
 buffer 6
 capacity 6
 commands 45
 data 45
 defect data 6
 device capacity 46
 error 58
 extended 6
 hit 58
 operations 58
 POS read and write
 operations 10
 prefetch 47
 read-only memory (ROM) 4
 verify 48
reassign block command 49, 59
registers
 attention 14, 19
 basic control 12, 16
 basic status 12, 19
 command and interrupt 4
 command interface 13, 19
 interrupt status 12, 17, 24

registers (*continued*)
 I/O 12
 POS 8, 43
removable media bit (RMB) 63
request
 attention 14
 codes 14
 sense command 50
 sense data block 50
reselection, device 3
reserved areas, warning 1
reset command 54, 77
resetting the adapter 20
reset, hardware 32
residual byte count 38
retries 58
retry counts 38
ROM (read-only memory)
 BIOS 12
 segment address select 9
 test 21

S

SCB (subsystem control block)
 address 13
 architecture vs. adapter 65
 commands not supported 65
 long 15
 structure 25
 transfer 24
SCSI (small computer system
interface)
 adapter ID 63
 address switches (ID) 63
 bus 4
 bus cables 64
 bus controller 3
 bus parity error 59
 commands 6
 common command set 1, 6
 conformance statement 5
 devices 60, 77
 error recovery 59, 60, 61

- SCSI (small computer system interface) (*continued*)
 - ID 6, 63
 - logical unit number (LUN) 29
 - messages 7
 - mode select command 58
 - phase change detection 3
 - physical unit number (PUN) 29
 - selection timeout 60
 - signals 78, 79
 - standard 5
 - segment number 52
 - selection time-out 63
 - selection, device 3
 - send other SCSI command 6, 15, 55
 - sense data block 51
 - sense key 52
 - set features command 60
 - signals
 - device 76
 - hardware interrupt 44
 - SCSI 78, 79
 - system 'reset' (+CHRESET) 20
 - 'card setup' 8
 - 'channel reset' 10
 - small computer system interface (SCSI) 1
 - soft errors 63
 - soft reset 20, 54
 - specifications, mechanical 80
 - SS option bit 26
 - status
 - adapter 19
 - bit descriptions 37
 - codes 39
 - commands 27
 - messages, SCSI 7
 - status blocks
 - command complete 24, 28, 37
 - device capacity 46
 - get command complete 28
 - POS and adapter information 42
 - status blocks (*continued*)
 - termination (TSB) 26, 36
 - storage device 33
 - subsystem control block (SCB) 24
 - supported devices 6
 - synchronous data transfer request 5, 25
 - system
 - configuration 8
 - error-recovery procedures 60
 - interface 12, 27
 - interface/bus master DMA controller 3
 - interrupt controller 15
 - interrupt (IRQ14) 17
- T**
- terminal power 5, 78, 79
 - termination
 - networks 64
 - status 37
 - status block 36, 58, 63
 - time-out
 - adapter 60
 - error 60
 - global command 60
 - operational 60
 - selection 60, 63
 - values, adapter 60
 - transfer rate, device 32
 - transfer rate, data 1
 - transfers 4
 - TSB (termination status block) 58, 63
 - TTL (transistor-transistor logic) 76
- U**
- unique address 11
 - unit attention 62

V

virtual page mode 24

W

wait states 12

warning, POS 8

warning, reserved areas 1

write

 commands 57

 data 56

 operations 59

 with verify 57



9068X23650001