

IBM iLM300 MicroPortable 投影機



# 使用手冊



IBM iLM300 MicroPortable 投影機



# 使用手冊

註: 在使用此資訊及其所支援的產品前，請先閱讀第 41 頁的附錄 F, 『Warranty information』及第 51 頁的附錄 G, 『Notices』中的資訊。

# 目錄

安全性：請先閱讀	v
關於本書	vii
註冊您的選用設備	vii
<b>第 1 章 安裝投影機</b>	<b>1</b>
簡介	1
影像解析度	1
相容性	1
打開投影機的包裝	2
使用準則	3
設置投影機	5
將電腦連接至投影機	5
連接至視訊播放機	7
<b>第 2 章 使用投影機</b>	<b>9</b>
調整影像	9
調整影像焦點	9
使用投影機按鍵面板及遙控器	10
按鍵面板或遙控器	10
使用遙控器	11
Left (L) 及 Right (R) 遙控按鈕	11
向上/下按鈕	11
使用螢幕功能表	12
導覽螢幕功能表	12
Basic 功能表	13
Setup 功能表	14
<b>附錄 A. 產品規格及配件</b>	<b>25</b>
規格	25
配件	25
更換燈泡	25
<b>附錄 B. 維護與疑難排解</b>	<b>27</b>
清潔鏡頭	27
更換投影燈泡	27
更換遙控器的電池	29
疑難排解	30
增加安全	31
<b>附錄 C. 攜帶型與筆記型電腦中的啟動方法</b>	<b>33</b>
<b>附錄 D. 使用視訊鏡映</b>	<b>37</b>
在 PowerBook 電腦上使用視訊鏡映	37
使用 Simulscan	37
<b>附錄 E. Projected image size</b>	<b>39</b>
<b>附錄 F. Warranty information</b>	<b>41</b>
Warranty period	41
Replacement lamps	41

Service and support . . . . .	41
Warranty information on the World Wide Web . . . . .	41
Online technical support . . . . .	41
Telephone technical support . . . . .	42
IBM Statement of Limited Warranty Z125-4753-06 8/2000 . . . . .	43
Part 1 - General Terms. . . . .	43
Part 2 - Country-unique Terms . . . . .	45
<b>附錄 G. Notices . . . . .</b>	<b>51</b>
Trademarks. . . . .	51
Federal Communications Commission (FCC) statement . . . . .	54

---

## 安全性：請先閱讀

請在安裝此產品前，先閱讀此安全性資訊。

مج، يجب قراءة دات السلامة

Antes de instalar este produto, leia as Informações de Segurança.

在安裝本產品之前，請仔細閱讀 **Safety Information**  
(安全信息)。

Prije instalacije ovog produkta obavezno pročitajte Sigurnosne Upute.

Před instalací tohoto produktu si přečtěte příručku bezpečnostních instrukcí.

Læs sikkerhedsforskrifterne, før du installerer dette produkt.

Ennen kuin asennat tämän tuotteen, lue turvaohjeet kohdasta Safety Information.

Avant d'installer ce produit, lisez les consignes de sécurité.

Vor der Installation dieses Produkts die Sicherheitshinweise lesen.

Πριν εγκαταστήσετε το προϊόν αυτό, διαβάστε τις πληροφορίες ασφάλειας  
(safety information).

לפני שתתקינו מוצר זה, קראו את הוראות הבטיחות.

A termék telepítése előtt olvassa el a Biztonsági előírásokat!

Prima di installare questo prodotto, leggere le Informazioni sulla Sicurezza.

製品の設置の前に、安全情報をお読みください。

본 제품을 설치하기 전에 안전 정보를 읽으십시오.

Пред да се инсталира овој продукт, прочитајте информацијата за безбедност.

Lees voordat u dit product installeert eerst de veiligheidsvoorschriften.

Les sikkerhetsinformasjonen (Safety Information) før du installerer dette produktet.

Przed zainstalowaniem tego produktu, należy zapoznać się  
z książką "Informacje dotyczące bezpieczeństwa" (Safety Information).

Antes de instalar este produto, leia as Informações sobre Segurança.

Перед установкой продукта прочтите инструкции по  
технике безопасности.

Pred inštaláciou tohto zariadenia si pečítajte Bezpečnostné predpisy.

Pred namestitvijo tega proizvoda preberite Varnostne informacije.

Antes de instalar este producto lea la información de seguridad.

Läs säkerhetsinformationen innan du installerar den här produkten.

安裝本產品之前，請先閱讀「安全資訊」。



---

## 關於本書

本手冊包含 iLM300 IBM® MicroPortable 投影機設定、使用、維護及疑難排解的說明。

本手冊包含下列語言的產品說明、安裝及軟體說明：

法文

德文

義大利文

西班牙文

巴西葡萄牙文

簡體中文

繁體中文

附錄包含了產品規格、配件及說明與服務。它也包含了產品保證與注意事項。

**註：** 本手冊中的圖例可能會與您的機器有些許不同。



---

## 第 1 章 安裝投影機

本章涵蓋投影機的設定及使用方法。

---

### 簡介

IBM® iLM300 MicroPortable 投影機是專為機動簡報人員所設計。它會使用「數位光線處理 (DLP)」技術，產生鮮活清晰的影像，並且配備了 M1-DA 接頭。本投影機可輕鬆地連接、使用、運送及維護。

### 影像解析度

投影的 XGA 解析度為 1024 x 768。投影機最高可與 1280 x 1024 的螢幕解析度相容。如果您的電腦螢幕解析度高於 1280 x 1024，請先將它重設為較低的解析度，再連接投影機。

註：影像會自動將 640 x 480 以及 800 x 600 影像展開至 1024 x 768。

### 相容性

本投影機與大多數的電腦與視訊裝置相容，其中包含了：

- IBM 相容電腦（包含筆記型電腦，解析度最高可至 1280 x 1024）。
- Apple Macintosh 及 PowerBook 電腦解析度最高可至 1280 x 1024。
- 大多數的標準卡式錄放影機 (VCR)、DVD 播放機、攝錄像機以及影碟機。

---

### 打開投影機的包裝

#### 請注意

本產品包含的「金屬弧形燈泡」含有汞。棄置此燈泡的方式需按照當地的法律規章。

本投影機隨附了下列圖例所顯示的物品。請檢查並確定所有的物品均含在內。如果缺少了任何物品，請立刻與您的購買處聯絡。

如果您曾經設定簡報系統，請使用此選用設備內附的快速入門卡。請參閱 CD 中的使用手冊，以便取得連接與操作投影機的完整資訊。

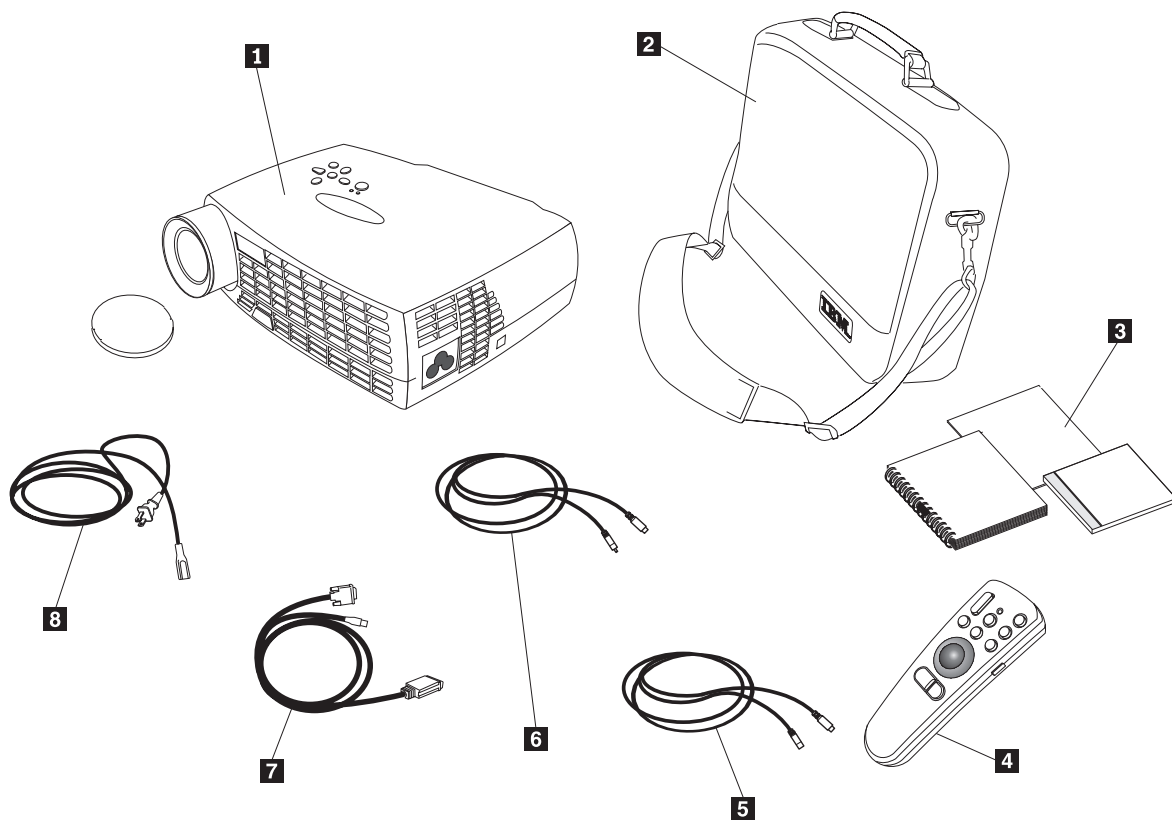

- 1** iLM300 IBM MicroPortable 投影機與鏡頭蓋
- 2** 軟式背包
- 3** 快速入門卡以及多國語言的線上使用手冊 CD
- 4** 遙控器
- 5** S 視訊線
- 6** 複合式視訊線

- 7** MI-DA 資料接線（類比至數位），包含 USB 滑鼠
- 8** 電源線

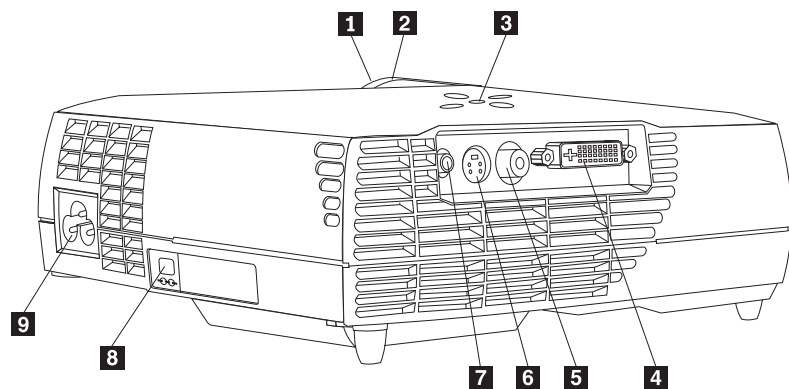

- 1** 縮放環
- 2** 焦距調整環
- 3** 按鍵面板
- 4** 電腦接頭
- 5** 視訊
- 6** S 視訊
- 7** 音訊輸入
- 8** 安全鎖
- 9** 電源線

---

## 使用準則

請在使用投影機時遵守下列準則。

**請注意：**

請勿在開啓燈泡電源時，直視投影鏡頭。強光可能會傷害您的眼睛。

**請注意：**

使用投影機時，請遵守下列準則。

- 請勿阻塞投影機的支架。阻礙氣流會使投影機過熱而關閉。如果發生此情況，您必須在嘗試重新啓動投影機前，先等候一分鐘。
- 請您以操作其他具有玻璃元件產品的方式來操作投影機。請特別小心避免掉落。
- 請勿讓投影機過長時間地曝曬於直接照射的陽光下或處於極冷環境中。如果發生這種情況，請讓投影機到達室溫後再使用。
- 請使用攜帶箱來運送投影機。請參閱「附錄 A」中的「配件」來取得訂購投影機機殼及其他配件的資訊。

---

## 設置投影機

請在啓動投影機前確定所有的接線已接上。請使用下列程序設置投影機：

1. 將投影機放置於平坦的表面。
  - 投影機與電源的距離必須在 3 公尺（10 英尺）內；與電腦的距離必須在 1.8 公尺（6 英尺）以內。
  - 如果您要從半透明式螢幕的後方投影，請將投影機設置於螢幕的後方。請參閱第 18 頁的『System 功能表』中對後方投影的說明，以取得倒轉影像的說明。
2. 將投影機放置於與螢幕保持適當距離的地方。
  - 如果影像太大或太小，請設定縮放調整環以便調整大小，或將投影機向前或向後移動。在您完成本章節所說明的所有連接後，您就可以開始調整。下列圖例會顯示三種投影影像大小。如果需要關於影像大小的更多資訊，請參閱第 39 頁的附錄 E，『Projected image size』。

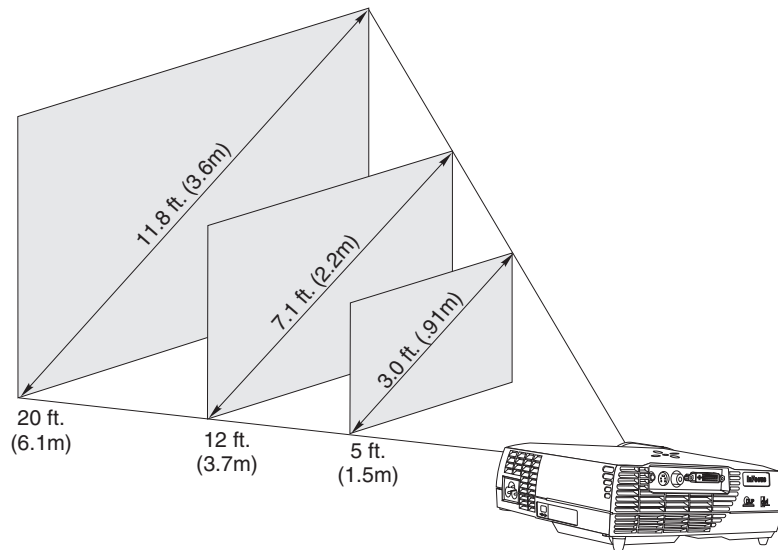

3. 請確定投影機已拔除電源而電腦已關閉。



#### 危險

存在於電源、電話及通訊接線中的電流是具有危險性的。

若要避免觸電的危險，請注意：

- 在有電力風暴的環境中，請勿連接或拆卸投影機的接線，也應避免在該環境中進行安裝、保養或重新配置本項產品。
- 將所有電源線連接至已正常通電的插座。
- 其它與投影機連接搭配的設備，也應使用符合安全規格的電源插座。
- 儘可能使用一隻手進行訊號線連接的工作（避免短路）。
- 當本產品可以目視到有結構性的損害，或處於有水或火的環境中時，請勿開啓投影機。
- 除非在安裝及配置程序中另有註明，否則在開啓裝備的外殼時，應先拆除電源線、電信系統、網路和數據機等週邊設備。
- 在安裝、移動或開啓本產品的外殼，或是連附屬裝置時，請依照下表中的注意事項連接和拆除接線。

若要連接：

1. 關閉所有的電源。
2. 先連接所有裝置的接線。
3. 將訊號線連接至連接器的接頭。
4. 將電源線插入插座中。
5. 開啓裝置的電源。

若要拆除接線：

1. 關閉所有的電源。
2. 首先，拔掉插座上的電源線。
3. 移除接頭上的訊號線。
4. 拆除裝置上所有的接線。

註：如果您要將投影機連接至電腦，請確定電腦與投影機之間的距離小於 6 英尺。

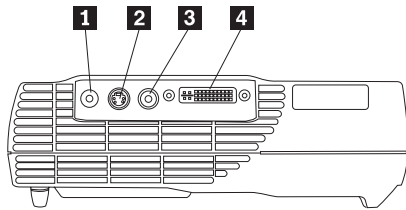

**1** 音訊輸入

**2** S 視訊

**3** 視訊

**4** 電腦/USB 滑鼠

## 將電腦連接至投影機

投影機隨附一條電腦線。如果您的電腦具有數位輸出埠，您可以使用另行出售的選用數位電腦線。請參閱第 25 頁的『配件』以便取得訂購資訊。

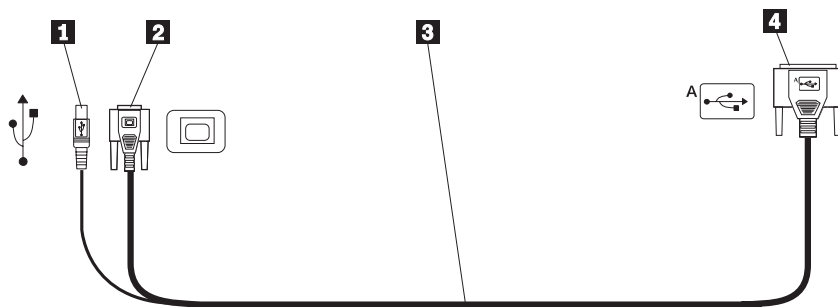

**1** 連接至 USB 滑鼠

**2** 連接至電腦視訊

**3** 連接至投影機

**4** 類比電腦線

1. 請依照以下圖例所顯示，將電腦線單一接頭的一端插入投影機的接頭。
2. 將電腦線另外一端的藍色接頭插入電腦的視訊接頭。
3. 如果您要在 PowerPoint™ 簡報中，使用遙控器來前進至下一張幻燈片，請將 USB 接線插入電腦的 USB 滑鼠接頭。

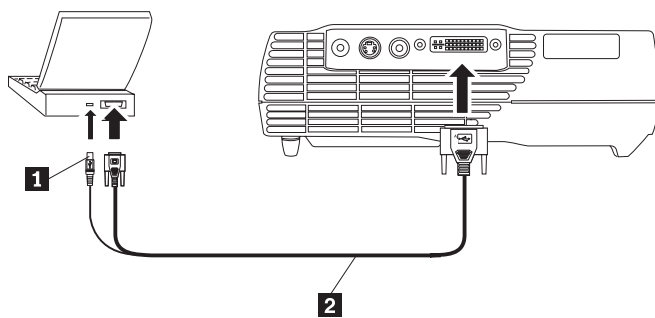

**1** USB 滑鼠

**2** 電腦線

### 附註：

1. 許多筆記型電腦無法在連接上次要顯示裝置（如投影機）時，自動開啓外部視訊埠。請參閱電腦手冊以取得啓動外部視訊埠的指令。請在您的 IBM ThinkPad® 按下 Fn+F7 以啓動外部顯示。請參閱第 33 頁的附錄 C，『攜帶型與筆記型電腦中的啓動方法』中列出選定筆記型電腦啓動指令的圖表。

2. 如果您要將投影機連接至沒有 15-Pin 接頭的較舊型 Macintosh 電腦，您必須使用 Macintosh 配接卡以便連接電腦與投影機。
3. 只有 Microsoft® Windows® 98、Microsoft Windows 2000 Professional 以及 Apple OS 9.0 以上版本才能支援 USB 滑鼠。
4. 您不需要在連接 USB 滑鼠後重新啟動電腦。

關於啟動投影機及電腦的資訊，請前往第 7 頁的『啟動投影機以及調整影像』。

## 連接至視訊播放機

請使用下列程序來連接視訊播放機。

- 如果您的視訊播放機是使用具有兩個圓形接頭的複合式視訊接頭，請使用複合式視訊線。
- 如果您的視訊播放機是使用具有四個圓形接頭的 S 視訊接頭，請使用 S 視訊線。S 視訊所提供的視訊可產生較高品質的影像。

**警告：** 您的視訊播放機可能也有「視訊輸出」接頭來連接同軸電纜。切勿使用它來連接投影機。

1. 請將複合式視訊線的黃色接頭接到視訊播放機的「視訊輸出」接頭。此接頭可能會標示為「連接至顯示器 (To Monitor)」。
2. 請將圓形的黃色接頭接到投影機的 Composite Video 接頭。

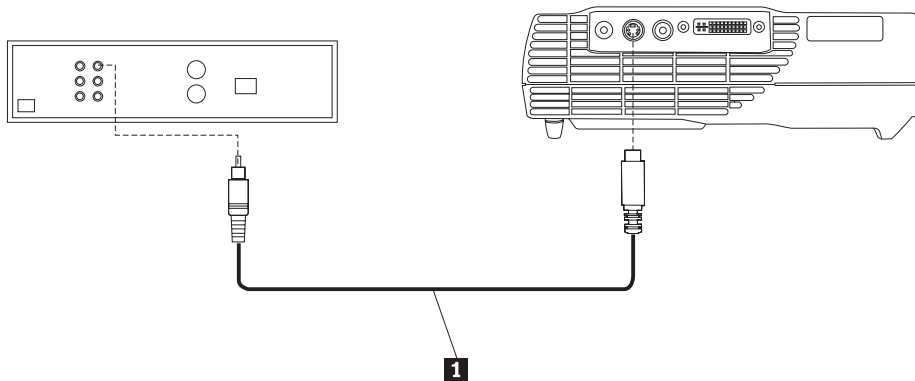

### 1 S 視訊線

本投影機與這些主要的廣播視訊標準相容：NTSC、NTSC 4.43、PAL、PAL-M、PAL-N、PAL-60 以及 SECAM。本投影機會根據進入的視訊來自動調整，以便將效能最佳化。



### 危險

存在於電源、電話及通訊接線中的電流是具有危險性的。

若要避免觸電的危險，請注意：

- 在有電力風暴的環境中，請勿連接或拆卸投影機的接線，也應避免在該環境中進行安裝、保養或重新配置本項產品。
- 將所有電源線連接至已正常通電的電源插座。
- 其它與投影機連接搭配的設備，也應使用符合安全規格的電源插座。



## 危險

存在於電源、電話及通訊接線中的電流是具有危險性的。

- 儘可能使用一隻手進行訊號線連接的工作（避免短路）。
- 當本產品可以目視到有結構性的損害，或處於有水或火的環境中時，請勿開啓投影機。
- 除非在安裝及配置程序中另有註明，否則在開啓裝置外殼前，應先拔除已連接的電源線、電信系統、網路及數據機。
- 在安裝、移動或開啓本產品的外殼，或是連附屬裝置時，請依照下表中的注意事項連接和拆除接線。

### 若要連接：

1. 關閉所有的電源。
2. 先連接所有裝置的接線。
3. 將訊號線連接至連接器的接頭。
4. 將電源線插入插座中。
5. 開啓裝置的電源。

### 若要拆除接線：

1. 關閉所有的電源。
2. 首先，拔掉插座上的電源線。
3. 移除接頭上的訊號線。
4. 拆除裝置上所有的接線。

## 啓動投影機以及調整影像

請使用下列程序啓動投影機及調整影像。

1. 拿下鏡頭蓋。
2. 將電源線接到投影機側面，然後插到電源插座中。建議您使用穩壓保護的多孔延長線。您僅可使用投影機內附的電源線。

**註：**對於某些電腦，啓動設備的次序非常重要。對多數的電腦而言，其他所有的裝置啓動後，才要啓動電腦。請參閱電腦的說明文件以便決定次序。

3. 請按下投影機頂端的 Power 按鈕。風扇會先啓動，然後投影機頂端的 LED 會亮起為綠色，直到啓動螢幕出現為止。影像達到完全的亮度大約需要一分鐘。
4. 如果您是連接至視訊播放機，請開啓它。
  - 視訊影像會顯示在投影螢幕上。如果沒有，請按下按鍵面板上的 Select 按鈕或遙控器上的 Video 按鈕以便顯示視訊影像。
5. 開啓您的電腦。

**註：**在您第一次將電腦連接至投影機時，電腦可能會顯示訊息說明發現新的硬體。「加入新的硬體」視窗可能會開啓。請使用精靈，安裝隨插即用顯示器的正確裝置驅動程式。

- 電腦影像會顯示在投影螢幕上。如果沒有，請按下按鍵面板上的 Select 按鈕或遙控器上的 Computer 按鈕以便顯示電腦影像。
- 請確定筆記型電腦的外部視訊埠在作用中；請參閱第 33 頁的附錄 C, 『攜帶型與筆記型電腦中的啓動方法』以便取得詳細資訊。
- 請在需要時使用投影機的螢幕功能表來調整影像。若要顯示功能表，請按下按鍵面板或遙控器上的 Menu 按鈕。關於功能表的更多資訊，請參閱第 12 頁的『使用螢幕功能表』。

## 關閉投影機

請按下 Power 按鈕以便關閉投影機。如果您要再開啓燈泡，請先等候 90 秒讓燈泡冷卻。燈泡在過熱時會不亮。

**註：**若要延長燈泡的壽命，請讓投影機風扇運轉最少五分鐘再拔除電源線。



---

## 第 2 章 使用投影機

本章會說明如何使用與調整投影機。它也會提供按鍵面板、遙控器按鈕以及螢幕功能表中可用選項的參照。

---

### 調整影像

請執行下列步驟以便調整影像：

- 請確定您是以正確的次序開啓設備。相關資訊，請參閱第 7 頁的『啓動投影機以及調整影像』。
- 如果影像未完全顯示，請縮放影像、調整投影機的高度或調整影像的水平或垂直位置來使影像置中。請確定投影機與螢幕呈 90 度角。
- 如果影像未套合投影區，或者不夠方正，則請使用投影機頂端的 Keystone 按鈕。另外，也請參閱第 12 頁的『Basic 功能表』底下的 keystone 功能。
- 如果影像失焦，請按照下列方式旋轉對焦鏡頭。
- 如果顯示的顏色不正確，請調整亮度、對比度、濃淡度或色彩。相關資訊，請參閱第 14 頁的『Setup 功能表』。

### 調整影像焦點

若要使影像聚焦，請旋轉下列圖例中的焦距調整環 **1** 直到影像清晰為止。若要調整影像大小，請旋轉縮放調整環 **2**。

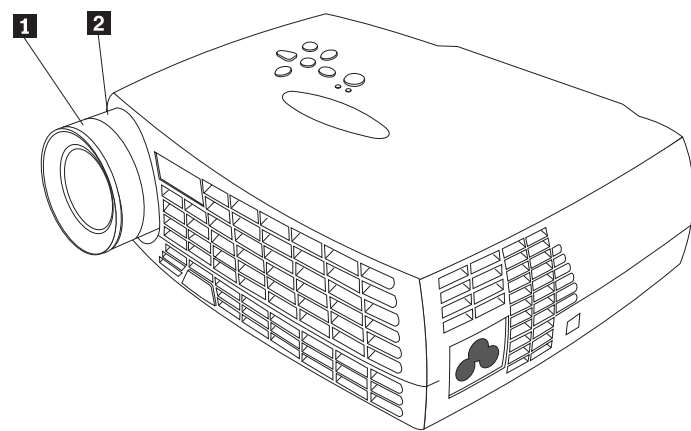

**註：**若要取得最佳的整體對焦品質，請開啓功能表然後使文字對焦。將焦點放在文字可以確保最佳的整體影像品質。請參閱第 12 頁的『導覽螢幕功能表』以便取得開啓功能表的資訊。

本投影機配備了可自行鎖定及快速鬆脫的分段式支撐架以及按鈕。若要升起投影機：

1. 請按住分段按鈕 **1**。
2. 請將投影機升至您要的高度，然後釋放按鈕以便鎖定分段式支撐架 **2**。

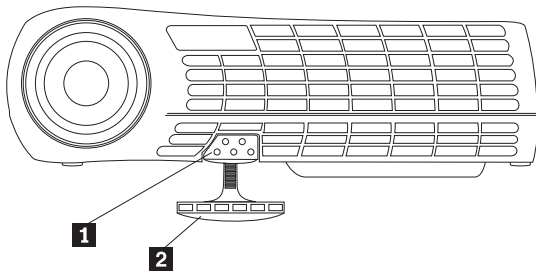

## 使用投影機按鍵面板及遙控器

在投影機按鍵面板的左下方，以及遙控器的右下方，使用 **Menu** 按鈕可顯示螢幕功能表。使用投影機按鍵面板上的 **Select** 按鈕或遙控器右下方的 **Computer** 及 **Video** 按鈕，可在連接到投影機的裝置間選擇。請參閱第 12 頁的『使用螢幕功能表』以便取得詳細資訊。

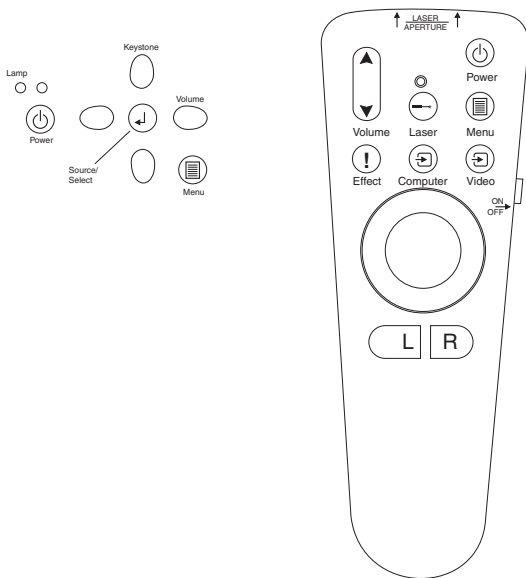

## 按鍵面板或遙控器

與投影機連接的影像來源多於一個時，選擇的方式為

- 按下按鍵面板上的 **Select** 按鈕
- 按下遙控器上的 **Computer** 或 **Video** 按鈕
- 使用螢幕功能表中的 **SourceSearch** 功能，自動偵測連接來源的種類。請參閱第 18 頁的 "SourceSearch"。

**註:** 如果未啟動 **SourceSearch** 功能，且有多個裝置連接到投影機，您可能需要按下 **Select** 按鈕一次以上才找到作用中的來源。如果您正使用 **Select** 按鈕，則來源的輪換次序為：類比資料、數位資料、S 視訊以及複合式視訊。

## 使用遙控器

使用遙控器上的 **L** 及 **R** 按鈕可以移動簡報的幻燈片。將投影機電腦線上的 USB 滑鼠接頭接到電腦上。請參閱第 5 頁的『將電腦連接至投影機』以便取得詳細資訊。

請將遙控器指向投影螢幕或投影機的前方（不是指向電腦）。最佳作業距離為大約 7.6 公尺（25 英呎）。如果您將遙控器指向投影螢幕，螢幕與投影機的往返距離必須小於或等於 7.6 公尺（25 英呎）。請將遙控器直接指向投影機以便取得最佳效果。

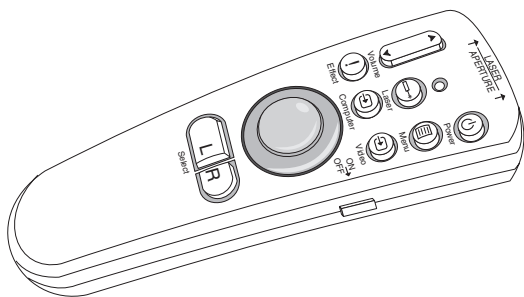

按下紅色雷射按鈕來使用遙控前端的雷射指示燈。使用雷射指示燈來強調簡報的重點。

### Left (L) 及 Right (R) 遙控按鈕

這些按鈕的動作與電腦鍵盤中的 Page Up 以及 Page Down 按鈕類似。您可以使用這些按鈕在幻燈片展示中移動幻燈片。若要使用此功能，請將電腦線上的 USB 滑鼠接頭連接至電腦。相關資訊，請參閱第 5 頁的『將電腦連接至投影機』。

### 向上/下按鈕

您可以使用這些按鈕來導覽及調整螢幕功能表。相關資訊，請參閱第 12 頁的『使用螢幕功能表』。

## 使用螢幕功能表

投影機具有螢幕功能表，您可以在其上進行調整，對無法在按鍵面板上直接使用的各種設定值做變更。

### 導覽螢幕功能表

下列慣例適用於使用螢幕功能表：

- 按下遙控器或投影機按鍵面板上的 **Menu** 按鈕來開啓螢幕功能表。
- 使用遙控器上的軌跡球及按鍵面板與遙控上的方向按鈕來導覽功能表。
- 按下遙控器上的 **L/Select** 按鈕來選取功能表選項。

**註：**某些功能表項目可能會無法使用（變暗）。這表示無法使用該項目或必須先選取其他項目，才能使用該項目。

- 再次按下 **Menu** 來關閉功能表。

**註：**如果沒有活動，功能表會在 30 秒後自動關閉。

您所做的任何設定值變更都會被儲存。自訂標誌之類的部份變更要等到將投影機關閉並重新啓動後才會生效。

若要開啓螢幕功能表，請按下按鍵面板或遙控器上的 **Menu** 按鈕。第一個功能表為 **Basic** 功能表。按向下按鈕會使游標向下移動；按向上按鈕則會使游標向上。所選取的功能表選項會反白。



請使用方向按鈕來調整設定，或加以開啓及關閉。完成時請按下 **L/Select** 按鈕。按向上及向下按鈕以便移動至其他的設定。完成調整時，導覽至 **Exit Arrow**，然後按下 **L/Select**。您會回到上一個功能表。按下 **Menu** 來結束功能表系統，或導覽至另一子功能表。

下列各節提供功能表的概觀。

### Basic 功能表

在 **Basic** 功能表中，您可以針對對比、亮度、色彩、Keystone、重設設定值等進行變更。您也可以存取 **Setup** 功能表。

#### Contrast

調整對比（明暗比），其值為 0 - 100。

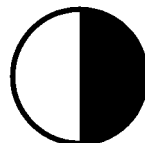

#### Brightness

調整映像的一般亮度，其值為 0 - 100。

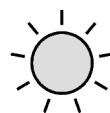

## Color

調整色彩亮度，其值為 0 - 100。

## Keystone

調整影像角度使影像方正，或將影像套合到投影區。

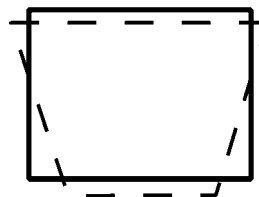

若要直接使用 keystone 校正，請即按下投影機按鍵面板上的向左及向右鍵，而不用進入螢幕選單。使用投影機按鍵面板上的向上及向下鍵來調整影像角度，其值範圍為 -63 到 +64。



Keystone



請按下按鈕來減少影像的上半部 **1**，以及按下 Keystone 按鈕來減少下半部 **2**。

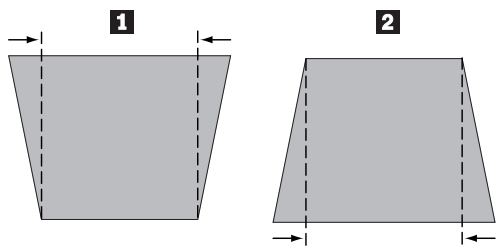

## Setup

使用 Setup 選項來存取其他有關圖片品質、功能表語言、影像效果及服務的功能表。相關資訊，請參閱『Setup 功能表』。



## Reset

使用 Reset 選項，使設定值對目前連接的來源裝置進行同步化。



## About

使用此選項來取得目前使用功能的相關資訊。



## Setup 功能表

若要存取 Setup 功能表，請按下 Menu 按鈕來顯示 Basic 功能表。按下向下鍵來強調顯示 Setup，然後按下 Select 來開啓 Setup 功能表。

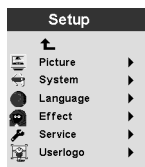

Picture、System、Language、Effect 及 Service 都具有子功能表。下列各節解釋 Setup 功能表選項。



## Picture

使用 Picture 選項來顯示 Screen Aspect、Color Temp、Sharpness、Application、ARLs、Tune、Width、Position 及 Tint 等選擇的功能表。

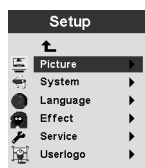

關於 Picture 功能表的更多資訊，請參閱第 16 頁的『Picture 功能表』。

## System

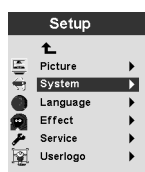

關於 System 功能表的更多資訊，請參閱第 18 頁的『System 功能表』。

## Language

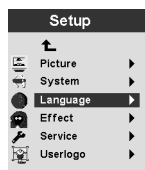

關於 Language 功能表的更多資訊，請參閱第 19 頁的『Language 功能表』。

## Effect

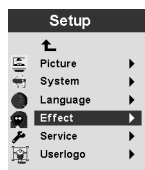

關於 Effect 功能表的更多資訊，請參閱第 19 頁的『Effect 功能表』。

## Service

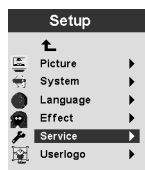

關於 Service 功能表的更多資訊，請參閱第 20 頁的『Service 功能表』。

## Userlogo



關於 Userlogo 功能表的更多資訊，請參閱第 21 頁的『User's Logo 功能表』。

## Picture 功能表

下節含有 Picture 功能表中項目的說明。

### Screen Aspect

選取水平對垂直的比例。預設設定值為 4:3。

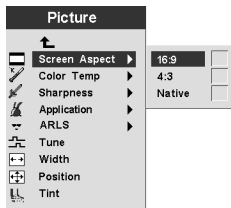

### Color Temp

變更投影色彩的亮度。預設值為 7300 Kelvin。

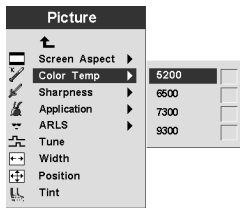

### Sharpness

設定視訊影像的清晰度。預設值設為最清晰。

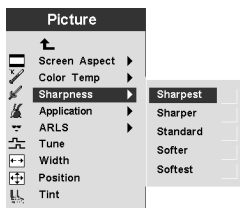

### Application

設定顯示資訊的來源是從 Normal、Home theatre、或從 Photograph。

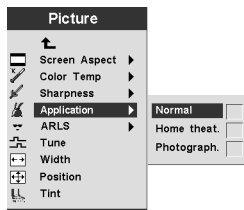

## ARLS

使用 Automatic Room Light Sensor (ARLS)，您可以調整影像設定值來針對室內周圍燈光的亮度進行補償。

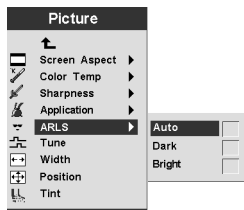

## Tune

微調電腦類比影像。

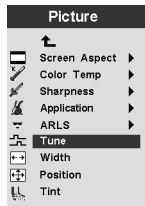

## Width

調整電腦類比影像寬度。

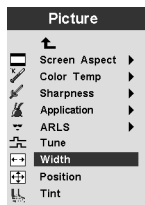

## Position

使用遙控上的軌跡球或按鍵面板上的方向鍵來調整螢幕上投影的位置。

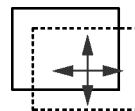
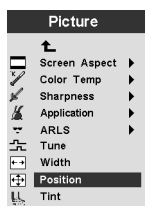

## 濃淡度

濃淡度會調整投影影像中紅色與綠色的平衡。

註：Tint 選項僅適用於 Video (NTSC) 模式。

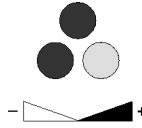
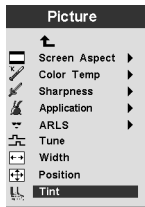

## System 功能表

從 Basic 功能表中，選取 **Setup** → **System** 來顯示 System 功能表。

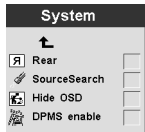

### Rear

如果影像是要投射到透明投影螢幕的背面，請選取 **Rear**。此設定值會翻轉影像，如此從正面來看，影像即為可辨識的。



### SourceSearch

選取 SourceSearch 可自動讓投影機判定目前影像的來源。再次選取 SourceSearch 可關閉此自動功能。

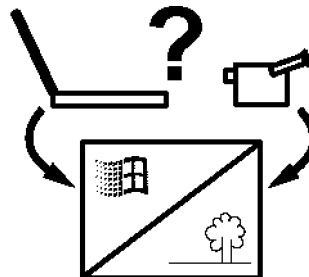
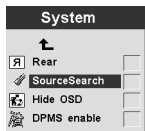

### Hide OSD

選取 Hide OSD 來啓用/停用螢幕顯示。

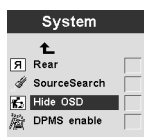

## DPMS enable

選取此功能可啓用/停用顯示投影機電源管理設定值。

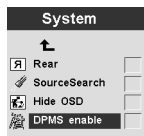

## Language 功能表

從 Basic 功能表中，選取 **Setup** → **Language**。導覽到您要選擇的語言。投影機的螢幕功能表會以此語言顯示。



## Effect 功能表

使用此功能表中的一個項目來排定遙控上的 Effect 按鈕。

從 Basic 功能表中，選取 **Setup** → **Effect**。選擇您最常使用的功能。任何時候您都可以返回此功能表，為 Effect 按鈕選擇不同的項目。

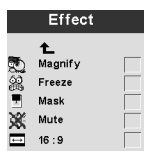

## Magnify

若要以放大的方式來強調顯示影像的一部份，請選取 Magnify。

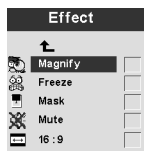

## Freeze

若要在某一點停止簡報（包括所有動畫），請選取 Freeze。

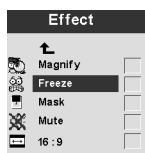

## Mask

若要隱藏或取消隱藏顯示影像的一部份，請選取 Mask。使用遙控的軌跡球來移動影像上的遮罩。

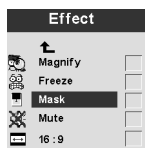

## Mute

若要使用遙控的 Effect 按鈕來關閉聲音，請選取 Mute。

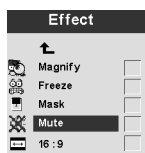

## 16:9

如果同一簡報中有各種螢幕大小，可使用此項目。選取 16:9，可使用 Effect 按鈕來啟動 16:9 比例。

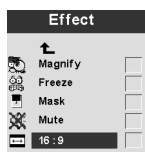

## Service 功能表

使用此功能表上的選項來執行維護功能。Service Code 僅針對經過訓練的技術人員而保留。

從 Basic 功能表中，選取 **Setup** → **Service**。

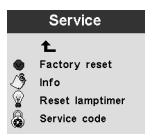

## Factory Reset

使用 **Factory Reset** 來自動將所有設定值設回出廠預設值。

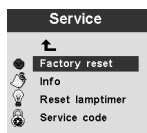

## Info

選取 **Info** 來顯示關於投影機設定值的進一步資訊。

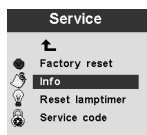

## Reset Lamptimer

請於更換投影燈泡時選取此選項。燈泡計時器會顯示燈泡使用了多少小時。相關資訊，請參閱第 27 頁的『更換投影燈泡』。

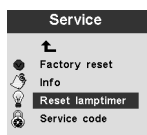

## Service Code

此功能表僅供經過訓練的維修人員使用。如果顯示了數字代碼，請向維修技術人員提報此號碼。



## User's Logo 功能表

使用此功能表中的項目來決定開啓燈泡電源而未連接任何來源時，投影機要顯示什麼標誌。您也可以選擇使投影機顯示您自己的標誌。



### Default

Default 為投影機標誌螢幕。

### Blue 及 Black

選取 Blue 或 Black，使投影機在尚未連接任何來源時顯示純色背景。

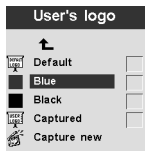
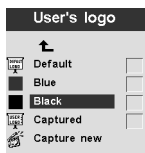

## Captured

選取此項目，投影機會顯示您自己製備的標誌。

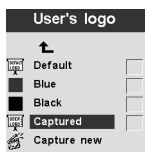

## Capture new

選取此項目來定義新的標誌。請參閱下列關於擷取新標誌的說明。

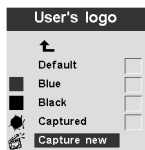

**Capture New:** 若要定義新標誌，請執行下列步驟：

1. 當您希望使用的影像顯示時，按下 Menu 按鈕。
2. 選取 Basic → Setup → User's Logo → Capture New



3. 使用遙控的軌跡球來選取要擷取的區域。

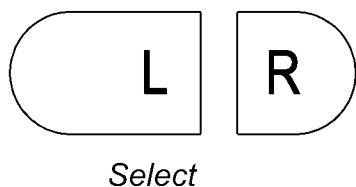
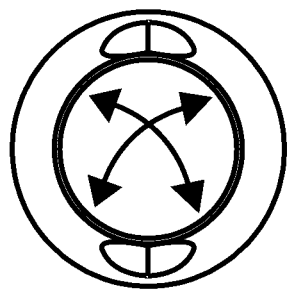

4. 若要調整擷取區域的大小，請使用遙控或按鍵面板的 **Volume** 按鈕。向上鍵 ↑ 可將擷取區域調大，向下鍵 ↓ 則可將擷取區域調小。

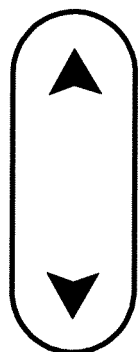

**Volume**

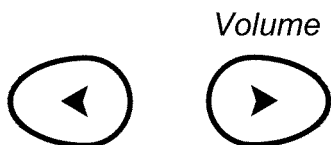

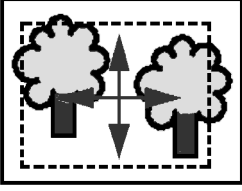

5. 按下遙控器上的 **L/Select** 來確認。檢查是否有影像擷取成功的確認訊息。
6. 將投影機關閉並重新啓動，即可使用新建立的影像作為您的標誌。

---

## 附錄 A. 產品規格及配件

本附錄列出投影機的規格。

---

### 規格

iL300 投影機必須在指定的溫度和溼度範圍內操作及儲存。

#### 溫度

操作時	在海平面高度時為 50 至 95° F (10 至 35° C) 在 10,000 英尺時為 50 至 77° F (10 至 25° C)
未操作時	-4 至 158° F (-20 至 70° C)

#### 高度

操作時	0 至 10 000 英尺 (3,048 公尺)
未操作時	0 至 20 000 英尺 (6,096 公尺)

#### 濕度

操作與未操作時	相對溼度 10% 至 95% (在常壓下)
---------	-----------------------

#### 體積

6.06 x 7.83 x 2.48 英寸 (15.4 x 19.9 x 6.3 公分)

#### 重量

淨重 2.4 磅 (1.1 公斤)

#### 光學

焦距	4.9 - 32.8 英尺 (1.5 - 10 公尺)
----	-----------------------------

#### 光源

類型	120 瓦 UHP 燈泡
----	--------------

#### 輸入電源需求

100-120VAC 2A ; 50/60Hz 200-240VAC 1A ; 50Hz

---

### 配件

您的投影機有多種配件可用，並且會時常增加新型的配件。請造訪 IBM 網站 <http://www.pc.ibm.com/us/accessories/projectors/index.html>，從投影機的多種配件中選取。

### 更換燈泡

如果您的投影燈泡在保證的範圍內，請參閱第 42 頁的『Telephone technical support』，以取得連絡 IBM 求取新燈泡的相關資訊。

對於其他所有的更換燈泡，請從 IBM 網站 <http://www.pc.ibm.com/us/accessories/projectors/index.html> 訂購新燈泡。



---

## 附錄 B. 維護與疑難排解

本章節會說明如何：

- 清潔鏡頭
- 更換投影燈泡
- 更換遙控器的電池
- 使用安全鎖功能
- 投影機疑難排解

---

### 清潔鏡頭

請遵循下列步驟來清潔投影鏡頭：

1. 請將不具腐蝕性的相機鏡頭清潔液，倒在乾的軟布上。
  - 請勿使用過量的清潔液，並且不要將清潔液直接倒在鏡頭上。
  - 具有腐蝕性的清潔液、溶劑或其他有害化學藥品可能會刮傷鏡頭。
2. 用清潔布輕輕地朝同一方向擦拭鏡頭。
3. 如果您並不會立刻使用投影機，請重新蓋上鏡頭蓋。

---

### 更換投影燈泡

**請注意：**

為避免燙傷，請在打開燈泡前，讓投影機冷卻至少 60 分鐘。請勿在投影機作業時取出燈泡模組。



**請小心：**

下列的標籤是指出附近有會發出高熱的表面。



螢幕 Service 功能表中的燈泡計時器會計算燈泡已經使用的小時數。請參閱第 20 頁的『Service 功能表』的「燈泡計時器」。請定期查看燈泡計時器，看燈泡使用經過了多久時間。當螢幕左下角出現 Change Lamp 警告時，請更換燈泡。請參閱第 41 頁的『Replacement lamps』以取得訂購資訊。

若要執行此程序，請將投影機底部朝上，置放在平坦乾淨的表面（如桌面）上。若要更換投影燈泡，請執行下列步驟：

1. 關閉投影機，從投影機及從電源插座處將電源線拔除。

2. 請等候 60 分鐘以便讓投影機徹底冷卻。
3. 在平坦乾淨的表面上，將投影機翻過來，使其底部朝向您。使用螺絲起子，將鎖住燈罩的螺絲鬆開，輕輕地開啓燈罩邊緣。

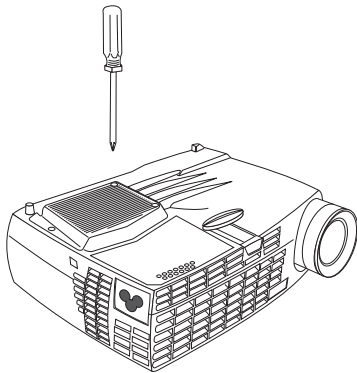

4. 小心地移除燈罩，以合於環保的方式丟棄之。

**請注意：**

本產品包含的金屬弧形燈泡含有汞，它是一種腐蝕性的物質。請按照當地的法律規章所規定的方式來丟棄此燈泡。

**請注意：**

在移除燈泡模組時請務必小心。若是燈泡意外破裂，則會產生許多小的玻璃碎片。燈泡模組的設計中即可容納這些碎片，但是在移除燈泡模組時，仍請多加注意。

**請注意：**

請勿掉落燈泡模組或觸碰玻璃燈泡。玻璃可能會破裂而使您受傷。您手上的油污可能會減短燈泡的壽命。

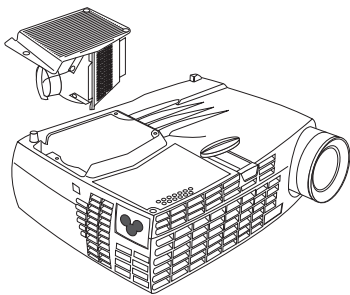

5. 插入新的燈罩。輕輕地將當燈罩壓進適當位置。
6. 鎖緊螺絲。將投影機翻正。
7. 將電源線接到投影機背部及電源插座。按下投影機頂端的電源按鈕來開啓電源。
8. 若要重設燈泡計時器，請參閱第 21 頁的「重設燈泡計時器」以取得詳細資訊。

---

## 更換遙控器的電池

電池的壽命會因為遙控器的使用頻率及使用時間而有所不同。電池電量過低時的徵兆包含了在使用遙控器時常無反應，以及作業距離變短。

請遵循下列步驟更換電池：

1. 讓您手中的遙控器面朝下。
2. 將電池蓋的卡栓向遙控器背面按下，然後滑動電池蓋將其打開。
3. 移除舊的電池，然後以不傷害環境的方式棄置。
4. 安裝兩顆新的 AAA 鹼性電池。請確定電池的安裝方向正確。
5. 將電池蓋滑進適當、鎖上的位置。

---

## 疑難排解

**問題：投影機無法運作。**

- 請確定電源線已適當地連接至可正常運作的 AC 電源插座。請確定電源線也適當地連接至投影機。
- 如果投影機的電源線是插入多孔延長線，請確定已啟動多孔延長線。
- 請確定投影機已開啓。

**問題：投影機正在運作，但是投影螢幕上沒有出現任何東西。**

- 請確定您已拿下投影機前方的投影鏡頭蓋。
- 請檢查投影燈泡並確認燈泡已牢固地連接至燈泡模組。相關資訊，請參閱第 27 頁的『更換投影燈泡』。

**問題：僅顯示了啟動螢幕。**

- 請驗證已正確地連接了接線。請參閱第 5 頁的『將電腦連接至投影機』以便取得連接的程序。
- 請確定接線的接腳未被彎曲。
- 請驗證已連接了適當的輸入來源。請參閱第 18 頁的 "SourceSearch"，將投影機設定成自動偵測您使用的設備類型。
- 您可能需要將該設備全部關閉，然後再依照適當的次序一一開啓。請參閱電腦的說明文件以確定正確的次序。
- 請確定已開啓電腦的外部視訊埠。請參閱第 33 頁的附錄 C, 『攜帶型與筆記型電腦中的啟動方法』以取得一些常用的鍵盤指令，或參閱您的電腦手冊以取得詳細資訊。
- 請確定電腦的顯示配接卡已正確安裝並設定。
- 請確定電腦具有相容的顯示配接卡。此投影機無法與 CGA 或 EGA 相容。

如果您使用的是 Windows 98：

1. 按一下**我的電腦** → **控制台** → **顯示器**。
2. 按一下**設定值**標籤。
3. 驗證桌面解析度是否設為 **1280 x1024** 或更低。

**問題：投影螢幕上看不見色彩或文字。**

嘗試調整亮度或對比，到可看見文字為止。若要調整亮度或對比，請參閱第 12 頁的『Basic 功能表』的相關資訊。



**問題：螢幕解析度不正確。**

- 請確定電腦顯示配接卡所設定的解析度為 1280 x 1024 以下。

**問題：影像未在螢幕的中央。**

- 移動投影機以便將影像重新定位。
- 使用功能表來將影像重新定位。相關資訊，請參閱第 9 頁的『調整影像』。
- 請確定投影機與螢幕呈 90 度角。

**問題：螢幕上的影像太寬或太窄。**

- 調整縮放或投影機的放置方式。
- 如果解析度大於 1280 x 1024，請調整您的顯示配接卡。
- 使用投影機按鍵面板上的 Keystone 按鈕或 Basic 螢幕功能表的 Keystone 選項來調整投影的角度。

**問題：影像失焦。**

- 轉動焦距調整環，使影像對焦。
- 請確定投影螢幕與投影機之間的距離大於或等於 1.5 公尺（5 英尺）。
- 請檢查投影鏡頭是否需要清潔。

**問題：影像與功能表的左右位置相反。**

- 您可能啟動了後方投影模式。關閉後方投影。請參閱第 18 頁的 "Rear"。

**問題：影像有斑紋。**

- 執行出廠重設。相關資訊，請參閱第 20 頁的『Service 功能表』。

**問題：投影的色彩與電腦或視訊播放機的色彩不同。**

電腦影像與投影的影像之間，也與不同顯示器上的顯示畫面一樣，會有某些差距。從螢幕 Picture 功能表調整亮度、色調及對比。相關資訊，請參閱第 16 頁的『Picture 功能表』。

**問題：燈泡變暗了。**

燈泡在長時間使用後，亮度會變低。使用第 27 頁的『更換投影燈泡』中說明的更換燈泡來檢查燈泡計時器。

**問題：燈泡不亮了。**

- 微小的電力波動都可能使燈泡熄滅。請將投影機的電源線拔除，至少等一分鐘，再重新接上電源線。
- 投影機過熱了。請確定投影機通風口未被阻塞。使用風扇冷卻投影機五分鐘，再重新開啓燈泡。

---

## 增加安全

配合另外購買的接線圈來使用安全接頭。請前往全球資訊網上的 <http://www.compu-lock.com> 以取得訂購資訊。

請參閱以第 1 頁的『打開投影機的包裝』開頭的投影機詳細圖例說明，了解投影機安全接頭的位置。請參閱接線隨附的資訊以便取得如何將投影機上鎖的說明。

**註：**接上接線後，無法移除燈泡。



## 附錄 C. 攜帶型與筆記型電腦中的啟動方法

許多筆記型電腦無法在連接上投影機時，自動開啓外部視訊埠。某些筆記型電腦的啟動指令會列在下表中。  
 (如果您的電腦未在表中或其中的指令無效，請參閱電腦的說明文件以取得適當的指令。) 對於多數的筆記型電腦，啟動功能鍵會有 CRT/LCD 標示或有下列圖示：



**註:** 請探訪 <http://www.infocus.com/> 以便取得現行大多數的啟動方法圖表。它的位置是在 Service and Support 鏈結中。

**註:** 通常，按一次按鍵指令會啟動外部視訊埠；按下第二次會啟動外部及內部視訊埠；按下第三次則會啟動內部視訊埠。請參閱電腦的說明文件以便取得您所使用機型的詳細資訊。

電腦	啟動視訊埠的按鍵指令	停用視訊埠的按鍵指令
Acer	Ctrl+Alt+Esc (設定時)	Ctrl+Alt+Esc (設定時)
AST* **	FN+D 或 Ctrl+D Ctrl+FN+D FN+F5 在 A:\VGA\CRT 鍵入	FN+D 或 Ctrl+D Ctrl+FN+D FN+F5 在 A:\VGA\CRT 下鍵入
AMS	FN+F12	FN+F12
AMT	FN+F2 設定螢幕	FN+F2 設定螢幕
AT&T	FN+F3 FN+F6	FN+F3 F+-F6
Advanced Logic Research	Ctrl+Alt+V	Ctrl+Alt+V
Altima	Shift-Ctrl-Alt-C setup VGA/Conf.Simulscan	Shift-Ctrl-Alt-L setup VGA/Conf.Simulscan
Ambra**	FN-F12 FN-F5 F2/Choose Option/F5	FN-F12 FN-F5 F2/Choose Option/F5
Amrel* **	設定功能表 Shift-Ctrl-D	設定功能表 Shift-Ctrl-D
Apple	請參閱 Mac Portable 及 Mac PowerBook	
Aspen	自動	自動
Award	FN-F6	FN-F6
BCC*	自動	重新啟動電腦
Bondwell	啟動後的 LCD 或 CRT 選項	重新啟動後使用出現的 LCD 或 CRT 選項
Chaplet**	設定螢幕 FN-F6 FN-F4	設定螢幕 FN-F6 FN-F4
Chembook	FN-F6	FN-F6
Commax	Ctrl-Alt-#6	Ctrl-Alt-#5
Compaq* **	Ctrl-Alt-< FN-F4 自動	Ctrl-Alt-> FN-F4 自動
Compuadd* **	mode/? (設定選項中) 自動 在螢幕設定選項中按下 Alt-F	mode/? (設定選項中) 自動 在螢幕設定選項中按下 Alt-F
Data General	Ctrl-Alt-Command	Ctrl-Alt-Command

電腦	啟動視訊埠的按鍵指令	停用視訊埠的按鍵指令
Data General Walkabout	在 DOS 提示下鍵入 2 CRT/X	重新啟動
Datavue	Ctrl-Shift-M	Ctrl-Shift-M
DEC**	FN-F5	FN-F5
	FN-F4	FN-F4
Dell**	Ctrl-Alt-<	Ctrl-Alt->
	Ctrl-Alt-F10	Ctrl-Alt-F10
	FN-F8 (CRT/LCD)	FN-F8
	FN-D	FN-D
	FN-F12	FN-F12
Digital*	自動	重新開機
	FN-F2	FN-F2
Dolch	使用 DIP 開關來調整為 CRT	使用 DIP 開關來調整為 LCD
Epson	使用 DIP 開關來調整為 CRT	使用 DIP 開關來調整為 LCD
Everex*	設定螢幕選項	設定螢幕選項
For-A	Ctrl-Alt-Shift-C	Ctrl-Shift-Alt-L
Fujitsu	FN-F10	
Gateway	FN-F3 FN-F1/再按一次 FN-F1，則會同時啟動	FN-F3 FN-F1
Grid* **	FN-F2，然後選取 <b>auto</b> 或 <b>simultaneous</b>	FN-F2
	Ctrl-Alt-Tab	Ctrl-Alt-Tab
Hitachi	FN-F7	FN-F7
Honeywell	FN-F10	FN-F10
Hyundai	設定螢幕選項	設定螢幕選項
IBM 970*	自動	暖開機
IBM ThinkPad**	重新開機後進入設定功能表 FN-F7，然後從設定功能表中選取選項 FN-F1，然後選取選項 FN-F5，然後選取選項 PS/2 SC 選取選項（例如 CRT、LCD）	FN-F2
Infotel	FN-F12	FN-F12
Kaypro	啟動時插入顯示器接頭	拔掉顯示器接頭
Kris Tech	FN-F8	FN-F8
Leading Edge	FN-T	FN-T
Mac Portable 100	無視訊埠；無法相容	
Mac PowerBook 140、145、150、170 160、165、180、520、540、5300	無視訊埠；需要協力廠商提供的介面 請先進入「控制面板」資料夾，然後進入「PowerBook 顯示器」資料夾；選取「啟動視訊鏡映」	暖開機
210、230、250、270、280、2300	需要 Apple Docking Station 或 Mini Dock	
Magitronic	FN-F4	FN-F4
Mastersport	FN-F2	FN-F1
Micro Express*	自動	暖開機
Micron	FN-F2	FN-F2
Microslate*	自動	暖開機
Mitsubishi	SW2 On-Off-Off-Off	SW2 Off-On-On-On
NCR	設定螢幕選項	設定螢幕選項
NEC* **	設定螢幕選項 在 DOS 提示中鍵入 CRT	設定螢幕選項 在 DOS 提示中鍵入 LCD
	FN-F3	FN-F3
Olivetti*	自動	自動
	FN-O/*	FN-O/*

電腦	啓動視訊埠的按鍵指令	停用視訊埠的按鍵指令
Packard Bell* **	FN-F0 Ctrl-Alt-<	FN-F0 Ctrl-Alt->
Panasonic	FN-F2	FN-F2
Prostar	在啓動時按下 Ctrl-Alt-S	在啓動時按下 Ctrl-Alt-S
Samsung*	設定螢幕選項	設定螢幕選項
Sanyo	設定螢幕選項	設定螢幕選項
Sharp	使用 DIP 開關來調整為 CRT	使用 DIP 開關來調整為 LCD
Sun SPARC-Dataview	Ctrl-Shift-M	Ctrl-Shift-M
Tandy**	Ctrl-Alt-Insert 設定螢幕選項	Ctrl-Alt-Insert 設定螢幕選項
Tangent	FN-F5	FN-F5
Texas Instruments*	設定螢幕選項	設定螢幕選項
Top-Link* **	設定螢幕選項	設定螢幕選項
Toshiba* **	FN-F6 Ctrl-Alt-End FN-End FN-F5 設定螢幕選項	FN-F6 Ctrl-Alt-Home FN-Home FN-F5 設定螢幕選項
Twinhead*	FN-F7 FN-F5 自動	FN-F7 FN-F5 自動
WinBook	Ctrl-Alt-F10	Ctrl-Alt-F10
Wyse	軟體驅動	軟體驅動
Zenith**	FN-F10 FN-F2 FN-F1	FN-F10 FN-F2 FN-F1
Zeos **	Ctrl-Shift-D FN-F1	Ctrl-Shift-D FN-F1

\* 這些製造廠商所提供的某些機型，會在連接某些種類的顯示裝置時，自動將視訊傳送至外部 CRT 埠。

\*\* 這些製造廠商依照電腦機型的不同，提供了多種按鍵指令。



---

## 附錄 D. 使用視訊鏡映

---

### 在 PowerBook 電腦上使用視訊鏡映

當您開啓視訊鏡映時（在較新型的 PowerBook 電腦上稱爲 SimulScan），投影機會顯示與 PowerBook 內建螢幕上所出現者相同的資訊。當關閉視訊鏡映時，投影機會以單獨顯示器的方式來運作。

若是第一次開啓視訊鏡映：

1. 請開啓「顯示器」控制面板；然後按一下**顯示器 2**。
2. 設定您所要的色彩數。
3. 請開啓「控制帶」，然後按一下顯示器的圖示。
4. 選取**開啓視訊鏡映**。

您現在可以從「控制帶」開啓或關閉視訊鏡映，而不需要再次開啓顯示器控制面板。在使用視訊鏡映以及高彩的圖形（例如幻燈片展示）時，投射的影像有時候可能會變爲黑白色。如果發生此現象，請執行下列步驟：

1. 關閉視訊鏡映。
2. 開啓顯示器控制面板。
3. 將白色的功能表列移動至**顯示器 2**，以便將投影機設定爲主要顯示器。
4. 重新啓動 PowerBook 電腦。

### 使用 Simulscan

某些較新型的 PowerBook 電腦會以不同的方式在外部顯示器或投影機上顯示影像。在使用 SimulScan 的時候，投影機會顯示與 PowerBook 電腦上出現者相同的資訊。若要選取 SimulScan：

1. 開啓「控制面板」，然後按兩下**顯示器與音效**。
2. 請在「解析度」清單中選取 SimulScan 模式，然後按一下**確定**。
3. 如果這樣變更了顯示器設定，則會開啓一個視窗。請按一下**確定**以便確認變更。





## Appendix E. Projected image size

Use the following graph and table to help you determine projected image sizes.

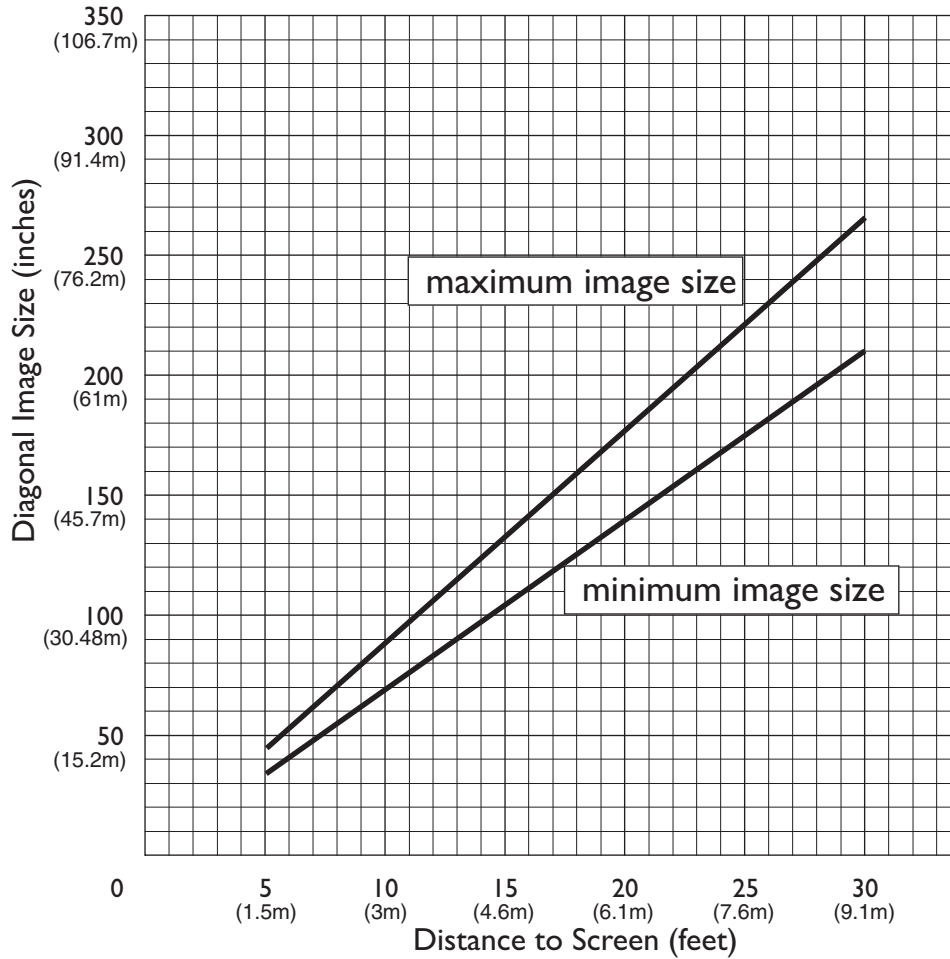

Table 1. Image size, width and height-maximum image size

<b>Diagonal image size</b>	<b>Image width</b>	<b>Maximum distance</b>	<b>Minimum distance</b>
152.4 c (60 in)	121.9 c (48 in)	2.59 m (8.5 ft.)	2.10 m (6.9 ft.)
183 c (72 in)	147.3 c (58 in)	3.1 m (10.2 ft.)	2.53 m (8.3 ft.)
213.4 c (84 in)	170 c (67 in)	3.62 m(11.9 ft.)	2.95 m (9.7 ft.)
229.6 c (90 in)	182.48 c (72 in)	3.87 m (12.7 ft.)	3.13 m (10.4 ft.)
254 c (100 in)	203.2 c (80 in)	4.29 m (14.1 ft.)	3.53 m (11.6 ft.)
304.8 c (120 in)	243.8 c (96 in)	5.18 m (17.0 ft.)	4.23 m (13.9 ft.)
381 c (150 in)	304.8 c (120 in)	6.46 m (21.2 ft.)	5.3 m (17.4 ft.)

---

## 附錄 F. Warranty information

This section contains the warranty period for your product, information about obtaining warranty service and support, and the IBM Statement of Limited Warranty.

---

### Warranty period

Contact your place of purchase for warranty service information. Some IBM Machines are eligible for on-site warranty service depending on the country or region where service is performed.

<b>Machine</b> - IBM iLM300 MicroPortable Projector
---

<b>Warranty period</b> - Three years
--------------------------------------

<b>Machine</b> - IBM iLM300 MicroPortable Projector Lamp module
---

<b>Warranty period</b> - Three months
---------------------------------------

### Replacement lamps

During the warranty period, order replacement lamps by calling the IBM HelpCenter. See 第 42 頁的『Telephone technical support』. Request Part Number 33L3456.

After the warranty period, order replacement lamps (Part Number 33L3456) from IBM using the World Wide Web. The Web site address is <http://www.pc.ibm.com/us/accessories/projectors/index.html>.

---

### Service and support

The following information describes the technical support that is available for your product, during the warranty period or throughout the life of the product. Refer to your IBM Statement of Limited Warranty for a full explanation of IBM warranty terms.

### Warranty information on the World Wide Web

The IBM Machine Warranties Web site at [http://www.ibm.com/servers/support/machine\\_warranties/](http://www.ibm.com/servers/support/machine_warranties/) contains a worldwide overview of the IBM Limited Warranty for IBM Machines, a glossary of terms used in the Statement of Limited Warranty, Frequently Asked Questions (FAQ), and links to Product Support Web pages. The IBM Statement of Limited Warranty is available from this Web site in 29 languages in Portable Document Format (PDF).

### Online technical support

Online technical support is available during the life of your product through the Personal Computing Support Web site at <http://www.ibm.com/pc/support/>.

During the warranty period, assistance for replacement or exchange of defective components is available. In addition, if your IBM option is installed in an IBM computer, you might be entitled to service at your location. Your technical support representative can help you determine the best alternative.

## Telephone technical support

Installation and configuration support through the IBM HelpCenter® will be withdrawn or made available for a fee, at IBM's discretion, 90 days after the option has been withdrawn from marketing. Additional support offerings, including step-by-step installation assistance, are available for a nominal fee.

To assist the technical support representative, have available as much of the following information as possible:

- Option name
- Option number
- Proof of purchase
- Computer manufacturer, model, serial number (if IBM), and manual
- Exact wording of the error message (if any)
- Description of the problem
- Hardware and software configuration information for your system

If possible, be at your computer. Your technical support representative might want to walk you through the problem during the call.

For the support telephone number and support hours by country, refer to the following table. If the number for your country or region is not listed, contact your IBM reseller or IBM marketing representative. Response time may vary depending on the number and nature of the calls received.

<b>Support 24 hours a day, 7 days a week</b>	
Canada (Toronto only)	416-383-3344
Canada (all other)	1-800-565-3344
U.S.A. and Puerto Rico	1-800-772-2227
All other countries and regions	Go to <a href="http://www.ibm.com/pc/support/">http://www.ibm.com/pc/support/</a> , and click <b>Support Phone List</b> .

---

## IBM Statement of Limited Warranty Z125-4753-06 8/2000

### Part 1 - General Terms

This Statement of Limited Warranty includes Part 1 - General Terms and Part 2 - Country-unique Terms. The terms of Part 2 replace or modify those of Part 1. The warranties provided by IBM in this Statement of Limited Warranty apply only to Machines you purchase for your use, and not for resale, from IBM or your reseller. The term 『Machine』 means an IBM machine, its features, conversions, upgrades, elements, or accessories, or any combination of them. The term 『Machine』 does not include any software programs, whether pre-loaded with the Machine, installed subsequently or otherwise. Unless IBM specifies otherwise, the following warranties apply only in the country where you acquire the Machine. Nothing in this Statement of Limited Warranty affects any statutory rights of consumers that cannot be waived or limited by contract. If you have any questions, contact IBM or your reseller.

**The IBM Warranty for Machines:** IBM warrants that each Machine 1) is free from defects in materials and workmanship and 2) conforms to IBM's Official Published Specifications ( 『Specifications』 ). The warranty period for a Machine is a specified, fixed period commencing on its Date of Installation. The date on your sales receipt is the Date of Installation unless IBM or your reseller informs you otherwise.

If a Machine does not function as warranted during the warranty period, and IBM or your reseller are unable to either 1) make it do so or 2) replace it with one that is at least functionally equivalent, you may return it to your place of purchase and your money will be refunded.

**Extent of Warranty:** The warranty does not cover the repair or exchange of a Machine resulting from misuse, accident, modification, unsuitable physical or operating environment, improper maintenance by you, or failure caused by a product for which IBM is not responsible. The warranty is voided by removal or alteration of Machine or parts identification labels.

**THESE WARRANTIES ARE YOUR EXCLUSIVE WARRANTIES AND REPLACE ALL OTHER WARRANTIES OR CONDITIONS, EXPRESS OR IMPLIED, INCLUDING, BUT NOT LIMITED TO, THE IMPLIED WARRANTIES OR CONDITIONS OF MERCHANTABILITY AND FITNESS FOR A PARTICULAR PURPOSE. THESE WARRANTIES GIVE YOU SPECIFIC LEGAL RIGHTS AND YOU MAY ALSO HAVE OTHER RIGHTS WHICH VARY FROM JURISDICTION TO JURISDICTION. SOME JURISDICTIONS DO NOT ALLOW THE EXCLUSION OR LIMITATION OF EXPRESS OR IMPLIED WARRANTIES, SO THE ABOVE EXCLUSION OR LIMITATION MAY NOT APPLY TO YOU. IN THAT EVENT, SUCH WARRANTIES ARE LIMITED IN DURATION TO THE WARRANTY PERIOD. NO WARRANTIES APPLY AFTER THAT PERIOD.**

**Items Not Covered by Warranty:** IBM does not warrant uninterrupted or error-free operation of a Machine. Any technical or other support provided for a Machine under warranty, such as assistance via telephone with 『how-to』 questions and those regarding Machine set-up and installation, will be provided **WITHOUT WARRANTIES OF ANY KIND.**

**Warranty Service:** To obtain warranty service for a Machine, contact IBM or your reseller. If you do not register your Machine with IBM, you may be required to present proof of purchase.

During the warranty period, IBM or your reseller, if approved by IBM to provide warranty service, provides without charge certain types of repair and exchange service to keep Machines in, or restore them to, conformance with their Specifications. IBM or your reseller will inform you of the available types of service for a Machine based on its country of installation. At its discretion, IBM or your reseller will 1) either repair or exchange the

failing Machine and 2) provide the service either at your location or a service center. IBM or your reseller will also manage and install selected engineering changes that apply to the Machine.

Some parts of IBM Machines are designated as Customer Replaceable Units (called 『CRUs』), e.g., keyboards, memory, or hard disk drives. IBM ships CRUs to you for replacement by you. You must return all defective CRUs to IBM within 30 days of your receipt of the replacement CRU. You are responsible for downloading designated Machine Code and Licensed Internal Code updates from an IBM Internet Web site or from other electronic media, and following the instructions that IBM provides.

When warranty service involves the exchange of a Machine or part, the item IBM or your reseller replaces becomes its property and the replacement becomes yours. You represent that all removed items are genuine and unaltered. The replacement may not be new, but will be in good working order and at least functionally equivalent to the item replaced. The replacement assumes the warranty service status of the replaced item. Many features, conversions, or upgrades involve the removal of parts and their return to IBM. A part that replaces a removed part will assume the warranty service status of the removed part.

Before IBM or your reseller exchanges a Machine or part, you agree to remove all features, parts, options, alterations, and attachments not under warranty service.

You also agree to

1. ensure that the Machine is free of any legal obligations or restrictions that prevent its exchange;
2. obtain authorization from the owner to have IBM or your reseller service a Machine that you do not own; and
3. where applicable, before service is provided:
  - a. follow the problem determination, problem analysis, and service request procedures that IBM or your reseller provides;
  - b. secure all programs, data, and funds contained in a Machine;
  - c. provide IBM or your reseller with sufficient, free, and safe access to your facilities to permit them to fulfill their obligations; and
  - d. inform IBM or your reseller of changes in a Machine's location.

IBM is responsible for loss of, or damage to, your Machine while it is 1) in IBM's possession or 2) in transit in those cases where IBM is responsible for the transportation charges.

Neither IBM nor your reseller is responsible for any of your confidential, proprietary or personal information contained in a Machine which you return to IBM or your reseller for any reason. You should remove all such information from the Machine prior to its return.

**Limitation of Liability:** Circumstances may arise where, because of a default on IBM's part or other liability, you are entitled to recover damages from IBM. In each such instance, regardless of the basis on which you are entitled to claim damages from IBM (including fundamental breach, negligence, misrepresentation, or other contract or tort claim), except for any liability that cannot be waived or limited by applicable laws, IBM is liable for no more than

1. damages for bodily injury (including death) and damage to real property and tangible personal property; and
2. the amount of any other actual direct damages, up to the charges (if recurring, 12 months' charges apply) for the Machine that is subject of the claim. For purposes of this item, the term 『Machine』 includes Machine Code and Licensed Internal Code.

This limit also applies to IBM's suppliers and your reseller. It is the maximum for which IBM, its suppliers, and your reseller are collectively responsible.

**UNDER NO CIRCUMSTANCES IS IBM LIABLE FOR ANY OF THE FOLLOWING: 1) THIRD-PARTY CLAIMS AGAINST YOU FOR DAMAGES (OTHER THAN THOSE UNDER THE FIRST ITEM LISTED ABOVE); 2) LOSS OF, OR DAMAGE TO, YOUR RECORDS OR DATA; OR 3) SPECIAL, INCIDENTAL, OR INDIRECT DAMAGES OR FOR ANY ECONOMIC CONSEQUENTIAL DAMAGES, LOST PROFITS OR LOST SAVINGS, EVEN IF IBM, ITS SUPPLIERS OR YOUR RESELLER IS INFORMED OF THEIR POSSIBILITY. SOME JURISDICTIONS DO NOT ALLOW THE EXCLUSION OR LIMITATION OF INCIDENTAL OR CONSEQUENTIAL DAMAGES, SO THE ABOVE LIMITATION OR EXCLUSION MAY NOT APPLY TO YOU.**

**Governing Law:** Both you and IBM consent to the application of the laws of the country in which you acquired the Machine to govern, interpret, and enforce all of your and IBM's rights, duties, and obligations arising from, or relating in any manner to, the subject matter of this Agreement, without regard to conflict of law principles.

## **Part 2 - Country-unique Terms**

### **AMERICAS**

#### **BRAZIL**

**Governing Law:** *The following is added after the first sentence:*

Any litigation arising from this Agreement will be settled exclusively by the court of Rio de Janeiro.

#### **NORTH AMERICA**

**Warranty Service:** *The following is added to this Section:*

To obtain warranty service from IBM in Canada or the United States, call 1-800-IBM-SERV (426-7378).

#### **CANADA**

**Governing Law:** *The following replaces 『laws of the country in which you acquired the Machine』 in the first sentence:*

laws in the Province of Ontario.

#### **UNITED STATES**

**Governing Law:** *The following replaces 『laws of the country in which you acquired the Machine』 in the first sentence:*

laws of the State of New York.

### **ASIA PACIFIC**

#### **AUSTRALIA**

**The IBM Warranty for Machines:** *The following paragraph is added to this Section:*

The warranties specified in this Section are in addition to any rights you may have under the Trade Practices Act 1974 or other similar legislation and are only limited to the extent permitted by the applicable legislation.

**Limitation of Liability:** *The following is added to this Section:*

Where IBM is in breach of a condition or warranty implied by the Trade Practices Act 1974 or other similar legislation, IBM's liability is limited to the repair or replacement of the goods or the supply of equivalent goods. Where that condition or warranty relates to right to sell, quiet possession or clear title, or the goods are of a kind ordinarily acquired for personal, domestic or household use or consumption, then none of the limitations in this paragraph apply.

**Governing Law:** *The following replaces 『laws of the country in which you acquired the Machine』 in the first sentence:*

laws of the State or Territory.

## **CAMBODIA, LAOS, AND VIETNAM**

**Governing Law:** *The following replaces 『laws of the country in which you acquired the Machine』 in the first sentence:*

laws of the State of New York.

*The following is added to this Section:*

Disputes and differences arising out of or in connection with this Agreement shall be finally settled by arbitration which shall be held in Singapore in accordance with the rules of the International Chamber of Commerce (ICC). The arbitrator or arbitrators designated in conformity with those rules shall have the power to rule on their own competence and on the validity of the Agreement to submit to arbitration. The arbitration award shall be final and binding for the parties without appeal and the arbitral award shall be in writing and set forth the findings of fact and the conclusions of law.

All proceedings shall be conducted, including all documents presented in such proceedings, in the English language. The number of arbitrators shall be three, with each side to the dispute being entitled to appoint one arbitrator.

The two arbitrators appointed by the parties shall appoint a third arbitrator before proceeding upon the reference. The third arbitrator shall act as chairman of the proceedings. Vacancies in the post of chairman shall be filled by the president of the ICC. Other vacancies shall be filled by the respective nominating party. Proceedings shall continue from the stage they were at when the vacancy occurred.

If one of the parties refuses or otherwise fails to appoint an arbitrator within 30 days of the date the other party appoints its, the first appointed arbitrator shall be the sole arbitrator, provided that the arbitrator was validly and properly appointed.

The English language version of this Agreement prevails over any other language version.

## **HONG KONG AND MACAU**

**Governing Law:** *The following replaces 『laws of the country in which you acquired the Machine』 in the first sentence:*

laws of Hong Kong Special Administrative Region.

## **INDIA**

**Limitation of Liability:** *The following replaces items 1 and 2 of this Section:*

1. liability for bodily injury (including death) or damage to real property and tangible personal property will be limited to that caused by IBM's negligence;
2. as to any other actual damage arising in any situation involving nonperformance by IBM pursuant to, or in any way related to the subject of this Statement of Limited Warranty, IBM's liability will be limited to the charge paid by you for the individual Machine that is the subject of the claim.

## **JAPAN**

**Governing Law:** *The following sentence is added to this Section:*

Any doubts concerning this Agreement will be initially resolved between us in good faith and in accordance with the principle of mutual trust.



## NEW ZEALAND

**The IBM Warranty for Machines:** *The following paragraph is added to this Section:*

The warranties specified in this Section are in addition to any rights you may have under the Consumer Guarantees Act 1993 or other legislation which cannot be excluded or limited. The Consumer Guarantees Act 1993 will not apply in respect of any goods which IBM provides, if you require the goods for the purposes of a business as defined in that Act.

**Limitation of Liability:** *The following is added to this Section:*

Where Machines are not acquired for the purposes of a business as defined in the Consumer Guarantees Act 1993, the limitations in this Section are subject to the limitations in that Act.

## PEOPLE'S REPUBLIC OF CHINA (PRC)

**Governing Law:** *The following replaces this Section:*

Both you and IBM consent to the application of the laws of the State of New York (except when local law requires otherwise) to govern, interpret, and enforce all your and IBM's rights, duties, and obligations arising from, or relating in any manner to, the subject matter of this Agreement, without regard to conflict of law principles.

Any disputes arising from or in connection with this Agreement will first be resolved by friendly negotiations, failing which either of us has the right to submit the dispute to the China International Economic and Trade Arbitration Commission in Beijing, the PRC, for arbitration in accordance with its arbitration rules in force at the time. The arbitration tribunal will consist of three arbitrators. The language to be used therein will be English and Chinese. An arbitral award will be final and binding on all the parties, and will be enforceable under the Convention on the Recognition and Enforcement of Foreign Arbitral Awards (1958).

The arbitration fee will be borne by the losing party unless otherwise determined by the arbitral award.

During the course of arbitration, this Agreement will continue to be performed except for the part which the parties are disputing and which is undergoing arbitration.

## EUROPE, MIDDLE EAST, AFRICA (EMEA)

**THE FOLLOWING TERMS APPLY TO ALL EMEA COUNTRIES:**

The terms of this Statement of Limited Warranty apply to Machines purchased from IBM or an IBM reseller.

**Warranty Service:** If you purchase an IBM Machine in Austria, Belgium, Denmark, Estonia, Finland, France, Germany, Greece, Iceland, Ireland, Italy, Latvia, Lithuania, Luxembourg, Netherlands, Norway, Portugal, Spain, Sweden, Switzerland or United Kingdom, you may obtain warranty service for that Machine in any of those countries from either (1) an IBM reseller approved to perform warranty service or (2) from IBM. If you purchase an IBM Personal Computer Machine in Albania, Armenia, Belarus, Bosnia and Herzegovina, Bulgaria, Croatia, Czech Republic, Georgia, Hungary, Kazakhstan, Kirghizia, Federal Republic of Yugoslavia, Former Yugoslav Republic of Macedonia (FYROM), Moldova, Poland, Romania, Russia, Slovak Republic, Slovenia, or Ukraine, you may obtain warranty service for that Machine in any of those countries from either (1) an IBM reseller approved to perform warranty service or (2) from IBM.

If you purchase an IBM Machine in a Middle Eastern or African country, you may obtain warranty service for that Machine from the IBM entity within the country of purchase, if that IBM entity provides warranty service in that country, or from an IBM reseller, approved by IBM to perform warranty service on that Machine in

that country. Warranty service in Africa is available within 50 kilometers of an IBM authorized service provider. You are responsible for transportation costs for Machines located outside 50 kilometers of an IBM authorized service provider.

**Governing Law:** The applicable laws that govern, interpret and enforce rights, duties, and obligations of each of us arising from, or relating in any manner to, the subject matter of this Statement, without regard to conflict of laws principles, as well as Country-unique terms and competent court for this Statement are those of the country in which the warranty service is being provided, except that in 1) Albania, Bosnia-Herzegovina, Bulgaria, Croatia, Hungary, Former Yugoslav Republic of Macedonia, Romania, Slovakia, Slovenia, Armenia, Azerbaijan, Belarus, Georgia, Kazakhstan, Kyrgyzstan, Moldova, Russia, Tajikistan, Turkmenistan, Ukraine, and Uzbekistan, the laws of Austria apply; 2) Estonia, Latvia, and Lithuania, the laws of Finland apply; 3) Algeria, Benin, Burkina Faso, Cameroon, Cape Verde, Central African Republic, Chad, Congo, Djibouti, Democratic Republic of Congo, Equatorial Guinea, France, Gabon, Gambia, Guinea, Guinea-Bissau, Ivory Coast, Lebanon, Mali, Mauritania, Morocco, Niger, Senegal, Togo, and Tunisia, this Agreement will be construed and the legal relations between the parties will be determined in accordance with the French laws and all disputes arising out of this Agreement or related to its violation or execution, including summary proceedings, will be settled exclusively by the Commercial Court of Paris; 4) Angola, Bahrain, Botswana, Burundi, Egypt, Eritrea, Ethiopia, Ghana, Jordan, Kenya, Kuwait, Liberia, Malawi, Malta, Mozambique, Nigeria, Oman, Pakistan, Qatar, Rwanda, Sao Tome, Saudi Arabia, Sierra Leone, Somalia, Tanzania, Uganda, United Arab Emirates, United Kingdom, West Bank/Gaza, Yemen, Zambia, and Zimbabwe, this Agreement will be governed by English Law and disputes relating to it will be submitted to the exclusive jurisdiction of the English courts; and 5) in Greece, Israel, Italy, Portugal, and Spain any legal claim arising out of this Statement will be brought before, and finally settled by, the competent court of Athens, Tel Aviv, Milan, Lisbon, and Madrid, respectively.

***THE FOLLOWING TERMS APPLY TO THE COUNTRY SPECIFIED:***

**AUSTRIA AND GERMANY**

**The IBM Warranty for Machines:** *The following replaces the first sentence of the first paragraph of this Section:*

The warranty for an IBM Machine covers the functionality of the Machine for its normal use and the Machine's conformity to its Specifications.

*The following paragraphs are added to this Section:*

The minimum warranty period for Machines is six months. In case IBM or your reseller is unable to repair an IBM Machine, you can alternatively ask for a partial refund as far as justified by the reduced value of the unrepaired Machine or ask for a cancellation of the respective agreement for such Machine and get your money refunded.

**Extent of Warranty:** *The second paragraph does not apply.*

**Warranty Service:** *The following is added to this Section:*

During the warranty period, transportation for delivery of the failing Machine to IBM will be at IBM's expense.

**Limitation of Liability:** *The following paragraph is added to this Section:*

The limitations and exclusions specified in the Statement of Limited Warranty will not apply to damages caused by IBM with fraud or gross negligence and for express warranty.

*The following sentence is added to the end of item 2:*

IBM's liability under this item is limited to the violation of essential contractual terms in cases of ordinary negligence.

## EGYPT

**Limitation of Liability:** *The following replaces item 2 in this Section:*

as to any other actual direct damages, IBM's liability will be limited to the total amount you paid for the Machine that is the subject of the claim. For purposes of this item, the term 『Machine』 includes Machine Code and Licensed Internal Code.

*Applicability of suppliers and resellers (unchanged).*

## FRANCE

**Limitation of Liability:** *The following replaces the second sentence of the first paragraph of this Section:*

In such instances, regardless of the basis on which you are entitled to claim damages from IBM, IBM is liable for no more than: *(items 1 and 2 unchanged).*

## IRELAND

**Extent of Warranty:** *The following is added to this Section:*

Except as expressly provided in these terms and conditions, all statutory conditions, including all warranties implied, but without prejudice to the generality of the foregoing all warranties implied by the Sale of Goods Act 1893 or the Sale of Goods and Supply of Services Act 1980 are hereby excluded.

**Limitation of Liability:** *The following replaces items one and two of the first paragraph of this Section:*

1. death or personal injury or physical damage to your real property solely caused by IBM's negligence; and
2. the amount of any other actual direct damages, up to 125 percent of the charges (if recurring, the 12 months' charges apply) for the Machine that is the subject of the claim or which otherwise gives rise to the claim.

*Applicability of suppliers and resellers (unchanged).*

*The following paragraph is added at the end of this Section:*

IBM's entire liability and your sole remedy, whether in contract or in tort, in respect of any default shall be limited to damages.

## ITALY

**Limitation of Liability:** *The following replaces the second sentence in the first paragraph:*

In each such instance unless otherwise provided by mandatory law, IBM is liable for no more than:

1. *(unchanged)*
2. as to any other actual damage arising in all situations involving nonperformance by IBM pursuant to, or in any way related to the subject matter of this Statement of Warranty, IBM's liability, will be limited to the total amount you paid for the Machine that is the subject of the claim.

*Applicability of suppliers and resellers (unchanged).*

*The following replaces the third paragraph of this Section:*

Unless otherwise provided by mandatory law, IBM and your reseller are not liable for any of the following: *(items 1 and 2 unchanged)* 3) indirect damages, even if IBM or your reseller is informed of their possibility.

## SOUTH AFRICA, NAMIBIA, BOTSWANA, LESOTHO AND SWAZILAND

**Limitation of Liability:** *The following is added to this Section:*

IBM's entire liability to you for actual damages arising in all situations involving nonperformance by IBM in

respect of the subject matter of this Statement of Warranty will be limited to the charge paid by you for the individual Machine that is the subject of your claim from IBM.

## **UNITED KINGDOM**

**Limitation of Liability:** *The following replaces items 1 and 2 of the first paragraph of this Section:*

1. death or personal injury or physical damage to your real property solely caused by IBM's negligence;
2. the amount of any other actual direct damages or loss, up to 125 percent of the charges (if recurring, the 12 months' charges apply) for the Machine that is the subject of the claim or which otherwise gives rise to the claim;

*The following item is added to this paragraph:*

3. breach of IBM's obligations implied by Section 12 of the Sale of Goods Act 1979 or Section 2 of the Supply of Goods and Services Act 1982.

*Applicability of suppliers and resellers (unchanged).*

*The following is added to the end of this Section:*

IBM's entire liability and your sole remedy, whether in contract or in tort, in respect of any default shall be limited to damages.

---

## 附錄 G. Notices

IBM may not offer the products, services, or features discussed in this document in all countries. Consult your local IBM representative for information on the products and services currently available in your area. Any reference to an IBM product, program, or service is not intended to state or imply that only that IBM product, program, or service may be used. Any functionally equivalent product, program, or service that does not infringe any IBM intellectual property right may be used instead. However, it is the user's responsibility to evaluate and verify the operation of any non-IBM product, program, or service.

IBM may have patents or pending patent applications covering subject matter described in this document. The furnishing of this document does not give you any license to these patents. You can send license inquiries, in writing, to:

*IBM Director of Licensing  
IBM Corporation  
North Castle Drive  
Armonk, NY 10504-1785  
U.S.A.*

INTERNATIONAL BUSINESS MACHINES CORPORATION PROVIDES THIS PUBLICATION 『AS IS』 WITHOUT WARRANTY OF ANY KIND, EITHER EXPRESS OR IMPLIED, INCLUDING, BUT NOT LIMITED TO, THE IMPLIED WARRANTIES OF NON-INFRINGEMENT, MERCHANTABILITY OR FITNESS FOR A PARTICULAR PURPOSE. Some jurisdictions do not allow disclaimer of express or implied warranties in certain transactions, therefore, this statement may not apply to you.

This information could include technical inaccuracies or typographical errors. Changes are periodically made to the information herein; these changes will be incorporated in new editions of the publication. IBM may make improvements and/or changes in the product(s) and/or the program(s) described in this publication at any time without notice.

IBM may use or distribute any of the information you supply in any way it believes appropriate without incurring any obligation to you.

Any references in this publication to non-IBM Web sites are provided for convenience only and do not in any manner serve as an endorsement of those Web sites. The materials at those Web sites are not part of the materials for this IBM product, and use of those Web sites is at your own risk.

Any performance data contained herein was determined in a controlled environment. Therefore, the result obtained in other operating environments may vary significantly. Some measurements may have been made on development-level systems and there is no guarantee that these measurements will be the same on generally available systems. Furthermore, some measurements may have been estimated through extrapolation. Actual results may vary. Users of this document should verify the applicable data for their specific environment.

---

## Trademarks

The following terms are trademarks of the IBM Corporation in the United States or other countries or both:

IBM  
HelpCenter

Microsoft, PowerPoint and Windows are trademarks or registered trademarks of Microsoft in the United States or other countries or both.

Other company, product, and service names may be trademarks or service marks of others.

---

## **Federal Communications Commission (FCC) statement**

**Note:** This equipment has been tested and found to comply with the limits for a Class A digital device, pursuant to Part 15 of the FCC Rules. These limits are designed to provide reasonable protection against harmful interference when the equipment is operated in a commercial environment. This equipment generates, uses, and can radiate radio frequency energy and, if not installed and used in accordance with the instruction manual, may cause harmful interference to radio communications. Operation of this equipment in a residential area is likely to cause harmful interference, in which case the user will be required to correct the interference at his own expense.

Properly shielded and grounded cables and connectors must be used in order to meet FCC emission limits. IBM is not responsible for any radio or television interference caused by using other than recommended cables and connectors or by unauthorized changes or modifications to this equipment. Unauthorized changes or modifications could void the user's authority to operate the equipment.

This device complies with Part 15 of the FCC Rules. Operation is subject to the following two conditions: (1) this device may not cause harmful interference, and (2) this device must accept any interference received, including interference that may cause undesired operation.

## **Industry Canada Class A emission compliance statement**

This Class A digital apparatus complies with Canadian ICES-003.

## **Avis de conformité a la réglementation d'Industrie Canada**

Cet appareil numérique de la classe A est conforme à la norme NMB-003 du Canada.

## **Deutsche EMV-Direktive (electromagnetische Verträglichkeit)**

Dieses Gerät ist berechtigt in Übereinstimmung mit dem deutschen EMVG vom 9.Nov.92 das EG-Konformitätszeichen zu führen.

Der Aussteller der Konformitätserklärung ist die IBM UK, Greenock.

Dieses Gerät erfüllt die Bedingungen der EN 55022 Klasse A. Für diese Klasse von Geräten gilt folgende Bestimmung nach dem EMVG:

Geräte dürfen an Orten, für die sie nicht ausreichend entstört sind, nur mit besonderer Genehmigung des Bundesministers für Post und Telekommunikation oder des Bundesamtes für Post und Telekommunikation betrieben werden. Die Genehmigung wird erteilt, wenn keine elektromagnetischen Störungen zu erwarten sind.

(Auszug aus dem EMVG vom 9.Nov.92, Para.3. Abs.4)

<b>Hinweis:</b> Dieses Genehmigungsverfahren ist von der Deutschen Bundespost noch nicht veröffentlicht worden.
---

## **European Union - EMC directive**

This product is in conformity with the protection requirements of EU Council Directive 89/366/ECC on the approximation of the laws of the Member States relating to electromagnetic compatibility.

IBM cannot accept responsibility for any failure to satisfy the protection requirements resulting from a non-recommended modification of the product, including the fitting of non-IBM option cards.

This product has been tested and found to comply with the limits for Class A Information Technology Equipment according to CISPR 22/European Standard EN 55022. The limits for Class A equipment were derived for commercial and industrial environments to provide reasonable protection against interference with licensed communication equipment.

**Warning:** This is a Class A product. In a domestic environment this product may cause radio interference in which case the user may be required to take adequate measures.

### **Union Européenne - Directive Conformité électromagnétique**

Ce produit est conforme aux exigences de protection de la Directive 89/336/EEC du Conseil de l'UE sur le rapprochement des lois des États membres en matière de compatibilité électromagnétique.

IBM ne peut accepter aucune responsabilité pour le manquement aux exigences de protection résultant d'une modification non recommandée du produit, y compris l'installation de cartes autres que les cartes IBM.

Ce produit a été testé et il satisfait les conditions de l'équipement informatique de Classe A en vertu de CISPR22/Standard européen EN 55022. Les conditions pour l'équipement de Classe A ont été définies en fonction d'un contexte d'utilisation commercial et industriel afin de fournir une protection raisonnable contre l'interférence d'appareils de communication autorisés.

**Avertissement :** Ceci est un produit de Classe A. Dans un contexte résidentiel, ce produit peut causer une interférence radio exigeant que l'utilisateur prenne des mesures adéquates.

### **Union Europea - Normativa EMC**

Questo prodotto è conforme alle normative di protezione ai sensi della Direttiva del Consiglio dell'Unione Europea 89/336/CEE sull'armonizzazione legislativa degli stati membri in materia di compatibilità elettromagnetica.

IBM non accetta responsabilità alcuna per la mancata conformità alle normative di protezione dovuta a modifiche non consigliate al prodotto, compresa l'installazione di schede e componenti di marca diversa da IBM.

Le prove effettuate sul presente prodotto hanno accertato che esso rientra nei limiti stabiliti per le apparecchiature di informatica Classe A ai sensi del CISPR 22/Norma Europea EN 55022. I limiti delle apparecchiature della Classe A sono stati stabiliti al fine di fornire ragionevole protezione da interferenze mediante dispositivi di comunicazione in concessione in ambienti commerciali ed industriali.

**Avvertimento:** Questo è un prodotto appartenente alla Classe A. In ambiente domestico, tale prodotto può essere causa di interferenze radio, nel qual caso l'utente deve prendere misure adeguate.

### **Unione Europea - Directiva EMC (Conformidad electromagnética)**

Este producto satisface los requisitos de protección del Consejo de la UE, Directiva 89/336/CEE en lo que a la legislación de los Estados Miembros sobre compatibilidad electromagnética se refiere.

IBM no puede aceptar responsabilidad alguna si este producto deja de satisfacer dichos requisitos de protección como resultado de una modificación no recomendada del producto, incluyendo el ajuste de tarjetas de opción que no sean IBM.

Este producto ha sido probado y satisface los límites para Equipos Informáticos Clase A de conformidad con el Estándar CISPR22 y el Estándar Europeo EN 55022. Los límites para los equipos de Clase A se han establecido para entornos comerciales e industriales a fin de proporcionar una protección razonable contra las interferencias con dispositivos de comunicación licenciados.

**Advertencia:** Este es un producto de Clase A. En un entorno doméstico este producto podría causar radiointerferencias en cuyo caso el usuario deberá tomar las medidas adecuadas.

## 声 明

**此为 A 级产品，在生活环境中，  
该产品可能会造成无线电干扰。  
在这种情况下，可能需要用户对其  
干扰采取切实可行的措施。**

警告使用者：  
這是甲類的資訊產品，在  
居住的環境中使用時，可  
能會造成射頻干擾，在這  
種情況下，使用者會被要  
求採取某些適當的對策。

この装置は、情報処理装置等電波障害自主規制協議会（VCCI）の基準に  
基づくクラスA情報技術装置です。この装置を家庭環境で使用すると電波妨害を  
引き起こすことがあります。この場合には使用者が適切な対策を講ずるよう要求  
されることがあります。







Part Number: 33L3529

Printed in U.S.A.

(1P) P/N: 33L3529

