

IBM ThinkVision™ L190p Monitor

The IBM logo, consisting of the letters 'IBM' in a bold, sans-serif font, where each letter is formed by eight horizontal stripes of varying lengths.

L190p

User's Guide

English

First Edition (September/2003)

Note: For important information, refer to the Monitor Safety and Warranty manual that comes with this monitor.

Contents

- Safety (Read first) 2**
- Setting up the monitor 3**
 - Product Description 3
 - Handling Instructions 3
 - Workplace Preparation 4
 - Adjusting the Monitor Position 5
 - Working Practices 5
 - Caring for your Monitor. 6
 - Connecting your Monitor for Analog 7
 - Connecting your Monitor for Digital 8
 - Switching on your Monitor 9
- Device Driver Installation 10**
 - Windows XP 10
 - Windows Millennium 10
 - Windows 2000 11
 - Windows 98 11
 - Windows 95 12
- Auto Image Setup (Analog Only) 14**
 - Auto Image Setup 14
 - Auto Image Setup for DOS 15
 - Auto Image Setup for Windows 3.1, Windows 95, Windows 98, Windows 2000
Windows NT, Windows Me or Windows XP 16
- Manual Image Setup 18**
- Adjusting Your LCD Monitor 19**
 - User controls 19
 - On-screen display (OSD) controls 21
- Further Information 25**
 - Display modes 25
 - Power Management 27
 - Product Disposal 27
- Troubleshooting 28**
 - Further Help 31
- Specifications 32**
- Service Information 34**
- Notices and Trademarks 35**



Safety: Read first

Before installing this product, read the Safety Information.

Avant d'installer ce produit, lisez les consignes de sécurité.

Vor der Installation dieses Produkts die Sicherheitshinweise lesen.

Πριν εγκαταστήσετε το προϊόν αυτό, διαβάστε τις πληροφορίες ασφάλειας (safety information).

לפני שתתקין מוצר זה, קראו את הוראות הבטיחות.

A termék telepítése előtt olvassa el a Biztonsági előírásokat!

Prima di installare questo prodotto, leggere le Informazioni sulla Sicurezza.

Antes de instalar este produto, leia as Informações de Segurança.

Läs säkerhetsinformationen innan du installerar den här produkten.

Prije instalacije ovog produkta obavezno pročitajte Sigurnosne Upute.

Les sikkerhetsinformasjonen (Safety Information) før du installerer dette produktet.

Przed zainstalowaniem tego produktu, należy zapoznać się z książką "Informacje dotyczące bezpieczeństwa" (Safety Information).

Пред да се инсталира овој продукт, прочитајте информацијата за безбедност.

Pred inštaláciou tohto zariadenia si pečítajte Bezpečnostné predpisy.

Pred namestitvijo tega proizvoda preberite Varnostne informacije.

Ennen kuin asennat t m n tuotteen, lue turvaohjeet kohdasta Safety Information.

Před instalac tohoto produktu si přečtěte příručku bezpečnostních instrukcí.

在安装本产品之前，请仔细阅读 **Safety Information** (安全信息)。

安裝本產品之前，請先閱讀「安全資訊」。

مج، يجب قراءة دات السلامة

Læs sikkerhedsforskrifterne, før du installerer dette produkt.

製品の設置の前に、安全情報をお読みください。

본 제품을 설치하기 전에 안전 정보를 읽으십시오.

Antes de instalar este producto lea la información de seguridad.

Antes de instalar este produto, leia as Informações de Segurança.

Перед установкой продукта прочтите инструкции по технике безопасности.

Lees voordat u dit product installeert eerst de veiligheidsvoorschriften.

Setting up the monitor

Product Description

The **IBM ThinkVision L190p Monitor** works with a computer with a suitable on-board sub-system or Video Adapter card that can support SXGA 1280 x 1024, XGA 1024 x 768, SVGA 800 x 600, or VGA 640 x 480 at 60 Hz.

In addition to your monitor, your option package includes the followings:

- *User's Guide and Installation Files CD*
- Monitor Warranty and Safety manual
- *IBM ThinkVision L190p Monitor Setup Guide*
- Power Cord
- IBM ThinkVision L190p Monitor
- Analog Interface Cable - Attached to Monitor
- Digital Interface Cable - Detached from Monitor

Handling Instructions

Do not support the monitor within the screen area. The Liquid Crystal Display is glass and can be damaged by rough handling or excessive pressure.

1. Remove the shipping clip for cable as shown below.

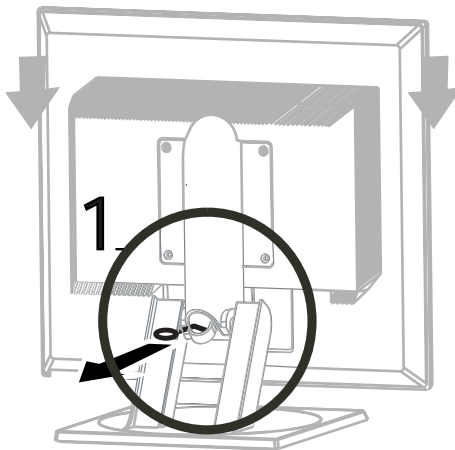

2. Lift the monitor by placing your hands where indicated below.

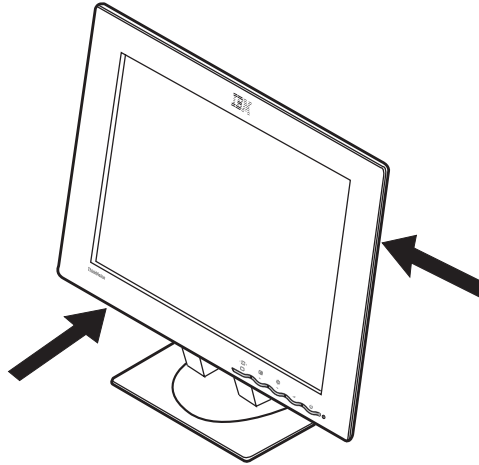

3. Before using your monitor for the first time, remove the clear protective film from the front of the screen.

Workplace Preparation

i This section gives advice on what you should consider before you set up your monitor.

Height

Position the monitor so that the top of the screen is slightly below your eye level when you sit at your workstation.

Orientation

Choose a position that gives the least reflection from lights and windows, usually at a right angle to any windows. Position the monitor directly in front of you so that you do not have to twist your body to use it. Tilt the monitor to a comfortable viewing angle.

Adjusting the Monitor Position

Viewing Angle

You can tilt the screen backward and forward, swivel left or right as well as lift up and down as shown below.

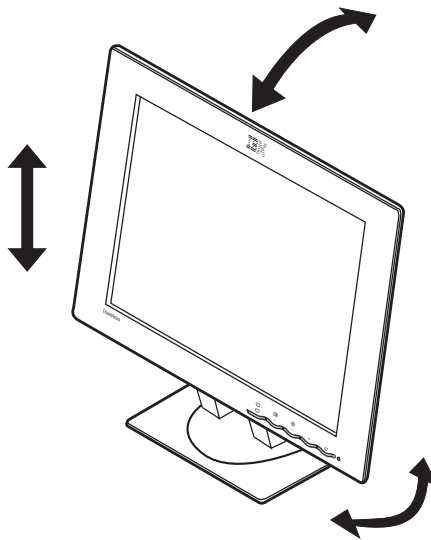

Working Practices

i This section gives advice on how you can work comfortably and reduce fatigue.

Rest

Take regular breaks. Vary your posture, stand up and stretch occasionally as prolonged use of computer workstations can be tiring.

Back

Sit back in your chair and use the backrest.

Hands

Adjust the seat height so that your forearms are approximately horizontal and your wrists are straight when using the keyboard. Your upper arms should be relaxed with your elbows near your body.

Use a light touch on the keyboard, keeping your hands and fingers relaxed. Allow a space in front of the keyboard to rest your wrists when not typing. Consider using a wristpad.

Eyesight

Working with monitors, in common with any prolonged close work, can be visually demanding. Look away from the screen periodically and have your eyesight checked regularly.

Screen settings

Set the screen brightness and contrast to a comfortable level. You may have to adjust this as the lighting changes during the day. Many application programs let you select color combinations which can help you to view in comfort. See the *User controls* section on page 19 for more information.

Caring for your Monitor

Be sure to turn off the power before you perform any maintenance on the monitor. Clean your monitor as follows:

- Gently wipe the device covers and the screen with a soft cloth.
- Remove finger marks and grease with a damp cloth and mild detergent; do not use solvents or abrasives
- Never use flammable cleaning material to clean your IBM monitor or any other electrical apparatus.
- Connect the power cord to the power port on the back of your monitor if the power cord supplied is not attached to the monitor. Then insert the plug into a properly grounded electrical outlet.

Connecting your Monitor for Analog

Be sure to read the '**Safety Information**' at the front of this User Guide before carrying out this procedure.

1. Turn off your computer and all attached devices.
2. Connect the signal cable to the video port on the back of your computer. This port might be directly attached to your computer (figure A), or it might be part of a video adapter card (figure B). The video port on your computer or video adapter card might be blue to match the blue connector on your monitor's video cable.

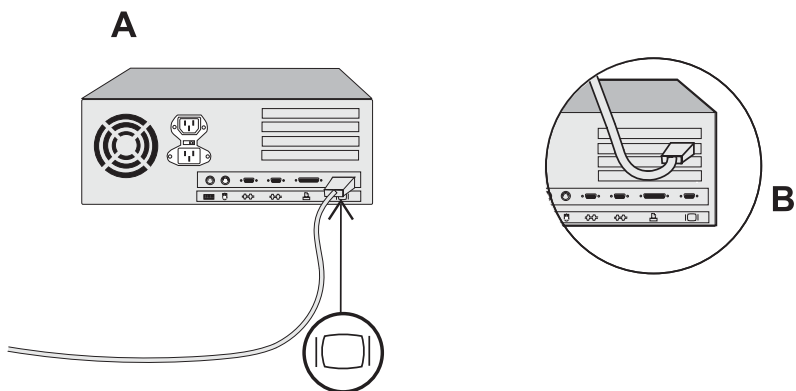

3. Connect the power cord to the power port on the back of your monitor if the power cord supplied is not attached to the monitor. Then insert the plug into a properly grounded electrical outlet.

Connecting your Monitor for Digital

1. Turn off your computer and all attached devices.

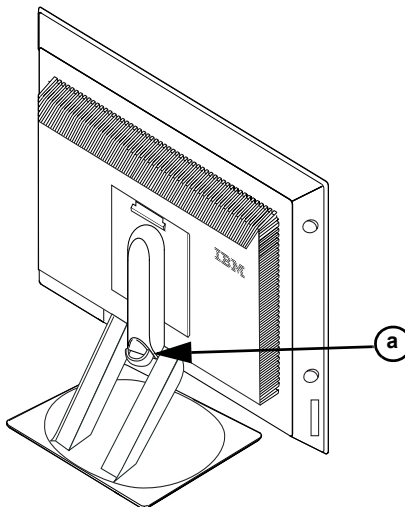

2. Tilt monitor all the way forward.
3. Connect the DVI connector at the end of the DVI-D signal cable (shipped with your Monitor) to the DVI port located on the back of the Monitor. See picture below.

Connecting DVI Cable

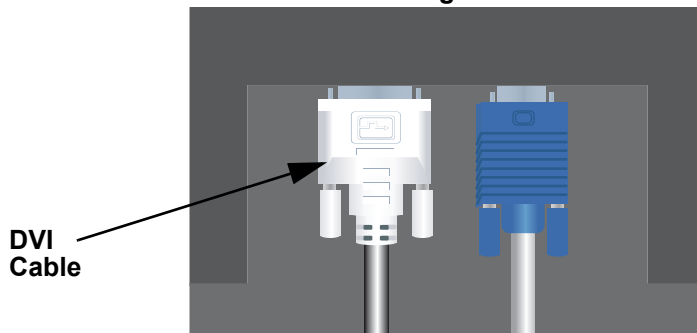

4. Connect the DVI connector at the other end of the signal cable to the DVI port located on the back of the graphics adapter. See picture below.

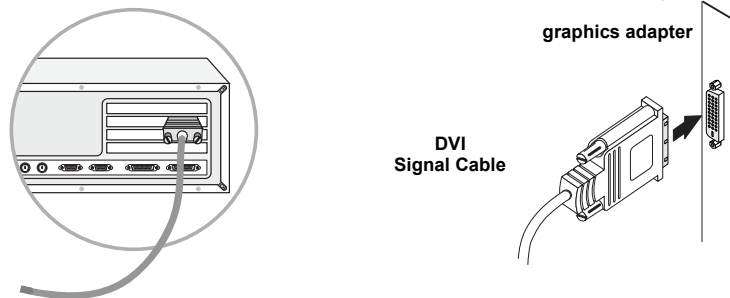

5. Connect the power cord to the power port on the back of your monitor if the power cord supplied is not attached to the monitor. Then insert the plug into a properly grounded electrical outlet.
6. Use the cable holder (a) to neatly organize the video and power cables.
7. Switch on the power source and your computer. To turn on the monitor, push and release the power switch \odot . To switch it off, push and release the power switch again.

Switching on your Monitor

1. Switch on the power source and your computer.
2. Switch on your monitor by pushing and releasing the power switch marked \odot .
(To switch off your monitor, push and release the power switch again).
3. To update or install device drivers, follow the instructions in the Device Driver Installation section found on page 10.
4. To optimize the displayed image, run Auto Image Setup by following the instructions in the Auto Image Setup section found on page 14.

Device Driver Installation

Use the *User's Guide and Installation Files CD* that comes with your monitor to install the appropriate device driver for your operating system.

Installing the Windows XP device driver

To manually install or update the device driver for the Microsoft® Windows® XP operating system, perform the following steps:

1. Insert the *User's Guide and Installation Files CD* into the computer CD-ROM drive.
2. Click **Start → Control Panel → Appearance & Themes** and then click the **Display** icon.
3. In the Display Properties window, click the **Settings** tab, and then click **Advanced**.
4. Click the **Monitor** tab, and then click **Properties → Driver tab → Update Driver**.
5. When the Hardware Update Wizard window opens, select "Install the software automatically," click **Next>** and then **Finish** to complete the installation.
6. Close the Display Properties window.
7. Remove the *User's Guide and Installation Files CD* from the computer CD-ROM drive.

Installing the Windows Me device driver

To manually install or update the device driver for the Microsoft® Windows® Millennium Edition operating system, perform the following steps:

1. Click **Start → Settings → Control Panel** and then double-click **Display**.
2. In the Display Properties window, click the **Settings** tab, and then click **Advanced**.
3. Click the **Monitor** tab, and then click **Change → Specify the location of the driver → Next**.
4. When the Update Device Driver Wizard window opens, select "Display a list of all the drivers in a specific location, so you can select the driver you want," and click **Next>**.
5. Insert the the *User's Guide and Installation Files CD* into the computer CD-ROM drive, then click **Have Disk**.
6. Type d:\ (change the drive letter to match your CD-ROM drive if it is not drive D) in the **Copy manufacturer's files from:** box, then click **OK**.

7. Click **Next>**, **Next>**, and then **Finish** to complete the installation.
8. Close the Display Properties window.
9. Remove the *User's Guide and Installation Files CD* from the computer CD-ROM drive.

Installing the Windows 2000 device driver

To manually install or update the device driver for the Microsoft® Windows® 2000 Professional operating system, perform the following steps:

1. Click **Start → Settings → Control Panel** and then double-click **Display**.
2. In the Display Properties window, click the **Settings** tab, and then click **Advanced**.
3. Click the **Monitor** tab, and then click **Properties → Driver → Update Driver**.
4. When the Update Device Driver Wizard window opens, select "Search for a suitable driver for my device," and click **Next>**.
5. Insert the *User's Guide and Installation Files CD* into the computer CD-ROM drive, type d:\ (change the drive letter to match your CD-ROM drive if it is not drive D) in the **Copy manufacturer's files from:** box, click **Next>** and then **Finish** to complete the installation.
6. Close the Display Properties window.
7. Remove the *User's Guide and Installation Files CD* from the computer CD-ROM drive.

Installing the Windows 98 device driver

Windows 98 automatically detects the new monitor and displays the Add New Hardware Wizard window if the device driver is not already installed.

1. Insert the Device Driver and *User's Guide* CD into the computer CD-ROM drive, and click **Next>** twice when the Add New Hardware Wizard window opens.
2. Click the **CD-ROM drive** box to install the device drivers from the CD and then click **Next>**.
3. Confirm that the device driver was found on the CD, and click **Next>** twice to install the device driver.
4. Click **Finish** to close the Add New Hardware Wizard window.

To manually install or update the device driver for the Microsoft® Windows® 98 operating system, perform the following steps:

1. Click **Start → Settings → Control Panel** and then double-click **Display**.
2. In the Display Properties window, click the **Settings** tab, and then click **Advanced**.
3. Click the **Monitor** tab, and then click **Change**.
4. When the Update Device Driver Wizard window opens, follow the steps in the previous paragraph.
5. Remove the *User's Guide and Installation Files CD* from the computer CD-ROM drive.

Installing the Windows 95 device driver

Right-click the My Computer icon on the computer desktop and then select **Properties → System** to view the version number listed in the System window. Perform the steps below for the appropriate version.

If you have Windows 95 Version 4.00.950A, use the following steps to manually install or update the device driver:

1. Click **Start → Settings → Control Panel** and then double-click **Display**.
2. In the Display Properties window, click the **Settings** tab and then click **Change Display Type**.
3. In the **Change Display Type** window, click **Change** and then click **Have Disk**.
4. Insert the *User's Guide and Installation Files CD* into the computer CD-ROM drive, type d:\ (change the drive letter to match your CD-ROM drive if it is not drive D) in the **Copy manufacturer's files from:** box, and click **OK**.
5. In the Select Device window, click the appropriate monitor model and then click **OK**.
6. In the Change Display Type window, click **Close**.
7. In the Display Properties window, click **OK**.
8. Remove the *User's Guide and Installation Files CD* from the computer CD-ROM drive.

If you have Windows 95 Version 4.00.950B, use the following steps to manually install or update the device driver:

1. Click **Start → Settings → Control Panel** and then double-click **Display**.
2. In the Display Properties window, click the **Settings** tab and then click **Advanced Properties**.
3. In the Advanced Display Properties window, click the **Monitor** tab and then click **Change**.

4. In the Select Device window, click **Have Disk**.
5. Insert the *User's Guide and Installation Files CD* into the computer CD-ROM drive, type d:\ (change the drive letter to match your CD-ROM drive if it is not drive D) in the **Copy manufacturer's files from:** box, and click **OK**.
6. In the Select Device window, click the appropriate monitor model and then click **OK**.
7. In the Advanced Display Properties window, click **Close**.
8. In the Display Properties window, click **OK**.
9. Remove the *User's Guide and Installation Files CD* from the computer CD-ROM drive.

Auto Image Setup (Analog Only)

Auto Image Setup

i The Setup Utility included on the setup diskette is for displaying dot patterns. They do not replace or modify the display driver.

The Auto Image Setup instructions require the monitor to be warmed up for 15 minutes. This is not required for normal operation.

When you first use your monitor you must perform Auto Image Setup. This procedure sets up your monitor to process the video signals from your computer without image discoloration or smearing. After you perform Auto Image Setup, the settings are stored and used each time you turn on the monitor.

To optimise the displayed image a set-up utility is provided on the CD. Operation of the utility is dependent on the operating system on your computer. For correct operation locate the operating system on your computer from the table below and follow the appropriate instructions. You can choose to run AUTO IMAGE SETUP for each operating system that you use. This means that if you sometimes use your monitor while running any version of Windows and sometimes also use it from within DOS (not a DOS window), you must run AUTO IMAGE SETUP for both Windows and DOS. You can run versions of AUTO IMAGE SETUP in any order.

Operating System	Corresponding Auto Image Setup procedure
DOS	<i>Auto Image Setup for DOS on page 15</i>
Windows 3.1, Windows 95, Windows 98, Windows 2000, Microsoft Windows NT [®] , Windows Me or Windows XP	Auto Image Setup for Windows 3.1, Windows 95, Windows 98, Windows NT, Windows 2000, Windows Me or Windows XP

Before you begin AUTO IMAGE SETUP for your computer:

1. Make sure the computer's video mode is set in the range of the supported screen resolution shown in the Table on page 26.

You should perform AUTO IMAGE SETUP for each screen mode you use.

i The AUTO IMAGE SETUP process only applies to the current screen mode. When a new mode is selected, repeat this section to reset the monitor

Auto Image Setup for DOS

i If the monitor is in standby mode (STANDBY ON), it may automatically turn off while you are waiting for it to warm up. If this happens, switch off the monitor and switch it on again after a few seconds.

i If you are using PC-DOS/V, change to U.S. mode by typing 'CHEV US' and pressing ENTER at the command prompt.









i The size and diversity of the dot pattern varies with the screen resolution.

To optimize the displayed image automatically in DOS, do the following:

1. Turn on the monitor first; then turn on the computer.

If the message CHECK SIGNAL CABLE is displayed, or if nothing is displayed, check:

- that the video interface cable is connected properly.
- the correct video adapter card is installed.
- the correct supported display mode is selected for your computer.

2. Wait approximately 15 minutes, until the monitor warms up.
 3. Insert the *User's Guide and Installation Files CD* into the computer CD-ROM drive.
 4. Display the command prompt screen of the DOS full-screen display.
 5. Type d:\ (change the drive letter to match your CD-ROM drive if it is not drive D).
 6. Type **TESTPATD** and press ENTER.
 7. Select from the screen the number for the color or text mode you want to set up.
 8. Select from the screen the number for the video mode you want to set up. You can repeat this process for as many of the color and video modes as you need.
 9. When the dot pattern appears, press the OSD Enter button  at the bottom of the monitor to display the initial OSD menu.
 10. Use an Arrow button ( or ) to select the Image Setup icon  then press the OSD Enter  button to access the function.
 11. Using an Arrow button ( or ), select AUTOMATIC and press the OSD Enter button . This activates the AUTO IMAGE SETUP procedure, which will optimize the display settings with the provided dot-patterns. The screen will flash off several times and you might notice small changes to the test pattern.
 12. When finished, the OSD main menu returns. Press the Exit button  to exit from the OSD.
 13. Press the ESCAPE key to exit the test pattern program.
 14. Type **Exit** at the command prompt to return to Windows.
- If you use other operating systems, perform the appropriate Auto Image Setup for those systems using instructions given in "***Auto Image Setup for Windows 3.1, Windows95, Windows 98, Windows NT, Windows Me or Windows XP*** on page 16"

Auto Image Setup for Windows 3.1, Windows 95, Windows 98, Windows NT, Windows 2000, Windows Me or Windows XP

To optimize the displayed image automatically in Windows 3.1 , Windows 95, Windows 98, Windows NT, Windows 2000, Windows Me, or Windows XP, do the following:









i If the monitor is in standby mode (STANDBY ON), it may automatically turn off while you are waiting for it to warm up.

1. Turn on the monitor first; then the computer.
If the message CHECK SIGNAL CABLE is displayed, or if nothing is displayed, check:
 - that the video interface cable is connected properly.
 - the correct video adapter card is installed.
 - the correct supported display mode is selected for your computer.
2. Wait approximately 15 minutes, until the monitor warms up.
3. Drag the icon bar and tool bar, if they are displayed, to the bottom of the screen.
4. Insert the *User's Guide and Installation Files CD* into the computer CD-ROM drive.
5. Check the operating system installed on your computer and follow the instructions from the table below.

i The size and diversity of the dot pattern varies with the screen resolution.

Operating system installation steps

Operating System	Step1	Step2	Step3	Step4
Windows 3.1	Open PROGRAM MANAGER	Select FILE	Select RUN	Type d:\TESTPAT (change the drive letter to match your CD- ROM drive if it is not drive D) and press ENTER
Windows NT 3.5				
Windows 95, Windows 98, Windows 2000, Windows NT, Windows Me or Windows XP	Select START	Select RUN		

6. When the test pattern appears, press the OSD Enter button  at the bottom of the monitor to display the initial OSD menu.
7. Use an Arrow button ( or ) to select the Image Setup icon  and press the OSD Enter button  to access the function.
8. Using an Arrow button ( or ), select AUTOMATIC and press the OSD Enter button . This activates the AUTO IMAGE SETUP procedure, which will optimize the display settings with the provided test pattern.

i Position the mouse pointer at the bottom center of the screen. This allows AUTO IMAGE SETUP to run properly

The screen will dim, blink on and off several times, and you might notice small changes to the test pattern.

To abort the AUTO IMAGE SETUP function, press the Esc key.

















9. When finished, the OSD main menu returns. Press the Exit button  once to exit from the OSD.
10. Press the Esc key to return to Windows.

You have completed the monitor setup for Windows. If you are using the DOS operating system, go to **Auto Image Setup for DOS** on page 15.

Manual Image Setup

Normally, you can complete the setup procedure using AUTO IMAGE SETUP; however, if your screen image is still distorted after you perform AUTO IMAGE SETUP or the Installation CD does not run on your system, perform MANUAL IMAGE SETUP.

i If the monitor is in standby mode (STANDBY ON), it might automatically turn off while you are waiting for it to warm up.

1. Have your monitor turned on for about 15 minutes, until the monitor warms up.
2. Display the image you most frequently use on the screen.
3. Press the OSD Enter button  at the bottom of the monitor to display the initial OSD menu.
4. Use an Arrow button ( or ) to select the Image Setup icon  and press the OSD Enter button  to access the function.
5. Using an Arrow button ( or ), select MANUAL, press  and then press  again to access the Clock function (see page 22) .
6. Use the Arrow buttons ( or ) to manually adjust the image (as much as possible).
7. Next press the  button to select Phase.
8. Use the Arrow buttons ( or ), again to tune the image to your liking. To save, press the  button two times.
9. When finished, press the Exit button  to exit from the OSD.

You have completed the monitor manual image setup procedure.

Adjusting Your LCD Monitor

User controls



User control features

- Direct access controls

Icon	Control	Description	OSD
1 → ← 2	Input Change	Switches the video input source.	Inactive
⏪	Image Setup	Activates automatic image adjustment.	Inactive
☀	Brightness	Directly accesses to Brightness on the OSD main menu.	Active
↵	OSD Enter	Displays the OSD main menu.	Active
⏻	Power Switch	Switches the monitor on and off.	-

- Main OSD menu controls

Icon	Control	Description	OSD
↶	Exit	Exits from menus and sub-menus Exits the OSD.	Active
←	Left Arrow	Moves the cursor to highlight icons and other options.	Active
→	Right Arrow	Moves the cursor to highlight icons and other options.	Active
↵	OSD Enter	Enters menus and sub-menus and selects the highlighted option.	Active

i The image is already optimized for many display modes; however the user controls can be used to adjust the image to your liking.

i The settings are saved after adjustment and when exiting the OSD and will be effective thereafter.

Operation

- Press the OSD Enter \leftarrow button to display the main OSD menu.
- Use the Arrow buttons to move among the icons. Select an icon and press OSD Enter to access that function. If there is a sub-menu, you can move between options using the Arrow buttons, then press OSD Enter to select that function. Use the Arrow buttons to make adjustments. Press the \leftarrow button to save.
- Press the Exit button to move backwards through the sub-menus and exit from the OSD.

OSD Lock / Unlock

This feature allows you to secure the current control settings, while allowing the user to adjust Brightness and Contrast, so that they cannot be inadvertently changed. You can unlock the OSD controls at any time by using the same procedure.

Push and hold the OSD Enter button for 10 seconds to Lock or to Unlock. When locked, a “LOCKED” message will be displayed.

On-screen display (OSD) controls

The settings adjustable with the user controls are viewed through the On-Screen Display (OSD). Press the OSD Enter button (↵) to activate the OSD.





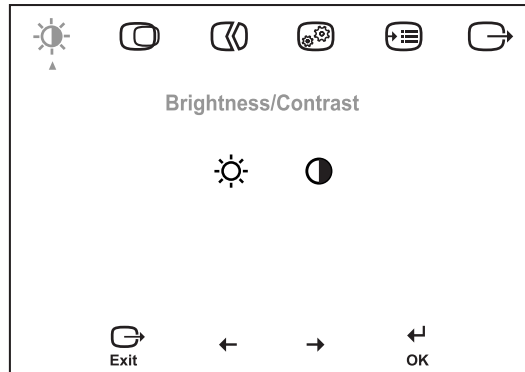

i The LCD monitor needs time to become thermally stable the first time you turn it on each day. Thus, to achieve more accurate adjustments for parameters, allow the LCD monitor to warm up (be On) for at least 15 minutes before making any screen adjustments.



Initial appearance of OSD



















OSD functions

OSD Icon on Main Menu	Submenu	Description	Controls and Adjustments (Analog)		Controls and Adjustments (Digital)
 Brightness/ Contrast	 Brightness	Adjusts brightness.	 ←	 →	Same as Analog
	 Contrast	Adjusts contrast.	 ←	 →	Controls Locked
 Image Position	 Horizontal Position	Moves the screen left or right.	 ←	 →	Controls Locked
	 Vertical Position	Moves the screen up or down.	 ←	 →	Controls Locked

OSD Icon on Main Menu	Submenu	Description	Controls and Adjustments (Analog)	Controls and Adjustments (Digital)
 Image Setup	 Automatic	Activates automatic image adjustment.		Controls Locked
	 Manual <ul style="list-style-type: none"> • Clock • Phase 	Use the ← or → button to adjust away the interference. If satisfactory results are not obtained using the Phase adjustment, use the Clock adjustment and then use Phase again.		
 Image Properties	 Color	Adjusts intensity of red, green and blue.		Same as Analog
	1. Mode 1 (Preset Mode) <ul style="list-style-type: none"> • 6500K • 7200K • 9300K 	6500K adjusts the screen more red. 7200K adjusts the screen to the default color settings. 9300K adjusts the screen more blue.		
	2. Mode 2 (Custom) <ul style="list-style-type: none"> • Red • Green • Blue 	Increases or decreases 'red'. Increases or decreases 'green'. Increases or decreases 'blue'.		
	 Sharpness			Same as Analog
	1. Mode 1	adjusts the image softer.		
	2. Default	returns the image sharpness to the default settings.		
	3. Mode 2	adjust the image sharper.		
 Input video signal	This monitor can accept video signals through two different connectors. Most desktop computers use a D-SUB connector. Select digital among OSD Controls when you use DVI connector.	1 - selects D-SUB (Analog) 2 -selects DVI-Digital	Same as Analog	

 <p>Options</p>	 <p>Information</p>	<p>Shows resolution, refresh rate, and product details. Note: This screen does not allow any changes to the settings.</p>		<p>Same as Analog</p>
	 <p>Language</p>	<p>The language chosen affects only the language of the OSD. It has no effect on any software running on the computer.</p>	<p>Select one of the 5 languages (English, French, Italian, German and Spanish) to use for the OSD.</p>	

OSD Icon on Main Menu	Submenu	Description	Controls and Adjustments (Analog)	Controls and Adjustments (Digital)				
 <p>Options (Continued)</p>	 <p>Menu Position</p> <p>1. Default</p> <p>2. Custom</p> <ul style="list-style-type: none"> • Horizontal (H) • Vertical (V) 	<p>Adjusts menu location on the screen.</p> <p>Returns the menu position to the default settings.</p> <p>Changes the horizontal position of OSD.</p> <p>Changes the vertical position of OSD.</p>	<table border="1" data-bbox="806 447 1071 673"> <tr> <td data-bbox="806 447 939 560">  ← </td> <td data-bbox="939 447 1071 560">  → </td> </tr> <tr> <td data-bbox="806 560 939 673">  ← </td> <td data-bbox="939 560 1071 673">  → </td> </tr> </table>	 ←	 →	 ←	 →	<p>Same as Analog</p>
	 ←	 →						
	 ←	 →						
 <p>Reset</p> <ul style="list-style-type: none"> • Cancel • Reset 	<p>Resets monitor to the original settings.</p> <p>Does not make the adjustment. Resets the settings.</p>							
 <p>Accessibility</p> <ul style="list-style-type: none"> • Button repeat rate • Menu time out 	<p>Changes button repeat rate and menu time out setting.</p> <p>Selects ← or → button repeating rate.</p> <p>Sets the length of time the OSD will remain active after the last time a button is pressed.</p>	<table border="1" data-bbox="806 989 1071 1376"> <tr> <td data-bbox="806 989 1071 1249"> <p>Off - increases by 1 each time the button is pressed. Default - increases continuously while the button is pressed. Slow - increases by 1 every 2 seconds while the button is pressed.</p> </td> </tr> <tr> <td data-bbox="806 1249 1071 1376"> <p>Use the ← or → button to select time from 5 to 60 seconds.</p> </td> </tr> </table>	<p>Off - increases by 1 each time the button is pressed. Default - increases continuously while the button is pressed. Slow - increases by 1 every 2 seconds while the button is pressed.</p>	<p>Use the ← or → button to select time from 5 to 60 seconds.</p>				
<p>Off - increases by 1 each time the button is pressed. Default - increases continuously while the button is pressed. Slow - increases by 1 every 2 seconds while the button is pressed.</p>								
<p>Use the ← or → button to select time from 5 to 60 seconds.</p>								

Further Information

Display modes

The display mode the monitor uses is controlled by the computer. Therefore, refer to your computer documentation for details on how to change display modes.

The image size, position and shape might change when the display mode changes. This is normal and the image can be readjusted using **AUTO IMAGE SETUP** and the monitor controls.

Unlike CRT monitors, which require a high refresh rate to minimize flicker, TFT technology is inherently flicker-free. If possible, configure your computer for 1280 × 1024 addressability at 60Hz vertical refresh rate.

For the display modes listed on the next page, the screen image has been optimized during manufacture.

i For image problems, you may want to run AUTO Setup again before consulting to this section. In most cases, AUTO SETUP can fix the problems. See **Auto Image Setup for DOS** on page 15 for details.

Factory Set Display Modes

Addressability	Refresh Rate	Horizontal Frequency	Analog	Digital
640 × 350	70 Hz	31.5 kHz	Yes	Yes
640 × 480	60 Hz	31.5 kHz	Yes	Yes
640 × 480	72 Hz	37.8 kHz	Yes	Yes
640 × 480	75 Hz	37.5 kHz	Yes	Yes
720 × 400	70 Hz	31.4 kHz	Yes	Yes
800 × 600	60 Hz	37.8 kHz	Yes	Yes
800 × 600	72 Hz	48.0 kHz	Yes	Yes
800 × 600	75 Hz	46.8 kHz	Yes	Yes
1024 × 768	60 Hz	48.4 kHz	Yes	Yes
1024 × 768	70 Hz	56.5 kHz	Yes	Yes
1024 × 768	75 Hz	60.0 kHz	Yes	Yes
1280 × 1024†	60 Hz	48.4 kHz	Yes	Yes
1280 × 1024	75 Hz	80.0 kHz	Yes	Yes
640 × 480	66 Hz(MAC)	35.0 kHz	Yes	Yes
832 X 624	75 Hz(MAC)	49.7 kHz	Yes	Yes
1024 × 768	75 Hz(MAC)	60.2 kHz	Yes	Yes
1152 x 864	75 Hz	67.5 kHz	Yes	Yes
1152 x 870	75 Hz	68.7 kHz	Yes	Yes
1152 x 900	66 Hz(SUN)	61.8 kHz	Yes	Yes
1280 x 1024	72 Hz(HP)	78.1 kHz	Yes	Yes
1280 x 1024	76 Hz(SUN)	81.1 kHz	Yes	Yes

† Recommended

‘Note: VESA timings are as detailed in the VESA “Display Monitor Timing Specification”. Version 1.0, Revision 0.8, dated 09/17/98.’

Power Management

If your computer has previously been used with a CRT monitor and is currently configured to a display mode outside the range that the Flat Panel monitor can display, you may need to re-attach the CRT monitor temporarily until you have re-configured the computer, preferably to 1280 x 1024 at 60Hz.

To benefit from power management, the monitor must be used in conjunction with a computer that implements the Video Electronics Standards Association (VESA) Display Power Management Signaling (DPMS) Standard.

The power management feature is invoked when the computer recognizes that you have not used your mouse or keyboard for a user-definable period. There are several states as described in the table below.

As an ENERGY STAR® Partner, IBM has determined that this product meets the ENERGY STAR® guidelines for energy efficiency.

For optimal performance, switch off your monitor at the end of each working day, or whenever you expect to leave it unused for long periods during the day.

State	Power Indicator	Screen	Restoring Operation	Compliance
On	Blinking green	Normal		
Active off	Blinking green	Blank	Press a key or move the mouse. *	ENERGY STAR®

* There may be a slight delay before the picture reappears.

Product Disposal

The fluorescent lamp in the liquid crystal display contains a small amount of mercury. Dispose of it as required by local ordinances and regulations.

Troubleshooting

If you have a problem setting up or using your monitor, you might be able to solve it yourself. Before calling your retailer or IBM, try the suggested actions that are appropriate to your problem.

Problem	Possible Cause	Suggested Action	Reference
Computer does not boot after the graphics adapter is installed	There is another graphics adapter in the computer	<ul style="list-style-type: none"> ◆ Remove the other graphics adapter plugged into one of the expansion slot. ◆ If the card is built-in to the motherboard, check your system manual for instructions on how to disable the built-in adapter. 	Connecting your Monitor for Analog section on page 7
The screen image is garbled or unusable (rolling screen images, overlapping screen images or a blank screen)	The display driver is trying to use a setting your monitor does not support	<ul style="list-style-type: none"> ◆ Select the correct monitor again. 	Connecting your Monitor for Analog section on page 7
Screen is blank and power indicator is off	No power to monitor	<ul style="list-style-type: none"> ◆ Ensure that the electrical outlet and the monitor are both switched on. ◆ Check that the power cord is firmly plugged into the electrical outlet and the power supply unit. ◆ If the power cord plug has a removable fuse, replace it. ◆ Try another power cord. ◆ Try another electrical outlet. 	Connecting your Monitor for Analog section on page 7

Problem	Possible Cause	Suggested Action	Reference
Screen is blank and power indicator is steady green	Brightness and Contrast may be too low	<ul style="list-style-type: none"> ◆ Adjust brightness and contrast. 	User controls section on page User controls19
Screen is blank and power indicator is steady amber	The monitor is in the Power Management Standby state	<ul style="list-style-type: none"> ◆ Press any key on the keyboard or move the mouse to restore operation. ◆ Check the Power Management software on your computer 	Power Management section on page Power Management27
	The monitor is not receiving a video signal	<ul style="list-style-type: none"> ◆ Check that the signal cable is firmly connected to the computer. ◆ Check that no pins are bent in the signal cable connector. 	Connecting your Monitor for Analog section on page 7
	The monitor is in the Power Management Suspend or Off state	<ul style="list-style-type: none"> ◆ Press any key on the keyboard or move the mouse to restore operation. ◆ Check the Power Management software on your computer. 	Power Management section on page Power Management27
Screen is blank and power indicator is Flashing green every 0.5 second	Display mode of the computer is outside the range of the monitor	<ul style="list-style-type: none"> ◆ Reconfigure the computer to use a supported display mode. 	Further Information section on page Further Information25
Image appears to be smeared	There are noises in the video signal	<ul style="list-style-type: none"> ◆ Select Image Setup menu in the OSD. Then select MANUAL to adjust Phase/Clock settings. 	User controls section on page User controls19
Image appears to be discolored	The Color setting may be incorrect	<ul style="list-style-type: none"> ◆ Adjust the Color settings. 	User controls section on page User controls19

Problem	Possible Cause	Suggested Action	Reference
<p>A few dots are missing, discolored, or inappropriately lighted.</p>	<ul style="list-style-type: none"> ◆ The LCD contains over 3,900,000 thin-film transistors (TFTs). A small number of missing, discolored, or lighted dots may be present on the screen, which is an intrinsic characteristic of the TFT LCD technology and is not an LCD defect. 		

Further Help

If you are unable to correct the problem yourself, you may seek further help as follows:

Call the IBM HelpCenter[®].

In the US call 1-800-IBM-SERV (800-426-7378)

In Canada (Toronto Only) call 416-383-3344

In Canada (all others) call 1-800-565-3344

***i** If possible, stay by your computer. Your Technical Support Representative may wish to go through the problem with you during the call.*

***i** More help, late-breaking news and details of the latest accessories for these products may be found on the worldwide web at:*

<http://www.pc.ibm.com/us/accessories>

In other countries contact your dealer, retailer, or other IBM authorized Servicer.

Before calling, please have available as much of the following information as possible:

1. Model and serial number from the label on your monitor.
2. Purchase receipt.
3. Description of problem.
4. Computer type and model.
5. System configuration (hardware fitted, etc.).
6. System BIOS version number.
7. Operating System and version number.
8. Display driver version number.
9. Video Adapter Type.

Specifications

This color monitor (Type-model 2704-Hx7) uses a 19-inch TFT LCD

Dimensions	A. Lower Position Height : Depth : Width :	387.1 mm (15.24 in.) 237.0 mm (9.33 in.) 441.0 mm (17.36 in.)
	B. Higher Position Height : Depth : Width :	467.1 mm (18.39 in.) 237.0 mm (9.33 in.) 441.0 mm (17.36 in.)
Weight	Unpackaged: Packaged:	7.6Kg (16.76 lb) 9.8Kg (21.60 lb)
Tilt / Swivel / Lift	Tilt: Swivel: Lift :	- 0° / + 30° - 135° / + 135° 80 mm (stroke)
Image	Viewable Image Size: Maximum Height: Maximum Width: Pixel Pitch:	481.9.7 mm (19.0 in.) 376.32 mm (14.8 in.) 301.06 mm (11.9 in.) 0.294 mm (.012 in.) (H) × 0.294 mm (.012 in.) (V)
Power Input	Supply Voltage: Max Supply Current:	90 - 260 V ac, 60/50 ± 3 Hz 1.5 A at 120 V ac
Power Consumption	Normal Operation: DPMS Stand-by: DPMS Suspend: DPMS off:	< 40 W < 2 W for Analog, < 3 W for Digital < 2 W for Analog, < 3 W for Digital < 2 W for Analog, < 3 W for Digital
Video Input(Analog)	Input Signal: Horiz. Addressability: Vert. Addressability: Clock Frequency:	Analog Direct Drive, 75 ohm 0.7 V 1280 pixels (max) 1024 lines (max) 135 MHz
Video Input(Digital)	Interface: Input Signal: Horiz. Addressability: Vert. Addressability: Clock Frequency:	DVI VESA TMDS (Panel Link ™) 1280 pixels (max) 1024 lines (max) 135 MHz
Communications	VESA DDC:	2 B
Supported Display Modes	VESA Standard modes between Horiz. Frequency: Vert. Frequency:	IBM, VESA, HP, Sun, Mac 31 kHz - 81 kHz (Digital & Analog) 55 Hz - 76 Hz

Environment	Temperature: Operating: Storage: Shipping: Humidity: Operating: Storage: Shipping:	10 to 35° C (50 to 95° F) - 20 to 60° C (-4 to 140° F) - 20 to 60° C (-4 to 140° F) 10 to 80% 5 to 95% 5 to 95%
-------------	---	--

Service Information

The following parts are for use by IBM service, or IBM authorized dealers, to support the customer warranty. Parts are for service use only.

Model Type 2704

73P2534	2704-HB7	Monitor - Stealth Black
73P2535	2704-HG7	Monitor - Ash Grey
73P2536	2704-HB7	Stand - Stealth Black
73P2537	2704-HG7	Stand - Ash Grey
31P9590	2704-HB7, 2704-HG7	Analog Video Cable
31P9591	2704-HB7, 2704-HG7	Digital Video Cable
73P2538	2704-HB7, 2704-HG7	User's Guide CD
73P2539	2704-HB7, 2704-HG7	Setup Guide

Notices and Trademarks

This section contains information on notices and trademarks.

Notices

IBM may not offer the products, services, or features discussed in this document in all countries. Consult your local IBM representative for information on the products and services currently available in your area. Any reference to an IBM product, program, or service is not intended to state or imply that only that IBM product, program, or service may be used. Any functionally equivalent product, program, or service that does not infringe any IBM intellectual property right may be used instead. However, it is the user's responsibility to evaluate and verify the operation of any non-IBM product, program, or service.

IBM may have patents or pending patent applications covering subject matter described in this document. The furnishing of this document does not give you any license to these patents. You can send license inquiries, in writing, to:

*IBM Director of Licensing
IBM Corporation
North Castle Drive
Armonk, NY 10504-1785
U.S.A.*

The following paragraph does not apply to the United Kingdom or any country where such provisions are inconsistent with local law: INTERNATIONAL BUSINESS MACHINES CORPORATION PROVIDES THIS PUBLICATION "AS IS" WITHOUT WARRANTY OF ANY KIND, EITHER EXPRESS OR IMPLIED, INCLUDING, BUT NOT LIMITED TO, THE IMPLIED WARRANTIES OF NON-INFRINGEMENT, MERCHANTABILITY OR FITNESS FOR A PARTICULAR PURPOSE. Some states do not allow disclaimer of express or implied warranties in certain transactions, therefore, this statement may not apply to you.

This information could include technical inaccuracies or typographical errors. Changes are periodically made to the information herein; these changes will be incorporated in new editions of the publication. IBM may make improvements and/or changes in the product(s) and/or the program(s) described in this publication at any time without notice.

IBM may use or distribute any of the information you supply in any way it believes appropriate without incurring any obligation to you.

Any references in this publication to non-IBM Web sites are provided for convenience only and do not in any manner serve as an endorsement of those Web sites. The materials at those Web sites are not part of the materials for this IBM product, and use of those Web sites is at your own risk.

Trademarks

The following terms, used in this publication, are trademarks or service marks of the IBM Corporation in the United States, other countries, or both:

HelpCenter IBM

ENERGY STAR[®] is a U.S. Govt. registered trademark.

Microsoft[®] Windows[®], and Windows NT are trademarks of Microsoft Corporation in the United States, other countries, or both.

Other company, product, and service names may be trademarks or service marks of others.

© Copyright International Business Machines Corporation 2003. All rights reserved.