

IBM FASTT Storage Manager Version
8.21



Installation and Support Guide for Linux



IBM FAStT Storage Manager Version 8.21



Installation and Support Guide for Linux

Note

Before using this information and the product it supports, be sure to read the general information in Appendix C, "Notices" on page 53.

Fourth Edition (July 2002)

© Copyright International Business Machines Corporation 2001, 2002. All rights reserved.

US Government Users Restricted Rights – Use, duplication or disclosure restricted by GSA ADP Schedule Contract with IBM Corp.

Contents

Figures	v
Tables	vii
About this book	ix
How this book is organized.	ix
Notices used in this book	x
Related publications	x
Chapter 1. Introduction	1
New features	1
Supported machine types	4
Terms to know	4
IBM FASiT Storage Manager 8.21 software	5
Storage Manager Version 8.21 Client	5
Storage Manager 8.21 Runtime	5
Storage Manager 8.21 Utility	5
IBM FASiT Host Adapter device driver.	5
IBM FASiT Management Suite Java	6
Managing the storage subsystem	6
Where to install the software components	7
Management stations	7
Host computers	8
Installation types.	8
Managing coexisting storage subsystems	9
System requirements	10
Hardware requirements	10
Firmware requirements	12
Software requirements	12
Operating system requirements	13
Number of supported logical drives	13
Chapter 2. Preparing for installation	15
Reviewing a sample network.	15
Preparing a network installation.	15
Naming the storage subsystems	16
Identifying the hardware Ethernet MAC address for each controller.	17
Assigning IP addresses for hosts and controllers	20
Setting up the DHCP or BOOTP-compatible server	20
Setting up a Windows NT DHCP server.	20
Setting up a Windows 2000 DHCP server	25
Setting up a NetWare DHCP server	27
Setting up a UNIX BOOTP server	30
Verifying the TCP/IP protocol and setting up the host or DNS table.	31
Chapter 3. Installing software	33
New installation process	33
Uninstalling Storage Manager	34
Installing the Storage Manager 8.21 software package	34
Installing Storage Manager 8.21 Runtime	34
Verifying the Storage Manager 8.21 Runtime installation.	35
Installing the Storage Manager 8.21 Client.	35
Verifying the Storage Manager 8.21 client installation.	35

Disabling and enabling the Event Monitor	35
Installing the Storage Manager 8.21 Utility	36
Verifying the Storage Manager 8.21 Utility installation.	36
Uninstalling IBM FASTT Management Suite Java	36
Installing IBM FASTT Management Suite Java	37
Installing the IBM Host Adapter device driver (qla2200.o or qla2300.o)	37
Chapter 4. Completing the installation	39
Performing an initial automatic discovery of storage subsystems.	39
Adding devices	41
Setting up alert notifications	42
Naming storage subsystems	42
Downloading firmware and NVSRAM.	43
Downloading firmware	43
Downloading NVSRAM	43
Creating arrays and logical drives	44
Defining the default host type	44
Configuring heterogeneous hosts	44
Identifying logical drives by operating system device names	45
Performing other storage-subsystem management tasks	45
Chapter 5. Linux operating-system support	47
Supported logical drives	47
Linux limitations	47
Appendix A. Storage subsystem/controller information record	49
Appendix B. Getting help and technical assistance	51
Before you call	51
Using the documentation	51
Getting help and information from the World Wide Web	51
Software service and support	52
Hardware service and support	52
Appendix C. Notices	53
Edition notice	53
Trademarks	54
Important notes.	54
Index	57

Figures

1. Direct (out-of-band) managed storage subsystems	7
2. Sample software installation	8
3. Sample coexistence installation	10
4. Sample network when using direct-managed storage subsystems	15
5. Locating the Ethernet MAC address for machine type 3542	17
6. Removing the controller-unit bezel (machine types 3552 and 1742)	18
7. Replacing the controller-unit bezel (machine types 3552 and 1742)	19
8. Create Scope - (Local) window	21
9. DHCP Options: Global window	22
10. IP Address Array Editor window	23
11. Active Leases window	24
12. Add Option Type window	24
13. New Scope Wizard: IP Address Range window.	26
14. Confirm Initial Automatic Discovery window	40
15. Enterprise Management window	41
16. Subsystem Management window	43

Tables

1. Machine type and supported storage-management software	4
2. New terminology	4
3. Configurations for existing storage subsystems	9
4. Hardware requirements for Storage Manager 8.21 software	11
5. Installation requirements by software package	12
6. Logical drives without the remote mirror option enabled	13
7. Logical drives using the remote mirror option	13
8. Sample information record	16
9. Global options for a Windows NT DHCP server	22
10. Required entries for setting up the UNIX BOOTP server	30
11. Linux limitations and workarounds	47
12. Storage subsystem information record and controller information record	49

About this book

This book provides information about setting up, installing, configuring, and working with IBM® Fibre Array Storage Technology (FAStT) Storage Manager Version 8.21. Operating system environments supported are Red Hat Linux® Versions 7.1 and 7.2, SuSE Linux Version 7.3, and TurboLinux Version 7.0.

This *Installation and Support Guide* is for system administrators. Use this guide to:

- Determine the hardware and software that are required to install the storage-management software.
- Integrate the necessary hardware components into your network.
- Install the FAStT Storage Manager software.
- Upgrade controller firmware, if necessary.
- Identify storage-management features that are unique to your specific installation.

How this book is organized

Chapter 1, “Introduction” on page 1 provides an overview of IBM FAStT Storage Manager Version 8.21 and describes storage-subsystem management methods, configuration types, types of installations, and installation requirements.

Chapter 2, “Preparing for installation” on page 15 discusses preparing for a network installation, including setting up a Dynamic Host Configuration Protocol/Boot Protocol (DHCP/BOOTP) server, UNIX® Boot Protocol (BOOTP) server, or a Novell NetWare server.

Chapter 3, “Installing software” on page 33 provides procedures for installing the software in a standard (noncluster) environment.

Chapter 4, “Completing the installation” on page 39 discusses starting the Enterprise Management window, downloading firmware, applying NVSRAM, adding devices, and subsystem management tasks.

Chapter 5, “Linux operating-system support” on page 47 discusses Linux operating system limitations.

Appendix A, “Storage subsystem/controller information record” on page 49 provides a data sheet template that you can use to create a controller information record.

Appendix B, “Getting help and technical assistance” on page 51 provides information about how to obtain help, service, or technical assistance.

Appendix C, “Notices” on page 53 provides product notices and trademark information.

Notices used in this book

This book contains the following notices designed to highlight key information:

- **Notes:** These notices provide important tips, guidance, or advice.
- **Important:** These notices provide information that might help you avoid inconvenient or problem situations.
- **Attention:** These notices indicate possible damage to programs, devices, or data. An attention notice is placed just before the instruction or situation in which damage could occur.

Related publications

The following publications are available in Adobe Acrobat Portable Document Format (PDF) on the IBM FAStT Storage Manager CD or go to <http://www.ibm.com/pc/support/>.

- *IBM FAStT Storage Manager Version 8.21 Installation and Support Guide for Linux[®]* (this book)
- *IBM FAStT Storage Manager Version 8.21 Installation and Support Guide for Microsoft Windows NT[®] and Windows[®] 2000*
- *IBM FAStT Storage Manager Version 8.21 Installation and Support Guide for Novell NetWare*
- *IBM FAStT Remote Mirror Option Installation and User's Guide*
- *IBM TotalStorage[™] FAStT700 Fibre Channel Storage Server Installation Guide*
- *IBM TotalStorage FAStT700 Fibre Channel Storage Server User's Guide*
- *IBM FAStT700 Fibre Channel Cabling Instructions*
- *IBM FAStT Host Adapter Installation and User's Guide*
- *IBM FAStT FC-2 Host Bus Adapter Installation and User's Guide*
- *IBM TotalStorage FAStT FC2-133 Host Bus Adapter Installation and User's Guide*
- *IBM FAStT500 RAID Controller Enclosure Unit Installation Guide*
- *IBM FAStT500 RAID Controller Enclosure Unit User's Guide*
- *IBM TotalStorage FAStT EXP700 Storage Expansion Unit Installation and User's Guide*
- *IBM Netfinity[®] Fibre Channel Cabling Instructions*
- *IBM FAStT200 and FAStT200 High Availability Storage Servers Installation and User's Guide*
- *IBM FAStT200 Fibre Channel Cabling Instructions*

The following diagnostic publications might be of interest:

- *IBM FAStT MSJ User's Guide*
- *IBM Fibre Channel Hardware Maintenance Manual*
- *IBM Fibre Channel Problem Determination Guide*
- *IBM Fibre Channel Basic SAN Configuration Setup Guide*

In addition, the following IBM Redbooks™ might be of interest:

- *Fibre Array Storage Technology, A FASTT Introduction*
- *Implementing Netfinity Disk Subsystems: ServeRAID™ SCSI, Fibre Channel, and SSA*
- *Tuning Netfinity Servers for Performance: Getting the most out of Windows 2000 and Windows NT 4.0*
- *Netfinity Director: Integration and Tools*
- *Netfinity Clustering Planning Guide*

You can download these Redbooks from <http://www.ibm.com/redbooks/>.

Chapter 1. Introduction

This installation and support guide provides information for preparing, installing, configuring, and starting the IBM FASTT Storage Manager Version 8.21 program. Operating systems supported are Red Hat Linux version 7.1 and 7.2, SuSE Linux Version 7.3, and TurboLinux Version 7.0.

Before you begin the installation of this product, consult the README.TXT file first. The README file is located in the root directory of the installation CD. Go to the <http://www.ibm.com/pc/support> IBM Web page for the latest installation and user information about the storage-management software and hardware components.

When you finish the installation process, refer to the following online help systems.

- Enterprise Management window Help - Use this online help system to learn more about working with the entire management domain.
- Subsystem Management window Help - Use this online help system to learn more about managing individual storage subsystems.

You can access these help systems from within Storage Manager 8.21 Client. From either an Enterprise Management or Subsystem Management window, click **Help** or press F1.

After installing IBM FASTT Storage Manager Version 8.21, consider installing the FASTT Management Suite Java™ (FASTT-MSJ) diagnostic program. You can use this program to verify the status of the Fiber Channel connections before using the storage subsystem. The program and the *IBM FASTT MSJ User's Guide* are located on the *IBM FASTT Storage Manager Version 8.21* CD.

New features

This section describes the new premium features and standard features that are part of the IBM FASTT Storage Manager Version 8.21 software. Your storage subsystem firmware must be at version 5.2x.xx if you want to use any of the features listed in this section. You must purchase the firmware upgrade option if your controller firmware is at version 04.x or earlier.

The following two premium features are available after purchasing a premium feature key:

- FlashCopy - FlashCopy is a premium feature that is part of the IBM FASTT Storage Manager 8.21 software and is enabled by purchasing a premium feature key. This feature supports the creation and management of FlashCopy logical drives. A FlashCopy logical drive is a logical point-in-time image of another logical drive, called a base logical drive, in the storage subsystem. A FlashCopy is the logical equivalent of a complete physical copy, but you create it much more quickly and it requires less disk space. Because a FlashCopy is a host addressable logical drive, you can perform backups using the FlashCopy while the base logical drive remains online and user-accessible. In addition, you can write to the FlashCopy logical drive to perform application testing or both scenario development and analysis. The maximum number of FlashCopy logical drives allowed is one half of the total logical drives supported by your controller model.
- Remote Mirror Option - The Remote Mirror Option is a premium feature that is part of the IBM FASTT Storage Manager 8.21 software. This feature is enabled by purchasing a premium feature key. The Remote Mirror Option is used for online,

real-time replication of data between storage subsystems over a remote distance. In the event of a disaster or unrecoverable error on one storage subsystem, the Remote Mirror Option enables you to promote a second storage subsystem to take over responsibility for normal input/output (I/O) operations. When the Remote Mirror option is enabled, the maximum number of logical drives per storage subsystem is reduced. For more information, refer to “Number of supported logical drives” on page 13.

In addition to the new premium features, the storage-management software includes the following new standard features:

- Dynamic logical-drive expansion - this feature enables you to increase the capacity of an existing logical drive. You can use the free capacity of a logical drive on an existing array, or add unconfigured capacity (new or unassigned drives) to that array. You can expand a logical drive dynamically without losing access to it, or to any other logical drives.
- 2048 logical drive support - this feature enables you to increase the number of defined logical drives up to 2048 for each storage subsystem. The number of logical drives will depend on your controller model. For more information, refer to “Number of supported logical drives” on page 13.
- Storage Partitioning - this feature gives you support for up to 64 storage partitions. Specifically, there is support for up to two host ports in each host and up to eight ports in each host group (supporting a four-way host group of dual-adapter hosts).
- Script Engine and Command Line Interface (CLI) Language - this feature expands previous version support to include:
 - Creation of and deletion of a FlashCopy logical drive.
 - The setting of FlashCopy logical drive attributes.
 - Supporting dynamic logical drive expansion for standard or repository logical drives.
 - Disabling or recreating of a FlashCopy.
 - Creating or deleting of logical drive-to-LUN mappings.
 - Uploading Read Link Status data from a storage subsystem to a comma delimited file on a management station.
 - Downloading a feature key file to a storage subsystem to enable a premium feature.
- Read Link Status Diagnostic (RLS) - this feature enhances controller diagnostics by enabling you to isolate the source of link problems on a Fibre Channel loop. During communication between devices, RLS error counts are detected within the traffic flow of the loop. Error count information is accumulated over a period of time for every component and device on the loop. The controller sets the baseline automatically; however, a new baseline is set manually through the Read Link Status Diagnostics window.
- Redesigned user interface - this feature supports a more integrated process of creating logical drives and then mapping them to hosts or host groups and logical unit numbers to create storage partitions. The previous Storage Partitions window is now a Mappings View that you can switch to from the Logical/Physical View. In the Subsystem Management window, the Mappings View displays storage partition topology such as the default and defined host groups, hosts, host ports in a tree, and FlashCopy logical drives.
- Controller default IP address - Unless a static IP address is assigned to the controller by the administrator, controllers A and B will automatically be assigned the following IP addresses:

- Controller A (192.168.128.101)
- Controller B (192.168.128.102)

The subnet mask for the default IP address is 255.255.255.0.

- Support for IBM TotalStorage FAStT EXP700 Storage Expansion Unit

Supported machine types

Table 1 provides a list of machine types and supported storage-management software.

Table 1. Machine type and supported storage-management software

Product name	Machine type	Model	Product release and firmware version	Supported storage-management software version
IBM FAStT200 Storage Server	3542	1RU 1RX	4.x, 5.20.xx.xx	7.10, 8.0, 8.2, 8.21
IBM FAStT200 High Availability Storage Server	3542	2RU 2RX	4.x, 5.20.xx.xx	7.10, 8.0, 8.2, 8.21
IBM FAStT500 RAID Controller Enclosure Unit	3552	1RU 1RX	4.x, 5.00.xx.xx 5.20.xx.xx 5.21.xx.xx	7.10, 8.0, 8.2, 8.21
IBM TotalStorage FAStT700 Fibre Channel Storage Server	1742	1RU 1RX	5.00.xx.xx 5.20.xx.xx 5.21.xx.xx	8.0, 8.2, 8.21

Note: Storage subsystem firmware must be at version 04.01.02.07 or later to be managed with Storage Manager 8.21.

Terms to know

If you are upgrading from a previous version of the IBM FAStT Storage Manager software, you might find that some of the terms you are familiar with have changed. It is important that you familiarize yourself with the new terminology. Table 2 provides some of the old and new terms.

Table 2. New terminology

Term used in previous versions	New term
RAID module	Storage subsystem
Drive group	Array
Volume	Logical drive

It is important to understand the distinction between the following two terms when reading this document:

Management station

A management station is a system that is used to manage the storage subsystem. It can be attached to the storage subsystem in the following ways:

- Through a Transmission Control Protocol/Internet Protocol (TCP/IP) Ethernet connection to the controllers in the storage subsystem.
- Through a TCP/IP network connection to a host computer with host-agent software installed on it, which in turn is directly attached to the storage subsystem through the Fibre Channel input/output (I/O) path.

Host computer

A host computer is a system that is directly attached to the storage subsystem through a Fibre Channel I/O path. This system is used to do the following:

- Serve data (typically in the form of files) from the storage subsystem
- Function as a connection point to the storage subsystem for a remote-management station

Notes:

1. All Linux operating systems are referred to in this book as Linux unless otherwise noted for installation procedures that might be operating system specific.
2. The terms host and host computer are used interchangeably throughout this book.
3. A host computer can also function as a management station.

IBM FAStT Storage Manager 8.21 software

Storage Manager Version 8.21 contains the following software packages for Linux environments:

- Storage Manager 8.21 Client (SMclient)
- Storage Manager 8.21 Runtime (SMruntime)
- Storage Manager 8.21 Utility software (SMutil)
- IBM FAStT Management Suite Java (FAStT MSJ)
- IBM Host Adapter device drivers (qla2200.o and qla2300.o)

Storage Manager Version 8.21 Client

The Storage Manager Version 8.21 client (SMclient) component provides the graphical user interface (GUI) for managing storage subsystems through the Ethernet network or from the host. The SM8client contains two main components:

- **Enterprise Management.** You can use the Enterprise Management component to add, remove, and monitor, storage subsystems within the management domain.
- **Subsystem Management.** You can use the Subsystem Management component to manage the components of an individual storage subsystem.

Storage Manager 8.21 Runtime

The Storage Manager 8.21 Runtime (SM Runtime) package contains the software JAVA Runtime for the SMclient and SMutil packages.

Storage Manager 8.21 Utility

Use the Storage Manager 8.21 utility (SMutil) software package to register and map new logical drives to the operating system. You can use the SMdevices utility to associate storage subsystem-logical drives with operating system device names.

IBM FAStT Host Adapter device driver

The IBM FAStT Host Adapter device drivers (qla2200.o and qla2300.o) enables your operating system to communicate with the host adapter. The IBM TotalStorage FAStT FC2-133 Host Bus Adapter is a high-performance, direct memory access (DMA), bus-master, host adapter designed, for high-end systems. The IBM FAStT Host Adapter supports all Fibre Channel (FC) peripheral devices that support

private-loop direct attach (PLDA) and fabric-loop attach (FLA). Refer to the *IBM TotalStorage FASTT FC2-133 Host Bus Adapter Installation and User's Guide* or go to the <http://www.ibm.com/pc/support> IBM Web page for the current README file and latest multipath I/O device drivers.

IBM FASTT Management Suite Java

The IBM FASTT Management Suite Java (FASTT MSJ) is part of the IBM FASTT Storage Manager software package. It provides multipath I/O device drivers for Linux. Based on a driver that resides on top of the hardware driver, the IBM FASTT Management Suite Java can be configured with a preferred and an alternate path for every logical drive. In case of a failure along the I/O path, the driver will send the I/O requests through the alternate path and Auto-Volume Transfer (AVT) will move the logical drive within the FASTT Storage Server. The IBM FASTT Management Suite Java agent (qlremote) is installed on the Linux system, which then can be configured from a management station running the IBM FASTT Management Suite Java.

Refer to the *IBM FASTT MSJ User's Guide* for the diagnostics installation procedure for Linux.

Managing the storage subsystem

You must manage storage systems using direct (out-of-band) management. You are then managing storage subsystems directly over the network through an Ethernet connection to each controller. To manage the storage subsystem through the Ethernet connections, you must define the IP address and host name for each controller and attach a cable to the Ethernet connectors on each of the storage subsystem controllers, as shown in Figure 1 on page 7.

Management of storage subsystems using the direct (out-of-band) management method has the following advantages:

- The Ethernet connections to the controllers enable a management station running SMclient to manage storage subsystems that are connected to a host running any of the operating systems that are supported by Storage Manager 8.21.
- You do not need to use an access logical drive to communicate with the controllers. You can configure the maximum number of logical drives that are supported by the operating system and the host adapter that you are using.

Managing storage subsystems using the direct (out-of-band) management method has the following disadvantages:

- Two Ethernet cables are required to connect the storage subsystem controllers to a network.
- When adding devices, you must specify an IP address or host name for each controller.
- A DHCP/BOOTP server and network preparation tasks are required. For a summary of the preparation tasks, see "Preparing a network installation" on page 15.

You can avoid DHCP/BOOTP server and network tasks by assigning static IP addresses to the controller, or by using a default IP address.

- To assign a static IP addresses, see the IBM support Web site for Retain Tip #H171389 Unable To Setup Networking Without DHCP/BOOTP.

- If the storage subsystem controllers have firmware version 05.00.xx. or later, they have the following default settings:

Note: If the storage subsystem controllers have firmware version 5.2x.xx.xx, they have the following default settings:

Controller	IP address	Subnet mask
A	192.168.128.101	255.255.255.0
B	192.168.128.102	255.255.255.0

Figure 1 shows a system in which storage in which subsystems are managed using the direct (out-of-band) management method.

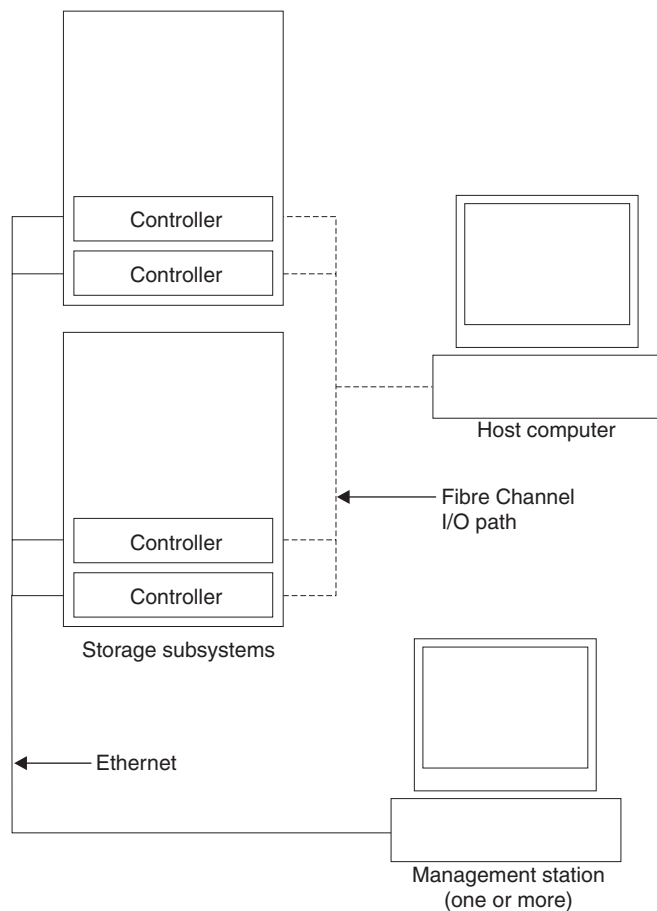

Figure 1. Direct (out-of-band) managed storage subsystems

Where to install the software components

You will need to install the software components on management stations and host computers.

Management stations

You must install the following software components on each management station:

- Storage Manager 8.21 Client (SMclient)

- IBM FAStT Management Suite Java (FAStT MSJ)
- Storage Manager 8.21 Runtime (SMRuntime)

Host computers

You must install the following software components on each host computer:

- IBM FAStT Management Suite Java (FAStT MSJ)
- IBM FAStT Host Management Suite Java agent (qlremote)
- IBM FAStT Host Adapter device driver
- Storage Manager 8.21 Runtime (SMRuntime)
- Storage Manager 8.21 Client
- Storage Manager 8.21 Utility

The SMclient must be installed on a host computer if you intend the host computer to act as a management station. If the host computer is not connected to a network, it must have TCP/IP software installed, and you must assign an IP address to the host.

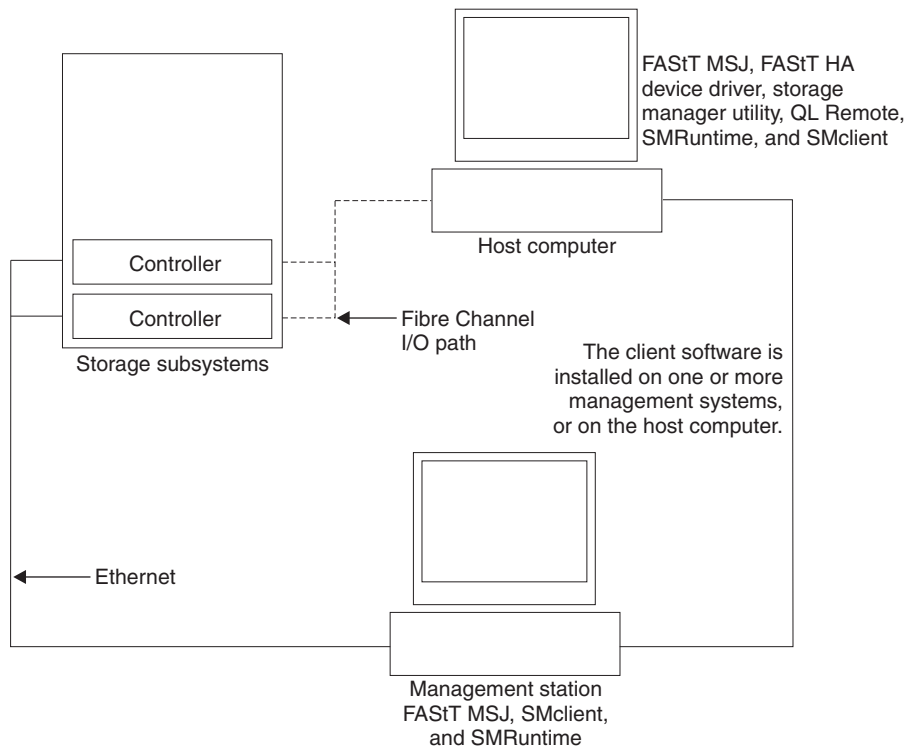

Figure 2. Sample software installation

Installation types

You can install the storage-management software in two types of hardware environments:

- **New storage subsystem environment.** You are installing the IBM TotalStorage FAStT Fibre Channel Storage Server using firmware 5.2x.xx and you will manage storage subsystems using Storage Manager 8.21.
- **Existing storage subsystem environment.** You are installing the storage-management software in an environment with existing storage

subsystems. See Table 3 for your installation options in an environment with existing storage subsystems.

Table 3. Configurations for existing storage subsystems

Existing storage subsystems with:	Options
Machine type 3542, 3552, controllers running firmware version 04.01.02.07 through 04.01.xx.xx. Note: If you have a level of firmware that is earlier than 04.01.02.07, you cannot use Red Hat Linux as your operating system.	Option 1 —Upgrade the controller firmware to version 5.2x.xx.xx and manage the storage subsystems with Storage Manager 8.21. You might need to purchase additional firmware. Option 2 —Install new storage subsystems and attach them to the same host as the existing storage subsystems. These existing and new storage subsystems are referred to as coexisting storage subsystems. See “Managing coexisting storage subsystems” for more information.

Managing coexisting storage subsystems

Storage subsystems are *coexisting storage subsystems* when the following conditions are met:

- There are multiple storage subsystems with controllers running different versions of firmware.
- These storage subsystems are attached to the same host.

For example, a coexisting situation exists when you have a new storage subsystem with controllers running firmware version 5.2x.xx.xx, and it is attached to the same host as one or more of the following configurations:

- A storage subsystem with controllers running firmware versions 04.01.02.07 through 04.01.xx.xx, which is managed by a separate management station with Storage Manager 7.02.
- A storage subsystem with controllers running firmware versions 04.01.02.07 through 04.01.xx.xx, which is managed with Storage Manager 8.21.

Figure 3 shows an example of an environment that includes coexisting storage subsystems.

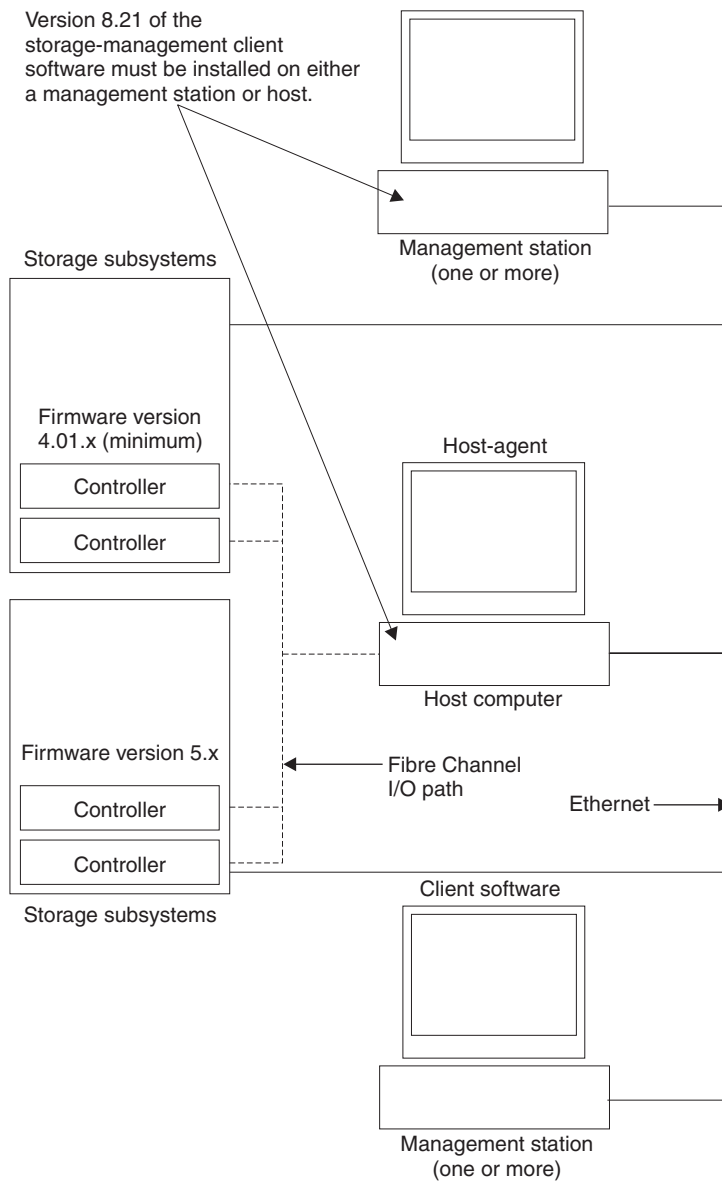

Figure 3. Sample coexistence installation

System requirements

This section provides detailed information about the hardware, software, and operating system requirements for Storage Manager Version 8.21.

Hardware requirements

Table 4 on page 11 lists the hardware that is required for installing Storage Manager 8 in a Linux environment. For the latest information about host adapters and host adapter device drivers, see the README file on the IBM FAST Storage Manager Version 8.21 installation CD or go to <http://www.ibm.com/pc/support>.

Table 4. Hardware requirements for Storage Manager 8.21 software

Hardware component	Requirements
A BOOTP server	<ul style="list-style-type: none"> • UNIX[®] BOOTP server • Microsoft Windows 2000 BOOTP-compatible DHCP server • NetWare DHCP server
Storage subsystems (one or more)	<p>Storage subsystems with controllers running firmware version 04.01.xx.xx</p> <p>Note: Read “Installation types” on page 8 for information on managing these storage subsystems when existing storage subsystems are physically connected to the same host that you will connect to the new storage subsystems.</p>
Fibre Channel host adapters	<p>The following Fibre Channel host adapters were tested with the storage-management software:</p> <ul style="list-style-type: none"> • IBM FASTt host adapter (part number: 00N6881) • IBM FASTt FC-2 host bus adapter (part number: 19K1246) • IBM TotalStorage FASTt FC2-133 host bus adapter (part number: 24P0960) <p>For information on specific host adapter requirements:</p> <ul style="list-style-type: none"> • Refer to the README file in the \linux\Host_Adapter directory on the installation CD. • Read the host adapter documentation. • Go to the http://www.ibm.com/pc/support Web site
Fibre Channel fabric switches (if needed for your configuration)	<p>The following Fibre Channel fabric switches were tested with the storage management software:</p> <ul style="list-style-type: none"> • IBM 8-port Fibre Channel switch (machine type: 2109-S08) • IBM 16-port Fibre Channel switch (machine type: 2109-S16) • IBM 16-port 2 Gbps Fibre Channel switch (machine type: 2019-F16) • IBM 8-port 2 Gbps Fibre Channel switch (machine type: 3534-F08) <p>For specific Fibre Channel switch setup requirements:</p> <ul style="list-style-type: none"> • Read the switch documentation • Go to the http://www.ibm.com/storage/fcswith Web site
Fibre Channel managed hub (if needed for your configuration)	<p>The IBM Fibre Channel managed hub (machine type: 3534) has been tested with the storage-management software.</p> <p>For specific Fibre Channel managed hub setup requirements:</p> <ul style="list-style-type: none"> • Read the documentation that comes with your managed hub. • Go to the http://www.ibm.com/storage/fchub Web site

Table 4. Hardware requirements for Storage Manager 8.21 software (continued)

Hardware component	Requirements
Management station (for client software)	<p>Your management station computer will require:</p> <ul style="list-style-type: none"> • Intel® Pentium® or Pentium-equivalent microprocessor (133 MHz or faster) • CD-ROM drive • Mouse or similar pointing device • A minimum of 128 MB system memory • Ethernet network interface adapter • AGP or PCI video adapter (AGP preferred), ISA adapters are not supported • Monitor setting of 1024 x 768 pixels with 64,000 colors. The minimum display setting that is allowed is 800 x 600 pixels with 256 colors. • 60 MB of free hard disk space • Ethernet network interface adapter • Hardware-based Windows acceleration: Desktop computers that use system memory for video memory are not preferred for use with the storage-management software. <p>Important: Many PC-based servers are not designed to run graphic-intensive software. If your server has difficulty running the storage-management software smoothly without video artifacts, you might need to upgrade the server video adapter.</p>

Firmware requirements

To utilize all the features of Storage Manager 8.21, your storage subsystem must contain controllers with firmware version 5.2x.xx.xx. To manage storage subsystems with Storage Manager 8.21, your existing storage subsystems must contain controllers with firmware versions 5.2x.xx.xx or higher. If you want to upgrade from firmware versions 04.01.xx.xx (or higher) to 5.2x.xx.xx, an optional firmware upgrade is available for purchase (for machine type 3552 only). For more information, contact your IBM service representative.

Software requirements

Table 5 lists the disk space and administrator privilege required for installing version 8.21 of the storage-management software in a Linux environment.

Table 5. Installation requirements by software package

Package	Disk space requirement
Storage Manager 8.21 Client (SMclient)	15 MB on /opt 2 MB on /tmp
IBM FAStT Management Suite Java (FAStT MSJ)	35 MB
Storage Manager 8.21 Utility (SMutil)	7 MB on/opt
IBM Host Adapter device driver	1 MB
Storage Manager 8.21 Runtime (SMRuntime)	42 MB on/opt 1 MB on/var

Operating system requirements

Each management station or host computer requires the following minimum operating system and kernel levels:

Operating system	Kernel
Red Hat Linux Versions 7.1 and 7.2	2.4.9-21
SuSE Linux Version 7.3	2.4.10
TurboLinux Version 7.0	2.4.9-3
Red Hat Advanced Server 2.1	2.4.9-E.3
Red Hat Linux Version 7.3	2.4.18-5

Note: There are limits on how many logical unit numbers (LUNs) you can use to access the logical drives on a single storage subsystem. Supported logical drive limits for Red Hat Linux version 7.1 are 128 maximum with 32 LUNs per storage partition.

Number of supported logical drives

There is a limit to how many logical unit numbers (LUNs) can access the logical drives on a single storage subsystem. The maximum number of logical drive that a FASTT storage subsystem supported with firmware version 5.2x.xx.xx depends on the model of the FASTT storage subsystem.

Table 6. Logical drives without the remote mirror option enabled

Model Type	Maximum logical drives	Maximum logical drives per storage unit partition	Maximum flashCopy logical drives
3542	512 ¹	32 ⁵	256 ²
3552	512 ¹	32 ⁵	256 ²
1742	2048 ¹	32 ⁵	1024 ²

Table 7. Logical drives using the remote mirror option

Model Type	Maximum logical drives	Maximum logical drives per storage unit partition	Maximum flashCopy logical drives
3542	N / A	N / A	N / A
3552	128 ^{3,6}	32 ⁵	64 ²
1742	256 ^{1,4,6}	32 ⁵	128 ²

Note: The access logical drive is also referred to as the Universal Xport Device.

¹When using firmware version 5.xx.xx, the firmware reserves one logical drive for use by the system.

² Maximum of four FlashCopy logical drives for each standard logical drive

³ Maximum of eight remote mirror pairs

⁴ Maximum of 16 remote mirror pairs

⁵The host-agent management method uses a special logical drive, called an *access logical drive*, to communicate with the controllers on the storage subsystem. The access logical drive uses one of the available LUNs. Therefore, managing storage subsystems with the host-agent software limits you to one fewer LUN than the maximum number supported by the operating system and the host adapter.

⁶For firmware version 5.2x.xx.xx, the maximum number of logical drives includes the flashcopy repository logical drives and the remote mirror logical drives, in addition to the standard data logical drives. If the remote mirror option is enabled, two logical drives are reserved for use by the system.

Chapter 2. Preparing for installation

This chapter provides information to help you plan for the installation of the storage-management software.

Reviewing a sample network

The example in Figure 4 shows a direct-managed storage subsystem. Network A contains the following components:

- DHCP BOOTP server
- Network Management Station (NMS) for Simple Network Management Protocol (SNMP) traps
- Host that is connected to a storage subsystem through a Fibre Channel I/O path
- Management station connected by Ethernet cable to the storage subsystem controllers

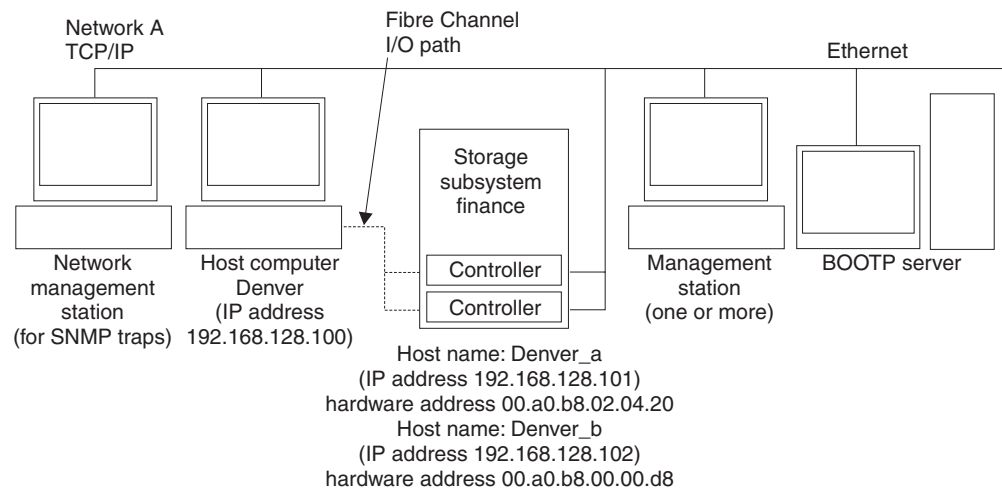

Figure 4. Sample network when using direct-managed storage subsystems

Preparing a network installation

To begin installing the storage-management software, ensure that the network components are set up and operating properly, and that you have all the host and controller information needed for the software to operate correctly.

The following list provides a high-level overview of the tasks involved in setting-up a network installation.

- Step 1. Install all hardware components (host computers, storage subsystems, and cables) that you want to connect to the network. You might need to refer to the installation guide specific to the hardware components for proper installation.
- Step 2. Establish a naming convention for the storage subsystems connected to the network. Refer to “Naming the storage subsystems” on page 16 for more information.

Step 3. Record the storage subsystem names and management types in Table 12 on page 49. An example of a completed information record is shown in Table 8.

Note: Throughout the remaining steps, you will need to return to Table 12 on page 49 to record information such as hardware Ethernet addresses and IP addresses.

Step 4. Determine the hardware Ethernet addresses for each controller in storage subsystems that are connected to the network. Refer to “Identifying the hardware Ethernet MAC address for each controller” on page 17 for more information.

Step 5. Obtain the following information from the network administrator. The IP address of each controller in the storage subsystems is to configure the DHCP BOOTP server. Refer to “Assigning IP addresses for hosts and controllers” on page 20 for more information.

Step 6. Set up the DHCP BOOTP server to provide network configuration information for a specific controller.

Step 7. Verify that the TCP/IP software is installed, and set up the host or DNS table. Installing the client software on a management station ensures that the management station is configured to reach the controllers over the network.

Step 8. Power on the devices connected to the network.

Table 8 shows a sample information record for a direct-managed storage subsystem and a host-agent managed storage subsystem.

Table 8. Sample information record

Storage subsystem name	Management type	Controllers—Ethernet and IP addresses, and host name		Host—IP address and host name
		Controller A	Controller B	
Finance	Direct	Hardware Ethernet address = 00a0b8020420	Hardware Ethernet address = 00a0b80000d8	
		IP address = 192.168.128.101	IP address = 192.168.128.102	
		Host = Denver_a	Host = Denver_b	

Naming the storage subsystems

As you set up your network, decide on a naming convention for the storage subsystems. When you install the storage-management software and start it for the first time, all storage subsystems in the management domain are displayed as <unnamed>. Use the Subsystem Management window to rename the individual storage subsystems.

Consider the following when naming storage subsystems:

- There is a 30-character limit. All leading and trailing spaces are deleted from the name.
- Use a unique, meaningful naming scheme that is easy to understand and remember.
- Avoid arbitrary names or names that might quickly lose their meaning.

- The software displays storage-subsystem names with the prefix Storage Subsystem. Therefore, if you rename a storage subsystem to Finance, it is displayed as:

Storage Subsystem Finance

If you plan to manage your storage subsystem using the direct-management method, go to “Identifying the hardware Ethernet MAC address for each controller”. If you plan to manage your storage subsystem using the host-agent management method, go to “Assigning IP addresses for hosts and controllers” on page 20.

Identifying the hardware Ethernet MAC address for each controller

To manage your storage subsystem using the direct-management method, you need to identify the Ethernet MAC address for each controller.

To identify the hardware Ethernet MAC address for machine type 3542, do the following:

1. Locate the Ethernet MAC address at the back of the unit, under the controller Gigabit Interface Converter (GBIC) ports, as shown in Figure 5. The number will be in the form xx.xx.xx.xx.xx.xx (for example, 00.a0.b8.20.00.d8).
2. Record each Ethernet address in the information record (Table 12 on page 49).

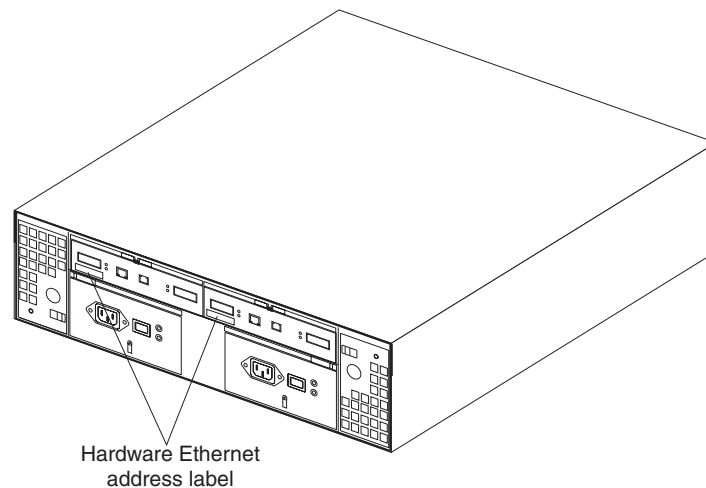

Figure 5. Locating the Ethernet MAC address for machine type 3542

To identify the hardware Ethernet MAC address for machine types 3552 and 1742, do the following:

1. Remove the front bezel from the controller unit, as shown in Figure 6 on page 18. Carefully pull the bottom of the bezel out **1** to release the pins; then,

slide the bezel down **2** .

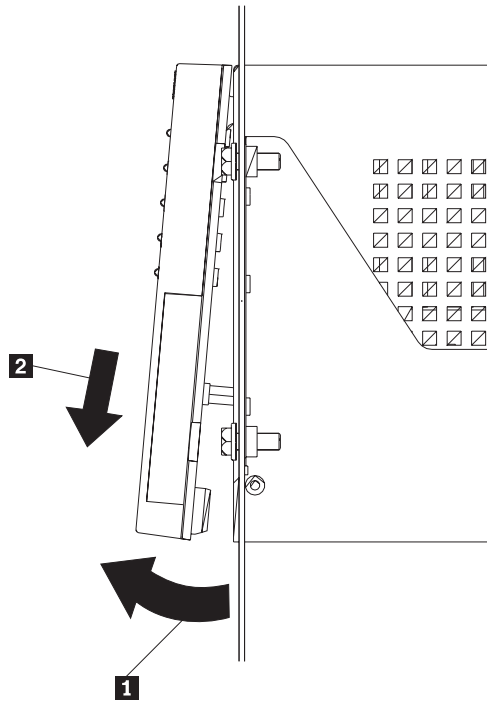

Figure 6. Removing the controller-unit bezel (machine types 3552 and 1742)

2. On the front of each controller, look for a label with the controller hardware Ethernet address. The number will be in the form xx.xx.xx.xx.xx.xx (for example, 00.a0.b8.00.00.d8).
3. Record each Ethernet address in the information record (Table 12 on page 49).
4. To replace the bezel, slide the top edge under the lip on the chassis **1** ; then, push the bezel bottom until the pins snap into the mounting holes **2** , as shown in Figure 7 on page 19.

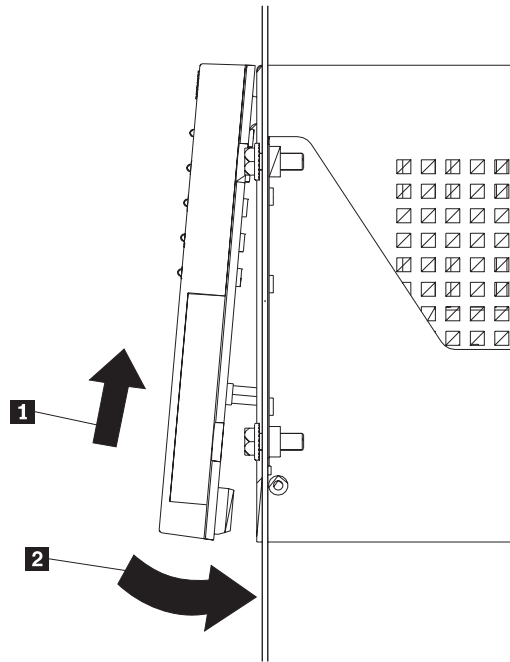

Figure 7. Replacing the controller-unit bezel (machine types 3552 and 1742)

5. Continue with “Assigning IP addresses for hosts and controllers” on page 20.

Assigning IP addresses for hosts and controllers

If you plan to manage our storage subsystem using the direct-management method, assign a unique IP address for each host and controller in all storage subsystems on the network. Record the IP address for each controller in the information record (Table 12 on page 49). Then, go to “Setting up the DHCP or BOOTP-compatible server”.

Note: If you want to assign static IP addresses for the controllers, refer to the IBM support Web site for Retain Tip #H171389 “Unable To Setup Networking Without DHCP/BOOTP”. Then, go to “Verifying the TCP/IP protocol and setting up the host or DNS table” on page 31.

If you plan to manage your storage subsystem using the host-agent management method, assign an IP address for each host on which you will install the host-agent software. Record the IP address for each host in the information record (Table 10 on page 45). Then, go to “Verifying the TCP/IP protocol and setting up the host or DNS table” on page 31.

Setting up the DHCP or BOOTP-compatible server

To directly manage storage subsystems through the Ethernet connection to each controller, you will need to set up a DHCP or BOOTP-compatible server and configure the following options:

- Router/Gateway
- DNS Server
- Host name
- DNS Domain Name

This section provides instructions for setting up a DHCP server on Windows NT, Windows 2000, and Novell NetWare, as well as instructions for setting up a UNIX BOOT server.

Note: The remote management station (RMS) and network management station (NMS) entries used in previous versions of the storage-management software are not required when using Storage Manager Version 8.2.

Setting up a Windows NT DHCP server

You must use a version of DHCP that supports BOOTP static addressing. To use a DHCP server, you must have a DHCP Manager installed. If a DHCP Manager is installed on the system, go to “Setting up a DHCP server” on page 21. If a DHCP Manager is not installed, use the following installation procedure to install one.

Installing the DHCP Manager

Use the following procedure to install the DHCP Manager:

1. Click **Start** → **Settings** → **Control Panel**.
2. Click **Network**. The Network window opens.
3. Click **Services**.
4. From the **Services** tab, click **Add**.
5. Click **Microsoft DHCP Server**; then, click **OK**.
6. Specify the path to the Windows NT Install file; then, click **Continue**. A dialogue windows opens, stating that a static IP address is required.
7. Click **OK**. The Network window opens.

8. Click **Protocols**.
9. Click **TCP/IP Protocol**; then, click **Properties**.
10. Verify that the IP address information is correct; then, click **OK**.
11. Continue to “Setting up a DHCP server”.

Note: After installing the DHCP Manager, you can refer to its online help for additional information.

Setting up a DHCP server

Use the following procedure, along with the information you recorded in Table 12 on page 49, to set up a DHCP server.

1. Click **Start** → **Programs** → **Administrative Tools** → **DHCP Manager**. The DHCP Manager window opens.
2. Create a scope. A scope defines a group of controllers that you want to configure using the DHCP server.
 - a. Click **Local Machine**.
 - b. Click **Scope** → **Create**. The Create Scope - (Local) window opens.

Figure 8. Create Scope - (Local) window

- c. Type the starting and ending IP addresses of the controllers that you are configuring for the network.

For example, if you are configuring 50 controllers on a 153.79.144.0 subnet, set the starting address to 153.79.144.1 and the ending address to 153.79.144.50.

Note: If each field does not contain at least three characters, press the period (.) key to advance to the next field. If you have only one controller, type its address for both the starting and ending address.

- d. Type the subnet mask (obtained from your network administrator).
 - e. Set the Lease Duration to **Unlimited**. This makes the DHCP connection permanent.
 - f. Type a scope name and comment.
 - g. Click **OK**.
 - h. When the scope successfully completes, click **Yes** to activate it. This returns you to the DHCP Manager window.
3. Configure global scope options. Table 7 shows the global options that need to be set.

Table 9. Global options for a Windows NT DHCP server

Number	Description	Notes
003	Router/Gateway	
006	DNS Server	
012	Host name	Unique for each controller
015	DNS domain name	For example, ibm.com

You can apply options to specific controllers later using step 5 on page 23.

- a. Click **DHCP Options → Global**. The DHCP Options: Global window opens.

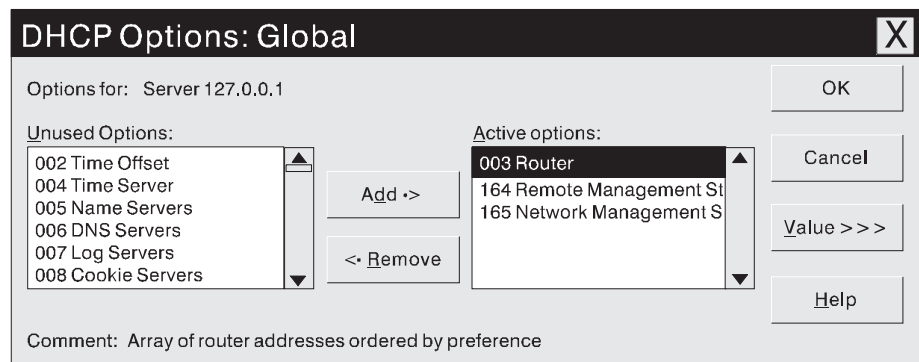

Figure 9. DHCP Options: Global window

- b. To make a global option active, select an item in the Unused Options list; then, click **Add** to move it to the Active options list.
- c. Click **Value** to assign a value to the active option.
If the **Value** field is not available, click **Edit Array**; the Edit Array Editor window opens. Do one of the following:
 - If you need to add an IP address, complete the following procedure:

- 1) Click **Edit Array**. The IP Address Array Editor window opens.

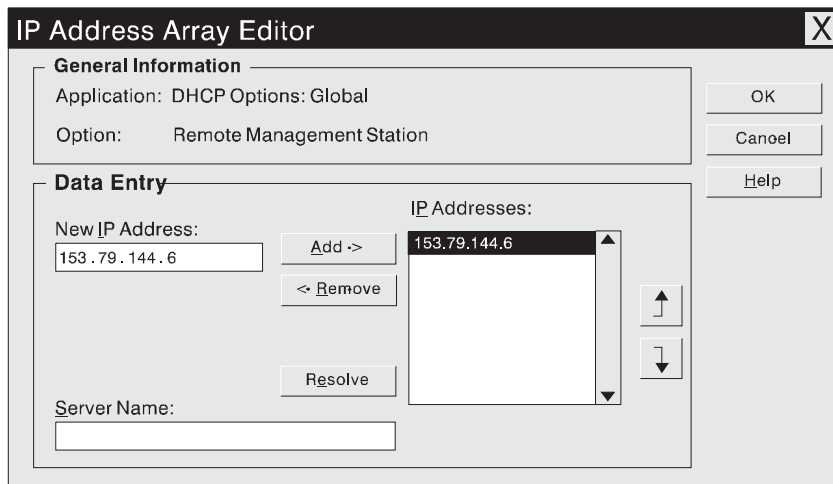

Figure 10. IP Address Array Editor window

- 2) Type a unique IP address for the option that you added.
- 3) Click **Add** to move the New IP Address to the IP Addresses list.
- 4) Click **OK**. This returns you to the DHCP Options: Global window.
 - If you do not need to add an IP address, click **Cancel**. This returns you to the DHCP Options: Global window.
- d. Repeat step 3b through step 3c on page 22 until all global options are added.
- e. When you finish adding the Global Scope Options, click **OK** at the DHCP Options: Global window.
4. Create a reservation for each controller. Use the information record (Table 12 on page 49) to make sure that you include all of the controllers on the network.
 - a. Click **Scope → Add Reservations**.
 - b. In the **IP Address** field, type the IP address for the first controller on your data sheet.
 - c. In the **Unique Identifier** field, type the controller hardware Ethernet address. Do not type decimal points or spaces.
 - d. In the **Client Name** field, type the controller eight-character name.
 - e. Click **Add**.
 - f. Repeat step 4b through step 4e for each controller that is listed on information record (Table 12 on page 49).
 - g. When you finish adding the information for all of the controllers, click **Close**. This returns you to the DHCP Manager window.
5. Configure controller-specific options. By creating a controller-specific option, you can associate a controller configuration entry with a specific controller.

Note: If you set an option as **Global Scope**, it applies to every controller in this group and does not need to be added again.

- a. Click **Scope** → **Active Leases**. The Active Leases window opens.

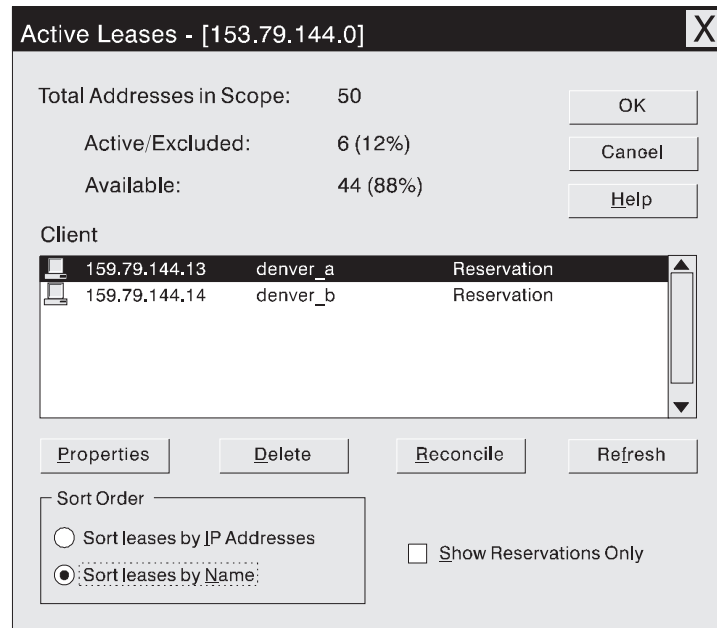

Figure 11. Active Leases window

- b. Select a controller in the list.
- c. Click **Properties**. The Add Option Type window opens. The Unique Identifier is the hardware Ethernet address from step 4c.

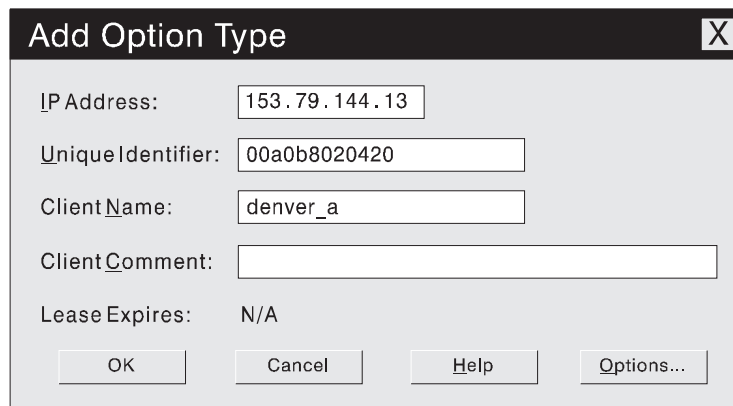

Figure 12. Add Option Type window

- d. Click **Options**. The DHCP Options: Reservations window opens.
- e. Select an option from the Unused Options list, and click **Add** to move it to the Active Options list.
- f. Click **Value** to assign a value to the active option.
- g. Type the information for the value of the option. For example, type the host name for the controller from your information record (Table 12 on page 49) in the String field. Click **Edit** if the value that you need to add is an IP address for a router.

- h. Repeat step 5e through step 5g until you finish adding specific options for this controller.
 - i. Click **OK**. This returns you to the Add Option Type window.
 - j. Click **OK**. This returns you to the Active Leases window.
 - k. Repeat step 5b through step 5j until you finish adding controller-specific options for every controller.
 - l. Click **OK** on the Active Leases window. This returns you to the DHCP Manager window.
6. Do the following to add a network management custom option:
 - a. From the DHCP Manager window, select a scope; then, select **DHCP Options: Defaults**. The DHCP Option: Defaults window opens.
 - b. In the **Name** field, type Network Management Station.
 - c. In the **Data Type** field, select **IP Address**; then, select the **Array** check box.
 - d. In the **Identifier** field, type 165.
 - e. In the **Description** field, type a description of the SNMP servers to which the controllers will send alerts.
 - f. Click **OK**.
 7. Continue with “Verifying the TCP/IP protocol and setting up the host or DNS table” on page 31.

Setting up a Windows 2000 DHCP server

You must use a version of DHCP that supports BOOTP static addressing. To use a DHCP server, you must have a DHCP Manager installed. If a DHCP Manager is installed on the system, go to “Setting up a DHCP server” on page 21.

Installing the DHCP Manager

To install the DHCP Manager, do the following:

1. Click **Start** → **Administrative Tools** → **Configure Your Server**. The Configure Your Server window opens.
2. In the left pane, double-click **Networking**; then, click **DHCP**
3. In the right pane, click **Start**. The Windows Components Wizard starts.
4. In the **Components** field, select **Networking Services**; then, click **Details**.

Note: Do not select the check box; you do not want to install all of the Networking Services subcomponents.

The Networking Services window opens

5. In the **Subcomponents of Networking Services** field, select **Dynamic Host Configuration Protocol (DHCP)**.
6. Click **OK**; the Windows Components Wizard window opens.
7. Click **Next** to start the installation process.
8. If prompted, type the full path to the Windows 2000 distribution files and click **Continue**.
9. When the installation has successfully completed, the Configure Your Server Window opens.
10. Click **Next**.
11. Click **Open the DHCP Manager**. The DHCP window opens.
12. Continue with step 2 on page 26. of “Setting up a DHCP server” on page 21.

Note: After installing the DHCP Manager, you can refer to its online help for additional information.

Setting up a DHCP server

Use the following procedure to create a scope and to set up a DHCP server. A scope defines a group of controllers by their IP addresses. You must create and configure a scope so that dynamic IP addresses can be assigned to controllers on your network. Refer to the information record (Table 12 on page 49). Before you begin, read through the instructions to determine what information is required; then, request the information from your network administrator.

1. Click **Start** → **Programs** → **Administrative Tools** → **DHCP**. The DHCP window opens.
2. In the Console tree, right-click the server you want to configure; click **New Scope**. The New Scope Wizard starts.
3. Follow the on-screen instructions to define the scope of IP addresses for TCP/IP clients. You will define the following:
 - a. Scope name and description
 - b. IP address range for the controllers you are configuring and the subnet mask

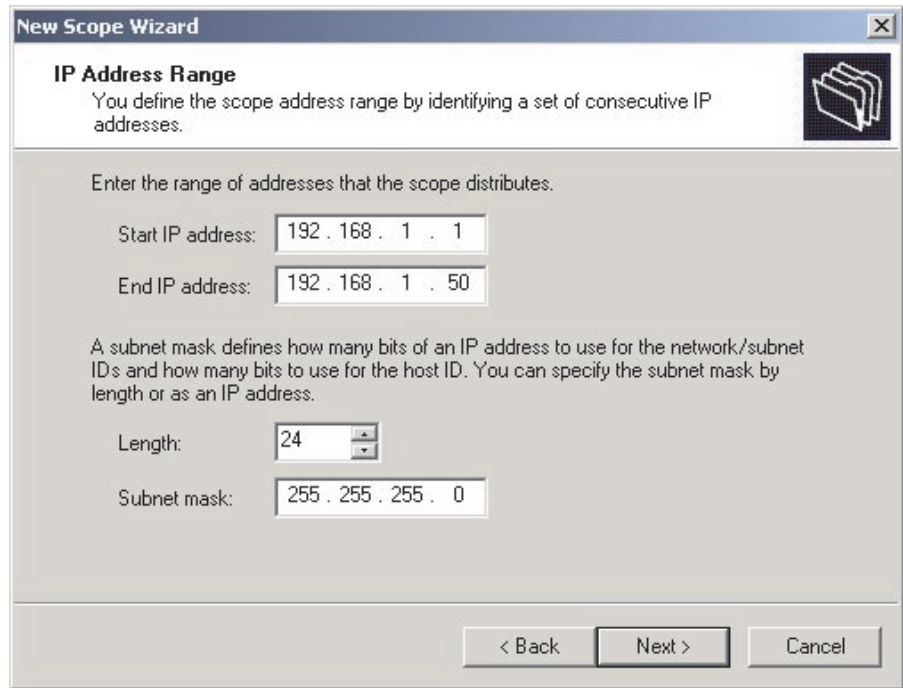

Figure 13. New Scope Wizard: IP Address Range window

- c. IP addresses that you want to exclude from the IP address range
 - d. IP address lease duration
 - e. Common DHCP options:
 - IP address for a router
 - Domain name and DNS servers
4. When you have defined the scope, click **Yes, I want to activate this scope now**. The wizard ends, and the DHCP window appears.
 5. In the Console tree, open the scope folder.
 6. Right-click **Reservations**; then, select **New Reservations**. The New Reservations window opens.
 7. To define the IP address reservation, type the following information:

- a. Reservation name
 - b. IP address
 - c. Ethernet hardware MAC address
 - d. Description
8. In the **Supported Type** field, select **Both (DHCP and BOOTP)**.
 9. Click **Add**.
 10. Repeat steps 5 through 9 for each controller in the network.
 11. Restart the DHCP server and then restart the storage subsystem so that all modifications are applied.
 12. Go to “Verifying the TCP/IP protocol and setting up the host or DNS table” on page 31.

Setting up a NetWare DHCP server

A NetWare DHCP server automatically assigns IP addresses and other configuration information to clients upon request or when the clients are restarted.

To set up a NetWare DHCP server, you must complete the following tasks:

1. Install DNS/DHCP Services, either during or after installing NetWare 5.
2. Install the DNS/DHCP Management Console.
3. Create the DHCP server object.
4. Create the subnet address.
5. Create the subnet address range.
6. Create the IP address object.
7. Start the DHCP server.

Installing NetWare 5.1 with DNS/DHCP Services

This section contains instructions for adding Novell DNS/DHCP services during and after the NetWare 5.1 installation.

Adding Novell DNS/DHCP Services during the NetWare 5.1 installation: Do the following to add Novell DNS/DHCP Services during the Netware 5.1 installation:

1. From the Installation Options window, select **Custom**.
2. From the Components window, select the **Novell DNS/DHCP Services** check box.
3. Follow the on-screen instructions to complete the NetWare 5.1 installation.

Adding Novell DNS/DHCP Services after the NetWare 5.1 installation: Do the following to add Novell DNS/DHCP Services after the Netware 5.1 installation:

1. Insert the *NetWare 5.1 Installation CD* into the CD-ROM drive; then, mount the CD as a volume.
2. Load NWCONFIG and select **Product Options**.
3. Select **Install a Product not Listed**.
4. Press F3 and specify the volume name of the CD. The X Server-Graphical Console window opens.
5. In the **Additional Products and Services** dialog box, select the **Novell DNS/DHCP Services** check box.
6. Follow the on-screen instructions to complete installation.

Note: Installing the DNS/DHCP Service will extend the Novell Directory Services (NDS) schema and create the following NDS objects:

- DNSDHCP-GROUP Group object
- DNS/DHCP Locator object
- RootServerInfo Zone object

Installing the DNS/DHCP Management Console

Do the following to install the DNS/DHCP Management Console and NetWare Administrator snap-in files on the client workstation you will use to administer DNS and DHCP:

1. If you have not already done so, install the latest version of Novell Client 32 on your workstation.
2. From the workstation, run the SYS:PUBLIC\DNSDHCP\SETUP.EXE program.
3. Install the DNS/DHCP Management Console on the local hard-disk drive.
4. Install the NetWare Administrator snap-in files in the SYS:PUBLIC\WIN32 directory.
5. Restart the workstation.
6. To start the DNS/DHCP Management Console, double-click the shortcut icon on the desktop, enter the NDS Tree NAME, and click **Launch**.

Note: You can install the DNS/DHCP Management Console on a workstation, or you can access it from the Tools menu of the NetWare Administrator utility.

Creating the DHCP server object

Use the DHCP Management Console to create a DHCP server object. A DHCP server object can be created under any of the following objects:

- Organization (O)
- Organization Unit (OU)
- Country (C)
- Locality (L)

Do the following to create a DHCP server object:

1. From the DHCP Management Console, click the **DHCP Service** tab.
2. In the left pane, select **Our Network**.
3. Click **Create**. The Create New DHCP Object window opens.
4. Select **DHCP Server**; then, click **OK**. The Create DHCP Server window opens.
5. Select a server; then, click **Create**. This creates the DHCP server object in NDS, called DHCP_servername.
6. In the DHCP Management Console, locate the icon for the DHCP server object at the bottom of the DHCP Service tab. The server object is displayed with a red line through it. The red line indicates that DHCP server has not been started.
7. Continue with "Creating a subnet object".

Creating a subnet object

You must do the following to create a DHCP subnet object for each of the subnets for which you want to assign addresses:

1. In the DNS/DHCP Management Console, click the **DHCP Service** tab.
2. Select **Our Network** or the **DHCP Server Object**.
3. Click **Create**. The Create New DHCP Object window opens.
4. Select **Subnet**; then, click **OK**. The Create Subnet window opens.
5. For each subnet, type the following information:

- Subnet name
 - NDS context
 - Subnet address
 - Subnet mask
 - Default DHCP Server
6. Click **Create**. The DHCP subnet object is created and displayed in the DNS/DHCP Management Console.

Creating subnet address ranges

Do the following to create a subnet address range object:

1. From the DNS/DHCP Management Console, click the **DHCP Service** tab.
2. Select the subnet object under which you want to create the subnet address range object; then, click **Create**. The Create New DHCP Record window opens.
3. Select **Subnet Address Range**; then, click **OK**. The Create New Subnet Address Range window opens.
4. Type the following information for the subnet address range:
 - Subnet address range name
 - Starting address
 - Ending address
5. Click **Create**.
6. Select the **Define Additional Properties** check box; then, set the Range Type to **Dynamic BOOTP and DHCP**.

Creating IP address objects

Use the DNS/DHCP Management Console to create IP address objects. IP address objects are used for the following purposes:

- To exclude an IP address from assignment
- To assign an IP address manually to a specific host
- To record dynamic IP address leases

Do the following to create an IP address object:

1. From the DNS/DHCP Management Console, click the **DHCP Service** tab.
2. Select the subnet object of the target IP address; then, click **Create**.
3. Select **IP Address**; then, click **OK**. The Create IP Address window opens.
4. In the **IP Address** field, type the IP address for the first controller.
5. In the **Assignment** field, select **Manual**.
6. In the **Client Identifier** field, specify the MAC address.
7. In the **MAC Address** field, enter the hardware Ethernet MAC address for the controller.
8. Select the **Define Additional Properties** check box.
9. In the **Host name** field, type the eight-character name for the controller.
10. In the Usage field, select **Permanent**.
11. Repeat step 3 through step 10 for each controller.

Starting the DHCP server

To start the DHCP server, type the following at the DHCP server console:

```
LOAD DHCP SRVR
```

The DHCP server can now respond to client requests and assign IP addresses.

Notes:

1. To load the DHCP server automatically each time the server starts, place the DHCP SRVR command in the SYS:\SYSTEM\AUTOEXEC.NCF directory.
2. For additional information about setting up, configuring, or using Novell DNS/DHCP Services, refer to the NetWare 5.1 documentation, located on the Novell Documentation CD or go to the <http://www.novell.com/documentation> Web site.

Setting up a UNIX BOOTP server

To use a UNIX BOOTP server, you must set up a BOOTP table. Table 10 and the information record (Table 12 on page 49) provide the information needed.

Table 10. Required entries for setting up the UNIX BOOTP server

Entry	Description	Sample format in BOOTP server
Subnet mask	Mask that is used to route packets to defined subnets	dot notation (sm=255.255.255.0)
Router	IP address of the host computer that routes packets to networks	dot notation (gw=192.168.128.1)
Host name for the controller	Host name that is associated with the controller (refer to Table 12 on page 49)	host name (Denver_a)
IP address	IP address of the controller (refer to Table 12 on page 49)	dot notation (ip=192.168.128.101)
Ethernet address	The Ethernet address of the controller hardware (refer to Table 12 on page 49)	hexadecimal notation (ha=00a0b8020420)

To set up a UNIX BOOTP server, do the following:

1. Use a text editor to edit the bootptab file in the /etc directory.

The following is an example of the BOOTP table used to configure a network

```
s4.default:\ (common settings)
ht=ether:\
sm=255.255.248.0:\
gw=192.168.128.1:\
hn:
denver_a:\
tc=s4.default:\ (common settings)
ip=192.168.128.101:\
ha=00a0b8020420:
denver_b:\
tc=s4.default:\
ip=192.168.128.102:\
ha=00a0b80000d8:
```

where the s4.default:\ entry denotes settings that are common to all controllers, and the tc=s4.default:\ entry associates this common setting group to a specific controller.

2. If the storage subsystem is running, shut down and then restart the subsystem. This will ensure that the parameters in the BOOTP table take effect.
3. Continue with “Verifying the TCP/IP protocol and setting up the host or DNS table” on page 31.

Verifying the TCP/IP protocol and setting up the host or DNS table

Make sure that the host names for the controller match the IP addresses for the controllers. Use the following procedure to verify that the TCP/IP-protocol software is installed on the management station, and to set up the host or DNS (Domain Name System) table.

1. Update either the host table or DNS table to specify a host name to associate with an IP address. If you do not have a DNS, edit the host table found in the following directory (your directory might be different if the operating system is not installed on the root).
`/etc/hosts`
2. To manage storage subsystems through a firewall, configure the firewall to open port 2463 to TCP data.

The following is a sample of a Linux host file. Do not remove the following line, or various programs that require network functionality will fail.

```
127.0.0.1 rh71_8500 localhost.localdomain localhost 102.54.94.97 rhino.acme.com x.acme.com
```

Chapter 3. Installing software

This chapter describes how to install the storage-management software.

Important: Always check for a README file on any installation media. This README file might contain important information that was not available when this *Installation and Support Guide* was written.

New installation process

To begin installing the storage-management software, ensure that the network components are set up and operating properly, and that you have all the host and controller information needed for the software to operate. Be sure to install the software on the management stations as well as the attached host computers.

Use the following task list as a guide for installing the software on a standard configuration.

1. Uninstall the earlier version Storage Manager (use this procedure when installing Storage Manager 8.21 on an existing storage subsystem).
2. Install Storage Manager 8.21 Runtime.
3. Verify the installation of the Storage Manager 8.21 Runtime.
4. Install Storage Manager 8.21 Utility.
5. Verify the installation of the Storage Manager 8.21 Utility.
6. Install Storage Manager Client 8.21 Client.
7. Verify the installation of Storage Manager Client 8.21 Client.
8. Disable and enable the Event Monitor.
9. Uninstall IBM FAStT Management Suite Java (use this procedure when installing Storage Manager 8.21 on an existing storage subsystem).
10. Install IBM FAStT Management Suite Java.
11. Install the IBM Host Adapter (HA) device driver (qla2200.o or qla2300.o)

Uninstalling Storage Manager

To uninstall Storage Manager, do the following:

Note: You do not need to restart your host computer after removing a software component. During the software removal process, the host keeps existing storage subsystem mappings and storage partition configurations, which the new client software will recognize.

1. Be sure you have root privileges, which are required to perform this uninstallation procedure.

2. To begin uninstalling Storage Manager, type:

```
rpm -qa|grep SM
```

3. Press Enter. The SM packages are listed.

4. At the prompt, type the following and press Enter:

```
rpm -e component-name
```

Where *component-name* is the name of the storage-management software package that you want to uninstall. The system prompt displays when the software removal completes.

5. Verify that the removal was successful. At the system prompt, type the following and press Enter:

```
rpm -qi component-name
```

Where *component-name* is the name of the storage-management software package that you want to uninstall. If the uninstallation process was successful, the host will display a message indicating that the software is not installed.

6. Repeat steps 2 through 4 to remove each Storage Manager component and associated directory.

7. Click **Completed** in the Installation Activity pane.

8. Do one of the following three options:

- If you are installing a management station, go to “Installing the Storage Manager 8.21 software package”.
- If you are installing IBM FAStT Storage Manager Version 8.21 on a host computer, go to “Installing the Storage Manager 8.21 software package”.
- If you remove the storage-management software and do not plan to reinstall the software on a management station or host computer, you have successfully completed all procedures.

Installing the Storage Manager 8.21 software package

Use the procedures in this section to install the software package on a management station or host computer.

Installing Storage Manager 8.21 Runtime

To install SMRuntime, do the following:

1. Close all open programs.

2. Insert the *IBM FAStT Storage Manager Version 8.21* CD into the CD-ROM drive.

3. To mount the CD-ROM, type the following and press Enter:

```
mount /mnt/cdrom
```

4. Type the following and press Enter:

- ```
cd /mnt/cdrom/linux
```
5. Type the following:  

```
rpm -ivh SMruntime
```
  6. Press Tab; then, press Enter.

## Verifying the Storage Manager 8.21 Runtime installation

To verify that the installation was successful, do the following:

1. At the system prompt, type the following and press Enter:  

```
rpm -qi SMRuntime
```

The verification process displays a message that describes the SMRuntime software, including version numbers, copyright license, installation time, and general software package description.

If no failure is reported, go to step 2. If the verification reports a failure, repeat steps 1 through 6 of the installation procedure.

2. Continue with “Installing the Storage Manager 8.21 Client”.

## Installing the Storage Manager 8.21 Client

To install the SMclient, do the following:

1. Close all open programs.
2. Insert the *IBM FASTT Storage Manager Version 8.21* CD into the CD-ROM drive.
3. To mount the CD-ROM, type the following and press Enter:  

```
mount /mnt/cdrom
```
4. Type the following and press Enter:  

```
cd /mnt/cdrom/linux
```
5. Type the following:  

```
rpm -ivh SMclient
```
6. Press Tab; then, press Enter.

## Verifying the Storage Manager 8.21 client installation

To verify that the installation was successful, do the following:

1. At the system prompt, type the following and press Enter:  

```
rpm -qi SMclient
```

The verification process displays a message that describes the SMclient software, including version numbers, copyright license, installation time, and general software package description.

If no failure is reported, continue to step 2. If the verification reports a failure, repeat steps 1 through 6 of the installation procedure.

2. Continue the installation with “Installing IBM FASTT Management Suite Java” on page 37 if you are installing a new storage subsystem. If you are installing the storage-management software on an existing storage subsystem, continue with “Disabling and enabling the Event Monitor”.

## Disabling and enabling the Event Monitor

The Event Monitor, which comes with the client software, is installed automatically during the client software installation. The Event Monitor handles storage

subsystem error notification through e-mail or SNMP traps when the storage-management software is not actively running on the storage-management station or host computer.

**Important:** If you have installed the client software on multiple hosts, you might receive duplicate error messages from the same storage subsystem. To avoid receipt of duplicate error messages, disable the Event Monitor on all but one system. You must run the Event Monitor on one host that will run continually.

To disable the Event Monitor, type the following and press Enter:

```
/etc/rc.d/init.d/SMmonitor stop
```

To enable the Event Monitor, type the following and press Enter:

```
/etc/rc.d/init.d/SMmonitor start
```

## Installing the Storage Manager 8.21 Utility

To install the SMutility, do the following:

1. Close all open programs.
2. Insert the *IBM FAST Storage Manager Version 8.21* CD into the CD-ROM drive.
3. To mount the CD-ROM, type the following and press Enter.  

```
mount /mnt/cdrom
```
4. Type the following and press Enter:  

```
cd /mnt/cdrom/linux
```
5. Type the following:  
Type `rpm -ivh SMutil`
6. Press Tab; then, press Enter.

## Verifying the Storage Manager 8.21 Utility installation

To verify that the installation was successful, do the following:

1. At the system prompt, type the following and press Enter:  

```
rpm -qi SMutility
```

The verification process displays a message that describes the SMutility software.

If no failure is reported, continue to step 2. If the verification reports a failure, repeat steps 1 through 6 of the installation procedure.

2. Continue with “Uninstalling IBM FAST Management Suite Java”.

---

## Uninstalling IBM FAST Management Suite Java

If you are installing Storage Manager 8.21 in an environment with existing storage subsystems, you need to uninstall older versions of IBM FAST Management Suite Java and then install the version of IBM FAST Management Suite Java that came on the *IBM FAST Storage Manager Version 8.21 CD*.

To uninstall FAST MSJ, do the following:

1. From a command prompt, type the following:  

```
/usr/FAST_MSJ_Uninstaller
```
2. Press Tab; then, press Enter.

---

## Installing IBM FAS*t*T Management Suite Java

The IBM FAS*t*T Management Suite Java (FAS*t*T MSJ) software includes the FAS*t*T GUI device driver that is required for failover support. You can use the GUI to configure logical drives, storage, and failover.

**Note:** For additional information, refer to the online help.

To install IBM FAS*t*T Management Suite Java, do the following:

1. Insert the *IBM FAS*t*T Storage Manager Version 8.21* CD into the CD-ROM Drive.
2. From the X-windows GUI, open a command window.
3. Type the following and press Enter:  

```
cd /mnt/cdrom/FAStT_MSJ/linux
```
4. To run the installer for FAS*t*T MSJ, type the following at a prompt:  

```
sh FAStT
```
5. Press Tab; then, press Enter. The Introduction window opens.
6. Click **Next**.
7. Start your Linux server again.
8. Continue with “Installing the IBM Host Adapter device driver (qla2200.o or qla2300.o)”.

For additional configuration information, refer to the *IBM FAS*t*T MSJ User's Guide*.

---

## Installing the IBM Host Adapter device driver (qla2200.o or qla2300.o)

The IBM Host Adapter device driver enables the operating system to communicate with the host adapter. The IBM FAS*t*T Host Adapter, IBM FAS*t*T FC-2 Host Bus Adapter, and IBM TotalStorage FAS*t*T FC2-133 Host Bus Adapter are high-performance, direct memory access (DMA), bus-master, host adapters that are designed for high-end systems. These host bus adapters support all Fibre Channel (FC) peripheral devices that support private-loop direct attach (PLDA) and fabric-loop attach (FLA). For more information, refer to the *IBM FAS*t*T Host Adapter Installation and User's Guide*, *IBM FAS*t*T FC-2 Host Bus Adapter Installation and User's Guide*, or the *IBM TotalStorage FAS*t*T FC2-133 Host Bus Adapter Installation and User's Guide*. Go to the <http://www.ibm.com/pc/support> IBM Web page for the current README file and latest multipath I/O device driver.



---

## Chapter 4. Completing the installation

This chapter contains procedures for using Enterprise Management and Subsystem Management to complete the following installation tasks:

1. Perform an initial automatic discovery of storage subsystems.
2. Add devices.
3. Set up alert notifications.
4. Name the storage subsystems.
5. Download firmware and NVSRAM.
6. Create arrays and logical drives.
7. Define host-types.
8. Configuration of heterogeneous hosts.
9. Identifying logical drives by operating system device names.
10. Perform other storage subsystem tasks.

The Enterprise Management window opens when you start FASTT Storage Manager. Use the Enterprise Management window to do the following:

- Add and discover the storage subsystems
- View all storage subsystems in your management domain
- Perform batch storage subsystem management tasks using the Script Editor

---

### Performing an initial automatic discovery of storage subsystems

To perform an initial automatic discovery of storage subsystems, do the following:

1. At the command prompt type:

```
SMclient
```

**Note:** If /opt/SMclient is not contained in the path environment, the full path name is required on the command line:

```
/opt/IBM_FASTT/client/SMclient
```

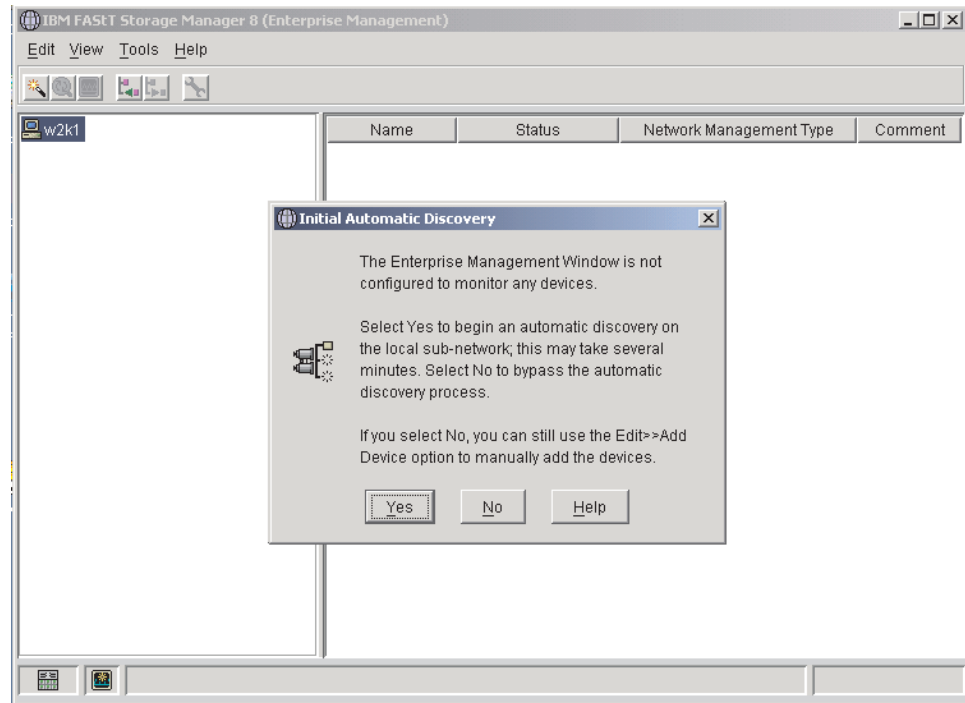

Figure 14. Confirm Initial Automatic Discovery window

**Note:** The Enterprise Management window might take several minutes to open. No wait cursor is displayed.

2. Click **Yes** to begin an initial automatic discovery of hosts and storage subsystems attached to the local subnetwork.

After the initial automatic discovery is complete, the Enterprise Management window displays all hosts and storage subsystems attached to the local subnetwork.

**Note:** The Enterprise Management window might take up to a minute to refresh after an initial automatic discovery.

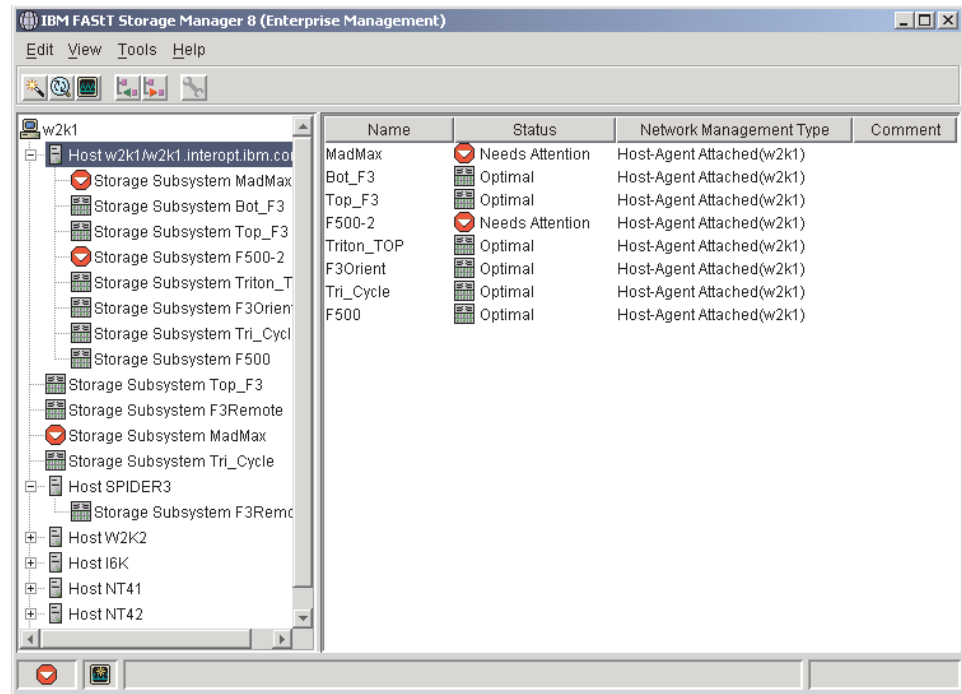

Figure 15. Enterprise Management window

3. Verify that each host and storage subsystem is displayed in the Enterprise Manager window.

If a host or storage subsystem is not displayed, do the following:

- Check the hardware and connections for possible problems (refer to the hardware documentation for specific procedures).
- Refer to the Enterprise Management online help for additional information about discovering storage subsystems.
- Verify that all hosts and storage subsystems are on the local subnetwork. If they are not, use the Add Device option.

**Note:** In certain situations, a storage subsystem might be duplicated in the device tree after an automatic discovery. You can remove a duplicate storage-management icon from the device tree by using the Remove Device option in the Enterprise Management window.

4. Verify that the status of each storage subsystem is Optimal. If a device shows a status of Unresponsive, use the software to remove the device from the management domain and then add it again. Refer to the Enterprise Management window online help for instructions on removing and adding devices.
5. Continue with “Adding devices”.

## Adding devices

You can add more hosts or storage subsystems outside the local subnetwork. For more information about this option, refer to the Enterprise Management window online help.

**Important:** When you add new storage subsystems to existing storage subsystems that are managed using the direct-management method, be sure to specify the IP addresses for both controllers.

Continue with “Setting up alert notifications”.

---

## Setting up alert notifications

After you add devices to the management domain, you can set up alert notification to report critical events on the storage subsystems. The following alert-notification options are available:

- Notification to a designated network management station (NMS) using Simple Network Management Protocol (SNMP) traps
- Notification to designated e-mail addresses
- Notification to designated alphanumeric pagers (requires additional software to convert e-mail messages)

**Note:** If you do not install Event Monitor, you must monitor storage subsystems within the management domain. The Enterprise Management window must remain open; if you close the window, you will not receive alert notifications. Refer to the Enterprise Management window online help for additional information.

To set up alert notification to an NMS using SNMP traps, do the following:

1. Insert the *IBM FAST Storage Manager Version 8.21* CD into the CD-ROM drive on a network management station (NMS). You need to set up the designated management station only once.
2. Copy the SM8.MIB file from the SM8mib directory to the NMS.
3. Follow the steps required by your NMS to compile the management information base (MIB) file. (For details, contact your network administrator or see the documentation specific to the storage management product you are using.)
4. Continue with “Naming storage subsystems”.

---

## Naming storage subsystems

To name your storage subsystem, do the following:

1. In the Enterprise Management window, select a storage subsystem.



2. Click **Tools** → **Manage Device**. The Subsystem Management window opens, as shown in Figure 16.

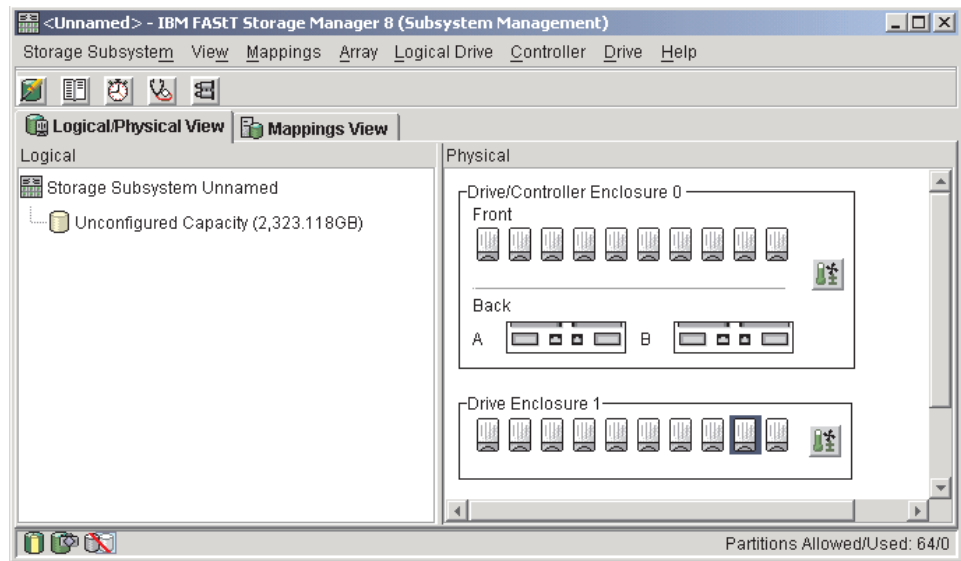

Figure 16. Subsystem Management window

3. Click **Storage Subsystem** → **Rename**. The Rename Storage Subsystem window opens.
4. Type the name of the storage subsystem (refer to Table 12 on page 49); then, click **OK**.
5. Repeat for each unnamed storage subsystem. For more information, refer to the topic on renaming storage subsystems in the Subsystem Management window online help.
6. Continue with “Downloading firmware and NVSRAM”.

---

## Downloading firmware and NVSRAM

This section provides instructions for downloading firmware and NVSRAM. You must download firmware version 5.2x.xx.xx before you download NVSRAM.

### Downloading firmware

To download firmware version 5.2x.xx.xx, do the following:

1. From the Enterprise Management window, select a storage subsystem.
2. Click **Tools** → **Manage Device**. The Subsystem Management window opens.
3. Click **Storage Subsystem** → **Download** → **Firmware**. Follow the on-screen instructions.
4. Continue with “Downloading NVSRAM”.

### Downloading NVSRAM

To download NVSRAM, do the following:

1. From the Enterprise Management window, select a storage subsystem.
2. Click **Tools** → **Manage Device**. The Subsystem Management window opens.
3. Click **Storage Subsystem** → **Download** → **NVSRAM**. Follow the on-screen instructions.

4. Continue with “Creating arrays and logical drives”.

---

## Creating arrays and logical drives

A *logical drive* is the basic structure you create to store data on the storage subsystem. The operating system recognizes a logical drive as a single drive. Choose a RAID level to meet application needs for data availability and maximize Fibre Channel I/O performance.

To create arrays and logical drives, do the following:

1. From the Enterprise Management window, select a storage subsystem.
2. Click **Tools** → **Manage Device**. The Subsystem Management window opens.
3. Click the **Logical/Physical View** tab.
4. Click **Logical Drive** → **Create**. The Logical Drive Create wizard starts. Follow the online instructions to create arrays and logical drives.
5. Continue with “Defining the default host type”.

**Note:** (For cluster configurations) If you add or delete logical drives, you must make them known to both node A and node B.

---

## Defining the default host type

Before using the logical drives in a host computer, you must specify the host type. The host type determines how the storage subsystem controllers will work with each particular operating system on the hosts to which it is connected. If all of the host computers connected to the same storage subsystem have the same operating system installed, and you do not want to define partitioning, you can define a default host type.

To define a default host type, do the following:

1. Click **Storage subsystem** → **Change** → **Default host-type**. The Default Host-type window opens.
2. From the pull-down menu, select the host type.
3. Click **OK**.

If you have hosts with different operating systems or if you want to define partitions for the hosts, continue with “Configuring heterogeneous hosts”.

---

## Configuring heterogeneous hosts

The heterogeneous hosts feature enables hosts that run operating systems to access a single storage subsystem. Previous releases of IBM FASTT Storage Manager (versions 7.02 or earlier) required that hosts run the same operating system in order to access a single storage subsystem.

Host computers can run completely different operating systems (for example, Solaris and Windows NT) or variants of the same operating system (for example, Windows NT running in a cluster environment or Windows NT running in a noncluster environment). When a host type is specified in the Define New Host Port window, the heterogeneous hosts feature enables the controllers in the storage subsystem to tailor their behavior (such as LUN reporting) to the needs of the host.

**Important:** To use the heterogeneous host feature, the following conditions must be met:

- Storage partitioning is enabled.
- During host-port definition, you must set each host type to the appropriate operating system so that the firmware on each controller can respond correctly to the host.

To start the heterogeneous host configuration, do the following:

1. From the Subsystem Management window, click **Configure** → **Storage Partition**.
2. Follow the on-screen instructions.
3. To display the association between a storage subsystem and operating system device name, continue with “Identifying logical drives by operating system device names”. Otherwise, continue with “Performing other storage-subsystem management tasks”.

**Note:** Partitioning is a premium feature. If you disable partitioning and you did not save a copy of your key file to disk, you *must* contact your IBM technical-support representative to obtain a key to re-enable partitioning.

---

## Identifying logical drives by operating system device names

The SMutil software package includes a utility that lets you see which storage subsystem logical drive is associated with a particular operating system device name. This capability is useful for operations such as data placement and logical drive deletion.

Type the following and press Enter:

```
SMdevices
```

The software displays device identification information similar to the following, where:

- /dev/... = Linux device node name
- Storage subsystem = storage subsystem name
- Logical drive = logical drive name
- LUN = logical unit number associated with the logical drive
- WWN = world wide name for the logical drive

```
/dev/sdb (/dev/sgc)[Storage subsystem <name>, Logical drive 1, LUN 0,
Logical drive WWN<600a0b8000091c9c000000df3bcedaae>, Alternate Path:
In Use]
/dev/sdc (/dev/sgc) [Storage subsystem <name>, Logical drive 2, LUN 1,
Logical drive WWN <600a0b8000091c9c000000e33bcedb05>, Alternate Path:
Not In Use]
/dev/sdd (/dev/sgc)[Storage subsystem <name>, Logical drive 3, LUN 2,
Logical drive WWN <600a0b8000091c9c000000e73bcedb5c>, Alternate Path:
In Use]
```

---

## Performing other storage-subsystem management tasks

Other storage subsystem management tasks you can perform include the following:

- Locating a storage subsystem
- Viewing a storage subsystem profile
- Entering or changing a storage subsystem password
- Creating and managing of logical drives and subsystems
- Using the Performance Monitor

- Creating storage partitions (if applicable) and heterogeneous hosts

**Note:** To create storage partitions, you must obtain the worldwide name or port name of each host adapter in every host connected to the storage subsystem.

For more information about these and other storage subsystem management tasks, refer to the appropriate topics in the Subsystem Management online help.

---

## Chapter 5. Linux operating-system support

This chapter contains information that is specific to operating the storage-management software in a Linux environment.

---

### Supported logical drives

The supported logical drive limits are as follows:

- When using Linux Storage Management Services (SMS), you can configure up to 128 LUNs or the maximum for the host adapter model.
- Host adapters support a specific number of logical drives. Refer to the host-adapter documentation for specific information.

---

### Linux limitations

**Important:** Always check for a README file on any installation media. This README file contains information that was not available when this *Installation and Support Guide* was prepared.

Table 11 explains the limitations that apply when you use the IBM FAStT Storage Manager Version 8.21 in a Linux operating system environment.

*Table 11. Linux limitations and workarounds*

| Limitations                                                                                                                                                                                              | Workaround                                                                                                                                                                                                                |
|----------------------------------------------------------------------------------------------------------------------------------------------------------------------------------------------------------|---------------------------------------------------------------------------------------------------------------------------------------------------------------------------------------------------------------------------|
| Vixel Rapport 2000 Fibre Channel hubs using controllers with firmware version 04.01.02 cause problems, including damage to data, system instability, and disrupted loop activity.                        | Do not use Vixel Rapport 2000 Fibre Channel hubs when your system is operating in a controller or an I/O path fault-tolerant environment.                                                                                 |
| The maximum number of physical drives that can be in a single RAID 5 logical drive is 29. The maximum number of physical drives that can be in a single RAID 1 logical drive is 28.                      | None.                                                                                                                                                                                                                     |
| After removing all drives from a storage subsystem, you are prompted for a password at software startup or when you perform protected operations, all passwords you enter fail.                          | Add one of the drives to the storage subsystem and attempt the operation again.                                                                                                                                           |
| Removing a set of drives that are configured with logical drives from one storage subsystem for insertion into another storage subsystem, is not supported because it might cause loss of configuration. | Contact an IBM technical support representative for assistance.                                                                                                                                                           |
| A standard non-network configuration is not supported when the Linux host does not have the TCP/IP software installed.                                                                                   | Install the TCP/IP software on the Linux host computer and assign the host a static IP address.                                                                                                                           |
| Multipath failover will work if the storage controllers are in only active/active mode.                                                                                                                  | When you configure the storage subsystem, change both controllers to active status.                                                                                                                                       |
| When you configure a new storage subsystem with a single controller, you must place the controller in slot A.                                                                                            | The controller firmware does not recognize or communicate with a single controller until slot A is populated. This restriction does not apply to storage subsystems that were originally configured with two controllers. |

Table 11. Linux limitations and workarounds (continued)

| <b>Limitations</b>                                                                                                                                                                                | <b>Workaround</b>                                                                                     |
|---------------------------------------------------------------------------------------------------------------------------------------------------------------------------------------------------|-------------------------------------------------------------------------------------------------------|
| Your windows and online help display a brownish hash pattern when you run in 256 color mode.                                                                                                      | Run the Storage Manager 8 application in a higher display mode.                                       |
| When performing a redundancy check (parity scan) from the storage-management application, machine type 3542 can take several minutes longer than machine type 1742 and 3552 controller platforms. | None.                                                                                                 |
| You might not see the maximum number of drives during Automatic Configuration if you are using drives of different capacities.                                                                    | Use Manual Configuration to select individual drives and select the maximum number of drives allowed. |
| When you connect an IBM TotalStorage FASTT EXP700 Storage Expansion Unit to a FASTT200, the drive speed must be set to 1 GB per second.                                                           | None.                                                                                                 |







---

## Appendix B. Getting help and technical assistance

If you need help, service, or technical assistance or just want more information about IBM® products, you will find a wide variety of sources available from IBM to assist you. This appendix contains information about where to go for additional information about IBM and IBM products, what to do if you experience a problem with your xSeries™ or IntelliStation® system, and whom to call for service, if it is necessary.

---

### Before you call

Before you call, make sure that you have taken these steps to try to solve the problem yourself:

- Check all cables to make sure that they are connected.
- Check the power switches to make sure that the system is turned on.
- Use the troubleshooting information in your system documentation, and use the diagnostic tools that come with your system.
- Go to the IBM Support Web site at <http://www.ibm.com/pc/support/> to check for technical information, hints, tips, and new device drivers.
- Use an IBM discussion forum on the IBM Web site to ask questions.

You can solve many problems without outside assistance by following the troubleshooting procedures that IBM provides in the online help or in the publications that are provided with your system and software. The information that comes with your system also describes the diagnostic tests that you can perform. Most xSeries and IntelliStation systems, operating systems, and programs come with information that contains troubleshooting procedures and explanations of error messages and error codes. If you suspect a software problem, see the information for the operating system or program.

---

### Using the documentation

Information about your IBM xSeries or IntelliStation system and preinstalled software, if any, is available in the documentation that comes with your system. That documentation includes printed books, online books, README files, and help files. See the troubleshooting information in your system documentation for instructions for using the diagnostic programs. The troubleshooting information or the diagnostic programs might tell you that you need additional or updated device drivers or other software. IBM maintains pages on the World Wide Web where you can get the latest technical information and download device drivers and updates. To access these pages, go to <http://www.ibm.com/pc/support/> and follow the instructions. Also, you can order publications through the IBM Publications Ordering System at <http://www.elink.ibm.com/public/applications/publications/cgibin/pbi.cgi>.

---

### Getting help and information from the World Wide Web

On the World Wide Web, the IBM Web site has up-to-date information about IBM xSeries and IntelliStation products, services, and support. The address for IBM xSeries information is <http://www.ibm.com/eserver/xseries/>. The address for IBM IntelliStation information is <http://www.ibm.com/pc/intellistation/>.

You can find service information for your IBM products, including supported options, at <http://www.ibm.com/pc/support/>. If you click **Profile** from the support page, you can create a customized support page. The support page has many sources of information and ways for you to solve problems, including:

- Diagnosing problems, using the IBM Online Assistant
- Downloading the latest device drivers and updates for your products
- Viewing Frequently Asked Questions (FAQ)
- Viewing hints and tips to help you solve problems
- Participating in IBM discussion forums
- Setting up e-mail notification of technical updates about your products

---

## Software service and support

Through IBM Support Line, you can get telephone assistance, for a fee, with usage, configuration, and software problems with xSeries servers, IntelliStation workstations, and appliances. For information about which products are supported by Support Line in your country or region, go to <http://www.ibm.com/services/sl/products/>.

For more information about Support Line and other IBM services, go to <http://www.ibm.com/services/>, or go to <http://www.ibm.com/planetwide/> for support telephone numbers.

---

## Hardware service and support

You can receive hardware service through IBM Integrated Technology Services or through your IBM reseller, if your reseller is authorized by IBM to provide warranty service. Go to <http://www.ibm.com/planetwide/> for support telephone numbers.

In the U.S. and Canada, hardware service and support is available 24 hours a day, 7 days a week. In the U.K., these services are available Monday through Friday, from 9 a.m. to 6 p.m.

---

## Appendix C. Notices

IBM may not offer the products, services, or features discussed in this document in other countries. Consult your local IBM representative for information on the products and services currently available in your area. Any reference to an IBM product, program, or service is not intended to state or imply that only that IBM product, program, or service may be used. Any functionally equivalent product, program, or service that does not infringe any IBM intellectual property right may be used instead. However, it is the user's responsibility to evaluate and verify the operation of any non-IBM product, program, or service.

IBM may have patents or pending patent applications covering subject matter described in this document. The furnishing of this document does not give you any license to these patents. You can send license inquiries, in writing, to:

*IBM Director of Licensing  
IBM Corporation  
North Castle Drive  
Armonk, NY 10504-1785  
U.S.A.*

INTERNATIONAL BUSINESS MACHINES CORPORATION PROVIDES THIS PUBLICATION "AS IS" WITHOUT WARRANTY OF ANY KIND, EITHER EXPRESS OR IMPLIED, INCLUDING, BUT NOT LIMITED TO, THE IMPLIED WARRANTIES OF NON-INFRINGEMENT, MERCHANTABILITY OR FITNESS FOR A PARTICULAR PURPOSE. Some jurisdictions do not allow disclaimer of express or implied warranties in certain transactions, therefore, this statement may not apply to you.

This information could include technical inaccuracies or typographical errors. Changes are periodically made to the information herein; these changes will be incorporated in new editions of the publication. IBM may make improvements and/or changes in the product(s) and/or the program(s) described in this publication at any time without notice.

Any references in this publication to non-IBM Web sites are provided for convenience only and do not in any manner serve as an endorsement of those Web sites. The materials at those Web sites are not part of the materials for this IBM product, and use of those Web sites is at your own risk.

IBM may use or distribute any of the information you supply in any way it believes appropriate without incurring any obligation to you.

---

### Edition notice

**© COPYRIGHT INTERNATIONAL BUSINESS MACHINES CORPORATION, 2002.  
All rights reserved.**

Note to U.S. Government Users — Documentation related to restricted rights — Use, duplication or disclosure is subject to restrictions set forth in GSA ADP Schedule Contract with IBM Corp.

---

## Trademarks

The following terms are trademarks of International Business Machines Corporation in the United States, other countries, or both:

|                 |                             |
|-----------------|-----------------------------|
| e-business logo | Predictive Failure Analysis |
| FlashCopy       | Redbooks                    |
| IBM             | ServeRAID                   |
| IntelliStation  | ServerProven                |
| Netfinity       | TotalStorage                |

Lotus, Lotus Notes, and Domino are trademarks of Lotus Development Corporation and/or IBM Corporation in the United States, other countries, or both.

Intel, Celeron, MMX, LANDesk, Pentium, Pentium II Xeon, Pentium III Xeon, and Xeon are trademarks of Intel Corporation in the United States, other countries, or both.

Microsoft, Windows, and Windows NT are trademarks of Microsoft Corporation in the United States, other countries, or both.

UNIX is a registered trademark of The Open Group in the United States and other countries.

Java and all Java-based trademarks and logos are trademarks or registered trademarks of Sun Microsystems, Inc. in the United States, other countries, or both.

Linux is a registered trademark of Linus Torvalds.

Other company, product, or service names may be the trademarks or service marks of others.

---

## Important notes

Processor speeds indicate the internal clock speed of the microprocessor; other factors also affect application performance.

CD-ROM drive speeds list the variable read rate. Actual speeds vary and are often less than the maximum possible.

When referring to processor storage, real and virtual storage, or channel volume, KB stands for approximately 1000 bytes, MB stands for approximately 1 000 000 bytes, and GB stands for approximately 1 000 000 000 bytes.

When referring to hard disk drive capacity or communications volume, MB stands for 1 000 000 bytes, and GB stands for 1 000 000 000 bytes. Total user-accessible capacity may vary depending on operating environments.

Maximum internal hard disk drive capacities assume the replacement of any standard hard disk drives and population of all hard disk drive bays with the largest currently supported drives available from IBM.

Maximum memory may require replacement of the standard memory with an optional memory module.

IBM makes no representation or warranties regarding non-IBM products and services that are ServerProven<sup>®</sup>, including but not limited to the implied warranties of merchantability and fitness for a particular purpose. These products are offered and warranted solely by third parties.

IBM makes no representations or warranties with respect to non-IBM products. Support (if any) for the non-IBM products is provided by the third party, not IBM.

Some software may differ from its retail version (if available), and may not include user manuals or all program functionality.



---

# Index

## A

- administrator privilege requirements 12
- alert notifications 42
- automatic host discovery 40
- automatic storage subsystem discovery 40

## B

- BOOTP server
  - UNIX 30
  - using Microsoft DHCP 20, 21, 24
- BOOTP table 30

## C

- controller
  - IP address 16
- creating arrays and logical drives 44

## D

- device drivers
  - IBM FASTT Host Adapter
    - NetWare (QL2x00) 5
- DHCP BOOTP server 15
- DHCP/BOOTP server
  - setting up 26

## E

- Enterprise Management window 5
  - adding devices 41
  - alert notifications 42
  - Help 1
- Ethernet MAC address 17
- existing storage subsystem 8
- existing storage subsystems 34

## F

- fabric switches 11
- Fibre Channel
  - fabric switches 11
  - host adapter 11
- firmware, downloading 43

## H

- hardware Ethernet address (pre-installation task) 16
- heterogeneous hosts
  - defining types 44
  - overview 44
- host adapters 11
- host port, defined 45
- host table
  - pre-installation tasks 16

- host table setup 31

## I

- IBM FASTT Host Adapter device driver
  - QL2x00 5, 37
- IBM FASTT Management Suite Java 37
- installation types
  - hardware environments 8
  - new storage subsystems 8
- IP addresses
  - pre-installation tasks 16

## L

- Linux multipath I/O support
  - FASTT Management Suite Java 6

## M

- MAC address, Ethernet 17
- managed hub 11
- management methods
  - direct (out-of-band) 6
- management station 11
- Microsoft DHCP server
  - setting up 21, 24
  - using 20

## N

- naming storage subsystems
  - naming 16
- new storage subsystem 8
- notes, important 54

## O

- obtaining 16
- operating system requirements 10
- operating system support
  - Linux 47

## P

- premium feature key 1
- preparing for installation 15
- publications, related x

## R

- Red Hat Linux
  - installation process 34
  - logical drive limits 47
  - software installation
    - README 33

## Red Hat Linux *(continued)*

- software packages
  - installing IBM FAStT Management Suite Java 37
  - installing Storage Manager 7 client 34, 35, 36
  - installing the IBM Host Adapter device driver (qla2200.o or qla2300.o) 37
- related publications x

## S

- sample network 15
- setting up the host or DNS table 31
- Simple Network Management Protocol (SNMP)
  - traps 15
- software packages
  - components of 5
  - disk space requirements 12
  - FAStT MSJ 6
  - installing the host adapter device driver (QL2x00) 37
  - Storage Manager 8 agent 5
  - Storage Manager 8 client 5
  - Storage Manager 8 Utility 5
- starting Subsystem Management 42
- storage management software
  - hardware requirements 11
    - fabric switches 11
    - host adapters 11
    - managed hub 11
    - UNIX BOOP server 11
  - new terminology 4
- Storage Manager 8 client 5
- storage subsystem 11
- storage subsystems 11
  - naming 42
- Storage-management software
  - installation requirements 10
- Subsystem Management 5
- Subsystem Management window
  - Help 1

## T

- TCP/IP protocol verification 31
- trademarks 54

## U

- Universal Xport device 13







Part Number: 02R0670

Printed in U.S.A.

(1P) P/N: 02R0670

