



**@server**

xSeries 205

Type 8480

# User's Guide





IBM xSeries 205  
Type 8480



# User's Guide

**Note:**

Before using this information and the product it supports, be sure to read the information in Appendix B, "Warranty information" on page 29.

**Second Edition (September 2002)**

**© Copyright International Business Machines Corporation 2002. All rights reserved.**

US Government Users Restricted Rights – Use, duplication or disclosure restricted by GSA ADP Schedule Contract with IBM Corp.

# Contents

<b>Safety information</b> .....	v
<b>Chapter 1. Introducing the xSeries 205 Type 8480 server</b> .....	1
Related publications .....	2
Notices and statements used in this book .....	2
Features and specifications .....	3
What your xSeries 205 Type 8480 server offers .....	4
Reliability, availability, and serviceability features .....	5
Server controls, LEDs, and connectors .....	5
Server controls and LEDs .....	6
Server connectors .....	7
Server power features .....	8
<b>Chapter 2. Configuring your server</b> .....	11
Using the Configuration/Setup Utility program .....	11
Starting the Configuration/Setup Utility program .....	11
Configuration/Setup Utility menu choices .....	12
Using passwords .....	18
Enabling Broadcom NetXtreme Gigabit Ethernet Boot Agent .....	20
Using the ServerGuide Setup and Installation CD .....	20
ServerGuide features .....	20
Setup and configuration overview .....	21
System Partition .....	22
Typical operating-system installation .....	22
Setting up or updating multiple servers .....	23
Installing your operating system without ServerGuide .....	23
Configuring the Gigabit Ethernet controller .....	23
Using the SCSISelect Utility program .....	24
Starting the SCSISelect Utility program .....	24
SCSISelect menu choices .....	25
Using the Boot Menu program .....	25
<b>Appendix A. Getting help and technical assistance</b> .....	27
Before you call .....	27
Using the documentation .....	27
Getting help and information from the World Wide Web .....	27
Software service and support .....	28
Hardware service and support .....	28
<b>Appendix B. Warranty information</b> .....	29
Warranty period .....	29
Problem determination .....	29
Warranty service and support .....	30
International Warranty Service .....	30
Purchasing additional services .....	31
IBM Statement of Limited Warranty Z125-4753-06 8/2000 .....	32
Part 1 - General Terms .....	32
Part 2 - Country-unique Terms .....	34
<b>Appendix C. Notices</b> .....	41
Edition notice .....	41
Trademarks .....	42
Important notes .....	42
Electronic emission notices .....	43

Federal Communications Commission (FCC) statement . . . . .	43
Industry Canada Class B emission compliance statement . . . . .	44
Avis de conformité à la réglementation d'Industrie Canada . . . . .	44
European Union EMC Directive conformance statement . . . . .	44
Japanese Voluntary Control Council for Interference (VCCI) statement . . . . .	44
Power cords . . . . .	44
<b>Index</b> . . . . .	<b>47</b>

# Safety information

Before installing this product, read the Safety Information.

قبل تركيب هذا المنتج، يجب قراءة الملاحظات الأمنية

Antes de instalar este produto, leia as Informações de Segurança.

在安装本产品之前，请仔细阅读 **Safety Information** (安全信息)。

安裝本產品之前，請先閱讀「安全資訊」。

Prije instalacije ovog produkta obavezno pročitajte Sigurnosne Upute.

Před instalací tohoto produktu si přečtěte příručku bezpečnostních instrukcí.

Læs sikkerhedsforskrifterne, før du installerer dette produkt.

Lees voordat u dit product installeert eerst de veiligheidsvoorschriften.

Ennen kuin asennat tämän tuotteen, lue turvaohjeet kohdasta Safety Information.

Avant d'installer ce produit, lisez les consignes de sécurité.

Vor der Installation dieses Produkts die Sicherheitshinweise lesen.

Πριν εγκαταστήσετε το προϊόν αυτό, διαβάστε τις πληροφορίες ασφάλειας (safety information).

לפני שתתקינו מוצר זה, קראו את הוראות הבטיחות.

A termék telepítése előtt olvassa el a Biztonsági előírásokat!

Prima di installare questo prodotto, leggere le Informazioni sulla Sicurezza.

製品の設置の前に、安全情報をお読みください。

본 제품을 설치하기 전에 안전 정보를 읽으십시오.

Пред да се инсталира овој продукт, прочитајте информацијата за безбедност.

Les sikkerhetsinformasjonen (Safety Information) før du installerer dette produktet.

Przed zainstalowaniem tego produktu, należy zapoznać się z książką "Informacje dotyczące bezpieczeństwa" (Safety Information).

Перед установкой продукта прочтите инструкции по технике безопасности.

Pred inštaláciou tohto zariadenia si pečítajte Bezpečnostné predpisy.

Antes de instalar este produto, leia as Informações sobre Segurança.

Pred namestitvijo tega proizvoda preberite Varnostne informacije.

Antes de instalar este producto, lea la información de seguridad.

Läs säkerhetsinformationen innan du installerar den här produkten.

**Statement 1:**



**DANGER**

**Electrical current from power, telephone, and communication cables is hazardous.**

**To avoid a shock hazard:**

- **Do not connect or disconnect any cables or perform installation, maintenance, or reconfiguration of this product during an electrical storm.**
- **Connect all power cords to a properly wired and grounded electrical outlet.**
- **Connect to properly wired outlets any equipment that will be attached to this product.**
- **When possible, use one hand only to connect or disconnect signal cables.**
- **Never turn on any equipment when there is evidence of fire, water, or structural damage.**
- **Disconnect the attached power cords, telecommunications systems, networks, and modems before you open the device covers, unless instructed otherwise in the installation and configuration procedures.**
- **Connect and disconnect cables as described in the following table when installing, moving, or opening covers on this product or attached devices.**

<b>To Connect:</b>	<b>To Disconnect:</b>
1. Turn everything OFF.	1. Turn everything OFF.
2. First, attach all cables to devices.	2. First, remove power cords from outlet.
3. Attach signal cables to connectors.	3. Remove signal cables from connectors.
4. Attach power cords to outlet.	4. Remove all cables from devices.
5. Turn device ON.	



**Statement 2:**



**CAUTION:**

When replacing the lithium battery, use only IBM Part Number 33F8354 or an equivalent type battery recommended by the manufacturer. If your system has a module containing a lithium battery, replace it only with the same module type made by the same manufacturer. The battery contains lithium and can explode if not properly used, handled, or disposed of.

*Do not:*

- Throw or immerse into water
- Heat to more than 100° C (212° F)
- Repair or disassemble

Dispose of the battery as required by local ordinances or regulations.

**Statement 3:**



**CAUTION:**

When laser products (such as CD-ROMs, DVD drives, fiber optic devices, or transmitters) are installed, note the following:

- Do not remove the covers. Removing the covers of the laser product could result in exposure to hazardous laser radiation. There are no serviceable parts inside the device.
- Use of controls or adjustments or performance of procedures other than those specified herein might result in hazardous radiation exposure.



**DANGER**

Some laser products contain an embedded Class 3A or Class 3B laser diode. Note the following.

Laser radiation when open. Do not stare into the beam, do not view directly with optical instruments, and avoid direct exposure to the beam.

Class 1 Laser Product  
Laser Klasse 1  
Laser Klass 1  
Luokan 1 Laserlaite  
Appareil À Laser de Classe 1

**Statement 4:**

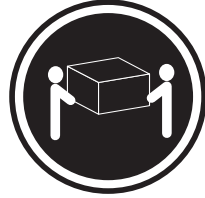

≥ 18 kg (39.7 lb)



≥ 32 kg (70.5 lb)



≥ 55 kg (121.2 lb)

**CAUTION:**  
Use safe practices when lifting.

**Statement 5:**



**CAUTION:**  
The power control button on the device and the power switch on the power supply do not turn off the electrical current supplied to the device. The device also might have more than one power cord. To remove all electrical current from the device, ensure that all power cords are disconnected from the power source.

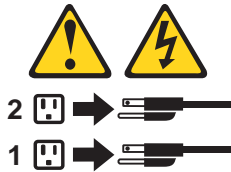

**Statement 8:**



**CAUTION:**

**Never remove the cover on a power supply or any part that has the following label attached.**



**Hazardous voltage, current, and energy levels are present inside any component that has this label attached. There are no serviceable parts inside these components. If you suspect a problem with one of these parts, contact a service technician.**



## Chapter 1. Introducing the xSeries 205 Type 8480 server

Thank you for selecting an IBM® eServer® xSeries™ 205 Type 8480 server. Your server is a high-performance server, based on IBM X-Architecture™ technologies. It is ideally suited for networking environments that require superior microprocessor performance, efficient memory management, flexibility, and large amounts of reliable data storage.

Performance, ease of use, reliability, and expansion capabilities were key considerations in the design of your server. These design features make it possible for you to customize the system hardware to meet your needs today and provide flexible expansion capabilities for the future.

Your xSeries 205 server contains several IBM X-Architecture technologies, which provide increased performance, reliability, and availability. The X-Architecture technologies provided in your server include the recent advancements in X-Architecture features. For more information about the X-Architecture features, see “What your xSeries 205 Type 8480 server offers” on page 4 and “Reliability, availability, and serviceability features” on page 5. You can obtain more information about the IBM X-Architecture technologies and features at <http://www.ibm.com/pc/us/eserver/xseries/xarchitecture> on the World Wide Web.

If you have access to the Internet, you can obtain up-to-date information about your server and other IBM server products at <http://www.ibm.com/eserver/xseries/> on the World Wide Web.

For service, assistance, or information, see Appendix A, “Getting help and technical assistance” on page 27.

The following illustration shows the locations of the server model and serial number labels. You will need these numbers to register your server with IBM.

**Note:** The illustrations in this document might differ slightly from your hardware.

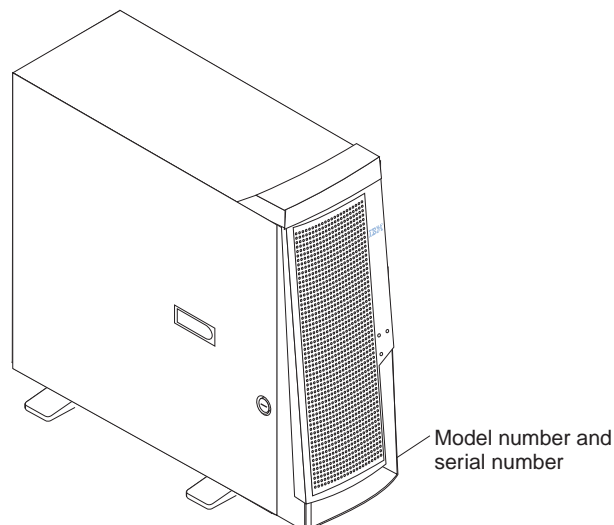

---

## Related publications

The following documentation comes with your server:

- *User's Guide*  
This publication is in Portable Document Format (PDF) on the IBM *xSeries Documentation* CD. It contains general information about your server.
- *Installation Guide*  
This printed publication contains basic setup and installation instructions.
- *Option Installation Guide*  
This publication is in PDF on the IBM *xSeries Documentation* CD. It contains complete instructions for installing, removing, and connecting optional devices that your server supports.
- *Safety Book*  
This publication is in PDF on the IBM *xSeries Documentation* CD. It contains translated caution and danger statements. Each caution and danger statement that appears in the documentation has a number that you can use to locate the corresponding statement in your language in the *Safety Book*.
- *Hardware Maintenance Manual and Troubleshooting Guide*  
This publication is in PDF on the IBM *xSeries Documentation* CD. It contains information to help you solve problems yourself, and it contains information for service technicians.

Depending on your server model, additional publications might be included on the IBM *xSeries Documentation* CD.

---

## Notices and statements used in this book

The caution and danger statements that appear in this book are also in the multilingual *Safety Book* on the IBM *xSeries Documentation* CD. Each statement is numbered for reference to the corresponding statement in the *Safety Book*.

The following notices and statements are used in the documentation:

- **Notes:** These notices provide important tips, guidance, or advice.
- **Important:** These notices provide information or advice that might help you avoid inconvenient or problem situations.
- **Attention:** These notices indicate potential damage to programs, devices, or data. An attention notice is placed just before the instruction or situation in which damage could occur.
- **Caution:** These statements indicate situations that can be potentially hazardous to you. A caution statement is placed just before the description of a potentially hazardous procedure step or situation.
- **Danger:** These statements indicate situations that can be potentially lethal or extremely hazardous to you. A danger statement is placed just before the description of a potentially lethal or extremely hazardous procedure step or situation.

## Features and specifications

The following table provides a summary of the features and specifications. Some features and specifications are not available on all models.

<p><b>Microprocessor:</b> Supports one microprocessor — Intel® Pentium® 4 with 128 KB, 256 KB, or 512 KB Level-2 cache and 400 MHz or 533 MHz front side bus (FSB)</p> <p><b>Memory:</b></p> <ul style="list-style-type: none"> <li>• Minimum: 128 MB</li> <li>• Maximum: 2.0 GB</li> <li>• Type: PC2100 266 MHz double-density RAM (DDR) DIMMs</li> <li>• Slots: Two dual inline</li> </ul> <p><b>Drives:</b> (depending on your model)</p> <ul style="list-style-type: none"> <li>• Diskette: 1.44 MB</li> <li>• Hard disk drive: IDE or SCSI</li> <li>• One of the following: <ul style="list-style-type: none"> <li>— CD-ROM: IDE</li> <li>— DVD-ROM: IDE</li> <li>— CD-RW: IDE</li> </ul> </li> </ul> <p><b>Expansion bays:</b> (depending on your model)</p> <ul style="list-style-type: none"> <li>• Two 5.25-in. bays (one CD-ROM drive installed)</li> <li>• Two 3.5-in. bays (one diskette drive installed)</li> <li>• Three 3.5-in. hard disk drive bays: hot-swap drive bays (some models) or non-hot-swap drive bays with a hard disk drive installed (some models)</li> </ul> <p><b>PCI expansion slots:</b></p> <ul style="list-style-type: none"> <li>• Three 33 MHz/32-bit on the system board (some models come with a SCSI adapter installed)</li> <li>• Two 33 MHz/32-bit on the PCI extender board</li> </ul> <p><b>Video controller:</b> ATI Rage XL video controller with 16 MB SDRAM video memory on the PCI extender card</p> <p><b>Power supply:</b> One 340 watt (90-240 V ac)</p>	<p><b>Size and weight:</b></p> <ul style="list-style-type: none"> <li>• Height: 445 mm (17.5 in.)</li> <li>• Depth: 498 mm (19.6 in.)</li> <li>• Width: 165 mm (6.5 in.)</li> <li>• Weight: approximately 19.5 kg (43 lb) when fully configured or 15.9 kg (35 lb) minimum</li> </ul> <p><b>Integrated functions:</b></p> <ul style="list-style-type: none"> <li>• Broadcom 5702 10/100/1000 Ethernet controller on the system board with RJ-45 Ethernet port</li> <li>• Two serial ports</li> <li>• One parallel port</li> <li>• Two USB ports</li> <li>• Keyboard port</li> <li>• Mouse port</li> <li>• Audio ports <ul style="list-style-type: none"> <li>— Line out</li> <li>— Line in</li> <li>— Mic</li> </ul> </li> <li>• Dual-channel bus mastering IDE controller</li> <li>• Support for IBM Remote Supervisor Adapter</li> </ul> <p><b>Acoustical noise emissions:</b></p> <ul style="list-style-type: none"> <li>• Sound power, idling: 5.1 bel maximum</li> <li>• Sound power, operating: 5.3 bel maximum</li> </ul> <p><b>Environment:</b></p> <ul style="list-style-type: none"> <li>• Air temperature: <ul style="list-style-type: none"> <li>— Server on: 10° to 35° C (50.0° to 95.0° F). Altitude: 0 to 2133 m (6998.0.7 ft)</li> <li>— Server off: 10° to 43° C (50.0° to 109.4° F). Maximum altitude: 2133 m (6998.0 ft)</li> </ul> </li> <li>• Humidity: <ul style="list-style-type: none"> <li>— Computer on: 8% to 80%</li> <li>— Computer off: 8% to 80%</li> </ul> </li> </ul>	<p><b>Heat output:</b> Approximate heat output in British thermal units (Btu) per hour</p> <ul style="list-style-type: none"> <li>• Minimum configuration: 341 Btu (100 watts)</li> <li>• Maximum configuration: 1604 Btu (470 watts)</li> </ul> <p><b>Electrical input:</b></p> <ul style="list-style-type: none"> <li>• Sine-wave input (50-60 Hz) required</li> <li>• Input voltage low range: <ul style="list-style-type: none"> <li>— Minimum: 90 V ac</li> <li>— Maximum: 137 V ac</li> </ul> </li> <li>• Input voltage high range: <ul style="list-style-type: none"> <li>— Minimum: 180 V ac</li> <li>— Maximum: 265 V ac</li> </ul> </li> <li>• Input kilovolt-amperes (kVA) approximately: <ul style="list-style-type: none"> <li>— Minimum: 0.095 kVA</li> <li>— Maximum: 0.470 kVA</li> </ul> </li> </ul> <p><b>Notes:</b></p> <ol style="list-style-type: none"> <li>1. Power consumption and heat output vary depending on the number and type of optional features installed and the power-management optional features in use.</li> <li>2. These levels were measured in controlled acoustical environments according to the procedures specified by the American National Standards Institute (ANSI) S12.10 and ISO 7779 and are reported in accordance with ISO 9296. Actual sound-pressure levels in a given location might exceed the average values stated because of room reflections and other nearby noise sources. The declared sound-power levels indicate an upper limit, below which a large number of computers will operate.</li> </ol>
---	---	---

---

## What your xSeries 205 Type 8480 server offers

Your server takes advantage of advancements in data storage, memory management, systems management, and network environments that require superior microprocessor performance. Your server includes:

- **IBM X-Architecture technology**

IBM X-Architecture features leverage proven innovative IBM technologies to build powerful, scalable, reliable Intel-processor-based servers. X-Architecture features include Light Path Diagnostics™, hot swappable hard disk drives, and predictive failure analysis (PFA).

- **High performance graphics controller**

Your server comes with a graphics controller on the PCI extender board. This high-performance controller supports high resolutions and includes many performance-enhancing features for your operating-system environment.

- **Large system memory**

The memory bus in your server supports up to 2.0 GB of system memory. The memory controller provides error code correction (ECC) support for up to two industry-standard PC2100, 3.3V, 184-pin, 266 Megahertz (MHz), unregistered, double data rate synchronous dynamic random access memory (DDR-SDRAM) dual inline memory modules (DIMMs).

- **Systems-management capabilities**

Your server comes with features that a network administrator or file server can use to remotely manage and control your server. Some of the features include: Wake on LAN®, IBM Director, Remote Administration, and System Migration Assistant. See Chapter 2, "Configuring your server" on page 11 for more information.

If you have a Remote Supervisor adapter installed on your Advanced System Management (ASM) interconnected network, you can view the system health, turn on and turn off, and restart the server, view the error log, view the vital product data, and send alerts over the ASM interconnect network. To order an optional Remote Supervisor adapter, contact your IBM reseller or IBM marketing representative.

- **Integrated network environment support**

Your server comes with an Ethernet controller on the system board. This Ethernet controller has an interface for connecting to 10-Mbps, 100-Mbps, or 1 Gbps networks. The server automatically selects between 10BASE-T, 100BASE-TX, and 1 Gigabit environments. The controller provides full-duplex (FDX) capability, which enables simultaneous transmission and reception of data on the Ethernet local area network (LAN).

### **IBM ServerGuide™ Setup and Installation CD**

The *ServerGuide Setup and Installation* CD that is included with your server provides programs to help you set up your server and install the network operating system (NOS). The ServerGuide program detects the hardware options that are installed and provides the correct configuration programs and device drivers.

For more information about the *ServerGuide Setup and Installation* CD, see "Using the ServerGuide Setup and Installation CD" on page 20.

- **ServeRAID support**

Your server supports ServeRAID adapter technology for use of redundant array of independent drive (RAID) configurations of hard disk drives. For more information about ServeRAID, go to <http://www.ibm.com/pc/support> on the World Wide Web.



- **IBM Director**

IBM Director is a workgroup-hardware-management tool that you can use to centrally manage xSeries servers. For more information about IBM Director, go to <http://www.ibm.com/pc/us/software/sysmgmt/> on the World Wide Web.

- **Device Drivers and IBM Enhanced Diagnostics CD**

Your server comes with a *Device Drivers and Enhanced Diagnostics* CD. Use the IBM Enhanced Diagnostics program on this CD to diagnose problems with your server.

---

## Reliability, availability, and serviceability features

Three important server design features are reliability, availability, and serviceability (RAS). The RAS features help to ensure the integrity of the data that is stored in your server, the availability of the server when you need it, and the ease with which you can diagnose and repair problems.

Your server has the following RAS features:

- Boot block recovery
- Automatic restart after a power failure
- Power-on self-test (POST)
- Hot-swap hard disk drives
- Upgradeable basic input/output system (BIOS), diagnostics, and POST
- Error correction code (ECC) synchronous dynamic random access memory (SDRAM) with serial presence detect (SPD)
- Cyclic redundancy checking on the small computer systems interface (SCSI) data bus
- Predictive failure analysis<sup>®</sup> (PFA) on memory, microprocessor, hard disk drives, fans, and power supply
- Auto-restart initial program load (IPL) power supply
- Wake on LAN capability
- Error codes and messages
- Monitoring support for temperatures, voltages, and fan speed
- Cooling fans with speed-sensing capability
- Failover Ethernet support
- Microprocessor built-in self-test (BIST)
- Vital product data (VPD); includes serial number information and replacement part numbers, stored in nonvolatile memory, for easier remote maintenance
- Diagnostic support of Ethernet and RAID adapters
- Read-only memory (ROM) checksums
- Nonmaskable interrupt (NMI) jumper
- Key lock support for physical security

---

## Server controls, LEDs, and connectors

This section describes the controls, light-emitting diodes (LEDs), and connectors on your server.

## Server controls and LEDs

The following illustration shows the controls and LEDs on the server.

**Note:** The front bezel door is not shown so that the drive bays are visible.

### Front View:

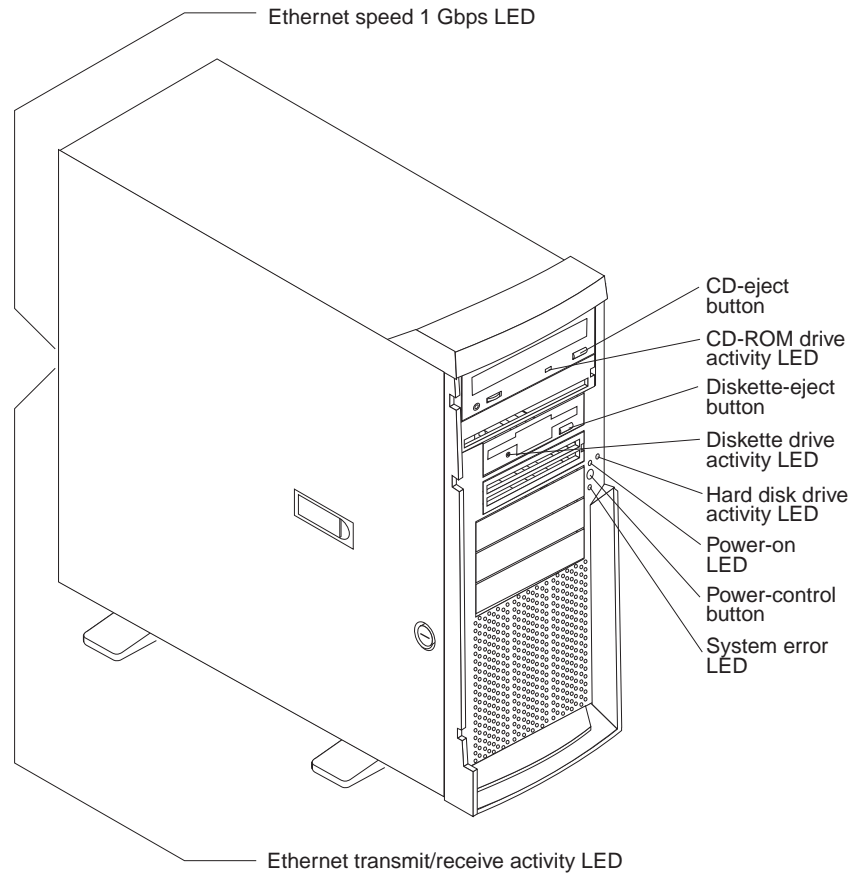

**Ethernet speed 1 Gbps LED:** When this LED on the Ethernet connector is lit, it indicates that the Ethernet network speed is 1 Gbps. When this LED is off, it indicates that the Ethernet network speed is 10 Mbps or 100 Mbps.

**CD-eject button:** Press this button to release a CD from the CD-ROM drive.

**CD-ROM drive activity LED:** When this LED is lit, it indicates that the CD-ROM drive is in use.

**Diskette-eject button:** Press this button to release a diskette from the diskette drive.

**Diskette drive activity LED:** When this LED is lit, it indicates that the diskette drive is in use.

**Hard disk drive activity LED:** When this LED is flashing, it indicates that the hard disk drive is in use.

**Power-on LED:** When this LED is lit, it indicates that the server is turned on.

**Power-control button:** Press this button to turn the server on and off manually.

**Ethernet transmit/receive activity LED:** When this LED on the Ethernet connector is lit, it indicates that there is activity between the server and the network.

## Server connectors

The following illustration shows the connectors on the rear of the server.

### Rear View:

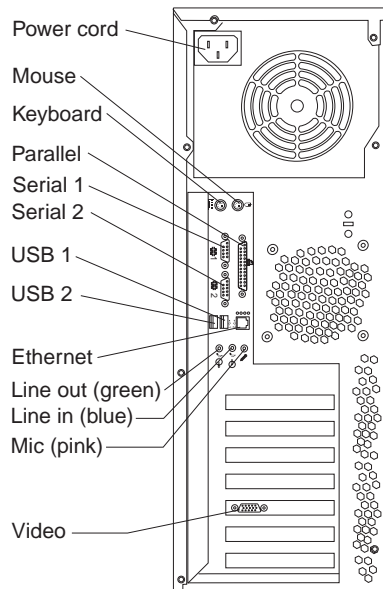

**Power-cord connector:** Connect the power cord to this connector.

**Mouse connector:** Connect a mouse or other PS/2<sup>®</sup> device to this connector.

**Keyboard connector:** Connect a PS/2 keyboard to this connector.

**Parallel connector:** Connect a parallel device to this connector.

**Serial 1 connector:** Connect a 9-pin serial device to this connector.

**Serial 2 connector:** Connect a 9-pin serial device to this connector

**USB 1 connector:** Connect a USB device to this connector.

**USB 2 connector:** Connect a USB device to this connector.

**Ethernet connector:** Use this connector to connect the server to a network.

**Mic connector (pink):** Connect a microphone to this connector.

**Line out connector (green):** Connect an audio output device, such as speakers, to this connector.

**Line in connector (blue):** Connect an audio input device, such as a stereo, to this connector.

**Video connector:** Connect a monitor to this connector.

If you have an optional Remote Supervisor Adapter (system-management adapter) installed in PCI slot 1, your server has additional connectors and LEDs. See the *Option Installation Guide* for more information about these connectors and LEDs.

## Server power features

When you connect the server to an ac power source, the server goes into Standby mode. After approximately 20 seconds, the power-control button becomes active, and you can turn on the server and start the operating system by pressing the power-control button. The following section describes other ways in which the server can be turned on.

A power-control-button shield comes with your server. You can install this disk-shaped shield to prevent the server from being turned off accidentally.

**Turning on the server:** After the server is connected to an ac power source, it can be turned on in any of the following ways:

- You can press the power-control button.
- If a power failure occurs while the server is turned on, the server will restart automatically when power is restored.
- If your operating system supports the system-management software for an optional Remote Supervisor Adapter, the system-management software can turn on the server.
- If your operating system supports the Wake on LAN feature, the Wake on LAN feature can turn on the server.

**Turning off the server:** Some operating systems require an orderly shutdown before you turn off the server. See your operating-system documentation for information about shutting down the operating system.

### Statement 5:



### CAUTION:

The power control button on the device and the power switch on the power supply do not turn off the electrical current supplied to the device. The device also might have more than one power cord. To remove all electrical current from the device, ensure that all power cords are disconnected from the power source.

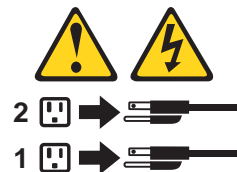

The server can be turned off in any of the following ways:

- You can press the power-control button to start an orderly shutdown of the operating system, if your operating system supports this feature, and turn off the server.
- If the operating system stops functioning, you can press and hold the power-control button for more than 4 seconds to turn off the server.
- If the Wake on LAN feature turned on the server, the Wake on LAN feature can turn off the server.
- You can remove all power from the computer by disconnecting the server from the ac power source.

**Standby mode:** When the server is connected to an ac power source but has not been turned on, it is in Standby mode. When the server is in Standby mode, the operating system is not running, and all core logic except for the service processor is shut down. The power-on LED flashes to indicate that the server is in Standby mode. The server can respond to requests from the service processor, such as a remote request to turn on the server.

To put the server into Standby mode when the server is turned on, shut down the operating system (see your operating-system documentation), and press the power-control button.

You can also put the server into Standby mode through a request from the service processor.



---

## Chapter 2. Configuring your server

You can use the following configuration programs to customize your server hardware:

- **Configuration/Setup Utility program**

The Configuration/Setup Utility program is part of the *basic input/output system (BIOS)* code that comes with your server. You can use this program to configure serial port assignments, change interrupt request (IRQ) settings, change the device startup sequence, set the date and time, and set passwords.

- **Broadcom NetXtreme Gigabit Ethernet Boot Agent**

The Broadcom NetXtreme Gigabit Ethernet Boot Agent is part of the BIOS code that comes with your server. You can enable the Broadcom NetXtreme Gigabit Ethernet Boot Agent in the Configuration/Setup Utility program. The Broadcom NetXtreme Gigabit Ethernet Boot Agent enables you to configure the network as a startable device and customize where the network option appears in your startup sequence.

- **ServerGuide Setup and Installation CD**

The *ServerGuide Setup and Installation* CD provides software setup tools and installation tools that are specifically designed for your IBM server. Use this CD during the initial installation of your server to configure basic hardware features and to simplify your network operating system (NOS) installation. See “Using the ServerGuide Setup and Installation CD” on page 20 for more information.

- **Ethernet controller configuration process**

To configure the Ethernet controller, see “Configuring the Gigabit Ethernet controller” on page 23.

- **SCSISelect Utility program (some models)**

If your server comes with a SCSI controller on the PCI extender card, you can use the SCSISelect Utility program to configure devices that are attached to the SCSI controller. Use this program to change default values, resolve configuration conflicts, and perform a low-level format on a SCSI hard disk drive.

- **Boot Menu program**

The Boot Menu program is part of the BIOS code that comes with your server. You can use the Boot Menu program to change startup sequence for one startup session without changing settings in the Configuration/Setup Utility program.

---

### Using the Configuration/Setup Utility program

This section provides the instructions for starting the Configuration/Setup Utility program and descriptions of the menu choices that are available.

### Starting the Configuration/Setup Utility program

The Configuration/Setup Utility program starts automatically when POST detects that newly installed or removed hardware is not reflected in your current configuration. A power-on-self-test (POST) error message is displayed. See the *Hardware Maintenance Manual and Troubleshooting Guide* for details about the POST error messages.

Complete the following steps to start the Configuration/Setup Utility program:

1. Turn on the server and watch the monitor screen. If your server is already on when you start this procedure, you must shut down the operating system, turn off the server, wait a few seconds until all in-use LEDs go off, and restart the server. Do not use Ctrl+Alt+Del to restart the server.
2. When the message Press F1 for Configuration/Setup, Press F12 for Boot Menu appears at the bottom of the screen during startup, press F1. (This prompt appears on the screen for only a few seconds. You must press F1 quickly.)

**Note:** If you have set both administrator and user passwords, you must type the administrator password to access the full Configuration/Setup Utility menu.

3. Follow the instructions that appear on the screen.

Use the Up Arrow (↑) and Down Arrow (↓) keys to select menu choices in any Configuration/Setup Utility menu. Some menu choices provide information only. Some menu choices show fields that you can change. These fields are enclosed by square brackets. You can change the settings in these fields by using Left Arrow (←) and Right Arrow (→) keys to change the settings, or you can type information in the field.

To reload the current setting for a menu item, press F9. To reload the default setting for a menu item, press F10.

## Configuration/Setup Utility menu choices

From the Configuration/Setup Utility main menu, you can select settings that you want to change. The Configuration/Setup Utility main menu is similar to the one in the following illustration.

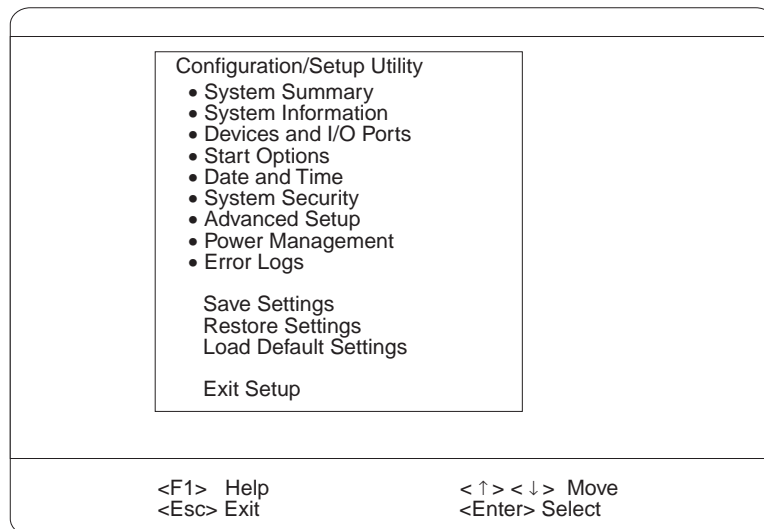

### Notes:

1. You can press F1 to display help information for a selected menu item.
2. The choices on some menus might differ slightly, depending on the BIOS version in your server.

The following choices are available from the main menu:

- **System Summary**



This choice contains general information about your server, such as a summary of components and server configuration. You can view information about the type and speed of the microprocessor and the amount of memory that is installed

Changes that you make to configuration settings appear on this summary screen. You cannot edit the fields of the configuration and system information.

- **System Information**

Select this choice to view the machine type and model number, the server serial number, and the revision level or issue date of the BIOS code that is stored in the flash electrically erasable programmable ROM (EEPROM).

- **Devices and I/O Ports**

Select this choice to view or change the assignments for devices and input/output ports.

- **Mouse**

Select this choice to enable a mouse or PS/2 pointing device.

- **Diskette Drive A**

Select this choice to set the type of diskette drive installed in your server. You can disable the diskette drive, or you can enable various types of diskette drives.

- **Floppy Disk Controller**

Select this choice to enable or disable the diskette drive controller.

- **IDE Controller**

Select this choice to enable the primary IDE controller, the secondary IDE controller, or both IDE controllers.

- **System Board Ethernet**

Select this choice to set the system-board Ethernet controller to **Enabled** or **Disabled**.

- **System Board Ethernet PXE/DHCP**

Select this choice to enable the Broadcom NetXtreme Gigabit Ethernet Boot Agent or to enable Dynamic Host Configuration Protocol (DHCP).

- **ASF POST Function**

Select this choice to enable or disable the Alert Standard Format (ASF) POST function. If you enable this function, you can manage the server remotely from another system using a system management software program, such as IBM Director Agent.

- **Audio Support**

Select this choice to enable or disable audio support.

- **Serial Port Setup**

Select this choice to configure the serial ports. If the port is set to **Enabled**, you can set the base input/output (I/O) address and the interrupt level. If the port is set to **Automatic**, the operating system automatically configures these settings.

- **USB Setup**

Select this choice to configure the USB ports in your server. The USB Support setting determines whether BIOS support for USB devices will be enabled when you start the server. You can also enable or disable support for a USB keyboard or mouse.

- **Parallel Port Setup**

Select this choice to configure the parallel port of your server. If the port is set to **Enabled**, you can set the base input/output (I/O) address, the interrupt, and the Parallel Port Extended Mode. If the port is set to **Disabled**, the operating system automatically configures these settings. If you set the Parallel Port Extended Mode to **ECP**, you can set the Extended Mode direct memory address (DMA). The parallel port address can be specified or disabled. If you need to change this field, set the address so that it does not conflict with other hardware.

Complete the following steps to view or change the parallel-connector assignment:

1. From the Configuration/Setup Utility main menu, select **Devices and I/O Ports** and press Enter.
2. Select **Parallel Port Setup** and press Enter.
3. Use the Left Arrow (←) and Right Arrow (→) keys to change settings and press Esc.

**Note:** When you configure the parallel connector as bidirectional, use an IEEE 1284-compliant cable. The cable must not exceed 3 meters (9.8 ft).

4. Follow the instructions on the screen to save your changes and exit from the Configuration/Setup Utility menu.

#### — IDE Hard Disk Drive 0, 1, 2, and 3

Select this choice to view or change the settings for IDE drives 0, 1, 2, and 3. You can set each drive to **Compatible** mode or **High Performance** mode. If an IDE device attached to the system-board IDE controller does not function properly or causes other IDE devices attached to the same controller to function improperly, set this field to **Compatible**.

#### • Start Options

You can select keyboard operating characteristics, such as the keyboard speed and whether the server starts with the keyboard number lock on or off. You also can enable the server to run without a diskette drive, monitor, or keyboard.

Select this choice to view or change the start options. Start options take effect when you start your server.

The following menu items are available in the **Start Options** menu:

#### — Startup Sequence

The server uses a startup sequence to determine the order in which the server checks devices to find a boot record. For example, you can define a startup sequence that checks for a startable diskette in the diskette drive, then checks the hard disk drive in bay 1, and then checks the CD-ROM drive.

You can also enable the server to start from the network by enabling the Broadcom NetXtreme Gigabit Ethernet Boot Agent to customize the network as the first startable device in the startup sequence.

To change the startup sequence of your server, complete the following steps:

1. From the Configuration/Setup Utility program, select **Start Options** and press Enter.
2. Select **Startup Sequence** and press Enter.
3. Select the device that you want to be the first startable device using the Left Arrow (←) and Right Arrow (→) keys. Choices available include the diskette drive, hard disk drives, and the network.
4. After customizing the desired order of startup devices, press Esc until you return to the main menu.

5. Select **Save Settings** and Press Enter.
- **Fast Power On Self Test**  
You can select **Auto** to speed up the system POST process by bypassing some testing procedures.
  - **Power On Logos**  
Select **Enabled** to display the IBM logo during POST.
  - **Keyboard NumLock State**  
Select **Enabled** to activate the keyboard numbers lock upon startup.
  - **Memory Test**  
This item is set to **Enabled**. You cannot alter this setting.
  - **Configuration Table**  
Select **Enabled** to display the preboot system configuration table.
  - **Date and Time**  
Select this choice to set the system date and time. The system time is in a 24-hour format (hour:minute:second).
  - **System Security**  
Select this choice to set an administrator password or a user password. This choice appears only on the full Configuration/Setup Utility main menu.  
You can set the server to prompt you for an administrator password or user password at startup. You can also set the security on diskette and hard disk drives to protect your data from tampering.  
Select **Administrator Password** to set or change an administrator password.  
**Attention:** If an administrator password is set and then forgotten, it cannot be overridden or removed. You must replace the system board.  
The administrator password provides access to all choices on the Configuration/Setup Utility main menu. You can set, change, or delete both the administrator and user passwords and enable a user to change the user password.  
You must set an administrator password to set a user password. A user password grants a user access to the server for use but denies the user access to configuration settings.  
You must set a user password to set a **Password on Boot**. If this setting is enabled, the server will require a password at startup.  
If you set an administrator password and a user password, you can set you diskette drive and hard disk drive security settings to prevent tampering with important data. You can set **Floppy Drive** and **Hard Disk Drive** security settings to **Normal**, **Write Protect All Sectors**, and **Write Protect Boot Sectors**.
  - **Advanced Setup**  
Select this choice to change the values for advanced hardware features, such as PCI configuration and Plug and Play operating-system settings.  
A message appears above the choices on this menu to alert you that the system might malfunction if these options are configured incorrectly. Follow the instructions on the screen carefully.
  - **Power Management**  
Select this choice to enable or disable system power settings.  
The following choices are available in this menu item:
    - **APM BIOS Mode**

This field controls the Advanced Power Management (APM) support to your operating system. Enable this setting when your operating system supports APM-enabled servers. Select **Enabled** to reduce power consumption or **Disabled** to deactivate the power-management features and timers.

- **IDE Hard Disk Standby Timer**  
This field controls what IRQ the Advanced Configuration and Power Interface (ACPI) uses.
- **Time to Low Power**  
Select this choice to set the time that will elapse from the last keyboard or mouse activity until the server assumes a low power sleep state.
- **Sleep Mode**  
You can set this menu choice only if Time to Low Power is set.
- **Power Switch < 4 sec.**  
You can set this to **Power Off** or **Suspend**.
- **System wake-up event**  
Select this choice to control the event that occurs when the server wakes up.
- **Serial Port Ring Detect**  
Set this menu choice to **Enabled** to set the server to wake up when activity is detected on the serial port modem.
- **Wake Up on Alarm**  
Select this choice to set the server to wake up at a certain day or time. You can set this to **Disabled**, **Time**, and **Date/Time**.
- **Alarm Day of Month**  
You can set this menu item only if you have set **Wake Up on Alarm** to **Time** or **Date/Time**. Set the day of the month for the server to wake up.
- **Alarm Time**  
You can set this menu item only if you have set **Wake Up on Alarm** to **Time** or **Date/Time**. Set the time of the day for the server to wake up.
- **ACPI Sleep State**  
Select which power level your server uses in Standby mode. If S1 is selected, power is maintained to all devices, but all processor activity is halted. If S3 is selected, power is maintained only for the main memory. Exit from the S3 state might not be supported by all installed adapters.
- **Restart on AC/Power Failure**  
This field controls whether the system will stay on after ac power is removed and then restored. Select **Power On** if you use a power strip to turn on the server. Select **Stay Off** if you want the server to remain off after power is restored. Select **Last State** to have the server return to its previous state.
- **Error Logs**  
Select this menu choice to view any errors that occur during POST.
- **Save Settings**  
Select this choice to save your customized settings.
- **Restore Settings**  
Select this choice to restore the previous settings.
- **Load Default Settings**  
Select this choice to restore the factory settings.
- **Exit Setup**  
Select this choice to exit from the Configuration/Setup Utility program.  
If you have made any changes, the program will prompt you to save the changes or exit without saving the changes.

## Using passwords

The **System Security** choice appears only on the full Configuration/Setup Utility menu. After you select this choice, you can implement an administrator password.

The administrator password provides access to all choices on the Configuration/Setup Utility main menu. You can set, change, or delete the administrator password.

**Attention:** If you set an administrator password and then forget it, you cannot override or remove it. You must replace the system board.

The administrator password has the following features:

- No password is required to start the system.
- Type the password to access the Configuration/Setup Utility program.
- All choices are available on the Configuration/Setup Utility main menu.

Complete the following steps to set an administrator password:

1. From the Configuration/Setup Utility main menu, select **System Security** and press Enter.
2. Select **Administrator Password** and press the Right Arrow (→) key.
3. Type the password you want to set in the **Enter Password** field and press Enter.
4. Type the password again in the **Enter Password again** field and press Enter.
5. Press Enter to **Set or Change Password**. The setting in the **Administrator Password** field changes to **Present**.
6. Press Esc until you return to the main menu.
7. Select **Save Settings** and Press Enter.

After you have set an administrator password, you can then set a user password to authorize a user to operate the server. You must set an administrator password to set a user password.

You can use any combination of up to seven characters (A Z, a z, 0 9, and blanks) for your user password. Keep a record of your password in a secure place. If you forget the user password, you can regain access to the server through one of the following methods:

- Type the administrator password at the power-on prompt. Start the Configuration/Setup Utility program and change the user password.
- Change the position of the password check jumper (JP1) as described in "Setting the password check jumper:" on page 19.
- Remove the battery and then install the battery. See the *Hardware Maintenance Manual and Troubleshooting Guide* for instructions.

To set a user password, complete the following steps:

1. Set an administrator password. See the instructions on page 18.
2. Select **User Password** and press the Right Arrow (→) key.
3. Type the password you want to set in the **Enter Password** field and press Enter.
4. Type the password again in the **Enter Password Again** field and press Enter.
5. Press Enter to **Set or Change Password**. The setting in the **User Password** field changes to **Present**.
6. Select **Save Settings** and press Enter.

If you set a user password, you can then enable Password on Boot. If you enable this setting, you must type a user password when you start the server.

**Setting the password check jumper:** The following illustration shows the location of the password check jumper (JP1) on the system board.

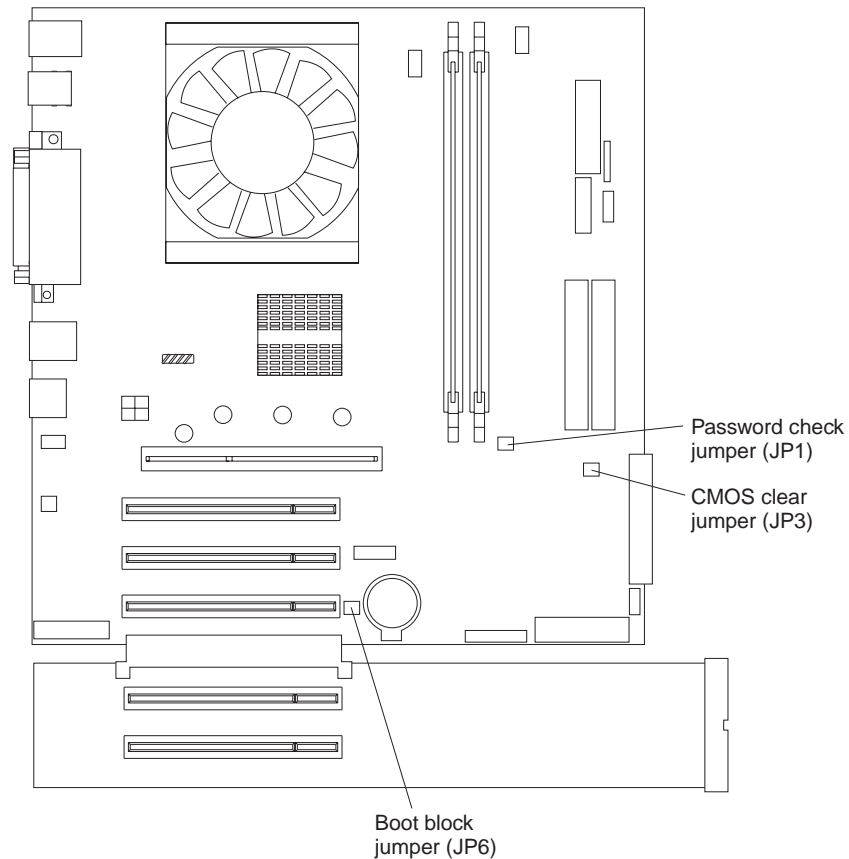

Complete the following steps to set the password check jumper:

1. Review the “Safety information” on page v.
2. Turn off the server and peripheral devices and disconnect all external cables and power cords; then, remove the cover. See the *Option Installation Guide* for instructions.
3. Move the jumper from pins 1 and 2 to pins 2 and 3. This clears the power-on password for one boot cycle.

You can now start the server one time without having to use the user password, but if you do not use the Configuration/Setup Utility program to change or delete the password, the next time you start the server, the original power-on password will be reinstated.

4. Connect the server to a power source, keyboard, monitor, and mouse.
5. Turn on the server.

You can now start the Configuration/Setup Utility program and either delete the old password or set a new user password.

---

## Enabling Broadcom NetXtreme Gigabit Ethernet Boot Agent

The Broadcom NetXtreme Gigabit Ethernet Boot Agent is part of the BIOS code that comes with your server. You can enable the Broadcom NetXtreme Gigabit Ethernet Boot Agent in the Configuration/Setup Utility program. The Broadcom NetXtreme Gigabit Ethernet Boot Agent enables you to configure the network as a startable device and customize where the network appears in your startup order.

To enable Broadcom NetXtreme Gigabit Ethernet Boot Agent, complete the following steps:

1. From the Configuration/Setup Utility main menu, select **Devices and I/O Ports** and press Enter.
2. Select **System Board Ethernet PXE/DHCP** and use the Right Arrow (→) key to set it to Enabled.
3. Select **Save Settings** and press Enter.

---

## Using the ServerGuide Setup and Installation CD

The *ServerGuide Setup and Installation* CD includes an easy-to-use setup and installation program that is specifically designed for your server. The ServerGuide program detects the server model and hardware options that are installed and uses that information during setup to configure the hardware. The ServerGuide program simplifies operating-system installations by providing updated device drivers and, in some cases, installing them automatically.

If a later version of the ServerGuide program is available, you can download a free image of the *ServerGuide Setup and Installation* CD, or you can purchase the CD. To download the latest ServerGuide program, go to the IBM ServerGuide Web page at <http://www.ibm.com/pc/qtechinfo/MIGR-4ZKPPT.html>. To purchase the latest *ServerGuide Setup and Installation* CD, see the “ServerGuide Updates” flyer that comes with your server library, or go to the ServerGuide fulfillment Web site at <http://www.ibm.com/pc/coupon/>.

The ServerGuide program has the following features to make setup easier:

- An easy-to-use interface with online help
- Diskette-free setup, and configuration programs that are based on detected hardware
- Performance Optimizer program, which easily tunes your SCSI RAID adapter settings for your server environment
- A system BIOS update program, which updates the BIOS code directly from the CD
- Device drivers that are provided for your server model and detected hardware
- Operating-system partition size and file-system type that are selectable during setup

### ServerGuide features

Features and functions can vary slightly with different versions of the ServerGuide program. To learn more about the version that you have, start the *ServerGuide Setup and Installation* CD and view the online overview. Not all features are supported on all server models.



The ServerGuide program requires a supported IBM server with an enabled startable (bootable) CD-ROM drive. In addition to the *ServerGuide Setup and Installation* CD, you must have your operating-system CD to install your operating system.

The ServerGuide program has the following features:

- Sets system date and time.
- Detects the SCSI RAID adapter or controller and runs the SCSI RAID configuration program.
- Updates the licensed internal code (firmware) level without diskettes.
- Checks the system BIOS code and microcode (firmware) levels of supported options to determine whether a later level is available from the CD. You can perform updates without using diskettes.
- Provides the Performance Optimizer program to easily tune your SCSI RAID adapter settings for your server environment.
- Creates a System Partition on the default drive. You can run server-specific utility programs after setup.
- Detects installed hardware options and provides updated device drivers for most adapters and devices.
- Creates a setup-replication diskette for replicating setup selections for other servers of the same model.
- Provides diskette-free installation for supported operating systems.
- Provides a replicated installation path for multiple installations of supported operating systems.
- Includes an online README file with links to tips for your hardware and operating-system installation.

## Setup and configuration overview

When you use the *ServerGuide Setup and Installation* CD, you do not need setup diskettes. You can use the CD to configure any supported IBM server model. The ServerGuide program checks your system BIOS, service processors, and other system hardware to determine if system updates are available. The setup program provides a list of tasks that are required to set up your server model. On SCSI RAID servers, you can run the SCSI RAID configuration program to create logical drives.

**Note:** Features and functions can vary slightly with different versions of the ServerGuide program.

When you start the *ServerGuide Setup and Installation* CD, the program performs the following tasks:

- The ServerGuide program prompts you for your language, country, and keyboard layout. (This information is stored and later passed to the operating-system installation program.)
- The ServerGuide program displays choices for running the configuration programs. For example:
  - The Express Configuration method runs the required programs for your server, based on the hardware that is detected.
  - The Custom Configuration method displays all programs that are available for your server, and you decide which programs to run.
  - The Replicated Configuration method provides the option of duplicating your setup selections to other servers that are the same model.
- If you select the Custom Configuration method, the following features are optional. If you select the Express Configuration method, some or all of these features are run, depending on the hardware that is detected:
  - The Set Date and Time feature is provided so that you do not have to use the Configuration/Setup Utility program to access these settings.

- The Clear Hard Disks feature is provided so you can delete all partitions on all hard disk drives. If the server has a SCSI RAID adapter installed, you can select to restore the configuration on the SCSI RAID adapter to the factory default settings.
- The ServerGuide program checks the system BIOS code and microcode (firmware) levels for supported options and then checks the CD for a newer level. The CD content might be newer than the BIOS code and firmware level. The ServerGuide program can perform a flash update of the BIOS code and supported microcode (firmware) options without using diskettes.
- The SCSI RAID configuration program starts, leading you through the entire configuration process.
- The Performance Optimizer program easily tunes your server for your environment.
- The ServerGuide program creates a System Partition on the default drive.
- The ServerGuide program displays a confirmation summary, so that you will know when you have completed all the required tasks. Then, you are ready to install your operating system.

**Notes:**

1. Plug and Play adapters are configured automatically. Non-Plug and Play adapters might require switch settings, additional device drivers, and installation after the operating system is installed. See the documentation that comes with the adapter.
2. Diagnostics for your server come in BIOS code or on a separate diagnostics CD.

## System Partition

The ServerGuide program creates a 50 MB System Partition on the default drive. The System Partition contains server-specific utility programs such as service processor disk operating system (DOS) utilities, system diagnostics, flash BIOS updates, and other programs. Programs in the System Partition vary by server model, and not all server models run utility programs from the System Partition. To determine which ones do, start the *ServerGuide Setup and Installation* CD and view the online overview.

After setup is complete, you can access programs in the System Partition by restarting the server and pressing Alt+F1 when the prompt is displayed. The **System Partition** menu displays the programs that are available on your server model.

## Typical operating-system installation

You can use the ServerGuide program to shorten your installation time. The ServerGuide program provides the device drivers that are required for your hardware and for the operating system that you are installing. This section describes a typical ServerGuide operating-system installation.

**Note:** Features and functions can vary slightly with different versions of the ServerGuide program.

1. After you have completed the setup process, the operating-system installation program starts. (You will need your operating-system CD to complete the installation.)
2. The ServerGuide program stores information about the server model, service processor, hard disk drive controllers, and network adapters. Then, the program checks the CD for newer device drivers. This information is stored and then passed to the operating-system installation program.

3. With some operating-system installations, you can create an operating-system-replication diskette for setting up additional servers. This diskette contains the Internet protocol (IP) address, server name, and other selections.
4. The ServerGuide program presents operating-system partition options that are based on your operating-system selection and the installed hard disk drives.
5. If you are installing the operating system from diskette, the ServerGuide program lists the diskettes that you must create and the optional diskettes that you might want to create. The diskettes that you can create are the device-driver diskettes for the installed adapters or controllers.
6. The ServerGuide program prompts you to insert your operating-system CD and restart the server. At this point, the installation program for the operating system takes control to complete the installation.

## Setting up or updating multiple servers

You can use the ServerGuide program to create diskettes that help you set up or update multiple servers. You can modify information on the diskettes as you use them to set up or update other servers.

**Note:** Availability and function can vary by server model and by the hardware that is installed.

You can create a setup-replication diskette, which contains your hardware configuration selections. Use this diskette to replicate selections to other servers that are of the same model.

You can create an operating-system-replication diskette, which contains information that you need to complete multiple installations. Not all operating systems support operating-system-replication diskettes.

## Installing your operating system without ServerGuide

If you have already configured the server hardware and you decide not to use the ServerGuide program to install your operating system, complete the following steps to download the latest operating-system installation instructions from the IBM Support Web page:

1. Go to <http://www.ibm.com/pc/support/>.
2. Under **Browse**, click **Servers**.
3. From the **Family** drop-down list, select your server model.
4. If NOS installation instructions are available for your server model, **OS installation** is in the list in the upper-left corner of the Web page. Click **OS installation** and select the instructions for your operating system.

---

## Configuring the Gigabit Ethernet controller

The server comes with an integrated Ethernet controller. This controller provides an interface for connecting to 10-Mbps, 100-Mbps, or 1000-Mbps networks and provides full duplex (FDX) capability, which enables simultaneous transmission and reception of data on the Ethernet local area network (LAN). You do not need to set any jumpers or configure the Ethernet controller for your operating system before you use the Ethernet controller. However, you must install a device driver to enable your operating system to address the Ethernet controller. The device drivers are provided on the *Device Drivers and IBM Enhanced Diagnostics* CD.

When you connect your server to the network, the Ethernet controller automatically detects the data-transfer rate (10-Mbps, 100-Mbps, or 1000-Mbps) on the network and

then sets the controller to operate at the appropriate rate. In addition, if the Ethernet ports that your server is connected to support auto-negotiation, the Gigabit Ethernet controller will set the appropriate duplex state. That is, the Ethernet controller will adjust to the network data rate, whether the data rate is standard Ethernet (10BASE-T), Fast Ethernet (100BASE-TX/1000BASE-T), half duplex (HDX), or full duplex (FDX). The controller supports half-duplex (HDX) and full-duplex (FDX) modes at both speeds.

For information about configuring your Ethernet controller, see the *Device Drivers and IBM Enhanced Diagnostics* CD that comes with your server. For updated information about configuring your Ethernet controller, go to the IBM Support Web site at <http://www.ibm.com/pc/support/> and navigate to the area for your specific server type. From this area you can download documentation, the most current device drivers for your server, and software that supports advanced networking functions. After downloading, run the downloaded program *launch.exe*.

Your Ethernet controller supports optional modes, such as teaming, priority packets, load balancing, fault tolerance, and virtual LANs, which provide higher performance, security, and throughput for your server. These modes apply to the integrated Ethernet controller and to the controllers on supported Ethernet adapters.

---

## Using the SCSISelect Utility program

SCSISelect is a menu-driven configuration utility program for servers that come with a SCSI adapter installed. You can use SCSISelect to:

- View the default SCSI IDs
- Locate and correct configuration conflicts
- Perform a low-level format on a SCSI hard disk

The following sections provide instructions for starting the SCSISelect Utility program and descriptions of the menu choices available.

## Starting the SCSISelect Utility program

Complete the following steps to start the SCSISelect utility program:

1. Turn on the server.
2. When the <<< Press <CTRL><A> for SCSISelect Utility! >>> prompt appears, press Ctrl+A.  
**Note:** If an administrator password has been set, you are prompted to type the password to start the SCSISelect Utility program.
3. When the Would you like to configure the host adapter or run the SCSI disk utility? question appears, make your selection and press Enter.
4. Use the arrow keys to select a choice from the menu.
5. Follow the instructions on the screen to change the settings of the selected items, and press Enter.

## SCSISelect menu choices

The following choices appear on the SCSISelect Utility menu:

- **Configure/View Host Adapter Settings**

Select this choice to view or change the SCSI controller settings. To reset the SCSI controller to its default values, press F6; then, follow the instructions that appear on the screen.

You can view or change the following controller settings:

- **Host Adapter SCSI ID**

Select this choice to view the SCSI controller ID, normally 7.

- **SCSI Parity Checking**

This choice is set to **Enabled** and cannot be changed.

- **Host Adapter SCSI Termination**

This choice is set to **Enabled** and cannot be changed.

- **Boot Device Options**

Select this choice to configure startable device parameters. Before you can make updates, you must know the ID of the device for which you want to configure parameters.

- **SCSI Device Configuration**

Select this choice to configure SCSI device parameters. Before you can make updates, you must know the ID of the device whose parameters you want to configure.

**Note:** The Maximum Sync Transfer Rate represents the transfer rate for Ultra SCSI devices.

- The transfer rate for Ultra3 SCSI LVD devices is 160 MBps.
- The transfer rate for Ultra2 SCSI LVD devices is 80 MBps.
- The transfer rate for Fast SCSI devices is 20 MBps.

- **Advanced Configuration Options**

Select this choice to view or change the settings for advanced configuration options.

- **SCSI Disk Utilities**

Select this choice to view the SCSI IDs that are assigned to each device or to format a SCSI device.

To use the utility program, select a drive from the list. Read the screens carefully before making a selection.

**Note:** If you press Ctrl+A before the selected drives are ready, an Unexpected SCSI Command Failure screen might appear. Restart the server and watch the SCSISelect messages as each drive spins up. After the drive that you want to view or format spins up, press Ctrl+A.

---

## Using the Boot Menu program

The Boot Menu program is a built-in, menu-driven configuration utility program that you can use to temporarily redefine the first startup device without changing settings in the Configuration/Setup Utility program.

Complete the following steps to use the Boot Menu program to change the startup sequence of your server:

1. Turn off the server.
2. Restart the server.
3. Press F12.
4. Select the startup device.

The next time the server is started, it returns to the startup sequence set in the Configuration/Setup Utility program.

---

## Appendix A. Getting help and technical assistance

If you need help, service, or technical assistance or just want more information about IBM products, you will find a wide variety of sources available from IBM to assist you. This appendix contains information about where to go for additional information about IBM and IBM products, what to do if you experience a problem with your xSeries or IntelliStation® system, and whom to call for service, if it is necessary.

---

### Before you call

Before you call, make sure that you have taken these steps to try to solve the problem yourself:

- Check all cables to make sure that they are connected.
- Check the power switches to make sure that the system is turned on.
- Use the troubleshooting information in your system documentation, and use the diagnostic tools that come with your system.
- Go to the IBM Support Web site at <http://www.ibm.com/pc/support/> to check for technical information, hints, tips, and new device drivers.
- Use an IBM discussion forum on the IBM Web site to ask questions.

You can solve many problems without outside assistance by following the troubleshooting procedures that IBM provides in the online help or in the publications that are provided with your system and software. The information that comes with your system also describes the diagnostic tests that you can perform. Most xSeries and IntelliStation systems, operating systems, and programs come with information that contains troubleshooting procedures and explanations of error messages and error codes. If you suspect a software problem, see the information for the operating system or program.

---

### Using the documentation

Information about your IBM xSeries or IntelliStation system and preinstalled software, if any, is available in the documentation that comes with your system. That documentation includes printed books, online books, README files, and help files. See the troubleshooting information in your system documentation for instructions for using the diagnostic programs. The troubleshooting information or the diagnostic programs might tell you that you need additional or updated device drivers or other software. IBM maintains pages on the World Wide Web where you can get the latest technical information and download device drivers and updates. To access these pages, go to <http://www.ibm.com/pc/support/> and follow the instructions. Also, you can order publications through the IBM Publications Ordering System at <http://www.elink.ibm.com/public/applications/publications/cgibin/pbi.cgi>.

---

### Getting help and information from the World Wide Web

On the World Wide Web, the IBM Web site has up-to-date information about IBM xSeries and IntelliStation products, services, and support. The address for IBM xSeries information is <http://www.ibm.com/eserver/xseries/>. The address for IBM IntelliStation information is <http://www.ibm.com/pc/intellistation/>.

You can find service information for your IBM products, including supported options, at <http://www.ibm.com/pc/support/>. If you click **Profile** from the support page, you can

create a customized support page. The support page has many sources of information and ways for you to solve problems, including:

- Diagnosing problems, using the IBM Online Assistant
- Downloading the latest device drivers and updates for your products
- Viewing Frequently Asked Questions (FAQ)
- Viewing hints and tips to help you solve problems
- Participating in IBM discussion forums
- Setting up e-mail notification of technical updates about your products

---

## Software service and support

Through IBM Support Line, you can get telephone assistance, for a fee, with usage, configuration, and software problems with xSeries servers, IntelliStation workstations, and appliances. For information about which products are supported by Support Line in your country or region, go to <http://www.ibm.com/services/sl/products/>.

For more information about Support Line and other IBM services, go to <http://www.ibm.com/services/>, or go to <http://www.ibm.com/planetwide/> for support telephone numbers.

---

## Hardware service and support

You can receive hardware service through IBM Integrated Technology Services or through your IBM reseller, if your reseller is authorized by IBM to provide warranty service. Go to <http://www.ibm.com/planetwide/> for support telephone numbers.

In the U.S. and Canada, hardware service and support is available 24 hours a day, 7 days a week. In the U.K., these services are available Monday through Friday, from 9 a.m. to 6 p.m.



## Appendix B. Warranty information

This section contains information about your warranty period and the service and support that are provided by your warranty.

### Warranty period

The warranty period varies by machine type and country or region.

Contact your place of purchase for warranty service information. Some IBM Machines are eligible for on-site warranty service depending on the country or region where service is performed.

**Prior to on-site warranty service, you are required to go through problem determination with an IBM service specialist call center technician.**

A warranty period of 3 years on parts and 1 year on labor means that IBM will provide warranty service without charge for:

1. parts and labor during the first year of the warranty period
2. parts only, on an exchange basis, in the second and third years of the warranty period. IBM will charge you for any labor it provides in performance of the repair or replacement.

The IBM Machine Warranties Web site at [http://www.ibm.com/servers/support/machine\\_warranties/](http://www.ibm.com/servers/support/machine_warranties/) contains a worldwide overview of the IBM Statement of Limited Warranty for IBM Machines, a glossary of terms used in the Statement of Limited Warranty, Frequently Asked Questions (FAQ), and links to Product Support Web pages. The IBM Statement of Limited Warranty is available from this Web site in 29 languages in Portable Document Format (PDF).

**Machine - IBM @server xSeries 205 Type 8480**

Country or region	Warranty period	Service delivery method
Worldwide	1 year	On-site

### Problem determination

Prior to on-site warranty service, you are required to go through problem determination with an IBM service specialist call center technician. The service specialist will run diagnostic tests on the hardware and check the software.

**Running diagnostics:** The IBM service specialist will help you determine whether your equipment is functioning as specified. It might be necessary to isolate the failing xSeries, Netfinity®, or IntelliStation system; IBM component; or both from any active production environment to run diagnostics and perform defect-isolation programs. You are responsible for making the system, IBM component, or both available for running diagnostics and defect-isolation programs.

**Checking software:** The IBM service specialist will help you ensure that the correct BIOS code, firmware, device drivers, and other supporting IBM software are installed and correctly configured. It might be necessary to manually gather information about the relevant software levels or run IBM-approved utility programs to gather this information. It might be necessary to isolate the failing system from any

active production environment to gather this information. You are responsible, with assistance from the service specialist, for gathering this information. The IBM Statement of Limited Warranty does not include on-site assistance with this activity.

## Warranty service and support

With the original purchase of an IBM xSeries or IntelliStation system, you have access to extensive service and support. During the IBM Machine warranty period, you may call IBM or your reseller for problem-determination assistance under the terms of the IBM Statement of Limited Warranty.

The following services are available during the warranty period:

- **Problem determination** - Trained personnel are available to assist you with determining if you have a hardware problem and deciding what action is necessary to fix the problem.
- **IBM hardware repair** - If the problem is determined to be caused by IBM hardware under warranty, trained service personnel are available to provide the applicable level of service, either on-site or at an IBM service center as determined by IBM.
- **Engineering Change management** - Occasionally, there might be changes that are required after a product has been shipped from IBM. In those instances, IBM will make Engineering Changes (ECs) available that apply to your hardware.
- **Customer replaceable units (CRUs)** - Some parts of IBM xSeries and IntelliStation systems are designated as customer replaceable units. IBM ships CRUs to you for replacement by you. CRUs include keyboards, monitors, memory, diskette drives, hard disk drives, and mice (this list is not inclusive of all CRUs).

The following items are not covered under warranty service:

- Replacement or use of non-IBM parts. All IBM parts contain a 7-character identification in the format IBM FRU XXXXXXX.
- Identification of software problem sources.
- Installation of customer replaceable units (CRUs).
- Installation and configuration of BIOS code, firmware, or device drivers that are designated as customer installable.

See the IBM Statement of Limited Warranty for a full explanation of IBM warranty terms. Be sure to retain your proof of purchase to obtain warranty service.

Please have the following information ready when you call:

- The machine type and model of your IBM hardware product (if available)
- Serial numbers of your IBM hardware products
- A description of the problem
- The exact wording of any error messages
- Hardware and software configuration information

## International Warranty Service

If you travel with your xSeries or IntelliStation system or relocate it to a country or region where your system is sold and serviced by IBM or IBM resellers authorized to perform warranty service, International Warranty Service (IWS) is available during the warranty period. Eligible IBM systems are identified by their four-digit machine types.

You can obtain IWS through the service delivery method (such as depot, carry-in, or on-site) provided in the servicing country or region. Service methods and procedures

vary by country or region, and some service or parts might not be available in all countries and regions. Service centers in certain countries or regions might not be able to service all models of a particular machine type. In addition, some countries or regions might have fees and restrictions that apply at the time of service.

To determine whether your system is eligible for IWS, go to <http://www.ibm.com/pc/support/> and click **Warranty lookup**.

## **Purchasing additional services**

During and after the warranty period, you can purchase additional services, such as support for IBM and non-IBM hardware, operating systems, and application programs; network setup and configuration; upgraded or extended hardware repair services; and custom installations. Service availability and service name might vary by country or region.

For more information about these services, contact your IBM marketing representative.

## **Part 1 - General Terms**

This Statement of Limited Warranty includes Part 1 - General Terms and Part 2 - Country-unique Terms. The terms of Part 2 replace or modify those of Part 1. The warranties provided by IBM in this Statement of Limited Warranty apply only to Machines you purchase for your use, and not for resale, from IBM or your reseller. The term "Machine" means an IBM machine, its features, conversions, upgrades, elements, or accessories, or any combination of them. The term "Machine" does not include any software programs, whether pre-loaded with the Machine, installed subsequently or otherwise. Unless IBM specifies otherwise, the following warranties apply only in the country where you acquire the Machine. Nothing in this Statement of Limited Warranty affects any statutory rights of consumers that cannot be waived or limited by contract. If you have any questions, contact IBM or your reseller.

**The IBM Warranty for Machines:** IBM warrants that each Machine 1) is free from defects in materials and workmanship and 2) conforms to IBM's Official Published Specifications ("Specifications"). The warranty period for a Machine is a specified, fixed period commencing on its Date of Installation. The date on your sales receipt is the Date of Installation unless IBM or your reseller informs you otherwise.

If a Machine does not function as warranted during the warranty period, and IBM or your reseller are unable to either 1) make it do so or 2) replace it with one that is at least functionally equivalent, you may return it to your place of purchase and your money will be refunded.

**Extent of Warranty:** The warranty does not cover the repair or exchange of a Machine resulting from misuse, accident, modification, unsuitable physical or operating environment, improper maintenance by you, or failure caused by a product for which IBM is not responsible. The warranty is voided by removal or alteration of Machine or parts identification labels.

**THESE WARRANTIES ARE YOUR EXCLUSIVE WARRANTIES AND REPLACE ALL OTHER WARRANTIES OR CONDITIONS, EXPRESS OR IMPLIED, INCLUDING, BUT NOT LIMITED TO, THE IMPLIED WARRANTIES OR CONDITIONS OF MERCHANTABILITY AND FITNESS FOR A PARTICULAR PURPOSE. THESE WARRANTIES GIVE YOU SPECIFIC LEGAL RIGHTS AND YOU MAY ALSO HAVE OTHER RIGHTS WHICH VARY FROM JURISDICTION TO JURISDICTION. SOME JURISDICTIONS DO NOT ALLOW THE EXCLUSION OR LIMITATION OF EXPRESS OR IMPLIED WARRANTIES, SO THE ABOVE EXCLUSION OR LIMITATION MAY NOT APPLY TO YOU. IN THAT EVENT, SUCH WARRANTIES ARE LIMITED IN DURATION TO THE WARRANTY PERIOD. NO WARRANTIES APPLY AFTER THAT PERIOD.**

**Items Not Covered by Warranty:** IBM does not warrant uninterrupted or error-free operation of a Machine. Any technical or other support provided for a Machine under warranty, such as assistance via telephone with "how-to" questions and those regarding Machine set-up and installation, will be provided **WITHOUT WARRANTIES OF ANY KIND.**

**Warranty Service:** To obtain warranty service for a Machine, contact IBM or your reseller. If you do not register your Machine with IBM, you may be required to present proof of purchase.

During the warranty period, IBM or your reseller, if approved by IBM to provide warranty service, provides without charge certain types of repair and exchange service to keep Machines in, or restore them to, conformance with their Specifications.

IBM or your reseller will inform you of the available types of service for a Machine based on its country of installation. At its discretion, IBM or your reseller will 1) either repair or exchange the failing Machine and 2) provide the service either at your location or a service center. IBM or your reseller will also manage and install selected engineering changes that apply to the Machine.

Some parts of IBM Machines are designated as Customer Replaceable Units (called "CRUs"), e.g., keyboards, memory, or hard disk drives. IBM ships CRUs to you for replacement by you. You must return all defective CRUs to IBM within 30 days of your receipt of the replacement CRU. You are responsible for downloading designated Machine Code and Licensed Internal Code updates from an IBM Internet Web site or from other electronic media, and following the instructions that IBM provides.

When warranty service involves the exchange of a Machine or part, the item IBM or your reseller replaces becomes its property and the replacement becomes yours. You represent that all removed items are genuine and unaltered. The replacement may not be new, but will be in good working order and at least functionally equivalent to the item replaced. The replacement assumes the warranty service status of the replaced item. Many features, conversions, or upgrades involve the removal of parts and their return to IBM. A part that replaces a removed part will assume the warranty service status of the removed part.

Before IBM or your reseller exchanges a Machine or part, you agree to remove all features, parts, options, alterations, and attachments not under warranty service.

You also agree to

1. ensure that the Machine is free of any legal obligations or restrictions that prevent its exchange;
2. obtain authorization from the owner to have IBM or your reseller service a Machine that you do not own; and
3. where applicable, before service is provided:
  - a. follow the problem determination, problem analysis, and service request procedures that IBM or your reseller provides;
  - b. secure all programs, data, and funds contained in a Machine;
  - c. provide IBM or your reseller with sufficient, free, and safe access to your facilities to permit them to fulfill their obligations; and
  - d. inform IBM or your reseller of changes in a Machine's location.

IBM is responsible for loss of, or damage to, your Machine while it is 1) in IBM's possession or 2) in transit in those cases where IBM is responsible for the transportation charges.

Neither IBM nor your reseller is responsible for any of your confidential, proprietary or personal information contained in a Machine which you return to IBM or your reseller for any reason. You should remove all such information from the Machine prior to its return.

**Limitation of Liability:** Circumstances may arise where, because of a default on IBM's part or other liability, you are entitled to recover damages from IBM. In each such instance, regardless of the basis on which you are entitled to claim damages from IBM (including fundamental breach, negligence, misrepresentation, or other contract or tort claim), except for any liability that cannot be waived or limited by applicable laws, IBM is liable for no more than

1. damages for bodily injury (including death) and damage to real property and tangible personal property; and
2. the amount of any other actual direct damages, up to the charges (if recurring, 12 months' charges apply) for the Machine that is subject of the claim. For purposes

of this item, the term "Machine" includes Machine Code and Licensed Internal Code.

This limit also applies to IBM's suppliers and your reseller. It is the maximum for which IBM, its suppliers, and your reseller are collectively responsible.

**UNDER NO CIRCUMSTANCES IS IBM LIABLE FOR ANY OF THE FOLLOWING: 1) THIRD-PARTY CLAIMS AGAINST YOU FOR DAMAGES (OTHER THAN THOSE UNDER THE FIRST ITEM LISTED ABOVE); 2) LOSS OF, OR DAMAGE TO, YOUR RECORDS OR DATA; OR 3) SPECIAL, INCIDENTAL, OR INDIRECT DAMAGES OR FOR ANY ECONOMIC CONSEQUENTIAL DAMAGES, LOST PROFITS OR LOST SAVINGS, EVEN IF IBM, ITS SUPPLIERS OR YOUR RESELLER IS INFORMED OF THEIR POSSIBILITY. SOME JURISDICTIONS DO NOT ALLOW THE EXCLUSION OR LIMITATION OF INCIDENTAL OR CONSEQUENTIAL DAMAGES, SO THE ABOVE LIMITATION OR EXCLUSION MAY NOT APPLY TO YOU.**

**Governing Law:** Both you and IBM consent to the application of the laws of the country in which you acquired the Machine to govern, interpret, and enforce all of your and IBM's rights, duties, and obligations arising from, or relating in any manner to, the subject matter of this Agreement, without regard to conflict of law principles.

## Part 2 - Country-unique Terms

### AMERICAS

#### **BRAZIL**

**Governing Law:** *The following is added after the first sentence:*

Any litigation arising from this Agreement will be settled exclusively by the court of Rio de Janeiro.

#### NORTH AMERICA

**Warranty Service:** *The following is added to this Section:*

To obtain warranty service from IBM in Canada or the United States, call 1-800-IBM-SERV (426-7378).

#### **CANADA**

**Governing Law:** *The following replaces "laws of the country in which you acquired the Machine" in the first sentence:*

laws in the Province of Ontario.

#### **UNITED STATES**

**Governing Law:** *The following replaces "laws of the country in which you acquired the Machine" in the first sentence:*

laws of the State of New York.

### ASIA PACIFIC

#### **AUSTRALIA**

**The IBM Warranty for Machines:** *The following paragraph is added to this Section:*

The warranties specified in this Section are in addition to any rights you may have under the Trade Practices Act 1974 or other similar legislation and are only limited to the extent permitted by the applicable legislation.

**Limitation of Liability:** *The following is added to this Section:*

Where IBM is in breach of a condition or warranty implied by the Trade Practices Act 1974 or other similar legislation, IBM's liability is limited to the repair or replacement of the goods or the supply of equivalent goods. Where that condition or warranty relates to right to sell, quiet possession or clear title, or the goods are of a kind ordinarily acquired for personal, domestic or household use or consumption, then none of the limitations in this paragraph apply.

**Governing Law:** *The following replaces "laws of the country in which you acquired the Machine" in the first sentence:*  
laws of the State or Territory.

## **CAMBODIA, LAOS, AND VIETNAM**

**Governing Law:** *The following replaces "laws of the country in which you acquired the Machine" in the first sentence:*  
laws of the State of New York.

*The following is added to this Section:*

Disputes and differences arising out of or in connection with this Agreement shall be finally settled by arbitration which shall be held in Singapore in accordance with the rules of the International Chamber of Commerce (ICC). The arbitrator or arbitrators designated in conformity with those rules shall have the power to rule on their own competence and on the validity of the Agreement to submit to arbitration. The arbitration award shall be final and binding for the parties without appeal and the arbitral award shall be in writing and set forth the findings of fact and the conclusions of law.

All proceedings shall be conducted, including all documents presented in such proceedings, in the English language. The number of arbitrators shall be three, with each side to the dispute being entitled to appoint one arbitrator.

The two arbitrators appointed by the parties shall appoint a third arbitrator before proceeding upon the reference. The third arbitrator shall act as chairman of the proceedings. Vacancies in the post of chairman shall be filled by the president of the ICC. Other vacancies shall be filled by the respective nominating party. Proceedings shall continue from the stage they were at when the vacancy occurred.

If one of the parties refuses or otherwise fails to appoint an arbitrator within 30 days of the date the other party appoints its, the first appointed arbitrator shall be the sole arbitrator, provided that the arbitrator was validly and properly appointed.

The English language version of this Agreement prevails over any other language version.

## **HONG KONG AND MACAU**

**Governing Law:** *The following replaces "laws of the country in which you acquired the Machine" in the first sentence:*  
laws of Hong Kong Special Administrative Region.

## **INDIA**

**Limitation of Liability:** *The following replaces items 1 and 2 of this Section:*

1. liability for bodily injury (including death) or damage to real property and tangible personal property will be limited to that caused by IBM's negligence;
2. as to any other actual damage arising in any situation involving nonperformance by IBM pursuant to, or in any way related to the subject of this Statement of

Limited Warranty, IBM's liability will be limited to the charge paid by you for the individual Machine that is the subject of the claim.

## **JAPAN**

**Governing Law:** *The following sentence is added to this Section:*

Any doubts concerning this Agreement will be initially resolved between us in good faith and in accordance with the principle of mutual trust.

## **NEW ZEALAND**

**The IBM Warranty for Machines:** *The following paragraph is added to this Section:*

The warranties specified in this Section are in addition to any rights you may have under the Consumer Guarantees Act 1993 or other legislation which cannot be excluded or limited. The Consumer Guarantees Act 1993 will not apply in respect of any goods which IBM provides, if you require the goods for the purposes of a business as defined in that Act.

**Limitation of Liability:** *The following is added to this Section:*

Where Machines are not acquired for the purposes of a business as defined in the Consumer Guarantees Act 1993, the limitations in this Section are subject to the limitations in that Act.

## **PEOPLE'S REPUBLIC OF CHINA (PRC)**

**Governing Law:** *The following replaces this Section:*

Both you and IBM consent to the application of the laws of the State of New York (except when local law requires otherwise) to govern, interpret, and enforce all your and IBM's rights, duties, and obligations arising from, or relating in any manner to, the subject matter of this Agreement, without regard to conflict of law principles.

Any disputes arising from or in connection with this Agreement will first be resolved by friendly negotiations, failing which either of us has the right to submit the dispute to the China International Economic and Trade Arbitration Commission in Beijing, the PRC, for arbitration in accordance with its arbitration rules in force at the time. The arbitration tribunal will consist of three arbitrators. The language to be used therein will be English and Chinese. An arbitral award will be final and binding on all the parties, and will be enforceable under the Convention on the Recognition and Enforcement of Foreign Arbitral Awards (1958).

The arbitration fee will be borne by the losing party unless otherwise determined by the arbitral award.

During the course of arbitration, this Agreement will continue to be performed except for the part which the parties are disputing and which is undergoing arbitration.

## **EUROPE, MIDDLE EAST, AFRICA (EMEA)**

**THE FOLLOWING TERMS APPLY TO ALL EMEA COUNTRIES:**

The terms of this Statement of Limited Warranty apply to Machines purchased from IBM or an IBM reseller.

**Warranty Service:** If you purchase an IBM Machine in Austria, Belgium, Denmark, Estonia, Finland, France, Germany, Greece, Iceland, Ireland, Italy, Latvia, Lithuania, Luxembourg, Netherlands, Norway, Portugal, Spain, Sweden, Switzerland or United Kingdom, you may obtain warranty service for that Machine in any of those countries from either (1) an IBM reseller approved to perform warranty service or (2) from IBM. If you purchase an IBM Personal Computer Machine in Albania, Armenia, Belarus,



Bosnia and Herzegovina, Bulgaria, Croatia, Czech Republic, Georgia, Hungary, Kazakhstan, Kirghizia, Federal Republic of Yugoslavia, Former Yugoslav Republic of Macedonia (FYROM), Moldova, Poland, Romania, Russia, Slovak Republic, Slovenia, or Ukraine, you may obtain warranty service for that Machine in any of those countries from either (1) an IBM reseller approved to perform warranty service or (2) from IBM.

If you purchase an IBM Machine in a Middle Eastern or African country, you may obtain warranty service for that Machine from the IBM entity within the country of purchase, if that IBM entity provides warranty service in that country, or from an IBM reseller, approved by IBM to perform warranty service on that Machine in that country. Warranty service in Africa is available within 50 kilometers of an IBM authorized service provider. You are responsible for transportation costs for Machines located outside 50 kilometers of an IBM authorized service provider.

**Governing Law:** The applicable laws that govern, interpret and enforce rights, duties, and obligations of each of us arising from, or relating in any manner to, the subject matter of this Statement, without regard to conflict of laws principles, as well as Country-unique terms and competent court for this Statement are those of the country in which the warranty service is being provided, except that in 1) Albania, Bosnia-Herzegovina, Bulgaria, Croatia, Hungary, Former Yugoslav Republic of Macedonia, Romania, Slovakia, Slovenia, Armenia, Azerbaijan, Belarus, Georgia, Kazakhstan, Kyrgyzstan, Moldova, Russia, Tajikistan, Turkmenistan, Ukraine, and Uzbekistan, the laws of Austria apply; 2) Estonia, Latvia, and Lithuania, the laws of Finland apply; 3) Algeria, Benin, Burkina Faso, Cameroon, Cape Verde, Central African Republic, Chad, Congo, Djibouti, Democratic Republic of Congo, Equatorial Guinea, France, Gabon, Gambia, Guinea, Guinea-Bissau, Ivory Coast, Lebanon, Mali, Mauritania, Morocco, Niger, Senegal, Togo, and Tunisia, this Agreement will be construed and the legal relations between the parties will be determined in accordance with the French laws and all disputes arising out of this Agreement or related to its violation or execution, including summary proceedings, will be settled exclusively by the Commercial Court of Paris; 4) Angola, Bahrain, Botswana, Burundi, Egypt, Eritrea, Ethiopia, Ghana, Jordan, Kenya, Kuwait, Liberia, Malawi, Malta, Mozambique, Nigeria, Oman, Pakistan, Qatar, Rwanda, Sao Tome, Saudi Arabia, Sierra Leone, Somalia, Tanzania, Uganda, United Arab Emirates, United Kingdom, West Bank/Gaza, Yemen, Zambia, and Zimbabwe, this Agreement will be governed by English Law and disputes relating to it will be submitted to the exclusive jurisdiction of the English courts; and 5) in Greece, Israel, Italy, Portugal, and Spain any legal claim arising out of this Statement will be brought before, and finally settled by, the competent court of Athens, Tel Aviv, Milan, Lisbon, and Madrid, respectively.

***THE FOLLOWING TERMS APPLY TO THE COUNTRY SPECIFIED:***

**AUSTRIA AND GERMANY**

**The IBM Warranty for Machines:** *The following replaces the first sentence of the first paragraph of this Section:*

The warranty for an IBM Machine covers the functionality of the Machine for its normal use and the Machine's conformity to its Specifications.

*The following paragraphs are added to this Section:*

The minimum warranty period for Machines is six months. In case IBM or your reseller is unable to repair an IBM Machine, you can alternatively ask for a partial refund as far as justified by the reduced value of the unrepaired Machine or ask for a cancellation of the respective agreement for such Machine and get your money refunded.

**Extent of Warranty:** *The second paragraph does not apply.*

**Warranty Service:** *The following is added to this Section:*

During the warranty period, transportation for delivery of the failing Machine to IBM will be at IBM's expense.

**Limitation of Liability:** *The following paragraph is added to this Section:*

The limitations and exclusions specified in the Statement of Limited Warranty will not apply to damages caused by IBM with fraud or gross negligence and for express warranty.

*The following sentence is added to the end of item 2:*

IBM's liability under this item is limited to the violation of essential contractual terms in cases of ordinary negligence.

## EGYPT

**Limitation of Liability:** *The following replaces item 2 in this Section:*

as to any other actual direct damages, IBM's liability will be limited to the total amount you paid for the Machine that is the subject of the claim. For purposes of this item, the term "Machine" includes Machine Code and Licensed Internal Code.

*Applicability of suppliers and resellers (unchanged).*

## FRANCE

**Limitation of Liability:** *The following replaces the second sentence of the first paragraph of this Section:*

In such instances, regardless of the basis on which you are entitled to claim damages from IBM, IBM is liable for no more than: *(items 1 and 2 unchanged).*

## IRELAND

**Extent of Warranty:** *The following is added to this Section:*

Except as expressly provided in these terms and conditions, all statutory conditions, including all warranties implied, but without prejudice to the generality of the foregoing all warranties implied by the Sale of Goods Act 1893 or the Sale of Goods and Supply of Services Act 1980 are hereby excluded.

**Limitation of Liability:** *The following replaces items one and two of the first paragraph of this Section:*

1. death or personal injury or physical damage to your real property solely caused by IBM's negligence; and
2. the amount of any other actual direct damages, up to 125 percent of the charges (if recurring, the 12 months' charges apply) for the Machine that is the subject of the claim or which otherwise gives rise to the claim.

*Applicability of suppliers and resellers (unchanged).*

*The following paragraph is added at the end of this Section:*

IBM's entire liability and your sole remedy, whether in contract or in tort, in respect of any default shall be limited to damages.

## ITALY

**Limitation of Liability:** *The following replaces the second sentence in the first paragraph:*

In each such instance unless otherwise provided by mandatory law, IBM is liable for no more than:

1. *(unchanged)*
2. as to any other actual damage arising in all situations involving nonperformance by

IBM pursuant to, or in any way related to the subject matter of this Statement of Warranty, IBM's liability, will be limited to the total amount you paid for the Machine that is the subject of the claim.

*Applicability of suppliers and resellers (unchanged).*

*The following replaces the third paragraph of this Section:*

Unless otherwise provided by mandatory law, IBM and your reseller are not liable for any of the following: *(items 1 and 2 unchanged)* 3) indirect damages, even if IBM or your reseller is informed of their possibility.

## **SOUTH AFRICA, NAMIBIA, BOTSWANA, LESOTHO AND SWAZILAND**

**Limitation of Liability:** *The following is added to this Section:*

IBM's entire liability to you for actual damages arising in all situations involving nonperformance by IBM in respect of the subject matter of this Statement of Warranty will be limited to the charge paid by you for the individual Machine that is the subject of your claim from IBM.

## **UNITED KINGDOM**

**Limitation of Liability:** *The following replaces items 1 and 2 of the first paragraph of this Section:*

1. death or personal injury or physical damage to your real property solely caused by IBM's negligence;
2. the amount of any other actual direct damages or loss, up to 125 percent of the charges (if recurring, the 12 months' charges apply) for the Machine that is the subject of the claim or which otherwise gives rise to the claim;

*The following item is added to this paragraph:*

3. breach of IBM's obligations implied by Section 12 of the Sale of Goods Act 1979 or Section 2 of the Supply of Goods and Services Act 1982.

*Applicability of suppliers and resellers (unchanged).*

*The following is added to the end of this Section:*

IBM's entire liability and your sole remedy, whether in contract or in tort, in respect of any default shall be limited to damages.



---

## Appendix C. Notices

This publication was developed for products and services offered in the U.S.A.

IBM may not offer the products, services, or features discussed in this document in other countries. Consult your local IBM representative for information on the products and services currently available in your area. Any reference to an IBM product, program, or service is not intended to state or imply that only that IBM product, program, or service may be used. Any functionally equivalent product, program, or service that does not infringe any IBM intellectual property right may be used instead. However, it is the user's responsibility to evaluate and verify the operation of any non-IBM product, program, or service.

IBM may have patents or pending patent applications covering subject matter described in this document. The furnishing of this document does not give you any license to these patents. You can send license inquiries, in writing, to:

*IBM Director of Licensing  
IBM Corporation  
North Castle Drive  
Armonk, NY 10504-1785  
U.S.A.*

INTERNATIONAL BUSINESS MACHINES CORPORATION PROVIDES THIS PUBLICATION "AS IS" WITHOUT WARRANTY OF ANY KIND, EITHER EXPRESS OR IMPLIED, INCLUDING, BUT NOT LIMITED TO, THE IMPLIED WARRANTIES OF NON-INFRINGEMENT, MERCHANTABILITY OR FITNESS FOR A PARTICULAR PURPOSE. Some jurisdictions do not allow disclaimer of express or implied warranties in certain transactions, therefore, this statement may not apply to you.

This information could include technical inaccuracies or typographical errors. Changes are periodically made to the information herein; these changes will be incorporated in new editions of the publication. IBM may make improvements and/or changes in the product(s) and/or the program(s) described in this publication at any time without notice.

Any references in this publication to non-IBM Web sites are provided for convenience only and do not in any manner serve as an endorsement of those Web sites. The materials at those Web sites are not part of the materials for this IBM product, and use of those Web sites is at your own risk.

IBM may use or distribute any of the information you supply in any way it believes appropriate without incurring any obligation to you.

---

### Edition notice

**© COPYRIGHT INTERNATIONAL BUSINESS MACHINES CORPORATION, 2002.  
All rights reserved.**

Note to U.S. Government Users — Documentation related to restricted rights — Use, duplication or disclosure is subject to restrictions set forth in GSA ADP Schedule Contract with IBM Corp.

---

## Trademarks

The following terms are trademarks of International Business Machines Corporation in the United States, other countries, or both:

Alert on LAN	ServerGuide
e-business logo	ServerProven
IBM	TechConnect
Light Path Diagnostics	Update Connector
Predictive Failure Analysis	Wake on LAN
PS/2	X-Architecture
ServeRAID	xSeries

Lotus, Lotus Notes, SmartSuite, and Domino are trademarks of Lotus Development Corporation and/or IBM Corporation in the United States, other countries, or both.

Intel, Celeron, LANDesk, MMX, NetBurst, Pentium, Pentium II Xeon, Pentium III Xeon, and Xeon are trademarks of Intel Corporation in the United States, other countries, or both.

Microsoft, Windows, and Windows NT are trademarks of Microsoft Corporation in the United States, other countries, or both.

UNIX is a registered trademark of The Open Group in the United States and other countries.

Java and all Java-based trademarks and logos are trademarks or registered trademarks of Sun Microsystems, Inc. in the United States, other countries, or both.

Linux is a registered trademark of Linus Torvalds.

Other company, product, or service names may be trademarks or service marks of others.

---

## Important notes

Processor speeds indicate the internal clock speed of the microprocessor; other factors also affect application performance.

CD-ROM drive speeds list the variable read rate. Actual speeds vary and are often less than the maximum possible.

When referring to processor storage, real and virtual storage, or channel volume, KB stands for approximately 1000 bytes, MB stands for approximately 1 000 000 bytes, and GB stands for approximately 1 000 000 000 bytes.

When referring to hard disk drive capacity or communications volume, MB stands for 1 000 000 bytes, and GB stands for 1 000 000 000 bytes. Total user-accessible capacity may vary depending on operating environments.

Maximum internal hard disk drive capacities assume the replacement of any standard hard disk drives and population of all hard disk drive bays with the largest currently supported drives available from IBM.

Maximum memory may require replacement of the standard memory with an optional memory module.

IBM makes no representation or warranties regarding non-IBM products and services that are ServerProven, including but not limited to the implied warranties of merchantability and fitness for a particular purpose. These products are offered and warranted solely by third parties.

IBM makes no representations or warranties with respect to non-IBM products. Support (if any) for the non-IBM products is provided by the third party, not IBM.

Some software may differ from its retail version (if available), and may not include user manuals or all program functionality.

---

## Electronic emission notices

IBM xSeries 205 Type 8480

## Federal Communications Commission (FCC) statement

**Note:** This equipment has been tested and found to comply with the limits for a Class B digital device, pursuant to Part 15 of the FCC Rules. These limits are designed to provide reasonable protection against harmful interference in a residential installation. This equipment generates, uses, and can radiate radio frequency energy and, if not installed and used in accordance with the instructions, may cause harmful interference to radio communications. However, there is no guarantee that interference will not occur in a particular installation. If this equipment does cause harmful interference to radio or television reception, which can be determined by turning the equipment off and on, the user is encouraged to try to correct the interference by one or more of the following measures:

- Reorient or relocate the receiving antenna.
- Increase the separation between the equipment and receiver.
- Connect the equipment into an outlet on a circuit different from that to which the receiver is connected.
- Consult an IBM authorized dealer or service representative for help.

Properly shielded and grounded cables and connectors must be used in order to meet FCC emission limits. Proper cables and connectors are available from IBM authorized dealers. IBM is not responsible for any radio or television interference caused by using other than recommended cables and connectors or by unauthorized changes or modifications to this equipment. Unauthorized changes or modifications could void the user's authority to operate the equipment.

This device complies with Part 15 of the FCC Rules. Operation is subject to the following two conditions: (1) this device may not cause harmful interference, and (2) this device must accept any interference received, including interference that may cause undesired operation.

Responsible party:

International Business Machines Corporation  
New Orchard Road  
Armonk, NY 10504

Telephone: 1-919-543-2193

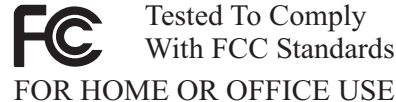

## Industry Canada Class B emission compliance statement

This Class B digital apparatus complies with Canadian ICES-003.

## Avis de conformité à la réglementation d'Industrie Canada

Cet appareil numérique de la classe B est conforme à la norme NMB-003 du Canada.

## European Union EMC Directive conformance statement

This product is in conformity with the protection requirements of EU Council Directive 89/336/EEC on the approximation of the laws of the Member States relating to electromagnetic compatibility. IBM cannot accept responsibility for any failure to satisfy the protection requirements resulting from a nonrecommended modification of the product, including the fitting of non-IBM option cards.

This product has been tested and found to comply with the limits for Class B Information Technology Equipment according to CISPR 22/European Standard EN 55022. The limits for Class B equipment were derived for typical residential environments to provide reasonable protection against interference with licensed communication devices.

## Japanese Voluntary Control Council for Interference (VCCI) statement

この装置は、情報処理装置等電波障害自主規制協議会（VCCI）の基準に基づくクラスB情報技術装置です。この装置は、家庭環境で使用することを目的としていますが、この装置がラジオやテレビジョン受信機に近接して使用されると、受信障害を引き起こすことがあります。  
取扱説明書に従って正しい取り扱いをして下さい。

---

## Power cords

For your safety, IBM provides a power cord with a grounded attachment plug to use with this IBM product. To avoid electrical shock, always use the power cord and plug with a properly grounded outlet.

IBM power cords used in the United States and Canada are listed by Underwriter's Laboratories (UL) and certified by the Canadian Standards Association (CSA).

For units intended to be operated at 115 volts: Use a UL-listed and CSA-certified cord set consisting of a minimum 18 AWG, Type SVT or SJT, three-conductor cord, a maximum of 15 feet in length and a parallel blade, grounding-type attachment plug rated 15 amperes, 125 volts.

For units intended to be operated at 230 volts (U.S. use): Use a UL-listed and CSA-certified cord set consisting of a minimum 18 AWG, Type SVT or SJT, three-conductor cord, a maximum of 15 feet in length and a tandem blade, grounding-type attachment plug rated 15 amperes, 250 volts.

For units intended to be operated at 230 volts (outside the U.S.): Use a cord set with a grounding-type attachment plug. The cord set should have the appropriate safety approvals for the country in which the equipment will be installed.



IBM power cords for a specific country or region are usually available only in that country or region.

IBM power cord part number	Used in these countries and regions
13F9940	Argentina, Australia, China (PRC), New Zealand, Papua New Guinea, Paraguay, Uruguay, Western Samoa
13F9979	Afghanistan, Algeria, Andorra, Angola, Austria, Belgium, Benin, Bulgaria, Burkina Faso, Burundi, Cameroon, Central African Rep., Chad, China (Macau S.A.R.), Czech Republic, Egypt, Finland, France, French Guiana, Germany, Greece, Guinea, Hungary, Iceland, Indonesia, Iran, Ivory Coast, Jordan, Lebanon, Luxembourg, Malagasy, Mali, Martinique, Mauritania, Mauritius, Monaco, Morocco, Mozambique, Netherlands, New Caledonia, Niger, Norway, Poland, Portugal, Romania, Senegal, Slovakia, Spain, Sudan, Sweden, Syria, Togo, Tunisia, Turkey, former USSR, Vietnam, former Yugoslavia, Zaire, Zimbabwe
13F9997	Denmark
14F0015	Bangladesh, Burma, Pakistan, South Africa, Sri Lanka
14F0033	Antigua, Bahrain, Brunei, Channel Islands, China (Hong Kong S.A.R.), Cyprus, Dubai, Fiji, Ghana, India, Iraq, Ireland, Kenya, Kuwait, Malawi, Malaysia, Malta, Nepal, Nigeria, Polynesia, Qatar, Sierra Leone, Singapore, Tanzania, Uganda, United Kingdom, Yemen, Zambia
14F0051	Liechtenstein, Switzerland
14F0069	Chile, Ethiopia, Italy, Libya, Somalia
14F0087	Israel
1838574	Thailand
6952301	Bahamas, Barbados, Bermuda, Bolivia, Brazil, Canada, Cayman Islands, Colombia, Costa Rica, Dominican Republic, Ecuador, El Salvador, Guatemala, Guyana, Haiti, Honduras, Jamaica, Japan, Korea (South), Liberia, Mexico, Netherlands Antilles, Nicaragua, Panama, Peru, Philippines, Saudi Arabia, Suriname, Taiwan, Trinidad (West Indies), United States of America, Venezuela



# Index

## A

acoustical noise emissions 3  
administrator password 15, 18

## B

Broadcom NetXtreme Gigabit Ethernet Boot Agent  
20

## C

CD-ROM drive  
    activity LED 6  
    eject button 6  
    specifications 3  
configuration  
    with ServerGuide 21  
configuration programs  
    Boot Menu program 11  
    Broadcom NetXtreme Gigabit Ethernet Boot  
        Agent Utility 11  
    Configuration/Setup Utility program 11  
    Ethernet controller configuration process 11  
    general 11  
    SCSISelect Utility program 11  
    Server Guide Setup and Installation CD 11  
Configuration/Setup Utility program  
    menu choices 12  
    starting 11  
    using 11  
configuring  
    server 11  
configuring the server 11  
connector  
    audio 7  
    Ethernet 7  
    keyboard 7  
    mouse 7  
    parallel 7  
    power cord 7  
    serial 7  
    universal serial bus (USB) 7

## D

depth 3  
Device Drivers and IBM Enhanced Diagnostics CD 5  
diskette  
    drive activity LED 6  
    eject button 6  
diskette drive  
    preinstalled 3

## E

electrical input 3  
environment  
    air temperature 3  
    humidity 3  
Ethernet  
    configuring 23  
    connector 7  
    controller 4  
    Gigabit Ethernet controller 23  
    speed LED 6  
    transmit/receive activity LED 6  
expansion  
    bays 3  
    PCI slots 3

## F

Fast Ethernet 24  
features  
    power 8  
    RAS 5  
    server 3  
    ServerGuide 21

## H

hard disk drive  
    activity LED 6  
heat output 3

## I

IBM Director 5  
input/output (I/O)  
    address 13  
    devices 13  
    ports 13  
integrated  
    functions 3  
    network environment support 4

## J

jumper  
    boot block 19  
    password check 19

## L

local area network (LAN) 4

## M

memory  
  modules 4  
  specifications 3, 4  
  system 4  
model number 1

## N

NOS installation  
  with ServerGuide 22  
  without ServerGuide 23  
notes, important 42  
notices  
  attention 2  
  book 2  
  caution 2  
  danger 2  
  important 2

## P

password  
  administrator 15, 18  
  check jumper 15, 19  
  setting 15  
  using 18  
power  
  control button 6  
  cords 44  
  indicator LED 6  
  management 15  
  supply 3

## R

RAS features 5  
related publications 2

## S

SCSISelect Utility program  
  general 11  
  menu choices 25  
  starting 24  
  using 24  
serial number 1  
server  
  model number 1  
  serial number 1  
ServerGuide  
  features 21  
  NOS installation 22  
  setting up multiple servers 23  
  Setup and Installation CD 20

  using 20  
setting  
  administrator password 18  
  password check jumper 19  
  user password 18  
setting up  
  multiple servers 23  
setup  
  with ServerGuide 21  
size 3  
software coupon  
  ServerGuide 20  
specifications  
  memory 3  
  server 3  
starting  
  Configuration/Setup Utility program 11  
  SCSISelect Utility program 24  
statements  
  attention 2  
  caution 2  
  danger 2  
  important 2  
system  
  partition 22  
system management capabilities 4

## T

temperature, air 3  
trademarks 42

## U

using  
  Boot Menu program 25  
  Configuration/Setup Utility program 11  
  passwords 15, 18  
  SCSISelect Utility program 24  
  ServerGuide  
    Setup and Installation CD 20  
utility  
  Configuration/Setup 11  
  SCSISelect 24

## V

video controller 3  
  connector 7  
  support 4

## W

Web site, ServerGuide 20  
weight 3  
width 3

# X

X-Architecture  
features 4  
technologies 1







Part Number: 02R2937

Printed in the United States of America.

02R2937

