



xSeries 205 Type 8480

Installation Guide

Welcome...

Thank you for buying an IBM xSeries server.

This server *Installation Guide* contains information for setting up and configuring your server.

For detailed information about your server, view the *User's Guide* on the Documentation CD.

You can also find the most current information about your server on the IBM Web site at: <http://www.ibm.com/pc/support>

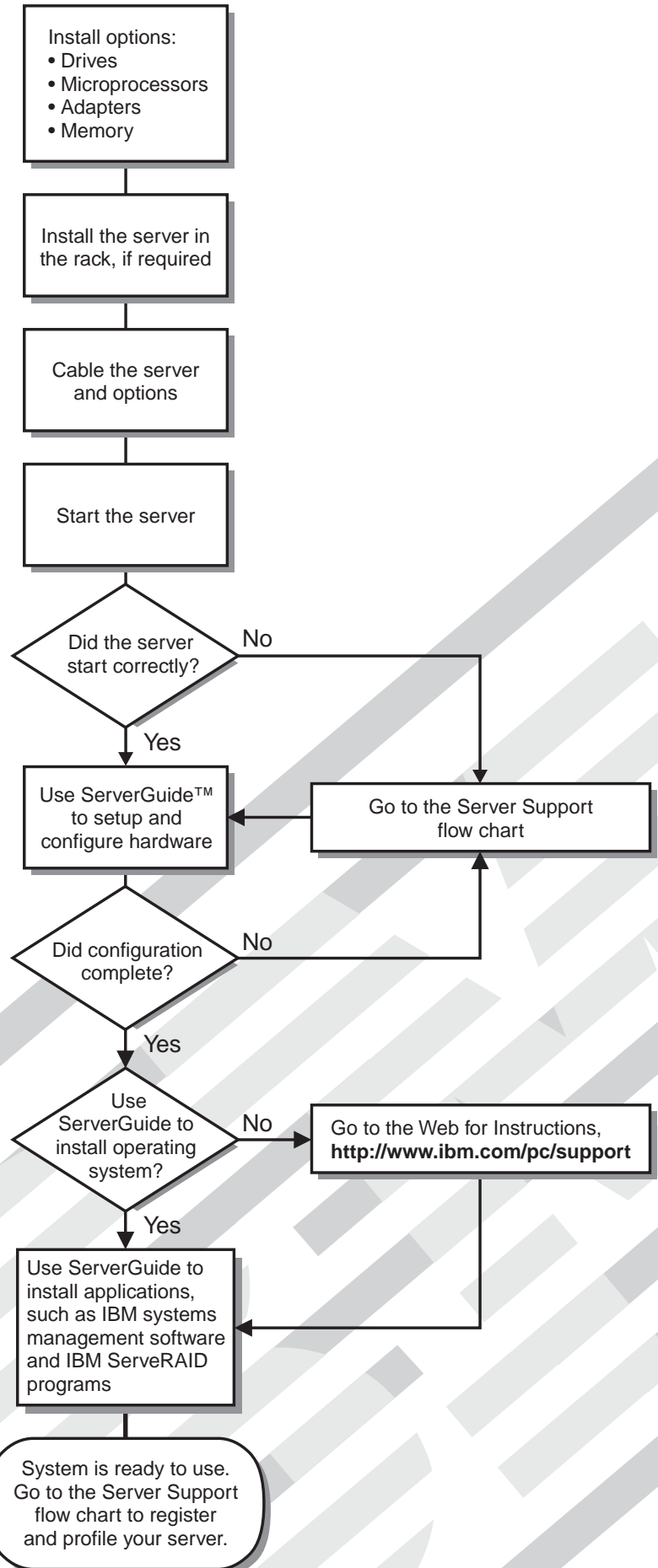

Server Support

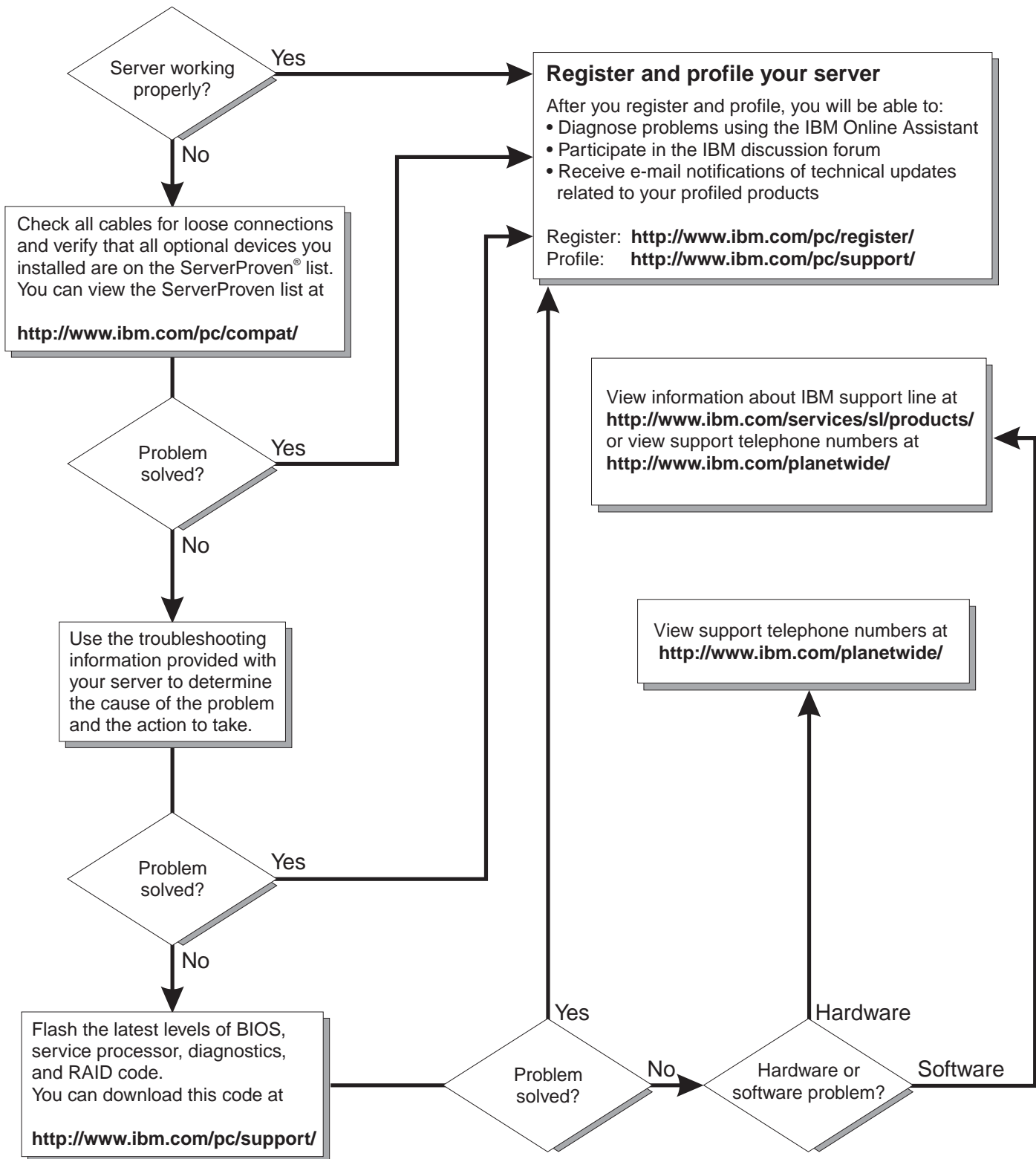

IBM xSeries 205
Type 8480



Installation Guide

Note:

Before using this information and the product it supports, be sure to read the general information in Appendix B, "Warranty information" on page 43 and Appendix C, "Notices" on page 55.

First Edition (August 2002)

© Copyright International Business Machines Corporation 2002. All rights reserved.

US Government Users Restricted Rights – Use, duplication or disclosure restricted by GSA ADP Schedule Contract with IBM Corp.

Contents

Safety	v
Chapter 1. Introduction	1
Features and specifications	2
Notices and statements used in this book	3
Major components of the xSeries 205 Type 8480.	3
System-board internal cable connectors	4
Chapter 2. Installing options	5
Installation guidelines	5
System reliability guidelines	5
Working inside the server with the power on	5
Handling static-sensitive devices	6
Moving the stabilizing feet.	6
Removing the side cover	8
Removing the frame-support bracket	9
Working with adapters	10
Adapter considerations.	10
Installing an adapter	11
Installing a SCSI or RAID adapter	13
Installing internal drives	14
Preinstallation steps (all bays)	15
Power and signal cables for internal drives	15
Installing a drive in bay 2 or 4.	16
Installing a non-hot-swap hard disk drive in bay 5, 6, or 7	19
Installing a hot-swap hard disk drive in bay 5, 6, or 7.	20
Installing memory modules.	23
Installing a security rope clip.	24
Installing the side cover	25
Cabling the server.	26
Chapter 3. Server controls, LEDs, and power	29
Server controls and LEDs.	29
Server power features.	30
Turning on the server	30
Turning off the server	30
Standby mode	31
Chapter 4. Configuring your server	33
Starting the Configuration/Setup Utility program	33
Starting the Broadcom NetXtreme Gigabit Ethernet Boot Agent program	34
Starting the SCSISelect Utility program	34
Using the ServerGuide Setup and Installation CD	34
Chapter 5. Solving problems	35
Diagnostic tools overview	35
Power-on self-test (POST)	35
POST beep codes	36
POST error messages	36
ServerGuide startup problems	37
Troubleshooting chart	38
Appendix A. Getting help and technical assistance	41
Before you call	41

Using the documentation	41
Getting help and information from the World Wide Web	41
Software service and support.	42
Hardware service and support	42
Appendix B. Warranty information	43
Warranty period	43
Problem determination.	43
Warranty service and support	44
International Warranty Service	44
Purchasing additional services.	45
IBM Statement of Limited Warranty Z125-4753-06 8/2000	46
Part 1 - General Terms.	46
Part 2 - Country-unique Terms	48
Appendix C. Notices.	55
Edition notice	55
Trademarks.	56
Important notes	56
Electronic emission notices	57
Federal Communications Commission (FCC) statement.	57
Industry Canada Class B emission compliance statement	58
Avis de conformité à la réglementation d'Industrie Canada.	58
European Union EMC Directive conformance statement.	58
Japanese Voluntary Control Council for Interference (VCCI) statement	58
Power cords	58
Index	61

Safety

Before installing this product, read the Safety Information.

قبل تركيب هذا المنتج، يجب قراءة الملاحظات الأمنية

Antes de instalar este produto, leia as Informações de Segurança.

在安装本产品之前，请仔细阅读 **Safety Information** (安全信息)。

安裝本產品之前，請先閱讀「安全資訊」。

Prije instalacije ovog produkta obavezno pročitajte Sigurnosne Upute.

Před instalací tohoto produktu si přečtěte příručku bezpečnostních instrukcí.

Læs sikkerhedsforskrifterne, før du installerer dette produkt.

Lees voordat u dit product installeert eerst de veiligheidsvoorschriften.

Ennen kuin asennat tämän tuotteen, lue turvaohjeet kohdasta Safety Information.

Avant d'installer ce produit, lisez les consignes de sécurité.

Vor der Installation dieses Produkts die Sicherheitshinweise lesen.

Πριν εγκαταστήσετε το προϊόν αυτό, διαβάστε τις πληροφορίες ασφάλειας (safety information).

לפני שתתקינו מוצר זה, קראו את הוראות הבטיחות.

A termék telepítése előtt olvassa el a Biztonsági előírásokat!

Prima di installare questo prodotto, leggere le Informazioni sulla Sicurezza

本製品を導入する前に、安全情報資料を御読みください。

본 제품을 설치하기 전에 안전 정보를 읽으십시오.

Пред да се инсталира овој продукт, прочитајте информацијата за безбедност.

Les sikkerhetsinformasjonen (Safety Information) før du installerer dette produktet.

Przed zainstalowaniem tego produktu, należy zapoznać się z książką "Informacje dotyczące bezpieczeństwa" (Safety Information).

Antes de instalar este produto, leia as Informações sobre Segurança.

Перед установкой продукта прочтите инструкции по технике безопасности.

Pred inštaláciou tohto zariadenia si pečítajte Bezpečnostné predpisy.

Pred namestitvijo tega proizvoda preberite Varnostne informacije.

Antes de instalar este producto lea la información de seguridad.

Läs säkerhetsinformationen innan du installerar den här produkten.

Statement 1:



DANGER

Electrical current from power, telephone, and communication cables is hazardous.

To avoid a shock hazard:

- **Do not connect or disconnect any cables or perform installation, maintenance, or reconfiguration of this product during an electrical storm.**
- **Connect all power cords to a properly wired and grounded electrical outlet.**
- **Connect to properly wired outlets any equipment that will be attached to this product.**
- **When possible, use one hand only to connect or disconnect signal cables.**
- **Never turn on any equipment when there is evidence of fire, water, or structural damage.**
- **Disconnect the attached power cords, telecommunications systems, networks, and modems before you open the device covers, unless instructed otherwise in the installation and configuration procedures.**
- **Connect and disconnect cables as described in the following table when installing, moving, or opening covers on this product or attached devices.**

To Connect:	To Disconnect:
1. Turn everything OFF.	1. Turn everything OFF.
2. First, attach all cables to devices.	2. First, remove power cords from outlet.
3. Attach signal cables to connectors.	3. Remove signal cables from connectors.
4. Attach power cords to outlet.	4. Remove all cables from devices.
5. Turn device ON.	

Statement 2:



CAUTION:

When replacing the lithium battery, use only IBM® Part Number 33F8354 or an equivalent type battery recommended by the manufacturer. If your system has a module containing a lithium battery, replace it only with the same module type made by the same manufacturer. The battery contains lithium and can explode if not properly used, handled, or disposed of.

Do not:

- Throw or immerse into water
- Heat to more than 100° C (212° F)
- Repair or disassemble

Dispose of the battery as required by local ordinances or regulations.

Statement 3:



CAUTION:

When laser products (such as CD-ROMs, DVD drives, fiber optic devices, or transmitters) are installed, note the following:

- Do not remove the covers. Removing the covers of the laser product could result in exposure to hazardous laser radiation. There are no serviceable parts inside the device.
- Use of controls or adjustments or performance of procedures other than those specified herein might result in hazardous radiation exposure.



DANGER

Some laser products contain an embedded Class 3A or Class 3B laser diode. Note the following.

Laser radiation when open. Do not stare into the beam, do not view directly with optical instruments, and avoid direct exposure to the beam.

Class 1 Laser Product
Laser Klasse 1
Laser Klass 1
Luokan 1 Laserlaite
Appareil À Laser de Classe 1

Statement 4:

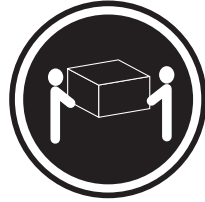

≥ 18 kg (39.7 lb)



≥ 32 kg (70.5 lb)

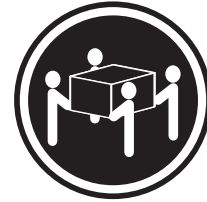

≥ 55 kg (121.2 lb)

CAUTION:
Use safe practices when lifting.

Statement 5:



CAUTION:
The power control button on the device and the power switch on the power supply do not turn off the electrical current supplied to the device. The device also might have more than one power cord. To remove all electrical current from the device, ensure that all power cords are disconnected from the power source.

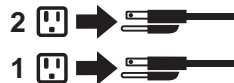

Statement 8:



CAUTION:

Never remove the cover on a power supply or any part that has the following label attached.



Hazardous voltage, current, and energy levels are present inside any component that has this label attached. There are no serviceable parts inside these components. If you suspect a problem with one of these parts, contact a service technician.

Chapter 1. Introduction

Thank you for purchasing an IBM® *@server* xSeries™ 205 Type 8480 server with IBM X-Architecture™ technologies. This *Installation Guide* contains instructions for setting up your IBM xSeries 205 Type 8480 server and basic instructions for installing some options. More detailed instructions are in the *Option Installation Guide* on the IBM *xSeries Documentation* CD, which comes with your server. This publication contains information about:

- Setting up and cabling your server
- Starting and configuring your server
- Installing your operating system

Packaged with this Installation Guide are software CDs that you can use to configure the hardware, install device drivers, and install the operating system.

Also included is an IBM Documentation CD that contains detailed information about this server.

If you have access to the World Wide Web, you can obtain up-to-date information about your server and other IBM server products at <http://www.ibm.com/eserver/xseries/>.

Record information about your server in the following table.

Product name	IBM <i>@server</i> xSeries 205 server
Machine type	8480
Model number	_____
Serial number	_____
Key serial number	_____
Key manufacturer	_____
Key phone number	_____

The server model and serial numbers are on labels on the lower-right side of the bezel.

Important: Your server keys cannot be duplicated by a locksmith. If you lose them, order replacement keys from the key manufacturer. The key serial number and the telephone number of the manufacturer are on a tag attached to the keys.

If you plan to install your server in a rack, you need to purchase a *Tower-to-Rack Kit* conversion kit. For a list of supported options for your server, see the ServerProven® list at <http://www.ibm.com/pc/compat/>.

Features and specifications

The following table provides a summary of the features and specifications of your xSeries 205 Type 8480 server. Depending on your server model, some features and specifications might not apply.

Table 1. Features and Specifications

<p>Microprocessor: Supports one microprocessor — Intel® Pentium® 4 with 128 KB, 256 KB, or 512 KB Level-2 cache and 400 MHz or 533 MHz front side bus (FSB)</p> <p>Memory:</p> <ul style="list-style-type: none"> • Minimum: 128 MB • Maximum: 2.0 GB • Type: PC2100 266 MHz double-density RAM (DDR) DIMMs • Slots: Two dual inline <p>Drives: (depending on your model)</p> <ul style="list-style-type: none"> • Diskette: 1.44 MB • Hard disk drive: IDE or SCSI • One of the following: <ul style="list-style-type: none"> — CD-ROM: IDE — DVD-ROM: IDE — CD-RW: IDE <p>Expansion bays: (depending on your model)</p> <ul style="list-style-type: none"> • Two 5.25-in. bays (one CD-ROM drive installed) • Two 3.5-in. bays (one diskette drive installed) • Three 3.5-in. hard disk drive bays: hot-swap drive bays (some models) or non-hot-swap drive bays with a hard disk drive installed (some models) <p>PCI expansion slots:</p> <ul style="list-style-type: none"> • Three 33 MHz/32-bit on the system board (some models come with a SCSI adapter installed) • Two 33 MHz/32-bit on the PCI extender board <p>Video controller: ATI Rage XL video controller with 16 MB SDRAM video memory on the PCI extender card</p> <p>Power supply: One 340 watt (90-240 V ac)</p>	<p>Size:</p> <ul style="list-style-type: none"> • Height: 470 mm (18.5 in.) • Depth: 508 mm (19.9 in.) • Width: 165 mm (6.5 in.) • Weight: approximately 19.5 kg (43 lb) when fully configured or 15.9 kg (35 lb) minimum <p>Integrated functions:</p> <ul style="list-style-type: none"> • Broadcom 5702 10/100/1000 Ethernet controller on the system board with RJ-45 Ethernet connector • Two serial ports • Parallel port • Two USB ports • Keyboard port • Mouse port • Audio ports <ul style="list-style-type: none"> — Line out — Line in — Mic • Dual-channel bus mastering IDE controller • Support for IBM Remote Supervisor adapter <p>Acoustical noise emissions:</p> <ul style="list-style-type: none"> • Sound power, idling: 5.1 bel maximum • Sound power, operating: 5.3 bel maximum <p>Environment:</p> <ul style="list-style-type: none"> • Air temperature: <ul style="list-style-type: none"> — Server on: 10° to 35° C (50.0° to 95.0° F). Altitude: 0 to 2133 m (6998.0 ft) — Server off: 10° to 43° C (50.0° to 109.4° F). Maximum altitude: 2133 m (6998.0 ft) • Humidity: <ul style="list-style-type: none"> — Server on: 8% to 80% — Server off: 8% to 80% 	<p>Heat output: Approximate heat output in British thermal units (Btu) per hour:</p> <ul style="list-style-type: none"> • Minimum configuration: 341 Btu (100 watts) • Maximum configuration: 1604 Btu (470 watts) <p>Electrical input:</p> <ul style="list-style-type: none"> • Sine-wave input (50-60 Hz) required • Input voltage low range: <ul style="list-style-type: none"> — Minimum: 90 V ac — Maximum: 137 V ac • Input voltage high range: <ul style="list-style-type: none"> — Minimum: 180 V ac — Maximum: 265 V ac • Input kilovolt-amperes (kVA) approximately: <ul style="list-style-type: none"> — Minimum: 0.095 kVA — Maximum: 0.470 kVA <p>Notes:</p> <ol style="list-style-type: none"> 1. Power consumption and heat output vary depending on the number and type of optional features installed and the power-management optional features in use. 2. These levels were measured in controlled acoustical environments according to the procedures specified by the American National Standards Institute (ANSI) S12.10 and ISO 7779 and are reported in accordance with ISO 9296. Actual sound-pressure levels in a given location might exceed the average values stated because of room reflections and other nearby noise sources. The declared sound-power levels indicate an upper limit, below which a large number of computers will operate.
---	---	--

Notices and statements used in this book

The caution and danger statements that appear in this book are also in the multilingual *Safety Book* on the IBM *xSeries Documentation CD*. Each statement is numbered for reference to the corresponding statement in the *Safety Book*.

The following notices and statements are used in the documentation:

- **Notes:** These notices provide important tips, guidance, or advice.
- **Important:** These notices provide information or advice that might help you avoid inconvenient or problem situations.
- **Attention:** These notices indicate potential damage to programs, devices, or data. An attention notice is placed just before the instruction or situation in which damage could occur.
- **Caution:** These statements indicate situations that can be potentially hazardous to you. A caution statement is placed just before the description of a potentially hazardous procedure step or situation.
- **Danger:** These statements indicate situations that can be potentially lethal or extremely hazardous to you. A danger statement is placed just before the description of a potentially lethal or extremely hazardous procedure step or situation.

Major components of the xSeries 205 Type 8480

The following illustration shows the locations of major components in your server.

Note: The illustrations in this document might differ slightly from your hardware.

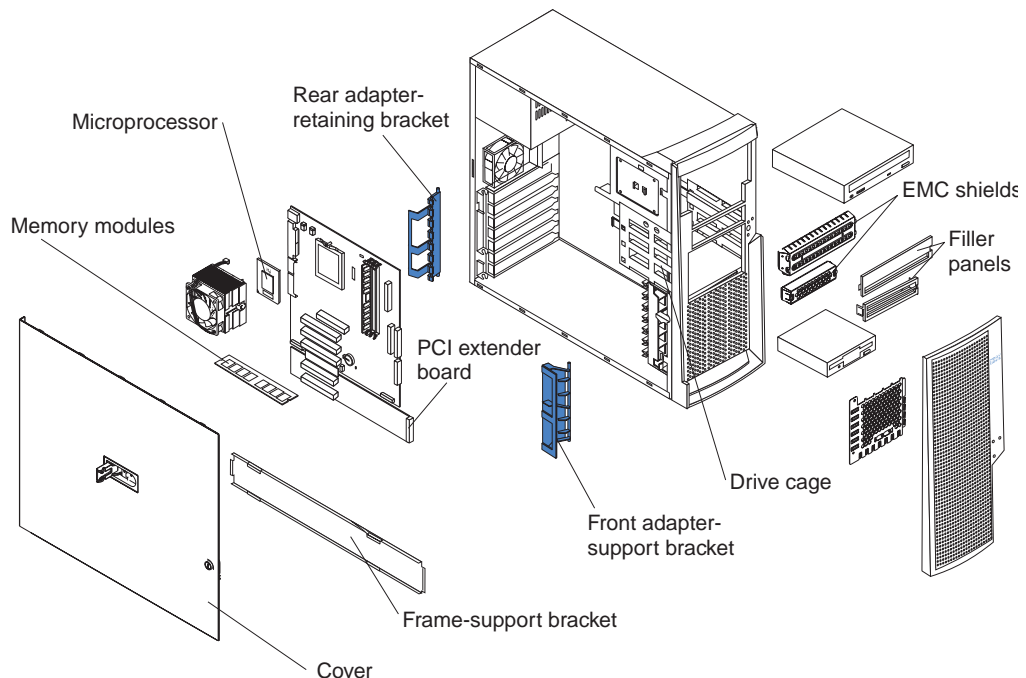

System-board internal cable connectors

The following illustration identifies system and extender board connectors for internal cables.

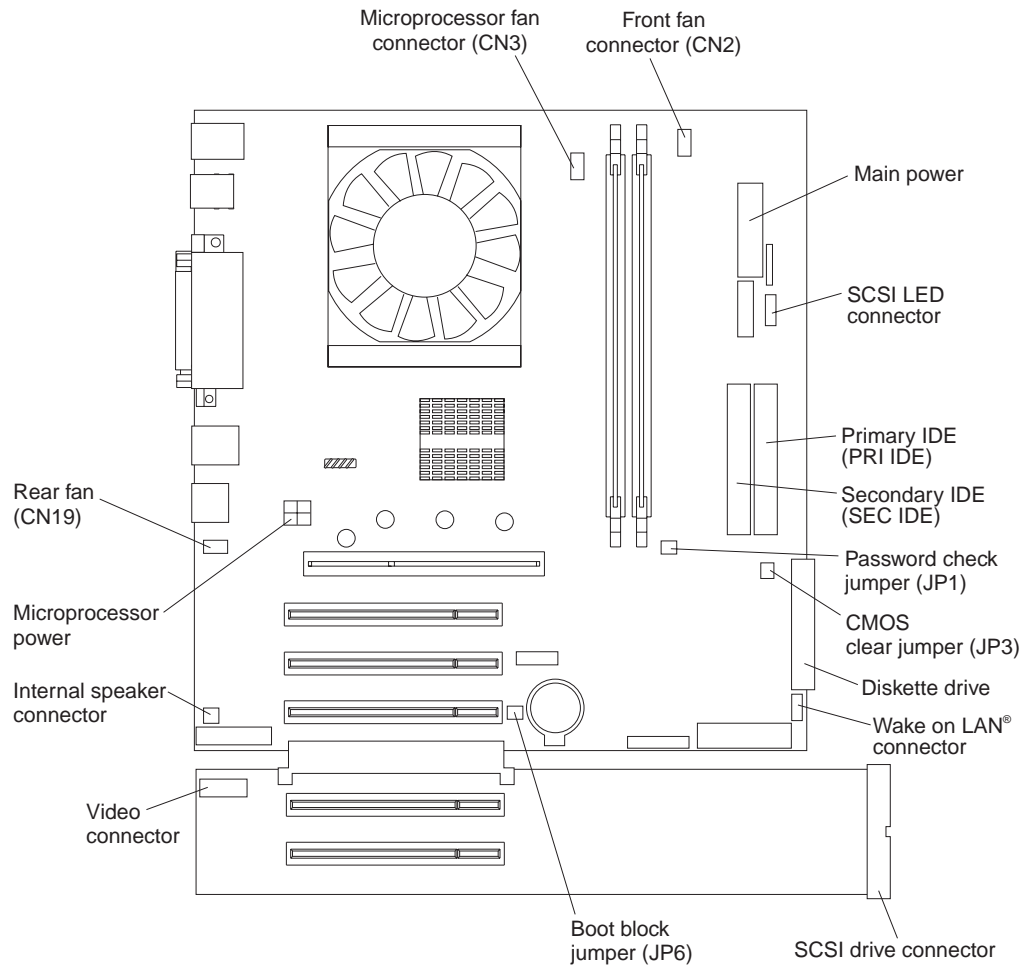

Chapter 2. Installing options

This chapter provides basic instructions for installing hardware options in your server. These instructions are intended for users who are experienced with setting up IBM server hardware. If you need more detailed instructions, see the *Option Installation Guide* on the IBM xSeries Documentation CD.

Installation guidelines

Before you begin installing options in your server, read the following information:

- Read the guidelines in “Handling static-sensitive devices” on page 6, and read the safety statements in “Safety” on page v. This information will help you work safely with your server and options.
- Make sure that you have an adequate number of properly grounded electrical outlets for your server, monitor, and other devices that you will connect to the server.
- Back up all important data before you make changes to disk drives.
- Have a small flat-blade screwdriver available.
- Before accessing the inside of the server, rotate the two front stabilizing feet a quarter turn inward toward the server, so that they do not break. Before returning the server to an upright position, rotate the front stabilizing feet a quarter turn outward from the server.
- For a list of supported options for your server, go to <http://www.ibm.com/pc/compat/> on the World Wide Web.

System reliability guidelines

To help ensure proper system cooling and system reliability, make sure that:

- Each of the drive bays has a drive or a filler panel and electromagnetic compatibility (EMC) shield installed in it.
- There is adequate space around the server to allow the server cooling system to work properly. Leave approximately 50 mm (2 in.) of open space around the front and rear of the server. Do not place objects in front of the fans.
- You have followed the cabling instructions that come with optional adapters.
- You have replaced a failed fan as soon as possible.

Working inside the server with the power on

Your server supports hot-plug, hot-add, and hot-swap devices and is designed to operate safely while it is turned on and the cover is removed. Follow these guidelines when you work inside a server that is turned on:

- Avoid wearing loose-fitting clothing on your forearms. Button long-sleeved shirts before working inside the server; do not wear cuff links while you are working inside the server.
- Do not allow your necktie or scarf to hang inside the server.
- Remove jewelry, such as bracelets, necklaces, rings, and loose-fitting wrist watches.
- Remove items from your shirt pocket, such as pens and pencils, that could fall into the server as you lean over it.
- Avoid dropping any metallic objects, such as paper clips, hairpins, and screws, into the server.

Handling static-sensitive devices

Attention: Static electricity can damage electronic devices, including your server. To avoid damage, keep static-sensitive devices in their static-protective packages until you are ready to install them.

To reduce the possibility of damage from electrostatic discharge, observe the following precautions:

- Limit your movement. Movement can cause static electricity to build up around you.
- Handle the device carefully, holding it by its edges or its frame.
- Do not touch solder joints, pins, or exposed circuitry.
- Do not leave the device where others can handle and damage it.
- While the device is still in its static-protective package, touch it to an unpainted metal part of the server for at least 2 seconds. This drains static electricity from the package and from your body.
- Remove the device from its package and install it directly into the server without setting down the device. If it is necessary to set down the device, place it back into its static-protective package. Do not place the device on your server cover or on a metal surface.
- Take additional care when handling devices during cold weather. Heating reduces indoor humidity and increases static electricity.

Moving the stabilizing feet

When the four feet on the bottom of the server are in the stabilizing position, they provide additional stability.

Complete the following steps to place the feet in the stabilizing position:

1. Place the server on its side.
2. Locate the release tab inside the foot; then, lift up on the tab.

The following illustration shows the rear feet on the bottom rear of the server.

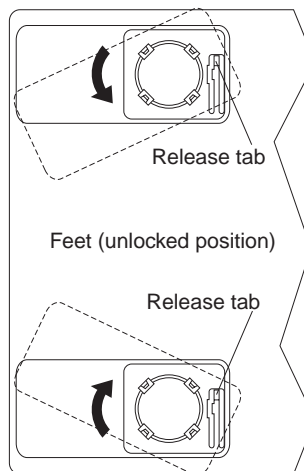

3. Rotate the foot inward to the unlocked position; then, remove the foot from the server.

4. Align the post in the center of the foot with the hole on the bottom of the server and place the foot between the guides as indicated.

The following illustration shows the rear feet on the bottom rear of the server.

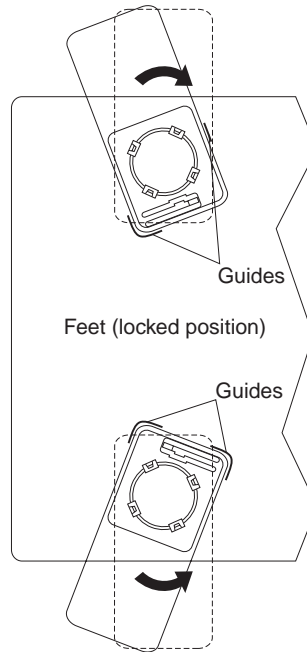

5. Rotate the foot outward until the foot locks into place.
6. Complete steps through for each foot.

Attention: When you need to access the inside of the server to install options, you might find it easier to lay the server on its side. If you do so, make sure the feet are in the horizontal position (see the previous steps). Otherwise, the feet might break off from the server because of the weight of the server.

Removing the side cover

Complete the following steps to remove the side cover of the server:

1. Review the safety precautions listed in “Safety” on page v.
2. Turn off the server and peripheral devices and disconnect all external cables and power cords.
3. If necessary, unlock the side cover.
4. Pull out on the cover-release latch, which will slide the side cover toward the rear of the server approximately 12.7 mm (0.5 in.). Then, remove the side cover from the server and set it aside.

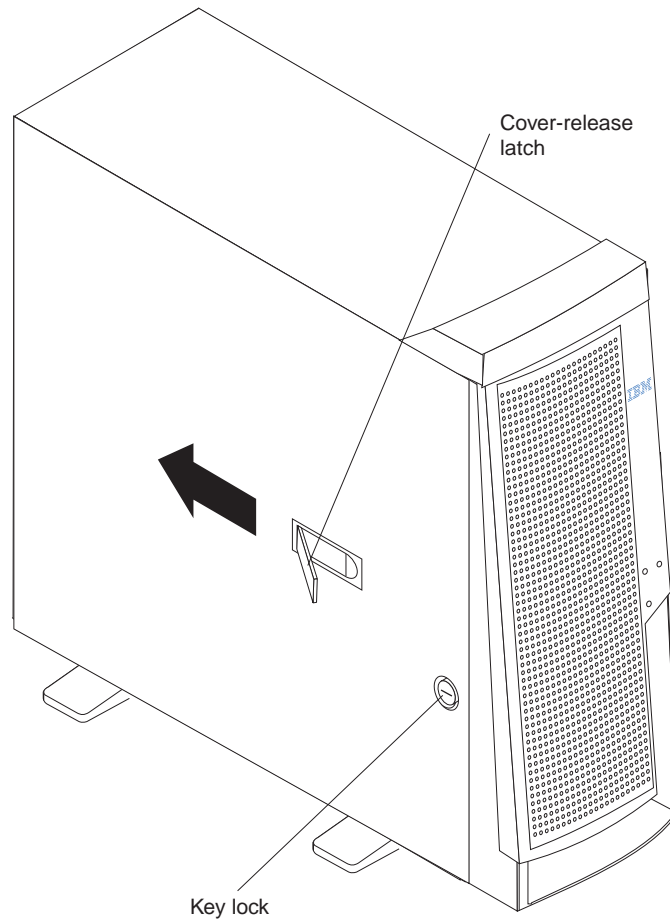

To replace the side cover, see “Installing the side cover” on page 25.

Attention: For proper cooling and airflow, replace the side cover before turning on the server. Operating the server with the side cover removed might damage server components.

Removing the frame-support bracket

When working with some options such as hard disk drives, microprocessors, and memory modules, you must first remove the frame-support bracket to access the location of the option.

Complete the following steps to remove the frame-support bracket:

1. Review the safety precautions listed in “Safety” on page v.
2. Turn off the server and peripheral devices and disconnect all external cables and power cords; then, remove the side cover. See “Removing the side cover” on page 8 for details.
3. Pull the end of the frame-support-bracket out approximately 152.4 mm (6 in.) from the rear of the server.
4. Pull the front end of the frame-support bracket away from the server and place the assembly aside.

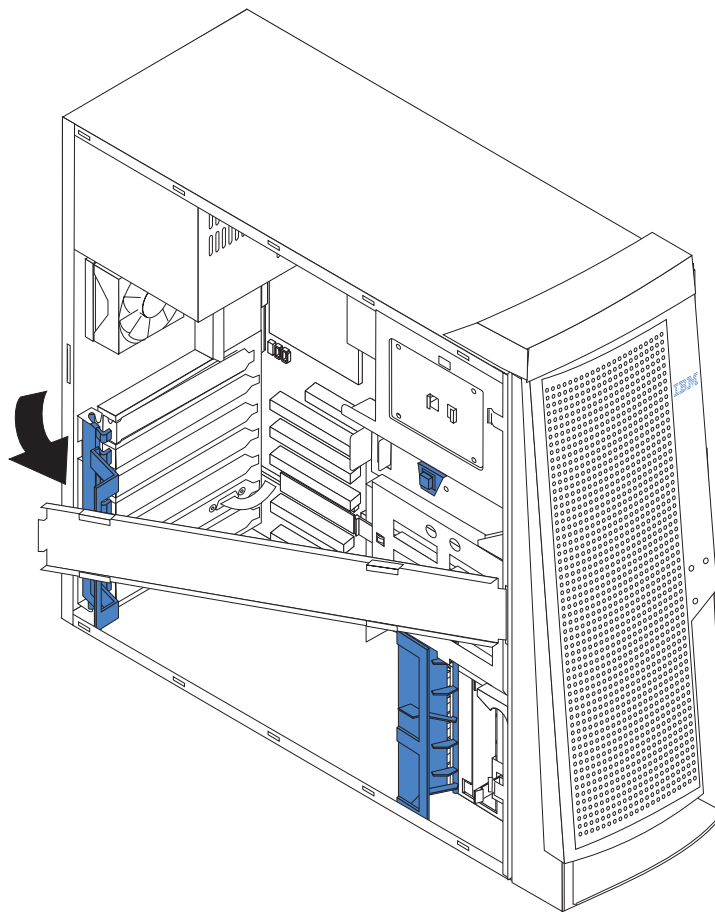

To reinstall the frame-support bracket, reverse these steps.

Working with adapters

Your server comes with five PCI adapter connectors, or *slots* and one AGP slot. You can install one AGP video adapter in the AGP slot. All PCI expansion slots are 32-bit, 33 MHz slots.

The following illustration shows the location of the PCI expansion slots on the system board and PCI extender board.

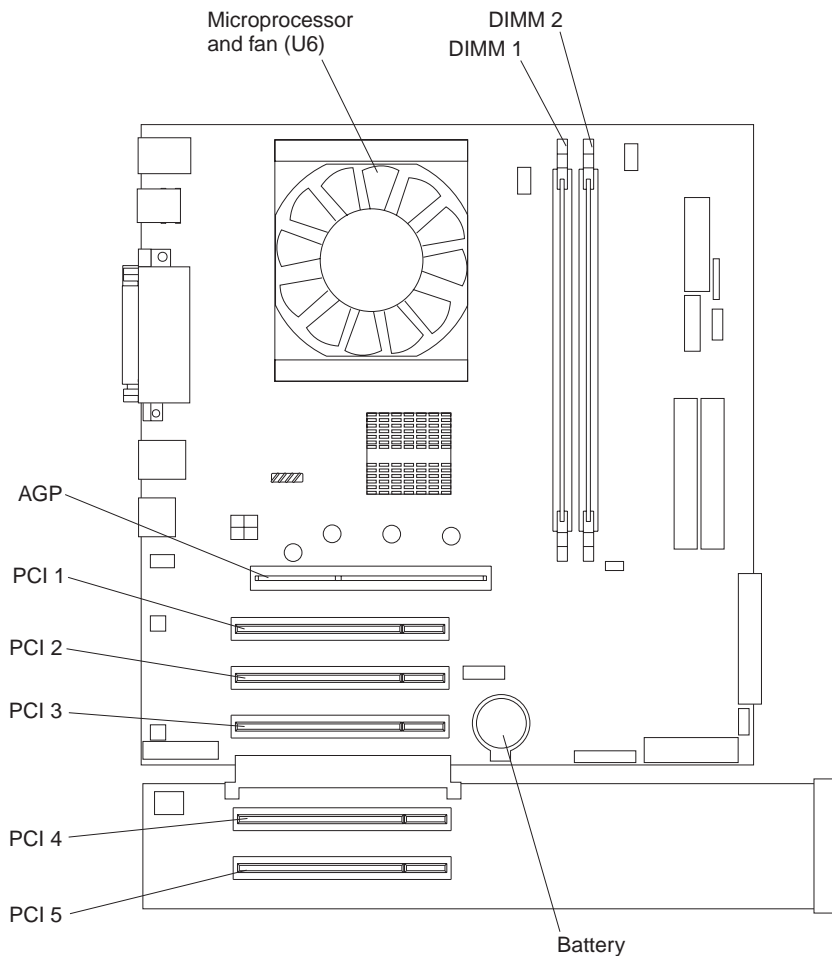

Adapter considerations

Before you install an adapter, review the following information:

- Locate the documentation that comes with the adapter and follow those instructions in addition to the instructions in this chapter. If you need to change switch or jumper settings on your adapter, follow the instructions that come with the adapter.
- You can install full-length adapters in all five PCI expansion slots.
- Your server supports 5.0V and universal PCI adapters; it does not support 3.3V adapters.
- Your server uses a rotational interrupt technique to configure PCI adapters. Therefore, you can install a variety of PCI adapters that currently do not support sharing of PCI interrupts.

- If you are installing an adapter that will control your startup (boot) drive, install the adapter in PCI expansion slot 2.
- PCI expansion slots 1 through 5 are on PCI bus 0.
The system scans the AGP slot and PCI expansion slots 1 through 5 to assign system resources; then, the system starts (boots) devices in the following order, if you have not changed the default boot sequence: the AGP slot, PCI expansion slots 1 through 5; then, the system board integrated drive electronics (IDE) or SCSI devices.
- For a list of supported options for your server, go to <http://www.ibm.com/pc/compat/> on the World Wide Web.

Installing an adapter

Complete the following steps to install an adapter.

Attention: When you handle static-sensitive devices, take precautions to avoid damage from static electricity. For details about handling these devices, see “Handling static-sensitive devices” on page 6.

1. Review the safety precautions listed in “Safety” on page v.
2. Turn off the server and peripheral devices and disconnect all external cables and power cords; then, remove the side cover. For more information about removing the side cover, see “Removing the side cover” on page 8.
3. Remove the frame-support bracket. See “Removing the frame-support bracket” on page 9.
4. If you are installing a full-length adapter, rotate the front adapter-support bracket to the open (unlocked) position.
5. Rotate the rear adapter-retaining bracket to the open (unlocked) position, and then remove it from the server.
6. Remove the PCI expansion-slot cover. From the rear of the server, press in on the slot cover. Grasp it and pull it out of the slot. Store it in a safe place for future use.
Attention: PCI expansion-slot covers must be installed on all vacant slots. This maintains the electronic emissions characteristics of the server and ensures proper cooling of server components.
7. Touch the static-protective package containing the adapter to any unpainted metal surface on the server. Then, remove the adapter from the static-protective package. Avoid touching the components and gold-edge connectors on the adapter.
8. Place the adapter on a flat, static-protective surface, and set any jumpers or switches as described by the adapter manufacturer.

9. Carefully grasp the adapter by its top edge or upper corners, and align it with the expansion slot guides; then, press the adapter *firmly* into the PCI expansion slot.

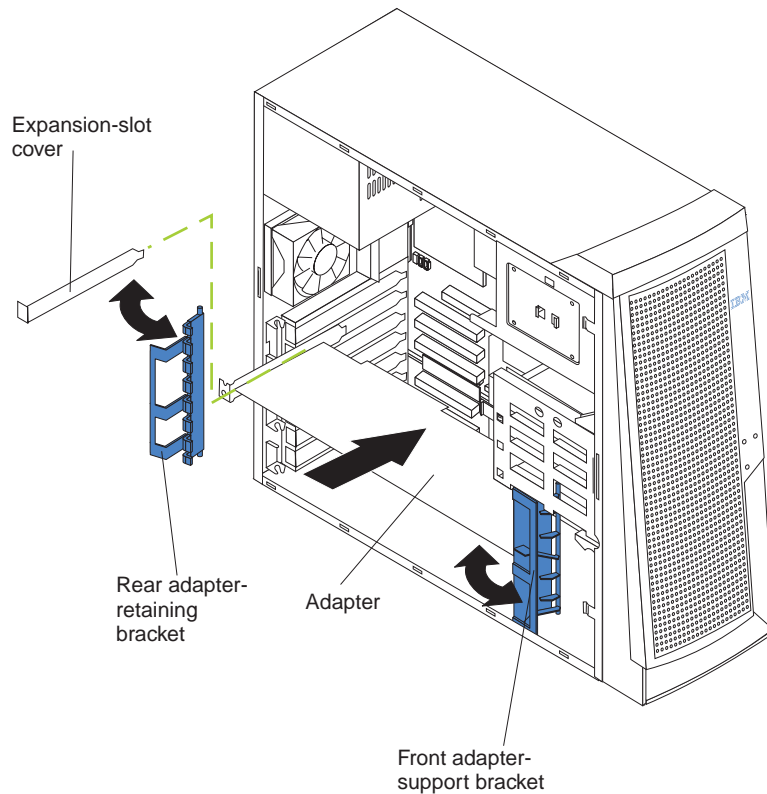

Attention: When you install an adapter in the server, be sure that it is completely and correctly seated in the PCI expansion slot before you turn on the server. Incomplete insertion might cause damage to the system board or the adapter.

10. Connect required cables to the adapter.

Attention: Route cables so that they do not block airflow from the fans.

11. If you have another adapter to install, do so now.
12. If you have installed a full-length adapter, rotate the front adapter-support bracket to the closed (locked) position.
13. Reinstall the rear adapter-retaining bracket; then, rotate the bracket to the closed (locked) position.
14. If you have other options to install, do so now.
15. Reinstall the side cover (see “Installing the side cover” on page 25 for details).
16. Reconnect the external cables and power cords; then, turn on the peripheral devices and the server.

Installing a SCSI or RAID adapter

Complete the following steps to install a SCSI or RAID adapter:

1. If you have not already installed the SCSI adapter, complete steps 1 through 10 of “Installing an adapter” on page 11. Then, return to this procedure to complete the installation.
2. Connect one end of the SCSI signal cable (purchased separately) to the adapter; then, connect one or more of the signal cable connectors to the rear of the SCSI devices.
3. Connect the SCSI activity indicator cable (purchased separately) to the adapter and to the SCSI LED connector on the system board. See “System-board internal cable connectors” on page 4.

Note: If you are installing an adapter that will control your startup (boot) drive, install the adapter in PCI expansion slot 2.

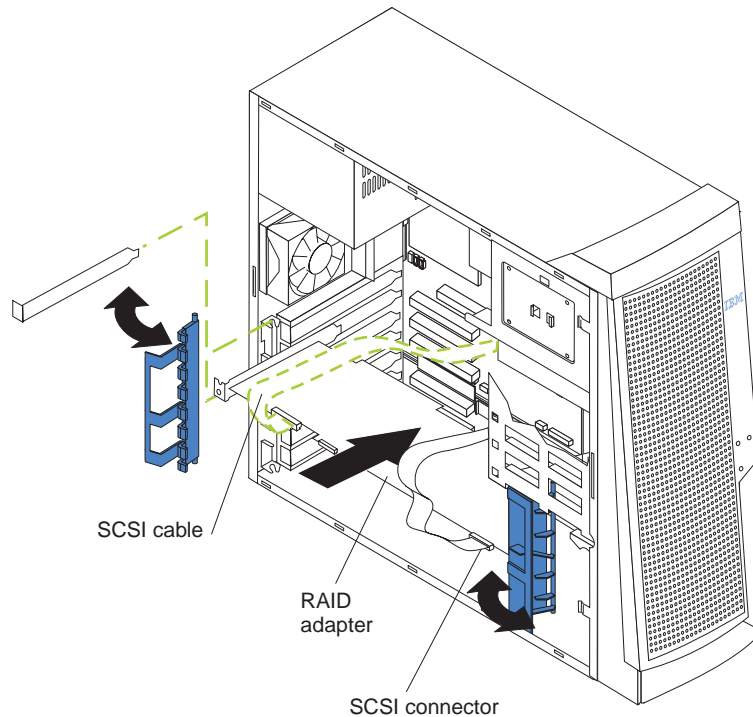

4. If you have another adapter to install, do so now.
5. If you have installed a full-length adapter, rotate the front adapter-support bracket to the closed (locked) position.
6. Reinstall the rear adapter-retaining bracket; then, rotate the bracket to the closed (locked) position.
7. If you have other options to install, do so now.
8. Reinstall the frame-support bracket.
9. Reinstall the side cover. See “Installing the side cover” on page 25 for details.
10. Reconnect the external cables and power cords; then, turn on the peripheral devices and the server.

Installing internal drives

Your server comes with an IDE CD-ROM drive installed in bay 1 and a 3.5-in., 1.44 MB diskette drive in bay 3. Some models have a hard disk drive installed in bay 5.

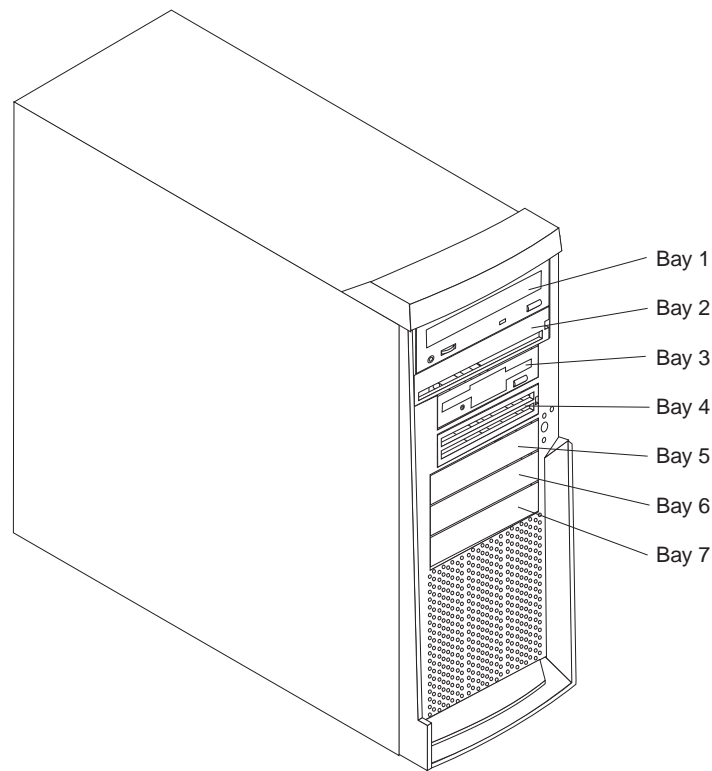

Before you install an internal drive, review the following information:

- Diskette drives, tape drives, and CD-ROM drives are removable-media drives. You can install removable-media drives in bays 1, 2, 3, and 4.
- You can install a 3.5-in., slim-high or a 5.25-in., half-high, removable-media drive, such as a tape backup drive, in bay 2.
- You can install only a 3.5-in., slim-high, removable-media drive in bay 4.
- The xSeries 205 server supports only one diskette drive, which uses 1 MB and 2 MB diskettes.
- Before you install a 3.5-in. drive in a 5.25-in. bay, you must attach the 5.25-in. conversion kit, supplied with your option, to the 3.5-in. drive. See the documentation that comes with the option for the conversion kit installation instructions.

Note: Only 3.5-in. options that come with proper mounting hardware are supported in the 5.25-in. bays.

- If you have a tape backup drive in your server, use a dry-process cleaning cartridge to clean the tape head 2 hours after you first use a new data cartridge. Then, clean the tape head once a month, or after each 8 hours of continuous read/write operations, whichever occurs first. For complete details about the tape backup drive, see the documentation that comes with your server or your backup option.
- The electromagnetic interference (EMI) integrity and cooling of the server are both protected by having bays 1 through 4 covered or occupied. When you install a drive, save the EMC shield and filler panel from the bay, in case you later remove the drive and do not replace it with another.

- For a list of supported options for your server, go to <http://www.ibm.com/pc/compat/> on the World Wide Web.

Preinstallation steps (all bays)

Before you install drives in your server, verify that you have all the cables and any other equipment specified in the documentation that comes with the drive. You might also need to perform certain preinstallation activities. Some of the steps are required only during the initial installation of an option.

1. Read “Safety” on page v, “Handling static-sensitive devices” on page 6, and the documentation that comes with your drive.
2. Choose the bay in which you want to install the drive.
3. Check the instructions that come with the drive to see if you need to set any switches or jumpers on the drive.

Power and signal cables for internal drives

Your server uses cables to connect IDE devices to the power supply and to the system board. The following cables are provided:

- Four-wire power cables connect the drives to the power supply. At the end of these cables are plastic connectors that can be attached to different drives; these connectors vary in size. Also, certain power cables are attached to the system board.
- Flat signal cables, also called ribbon cables, connect IDE and diskette drives to the system board. There are two sizes of ribbon cables that come with your server:
 - The wider IDE signal cable has two or three connectors.
 - If the cable has three connectors, one of these connectors is attached to the drive, one is a spare, and the third is attached to the primary or secondary IDE connector on the system board.
 - If the cable has two connectors, one of these connectors is attached to the hard disk drive, and the other is attached to the primary or secondary IDE connector on the system board.
 - Note:** The CD-ROM drive is attached to an ATA 66 signal cable. The hard disk drive is attached to an ATA 100 signal cable. ATA 66 and ATA 100 signal cables are color-coded. The blue connector attaches to the system board. The black connector attaches to the primary device. If the cable has a gray middle connector, it attaches to the secondary device. If you are installing a hard disk drive, you must change the switch setting on the CD-ROM drive to secondary and change the connector used for the CD-ROM drive to the gray middle connector.
 - The narrower signal cable has two connectors, one to attach to the diskette drive, and the other to attach to the connector (FDD1) on the system board.
- SCSI signal cables connect SCSI devices to a SCSI adapter or to the internal SCSI connector on the extender card (some models). If you have a SCSI adapter installed in your server, the SCSI signal cable has four connectors. One connector is attached to the SCSI connector on the extender card, two connectors are spares, and the fourth connector is attached to a SCSI hard disk drive.

To locate connectors on the system board, see “System-board internal cable connectors” on page 4.

Review the following information before connecting power and signal cables to internal drives:

- The drives that are preinstalled in your server come with power and signal cables attached. If you replace any drives, it is important to remember which cable is attached to which drive.
- When you install a drive, ensure that the drive connector at the end of the signal cable is always connected to a drive, and ensure that the drive connector at the other end is connected to the system board.
- If you have only one IDE device on a cable, it must be set as a primary device.
- If two IDE devices are used on a single cable, one must be designated as the primary device and the other as the secondary device; otherwise, the server might not detect some of the IDE devices. The primary and secondary designation is determined by switch or jumper settings on each IDE device.
- If two IDE devices are on a single cable and only one is a hard disk drive, the hard disk drive must be set as a primary device.
- You must set the SCSI ID for any SCSI device that you install in your server. Each SCSI device has its own methods and considerations for setting the SCSI ID. See the instructions that come with the device for details about setting the SCSI ID for the SCSI device.

Installing a drive in bay 2 or 4

Complete the following steps to install a drive in bay 2 or 4.

Attention: When you handle static-sensitive devices, take precautions to avoid damage from static electricity. For details on handling these devices, see “Handling static-sensitive devices” on page 6.

1. Review the safety precautions listed in “Safety” on page v.
2. Turn off the server and peripheral devices and disconnect the external cables and power cords; then, remove the side cover (see “Removing the side cover” on page 8 for details).
3. Remove the frame-support bracket and disconnect the fan cable from the connector on the system board. See “Removing the frame-support bracket” on page 9 for details.
4. Use a screwdriver to gently pry the filler panel and EMC shield away from the server.

Note: If you are installing a drive that is a laser product, observe the following safety precaution.

Statement 3



CAUTION:

When laser products (such as CD-ROMs, DVD drives, fiber optic devices, or transmitters) are installed, note the following:

- **Do not remove the covers. Removing the covers of the laser product could result in exposure to hazardous laser radiation. There are no serviceable parts inside the device.**
- **Use of controls or adjustments or performance of procedures other than those specified herein might result in hazardous radiation exposure.**



Danger

Some laser products contain an embedded Class 3A or Class 3B laser diode. Note the following. Laser radiation when open. Do not stare into the beam, do not view directly with optical instruments, and avoid direct exposure to the beam.

Class 1 Laser Product
Laser Klasse 1
Laser Klass 1
Luokan 1 Laserlaite
Appareil À Laser de Classe 1

5. Touch the static-protective package containing the drive to any unpainted metal surface on the server; then, remove the drive from the package and place it on a static-protective surface.
6. Set any jumpers or switches on the drive according to the documentation that comes with the drive.

7. Install the drive:

- If you are installing a 5.25-in. drive in bay 2, push the drive into the bay. Then, use the two screws that come with your option to attach the drive to the drive cage.
- If you are installing a 3.5-in. drive in bay 2, you must attach the 5.25-in. conversion kit, supplied with your option, to the 3.5-in. drive.

Note: You can install a 3.5-in. device only in bay 4.

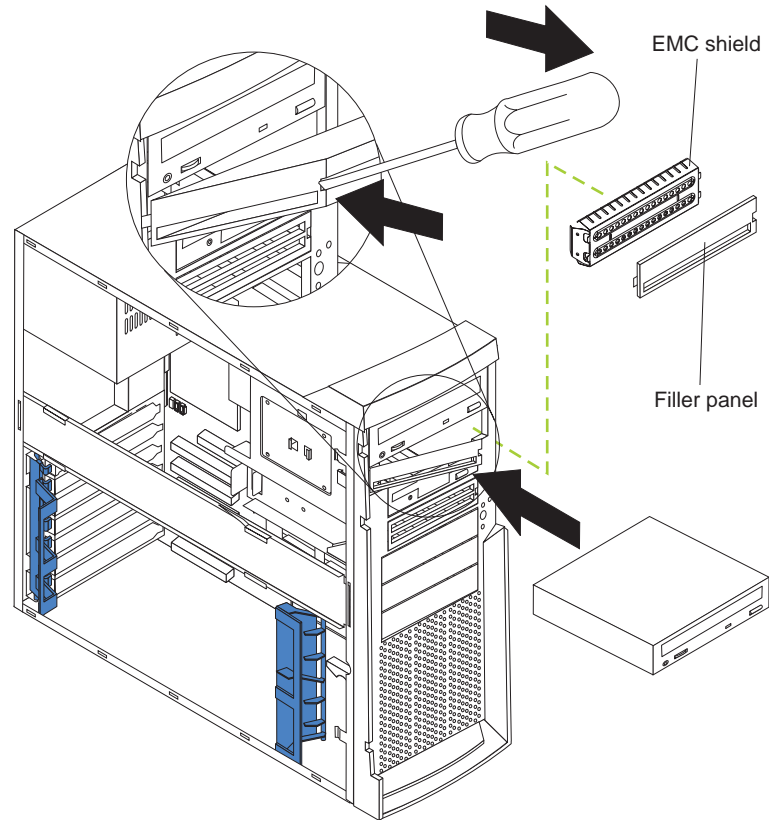

8. Cable the drive. For details about the power and signal cables for the drive, see “Power and signal cables for internal drives” on page 15.

- If the drive is an IDE device, plug one connector of the IDE signal cable into the back of the drive and the other end of the cable into the IDE connector (IDE1) on the system board. For the location of the IDE connectors, see “System-board internal cable connectors” on page 4.
- If the drive is a SCSI device, your server must have a SCSI controller or adapter installed. Plug one connector of the SCSI signal cable into the back of the drive and the other end of the cable into the connector on the SCSI controller or adapter. See “Installing an adapter” on page 11.

Note: Make sure to route the signal cable so that it does not block the airflow to the rear of the drives or over the microprocessor.

9. If you have another drive to install or remove, do so now.

10. Plug one of the power cables from the power supply into the back of the drive. The connectors are keyed and can be inserted only one way.

11. Replace the frame-support bracket.

12. If you have other options to install, do so now.

13. Reinstall the side cover. See “Installing the side cover” on page 25 for details.

14. Reconnect the external cables and power cords; then, turn on the peripheral devices and the server.

Installing a non-hot-swap hard disk drive in bay 5, 6, or 7

Complete the following steps to install a hard disk drive in bay 5, 6, or 7.

Attention: When you handle static-sensitive devices, take precautions to avoid damage from static electricity. For details on handling these devices, see “Handling static-sensitive devices” on page 6.

1. Review the safety precautions listed in “Safety” on page v.
2. Read the information in “Preinstallation steps (all bays)” on page 15.
3. Turn off the server and peripheral devices and disconnect all external cables and power cords; then, remove the cover (see “Removing the side cover” on page 8 for details).
4. Remove the frame-support bracket. See “Removing the frame-support bracket” on page 9 for details.
5. Access the drive cage:
 - a. If your server has hard disk drives installed in the drive cage, disconnect the power and signal cables from the rear of the drives.
 - b. Rotate the drive cage out of the server until it locks into place over the drive-cage-retention tab.

Note: Before you install a hard disk drive, ensure that the drive cage locks into place over the drive-cage-retention tab by pressing on the side of the drive cage.
6. Touch the static-protective package containing the drive to any unpainted metal surface on the server; then, remove the drive from the package and place it on a static-protective surface.
7. Set any jumpers or switches on the drive according to the documentation that comes with the drive.
8. Attach the blue plastic guide rails to the sides of the drive using the screws and guide rails provided in the drive cage.
9. Slide the drive into the drive cage until the plastic tabs on the guide rails lock into place in the drive cage.

10. Press in on the drive-cage-retention tab, and rotate the drive cage back into the server.

Note: Clear any cables that might impede the replacement of the drive cage.

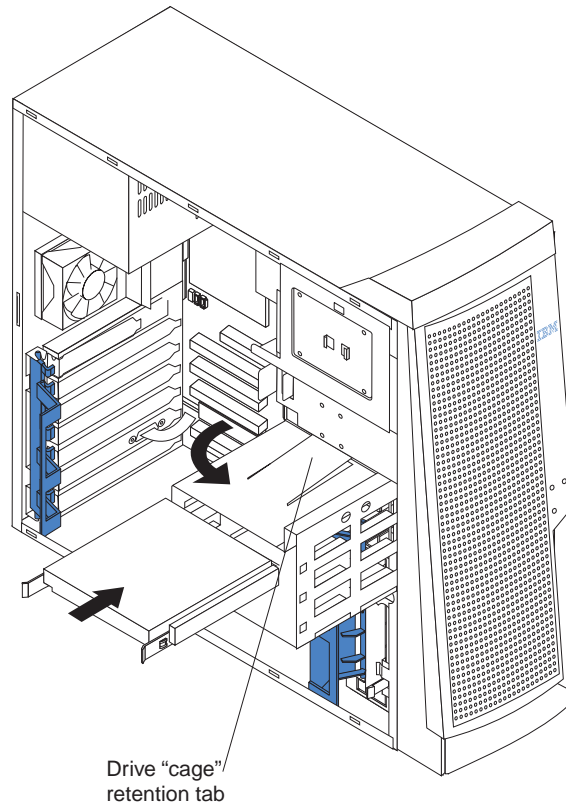

11. Connect the power and signal cables to the rear of each drive.

Note: Make sure to route the signal cable so that it does not block the airflow to the rear of the drives or over the microprocessor.

12. If you have other options to install or remove, do so now.
13. Replace the frame-support bracket. See "Removing the frame-support bracket" on page 9 for details.
14. Reinstall the side cover. See "Installing the side cover" on page 25 for details.
15. Reconnect the external cables and power cords; then, turn on the peripheral devices and the server.

Installing a hot-swap hard disk drive in bay 5, 6, or 7

If your server is a hot-swap model, you can install or replace a hard disk drive without turning off the server. Therefore, you can continue to operate your system while a hard disk drive is removed or installed. To do this, you must install a hot-swap hard disk drive. If a hot-swap disk drive is connected to an optional controller, such as a RAID controller that supports this function, and if your hot-swap drive becomes defective, the RAID controller can rebuild the data from that drive onto another hot-swap drive. See the information that comes with your RAID controller for details.

Each hot-swap drive has two LEDs: the hard disk drive activity LED and the hard disk drive status LED. When the green hard disk drive activity LED is flashing, the controller is accessing the hard disk drive. When this occurs, the hard disk drive activity LED on the front of the server is also lit. If the amber hard disk drive status LED for a drive is lit continuously, that individual drive is faulty and requires

replacement. When the hard disk drive status LED indicates a drive fault, you can replace a hot-swap drive without turning off the server.

Each hot-swap drive that you plan to install comes mounted in a hot-swap-drive tray. The drive must have a single connector attachment (SCA) connector. Hot-swap-drive trays come with hot-swap drives.

The hot-swap bays are connected to a SCSI backplane. This backplane is the printed circuit board behind the bay. The backplane controls the SCSI IDs for the hot-swap drives.

The following illustration shows the hot-swap-drive backplane component locations, as viewed from the front of the server.

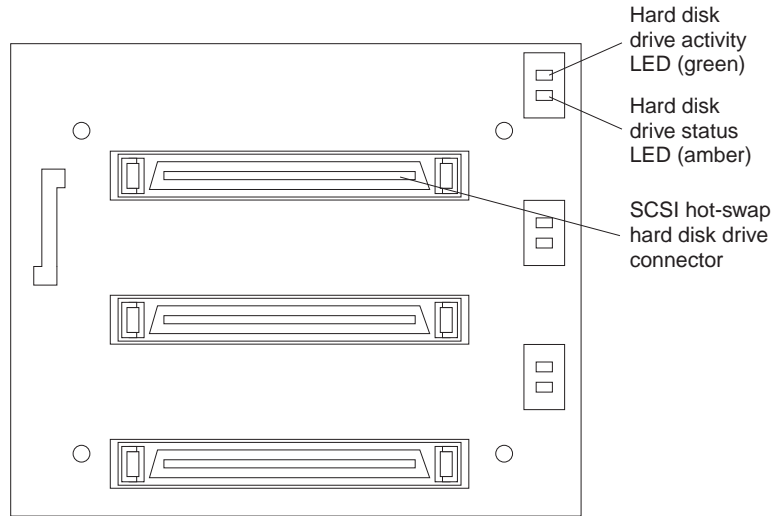

Note: The hard disk drive activity LED and hard disk drive status LED on the backplane match the hard disk drive activity LED and hard disk drive status LED on the hot-swap drive.

The following illustration shows the rear connectors on the hot-swap-drive backplane, as viewed from the rear of the server.

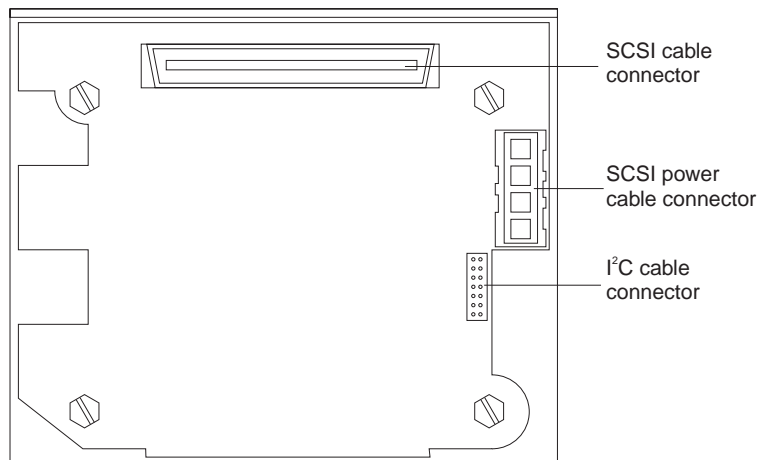

Note: When you install hot-swap hard disk drives, install them in the following order: bay 7, bay 6, and bay 5.

Attention:

- When you handle static-sensitive devices, take precautions to avoid damage from static electricity. For details on handling these devices, see “Handling static-sensitive devices” on page 6.
- To maintain proper system cooling, do not operate the server for more than 10 minutes without either a drive or a filler panel installed in each bay.

Complete the following steps to install a hot-swap hard disk drive in bay 5, 6, or 7.

Note: You do not have to turn off the server to install hot-swap hard disk drives in these bays.

1. Read the information in “Preinstallation steps (all bays)” on page 15.
2. Remove the filler panel from one of the empty hot-swap bays by inserting your finger into the depression at the left side of the filler panel and pulling it away from the server.
3. Install the hard disk drive in the hot-swap bay:
 - a. Ensure that the tray handle is open (that is, perpendicular to the drive).
 - b. Align the drive-tray assembly with the guide rails in the bay.
 - c. Gently push the drive-tray assembly into the bay until the drive stops.
 - d. Push the tray handle to the closed (locked) position.

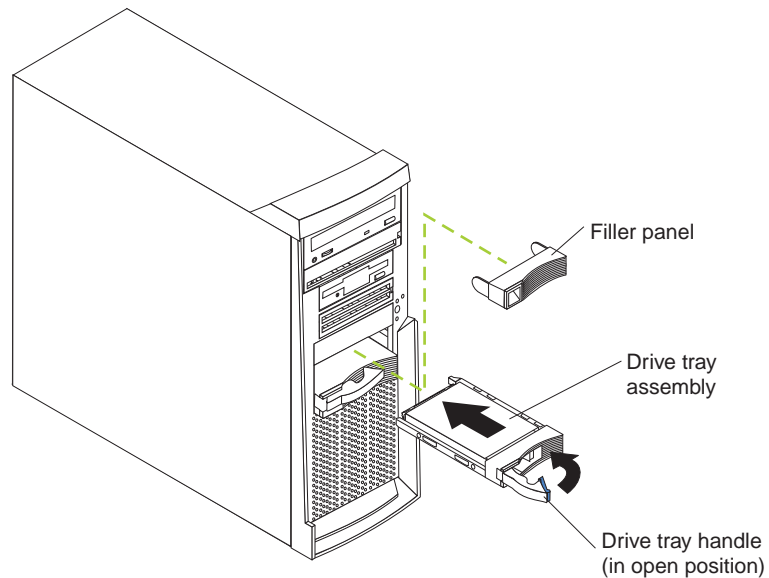

- e. Check the hard disk drive status LED to verify that the hard disk drive is operating properly.

If the amber disk drive status LED for the drive is lit continuously, that individual drive is faulty and needs to be replaced. If the green hard disk drive activity LED is flashing, the drive is being accessed.

Note: If you install a RAID adapter in your server, you might need to reconfigure your disk arrays after installing hard disk drives. See the information that comes with your RAID adapter.

4. If you have other options to install, do so now.

Installing memory modules

Your server comes with a dual inline memory module (DIMM) installed on the system board in DIMM connector 1.

Before you install memory modules, review the following information:

- When installing additional memory modules, install the second memory module in DIMM connector 2. (See the illustration on page 24 for memory connector locations.)
- Your xSeries 205 server supports 256 MB, 512 MB, and 1.0 GB DIMMs. Your server supports a minimum of 256 MB and a maximum of 2.0 GB of system memory. See the ServerProven list at <http://www.ibm.com/pc/compat/> for a list of memory modules for use with your server.

Complete the following steps to install a DIMM.

Attention: When you handle static-sensitive devices, take precautions to avoid damage from static electricity. For details on handling these devices, see “Handling static-sensitive devices” on page 6.

1. Review the safety precautions listed in “Safety” on page v.
2. Turn off the server and peripheral devices and disconnect all external cables and power cords; then, remove the side cover (see “Removing the side cover” on page 8 for details).
3. Remove the frame-support bracket. See “Removing the frame-support bracket” on page 9 for details.
4. Touch the static-protective package containing the DIMM to any unpainted metal surface on the server. Then, remove the DIMM from the package.
5. Gently open the retaining clip on each end of the DIMM connector. Turn the DIMM so that the pins align correctly with the connector.
6. Insert the DIMM into the connector. Firmly press the DIMM straight down into the connector by applying pressure on both ends of the DIMM simultaneously. The retaining clips snap into the locked position when the DIMM is firmly seated in the connector.

7. If there is a gap between the DIMM and the retaining clips, the DIMM has not been properly installed. In this case, open the retaining clips and remove the DIMM; then, reinsert it.

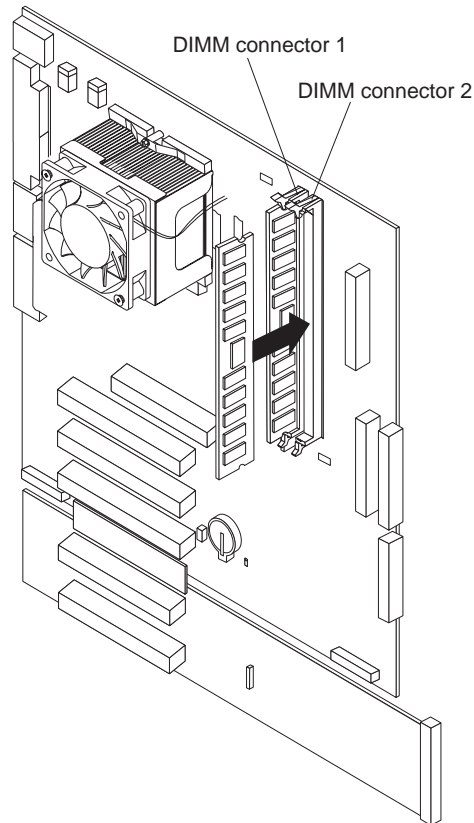

8. If you have other options to install or remove, do so now.
9. Replace the frame-support bracket. See “Removing the frame-support bracket” on page 9.
10. Replace the side cover. See “Installing the side cover” on page 25.
11. Reconnect the external cables and power cords; then, turn on the peripheral devices and the server.

If you want to remove a DIMM, reverse these steps.

Installing a security rope clip

To help prevent hardware theft, you can add a security clip and cable to your server. After you add the security cable, make sure that it does not interfere with other cables that are connected to the server.

Before you begin:

- Obtain the following items:
 - A flat-blade screwdriver
 - An adjustable wrench
 - A 19 mm (0.75 in.) rope clip or wire rope (similar to National Manufacturing No. 3230, Stock No. 176-735)
 - Threaded nuts that fit the rope clip

- A security cable
- A lock, such as a combination lock or padlock
- Read “Safety” on page v and “Handling static-sensitive devices” on page 6.

Complete the following steps to install a rope clip:

1. Turn off the server and peripheral devices and disconnect all external cables and power cords; then, remove the side cover (see “Removing the side cover” on page 8 for details).
2. Use a screwdriver to remove the two metal knockouts.
3. Insert the rope clip through the rear panel; then, attach and tighten the nuts.

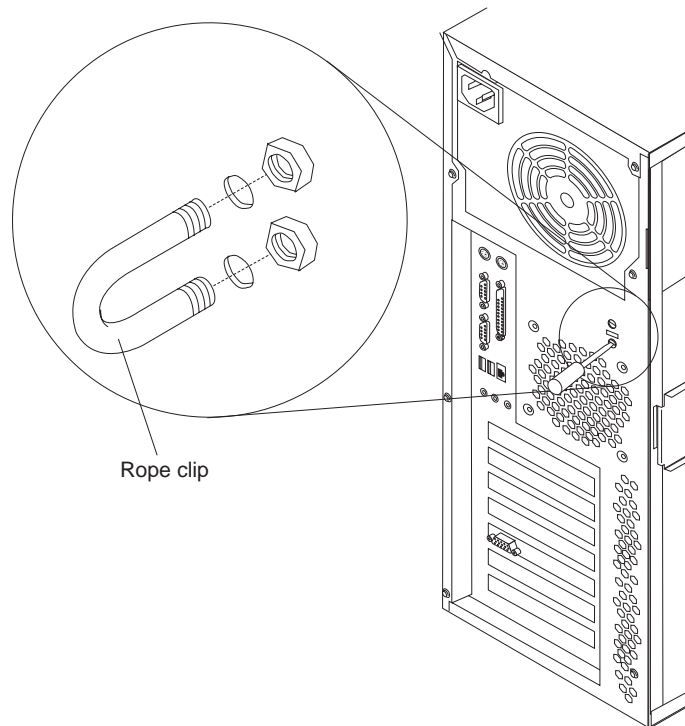

4. If you have other options to install or remove, do so now.
5. Reinstall the side cover. See “Installing the side cover” for details.
6. Thread the cable through the rope clip and around an object that is a part of or permanently secured to the building structure or foundation, and from which it cannot be removed; then, fasten the cable ends together with a lock.
7. Reconnect the external cables and power cords; then, turn on the peripheral devices and the server.

Installing the side cover

Note: If you removed the frame-support bracket after you removed the side cover, reinstall it before you install the side cover. See “Removing the frame-support bracket” on page 9 for details.

Complete the following steps to install the side cover:

1. Clear any cables that might impede the reinstallation of the side cover.
2. Install the side cover.

Note: The cover-release latch must be in the unlocked (opened) position before you install the side cover on the server.

- a. Insert the tabs inside the cover into the slots on the server chassis.
- b. Close the cover-release latch to secure the side cover in place.

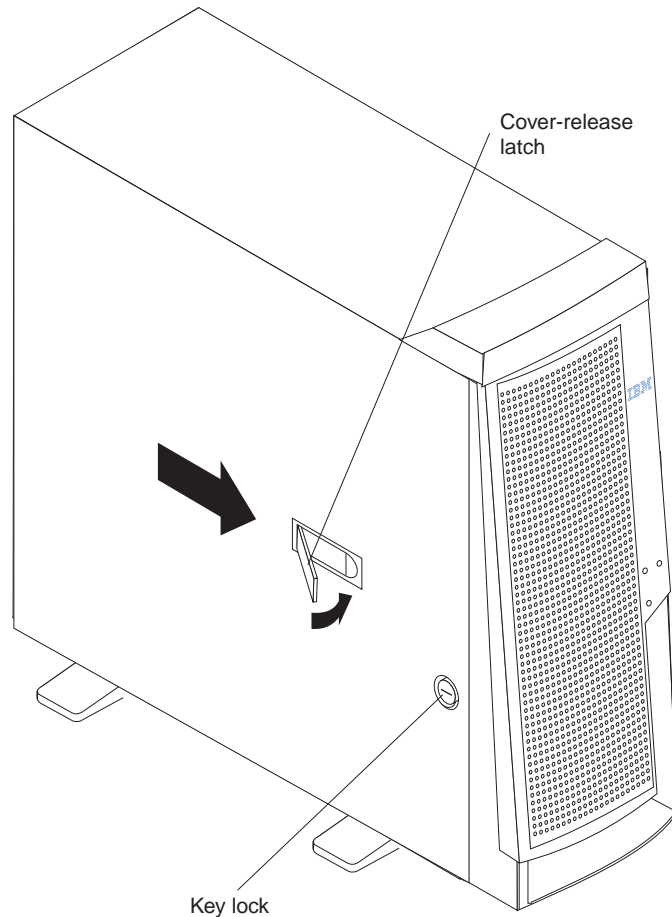

Note: Make sure each tab on the side cover is in its corresponding slot before closing the cover-release latch.

3. Lock the side cover.
4. If you have not done so already, make sure the stabilizing feet are in the stabilizing position so that they properly support the server. See “Moving the stabilizing feet” on page 6.
5. Reconnect the external cables and power cords to the server, and then plug the power cords into properly grounded electrical outlets.
6. Turn on the peripheral devices; then, turn on the server.

Cabling the server

If your server cables and connector panel have color-coded connections, match the color of each cable end with the color of the connector. For example, match a blue

cable end with a blue panel connector, a red cable end with a red connector, and so on.

The following illustration shows the I/O connectors on the rear of the server.

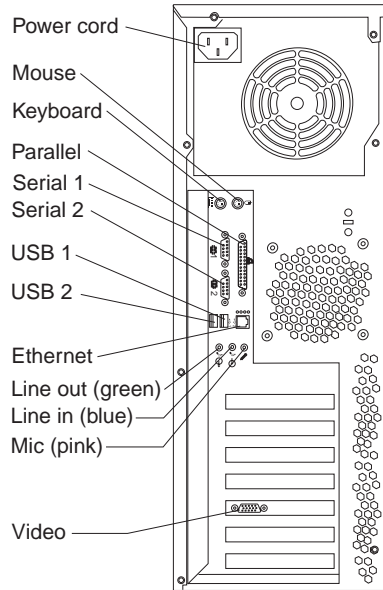

Your server has one keyboard connector on the back of the server. Use this connector to attach a keyboard or optional concole switch to the server.

You can also connect a USB keyboard to the server using one of the USB connectors. After installing a USB keyboard, you might need to use the Configuration/Setup Utility program to enable keyboardless operation and prevent the POST error message 301 from being displayed during startup. For detailed information about this option and how to connect it to your server, see the documentation that comes with the option.

Chapter 3. Server controls, LEDs, and power

This chapter describes the controls and light-emitting diodes (LEDs) and how to turn the server on and off.

Server controls and LEDs

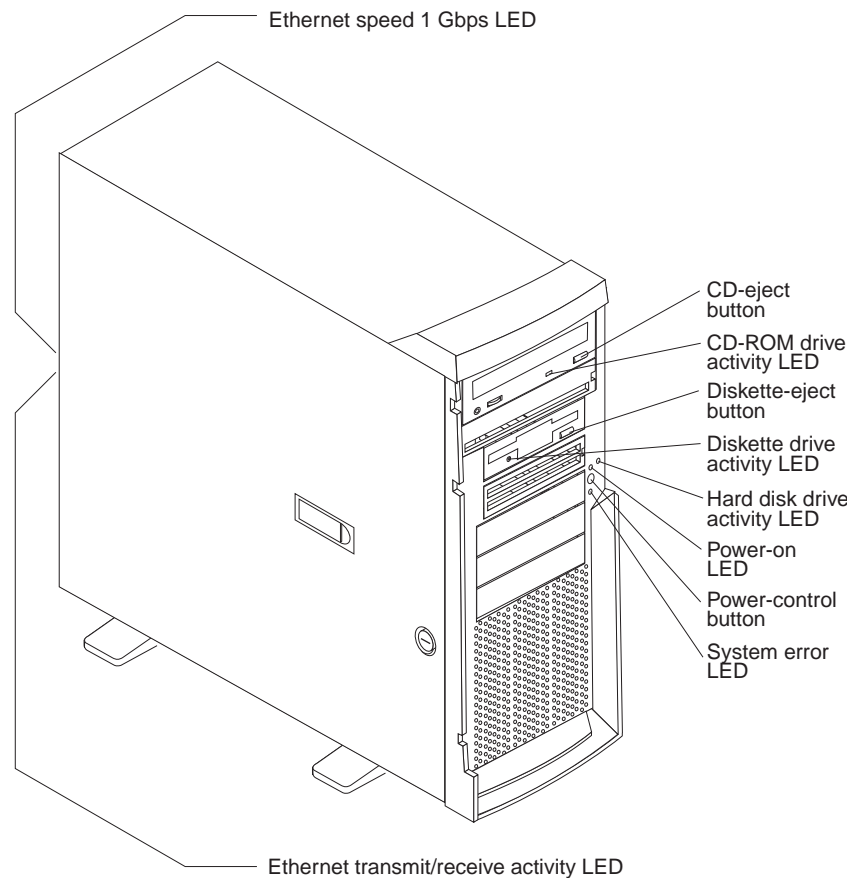

Ethernet speed 1 Gbps LED: When this LED on the Ethernet (RJ-45) connector is lit, the Ethernet speed is 1 Gbps. When the LED is off, the Ethernet speed is 10 Mbps or 100 Mbps.

Ethernet transmit/receive activity LED: When this LED on the Ethernet (RJ-45) connector is lit, there is activity between the server and the network.

CD-eject button: Push this button to open the tray to insert or remove a CD.

CD-ROM drive activity LED: When this LED is lit, the CD-ROM drive is in use.

Diskette-eject button: Push this button to release a diskette from the drive.

Diskette drive activity LED When this LED is lit, the diskette drive is in use.

Hard disk drive activity LED: When this LED is lit, the hard disk drive is in use.

Power-on LED: This LED is lit when the server is turned on.

Power-control button: Press this button to manually turn the server on or off.

Server power features

When you connect the server to an ac power source, the server goes into Standby mode. After approximately 20 seconds, the power-control button becomes active, and you can turn on the server and start the operating system by pressing the power-control button. The following section describes other ways in which the server can be turned on.

A power-control-button shield comes with your server. You can install this disk-shaped shield to prevent the server from being turned off accidentally.

Turning on the server

After the server is connected to an ac power source, it can be turned on in any of the following ways:

- You can press the power-control button.
- If a power failure occurs while the server is turned on, the server will restart automatically when power is restored.
- If your operating system supports the system-management software for an optional Remote Supervisor Adapter, the system-management software can turn on the server.
- If your operating system supports the Wake on LAN[®] feature, the Wake on LAN feature can turn on the server.

Turning off the server

Some operating systems require an orderly shutdown before you turn off the server. See your operating-system documentation for information about shutting down the operating system.

Statement 5



CAUTION:

The power control button on the device and the power switch on the power supply do not turn off the electrical current supplied to the device. The device also might have more than one power cord. To remove all electrical current from the device, ensure that all power cords are disconnected from the power source.

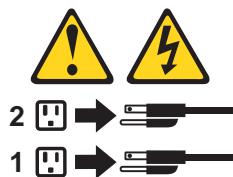

The server can be turned off in any of the following ways:

- You can press the power-control button to start an orderly shutdown of the operating system, if your operating system supports this feature, and turn off the server.
- If the operating system stops functioning, you can press and hold the power-control button for more than 4 seconds to turn off the server.
- If the Wake on LAN feature turned on the server, the Wake on LAN feature can turn off the server.
- You can remove all power from the server by disconnecting the server from the ac power source.

Standby mode

When the server is connected to an ac power source but has not been turned on, it is in Standby mode. When the server is in Standby mode, the operating system is not running, and all core logic except for the service processor is shut down. The power-on LED flashes to indicate that the server is in Standby mode. The server can respond to requests from the service processor, such as a remote request to turn on the server.

To put the server into Standby mode when the server is turned on, shut down the operating system (see your operating-system documentation), and press the power-control button.

You can also put the server into Standby mode through a request from the service processor.

Chapter 4. Configuring your server

The following configuration programs are provided with your server.

- **Configuration/Setup Utility**

This program is part of the basic input/output system (BIOS) code that comes with your server. You can use this program to configure serial- and parallel-connector assignments, change the drive startup sequence, set the date and time, and set passwords. For more information about how to start this utility, see “Starting the Configuration/Setup Utility program”.

- **Broadcom NetXtreme Gigabit Ethernet Boot Agent**

The Broadcom NetXtreme Gigabit Ethernet Boot Agent is part of the BIOS code that comes with your server. You can enable the Broadcom NetXtreme Gigabit Ethernet Boot Agent in the Configuration/Setup Utility program. The Broadcom NetXtreme Gigabit Ethernet Boot Agent enables you to configure the network option as a startable device and customize where the network appears in your startup sequence.

- **SCSISelect Utility (some models)**

With the SCSISelect Utility program, you can configure the devices that are connected to the optional SCSI controller or adapter. Use this program to change default values, resolve configuration conflicts, and perform a low-level format on a SCSI hard disk drive. For information about how to start this utility, see “Starting the SCSISelect Utility program” on page 34.

- **ServerGuide Setup and Installation CD**

The *ServerGuide™ Setup and Installation* CD includes software setup and installation tools that are specifically designed for IBM xSeries servers. You can use this CD during the initial installation of your server to configure the server hardware and to simplify your NOS installation. The *ServerGuide Setup and Installation* CD also contains a collection of application programs that you can install after your server is up and running. See “Using the ServerGuide Setup and Installation CD” on page 34.

See the *User's Guide* on the *IBM xSeries Documentation* CD for detailed instructions for using the configuration programs and *ServerGuide Setup and Installation* CD.

Starting the Configuration/Setup Utility program

The Configuration/Setup Utility program is a menu-driven utility that is part of the BIOS code that comes with your server. You can use it to:

- Configure serial connector assignments
- Change the drive startup sequence
- Enable USB keyboard and mouse support
- Resolve configuration conflicts
- Set the date and time
- Set passwords

Complete the following steps to start the Configuration/Setup Utility program:

1. Turn on the server and watch the monitor screen.
2. When the message Press F1 for Configuration/Setup appears, press F1.
3. Follow the instructions that appear on the screen.

Starting the Broadcom NetXtreme Gigabit Ethernet Boot Agent program

The Broadcom NetXtreme Gigabit Ethernet Boot Agent is part of the BIOS code that comes with your server. You can enable the Broadcom NetXtreme Gigabit Ethernet Boot Agent in the Configuration/Setup Utility program. You can use the Broadcom NetXtreme Gigabit Ethernet Boot Agent to configure the network as a startable device and customize where the network appears in your startup sequence. For more information about enabling this feature, see the *User's Guide* on the *IBM xSeries Documentation CD*.

Starting the SCSISelect Utility program

SCSISelect is a menu-driven configuration utility program for models that come with a SCSI adapter installed. You can use SCSISelect to:

- View the default SCSI IDs
- Locate and correct configuration conflicts

Note: If your server has a redundant arrays of independent disks (RAID) adapter installed, use the configuration method that is supplied with the RAID adapter to view or change SCSI settings for devices attached to the adapter.

Complete the following steps to start the SCSISelect Utility program:

1. Turn on the server.
2. When the <<< Press <CTRL><A> for SCSISelect Utility! >>> prompt appears, press Ctrl+A.
3. When the Would you like to configure the host adapter or run the SCSI disk utility? question appears, make your selection and press Enter.
4. Use the arrow keys to select a choice from the menu.
5. Follow the instructions on the screen to change the settings of the selected items; then, press Enter.

Using the ServerGuide Setup and Installation CD

The *ServerGuide Setup and Installation CD* provides state-of-the-art programs to detect the server model and hardware options that are installed, configure the server hardware, provide device drivers, and install your network operating system (NOS).

Note: If the *ServerGuide Setup and Installation CD* does not start, see the *Hardware Maintenance Manual and Troubleshooting Guide*.

1. Insert the *ServerGuide Setup and Installation CD*, and restart the server.
2. Follow the instructions that appear on the screen to:
 - a. Select your language.
 - b. Select your keyboard layout and country.
 - c. View the overview to learn about ServerGuide features.
 - d. View the README file to review installation tips about your NOS and adapter.
 - e. Start the setup and hardware configuration programs.
 - f. Start the NOS installation. You will need your copy of the NOS CD.

Note: For information about the supported NOS versions, see the *ServerGuide Setup and Installation CD* label.

Chapter 5. Solving problems

This section provides basic troubleshooting information to help you resolve some common problems that might occur with your server.

If you cannot locate and correct the problem using the information in this section, see the *Hardware Maintenance Manual and Troubleshooting Guide* on the *IBM xSeries Documentation CD*.

Diagnostic tools overview

The following tools are available to help you identify and resolve hardware-related problems:

- **POST beep codes**

The power-on self-test (POST) beep codes indicate the detection of a problem. See the *Hardware Maintenance Manual and Troubleshooting Guide* for more details.

- **Diagnostic programs and error messages**

The server-diagnostic programs are provided on the *Device Driver and IBM Enhanced Diagnostics CD*. These programs test the major components of your server.

Note: See *Hardware Maintenance Manual and Troubleshooting Guide* on the *IBM xSeries Documentation CD* for more detailed information about the diagnostic programs.

- **Troubleshooting chart**

This chart lists problem symptoms and steps to correct the problems. See the "Troubleshooting chart" on page 38 for more information.

- **Customized support page**

You can create a customized support page on the World Wide Web that is specific to your hardware, including frequently asked questions, parts information, technical hints and tips, and downloadable files. In addition, you can choose to receive electronic mail (e-mail) notifications whenever new information becomes available about your registered products.

After you register and profile your xSeries 205 server, you can diagnose problems using the IBM Online Assistant, and you can participate in the IBM discussion forum. For more detailed information about registering and creating a customized profile for your IBM products, go to the following addresses on the Web:

- <http://www.ibm.com/pc/register/>
- <http://www.ibm.com/pc/support/>

Power-on self-test (POST)

When you turn on the server, the Power On Self-Test (POST) performs a series of tests to check the operation of system components and some of the installed options.

If POST finishes without detecting any problems, the first window of your operating system or application program appears.

If POST detects a problem, more than one beep sounds and an error message appears on your screen.

Notes:

1. If you have a user password set, you must type the password and press Enter, when prompted, before the operating system will load.
2. A single problem might cause several error messages. When this occurs, work to correct the cause of the first error message. After you correct the cause of the first error message, the other error messages usually will resolve the next time you run the test.

POST beep codes

The possible types of beep codes are as follows:

No beeps

If no beep occurs after your server completes POST, call for service.

Continuous beep

Your microprocessor has failed, or your system board or speaker subsystem might contain a failing component. If the system continues through POST with no errors, call for service. If no video appears, the microprocessor processor has failed. Call for service.

POST error messages

The following table provides an abbreviated list of the error messages that might appear during POST.

Note: See the *Hardware Maintenance Manual and Troubleshooting Guide* on the *IBM Documentation CD* for more information about the POST error messages.

POST message	Failing device or problem found	Suggested action
162	Change in device configuration	Verify that your optional devices are turned on and installed correctly.
163	Time of day has not been set	Set the correct date and time.
164	Change in memory configuration	Verify that your memory is installed properly; then, restart the server and run the Configuration/Setup Utility program.
201	Change in memory configuration	Verify that your memory is fully seated and installed properly.
289	Failing DIMM was disabled	Verify that your memory is correct for your server and that it is installed properly.
301 303	Keyboard and keyboard controller	Ensure that the keyboard cable is connected and nothing is resting on the keyboard keys.
11xx	Serial port error	Verify that the serial cable is connected correctly.
1162	Serial port configuration error	Start the Configuration/Setup Utility program and ensure that the IRQ and I/O port assignments needed by the serial port are available.
1601	BIOS code update needed	Download and install the latest level of system BIOS code.
1800	PCI adapter hardware interrupt	Start the Configuration/Setup Utility program and verify that the interrupt resource settings are correct.
2400® 2462	Video adapter and memory	Verify that the monitor is connected correctly.

POST message	Failing device or problem found	Suggested action
00180xxx	A PCI adapter requested a resource that is not available	Start the Configuration/Setup Utility program and ensure that the resources needed by the PCI adapter are available.
012980xx 012981xx	Data for microprocessor	Download and install the latest level of system BIOS code.
I9990305	POST could not find an operating system	Install your operating system.

ServerGuide startup problems

Look for the symptom in the left column of the chart. Probable solutions to the problem are in the right column.

Setup and Installation CD

Symptom	Suggested action
<i>Setup and Installation CD</i> will not start.	<ul style="list-style-type: none"> Ensure that the system is a supported server with a startable (bootable) CD-ROM drive. If the startup (boot) sequence settings have been altered, ensure that the CD-ROM drive is first in the startup sequence. If more than one CD-ROM drive is installed, ensure that only one drive is set as the primary drive. Start the CD from the primary drive.
ServeRAID™ program cannot view all installed drives or cannot install NOS.	<ul style="list-style-type: none"> Ensure that there are no duplicate SCSI IDs or IRQ assignments. Ensure that the hard disk drive is connected properly.
The Operating System Installation program continuously loops.	Make more space available on the hard disk.
ServerGuide will not start <i>your</i> NOS CD.	Ensure that the NOS CD you have is supported by the ServerGuide program. See the <i>Setup and Installation</i> CD label for a list of supported NOS versions.
Cannot install NOS — option is unavailable.	Ensure that the NOS is supported on your server. If the NOS is supported, either there is no logical drive defined (if you installed a ServeRAID adapter) or the ServerGuide System Partition is not present. Run the ServerGuide setup and configuration program, and ensure that setup is complete.

Troubleshooting chart

Notes:

1. See the *Hardware Maintenance Manual and Troubleshooting Guide* on the *IBM xSeries Documentation* CD for more detailed troubleshooting charts.
2. If you cannot find the problem in the troubleshooting chart, run the diagnostic programs. If you have run the diagnostic test programs, or if running the tests does not reveal the problem, call for service.

Monitor	Suggested Action
The screen is blank.	Verify that: <ol style="list-style-type: none"> 1. The server power cord is plugged into the server and a working electrical outlet. 2. The monitor cables are connected properly. 3. The monitor is turned on, and the brightness and contrast controls are adjusted correctly. If the items above are correct and the screen remains blank, call for service.
Only the cursor appears.	Call for service.
The monitor works when you turn on the server, but goes blank when you start some application programs.	Verify that: <ol style="list-style-type: none"> 1. The primary monitor cable is attached to the video connector. 2. You installed the necessary device drivers for the applications. Some IBM monitors have their own self-tests. If you suspect a problem with your monitor, refer to the information that comes with the monitor for adjusting and testing instructions. If the items above are correct and the screen remains blank, call for service.
Wavy, unreadable, rolling, distorted screen, or screen jitter.	If the monitor self-tests show the monitor is OK, consider the location of the monitor. Magnetic fields around other devices (such as transformers, appliances, fluorescent lights, and other monitors) can cause screen jitter or wavy, unreadable, rolling, or distorted screen images. If this happens, turn off the monitor. (Moving a color monitor while it is turned on might cause screen discoloration.) Then, move the device and the monitor at least 305 mm (12 in.) apart. Turn on the monitor. Notes: <ol style="list-style-type: none"> 1. To prevent diskette drive read/write errors, be sure the distance between monitors and diskette drives is at least 76 mm (3 in.). 2. Non-IBM monitor cables might cause unpredictable problems. 3. An enhanced monitor cable with additional shielding is available for the 9521 and 9527 monitors. For information about the enhanced monitor cable, see your IBM reseller or IBM marketing representative. If the problem remains, call for service.
Wrong characters appear on the screen.	If the wrong language is displayed, update the BIOS code with the correct language. If the problem remains, call for service.
Power	Suggested action
The server does not turn on.	Verify that: <ol style="list-style-type: none"> 1. The power cables are properly connected to the server. 2. The electrical outlet functions properly. 3. The type of memory that is installed is correct. 4. If you just installed an option, remove it, and restart the server. If the server now turns on, you might have installed more options than the power supply supports. If the problem remains, call for service.

Memory	Suggested action
<p>The amount of memory displayed is less than the amount of memory installed.</p>	<p>Verify that:</p> <ol style="list-style-type: none"> 1. The memory modules are seated properly. 2. You have installed the correct type of memory. 3. If you changed the memory, you must update the memory configuration with the Configuration/Setup Utility program. 4. All banks of memory on the DIMMs are enabled. The server might have automatically disabled a DIMM bank if it detected a problem, or a DIMM bank could have been manually disabled. <p>If the problem persists, call for service.</p>
Option	Suggested action
<p>An IBM option that was just installed does not work.</p>	<p>Verify that:</p> <ol style="list-style-type: none"> 1. The option is designed for the server. 2. You followed the installation instructions that came with the option. 3. The option is installed correctly. 4. You have not loosened any other installed options or cables. 5. You updated the configuration information in the Configuration/Setup Utility program. Whenever memory or an option is changed, you must update the configuration. <p>If the problem remains, call for service.</p>
Expansion enclosure	Suggested action
<p>The SCSI expansion enclosure used to work, but does not work now.</p>	<p>Verify that:</p> <ol style="list-style-type: none"> 1. The cables for all external SCSI options are connected correctly. 2. The last option in each SCSI chain, or the end of the SCSI cable, is terminated correctly. 3. External SCSI options are turned on. You must turn on an external SCSI options before turning on the server. <p>For more information, see your SCSI and expansion enclosure documentation.</p>

Appendix A. Getting help and technical assistance

If you need help, service, or technical assistance or just want more information about IBM products, you will find a wide variety of sources available from IBM to assist you. This appendix contains information about where to go for additional information about IBM and IBM products, what to do if you experience a problem with your xSeries or IntelliStation® system, and whom to call for service, if it is necessary.

Before you call

Before you call, make sure that you have taken these steps to try to solve the problem yourself:

- Check all cables to make sure that they are connected.
- Check the power switches to make sure that the system is turned on.
- Use the troubleshooting information in your system documentation, and use the diagnostic tools that come with your system.
- Go to the IBM Support Web site at <http://www.ibm.com/pc/support/> to check for technical information, hints, tips, and new device drivers.
- Use an IBM discussion forum on the IBM Web site to ask questions.

You can solve many problems without outside assistance by following the troubleshooting procedures that IBM provides in the online help or in the publications that are provided with your system and software. The information that comes with your system also describes the diagnostic tests that you can perform. Most xSeries and IntelliStation systems, operating systems, and programs come with information that contains troubleshooting procedures and explanations of error messages and error codes. If you suspect a software problem, see the information for the operating system or program.

Using the documentation

Information about your IBM xSeries or IntelliStation system and preinstalled software, if any, is available in the documentation that comes with your system. That documentation includes printed books, online books, README files, and help files. See the troubleshooting information in your system documentation for instructions for using the diagnostic programs. The troubleshooting information or the diagnostic programs might tell you that you need additional or updated device drivers or other software. IBM maintains pages on the World Wide Web where you can get the latest technical information and download device drivers and updates. To access these pages, go to <http://www.ibm.com/pc/support/> and follow the instructions. Also, you can order publications through the IBM Publications Ordering System at <http://www.elink.ibm.com/public/applications/publications/cgibin/pbi.cgi>.

Getting help and information from the World Wide Web

On the World Wide Web, the IBM Web site has up-to-date information about IBM xSeries and IntelliStation products, services, and support. The address for IBM xSeries information is <http://www.ibm.com/eserver/xseries/>. The address for IBM IntelliStation information is <http://www.ibm.com/pc/intellistation/>.

You can find service information for your IBM products, including supported options, at <http://www.ibm.com/pc/support/>. If you click **Profile** from the support page, you can

create a customized support page. The support page has many sources of information and ways for you to solve problems, including:

- Diagnosing problems, using the IBM Online Assistant
- Downloading the latest device drivers and updates for your products
- Viewing Frequently Asked Questions (FAQ)
- Viewing hints and tips to help you solve problems
- Participating in IBM discussion forums
- Setting up e-mail notification of technical updates about your products

Software service and support

Through IBM Support Line, you can get telephone assistance, for a fee, with usage, configuration, and software problems with xSeries servers, IntelliStation workstations, and appliances. For information about which products are supported by Support Line in your country or region, go to <http://www.ibm.com/services/sl/products/>.

For more information about Support Line and other IBM services, go to <http://www.ibm.com/services/>, or go to <http://www.ibm.com/planetwide/> for support telephone numbers.

Hardware service and support

You can receive hardware service through IBM Integrated Technology Services or through your IBM reseller, if your reseller is authorized by IBM to provide warranty service. Go to <http://www.ibm.com/planetwide/> for support telephone numbers.

In the U.S. and Canada, hardware service and support is available 24 hours a day, 7 days a week. In the U.K., these services are available Monday through Friday, from 9 a.m. to 6 p.m.

Appendix B. Warranty information

This section contains information about your warranty period and the service and support that are provided by your warranty.

Warranty period

The warranty period varies by machine type and country or region.

Contact your place of purchase for warranty service information. Some IBM Machines are eligible for on-site warranty service depending on the country or region where service is performed.

Prior to on-site warranty service, you are required to go through problem determination with an IBM service specialist call center technician.

A warranty period of 3 years on parts and 1 year on labor means that IBM will provide warranty service without charge for:

1. parts and labor during the first year of the warranty period
2. parts only, on an exchange basis, in the second and third years of the warranty period. IBM will charge you for any labor it provides in performance of the repair or replacement.

The IBM Machine Warranties Web site at http://www.ibm.com/servers/support/machine_warranties/ contains a worldwide overview of the IBM Statement of Limited Warranty for IBM Machines, a glossary of terms used in the Statement of Limited Warranty, Frequently Asked Questions (FAQ), and links to Product Support Web pages. The IBM Statement of Limited Warranty is available from this Web site in 29 languages in Portable Document Format (PDF).

Machine - IBM @server xSeries 205 Type 8480

Country or region	Warranty period	Service delivery method
Worldwide	1 year	On-site

Problem determination

Prior to on-site warranty service, you are required to go through problem determination with an IBM service specialist call center technician. The service specialist will run diagnostic tests on the hardware and check the software.

Running diagnostics: The IBM service specialist will help you determine whether your equipment is functioning as specified. It might be necessary to isolate the failing xSeries, Netfinity®, or IntelliStation system; IBM component; or both from any active production environment to run diagnostics and perform defect-isolation programs. You are responsible for making the system, IBM component, or both available for running diagnostics and defect-isolation programs.

Checking software: The IBM service specialist will help you ensure that the correct BIOS code, firmware, device drivers, and other supporting IBM software are installed and correctly configured. It might be necessary to manually gather information about the relevant software levels or run IBM-approved utility programs to gather this information. It might be necessary to isolate the failing system from any

active production environment to gather this information. You are responsible, with assistance from the service specialist, for gathering this information. The IBM Statement of Limited Warranty does not include on-site assistance with this activity.

Warranty service and support

With the original purchase of an IBM xSeries or IntelliStation system, you have access to extensive service and support. During the IBM Machine warranty period, you may call IBM or your reseller for problem-determination assistance under the terms of the IBM Statement of Limited Warranty.

The following services are available during the warranty period:

- **Problem determination** - Trained personnel are available to assist you with determining if you have a hardware problem and deciding what action is necessary to fix the problem.
- **IBM hardware repair** - If the problem is determined to be caused by IBM hardware under warranty, trained service personnel are available to provide the applicable level of service, either on-site or at an IBM service center as determined by IBM.
- **Engineering Change management** - Occasionally, there might be changes that are required after a product has been shipped from IBM. In those instances, IBM will make Engineering Changes (ECs) available that apply to your hardware.
- **Customer replaceable units (CRUs)** - Some parts of IBM xSeries and IntelliStation systems are designated as customer replaceable units. IBM ships CRUs to you for replacement by you. CRUs include keyboards, monitors, memory, diskette drives, hard disk drives, and mice (this list is not inclusive of all CRUs).

The following items are not covered under warranty service:

- Replacement or use of non-IBM parts. All IBM parts contain a 7-character identification in the format IBM FRU XXXXXXX.
- Identification of software problem sources.
- Installation of customer replaceable units (CRUs).
- Installation and configuration of BIOS code, firmware, or device drivers that are designated as customer installable.

See the IBM Statement of Limited Warranty for a full explanation of IBM warranty terms. Be sure to retain your proof of purchase to obtain warranty service.

Please have the following information ready when you call:

- The machine type and model of your IBM hardware product (if available)
- Serial numbers of your IBM hardware products
- A description of the problem
- The exact wording of any error messages
- Hardware and software configuration information

International Warranty Service

If you travel with your xSeries or IntelliStation system or relocate it to a country or region where your system is sold and serviced by IBM or IBM resellers authorized to perform warranty service, International Warranty Service (IWS) is available during the warranty period. Eligible IBM systems are identified by their four-digit machine types.

You can obtain IWS through the service delivery method (such as depot, carry-in, or on-site) provided in the servicing country or region. Service methods and procedures

vary by country or region, and some service or parts might not be available in all countries and regions. Service centers in certain countries or regions might not be able to service all models of a particular machine type. In addition, some countries or regions might have fees and restrictions that apply at the time of service.

To determine whether your system is eligible for IWS, go to <http://www.ibm.com/pc/support/> and click **Warranty lookup**.

Purchasing additional services

During and after the warranty period, you can purchase additional services, such as support for IBM and non-IBM hardware, operating systems, and application programs; network setup and configuration; upgraded or extended hardware repair services; and custom installations. Service availability and service name might vary by country or region.

For more information about these services, contact your IBM marketing representative.

Part 1 - General Terms

This Statement of Limited Warranty includes Part 1 - General Terms and Part 2 - Country-unique Terms. The terms of Part 2 replace or modify those of Part 1. The warranties provided by IBM in this Statement of Limited Warranty apply only to Machines you purchase for your use, and not for resale, from IBM or your reseller. The term "Machine" means an IBM machine, its features, conversions, upgrades, elements, or accessories, or any combination of them. The term "Machine" does not include any software programs, whether pre-loaded with the Machine, installed subsequently or otherwise. Unless IBM specifies otherwise, the following warranties apply only in the country where you acquire the Machine. Nothing in this Statement of Limited Warranty affects any statutory rights of consumers that cannot be waived or limited by contract. If you have any questions, contact IBM or your reseller.

The IBM Warranty for Machines: IBM warrants that each Machine 1) is free from defects in materials and workmanship and 2) conforms to IBM's Official Published Specifications ("Specifications"). The warranty period for a Machine is a specified, fixed period commencing on its Date of Installation. The date on your sales receipt is the Date of Installation unless IBM or your reseller informs you otherwise.

If a Machine does not function as warranted during the warranty period, and IBM or your reseller are unable to either 1) make it do so or 2) replace it with one that is at least functionally equivalent, you may return it to your place of purchase and your money will be refunded.

Extent of Warranty: The warranty does not cover the repair or exchange of a Machine resulting from misuse, accident, modification, unsuitable physical or operating environment, improper maintenance by you, or failure caused by a product for which IBM is not responsible. The warranty is voided by removal or alteration of Machine or parts identification labels.

THESE WARRANTIES ARE YOUR EXCLUSIVE WARRANTIES AND REPLACE ALL OTHER WARRANTIES OR CONDITIONS, EXPRESS OR IMPLIED, INCLUDING, BUT NOT LIMITED TO, THE IMPLIED WARRANTIES OR CONDITIONS OF MERCHANTABILITY AND FITNESS FOR A PARTICULAR PURPOSE. THESE WARRANTIES GIVE YOU SPECIFIC LEGAL RIGHTS AND YOU MAY ALSO HAVE OTHER RIGHTS WHICH VARY FROM JURISDICTION TO JURISDICTION. SOME JURISDICTIONS DO NOT ALLOW THE EXCLUSION OR LIMITATION OF EXPRESS OR IMPLIED WARRANTIES, SO THE ABOVE EXCLUSION OR LIMITATION MAY NOT APPLY TO YOU. IN THAT EVENT, SUCH WARRANTIES ARE LIMITED IN DURATION TO THE WARRANTY PERIOD. NO WARRANTIES APPLY AFTER THAT PERIOD.

Items Not Covered by Warranty: IBM does not warrant uninterrupted or error-free operation of a Machine. Any technical or other support provided for a Machine under warranty, such as assistance via telephone with "how-to" questions and those regarding Machine set-up and installation, will be provided **WITHOUT WARRANTIES OF ANY KIND.**

Warranty Service: To obtain warranty service for a Machine, contact IBM or your reseller. If you do not register your Machine with IBM, you may be required to present proof of purchase.

During the warranty period, IBM or your reseller, if approved by IBM to provide warranty service, provides without charge certain types of repair and exchange service to keep Machines in, or restore them to, conformance with their Specifications.

IBM or your reseller will inform you of the available types of service for a Machine based on its country of installation. At its discretion, IBM or your reseller will 1) either repair or exchange the failing Machine and 2) provide the service either at your location or a service center. IBM or your reseller will also manage and install selected engineering changes that apply to the Machine.

Some parts of IBM Machines are designated as Customer Replaceable Units (called "CRUs"), e.g., keyboards, memory, or hard disk drives. IBM ships CRUs to you for replacement by you. You must return all defective CRUs to IBM within 30 days of your receipt of the replacement CRU. You are responsible for downloading designated Machine Code and Licensed Internal Code updates from an IBM Internet Web site or from other electronic media, and following the instructions that IBM provides.

When warranty service involves the exchange of a Machine or part, the item IBM or your reseller replaces becomes its property and the replacement becomes yours. You represent that all removed items are genuine and unaltered. The replacement may not be new, but will be in good working order and at least functionally equivalent to the item replaced. The replacement assumes the warranty service status of the replaced item. Many features, conversions, or upgrades involve the removal of parts and their return to IBM. A part that replaces a removed part will assume the warranty service status of the removed part.

Before IBM or your reseller exchanges a Machine or part, you agree to remove all features, parts, options, alterations, and attachments not under warranty service.

You also agree to

1. ensure that the Machine is free of any legal obligations or restrictions that prevent its exchange;
2. obtain authorization from the owner to have IBM or your reseller service a Machine that you do not own; and
3. where applicable, before service is provided:
 - a. follow the problem determination, problem analysis, and service request procedures that IBM or your reseller provides;
 - b. secure all programs, data, and funds contained in a Machine;
 - c. provide IBM or your reseller with sufficient, free, and safe access to your facilities to permit them to fulfill their obligations; and
 - d. inform IBM or your reseller of changes in a Machine's location.

IBM is responsible for loss of, or damage to, your Machine while it is 1) in IBM's possession or 2) in transit in those cases where IBM is responsible for the transportation charges.

Neither IBM nor your reseller is responsible for any of your confidential, proprietary or personal information contained in a Machine which you return to IBM or your reseller for any reason. You should remove all such information from the Machine prior to its return.

Limitation of Liability: Circumstances may arise where, because of a default on IBM's part or other liability, you are entitled to recover damages from IBM. In each such instance, regardless of the basis on which you are entitled to claim damages from IBM (including fundamental breach, negligence, misrepresentation, or other contract or tort claim), except for any liability that cannot be waived or limited by applicable laws, IBM is liable for no more than

1. damages for bodily injury (including death) and damage to real property and tangible personal property; and
2. the amount of any other actual direct damages, up to the charges (if recurring, 12 months' charges apply) for the Machine that is subject of the claim. For purposes

of this item, the term "Machine" includes Machine Code and Licensed Internal Code.

This limit also applies to IBM's suppliers and your reseller. It is the maximum for which IBM, its suppliers, and your reseller are collectively responsible.

UNDER NO CIRCUMSTANCES IS IBM LIABLE FOR ANY OF THE FOLLOWING: 1) THIRD-PARTY CLAIMS AGAINST YOU FOR DAMAGES (OTHER THAN THOSE UNDER THE FIRST ITEM LISTED ABOVE); 2) LOSS OF, OR DAMAGE TO, YOUR RECORDS OR DATA; OR 3) SPECIAL, INCIDENTAL, OR INDIRECT DAMAGES OR FOR ANY ECONOMIC CONSEQUENTIAL DAMAGES, LOST PROFITS OR LOST SAVINGS, EVEN IF IBM, ITS SUPPLIERS OR YOUR RESELLER IS INFORMED OF THEIR POSSIBILITY. SOME JURISDICTIONS DO NOT ALLOW THE EXCLUSION OR LIMITATION OF INCIDENTAL OR CONSEQUENTIAL DAMAGES, SO THE ABOVE LIMITATION OR EXCLUSION MAY NOT APPLY TO YOU.

Governing Law: Both you and IBM consent to the application of the laws of the country in which you acquired the Machine to govern, interpret, and enforce all of your and IBM's rights, duties, and obligations arising from, or relating in any manner to, the subject matter of this Agreement, without regard to conflict of law principles.

Part 2 - Country-unique Terms

AMERICAS

BRAZIL

Governing Law: *The following is added after the first sentence:*

Any litigation arising from this Agreement will be settled exclusively by the court of Rio de Janeiro.

NORTH AMERICA

Warranty Service: *The following is added to this Section:*

To obtain warranty service from IBM in Canada or the United States, call 1-800-IBM-SERV (426-7378).

CANADA

Governing Law: *The following replaces "laws of the country in which you acquired the Machine" in the first sentence:*

laws in the Province of Ontario.

UNITED STATES

Governing Law: *The following replaces "laws of the country in which you acquired the Machine" in the first sentence:*

laws of the State of New York.

ASIA PACIFIC

AUSTRALIA

The IBM Warranty for Machines: *The following paragraph is added to this Section:*

The warranties specified in this Section are in addition to any rights you may have under the Trade Practices Act 1974 or other similar legislation and are only limited to the extent permitted by the applicable legislation.

Limitation of Liability: *The following is added to this Section:*

Where IBM is in breach of a condition or warranty implied by the Trade Practices Act 1974 or other similar legislation, IBM's liability is limited to the repair or replacement of the goods or the supply of equivalent goods. Where that condition or warranty relates to right to sell, quiet possession or clear title, or the goods are of a kind ordinarily acquired for personal, domestic or household use or consumption, then none of the limitations in this paragraph apply.

Governing Law: *The following replaces "laws of the country in which you acquired the Machine" in the first sentence:*
laws of the State or Territory.

CAMBODIA, LAOS, AND VIETNAM

Governing Law: *The following replaces "laws of the country in which you acquired the Machine" in the first sentence:*
laws of the State of New York.

The following is added to this Section:

Disputes and differences arising out of or in connection with this Agreement shall be finally settled by arbitration which shall be held in Singapore in accordance with the rules of the International Chamber of Commerce (ICC). The arbitrator or arbitrators designated in conformity with those rules shall have the power to rule on their own competence and on the validity of the Agreement to submit to arbitration. The arbitration award shall be final and binding for the parties without appeal and the arbitral award shall be in writing and set forth the findings of fact and the conclusions of law.

All proceedings shall be conducted, including all documents presented in such proceedings, in the English language. The number of arbitrators shall be three, with each side to the dispute being entitled to appoint one arbitrator.

The two arbitrators appointed by the parties shall appoint a third arbitrator before proceeding upon the reference. The third arbitrator shall act as chairman of the proceedings. Vacancies in the post of chairman shall be filled by the president of the ICC. Other vacancies shall be filled by the respective nominating party. Proceedings shall continue from the stage they were at when the vacancy occurred.

If one of the parties refuses or otherwise fails to appoint an arbitrator within 30 days of the date the other party appoints its, the first appointed arbitrator shall be the sole arbitrator, provided that the arbitrator was validly and properly appointed.

The English language version of this Agreement prevails over any other language version.

HONG KONG AND MACAU

Governing Law: *The following replaces "laws of the country in which you acquired the Machine" in the first sentence:*
laws of Hong Kong Special Administrative Region.

INDIA

Limitation of Liability: *The following replaces items 1 and 2 of this Section:*

1. liability for bodily injury (including death) or damage to real property and tangible personal property will be limited to that caused by IBM's negligence;
2. as to any other actual damage arising in any situation involving nonperformance by IBM pursuant to, or in any way related to the subject of this Statement of

Limited Warranty, IBM's liability will be limited to the charge paid by you for the individual Machine that is the subject of the claim.

JAPAN

Governing Law: *The following sentence is added to this Section:*

Any doubts concerning this Agreement will be initially resolved between us in good faith and in accordance with the principle of mutual trust.

NEW ZEALAND

The IBM Warranty for Machines: *The following paragraph is added to this Section:*

The warranties specified in this Section are in addition to any rights you may have under the Consumer Guarantees Act 1993 or other legislation which cannot be excluded or limited. The Consumer Guarantees Act 1993 will not apply in respect of any goods which IBM provides, if you require the goods for the purposes of a business as defined in that Act.

Limitation of Liability: *The following is added to this Section:*

Where Machines are not acquired for the purposes of a business as defined in the Consumer Guarantees Act 1993, the limitations in this Section are subject to the limitations in that Act.

PEOPLE'S REPUBLIC OF CHINA (PRC)

Governing Law: *The following replaces this Section:*

Both you and IBM consent to the application of the laws of the State of New York (except when local law requires otherwise) to govern, interpret, and enforce all your and IBM's rights, duties, and obligations arising from, or relating in any manner to, the subject matter of this Agreement, without regard to conflict of law principles.

Any disputes arising from or in connection with this Agreement will first be resolved by friendly negotiations, failing which either of us has the right to submit the dispute to the China International Economic and Trade Arbitration Commission in Beijing, the PRC, for arbitration in accordance with its arbitration rules in force at the time. The arbitration tribunal will consist of three arbitrators. The language to be used therein will be English and Chinese. An arbitral award will be final and binding on all the parties, and will be enforceable under the Convention on the Recognition and Enforcement of Foreign Arbitral Awards (1958).

The arbitration fee will be borne by the losing party unless otherwise determined by the arbitral award.

During the course of arbitration, this Agreement will continue to be performed except for the part which the parties are disputing and which is undergoing arbitration.

EUROPE, MIDDLE EAST, AFRICA (EMEA)

THE FOLLOWING TERMS APPLY TO ALL EMEA COUNTRIES:

The terms of this Statement of Limited Warranty apply to Machines purchased from IBM or an IBM reseller.

Warranty Service: If you purchase an IBM Machine in Austria, Belgium, Denmark, Estonia, Finland, France, Germany, Greece, Iceland, Ireland, Italy, Latvia, Lithuania, Luxembourg, Netherlands, Norway, Portugal, Spain, Sweden, Switzerland or United Kingdom, you may obtain warranty service for that Machine in any of those countries from either (1) an IBM reseller approved to perform warranty service or (2) from IBM. If you purchase an IBM Personal Computer Machine in Albania, Armenia, Belarus,

Bosnia and Herzegovina, Bulgaria, Croatia, Czech Republic, Georgia, Hungary, Kazakhstan, Kirghizia, Federal Republic of Yugoslavia, Former Yugoslav Republic of Macedonia (FYROM), Moldova, Poland, Romania, Russia, Slovak Republic, Slovenia, or Ukraine, you may obtain warranty service for that Machine in any of those countries from either (1) an IBM reseller approved to perform warranty service or (2) from IBM.

If you purchase an IBM Machine in a Middle Eastern or African country, you may obtain warranty service for that Machine from the IBM entity within the country of purchase, if that IBM entity provides warranty service in that country, or from an IBM reseller, approved by IBM to perform warranty service on that Machine in that country. Warranty service in Africa is available within 50 kilometers of an IBM authorized service provider. You are responsible for transportation costs for Machines located outside 50 kilometers of an IBM authorized service provider.

Governing Law: The applicable laws that govern, interpret and enforce rights, duties, and obligations of each of us arising from, or relating in any manner to, the subject matter of this Statement, without regard to conflict of laws principles, as well as Country-unique terms and competent court for this Statement are those of the country in which the warranty service is being provided, except that in 1) Albania, Bosnia-Herzegovina, Bulgaria, Croatia, Hungary, Former Yugoslav Republic of Macedonia, Romania, Slovakia, Slovenia, Armenia, Azerbaijan, Belarus, Georgia, Kazakhstan, Kyrgyzstan, Moldova, Russia, Tajikistan, Turkmenistan, Ukraine, and Uzbekistan, the laws of Austria apply; 2) Estonia, Latvia, and Lithuania, the laws of Finland apply; 3) Algeria, Benin, Burkina Faso, Cameroon, Cape Verde, Central African Republic, Chad, Congo, Djibouti, Democratic Republic of Congo, Equatorial Guinea, France, Gabon, Gambia, Guinea, Guinea-Bissau, Ivory Coast, Lebanon, Mali, Mauritania, Morocco, Niger, Senegal, Togo, and Tunisia, this Agreement will be construed and the legal relations between the parties will be determined in accordance with the French laws and all disputes arising out of this Agreement or related to its violation or execution, including summary proceedings, will be settled exclusively by the Commercial Court of Paris; 4) Angola, Bahrain, Botswana, Burundi, Egypt, Eritrea, Ethiopia, Ghana, Jordan, Kenya, Kuwait, Liberia, Malawi, Malta, Mozambique, Nigeria, Oman, Pakistan, Qatar, Rwanda, Sao Tome, Saudi Arabia, Sierra Leone, Somalia, Tanzania, Uganda, United Arab Emirates, United Kingdom, West Bank/Gaza, Yemen, Zambia, and Zimbabwe, this Agreement will be governed by English Law and disputes relating to it will be submitted to the exclusive jurisdiction of the English courts; and 5) in Greece, Israel, Italy, Portugal, and Spain any legal claim arising out of this Statement will be brought before, and finally settled by, the competent court of Athens, Tel Aviv, Milan, Lisbon, and Madrid, respectively.

THE FOLLOWING TERMS APPLY TO THE COUNTRY SPECIFIED:

AUSTRIA AND GERMANY

The IBM Warranty for Machines: *The following replaces the first sentence of the first paragraph of this Section:*

The warranty for an IBM Machine covers the functionality of the Machine for its normal use and the Machine's conformity to its Specifications.

The following paragraphs are added to this Section:

The minimum warranty period for Machines is six months. In case IBM or your reseller is unable to repair an IBM Machine, you can alternatively ask for a partial refund as far as justified by the reduced value of the unrepaired Machine or ask for a cancellation of the respective agreement for such Machine and get your money refunded.

Extent of Warranty: *The second paragraph does not apply.*

Warranty Service: *The following is added to this Section:*

During the warranty period, transportation for delivery of the failing Machine to IBM will be at IBM's expense.

Limitation of Liability: *The following paragraph is added to this Section:*

The limitations and exclusions specified in the Statement of Limited Warranty will not apply to damages caused by IBM with fraud or gross negligence and for express warranty.

The following sentence is added to the end of item 2:

IBM's liability under this item is limited to the violation of essential contractual terms in cases of ordinary negligence.

EGYPT

Limitation of Liability: *The following replaces item 2 in this Section:*

as to any other actual direct damages, IBM's liability will be limited to the total amount you paid for the Machine that is the subject of the claim. For purposes of this item, the term "Machine" includes Machine Code and Licensed Internal Code.

Applicability of suppliers and resellers (unchanged).

FRANCE

Limitation of Liability: *The following replaces the second sentence of the first paragraph of this Section:*

In such instances, regardless of the basis on which you are entitled to claim damages from IBM, IBM is liable for no more than: *(items 1 and 2 unchanged).*

IRELAND

Extent of Warranty: *The following is added to this Section:*

Except as expressly provided in these terms and conditions, all statutory conditions, including all warranties implied, but without prejudice to the generality of the foregoing all warranties implied by the Sale of Goods Act 1893 or the Sale of Goods and Supply of Services Act 1980 are hereby excluded.

Limitation of Liability: *The following replaces items one and two of the first paragraph of this Section:*

1. death or personal injury or physical damage to your real property solely caused by IBM's negligence; and
2. the amount of any other actual direct damages, up to 125 percent of the charges (if recurring, the 12 months' charges apply) for the Machine that is the subject of the claim or which otherwise gives rise to the claim.

Applicability of suppliers and resellers (unchanged).

The following paragraph is added at the end of this Section:

IBM's entire liability and your sole remedy, whether in contract or in tort, in respect of any default shall be limited to damages.

ITALY

Limitation of Liability: *The following replaces the second sentence in the first paragraph:*

In each such instance unless otherwise provided by mandatory law, IBM is liable for no more than:

1. *(unchanged)*
2. as to any other actual damage arising in all situations involving nonperformance by

IBM pursuant to, or in any way related to the subject matter of this Statement of Warranty, IBM's liability, will be limited to the total amount you paid for the Machine that is the subject of the claim.

Applicability of suppliers and resellers (unchanged).

The following replaces the third paragraph of this Section:

Unless otherwise provided by mandatory law, IBM and your reseller are not liable for any of the following: *(items 1 and 2 unchanged)* 3) indirect damages, even if IBM or your reseller is informed of their possibility.

SOUTH AFRICA, NAMIBIA, BOTSWANA, LESOTHO AND SWAZILAND

Limitation of Liability: *The following is added to this Section:*

IBM's entire liability to you for actual damages arising in all situations involving nonperformance by IBM in respect of the subject matter of this Statement of Warranty will be limited to the charge paid by you for the individual Machine that is the subject of your claim from IBM.

UNITED KINGDOM

Limitation of Liability: *The following replaces items 1 and 2 of the first paragraph of this Section:*

1. death or personal injury or physical damage to your real property solely caused by IBM's negligence;
2. the amount of any other actual direct damages or loss, up to 125 percent of the charges (if recurring, the 12 months' charges apply) for the Machine that is the subject of the claim or which otherwise gives rise to the claim;

The following item is added to this paragraph:

3. breach of IBM's obligations implied by Section 12 of the Sale of Goods Act 1979 or Section 2 of the Supply of Goods and Services Act 1982.

Applicability of suppliers and resellers (unchanged).

The following is added to the end of this Section:

IBM's entire liability and your sole remedy, whether in contract or in tort, in respect of any default shall be limited to damages.

Appendix C. Notices

This publication was developed for products and services offered in the U.S.A.

IBM may not offer the products, services, or features discussed in this document in other countries. Consult your local IBM representative for information on the products and services currently available in your area. Any reference to an IBM product, program, or service is not intended to state or imply that only that IBM product, program, or service may be used. Any functionally equivalent product, program, or service that does not infringe any IBM intellectual property right may be used instead. However, it is the user's responsibility to evaluate and verify the operation of any non-IBM product, program, or service.

IBM may have patents or pending patent applications covering subject matter described in this document. The furnishing of this document does not give you any license to these patents. You can send license inquiries, in writing, to:

*IBM Director of Licensing
IBM Corporation
North Castle Drive
Armonk, NY 10504-1785
U.S.A.*

INTERNATIONAL BUSINESS MACHINES CORPORATION PROVIDES THIS PUBLICATION "AS IS" WITHOUT WARRANTY OF ANY KIND, EITHER EXPRESS OR IMPLIED, INCLUDING, BUT NOT LIMITED TO, THE IMPLIED WARRANTIES OF NON-INFRINGEMENT, MERCHANTABILITY OR FITNESS FOR A PARTICULAR PURPOSE. Some jurisdictions do not allow disclaimer of express or implied warranties in certain transactions, therefore, this statement may not apply to you.

This information could include technical inaccuracies or typographical errors. Changes are periodically made to the information herein; these changes will be incorporated in new editions of the publication. IBM may make improvements and/or changes in the product(s) and/or the program(s) described in this publication at any time without notice.

Any references in this publication to non-IBM Web sites are provided for convenience only and do not in any manner serve as an endorsement of those Web sites. The materials at those Web sites are not part of the materials for this IBM product, and use of those Web sites is at your own risk.

IBM may use or distribute any of the information you supply in any way it believes appropriate without incurring any obligation to you.

Edition notice

© COPYRIGHT INTERNATIONAL BUSINESS MACHINES CORPORATION, 2002.
All rights reserved.

Note to U.S. Government Users — Documentation related to restricted rights — Use, duplication or disclosure is subject to restrictions set forth in GSA ADP Schedule Contract with IBM Corp.

Trademarks

The following terms are trademarks of International Business Machines Corporation in the United States, other countries, or both:

e-business logo	ServerGuide
IBM	ServerProven
IntelliStation	TechConnect
Light Path Diagnostics	Update Connector
Predictive Failure Analysis	Wake on LAN
PS/2	X-Architecture
ServeRAID	xSeries

Lotus, Lotus Notes, SmartSuite, and Domino are trademarks of Lotus Development Corporation and/or IBM Corporation in the United States, other countries, or both.

Intel, Celeron, LANDesk, MMX, NetBurst, Pentium, Pentium II Xeon, Pentium III Xeon, and Xeon are trademarks of Intel Corporation in the United States, other countries, or both.

Microsoft, Windows, and Windows NT are trademarks of Microsoft Corporation in the United States, other countries, or both.

UNIX is a registered trademark of The Open Group in the United States and other countries.

Java and all Java-based trademarks and logos are trademarks or registered trademarks of Sun Microsystems, Inc. in the United States, other countries, or both.

Linux is a registered trademark of Linus Torvalds.

Other company, product, or service names may be trademarks or service marks of others.

Important notes

Processor speeds indicate the internal clock speed of the microprocessor; other factors also affect application performance.

CD-ROM drive speeds list the variable read rate. Actual speeds vary and are often less than the maximum possible.

When referring to processor storage, real and virtual storage, or channel volume, KB stands for approximately 1000 bytes, MB stands for approximately 1 000 000 bytes, and GB stands for approximately 1 000 000 000 bytes.

When referring to hard disk drive capacity or communications volume, MB stands for 1 000 000 bytes, and GB stands for 1 000 000 000 bytes. Total user-accessible capacity may vary depending on operating environments.

Maximum internal hard disk drive capacities assume the replacement of any standard hard disk drives and population of all hard disk drive bays with the largest currently supported drives available from IBM.

Maximum memory may require replacement of the standard memory with an optional memory module.

IBM makes no representation or warranties regarding non-IBM products and services that are ServerProven, including but not limited to the implied warranties of merchantability and fitness for a particular purpose. These products are offered and warranted solely by third parties.

IBM makes no representations or warranties with respect to non-IBM products. Support (if any) for the non-IBM products is provided by the third party, not IBM.

Some software may differ from its retail version (if available), and may not include user manuals or all program functionality.

Electronic emission notices

IBM @server xSeries 205 Type 8480

Federal Communications Commission (FCC) statement

Note: This equipment has been tested and found to comply with the limits for a Class B digital device, pursuant to Part 15 of the FCC Rules. These limits are designed to provide reasonable protection against harmful interference in a residential installation. This equipment generates, uses, and can radiate radio frequency energy and, if not installed and used in accordance with the instructions, may cause harmful interference to radio communications. However, there is no guarantee that interference will not occur in a particular installation. If this equipment does cause harmful interference to radio or television reception, which can be determined by turning the equipment off and on, the user is encouraged to try to correct the interference by one or more of the following measures:

- Reorient or relocate the receiving antenna.
- Increase the separation between the equipment and receiver.
- Connect the equipment into an outlet on a circuit different from that to which the receiver is connected.
- Consult an IBM authorized dealer or service representative for help.

Properly shielded and grounded cables and connectors must be used in order to meet FCC emission limits. Proper cables and connectors are available from IBM authorized dealers. IBM is not responsible for any radio or television interference caused by using other than recommended cables and connectors or by unauthorized changes or modifications to this equipment. Unauthorized changes or modifications could void the user's authority to operate the equipment.

This device complies with Part 15 of the FCC Rules. Operation is subject to the following two conditions: (1) this device may not cause harmful interference, and (2) this device must accept any interference received, including interference that may cause undesired operation.

Responsible party:

International Business Machines Corporation
New Orchard Road
Armonk, NY 10504

Telephone: 1-919-543-2193

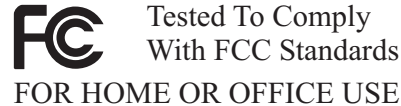

Industry Canada Class B emission compliance statement

This Class B digital apparatus complies with Canadian ICES-003.

Avis de conformité à la réglementation d'Industrie Canada

Cet appareil numérique de la classe B est conforme à la norme NMB-003 du Canada.

European Union EMC Directive conformance statement

This product is in conformity with the protection requirements of EU Council Directive 89/336/EEC on the approximation of the laws of the Member States relating to electromagnetic compatibility. IBM cannot accept responsibility for any failure to satisfy the protection requirements resulting from a nonrecommended modification of the product, including the fitting of non-IBM option cards.

This product has been tested and found to comply with the limits for Class B Information Technology Equipment according to CISPR 22/European Standard EN 55022. The limits for Class B equipment were derived for typical residential environments to provide reasonable protection against interference with licensed communication devices.

Japanese Voluntary Control Council for Interference (VCCI) statement

この装置は、情報処理装置等電波障害自主規制協議会（VCCI）の基準に基づくクラスB情報技術装置です。この装置は、家庭環境で使用することを目的としていますが、この装置がラジオやテレビジョン受信機に近接して使用されると、受信障害を引き起こすことがあります。
取扱説明書に従って正しい取り扱いをして下さい。

Power cords

For your safety, IBM provides a power cord with a grounded attachment plug to use with this IBM product. To avoid electrical shock, always use the power cord and plug with a properly grounded outlet.

IBM power cords used in the United States and Canada are listed by Underwriter's Laboratories (UL) and certified by the Canadian Standards Association (CSA).

For units intended to be operated at 115 volts: Use a UL-listed and CSA-certified cord set consisting of a minimum 18 AWG, Type SVT or SJT, three-conductor cord, a maximum of 15 feet in length and a parallel blade, grounding-type attachment plug rated 15 amperes, 125 volts.

For units intended to be operated at 230 volts (U.S. use): Use a UL-listed and CSA-certified cord set consisting of a minimum 18 AWG, Type SVT or SJT, three-conductor cord, a maximum of 15 feet in length and a tandem blade, grounding-type attachment plug rated 15 amperes, 250 volts.

For units intended to be operated at 230 volts (outside the U.S.): Use a cord set with a grounding-type attachment plug. The cord set should have the appropriate safety approvals for the country in which the equipment will be installed.

IBM power cords for a specific country or region are usually available only in that country or region.

IBM power cord part number	Used in these countries and regions
13F9940	Argentina, Australia, China (PRC), New Zealand, Papua New Guinea, Paraguay, Uruguay, Western Samoa
13F9979	Afghanistan, Algeria, Andorra, Angola, Austria, Belgium, Benin, Bulgaria, Burkina Faso, Burundi, Cameroon, Central African Rep., Chad, China (Macau S.A.R.), Czech Republic, Egypt, Finland, France, French Guiana, Germany, Greece, Guinea, Hungary, Iceland, Indonesia, Iran, Ivory Coast, Jordan, Lebanon, Luxembourg, Malagasy, Mali, Martinique, Mauritania, Mauritius, Monaco, Morocco, Mozambique, Netherlands, New Caledonia, Niger, Norway, Poland, Portugal, Romania, Senegal, Slovakia, Spain, Sudan, Sweden, Syria, Togo, Tunisia, Turkey, former USSR, Vietnam, former Yugoslavia, Zaire, Zimbabwe
13F9997	Denmark
14F0015	Bangladesh, Burma, Pakistan, South Africa, Sri Lanka
14F0033	Antigua, Bahrain, Brunei, Channel Islands, China (Hong Kong S.A.R.), Cyprus, Dubai, Fiji, Ghana, India, Iraq, Ireland, Kenya, Kuwait, Malawi, Malaysia, Malta, Nepal, Nigeria, Polynesia, Qatar, Sierra Leone, Singapore, Tanzania, Uganda, United Kingdom, Yemen, Zambia
14F0051	Liechtenstein, Switzerland
14F0069	Chile, Ethiopia, Italy, Libya, Somalia
14F0087	Israel
1838574	Thailand
6952301	Bahamas, Barbados, Bermuda, Bolivia, Brazil, Canada, Cayman Islands, Colombia, Costa Rica, Dominican Republic, Ecuador, El Salvador, Guatemala, Guyana, Haiti, Honduras, Jamaica, Japan, Korea (South), Liberia, Mexico, Netherlands Antilles, Nicaragua, Panama, Peru, Philippines, Saudi Arabia, Suriname, Taiwan, Trinidad (West Indies), United States of America, Venezuela

Index

A

acoustical noise emissions 2
adapter
 considerations 10
 full length 10
 installing 11
 PCI bus 11

B

bay
 2 or 4 16
 5, 6, or 7 19
 filler panel 16
 open 20
beep codes 36

C

cables
 internal drives 15
 power 15
 signal 15
cabling
 connectors on back 26
 SCSI device 18, 20
 server 26
CD-ROM drive
 installing 14
 specifications 2
components
 location of 3
 major 3
configuration programs 33
Configuration/Setup Utility program 33
controls and LEDs 29
cover
 installing 25
 removing 8

D

devices
 handling static-sensitive 6
diagnostic tools 35
DIMM
 connector locations 23
 installing 23
diskette drive
 installing 14
 preinstalled 2
drive
 bay filler panel 16
 cabling 18

installing 14

E

electrical input 2
environment
 air temperature 2
 humidity 2
Ethernet
 speed 1 Gbps LED 29
 transmit/receive activity LED 29
expansion
 bays 2
 PCI slots 2

F

features, server 2
filler panel 16
frame-support bracket, removing 9

G

guidelines
 installation 5
 system reliability 5

H

handling static-sensitive devices 6
hard disk drive, installing 14
heat output 2

I

installing
 adapters 11
 drive 13
 hard disk drive 19, 20
 hot-swap hard disk drive 20
 internal drives 14
 memory modules 23
 non-hot-swap hard disk drive 19
 options 5
 redundant arrays of independent drives (RAID)
 adapter 13
 security rope clip 24
 side cover 25
 small computer systems interface (SCSI)
 adapter 13
integrated
 functions 2
 system management processor 2

internal
cable connectors 4
drives 14

L

LED
CD-ROM drive activity 29
diskette drive activity 29
Ethernet speed 1 Gbps 29
Ethernet transmit/receive activity 29
hard disk drive activity 29
power-on 29

M

major components 3
memory
installing 23
modules 23
order of installation 23
specifications 2

N

NOS See operating system
notes, important 56
notices
attention 3
book 3
caution 3
danger 3
important 3

O

operating system, installing 34

P

PCI
bus 11
expansion slots 10
extender board 10
power
features 30
supply 2
power cords 58
power-on self-test (POST)
beep codes 35
error messages 36

R

removable media drives, installing 14

removing
frame-support bracket 9
side cover 8

S

Safety v
SCSISelect Utility program 33, 34
server
cabling 26
configuring 33, 34
keys 1
model number 1
serial number 1
turning off 30
turning on 30
ServerGuide
Setup and Installation CD 34
startup problems 37
small computer systems interface (SCSI)
adapter 13
adapter boot option 11
device 18
hot-swap backplane 21
specifications
memory 2
server 2
stabilizing feet 6
statements
attention 3
caution 3
danger 3
important 3
support page, customized 35

T

tape drive
installing 14
trademarks 56
troubleshooting
basic 35
chart 38
turning off the server 30
turning on the server 30

U

utility
Configuration/Setup 33
SCSISelect 34

V

video controller 2

W

Web site
 compatible options 23
 xSeries 1

X

xSeries
 Web address 1



Part Number: 33P2410

Printed in the United States of America.

33P2410

