

IBM

@server

xSeries 440

## Option Installation Guide

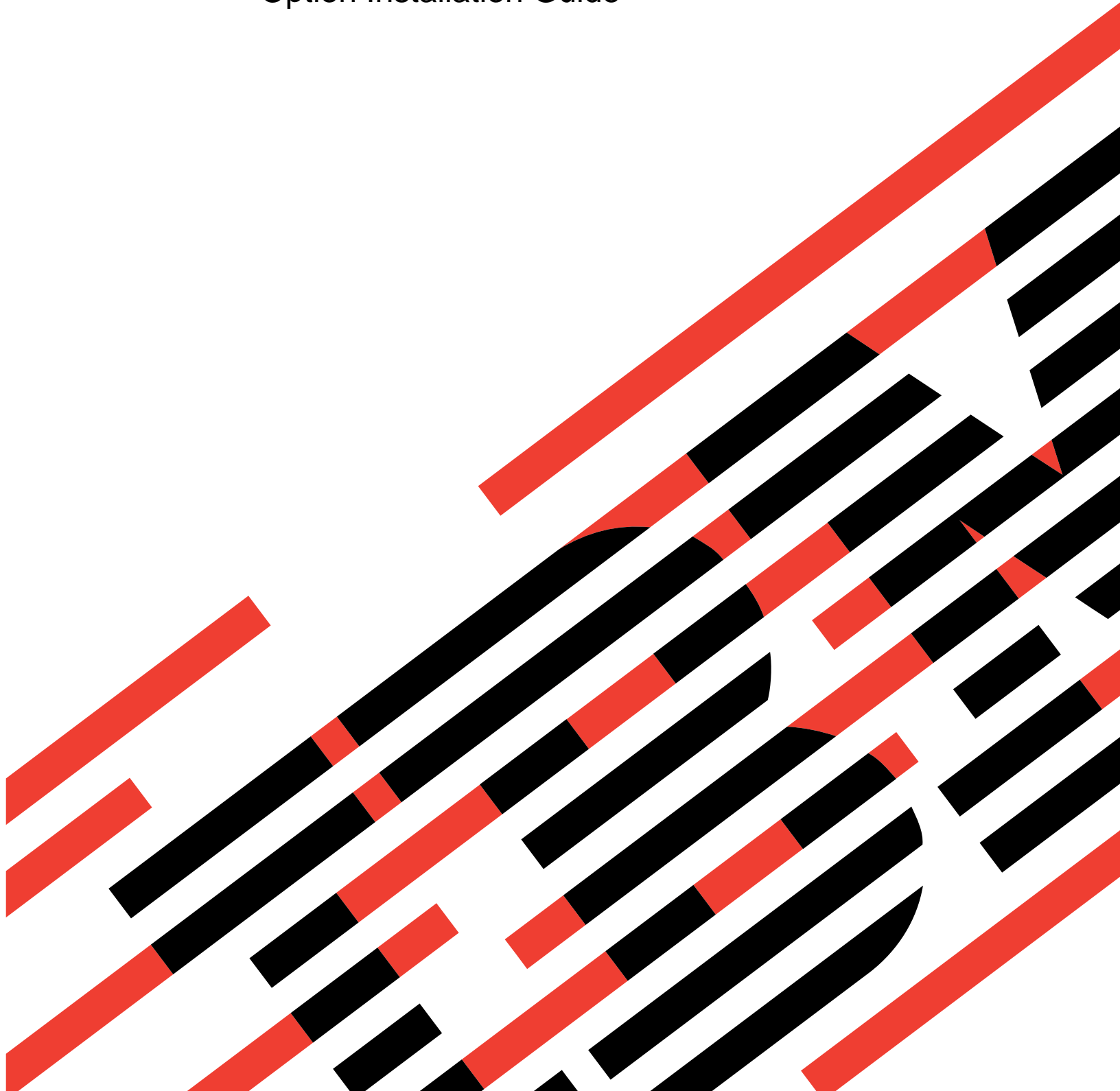





xSeries 440

## Option Installation Guide

SC59-P678-70

**Note:** Before using this information and the product it supports, be sure to read the general information in Appendix A, "Notices" on page 63.

**Fourth Edition (November 2002)**

**© Copyright International Business Machines Corporation 2002. All rights reserved.**

US Government Users Restricted Rights – Use, duplication or disclosure restricted by GSA ADP Schedule Contract with IBM Corp.

# Contents

<b>Safety</b> . . . . .	v
<b>Chapter 1. Introduction</b> . . . . .	1
Related publications . . . . .	1
Major components of the xSeries 440 . . . . .	2
Center plane connectors and LEDs . . . . .	3
SMP Expansion Module connectors and LEDs . . . . .	4
PCI-X planar internal connectors and LEDs. . . . .	6
I/O board internal connectors . . . . .	7
Remote Supervisor Adapter component locations . . . . .	7
<b>Chapter 2. Installing options</b> . . . . .	9
Before you begin . . . . .	9
Working inside the server with power on . . . . .	9
Handling static-sensitive devices . . . . .	10
System reliability considerations. . . . .	10
Safety information . . . . .	11
Opening the cover. . . . .	16
Removing and replacing the bezel . . . . .	16
Removing and replacing a hot-swap power supply. . . . .	17
PCI and PCI-X adapters . . . . .	19
PCI and PCI-X adapter considerations. . . . .	19
Installing adapters . . . . .	20
Cabling a ServeRAID adapter . . . . .	22
Installing or replacing a drive . . . . .	24
Hot-swap hard disk drive . . . . .	24
Diskette drive . . . . .	25
CD-ROM or DVD-ROM drive . . . . .	26
SMP Expansion Module . . . . .	27
Removing an SMP Expansion Module and cover . . . . .	28
DIMMs . . . . .	31
Installing and replacing a microprocessor . . . . .	36
Reinstalling an SMP Expansion Module and cover . . . . .	41
Replacing and troubleshooting fans . . . . .	44
Replacing fans 1 and 2. . . . .	44
Replacing fans 3 and 4. . . . .	45
Replacing the battery . . . . .	47
Closing the cover . . . . .	49
Cabling the server. . . . .	50
SMP expansion port cabling. . . . .	52
RXE expansion port cabling . . . . .	52
RXE management port cabling . . . . .	54
Power cabling . . . . .	54
SCSI cabling. . . . .	55
USB cabling . . . . .	55
Video cabling . . . . .	55
Auxiliary pointing device cabling. . . . .	55
Keyboard cabling . . . . .	55
Gigabit Ethernet cabling. . . . .	55
Remote Supervisor Adapter cabling. . . . .	55
<b>Chapter 3. I/O connectors and indicators</b> . . . . .	57
Universal Serial Bus ports . . . . .	58
USB cables and hubs. . . . .	58

USB-port connectors .....	58
Keyboard connector .....	58
Video connector .....	58
Auxiliary-device (pointing device) connector .....	59
RXE Expansion Port .....	59
SMP Expansion Port .....	59
Remote Supervisor Adapter communication ports .....	59
Gigabit Ethernet port .....	60
Configuring the Gigabit Ethernet controller .....	61
Ethernet port connector .....	61
<b>Appendix A. Notices</b> .....	<b>63</b>
Edition notice .....	63
Trademarks .....	64
Important notes .....	65
Electronic emission notices .....	65
Federal Communications Commission (FCC) statement .....	65
Industry Canada Class A emission compliance statement .....	66
Australia and New Zealand Class A statement .....	66
United Kingdom telecommunications safety requirement .....	66
European Union EMC Directive conformance statement .....	66
Taiwanese Class A warning statement .....	66
Japanese Voluntary Control Council for Interference (VCCI) statement .....	67
Power cords .....	67
<b>Index</b> .....	<b>69</b>

# Safety

Before installing this product, read the Safety Information.

قبل تركيب هذا المنتج، يجب قراءة الملاحظات الأمنية

Antes de instalar este produto, leia as Informações de Segurança.

在安装本产品之前，请仔细阅读 **Safety Information** (安全信息)。

安裝本產品之前，請先閱讀「安全資訊」。

Prije instalacije ovog produkta obavezno pročitajte Sigurnosne Upute.

Před instalací tohoto produktu si přečtěte příručku bezpečnostních instrukcí.

Læs sikkerhedsforskrifterne, før du installerer dette produkt.

Lees voordat u dit product installeert eerst de veiligheidsvoorschriften.

Ennen kuin asennat tämän tuotteen, lue turvaohjeet kohdasta Safety Information.

Avant d'installer ce produit, lisez les consignes de sécurité.

Vor der Installation dieses Produkts die Sicherheitshinweise lesen.

Πριν εγκαταστήσετε το προϊόν αυτό, διαβάστε τις πληροφορίες ασφάλειας (safety information).

לפני שתתקינו מוצר זה, קראו את הוראות הבטיחות.

A termék telepítése előtt olvassa el a Biztonsági előírásokat!

Prima di installare questo prodotto, leggere le Informazioni sulla Sicurezza.

製品の設置の前に、安全情報をお読みください。

본 제품을 설치하기 전에 안전 정보를 읽으십시오.

Пред да се инсталира овој продукт, прочитајте информацијата за безбедност.

Les sikkerhetsinformasjonen (Safety Information) før du installerer dette produktet.

Przed zainstalowaniem tego produktu, należy zapoznać się z książką "Informacje dotyczące bezpieczeństwa" (Safety Information).

Antes de instalar este produto, leia as Informações sobre Segurança.

Перед установкой продукта прочтите инструкции по технике безопасности.

Pred inštaláciou tohto zariadenia si pečítajte Bezpečnostné predpisy.

Pred namestitvijo tega proizvoda preberite Varnostne informacije.

Antes de instalar este producto, lea la información de seguridad.

Läs säkerhetsinformationen innan du installerar den här produkten.

**Statement 1:**



**DANGER**

**Electrical current from power, telephone, and communication cables is hazardous.**

**To avoid a shock hazard:**

- **Do not connect or disconnect any cables or perform installation, maintenance, or reconfiguration of this product during an electrical storm.**
- **Connect all power cords to a properly wired and grounded electrical outlet.**
- **Connect to properly wired outlets any equipment that will be attached to this product.**
- **When possible, use one hand only to connect or disconnect signal cables.**
- **Never turn on any equipment when there is evidence of fire, water, or structural damage.**
- **Disconnect the attached power cords, telecommunications systems, networks, and modems before you open the device covers, unless instructed otherwise in the installation and configuration procedures.**
- **Connect and disconnect cables as described in the following table when installing, moving, or opening covers on this product or attached devices.**

**To Connect:**

1. Turn everything OFF.
2. First, attach all cables to devices.
3. Attach signal cables to connectors.
4. Attach power cords to outlet.
5. Turn device ON.

**To Disconnect:**

1. Turn everything OFF.
2. First, remove power cords from outlet.
3. Remove signal cables from connectors.
4. Remove all cables from devices.



**Statement 2:**



**CAUTION:**

When replacing the lithium battery, use only IBM Part Number 33F8354 or an equivalent type battery recommended by the manufacturer. If your system has a module containing a lithium battery, replace it only with the same module type made by the same manufacturer. The battery contains lithium and can explode if not properly used, handled, or disposed of.

*Do not:*

- Throw or immerse into water
- Heat to more than 100°C (212°F)
- Repair or disassemble

Dispose of the battery as required by local ordinances or regulations.

**Statement 3:**



**CAUTION:**

When laser products (such as CD-ROMs, DVD drives, fiber optic devices, or transmitters) are installed, note the following:

- Do not remove the covers. Removing the covers of the laser product could result in exposure to hazardous laser radiation. There are no serviceable parts inside the device.
- Use of controls or adjustments or performance of procedures other than those specified herein might result in hazardous radiation exposure.



**DANGER**

Some laser products contain an embedded Class 3A or Class 3B laser diode. Note the following.

Laser radiation when open. Do not stare into the beam, do not view directly with optical instruments, and avoid direct exposure to the beam.

**Statement 4:**

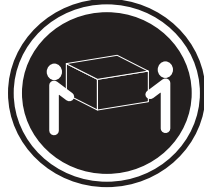

≥ 18 kg (39.7 lb)



≥ 32 kg (70.5 lb)



≥ 55 kg (121.2 lb)

**CAUTION:**  
Use safe practices when lifting.

**Statement 5:**



**CAUTION:**  
The power control button on the device and the power switch on the power supply do not turn off the electrical current supplied to the device. The device also might have more than one power cord. To remove all electrical current from the device, ensure that all power cords are disconnected from the power source.

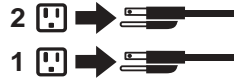

**Statement 8:**



**CAUTION:**

Never remove the cover on a power supply or any part that has the following label attached.



Hazardous voltage, current, and energy levels are present inside any component that has this label attached. There are no serviceable parts inside these components. If you suspect a problem with one of these parts, contact a service technician.



---

## Chapter 1. Introduction

There are many optional devices supported by your server. This *Option Installation Guide* provides the information needed to install, remove, and connect optional devices supported by your server.

---

### Related publications

In addition to this *Option Installation Guide*, the following xSeries 440 documentation is provided with your server:

- *Installation Guide*  
This printed publication contains setup and installation instructions. This publication is also provided in Portable Document Format (PDF) on the *IBM® xSeries™ Documentation CD*.
- *Rack Installation Instructions*  
This printed publication contains the instructions needed to install your server in a rack cabinet. This publication is also provided in PDF on the *IBM xSeries Documentation CD*.
- *Safety Information*  
This multilingual publication is provided in PDF on the *IBM xSeries Documentation CD*. It contains translated versions of the caution and danger statements that appear in the documentation for your server. Each caution and danger statement has an assigned number, which you can use to locate the corresponding statement in your native language.
- *User's Guide*  
This publication is provided in PDF on the *IBM xSeries Documentation CD*. It contains general information about your server.
- *Troubleshooting Guide*  
This publication is provided in PDF on the *IBM xSeries Documentation CD*. It contains the information needed to help you solve problems yourself, or provide helpful information to a service technician.

Depending on your server model, additional publications might be included on the *IBM xSeries Documentation CD*.

## Major components of the xSeries 440

The following illustration shows the locations of major components in your server.

**Note:** The illustrations in this document might differ slightly from your hardware.

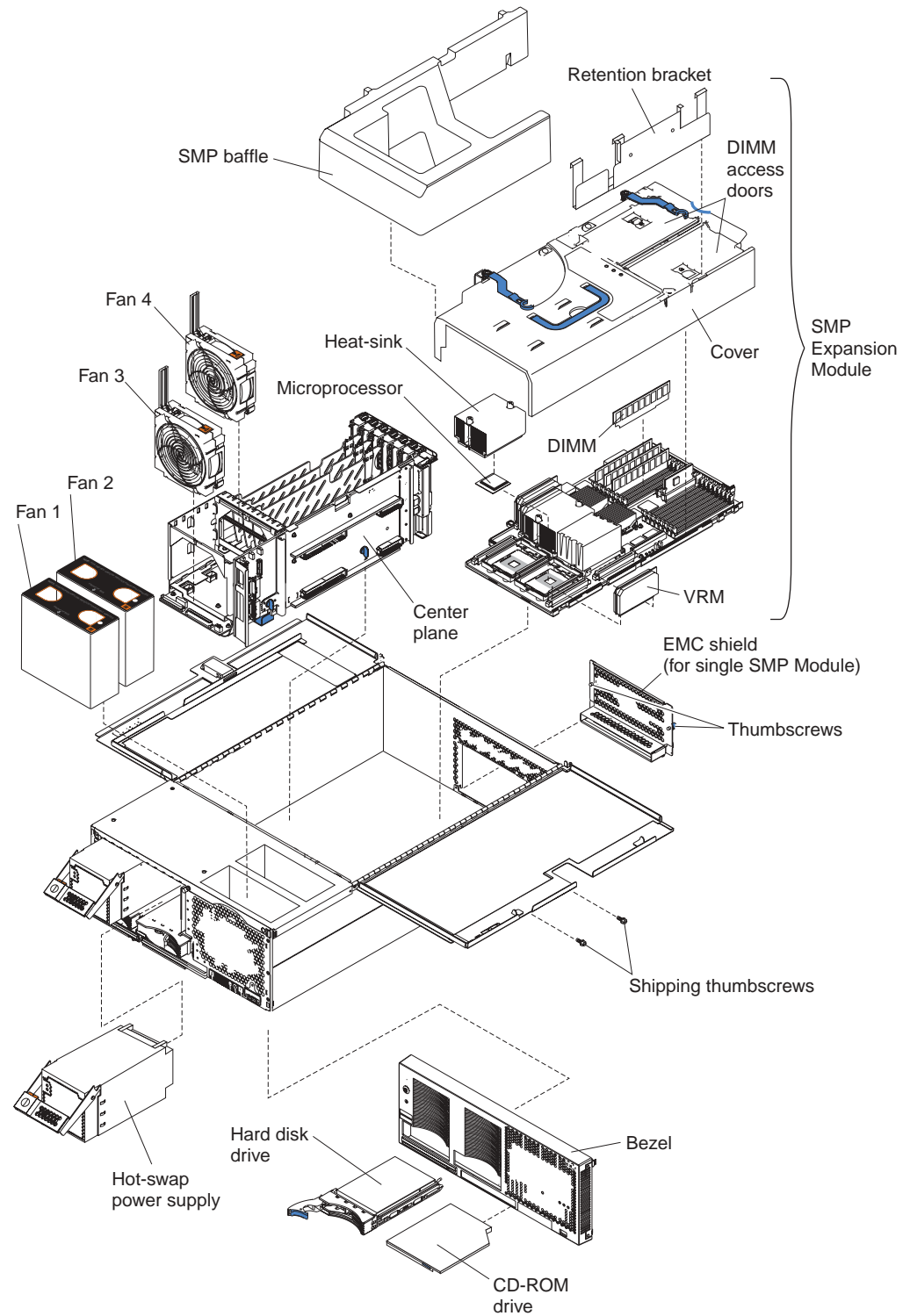

## Center plane connectors and LEDs

The following illustrations identify the connectors and LEDs on the center plane. This center plane is used to connect the power and signal paths for the SMP Expansion Module, I/O board, and the Remote Supervisor Adapter.

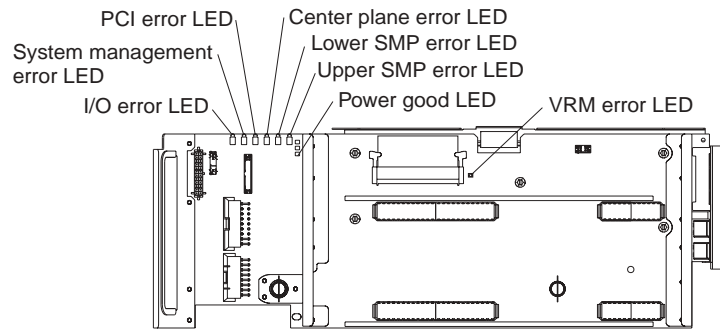
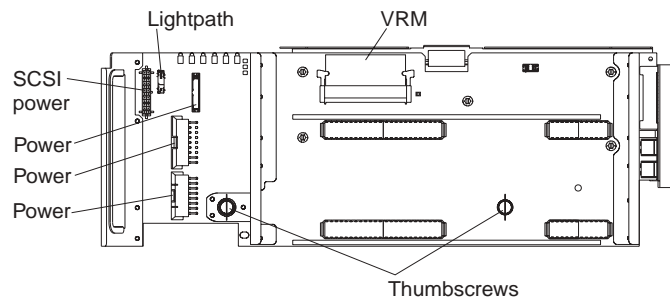

## SMP Expansion Module connectors and LEDs

The following illustrations identify the connectors, switches, and LEDs on the SMP Expansion Module.

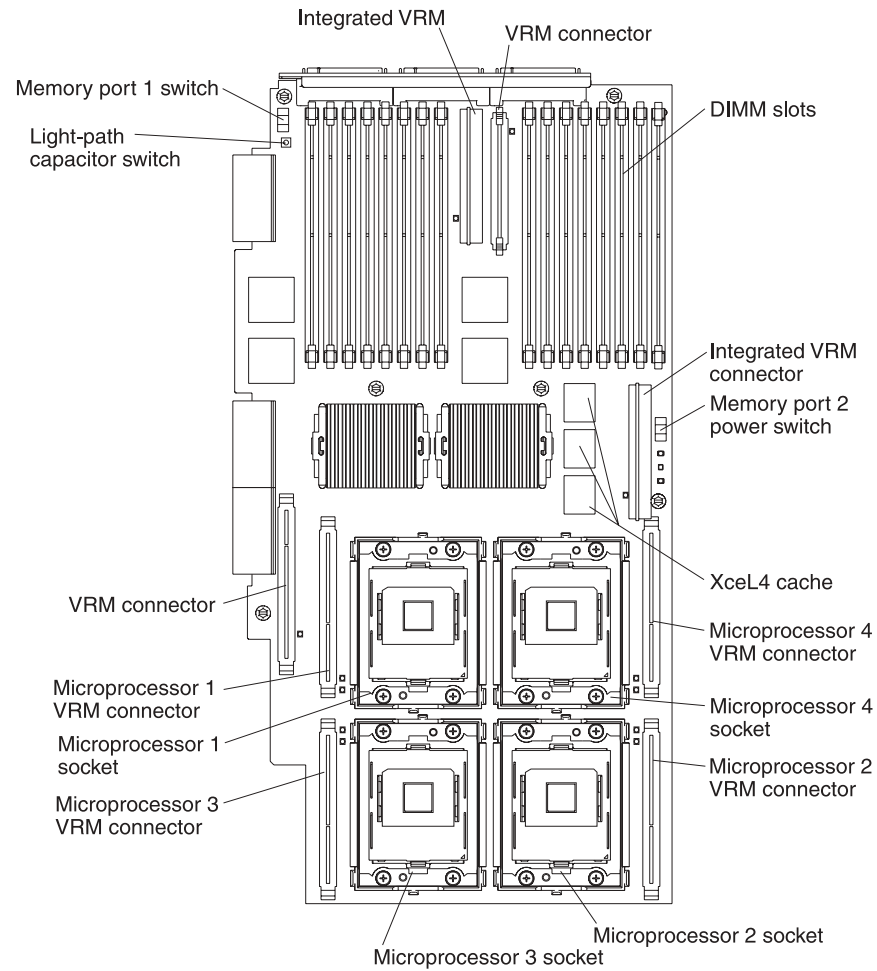



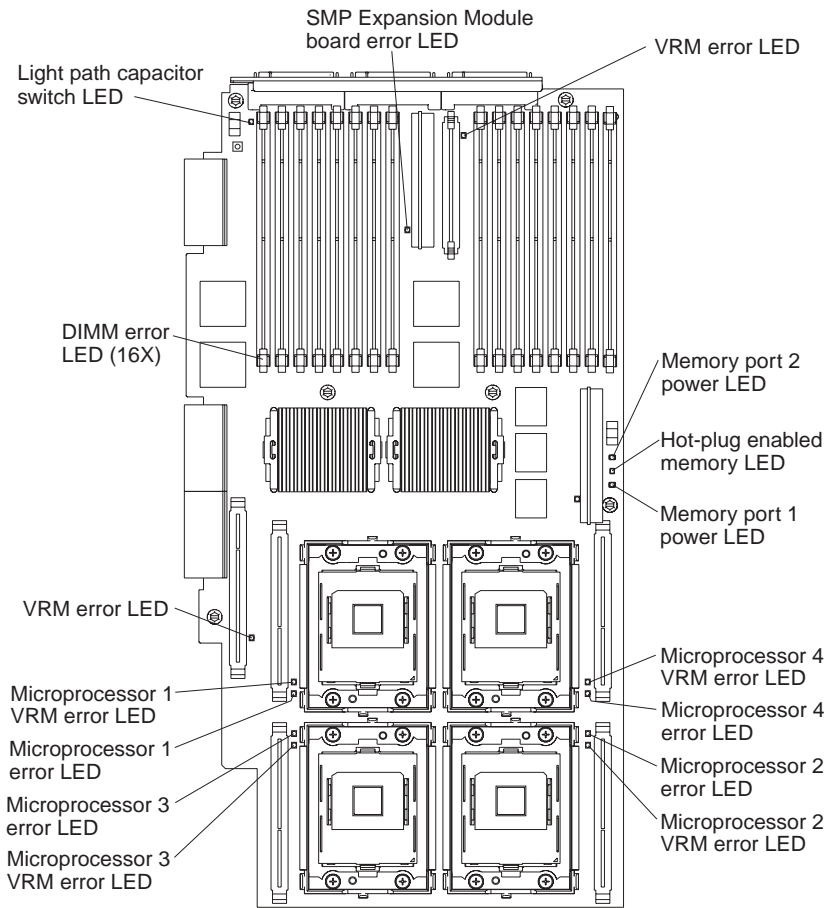

## PCI-X planar internal connectors and LEDs

The following illustration identifies the internal connectors and LEDs on the PCI-X planar. This planar enables you to install adapters in the server.

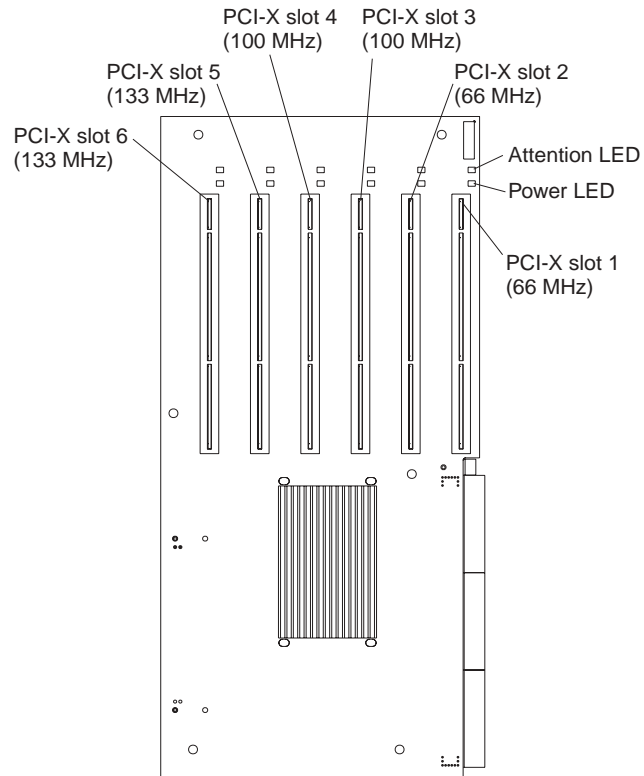

## I/O board internal connectors

The following illustration identifies the internal connectors on the I/O board. This board supports the input and output ports in the server.

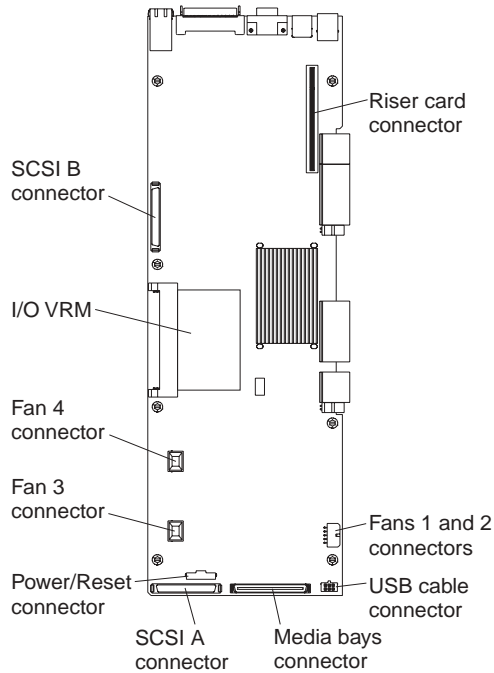

## Remote Supervisor Adapter component locations

The following illustration identifies the connectors and LEDs on the Remote Supervisor Adapter.

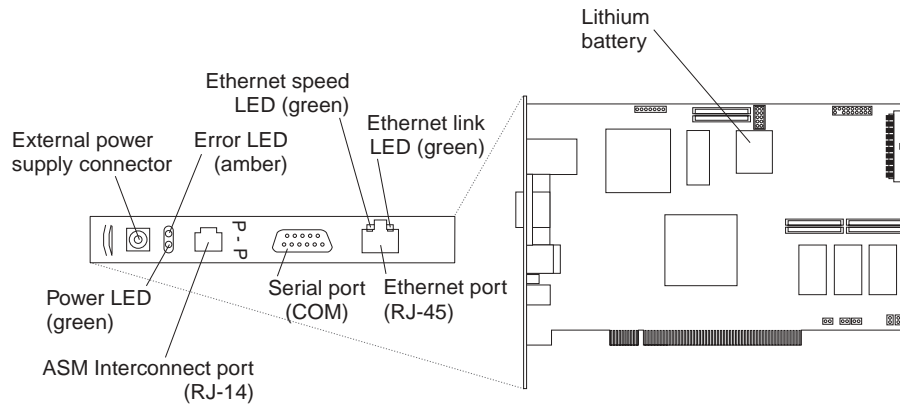



---

## Chapter 2. Installing options

This chapter provides instructions to help you install options in your server. Some option-removal instructions are provided in case you need to remove one option to install another. For a list of supported options for your server, see the ServerProven<sup>®</sup> list at <http://www.ibm.com/pc/compat/>.

---

### Before you begin

Before you begin to install options in your server, read the following information:

- Become familiar with the information provided in “Handling static-sensitive devices” on page 10, and the safety information beginning on page 11. These guidelines will help you work safely while working with your server or options.
- Make sure that you have an adequate number of properly grounded electrical outlets for your server, monitor, and any other options that you intend to install.
- Back up all important data before you make changes to disk drives.
- For a list of supported options for the xSeries 440 server, see <http://www.ibm.com/pc/us/compat/> on the World Wide Web.

**Note:** Some preconfigured servers have a unique list of supported options. See the software documentation provided with those servers for more information.

---

### Working inside the server with power on

Your server supports hot-swap devices and is designed to operate safely while turned on with the cover removed. Follow these guidelines when you work inside a server that is turned on:

- Avoid loose-fitting clothing on your forearms. Button long-sleeved shirts before working inside the server; do not wear cuff links while you are working inside the server.
- Do not allow your necktie or scarf to hang inside the server.
- Remove jewelry, such as bracelets, rings, necklaces, and loose-fitting wrist watches.
- Remove items from your shirt pocket (such as pens or pencils) that could fall into the server as you lean over it.
- Take care to avoid dropping any metallic objects, such as paper clips, hair pins, or screws, into the server.

---

## Handling static-sensitive devices

**Attention:** Static electricity can damage electronic devices and your system. To avoid damage, keep static-sensitive devices in their static-protective packages until you are ready to install them.

To reduce the possibility of electrostatic discharge, observe the following precautions:

- Limit your movement. Movement can cause static electricity to build up around you.
- Handle the device carefully, holding it by its edges or its frame.
- Do not touch solder joints, pins, or exposed printed circuitry.
- Do not leave the device where others can handle and possibly damage the device.
- While the device is still in its anti-static package, touch it to an unpainted metal part of the system unit for at least 2 seconds. (This drains static electricity from the package and from your body.)
- Remove the device from its package and install it directly into your system unit without setting it down. If it is necessary to set the device down, place it in its static-protective package. Do not place the device on your system unit cover or on a metal table.
- Take additional care when handling devices during cold weather because heating reduces indoor humidity and increases static electricity.

---

## System reliability considerations

To help ensure proper cooling and system reliability, make sure that:

- Each of the drive bays has either a drive or a filler panel installed.
- There is space around the server to allow the cooling system to work properly.
- Cables for optional adapters are routed according to the instructions that are provided with the adapters.
- All microprocessors are the same size and clock speed.
- When two SMP Expansion modules are installed, they are connected together through the SMP Expansion Ports.
- An SMP baffle is installed on top of the lower SMP Expansion module when only one module is installed.
- For proper cooling, do not leave the cover open for more than 30 minutes.
- A failed fan is replaced within 48 hours.
- The top cover is closed during normal operation.
- Do not remove a defective power supply until a replacement is available.

---

## Safety information

Before installing this product, read the Safety Information.

قبل تركيب هذا المنتج، يجب قراءة الملاحظات الأمنية

Antes de instalar este produto, leia as Informações de Segurança.

在安装本产品之前，请仔细阅读 **Safety Information** (安全信息)。

安裝本產品之前，請先閱讀「安全資訊」。

Prije instalacije ovog produkta obavezno pročitajte Sigurnosne Upute.

Před instalací tohoto produktu si přečtěte příručku bezpečnostních instrukcí.

Læs sikkerhedsforskrifterne, før du installerer dette produkt.

Lees voordat u dit product installeert eerst de veiligheidsvoorschriften.

Ennen kuin asennat tämän tuotteen, lue turvaohjeet kohdasta Safety Information.

Avant d'installer ce produit, lisez les consignes de sécurité.

Vor der Installation dieses Produkts die Sicherheitshinweise lesen.

Πριν εγκαταστήσετε το προϊόν αυτό, διαβάστε τις πληροφορίες ασφάλειας (safety information).

לפני שתתקינו מוצר זה, קראו את הוראות הבטיחות.

A termék telepítése előtt olvassa el a Biztonsági előírásokat!

Prima di installare questo prodotto, leggere le Informazioni sulla Sicurezza.

製品の設置の前に、安全情報をお読みください。

본 제품을 설치하기 전에 안전 정보를 읽으십시오.

Пред да се инсталира овој продукт, прочитајте информацијата за безбедност.

Les sikkerhetsinformasjonen (Safety Information) før du installerer dette produktet.

Przed zainstalowaniem tego produktu, należy zapoznać się z książką "Informacje dotyczące bezpieczeństwa" (Safety Information).

Antes de instalar este produto, leia as Informações sobre Segurança.

Перед установкой продукта прочтите инструкции по технике безопасности.

Pred inštaláciou tohto zariadenia si pečítajte Bezpečnostné predpisy.

Pred namestitvijo tega proizvoda preberite Varnostne informacije.

Antes de instalar este producto, lea la información de seguridad.

Läs säkerhetsinformationen innan du installerar den här produkten.

**Statement 1:**



**DANGER**

**Electrical current from power, telephone, and communication cables is hazardous.**

**To avoid a shock hazard:**

- **Do not connect or disconnect any cables or perform installation, maintenance, or reconfiguration of this product during an electrical storm.**
- **Connect all power cords to a properly wired and grounded electrical outlet.**
- **Connect to properly wired outlets any equipment that will be attached to this product.**
- **When possible, use one hand only to connect or disconnect signal cables.**
- **Never turn on any equipment when there is evidence of fire, water, or structural damage.**
- **Disconnect the attached power cords, telecommunications systems, networks, and modems before you open the device covers, unless instructed otherwise in the installation and configuration procedures.**
- **Connect and disconnect cables as described in the following table when installing, moving, or opening covers on this product or attached devices.**

**To Connect:**

1. Turn everything OFF.
2. First, attach all cables to devices.
3. Attach signal cables to connectors.
4. Attach power cords to outlet.
5. Turn device ON.

**To Disconnect:**

1. Turn everything OFF.
2. First, remove power cords from outlet.
3. Remove signal cables from connectors.
4. Remove all cables from devices.



**Statement 2:**



**CAUTION:**

When replacing the lithium battery, use only IBM Part Number 33F8354 or an equivalent type battery recommended by the manufacturer. If your system has a module containing a lithium battery, replace it only with the same module type made by the same manufacturer. The battery contains lithium and can explode if not properly used, handled, or disposed of.

*Do not:*

- Throw or immerse into water
- Heat to more than 100°C (212°F)
- Repair or disassemble

Dispose of the battery as required by local ordinances or regulations.

**Statement 3:**



**CAUTION:**

When laser products (such as CD-ROMs, DVD drives, fiber optic devices, or transmitters) are installed, note the following:

- Do not remove the covers. Removing the covers of the laser product could result in exposure to hazardous laser radiation. There are no serviceable parts inside the device.
- Use of controls or adjustments or performance of procedures other than those specified herein might result in hazardous radiation exposure.



**DANGER**

Some laser products contain an embedded Class 3A or Class 3B laser diode. Note the following.

Laser radiation when open. Do not stare into the beam, do not view directly with optical instruments, and avoid direct exposure to the beam.

**Statement 4:**

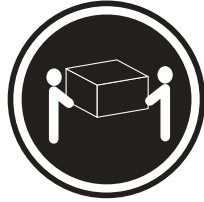

≥ 18 kg (39.7 lb)



≥ 32 kg (70.5 lb)



≥ 55 kg (121.2 lb)

**CAUTION:**  
Use safe practices when lifting.

**Statement 5:**



**CAUTION:**  
The power control button on the device and the power switch on the power supply do not turn off the electrical current supplied to the device. The device also might have more than one power cord. To remove all electrical current from the device, ensure that all power cords are disconnected from the power source.

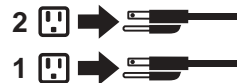

**Statement 8:**



**CAUTION:**

Never remove the cover on a power supply or any part that has the following label attached.



Hazardous voltage, current, and energy levels are present inside any component that has this label attached. There are no serviceable parts inside these components. If you suspect a problem with one of these parts, contact a service technician.

---

## Opening the cover

Complete the following steps to open the server cover:

1. Review the information in "Working inside the server with power on" and "Before you begin" on page 9.
2. Slide the server out from the rack.

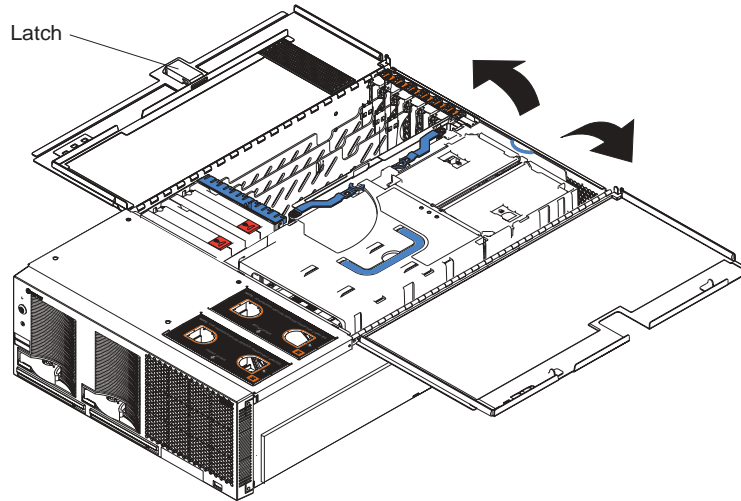

3. Pull the release latch on the left half of the top cover to the right.
4. Using the finger hole in the release latch, open the left half of the cover; then, open the right half of the cover.

**Attention:** For proper cooling and airflow, close the cover before turning on the server. Operating the server for extended periods of time (over 30 minutes) with the cover open might damage server components.

---

## Removing and replacing the bezel

Complete the following steps to remove and replace the server bezel:

1. Remove the bezel.
  - a. Press on the two tabs at the top edge of the bezel, and pull the top of the bezel slightly away from the server.
  - b. Press on the two tabs at the bottom edge of the bezel, and pull the bezel off the server. Store the bezel in a safe place.
2. Replace the bezel.
  - a. Align the four tabs with the slots in the server chassis.
  - b. Press firmly against the front of the bezel until it snaps into place.

## Removing and replacing a hot-swap power supply

Your server comes with two hot-swap power supplies, which can be removed and replaced without turning off the server. This section provides the information to properly remove and replace these power supplies.

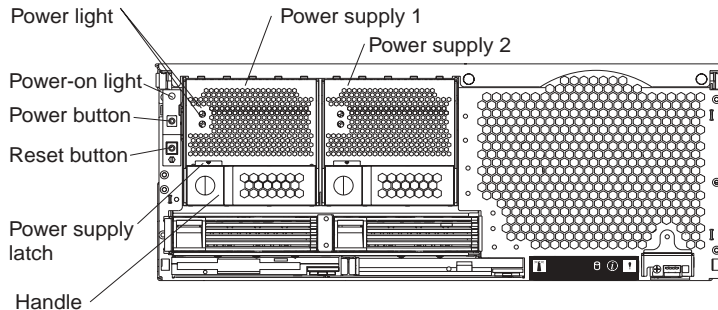

Before you continue with the power supply-installation procedure review the following information.

### Notes:

1. During normal operation, both power supplies must be installed for proper operation and cooling.
2. The xSeries 440 server requires a 220 V power connection for full power-supply redundancy. Whenever possible, use a 220 V connection for all configurations. However, you can use a 110 V connection, but without power-supply redundancy.

If you install or remove a power supply, observe the following precautions.

### Statement 8:



### CAUTION:

Never remove the cover on a power supply or any part that has the following label attached.



**Hazardous voltage, current, and energy levels are present inside any component that has this label attached. There are no serviceable parts inside these components. If you suspect a problem with one of these parts, contact a service technician.**

Complete the following steps to remove and replace a power supply.

1. Review the information in “Before you begin” on page 9 through “Safety information” on page 11.
2. Remove the front bezel (see “Removing and replacing the bezel” on page 16 for instructions on removing the front bezel).

3. To remove the power supply from the server, press the release latch; then, lift the handle on the power supply to the open position and pull the power supply out from the server.

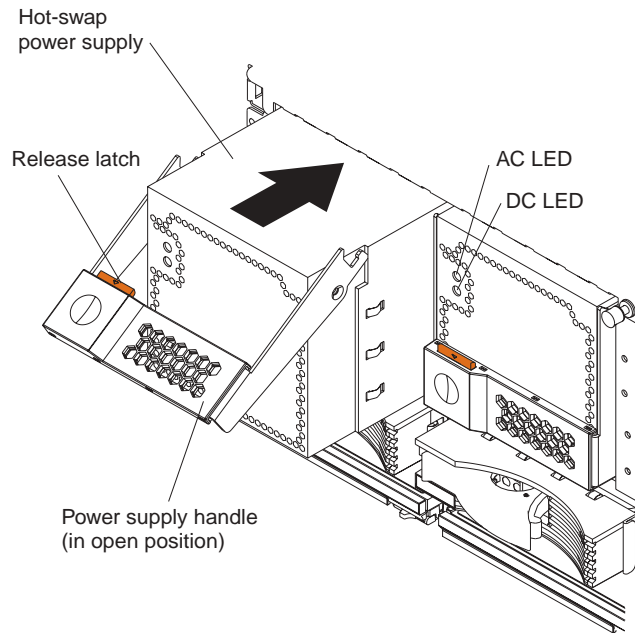

4. Install the new power supply:
  - a. Place the handle on the power supply in the open position.
  - b. Slide the power supply into the chassis and press the handle to the closed position.
5. Verify that the dc power light and the ac power light on the power supply are lit, indicating that the power supply is operating properly.
6. Replace the front bezel on the server (see "Removing and replacing the bezel" on page 16 for instructions).

---

## PCI and PCI-X adapters

This section provides information about the expansion slots on the system board and peripheral component interconnect (PCI or PCI-X) adapters.

The following illustration shows the location of the PCI-X expansion slots on the PCI-X board.

**Note:** The illustrations in this document might differ slightly from your hardware.

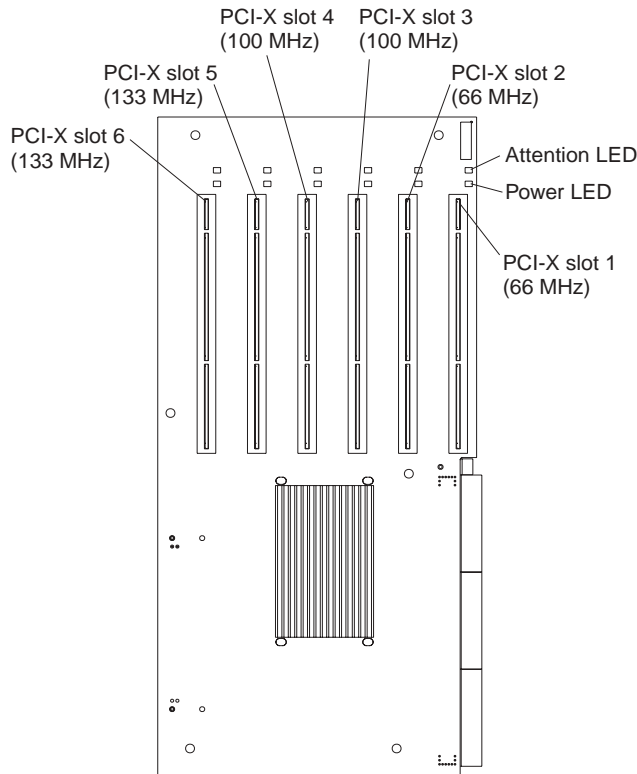

## PCI and PCI-X adapter considerations

Before you install adapters, review the following:

- Locate the documentation that comes with the adapter and follow those instructions in addition to the instructions in this chapter.
- If you need to change the switch settings or jumper settings on your adapter, follow the instructions that come with the adapter.
- Video adapters are not supported.
- Some long adapters have extension handles or brackets installed. Before installing the adapter, you must remove the extension handle or bracket.
- Your server uses a rotational interrupt technique to configure PCI-X adapters. You can use this technique to install PCI-X adapters that currently do not support sharing of PCI-X interrupts.
- The xSeries 440 server scans devices and PCI-X slots to assign system resources in the following order: CD-ROM drive; disk drives; integrated SCSI devices; s in the following order: CD-ROM drive; disk drives; integrated SCSI devices; PCI-X slots 1, 2, 6, 5, 3, 4; and the integrated Ethernet controller. If an RXE-100 enclosure is attached to the server, the scan continues in sequence with PCI slots 11, 12, 9, 10, 7, 8, 17, 18, 15, 16, 13, and 14.

- You can use the Configuration/Setup Utility program to change the sequence and have the server scan one of the first six PCI slots before it scans the integrated devices. You cannot change the scan sequence of the PCI slots in an RXE-100 enclosure.
- You can install both PCI and PCI-X adapters in the same bus. However, if you install a PCI adapter and a PCI-X adapter in the same bus, the PCI-X features of the PCI-X adapter will be disabled and the adapter will function as a PCI adapter.
- You can install PCI or PCI-X adapters of speeds faster than what is labeled for a particular PCI-X bus. For example, if you install two 133 MHz adapters into slots that are labeled as 100 MHz slots, the adapters will operate at 100 MHz.
- If you install a 33 MHz and a 66 MHz adapter in the same bus, the bus speed will match that of the slowest adapter.
- If a single 133 MHz adapter is installed in PCI-X Bus B (slot 3 and 4), and the other slot in PCI-X Bus B is empty, the adapter will operate at 133 MHz.
- Your server supports six hot-plug 64-bit adapters in the expansion slots located on the PCI-X board.

**Note:** You can add up to 12 additional PCI-X slots to your server by connecting your server to a remote expansion enclosure. For more information about the expansion enclosure and how to connect your server to it, see the documentation that comes with your expansion enclosure.

Bus	Slot	Supported adapter speed (MHz)
A	1	66
A	2	66
B	3	100 (133 if slot 4 is empty)
B	4	100 (133 if slot 3 is empty)
C	5	133
D	6	133

- Your server supports 3.3 V adapters; it does not support 5.0 V adapters.

## Installing adapters

Complete the following steps to install an adapter.

**Attention:** When you handle static-sensitive devices, take precautions to avoid damage from static electricity. For details on handling these devices, see “Handling static-sensitive devices” on page 10.

1. Review the information in “Working inside the server with power on” on page 9, “Before you begin” on page 9, and “Safety information” on page 11.



2. You must disable the Active PCI-X slots in your server using the operating system before you insert or remove a hot-plug PCI or PCI-X adapter.

**Note:** Some operating systems do not support the enabling and disabling of a PCI-X slot. If your operating system does not support this function, then turn off your server, and disconnect all external cables and power cords before proceeding.

3. Pull out on the quick release latches on each side of the server; then, pull the server out of its rack enclosure until it stops.

4. Open the top cover.

**Note:** Inside your server there are six PCI-X slots: two 66 MHz, two 100 MHz, and two 133 MHz. Before attempting to install a new adapter, be sure there is an available slot for it. If you need additional PCI-X slots, you can purchase a Remote Expansion Enclosure either from your IBM marketing representative or authorized reseller.

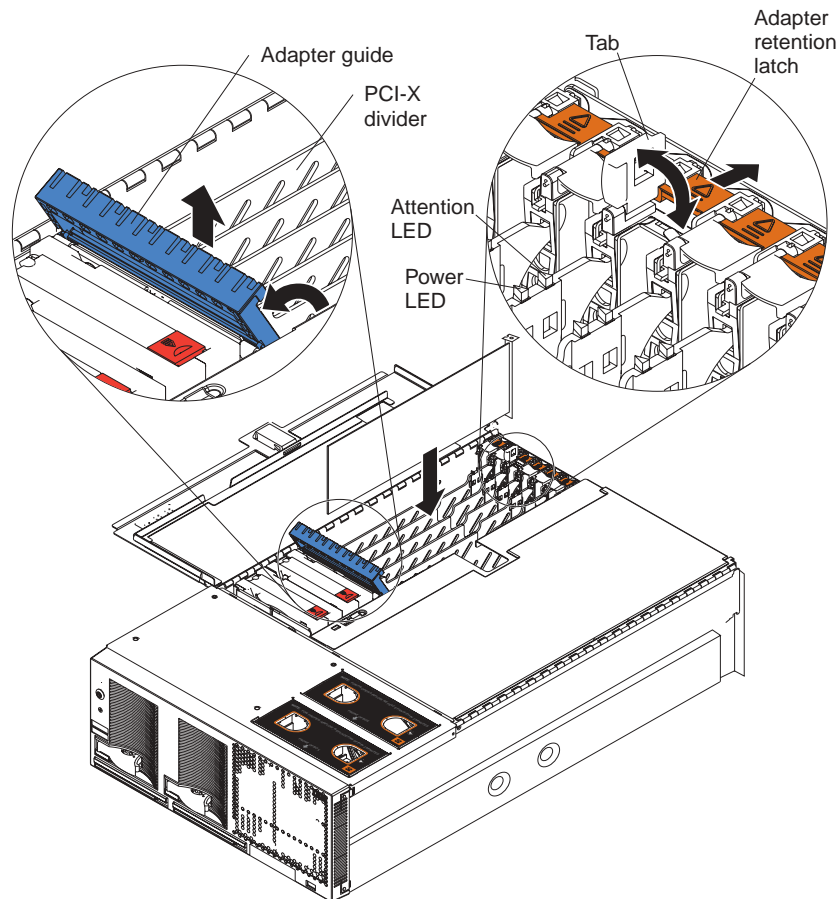

5. Set any jumpers or switches as described by the adapter manufacturer.

6. Install the adapter:

- a. Open the blue adapter guide by lifting the front edge, as shown in the illustration.
- b. Remove the PCI-X divider from the PCI-X slot by grasping the divider along the top edge and lifting it from the server.
- c. Push the orange adapter retention latch toward the rear of the server and open the tab.
- d. Remove the expansion-slot cover.

- e. Carefully grasp the adapter by its top edge or upper corners and align it with the connector on the PCI-X board.
 

**Note:** Some long adapters have extension handles or brackets installed. Before installing a long adapter, you must remove the extension handle or bracket.
  - f. Press the adapter *firmly* into the adapter connector.
 

**Attention:** When you install an I/O adapter, be sure the adapter is correctly seated in the connector slot. Improperly seated adapters might cause damage to the board, the riser card, or the adapter.
  - g. Reinstall the PCI-X dividers between the Active PCI adapter slots.
  - h. Push down on the blue adapter guide to keep the adapter steady.
  - i. Close the tab. The orange adapter retention latch will click into place, securing the adapter.
7. Connect the internal cables to the adapter. If you are installing a ServeRAID™ adapter, see “Cabling a ServeRAID adapter” for instructions.
  8. If you have other options to install or remove, do so now.
  9. Close the cover on the server.
  10. Enable the slot or turn on the server, depending on your operating system.

## Cabling a ServeRAID adapter

Some xSeries 440 models come with an optional IBM ServeRAID adapter installed to control the internal hot-swap hard disk drives and external hard disk drives. If your server did not come with an optional IBM ServeRAID adapter installed; then, see your ServeRAID adapter option documentation for complete instructions on installing a ServeRAID adapter in your server and for additional information on ServeRAID adapters.

Servers without an optional IBM ServeRAID adapter installed come with two SCSI cables:

- One end of the first SCSI cable is attached to the connector on the SCSI backplane, and the other end is attached to the connector for the integrated SCSI controller behind fans 3 and 4.
- The second SCSI cable is preinstalled along the inside of the server chassis and both ends are loose inside the server. When you install a ServeRAID adapter, you will connect this cable to the adapter and the SCSI backplane.

The following procedure describes the internal cabling needed to install a ServeRAID adapter.

**Important:** When installing multiple ServeRAID adapters in a server that has the PCI-X slot enabled for high scan (boot) priority, ensure that the ServeRAID adapter controlling the startup (boot) drive is installed in a PCI slot that is scanned before the PCI slots that contain the other ServeRAID adapters. See “PCI and PCI-X adapter considerations” on page 19.

Complete the following steps to cable the ServeRAID adapter.

1. Review the information in “Before you begin” on page 9 through “Safety information” on page 11.
2. Turn off the server and disconnect all power cords and external cables; then, open the server cover (see “Opening the cover” on page 16).
3. Remove fans 3 and 4, which are located just behind the PCI-X slots.

4. Disconnect the short SCSI cable from the SCSI backplane and the integrated SCSI controller; then, store this short cable in a safe place for future use.
5. Install the ServeRAID adapter in the PCI-X slot (see “Installing adapters” on page 20).
6. Locate one end of the preinstalled SCSI cable and connect it to the ServeRAID adapter.

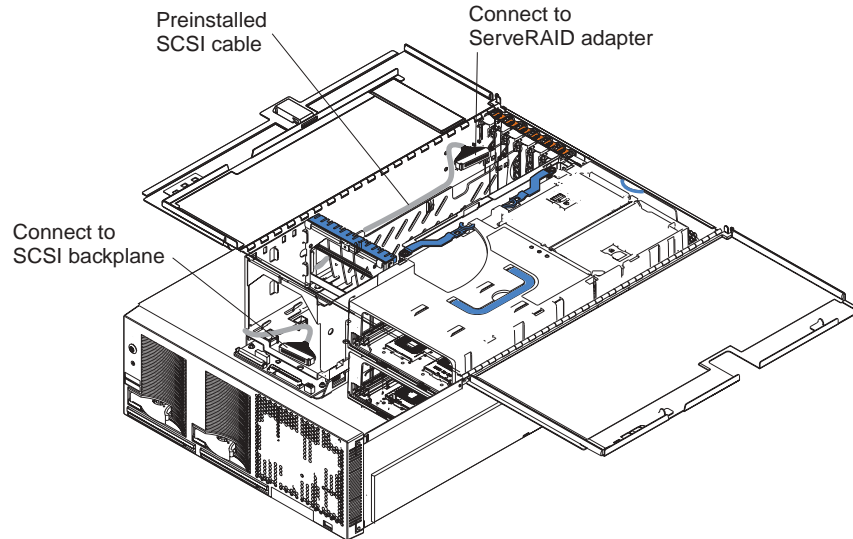

7. Locate the other end of the preinstalled SCSI cable and connect it to the SCSI backplane.

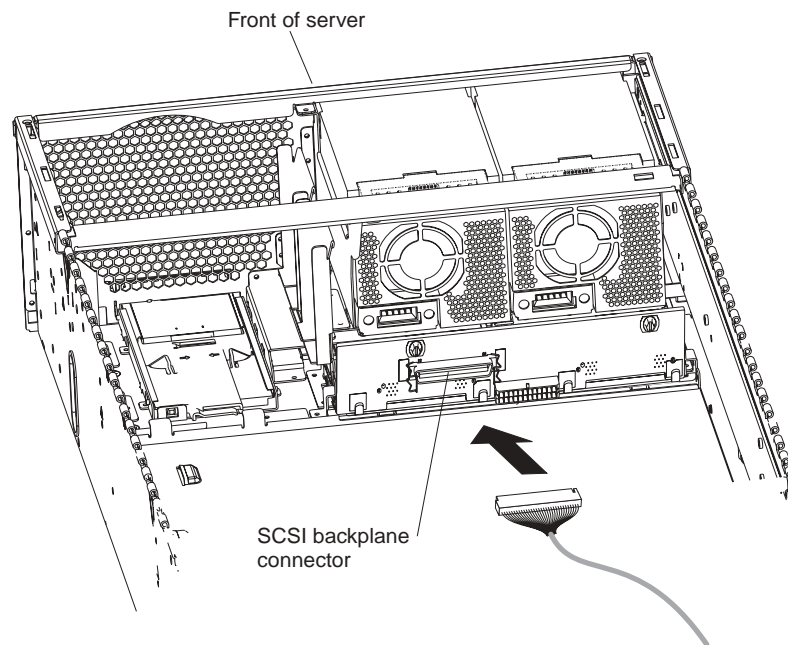

8. Reinstall fans 3 and 4.
9. If you have other options to install or remove, do so now.
10. Close the cover on the server; then, reinstall the server in the rack and connect all external cables.
11. Turn on the server.

---

## Installing or replacing a drive

This section contains instructions for installing and replacing a hot-swap hard disk drive, diskette drive, CD-ROM drive, and DVD-ROM drive.

### Hot-swap hard disk drive

Complete the following steps to install or replace a hot-swap hard disk drive:

**Attention:** When you handle static-sensitive devices, take precautions to avoid damage from static electricity. For details on handling these devices, see “Handling static-sensitive devices” on page 10.

1. Inspect the drive for any signs of damage.
2. Review the information in “Before you begin” on page 9 and “Safety information” on page 11.
3. Check the instructions that come with the drive for more information about installing your drive.
4. Remove the filler panel or defective hard disk drive from the hard disk drive bay.
5. Install the new hard disk drive in the drive bay:
  - a. Ensure that the handle on the hard disk drive tray is in the open position.
  - b. Slide the drive into the bay until it stops.
  - c. Push the handle on the front of the hard disk drive closed.

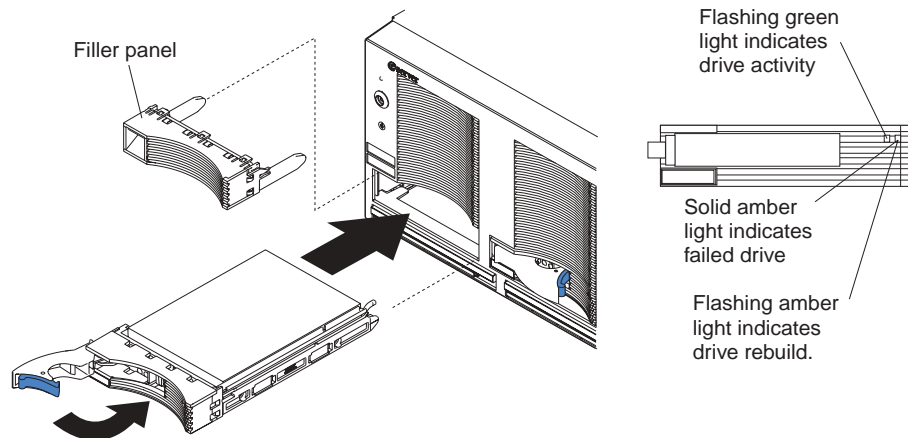

6. If you have other options to install or remove, do so now.

## Diskette drive

Drive considerations:

- Your xSeries 440 server supports the installation of up to two diskette drives.
- If only one diskette drive is installed, it must be installed in the left drive bay.

Complete the following steps to remove and install a diskette drive in your server:

1. Review the information in “Before you begin” on page 9 and “Safety information” on page 11.

**Attention:** The IDE drives installed in your server are not hot-swappable.

2. Turn off the server and disconnect the power cord from the back of the server.
3. Push the diskette drive eject button to the right.
4. Using the tab, pull the diskette drive partially out of the server; then, grasp the drive and remove it from the server.
5. Install the new diskette drive:

- a. Inspect the drive for any signs of damage.
- b. Slide the drive into the left drive bay until it stops.

**Note:** In the unlikely event that no other IDE drives are installed, the diskette drive must be installed in the right external removable media bay.

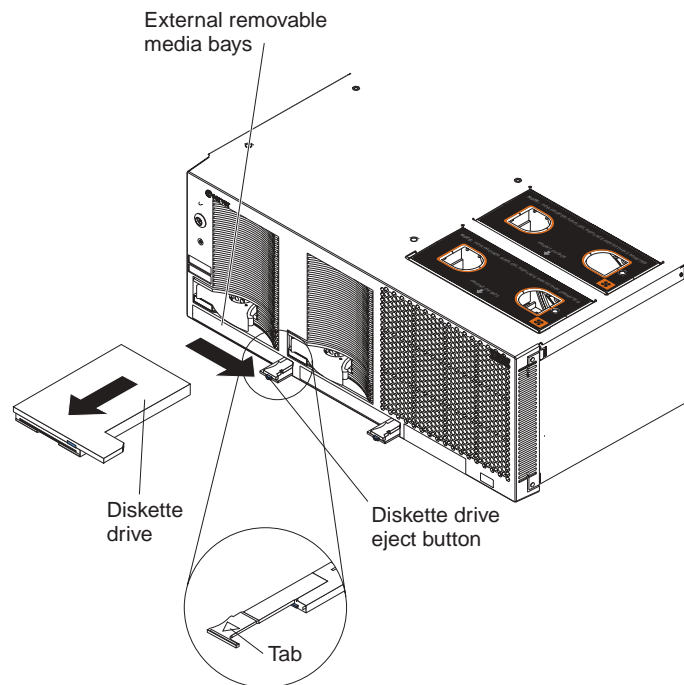

6. If you have other options to install or remove, do so now. Otherwise, connect the power cords and turn on the server.

## CD-ROM or DVD-ROM drive

Drive considerations:

- Your xSeries 440 server supports the installation of up to two CD-ROM drives, or two DVD-ROM drives.
- If no other IDE drives are installed, the diskette drive must be installed in the right external removable media bay. CD-ROM or DVD-ROM drives can be installed in either external removable media bay.

Complete the following steps to remove and install a CD-ROM or DVD-ROM drive in your server:

1. Review the information in “Before you begin” on page 9 and “Safety information” on page 11.

**Attention:** The IDE drives installed in your server are not hot-swappable.

2. Turn off the server and disconnect the power cords from the back of the server.
3. Push the CD-ROM or DVD-ROM eject button to the right.
4. Using the tab, pull the CD-ROM or DVD-ROM drive partially out of the server; then, grasp the drive and remove it from the server.
5. Install the new CD-ROM or DVD-ROM drive:
  - a. Inspect the drive for any signs of damage.
  - b. Slide the CD-ROM or DVD-ROM drive into the drive bay until it stops.

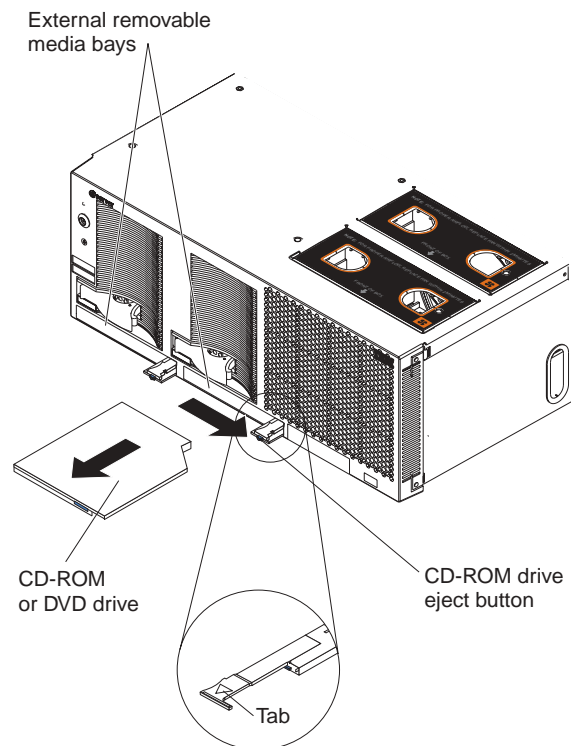

6. If you have other options to install or remove, do so now. Otherwise, connect the power cords and turn on the server.

---

## SMP Expansion Module

The SMP Expansion Module contains the Xcel4™ system cache, DIMMs, microprocessors, and voltage regulator modules (VRMs) needed to run your server. This section contains the information needed to install and remove the SMP Expansion Module, microprocessors, VRMs, and DIMMs.

SMP Expansion Module considerations:

- Use two hands to install or remove an SMP Expansion Module. Do not allow the expansion module to come in contact with the center planar while lifting it out or putting into the server
- For your server to operate properly, there must be a minimum of one SMP Expansion Module installed.
- An SMP Expansion Module must contain at least one microprocessor and four DIMMs.
- If there is only one SMP Expansion Module installed in the server, an SMP baffle must be installed in place of the upper SMP Expansion Module to ensure proper cooling of the server.
- When the minimum number of microprocessors are installed in the SMP Expansion Module, a microprocessor baffle must be installed in microprocessor socket 4 to ensure proper cooling within the server.
- Before removing or installing SMP Expansion Modules, you must remove the retention bracket or brackets and electromagnetic compatibility (EMC) shield from the rear of the server.
- You must run the Configuration/Setup Utility program whenever you remove or replace an SMP Expansion Module or one of its associated options.

**Note:** The illustrations in this document might differ slightly from your hardware.

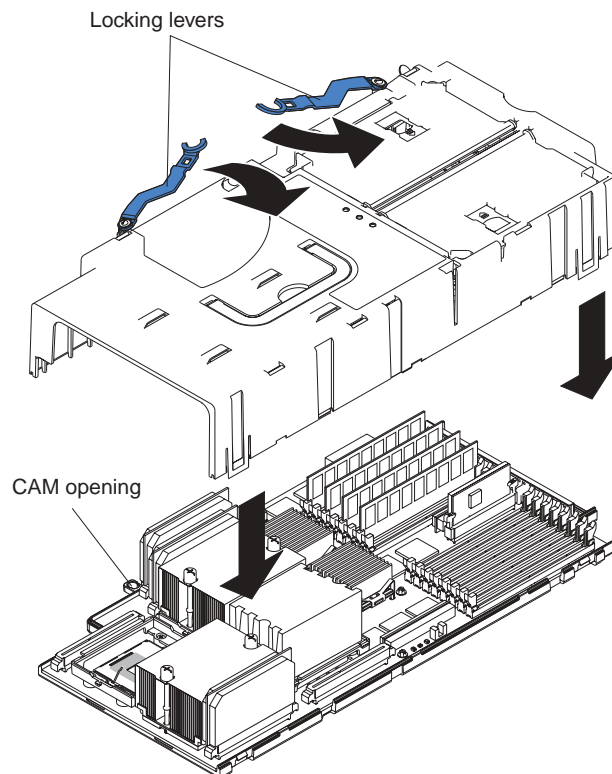

## Removing an SMP Expansion Module and cover

While installing options, you might need to remove one or both of the SMP Expansion Modules. This section provides instructions on removing an SMP Expansion Module from the server and removing the cover from the module.

Complete the following steps to remove an SMP Expansion Module from the server:

1. Review the information in “Before you begin” on page 9, “Handling static-sensitive devices” on page 10, and the safety information beginning on page 11.
2. Turn off the server and peripheral devices, disconnect the power cords and all external cables from the SMP Expansion Module; then, open the cover (see “Opening the cover” on page 16 for details).
3. If necessary, remove the SMP baffle and retention bracket from the server.

- a. Remove the shipping thumbscrews from the right side of the server.

**Note:** There are two shipping thumbscrews per retention bracket.

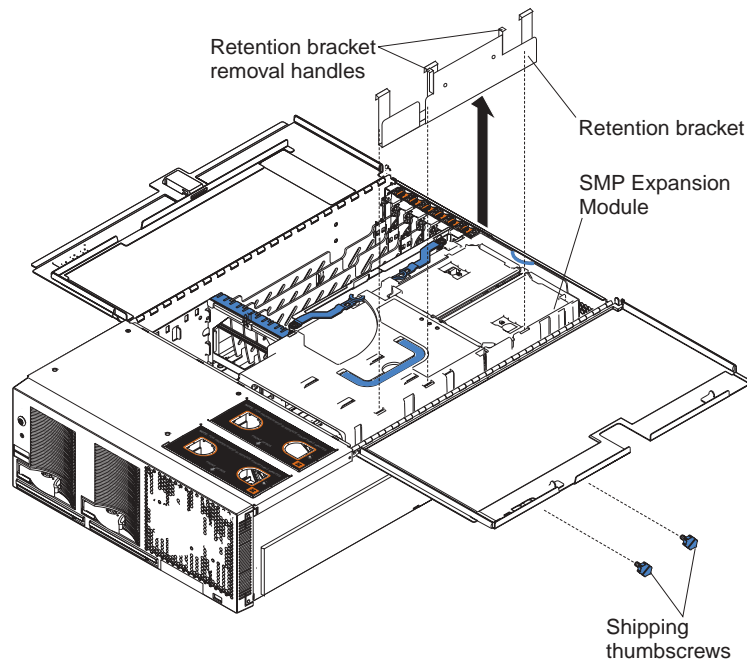

- b. Open the cover.
- c. Grasp the retention bracket by the removal handles and lift it up and out of the server. Store the retention bracket or brackets in a safe place for use later.

**Note:** If there is one SMP Expansion Module installed, you will need to remove the SMP baffle from the server; then, remove the retention bracket from the lower SMP Expansion Module as described in steps 3a through 3c.

4. To remove the EMC shield from the rear of the server:
  - a. If there are two SMP Expansion Modules installed in the server, you must disconnect the SMP Expansion Cables that are connected to the SMP Expansion Modules.



- b. Remove the blue thumbscrews holding the EMC shield to the server.

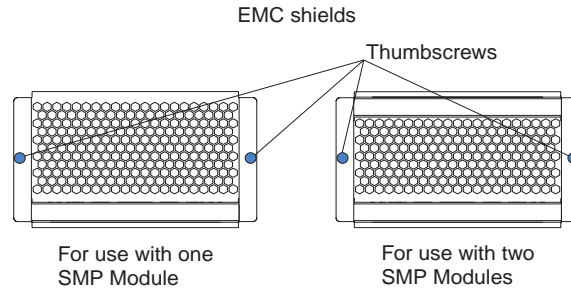

- c. Remove the EMC shield from the rear of the server.

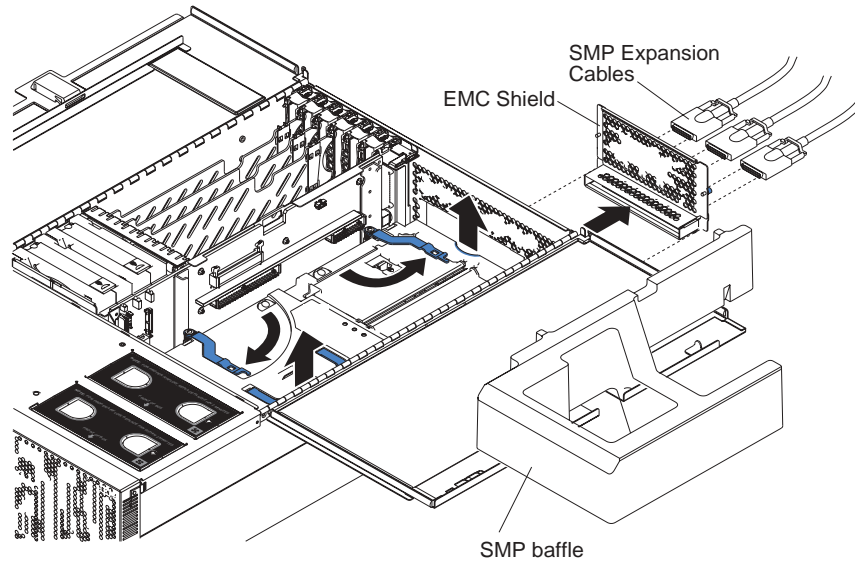

5. Grasp each of the locking levers and lift them up slightly.
6. Working from the right side of the server, rotate the two locking levers toward you until they are fully extended, as shown.

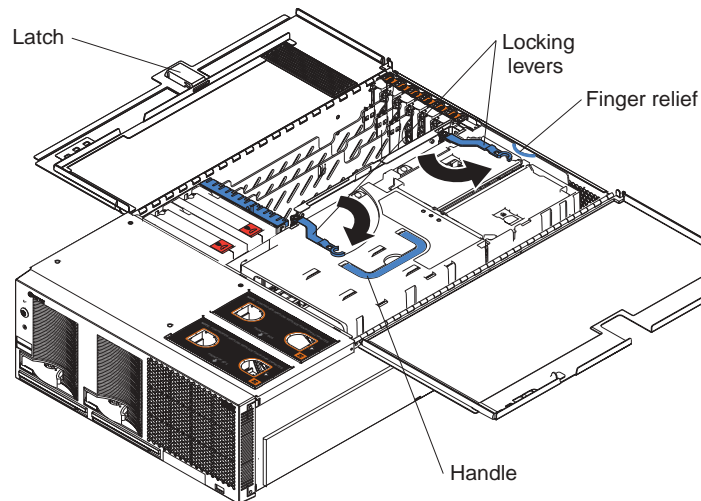

**Attention:** When removing the SMP Expansion Module from the server, lift it out carefully, taking care not to damage the components on the center plane.

7. Use the handle and the finger relief on the SMP Expansion Module cover to carefully lift the SMP Expansion Module out of the server.

**Note:** The illustrations in this document might differ slightly from your hardware.

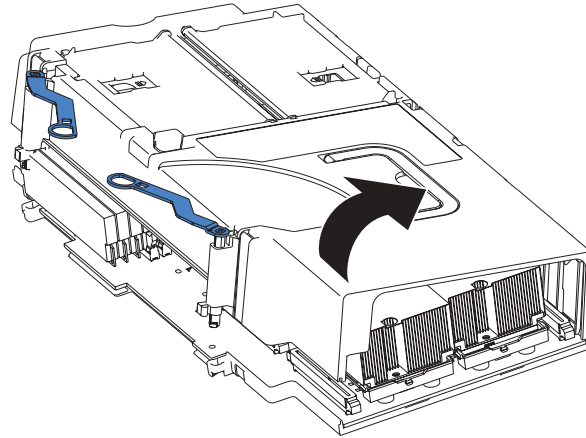

8. Remove the SMP Expansion Module cover:
  - a. Place the SMP Expansion Module on a flat, level surface.
  - b. Rotate the two locking levers just beyond the edge of the SMP Expansion Module cover until they stop; then, using the locking levers, lift the cover off the circuit board.

# DIMMs

This section contains instructions on installing, adding, and removing DIMMS. It includes information about Active Memory and memory mirroring. Before performing any of the procedures in this section, read the “Safety information” on page 11, “Handling static-sensitive devices” on page 10, and the DIMM considerations 32.

Your xSeries 440 server supports up to sixteen 3.3 V, 168 pin, 133 MHZ ECC SDRAM DIMMs in each SMP Expansion Module. With both SMP Expansion Modules installed, the server can support a maximum of 32 SDRAM DIMMS for a total of 32 GB of memory in your server.

**Notes:**

1. DIMMs can be removed and replaced through the access doors on the top of the SMP Expansion Module.
2. The illustrations in this document might differ slightly from your hardware.

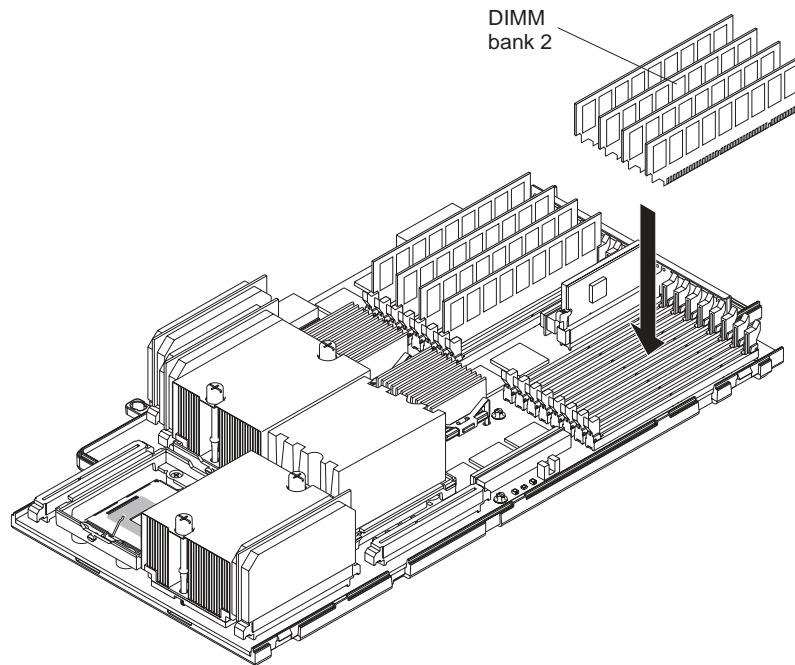

DIMM considerations:

- Your xSeries 440 server supports 512 MB and 1 GB DIMMs, for a maximum of 32 GB of system memory depending on your configuration. See the ServerProven list at <http://www.ibm.com/pc/compat/> for a list of memory modules you can use with your server.
- Your server comes with four 512 MB DIMMs installed in slots 1, 3, 5, and 7 in the SMP Expansion Module. When installing additional memory modules, you must install four DIMMS at a time and in the order described to maintain performance. (See the following figure for memory connector locations.)
- When installing or removing DIMMs, it must be done in banks of four and in the following order:
  1. Bank 1 = DIMM connectors 1, 3, 5, 7
  2. Bank 2 = DIMM connectors 9, 11, 13, 15
  3. Bank 3 = DIMM connectors 2, 4, 6, 8
  4. Bank 4 = DIMM connectors 10, 12, 14, 16

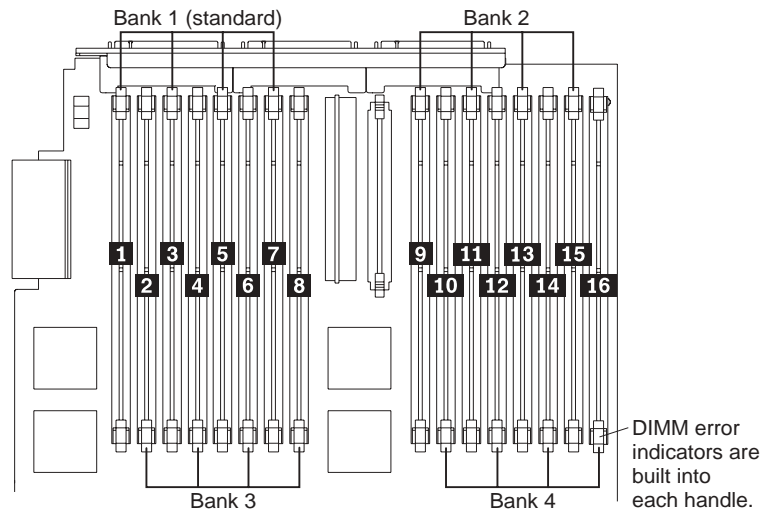

- Each DIMM in an individual bank must be of the same size and clock speed to ensure the server will operate properly. For example, in bank 1 your server came with four 512 MB DIMMs installed. In bank 2, you can install four 512 MB or four 1 GB DIMMs.
- When using memory mirroring, all of the DIMMs in each memory port must be the same size and clock speed.
- Memory ports:
  - Memory Port one
    - Bank 1 = DIMM connectors 1, 3, 5, 7
    - Bank 3 = DIMM connectors 2, 4, 6, 8
  - Memory Port two
    - Bank 2 = DIMM connectors 9, 11, 13, 15
    - Bank 4 = DIMM connectors 10, 12, 14, 16

- When you install or remove DIMMs, the server configuration information changes. Therefore, you must change and save the new configuration information by using the Configuration/Setup Utility program. When you restart the server, the system displays a message indicating that the memory configuration has changed. Start the Configuration/Setup Utility program and select **Save Settings**. If you need instructions, see *Chapter 2. Configuring your server* in the *User's Guide* on the *IBM Documentation CD*.

**Active Memory:** Active Memory is an IBM feature that improves the reliability of the DIMMs through memory mirroring, Memory scrubbing and Memory ProteXion™ technology.

- Memory mirroring allows you to improve the memory reliability of your server by creating a mirror of the data in memory port one and storing it in memory port two.

**Note:** For memory mirroring to work, you must have the same amount of memory in both memory ports. For more information about the memory ports, see the DIMM considerations on page 32.

Complete the following steps to enable memory mirroring:

1. Check your operating system documentation to be sure that it supports memory mirroring.
2. Install DIMMs of the same size and clock speed in the two memory ports.
3. Enable memory mirroring in the Configuration/Setup Utility:
  - a. Turn on the server and watch the monitor screen.
  - b. When the message Press F1 for Configuration/Setup appears, press F1.
  - c. From the Configuration/Setup Utility main menu, select **Advance Features**.
  - d. Select and enable memory mirroring.
  - e. Save and exit the Configuration/Setup Utility program.

How does memory mirroring work?

When memory mirroring is enabled, the data that is written to memory is stored in two locations. One copy is kept in the memory port one DIMMs, while a second copy is kept in the memory port two DIMMs. During the execution of the read command, the data is read from the DIMM with the least amount of reported memory errors through Memory scrubbing, which is enabled with memory mirroring.

If Memory scrubbing determines the DIMM is damaged beyond use, read and write operations are redirected to the remaining good DIMM. Memory scrubbing then reports the damaged DIMM and the Light Path Diagnostics feature displays the error. After the damaged DIMM is replaced, memory mirroring then copies the mirrored data back into the new DIMM.

- Memory scrubbing is an automatic daily test of all the system memory that detects and reports memory errors that might be developing before they cause a server outage.

**Note:** Memory scrubbing and Memory ProteXion technology work in conjunction with each other and do not require memory mirroring to be enabled to work properly.

When an error is detected, memory scrubbing determines if the error is recoverable or not. If it is recoverable, Memory ProteXion is enabled and the data that was stored in the damaged locations is rewritten to a new location. The error is then reported so that preventative maintenance can be performed. As long as there are enough good locations to allow the proper operation of the server, no further action is taken other than recording the error in the error logs.

If the error is not recoverable, memory scrubbing sends an error message to the Light Path Diagnostics feature, which then turns on the proper lights and LEDs to guide you to the damaged DIMM. If memory mirroring is enabled, then the mirrored copy of the data in the damaged DIMM is used to refresh the new DIMM once it is installed.

- Memory ProteXion reassigns memory bits to new locations within memory when recoverable errors have been detected.

When a recoverable error is found by Memory scrubbing, Memory ProteXion writes the data that was to be stored in the damaged memory locations to spare memory locations within the same DIMM.

**Removing and replacing DIMMs:** If you need to replace or upgrade the DIMMs in your server, you must remove the old DIMMs before you insert new ones. This section includes the instructions needed to properly remove and replace DIMMs from the SMP Expansion Module in your server.

**Attention:** When working with DIMMs or other options, you might need to remove one or both of the SMP Expansion Modules. Before removing an SMP Expansion Module, be sure to turn off the server and peripheral devices; then, disconnect all external cables and power cords.

Complete the following steps to remove a DIMM from your server SMP Expansion Module:

1. Review the information in “Before you begin” on page 9, “Handling static-sensitive devices” on page 10, and “Safety information” on page 11.
2. Turn off the server and peripheral devices, disconnect the power cords, and all external cables from the SMP Expansion Module; then, open the server cover (see “Opening the cover” on page 16 for details).
3. If necessary, remove the top SMP Expansion Module from the server. See “Removing an SMP Expansion Module and cover” on page 28 for instructions.
4. Open the DIMM access door that covers the DIMM you will be removing.

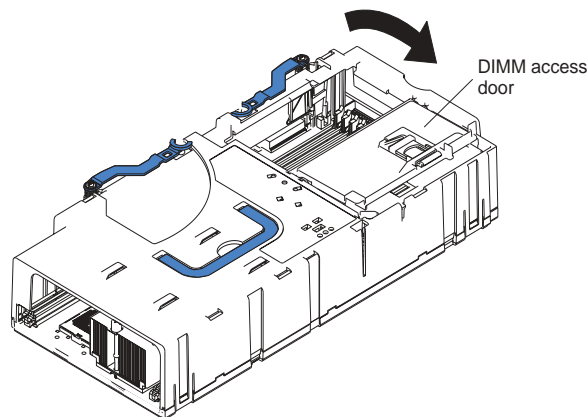

5. Open the retaining clip on each end of the DIMM connector.
6. Lift the DIMM straight up and out of the SMP Expansion Module.

7. Install a new DIMM:

- a. Touch the static-protective package containing the DIMM to any unpainted metal surface on the server. Then, remove the DIMM from the package.

**Attention:** To avoid breaking the retaining clips or damaging the DIMM connectors, open and close the clips gently.

- b. Insert the DIMM into the connector by aligning the DIMM edges with the slots at each end of the DIMM connector. Firmly press the DIMM straight down into the connector by applying pressure on both ends of the DIMM simultaneously. Be sure that the retaining clips snap into the locked position when the DIMM is firmly seated in the connector.

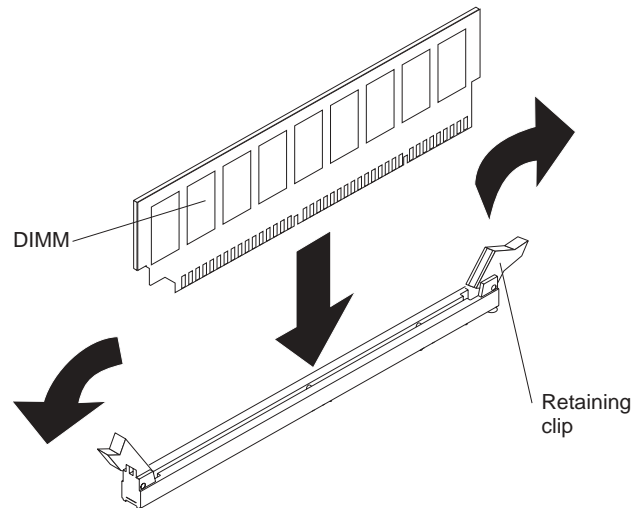

- c. If a gap exists between the DIMM and the retaining clips, the DIMM has not been properly installed. In this case, open the retaining clips and remove the DIMM; then, reinsert the DIMM.
8. Close the DIMM access door or reinstall the SMP Expansion Module cover (see “Reinstalling an SMP Expansion Module and cover” on page 41).
9. If you have other options to install or remove, do so now.
10. Close the server cover. See “Closing the cover” on page 49.

**Note:** When you install or remove DIMMs, the server configuration information changes. Therefore, you must change and save the new configuration information by using the Configuration/Setup Utility program. See the *User’s Guide* on the *Documentation CD*.

## Installing and replacing a microprocessor

This section describes how to install and remove microprocessors and VRMs. Before performing any of the procedures in this section, read “Safety” on page v, “Handling static-sensitive devices” on page 10, and Before you begin.

Your xSeries 440 Server supports up to two Intel Xeon DP or four Intel Xeon MP microprocessors in each SMP Expansion Module. With both SMP Expansion Modules installed, the server can support a maximum of four Intel Xeon DP or eight Intel Xeon MP microprocessors of the same type and speed.

**Note:** Do not install both Intel Xeon MP and Intel Xeon DP microprocessors in the same server or SMP Expansion Module.

Before you begin:

- Read the documentation that comes with the microprocessor to determine if you need to update the server basic input/output system (BIOS) code. For the most current level of BIOS code for the server, go to <http://www.ibm.com/pc/support/> on the World Wide Web.
- Obtain an SMP-capable operating system (optional). For a list of supported operating systems, go to <http://www.ibm.com/pc/us/compat/> on the World Wide Web.

**Attention:** To avoid damage and ensure proper server operation after you install a replacement or an additional microprocessor, use a microprocessor that has the same cache size and type, clock speed, and internal and external clock frequencies as the microprocessors already installed in the individual SMP Expansion Module. For a list of microprocessors supported by your server, see the ServerProven list at <http://www.ibm.com/pc/us/compat/> on the World Wide Web.

### Notes:

1. To order additional microprocessor or SMP Expansion Module options, contact your IBM marketing representative or authorized reseller.
2. The microprocessor in socket 1 of the bottom SMP Expansion Module is the startup (boot) microprocessor.
3. If you are adding additional Intel Xeon MP microprocessors to an SMP Expansion Module, populate the empty microprocessor sockets in numeric order, starting with socket 1. If you install the microprocessors in the wrong order, the server will not power on.
4. If you are adding additional Intel Xeon MP microprocessors to an SMP Expansion Module, always install the heat sink that comes with the microprocessor.
5. If you are adding additional Intel Xeon DP microprocessors to your server, you must have a second populated SMP Expansion Module with two Intel Xeon DP microprocessors installed. Server models that come with Intel Xeon DP microprocessors support a maximum of two microprocessors per SMP Expansion Module, and are installed in microprocessor sockets 1 and 4.

The following illustration shows the locations of the startup microprocessor and its VRM on the system board. It also shows the microprocessor baffles and the VRM slots for the other microprocessor sockets.



**Notes:**

1. The illustrations in this document might differ slightly from your hardware.
2. Remember, Intel Xeon DP microprocessors are supported in microprocessor sockets 1 and 4 only. Intel Xeon MP microprocessors are supported in microprocessor sockets 1,2,3, and 4.

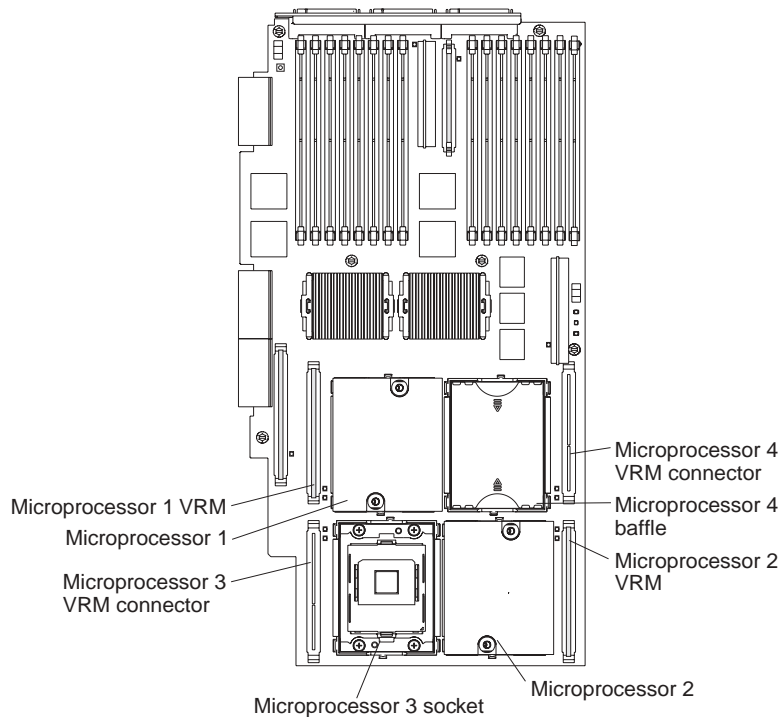

Complete the following steps to install a microprocessor:

1. Read the “Handling static-sensitive devices” on page 10 and “Safety information” on page 11.
2. Turn off the server and peripheral devices, disconnect the power cords, and disconnect all external cables from the SMP Expansion Module; then, open the cover (see “Opening the cover” on page 16 for details).
3. Remove the SMP Expansion Module in which you plan to install the microprocessor; then, remove the module cover and determine the socket where the microprocessor is to be installed. For details, see “Removing an SMP Expansion Module and cover” on page 28.

**Important:** Before continuing, you should determine which type of microprocessors are installed in your server. The easiest way to do this is by the locations of the installed microprocessors in the SMP Expansion Module. If the microprocessors are installed only in sockets 1 and 4, your server came with Intel Xeon DP microprocessors. If the microprocessors are installed in any other sockets, such as 1 and 2 or 1,2, and 3, then your server came with Intel Xeon MP microprocessors.

**Note:** If your server contains only one SMP Expansion Module, remove the SMP baffle above it to gain access to the module. If your server contains two SMP Expansion Modules, remove the top module to gain access to the bottom or lower SMP Expansion Module.

**Attention:** When you handle static-sensitive devices, take precautions to avoid damage from static electricity. For details on handling these devices, see “Handling static-sensitive devices” on page 10.

4. If you are installing a new microprocessor, go to step 5; otherwise, continue:
  - a. Verify that you have selected the correct microprocessor to be replaced. The LED next to the failing microprocessor will be on.

**Attention:** Before attempting to remove the heat sink from the microprocessor, note that the heat-conducting grease between the heat sink and the microprocessor might have formed a strong bond. Do not force the components apart; doing so can damage the microprocessor pins. If the heat sink does not separate from the microprocessor easily, loosen one heat sink captive mounting screw first. This allows one corner of the heat sink to be lifted off of the microprocessor; then, you can loosen the other captive mounting screw and remove the heat sink.

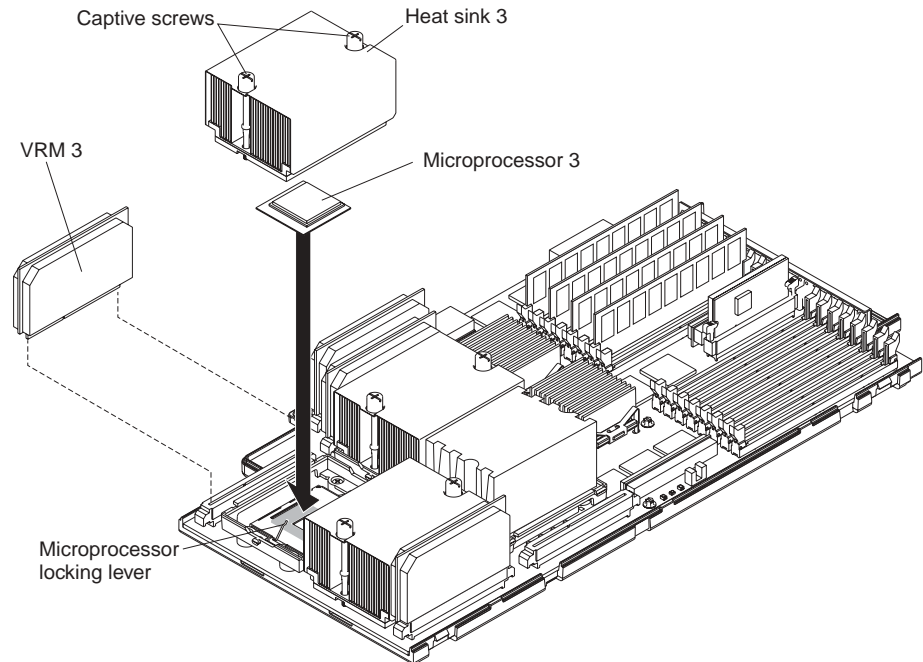

- b. Using a screwdriver, loosen the two captive mounting screws on the heat sink, alternating between screws until they release from the SMP board; then, remove the heat sink.
  - c. Lift the microprocessor locking lever to the open position and remove the microprocessor.
5. Install the VRM in the slot adjacent to the microprocessor socket.

**Attention:** If you are installing an additional microprocessor, note that the new microprocessor comes in a kit with a VRM. Some microprocessor options contain a VRM with a clip to secure the VRM in the slot. This clip is not needed for installations in your server and can be discarded. When installing a new microprocessor you must install the VRM that came in the kit.

- a. If you are replacing a failed VRM:
    - 1) Verify that you have selected the correct VRM to be replaced. The LED next to the failing VRM will be on.
    - 2) Grasp the VRM at both upper corners and lift it out of the slot.

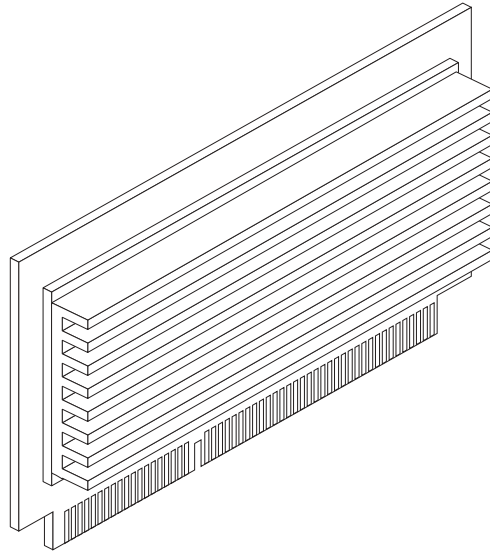

- b. Holding the new VRM by the upper corners, plug it *firmly* into the slot.
6. If necessary, remove the microprocessor baffle from the microprocessor socket. Keep the microprocessor baffle for possible future use.
  7. Touch the static-protective package containing the new microprocessor to any *unpainted* metal surface on the server; then, remove the microprocessor from the package.
  8. Install the microprocessor:
 

**Important:** When installing Intel Xeon DP microprocessors, you must install them in the following order: socket 1 then socket 4. When installing Intel Xeon MP microprocessors, you must install them in the following order: sockets 1,2,3, and then 4.

    - a. Ensure that the microprocessor locking lever is in the open position to permit plugging in the microprocessor.
    - b. Remove the protective tape from the microprocessor socket.
    - c. Align the triangle icon on the microprocessor with the triangle icon on the socket and press the microprocessor gently into the socket.
 

**Attention:** Make sure that the microprocessor is aligned correctly before you proceed. To avoid bending the pins on the microprocessor, do not use excessive force when pressing it into the socket.
    - d. Close the locking lever to secure the microprocessor.
  9. If you have installed an additional microprocessor:
    - a. Remove the heat sink from its package and detach the protective cover from the bottom of the heat sink
 

**Attention:** Do not disturb or contaminate the heat-conducting grease on the bottom of the new heat sink. Doing so damages its heat-conducting capability and exposes the new microprocessor to overheating.

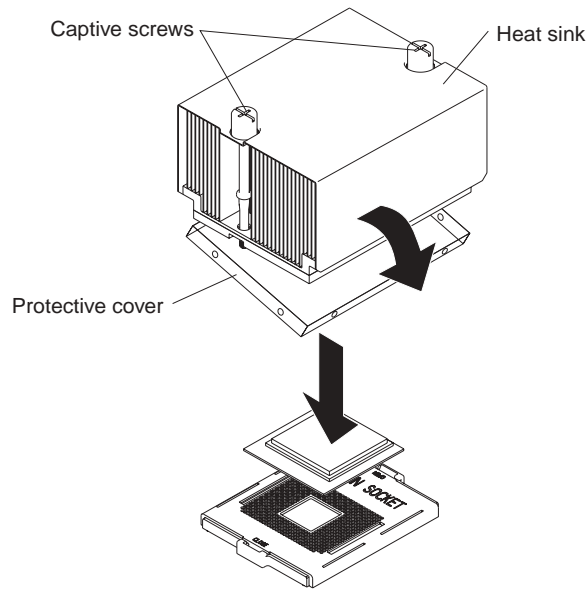

- b. Align the heat sink over the microprocessor; then, carefully set it down on top of the microprocessor.
  - c. Using a screwdriver, secure the heat sink to the microprocessor socket on the SMP board using the two captive mounting screws. Press firmly on the screws and tighten them, alternating between them. Do not overtighten the screws.
10. Close the SMP Expansion Module top cover; then, install the module in the server. For details, see “Reinstalling an SMP Expansion Module and cover” on page 41.
  11. If you have other options to install or remove, do so now.
  12. Close the cover on the server; then, reinstall the server in the rack and connect all external cables. For details, see “Closing the cover” on page 49.
  13. Turn on the server.

**Important:** If your server will not start after replacing or installing a microprocessor, you might have installed a microprocessor of a different type or the VRM is not installed properly. Verify that you have installed the proper microprocessor and that the VRM is properly installed.

**Note:** When you install or remove microprocessors, the server configuration information changes. Therefore, you must change and save the new configuration information by using the Configuration/Setup Utility program. See the *User's Guide* on the *Documentation CD*.

## Reinstalling an SMP Expansion Module and cover

After installing options in the SMP Expansion Module, you will need to reinstall the SMP Expansion Module cover and reinstall the SMP Expansion Module in the server.

Complete the following steps to reinstall the SMP Expansion Module cover:

1. Install the cover on the SMP Expansion Module:
  - a. Set the cover on top of the expansion module.
  - b. Extend the locking levers as shown in the illustration; then, let the cam on the front of the cover fall into the cam opening on the SMP Expansion Module circuit board.

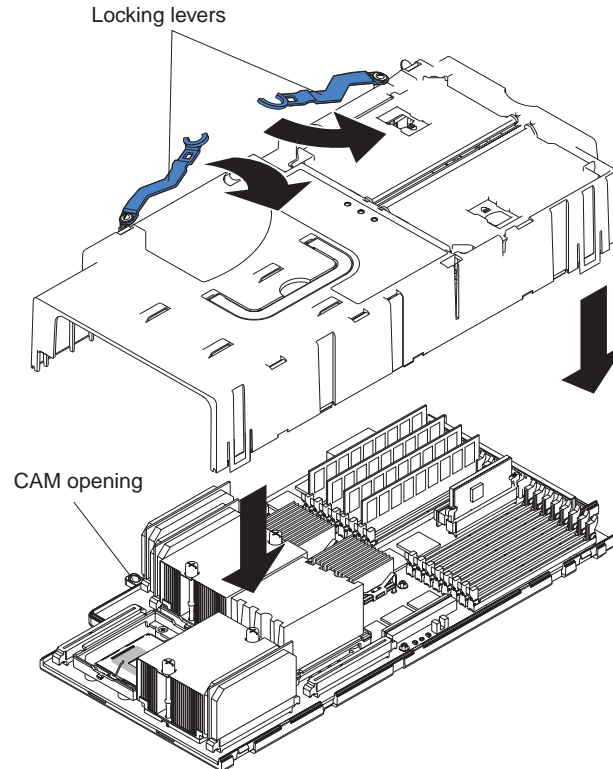

- c. Release the locking levers and align the rear of the cover with the rear edge of the circuit board.
    - d. Press down on the cover until it snaps into place.

- e. Lift slightly on the locking levers and rotate them back until they stop.

**Note:** The illustrations in this document might differ slightly from your hardware.

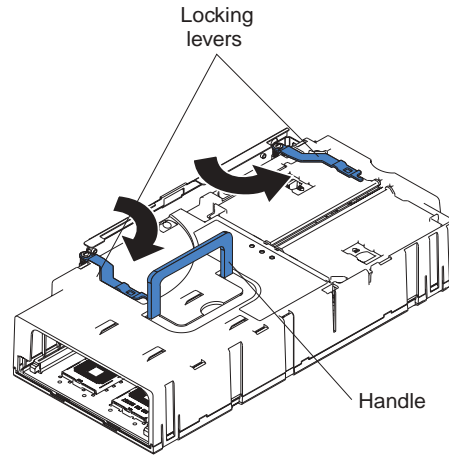

- 2. Install the SMP Expansion Module into the server.

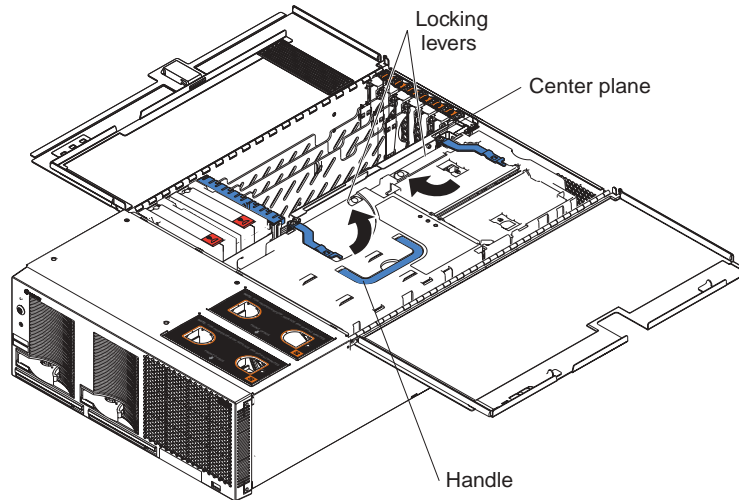

- a. Lift the SMP Expansion Module by its handle and use the finger relief to hold the SMP Expansion Module steady.
- b. Being careful not to damage the components on the center plane, place the SMP Expansion Module into the server.
- c. Release the handle and slide the SMP Expansion Module toward the center plane until it stops.

- d. Rotate the SMP Expansion Module locking levers forward until the SMP Expansion Module is securely fastened in place. See the following illustration.

**Note:** The illustrations in this document might differ slightly from your hardware.

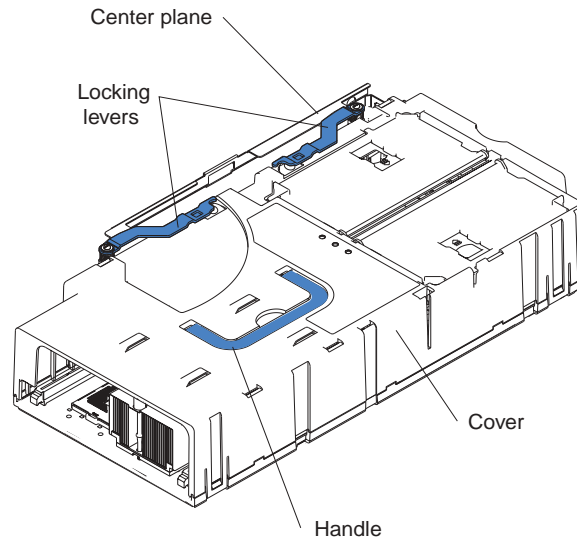

3. If you have other options to install or remove, do so now.
4. Close the cover on the server; then, reinstall the server in the rack and connect all external cables. For details, see “Closing the cover” on page 49.
5. Turn on the server.

**Notes:**

- a. If there are two SMP Expansion Modules installed in your server, you must install the retention bracket for each of the SMP Expansion Modules. Be sure to install the bottom retention bracket first, then repeat steps 2a through 2e for the top SMP Expansion Module.
- b. If the server is going to be shipped or moved over a long distance, you must reinstall the shipping thumbscrews.

---

## Replacing and troubleshooting fans

Your xSeries 440 server has four hot-swap fan assemblies, two 150 mm x 38 mm, and two 150 mm x 51 mm fans. The two 150 mm x 38 mm fans (fan 3 and fan 4) are located just behind the PCI-X planar and are used to cool the power supplies, PCI-X slots, and the I/O board. The two 150 mm x 51 mm fans (fan 1 and fan 2) are located toward the front of the server and are used to cool the SMP Expansion Modules. See the following illustration.

**Note:** The illustrations in this document might differ slightly from your hardware.

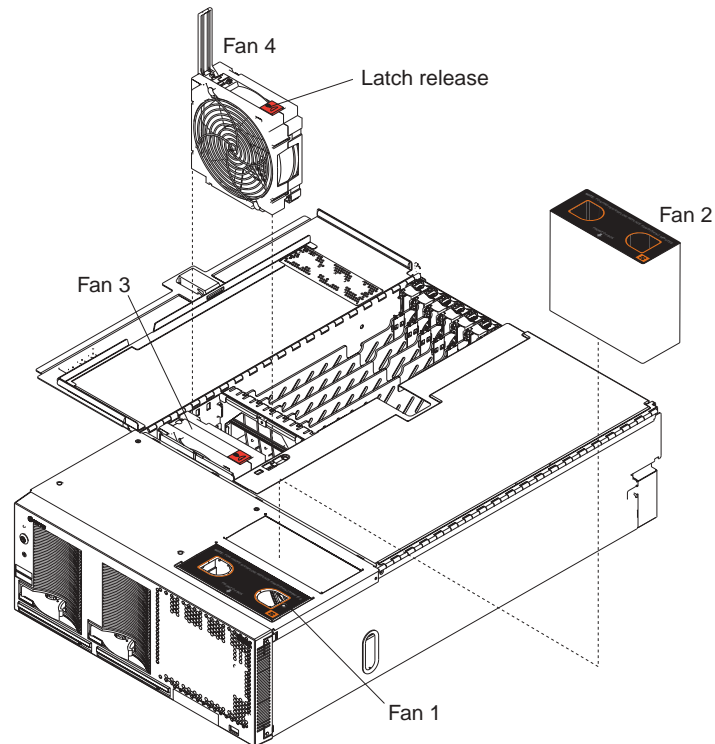

Each fan has a light located on the top left side. When the fan is operating correctly, this light is on. If a fan stops working, the Light Path Diagnostics feature will light a system-error light on the front of the server, indicating that there is a problem and guide you to the defective fan. When this occurs, first identify the defective fan; then, using the appropriate procedure, remove and replace the fan.

### Replacing fans 1 and 2

As shown in the following illustration, fans 1 and 2 are located on the right side of the server, and cool the SMP Expansion Modules. These fans are redundant, meaning that if one fails, the remaining fan will temporarily speed up to properly cool the SMP Expansion Modules. In the event of a failure, replace the malfunctioning fan within 48 hours.

Complete the following steps to replace fans 1 and 2:

1. Review the information in “Working inside the server with power on” on page 9 and “Before you begin” on page 9.

**Attention:** All fans must be replaced within 48 hours of failing.



2. Remove the fan from the server:
  - a. Place your fingers into the two finger holes on the top of the fan and squeeze them together.

**Note:** The illustrations in this document might differ slightly from your hardware.

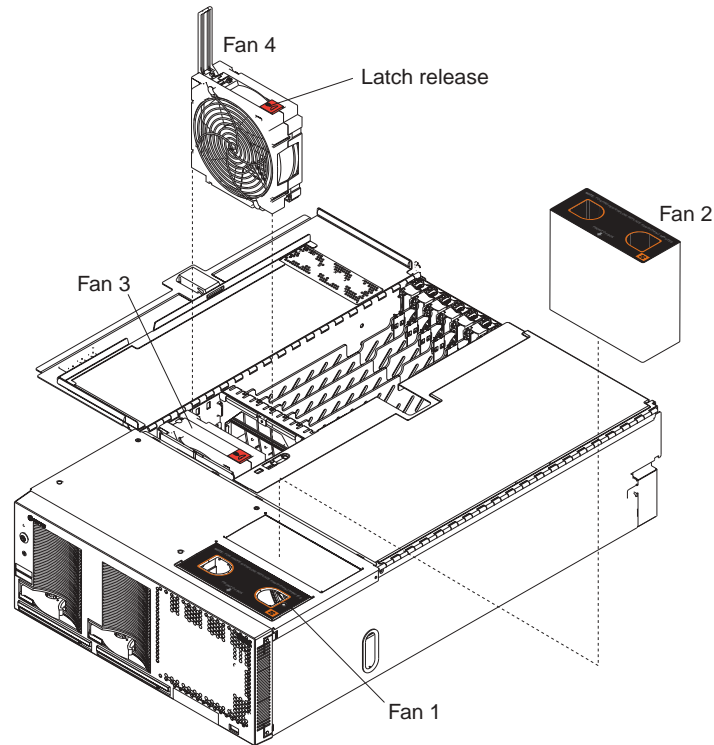

- b. Lift the fan out of the server.
3. Orient the new fan so that the light on the top of the fan is to the right side of the server.
4. Push the replacement fan assembly into the server until it clicks into place.
5. If you have other options to install or remove, do so now.
6. Close the server cover. See “Closing the cover” on page 49.

## Replacing fans 3 and 4

As shown in the illustration, these two fans (fan 3 and fan 4) are located in front of the I/O board and the PCI-X slots. They are used to cool the hard disk drives, I/O board, and PCI-X slots. These fans are redundant, meaning that if one fails, the remaining fan will temporarily speed up to properly cool the I/O components in the server. In the event of a failure, you must replace the malfunctioning fan within 48 hours.

Complete the following steps to replace fans 3 and 4:

1. Review the information in “Working inside the server with power on” on page 9 and “Before you begin” on page 9.

**Attention:** All fans must be replaced within 48 hours of failing.

2. Remove the fan from the server:

- a. Press the latch release to the right and let the handle come up.

**Note:** The illustrations in this document might differ slightly from your hardware.

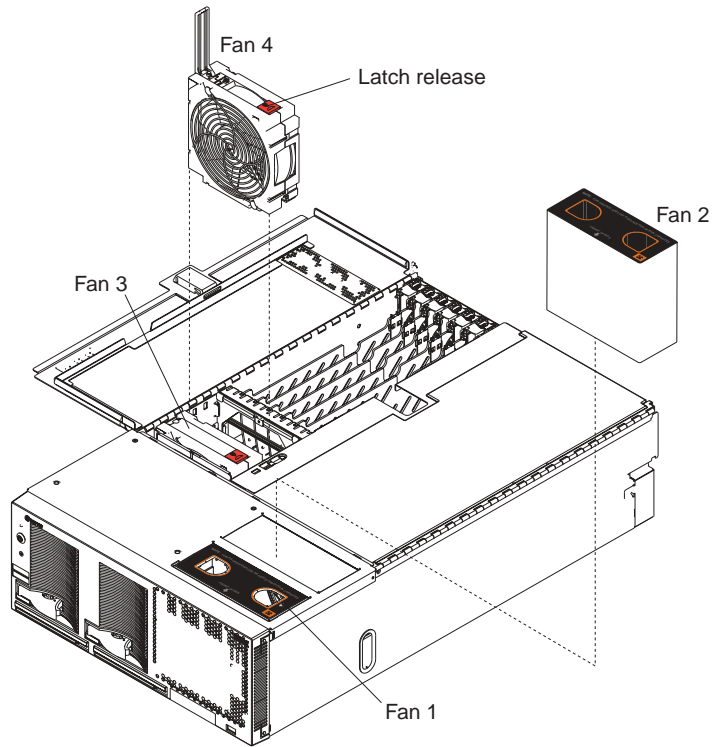

- b. Grasp the handle and lift the fan out of the server.

3. Orient the new fan so that the latch release on the top of the fan is to the right side of the server.
4. With the handle raised, push the replacement fan assembly into the server until it clicks into place.
5. Push the handle down until it clicks into place under the latch release.
6. If you have other options to install or remove, do so now.
7. Close the server cover. See "Closing the cover" on page 49.

---

## Replacing the battery

When replacing the battery you must replace it with a lithium battery of the same type, from the same manufacturer. To avoid possible danger, read and follow the safety statement below.

To order replacement batteries, call 1-800-772-2227 within the United States, and 1-800-465-7999 or 1-800-465-6666 within Canada. Outside the U.S. and Canada, call your IBM reseller or IBM marketing representative.

**Note:** After you replace the battery, you must reconfigure your server and reset the system date and time.

### Statement 2:



### CAUTION:

**When replacing the lithium battery, use only IBM Part Number 33F8354 or an equivalent type battery recommended by the manufacturer. If your system has a module containing a lithium battery, replace it only with the same module type made by the same manufacturer. The battery contains lithium and can explode if not properly used, handled, or disposed of.**

*Do not:*

- **Throw or immerse into water**
- **Heat to more than 100°C (212°F)**
- **Repair or disassemble**

**Dispose of the battery as required by local ordinances or regulations.**

Complete the following steps to replace the battery:

1. Read the “Safety information” on page 11, and follow any special handling and installation instructions supplied with the replacement battery.
2. Turn off the server and peripheral devices, disconnect the power cords, and all external cables from the server; then, open the cover (see “Opening the cover” on page 16 for details).
3. Remove fans 3 and 4 from the server (see “Replacing fans 3 and 4” on page 45 for details).

4. Remove the battery:
  - a. Use one finger to lift the battery clip over the battery.
  - b. Use one finger to slightly slide the battery out from its socket. The spring mechanism will push the battery out toward you as you slide it from the socket.
  - c. Use your thumb and index finger to pull the battery from under the battery clip.
  - d. Ensure that the battery clip is touching the base of the battery socket by pressing gently on the clip.

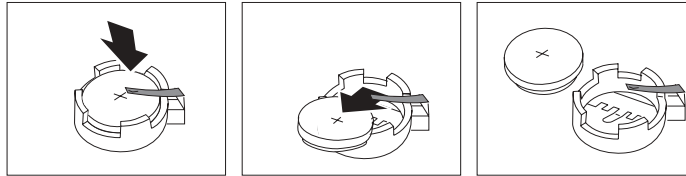

5. Insert the new battery:
  - a. Tilt the battery so that you can insert it into the socket, under the battery clip.
  - b. As you slide it under the battery clip, press the battery down into the socket.

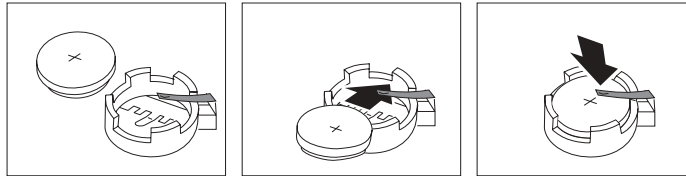

6. Install fans 3 and 4 in the server (see "Replacing fans 3 and 4" on page 45 for details).
7. Close the server cover, and connect the cables.
8. Turn on the server.
9. Start the Configuration/Setup Utility program and set configuration parameters.
  - Set the system date and time.
  - Set the power-on password.
  - Reconfigure your server.

---

## Closing the cover

Complete the following steps to install the server cover:

1. Close the cover by first closing the right side; then, close the left side and press down to latch the two halves of the cover in place.

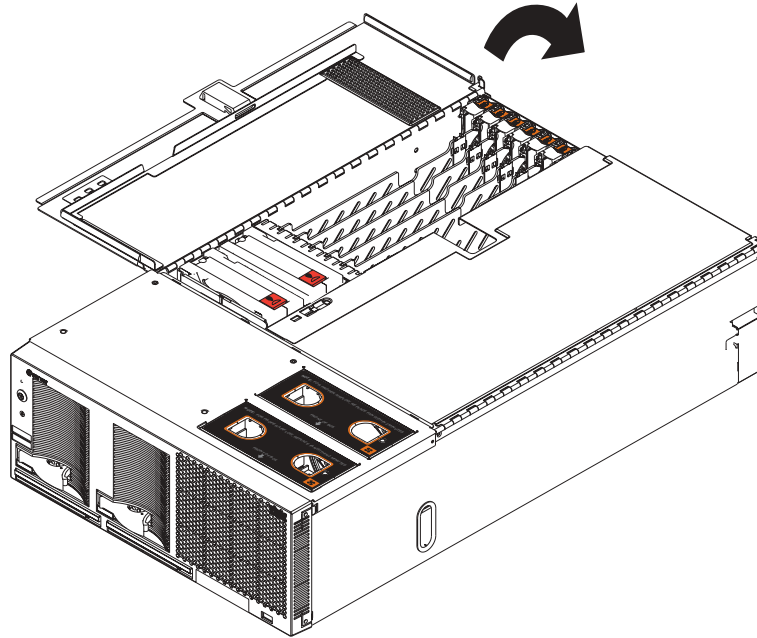

2. Reconnect all external cables and power cords to the server; then, plug the power cords into properly grounded electrical outlets. See Chapter 3, “I/O connectors and indicators” on page 57 for connector locations.
3. Turn on your server.

## Cabling the server

This section describes how to connect cables to the SMP Expansion Port, system power connectors, RXE Expansion Port, SCSI port, USB port, video port, auxiliary pointing device connector, keyboard port, Ethernet port, and RXE Management port. When instructed, see the appropriate documentation for more details.

For details about the locations and functions of all of the ports, indicators, and connectors see Chapter 3, "I/O connectors and indicators" on page 57.

### Notes:

1. See the following illustration to locate the connectors on the back of your server.
2. If your server model came with an operating system installed, such as Microsoft® Windows® 2000 Datacenter Server, see the software documentation provided with your server for additional cabling instructions.
3. The illustrations in this document might differ slightly from your hardware.

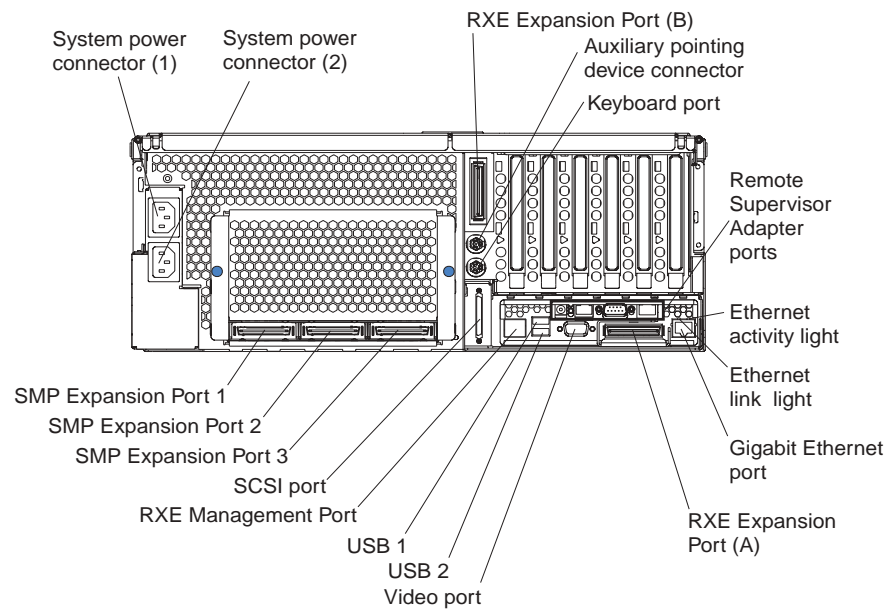

To effectively manage the cables on this server, keep groups of cables secured together, and do not run cables across the back of the server.

**Notes:**

1. Use cable ties to bundle similar cables together.
2. Use hook-and-loop fasteners to secure the cable bundles to the vertical rails of the rack cabinet.
3. When possible, separate data and power cables.
4. Do not secure cables too tightly. Overtightening can cause internal damage to the cables.

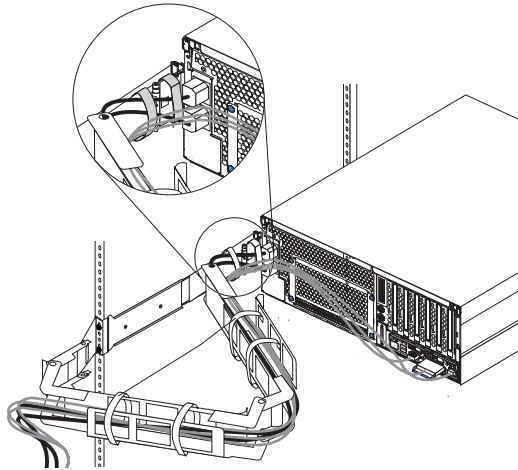

## SMP expansion port cabling

Each server has up to six SMP Expansion Ports located on the back, depending on your configuration. Three ports are located on each SMP Expansion Module in the server.

Complete the following steps to cable two SMP Expansion Modules in a single server together for up to 8-way operation:

**Note:** In the illustration you will see that the SMP Expansion Modules are numbered from bottom to top 0 and 1. You should also notice that the SMP Expansion ports are numbered left to right 1 through 3.

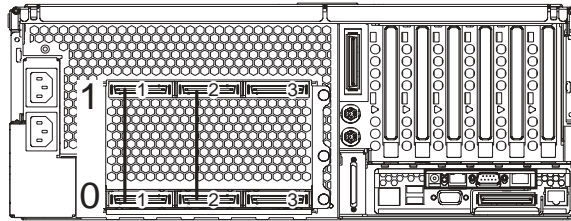

1. Using the two 10 inch long cables that came with your server, connect the two SMP Expansion Modules together.

**Note:** The 25.4 cm (10 in.) long SMP Expansion cables are supplied either with a server that already has two SMP Expansion Modules installed or as part of the option when a second SMP Expansion Module is purchased.

- a. Connect one end of the first cable to port 1 of SMP Expansion Module 0; then, connect the opposite end of the cable to port 1 of SMP Expansion Module 1.
- b. Connect one end of the second SMP Expansion cable to port 2 of SMP Expansion Module 0; then, connect the opposite end of the cable to port 2 of SMP Expansion Module 1.

**Notes:**

1. When multiple cables are connected between the SMP Expansion Module ports, SMP data is interleaved between the cables for better performance.
2. The SMP Expansion cables are not redundant.
3. If either of the two cables are removed or fail, the server will either turn off or restart, depending on your configuration.
4. The server will startup and operate with one cable attached between the two SMP Expansion Modules.

## RXE expansion port cabling

Your server has two RXE Expansion Ports located on the rear of the server. Use these ports to connect the server to a remote I/O enclosure and to expand the number of PCI-X slots that are available for use by the server. For detailed information about cabling the RXE Expansion Ports, see the documentation that comes with the remote I/O enclosure.



Complete the following steps to cable your one server to a remote I/O enclosure:

**Cabling an SMP Expansion Module:** If your server has one SMP Expansion Module installed complete the following steps:

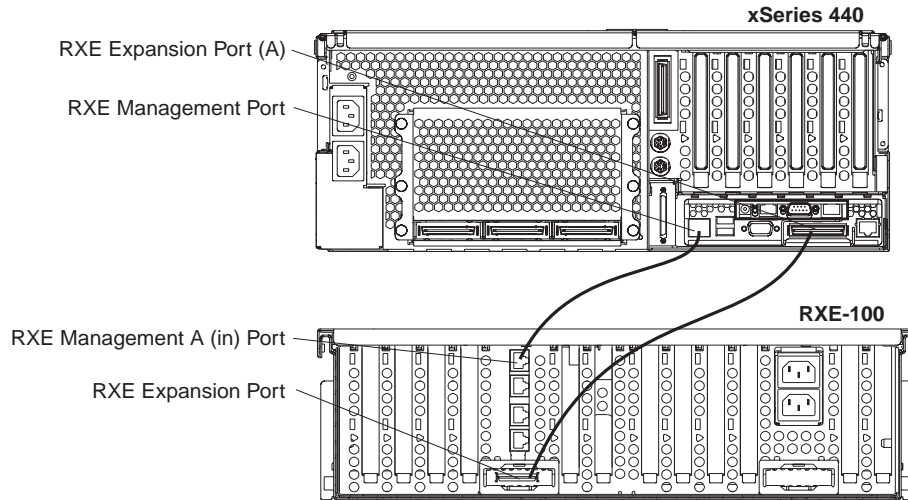

**Note:** For information on cabling the RXE Management Ports see, “RXE management port cabling” on page 54.

1. Using an RXE Expansion cable, connect one end of the cable to RXE Expansion Port (A) on the server.
2. Connect the opposite end of the cable to a RXE Expansion Port on the remote I/O enclosure.

**Cabling two SMP Expansion Modules:** If your server has two SMP Expansion Modules installed complete the following steps:

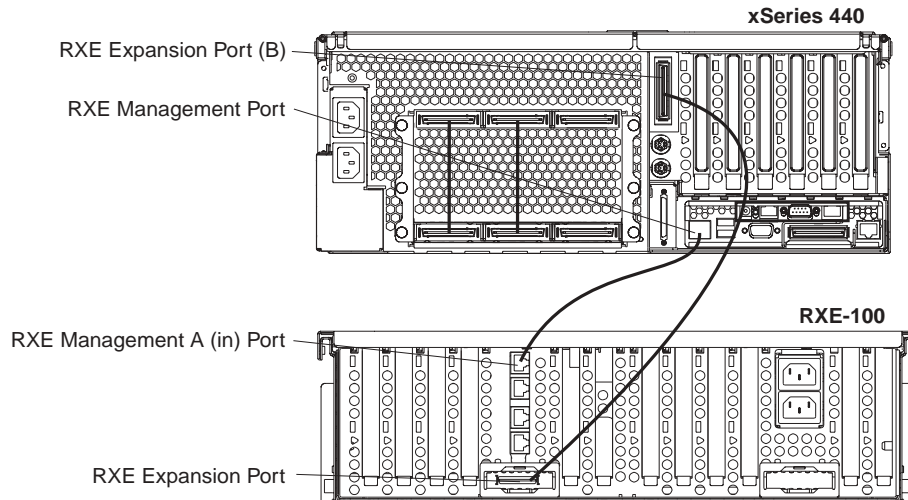

1. Using an RXE Expansion cable, connect one end of the cable to RXE Expansion Port (B) on the server.
2. Connect the opposite end of the cable to an RXE port on the remote I/O enclosure.

**Note:** When two SMP modules are installed, both of the RXE Expansion ports are active.

## RXE management port cabling

Your server has one RXE Management port located on the back of the server. Use this port to connect the server to the management port of an optional remote I/O enclosure. This port is used to manage the PCI-X slots in a remote I/O enclosure, including slot assignments and managing access.

Complete the following steps to cable the server RXE Management port to a remote I/O enclosure RXE Management port:

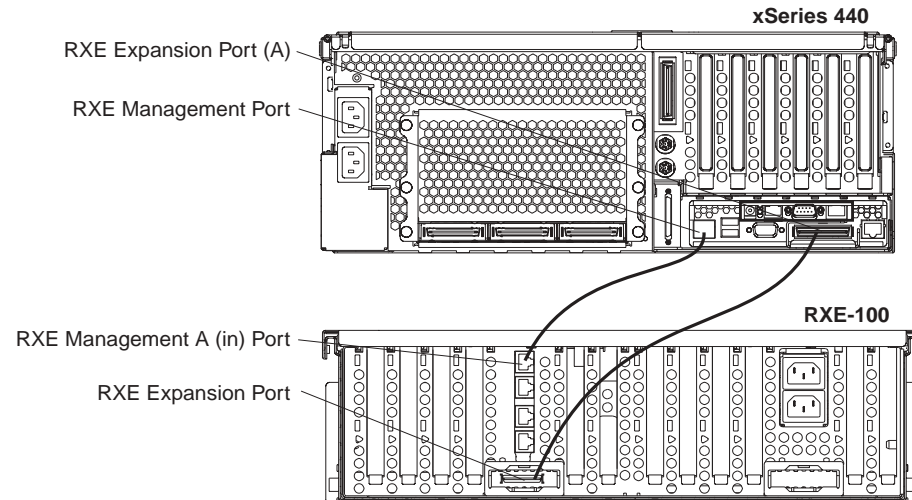

1. Using an RXE Management cable, connect one end of the cable to the RXE Management Port on the server.
2. Connect the opposite end of the cable to the RXE Management A (in) Port on the remote I/O enclosure.

### Notes:

- a. The RXE Management cabling is the same for a server with two SMP Expansion Modules.
- b. For details about cabling the server to the remote I/O enclosure and how the server and remote I/O work together, see the documentation that comes with the enclosure.

## Power cabling

Your server uses two power cords that can be connected to a primary power unit inside the rack cabinet, such as a properly grounded power distribution unit or uninterruptible power supply (UPS), or to an external source, such as a properly grounded electrical outlet.

Attach the power supply power cords as follows:

1. Connect a power supply cord to one of the system power connectors on the rear of the server.
2. Plug the other end of the power supply cord into a properly grounded electrical outlet or a primary power unit inside the rack cabinet.

**Note:** Plugging the power-supply cords into an electrical outlet might cause the server to start automatically. This is an acceptable action.

3. Turn on the server.

## SCSI cabling

Your server has one SCSI port located on the back of the server. Use this port to connect the server to an optional SCSI device such as the IBM FASTT series of extended enclosures. For detailed information about this option and how to connect it to your server, see the documentation that comes with the option.

## USB cabling

Your server has three USB ports, one on the front and two located on the back of the server. Use these ports to connect the server to an optional USB device. For detailed information about this USB option and how to connect it to your server, see the documentation that comes with the option.

## Video cabling

Your server has one video port located on the back of the server. Use this port to connect the server to a monitor or optional console switch. For detailed information about this option and how to connect it to your server, see the documentation that comes with the option.

## Auxiliary pointing device cabling

Your server has one auxiliary pointing device port located on the back of the server. Use this port to connect the server to a pointing device or optional console switch. For detailed information about this option and how to connect it to your server, see the documentation that comes with the option.

## Keyboard cabling

Your server has one keyboard port located on the back of the server. Use this port to connect the server to a keyboard or optional console switch. You can also connect a USB keyboard to the server using one of the USB ports. After installing a USB keyboard, you might need to use the Configuration/Setup utility to Enable keyboardless operation and prevent the POST error message 301 from being displayed during startup. For detailed information about this option and how to connect it to your server, see the documentation that comes with the option.

## Gigabit Ethernet cabling

Your server has one Ethernet port located on the back of the server. Use this port to connect the server to a LAN.

**Note:** A second Ethernet port is located on the Remote Supervisor Adapter. This port is used for specific supervisory functions and should not be confused with the Gigabit Ethernet port located next to the USB ports.

## Remote Supervisor Adapter cabling

Your server comes with a Remote Supervisor Adapter. For information about cabling the Remote Supervisor Adapter connectors, see the *User's Guide* on the *IBM Documentation CD*.



## Chapter 3. I/O connectors and indicators

This chapter provides the information about the I/O connectors and indicators on the server.

Your server has the following I/O connectors:

- Universal Serial Bus (USB) connectors
- Keyboard connector
- Video connector
- Auxiliary-device (pointing device) connector
- System management ports
  - One ASM interconnect (peer-to-peer) port (RJ-14)
  - One Ethernet port (remote server management using network, RJ-45)
  - One serial port (remote server management using modem)
  - One external power connector
- Ethernet connectors

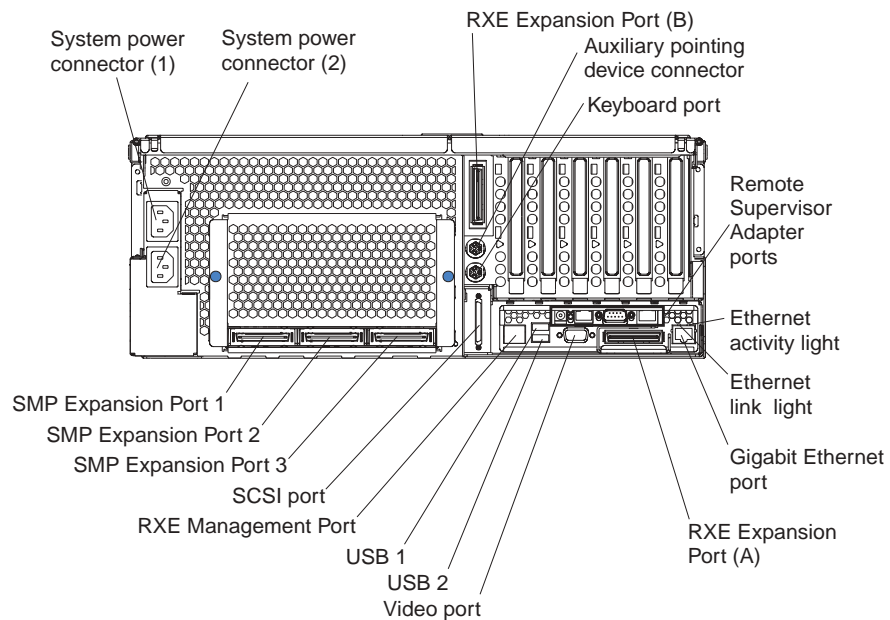

---

## Universal Serial Bus ports

Your server has three Universal Serial Bus (USB) ports, which are configured automatically. USB is a serial interface standard for telephony and multimedia devices. It uses Plug and Play technology to determine the type of device attached to the connector.

## USB cables and hubs

You need a 4-pin cable to connect devices to USB 1, USB 2, and USB 3. If you plan to attach more than three USB devices, you must use a hub to connect the devices. The hub provides multiple connectors for attaching additional external USB devices.

USB technology provides up to 12 Mbps speed with a maximum of 127 external devices and a maximum signal distance of 5 meters (16 ft) per segment.

## USB-port connectors

There are two USB-port connectors on the rear of the server and one USB-port connector on the front. These USB-port connectors are used to attach USB compatible devices to the server.

The following illustration shows the pin-number assignments for the USB-port connectors on your server.

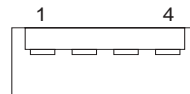

---

## Keyboard connector

There is one keyboard connector on the rear of the server.

**Note:** If you attach a standard keyboard to the keyboard connector, the USB ports and devices will be disabled during the power-on self-test (POST).

The following illustration shows the pin-number assignments for the keyboard connector on the end of the cable.

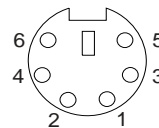

---

## Video connector

The following illustration shows the pin-number assignments for the 15-pin analog video connector on the rear of the server.

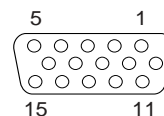

---

## Auxiliary-device (pointing device) connector

There is one auxiliary-device connector that supports a mouse or other pointing device located on the rear of the server just under the keyboard connector.

The following illustration shows the pin-number assignments for the auxiliary-device connector on the end of the cable.

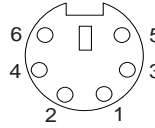

---

## RXE Expansion Port

There are two RXE Expansion Ports that are used to connect your server to a remote I/O enclosure.

The following illustration shows the pin-number assignments for the RXE Expansion Port on the end of the cable.

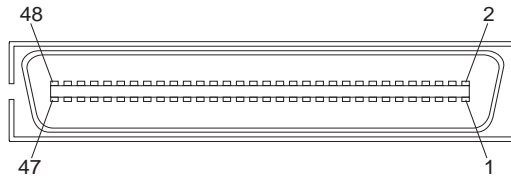

---

## SMP Expansion Port

There are up to six SMP Expansion Ports that are used to interconnect the SMP Modules in your server.

The following illustration shows the pin-number assignments for the SMP Expansion Port on the end of the cable.

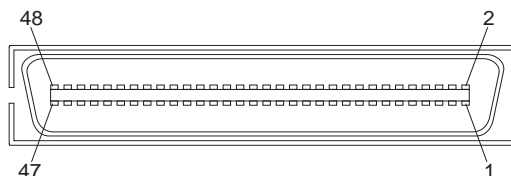

---

## Remote Supervisor Adapter communication ports

The server has four communication ports that are used by the Remote Supervisor Adapter. Three of the ports are located on the adapter and one is located at the lower left corner of the rear panel (as viewed from the rear).

If you want to use the Remote Supervisor Adapter to manage the server remotely or to connect the server to another server, connect the appropriate cables to the Remote Supervisor Adapter ports.

To enable remote server management through a network, use the Remote Supervisor Adapter Ethernet port (RJ-45). To enable remote server management using a modem, use the Remote Supervisor Adapter serial port. To connect the server with

another server, use the ASM interconnect port (RJ-14). See the Remote Supervisor Adapter documentation on the *IBM Documentation CD* for more information.

The following illustration shows the communication ports on the Remote Supervisor Adapter.

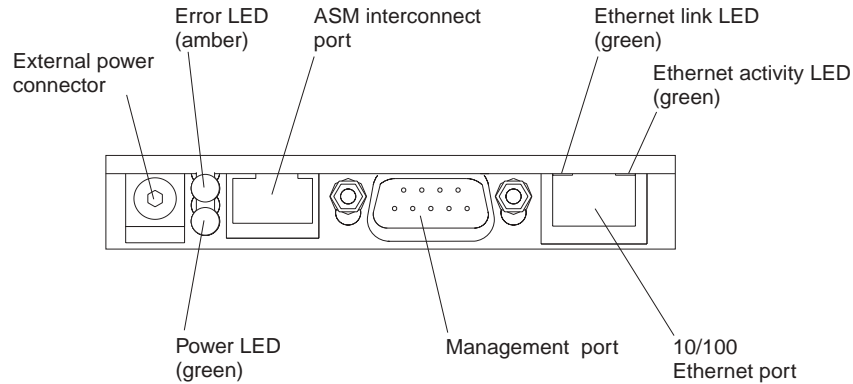

#### **External power connector**

This connector provides power to the Remote Supervisor Adapter, independent of the server power supply.

**Note:** This connector is not supported on this server.

#### **Error LED**

The amber Error LED indicates an error on the Remote Supervisor Adapter.

#### **Advanced System Management (ASM) interconnect port**

Attach an ASM Interconnect module (which comes with the server) to this port to connect the Remote Supervisor Adapter to the other devices on the ASM Interconnect network.

#### **Ethernet link LED**

This green light, located on the right of the Ethernet port, lights when there is an active link connection on the Ethernet controller for the Ethernet port.

#### **Ethernet activity LED**

This green light, located on the left of the Ethernet port, lights when there is activity on the Ethernet LAN connected to the Ethernet port.

#### **10/100 Ethernet port**

Connect a category 3 or category 5 Ethernet cable to this port to enable a LAN connection or TELNET session. The Ethernet port LEDs on the Remote Supervisor Adapter indicate the link is good and activity is taking place on the network.

#### **Management port**

Connect a serial cable to this port to enable system management through a modem, or connect a null modem cable to enable system management through a workstation or laptop computer.

#### **Power LEDs**

The green power LED indicates the status of the power connection.

---

## **Gigabit Ethernet port**

Your server comes with an integrated Gigabit Ethernet controller. This controller provides an interface for connecting to 10-Mbps, 100-Mbps, or 1000-Mbps networks and provides full-duplex (FDX) capability, which enables simultaneous transmission and reception of data on the Ethernet local area network (LAN).



To access the Ethernet port, connect a Category 3, 4, or 5 unshielded twisted-pair (UTP) cable to the RJ-45 connector on the rear of your server.

**Note:** The 100BASE-TX/1000BASE-T Fast Ethernet standard requires that the cabling in the network be Category 5 or higher.

The Ethernet (RJ-45) connector has two lights. The Ethernet-link status light is on the left. When this green light is on, there is an active connection on the Ethernet port. The Ethernet transmit/receive activity light is on the right. When this amber light is on, there is activity between the server and the network. These lights have the same functions as the Ethernet-link status light and the Ethernet transmit/receive activity light on the rear of the server (see the *User's Guide* on the *IBM Documentation CD*).

---

## Configuring the Gigabit Ethernet controller

The server comes with an integrated Ethernet controller. This controller provides an interface for connecting to 10-Mbps, 100-Mbps, or 1000-Mbps networks and provides full duplex (FDX) capability, which enables simultaneous transmission and reception of data on the Ethernet local area network (LAN).

When you connect your server to the network, the Ethernet controller automatically detects the data-transfer rate (10-Mbps, 100-Mbps, or 1000-Mbps) on the network and then sets the controller to operate at the appropriate rate. In addition, if the Ethernet ports that your server is connected to support auto-negotiation, the Gigabit Ethernet controller will set the appropriate duplex state. That is, the Ethernet controller will adjust to the network data rate, whether the data rate is standard Ethernet (10BASE-T), Fast Ethernet (100BASE-TX/1000BASE-T), half duplex (HDX), or full duplex (FDX). The controller supports half-duplex (HDX) and full-duplex (FDX) modes at both speeds.

**Note:** See the documentation on the *Broadcom NetXtreme Gigabit Ethernet Software* CD that came with your server for information about configuring the Ethernet controller.

---

## Ethernet port connector

The following illustration shows the pin-number assignments for the RJ-45 connector. These assignments apply to both 10BASE-T and 100/1000BASE-TX devices.

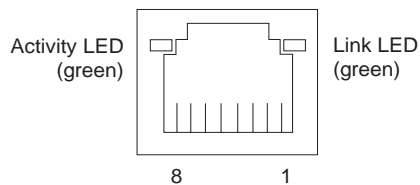



---

## Appendix A. Notices

This publication was developed for products and services offered in the U.S.A.

IBM may not offer the products, services, or features discussed in this document in other countries. Consult your local IBM representative for information on the products and services currently available in your area. Any reference to an IBM product, program, or service is not intended to state or imply that only that IBM product, program, or service may be used. Any functionally equivalent product, program, or service that does not infringe any IBM intellectual property right may be used instead. However, it is the user's responsibility to evaluate and verify the operation of any non-IBM product, program, or service.

IBM may have patents or pending patent applications covering subject matter described in this document. The furnishing of this document does not give you any license to these patents. You can send license inquiries, in writing, to:

*IBM Director of Licensing  
IBM Corporation  
North Castle Drive  
Armonk, NY 10504-1785  
U.S.A.*

INTERNATIONAL BUSINESS MACHINES CORPORATION PROVIDES THIS PUBLICATION "AS IS" WITHOUT WARRANTY OF ANY KIND, EITHER EXPRESS OR IMPLIED, INCLUDING, BUT NOT LIMITED TO, THE IMPLIED WARRANTIES OF NON-INFRINGEMENT, MERCHANTABILITY OR FITNESS FOR A PARTICULAR PURPOSE. Some jurisdictions do not allow disclaimer of express or implied warranties in certain transactions, therefore, this statement may not apply to you.

This information could include technical inaccuracies or typographical errors. Changes are periodically made to the information herein; these changes will be incorporated in new editions of the publication. IBM may make improvements and/or changes in the product(s) and/or the program(s) described in this publication at any time without notice.

Any references in this publication to non-IBM Web sites are provided for convenience only and do not in any manner serve as an endorsement of those Web sites. The materials at those Web sites are not part of the materials for this IBM product, and use of those Web sites is at your own risk.

IBM may use or distribute any of the information you supply in any way it believes appropriate without incurring any obligation to you.

---

### Edition notice

**© COPYRIGHT INTERNATIONAL BUSINESS MACHINES CORPORATION, 2002.  
All rights reserved.**

Note to U.S. Government Users — Documentation related to restricted rights — Use, duplication or disclosure is subject to restrictions set forth in GSA ADP Schedule Contract with IBM Corp.

---

## Trademarks

The following terms are trademarks of International Business Machines Corporation in the United States, other countries, or both:

Active Memory	PS/2
Active PCI	ServeRAID
Active PCI-X	ServerGuide
Alert on LAN	ServerProven
C2T Interconnect	TechConnect
Chipkill	Tivoli
EtherJet	Tivoli Enterprise
e-business logo	Update Connector
FlashCopy	Wake on LAN
IBM	XA-32
Light Path Diagnostics	XA-64
NetBAY	X-Architecture
Netfinity	XceL4
NetView	XpandOnDemand
OS/2 WARP	xSeries
Predictive Failure Analysis	

Lotus, Lotus Notes, SmartSuite, and Domino are trademarks of Lotus Development Corporation and/or IBM Corporation in the United States, other countries, or both.

Action Media, LANDesk, MMX, Pentium, and ProShare are trademarks of Intel Corporation in the United States, other countries, or both.

Microsoft, Windows, and Windows NT are trademarks of Microsoft Corporation in the United States, other countries, or both.

UNIX is a registered trademark of The Open Group in the United States and other countries.

Java and all Java-based trademarks and logos are trademarks or registered trademarks of Sun Microsystems, Inc. in the United States, other countries, or both.

Linux is a registered trademark of Linus Torvalds.

Other company, product, or service names may be trademarks or service marks of others.

---

## Important notes

Processor speeds indicate the internal clock speed of the microprocessor; other factors also affect application performance.

CD-ROM drive speeds list the variable read rate. Actual speeds vary and are often less than the maximum possible.

When referring to processor storage, real and virtual storage, or channel volume, KB stands for approximately 1000 bytes, MB stands for approximately 1 000 000 bytes, and GB stands for approximately 1 000 000 000 bytes.

When referring to hard disk drive capacity or communications volume, MB stands for 1000000 bytes, and GB stands for 1000 000 000 bytes. Total user-accessible capacity may vary depending on operating environments.

Maximum internal hard disk drive capacities assume the replacement of any standard hard disk drives and population of all hard disk drive bays with the largest currently supported drives available from IBM.

Maximum memory may require replacement of the standard memory with an optional memory module.

IBM makes no representation or warranties regarding non-IBM products and services that are ServerProven, including but not limited to the implied warranties of merchantability and fitness for a particular purpose. These products are offered and warranted solely by third parties.

IBM makes no representations or warranties with respect to non-IBM products. Support (if any) for the non-IBM products is provided by the third party, not IBM.

Some software may differ from its retail version (if available), and may not include user manuals or all program functionality.

---

## Electronic emission notices

### Federal Communications Commission (FCC) statement

**Note:** This equipment has been tested and found to comply with the limits for a Class A digital device, pursuant to Part 15 of the FCC Rules. These limits are designed to provide reasonable protection against harmful interference when the equipment is operated in a commercial environment. This equipment generates, uses, and can radiate radio frequency energy and, if not installed and used in accordance with the instruction manual, may cause harmful interference to radio communications. Operation of this equipment in a residential area is likely to cause harmful interference, in which case the user will be required to correct the interference at his own expense.

Properly shielded and grounded cables and connectors must be used in order to meet FCC emission limits. Properly shielded and grounded cables and connectors must be used in order to meet FCC emission limits. IBM is not responsible for any radio or television interference caused by using other than recommended cables and connectors or by using other than recommended cables and connectors or by unauthorized changes or modifications to this equipment. Unauthorized changes or modifications could void the user's authority to operate the equipment.

This device complies with Part 15 of the FCC Rules. Operation is subject to the following two conditions: (1) this device may not cause harmful interference, and (2) this device must accept any interference received, including interference that may cause undesired operation.

## Industry Canada Class A emission compliance statement

This Class A digital apparatus complies with Canadian ICES-003.

### Avis de conformité à la réglementation d'Industrie Canada

Cet appareil numérique de la classe A est conforme à la norme NMB-003 du Canada.

## Australia and New Zealand Class A statement

**Attention:** This is a Class A product. In a domestic environment this product may cause radio interference in which case the user may be required to take adequate measures.

## United Kingdom telecommunications safety requirement

### Notice to Customers

This apparatus is approved under approval number NS/G/1234/J/100003 for indirect connection to public telecommunication systems in the United Kingdom.

## European Union EMC Directive conformance statement

This product is in conformity with the protection requirements of EU Council Directive 89/336/EEC on the approximation of the laws of the Member States relating to electromagnetic compatibility. IBM cannot accept responsibility for any failure to satisfy the protection requirements resulting from a nonrecommended modification of the product, including the fitting of non-IBM option cards.

This product has been tested and found to comply with the limits for Class A Information Technology Equipment according to CISPR 22/European Standard EN 55022. The limits for Class A equipment were derived for commercial and industrial environments to provide reasonable protection against interference with licensed communication equipment.

**Attention:** This is a Class A product. In a domestic environment this product may cause radio interference in which case the user may be required to take adequate measures.

## Taiwanese Class A warning statement

警告使用者：  
這是甲類的資訊產品，在居住的環境中使用時，可能會造成射頻干擾，在這種情況下，使用者會被要求採取某些適當的對策。

## Japanese Voluntary Control Council for Interference (VCCI) statement

この装置は、情報処理装置等電波障害自主規制協議会（VCCI）の基準に基づきクラスA情報技術装置です。この装置を家庭環境で使用すると電波妨害を引き起こすことがあります。この場合には使用者が適切な対策を講ずるよう要求されることがあります。

### Power cords

For your safety, IBM provides a power cord with a grounded attachment plug to use with this IBM product. To avoid electrical shock, always use the power cord and plug with a properly grounded outlet.

IBM power cords used in the United States and Canada are listed by Underwriter's Laboratories (UL) and certified by the Canadian Standards Association (CSA).

For units intended to be operated at 115 volts: Use a UL-listed and CSA-certified cord set consisting of a minimum 18 AWG, Type SVT or SJT, three-conductor cord, a maximum of 15 feet in length and a parallel blade, grounding-type attachment plug rated 15 amperes, 125 volts.

For units intended to be operated at 230 volts (U.S. use): Use a UL-listed and CSA-certified cord set consisting of a minimum 18 AWG, Type SVT or SJT, three-conductor cord, a maximum of 15 feet in length and a tandem blade, grounding-type attachment plug rated 15 amperes, 250 volts.

For units intended to be operated at 230 volts (outside the U.S.): Use a cord set with a grounding-type attachment plug. The cord set should have the appropriate safety approvals for the country in which the equipment will be installed.

IBM power cords for a specific country or region are usually available only in that country or region.

IBM power cord part number	Used in these countries and regions
13F9940	Argentina, Australia, China (PRC), New Zealand, Papua New Guinea, Paraguay, Uruguay, Western Samoa
13F9979	Afghanistan, Algeria, Andorra, Angola, Austria, Belgium, Benin, Bulgaria, Burkina Faso, Burundi, Cameroon, Central African Rep., Chad, China (Macau S.A.R.), Czech Republic, Egypt, Finland, France, French Guiana, Germany, Greece, Guinea, Hungary, Iceland, Indonesia, Iran, Ivory Coast, Jordan, Lebanon, Luxembourg, Malagasy, Mali, Martinique, Mauritania, Mauritius, Monaco, Morocco, Mozambique, Netherlands, New Caledonia, Niger, Norway, Poland, Portugal, Romania, Senegal, Slovakia, Spain, Sudan, Sweden, Syria, Togo, Tunisia, Turkey, former USSR, Vietnam, former Yugoslavia, Zaire, Zimbabwe
13F9997	Denmark
14F0015	Bangladesh, Burma, Pakistan, South Africa, Sri Lanka
14F0033	Antigua, Bahrain, Brunei, Channel Islands, China (Hong Kong S.A.R.), Cyprus, Dubai, Fiji, Ghana, India, Iraq, Ireland, Kenya, Kuwait, Malawi, Malaysia, Malta, Nepal, Nigeria, Polynesia, Qatar, Sierra Leone, Singapore, Tanzania, Uganda, United Kingdom, Yemen, Zambia

IBM power cord part number	Used in these countries and regions
14F0051	Liechtenstein, Switzerland
14F0069	Chile, Ethiopia, Italy, Libya, Somalia
14F0087	Israel
1838574	Thailand
6952301	Bahamas, Barbados, Bermuda, Bolivia, Brazil, Canada, Cayman Islands, Colombia, Costa Rica, Dominican Republic, Ecuador, El Salvador, Guatemala, Guyana, Haiti, Honduras, Jamaica, Japan, Korea (South), Liberia, Mexico, Netherlands Antilles, Nicaragua, Panama, Peru, Philippines, Saudi Arabia, Suriname, Taiwan, Trinidad (West Indies), United States of America, Venezuela



# Index

## A

Active memory 33  
adapter  
    installing 19, 20  
    PCI bus 19  
    ServeRAID 22  
    working with 19

## B

battery replacement 47

## C

cable  
    connectors on back 50  
    management 50  
cabling  
    ServeRAID adapter 22  
Class A electronic emission notice 65  
components  
    location of 2  
    Remote Supervisor Adapter 7  
connector and port locations 57  
connectors  
    Ethernet 61  
cooling 10  
cover  
    close 49  
    removing 16

## D

DIMMs  
    31  
    considerations 32  
    order of installation 32  
    removing 34

## E

electronic emission Class A notice 65  
Ethernet  
    connector pin-number assignments 61  
    port 61  
Ethernet controller  
    configuring 61  
Ethernet port 61  
expansion slots  
    location 19  
    type 19

## F

fan  
    assemblies 44  
fans  
    replacing and troubleshooting 44  
    replacing SMP Expansion Module 44  
    replacing the PCI-X 45  
Fast Ethernet 61  
FCC Class A notice 65  
filler panel  
    power-supply bay 17

## H

handling static-sensitive devices 10  
hard disk drive  
    IDE 24  
    installing 24  
hardware, major 2  
hot-swap and hot-plug devices  
    power supplies 17  
hot-swap power supply  
    installing 17

## I

I/O board  
    internal connectors 7  
I/O connectors 57  
installation  
    order, microprocessors 36  
installing  
    adapters 19  
    battery 47  
    hot-swap power supply 17  
    options 9  
internal connectors  
    I/O board 7  
    PCI-X 6  
    SMP Expansion Module 4

## K

keyboard  
    connector 58

## M

management cable 50  
memory  
    configuration changes 33  
Memory mirroring 33

- microprocessor
  - order of installation 36
- mouse
  - connector 59

## N

- notes, important 65
- notices
  - electronic emission 65
  - FCC, Class A 65

## O

- option
  - installing 9
- order of installation, microprocessors 36

## P

- PCI
  - expansion slots 19
- PCI-X
  - internal connectors 6
- pin-number assignments
  - Ethernet 61
- pointing device
  - connector 59
- port
  - Ethernet 61
  - Remote Supervisor Adapter 59
  - USB 58
  - USB connector 58
- power cords 67
- power supply
  - installing 17
  - operating requirements 17

## R

- reinstalling
  - the SMP Expansion Module 41
- reliability, system 10
- Remote Supervisor Adapter 59
  - component locations 7
  - port 59
- replacing
  - PCI-X fans 45
  - SMP Expansion Module fans 44
- RXE Expansion Port
  - connector 59

## S

- ServeRAID adapter
  - cabling 22

- slots See expansion slots 19
- SMP
  - Expansion Module 27
    - internal connectors 4
    - removing 28
    - removing the cover 28
  - Expansion Port
    - connector 59
    - fans 44
- SMP Expansion Module
  - reinstalling the cover 41
  - reinstalling the SMP Expansion Module 41
- system
  - reliability 10

## T

- trademarks 64

## U

- United States electronic emission Class A notice 65
- United States FCC Class A notice 65
- USB
  - cables and hubs 58
  - connector 58
  - port connectors 58

## W

- Web site
  - compatible options 32, 36
- working inside server with power on 9





Part Number: 59P6787

SC59-P678-70



(1P) P/N: 59P6787

