



xSeries 255 Type 8685

Installation Guide

Welcome...

Thank you for buying an IBM xSeries server. Your server is based on the X-Architecture™ technology, and it features superior performance, availability, and scalability.

This server *Installation Guide* contains information for setting up and configuring your server.

For detailed information about your server, view the publications on the Documentation CD.

You can also find the most current information about your server on the IBM Web site at: <http://www.ibm.com/pc/support>

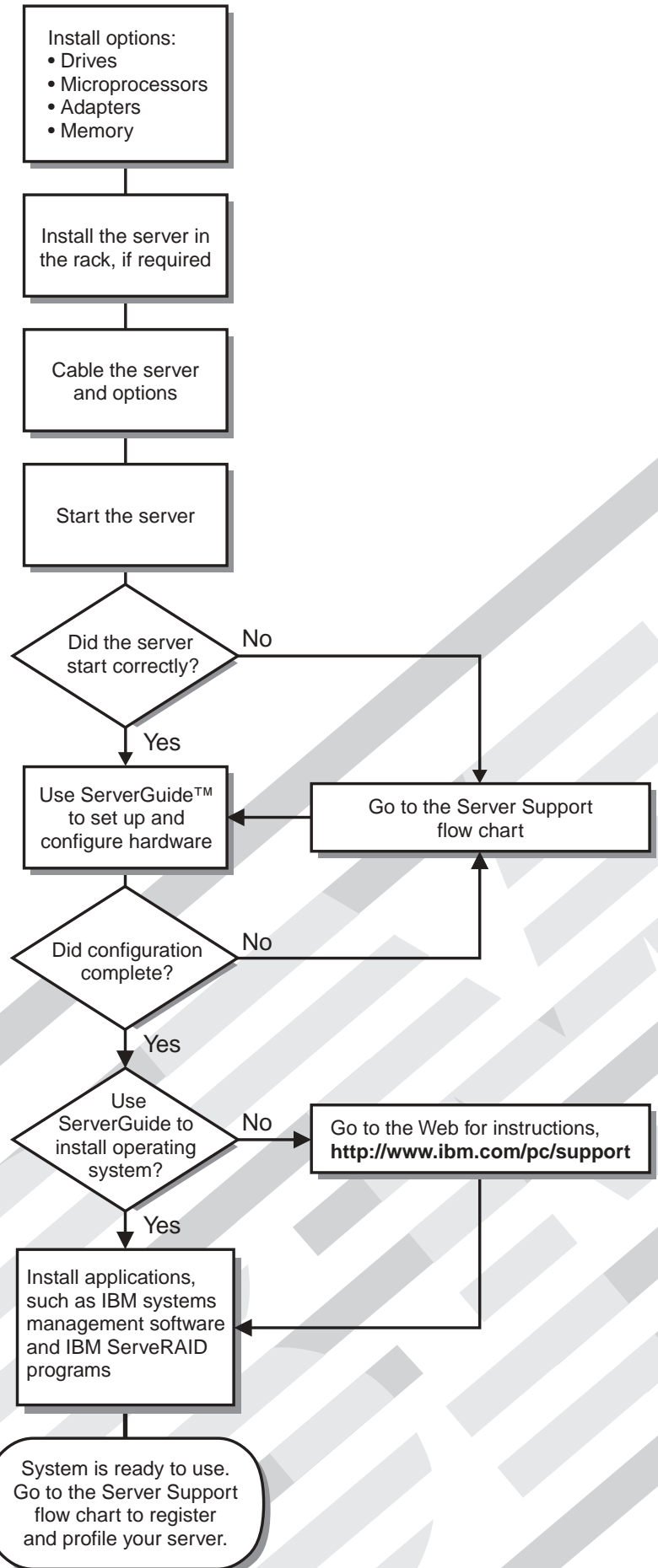

Server Support

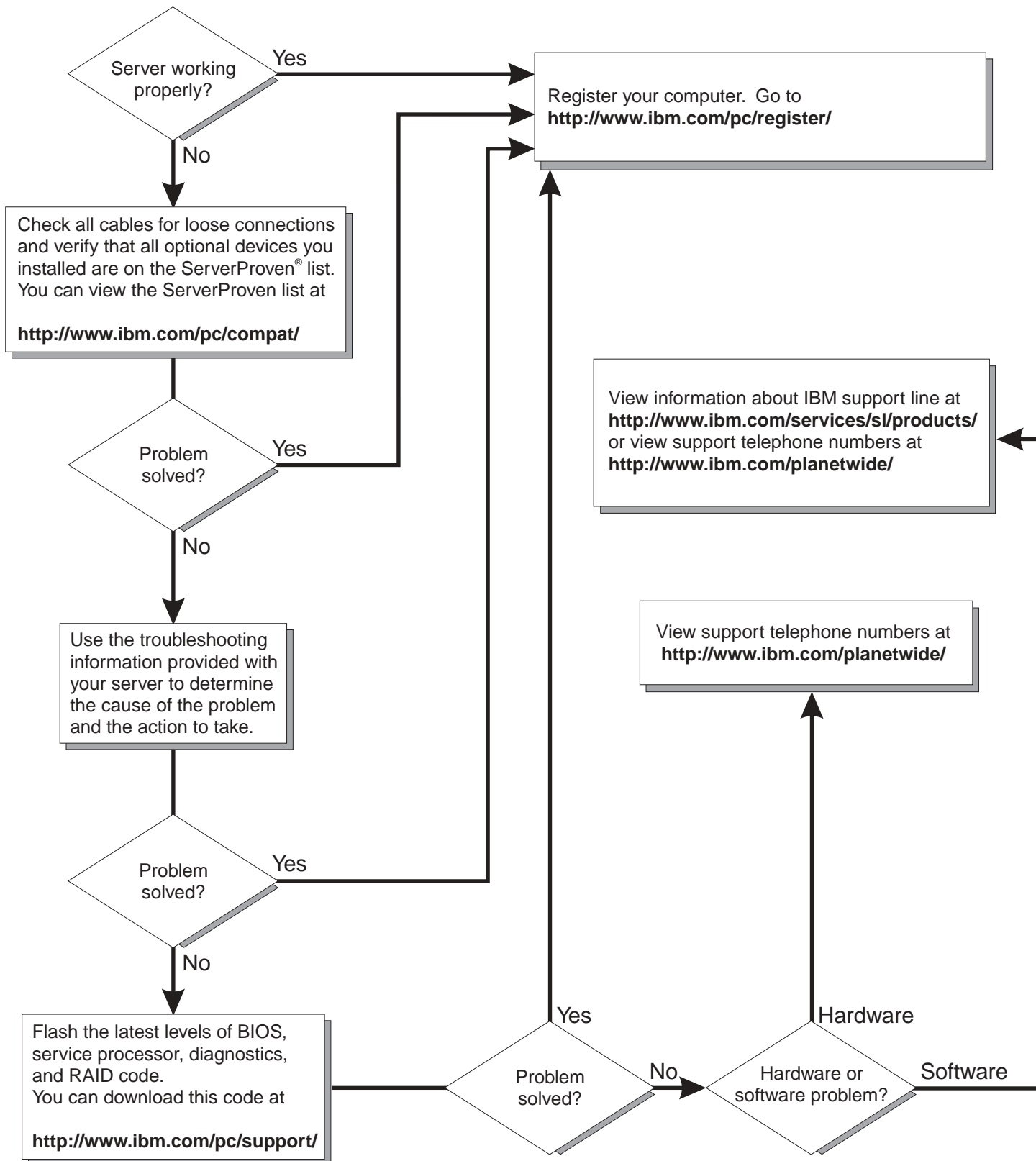

IBM xSeries 255
Type 8685



Installation Guide

Note:

Before using this information and the product it supports, read the general information in Appendix B, "Warranty information", on page 43 and Appendix C, "Notices", on page 61.

Second Edition (June 2003)

© Copyright International Business Machines Corporation 2003. All rights reserved.

US Government Users Restricted Rights – Use, duplication or disclosure restricted by GSA ADP Schedule Contract with IBM Corp.

Contents

Safety	v
Handling static-sensitive devices	x
Chapter 1. Introduction	1
Specifications and features	2
Notices and statements used in this book	2
Major components view of the xSeries 255 Type 8685 server	3
Chapter 2. Installing options	5
Working inside a server with the power on	5
Installing adapters	5
Cabling a RAID or SCSI adapter to the standard SCSI backplane	8
Installing memory modules	12
Installing a drive in a hot-swap bay	15
Installing an additional microprocessor	17
Installing a hot-swap power supply	20
Cabling the server.	23
Chapter 3. Server controls, indicators, and power	25
Server controls and indicators	25
Front view	25
Rear view	27
Server power features	28
Turning on the server	28
Turning off the server	29
Standby mode	30
Chapter 4. Configuring your server	31
Starting the utility programs	32
Using the Configuration/Setup Utility program	32
Using the SCSISelect Utility program	32
Using the ServerGuide CD	33
Chapter 5. Solving problems	35
POST beep code descriptions	35
POST error messages	36
ServerGuide problems	37
Troubleshooting chart	38
Appendix A. Getting help and technical assistance	41
Before you call	41
Using the documentation	41
Getting help and information from the World Wide Web	41
Software service and support	42
Hardware service and support	42
Appendix B. Warranty information	43
Part 1 - General Terms	43
Part 2 - Country-unique Terms	46
Part 3 - Warranty Information	57
Appendix C. Notices	61
Edition notice	61

Trademarks	62
Important notes.	62
Electronic emission notices	63
Federal Communications Commission (FCC) statement	63
Industry Canada Class A emission compliance statement	63
Australia and New Zealand Class A statement	64
United Kingdom telecommunications safety requirement.	64
European Union EMC Directive conformance statement.	64
Taiwanese Class A warning statement	64
Japanese Voluntary Control Council for Interference (VCCI) statement	65
Power cords	65
Index	67

Safety

Before installing this product, read the Safety Information.

قبل تركيب هذا المنتج، يجب قراءة الملاحظات الأمنية

Antes de instalar este produto, leia as Informações de Segurança.

在安装本产品之前，请仔细阅读 **Safety Information** (安全信息)。

安裝本產品之前，請先閱讀「安全資訊」。

Prije instalacije ovog produkta obavezno pročitajte Sigurnosne Upute.

Před instalací tohoto produktu si přečtěte příručku bezpečnostních instrukcí.

Læs sikkerhedsforskrifterne, før du installerer dette produkt.

Lees voordat u dit product installeert eerst de veiligheidsvoorschriften.

Ennen kuin asennat tämän tuotteen, lue turvaohjeet kohdasta Safety Information.

Avant d'installer ce produit, lisez les consignes de sécurité.

Vor der Installation dieses Produkts die Sicherheitshinweise lesen.

Πριν εγκαταστήσετε το προϊόν αυτό, διαβάστε τις πληροφορίες ασφάλειας (safety information).

לפני שתתקינו מוצר זה, קראו את הוראות הבטיחות.

A termék telepítése előtt olvassa el a Biztonsági előírásokat!

Prima di installare questo prodotto, leggere le Informazioni sulla Sicurezza.

製品の設置の前に、安全情報をお読みください。

본 제품을 설치하기 전에 안전 정보를 읽으십시오.

Пред да се инсталира овој продукт, прочитајте информацијата за безбедност.

Les sikkerhetsinformasjonen (Safety Information) før du installerer dette produktet.

Przed zainstalowaniem tego produktu, należy zapoznać się z książką "Informacje dotyczące bezpieczeństwa" (Safety Information).

Antes de instalar este produto, leia as Informações sobre Segurança.

Перед установкой продукта прочтите инструкции по технике безопасности.

Pred inštaláciou tohto zariadenia si pečítajte Bezpečnostné predpisy.

Pred namestitvijo tega proizvoda preberite Varnostne informacije.

Antes de instalar este producto, lea la información de seguridad.

Läs säkerhetsinformationen innan du installerar den här produkten.

Statement 1:



DANGER

Electrical current from power, telephone, and communication cables is hazardous.

To avoid a shock hazard:

- **Do not connect or disconnect any cables or perform installation, maintenance, or reconfiguration of this product during an electrical storm.**
- **Connect all power cords to a properly wired and grounded electrical outlet.**
- **Connect to properly wired outlets any equipment that will be attached to this product.**
- **When possible, use one hand only to connect or disconnect signal cables.**
- **Never turn on any equipment when there is evidence of fire, water, or structural damage.**
- **Disconnect the attached power cords, telecommunications systems, networks, and modems before you open the device covers, unless instructed otherwise in the installation and configuration procedures.**
- **Connect and disconnect cables as described in the following table when installing, moving, or opening covers on this product or attached devices.**

To Connect:	To Disconnect:
1. Turn everything OFF.	1. Turn everything OFF.
2. First, attach all cables to devices.	2. First, remove power cords from outlet.
3. Attach signal cables to connectors.	3. Remove signal cables from connectors.
4. Attach power cords to outlet.	4. Remove all cables from devices.
5. Turn device ON.	

Statement 2:



CAUTION:

When replacing the lithium battery, use only IBM Part Number 33F8354 or an equivalent type battery recommended by the manufacturer. If your system has a module containing a lithium battery, replace it only with the same module type made by the same manufacturer. The battery contains lithium and can explode if not properly used, handled, or disposed of.

Do not:

- Throw or immerse into water
- Heat to more than 100°C (212°F)
- Repair or disassemble

Dispose of the battery as required by local ordinances or regulations.

Statement 3:



CAUTION:

When laser products (such as CD-ROMs, DVD drives, fiber optic devices, or transmitters) are installed, note the following:

- Do not remove the covers. Removing the covers of the laser product could result in exposure to hazardous laser radiation. There are no serviceable parts inside the device.
- Use of controls or adjustments or performance of procedures other than those specified herein might result in hazardous radiation exposure.



DANGER

Some laser products contain an embedded Class 3A or Class 3B laser diode. Note the following.

Laser radiation when open. Do not stare into the beam, do not view directly with optical instruments, and avoid direct exposure to the beam.

Statement 4:

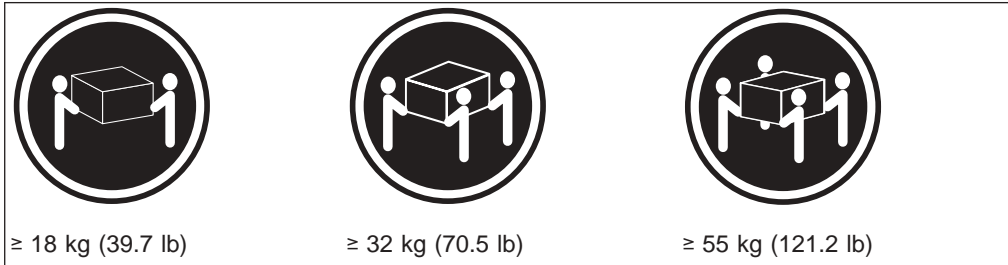

CAUTION:

Use safe practices when lifting.

Statement 5:



CAUTION:

The power control button on the device and the power switch on the power supply do not turn off the electrical current supplied to the device. The device also might have more than one power cord. To remove all electrical current from the device, ensure that all power cords are disconnected from the power source.

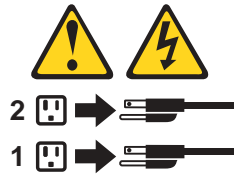

Statement 6:



CAUTION:

If you install a strain-relief bracket option over the end of the power cord that is connected to the device, you must connect the other end of the power cord to an easily accessible power source.

Statement 8:



CAUTION:

Never remove the cover on a power supply or any part that has the following label attached.



Hazardous voltage, current, and energy levels are present inside any component that has this label attached. There are no serviceable parts inside these components. If you suspect a problem with one of these parts, contact a service technician.

Statement 13:



DANGER

Overloading a branch circuit is potentially a fire hazard and a shock hazard under certain conditions. To avoid these hazards, ensure that your system electrical requirements do not exceed branch circuit protection requirements. Refer to the information that is provided with your device for electrical specifications.

Statement 14:



CAUTION:

Hazardous voltage, current, and energy levels might be present. Only a qualified service technician is authorized to remove the covers where the following label is attached.



Handling static-sensitive devices

Attention: Static electricity can damage electronic devices and your system. To avoid damage, keep static-sensitive devices in their static-protective packages until you are ready to install them.

To reduce the possibility of electrostatic discharge, observe the following precautions:

- Limit your movement. Movement can cause static electricity to build up around you.
- Handle the device carefully, holding it by its edges or its frame.
- Do not touch solder joints, pins, or exposed printed circuitry.
- Do not leave the device where others can handle and possibly damage the device.
- While the device is still in its static-protective package, touch it to an unpainted metal part of the system unit for at least 2 seconds. (This drains static electricity from the package and from your body.)
- Remove the device from its package and install it directly into your server without setting it down. If it is necessary to set the device down, place it in its static-protective package. Do not place the device on your server cover or on a metal table.
- Take additional care when handling devices during cold weather because heating reduces indoor humidity and increases static electricity.

Chapter 1. Introduction

Thank you for purchasing an IBM® *e*server xSeries™ 255 Type 8685 with IBM X-Architecture™ features. This *Installation Guide* provides the information needed to:

- Set up and cable your server
- Start and configure your server
- Install your network operating system (NOS)

Packaged with this *Installation Guide* are software CDs that help you configure hardware, install device drivers, and install the NOS.

Also included is an *xSeries Documentation* CD that provides detailed information about this server.

If you have access to the World Wide Web, you can obtain up-to-date information about your server model and other IBM server products at <http://www.ibm.com/eserver/xseries/> on the World Wide Web.

See the *Rack Installation Instructions* for complete rack installation and removal instructions.

Record your product information in this table.

Product name	_____
Machine type	_____
Model number	_____
Serial number	_____

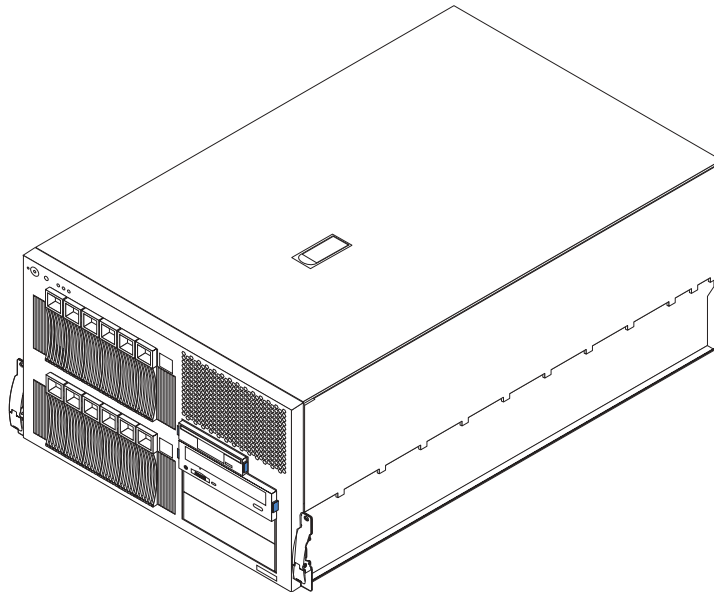

Specifications and features

The following table provides a summary of the features and specifications for your server.¹

Table 1. Features and specifications

<p>Microprocessor:</p> <ul style="list-style-type: none"> • Intel Xeon™ MP • 1 MB or 512 KB level-3 cache depending upon model • 400 MHz front-side bus (FSB) • Support for up to four microprocessors with Intel Hyper-Threading technology and Intel NetBurst™ microarchitecture <p>Memory:</p> <ul style="list-style-type: none"> • Maximum: 12 GB • Type: ECC, double-data rate (DDR), SDRAM, registered DIMMs • Slots: two-way or four-way interleaved, 12 slots • Hot Spare memory <p>Drives standard:</p> <ul style="list-style-type: none"> • Diskette: 1.44 MB • CD-ROM: IDE <p>Available expansion bays:</p> <ul style="list-style-type: none"> • Hot-swap: <ul style="list-style-type: none"> – Six slim-high in upper drive cage – Six slim-high in lower drive cage with optional SCSI backplane installed • Non-hot-swap: Two 5.25-inch <p>Expansion slots:</p> <ul style="list-style-type: none"> • Six hot-plug PCI-X 100 MHz/64-bit • One non-hot-plug PCI 33 MHz/32-bit <p>Hot-swap power supplies:</p> <p>370 W (115-230 V ac)</p> <ul style="list-style-type: none"> • Minimum: Two • Maximum: Four for redundancy <p>Redundant cooling:</p> <p>Nine hot-swap fans</p>	<p>Video:</p> <ul style="list-style-type: none"> • ATI RageXL video controller • Compatible with SVGA and VGA • 8 MB video memory <p>Size (tower model):</p> <ul style="list-style-type: none"> • Height: 356 mm (14.0 in.) • Depth: 700 mm (27.6 in.) • Width: 483 mm (19 in.) • Weight: 47 kg (104 lb) to 55 kg (121.2 lb) depending upon configuration <p>Size (7 U) (rack model):</p> <ul style="list-style-type: none"> • Height: 311 mm (12.3 in.) • Depth: 650 mm (25.6 in.) • Width: 440 mm (17.3 in.) • Weight: 47 kg (104 lb) to 55 kg (121.2 lb) depending upon configuration <p>Integrated functions:</p> <ul style="list-style-type: none"> • Dual-channel Ultra160 SCSI controller (one internal and one external channel) • Wake on LAN® support • One Broadcom 10/100/1000 Mbps Ethernet controller • One serial port • Four Universal Serial Bus ports • Keyboard port • Mouse port • Video port • Integrated system management processor (ISMP) with two ISMP (RS-485) RJ-45 connectors <p>Acoustical noise emissions:</p> <ul style="list-style-type: none"> • Sound power, idle: 6.3 bel maximum • Sound power, operating: 6.3 bel maximum • Bystander (1 m) Sound pressure, operating: 47 dBA maximum • Bystander (1 m) Sound pressure, idle: 47 dBA maximum 	<p>Environment:</p> <ul style="list-style-type: none"> • Air temperature: <ul style="list-style-type: none"> – Server on: 10° to 35°C (50° to 95°F). Altitude: 0 to 914 m (3000 ft). – Server on: 10° to 32°C (50° to 89.6°F). Altitude: 914 m (3000 ft) to 2133 m (7000 ft). – Server off: 10° to 43°C (50° to 110°F). Maximum altitude: 2133 m (7000 ft). • Humidity: <ul style="list-style-type: none"> – Server on: 8% to 80% – Server off: 8% to 80% <p>Heat output:</p> <p>Approximate heat output in British thermal units (Btu) per hour</p> <ul style="list-style-type: none"> • Minimum configuration: 461 Btu (0.14 kilowatts) • Maximum configuration: 3412 Btu (1.0 kilowatts) <p>Electrical input:</p> <ul style="list-style-type: none"> • Sine-wave input (50-60 Hz) required • Input voltage low range: <ul style="list-style-type: none"> – Minimum: 100 V ac – Maximum: 127 V ac • Input voltage high range: <ul style="list-style-type: none"> – Minimum: 200 V ac – Maximum: 240 V ac • Input kilovolt-amperes (kVA) approximately: <ul style="list-style-type: none"> – Minimum: 0.08 kVA – Maximum: 1.07 kVA
--	--	--

Notices and statements used in this book

The caution and danger statements used in this book also appear in the multilingual *Safety Information* book provided on the *IBM xSeries Documentation* CD. Each caution and danger statement is numbered for easy reference to the corresponding statements in the safety book.

The following types of notices and statements are used in this book:

- **Note:** These notices provide important tips, guidance, or advice.

1. Racks are marked in vertical increments of 1.75 inches each. Each increment is referred to as a unit, or "U." A 1-U-high device is 1.75 inches tall.

- **Important:** These notices provide information or advice that might help you avoid inconvenient or problem situations.
- **Attention:** These notices indicate possible damage to programs, devices, or data. An attention notice is placed just before the instruction or situation in which damage could occur.
- **Caution:** These statements indicate situations that can be potentially hazardous to you. A caution statement is placed just before the description of a potentially hazardous procedure step or situation.
- **Danger:** These statements indicate situations that can be potentially lethal or extremely hazardous to you. A danger statement is placed just before the description of a potentially lethal or extremely hazardous procedure step or situation.

Major components view of the xSeries 255 Type 8685 server

The orange color on components and labels in your server identifies hot-swap or hot-plug components. You can install or remove these components while the system is running, provided that your system is configured to support this function.

The blue color on components and labels indicates touch points where a component can be gripped, a latch moved, and so on.

The following illustration shows the major components of your server.

Note: The illustrations in this document might differ slightly from your hardware.

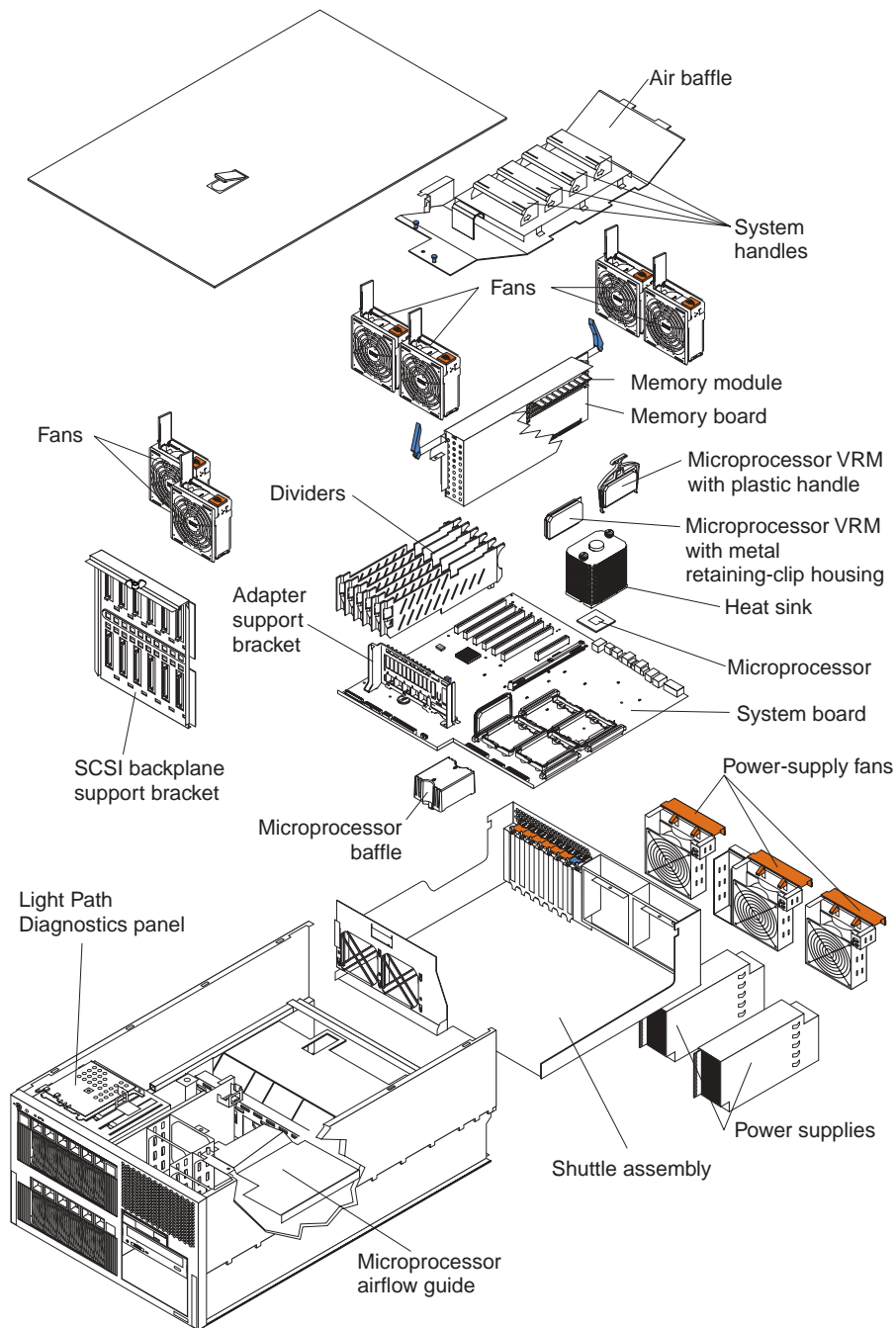

Chapter 2. Installing options

This chapter provides the basic information needed to install options in your server. This section is for all users but is written with the experienced user in mind. If you need more detailed installation information, see the *Option Installation Guide* on the *xSeries Documentation CD*.

Working inside a server with the power on

Your server supports hot-plug, hot-add, and hot-swap devices and is designed to operate safely while turned on with the cover removed. Follow these guidelines when you work inside a server that is turned on:

- Avoid loose-fitting clothing on your forearms. Button long-sleeved shirts before working inside the server; do not wear cuff links while you are working inside the server.
- Do not allow your necktie or scarf to hang inside the server.
- Remove jewelry, such as bracelets, necklaces, rings, and loose-fitting wrist watches.
- Remove items from your shirt pocket (such as pens or pencils) that could fall into the server as you lean over it.
- Avoid dropping any metallic objects, such as paper clips, hair pins, or screws, into the server.

Installing adapters

This section describes how to install hot-plug and non-hot-plug peripheral component interconnect (PCI) and PCI-X adapters. Before you install adapters, review the following:

- Slot 1 supports a non-hot-plug, 32-bit, 33 MHz, optional PCI adapter, such as the IBM Remote Supervisor Adapter. If you install the optional Remote Supervisor Adapter in this server, you must install the adapter in PCI slot 1. However, you can install other compatible adapters in this slot.

If you install the optional IBM Remote Supervisor Adapter in the server, use the ribbon cable that comes with the adapter to connect the adapter to the system-management connector (J16) on the system board. The external power adapter that comes with the IBM Remote Supervisor Adapter is not required with this server.

- Slots 2 through 7 support hot-plug, 64-bit, 100 MHz, PCI or PCI-X, 3.3 V adapters.
- If you install an adapter with a speed of less than 100 MHz, the speed of that PCI bus will be reduced to the speed of the slowest device on that bus.

To maintain an optimum speed for the Ethernet controller on PCI bus B (PCI-X slots 2 and 3), install the following types of adapters in PCI-X slots 4 through 7:

- Redundant array of independent disks (RAID) adapters
 - 33 MHz or 66 MHz speed adapters
 - PCI adapters
- Locate the documentation that comes with the adapter and follow those instructions in addition to the instructions in this chapter. If you need to change the switch or jumper settings on your adapter, follow the instructions that come with the adapter.

This section contains the procedure for installing a hot-plug or non-hot-plug PCI or PCI-X adapter. If your operating system supports hot-plug PCI or PCI-X adapters, you can replace a failing hot-plug PCI or PCI-X adapter with a new hot-plug PCI or PCI-X adapter of the same type without turning off power to the server. If your operating system and adapter also support the hot-add feature in slots 4 through 7, you can install a new adapter without turning off the power to the server.

Note: You do not have to turn off the server to install hot-plug adapters in the hot-plug slots. However, you must turn off the server when performing any steps that involve installing or removing cables.

Important: Do not remove a hot-plug PCI or PCI-X adapter before performing the operating-system-defined procedure for disabling the Active™ PCI-X (hot-plug) slot that contains the adapter. Failure to do so might cause your system to lock up. See your operating-system documentation.

For more detailed instructions, information, and additional system-board illustrations, see the *Option Installation Guide* on the *xSeries Documentation CD*.

The following illustration shows the location of the adapter slots for the xSeries 255 Type 8685 server.

Note: A cable is attached to the hot-plug PCI-X switch card at system-board connector J20 so that the hot-plug function will work properly for PCI-X slots 2 through 7. Do not disconnect this cable.

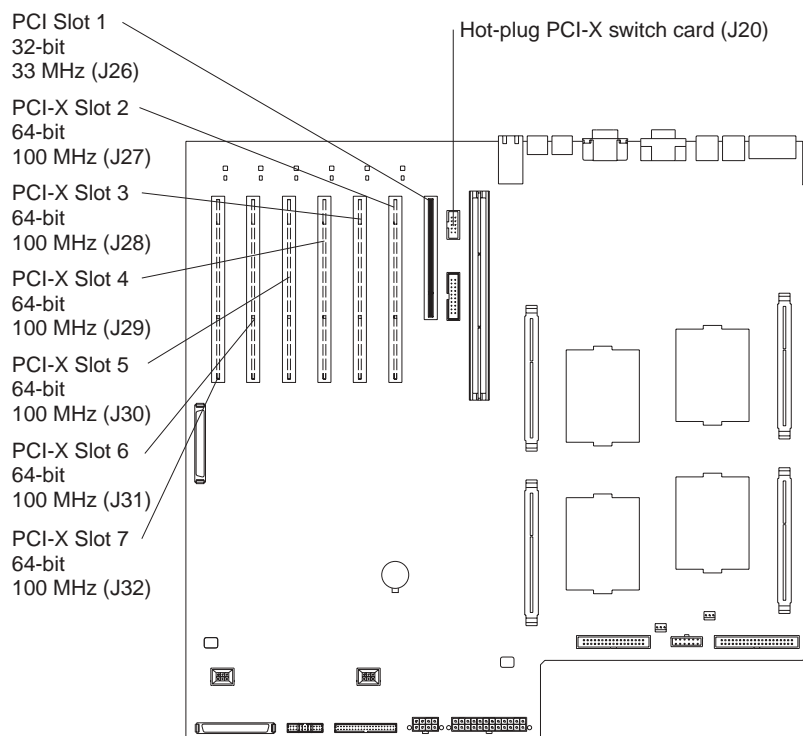

The following illustration shows how to install an adapter.

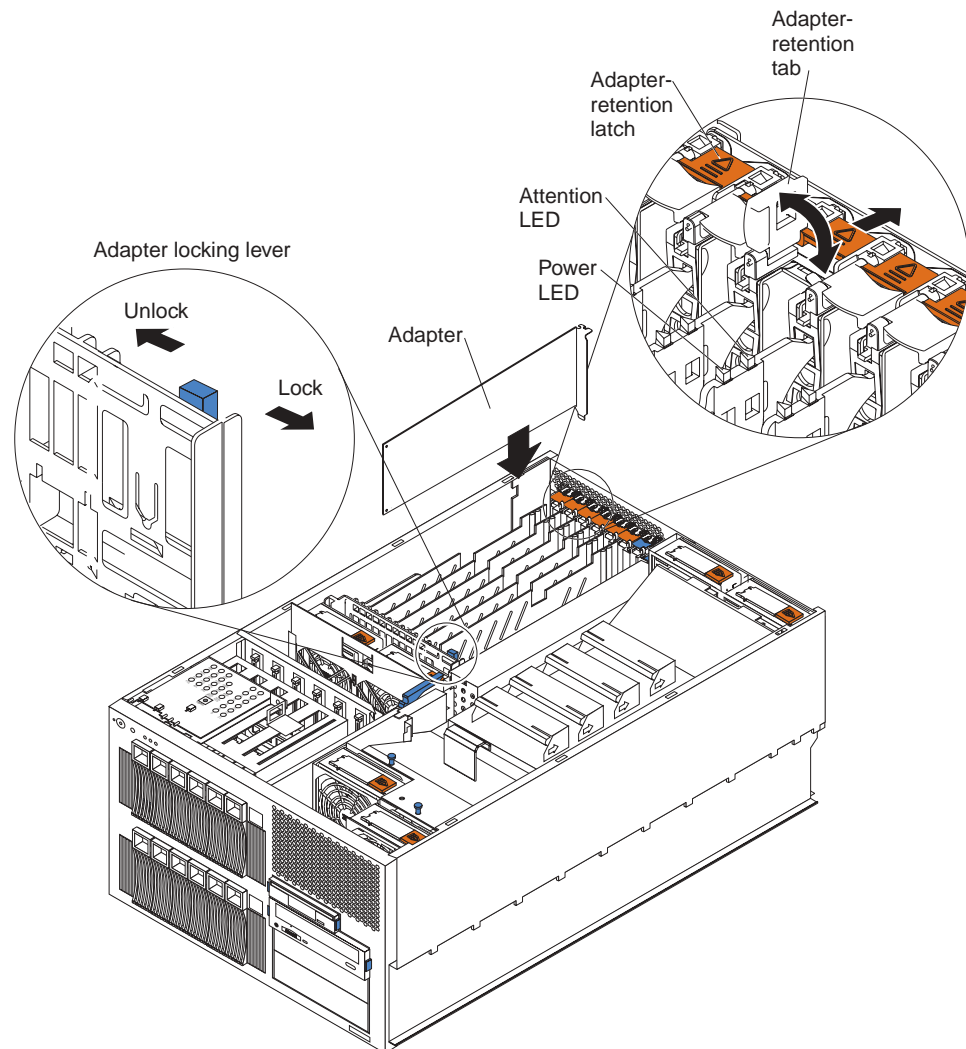

Complete the following steps to install an adapter.

1. Review the information beginning with “Safety” on page v through “Handling static-sensitive devices” on page x.
2. If you are installing a non-hot-plug adapter, turn off the server and disconnect all power cords and external cables.
3. Remove the top cover.
4. Select the slot in which you want to install the adapter.

Note: PCI-X slots 2 through 7 support hot-plug PCI and PCI-X adapters. If you are using the hot-add feature, be sure to install the adapters in PCI-X slots 4 through 7 to maintain an optimum speed for the Ethernet controller on PCI bus B (PCI-X slots 2 and 3).

5. If you are installing a hot-plug adapter or using the hot-add feature, disable the selected PCI-X slot from your operating system. (See the documentation that comes with your operating system for information about disabling a hot-plug PCI-X slot.) Disabling the PCI-X slot turns off the power-on LED for that PCI-X slot.

Attention: Make sure that the power-on LED for the hot-plug PCI slot is off before you continue with the next step.

6. Press the adapter-retention latch as indicated by the arrow to move the latch to the unlocked (open) position.
7. Lift the adapter-retention tab on the top of the expansion-slot cover; then, remove the expansion-slot cover.
8. If you are installing a full-length adapter, move the adapter locking lever to the unlocked (open) position on the adapter-support bracket as indicated by the arrow. Otherwise, continue with the next step.
9. If you need to set any jumpers or switches on the adapter, do so now.
10. Install the adapter in the slot; then, lower the adapter-retention tab over the top corner of the adapter. When the adapter-retention tab is completely closed, the adapter-retention latch snaps (locks) into place.
11. If you installed a full-length adapter, move the adapter locking lever to the locked position on the adapter-support bracket.
12. Connect any needed cables to the adapter.
13. If you installed a hot-plug adapter or used the hot-add feature, enable the PCI-X slot from your operating system. (See the documentation that comes with your operating system for information about enabling a hot-plug PCI-X slot.) Make sure that the power-on LED for the hot-plug PCI-X slot comes on. If the power-on LED does not come on, see the *Hardware Maintenance Manual and Troubleshooting Guide* for additional information.
14. If you have other options to install or remove, do so now; otherwise, reinstall the top cover. If you installed a non-hot-plug adapter, connect all cables and power cords.

Cabling a RAID or SCSI adapter to the standard SCSI backplane

Complete the following steps to cable a single small computer system interface (SCSI) channel on a RAID or SCSI adapter using the standard hot-swap drive SCSI backplane.

Note: Some server configurations require using two channels. For more detailed instructions and information, see the *Option Installation Guide* on the *xSeries Documentation CD*.

1. Review the information beginning with “Safety” on page v through “Handling static-sensitive devices” on page x.
2. Turn off the server and peripheral devices and disconnect all power cords and external cables.
3. If your server is a tower model, continue with the next step.
If your server is a rack model and you have already installed the server in a rack enclosure, you must disconnect the cable-management arm bracket from the server. See the *Rack Installation Instructions* on the *xSeries Documentation CD* for details.
4. Remove the top cover.
5. Remove the air baffle.

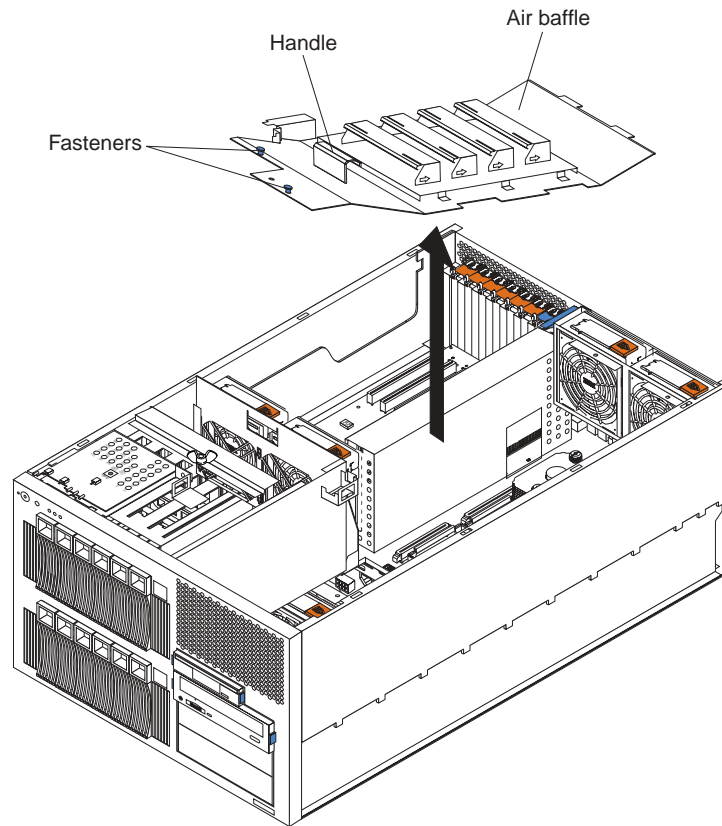

6. Open the microprocessor airflow guide located between the front fans and the microprocessors.

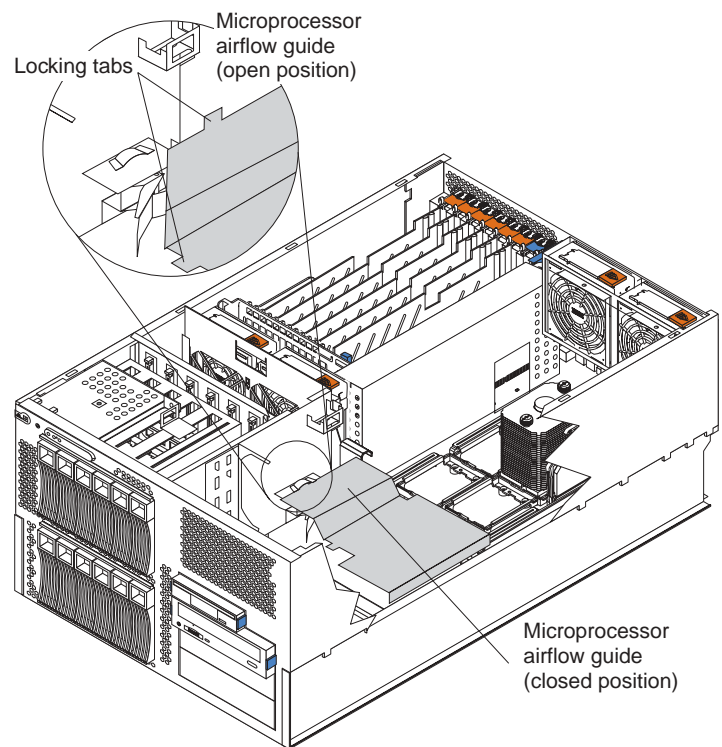

- Unlock the metal-hinge latch that secures the shuttle assembly in place. Then, slide the shuttle assembly toward the rear of the server, approximately 10 cm (4 in.).

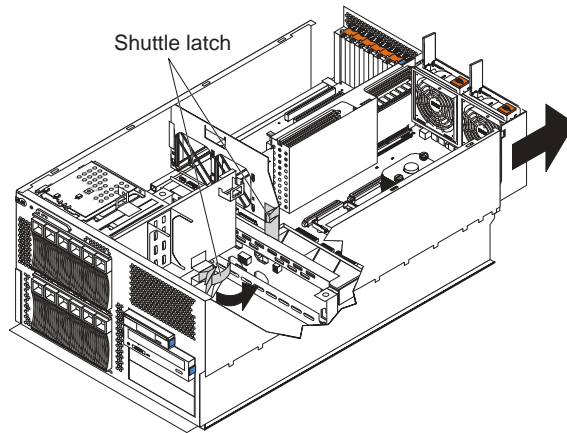

- Disconnect the internal integrated drive electronics (IDE) signal cable from the IDE system-board connector. Disconnect the diskette-drive signal cable and front-fan signal cable from the corresponding system-board connectors. See the *Option Installation Guide* on the *xSeries Documentation CD* for cable locations.
- If the server is a tower model, lift the shuttle assembly from the server.
- If you have not yet installed a RAID or SCSI adapter, install it now. Otherwise, continue with the next step. See the preceding adapter-installation procedure in this chapter and your RAID or SCSI adapter option documentation for additional information about installing a RAID or SCSI adapter in your server and connecting the SCSI cables to a RAID or SCSI adapter.
- Disconnect the SCSI signal cable from the internal SCSI connector (J15) on the system board.

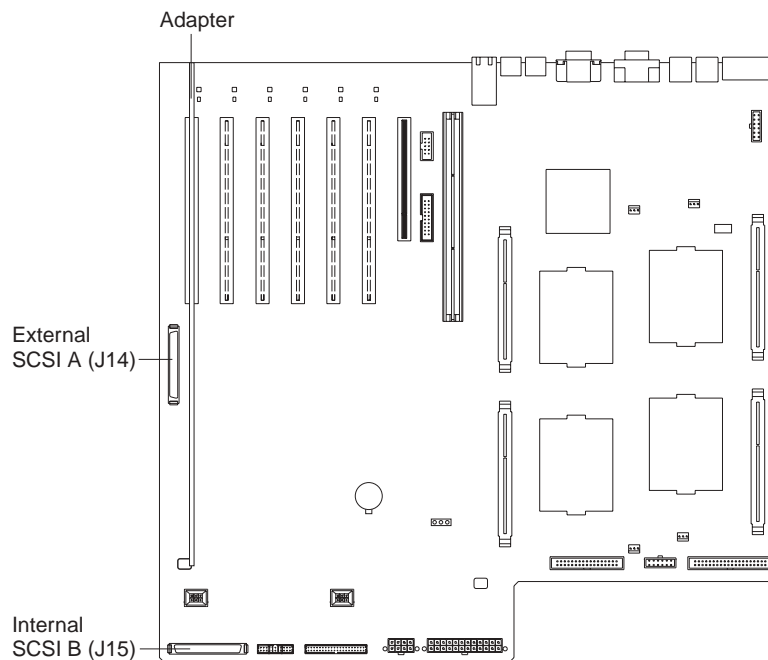

Attention: When you route the SCSI cable, observe the following precaution:

Do not block the ventilated space in front of the fan assembly.

12. If your server is a tower model, reinstall the shuttle assembly in the server.
13. Slide the shuttle assembly back into place and secure it by locking the metal-hinge latch.
14. Route the SCSI cable from the standard SCSI backplane through the opening in the adapter-support bracket to the internal channel connector on the RAID or SCSI adapter.

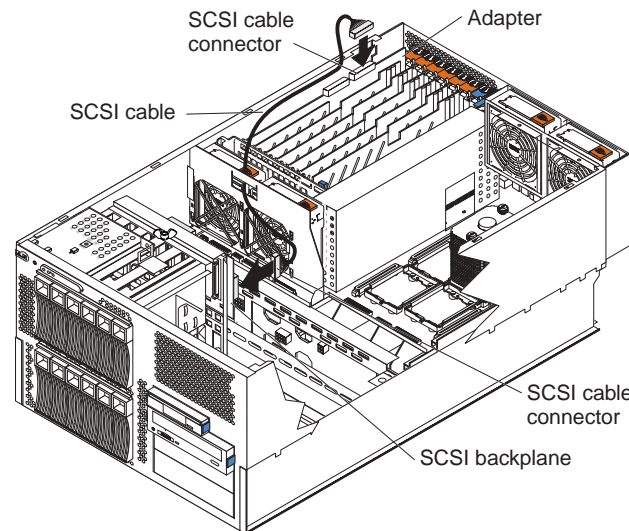

15. Reconnect the internal IDE signal cable to the IDE system-board connector. Reconnect the diskette-drive signal cable and front-fan signal cable to the corresponding system-board connectors. See the *Option Installation Guide* on the *xSeries Documentation CD* for cable locations.
16. Close the microprocessor airflow guide located between the front fans and the microprocessors. Insert the tabs into the corresponding slots.
17. Reinstall the air baffle and lock the blue fasteners.
18. If you have other options to install or remove, do so now; otherwise, reinstall the top cover.
19. If your server is a tower model, continue with the next step.
If your server is a rack model and you have already installed the server in a rack enclosure, you must reconnect the cable-management arm bracket to the server. See the *Rack Installation Instructions* on the *xSeries Documentation CD* for details.
20. Reconnect all cables and power cords.

Installing memory modules

Adding memory to your server is an easy way to make programs run faster. You can increase the amount of memory in your server by installing memory-module options. When you install memory, you must install a set of two or four matched dual inline memory modules (DIMMs).

Before you install memory, review the following:

- The DIMM options available for your server are 256 MB, 512 MB, and 1 GB. Your server supports a minimum of 512 MB and a maximum of 12 GB of system memory.
- The amount of usable memory will be reduced depending on the system configuration. A certain amount of memory must be reserved below the amount of installed memory for system resources. The BIOS will display the amount of installed memory.
- Your server comes with a minimum of two 256 MB DIMMs (for a total of 512 MB memory) installed in the DIMM 2 and DIMM 8 memory connectors (D2 and D8, respectively). You must have DIMMs installed in these connectors at all times.
- When you install additional DIMMs, be sure to install them in pairs or quads and follow the DIMM installation sequence in the illustration in this section. A pair or quad is also known as a memory bank. See Table 2 on page 13 for the DIMM connectors in each pair or quad.
- All the DIMMs in a single pair or quad must be the same size, speed, and type.
- Multiple pairs or quads of DIMMs do not have to contain DIMMs of the same size, speed, and type, unless the Hot Spare Memory feature is enabled.
- The memory board contains 12 DIMM connectors and supports two-way and four-way memory interleaving.

To use the four-way memory interleaving technology in your server, you must install DIMMs in all four connectors in each populated set.

- Install only 2.5 V, 184-pin, 72-bit, 100 MHz, double-data-rate (DDR), PC1600, registered synchronous dynamic random-access memory (SDRAM) dual inline memory modules (DIMMs) with error correcting code (ECC). Only 100 MHz, 72-bit, registered, synchronous memory is supported for the 256 MB, 512 MB, and 1 GB DIMMs. These DIMMs must be compatible with the latest PC1600 SDRAM Registered DIMM specification. For a list of supported options for your server, go to <http://www.ibm.com/us/compat/> on the World Wide Web.
- Installing or removing DIMMs changes the configuration information in the server. The Configuration/Setup Utility program automatically saves the new configuration information. When you restart the server, the system displays a message indicating that the memory configuration has changed. See the *User's Guide* on the *IBM xSeries Documentation* CD for more information about the Configuration/Setup Utility program.
- Your server supports the Hot Spare Memory feature in the event of an active memory pair or quad of DIMM failure. This feature, when enabled, disables the failed memory from the system configuration and activates a Hot Spare Memory pair or quad of DIMMs to replace the failed pair or quad of DIMMs. Before you can enable this feature, you must also install at least one additional pair or quad of DIMMs as described in this book. To ensure proper server operation and to avoid disabling the Hot Spare Memory feature, all additional pairs or quads of DIMMs must be the same size, speed, and type as the failed pair or quad of DIMMs.

You can enable the Hot Spare Memory feature through the Configuration/Setup Utility program. After you enable the Hot Spare Memory feature, the

Configuration/Setup Utility program assigns the Hot Spare Memory bank according to your server configuration. If your server has a two-way interleaved configuration, the Hot Spare Memory bank becomes the DIMMs in connectors D2 and D8. If your server has a four-way interleaved configuration, the Hot Spare Memory bank becomes the DIMMs in connectors D1, D2, D7, and D8. See the *User's Guide* on the *IBM xSeries Documentation* CD for further details about enabling the Hot Spare Memory feature.

When you install DIMMs, install them in the order listed in Table 2.

Table 2. DIMM installation order

Interleaving	Number of DIMMs	Install DIMMs in these connectors
Two-way	2	D2, D8 (standard)
Two-way	4	D2, D8 (standard) (Hot Spare memory bank for two-way interleaving) D4, D10
Two-way	6	D2, D8 (standard) (Hot Spare memory bank for two-way interleaving) D4, D10 D6, D12
Four-way	4	D2, D8, D1, D7
Four-way	8	D2, D8, D1, D7 (Hot Spare memory bank for four-way interleaving) D4, D10, D3, D9
Four-way	12	D2, D8, D1, D7 (Hot Spare memory bank for four-way interleaving) D4, D10, D3, D9 D6, D12, D5, D11

Complete the following steps to install a DIMM.

1. Review the information beginning with "Safety" on page v through "Handling static-sensitive devices" on page x.
2. Turn off the server and disconnect all power cords and external cables.
3. Remove the top cover.
4. Remove the air baffle.
5. Remove the memory-board assembly from the server and open the airflow guide.

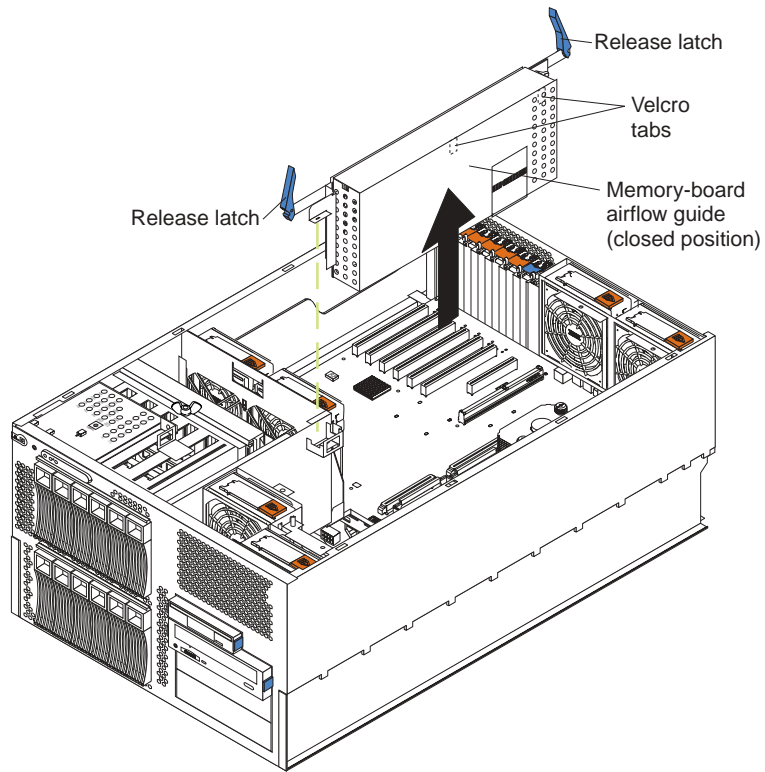

6. Select the connectors in which you want to install the DIMMs.
7. Install the DIMMs in the connectors.

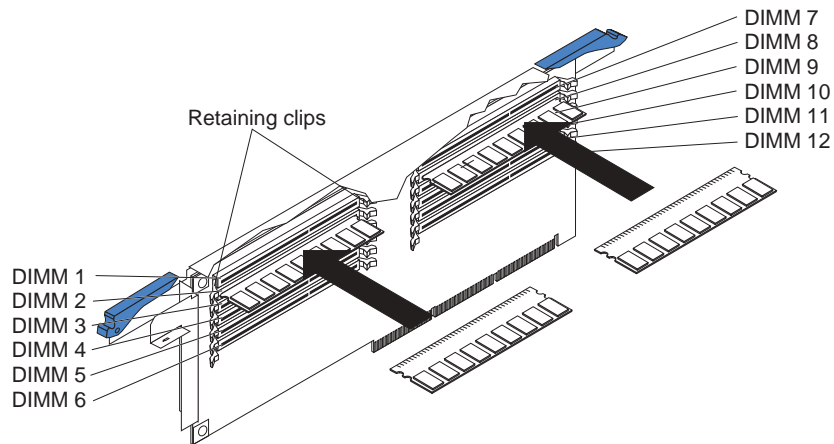

8. Reinstall the memory-board assembly in the server.
9. Reinstall the air baffle.
10. If you have other options to install or remove, do so now; otherwise, reinstall the top cover and connect all cables and power cords.

Installing a drive in a hot-swap bay

Your server supports up to a maximum of 12 26-mm (1-inch) slim-high, 3.5-inch, hot-swap hard disk drives in the hot-swap bays. The standard hot-swap bays are bays 1 through 6 (from left to right). The optional hot-swap bays are bays 7 through 12 (from left to right). Bays 1 through 6 are located in the standard (upper) hard disk drive cage, above bays 7 through 12 in the optional (lower) hard disk drive cage.

The SCSI IDs for the hot-swap drives are printed on the bezel, immediately adjacent to the hot-swap drive bays. The IDs are:

- 0 through 5 for bays 1 through 6
- 10 through 15 for bays 7 through 12

Notes:

1. The server does not support half-high hot-swap drives.
2. If you plan to install hot-swap drives in bays 7 through 12, you must first install an optional SCSI backplane. See the *Option Installation Guide* on the *IBM xSeries Documentation CD* for details.
3. If you plan to install 5.25-inch removable-media drives in your server, see the *Option Installation Guide* on the *IBM xSeries Documentation CD* for details.

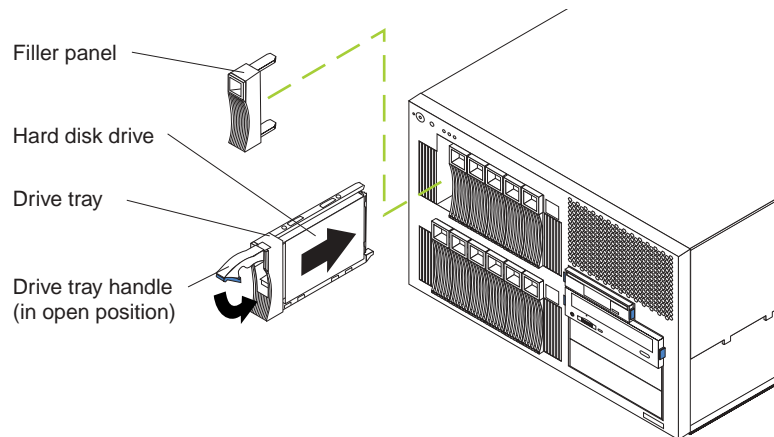

Complete the following steps to install a drive in a hot-swap bay.

Attention: To maintain proper system cooling, do not operate the server for more than 10 minutes without either a drive or filler panel installed in each bay.

1. Review the information beginning with “Safety” on page v through “Handling static-sensitive devices” on page x.
2. If you are installing drives in a tower model, remove the bezel (see the *Option Installation Guide* on the *IBM xSeries Documentation CD* for details).

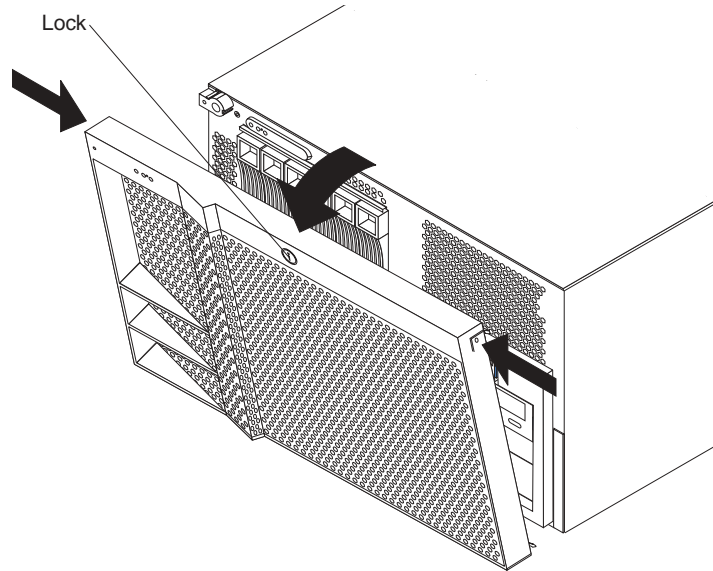

3. Remove the filler panel.
4. Place the drive handle in the open position and slide the drive into the bay.
5. Close the drive handle.
6. If you have other options to install or remove, do so now; otherwise, continue with the next step.
7. If you installed drives in a tower model, reinstall the bezel (see the *Option Installation Guide* on the *IBM xSeries Documentation CD* for details).

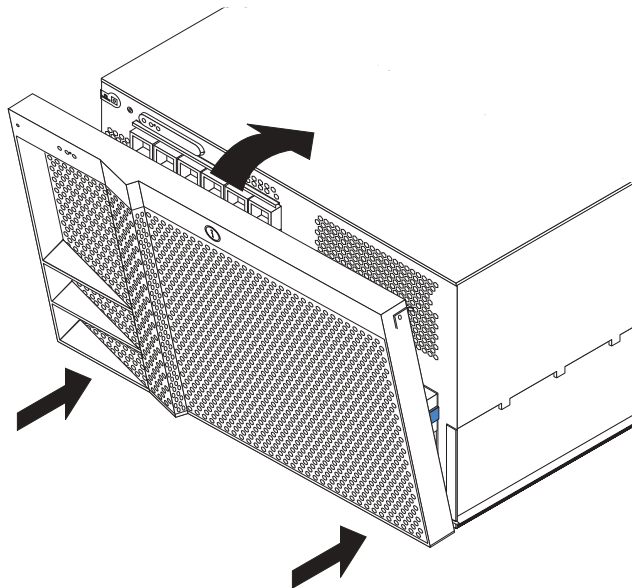

Installing an additional microprocessor

Your server comes with one microprocessor installed in microprocessor socket 1 (labeled CPU1) on the system board. The microprocessor in socket 1 is the startup (boot) microprocessor. If more than one microprocessor is installed, the microprocessor installed in the highest-numbered socket is the microprocessor from which the server will start. Therefore, the microprocessors installed in the lowest-numbered sockets are used as application microprocessors.

Attention: To avoid damage and ensure proper server operation when you install an additional microprocessor, use microprocessors that have the same cache size and type, and the same clock speed. Microprocessor internal and external clock frequencies must be identical.

Before you install microprocessors, review the following:

- To order additional microprocessor options, contact your IBM reseller or IBM marketing representative.
- When you install an additional microprocessor, you must also install the voltage regulator module (VRM) that comes with the microprocessor in the corresponding VRM connector.

A VRM metal retaining-clip housing comes installed in the empty microprocessor VRM connectors for microprocessors 3 and 4. When you install a VRM in connector 3 or 4, you must first remove the VRM metal retaining-clip housing from the appropriate VRM connector. You must also remove the metal retaining clip from the VRM metal retaining-clip housing when installing a VRM.

- The microprocessor speed is automatically set for your server; therefore, you do not have to set any microprocessor-speed jumpers or switches. For a list of supported microprocessor speeds, go to <http://www.ibm.com/eserver/> on the World Wide Web.
- The microprocessor sockets in this server contain built-in termination for the microprocessor bus; therefore, terminator cards are not required for empty microprocessor sockets. However, each empty microprocessor socket contains a protective, flat plastic cover that you must remove before you install a microprocessor in these sockets.
- To ensure proper server operation, microprocessor socket 4 contains a plastic microprocessor baffle that resembles a heat sink. You must remove the microprocessor baffle when you install a microprocessor in socket 4. Otherwise, the microprocessor baffle must remain in place to ensure proper airflow in your server.

When you install additional microprocessors and VRMs, install them in the order listed in Table 3. The corresponding VRM connector is located adjacent to the microprocessor socket.

Important: If you do not install the microprocessors in the correct order, the server will not operate properly.

Table 3. Microprocessor and VRM installation order

Microprocessor number	Microprocessor socket label	VRM connector
1 (standard)	CPU1	J34 (standard, plastic retaining clip provided on VRM housing)

Table 3. Microprocessor and VRM installation order (continued)

Microprocessor number	Microprocessor socket label	VRM connector
2	CPU2	J35 (plastic retaining clip provided on VRM housing)
3	CPU3	J36 (standard, metal retaining clip provided on VRM housing)
4	CPU4	J37 (standard, metal retaining clip provided on VRM housing)

The following illustration is a layout of the microprocessor socket locations and other microprocessor-related components on the system board.

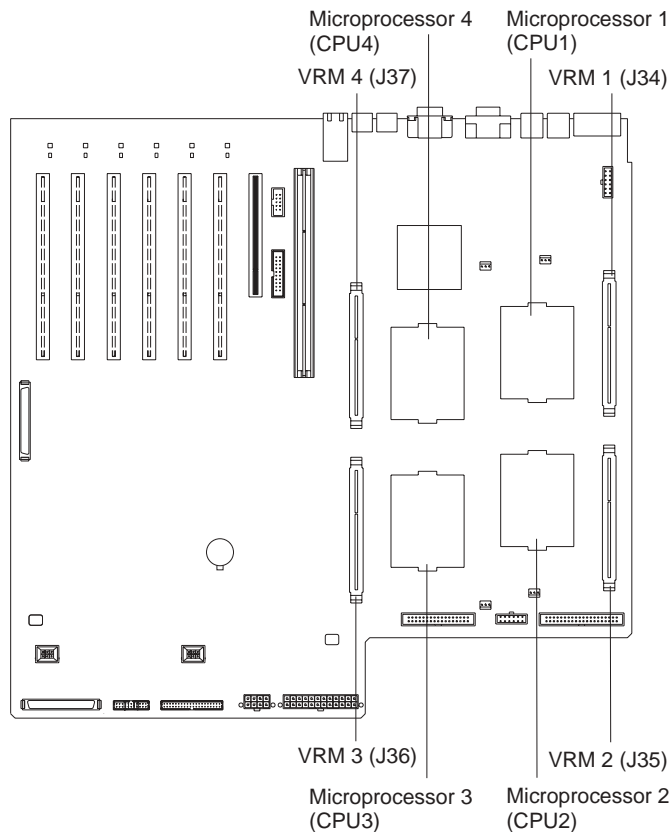

Complete the following steps to install an additional microprocessor.

1. Review the information beginning with "Safety" on page v through "Handling static-sensitive devices" on page x.
2. Turn off the server and disconnect all power cords and external cables.
3. Remove the top cover.
4. Remove the air baffle.
5. Select the socket in which you want to install the microprocessor.
6. Install a VRM in the corresponding VRM connector (see the preceding illustration for locations).

- If you are installing a VRM in connector 1 or 2, attach the plastic handle that comes with the option.

Note: Do not attach the plastic handle to the VRM for microprocessor 3 or 4.

- If you are installing a VRM in connector 3 or 4, do the following:
 - a. Remove the memory-board assembly from the server.
 - b. Remove the metal clip from the VRM housing (baffle).
 - c. Remove the VRM housing from the VRM connector.
 - d. Attach metal clip to the new VRM.
7. Remove the flat, plastic cover from the empty microprocessor socket.
If you are installing a microprocessor in socket 4, remove the plastic microprocessor baffle from socket 4. Store the plastic microprocessor baffle in a safe place. If you remove the microprocessor from socket 4, you must reinstall the microprocessor baffle in that socket.
8. Install the microprocessor.

Notes:

- a. This illustration shows how to install a microprocessor in socket 2. If you are installing a microprocessor in socket 3 or 4, see the *Option Installation Guide* on the *xSeries Documentation CD* for details and an illustration.
- b. The locations of the microprocessor-release lever and microprocessor orientation indicator might vary depending on the location of the microprocessor socket.

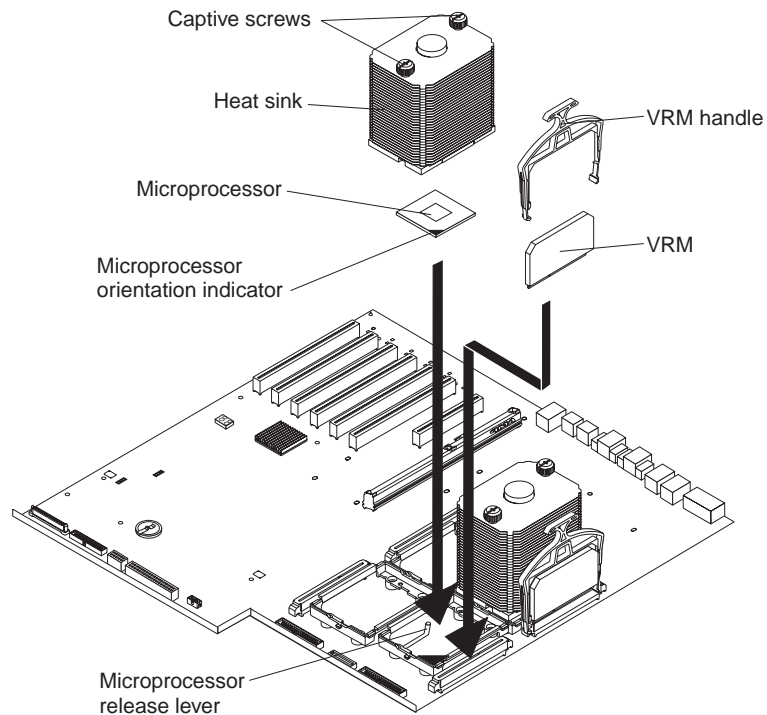

9. Remove the protective cover from the bottom of the heat sink; then, install a heat sink on the microprocessor.
10. If you installed a VRM for microprocessor 3 or 4, reinstall the memory-board assembly.
11. Reinstall the air baffle.

12. If you have other options to install or remove, do so now; otherwise, reinstall the top cover and connect all cables and power cords.

Installing a hot-swap power supply

Your server comes with two hot-swap power supplies. You can install two additional power supplies. Your server supports N+N line cords for power redundancy. For example, to ensure power redundancy for a full configuration, four power supplies must be installed in the server, and power cords must be connected to both power-cord connectors.

Note: To show the location of the power-supply bays, the three rear hot-swap fans are not included in this illustration.

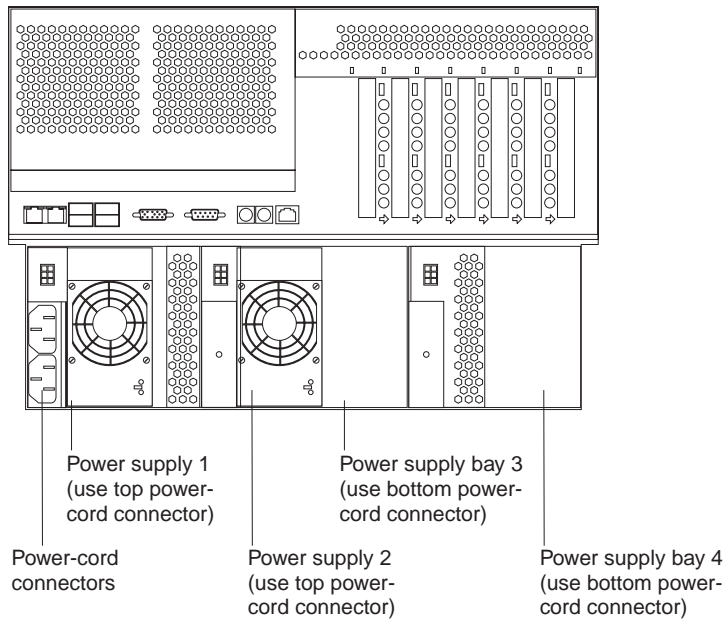

Before you install power-supplies, review the following precautions.

Note: During normal operation, each power-supply bay must have a fan installed for proper cooling.

Statement 8:



CAUTION:

Never remove the cover on a power supply or any part that has the following label attached.



Hazardous voltage, current, and energy levels are present inside any component that has this label attached. There are no serviceable parts inside these components. If you suspect a problem with one of these parts, contact a service technician.

Statement 6:



CAUTION:

If you install a strain-relief bracket option over the end of the power cord that is connected to the device, you must connect the other end of the power cord to an easily accessible power source.

Complete the following steps to install an additional power supply:

1. Review the information beginning with “Safety” on page v through “Handling static-sensitive devices” on page x.
2. Select the power-supply bay in which you want to install the power supply.
3. Press the release latch and remove the fan assembly from the power-supply bay.
4. Move the handle on the power supply to the open position.
5. Slide the power supply into the chassis, and close the handle.

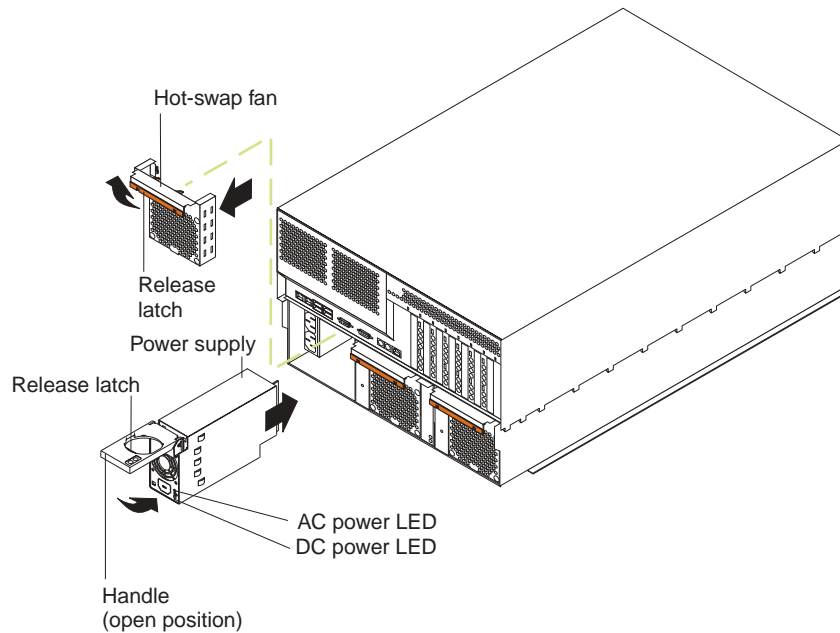

6. Depending on the number of power supplies installed in your server, plug one or two power cords into the corresponding connectors on the back of the server; then, plug the other end of the power cords into properly grounded electrical outlets. Power supplies 1 and 2 (PS1 and PS2, respectively) are connected to the top power-cord connector. Power supplies 3 and 4 (PS3 and PS4, respectively) are connected to the bottom power-cord connector.
7. If the server is not on, turn on the server.
8. Verify that the dc power LED and the ac power LED on the power supply are lit, indicating that the power supply is operating properly.
9. Reinstall the fan assembly in the power-supply bay.

Cabling the server

Notes:

1. You must turn off the server before connecting any cables to or disconnecting any cables from the server.
2. See the documentation that comes with your options for additional cabling instructions. It might be easier for you to route cables before you install certain options.
3. Cable identifiers are printed on the cables that come with your server and options. Use these identifiers to connect the cables to the correct connectors. For example, the hard disk drive cables are labeled "HDD option."

The following illustration shows the external cable connectors on the server. If you are installing a server in a rack, see the *Rack Installation Instructions* documentation for cabling instructions for your server.

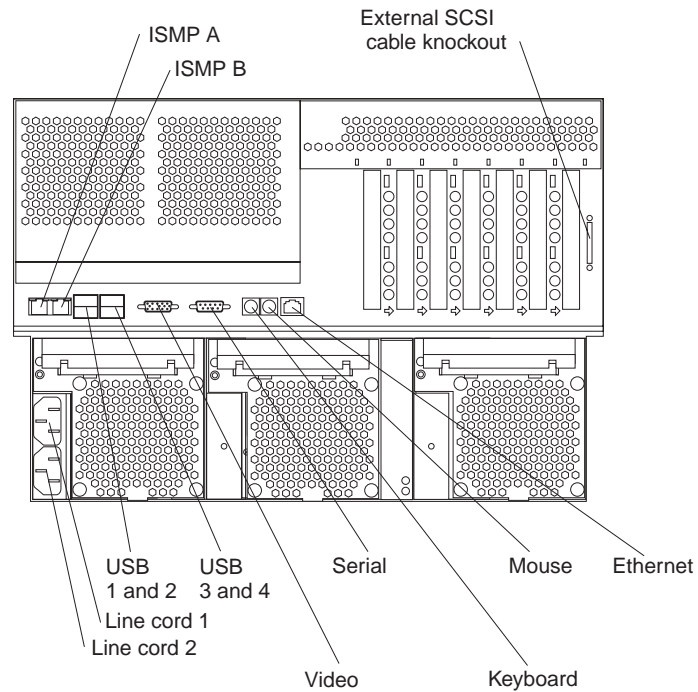

Chapter 3. Server controls, indicators, and power

This chapter identifies the controls and indicators on the front and rear of your server. It also describes the power features of your server.

Server controls and indicators

This section identifies the controls and indicators on the front and rear of your server.

Front view

Tower and rack models

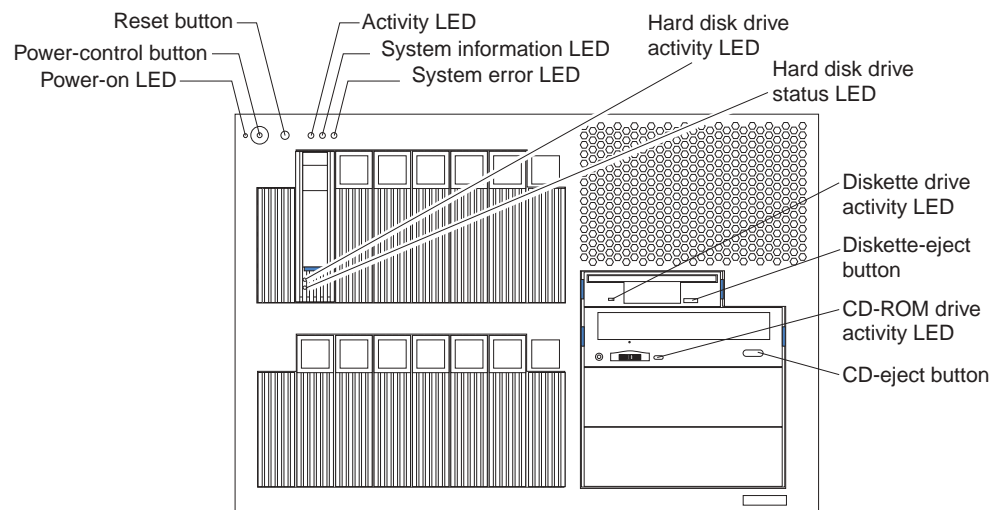

Notes:

1. The illustrations in this document might differ slightly from your hardware.
2. An amber LED illuminates when a system error or event has occurred. To identify the error or event, check the LEDs on the Light Path Diagnostics panel located on the server, or review the Error Log in the Configuration/Setup Utility program. For complete details about the Light Path Diagnostics panel, see the *Hardware Maintenance Manual and Troubleshooting Guide* on the *xSeries Documentation CD*. For more information about the Configuration/Setup Utility program, see the *User's Guide* on the *xSeries Documentation CD*.

Power-on (system power) LED: When this green LED is on, system power is present in the server. When this LED flashes, the server is in Standby mode (the system power supply is turned off and ac current is present). When this LED is off, a power supply, ac power, or an LED has failed.

Power-control button: Press this button to manually turn the server on or off or to place the server in Standby mode (see "Standby mode" on page 30).

Power-control button shield: You can install this circular disk over the power-control button to prevent accidental manual power-off. This disk is provided with your server.

Reset button: Press this button to reset the server and run the power-on self-test (POST).

ACT (activity) LED: This green LED is on when there is activity on the server.

INFO (system information) LED: When this amber LED is on, the server power supplies are nonredundant, or some other noncritical event has occurred. The event is recorded in the Error log. Check the Light Path Diagnostics panel for more detailed information.

FAULT (system-error) LED: This amber LED is on when a system error occurs. An LED on the Light Path Diagnostics panel will also be on to further isolate the error.

Hard disk drive activity LED: Each hot-swap drive has a hard disk drive activity LED. When this green LED is flashing, the drive is being accessed.

Hard disk drive status LED: Each hot-swap drive has a hard disk drive status LED. When this amber LED is on continuously, the drive has failed. If an optional SCSI or RAID adapter is installed in the server, when the LED flashes slowly (one flash per second), the drive is being rebuilt. When the LED flashes rapidly (three flashes per second), the controller is identifying the drive.

Diskette drive activity LED: When this LED is on, it indicates that the diskette drive is in use.

Diskette-eject button: Press this button to release a diskette from the drive.

CD-ROM drive activity LED: When this LED is on, it indicates that the CD-ROM drive is in use.

CD-eject button: Press this button to release a CD from the drive.

Rear view

Notes:

1. The illustrations in this document might differ slightly from your hardware.
2. An amber LED illuminates when a system error or event has occurred. To identify the error or event, check the LEDs on the Light Path Diagnostics panel located on the server, or review the Error Log in the Configuration/Setup Utility program. For complete details about the Light Path Diagnostics panel, see the *Hardware Maintenance Manual and Troubleshooting Guide* on the *xSeries Documentation CD*. For more information about the Configuration/Setup Utility program, see the *User's Guide* on the *xSeries Documentation CD*.

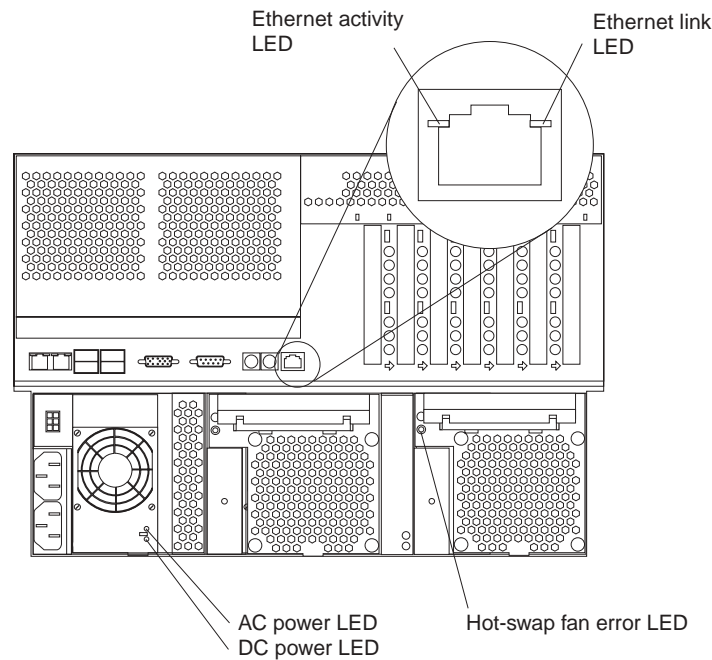

Ethernet activity LED: When this green LED is on, there is activity between the server and the network. The Ethernet activity LED is located on the Ethernet (RJ-45) connector on the rear of the server.

Ethernet link LED: When this green LED is on, there is an active connection on the Ethernet port. The Ethernet link LED is located on the Ethernet (RJ-45) connector on the rear of the server.

Hot-swap fan error LEDs: These LEDs provide status information about fans 7, 8, and 9 (the bottom rear fans in the power-supply bays).

AC power LED: This green LED provides status information about the power supply. During typical operation, both the ac and dc power LEDs are on.

DC power LED: This green LED provides status information about the power supply. During typical operation, both the ac and dc power LEDs are on.

Server power features

This section contains information about how to properly turn your server on and off.

Turning on the server

Statement 13:



DANGER

Overloading a branch circuit is potentially a fire hazard and a shock hazard under certain conditions. To avoid these hazards, ensure that your system electrical requirements do not exceed branch circuit protection requirements. Refer to the information that is provided with your device for electrical specifications.

After you plug one end of each server power cord into the power-supply outlet on the rear of the server and the other end of each power cord into an electrical outlet, the server can start in any of the following ways:

- You can press the power-control button on the front of the server to start the server.

Notes:

1. You can install a circular disk over the power-control button to prevent accidental manual power-off. This disk, known as the power-control button shield, comes with your server.
 2. After you plug the power cords of your server into the electrical outlets, wait approximately 20 seconds before pressing the power-control button. During this time, the ISMP is initializing; therefore, the power-control button does not respond.
- If the server is turned on and a power failure occurs, the server will start automatically when power is restored.
 - If ac power is present, the server is in Standby mode, and the server is connected to an Advanced System Management (ASM) interconnect network, which contains at least one system with an optional Remote Supervisor Adapter installed, the server can be turned on from the Remote Supervisor Adapter user interface.
 - If ac power is present, the server is in Standby mode, and an optional Remote Supervisor Adapter is installed in the server, the server can be turned on from the Remote Supervisor Adapter user interface.
 - When you plug in your server for the first time, the Wake on LAN feature can turn on the server.
 - If your server was previously turned on, it must be properly placed in Standby mode for the Wake on LAN feature to turn on the server.
 - If your operating system supports the Preboot eXecution Environment (PXE) option and the PXE option is enabled through the **Planar Ethernet PXE/DHCP** menu choice under **Start Options** on the Configuration/Setup Utility program menu, the integrated Gigabit Ethernet controller can turn on the server.

Note: For more detailed information about the PXE option, see the *User's Guide* on the *IBM xSeries Documentation CD*. For information about the integrated Gigabit Ethernet controller, see the *Option Installation Guide* on the *IBM xSeries Documentation CD*.

Complete the following steps to manually turn on the server:

1. Review the information beginning with "Safety" on page v through "Handling static-sensitive devices" on page x.
2. Turn on all external devices, such as the monitor.
3. Plug the server power cords into the power source.
4. Press the power-control button on the front of the server.

Note: While the server is turning on, the power-on LED on the front of the server is lit.

Turning off the server

The server can be turned off in any of the following ways:

- If the system is connected to an ASM interconnect network that contains at least one system with an optional Remote Supervisor Adapter installed, the system can be turned off from the Remote Supervisor Adapter user interface.
- If an optional Remote Supervisor Adapter is installed in the system, the system can be turned off from the Remote Supervisor Adapter user interface.

Complete the following steps to manually turn off the server:

1. Review the information beginning with "Safety" on page v through "Handling static-sensitive devices" on page x.
2. See your operating system documentation for the proper procedure to shut down the operating system.

When you turn off the server, observe the following precaution.

Statement 5:



CAUTION:

The power control button on the device and the power switch on the power supply do not turn off the electrical current supplied to the device. The device also might have more than one power cord. To remove all electrical current from the device, ensure that all power cords are disconnected from the power source.

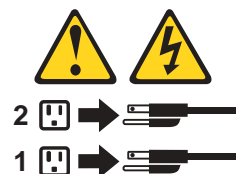

3. Press the power-control button on the front of the server. This will put the server in Standby mode.

Note: You might need to press and hold the power-control button for more than 4 seconds to cause an immediate shutdown of the server and to force it into Standby mode. You can use this feature if the operating system stops functioning.

4. Disconnect the server from the power source.

Note: After disconnecting all the power cords, wait approximately 15 seconds for your system to stop running. Watch for the power-on LED on the front of the server to stop flashing.

Standby mode

Standby mode refers to the condition in which the server operating system is not running and all core logic is shut down except for the optional Remote Supervisor Adapter. In Standby mode, the server can respond to ISMP requests, such as a remote request to turn on the server. When the server is in Standby mode, the power-on LED on the front of the server flashes (when the server is running, the power-on LED stays on and does not flash).

You can put the server in Standby mode in any of the following ways:

- You can press the power-control button on the server. This starts an orderly shutdown of the operating system, if this feature is supported by your operating system.
- If the server is connected to an ASM interconnect network which contains at least one system with an optional Remote Supervisor Adapter installed, the server can be placed in Standby mode from the Remote Supervisor Adapter user interface.
- If an optional Remote Supervisor Adapter is installed in the server, the server can be placed in Standby mode from the Remote Supervisor Adapter user interface.

Attention: You must disconnect all the server power cords from the electrical outlets to remove all power from the server.

Complete the following steps to put the server in Standby mode:

1. See the operating-system documentation for the proper procedure to shut down the operating system.

Note: Each operating system is different. Read all the documentation about shutting down the operating system before continuing.

2. Press the power-control button on the front of the server.

Notes:

- a. After you place the server in Standby mode, wait at least 5 seconds before you turn on the server again.
- b. You might need to press and hold the power-control button for more than 4 seconds to cause an immediate shutdown of the operating system and to force it into Standby mode. You can use this feature if the operating system stops functioning.

The ISMP can put the server in Standby mode as an automatic response to a critical system failure. You can also put the server into Standby mode remotely by means of an optional Remote Supervisor Adapter or through connection to an ASM interconnect network.

Chapter 4. Configuring your server

The following configuration programs are provided with your server.

- **Configuration/Setup Utility**

The Configuration/Setup Utility program is part of the *basic input/output system (BIOS)* code that comes with your server. You can use this program to configure serial and parallel port assignments, change interrupt request (IRQ) settings, change the drive startup sequence, set the date and time, and set passwords. For information about how to start this utility, see “Using the Configuration/Setup Utility program” on page 32.

- **SCSISelect Utility program**

With the built-in SCSISelect Utility program, you can configure the devices that are attached to the integrated SCSI controller. Use this program to change default values, resolve configuration conflicts, and perform a low-level format on a SCSI hard disk drive. For information about how to start this utility, see “Using the SCSISelect Utility program” on page 32.

- **ServerGuide™ CD**

The ServerGuide CD includes software setup and installation tools that are specifically designed for your IBM server. You can use this CD during the initial installation of your server to configure the server hardware and simplify your network operating system installation. See “Using the ServerGuide CD” on page 33 for more information.

- **SCSI or RAID programs**

If you install an optional SCSI or redundant array of independent disks (RAID) adapter, you must use the SCSI or RAID configuration program to define and configure your disk-array subsystem before you install your operating system.

Attention: See the *User's Guide* on the *IBM xSeries Documentation* CD for detailed instructions for using the configuration programs and ServerGuide CD.

Starting the utility programs

This section provides the instructions for starting the utility programs. For more detailed information about these utility programs, see the *User's Guide* on the *IBM xSeries Documentation CD*.

Using the Configuration/Setup Utility program

The Configuration/Setup Utility program is a menu-driven utility program that is part of the BIOS code that comes with your server. You can use it to:

- Configure serial port assignments
- Change the drive startup sequence
- Enable Universal Serial Bus (USB) keyboard and mouse support
- Resolve configuration conflicts
- Set the date and time
- Set passwords

Complete the following steps to start the Configuration/Setup Utility program:

1. Turn on the server and watch the monitor screen.
2. When the message Press F1 for Configuration/Setup appears, press F1.
3. Follow the instructions that appear on the screen.

Using the SCSISelect Utility program

SCSISelect is a built-in, menu-driven configuration utility program that you can use to:

- View the default SCSI IDs
- Locate and correct configuration conflicts

Note: If your server has a redundant array of independent disks (RAID) adapter installed, use the configuration method that is supplied with the RAID adapter to view or change SCSI settings for devices attached to the adapter.

The following sections provide the instructions needed to start the SCSISelect Utility and descriptions of the menu choices available.

Complete the following steps to start the SCSISelect utility program:

1. Turn on the server.
2. When the <<< Press <CTRL><A> for SCSISelect Utility! >>> prompt appears, press Ctrl+A.
3. When the Would you like to configure the host adapter or run the SCSI disk utility? question appears, make your selection and press Enter.
4. Use the arrow keys to select a choice from the menu.
 - Press Esc to exit the SCSISelect Utility program.
 - Press the F5 key to switch between color and monochrome modes (if your monitor permits).
5. Follow the instructions on the screen to change the settings of the selected items; then, press Enter.

Using the ServerGuide CD

The ServerGuide CD provides state-of-the-art programs to detect the server model and hardware options that are installed, configure the server hardware, provide device drivers, and install your network operating system (NOS).

Note: If the ServerGuide CD does not start, see “ServerGuide problems” on page 37.

1. Insert the *Setup and Installation* CD, and restart the server.
2. Follow the instructions that appear on the screen to:
 - a. Select your language.
 - b. Select your keyboard layout and country.
 - c. View the Overview to learn about ServerGuide features.
 - d. View the README file to review installation tips about your NOS and adapter.
 - e. Start the setup and hardware configuration programs.
 - f. Start the NOS installation. You will need your copy of the NOS CD.

Note: For information about the supported NOS versions, refer to the *Setup and Installation* CD label.

Chapter 5. Solving problems

This section provides basic troubleshooting information to help you resolve some common problems that might occur while setting up your server.

If you cannot locate and correct the problem using the information in this section, see the *Hardware Maintenance Manual and Troubleshooting Guide* on the *IBM xSeries Documentation CD* and the “Server Support” flowchart in the front of this booklet.

POST beep code descriptions

POST emits one beep to signal successful completion. If POST detects a problem during startup, other beep codes might occur. You can use the following beep code descriptions to help identify and resolve problems that are detected during startup.

Note: See the “Solving problems” section of the *Hardware Maintenance Manual and Troubleshooting Guide* on the *IBM xSeries Documentation CD* for more information about the POST beep codes.

Table 4. POST beep code descriptions

Beep code	Descriptions of the POST beep codes
No beep	Call for service.
Continuous	If no video appears, the startup microprocessor failed. Verify that the startup microprocessor is installed correctly. If it is, replace the startup microprocessor. If the problem remains, call for service.
One short	POST completed successfully. One beep also occurs after POST if you enter an incorrect password.
Two short	Follow the instructions that appear on the screen.
Three short	POST detected a system memory error. Verify that the memory is installed correctly. If it is, replace the failing memory module. Important: In some memory configurations, the 3-3-3 beep code might sound during POST followed by a blank monitor screen. If this occurs and the Boot Fail Count feature in the Start Options menu of the Configuration/Setup Utility program is set to Enabled (its default setting), you must restart the server three times to force the system BIOS to reset the memory connector or pair or quad of connectors from Disabled to Enabled .
Repeating short	The system board might contain a failing component. <ol style="list-style-type: none">1. Verify that the keyboard and pointing devices are connected properly.2. Ensure that nothing is resting on the keyboard.3. Disconnect the pointing device; then, restart the server. If the problem goes away, replace the pointing device. If the problem remains, call for service.
One long and one short	If the video controller on the system board is being used, call for service. If you installed an optional video adapter, replace the failing adapter
One long and two short	A video I/O adapter ROM is not readable, or the video subsystem is defective. If you installed an optional video adapter, replace the failing adapter. If the problem remains, call for service.
One long and three short	The system-board video subsystem has not detected a monitor connection to the server. Ensure that the monitor is connected to the server. If the problem remains, replace the monitor.
Two long and two short	POST does not support the optional video adapter. Replace the optional video adapter with one that is supported by the server or use the integrated video controller.
All other beep codes	<ol style="list-style-type: none">1. Verify that the system memory modules are installed correctly.2. Turn off the server; then, restart the server. If the problem remains, call for service.

POST error messages

The following table provides an abbreviated list of the error messages that might appear during POST.

Note: See the “Solving problems” section of the *Hardware Maintenance Manual and Troubleshooting Guide* on the *xSeries Documentation CD* for more information about the POST beep codes.

Table 5. Abbreviated list of POST error messages

POST message	Failing device or problem found	Suggested action
129	L1 cache of a microprocessor	Check the installation of your microprocessors.
161	Real-time clock battery has failed	Replace the battery yourself or call for service.
162	Change in device configuration	Verify that your optional devices are turned on and installed correctly.
163	Time of day has not been set	Set the correct date and time.
164	Change in memory configuration	Verify that your memory is installed properly; then, restart the server and run the Configuration/Setup Utility program.
201	Change in memory configuration	Verify that your memory is fully seated and installed properly.
229	L2 cache of a microprocessor	Check the installation of your microprocessors.
289	Failing DIMM was disabled	Verify that your memory is correct for your server and that it is installed properly.
301 303	Keyboard and keyboard controller	Ensure that the keyboard cable is connected and nothing is resting on the keyboard keys.
962	Parallel port configuration error	Start the Configuration/Setup program and verify that the parallel-port setting is correct.
11xx	Serial port error	Verify that the serial cable is connected correctly.
1162	Serial port configuration conflict	Start the Configuration/Setup program and ensure that the IRQ and I/O port assignments needed by the serial port are available.
1601	BIOS code update needed	Download and install the latest system BIOS code level.
1800	PCI adapter hardware interrupt	Start the Configuration/Setup program and verify that the interrupt resource settings are correct.
2400 2462	Video controller and memory	Verify that the monitor is connected correctly.
00019xxx	Processor <i>x</i> is not functioning or failed the built-in test	Verify that processor <i>x</i> is installed correctly. If the problem remains, replace processor <i>x</i> .
00180xxx	A PCI adapter requested a resource that is not available	Start the Configuration/Setup program and ensure that the resources needed by the PCI adapter are available.
012980xx 012981xx	Data for processor <i>x</i>	Download and install the latest system BIOS code level.
01298200	Microprocessor speed mismatch	Install microprocessors with identical speeds.
I9990305	POST could not find an operating system.	Install your operating system.

ServerGuide problems

Look for the symptom in the left column of the chart. Probable solutions to the problem are in the right column.

Table 6. Setup and Installation CD

Symptom	Suggested action
Setup and Installation CD will not start.	<ul style="list-style-type: none">• Ensure that the system is a supported server with a startable (bootable) CD-ROM drive.• If the startup (boot) sequence settings have been altered, ensure that the CD-ROM drive is first in the startup sequence.• If more than one CD-ROM drive is installed, ensure that only one drive is set as the primary drive. Start the CD from the primary drive.
ServeRAID™ program cannot view all installed drives - or - cannot install NOS.	<ul style="list-style-type: none">• Ensure that there are no duplicate SCSI IDs or IRQ assignments.• Ensure that the hard disk drive is connected properly.
The Operating System Installation program continuously loops.	Make more space available on the hard disk.
ServerGuide will not start your NOS CD.	Ensure that the NOS CD you have is supported by the ServerGuide program. See the Setup and Installation CD label for a list of supported NOS versions.
Cannot install NOS - option is unavailable.	Ensure that the NOS is supported on your server. If the NOS is supported, either there is no logical drive defined (ServeRAID systems) or the ServerGuide System Partition is not present. Run the ServerGuide setup and configuration program, and ensure that setup is complete.

Troubleshooting chart

See the “Solving problems” section of the *Troubleshooting Guide* on the xSeries *Documentation* CD for more detailed troubleshooting charts.

If you cannot find the problem in the troubleshooting charts, run the diagnostic programs. If you have run the diagnostic test programs, or if running the tests does not reveal the problem, call for service.

Monitor problems	Suggested action
Testing	<p>Some IBM monitors have their own self-tests. If you suspect a problem with your monitor, see the information that comes with the monitor for adjusting and testing instructions.</p> <p>If you still cannot find the problem, call for service.</p>
The screen is blank.	<p>Verify that:</p> <ul style="list-style-type: none"> • The server power cord is plugged into the server and a working electrical outlet. • The monitor cables are connected properly. • The monitor is turned on and the Brightness and Contrast controls are adjusted correctly. <p>Important: In some memory configurations, the 3-3-3 beep code might sound during POST followed by a blank monitor screen. If this occurs and the Boot Fail Count feature in the Start Options menu of the Configuration/Setup Utility program is set to Enabled (its default setting), you must restart the server three times to force the system BIOS to reset the memory connector or pair or quad of connectors from Disabled to Enabled.</p> <p>If the items above are correct and the screen remains blank, call for service.</p>
Only the cursor appears.	Call for service.
The monitor works when you turn on the server, but goes blank when you start some application programs.	<p>Verify that:</p> <ol style="list-style-type: none"> 1. The primary monitor cable is connected to the video port. 2. You installed the necessary device drivers for the applications. <p>If the items above are correct and the screen remains blank, call for service.</p>
The screen is wavy, unreadable, rolling, distorted, or has screen jitter.	<p>If the monitor self-tests show the monitor is OK, consider the location of the monitor. Magnetic fields around other devices (such as transformers, appliances, fluorescent lights, and other monitors) can cause screen jitter or wavy, unreadable, rolling, or distorted screen images. If this happens, turn off the monitor. (Moving a color monitor while it is turned on might cause screen discoloration.) Then move the device and the monitor at least 305 mm (12 in.) apart. Turn on the monitor.</p> <p>Notes:</p> <ol style="list-style-type: none"> 1. To prevent diskette drive read/write errors, be sure the distance between monitors and diskette drives is at least 76 mm (3 in.). 2. Non-IBM monitor cables might cause unpredictable problems. 3. An enhanced monitor cable with additional shielding is available for the 9521 and 9527 monitors. For information about the enhanced monitor cable, see your IBM reseller or IBM marketing representative. <p>If the problem remains, call for service.</p>
Wrong characters appear on the screen.	<p>If the wrong language is displayed, update the BIOS with the correct language.</p> <p>If the problem remains, call for service.</p>

Power problems	Suggested action
The server does not power on.	Verify that: <ol style="list-style-type: none"> 1. The power cables are properly connected to the server. 2. The electrical outlet functions properly. 3. The type of memory that is installed is correct. 4. If you just installed an option, remove it, and restart the server. If the server now powers on, you might have installed more options than the power supply can support. 5. The LEDs on the power supply are on. If the problem remains, call for service.
The system does not power off.	Verify if you are using an ACPI or non-ACPI operating system. If you are using a non-ACPI operating system: <ol style="list-style-type: none"> 1. Press Ctrl+Alt+Delete. 2. Turn off the system by using the power-control button. If the problem remains or if you are using an ACPI aware operating system, call for service.
Microprocessor problems	Suggested action
The server emits a continuous tone during POST.	The startup (boot) microprocessor is not working properly. Verify that the startup microprocessor is seated properly. If it is, replace the startup microprocessor. If the problem remains, call for service.
Memory problems	Suggested action
The amount of memory displayed is less than the amount of memory installed.	Verify that: <ul style="list-style-type: none"> • The memory modules are seated properly. • You have installed the correct type of memory. • If you changed the memory, you updated the memory configuration with the Configuration/Setup Utility program. • All pairs or quads of memory on the DIMMs are enabled. The server might have automatically disabled a DIMM pair or quad when it detected a problem, or a DIMM pair or quad might have been manually disabled. Look in the POST error log for error message 289: <ul style="list-style-type: none"> • If the DIMM was disabled by a system-management interrupt (SMI), replace the DIMM. • If the DIMM was disabled by POST: <ol style="list-style-type: none"> 1. Start the Configuration/Setup Utility program. 2. Enable the DIMM. 3. Save the configuration and restart the server. • If you continue to get this error, replace the DIMM. If the problem remains, call for service.

Expansion enclosure problems	Suggested action
The SCSI expansion enclosure used to work, but does not work now.	Verify that: <ol style="list-style-type: none"> 1. The cables for all external SCSI options are connected correctly. 2. The last option in each SCSI chain, or the end of the SCSI cable, is terminated correctly. 3. Any external SCSI option is turned on. You must turn on an external SCSI option before turning on the server. For more information, see the documentation for your SCSI options and expansion enclosure.
Option problems	Suggested action
An IBM option that was just installed does not work.	Verify that: <ol style="list-style-type: none"> 1. The server supports the option. See the “Server Support” flowchart for information about obtaining ServerProven[®] compatibility information from the World Wide Web. 2. You followed the installation instructions that came with the option. 3. The option is installed correctly. 4. You have not loosened any other installed options or cables. 5. You updated the configuration information using the Configuration/Setup Utility program. Whenever memory or an option is changed, you must update the configuration. If the problem remains, call for service.
Service processor problems	Suggested action
Service Processor Manager reports a general monitor failure	Disconnect the server from all electrical sources, wait for 30 seconds, reconnect the server to the electrical sources, and restart the server. If a problem remains, call for service.

Appendix A. Getting help and technical assistance

If you need help, service, or technical assistance or just want more information about IBM products, you will find a wide variety of sources available from IBM to assist you. This chapter contains information about where to go for additional information about IBM and IBM products, what to do if you experience a problem with your xSeries or IntelliStation® system, and whom to call for service, if it is necessary.

Before you call

Before you call, make sure that you have taken these steps to try to solve the problem yourself:

- Check all cables to make sure that they are connected.
- Check the power switches to make sure that the system is turned on.
- Use the troubleshooting information in your system documentation, and use the diagnostic tools that come with your system.
- Go to the IBM Support Web site at <http://www.ibm.com/pc/support/> to check for technical information, hints, tips, and new device drivers.
- Use an IBM discussion forum on the IBM Web site to ask questions.

You can solve many problems without outside assistance by following the troubleshooting procedures that IBM provides in the online help or in the publications that are provided with your system and software. The information that comes with your system also describes the diagnostic tests that you can perform. Most xSeries and IntelliStation systems, operating systems, and programs come with information that contains troubleshooting procedures and explanations of error messages and error codes. If you suspect a software problem, see the information for the operating system or program.

Using the documentation

Information about your IBM xSeries or IntelliStation system and preinstalled software, if any, is available in the documentation that comes with your system. That documentation includes printed books, online books, README files, and help files. See the troubleshooting information in your system documentation for instructions for using the diagnostic programs. The troubleshooting information or the diagnostic programs might tell you that you need additional or updated device drivers or other software. IBM maintains pages on the World Wide Web where you can get the latest technical information and download device drivers and updates. To access these pages, go to <http://www.ibm.com/pc/support/> and follow the instructions. Also, you can order publications through the IBM Publications Ordering System at <http://www.elink.ibm.com/public/applications/publications/cgibin/pbi.cgi>.

Getting help and information from the World Wide Web

On the World Wide Web, the IBM Web site has up-to-date information about IBM xSeries and IntelliStation products, services, and support. The address for IBM xSeries information is <http://www.ibm.com/eserver/xseries/>. The address for IBM IntelliStation information is <http://www.ibm.com/pc/intellistation/>.

You can find service information for your IBM products, including supported options, at <http://www.ibm.com/pc/support/>. If you click **Profile** from the support page, you can create a customized support page. The support page has many sources of information and ways for you to solve problems, including:

- Diagnosing problems, using the IBM Online Assistant
- Downloading the latest device drivers and updates for your products
- Viewing Frequently Asked Questions (FAQ)
- Viewing hints and tips to help you solve problems
- Participating in IBM discussion forums
- Setting up e-mail notification of technical updates about your products

Software service and support

Through IBM Support Line, you can get telephone assistance, for a fee, with usage, configuration, and software problems with xSeries servers, IntelliStation workstations, and appliances. For information about which products are supported by Support Line in your country or region, go to <http://www.ibm.com/services/sl/products/>.

For more information about Support Line and other IBM services, go to <http://www.ibm.com/services/>, or go to <http://www.ibm.com/planetwide/> for support telephone numbers.

Hardware service and support

You can receive hardware service through IBM Integrated Technology Services or through your IBM reseller, if your reseller is authorized by IBM to provide warranty service. Go to <http://www.ibm.com/planetwide/> for support telephone numbers.

In the U.S. and Canada, hardware service and support is available 24 hours a day, 7 days a week. In the U.K., these services are available Monday through Friday, from 9 a.m. to 6 p.m.

Appendix B. Warranty information

Part 1 - General Terms

Part 1 - General Terms

*This Statement of Limited Warranty includes Part 1 - General Terms, Part 2 - Country-unique Terms, and Part 3 - Warranty Information. The terms of Part 2 replace or modify those of Part 1. The warranties provided by IBM in this Statement of Limited Warranty apply only to Machines you purchase for your use, and not for resale. The term "Machine" means an IBM machine, its features, conversions, upgrades, elements, or accessories, or any combination of them. The term "Machine" does not include any software programs, whether pre-loaded with the Machine, installed subsequently or otherwise. **Nothing in this Statement of Limited Warranty affects any statutory rights of consumers that cannot be waived or limited by contract.***

What this Warranty Covers

IBM warrants that each Machine 1) is free from defects in materials and workmanship and 2) conforms to IBM's Official Published Specifications ("Specifications") which are available on request. The warranty period for the Machine starts on the original Date of Installation and is specified in Part 3 - Warranty Information. The date on your invoice or sales receipt is the Date of Installation unless IBM or your reseller informs you otherwise. Many features, conversions, or upgrades involve the removal of parts and their return to IBM. A part that replaces a removed part will assume the warranty service status of the removed part. Unless IBM specifies otherwise, these warranties apply only in the country or region in which you purchased the Machine.

THESE WARRANTIES ARE YOUR EXCLUSIVE WARRANTIES AND REPLACE ALL OTHER WARRANTIES OR CONDITIONS, EXPRESS OR IMPLIED, INCLUDING, BUT NOT LIMITED TO, THE IMPLIED WARRANTIES OR CONDITIONS OF MERCHANTABILITY AND FITNESS FOR A PARTICULAR PURPOSE. SOME STATES OR JURISDICTIONS DO NOT ALLOW THE EXCLUSION OF EXPRESS OR IMPLIED WARRANTIES, SO THE ABOVE EXCLUSION MAY NOT APPLY TO YOU. IN THAT EVENT, SUCH WARRANTIES ARE LIMITED IN DURATION TO THE WARRANTY PERIOD. NO WARRANTIES APPLY AFTER THAT PERIOD. SOME STATES OR JURISDICTIONS DO NOT ALLOW LIMITATIONS ON HOW LONG AN IMPLIED WARRANTY LASTS, SO THE ABOVE LIMITATION MAY NOT APPLY TO YOU.

What this Warranty Does not Cover

This warranty does not cover the following:

- any software programs, whether pre-loaded or shipped with the Machine, or installed subsequently;
- failure resulting from misuse (including but not limited to use of any Machine capacity or capability, other than that authorized by IBM in writing), accident, modification, unsuitable physical or operating environment, or improper maintenance by you;
- failure caused by a product for which IBM is not responsible; and
- any non-IBM products, including those that IBM may procure and provide with or integrate into an IBM Machine at your request.

The warranty is voided by removal or alteration of identification labels on the Machine or its parts.

IBM does not warrant uninterrupted or error-free operation of a Machine.

Any technical or other support provided for a Machine under warranty, such as assistance via telephone with “how-to” questions and those regarding Machine set-up and installation, is provided **WITHOUT WARRANTIES OF ANY KIND**.

How to Obtain Warranty Service

If the Machine does not function as warranted during the warranty period, contact IBM or your reseller to obtain warranty service. If you do not register the Machine with IBM, you may be required to present proof of purchase as evidence of your entitlement to warranty service.

What IBM Will Do to Correct Problems

When you call for service, you must follow the problem determination and resolution procedures that IBM specifies. A technician will attempt to make an initial diagnosis of your problem and help you resolve it over the telephone.

The type of warranty service applicable to your Machine is specified in Part 3 - Warranty Information.

You are responsible for downloading and installing designated Machine Code (microcode, basic input/output system code (called “BIOS”), utility programs, device drivers, and diagnostics delivered with an IBM Machine) and other software updates from an IBM Internet Web site or from other electronic media, and following the instructions that IBM provides.

If your problem can be resolved with a Customer Replaceable Unit (“CRU”) (e.g., keyboard, mouse, speaker, memory, hard disk drive and other easily replaceable parts), IBM will ship these parts to you for replacement by you.

If the Machine does not function as warranted during the warranty period and your problem cannot be resolved over the telephone, through your application of Machine Code or software updates, or with a CRU, IBM or your reseller, if approved by IBM to provide warranty service, will either, at its discretion, 1) repair it to make it function as warranted, or 2) replace it with one that is at least functionally equivalent. If IBM is unable to do either, you may return the Machine to your place of purchase and your money will be refunded.

IBM or your reseller will also manage and install selected engineering changes that apply to the Machine.

Exchange of a Machine or Part

When the warranty service involves the exchange of a Machine or part, the item IBM or your reseller replaces becomes its property and the replacement becomes yours. You represent that all removed items are genuine and unaltered. The replacement may not be new, but will be in good working order and at least functionally equivalent to the item replaced. The replacement assumes the warranty service status of the replaced item.

Your Additional Responsibilities

Before IBM or your reseller exchanges a Machine or part, you agree to remove all features, parts, options, alterations, and attachments not under warranty service.

You also agree to:

1. ensure that the Machine is free of any legal obligations or restrictions that prevent its exchange;
2. obtain authorization from the owner to have IBM or your reseller service a Machine that you do not own; and
3. where applicable, before service is provided:
 - a. follow the service request procedures that IBM or your reseller provides;
 - b. backup or secure all programs, data, and funds contained in the Machine;
 - c. provide IBM or your reseller with sufficient, free, and safe access to your facilities to permit IBM to fulfill its obligations; and
 - d. inform IBM or your reseller of changes in the Machine's location.
4. (a) ensure all information about identified or identifiable individuals (Personal Data) is deleted from the Machine (to the extent technically possible), (b) allow IBM, your reseller or an IBM supplier to process on your behalf any remaining Personal Data as IBM or your reseller considers necessary to fulfill its obligations under this Statement of Limited Warranty (which may include shipping the Machine for such processing to other IBM service locations around the world), and (c) ensure that such processing complies with any laws applicable to such Personal Data.

Limitation of Liability

IBM is responsible for loss of, or damage to, your Machine only while it is 1) in IBM's possession or 2) in transit in those cases where IBM is responsible for the transportation charges.

Neither IBM nor your reseller are responsible for any of your confidential, proprietary or personal information contained in a Machine which you return to IBM for any reason. You should remove all such information from the Machine prior to its return.

Circumstances may arise where, because of a default on IBM's part or other liability, you are entitled to recover damages from IBM. In each such instance, regardless of the basis on which you are entitled to claim damages from IBM (including fundamental breach, negligence, misrepresentation, or other contract or tort claim), except for any liability that cannot be waived or limited by applicable laws, IBM is liable for no more than

1. damages for bodily injury (including death) and damage to real property and tangible personal property; and
2. the amount of any other actual direct damages, up to the charges (if recurring, 12 months' charges apply) for the Machine that is subject of the claim. For purposes of this item, the term "Machine" includes Machine Code and Licensed Internal Code ("LIC").

This limit also applies to IBM's suppliers and your reseller. It is the maximum for which IBM, its suppliers, and your reseller are collectively responsible.

UNDER NO CIRCUMSTANCES IS IBM, ITS SUPPLIERS OR RESELLERS LIABLE FOR ANY OF THE FOLLOWING EVEN IF INFORMED OF THEIR POSSIBILITY: 1) THIRD PARTY CLAIMS AGAINST YOU FOR DAMAGES (OTHER THAN THOSE UNDER THE FIRST ITEM LISTED ABOVE); 2) LOSS OF, OR DAMAGE TO, DATA; 3) SPECIAL, INCIDENTAL, OR INDIRECT DAMAGES OR FOR ANY ECONOMIC CONSEQUENTIAL DAMAGES; OR 4) LOST

PROFITS, BUSINESS REVENUE, GOODWILL OR ANTICIPATED SAVINGS. SOME STATES OR JURISDICTIONS DO NOT ALLOW THE EXCLUSION OR LIMITATION OF INCIDENTAL OR CONSEQUENTIAL DAMAGES, SO THE ABOVE LIMITATION OR EXCLUSION MAY NOT APPLY TO YOU. SOME STATES OR JURISDICTIONS DO NOT ALLOW LIMITATIONS ON HOW LONG AN IMPLIED WARRANTY LASTS, SO THE ABOVE LIMITATION MAY NOT APPLY TO YOU.

Governing Law

Both you and IBM consent to the application of the laws of the country in which you acquired the Machine to govern, interpret, and enforce all of your and IBM's rights, duties, and obligations arising from, or relating in any manner to, the subject matter of this Statement of Limited Warranty, without regard to conflict of law principles.

THESE WARRANTIES GIVE YOU SPECIFIC LEGAL RIGHTS AND YOU MAY ALSO HAVE OTHER RIGHTS WHICH VARY FROM STATE TO STATE OR JURISDICTION TO JURISDICTION.

Jurisdiction

All of our rights, duties, and obligations are subject to the courts of the country in which you acquired the Machine.

Part 2 - Country-unique Terms

AMERICAS

ARGENTINA

Governing Law: *The following is added after the first sentence:*

Any litigation arising from this Statement of Limited Warranty will be settled exclusively by the Ordinary Commercial Court of the city of Buenos Aires.

BRAZIL

Governing Law: *The following is added after the first sentence:*

Any litigation arising from this Statement of Limited Warranty will be settled exclusively by the court of Rio de Janeiro, RJ.

PERU

Limitation of Liability: *The following is added at the end of this section:*

In accordance with Article 1328 of the Peruvian Civil Code the limitations and exclusions specified in this section will not apply to damages caused by IBM's willful misconduct ("dolo") or gross negligence ("culpa inexcusable").

NORTH AMERICA

How to Obtain Warranty Service: *The following is added to this Section:*

To obtain warranty service from IBM in Canada or the United States, call 1-800-IBM-SERV (426-7378).

CANADA

Limitation of Liability: *The following replaces item 1 of this section:*

1. damages for bodily injury (including death) or physical harm to real property and tangible personal property caused by IBM's negligence; and

Governing Law: *The following replaces "laws of the country in which you acquired the Machine" in the first sentence:*

laws in the Province of Ontario.

UNITED STATES

Governing Law: *The following replaces "laws of the country in which you acquired the Machine" in the first sentence:*

laws of the State of New York.

ASIA PACIFIC

AUSTRALIA

What this Warranty Covers: *The following paragraph is added to this section:*

The warranties specified in this Section are in addition to any rights you may have under the Trade Practices Act 1974 or other similar legislation and are only limited to the extent permitted by the applicable legislation.

Limitation of Liability: *The following is added to this section:*

Where IBM is in breach of a condition or warranty implied by the Trade Practices Act 1974 or other similar legislation, IBM's liability is limited to the repair or replacement of the goods or the supply of equivalent goods. Where that condition or warranty relates to right to sell, quiet possession or clear title, or the goods are of a kind ordinarily acquired for personal, domestic or household use or consumption, then none of the limitations in this paragraph apply.

Governing Law: *The following replaces "laws of the country in which you acquired the Machine" in the first sentence:*

laws of the State or Territory.

CAMBODIA, LAOS, AND VIETNAM

Governing Law: *The following replaces "laws of the country in which you acquired the Machine" in the first sentence:*

laws of the State of New York, United States of America.

CAMBODIA, INDONESIA, LAOS, AND VIETNAM

Arbitration: *The following is added under this heading:*

Disputes arising out of or in connection with this Statement of Limited Warranty shall be finally settled by arbitration which shall be held in Singapore in accordance with the Arbitration Rules of Singapore International Arbitration Center ("SIAC Rules") then in effect. The arbitration award shall be final and binding for the parties without appeal and shall be in writing and set forth the findings of fact and the conclusions of law.

The number of arbitrators shall be three, with each side to the dispute being entitled to appoint one arbitrator. The two arbitrators appointed by the parties shall appoint a third arbitrator who shall act as chairman of the proceedings. Vacancies in the post of chairman shall be filled by the president of the SIAC. Other vacancies shall

be filled by the respective nominating party. Proceedings shall continue from the stage they were at when the vacancy occurred.

If one of the parties refuses or otherwise fails to appoint an arbitrator within 30 days of the date the other party appoints its, the first appointed arbitrator shall be the sole arbitrator, provided that the arbitrator was validly and properly appointed.

All proceedings shall be conducted, including all documents presented in such proceedings, in the English language. The English language version of this Statement of Limited Warranty prevails over any other language version.

HONG KONG S.A.R. OF CHINA AND MACAU S.A.R. OF CHINA

Governing Law: *The following replaces “laws of the country in which you acquired the Machine” in the first sentence:*

laws of Hong Kong Special Administrative Region of China.

INDIA

Limitation of Liability: *The following replaces items 1 and 2 of this section:*

1. liability for bodily injury (including death) or damage to real property and tangible personal property will be limited to that caused by IBM's negligence; and
2. as to any other actual damage arising in any situation involving nonperformance by IBM pursuant to, or in any way related to the subject of this Statement of Limited Warranty, the charge paid by you for the individual Machine that is the subject of the claim. For purposes of this item, the term “Machine” includes Machine Code and Licensed Internal Code (“LIC”).

Arbitration: *The following is added under this heading:*

Disputes arising out of or in connection with this Statement of Limited Warranty shall be finally settled by arbitration which shall be held in Bangalore, India in accordance with the laws of India then in effect. The arbitration award shall be final and binding for the parties without appeal and shall be in writing and set forth the findings of fact and the conclusions of law.

The number of arbitrators shall be three, with each side to the dispute being entitled to appoint one arbitrator. The two arbitrators appointed by the parties shall appoint a third arbitrator who shall act as chairman of the proceedings. Vacancies in the post of chairman shall be filled by the president of the Bar Council of India. Other vacancies shall be filled by the respective nominating party. Proceedings shall continue from the stage they were at when the vacancy occurred.

If one of the parties refuses or otherwise fails to appoint an arbitrator within 30 days of the date the other party appoints its, the first appointed arbitrator shall be the sole arbitrator, provided that the arbitrator was validly and properly appointed.

All proceedings shall be conducted, including all documents presented in such proceedings, in the English language. The English language version of this Statement of Limited Warranty prevails over any other language version.

JAPAN

Governing Law: *The following sentence is added to this section:*

Any doubts concerning this Statement of Limited Warranty will be initially resolved between us in good faith and in accordance with the principle of mutual trust.

MALAYSIA

Limitation of Liability: *The word “SPECIAL” in item 3 of the fifth paragraph is deleted.*

NEW ZEALAND

What this Warranty Covers: *The following paragraph is added to this section:*

The warranties specified in this section are in addition to any rights you may have under the Consumer Guarantees Act 1993 or other legislation which cannot be excluded or limited. The Consumer Guarantees Act 1993 will not apply in respect of any goods which IBM provides, if you require the goods for the purposes of a business as defined in that Act.

Limitation of Liability: *The following is added to this section:*

Where Machines are not acquired for the purposes of a business as defined in the Consumer Guarantees Act 1993, the limitations in this section are subject to the limitations in that Act.

PEOPLE’S REPUBLIC OF CHINA (PRC)

Governing Law: *The following replaces “laws of the country in which you acquired the Machine” in the first sentence:*

laws of the State of New York, United States of America (except when local law requires otherwise).

PHILIPPINES

Limitation of Liability: *Item 3 in the fifth paragraph is replaced by the following:*

SPECIAL (INCLUDING NOMINAL AND EXEMPLARY DAMAGES), MORAL, INCIDENTAL, OR INDIRECT DAMAGES FOR ANY ECONOMIC CONSEQUENTIAL DAMAGES; OR

Arbitration: *The following is added under this heading:*

Disputes arising out of or in connection with this Statement of Limited Warranty shall be finally settled by arbitration which shall be held in Metro Manila, Philippines in accordance with the laws of the Philippines then in effect. The arbitration award shall be final and binding for the parties without appeal and shall be in writing and set forth the findings of fact and the conclusions of law.

The number of arbitrators shall be three, with each side to the dispute being entitled to appoint one arbitrator. The two arbitrators appointed by the parties shall appoint a third arbitrator who shall act as chairman of the proceedings. Vacancies in the post of chairman shall be filled by the president of the Philippine Dispute Resolution Center, Inc. Other vacancies shall be filled by the respective nominating party. Proceedings shall continue from the stage they were at when the vacancy occurred.

If one of the parties refuses or otherwise fails to appoint an arbitrator within 30 days of the date the other party appoints its, the first appointed arbitrator shall be the sole arbitrator, provided that the arbitrator was validly and properly appointed.

All proceedings shall be conducted, including all documents presented in such proceedings, in the English language. The English language version of this Statement of Limited Warranty prevails over any other language version.

SINGAPORE

Limitation of Liability: *The words “SPECIAL” and “ECONOMIC” in item 3 in the fifth paragraph are deleted.*

EUROPE, MIDDLE EAST, AFRICA (EMEA)

THE FOLLOWING TERMS APPLY TO ALL EMEA COUNTRIES:

The terms of this Statement of Limited Warranty apply to Machines purchased from IBM or an IBM reseller.

Hot to Obtain Warranty Service: If you purchase a Machine in Austria, Belgium, Cyprus, Denmark, Estonia, Finland, France, Germany, Greece, Iceland, Ireland, Italy, Latvia, Liechtenstein, Lithuania, Luxembourg, Monaco, Netherlands, Norway, Portugal, Spain, San Marino, Sweden, Switzerland, United Kingdom or Vatican State, you may obtain warranty service for that Machine in any of those countries from either (1) an IBM reseller approved to perform warranty service or (2) from IBM, provided the Machine has been announced and made available by IBM in the country in which you wish to obtain service. If you purchased a Personal Computer Machine in Albania, Armenia, Belarus, Bosnia and Herzegovina, Bulgaria, Croatia, Czech Republic, Georgia, Hungary, Kazakhstan, Kyrgyzstan, Federal Republic of Yugoslavia, Former Yugoslav Republic of Macedonia (FYROM), Moldova, Poland, Romania, Russia, Slovak Republic, Slovenia, or Ukraine, you may obtain warranty service for that Machine in any of those countries from either (1) an IBM reseller approved to perform warranty service or (2) from IBM.

If you purchase a Machine in a Middle Eastern or African country, you may obtain warranty service for that Machine from the IBM entity within the country of purchase, if that IBM entity provides warranty service in that country, or from an IBM reseller, approved by IBM to perform warranty service on that Machine in that country. Warranty service in Africa is available within 50 kilometers of an IBM approved service provider. You are responsible for transportation costs for Machines located outside 50 kilometers of an IBM approved service provider.

*Add the following paragraph in **Western Europe** (Austria, Belgium, Cyprus, Denmark, Finland, France, Germany, Greece, Iceland, Ireland, Italy, Liechtenstein, Luxembourg, Monaco, Netherlands, Norway, Portugal, Spain, San Marino, Sweden, Switzerland, United Kingdom, Vatican State):*

The warranty for Machines acquired in Western Europe shall be valid and applicable in all Western Europe countries provided the Machines have been announced and made available in such countries.

Governing Law:

The phrase “the laws of the country in which you acquired the Machine” is replaced by:

1) “the laws of Austria” in **Albania, Armenia, Azerbaijan, Belarus, Bosnia-Herzegovina, Bulgaria, Croatia, Georgia, Hungary, Kazakhstan, Kyrgyzstan, FYR Macedonia, Moldova, Poland, Romania, Russia, Slovakia, Slovenia, Tajikistan, Turkmenistan, Ukraine, Uzbekistan, and FR Yugoslavia;** 2)

“the laws of France” in **Algeria, Benin, Burkina Faso, Cameroon, Cape Verde, Central African Republic, Chad, Comoros, Congo Republic, Djibouti, Democratic Republic of Congo, Equatorial Guinea, French Guiana, French Polynesia, Gabon, Gambia, Guinea, Guinea-Bissau, Ivory Coast, Lebanon, Madagascar, Mali, Mauritania, Mauritius, Mayotte, Morocco, New Caledonia, Niger, Reunion, Senegal, Seychelles, Togo, Tunisia, Vanuatu, and Wallis & Futuna**; 3) “the laws of Finland” in **Estonia, Latvia, and Lithuania**; 4) “the laws of England” in **Angola, Bahrain, Botswana, Burundi, Egypt, Eritrea, Ethiopia, Ghana, Jordan, Kenya, Kuwait, Liberia, Malawi, Malta, Mozambique, Nigeria, Oman, Pakistan, Qatar, Rwanda, Sao Tome, Saudi Arabia, Sierra Leone, Somalia, Tanzania, Uganda, United Arab Emirates, the United Kingdom, West Bank/Gaza, Yemen, Zambia, and Zimbabwe**; and 5) “the laws of South Africa” in **South Africa, Namibia, Lesotho and Swaziland**.

Jurisdiction: *The following exceptions are added to this section:*

1) **In Austria** the choice of jurisdiction for all disputes arising out of this Statement of Limited Warranty and relating thereto, including its existence, will be the competent court of law in Vienna, Austria (Inner-City); 2) **in Angola, Bahrain, Botswana, Burundi, Egypt, Eritrea, Ethiopia, Ghana, Jordan, Kenya, Kuwait, Liberia, Malawi, Malta, Mozambique, Nigeria, Oman, Pakistan, Qatar, Rwanda, Sao Tome, Saudi Arabia, Sierra Leone, Somalia, Tanzania, Uganda, United Arab Emirates, West Bank/Gaza, Yemen, Zambia, and Zimbabwe** all disputes arising out of this Statement of Limited Warranty or related to its execution, including summary proceedings, will be submitted to the exclusive jurisdiction of the English courts; 3) in **Belgium and Luxembourg**, all disputes arising out of this Statement of Limited Warranty or related to its interpretation or its execution, the law, and the courts of the capital city, of the country of your registered office and/or commercial site location only are competent; 4) **in France, Algeria, Benin, Burkina Faso, Cameroon, Cape Verde, Central African Republic, Chad, Comoros, Congo Republic, Djibouti, Democratic Republic of Congo, Equatorial Guinea, French Guiana, French Polynesia, Gabon, Gambia, Guinea, Guinea-Bissau, Ivory Coast, Lebanon, Madagascar, Mali, Mauritania, Mauritius, Mayotte, Morocco, New Caledonia, Niger, Reunion, Senegal, Seychelles, Togo, Tunisia, Vanuatu, and Wallis & Futuna** all disputes arising out of this Statement of Limited Warranty or related to its violation or execution, including summary proceedings, will be settled exclusively by the Commercial Court of Paris; 5) **in Russia**, all disputes arising out of or in relation to the interpretation, the violation, the termination, the nullity of the execution of this Statement of Limited Warranty shall be settled by Arbitration Court of Moscow; 6) **in South Africa, Namibia, Lesotho and Swaziland**, both of us agree to submit all disputes relating to this Statement of Limited Warranty to the jurisdiction of the High Court in Johannesburg; 7) **in Turkey** all disputes arising out of or in connection with this Statement of Limited Warranty shall be resolved by the Istanbul Central (Sultanahmet) Courts and Execution Directorates of Istanbul, the Republic of Turkey; 8) in each of the following specified countries, any legal claim arising out of this Statement of Limited Warranty will be brought before, and settled exclusively by, the competent court of a) Athens for **Greece**, b) Tel Aviv-Jaffa for **Israel**, c) Milan for **Italy**, d) Lisbon for **Portugal**, and e) Madrid for **Spain**; and 9) **in the United Kingdom**, both of us agree to submit all disputes relating to this Statement of Limited Warranty to the jurisdiction of the English courts.

Arbitration: *The following is added under this heading:*

In Albania, Armenia, Azerbaijan, Belarus, Bosnia-Herzegovina, Bulgaria, Croatia, Georgia, Hungary, Kazakhstan, Kyrgyzstan, FYR Macedonia, Moldova,

Poland, Romania, Russia, Slovakia, Slovenia, Tajikistan, Turkmenistan, Ukraine, Uzbekistan, and FR Yugoslavia all disputes arising out of this Statement of Limited Warranty or related to its violation, termination or nullity will be finally settled under the Rules of Arbitration and Conciliation of the International Arbitral Center of the Federal Economic Chamber in Vienna (Vienna Rules) by three arbitrators appointed in accordance with these rules. The arbitration will be held in Vienna, Austria, and the official language of the proceedings will be English. The decision of the arbitrators will be final and binding upon both parties. Therefore, pursuant to paragraph 598 (2) of the Austrian Code of Civil Procedure, the parties expressly waive the application of paragraph 595 (1) figure 7 of the Code. IBM may, however, institute proceedings in a competent court in the country of installation.

In Estonia, Latvia and Lithuania all disputes arising in connection with this Statement of Limited Warranty will be finally settled in arbitration that will be held in Helsinki, Finland in accordance with the arbitration laws of Finland then in effect. Each party will appoint one arbitrator. The arbitrators will then jointly appoint the chairman. If arbitrators cannot agree on the chairman, then the Central Chamber of Commerce in Helsinki will appoint the chairman.

EUROPEAN UNION (EU)

THE FOLLOWING TERMS APPLY TO ALL EU COUNTRIES:

Consumers have legal rights under applicable national legislation governing the sale of consumer goods. Such rights are not affected by the warranties provided in this Statement of Limited Warranty.

How to Obtain Warranty Service: *The following is added to this section:*

To obtain warranty service from IBM in EU countries, see the telephone listing in Part 3 - Warranty Information.

You may contact IBM at the following address:

IBM Warranty & Service Quality Dept.
PO Box 30
Spango Valley
Greenock
Scotland PA16 0AH

AUSTRIA, DENMARK, FINLAND, GREECE, ITALY, NETHERLANDS, PORTUGAL, SPAIN, SWEDEN AND SWITZERLAND

Limitation of Liability: *The following replaces the terms of this section in its entirety:*

Except as otherwise provided by mandatory law:

1. IBM's liability for any damages and losses that may arise as a consequence of the fulfillment of its obligations under or in connection with this Statement of Limited Warranty or due to any other cause related to this Statement of Limited Warranty is limited to the compensation of only those damages and losses proved and actually arising as an immediate and direct consequence of the non-fulfillment of such obligations (if IBM is at fault) or of such cause, for a maximum amount equal to the charges you paid for the Machine. For purposes of this item, the term "Machine" includes Machine Code and Licensed Internal Code ("LIC").

The above limitation shall not apply to damages for bodily injuries (including death) and damages to real property and tangible personal property for which IBM is legally liable.

2. **UNDER NO CIRCUMSTANCES IS IBM, ITS SUPPLIERS OR RESELLERS LIABLE FOR ANY OF THE FOLLOWING, EVEN IF INFORMED OF THEIR POSSIBILITY: 1) LOSS OF, OR DAMAGE TO, DATA; 2) INCIDENTAL OR INDIRECT DAMAGES, OR FOR ANY ECONOMIC CONSEQUENTIAL DAMAGES; 3) LOST PROFITS, EVEN IF THEY ARISE AS AN IMMEDIATE CONSEQUENCE OF THE EVENT THAT GENERATED THE DAMAGES; OR 4) LOSS OF BUSINESS, REVENUE, GOODWILL, OR ANTICIPATED SAVINGS.**

FRANCE AND BELGIUM

Limitation of Liability: *The following replaces the terms of this section in its entirety:*

Except as otherwise provided by mandatory law:

1. IBM's liability for any damages and losses that may arise as a consequence of the fulfillment of its obligations under or in connection with this Statement of Limited Warranty is limited to the compensation of only those damages and losses proved and actually arising as an immediate and direct consequence of the non-fulfillment of such obligations (if IBM is at fault), for a maximum amount equal to the charges you paid for the Machine that has caused the damages. For purposes of this item, the term "Machine" includes Machine Code and Licensed Internal Code ("LIC").

The above limitation shall not apply to damages for bodily injuries (including death) and damages to real property and tangible personal property for which IBM is legally liable.

2. **UNDER NO CIRCUMSTANCES IS IBM, ITS SUPPLIERS OR RESELLERS LIABLE FOR ANY OF THE FOLLOWING, EVEN IF INFORMED OF THEIR POSSIBILITY: 1) LOSS OF, OR DAMAGE TO, DATA; 2) INCIDENTAL OR INDIRECT DAMAGES, OR FOR ANY ECONOMIC CONSEQUENTIAL DAMAGES; 3) LOST PROFITS, EVEN IF THEY ARISE AS AN IMMEDIATE CONSEQUENCE OF THE EVENT THAT GENERATED THE DAMAGES; OR 4) LOSS OF BUSINESS, REVENUE, GOODWILL, OR ANTICIPATED SAVINGS.**

THE FOLLOWING TERMS APPLY TO THE COUNTRY SPECIFIED:

AUSTRIA

What this Warranty Covers: *The following replaces the first sentence of the first paragraph of this section:*

The warranty for an IBM Machine covers the functionality of the Machine for its normal use and the Machine's conformity to its Specifications.

The following paragraphs are added to this section:

The warranty period for Machines is 12 months from the date of delivery. The limitation period for consumers in action for breach of warranty is the statutory period as a minimum. In case IBM or your reseller is unable to repair an IBM Machine, you can alternatively ask for a partial refund as far as justified by the reduced value of the unrepaired Machine or ask for a cancellation of the respective agreement for such Machine and get your money refunded.

The second paragraph does not apply.

What IBM Will Do to Correct Problems: *The following is added to this section:*

During the warranty period, transportation for delivery of the failing Machine to IBM will be at IBM's expense.

Limitation of Liability: *The following paragraph is added to this section:*

The limitations and exclusions specified in the Statement of Limited Warranty will not apply to damages caused by IBM with fraud or gross negligence and for express warranty.

The following sentence is added to the end of item 2:

IBM's liability under this item is limited to the violation of essential contractual terms in cases of ordinary negligence.

EGYPT

Limitation of Liability: *The following replaces item 2 in this section:*

as to any other actual direct damages, IBM's liability will be limited to the total amount you paid for the Machine that is the subject of the claim. For purposes of this item, the term "Machine" includes Machine Code and Licensed Internal Code ("LIC").

Applicability of suppliers and resellers (unchanged).

FRANCE

Limitation of Liability: *The following replaces the second sentence of the first paragraph of this section:*

In such instances, regardless of the basis on which you are entitled to claim damages from IBM, IBM is liable for no more than: (items 1 and 2 unchanged).

GERMANY

What this Warranty Covers: *The following replaces the first sentence of the first paragraph of this section:*

The warranty for an IBM Machine covers the functionality of the Machine for its normal use and the Machine's conformity to its Specifications.

The following paragraphs are added to this section:

The minimum warranty period for Machines is twelve months. In case IBM or your reseller is unable to repair an IBM Machine, you can alternatively ask for a partial refund as far as justified by the reduced value of the unrepaired Machine or ask for a cancellation of the respective agreement for such Machine and get your money refunded.

The second paragraph does not apply.

What IBM Will Do to Correct Problems: *The following is added to this section:*

During the warranty period, transportation for delivery of the failing Machine to IBM will be at IBM's expense.

Limitation of Liability: *The following paragraph is added to this section:*

The limitations and exclusions specified in the Statement of Limited Warranty will not apply to damages caused by IBM with fraud or gross negligence and for express warranty.

The following sentence is added to the end of item 2:

IBM's liability under this item is limited to the violation of essential contractual terms in cases of ordinary negligence.

HUNGARY

Limitation of Liability: *The following is added at the end of this section:*

The limitation and exclusion specified herein shall not apply to liability for a breach of contract damaging life, physical well-being, or health that has been caused intentionally, by gross negligence, or by a criminal act.

The parties accept the limitations of liability as valid provisions and state that the Section 314.(2) of the Hungarian Civil Code applies as the acquisition price as well as other advantages arising out of the present Statement of Limited Warranty balance this limitation of liability.

IRELAND

What this Warranty Covers: *The following is added to this section:*

Except as expressly provided in these terms and conditions, all statutory conditions, including all warranties implied, but without prejudice to the generality of the foregoing all warranties implied by the Sale of Goods Act 1893 or the Sale of Goods and Supply of Services Act 1980 are hereby excluded.

Limitation of Liability: *The following replaces the terms of this section in its entirety:*

For the purposes of this section, a "Default" means any act, statement, omission, or negligence on the part of IBM in connection with, or in relation to, the subject matter of this Statement of Limited Warranty in respect of which IBM is legally liable to you, whether in contract or tort. A number of Defaults which together result in, or contribute to, substantially the same loss or damage will be treated as one Default occurring on the date of occurrence of the last such Default.

Circumstances may arise where, because of a Default, you are entitled to recover damages from IBM.

This section sets out the extent of IBM's liability and your sole remedy.

1. IBM will accept unlimited liability for death or personal injury caused by the negligence of IBM.
2. Subject always to the **Items for Which IBM is Not Liable** below, IBM will accept unlimited liability for physical damage to your tangible property resulting from the negligence of IBM.

3. Except as provided in items 1 and 2 above, IBM's entire liability for actual damages for any one Default will not in any event exceed the greater of 1) EUR 125,000, or 2) 125% of the amount you paid for the Machine directly relating to the Default.

Items for Which IBM is Not Liable

Save with respect to any liability referred to in item 1 above, under no circumstances is IBM, its suppliers or resellers liable for any of the following, even if IBM or they were informed of the possibility of such losses:

1. loss of, or damage to, data;
2. special, indirect, or consequential loss; or
3. loss of profits, business, revenue, goodwill, or anticipated savings.

SLOVAKIA

Limitation of Liability: *The following is added to the end of the last paragraph:*

The limitations apply to the extent they are not prohibited under §§ 373-386 of the Slovak Commercial Code.

SOUTH AFRICA, NAMIBIA, BOTSWANA, LESOTHO AND SWAZILAND

Limitation of Liability: *The following is added to this section:*

IBM's entire liability to you for actual damages arising in all situations involving nonperformance by IBM in respect of the subject matter of this Statement of Warranty will be limited to the charge paid by you for the individual Machine that is the subject of your claim from IBM.

UNITED KINGDOM

Limitation of Liability: *The following replaces the terms of this section in its entirety:*

For the purposes of this section, a "Default" means any act, statement, omission, or negligence on the part of IBM in connection with, or in relation to, the subject matter of this Statement of Limited Warranty in respect of which IBM is legally liable to you, whether in contract or tort. A number of Defaults which together result in, or contribute to, substantially the same loss or damage will be treated as one Default.

Circumstances may arise where, because of a Default, you are entitled to recover damages from IBM.

This section sets out the extent of IBM's liability and your sole remedy.

1. IBM will accept unlimited liability for:
 - a. death or personal injury caused by the negligence of IBM; and
 - b. any breach of its obligations implied by Section 12 of the Sale of Goods Act 1979 or Section 2 of the Supply of Goods and Services Act 1982, or any statutory modification or re-enactment of either such Section.
2. IBM will accept unlimited liability, subject always to the **Items for Which IBM is Not Liable** below, for physical damage to your tangible property resulting from the negligence of IBM.
3. IBM's entire liability for actual damages for any one Default will not in any event, except as provided in items 1 and 2 above, exceed the greater of 1) Pounds

Sterling 75,000, or 2) 125% of the total purchase price payable or the charges for the Machine directly relating to the Default.

These limits also apply to IBM's suppliers and resellers. They state the maximum for which IBM and such suppliers and resellers are collectively responsible.

Items for Which IBM is Not Liable

Save with respect to any liability referred to in item 1 above, under no circumstances is IBM or any of its suppliers or resellers liable for any of the following, even if IBM or they were informed of the possibility of such losses:

1. loss of, or damage to, data;
2. special, indirect, or consequential loss; or
3. loss of profits, business, revenue, goodwill, or anticipated savings.

Part 3 - Warranty Information

This Part 3 provides information regarding the warranty applicable to your Machine, including the warranty period and type of warranty service IBM provides.

Warranty Period

The warranty period may vary by country or region and is specified in the table below.

Note: "Region" means either Hong Kong or Macau Special Administrative Region of China.

Machine - IBM @server xSeries 255

Country or Region of Purchase	Warranty Period	Type of Warranty Service*
Japan	Parts - 3 year, labor - 1 year	2
Worldwide	Parts - 3 year, labor - 3 year	2

* See "[Types of Warranty Service](#)" for the legend and explanations of warranty-service types.

A warranty period of 3 years on parts and 1 year on labor means that IBM provides warranty service without charge for:

1. parts and labor during the first year of the warranty period; and
2. parts only, on an exchange basis, in the second and third years of the warranty period. IBM will charge you for any labor provided in performance of the repair or replacement(s) in the second and third year of the warranty period.

Types of Warranty Service

If required, IBM provides repair or exchange service depending on the type of warranty service specified for your Machine in the above table and as described below. Warranty service may be provided by your reseller if approved by IBM to perform warranty service. Scheduling of service will depend upon the time of your call and is subject to parts availability. Service levels are response time objectives and are not guaranteed. The specified level of warranty service may not be

available in all worldwide locations, additional charges may apply outside IBM's normal service area, contact your local IBM representative or your reseller for country and location specific information.

1. Customer Replaceable Unit ("CRU") Service

IBM will ship CRU parts to you for your replacement. If IBM instructs you to return the replaced CRU, you are responsible for returning it to IBM in accordance with IBM's instructions. If you do not return the defective CRU, if IBM so instructs, within 30 days of your receipt of the replacement CRU, IBM may charge you for the replacement.

2. On-site Service

IBM or your reseller will either repair or exchange the failing Machine at your location and verify its operation. You must provide suitable working area to allow disassembly and reassembly of the IBM Machine. The area must be clean, well lit and suitable for the purpose. **For some Machines, certain repairs may require sending the Machine to an IBM service center.**

3. Courier or Depot Service*

You will disconnect the failing Machine for collection arranged by IBM. IBM will provide you with a shipping container for you to return your Machine to a designated service center. A courier will pick up your Machine and deliver it to the designated service center. Following its repair or exchange, IBM will arrange the return delivery of the Machine to your location. You are responsible for its installation and verification.

4. Customer Carry-In or Mail-In Service

You will deliver or mail as IBM specifies (prepaid unless IBM specifies otherwise) the failing Machine suitably packaged to a location IBM designates. After IBM has repaired or exchanged the Machine, IBM will make it available for your collection or, for Mail-in Service, IBM will return it to you at IBM's expense, unless IBM specifies otherwise. You are responsible for the subsequent installation and verification of the Machine.

* This type of service is called ThinkPad® EasyServ or EasyServ in some countries.

The IBM Machine Warranty World Wide Web site at http://www.ibm.com/servers/support/machine_warranties/ provides a worldwide overview of IBM Limited Warranty for Machines, a Glossary of IBM definitions, Frequently Asked Questions (FAQs) and Support by Product (Machine) with links to Product Support pages. **The IBM Statement of Limited Warranty is also available on this site in 29 languages.**

To obtain warranty service contact IBM or your IBM reseller. In Canada or the United States, call 1-800-IBM-SERV (426-7378). In the EU countries, see the telephone numbers below.

EU Country Telephone List

Phone numbers are subject to change without notice.

Austria -- 43-1-24592-5901	Italy -- 39-02-482-9202
Belgium -- 02-718-4339	Luxembourg -- 352-360385-1
Denmark -- 4520-8200	Netherlands -- 020-514-5770
Finland -- 358-9-4591	Portugal -- 351-21-7915-147
France -- 0238-557-450	Spain -- 34-91-662-4916
Germany -- 07032-15-4920	Sweden -- 46-8-477-4420

Greece -- 30-210-688-1220	United Kingdom -- 01475-555-055
Ireland -- 353-1-815-4000	

Appendix C. Notices

This publication was developed for products and services offered in the U.S.A.

IBM may not offer the products, services, or features discussed in this document in other countries. Consult your local IBM representative for information on the products and services currently available in your area. Any reference to an IBM product, program, or service is not intended to state or imply that only that IBM product, program, or service may be used. Any functionally equivalent product, program, or service that does not infringe any IBM intellectual property right may be used instead. However, it is the user's responsibility to evaluate and verify the operation of any non-IBM product, program, or service.

IBM may have patents or pending patent applications covering subject matter described in this document. The furnishing of this document does not give you any license to these patents. You can send license inquiries, in writing, to:

*IBM Director of Licensing
IBM Corporation
North Castle Drive
Armonk, NY 10504-1785
U.S.A.*

INTERNATIONAL BUSINESS MACHINES CORPORATION PROVIDES THIS PUBLICATION "AS IS" WITHOUT WARRANTY OF ANY KIND, EITHER EXPRESS OR IMPLIED, INCLUDING, BUT NOT LIMITED TO, THE IMPLIED WARRANTIES OF NON-INFRINGEMENT, MERCHANTABILITY OR FITNESS FOR A PARTICULAR PURPOSE. Some jurisdictions do not allow disclaimer of express or implied warranties in certain transactions, therefore, this statement may not apply to you.

This information could include technical inaccuracies or typographical errors. Changes are periodically made to the information herein; these changes will be incorporated in new editions of the publication. IBM may make improvements and/or changes in the product(s) and/or the program(s) described in this publication at any time without notice.

Any references in this publication to non-IBM Web sites are provided for convenience only and do not in any manner serve as an endorsement of those Web sites. The materials at those Web sites are not part of the materials for this IBM product, and use of those Web sites is at your own risk.

IBM may use or distribute any of the information you supply in any way it believes appropriate without incurring any obligation to you.

Edition notice

© COPYRIGHT INTERNATIONAL BUSINESS MACHINES CORPORATION, 2003.
All rights reserved.

Note to U.S. Government Users — Documentation related to restricted rights —
Use, duplication or disclosure is subject to restrictions set forth in GSA ADP
Schedule Contract with IBM Corp.

Trademarks

The following terms are trademarks of International Business Machines Corporation in the United States, other countries, or both:

Active Memory	PS/2 [®]
Active PCI	ServeRAID
Active PCI-X	ServerGuide
Alert on LAN [™]	ServerProven
C2T Interconnect	TechConnect [®]
Chipkill [™]	Tivoli [®]
EtherJet [™]	Tivoli Enterprise [™]
e-business logo	Update Connector [™]
FlashCopy [®]	Wake on LAN
IBM	XA-32
Light Path Diagnostics	XA-64
NetBAY	X-Architecture
Netfinity [®]	XceL4
NetView [®]	XpandOnDemand
OS/2 WARP [®]	xSeries
Predictive Failure Analysis [®]	

Lotus[®], Lotus Notes[®], and Domino[™] are trademarks of Lotus Development Corporation and/or IBM Corporation in the United States, other countries, or both.

Intel, Celeron, LANDesk[®], MMX[™], NetBurst, Pentium[®], Pentium II Xeon, Pentium III Xeon, and Xeon are trademarks of Intel Corporation in the United States, other countries, or both.

Microsoft[®], Windows[®], and Windows NT[®] are trademarks of Microsoft Corporation in the United States, other countries, or both.

UNIX[®] is a registered trademark of The Open Group in the United States and other countries.

Java[™] and all Java-based trademarks and logos are trademarks or registered trademarks of Sun Microsystems, Inc. in the United States, other countries, or both.

Linux is a registered trademark of Linus Torvalds.

Other company, product, or service names may be the trademarks or service marks of others.

Important notes

Processor speeds indicate the internal clock speed of the microprocessor; other factors also affect application performance.

CD-ROM drive speeds list the variable read rate. Actual speeds vary and are often less than the maximum possible.

When referring to processor storage, real and virtual storage, or channel volume, KB stands for approximately 1000 bytes, MB stands for approximately 1 000 000 bytes, and GB stands for approximately 1 000 000 000 bytes.

When referring to hard disk drive capacity or communications volume, MB stands for 1 000 000 bytes, and GB stands for 1 000 000 000 bytes. Total user-accessible capacity may vary depending on operating environments.

Maximum internal hard disk drive capacities assume the replacement of any standard hard disk drives and population of all hard disk drive bays with the largest currently supported drives available from IBM.

Maximum memory may require replacement of the standard memory with an optional memory module.

IBM makes no representation or warranties regarding non-IBM products and services that are ServerProven, including but not limited to the implied warranties of merchantability and fitness for a particular purpose. These products are offered and warranted solely by third parties.

IBM makes no representations or warranties with respect to non-IBM products. Support (if any) for the non-IBM products is provided by the third party, not IBM.

Some software may differ from its retail version (if available), and may not include user manuals or all program functionality.

Electronic emission notices

Federal Communications Commission (FCC) statement

Note: This equipment has been tested and found to comply with the limits for a Class A digital device, pursuant to Part 15 of the FCC Rules. These limits are designed to provide reasonable protection against harmful interference when the equipment is operated in a commercial environment. This equipment generates, uses, and can radiate radio frequency energy and, if not installed and used in accordance with the instruction manual, may cause harmful interference to radio communications. Operation of this equipment in a residential area is likely to cause harmful interference, in which case the user will be required to correct the interference at his own expense.

Properly shielded and grounded cables and connectors must be used in order to meet FCC emission limits. Properly shielded and grounded cables and connectors must be used in order to meet FCC emission limits. IBM is not responsible for any radio or television interference caused by using other than recommended cables and connectors or by using other than recommended cables and connectors or by unauthorized changes or modifications to this equipment. Unauthorized changes or modifications could void the user's authority to operate the equipment.

This device complies with Part 15 of the FCC Rules. Operation is subject to the following two conditions: (1) this device may not cause harmful interference, and (2) this device must accept any interference received, including interference that may cause undesired operation.

Industry Canada Class A emission compliance statement

This Class A digital apparatus complies with Canadian ICES-003.

Avis de conformité à la réglementation d'Industrie Canada

Cet appareil numérique de la classe A est conforme à la norme NMB-003 du Canada.

Australia and New Zealand Class A statement

Attention: This is a Class A product. In a domestic environment this product may cause radio interference in which case the user may be required to take adequate measures.

United Kingdom telecommunications safety requirement

Notice to Customers

This apparatus is approved under approval number NS/G/1234/J/100003 for indirect connection to public telecommunication systems in the United Kingdom.

European Union EMC Directive conformance statement

This product is in conformity with the protection requirements of EU Council Directive 89/336/EEC on the approximation of the laws of the Member States relating to electromagnetic compatibility. IBM cannot accept responsibility for any failure to satisfy the protection requirements resulting from a nonrecommended modification of the product, including the fitting of non-IBM option cards.

This product has been tested and found to comply with the limits for Class A Information Technology Equipment according to CISPR 22/European Standard EN 55022. The limits for Class A equipment were derived for commercial and industrial environments to provide reasonable protection against interference with licensed communication equipment.

Attention: This is a Class A product. In a domestic environment this product may cause radio interference in which case the user may be required to take adequate measures.

Taiwanese Class A warning statement

警告使用者：
這是甲類的資訊產品，在居住的環境中使用時，可能會造成射頻干擾，在這種情況下，使用者會被要求採取某些適當的對策。

Japanese Voluntary Control Council for Interference (VCCI) statement

この装置は、情報処理装置等電波障害自主規制協議会（VCCI）の基準に基づくクラスA情報技術装置です。この装置を家庭環境で使用すると電波妨害を引き起こすことがあります。この場合には使用者が適切な対策を講ずるよう要求されることがあります。

Power cords

For your safety, IBM provides a power cord with a grounded attachment plug to use with this IBM product. To avoid electrical shock, always use the power cord and plug with a properly grounded outlet.

IBM power cords used in the United States and Canada are listed by Underwriter's Laboratories (UL) and certified by the Canadian Standards Association (CSA).

For units intended to be operated at 115 volts: Use a UL-listed and CSA-certified cord set consisting of a minimum 18 AWG, Type SVT or SJT, three-conductor cord, a maximum of 15 feet in length and a parallel blade, grounding-type attachment plug rated 15 amperes, 125 volts.

For units intended to be operated at 230 volts (U.S. use): Use a UL-listed and CSA-certified cord set consisting of a minimum 18 AWG, Type SVT or SJT, three-conductor cord, a maximum of 15 feet in length and a tandem blade, grounding-type attachment plug rated 15 amperes, 250 volts.

For units intended to be operated at 230 volts (outside the U.S.): Use a cord set with a grounding-type attachment plug. The cord set should have the appropriate safety approvals for the country in which the equipment will be installed.

IBM power cords for a specific country or region are usually available only in that country or region.

IBM power cord part number	Used in these countries and regions
13F9940	Argentina, Australia, China (PRC), New Zealand, Papua New Guinea, Paraguay, Uruguay, Western Samoa
13F9979	Afghanistan, Algeria, Andorra, Angola, Austria, Belgium, Benin, Bulgaria, Burkina Faso, Burundi, Cameroon, Central African Rep., Chad, China (Macau S.A.R.), Czech Republic, Egypt, Finland, France, French Guiana, Germany, Greece, Guinea, Hungary, Iceland, Indonesia, Iran, Ivory Coast, Jordan, Lebanon, Luxembourg, Malagasy, Mali, Martinique, Mauritania, Mauritius, Monaco, Morocco, Mozambique, Netherlands, New Caledonia, Niger, Norway, Poland, Portugal, Romania, Senegal, Slovakia, Spain, Sudan, Sweden, Syria, Togo, Tunisia, Turkey, former USSR, Vietnam, former Yugoslavia, Zaire, Zimbabwe
13F9997	Denmark
14F0015	Bangladesh, Burma, Pakistan, South Africa, Sri Lanka

IBM power cord part number	Used in these countries and regions
14F0033	Antigua, Bahrain, Brunei, Channel Islands, China (Hong Kong S.A.R.), Cyprus, Dubai, Fiji, Ghana, India, Iraq, Ireland, Kenya, Kuwait, Malawi, Malaysia, Malta, Nepal, Nigeria, Polynesia, Qatar, Sierra Leone, Singapore, Tanzania, Uganda, United Kingdom, Yemen, Zambia
14F0051	Liechtenstein, Switzerland
14F0069	Chile, Ethiopia, Italy, Libya, Somalia
14F0087	Israel
1838574	Thailand
6952301	Bahamas, Barbados, Bermuda, Bolivia, Brazil, Canada, Cayman Islands, Colombia, Costa Rica, Dominican Republic, Ecuador, El Salvador, Guatemala, Guyana, Haiti, Honduras, Jamaica, Japan, Korea (South), Liberia, Mexico, Netherlands Antilles, Nicaragua, Panama, Peru, Philippines, Saudi Arabia, Suriname, Taiwan, Trinidad (West Indies), United States of America, Venezuela

Index

A

- AC power LED 27
- acoustical noise emissions 2
- ACT (activity) LED 26
- activity LEDs
 - CD-ROM drive 26
 - diskette drive 26
 - server 26
- adapter
 - cabling 8, 11
 - considerations 5
 - hot-plug devices 6
 - installing 5, 6
 - RAID 8, 10, 11
 - SCSI 8, 10, 11
 - SCSI connectors 11
 - specifications 2
- air baffle
 - removing 8
- airflow guide
 - memory board 13
 - microprocessor 9

B

- backplane, SCSI 11
- baffle
 - air 8
 - microprocessor 19
 - VRM 19
- beep codes 35

C

- cable
 - routing 23
 - SCSI 8, 11
- cabling
 - adapters 8, 11
 - external 23
 - the server 23
- CD
 - eject button 26
- CD-ROM drive
 - activity LED 26
 - specifications 2
- Class A electronic emission notice 63
- components
 - major 3
- configuration
 - Configuration/Setup Utility 31
 - hardware, cabling for 23
 - SCSI and RAID programs 31
 - server 31
 - ServerGuide CD 31
- Configuration/Setup Utility program 31
- configuring your server 31

- controls and indicators 25
- cooling 2

D

- DC power LED 27
- DIMM.
 - See memory module
- diskette
 - eject button 26
- diskette drive
 - activity LED 26
 - specifications 2
- documentation CD 1

E

- eject button
 - CD 26
 - diskette 26
- electrical input 2
- electronic emission Class A notice 63
- environment 2
- error messages
 - POST 36
- Ethernet activity LED 27
- Ethernet link LED 27
- external
 - cabling 23
 - connectors 23

F

- fan
 - power-supply bay 21
- FAULT (system-error) LED 26
- FCC Class A notice 63
- features 2

H

- hard disk drive activity LED 26
- hard disk drive status LED 26
- heat output 2
- Hot Spare Memory feature 12
- hot-plug adapter.
 - See adapter
- hot-swap and hot-plug devices
 - adapters 6
 - drives 15
 - power supplies 20
- hot-swap drive
 - installing 15
 - specifications 2
- hot-swap fan error LED 27
- hot-swap power supply
 - installing 20

I

- INFO (information) LED 26
- information LED 26
- installation order
 - memory modules 13
 - microprocessors 17
 - VRMs 17
- installing
 - hot-plug adapter 6
 - hot-swap drive 15
 - hot-swap power supply 20
 - microprocessors 18
 - VRMs 18

L

- LEDs
 - AC power 27
 - activity 26
 - CD-ROM drive activity 26
 - DC power 27
 - diskette drive activity 26
 - Ethernet activity 27
 - Ethernet link 27
 - front view 25
 - hard disk drive activity 26
 - hard disk drive status 26
 - hot-swap fan error 27
 - information 26
 - power-on 25
 - rear view 27
 - system error 26
 - system power 25
- lights.
 - See LEDs

M

- major components 3
- memory
 - installing 12
 - specifications 2
- memory board
 - airflow guide 13
- memory module
 - installing 12
 - order of installation 13
 - specifications 2
 - supported 12
- memory-board assembly
 - removing 13
- microprocessor
 - airflow guide 9
 - baffle 19
 - heat sink 19
 - installing 17
 - order of installation 17
 - socket cover 19
 - specifications 2
 - VRM 18

N

- NOS.
 - See operating system
- notes, important 62
- notices
 - electronic emission 63
 - FCC, Class A 63
 - used in this book 2

O

- operating system, installing 33
- order of installation
 - memory modules 13
 - microprocessors 17
 - VRMs 17

P

- PCI and PCI-X devices
 - considerations 5
- PCI bus speeds 5
- PCI-X expansion slots 2
- POST error messages 36
- power supply
 - installing 20
 - operating requirements 20
 - specifications 2
- power-control button 25
- power-control button shield 25, 28
- power-on LED 25
- problems, solving 35

R

- RAID adapter
 - cabling 8, 11
 - installing 10
- RAID configuration program 31
- removing
 - air baffle 8
 - cable-management arm bracket 8
 - memory-board assembly 13
 - shuttle assembly 10
- reset button 26

S

- SCSI adapter
 - cabling 8, 11
 - installing 10
- SCSI and RAID programs 31
- SCSI connectors
 - adapter 11
 - system board 10
- SCSISelect Utility program 31, 32
- ServerGuide
 - CD 31, 33
 - error symptoms 37

- shield
 - power-control button 25, 28
- shutting down the server 29
- shuttle assembly
 - removing 10
 - unlocking 10
- size 2
- solving problems 35
- specifications 2
- Standby mode 30
- starting the server 25, 28
- status LEDs 25, 27
- stopping the server 29
- system information LED 26
- system power LED 25
- system-error LED 26

T

- temperature 2
- trademarks 62
- troubleshooting chart 38
- turning off the server 29
- turning on the server 28

U

- United States electronic emission Class A notice 63
- United States FCC Class A notice 63
- unlocking
 - shuttle assembly 10

V

- video controller 2
- video specifications 2
- voltage regulator module
 - installation order 17
 - installing 18
- VRM
 - See voltage regulator module

W

- Web site
 - product information 1
- weight 2
- working inside a server with the power on 5



Part Number: 88P9204

Printed in U.S.A.

SC88-P920-40



(1P) P/N: 88P9204

