

IBM TotalStorage DS4000



Hard Drive and Storage Expansion Enclosure Installation and Migration Guide

IBM TotalStorage DS4000



Hard Drive and Storage Expansion Enclosure Installation and Migration Guide

Note:

Before using this information and the product it supports, be sure to read the general information in “Notices” on page 123.

Fourth Edition (February 2006)

This edition applies to DS4000 Storage Manager Version 9.16 software release levels and to all subsequent releases and modifications until otherwise indicated in new editions.

© Copyright International Business Machines Corporation 2006. All rights reserved.

US Government Users Restricted Rights – Use, duplication or disclosure restricted by GSA ADP Schedule Contract with IBM Corp.

Safety

The caution and danger statements that this document contains can be referenced in the multilingual *IBM® Safety Information* document that is provided with every IBM TotalStorage® DS4000 Storage Subsystem. Each caution and danger statement is numbered for easy reference to the corresponding statements in the translated document.

- **Danger:** These statements indicate situations that can be potentially lethal or extremely hazardous to you. A danger statement is placed just before the description of a potentially lethal or extremely hazardous procedure, step, or situation.
- **Caution:** These statements indicate situations that can be potentially hazardous to you. A caution statement is placed just before the description of a potentially hazardous procedure step or situation.
- **Attention:** These notices indicate possible damage to programs, devices, or data. An attention notice is placed just before the instruction or situation in which damage could occur.

Before installing this product, read the following danger and caution notices.

Statement 1:



DANGER

Electrical current from power, telephone, and communication cables is hazardous.

To avoid a shock hazard:

- **Do not connect or disconnect any cables or perform installation, maintenance, or reconfiguration of this product during an electrical storm.**
- **Connect all power cords to a properly wired and grounded electrical outlet.**
- **Connect to properly wired outlets any equipment that will be attached to this product.**
- **When possible, use one hand only to connect or disconnect signal cables.**
- **Never turn on any equipment when there is evidence of fire, water, or structural damage.**
- **Disconnect the attached power cords, telecommunications systems, networks, and modems before you open the device covers, unless instructed otherwise in the installation and configuration procedures.**
- **Connect and disconnect cables as described in the following table when installing, moving, or opening covers on this product or attached devices.**

To Connect:	To Disconnect:
<ol style="list-style-type: none">1. Turn everything OFF.2. First, attach all cables to devices.3. Attach signal cables to connectors.4. Attach power cords to outlet.5. Turn device ON.	<ol style="list-style-type: none">1. Turn everything OFF.2. First, remove power cords from outlet.3. Remove signal cables from connectors.4. Remove all cables from devices.

Statement 3:



CAUTION:

When laser products (such as CD-ROMs, DVD drives, fiber optic devices, or transmitters) are installed, note the following:

- Do not remove the covers. Removing the covers of the laser product could result in exposure to hazardous laser radiation. There are no serviceable parts inside the device.
- Use of controls or adjustments or performance of procedures other than those specified herein might result in hazardous radiation exposure.



DANGER

Some laser products contain an embedded Class 3A or Class 3B laser diode. Note the following.

Laser radiation when open. Do not stare into the beam, do not view directly with optical instruments, and avoid direct exposure to the beam.



Class 1 Laser statement

Class 1 Laser Product
Laser Klasse 1
Laser Klasse 1
Luokan 1 Laserlaitte
Appareil À Laser de Classe 1

IEC 825-11993 CENELEC EN 60 825

Statement 4:



		
≥ 18 kg (39.7 lb)	≥ 32 kg (70.5 lb)	≥ 55 kg (121.2 lb)

CAUTION:

Use safe practices when lifting.

Statement 5:



CAUTION:

The power control button on the device and the power switch on the power supply do not turn off the electrical current supplied to the device. The device also might have more than one power cord. To remove all electrical current from the device, ensure that all power cords are disconnected from the power source.

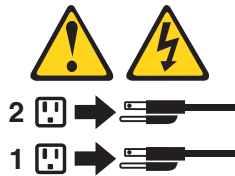

Statement 8:



CAUTION:

Never remove the cover on a power supply or any part that has the following label attached.



Hazardous voltage, current, and energy levels are present inside any component that has this label attached. There are no serviceable parts inside these components. If you suspect a problem with one of these parts, contact a service technician.

Contents

Safety	iii
Figures	xiii
Tables	xv
About this document	xvii
FAST product renaming	xvii
Who should read this document	xviii
Illustrations	xviii
Using this document	xviii
DS4000 installation process overview	xix
DS4000 Storage Subsystem publications	xix
DS4500 Storage Server library	xx
DS4400 Storage Server library	xxi
DS4300 Storage Server library	xxii
DS4100 Storage Server library	xxiii
DS4800 Storage Subsystem library	xxiv
DS4000 Storage Manager Version 9 publications	xxv
Other DS4000 and DS4000-related documents	xxvi
How to send your comments	xxvii
Chapter 1. Introduction	1
Intermixing storage expansion enclosures	3
Intermixing EXP500 and EXP700 storage expansion enclosures	9
Intermixing EXP700 or EXP100 and EXP710 storage expansion enclosures	11
Intermixing EXP810 and EXP710 storage expansion enclosures	16
IBM TotalStorage DS4000 Fibre Channel and Serial ATA Intermix Premium Feature	20
The FC/SATA Intermix premium feature installation	21
Restrictions	25
DS4000 Storage Subsystem drive loop schemes	27
Setting enclosure IDs	32
Determining firmware levels	37
Method one:	37
Method two:	38
Determining the product ID and model of a drive	38
DS4000 Storage Manager installation and support guides	39
Chapter 2. Prerequisites to adding capacity and hard drive migration	41
Verifying controller, NVSRAM, and ESM firmware file levels	42
Upgrading drive firmware levels	46
Downloading drive firmware	46
Bringing storage subsystems and drive loops into optimal state	49
Saving the storage subsystem profile	50
Handling static-sensitive devices	51
Chapter 3. Adding one or more new hard drives	53
Activity 1: Disabling the drive migration settings	54
Activity 2: Inserting drives	54
Activity 3: Re-enabling the drive migration settings	55
Chapter 4. Migrating one or more hard drives	59

Activity 1: Verifying the drive migration enable settings	60
Activity 2: Preliminary activities	60
Activity 3: Removing the drives to be migrated	62
Activity 4: Inserting the drives to be migrated	63
Migrating arrays within storage subsystems	64
Chapter 5. Adding expansion enclosures containing new hard drives	69
Activity 1: Preliminary activities	70
Activity 2: Cabling new storage expansion enclosures	72
Connecting new storage expansion enclosures at the end (bottom) of a drive loop	73
Connecting new storage expansion enclosures at the beginning (top) of a drive loop	79
Activity 3: Disabling DS4000 Storage Subsystem drive migration settings	85
Activity 4: Inserting drives and cabling additional storage expansion enclosures	85
Activity 5: Re-enabling drive migration settings	90
Chapter 6. Migrating expansion enclosures containing hard drives	93
Activity 1: Preliminary activities	94
Activity 2: Preparing and backing up the drives	95
Activity 3: Shutting down and moving the storage expansion unit	96
Activity 4: Verifying the drive migration enable settings	97
Activity 5: Installing and setting storage expansion unit IDs and speeds	97
Activity 6: Cabling, powering on, and verifying storage expansion unit operation	98
Connecting new storage expansion enclosures at the end (bottom) of a drive loop	99
Connecting new storage expansion enclosures at the beginning (top) of a drive loop	103
Activity 7: Inserting hard drives and placing logical drives online	108
Chapter 7. Upgrading a storage subsystem in a functioning configuration	111
Preliminary considerations: Storage Subsystem upgrade	111
Preliminary considerations: Firmware behavior during subsystem upgrade	115
DS4000 configuration behavior after upgrade and DS4000 Storage Subsystem replacement	115
Redeployed DS4000 configuration behavior in an original (replaced) DS4000 Storage Subsystem	116
Upgrading storage subsystems in functioning DS4000 configurations	117
Activity 1: Preliminary activities	117
Activity 2: Powering off the original DS4000 Storage Subsystem	119
Activity 3: Installing new DS4000 Storage Subsystems and setting minihub speed	119
Activity 4: Making connections	119
Activity 5: Powering on the expansion unit and setting IP addresses	119
Activity 6: Downloading firmware and NVSRAM and returning arrays online	121
Activity 7: Generating and applying premium feature SAFE key files	121
Redeploying the original (replaced) DS4000 Storage Subsystem	121
Accessing the DS4000 Storage Subsystem controller shell	121
Notices	123
Trademarks.	123
Important notes	124
Electronic emission notices	124
Federal Communications Commission (FCC) statement	124
Chinese class A compliance statement.	125
Industry Canada Class A emission compliance statement.	125

Australia and New Zealand Class A statement	125
United Kingdom telecommunications safety requirement	125
European Union EMC Directive conformance statement	125
Taiwan Class A warning statement	126
Japanese Voluntary Control Council for Interference (VCCI) statement	126
Glossary	127
Index	137

Figures

1. Installation process flow by current publications	xix
2. DS4000 EXP500 and EXP700 cabling in a mixed configuration.	10
3. Acceptable intermixed EXP700 (or EXP100) and EXP710 loop configuration (1 of 3).	12
4. Acceptable intermixed EXP700 (or EXP100) and EXP710 loop configuration (2 of 3).	13
5. Acceptable (not recommended) intermixed EXP700 (or EXP100) and EXP710 loop configuration (3 of 3)	14
6. Unacceptable intermixed EXP700 (or EXP100) and EXP710 loop configuration (1 of 2).	15
7. Unacceptable intermixed EXP700 (or EXP100) and EXP710 loop configuration (2 of 2).	16
8. Acceptable intermixed DS4000 EXP710 and EXP810 loop configuration	18
9. Acceptable intermixed DS4000 EXP710 and EXP810 loop configuration	19
10. Preferred intermixed DS4000 EXP710 and EXP810 loop configuration	20
11. Correct and incorrect ways to group DS4000 storage expansion enclosures in a redundant drive loop	26
12. Recommended cable loop scheme for connecting DS4000 storage devices	28
13. Not recommended alternate cable loop scheme for when connecting DS4000 storage devices	29
14. Not recommended alternate cable loop scheme for connecting DS4000 storage devices	30
15. Unacceptable cable loop scheme for connecting DS4000 storage devices.	31
16. Unacceptable cable loop scheme for connecting DS4000 storage devices.	32
17. EnableDriveMigration.scr file listing	56
18. DisableDriveMigration.scr file listing	57
19. Drive CRU assembly	63
20. Manner recommended for reordering a defined array using empty slots in one storage enclosure	65
21. Manner recommended for reordering a defined array using empty slots in two storage enclosures	65
22. Reordering multiple defined arrays across previously used slots in two storage enclosures	66
23. Subsystem Management Logical/Physical View of missing logical drives	66
24. EXP100, EXP500, EXP700, and EXP710 enclosure ID and speed switches	71
25. Cabling a single drive enclosure to the end of a functioning drive loop (step 1 of 3)	75
26. Cabling a single drive enclosure to the end of a functioning drive loop (step 2 of 3)	76
27. Cabling a single drive enclosure to the end of a functioning drive loop (step 3 of 3)	77
28. Cabling an EXP810 to the end of a functioning drive loop.	78
29. Cabling a single drive enclosure to the beginning of a functioning drive loop (step 1 of 3)	81
30. Cabling a single drive enclosure to the beginning of a functioning drive loop (step 2 of 3)	82
31. Cabling a single drive enclosure to the beginning of a functioning drive loop (step 3 of 3)	83
32. Cabling an EXP810 to the top of a functioning drive loop	84
33. Cabling a second drive enclosure to the end of a functioning drive loop.	86
34. Cabling a second drive enclosure to the beginning of a functioning drive loop	87
35. Recommended connection: Planned cabling of additional drive enclosures to the beginning of a functioning drive loop	88
36. Cabling a second EXP810 drive enclosure to the end of a functioning drive loop	89
37. Cabling a second EXP810 drive enclosure to the top of a functioning drive loop	90
38. Cabling a single drive enclosure to the end of a functioning drive loop (step 1 of 3).	101
39. Cabling a single drive enclosure to the end of a functioning drive loop (step 2 of 3).	102
40. Cabling a single drive enclosure to the end of a functioning drive loop (step 3 of 3).	103
41. Cabling a single drive enclosure to the beginning of a functioning drive loop (step 1 of 3)	106
42. Cabling a single drive enclosure to the beginning of a functioning drive loop (step 2 of 3)	107
43. Cabling a single drive enclosure to the beginning of a functioning drive loop (step 3 of 3)	108

Tables

1. Mapping of FAStT names to DS4000 Series names.	xvii
2. TotalStorage DS4500 Fibre Channel Storage Server document titles by user tasks	xx
3. TotalStorage DS4400 Fibre Channel Storage Server document titles by user tasks	xxi
4. TotalStorage DS4300 Fibre Channel Storage Server document titles by user tasks	xxii
5. TotalStorage DS4100 SATA Storage Server document titles by user tasks	xxiii
6. TotalStorage DS4800 Storage Subsystem document titles by user tasks	xxiv
7. TotalStorage DS4000 Storage Manager Version 9 titles by user tasks	xxv
8. TotalStorage DS4000 and DS4000–related document titles by user tasks	xxvi
9. Maximum allowable drives and drive loop pairs in DS4000 storage servers.	1
10. Mixed DS4000 expansion enclosure compatibility in storage subsystems by model	4
11. DS4000 expansion enclosure compatibility with DS4000 Storage Subsystems by model	5
12. DS4000 drive expansion enclosure models compatible in intermixed loop configurations only when contiguously grouped.	8
13. Supported EXP500 and EXP700 enclosure combinations per redundant drive loop pair	11
14. Supported EXP810 and EXP710 enclosure combinations per redundant drive channel/loop pair	17
15. ESM firmware levels by storage expansion enclosure type	22
16. Firmware versions based on storage subsystem controller type.	22
17. Drive types and their corresponding DS4000 Storage Subsystem and storage expansion enclosures	27
18. EXP500 Storage Expansion Enclosure ID settings	33
19. EXP100 Storage Expansion Enclosure ID settings	34
20. EXP700 or EXP710 Storage Expansion Enclosure ID settings	34
21. Intermixed EXP500 and EXP700 Storage Expansion Enclosure ID settings	35
22. Intermixed EXP700 and EXP710 Storage Expansion Enclosure ID settings	36
23. EXP810 only or intermixed EXP700 and EXP710 Storage Expansion Enclosure ID settings	36
24. Snapshot of profile information identifying the product ID of the drive in slot 1 of enclosure ID 1 as ST3146807FC.	39
25. Compatible controller firmware and NVSRAM version by machine type and model number	43
26. Compatible expansion unit ESM firmware version by machine type and model number	45
27. DS4000 storage Subsystems by their supported replacements	113

About this document

This document describes procedures for adding new Fibre Channel or SATA hard drives or new IBM TotalStorage DS4000 drive expansion enclosures containing new Fibre Channel or SATA hard drives to an existing IBM DS4000 Storage Subsystem configuration. This document also describes the procedure for migrating either Fibre Channel hard drives or IBM TotalStorage DS4000 storage expansion enclosures containing Fibre Channel hard drives from one DS4000 storage subsystem to another.

FAST product renaming

IBM has renamed some FAST family products. Table 1 identifies each DS4000 product name with its corresponding previous FAST product name. Note that this change of **product name only** indicates no change in functionality or warranty. All products listed below with new names are functionally-equivalent and fully-interoperable. Each DS4000 product retains full IBM service as outlined in service contracts issued for analogous FAST products.

Table 1. Mapping of FAST names to DS4000 Series names

Previous FAST Product Name	Current DS4000 Product Name
IBM TotalStorage FAST Storage Server	IBM TotalStorage DS4000
FAST	DS4000
FAST Family	DS4000 Mid-range Disk System
FAST Storage Manager vX.Y (for example v9.10)	DS4000 Storage Manager vX.Y (for example v9.10)
FAST100	DS4100
FAST600	DS4300
FAST600 with Turbo Feature	DS4300 Turbo
FAST700	DS4400
FAST900	DS4500
EXP700	DS4000 EXP700
EXP710	DS4000 EXP710
EXP100	DS4000 EXP100
FAST FlashCopy®	FlashCopy for DS4000
FAST VolumeCopy	VolumeCopy for DS4000
FAST Remote Mirror (RM)	Enhanced Remote Mirroring for DS4000
FAST Synchronous Mirroring	Metro Mirroring for DS4000
	Global Copy for DS4000 (New Feature = Asynchronous Mirroring without Consistency Group)
	Global Mirroring for DS4000 (New Feature = Asynchronous Mirroring with Consistency Group)

Who should read this document

This document is intended for system administrators who are familiar with the IBM TotalStorage DS4000 storage subsystem components, terminology, and DS4000 Storage Subsystem administrative tasks.

Illustrations

Illustrations contained in this document depict general visual characteristics of the DS4000 Storage Subsystem, storage expansion unit, and fibre channel drive hardware cited. They are not intended for use as detailed DS4000 storage hardware images.

Using this document

Before you proceed to complete any storage addition or migration procedures detailed in this publication, familiarize yourself with the principles, prerequisite instructions at Chapter 2, "Prerequisites to adding capacity and hard drive migration," on page 41, as well as the following storage addition or migration procedures applicable to your specific needs.

- Chapter 3, "Adding one or more new hard drives," on page 53
- Chapter 4, "Migrating one or more hard drives," on page 59
- Chapter 5, "Adding expansion enclosures containing new hard drives," on page 69
- Chapter 6, "Migrating expansion enclosures containing hard drives," on page 93
- Chapter 7, "Upgrading a storage subsystem in a functioning configuration," on page 111

Your familiarity with the principles, preliminary procedures, and detailed steps described in this document is critical to prevent loss of data availability, and in some cases, loss of data. If you have questions about the procedures described in this document, please contact the IBM Help Center in your geography for assistance.

Important:

1. Do not mix SATA and Fibre Channel drives in the same enclosure (DS4300, DS4100, EXP100, EXP500, EXP700, EXP710).
2. Do not place SATA drives in a fibre channel enclosure (DS4300, EXP700, EXP710, or EXP810) unless it is stated in the DS4000 Storage Subsystem or in the *Installation, User's, and Maintenance Guide* for a specific storage expansion enclosure.
3. Do not place fibre channel drives in a SATA enclosure (DS4100 or EXP100).
4. Do not mix SATA drive expansion enclosures (EXP100) and Fibre channel drive enclosures (EXP700 and EXP710) in the same drive loop or the same DS4000 Storage Subsystem unless you purchase the fibre channel/SATA intermix premium feature entitlement and upgrade the controller firmware to 06.10.11.xx or higher.
5. Do not mix EXP500 storage expansion enclosures with EXP710 and EXP810 storage expansion enclosures in a DS4000 Storage Subsystem configuration.
6. Do not mix EXP100 storage expansion enclosures with EXP810 storage expansion enclosures in a DS4000 Storage Subsystem configuration. Please contact your IBM reseller or representatives for information about mixing EXP100s and EXP810s in the future.

7. Always check the information that is shipped with the storage expansion enclosures, the DS4000 controller firmware readme files, the *Installation, User's, and Maintenance Guide* for your specific DS4000 Storage Subsystem and storage expansion enclosure, and this guide for:
- the latest storage subsystem/storage expansion enclosure compatibility.
 - any requirements of the installed microcode and firmware to support the DS4000 Storage Subsystem and storage expansion enclosure.

DS4000 installation process overview

The following flow chart gives an overview of the DS4000 hardware and the DS4000 Storage Manager software installation process. Lined arrows in the flow chart indicate consecutive steps in the hardware and software installation process. Labeled arrows indicate which current documents provide detailed information about those steps.

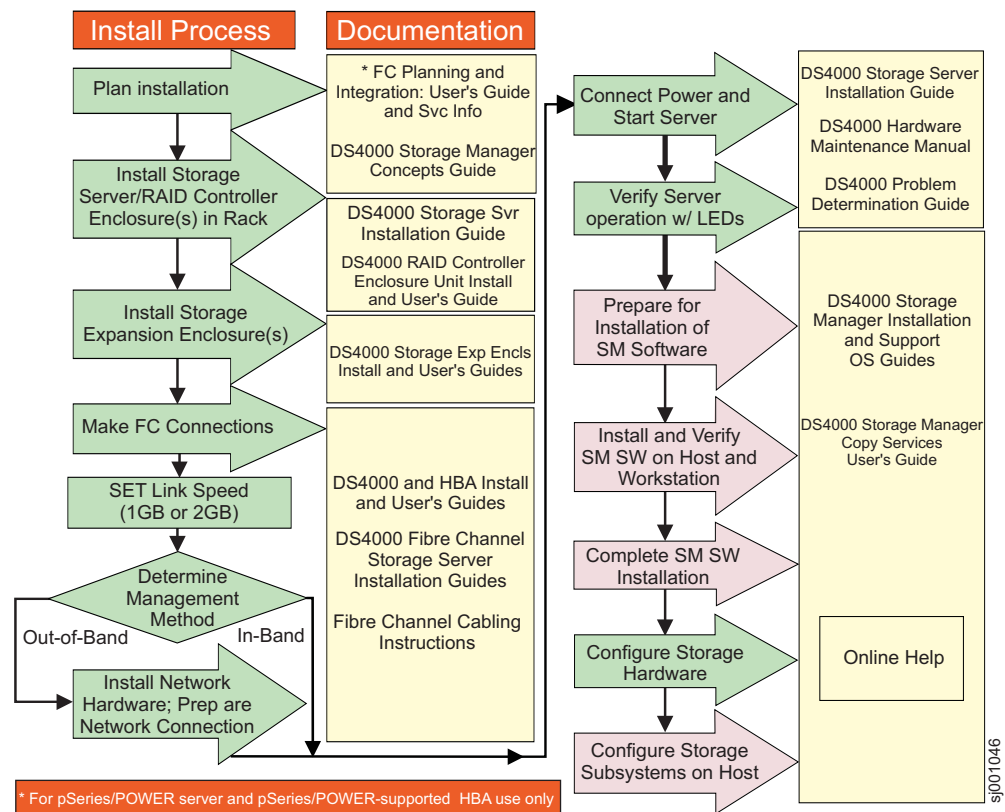

Figure 1. Installation process flow by current publications

DS4000 Storage Subsystem publications

The following tables present an overview of the DS4500, DS4400, DS4300, DS4100, and DS4800 Storage Subsystem product libraries, as well as other related documents. Each table lists documents that are included in the libraries and what common tasks they address.

You can access the documents listed in these tables at one of the following Web sites:

www.ibm.com/servers/storage/support/disk/

www.ibm.com/shop/publications/order/

DS4500 Storage Server library

Table 2 associates each document in the DS4500 (previously FAStT900) Storage Server library with its related common user tasks.

Table 2. TotalStorage DS4500 Fibre Channel Storage Server document titles by user tasks

Title	User Tasks					
	Planning	Hardware Installation	Software Installation	Configuration	Operation and Administration	Diagnosis and Maintenance
<i>IBM TotalStorage DS4500 Installation and Support Guide, GC26-7727</i>	✓	✓		✓		
<i>IBM TotalStorage DS4500 Fibre Channel Cabling Instructions, GC26-7729</i>	✓	✓				
<i>IBM TotalStorage DS4500 Storage Server User's Guide, GC26-7726</i>				✓	✓	✓
<i>IBM TotalStorage DS4500 Rack Mounting Instructions, GC26-7728</i>	✓	✓				

DS4400 Storage Server library

Table 3 associates each document in the DS4400 (previously FAStT700) Storage Server library with its related common user tasks.

Table 3. TotalStorage DS4400 Fibre Channel Storage Server document titles by user tasks

Title	User Tasks					
	Planning	Hardware Installation	Software Installation	Configuration	Operation and Administration	Diagnosis and Maintenance
<i>IBM DS4400 Fibre Channel Storage Server User's Guide, GC26-7730</i>	✓	✓		✓	✓	✓
<i>IBM DS4400 Fibre Channel Storage Server Installation and Support Guide, GC26-7731</i>	✓	✓		✓	✓	
<i>IBM DS4400 Fibre Channel Cabling Instructions, GC26-7732</i>	✓	✓				

DS4300 Storage Server library

Table 4 associates each document in the DS4300 (previously FAStT600) Storage Server library with its related common user tasks.

Table 4. TotalStorage DS4300 Fibre Channel Storage Server document titles by user tasks

Title	User Tasks					
	Planning	Hardware Installation	Software Installation	Configuration	Operation and Administration	Diagnosis and Maintenance
<i>IBM TotalStorage DS4300 Fibre Channel Storage Server Installation and User's Guide, GC26-7722</i>	✓	✓		✓		
<i>IBM TotalStorage DS4300 Rack Mounting Instructions, GC26-7724</i>	✓	✓				
<i>IBM TotalStorage DS4300 Fibre Channel Cabling Instructions, GC26-7725</i>	✓	✓				
<i>IBM TotalStorage DS4300 SCU Base Upgrade Kit, GC26-7740</i>		✓	✓			
<i>IBM TotalStorage DS4300 SCU Turbo Upgrade Kit, GC26-7741</i>		✓	✓			
<i>IBM TotalStorage DS4300 Turbo Models 6LU/6LX Upgrade Kit, GC26-7723</i>		✓	✓			

DS4100 Storage Server library

Table 5 associates each document in the DS4100 (previously FAStT100) Storage Server library with its related common user tasks.

Table 5. TotalStorage DS4100 SATA Storage Server document titles by user tasks

Title	User Tasks					
	Planning	Hardware Installation	Software Installation	Configuration	Operation and Administration	Diagnosis and Maintenance
<i>IBM TotalStorage DS4100 Installation, User's and Maintenance Guide, GC26-7733</i>	✓	✓		✓	✓	✓
<i>IBM TotalStorage DS4100 Fibre Channel Cabling Instructions, 24P8973</i>		✓				

DS4800 Storage Subsystem library

Table 6 associates each document in the DS4800 Storage Subsystem library with its related common user tasks.

Table 6. TotalStorage DS4800 Storage Subsystem document titles by user tasks

Title	User Tasks					
	Planning	Hardware Installation	Software Installation	Configuration	Operation and Administration	Diagnosis and Maintenance
<i>IBM TotalStorage DS4800 Installation, User's and Maintenance Guide, GC26-7748</i>	✓	✓		✓	✓	✓
<i>IBM TotalStorage DS4800 Installation and Cabling Overview, 22R4738</i>		✓				

DS4000 Storage Manager Version 9 publications

Table 7 associates each document in the DS4000 Storage Manager (previously FAST Storage Manager) library with its related common user tasks.

Table 7. TotalStorage DS4000 Storage Manager Version 9 titles by user tasks

Title	User tasks					
	Planning	Hardware installation	Software installation	Configuration	Operation and administration	Diagnosis and maintenance
<i>IBM TotalStorage DS4000 Storage Manager Version 9 Installation and Support Guide for Windows[®] 2000/Server 2003, NetWare, ESX Server, and Linux[®], GC26-7706</i>	✓		✓	✓		
<i>IBM TotalStorage DS4000 Storage Manager Version 9 Installation and Support Guide for AIX[®], UNIX[®], Solaris and Linux on POWER[™], GC26-7705</i>	✓		✓	✓		
<i>IBM TotalStorage DS4000 Storage Manager Version 9 Copy Services User's Guide, GC26-7707</i>	✓		✓	✓	✓	
<i>IBM TotalStorage DS4000 Storage Manager Version 9 Concepts Guide, GC26-7734</i>	✓	✓	✓	✓	✓	✓

Other DS4000 and DS4000-related documents

Table 8 associates each of the following documents with its related common user tasks.

Table 8. TotalStorage DS4000 and DS4000–related document titles by user tasks

Title	User Tasks					
	Planning	Hardware Installation	Software Installation	Configuration	Operation and Administration	Diagnosis and Maintenance
<i>IBM Safety Information, 33P2406</i>					✓	
<i>IBM TotalStorage DS4000 Quick Start Guide, GC26-7738</i>	✓	✓				
<i>IBM TotalStorage DS4000 Hardware Maintenance Manual,GC26-7702</i>						✓
<i>IBM TotalStorage DS4000 Problem Determination Guide, GC26-7703</i>						✓
<i>IBM Fibre Channel Planning and Integration: User's Guide and Service Information, SC23-4329</i>	✓	✓			✓	✓
<i>IBM TotalStorage DS4000 FC2-133 Host Bus Adapter Installation and User's Guide, GC26-7736</i>		✓			✓	
<i>IBM TotalStorage DS4000 FC2-133 Dual Port Host Bus Adapter Installation and User's Guide, GC26-7737</i>		✓			✓	
<i>IBM TotalStorage DS4000 Fibre Channel and Serial ATA Intermix Premium Feature Installation Overview GC26-7713</i>	✓	✓	✓	✓		
<i>Fibre Channel Solutions - IBM DS4000 EXP500 Installation and User's Guide, 59P5637</i>	✓	✓		✓	✓	✓

Table 8. TotalStorage DS4000 and DS4000–related document titles by user tasks (continued)

Title	User Tasks					
	Planning	Hardware Installation	Software Installation	Configuration	Operation and Administration	Diagnosis and Maintenance
<i>IBM TotalStorage DS4000 EXP700 and EXP710 Storage Expansion Enclosures Installation, User's, and Maintenance Guide, GC26-7735</i>	✓	✓		✓	✓	✓
<i>IBM TotalStorage DS4000 Hard Drive and Storage Expansion Enclosures Installation and Migration Guide, GC26-7704</i>	✓	✓				
<i>IBM DS4000 Management Suite Java™ User's Guide, 32P0081</i>					✓	✓
<i>IBM Netfinity® Fibre Channel Cabling Instructions, 19K0906</i>		✓				
<i>IBM Fibre Channel SAN Configuration Setup Guide, 25P2509</i>	✓		✓	✓	✓	

How to send your comments

Your feedback is important to help us provide the highest quality of information. If you have any comments about this document, please either fill out the Readers' comments form (RCF) at the back of this document and give it to an IBM representative, or submit it in one of the following ways:

- E-mail
 - Submit your comments over the Internet to:
starpubs@us.ibm.com
 - Submit your comments over IBMLink™ from the U.S.A. to:
STARPUBS at SJEVM5
 - Submit your comments over IBMLink from Canada to:
STARPUBS at TORIBM
 - Submit your comments over IBM Mail Exchange to:
USIB3WD at IBMMAIL

Be sure to include the name and order number of the document and, if applicable, the specific location of the text that you are commenting on, such as a page or table number.

- Mail

Complete the Readers' comments form (RCF) at the back of this document and return it by mail. If the RCF Business Reply Mailer has been removed, you can address your comments to:

International Business Machines Corporation
Information Development
Dept. GZW
9000 South Rita Road
Tucson, Arizona 85744-0001
U.S.A.

Chapter 1. Introduction

Scalability is a primary attribute of the IBM TotalStorage DS4000 Storage Subsystem family. Whenever the need arises, you can expand a DS4000 Storage Subsystem from its minimum to its maximum capacity configuration. To expand DS4000 Storage Subsystem configurations you can purchase additional equipment or, in some cases, migrate equipment from DS4000 Storage Subsystem configurations previously deployed.

The typical DS4000 Storage Subsystem drive connects to both Controller A and Controller B. Taken together, these connections represent dual drive loops or a redundant drive loop pair. You must connect drive loops in pairs to enable redundant drive loop configurations (two data paths per drive enclosure).

Note: In the DS4800 Storage Subsystem publications, these redundant drive loop pairs are referred to as redundant drive channel pairs. In addition, the DS4800 has two ports per drive channel. Even though you can cable two different fibre channel cable loops per drive channel, these two physically-cabled fibre channel loops are viewed logically as single drive channel or loop by the DS4800 controller.

Table 9 provides a list of the maximum allowable number of drives and drive loop pairs for each DS4000 Storage Subsystem by machine type and model number. It also specifies storage expansion enclosure license requirements.

Important:

Do not intermix fibre channel devices (such as the DS4300 Storage Subsystem and EXP700 and EXP710 storage expansion enclosure) and SATA devices (such as the DS4100 Storage Subsystem and EXP100 storage expansion enclosure) in the same storage subsystem environment unless you purchase the fibre channel/SATA intermix premium feature entitlement and upgrade the DS4000 Storage Subsystem controller firmware to 06.10.11.xx or higher. See “IBM TotalStorage DS4000 Fibre Channel and Serial ATA Intermix Premium Feature” on page 20 for more information.

Table 9. Maximum allowable drives and drive loop pairs in DS4000 storage servers

Product name	Machine type	Model number	Maximum number of drives	Maximum number of drive loop/channel pairs	Storage expansion unit license requirement
IBM TotalStorage DS4100 Storage Subsystem (Single Controller model)	1724	1SC, 1Sx	14	0	None. The DS4100 Single Controller Storage Subsystem does not support storage expansion enclosure attachment.
IBM TotalStorage DS4100 Storage Subsystem	1724	100	56	1	None

Table 9. Maximum allowable drives and drive loop pairs in DS4000 storage servers (continued)

Product name	Machine type	Model number	Maximum number of drives	Maximum number of drive loop/channel pairs	Storage expansion unit license requirement
IBM TotalStorage DS4300 Fibre Channel Storage Subsystem	1722	60X 60U	56	1	Purchase storage expansion enclosure entitlements in increments up to three storage expansion enclosures per DS4300 Storage Subsystem.
IBM TotalStorage DS4300 Fibre Channel Storage Subsystem (with Turbo option)			112	1	None. The DS4300 (with Turbo option) includes a seven storage expansion unit entitlement.
IBM TotalStorage DS4300 Fibre Channel Storage Subsystem (Single Controller model)		6LU 6LX	14	0	None. The DS4300 Single Controller Storage Subsystem does not support storage expansion enclosure attachment.
IBM TotalStorage DS4400 Fibre Channel Storage Subsystem ²	1742	1RU 1RX	224	2	None
IBM TotalStorage DS4500 Fibre Channel Storage Subsystem ²	1742	90X 90U	224	2	None
IBM TotalStorage DS4800 Fibre Channel Storage Subsystem ²	1815	82x or 84x ²	224	2	None

Table 9. Maximum allowable drives and drive loop pairs in DS4000 storage servers (continued)

Product name	Machine type	Model number	Maximum number of drives	Maximum number of drive loop/channel pairs	Storage expansion unit license requirement
IBM TotalStorage FAStT200 Fibre Channel Storage Subsystem	3542	1RU	38	1	None
		1RX			
IBM TotalStorage FAStT200 High Availability (HA) Fibre Channel Storage Subsystem ¹	3542	2RU	66	1	None
		2RX			
IBM TotalStorage FAStT500 Fibre Channel Storage Subsystem ²	3552	1RU	224	2	None
		1RX			

Notes:

1. The maximum number of drives supported by the FAStT200 HA Storage Subsystem (models 2RU and 2RX) assumes attachment to 4 14-drive storage expansion enclosures containing 56 fibre channel drives.
2. The maximum number of drives supported by FAStT500, DS4400, DS4500, and DS4800 Storage Subsystems assumes their attachment to 16 14-drive storage expansion enclosures. In addition, for the DS4800 storage subsystem, the maximum number of drives can also be supported by connecting 14 16-drive storage expansion enclosures.

Intermixing storage expansion enclosures

This section contains information on the following topics:

- Intermixing EXP500 and EXP700 storage expansion enclosures
- Intermixing EXP700 or EXP100 and EXP710 storage expansion enclosures
- Intermixing EXP810 and EXP710 storage expansion enclosures

For important information about using the Fibre Channel and SATA Intermix premium feature, including configuration and setup requirements, see “IBM TotalStorage DS4000 Fibre Channel and Serial ATA Intermix Premium Feature” on page 20.

For hardware compatibility, ensure that the environmental service module (ESM) firmware for each storage expansion enclosure and the storage server controller firmware are either at or above the levels that are recommended in Table 25 on page 43 and Table 26 on page 45.

DS4000 Storage Subsystems support the addition of external drive enclosures to:

- Provide additional storage capacity (as in the case of DS4400, DS4500, and DS4800 Storage Subsystems)
- Enable the expansion of a storage subsystem’s capacity beyond that of a given DS4000 Storage Subsystem chassis (as in the case of DS4100 and DS4300 Storage Subsystems)

When increasing the capacity of your storage subsystem in either of these ways, you might choose to add external drive enclosures of the same model and type or of different types. IBM does not support the combination of every DS4000 external drive enclosure type and model in every DS4000 Storage Subsystem configuration. Restrictions on the connection of drive enclosures that differ by model and type to DS4000 Storage Subsystems are documented in this section.

Table 10 indicates, by model, which DS4000 expansion enclosures can coexist in the same redundant drive loop of a DS4000 Storage Subsystem.

Table 10. Mixed DS4000 expansion enclosure compatibility in storage subsystems by model

DS4000 expansion enclosure	DS4000 EXP100 (SATA)	DS4000 EXP500 (Fibre Channel)	DS4000 EXP700 (Fibre Channel)	DS4000 EXP710 (Fibre Channel)	DS4000 EXP810 (Fibre Channel / SATA)
IBM TotalStorage DS4000 EXP100 (SATA)	✓ 1		✓ 2	✓ 2	
IBM TotalStorage DS4000 EXP500 (Fibre Channel)		✓ 4 (1 Gbps only)	✓ 3 (1 Gbps only)		
IBM TotalStorage DS4000 EXP700 (Fibre Channel)	✓ 2	✓ 3 (1 Gbps only)	✓ 3	✓ 5	
IBM TotalStorage DS4000 EXP710 (Fibre Channel)	✓ 2		✓ 5	✓ 5	✓ 6
IBM System Storage DS4000 EXP810 (Fibre Channel / SATA)				✓ 6	✓ 6 7

Table 10. Mixed DS4000 expansion enclosure compatibility in storage subsystems by model (continued)

<p>1 Requires controller firmware 06.10.11.xx or higher (DS4300 with Turbo option, DS4400, and DS4500), 06.12.03.xx or higher (DS4300 Base, DS4100 Base) or 06.14.xx.xx (DS4800).</p> <p>Note: There are versions of 05.41.xx.xx controller firmware that also provide DS4000 EXP100 support for DS4300 (with Base or Turbo option), DS4400, and DS4500 Storage Subsystems or versions of 05.42.xx.xx controller firmware that also provide DS4000 EXP100 support for DS4100 Storage Subsystems. However, IBM recommends that you use controller firmware version 06.12.xx.xx for the DS4100, DS4300 (with Base or Turbo option), DS4400, and DS4500 Storage Subsystems, instead.</p> <p>2 Supported only with fibre channel/SATA intermix entitlement purchase and controller firmware version 06.10.11.xx or higher. In addition, the storage subsystem must also be in the DS4000 Storage Subsystem list that support FC/SATA intermix premium feature.</p> <p>3 Requires controller firmware 05.2x.xx.xx or higher.</p> <p>4 Requires controller firmware 04.xx.xx.xx or higher.</p> <p>5 Requires controller firmware 06.10.11.xx or higher.</p> <p>6 Requires controller firmware 06.16.16.xx or higher.</p> <p>7 Currently, EXP810 does not support SATA drives or intermixing with EXP100 SATA drive expansion enclosures. Please contact your IBM representative or IBM Support for information about SATA support in future releases.</p>	
---	--

Table 11 indicates what DS4000 expansion enclosures can attach to DS4000 Storage Subsystems by model.

Table 11. DS4000 expansion enclosure compatibility with DS4000 Storage Subsystems by model

DS4000 storage device	DS4000 EXP100 (SATA)	DS4000 EXP500 (Fibre Channel)	DS4000 EXP700 (Fibre Channel)	DS4000 EXP710 (Fibre Channel)	DS4000 EXP810 (Fibre Channel and SATA)
DS4100 Storage Subsystem (Base model, SATA)	✓ 2				
DS4100 Storage Subsystem (Single Controller model, SATA)					

Table 11. DS4000 expansion enclosure compatibility with DS4000 Storage Subsystems by model (continued)

DS4300 Storage Subsystem (Single Controller model, Fibre Channel)					
DS4300 Storage Subsystem (Turbo option, Fibre Channel)	✓ 2 3		✓ 2	✓ 2 4	
DS4300 Storage Subsystem (Base model, Fibre Channel)	✓ 1		✓		
DS4400 Storage Subsystem (Fibre Channel)	✓ 2 3	✓ (1 Gbps only)	✓ 2	✓ 2 4	
DS4500 Storage Subsystem (Fibre Channel)	✓ 2 3	✓ (1 Gbps only)	✓ 2	✓ 2 4	
DS4800 Storage Subsystem (Fibre Channel)	✓ 2 3			✓ 2 4	✓ 5
FASt200 Storage Subsystem (Fibre Channel)		✓ (1 Gbps only)	✓ (1 Gbps only)		
FASt500 Storage Subsystem (Fibre Channel)		✓ (1 Gbps only)	✓ (1 Gbps only)		

Table 11. DS4000 expansion enclosure compatibility with DS4000 Storage Subsystems by model (continued)

<p>1 The DS4300 base will support FC/SATA intermix only when the controller firmware is of version 06.12.xx.xx or higher and the fibre channel/SATA intermix entitlement is purchased.</p> <p>In addition, although the DS4300 Storage Subsystem (Base model) will support fibre channel or SATA drives with controller firmware version 05.41.xx.xx, it will not support both in a mixed environment. It will, however, support SATA drives in an attached storage enclosure (only), but never in the DS4300 Storage Subsystem, itself. In addition, before the DS4300 Storage Subsystem (Base model) will support a DS4000 EXP100 drive enclosure, it is necessary to remove all fibre channel drives from the DS4300 chassis.</p> <p>2 The intermix of DS4000 EXP700 and EXP710 fibre channel drive enclosures with DS4000 EXP100 SATA drive enclosures in a given DS4000 Storage Subsystem is supported only with fibre channel/SATA intermix entitlement purchase and controller firmware version 06.10.11.xx or higher. The DS4800 Storage Subsystems do not support the attachment of EXP700 drive expansion enclosures. You must upgrade the EXP700 drive expansion enclosure to EXP710 before attaching to the DS4800 Storage Subsystem.</p> <p>3 DS4000 Storage Subsystems require the following firmware to manage EXP100 expansion enclosures.</p> <p>DS4100 Base Either 5.42.xx.xx or 06.12.1x.xx. Version 6.12.1x.xxx is recommended.</p> <p>DS4300 Base or Turbo and DS4500 Either 05.41.5x.xx or 06.1x.xx.xx. Version 06.12.xx.xx or higher is recommended.</p> <p>DS4400 06.1x.xx.xx. Version 06.12.xx.xx or higher is recommended.</p> <p>DS4800 Version 06.14.xx.xx or higher is recommended.</p> <p>4 Requires controller firmware version 06.1x.xx.xx or higher. Version 06.12.xx.xx or higher is recommended for DS4300 Base or Turbo, DS4400 and DS4500. For DS4800, version 06.14.xx.xx or higher is recommended.</p> <p>5 Requires controller firmware 06.16.16.xx or higher. Currently, EXP810 does not support SATA drives or intermixing with EXP100 SATA drive expansion enclosures. Also, the only DS4000 storage subsystem that supports the EXP810 is the DS4800 storage subsystem. Please contact your IBM representative or IBM Support for information about SATA support or other DS4000 storage subsystems in future releases.</p>	
--	--

Currently, IBM supports these different storage expansion enclosure models - EXP100, EXP500, EXP700, EXP710, and EXP810. Table 12 on page 8 lists those drive expansion enclosure models that are considered of the same storage enclosure type for the purpose grouping together in an intermixed SATA/fibre channel storage expansion enclosure loop configuration.

Note: EXP500 is not listed in Table 12 on page 8 because it is not supported in an intermixed SATA/fibre channel storage expansion enclosure loop configuration. Although the EXP810 models are listed in the table, intermixing the EXP810 and EXP100 SATA drive expansion enclosures is not currently supported. Please contact IBM Support for information about future

support.

Table 12. DS4000 drive expansion enclosure models compatible in intermixed loop configurations only when contiguously grouped

Group-compatible EXP100 models	Group-compatible EXP700 models	Group-compatible EXP710 and EXP810 models
1710-10X	1740-1RU	1740-710 , 1812-81A ²
1710-10U	1740-1RX	1740-1RU ¹ , 1812-81-H ²
1724-1XP		1740-1RX ¹

1. Consider and treat this EXP700 model as an EXP710 for grouping purposes only once upgraded with the DS4000 EXP700 field upgrade to switched ESMs.
2. Currently, EXP810 does not support SATA drives. Please contact your IBM representative or IBM Support for information about SATA support in future releases.

You can mix DS4000 TotalStorage EXP500 (which operates only at 1 Gbps) and DS4000 TotalStorage EXP700 (which operates at either 1 Gbps or 2 Gbps) storage expansion enclosures in the same redundant drive loop pair in all DS4400 and DS4500 Storage Subsystem configurations. However, you must set the EXP700 to 1 Gbps. There is no restriction to the physical sequence of mixed EXP700 and EXP500 expansion enclosures in the same redundant drive loop pair. You cannot mix these enclosures in the same redundant drive loop pair in DS4100, DS4300 and DS4800 Storage Subsystem configurations. See “Intermixing EXP500 and EXP700 storage expansion enclosures” on page 9 for more information.

The DS4100 Storage Subsystems support only the DS4000 EXP100 storage expansion enclosures. The DS4300 Storage Subsystems support only 2 Gbps storage expansion enclosures, such as the DS4000 EXP700/EXP710 or the DS4000 EXP100. The DS4800 Storage Subsystem supports only the DS4000 EXP710, EXP810, and EXP100 storage expansion enclosures.

Although you can intermix the EXP700 and EXP100 storage expansion enclosures with EXP710 storage expansion enclosures in the same redundant drive loop pair in a DS4000 Storage Subsystem configuration, you must group together all DS4000 EXP710 storage expansion enclosures in the redundant drive loop. See “Intermixing EXP700 or EXP100 and EXP710 storage expansion enclosures” on page 11 and Table 12 for additional information.

Currently, the EXP810 drive expansion enclosures can be intermixed in the same drive redundant channel pair with the EXP710 drive expansion enclosures only. See “Intermixing EXP810 and EXP710 storage expansion enclosures” on page 16 and Table 12 for additional information.

Do not intermix the EXP500 (which operates only at 1 Gbps) and EXP710, EXP810 or EXP100 (which operates only at 2 Gbps) storage expansion enclosures in the same redundant drive loop pair. Also, do not attach these storage expansion enclosures to the same controller.

Although there are no restrictions against cabling DS4000 EXP100 and DS4000 EXP700 storage expansion enclosures together. For ease of future maintenance and possible troubleshooting, however, IBM recommends that you group or plan your configuration to allow for grouping of all DS4000 drive expansion enclosures by type in a DS4000 Storage Subsystem redundant drive loop, if possible.

Attention: Even though IBM supports intermixing different drive expansion enclosure models in the same redundant drive loop, IBM recommends use of a single drive expansion enclosure model (for example, EXP100, EXP500, EXP700, EXP710, or EXP810) in a given redundant drive loop. IBM recommends as best practice the use of only one single drive expansion enclosure model.

Important:

Do not change the speed of a drive loop while the DS4000 Storage Subsystem is powered on. Such a speed change will cause unpredictable results. Also, the drive expansion enclosures must be power cycled for the new speed setting to be correctly recognized.

To change the speed of a drive loop:

- ___ Step 1. Prepare applications for DS4000 Storage Subsystem shutdown.
- ___ Step 2. Shutdown the DS4000 Storage Subsystem.
- ___ Step 3. Shutdown the DS4000 storage expansion enclosures.
- ___ Step 4. Change the fibre channel speed settings.
- ___ Step 5. Power on the DS4000 storage expansion enclosures.
- ___ Step 6. Power on the DS4000 Storage Subsystem.
- ___ Step 7. Restore DS4000 Storage Subsystem host application operations.

Note: For additional information on turning a storage server on and off, see the *DS4000 Storage Subsystem Installation, User's, and Maintenance Guide*. For more information on these guides, see the following Web site:

www.ibm.com/servers/storage/support/disk/

See “DS4000 Storage Subsystem drive loop schemes” on page 27 and “Setting enclosure IDs” on page 32 for details on cabling DS4000 Storage Subsystems and storage expansion enclosures together as well as setting their enclosure IDs.

Intermixing EXP500 and EXP700 storage expansion enclosures

When connecting the EXP500 and EXP700 enclosures in the same DS4000 Storage Subsystem, although the EXP700 storage expansion enclosure is capable of operating at 2 Gbps, you must set the fibre channel speed of drive loops in a mixed storage expansion enclosure environment to the lowest fibre channel speed supported by all hardware in the loop, which is 1 Gbps.

If one of the drive loops in a DS4000 Storage Subsystem configuration is set to 1 Gbps, you must set all of the drive loops to 1 Gbps. This speed restriction applies to all four drive loops in either the DS4400 or DS4500 Storage Subsystem configuration, even where some of the drive loops consist only of EXP700 storage expansion enclosures that might otherwise operate at 2 Gbps.

Figure 2 on page 10 illustrates cabling of DS4000 TotalStorage EXP500 and EXP700 storage expansion enclosures in a mixed configuration.

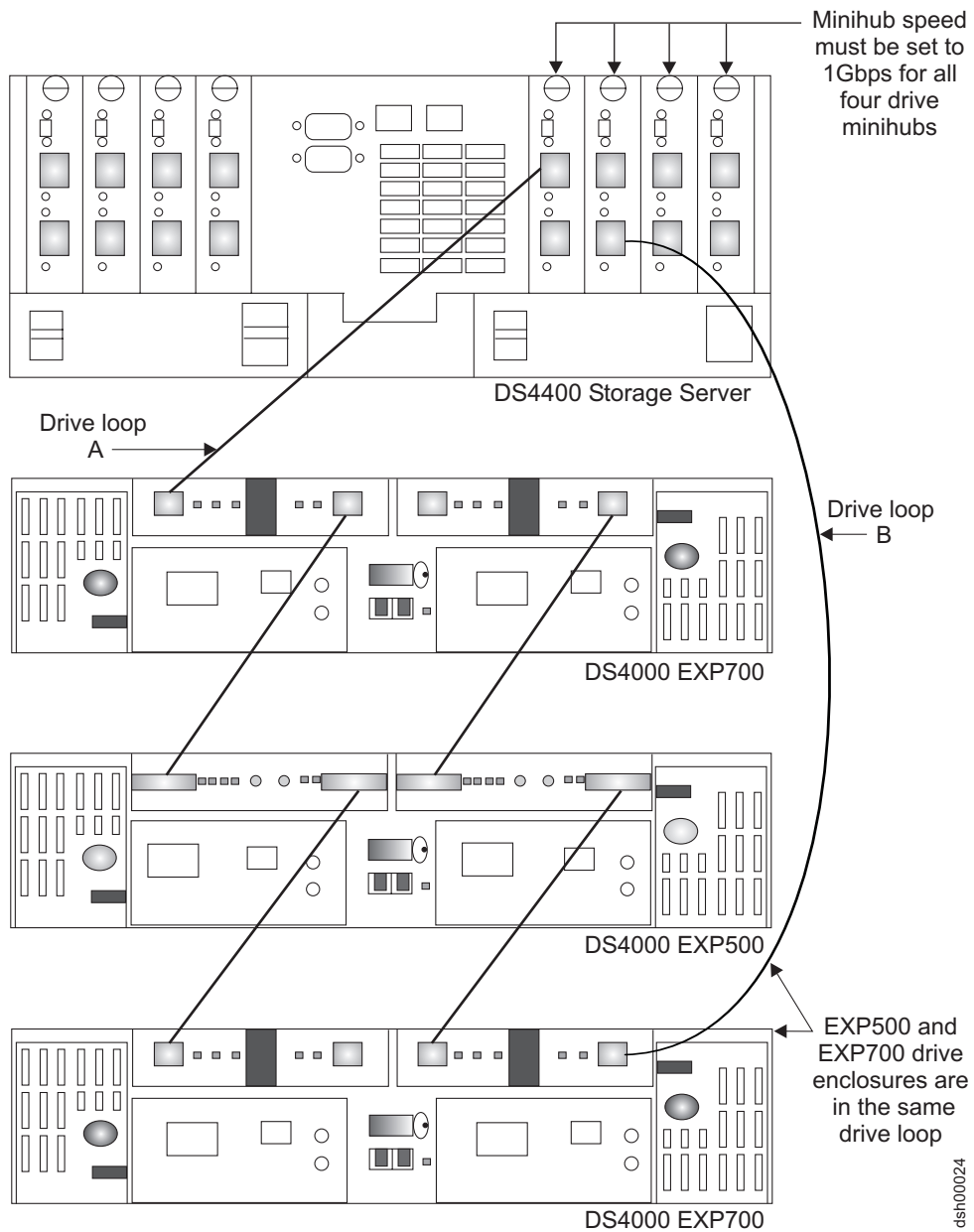

Figure 2. DS4000 EXP500 and EXP700 cabling in a mixed configuration

There are maximum limits to the number of fibre channel hard drives that you can configure in redundant drive loop pairs. The maximum number of drives dictates a fixed number of supported EXP500 and EXP700 drive enclosure combinations. Table 13 on page 11 lists the numbers of EXP500 and EXP700 storage expansion enclosures that you can combine for use in a single redundant drive loop pair. Table 13 on page 11 assumes that a DS4000 Storage Subsystem is generally capable of addressing the maximum of 112 fibre channel hard drives for each redundant drive loop pair.

Important:

IBM supports only those EXP500 and EXP700 Storage Expansion Unit combinations listed in Table 13 on page 11.

Table 13. Supported EXP500 and EXP700 enclosure combinations per redundant drive loop pair

Total number of EXP500 enclosures per redundant drive loop pair	Total number of EXP700 enclosures per redundant drive loop pair	Maximum number of storage expansion enclosures per redundant drive loop pair	Maximum number of drives per redundant drive loop pair
11	0	11	110
10	0	10	100
9	1	10	104
8	2	10	108
7	3	10	112
6	3	9	102
5	4	9	106
4	5	9	110
3	6	9	114
2	6	8	104
1	7	8	108
0	8	8	112

Note: The combination of three EXP500 and six EXP700 storage expansion enclosures has the maximum number of 114 drives per redundant drive loop pair. You can have this maximum number of hard drives per drive loop pair only in this mixed EXP500 and EXP700 configuration.

Intermixing EXP700 or EXP100 and EXP710 storage expansion enclosures

Attention: Before intermixing EXP700/EXP710 and EXP100 drive expansion enclosures in a DS4000 Storage Subsystem, you must purchase IBM TotalStorage DS4000 SATA and fibre channel storage expansion enclosure intermix entitlement and carefully read this section. Also, check the controller firmware requirements in Table 10 on page 4 for intermix compatibility.

It is possible to intermix EXP700 or EXP100, and EXP710 storage expansion enclosures in the same drive loop. To do so, however, you must group all of the EXP710 storage expansion enclosures together to enable the EXP710 Reliability and Serviceability (RAS) features and to optimize the data transferring between the EXP710. These intermixing requirements must also be met if you are upgrading some (but not all) of the EXP700 storage expansion enclosures in a drive loop with the EXP700 Models 1RU/1RX Switched-ESM Option Upgrade Kit (P/N 25R0166). Once upgraded, these EXP700 drive expansion enclosures are considered EXP710 drive expansion enclosures, even though the machine type and models might be still be shown as EXP700 machine types and models.

Important:

IBM does not support any configuration in which EXP710 drive expansion enclosures are not grouped together.

Figure 3 through Figure 5 on page 14 show three acceptable EXP700 and EXP710 intermixing cabling configurations in which all EXP710 storage expansion enclosures are grouped together. Note that in Figure 5 on page 14, the EXP710 storage expansion enclosures are grouped together, even though the EXP700 storage expansion enclosures are not grouped together.

Although illustrations Figure 3 through Figure 7 on page 16 incorporate the DS4000 DS4300 Storage Subsystem for the sake of example, other DS4000 storage servers might be acceptable replacements. The DS4000 EXP100 would also intermix successfully with an EXP710 when substituted for an EXP700 in an equivalent loop configuration.

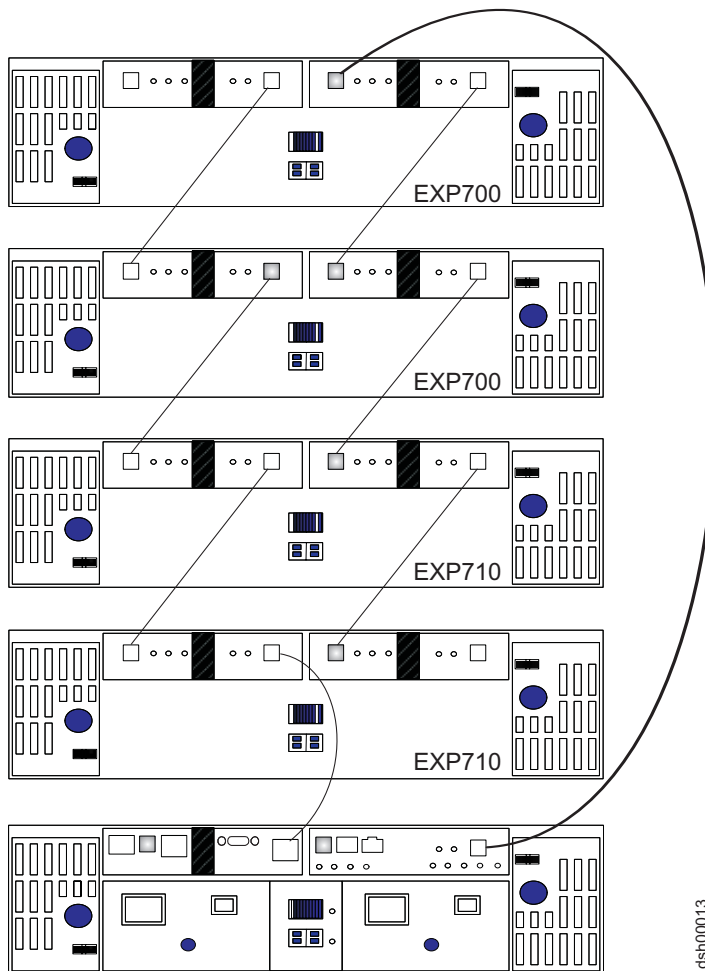
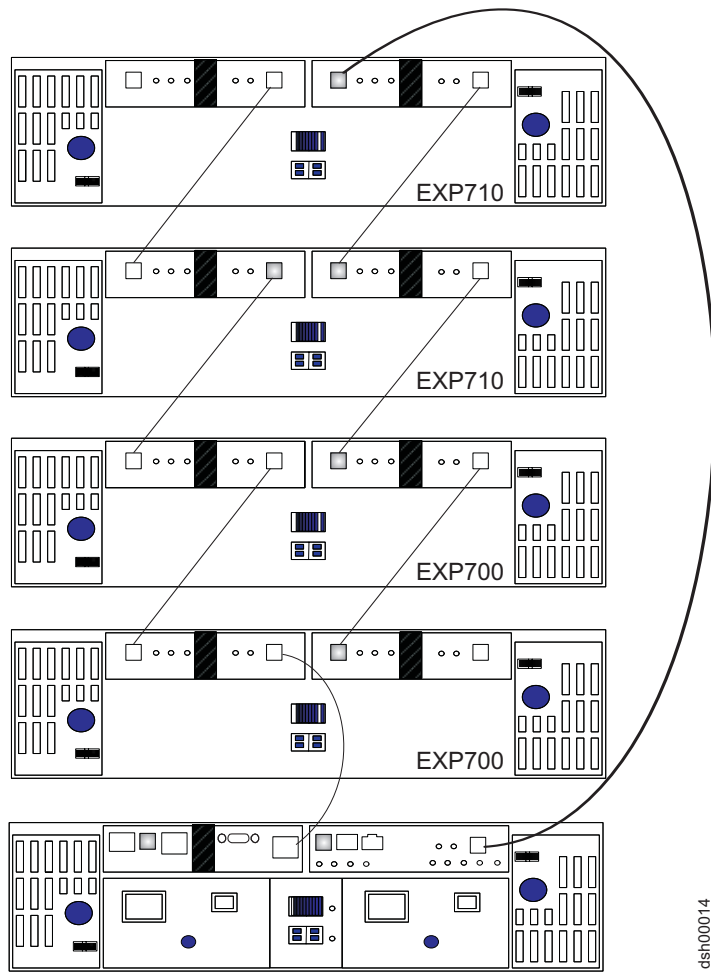
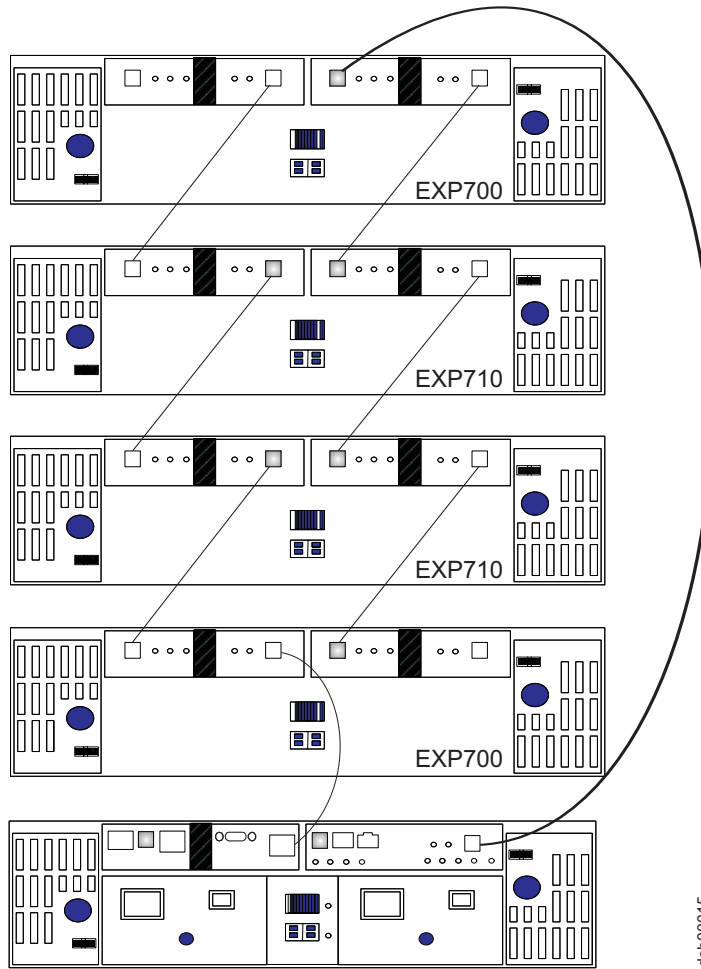

Figure 3. Acceptable intermixed EXP700 (or EXP100) and EXP710 loop configuration (1 of 3)



dsh00014

Figure 4. Acceptable intermixed EXP700 (or EXP100) and EXP710 loop configuration (2 of 3)



dsh00015

Figure 5. Acceptable (**not recommended**) intermixed EXP700 (or EXP100) and EXP710 loop configuration (3 of 3)

In Figure 6 on page 15 and Figure 7 on page 16, the intermixed configurations shown are not supported because the EXP710 storage expansion enclosures in the redundant drive loop are not grouped together. When substituting a DS4000 EXP100 for an EXP700 enclosure in an equivalent drive loop cabling configuration, the intermixed drive loop cabling is also not supported.

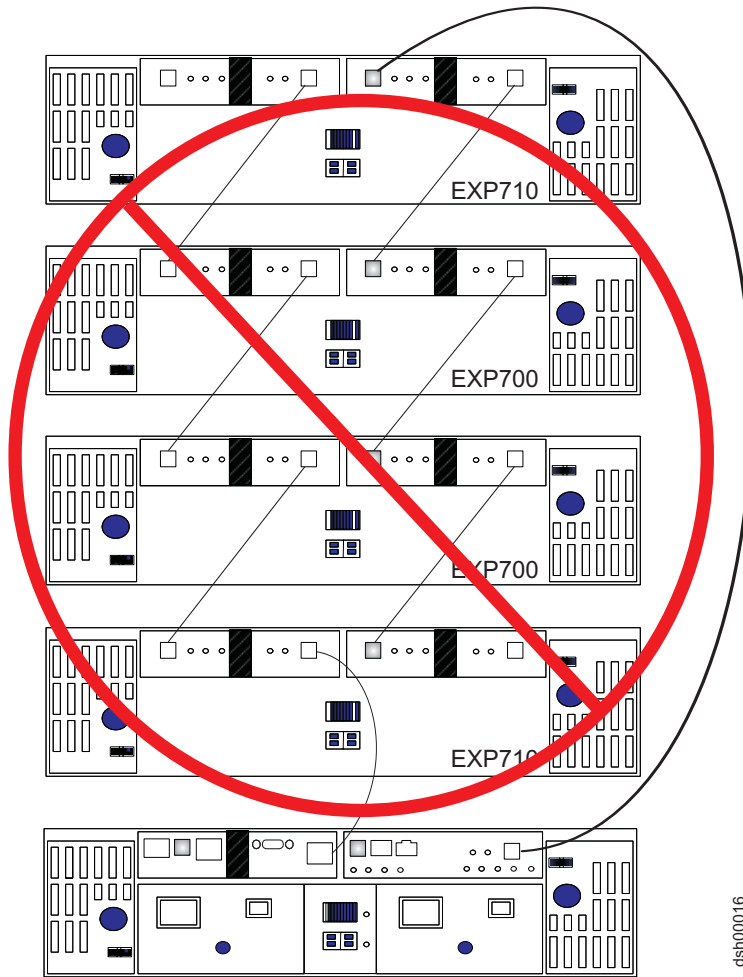

dsh00016

Figure 6. Unacceptable intermixed EXP700 (or EXP100) and EXP710 loop configuration (1 of 2)

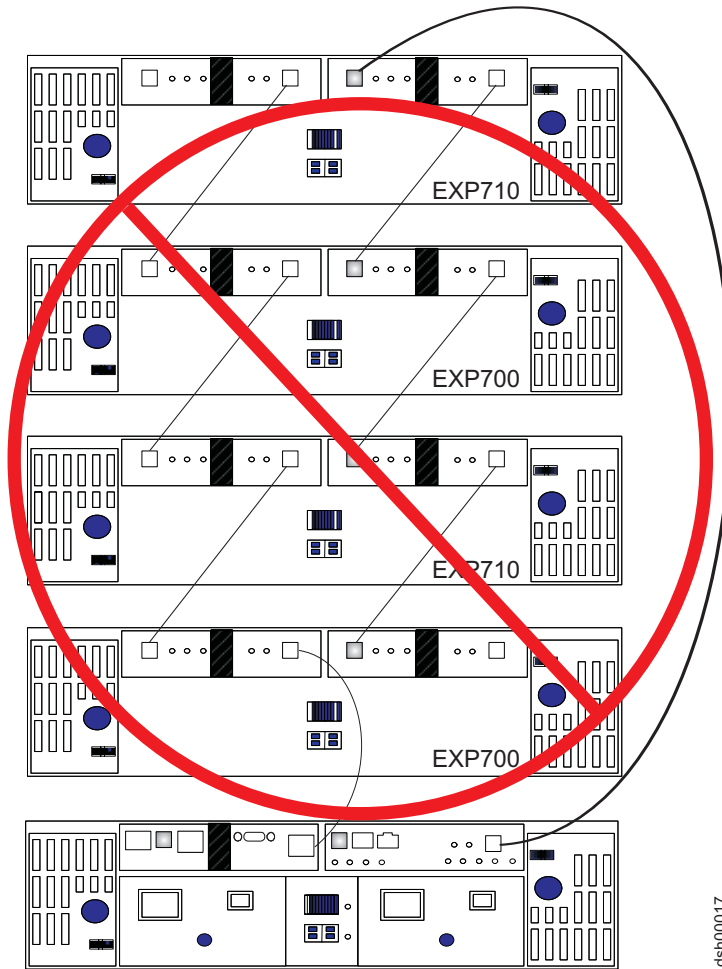

Figure 7. Unacceptable intermixed EXP700 (or EXP100) and EXP710 loop configuration (2 of 2)

Intermixing EXP810 and EXP710 storage expansion enclosures

In the initial EXP810 release, you can only intermix the EXP810 with the EXP710. Even though the storage expansion enclosures do not need to be grouped by drive enclosure type, IBM recommends that you *do* group them by enclosure type in a redundant drive channel pair to simplify maintenance and troubleshooting. In addition, the EXP810 Link Rate switch must be set at 2 Gbps.

Note: The Link Rate setting only becomes effective after the EXP810 is powered up. Do not change the setting while the EXP810 is operational. Schedule downtime to shut down the entire DS4000 configuration to change the Link Rate speed setting.

There are maximum limits to the number of fibre channel hard drives that you can configure in redundant drive channel pairs. The maximum number of drives dictates a fixed number of supported EXP710 and EXP810 drive enclosure combinations. Table 14 on page 17 lists the numbers of EXP710 and EXP810 storage expansion enclosures that you can combine for use in a single redundant drive channel/loop pair. Table 14 assumes that a DS4000 Storage Subsystem is generally capable of addressing the maximum of 112 fibre channel hard drives for each redundant drive channel/loop pair.

Table 14. Supported EXP810 and EXP710 enclosure combinations per redundant drive channel/loop pair

Total number of EXP810 enclosures per redundant drive channel/loop pair	Total number of EXP710 enclosures per redundant drive channel/loop pair	Maximum number of storage expansion drives per redundant drive channel/loop pair	Maximum number of drives in a mixed EXP710 and EXP810 drive channel/loop pair
0	8	8	112
1	6	7	100
2	5	7	102
3	4	7	104
4	3	7	106
5	2	7	108
6	1	7	110
7	0	7	112

IBM recommends that you *do not* mix EXP710s and EXP810s together in the same redundant drive channel/loop pair if you plan to operate the EXP810 at a higher speed when such support is available. Therefore, IBM recommends that you connect all of the EXP710s to a redundant drive channel pair and all of the EXP810s to the other (second) redundant drive channel pair in a DS4800 storage subsystem configuration.

Figure 8 on page 18 and Figure 9 on page 19 illustrate acceptable cabling of EXP710 and EXP810 storage expansion enclosures in a mixed configuration.

Figure 10 on page 20 shows a recommended cabling example of the EXP810 and EXP710 enclosures in the same drive channel pair in a DS4800 configuration. All of the EXP810 are cabled together to one port of the dual-port drive channel in each of the controllers. Similarly all of the EXP710s are cabled together to the other port of the dual-port drive channel.

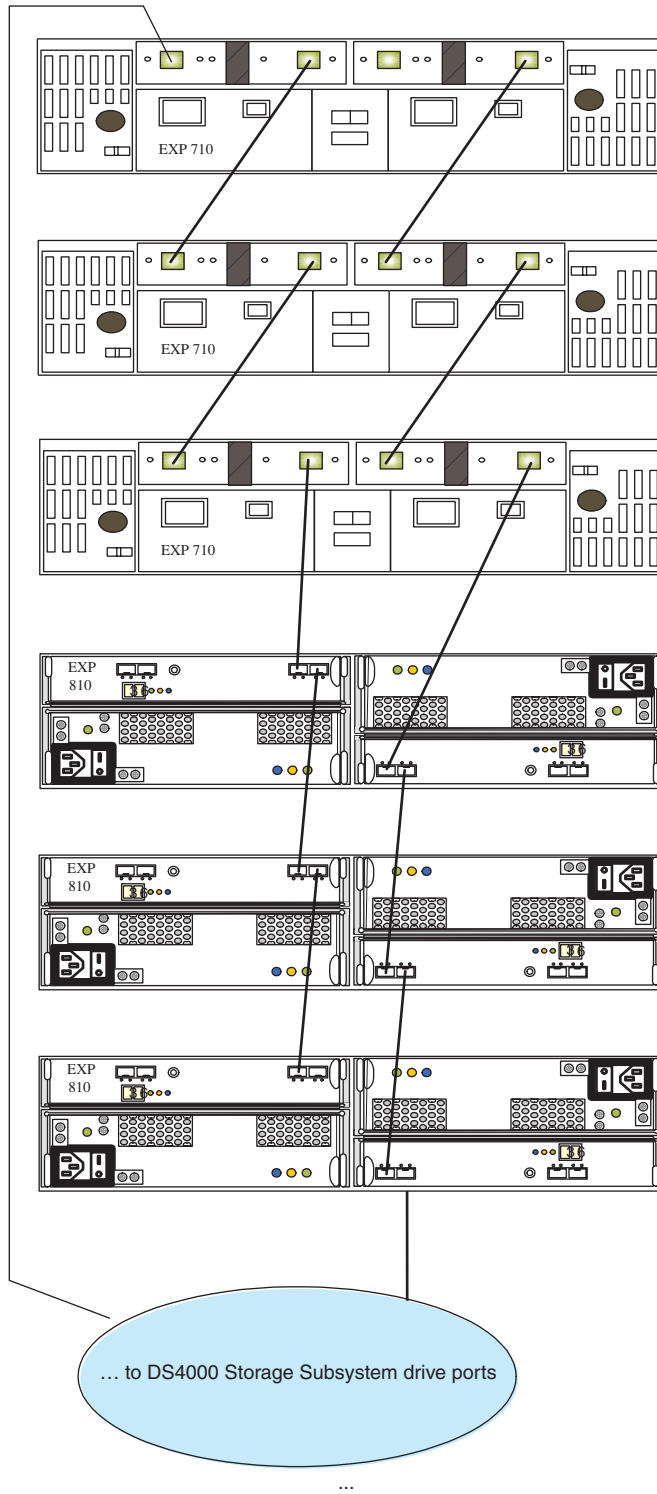

Figure 8. Acceptable intermixed DS4000 EXP710 and EXP810 loop configuration

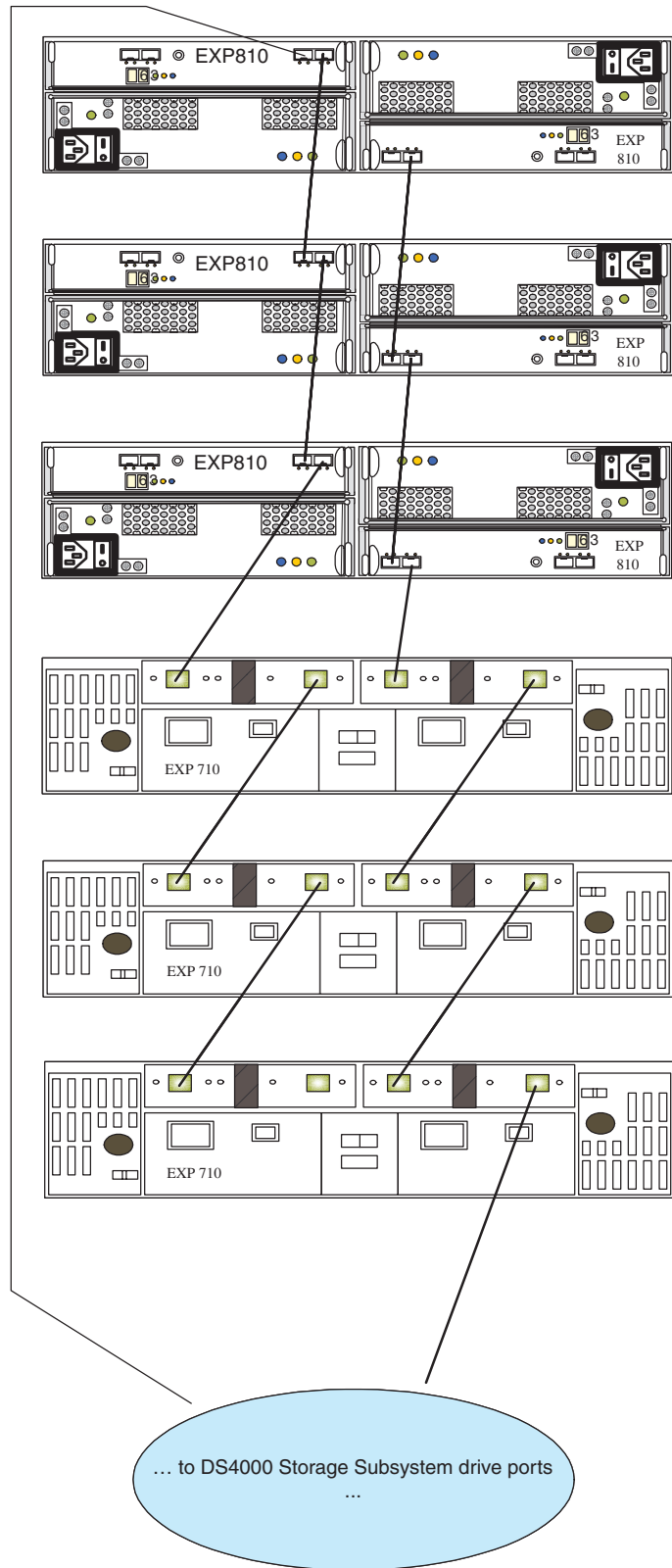

Figure 9. Acceptable intermixed DS4000 EXP710 and EXP810 loop configuration

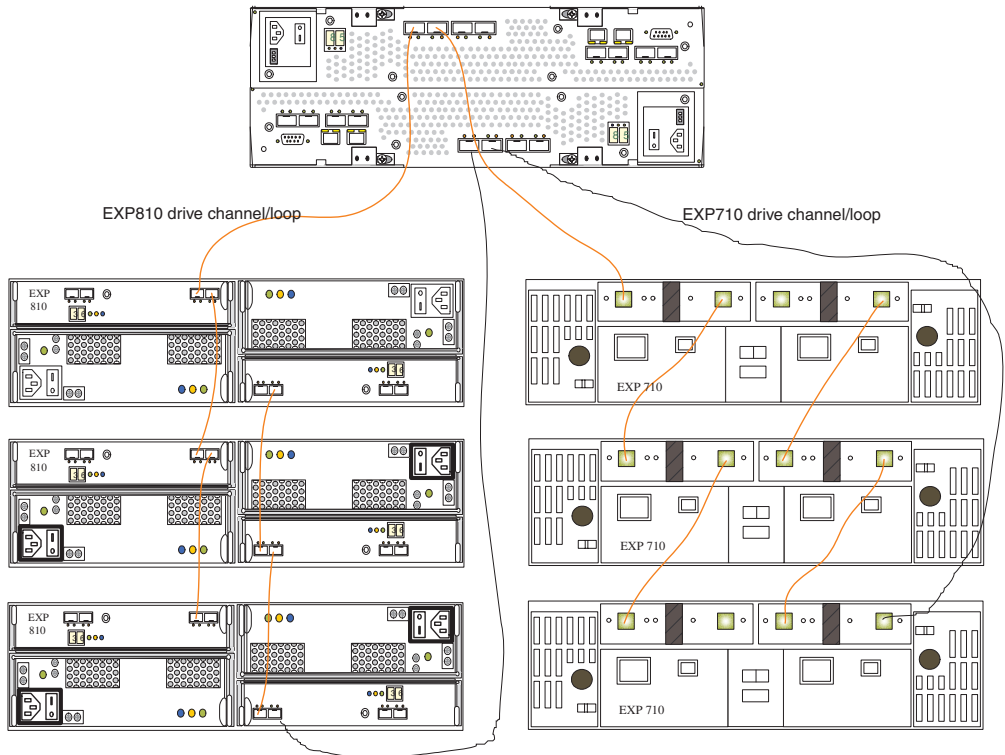

Figure 10. Preferred intermixed DS4000 EXP710 and EXP810 loop configuration

IBM TotalStorage DS4000 Fibre Channel and Serial ATA Intermix Premium Feature

Notes:

1. For the most current information on the DS4000 Fibre Channel and SATA (FC/SATA) Enclosure Intermix premium feature, see the IBM TotalStorage Support Web site:
www.ibm.com/servers/storage/support/disk/
2. Currently, the EXP810 does not support the FC/SATA feature. Contact your IBM representative or IBM Support for information about EXP810 FC/SATA support that might be available in future releases.

Note: For the most current information on the DS4000 Fibre Channel and SATA (FC/SATA) Enclosure Intermix premium feature, see the IBM TotalStorage Support Web site:

www.ibm.com/servers/storage/support/disk/

The DS4000 FC/SATA Intermix premium feature supports the concurrent attachment of Fibre Channel and SATA storage expansion enclosures to a single DS4000 controller configuration. With this premium feature, you can create and manage distinct arrays that are built from either Fibre Channel disks or SATA disks and allocate logical drives to the appropriate applications using a single DS4000 Storage Subsystem.

The TotalStorage DS4500, DS4400, and DS4300 with Standard/Base or Turbo options storage subsystems with this premium feature can support the attachment of DS4000 EXP700 and EXP710 Fibre Channel Disk Expansion enclosures and DS4000 EXP100 Serial ATA Disk Expansion enclosures concurrently. The TotalStorage DS4800 with this premium feature only supports the attachment of DS4000 EXP710 Fibre Channel and EXP100 SATA drive expansion enclosures concurrently. Please contact IBM for information regarding future DS4000 Storage Subsystem support.

The FC/SATA Intermix premium feature requires that you upgrade the DS4500, DS4400, or DS4300 Turbo storage subsystems to DS4000 Storage Manager version 9.10 or later (controller firmware level 6.10.10.xx or later) in the upgrade sequence in these instructions. The DS4800 is shipped with controller firmware version 06.14.xx.xx or later and the required DS4000 Storage Manager version 9.14 or later, so no upgrades would be required for the DS4800.

The FC/SATA Intermix Option installation kit includes the following items:

- The *IBM TotalStorage DS4000 Fibre Channel and Serial ATA Intermix Premium Feature Installation Overview*
- The DS4000 FC/SATA Intermix premium feature entitlement document
- The DS4000 FC/SATA Intermix premium feature activation document, which includes the feature activation code and the instructions about how to generate the key file
- The DS4000 Storage Subsystem NVSRAM Support for DS4000 FC/SATA Enclosure Intermix CD

Note: The NVSRAM file in this CD is for the DS4000 Storage Subsystems with controller firmware version 06.10.xx.xx only. Do not use this NVSRAM file if the DS4000 Storage Subsystems have controller firmware version 06.12.xx.xx or later installed. Use the NVSRAM files that are packaged with the version 06.12.xx.xx or later DS4000 Storage Subsystem controller firmware packages instead. In addition, the newer FC/SATA intermix option installation kit might not include this CD because the controller firmware 06.10.xx.xx is replaced with the controller firmware 06.12.1x.xx or higher.

The FC/SATA Intermix premium feature installation

Note: Currently, the EXP810 does not support the FC/SATA feature. Contact your IBM representative or IBM Support for information about EXP810 FC/SATA support that might be available in future releases.

To use the FC/SATA Intermix premium feature upgrade, perform the following steps:

1. Purchase an IBM TotalStorage DS4000 Fibre Channel/SATA Intermix entitlement. Contact your IBM reseller or representative for additional information.
2. Upgrade your DS4000 ESM firmware to the level that is compatible with each particular enclosure type.

Attention: You should perform any ESM code upgrades that are required before you perform any other code upgrades.

Table 15 on page 22 indicates which ESM firmware levels are compatible with each enclosure type.

Table 15. ESM firmware levels by storage expansion enclosure type

Storage expansion enclosure type	ESM firmware level
DS4000 EXP100	956x or higher is recommended (see note 1 and 3 below)
DS4000 EXP700 Note: The EXP700 is not supported on the DS4800 Storage Subsystem.	9326 or later (See note 2 below)
DS4000 EXP710	9631 or later

Notes:

1. You must upgrade the EXP100 ESM firmware to version 9554 first on those DS4000 Storage Subsystems on which the controller firmware version 05.41.1x.xx is installed. The EXP100 ESM firmware cannot be upgraded to version 9554 on those DS4000 Storage Subsystems on which other versions of controller firmware are installed.
2. You must upgrade the EXP700 ESM firmware to version 9326 or later before you upgrade the DS4000 Storage Subsystem controller firmware to version 06.1x.xx.xx.
3. 956x or higher is required to support the new SATA drive CRU and the new 400G SATA drive option/CRUs.
3. If necessary, upgrade your host software to DS4000 Storage Manager version 9.10 or later. You can download upgrades (which is currently at version 9.16) for the applicable DS4000 storage subsystem over the Internet from the IBM DS4000 Storage Manager Support Web site. Refer to the Storage Manager Installation and Support Guide for your operating system for information on how to install the software.
4. Upgrade your DS4000 Storage Subsystem controller firmware to version 06.10.10.xx or later to use with DS4000 Storage Manager host software version 9.10 or later to use with DS4000 Storage Manager host software version 9.10 or later. Table 16 indicates the latest firmware versions that are recommended for use with specific subsystem controllers.

Table 16. Firmware versions based on storage subsystem controller type

Storage subsystem controller	Firmware version
DS4300, DS4400, DS4500	06.12.xx.xx and later
DS4800	06.15.xx.xx and later (See <i>Attention</i> below)
<p>Attention: Currently, for the DS4800 Storage Subsystem, there are two different code levels to support the EXP100 and EXP810 storage expansion enclosures. If you have an:</p> <ul style="list-style-type: none"> • EXP100 attached to a DS4800 Storage Subsystem, you must use 6.15.xx.xx controller firmware version. • EXP810 attached to a DS4800 Storage Subsystem, you must use 6.16.xx.xx controller firmware version. • EXP710 attached to a DS4800 Storage Subsystem, you can use either 6.15.xx.xx or 6.16.xx.xx controller firmware version. <p>Using the incorrect firmware version may cause the controller to not recognize either the EXP810 or EXP100 storage expansion enclosures, causing drives in those enclosures to be reported as missing. This could result in failed logical drives and arrays.</p>	

For more information, refer to the IBM DS4000 Storage Manager Installation and Support Guide for the appropriate operating system of the host computer on which the DS4000 Storage Manager host software will be installed or upgraded.

The latest versions of the DS4000 Storage Subsystem controller firmware and the host software are available for download over the Internet from the DS4000 TotalStorage Support Web page:

www.ibm.com/servers/storage/support/disk/

5. Upgrade your DS4000 storage subsystem controller NVSRAM to the appropriate version of NVSRAM files based on the controller firmware version as indicated below.

Attention: To verify the DS4000 Storage Subsystem controller firmware version, right-click the controller icon in the Subsystem Management window of the DS4000 Storage Subsystem that you are working on. Select **Properties** in the pull-down list and, when the Properties window opens, look for the value on the right of the Firmware Version field.

If the installed controller firmware is of version 06.10.xx.xx

To implement the FC/SATA Intermix feature, download the appropriate NVSRAM file from the *DS4000 Storage Subsystem NVSRAM Support for DS4000 FC/SATA Enclosure Intermix* CD that is associated with your host operating system. The filenames of the NVSRAM files that enable the FC/SATA intermix premium feature have an “I” character prefix, for example, I1742F900R910V04.dlp. The appropriate NVSRAM file for a given storage subsystem can be found in one of the following directories:

- \NVS RAM\DS4300_FASTT600turbo
- \NVS RAM\DS4400_FASTT700
- \NVS RAM\DS4500_FASTT900

Notes:

- a. The controller firmware of the DS4300 Storage Subsystem with Standard/Base option must be at 06.12.xx.xx or later in order to support the DS4000 FC/SATA Intermix premium feature.
- b. The DS4800 Storage Subsystems are released with controller firmware version 06.14.xx.xx. There are no previous versions of controller firmware for it.

If the installed controller firmware is of version 06.12.xx.xx or later

Attention: Do not use the NVSRAM file in the DS4000 Storage Subsystem NVSRAM Support for DS4000 FC/SATA Enclosure Intermix CD. Install the appropriate NVRAM for your DS4000 Storage Subsystem that is packaged with the controller firmware that you installed in the DS4000 Storage Subsystem in step 4 on page 22 above.

The DS4000 FC/SATA Intermix premium feature is entitled and requires the use of a feature key to enable the option. To obtain the feature key identifier, you need a feature activation code, which is printed on the IBM premium feature activation card. You also need your controller unit IBM serial number, which is printed on the label on the back of your DS4000 Storage Subsystem. Follow the instructions in the FC/SATA intermix premium feature activation card for instructions about how to generate the required feature key and enable the FC/SATA intermix premium feature.

Attention: For DS4000 Storage Subsystems with controller firmware version 06.10.xx.xx installed, the FC/SATA Intermix premium feature is activated when you download the NVSRAM file. Nonetheless, you **MUST** generate the premium feature key and retain it because you will need it to activate the FC/SATA Intermix premium feature when the controller firmware is upgraded to version 06.12.xx.xx or higher. If you try to use the premium feature activation key with controller firmware version 06.10.xx.xx, you will get an error message that the Premium Feature that you are attempting to enable with this feature key file is not supported on the current configuration of this subsystem. For the DS4000 Storage Subsystems with the controller firmware version 06.12.xx.xx or later installed, you must generate the premium feature key file to enable the FC/SATA intermix feature. You cannot use the NVSRAM files included in the DS4000 FC/SATA Enclosure Intermix CD.

For more information about how to enable the premium feature or the feature key, read the activation instructions or contact your IBM representative.

Restrictions

Important: When you add drive expansion enclosures of different types, if the grouping of the enclosure types forces the new enclosures to be cabled in the middle of the drive loop, it is strongly recommended that you power down the configuration or schedule your installations during offpeak I/O periods. You can use the performance monitor function in the DS4000 Storage Manager Subsystem Management window to determine offpeak I/O periods.

If you cannot power down the configuration to install a new enclosure in the middle of the loop, you must use the DS4000 Storage Manager Subsystem Management window to verify that the interrupted drive loop is up and optimal before you modify the other drive loop. This minimizes the chance that arrays will fail because of cabling errors.

Therefore, it is also important to plan for additions to the configuration prior to your initial installation. It is also best practice to take these same precautions when you add new enclosures to either end of the redundant drive loop.

The following restrictions apply to the use of the DS4000 FC/SATA Intermix premium feature:

Compatible storage subsystems

Only the following DS4000 Storage Subsystems support the FC/SATA Intermix premium feature:

- DS4300 Standard/Base or Turbo
- DS4400
- DS4500
- DS4800

Contact IBM for information regarding future DS4000 Storage Subsystem support.

Grouping DS4000 storage expansion enclosures in a redundant drive loop

Attention:

Configurations that do not follow the DS4000 storage expansion enclosures grouping restriction are not supported.

You must group like DS4000 storage expansion enclosure types in adjacent positions on the Fibre Channel loop when they are intermixed in a DS4000 Storage Subsystem redundant drive loop configuration. Figure 11 on page 26 shows two ways to group your expansion enclosures based on model.

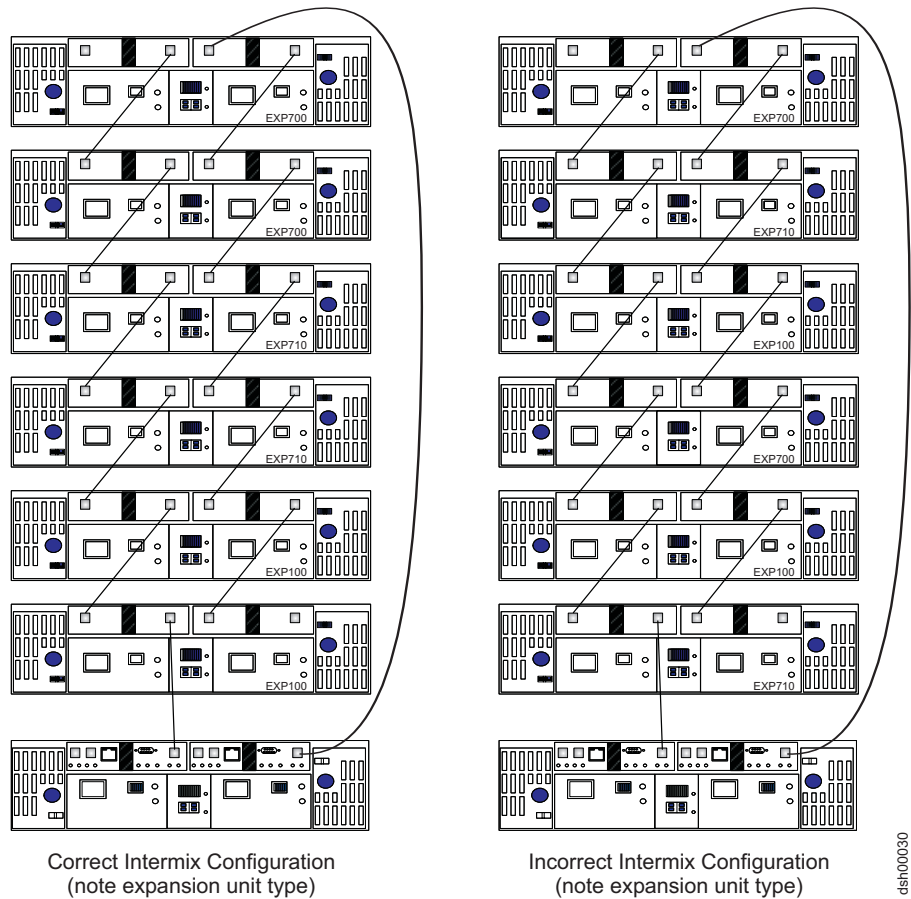

Figure 11. Correct and incorrect ways to group DS4000 storage expansion enclosures in a redundant drive loop

You must group like enclosure types together, regardless of type, as the configuration on the left shows. In the configuration on the left, the EXP700s are grouped together at the top of the loop, followed by the EXP710s, which are grouped together at the middle of the loop, followed by the EXP100s which are grouped together closest to the controller. The storage expansion enclosure types are indicated in the expansion unit types indicated in the lower right corner of each enclosure.

In the configuration on the right, the enclosures are cabled in a random order and are not grouped by type. IBM does not support DS4000 storage subsystem configurations when they are cabled in this way.

Note: For the purposes of the storage expansion enclosures grouping restriction, note the following considerations:

- All models of the EXP100 are considered to be the same from a grouping perspective. For example, the EXP100 1710-10X, 1710-10U, and the 1724-1XP are considered like enclosure types and must be grouped together.

- All models of the EXP700 are considered to be the same from a grouping perspective. For example, the EXP700 1740-1RU, and the 1740-1RX are considered like enclosure types and must be grouped together.
- Once the EXP700 has been upgraded with the EXP710 ESM firmware, it is considered an EXP710, regardless of the machine type and model.

Cannot mix drive types

Arrays must consist exclusively of either Fibre Channel or SATA drives. You cannot mix drive types in an array.

You cannot mix Fibre Channel and SATA drives in the same DS4000 Storage Subsystem or storage expansion enclosure. Table 17 lists the drive types and their corresponding DS4000 Storage Subsystems and storage expansion enclosures.

Table 17. Drive types and their corresponding DS4000 Storage Subsystem and storage expansion enclosures

Drive type	Storage subsystem type	Storage expansion enclosure type
SATA	DS4100	DS4000 EXP100
Fibre Channel	DS4300 Standard/Base or Turbo DS4400 DS4500 DS4800	DS4000 EXP700 DS4000 EXP710

Cannot intermix drive types for hot spares

SATA drives can function as hot spares for SATA drives only.

Fibre Channel drives can function as hot spares for Fibre Channel drives only.

DS4300 Standard/Base or Turbo intermix configuration restrictions

In DS4300 intermix configurations, if the FC/SATA Intermix premium feature is enabled along with the correct NVSRAM for Intermix is installed, the maximum number of expansion enclosures in a drive loop is limited to seven, regardless of whether there are drives in the DS4300 Storage Subsystem drive slots.

DS4000 Storage Subsystem drive loop schemes

Although a variety of cable loop schemes might function acceptably, IBM recommends consistent use of only one such scheme when connecting DS4000 Storage Subsystems and expansion enclosures. Figure 12 on page 28 illustrates the only cable loop scheme that IBM recommends when connecting DS4000 Storage Subsystems and expansion enclosures.

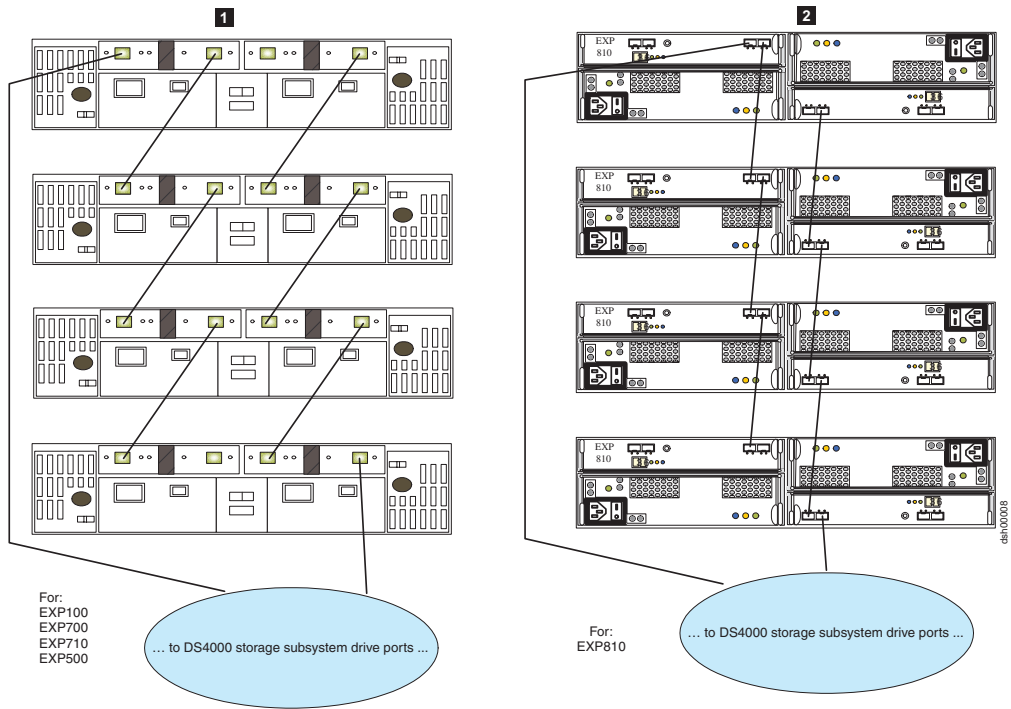

Figure 12. Recommended cable loop scheme for connecting DS4000 storage devices

Legend:

- 1** Recommended cabling for EXP100, EXP500, EXP700, and EXP710 with DS4000 Storage Subsystem
- 2** Recommended cabling for EXP810 with DS4000 Storage Subsystem

IBM recommends against inconsistent use of any cable loop scheme. Figure 13 on page 29 through Figure 16 on page 32 show unacceptable cabling loop schemes.

Attention: Do not make the cable schemes illustrated in Figure 13 on page 29 or Figure 16 on page 32 because they will affect the diagnostic ability in the event of drive loop failures.



Figure 13. Not recommended alternate cable loop scheme for when connecting DS4000 storage devices

Legend:

- 1** Not recommended cabling for EXP100, EXP500, EXP700, and EXP710 with DS4000 Storage Subsystem
- 2** Not recommended cabling for EXP810 with DS4000 Storage Subsystem

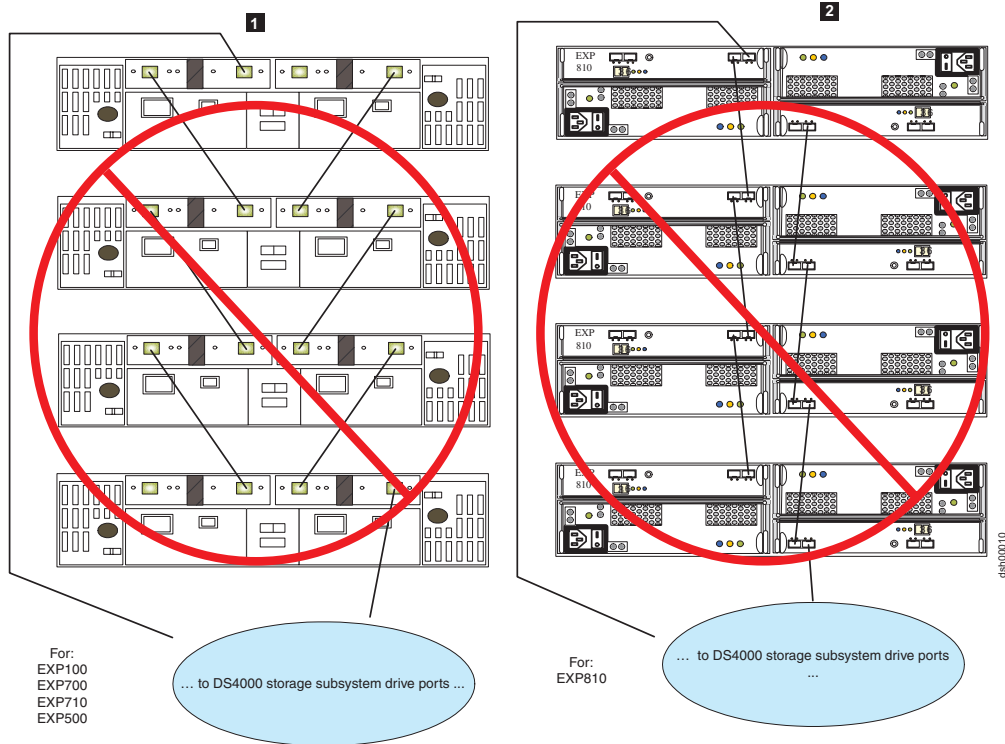

Figure 14. Not recommended alternate cable loop scheme for connecting DS4000 storage devices

Legend:

- 1** Not recommended cabling for EXP100, EXP500, EXP700, and EXP710 with DS4000 Storage Subsystem
- 2** Not recommended cabling for EXP810 with DS4000 Storage Subsystem

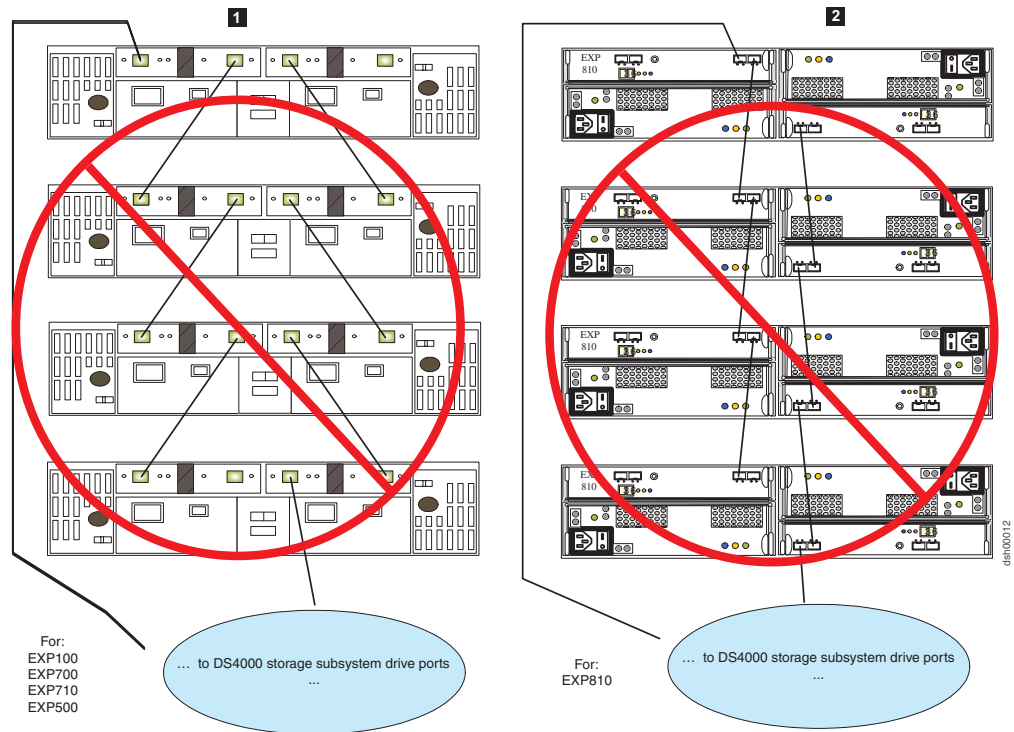

Figure 15. Unacceptable cable loop scheme for connecting DS4000 storage devices

Legend:

- 1** Unacceptable cabling for EXP100, EXP500, EXP700, and EXP710 with DS4000 Storage Subsystem
- 2** Unacceptable cabling for EXP810 with DS4000 Storage Subsystem

Note: The cable loop scheme in Figure 15 is unacceptable because both drive loops are connected to the IN port of the EXP700. Although this restriction does not specifically apply to other storage expansion enclosures, you should still avoid connecting both drive loops in the IN port to prevent accidental miscabling in the EXP700 environment.



Figure 16. Unacceptable cable loop scheme for connecting DS4000 storage devices

Legend:

- 1** Unacceptable cabling for EXP100, EXP500, EXP700, and EXP710 with DS4000 Storage Subsystem
- 2** Unacceptable cabling for EXP810 with DS4000 Storage Subsystem

Note: The cable loop scheme in Figure 16 is unacceptable because of the random pattern between the storage expansion enclosures.

Setting enclosure IDs

Each drive enclosure in a DS4000 Storage Subsystem drive loop must have a unique drive enclosure ID. DS4000 controllers use a combination of the enclosure ID and the number of the physical slot that a hard drive occupies to create a unique loop address or arbitrated loop physical address (AL_PA) for each drive in a drive loop. The enclosure ID consists of two digits, a tens (x10) digit and a ones (x1) digit. The possible values for the tens and the ones digits are 0-9 for EXP500 and EXP810 drive enclosures, and 0-7 for EXP100, EXP700, and EXP710 drive enclosures.

It is recommended as best practice that you give each drive expansion enclosure in a redundant drive loop a unique ones digit ID. This setting will enforce hard AL_PAs (unchangeable between Loop Initializations [LIPs]) for the drives and facilitate drive loop problem troubleshooting in the event of an error. If the ones digits are not unique, two or more devices will have the same hard AL_PA. In such a case, the controller will use soft AL_PAs for the devices that have identical hard AL_PAs.

You do not have to manually assign an enclosure ID for an EXP810 storage expansion enclosure. The enclosure ID is automatically assigned. However, if you

do manually assign the enclosure ID for the EXP810, ensure that the enclosure ID of the EXP810s in the same drive loop are unique.

Note: If you are using an EXP710 and EXP810 in a drive loop, you must set the enclosure ID for the EXP710. The EXP810 enclosure ID is automatically set.

The problem with soft addressing is that addresses can change between LIPs. This possibility increases the difficulty of troubleshooting drive loop problems because it is difficult to ascertain whether the same device with a different address or a different device might be causing a problem. Because the DS4000 Storage Subsystem can support more enclosures than available values of the enclosure ID ones digit, Table 18 through Table 22 on page 36 suggest enclosure ID settings for various drive expansion enclosure families to minimize soft addressing in a drive loop.

Table 18. EXP500 Storage Expansion Enclosure ID settings

Storage expansion enclosure	Enclosure ID setting for enclosure in the first redundant drive loop	Enclosure ID setting for enclosure in the second redundant drive loop if applicable/supported
1st unit (storage expansion enclosure or storage server with internal drive slots)	00	x0 (where x is 2-7)
2nd unit (EXP500)	01	x1 (where x is 2-7)
3rd unit (EXP500)	02	x2 (where x is 2-7)
4th unit (EXP500)	03	x3 (where x is 2-7)
5th unit (EXP500)	04	x4 (where x is 2-7)
6th unit (EXP500)	05	x5 (where x is 2-7)
7th unit (EXP500)	06	x6 (where x is 2-7)
8th unit (EXP500)	07	x7 (where x is 2-7)
9th unit (EXP500)	08	x8 (where x is 2-7)
10th unit (EXP500)	09	x9 (where x is 2-7)
11th unit (EXP500)	10	x0 (where x is 3-7)

Note: Drives in the 11th enclosures of each drive loop in Table 18 will have soft AL_PAs.

Table 19 on page 34 suggests enclosure ID settings that minimize soft addressing for EXP100 storage expansion enclosures in a drive loop.

Table 19. EXP100 Storage Expansion Enclosure ID settings

Storage expansion enclosure (unmixed)	Enclosure ID setting for enclosure in the first redundant drive loop	Enclosure ID setting for enclosure in the second redundant drive loop if applicable/supported
1st unit (EXP100 Expansion Enclosure or DS4000 Storage Subsystem with internal drive slots)	00	x0 (where x is 2-7)
2nd unit (EXP100)	01	x1 (where x is 2-7)
3rd unit (EXP100)	02	x2 (where x is 2-7)
4th unit (EXP100)	03	x3 (where x is 2-7)
5th unit (EXP100)	04	x4 (where x is 2-7)
6th unit (EXP100)	05	x5 (where x is 2-7)
7th unit (EXP100)	06	x6 (where x is 2-7)
8th unit (EXP100)	07	x7 (where x is 2-7)
9th unit (EXP100, where the first unit is a DS4300 only)	11	

Note: All drives in drive loops described in Table 19 will be assigned hard AL_PAs.

Table 20 suggests enclosure ID settings that minimize soft addressing for EXP700 or EXP710 storage expansion enclosures in a drive loop.

Table 20. EXP700 or EXP710 Storage Expansion Enclosure ID settings

Storage expansion enclosure (unmixed)	Enclosure ID setting for enclosure in the first redundant drive loop	Enclosure ID setting for enclosure in the second redundant drive loop if applicable/supported
1st unit (storage expansion enclosure or DS4000 Storage Subsystem with internal drive slots)	00	x0 (where x is 2-7)
2nd unit (EXP700)	01	x1 (where x is 2-7)
3rd unit (EXP700)	02	x2 (where x is 2-7)
4th unit (EXP700)	03	x3 (where x is 2-7)
5th unit (EXP700)	04	x4 (where x is 2-7)
6th unit (EXP700)	05	x5 (where x is 2-7)

Table 20. EXP700 or EXP710 Storage Expansion Enclosure ID settings (continued)

Storage expansion enclosure (unmixed)	Enclosure ID setting for enclosure in the first redundant drive loop	Enclosure ID setting for enclosure in the second redundant drive loop if applicable/supported
7th unit (EXP700)	06	x6 (where x is 2-7)
8th unit (EXP700)	07	x7 (where x is 2-7)

Note: All drives in drive loops described in Table 20 on page 34 will be assigned hard AL_PAs.

Table 21 suggests enclosure ID settings that minimize soft addressing for the EXP500 and EXP700 storage expansion enclosure when intermixed in a redundant drive loop.

Table 21. Intermixed EXP500 and EXP700 Storage Expansion Enclosure ID settings

Storage expansion enclosure models (intermixed)	Enclosure ID setting for enclosure in the first redundant drive loop	Enclosure ID setting for enclosure in the second redundant drive loop
1st unit (storage expansion enclosure or DS4000 Storage Subsystem with internal drive slots)	00	x0 (where x is 2-7)
2nd unit (EXP500 or EXP700)	01	x1 (where x is 2-7)
3rd unit (EXP500 or EXP700)	02	x2 (where x is 2-7)
4th unit (EXP500 or EXP700)	03	x3 (where x is 2-7)
5th unit (EXP500 or EXP700)	04	x4 (where x is 2-7)
6th unit (EXP500 or EXP700)	05	x5 (where x is 2-7)
7th unit (EXP500 or EXP700)	06	x6 (where x is 2-7)
8th unit (EXP500 or EXP700)	07	x7 (where x is 2-7)
9th unit (EXP500 or EXP700)	10	x0 (where x is 2-7)
10th unit (EXP500 or EXP700)	11	x1 (where x is 2-7)

Note: The drives in the 9th and 10th enclosures in each drive loop described in Table 21 will have soft AL_PAs.

Table 22 on page 36 suggests enclosure ID settings that minimize soft addressing for the EXP700 and EXP710 storage expansion enclosure when intermixed in a redundant drive loop.

Table 22. Intermixed EXP700 and EXP710 Storage Expansion Enclosure ID settings

Storage expansion enclosure models (intermixed)	Enclosure ID setting for enclosure in the first redundant drive loop	Enclosure ID setting for enclosure in the second redundant drive loop
1st unit (storage expansion enclosure or DS4000 Storage Subsystem with internal slots)	00	x0 (where x is 2-7)
2nd unit (EXP700 or EXP710)	01	x1 (where x is 2-7)
3rd unit (EXP700 or EXP710)	02	x2 (where x is 2-7)
4th unit (EXP700 or EXP710)	03	x3 (where x is 2-7)
5th unit (EXP700 or EXP710)	04	x4 (where x is 2-7)
6th unit (EXP700 or EXP710)	05	x5 (where x is 2-7)
7th unit (EXP700 or EXP710)	06	x6 (where x is 2-7)
8th unit (EXP700 or EXP710)	07	x7 (where x is 2-7)

Note: The drives in the 9th and 10th enclosures in each drive loop described in Table 22 will have soft AL_PAs.

Table 23 suggests enclosure ID settings that minimize soft addressing for the EXP810 only or the EXP710 and EXP810 storage expansion enclosures when intermixed in a redundant drive loop.

Table 23. EXP810 only or intermixed EXP700 and EXP710 Storage Expansion Enclosure ID settings

Storage expansion enclosure models (intermixed)	Enclosure ID setting for enclosure in the first redundant drive loop	Enclosure ID setting for enclosure in the second redundant drive loop
1st unit (EXP810)	00	either 7 or x0 (where x is 2-7)
2nd unit (EXP810 or EXP710)	01	either 8 for the EXP810 or x1 for both EXP810 and EXP710 (where x is 2-7)
3rd unit (EXP810 or EXP710)	02	either 9 for the EXP810 or x2 for both EXP810 and EXP710 (where x is 2-7)
4th unit (EXP810 or EXP710)	03	either 10 or x3 (where x is 2-7)
5th unit (EXP810 or EXP710)	04	either 11 or x4 (where x is 2-7)

Table 23. EXP810 only or intermixed EXP700 and EXP710 Storage Expansion Enclosure ID settings (continued)

Storage expansion enclosure models (intermixed)	Enclosure ID setting for enclosure in the first redundant drive loop	Enclosure ID setting for enclosure in the second redundant drive loop
6th unit (EXP810 or EXP710)	05	either 12 or x5 (where x is 2-7)
7th unit (EXP810 or EXP710)	06	either 13 or x6 (where x is 2-7)

Determining firmware levels

There are two different methods to determine DS4000 Storage Subsystem, expansion unit, drive, and ESM firmware versions. Each method uses the DS4000 Storage Manager client that manages the DS4000 storage subsystem with the attached expansion unit.

Method one:

For controllers with firmware version 6.1x.xx.xx or later, go to the Subsystem Management window and select **Storage Subsystem → View Profile**. For controllers with firmware version 5.xx.xx.xx or earlier select **View → Storage Subsystem Profile**. When, under either circumstance, the Storage Subsystem Profile window opens, select the **All** tab and scroll through the **Profile For Storage Subsystem** to locate the following information.

Note: The **Profile For Storage Subsystem** contains all the profile information for the entire subsystem. Therefore, it might be necessary to scroll through a large amount of information to locate the firmware version numbers.

DS4000 Storage Subsystem

- NVSRAM version
- Appware version (Appware is a reference to controller firmware).
- Bootware version (Bootware is a reference to controller firmware.)

See the following example or snapshot of profile information.

```
Controller in Enclosure 0, Slot A
Status: Online
Current configuration
Firmware version: 06.10.07.00
Appware version: 06.10.07.00
Bootware version: 06.10.07.00
NVSRAM version: 1722F600R910V05
```

Drives

- Firmware version

ESM

- ESM card firmware version

Method two:

Select the appropriate procedure from the following options and complete it to obtain the specified firmware version.

To obtain the controller firmware version:

Right click the Controller icon in the Physical View pane of the Subsystem Management window and select **Properties**. The Controller Enclosure properties window opens and displays the properties for that controller.

You must perform this step for each individual controller.

To obtain the drive firmware version:

Right Click the Drive icon in the Physical View pane of the Subsystem Management window and select **Properties**. The Drive Properties window opens and displays the properties for that drive.

You must perform this step for each individual drive.

To obtain the ESM firmware version:

1. In the Physical View pane of the Subsystem Management window, click the Drive Enclosure Component icon (which is the icon furthest to the right). The Drive Enclosure Component Information window opens.
2. Click the ESM icon in the left pane. The ESM information displays in the right pane of the Drive Enclosure Component Information window.
3. Locate the firmware version of each ESM in the drive enclosure.

To obtain the drive enclosure component firmware version:

1. Click the Drive Enclosure Component icon (the icon located furthest to the right) in the Drive Enclosure frame in the Physical View pane of the Subsystem Management window. The Drive Enclosure Component Information window opens.
2. Click the ESM icon in the left pane. The ESM information displays in the right pane of the Drive Enclosure Component Information window.
3. Locate the firmware version of each ESM in the drive enclosure.

You must perform this step for each drive expansion enclosure.

Determining the product ID and model of a drive

You can determine the product ID and model of a drive from the storage server profile through the menu option in the DS4000 Subsystem Management window. To get the profile, in the DS4000 Subsystem Management window, either click **View → Storage Subsystem Profile** (if the controller firmware version is 05.xx.xx, or earlier) or **Storage Subsystem → View Profile** (if the controller firmware version is 06.xx.xx, or later). When the Storage Subsystem Profile window displays, click on the **Drives** tab and scroll down to the information about the drive which product ID and model you want to verify. See Table 24 on page 39 for a sample profile indicating the product ID of the drive in slot 1 of enclosure ID 1 as ST3146807FC. In addition, the Speed and Current® Data Rate fields show that this drive is a 10Krpm drive and is operating at 2 Gbps fibre channel data rate.

Table 24. Snapshot of profile information identifying the product ID of the drive in slot 1 of enclosure ID 1 as ST3146807FC

```
HOT SPARE COVERAGE:
The following arrays are not protected: 1, 2

Total hot spare drives: 0
Standby: 0
In use: 0

DETAILS:
Drive at Enclosure 1, Slot 1
Drive port: 1, Channel: 1; ID: 8/0xD9
Drive port: 2, Channel: 2; ID: 8/0xD9
Drive path redundancy: OK
Status: Optimal
Raw capacity: 136.732 GB
Usable capacity: 136.732 GB
Current data rate: 2 Gbps
Product ID: ST3146807FC      !#
Firmware version: B350
Serial number: 3HY062YK00007309FAT1
Vendor: IBM-ESXS
Date of manufacture: May 29, 2002
World-wide name: 20:00:00:04:cf:56:43:fb
Drive type: fibre channel
Speed: 10033 RPM
Mode: Assigned
Associated array: 1

Drive at Enclosure 1, Slot 2
Drive port: 1, Channel: 2; ID: 9/0xD9
Drive port: 2, Channel: 1; ID: 9/0xD9
Drive path redundancy: OK
Status: Optimal
Raw capacity: 136.732 GB
Usable capacity: 136.732 GB
Current data rate: 2 Gbps
```

DS4000 Storage Manager installation and support guides

This publication frequently cites *IBM TotalStorage DS4000 Storage Manager installation and support guides* supporting various versions and operating system environments. There are currently two, namely:

- *IBM TotalStorage DS4000 Storage Manager Installation and Support Guide for AIX, HP-UX, Solaris and Linux on Power*
- *IBM TotalStorage DS4000 Storage Manager Installation and Support Guide for Intel-based Operating System Environments*

Visit the following Web site to access documentation related to your particular operating system and DS4000 Storage Manager version.

www.ibm.com/servers/storage/support/disk/

See “DS4000 Storage Subsystem publications” on page xix for more information.

Chapter 2. Prerequisites to adding capacity and hard drive migration

Perform the preliminary steps detailed in this chapter before you add storage capacity or migrate hard drives. After you meet these prerequisite requirements, proceed to any of the following sections to address your particular storage hardware addition or migration requirements:

- Chapter 3, “Adding one or more new hard drives,” on page 53
- Chapter 5, “Adding expansion enclosures containing new hard drives,” on page 69
- Chapter 4, “Migrating one or more hard drives,” on page 59
- Chapter 6, “Migrating expansion enclosures containing hard drives,” on page 93
- Chapter 7, “Upgrading a storage subsystem in a functioning configuration,” on page 111

Failure to perform the steps listed in this section might result in loss of data availability, and in some cases, loss of data. Perform the following steps on the DS4000 Storage Subsystem to which you will migrate or add new hard drives:

- ___ Step 1. Complete a full backup of all data residing on the DS4000 Storage Subsystem.
- ___ Step 2. Verify that the backup was successful.
- ___ Step 3. Verify that the DS4000 Storage Subsystem has the latest controller firmware, non-volatile storage random access memory (NVS RAM), and ESM firmware.

Attention: Before upgrading the controller firmware, please consult the readme file that is packaged with the firmware code for any special prerequisite tasks or any ESMs firmware version and/or stepping stone controller firmware that must be installed first before the controller can be upgraded to the firmware code that is in the firmware package. Failure to do this might result in lost of data availability. There are certain minimum controller firmware version requirements associated with various drive expansion enclosures. See Table 10 on page 4 and Table 11 on page 5 for related information.

- ___ Step 4. Verify that the drive firmware is at the latest level. If it is not, see “Upgrading drive firmware levels” on page 46.
- ___ Step 5. Verify that the DS4000 Storage Subsystem to which you will migrate the hard drives is in optimal state. If it is not, perform the appropriate steps listed in the Recovery Guru to bring the storage subsystem into optimal state.
- ___ Step 6. Use the Read_Link_Status function of the Storage Manager client program and the DS4000 Storage Subsystem management event log (MEL) to verify that the drive loops are in optimal state. If the DS4000 storage subsystem controller firmware is version 06.10.xx.xx or higher, use the drive channel diagnostics to determine if the drive loop is optimal.
- ___ Step 7. Investigate and resolve any errors that reported in the DS4000 Storage Subsystem MEL.
- ___ Step 8. Save and store the storage subsystem profile of the DS4000 Storage Subsystem.

- ___ Step 9. It is necessary to purchase the fibre channel/SATA intermix premium feature option and follow the associated instructions to activate the fibre channel/SATA premium feature.

Important:

Do not store DS4000 Storage Subsystem profiles in the same location as the logical drives defined on your DS4000 Storage Subsystem. Should you do so, and a RAID array failure occurs during subsequent migration, the data will be lost.

If you are migrating drives from another DS4000 Storage Subsystem, you must also perform the preceding steps 1 on page 41 through 8 on page 41 on the DS4000 Storage Subsystem from which you intend to migrate hard drives. You must also perform the following steps to flush server-cached I/O to disks.

- ___ Step 1. Stop all programs, services or processes in the host servers that access the logical drives defined in the migrated hard drives.
- ___ Step 2. Verify that there are no programs, services, or processes running in the background that might write data to the logical drives. (For example, Microsoft® MSCS service periodically writes to the “Quorum” disk.)
- ___ Step 3. Unmount the file systems to flush I/O from the server cache to disk.

Notes:

- a. In a Microsoft Windows environment, it is also necessary for you to remove the drive letter or the mount points of the mapped LUNs instead of unmounting the file systems.
- b. Consult documentation associated with your particular operating system for detailed information regarding the unmount procedure.

After you meet prerequisites described in this section, proceed to any of the following sections to address your particular drive migration requirements.

- Chapter 3, “Adding one or more new hard drives,” on page 53
- Chapter 5, “Adding expansion enclosures containing new hard drives,” on page 69
- Chapter 4, “Migrating one or more hard drives,” on page 59
- Chapter 6, “Migrating expansion enclosures containing hard drives,” on page 93
- Chapter 7, “Upgrading a storage subsystem in a functioning configuration,” on page 111

Verifying controller, NVSRAM, and ESM firmware file levels

The controller firmware and NVSRAM of the DS4000 Storage Subsystem to which you will migrate hard drives, and the ESM firmware in the DS4000 storage expansion enclosures must be at the levels indicated in Table 25 on page 43 to ensure firmware compatibility between the migrating and original hardware. Additionally, DS4000 Storage Manager version 8.3 or higher client software, in conjunction with the controller firmware level 5.30.xx.xx or higher, allows you to upgrade the ESM firmware while the storage subsystem receives I/O from the host server if you select only one drive expansion enclosure to download the ESM firmware at a time in the Select drive enclosure to download ESM firmware window.

Note: Always check the readme document included with the DS4000 Storage Subsystem controller firmware package for any “no I/Os” requirement during the controller firmware download. Certain controller firmware upgrade scenarios may require that you first quiesce host I/Os.

Tip: Even though you can upgrade the DS4000 Storage Subsystem and ESM firmware while it processes I/O from the host server, schedule upgrades to occur during time periods of low I/O between the DS4000 Storage Subsystems and host servers.

Table 25 lists IBM DS4000 machine types and model numbers, as well as their current firmware (AppWare or BootWare) and NVSRAM versions.

Table 25. Compatible controller firmware and NVSRAM version by machine type and model number

Product name/model	Machine type	Model number	Firmware version (AppWare / BootWare)	NVSRAM version
IBM TotalStorage DS4100 Storage Subsystem (Single Controller model)	1724	1SC	06.12.16.xx	N1724F10LR842V01
IBM TotalStorage DS4100 Storage Subsystem	1724	100	06.12.16.xx	N1724F100R912V05
IBM TotalStorage FAStT200 Fibre Channel Storage Subsystem	3542	1RU 1RX	05.30.23.00	N3542-1RUR830V09
IBM TotalStorage FAStT200 HA Fibre Channel Storage Subsystem		2RU 2RX	05.30.23.00	N3542-2RUR830V12
IBM TotalStorage FAStT500 Fibre Channel Storage Subsystem	3552	1RU 1RX	05.30.23.00 (Appware) 05.30.03.00 (Bootware)	N3552F500R830V05
IBM TotalStorage DS4300 Fibre Channel Storage Subsystem	1722	60X 60U	06.12.16.xx	N1722F600R912V05
IBM TotalStorage DS4300 Fibre Channel Storage Subsystem (with Turbo option)			06.12.16.xx	N1722F600R912V05
IBM TotalStorage DS4300 Fibre Channel Storage Subsystem (Single Controller model)		6LU 6LX	05.34.08.00	N1722F60LR834V04
IBM TotalStorage DS4400 Fibre Channel Storage Subsystem	1742	1RU 1RX	06.12.16.xx (Appware) 06.10.06.00 (Bootware)	N1742F700R912V05
IBM TotalStorage DS4500 Fibre Channel Storage Subsystem	1742	90X 90U	06.12.16.xx (Appware) 06.10.06.00 (Bootware)	N1742F900R912V06

Table 25. Compatible controller firmware and NVSRAM version by machine type and model number (continued)

Product name/model	Machine type	Model number	Firmware version (AppWare / BootWare)	NVSRAM version
IBM TotalStorage DS4800 Fibre Channel Storage Subsystem	1815	82x 84x 88x	<p>06.15.1x.xx for EXP100 and/or EXP710 storage expansion enclosures</p> <p>6.16.xx.xx for EXP810 and/or EXP710 storage expansion enclosures</p> <p>CAUTION: If you do not use the correct controller firmware version for the specific EXP100 or EXP810 storage expansion enclosure shown above, the storage expansion enclosure might not be seen by the controller, causing drives in the enclosures to be reported as missing. This could result in failed logical drives and arrays. EXP710 drive enclosures is supported by both controller firmware version 06.15.xx.xx and 06.16.xx.xx.</p>	N1815D480R915V05

Note: Visit the following Web site either to verify software version levels or to identify possible interim updates to firmware and NVSRAM file versions described in Table 25 on page 43.

www-1.ibm.com/servers/storage/support/disk/

Do not automatically update the DS4000 controller firmware and NVSRAM to the levels indicated in Table 25 on page 43 (or higher) before you upgrade the ESM firmware on the storage expansion enclosures to versions indicated in Table 26 on page 45. Consult the readme file that is included in the controller firmware code package for any prerequisite tasks or required ESM firmware upgrades or stepping

stone controller firmware upgrades that need to be performed first before upgrading the controller firmware to a particular version.

Table 26 lists IBM DS4000 storage expansion enclosure models by name, machine type, model number, and current ESM firmware version.

Table 26. Compatible expansion unit ESM firmware version by machine type and model number

DS4000 Storage Expansion Unit product name/model	Machine type	Model number	ESM firmware version
IBM TotalStorage DS4000 EXP100	1710	10U	9563 is required for the new 250 GB drive CRU and the 400G SATA drive option/CRU.
IBM TotalStorage DS4000 EXP500	3560	1RU 1RX	9166
IBM TotalStorage DS4000 EXP700	1740	1RU 1RX	9329
IBM TotalStorage DS4000 EXP710	1740	710	9631
IBM System Storage DS4000 EXP810	1812	81A, 81H	983x

Perform the following steps to upgrade ESM and controller firmware for a down-level DS4000 storage subsystem:

- ___ Step 1. Upgrade the DS4000 Storage Manager software to the latest version. That is DS4000 Storage Manager version 9.1x. For additional information, see the *IBM TotalStorage DS4000 Storage Manager installation and support guide* for the appropriate server operating system environment at:

www-1.ibm.com/servers/storage/support/disk/

Note: To ensure the highest level of software compatibility, update the host server's multi-path software (Redundant Disk Array Controller [RDAC], IBMSAN.CDM, or Linux failover adapter driver) to the level that is either supported by or released with the controller firmware that you intend to download. See the following Web site for current details on software compatibility:

www.ibm.com/servers/storage/support/disk/

- ___ Step 2. Upgrade the storage expansion enclosure ESM firmware. With DS4000 Storage Manager version 8.3 or higher and controller firmware version 05.3x.xx.xx or higher, you can update the ESM firmware while the DS4000 Storage Subsystem is processing I/O from the host server if the ESM firmware download is performed to only one storage expansion enclosure at a time. If you select multiple entries in the ESM firmware download window for ESM firmware download, you must quiesce I/Os from the host servers before starting the ESM firmware download process.

Important:

Even though the DS4000 Storage Subsystem supports controller and ESM firmware upgrade while the DS4000 Storage Subsystem processes I/O from the host server, schedule controller and ESM

firmware upgrades to occur during time periods of low I/O between the DS4000 Storage Subsystems and host servers.

- ___ Step 3. Upgrade the controller firmware and NVSRAM. See Table 25 on page 43 and the web site listed earlier in conjunction with step1 on page 45.

Note: See the readme file in the DS4000 Storage Manager controller firmware package associated with the appropriate host operating system environment for a support statement about the concurrent controller firmware download (that is, downloading code to the DS4000 Storage Subsystem while it is processing I/O from the host server).

Upgrading drive firmware levels

Attention: 1 Gbps fibre channel drives will not operate correctly in a 2 Gbps fibre channel drive loop. Always make certain that a fibre channel drive can operate at the fibre channel speed of the drive loop involved before inserting it into the drive slots in a DS4000 Storage Subsystem configuration. If needed, contact IBM support to ensure the compatibility of your drives before migrating them from one DS4000 configuration to another.

Before you begin migration, upgrade the drive firmware to the latest level. Do not move or migrate fibre channel drives from a 1 Gbps fibre channel environment to a 2 Gbps fibre channel environment unless you have installed the latest firmware documented to enable their operation in a 2 Gbps fibre channel environment.

Downloading drive firmware

Important:

The following procedures assume you using controller firmware at version 5.xx.xx.xx or later. If you are using an earlier version refer to the following IBM web site for the appropriate firmware version documentation:

www.ibm.com/servers/storage/support/disk/

This section provides instructions for downloading DS4000 drive firmware. See the online help for additional information.

Important:

1. IBM supports firmware download with I/O, sometimes referred to as "concurrent firmware download". This feature is not supported for drive firmware.
2. Before starting the drive firmware download process:
 - Stop all I/O activity before downloading drive firmware to a DS4000 Storage Server.
 - Unmount the file systems on all logical drives accessing the drives that you select for firmware upgrade.
 - Complete a full backup of all data residing on the drives that you select for firmware upgrade.

Downloading Storage Manager version 9.1x drive firmware

To download drive firmware for DS4000 storage subsystems with controller firmware version 06.xx.xx.xx using DS4000 Storage Manager version 9.1x, perform the following steps:

1. From the Enterprise Management window, select a storage subsystem.
2. On the Enterprise Management window's menu bar, click **Tools** → **Manage Device**. The Subsystem Management window opens.
3. On the Subsystem Management window's menu bar, click **Advanced** → **Maintenance** → **Download** → **Drive Firmware/Mode pages ...**. The Download Drive Firmware wizard window opens to the Introduction page. Read the instructions displayed and click **Next**.

Note: Storage Manager version 9.1x offers you the option to download and update up to four different firmware file types simultaneously. Previous Storage Manager versions did not offer this capability.

4. Click **Browse** to locate the server directory that contains the firmware that you plan to download.
5. Select the firmware file that you plan to download and click **OK**. The file appears listed in the "Selected Packages" window pane.

Note: Use the firmware files that are in the HDD_SM9x_format directory of the drive firmware web package.

6. Select the firmware file for any additional drive types that you intend to download and click **OK**. Additional files appear listed in the "Selected Packages" window pane. A maximum total of four drive types are possible.
7. Click **Browse** to repeat step 6 until you have selected each firmware file that you plan to download.
8. When you have finished specifying the firmware packages for download, select **Next**.
9. The Select Drive window opens, containing two tabs, a **Compatible Drives** tab and an **Incompatible Drives** tab. The **Compatible Drives** tab contains a list of the drives compatible to the firmware package types that you selected. From that list, select the drives to which you plan to download the drive firmware that you selected in steps 6 and 7.

Note: The firmware that you propose to download should be listed on the **Compatible Drives** tab. If your particular drives' product ID matches the firmware type, however, and it is not listed as compatible on the tab, contact your IBM technical support representative for additional instructions.

10. Select the **Compatible Drives** tab.
Press and hold the **Ctrl** key while using your mouse to select multiple drives individually, or press and hold the **shift** key while using your mouse to select multiple drives listed in series. The compatible firmware that you selected in steps 5 and 6 will download to the drives that you select.
11. Click **Finish** to initiate download of the drive firmware to each compatible drive that you selected in step 9.
12. The Download Drive Firmware warning opens and prompts: "Do you want to continue?" Type **yes** and click **OK** to start the drive firmware download.
13. The Download Progress window opens. Do not intervene until the download process completes.
14. Every drive scheduled for firmware download will be designated as in progress until successful or failed.

Note: Complete the following two steps if you receive a failure.

- a. Click the **Save as** button to save the error log.

- b. On the Subsystem Management window's menu bar, click **Advanced** → **Trouble Shooting** → **Open Event Log** and complete the following tasks necessary to save the storage subsystem event log before contacting your IBM Service Representative and proceeding to step 16.
 - 1) Click the **Select all** button.
 - 2) Click **Save the Storage Subsystem Event Log**.
15. When the **Close** button appears active, the drive firmware download process is complete.
16. Click **Close** to exit the Download Progress window.
17. Use either of the following procedures to determine or verify what level of drive firmware resides on a particular drive:
 - Right-click on that drive in the Logical/Physical View in the Subsystem Management window and click **Properties**. The associated drive firmware version will be listed in the drive properties table.
 - Right-click on **Storage Subsystem** → **View Profile** in the Logical/Physical View of the Subsystem Management window.

Downloading Storage Manager version 8.x drive firmware

To download drive firmware for DS4000 storage subsystem with controller firmware version 05.xx.xx.xx using either DS4000 Storage Manager version 8.x, or version 9.x, perform the following steps:

1. From the Enterprise Management window, select a storage subsystem.
2. Click **Tools** → **Manage Device**. The Subsystem Management window opens.
3. Click **Advanced** → **Download** → **Drive Firmware**. The Download Drive Firmware window opens. It presents a list of all installed drives.
4. From the list of all installed drives, select the drive to which you plan to download drive firmware.

Press and hold the **Ctrl** key while using your mouse to select multiple drives singly, or press and hold the **shift** key while selecting multiple drives in series by using your mouse pointer.
5. Click **Browse** to identify the directory that contains the drive firmware that you intend to download.

Note: Use the firmware files that are in the HDD_SM8x_format directory of the drive firmware web package.
6. Select the file containing the drive firmware that you intend to download.
7. Select **Start**. The Confirm Download window appears.
8. Type **yes** when the Confirm Download window prompts: Are you sure you want to continue?
9. The download begins and the Status window indicates progress. Do not intervene until the download process completes.
10. When the **Cancel** button appears active, the download process is complete. Press **Cancel** to close the Status window.
11. To determine or verify the level of drive firmware residing on a particular drive, click **View** → **Subsystem Profile** in the Logical/Physical View of the Subsystem Management window.

Bringing storage subsystems and drive loops into optimal state

Note: For additional information on how to make this determination, see the *DS4000 Problem Determination Guide* associated with your particular DS4000 hardware model.

After you have updated or verified that a DS4000 Storage Subsystem is using the latest firmware and NVSRAM:

- ___ Step 1. Bring the DS4000 Storage Subsystem to its optimal state before reconfiguring it with new hardware.
- ___ Step 2. Use the DS4000 Storage Manager client program to display the status of the DS4000 Storage Subsystem and to correct any problems that might cause the DS4000 Storage Subsystem to enter its Needs Attention state.
- ___ Step 3. Verify that all indicator lights on the storage subsystem are in their optimal state.
- ___ Step 4. In addition, use the Read_Link_Status function of the DS4000 Storage Manager client program and the DS4000 Storage Subsystem MEL to verify that all components in the drive loop are in their optimal states (that is, there are no drive loop component errors in the event log and no errors in the Read_Link_Status window.) If you are using controller firmware 06.10.xx.xx or later, use the drive channel diagnostics to determine if the drive loop is optimal. See the DS4000 Storage Manager Client program Subsystem Management window Online help for more information on the RLS and drive channel diagnostics if they are supported by the installed version of your controller firmware. Drive channel diagnostics are only available if you are using controller firmware version 06.10.xx.xx or later.
- ___ Step 5. If the arrays are in degraded state due to a failed drive, correct the problem before migration.

If necessary, contact the IBM Help Center in your geography for assistance with event log interpretation.

It is necessary for certain tasks to complete before proceeding to add drives or enclosures. Before you add drives or enclosures, verify that the storage subsystem involved is not performing any of the following tasks.

- Dynamic logical drive capacity expansion (dynamic volume expansion [DVE] or dynamic capacity expansion [DCE])
- Logical drive segment size modification
- Array RAID-level modification
- User-initiated array redundancy checking (menu option **Array** → **Check Redundancy** in the Subsystem Management window)
- Remote mirror logical drive synchronization
- FlashCopy or VolumeCopy logical drive creation
- Logical drive reconstruction or copyback. This action is sometimes referred to as logical drive sparing.

Saving the storage subsystem profile

Use the DS4000 Storage Manager client program to save a DS4000 Storage Subsystem profile. Such a profile is necessary to restore a storage subsystem configuration in the event of a catastrophic failure. Migration from one DS4000 Storage Subsystem configuration to another will require that you save both DS4000 Storage Subsystem configuration profiles involved. For details on this procedure, see one of the following:

- DS4000 Storage Manager client program Client Subsystem Management window online help
- *IBM TotalStorage DS4000 Storage Manager installation and support guide* associated with your particular operating system environment located at:
www-1.ibm.com/servers/storage/support/disk/
- *Saving a module profile report and state capture information to help prevent data loss* located at:
www-3.ibm.com/pc/support/site.wss/document.do?lnocid=MIGR-4VVPEF

Important:

Do not store DS4000 Storage Subsystem profiles in the same location as the logical drives defined on your DS4000 Storage Subsystem. Should you do so, and a RAID array failure occurs during subsequent migration, the data will be lost.

Handling static-sensitive devices

Attention: Static electricity can damage electronic devices and your system. To avoid damage, keep static-sensitive devices in their static-protective packages until you are ready to install them.

To reduce the possibility of electrostatic discharge (ESD), observe the following precautions:

- Limit your movement. Movement can cause static electricity to build up around you.
- Handle the device carefully, holding it by its edges or its frame.
- Do not touch solder joints, pins, or exposed printed circuitry.
- Do not leave the device where others can handle and possibly damage the device.
- While the device is still in its static-protective package, touch it to an unpainted metal part of the system unit for at least two seconds. This drains static electricity from the package and from your body.
- Remove the device from its package and install it directly into your system unit without setting it down. If it is necessary to set the device down, place it in its static-protective package. Do not place the device on your system unit cover or on a metal table. Take additional care when handling devices during cold weather because heating reduces indoor humidity and increases static electricity.

Chapter 3. Adding one or more new hard drives

While adding a hard drive to either a controller or a drive expansion enclosure, observe these important rules:

- Observe proper electrostatic discharge (ESD) procedures when handling electronic equipment. See “Handling static-sensitive devices” on page 51 for additional information.
- Never alter the physical configuration of a DS4000 Storage Subsystem while it is powered off unless you are instructed to do so as part of a DS4000 configuration procedure. Specifically, never attach storage components to, or remove storage components from, a configured DS4000 Storage Subsystem while it is powered off.
- Any hard drive, whether new or old, might contain configuration data. Unless you intend to migrate a drive from another DS4000 Storage Subsystem (retaining its configuration data), always use the following procedure to add one or more hard drives to a functioning DS4000 Storage Subsystem configuration.
- The following DS4000 Storage Subsystem devices support only 2 Gbps fibre channel hard drives:
 - DS4000 EXP700 storage expansion enclosures
 - DS4000 EXP710 storage expansion enclosures
 - DS4000 EXP810 storage expansion enclosures
 - DS4300 storage servers

1 Gbps fibre channel drives will not work properly when you insert them into the drive slots of the aforementioned DS4000 storage devices.

Attention: Always make certain that a fibre channel drive can operate at the fibre channel speed of the drive loop involved before inserting it into the drive slots in a DS4000 Storage Subsystem configuration. If needed, contact IBM support to ensure the compatibility of your drives before migrating them from one DS4000 configuration to another.

To identify a 1 Gbps fibre channel drive, locate the product’s label and examine its ID or Model Number. Hard drives with ID or Model Number values that end with “04FC” or “03FC” are 1 Gbps fibre channel drives. For example, “ST173404FC”, “ST318203FC” and “ST136403FC” are model numbers that appear on several 1 Gbps fibre channel hard drives. 1 Gbps fibre channel drives can also be mounted in a tray with the front bezel that is about .75 inches (1.9 centimeters) wider than the 2 Gbps drive tray bezel.

You can also obtain the drive product model and ID through the DS4000 Storage Subsystem profile. For information on how to do so, see “Determining the product ID and model of a drive” on page 38.

- The fibre channel drive option/CRU for the EXP700 and EXP710 is not compatible with the fibre channel drive option/CRU for the EXP810 even though the reported drive product ID is the same for both EXP710 and EXP810 drive CRU. Please consult the EXP710, EXP700 and EXP810 product documentation or the appropriate *Installation, User's, and Maintenance Guide* for the correct part number for drive options and drive CRUs for your drive expansion enclosure.
- Do not mix SATA and fibre channel drives or enclosures together in the same drive loop behind a DS4000 storage subsystem unless the FC/SATA intermix premium feature is purchased and the DS4000 Storage Subsystem is in the storage subsystem list that support FC/SATA intermix feature.
- Do not install SATA drives in fibre channel drive expansion enclosures.
- Do not install fibre channel drives in SATA drive expansion enclosures.

The following procedure outlines the steps necessary to add one or more new hard drives to empty drive slots in either DS4100, FAStT200, or DS4300 controllers or in EXP100, EXP500, EXP700, EXP710, or EXP810 storage expansion enclosures. If you plan to add a used drive, ensure that there is no configuration data on the drive that you need to preserve. Add drives to a DS4000 Storage Subsystem only while it is powered on and in optimal state. See the *DS4000 Problem Determination Guide* or “Bringing storage subsystems and drive loops into optimal state” on page 49 for additional information on how to make this determination.

Activity 1: Disabling the drive migration settings

Important: Unless you have already done so, please review the information in Chapter 1 and perform the prerequisites described in Chapter 2 before performing the activities described in this chapter.

Before you add drives to the subsystem, perform this activity to remove any configuration data that they might contain.

- ___ Step 1. Open the Storage Manager client program’s Enterprise Management window.
- ___ Step 2. Right-click on the name of the DS4000 Storage Subsystem to which you intend to add drives and click **Execute Script**.
- ___ Step 3. A script editor window opens. Click **File → Load Script**.
- ___ Step 4. A Load Script file selection window opens. Locate and select the file named `DisableDriveMigration.scr` and click **OK**. The `DisableDriveMigration.scr` file is normally located in the `SCRIPTS` directory of the IBM DS4000 Storage Manager Installation Compact Disc (CD). Use this file to reset the DS4000 storage subsystem setting to ignore configuration data that might reside on newly discovered hard drives. Figure 18 on page 57 provides a listing of the `DisableDriveMigration.scr` file.
- ___ Step 5. Click **Tools → Verify and Execute** to run the script.
- ___ Step 6. When the script completes execution, reset both DS4000 controllers to enable the DS4000 drive migration setting.

If you used the `DisableDriveMigration.scr` script associated with this document and described in Figure 17 on page 56, it is not necessary for you to perform this step because the last two commands in that script file automatically reset the controllers.

To reset the controllers, open the Storage Subsystem Management window and sequentially (one at a time) reset each controller by clicking **Advanced → Reset Controller**. Then, follow the instructions in the Reset Controller window when it opens.

Activity 2: Inserting drives

- ___ Step 1. Insert drives as pairs (two at a time) into the empty drive slots.
- ___ Step 2. Wait (up to five minutes) until each drive pair has fully spun up and displayed in the DS4000 Storage Subsystem Management window before inserting the next drive pair.

Activity 3: Re-enabling the drive migration settings

Perform this activity to re-enable the drive migration settings if you performed “Activity 1: Disabling the drive migration settings” on page 54 to disable DS4000 storage subsystem drive migration settings. If you do not, whenever you might subsequently, even momentarily remove a drive from the storage subsystem for any reason, its configuration data will be cleared. When the storage subsystem next recognizes such a drive, it will display it as unconfigured.

Attention: In order to prevent data loss, set the DS4000 Storage Subsystem drive migration to enable after you complete the hard drive addition process.

- ___ Step 1. Open the Storage Manager client program Enterprise Management window.
- ___ Step 2. Right-click on the name of the DS4000 Storage Subsystem to which you want to add drives and click **Execute Script**.
- ___ Step 3. A script editor window opens. Click **File → Load Script**.
- ___ Step 4. A Load Script file selection window opens. Locate, and select the file named EnableDriveMigration.scr and click **OK**. The file EnableDriveMigration.scr is normally located in the SCRIPTS directory of the IBM DS4000 Storage Manager Installation CD. Use this file to reset the DS4000 Storage Subsystem setting in order to check for configuration data that might reside on newly discovered hard drives. Figure 17 on page 56 provides a listing of the EnableDriveMigration.scr file.
- ___ Step 5. Click **Tools → Verify and Execute** to run the script.
- ___ Step 6. When the script completes execution, reset both DS4000 controllers to enable the DS4000 drive migration setting.

If you use the EnableDriveMigration.scr script associated with this document and described in Figure 17 on page 56, it is not necessary for you to perform this step because the last two commands in that script file automatically reset the controllers.

To reset the controllers, open the Storage Subsystem Management window and sequentially (one at a time) reset each controller by clicking **Advanced → Reset Controller**, and then following the instructions in the Reset Controller window when it opens.

Result: The newly added drives are ready for you to configure and map to host servers.

The next two figures list the EnableDriveMigration.scr and DisableDriveMigration.scr files.

```

// Name: Enable Drive Migration
//
// Date: 11-20-2005
// Revision: 1.4
//   Version 1.4 fixed the misleading on/off comment - CMVC 296330.
// Comments:
// This script is intended to work with controllers at Firmware 05.30.xx.xx and
// higher only.
//
// This script returned the FAStT to it's default operation of importing
// configuration information from disks.
//
// This script will reboot both controllers in the FAStT unit. If your
// hosts are configured for multi-path support, this can be done with I/O
// running to the controllers. If your hosts are not configured for
// redundant access you must schedule downtime before running this
// script.
//
// See the directions at the bottom of this script if you do not have multi
// path software installed and wish to prevent the controller restarts
//
// Show the current state of Drive Migration
show "Showing the current state of Drive Migration. The return value should";
show "be 82, which means drive migration is disable.";
show " ";
show controller[a] nvsrambyte[0x35];
show controller[b] nvsrambyte[0x35];
//
// Setting Drive Migration to Enable
show "Setting Drive Migration to Enable";
set controller[a] nvsrambyte[0x35] = 0x02,0x00;
set controller[b] nvsrambyte[0x35] = 0x02,0x00;
show "Showing the new state of Drive Migration. The return value should";
show "be 80, which means drive migration is enable. This should be the ";
show "default setting for the DS4000 controllers. ";
show " ";show controller[a] nvsrambyte[0x35];
show controller[b] nvsrambyte[0x35];
//
// Reset Controllers to make changes active. Note:
// To prevent the controllers from restarting, add '//' to the beginning
// of each of the lines below. This will comment out the restart of the
// controllers. Important: The controllers will have to be restarted for the
// changes in this script to take effect.
//
show "Resetting controller A";
reset Controller [a];
show "Resetting controller B";
reset Controller [b];
show "Drive Migration is now enabled.";

```

Figure 17. EnableDriveMigration.scr file listing

```

// Name: Disable Drive Migration
// Date: 11-20-2005
// Revision: 1.4
// Version 1.4 fixed the misleading on/off comment - CMVC 296330.
// Comments:
// This script is intended to work with controllers at Firmware 05.30.xx.xx and higher only.
// This script allows the addition of disk drives while the system is running
// and by clearing the configuration of any drives as unused capacity
// regardless of past configuration of these drives.
//
// Attention: This setting should not be left active after the new disks
// have been added to the subsystem. Leaving this setting active could
// cause the configuration for the DS4000/FASTt to be lost if the DS4000/FASTt
// is power cycled. Please run the EnableDriveMigration.scr after all of
// the disks are added. IN ADDITION, DO NOT USE THIS SCRIPT IF YOU WANT
// TO PRESERVE THE DATA IN THE DRIVES THAT YOU ARE PLANNING TO ADD INTO
// THE EXISTING DS4000 STORAGE SUBSYSTEM CONFIGURATION. Please refer to
// the DS4000 adding capacity and drive migration publication for more information.
//
// This script will reboot both controllers in the FASTt unit. If your
// hosts are configured for multi-path support, this can be done with I/O
// running to the controllers. If your hosts are not configured for
// redundant access you much schedule downtime before running this script.
//
// Show the current state of Drive Migration
show "Showing the current state of Drive Migration. The return value should";
show "be 80, which means drive migration is enable. This should be the ";
show "default setting for the DS4000 controllers. ";
show " ";
show controller[a] nvsrambyte[0x35];
show controller[b] nvsrambyte[0x35];
//
// Setting Drive Migration to Disable
show "Setting Drive Migration to Disable";
set controller[a] nvsrambyte[0x35] = 0x02,0x02;
set controller[b] nvsrambyte[0x35] = 0x02,0x02;
show "Showing the new state of Drive Migration. The return value should be";
show "82, which means drive migration is disable. Please run the enableDrive";
show "Migration.scr script as soon as you complete the inserting of ";
show "new drives into the DS4000 storage subsystem slots.";
show " ";
show controller[a] nvsrambyte[0x35];
show controller[b] nvsrambyte[0x35];
//
// Reset Controllers to make changes active
// To prevent the controllers from restarting, add '//' to the beginning of each of the
// lines below. This will comment out the restart of the controllers. Important: The
// controllers will have to be restarted for the changes in this script to take effect.
show "Resetting controller A";
reset Controller [a];
show "Resetting controller B";
reset Controller [b];
//
show "Drive Migration is now disabled. Add the new drives to the subsystem,";
show "then execute the EnableDriveMigrationScript.scr to re-enable drive ";
show "migration.";

```

Figure 18. DisableDriveMigration.scr file listing

Chapter 4. Migrating one or more hard drives

Note: When migrating hard drives from multiple DS4000 storage servers to a single DS4000 Storage Subsystem, move all of the hard drives from the first DS4000 Storage Subsystem as an independent "set" to the destination DS4000 Storage Subsystem. Before moving hard drives as a set from subsequent DS4000 Storage Subsystem, ensure that all of the hard drives from the previous set have been successfully transferred to the destination DS4000 Storage Subsystem. If you do not transfer hard drives as "sets" to the destination DS4000 Storage Subsystem, the newly relocated arrays/logical drives that are defined in these drives might not appear in the Subsystem Management window.

While migrating a hard drive to either a controller or a drive expansion enclosure, observe these important rules:

Note: If you encounter problems while migrating drives, stop any further action and contact IBM support to avoid data loss.

- Observe proper ESD procedures when handling electronic equipment. See "Handling static-sensitive devices" on page 51 for additional information.
- Never alter the physical configuration of a DS4000 Storage Subsystem while it is powered off unless you are instructed to do so as part of DS4000 configuration procedure. Specifically, never attach storage components to or remove storage components from a configured DS4000 Storage Subsystem while it is powered off.
- Any hard drive, whether new or old, might contain configuration data. Use this procedure to preserve the configuration and user data in one or more hard drives that you will migrate to a functioning DS4000 Storage Subsystem configuration. Do not use this procedure if you are unsure of the quality of the data on the hard drives.
- The following DS4000 Storage Subsystem devices support only 2 Gbps fibre channel hard drives:
 - DS4000 EXP700 storage expansion enclosures
 - DS4000 EXP710 storage expansion enclosures
 - DS4000 EXP810 storage expansion enclosures
 - DS4300 storage servers

1 Gbps fibre channel drives will not work properly when you insert them into the drive slots of the aforementioned DS4000 storage devices.

Attention: Always make certain that a fibre channel drive can operate at the fibre channel speed of the drive loop involved before inserting it into the drive slots in a DS4000 Storage Subsystem configuration. If needed, contact IBM support to ensure the compatibility of your drives before migrating them from one DS4000 configuration to another.

To identify a 1 Gbps fibre channel drive, locate the product's label and examine its ID or Model Number. Hard drives with ID or Model Number values that end with "04FC" or "03FC" are 1 Gbps fibre channel drives. For example, "ST173404FC", "ST318203FC" and "ST136403FC" are model numbers that appear on several 1 Gbps fibre channel hard drives. 1 Gbps fibre channel drives can also be mounted in a tray with the front bezel that is about .75 inches (1.9 centimeters) wider than the 2 Gbps drive tray bezel.

You can also obtain the drive product model and ID through the DS4000 Storage Subsystem profile. For information on how to do so, see “Determining the product ID and model of a drive” on page 38.

- The fibre channel drive option/CRU for the EXP700 and EXP710 is not compatible with the fibre channel drive option/CRU for the EXP810 even though the reported drive product ID is the same for both EXP710 and EXP810 drive CRU. Please consult the EXP710, EXP700 and EXP810 product documentation or the appropriate *Installation, User's, and Maintenance Guide* for the correct part number for drive options and drive CRUs for your drive expansion enclosure.
- Do not mix SATA and fibre channel drives or enclosures together in the same drive loop behind a DS4000 Storage Subsystem unless the FC/SATA intermix premium feature is purchased and the DS4000 Storage Subsystem is in the storage subsystem list that support FC/SATA intermix feature.
- Do not install SATA drives in fibre channel drive expansion enclosures.
- Do not install fibre channel drives in SATA drive expansion enclosures.

Activity 1: Verifying the drive migration enable settings

The DS4000 storage subsystem drive migration setting must be set to enable before inserting drives with configuration data. If not, the DS4000 controller ignores the configuration data in the drive and displays the drive as unconfigured and optimal. IBM recommends that you perform the steps to run the EnableDriveMigration script to ensure the drive migration setting is set to enable before inserting any drives with configuration data. See “Activity 3: Re-enabling the drive migration settings” on page 55 for instructions.

Activity 2: Preliminary activities

The following procedure describes the steps that you must perform to migrate one or more drives from a functioning DS4000 Storage Subsystem configuration to another DS4000 Storage Subsystem configuration. Drives described in the following steps are those that contain configuration data that you want to preserve. Add such drives to a DS4000 Storage Subsystem only while it is powered on and in its optimal state. See the *DS4000 Problem Determination Guide* or “Bringing storage subsystems and drive loops into optimal state” on page 49 for additional information on how to assess the state of a DS4000 Storage Subsystem.

Important:

Before you attempt to complete the drive migration procedure, review the information provided in Chapter 1 and perform the steps documented in Chapter 2, “Prerequisites to adding capacity and hard drive migration,” on page 41.

The procedure for migrating hard drives that contain configuration data that you want to preserve is as follows:

Before you remove drives from a functioning DS4000 Storage Subsystem, perform the following steps to ensure that you successfully migrate the drives to the destination DS4000 Storage Subsystem.

- ___ Step 1. Perform a backup of the logical drives defined in the hard drives that you plan to migrate.
- ___ Step 2. Stop all programs, services or processes in the host servers that access the logical drives defined in the migrated hard drives. Ensure that there are not any running background programs, services or

processes that write data to the logical drives. (For example, the Microsoft MSCS service periodically writes to the “Quorum” disk.)

- ___ Step 3. Unmount the file systems to flush I/O from the server cache to disks.

Notes:

- a. In a Microsoft Windows environment, remove the drive letter or the mount points of the mapped LUNs instead of unmounting the file systems.
 - b. Refer to the documentation associated with your particular operating system for detailed information regarding the Unmount procedure.
- ___ Step 4. Verify that the DS4000 Storage Subsystem controller and NVSRAM of both the source and destination systems are at or above levels described in Table 25 on page 43.
 - ___ Step 5. Verify that the names of the logical drives that are associated with hard drives on both the source and destination systems are unique. If they are not, make the necessary changes.
 - ___ Step 6. In addition to array configuration information, any storage partitioning configuration data that may reside on drives you plan to migrate will migrate with those drives when installed on another DS4000 Storage Subsystem. For this reason, take the following precautions to facilitate the migration process and prevent problems in storage partitioning configuration data migration.
 - a. If a DS4000 storage partitioning premium feature has been enabled both on a drive’s original and destination DS4000 storage servers, assure that the defined host ports, hosts, and host group names are unique to each DS4000 Storage Subsystem involved in the migration.
 - b. If you must use identical names on both DS4000 Storage Subsystems, make the names unique before you perform the drive migration.

If necessary, customize the storage partitioning information on the DS4000 Storage Subsystem to which you have migrated the drives after you complete the migration.
 - ___ Step 7. Delete any flashcopies of the logical drives defined on the drives that you plan to migrate.
 - ___ Step 8. Remove any remote mirror relationships using the logical drives defined on the drives that you plan to migrate.
 - ___ Step 9. Ensure that the arrays and logical drives are in optimal state before starting the migration process. See the *DS4000 Problem Determination Guide* associated with your particular DS4000 hardware model or “Bringing storage subsystems and drive loops into optimal state” on page 49 for additional information on how to make this determination.
 - ___ Step 10. Place the arrays defined in the hard drives that you plan to migrate in offline state. To do so, right-click on the name of the array in the Storage Subsystem Management window and click **Place** → **Offline**.
 - ___ Step 11. If you migrate drive expansion enclosures from a 1 Gbps fibre channel environment to a 2 Gbps fibre channel environment, verify that the fibre channel hard drives that you plan to migrate are each capable of 2 Gbps operation and that you have installed the latest firmware enabling them to work properly in a 2 Gbps fibre channel environment.

- ___ Step 12. Save the DS4000 Storage Subsystem profile of the functioning DS4000 Storage Subsystem configuration to which the migration will occur in a location other than that of the logical drives you plan to migrate.
- ___ Step 13. If you migrate the drives to a single controller DS4000 Storage Subsystem (for example, DS4300 Storage Subsystem, model 6LU or 6LX), change the logical drive's preferred owner to Controller A using the DS4000 Storage Manager client program before taking it offline and removing it from the DS4000 Storage Subsystem. To set Controller A as the logical drive preferred owner, right-click the logical drive entry in the Subsystem Management window and select **Change** → **Ownership/Preferred Path** → **Controller A**.

Activity 3: Removing the drives to be migrated

While the functioning DS4000 Storage Subsystem is still powered on, remove the hard drives that you plan to migrate one at a time using the following steps:

- ___ Step 1. Press on the inside of the bottom of the tray handle to release the blue latch.
- ___ Step 2. Lift the closed latch to its open position. (The latch is at a 90-degree angle to the front of the drive when open.)

Note: Your drive CRUs might have a different latching mechanism than the one shown in Figure 19 on page 63. Refer to the *Installation, User's, and Maintenance Guide* for your particular storage expansion enclosure for details.

- ___ Step 3. Using the handle, slowly pull the drive ½-inch out of its drive slot.
- ___ Step 4. Wait at least 30 seconds to allow the hard drive to spin down before fully removing it from the drive slot.
- ___ Step 5. Place the hard drive into an ESD bag or container before moving it to the new DS4000 Storage Subsystem.

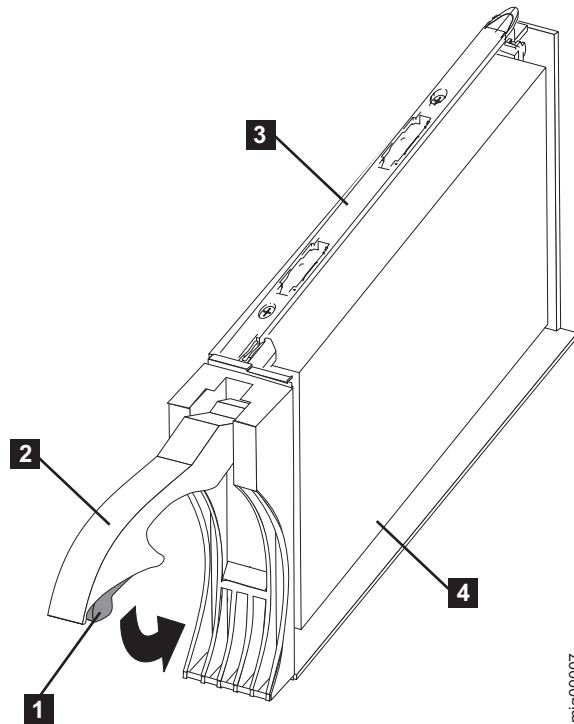

Figure 19. Drive CRU assembly

Legend:

- 1** Blue latch
- 2** Drive CRU handle
- 3** Tray
- 4** FC hard drive



Attention: Orient drives horizontally and place them in appropriate ESD bags or containers before relocation. When in transit, use only moving equipment that prevents shock to the drives. Never stack drives.

Activity 4: Inserting the drives to be migrated

Notes:

1. When migrating hard drives from multiple DS4000 Storage Subsystems to a single DS4000 Storage Subsystem, move all of the hard drives from the first DS4000 Storage Subsystem as an independent "set" to the destination DS4000 Storage Subsystem. Before moving hard drives as a set from subsequent DS4000 Storage Subsystems, ensure that all of the hard drives from the previous set have been successfully transferred to the destination DS4000 Storage Subsystem. If you do not transfer hard drives as "sets" to the destination DS4000 Storage Subsystem, the newly relocated arrays/logical drives that are defined using these drives might not appear in the Subsystem Management window.
2. Make sure the drives are compatible with the storage expansion enclosure. For example, insert a 2 GB drive into a storage expansion enclosure that supports 2 GB drives.

Perform the following steps to insert the drives to be migrated.

- ___ Step 1. While the destination DS4000 Storage Subsystem is powered on, insert the migrating drives into the empty drive slots in pairs. Wait (up to five minutes) until the inserted drive pair is fully spun up and displayed in the DS4000 Storage Subsystem Management window before inserting the next drive pair.
- ___ Step 2. As the DS4000 Storage Subsystem recognizes the drives, it reads and displays the array and logical drive information in the Logical/Physical view of the DS4000 Storage Subsystem Management window. The storage subsystem represents arrays in offline state until it recognizes that you have inserted all of the drives that comprise an array.
- ___ Step 3. After you migrate all of the drives, manually change the state of the arrays and logical drives involved from optimal to online state if it has not changed automatically. To do so, right-click on the array name in the Storage Subsystem Management window and select **Place** → **Online**. If any of the following conditions persist, contact the IBM Help Center in your geography for assistance:
 - The empty drive slot icon () displayed for the drive slot into which you inserted the migrating drive.
 - The Failed unconfigured drive icon () or the Failed configured drive icon () displayed for the drive slot into which you inserted the migrating drive.
 - Array configuration data on the drives you have added is incomplete.
 - You cannot bring the array online.

Attention: Do not initialize a drive that you want to keep (by right-clicking its icon and selecting **Initialize** from the pull-down menu) if it contains configuration or user data. Initializing any drives in a defined array causes all hard drives known to comprise that array to return to the Unconfigured Capacity storage pool, deleting their array definitions from the DS4000 Storage Subsystem configuration. The user data on such drives is lost.

Result: Once the arrays are online, they are ready to for you to configure and map to host servers. You might also then recreate flashcopies of the logical drives.
- ___ Step 4. Use the DS4000 Storage Manager program to view the storage partitioning definitions and make any necessary corrections.
- ___ Step 5. The DS4000 Storage Subsystem that the drives are migrated from will display the logical drives that are defined in these drives as “missing LUNs”. In order to remove these “missing LUNs” entries, right-click on each entry and select **Delete** from the pull-down menu.

Migrating arrays within storage subsystems

Important:

1. Ensure that your controller firmware is at or above the level documented in Table 25 on page 43. Do not rearrange more than two or three arrays at a time.
2. Unmount the file systems to flush I/O from the server cache to disks.

Notes:

- a. In a Microsoft Windows environment, remove the drive letter or the mount points of the mapped LUNs instead of unmounting the file systems.

- b. Consult documentation associated with your particular operating system for detailed information regarding the Unmount procedure.

Using the configuration data on existing drives, it is possible to redistribute the drives that made up an RAID array across a storage subsystem to which you may be adding expansion enclosures. Figure 20 illustrates a storage array distributed across three drives on a single storage device before and after reordering. When you redistribute each drive to a different position in the same storage enclosure as recommended, the array automatically redistributes accordingly.

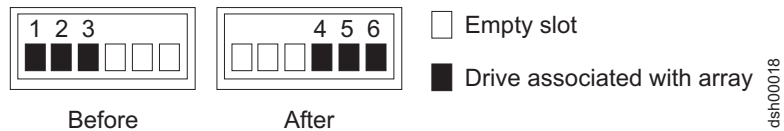

Figure 20. Manner recommended for reordering a defined array using empty slots in one storage enclosure

Figure 21 illustrates a storage array distributed across three drives on a single storage device before reordering across two storage devices. When the drives are redistributed across an additional storage enclosure in the storage subsystem as recommended, the array automatically redistributes accordingly.

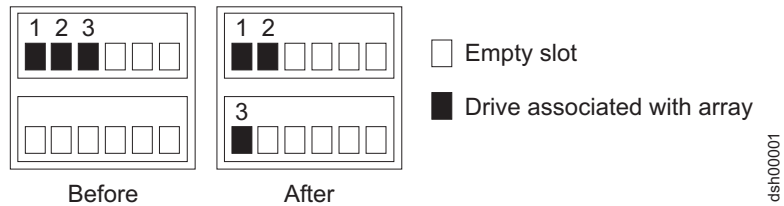

Figure 21. Manner recommended for reordering a defined array using empty slots in two storage enclosures

Figure 22 on page 66 illustrates two arrays distributed across five drives and two storage enclosures before and after reordering the same drives across other drive slots in the same two storage enclosures.

Important:

Before you attempt to reinsert any of the drives from either enclosure, place the array into offline state using the DS4000 Storage Manager client and completely remove all of the drives of both arrays from both storage enclosures and wait for the Storage Manager to remove the arrays/logical drives from the Storage Manager GUI window. After you insert the drives associated with the first array, wait until that array comes online in a DS4000 Storage Manager Subsystem Management window before you insert the drives associated with the second array.

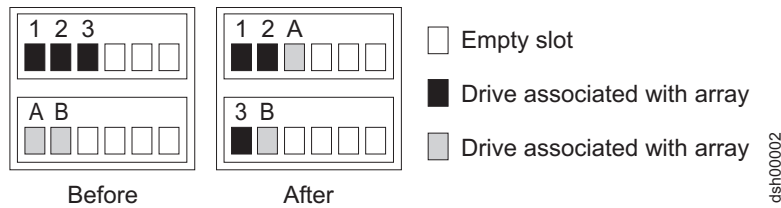

Figure 22. Reordering multiple defined arrays across previously used slots in two storage enclosures

Perform the following steps to ensure success when you reorder drives that make up arrays across different drive slots in the same DS4000 Storage Subsystem configuration.

1. Start the DS4000 Storage Manager Client program and open the Subsystem Management window (for the DS4000 Storage Subsystem which drives you intend to reorder).
2. Set the arrays that you plan to move offline.
3. Mark the drives in the arrays.
4. Unlatch the drives from their respective slots. Wait at least 2 minutes for each drive to spin down.
5. Slowly and carefully remove the drives from their slots.
6. Assure that all of the drives that made up the arrays are completely removed from their slots.
7. Wait for the storage manager to mark the arrays/logical drives as missing in the Subsystem Management window. See Figure 23. **Do not proceed to step 8 until all of the defined logical drives in the array(s) whose drives are removed from the DS4000 enclosures display as missing.**

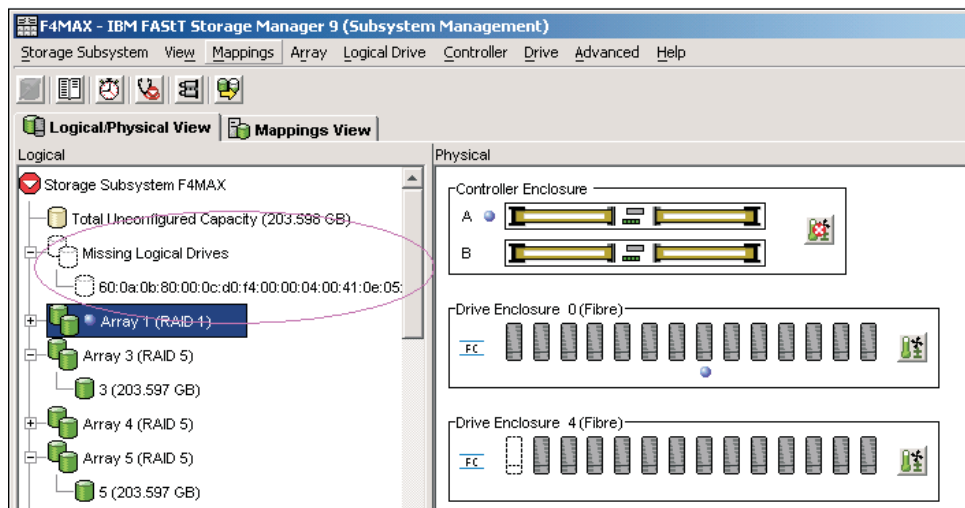

Figure 23. Subsystem Management Logical/Physical View of missing logical drives

8. Carefully reinsert all of the drives that made up a single array into the empty slots of the storage enclosure. Do not insert the drives into empty slots that are part of another array definition whose drives are still inserted in the storage enclosures. Data on the drives you insert will be replaced with the reconstructed data from the previously installed RAID array.
9. The system will recognize the array and bring it online when you finish inserting all of the drives.

10. Repeat steps 8 on page 66 and 9 on page 66 for each of the arrays that were removed from the storage enclosure.
11. Save the storage subsystem profile. See “Saving the storage subsystem profile” on page 50 for information on performing this activity.

Note: Do not reinsert drives from multiple arrays in random order into the storage enclosures.

Chapter 5. Adding expansion enclosures containing new hard drives

Important:

Observe proper ESD procedures when handling electronic equipment. See “Handling static-sensitive devices” on page 51 for additional information.

While adding storage expansion enclosures containing new hard drives, observe these important rules:

- Never alter the physical configuration of a DS4000 Storage Subsystem while it is powered off unless you are instructed to do so as part of DS4000 Storage Subsystem configuration procedure. Specifically, never attach storage components to or remove storage components from a configured DS4000 Storage Subsystem while it is powered off.
- Any hard drive, whether new or old, might contain configuration data. Unless you intend to migrate drives from another DS4000 Storage Subsystem (retaining their configuration data), always use the following procedure to add one or more storage expansion enclosures containing one or more hard drives to a functioning DS4000 Storage Subsystem configuration.
- The following DS4000 Storage Subsystem devices support only 2 Gbps fibre channel hard drives:
 - DS4000 EXP700 storage expansion enclosures
 - DS4000 EXP710 storage expansion enclosures
 - DS4000 EXP810 storage expansion enclosures
 - DS4300 storage servers

1 Gbps fibre channel drives will not work properly when you insert them into the drive slots of the aforementioned DS4000 storage devices.

Attention: Always make certain that a fibre channel drive can operate at the fibre channel speed of the drive loop involved before inserting it into the drive slots in a DS4000 Storage Subsystem configuration. If needed, contact IBM support to ensure the compatibility of your drives before migrating them from one DS4000 configuration to another.

To identify a 1 Gbps fibre channel drive, locate the product’s label and examine its ID or Model Number. Hard drives with ID or Model Number values that end with “04FC” or “03FC” are 1 Gbps fibre channel drives. For example, “ST173404FC”, “ST318203FC” and “ST136403FC” are model numbers that appear on several 1 Gbps fibre channel hard drives. 1 Gbps fibre channel drives can also be mounted in a tray with the front bezel that is about .75 inches (1.9 centimeters) wider than the 2 Gbps drive tray bezel.

You can also obtain the drive product model and ID through the DS4000 Storage Subsystem profile. For information on how to do so, see “Determining the product ID and model of a drive” on page 38.

- You can only intermix the EXP810 with the EXP710 in the same redundant drive channel/loop pair. Please contact IBM Support for information about intermixing the EXP810 with other drive expansion enclosures in the future.
- Do not mix SATA and fibre channel drives or enclosures together in the same drive loop unless you have met the fibre channel/SATA intermix requirements. See “Intermixing storage expansion enclosures” on page 3 for that information.
- Do not install SATA drives in fibre channel drive expansion enclosures.
- Do not install fibre channel drives in SATA drive expansion enclosures.

The following procedure describes the steps required to add one or more DS4000 storage expansion enclosures containing new drives to a functioning DS4000 Storage Subsystem configuration.

Activity 1: Preliminary activities

Important:

Before you attempt to complete the drive migration procedure, review the information provided in Chapter 1 and perform the steps documented in Chapter 2, “Prerequisites to adding capacity and hard drive migration,” on page 41.

Add a new DS4000 storage expansion enclosure as follows:

- ___ Step 1. Verify that the DS4000 Storage Subsystem is both powered on and in optimal state. See the *DS4000 Problem Determination Guide* associated with your particular DS4000 hardware model or “Bringing storage subsystems and drive loops into optimal state” on page 49 for additional information on how to make this determination. You can perform this process while the DS4000 Storage Subsystem is processing I/O from or to the host server. However, because the drive loops are interrupted momentarily during the addition process, schedule additions to occur during time periods of low I/O between the DS4000 Storage Subsystem and host servers.

Note: Though there are no restrictions against cabling EXP100 and EXP700 or EXP710 and EXP810 storage expansion enclosures together, for ease of future maintenance and possible problem troubleshooting, IBM recommends that you group or plan your configuration to allow for grouping of the drive expansion enclosures by type in a DS4000 Storage Subsystem redundant drive loop/channel pair, if possible.

Review the readme and the *IBM TotalStorage DS4000 Storage Manager installation and support guide* associated with the operating system environment of the host servers that connect to the DS4000 Storage Subsystem for any additional restrictions or required preparation tasks specific to your particular operating system environment. You will find the *IBM TotalStorage DS4000 Storage Manager installation and support guides* at:

www-1.ibm.com/servers/storage/support/disk/

Verify that the DS4000 Storage Subsystem support the DS4000 drive storage expansion enclosures that you trying to add.

- ___ Step 2. If the new storage expansion enclosure is not the same type as the existing storage expansion enclosures (some or all) see “Intermixing storage expansion enclosures” on page 3 for intermix information.

Note: You must group like DS4000 storage expansion enclosure types in adjacent positions on the Fibre Channel loop when they are intermixed in a DS4000 Storage Subsystem redundant drive loop configuration.

- ___ Step 3. Unpack and mount any additional storage expansion enclosures in the rack using the mounting hardware supplied with each storage expansion enclosure.

Important::

Do not fully insert hard drives into the enclosures at this time. Keep them unlatched and no less than ½-inch away from their full insertion points in the drive slots.

- ___ Step 4. Set the enclosure ID of the additional storage expansion enclosures. Each drive enclosure in the DS4000 Storage Subsystem drive loop must have a unique drive enclosure ID. In a EXP500 storage expansion enclosure, there is an enclosure ID switch mounted on each of two ESM canisters. Set each ESM canister's enclosure ID switch in the EXP500 drive enclosure to the same unique number in the drive loop. In EXP100, EXP700, and EXP710 storage expansion enclosures, there is only one enclosure ID switch, which is mounted between the power supplies. The EXP810 does not have a physical switch setting for the enclosure ID. Instead it has a display that shows its enclosure ID. The controller firmware automatically sets the enclosure ID. However, you can change the enclosure ID by using the DS4000 Storage Manager Client program. See the appropriate *DS4000 Installation, User's, and Maintenance Guide* for the particular storage expansion enclosure for additional information. Figure 24 illustrates the location of enclosure ID switches on the EXP100, EXP700, EXP710, and EXP500 storage enclosures.

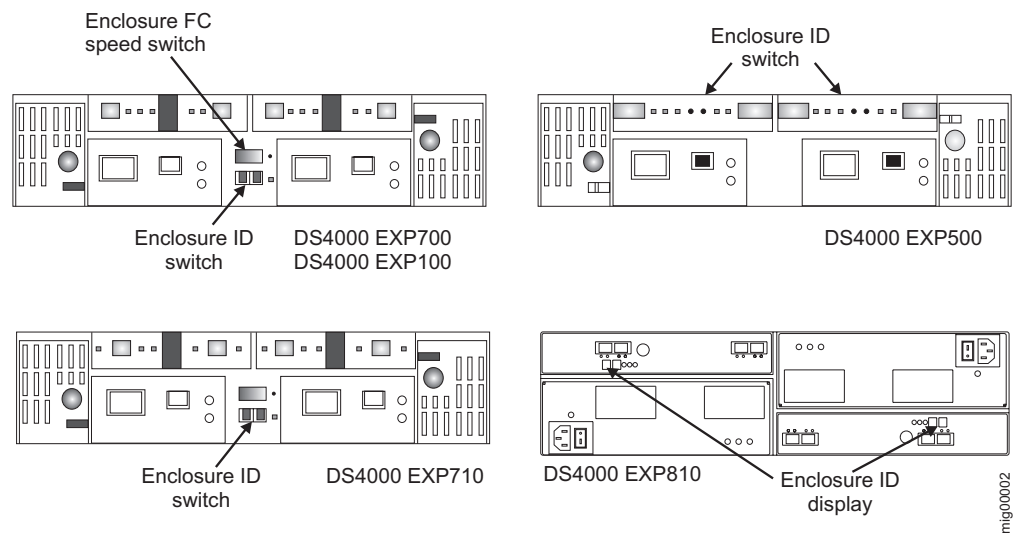

Figure 24. EXP100, EXP500, EXP700, and EXP710 enclosure ID and speed switches

If the DS4000 Storage Subsystem to which the storage expansion enclosure will attach is either a FAST200 or DS4300, the enclosure IDs of additional storage expansion enclosures must differ from the FAST200 or DS4300 Storage Subsystem enclosure IDs, which are normally set to “0” at the factory.

- ___ Step 5. Verify that the EXP700 Storage Expansion Unit speed switch is set to the correct drive loop speed.

Note: If a fibre channel enclosure speed switch was originally set to 1 Gbps, do not automatically set it to 2 Gbps unless you are sure that each fibre channel hard drive that it now contains is capable of 2 Gbps operation and that you have installed the latest firmware enabling their operation in a 2 Gbps fibre channel environment.

Activity 2: Cabling new storage expansion enclosures

To complete addition of DS4000 storage expansion enclosures, cable the new storage expansion enclosures to the end of the functioning storage expansion enclosure drive loop to which you are migrating them. Add only one enclosure at a time to a functioning drive loop if you intend to attach multiple storage expansion enclosures.

It is possible to connect new storage expansion enclosures at either end of a functioning storage expansion enclosure drive loop. The two options are:

1. The beginning, closest to the controller (at the top, directly attached to controller A) as described in Connecting new storage expansion enclosures at the beginning (top) of a drive loop
2. The end, furthest from the controller (at the bottom, directly attached to controller B) as described in Connecting new storage expansion enclosures at the end (bottom) of a drive loop

Of the two options, IBM recommends only option 2, connection to the end (at the bottom) of a functioning storage expansion enclosure drive loop, directly attached to controller B. This is recommended because if the existing DS4000 Storage Subsystem configuration is not planned for cabling in new storage expansion enclosures at the top of the drive loop, cluttered or entangle fibre channel drive loop cabling may hinder drive loop troubleshooting or cause fibre channel cabling errors. With this in mind, and depending on your requirements, however, follow either of the instruction sets at “Connecting new storage expansion enclosures at the end (bottom) of a drive loop” on page 73 or “Connecting new storage expansion enclosures at the beginning (top) of a drive loop” on page 79.

Depending on your DS4000 Storage Subsystem configuration, there might be unused drive ports that you can connect the new drive expansion enclosures to the DS4000 Storage Subsystem controllers. Use the appropriate information in your *DS4000 Installation, User's and Maintenance Guide* to attach the drive expansion enclosures to the DS4000 storage subsystem.

If your DS4000 Storage Subsystem (such as DS4400 or DS4500) has drive minihubs, do not use more than one port per drive minihub. Always leave one of the two drive ports empty in each drive minihub. After you connect the drive expansion enclosures to the DS4000 controller, see “Activity 3: Disabling DS4000 Storage Subsystem drive migration settings” on page 85.

The steps and graphics in “Connecting new storage expansion enclosures at the end (bottom) of a drive loop” on page 73 and “Connecting new storage expansion enclosures at the beginning (top) of a drive loop” on page 79 illustrate how to connect an EXP700 to a DS4300 storage subsystem drive loop. To connect an EXP810 to an existing DS4800 drive loop, perform the same steps. However, note that the port names are different on the EXP700 than on the EXP810.

Note: For an illustration of how to connect an EXP810 in a DS4800 Storage Subsystem drive loop configuration at the:

- End (bottom) of a drive loop, see Figure 28 on page 78.
- Top (beginning) of a drive loop, see Figure 32 on page 84.

Connecting new storage expansion enclosures at the end (bottom) of a drive loop

The cabling instructions illustrated in Figure 25 on page 75, Figure 26 on page 76, and Figure 27 on page 77 describe cabling a DS4000 EXP700 Storage Expansion Enclosure to the end (bottom) of a redundant drive loop of a functioning DS4300 Storage Subsystem (model 60X or 60U). IBM recommends that you add storage expansion enclosures to an existing drive loops only in this manner. See “DS4000 Storage Subsystem drive loop schemes” on page 27.

- ___ Step 1. Insert the small form-factor pluggables (SFPs) or gigabit interface converters (GBICs) into only those ports you intend to use. Do not leave GBICs or SFPs inserted into port slots without connecting them to other ports using cables.
- ___ Step 2. Extend one of the drive loops (that is, drive loop A) in a DS4000 Storage Subsystem redundant drive loop pair by connecting the OUT port of the last storage expansion enclosure to the IN port of the new storage expansion enclosure as shown in Figure 25 on page 75.

Note: The port name on an EXP810 is not labeled IN. See Figure 28 on page 78 for details.

Attention: Carefully reconfigure only one drive loop at a time, making sure that the drive loop that you modify is properly connected and in optimal state before you attempt to reconfigure another drive loop. Take this precaution to prevent the arrays from being inadvertently failed by the DS4000 Storage Subsystem controllers. This happens when two or more drives in the arrays cannot be reached through either drive loop in the redundant drive loop pair.

- ___ Step 3. Power on the newly added storage expansion enclosure unit.
- ___ Step 4. Wait a few seconds; verify that the port bypass LEDs of all of the ports in drive loop A, now extended to the new storage expansion enclosure, are not lit. Using the DS4000 Storage Manager Client Subsystem Management window, verify that the new storage expansion enclosure is added and displayed in the Logical/Physical view of the window. Correct any errors before proceeding to step 5. For port bypass:
 - ___ a. Verify that the SFPs and GBICs or fibre cables are in good condition.
 - ___ b. Remove and reinsert SFPs, GBICs and fibre cables.
 - ___ c. Ensure that the new drive expansion enclosure speed switch is set to the same speed as the existing drive expansion enclosures and the DS4000 Storage Subsystem speed setting.
 - ___ d. Verify that the ESM is good by physically removing and swapping it with the other ESM in the same drive expansion enclosure. For enclosure ID conflict, set the drive expansion enclosure ID switch to values unique from the current settings in the existing drive expansion enclosures and storage server.

Contact the IBM Help Center in your geography for assistance if the problems persist.

- ___ Step 5. In the other drive loop (that is, drive loop B) in a DS4000 Storage Subsystem redundant drive loop pair, remove the connection from the DS4000 Storage Subsystem drive loop port to the OUT port of the last storage expansion enclosure and connect it to the OUT port of the new drive enclosure as shown in Figure 26 on page 76.

Note: The port name on an EXP810 is not labeled 0UT. See Figure 28 on page 78 for details.

- ___ Step 6. Wait a few seconds; verify that the port bypass LEDs of the two ports in the connection between the DS4000 Storage Subsystem drive loop port and the 0UT port of the new drive enclosure are not lit. Using the DS4000 Storage Manager Client Subsystem Management window, verify that the **new** drive enclosure does not indicate the drive enclosure lost redundancy path error. See the preceding step 4 on page 73 for possible corrective actions, if needed.

Note: The existing storage expansion enclosures will be shown with drive enclosure lost redundancy path errors until you make the fibre channel cabling connection described in step 7.

- ___ Step 7. In drive loop B, cable the new drive enclosure's IN port to the 0UT port of the last enclosure in the already functioning storage expansion enclosure drive loop as shown in Figure 27 on page 77.
- ___ Step 8. Wait a few seconds; verify that the port bypass LEDs of all of the ports in drive loop B to which you have added a new connection are not lit. Using the DS4000 Storage Manager Client Subsystem Management window, verify that all of the drive enclosures in the DS4000 redundant drive loop pair to which the new enclosure was added does not report the drive enclosure lost redundancy path error.

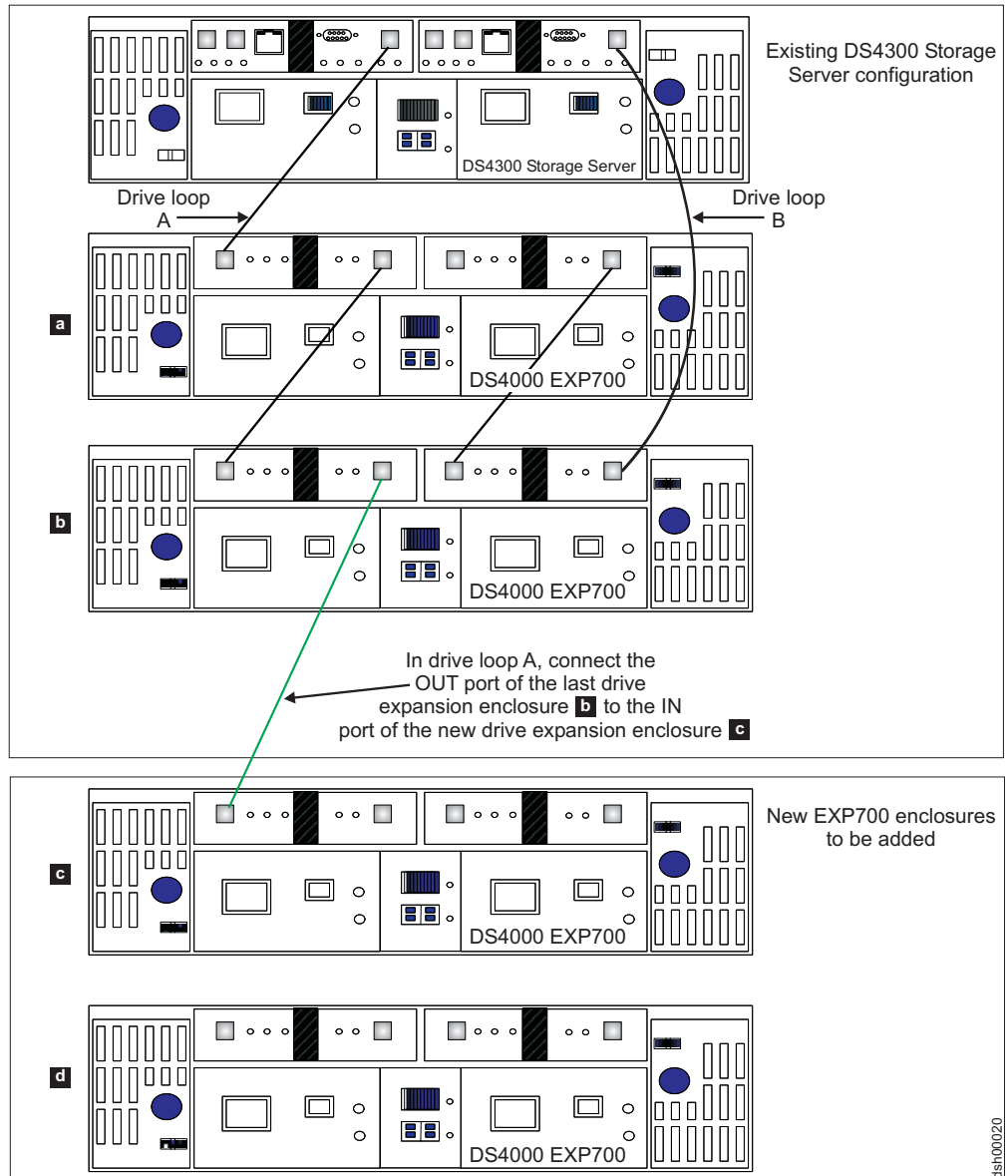

Figure 25. Cabling a single drive enclosure to the end of a functioning drive loop (step 1 of 3)

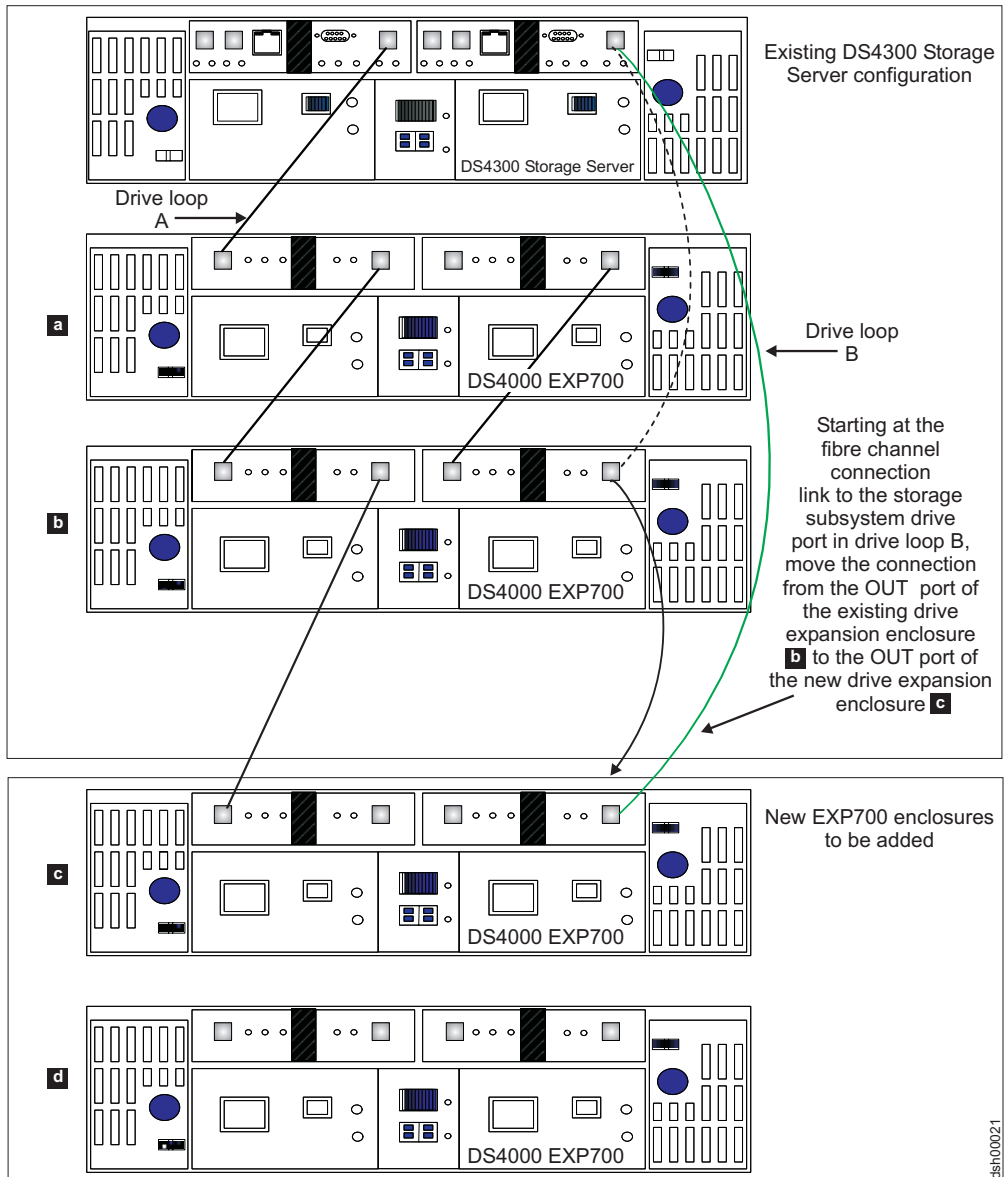

Figure 26. Cabling a single drive enclosure to the end of a functioning drive loop (step 2 of 3)

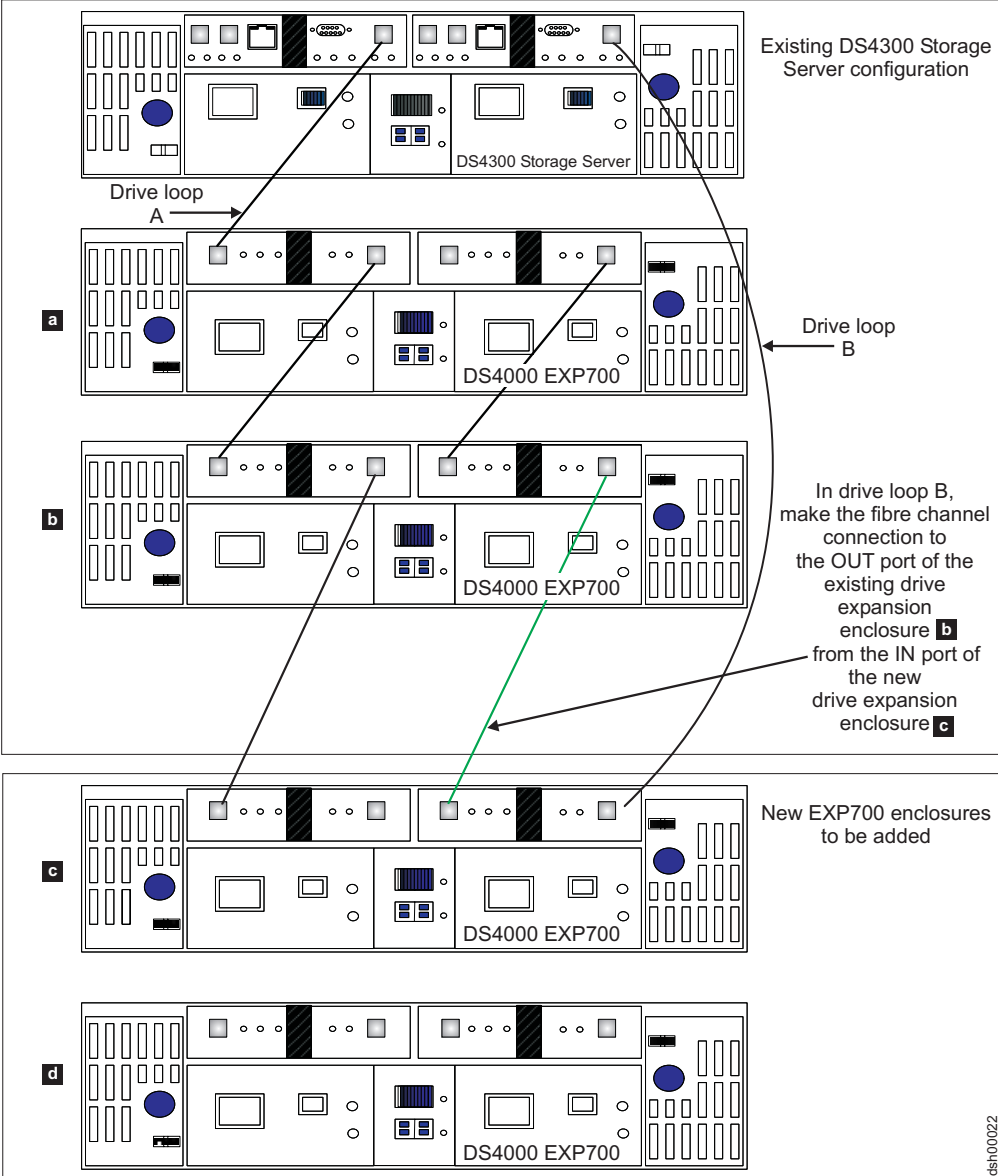

Figure 27. Cabling a single drive enclosure to the end of a functioning drive loop (step 3 of 3)

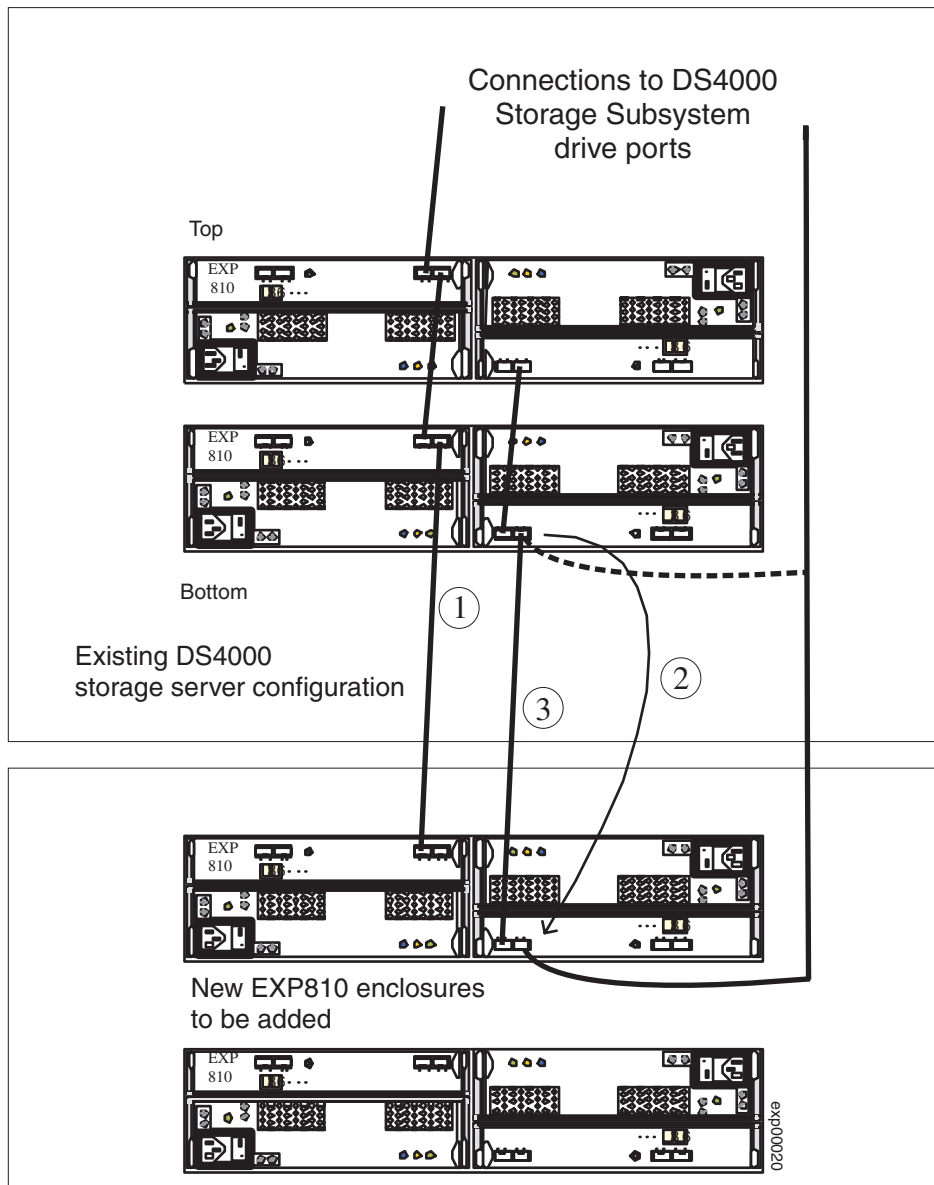

Figure 28. Cabling an EXP810 to the end of a functioning drive loop

To add an EXP810 to an existing drive channel, perform the following steps:

1. Connect port 1A of the A ESM in the existing EXP810 to port 1B of the A ESM in the new EXP810.
2. Move the existing connection from port 1B of the B ESM in the existing EXP810 to port 1B of the B ESM in the new EXP810.

Note: Dashed lines indicate fibre channel cable connections that are removed during the recabling.

3. Connect port 1B of the B ESM in the existing EXP810 to port 1A of the B ESM in the new EXP810.

Connecting new storage expansion enclosures at the beginning (top) of a drive loop

It is possible to add new storage expansion enclosures to either the beginning (top) or end (bottom) of a functioning storage expansion enclosure drive loop. The cabling instructions illustrated in Figure 29 on page 81, Figure 30 on page 82, and Figure 31 on page 83 describe cabling a DS4000 EXP700 Storage Expansion Enclosure to the beginning (top) of a redundant drive loop of a functioning DS4300 Storage Subsystem (model 60X or 60U). IBM recommends that you refrain from adding storage expansion enclosures in this manner, especially if there is insufficient rack space to allow the methodical, uncluttered, and uniform fibre channel cabling of such new enclosures. Without proper planning, disadvantages of adding expansion enclosures in this manner include cable management issues that contribute to avoidable troubleshooting difficulties. See Figure 35 on page 88 for the diagram of a properly planned new expansion enclosure addition at the beginning (top) of a functioning storage expansion enclosure drive loop.

The general cabling scheme for DS4000 external drive enclosures is described in the *IBM TotalStorage DS4000 Fibre Channel Cabling Guide* available at:

www-3.ibm.com/pc/support/site.wss/document.do?lnocid=MIGR-4KELS5

See also “DS4000 Storage Subsystem drive loop schemes” on page 27.

- ___ Step 1. Insert the small form-factor pluggables (SFPs) or gigabit interface converters (GBICs) into only those ports you intend to use. Do not leave GBICs or SFPs inserted into port slots without connecting them to other ports using cables.
- ___ Step 2. Extend one of the drive loops (that is, drive loop B) in a DS4000 Storage Subsystem redundant drive loop pair by connecting the IN port of the first (existing) storage expansion enclosure to the OUT port of the new storage expansion enclosure as shown in Figure 29 on page 81.

Note: The port name on an EXP810 is not labeled OUT. See Figure 32 on page 84 for details.

Attention: Carefully reconfigure only one drive loop at a time, making sure that the drive loop that you modify is properly connected and in optimal state before you attempt to reconfigure another drive loop. Take this precaution to prevent the arrays from being inadvertently failed by the DS4000 Storage Subsystem controllers. This happens when two or more drives in the arrays cannot be reached through either drive loop in the redundant drive loop pair.

- ___ Step 3. Power on the newly added storage expansion enclosure unit.
- ___ Step 4. Wait a few seconds; verify that the port bypass LEDs of all of the ports in drive loop B, now extended to the new storage expansion enclosure, are not lit. Using the DS4000 Storage Manager Client Subsystem Management window, verify that the new storage expansion enclosure is added and displayed in the Logical/Physical view of the window. Correct any errors before proceeding to step 5 on page 80. For port bypass:
 - ___ a. Verify that the SFPs and GBICs or fibre cables are in good condition.
 - ___ b. Remove and reinsert SFPs, GBICs and fibre cables.

- ___ c. Ensure that the new drive expansion enclosure speed switch is set to the same speed as the existing drive expansion enclosures and the DS4000 Storage Subsystem speed setting.
- ___ d. Verify that the ESM is good by physically removing and swapping it with the other ESM in the same drive expansion enclosure. For enclosure ID conflict, set the drive expansion enclosure ID switch to values unique from the current settings in the existing drive expansion enclosures and storage server.

Contact the IBM Help Center in your geography for assistance if the problems persist.

- ___ Step 5. In drive loop A, remove the connection from the DS4000 Storage Subsystem drive loop port to the IN port of the first storage expansion enclosure and connect it to the IN port of the new drive enclosure as shown in Figure 30 on page 82.

Note: The port name on an EXP810 is not labeled IN. See Figure 32 on page 84 for details.

- ___ Step 6. Wait a few seconds; verify that the port bypass LEDs of the two ports in the connection between the DS4000 Storage Subsystem drive loop port and the IN port of the new drive enclosure are not lit. Using the DS4000 Storage Manager Client Subsystem Management window, verify that the new drive enclosure does not indicate the drive enclosure lost redundancy path error. See the preceding step 4 on page 79 for possible corrective actions, if needed.
- ___ Step 7. In drive loop A, cable the new drive enclosure's OUT port to the IN port of the first enclosure in the already functioning storage expansion enclosure drive loop as shown in Figure 31 on page 83.
- ___ Step 8. Wait a few seconds; verify that the port bypass LEDs of all of the ports in drive loop A to which you have added a new connection are not lit. Using the DS4000 Storage Manager Client Subsystem Management window, verify that all of the drive enclosures in the DS4000 redundant drive loop pair to which the new enclosure was added does not report the drive enclosure lost redundancy path error.

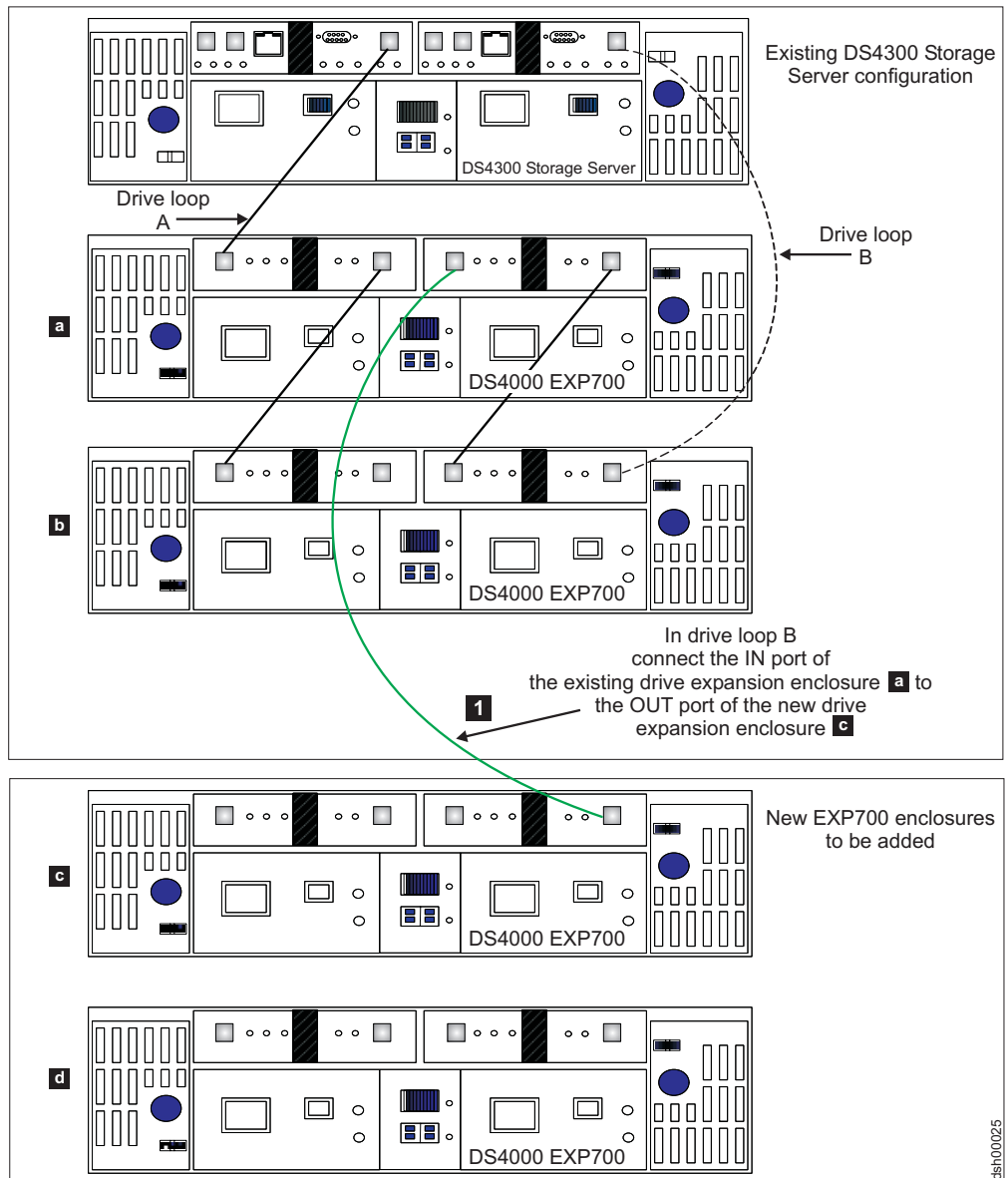

Figure 29. Cabling a single drive enclosure to the beginning of a functioning drive loop (step 1 of 3)

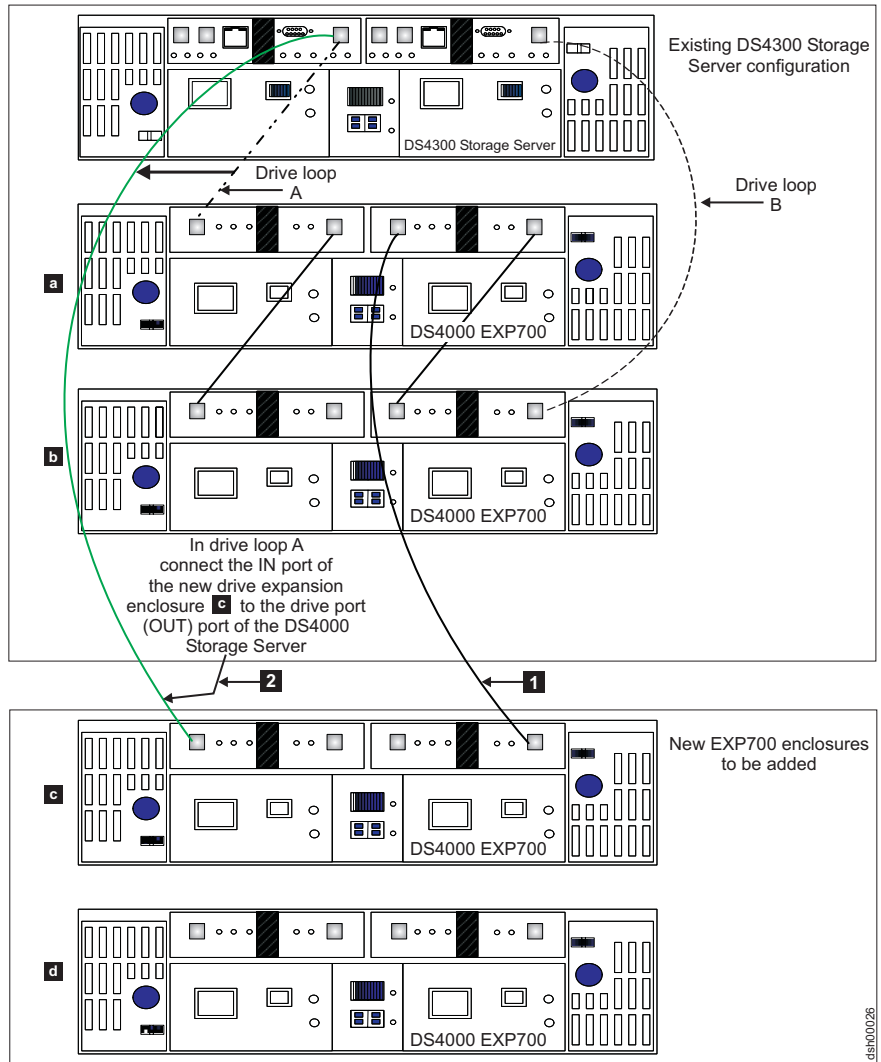

Figure 30. Cabling a single drive enclosure to the beginning of a functioning drive loop (step 2 of 3)

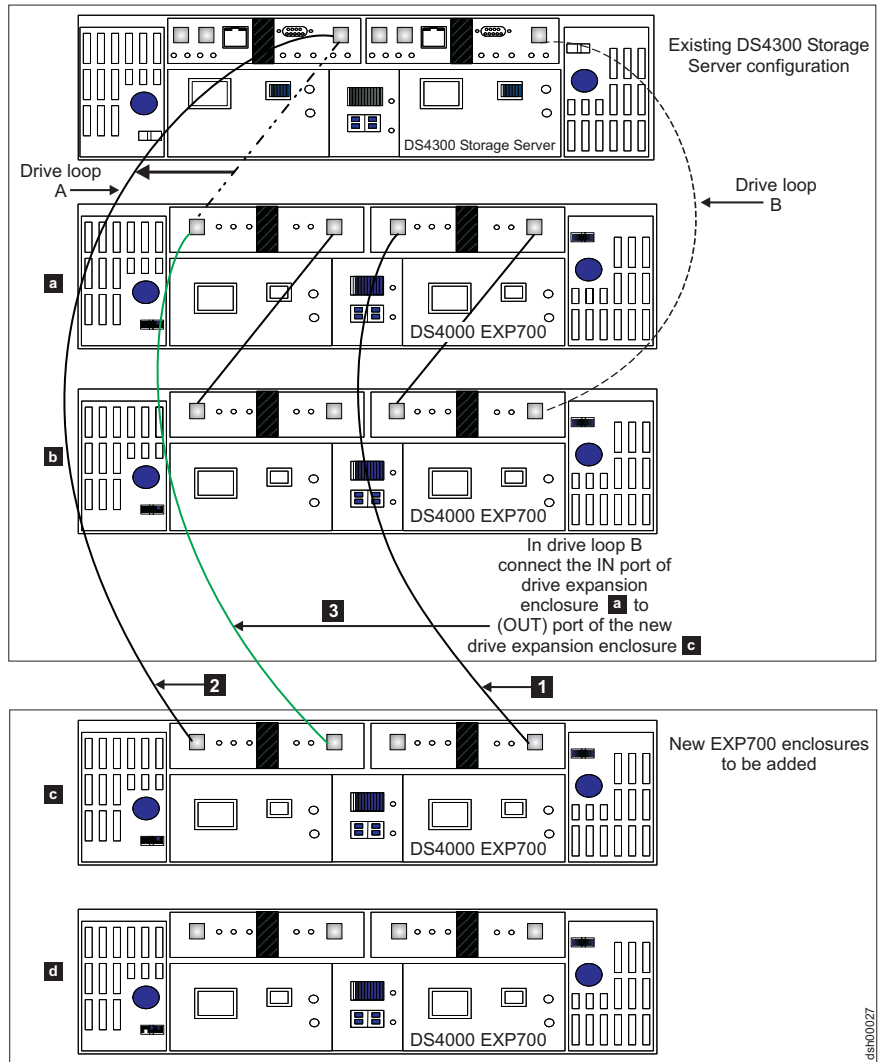

Figure 31. Cabling a single drive enclosure to the beginning of a functioning drive loop (step 3 of 3)

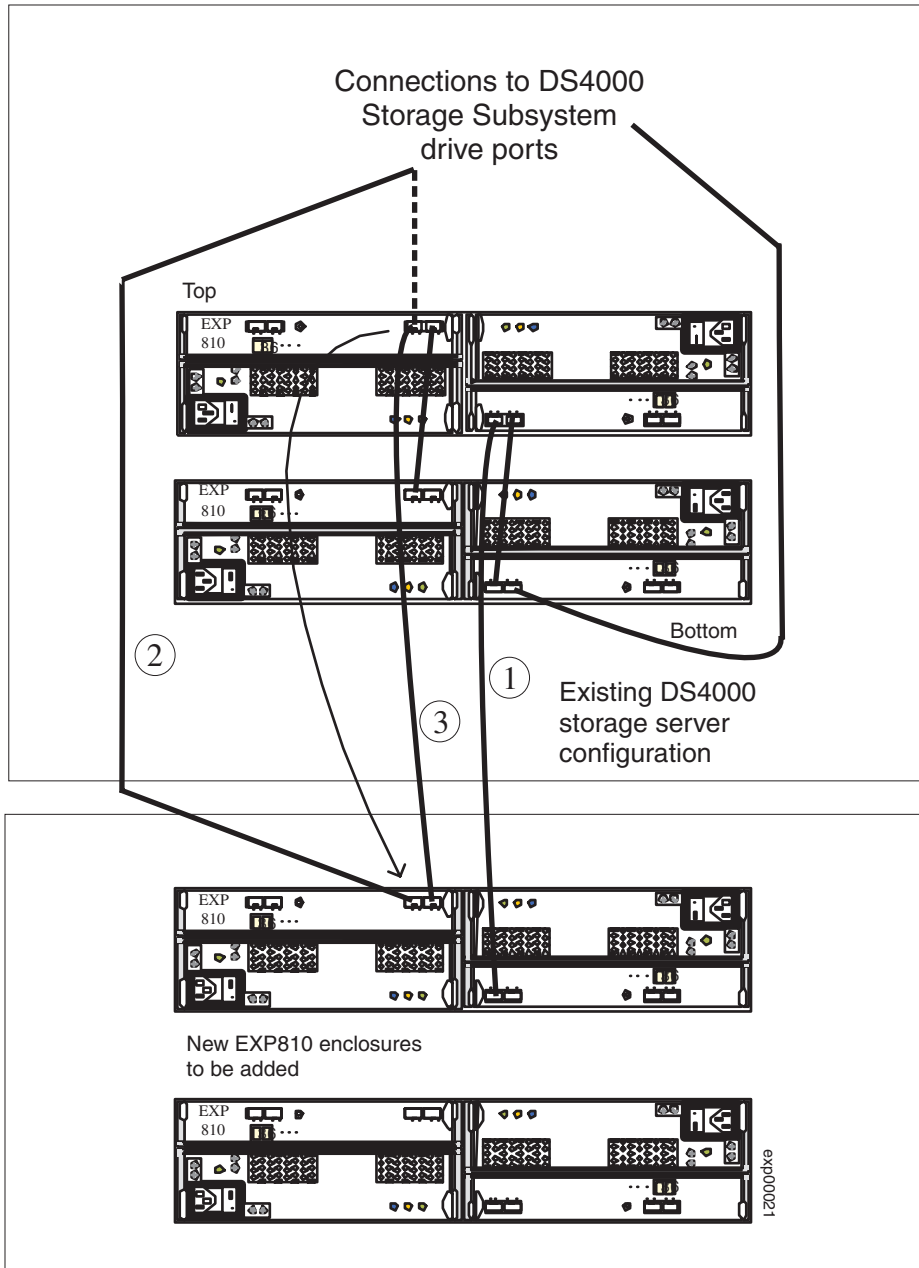

Figure 32. Cabling an EXP810 to the top of a functioning drive loop

To add an EXP810 to an existing drive channel at the top of the redundant drive loop pair, perform the following steps:

1. Connect port 1A of the B ESM in the existing EXP810 to port 1B of the B ESM in the new EXP810.
2. Move the existing connection from port 1B of the A ESM in the existing EXP810 to port 1B of the A ESM in the new EXP810.

Note: Dashed lines indicate fibre channel cable connections that are removed during the recabling.

3. Connect port 1B of the A ESM in the existing EXP810 to port 1A of the A ESM in the new EXP810.

Activity 3: Disabling DS4000 Storage Subsystem drive migration settings

When you have completed cabling the new storage expansion enclosures, disable DS4000 Storage Subsystem drive migration settings as follows:

- ___ Step 1. Open the Storage Manager Client program Enterprise Management window.
- ___ Step 2. Right-click on the name of the DS4000 Storage Subsystem to which you want to add drives, and select **Execute Script**.
- ___ Step 3. A script editor window opens. Click **File → Load Script**.
- ___ Step 4. A Load Script file selection window opens. Locate and select the `DisableDriveMigration.scr` file and click **OK**. The file `DisableDriveMigration.scr` file is normally in the `SCRIPTS` directory of the IBM DS4000 Storage Manager Installation CD. This file is used to reset the DS4000 Storage Subsystem setting, in order to treat all newly-discovered hard drives as “new” drives, and to ignore any configuration information that might exist in the new hard drives. Figure 18 on page 57 contains the `DisableDriveMigration.scr` file listing.
- ___ Step 5. Click **Tools → Verify and Execute** to run the script.
- ___ Step 6. When the script execution completes, reset both DS4000 controllers to make the disable drive migration settings effective. If you used the `DisableDriveMigration.scr` file described in this document in Figure 18 on page 57, you do not need to perform this step because the last two commands in the script file automatically reset the controllers. To reset the controllers, open the Storage Subsystem Management window and alternately (one at a time) reset each controller by clicking **Advanced → Reset Controller** and following the instructions in the Reset Controller window when it opens.

Activity 4: Inserting drives and cabling additional storage expansion enclosures

After you have disabled DS4000 Storage Subsystem drive migration settings, insert drives and connect additional storage expansion enclosures to complete the installation process as follows:

- ___ Step 1. Insert the appropriate drives into empty drive slots in the new enclosure in pairs (two at a time). Wait (up to 5 minutes) until the inserted drive pair fully spins up and displays in the DS4000 Storage Subsystem Management window before inserting the next drive pair.
- ___ Step 2. To connect additional storage expansion enclosures to the functioning drive loop pair, perform Activity 1: Preliminary activities step 3 on page 70 through step 1 on page 73, and Activity 2: Cabling new storage expansion enclosures steps as follows:
 - If you are connecting additional storage expansion enclosures to the end (bottom) of a drive loop, complete step 2 on page 73 through step 7 on page 74, and step 1 (immediately preceding this step) for each additional storage expansion enclosure that you intend to add. (See Figure 33 on page 86.)
 - If you are connecting additional storage expansion enclosures to the beginning (top) of a drive loop, complete step 2 on page 79 through step 7 on page 80, and step 1 (immediately preceding this step) for each additional storage expansion enclosure that you intend to add.

(See Figure 34 on page 87.) If you are willing to plan your connection of additional storage expansion enclosures to the beginning (top) of a drive loop, see Figure 35 on page 88 for alternate cabling instructions.

When you have completed adding enclosures, proceed to Activity 5: Re-enabling drive migration settings step1 on page 91 to re-enable the drive migration settings.

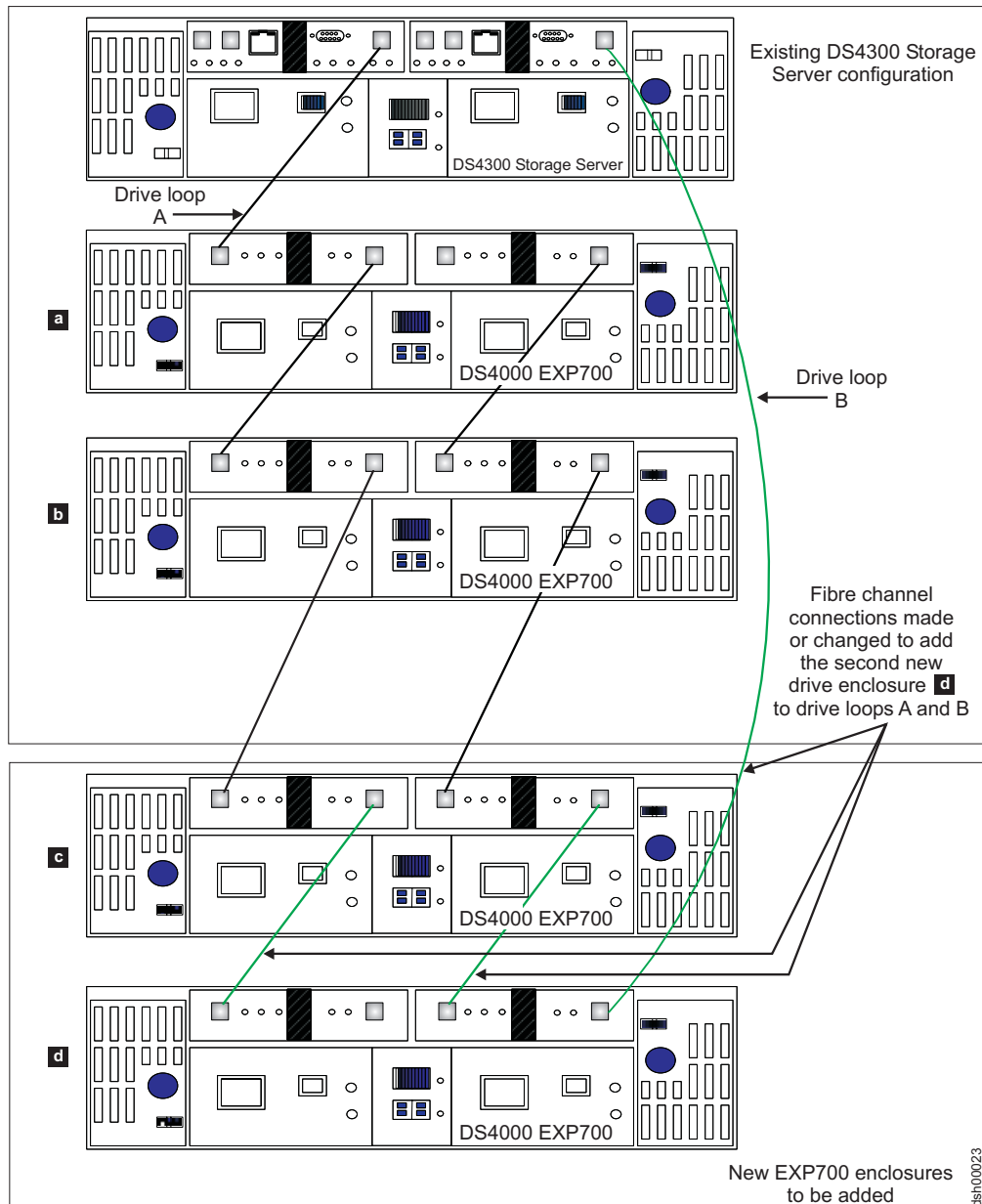

Figure 33. Cabling a second drive enclosure to the end of a functioning drive loop

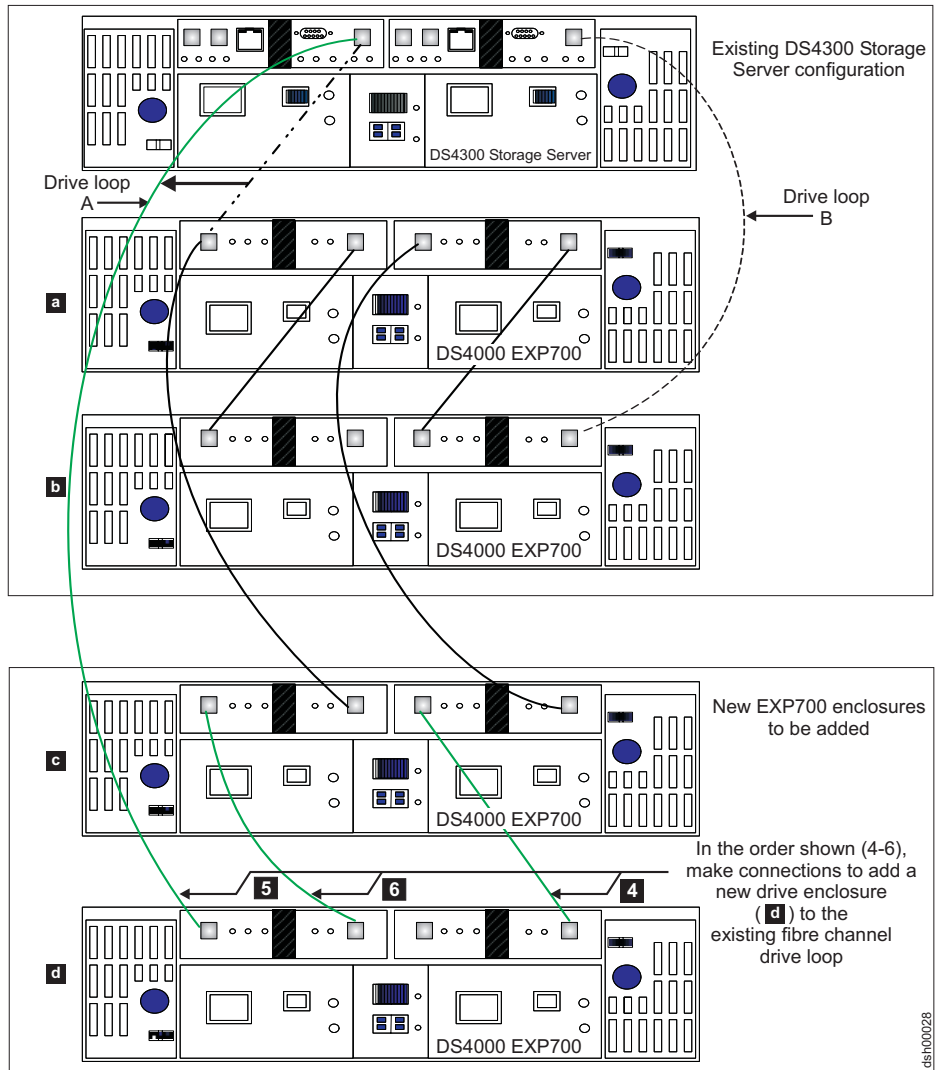

Figure 34. Cabling a second drive enclosure to the beginning of a functioning drive loop

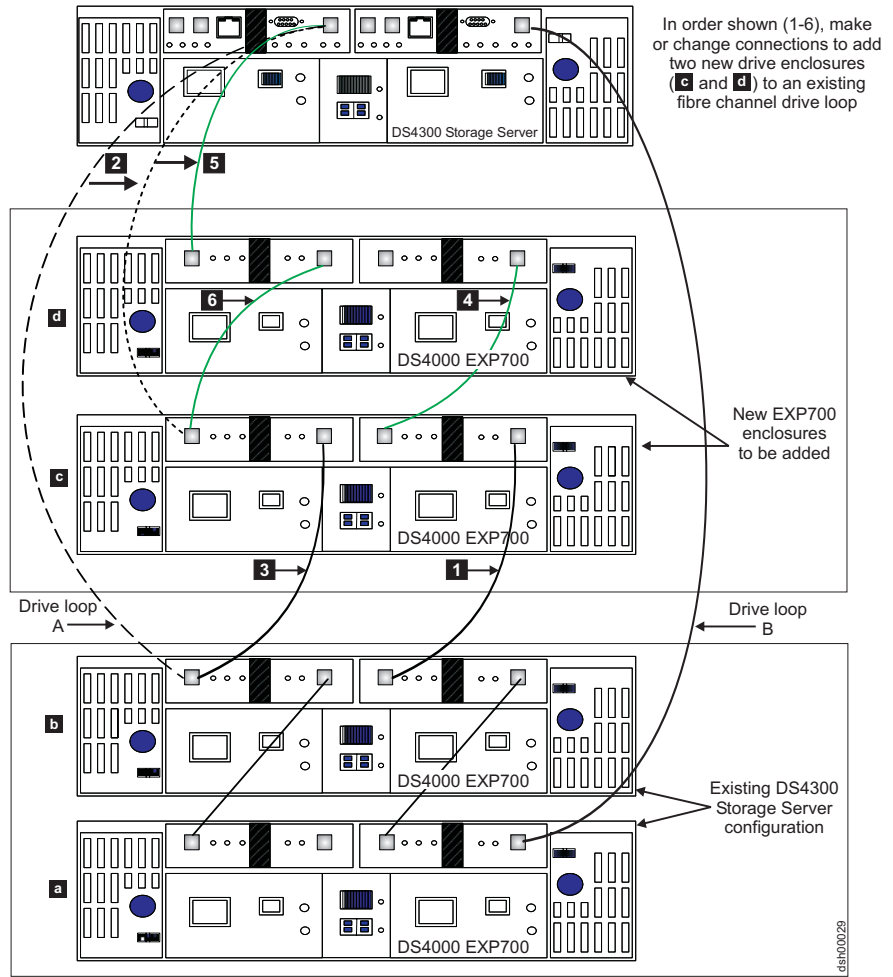

Figure 35. Recommended connection: Planned cabling of additional drive enclosures to the beginning of a functioning drive loop

Perform step 4 through step 6 as shown in Figure 36 on page 89 to add the second EXP810 to the end of an existing drive channel with existing EXP810s.

Note: Dashed lines indicate fibre channel cable connections that are removed during the recabling.

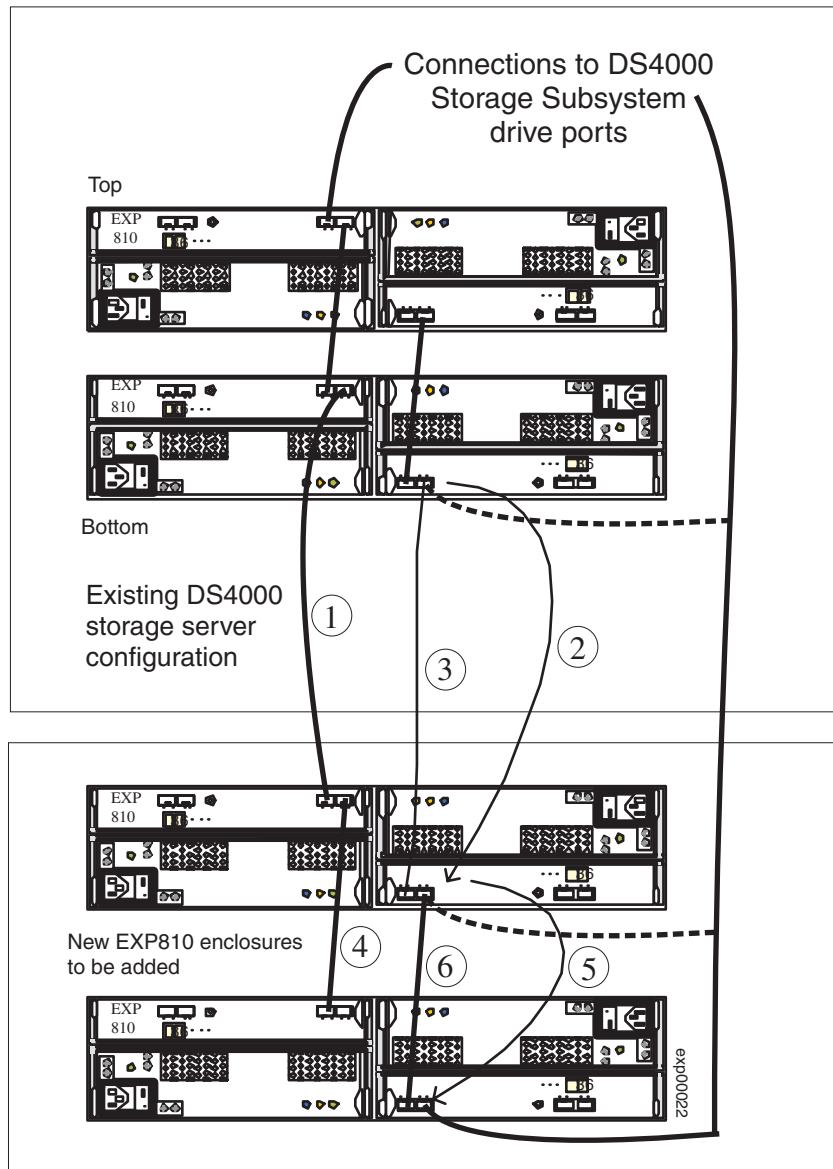

Figure 36. Cabling a second EXP810 drive enclosure to the end of a functioning drive loop

Perform step 4 through step 6 as shown in Figure 37 on page 90 to add the second EXP810 to the top of the redundant drive loop pair.

Note: Dashed lines indicate fibre channel cable connections that are removed during the recabling.

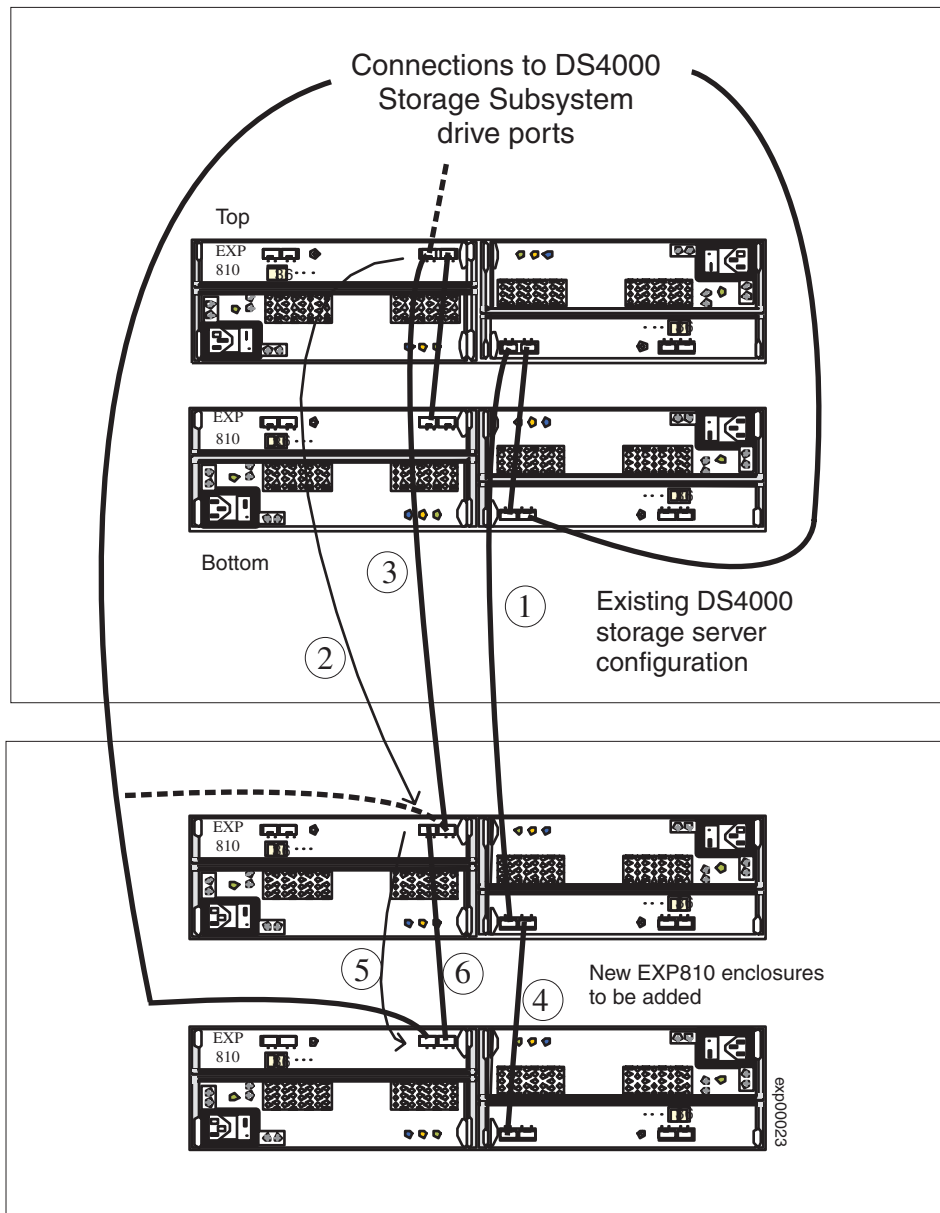

Figure 37. Cabling a second EXP810 drive enclosure to the top of a functioning drive loop

Activity 5: Re-enabling drive migration settings

If you performed steps 1 on page 85 through 6 on page 85 of Activity 3: Disabling DS4000 Storage Subsystem drive migration settings to disable DS4000 Storage Subsystem drive migration settings, perform the following steps 1 on page 91 through 6 on page 91 to re-enable the drive migration settings. If you should ever momentarily remove a drive from the DS4000 Storage Subsystem, the storage subsystem clears its configuration data when it later recognizes it. When this happens, the drive displays as unconfigured.

Attention: In order to prevent data loss, set the DS4000 Storage Subsystem drive migration setting to enable after you complete the hard drive addition process.

- ___ Step 1. Open the Storage Manager Client program Enterprise Management window.
- ___ Step 2. Right-click on the name of the DS4000 Storage Subsystem to which you want to add drives and click **Execute Script**.
- ___ Step 3. A script editor window opens. Click **File → Load Script**.
- ___ Step 4. A Load Script file selection window opens. Locate and select the EnableDriveMigration.scr file and click **OK**. The file EnableDriveMigration.scr file is normally in the SCRIPTS directory of the IBM DS4000 Storage Manager Installation CD. Use this file to reset the DS4000 Storage Subsystem setting in order to check for any configuration data that might exist on the newly discovered hard drives.
- ___ Step 5. Click **Tools → Verify and Execute** to run the script.
- ___ Step 6. When the script execution completes, reset both DS4000 controllers to make the setting effective.

If you use the EnableDriveMigration.scr script associated with this document and described in Figure 17 on page 56, it is not necessary for you to perform this step because the last two commands in that script file automatically reset the controllers. To reset the controllers, open the Storage Subsystem Management window and alternately (one at a time) reset each controller by clicking **Advanced → Reset Controller** and following the instructions in the Reset Controller window when it opens.
- ___ Step 7. Verify (and update, if needed) the DS4000 Storage Expansion Enclosure ESM firmware and drive firmware with the latest version from the following IBM DS4000 support web site.
www-1.ibm.com/servers/storage/support/disk/

Result: The newly added drives are now ready for you to configure and map to host servers.

Note: Listings of the EnableDriveMigration.scr and DisableDriveMigration.scr files are found in Figure 17 on page 56 and Figure 18 on page 57.

Chapter 6. Migrating expansion enclosures containing hard drives

Note: When migrating hard drives from multiple DS4000 Storage Subsystems to a single DS4000 Storage Subsystem, move all of the hard drives from the first DS4000 Storage Subsystem as an independent “set” to the destination DS4000 Storage Subsystem. Before moving hard drives as a set from subsequent DS4000 Storage Subsystems, ensure that all of the hard drives from the previous set have been successfully transferred to the destination DS4000 Storage Subsystem. If you do not transfer hard drives as “sets” to the destination DS4000 Storage Subsystem, the newly relocated arrays/logical drives that are defined in these drives might not appear in the Subsystem Management window.

While migrating a fibre channel or SATA hard drive to either a controller or a drive expansion enclosure, observe these important rules:

- Observe proper ESD procedures when handling electronic equipment. See “Handling static-sensitive devices” on page 51 for additional information.
- Never alter the physical configuration of a DS4000 Storage Subsystem while it is powered off unless you are instructed to do so as part of DS4000 configuration procedure. Specifically, never attach storage components to or remove storage components from a configured DS4000 Storage Subsystem while it is powered off.
- Use this procedure to preserve the configuration and user data in one or more fibre channel hard drives that you will migrate to a functioning DS4000 Storage Subsystem configuration. Do not use this procedure if you are unsure of the quality of the data on the hard drives. Import of incorrect configuration data from hard drives could cause a DS4000 Storage Subsystem failure.

Use this procedure to migrate one or more DS4000 storage expansion enclosures containing hard drives which themselves contain configuration data from a functioning DS4000 Storage Subsystem configuration to another DS4000 Storage Subsystem configuration.

Attention: Make additions to the DS4000 Storage Subsystem only while it is powered on and in optimal state. See “Bringing storage subsystems and drive loops into optimal state” on page 49 for additional information on how to make this determination. You can complete this process while the DS4000 Storage Subsystem is receiving I/O from the host server. However, because the drive loops are interrupted momentarily during the addition process, schedule the addition to occur during time periods of low I/O between the DS4000 Storage Subsystems and host servers.

Review the readme and the *IBM TotalStorage DS4000 Storage Manager installation and support guides* associated with the operating system environment of the host servers that connect to the DS4000 Storage Subsystem for information about any operating system-specific restrictions in addition to those detailed in this document. You will also find preliminary tasks that you may be required to complete detailed in that documentation. *IBM TotalStorage DS4000 Storage Manager installation and support guides* are located at the following Web site:

www-1.ibm.com/servers/storage/support/disk/

Tip: Before proceeding with the migration procedure, review and perform the steps outlined in Chapter 2, “Prerequisites to adding capacity and hard drive migration,” on page 41.

The procedure for migrating a new DS4000 storage expansion enclosure is as follows:

Activity 1: Preliminary activities

Important:

Before you attempt to complete the drive migration procedure, review the information provided in Chapter 1 and perform the steps documented in Chapter 2, “Prerequisites to adding capacity and hard drive migration,” on page 41.

Before disconnecting any storage expansion enclosures from a DS4000 Storage Subsystem, to ensure a successful migration of your drives to the DS4000 Storage Subsystem, perform the following steps:

- ___ Step 1. If the migrated storage expansion enclosure is not the same type as some or all of the existing storage expansion enclosures, review “Intermixing storage expansion enclosures” on page 3.

Note: You must group like DS4000 storage expansion enclosure types in adjacent positions on the Fibre Channel loop when they are intermixed in a DS4000 Storage Subsystem redundant drive loop configuration.

- ___ Step 2. Verify that both the functioning source and the destination DS4000 Storage Subsystem’s controller firmware and NVSRAM are at the levels recommended in Table 25 on page 43.
- ___ Step 3. Verify that the firmware of the ESMs in the storage expansion enclosures that you plan to migrate are at the levels recommended in Table 26 on page 45.
- ___ Step 4. Verify that the firmware of the ESMs in the storage expansion enclosures attached to the DS4000 Storage Subsystem to which you will migrate your drives is at the levels recommended in Table 26 on page 45.
- ___ Step 5. If you migrate storage expansion enclosures from a 1 Gbps fibre channel environment to a 2 Gbps fibre channel environment, verify that the fibre channel hard drives that you plan to migrate are each capable of 2 Gbps operation and that you have installed the latest firmware enabling them to work properly in a 2 Gbps fibre-channel environment.
- ___ Step 6. Verify that the names of the logical drives that are created using the hard drives in the migrated storage expansion enclosures are unique in the DS4000 Storage Subsystem to which these storage expansion enclosures will migrate. If they are not unique, make any necessary changes.
- ___ Step 7. If you migrate the drives to a single controller DS4000 Storage Subsystem (for example, DS4300 Storage Subsystem, model 6LU or 6LX), change the logical drive’s preferred owner to Controller A using the DS4000 Storage Manager Client program before taking it offline and removing it from the DS4000 Storage Subsystem. To set Controller A as the logical drive preferred owner, right-click the logical

drive entry in the Subsystem Management window and select **Change** → **Ownership/Preferred Path** → **Controller A**.

- ___ Step 8. In addition to array configuration information, any storage partitioning configuration data that may reside on drives you plan to migrate will migrate with those drives when installed on another DS4000 Storage Subsystem. For this reason, take the following precautions to facilitate the migration process and prevent problems in storage partitioning configuration data migration.
 - a. If a DS4000 storage partitioning premium feature has been enabled both on a drive's original and destination DS4000 Storage Subsystems, ensure that the defined host ports, hosts, and host group names are unique to each DS4000 Storage Subsystem involved in the migration.
 - b. If you must use identical names on both DS4000 Storage Subsystems, make the names unique before you perform the drive migration.

If necessary, customize the storage partitioning information on the DS4000 Storage Subsystem to which you have migrated the drives after you complete the migration.

- ___ Step 9. Delete any flashcopies of logical drives defined in the hard drives that you plan to migrate.
- ___ Step 10. Remove any remote mirror relationships that involve the logical drives defined on the drives that you plan to migrate.

Activity 2: Preparing and backing up the drives

- ___ Step 1. If the arrays and logical drives involved are not in optimal state, perform the steps necessary to bring these arrays and logical drives to their optimal state before attempting migration. See “Bringing storage subsystems and drive loops into optimal state” on page 49 for additional information on how to make this determination.
- ___ Step 2. If the drive enclosures that you plan to migrate are not in optimal state, perform the steps necessary to bring them to their optimal state before attempting migration. See “Bringing storage subsystems and drive loops into optimal state” on page 49 for additional information on how to make this determination.
- ___ Step 3. Perform a backup of the logical drives defined in the storage expansion enclosures that you plan to migrate.
- ___ Step 4. Monitor the DS4000 Storage Subsystem event log for any errors in the drive loop or its components for several days before migrating storage expansion enclosures.
- ___ Step 5. Stop all programs, services or processes in the host servers that access the logical drives defined in the migrated hard drives. Ensure that there are not any running background programs, services or processes that write data to the logical drives. (For example, Microsoft MSCS service periodically writes to the “Quorum” disk.)
- ___ Step 6. Unmount the file systems to flush I/O from the server cache to disks.

Notes:

- a. In a Microsoft Windows environment, remove the drive letter or the mount points of the mapped LUNs instead of unmounting the file systems.

- b. Refer to the documentation associated with your particular operating system for detailed information regarding the Unmount procedure.
- ___ Step 7. Save the DS4000 Storage Subsystem profile of the functioning DS4000 Storage Subsystem configuration to which the migration will occur in a location other than that of the logical drives you plan to migrate.
- ___ Step 8. Place the arrays defined in the storage expansion enclosures that you plan to migrate in offline state. In the Storage Subsystem Management window, right-click on the name of the array and click **Place → Offline**.

Activity 3: Shutting down and moving the storage expansion unit

- ___ Step 1. Because removing a storage expansion enclosure from a functioning DS4000 Storage Subsystem will disrupt its drive loops, shutdown the functioning destination DS4000 Storage Subsystem while you remove its storage expansion enclosures for reconfiguration. If you cannot shutdown the DS4000 Storage Subsystem, carefully reconfigure only one drive loop, making sure that the drive loop that you modify is connected correctly and in optimal state before you attempt to reconfigure the other drive loop. For additional information on making this determination, see “Bringing storage subsystems and drive loops into optimal state” on page 49.
 Take this precaution to prevent the arrays from being inadvertently failed by the DS4000 Storage Subsystem controllers because two or more drives in the arrays cannot be reached through either drive loop in the redundant drive loop pair.
 Perform the following steps to verify that the drive loops are in optimal state:
 - ___ Step a. Physically trace the actual cable connections making sure that connections are properly modified and that the cable connectors are firmly inserted into the SFPs or GBICs.
 - ___ Step b. Verify that the following LEDs are not lit or briefly flashed in the modified drive loop:
 - ESM Fault
 - port bypass
 - ID conflict
 - ___ Step c. Verify that the controller drive loop LED remains lit. If the controller drive loop LED becomes unlit momentarily, there are problems in the drive loop and the Loop Initialization Primitives (LIPs) are generated by the DS4000 Storage Subsystem controller.
 - ___ Step d. In the DS4000 Storage Manager Client Subsystem Management window, verify that there are no loss of ESM path redundancy errors in the storage expansion enclosures that are not migrated.
 Do not modify the second drive loop in the redundant drive loop pair until you are sure that the first modified drive loop is operating optimally.
- ___ Step 2. Power down the storage expansion enclosures and move them to the DS4000 Storage Subsystem to which you plan to migrate them.

Notes:

- A storage expansion enclosure with 14 drives weighs up to 100 lbs. (45 kg). If necessary, remove the drives and other storage expansion enclosure components to reduce the weight of the unit for easier handling. Mark each drive before removing it in order to return it to the same drive slot when you reassemble the components at the destination location.
- Move drives only in a horizontal position using an appropriate ESD bag or container and moving equipment that prevents shock to the drives during transit. Never stack drives.

Activity 4: Verifying the drive migration enable settings

The DS4000 storage subsystem drive migration setting must be set to enable before inserting drives with configuration data. If not, the DS4000 controller ignores the configuration data in the drive and displays the drive as unconfigured and optimal. Verify the drive migration setting on the DS4000 storage subsystem that the expansion enclosure will be migrated to. IBM recommends that you perform the steps to run the EnableDriveMigration script to ensure the drive migration setting is set to enable before inserting any drives with configuration data. See “Activity 3: Re-enabling the drive migration settings” on page 55 for instructions.

Activity 5: Installing and setting storage expansion unit IDs and speeds

- ___ Step 1. When the storage expansion enclosures and drives are at the location of the DS4000 Storage Subsystem to which they will be migrated, install them into the rack. If the drives were removed during transit, return them to the slots from which they were removed, unlatched and no less than ½-inch away from their full insertion points in the drive slots. If the drives were not removed, unlatch and pull them out no less than ½-inch away from their full insertion points in the drive slots.
- ___ Step 2. See Figure 24 on page 71 for an illustration of how to set the enclosure ID of the storage expansion enclosures. Each drive enclosure in the DS4000 Storage Subsystem drive loop must have a unique drive enclosure ID. In a EXP500 Storage Expansion Unit, there is an enclosure ID switch mounted on each of two ESM canisters. Set each ESM canister’s enclosure ID switch in the EXP500 drive enclosure to the same unique number in the drive loop. In the EXP100, EXP700 and EXP710 storage expansion enclosures, there is only enclosure ID switch, which is mounted between the power supplies. The EXP810 does not have a physical switch setting for the enclosure ID. Instead it has a LED that shows its enclosure ID. The controller firmware automatically sets the enclosure ID. However, you can change the enclosure ID by using the DS4000 Storage Manager Client program. To access the appropriate *DS4000 storage expansion unit installation and user’s guide* for additional information, use the following Web link:
www.storage.ibm.com/disk/fastt/index.html

Important:

If the DS4000 Storage Subsystem to which you will attach migrating hard drives is either a FAStT200 or DS4300 (model 60X or 60U), the enclosure IDs of additional storage expansion enclosures must differ from the FAStT200 or DS4300 Storage Subsystem’s enclosure IDs. These IDs are normally set to “0” at the factory.

- ___ Step 3. Verify that you set the enclosure speed switch of the DS4400 to the correct drive loop speed.

If the enclosure speed switch was originally set to 1 Gbps, do not automatically set it to 2 Gbps unless you are sure that each fibre channel hard drive it now contains is capable of 2 Gbps operation and that you have installed the latest firmware enabling their operation in a 2 Gbps fibre-channel environment.

Activity 6: Cabling, powering on, and verifying storage expansion unit operation

It is possible to connect new storage expansion enclosures at either end of a functioning storage expansion enclosure drive loop. The two options are:

1. the beginning, closest to the controller (at the top, directly attached to controller A) as described in Connecting new storage expansion enclosures at the beginning (top) of a drive loop
2. the end, furthest from the controller (at the bottom, directly attached to controller B) as described in Connecting new storage expansion enclosures at the end (bottom) of a drive loop

Of the two options, IBM recommends only option 2, connection to the end (at the bottom) of a functioning storage expansion enclosure drive loop, directly attached to controller B. This is recommended because if the existing DS4000 Storage Subsystem configuration is not planned for cabling in new storage expansion enclosures at the top of the drive loop, cluttered or entangle fibre channel drive loop cabling may hinder drive loop troubleshooting or cause fibre channel cabling errors. With this in mind, and depending on your requirements, however, follow either of the instruction sets at “Connecting new storage expansion enclosures at the end (bottom) of a drive loop” on page 99 or “Connecting new storage expansion enclosures at the beginning (top) of a drive loop” on page 103.

Depending on your DS4000 Storage Subsystem configuration, there might be unused drive ports that you can connect the new drive expansion enclosures to the DS4000 Storage Subsystem controllers. Use the appropriate information in your *DS4000 Installation, User's, and Maintenance Guide* to attach the drive expansion enclosures to the DS4000 storage subsystem.

If your DS4000 Storage Subsystem (such as DS4400 or DS4500) has drive minihubs, do not use more than one port per drive minihub. Always leave one of the two drive ports empty in each drive minihub. After you connect the drive expansion enclosures to the DS4000 controller, see “Activity 7: Inserting hard drives and placing logical drives online” on page 108.

The steps and graphics in “Connecting new storage expansion enclosures at the end (bottom) of a drive loop” on page 99 and “Connecting new storage expansion enclosures at the beginning (top) of a drive loop” on page 103 illustrate how to connect an EXP700 to a DS4300 storage subsystem drive loop. To connect an EXP810 to an existing DS4800 drive loop, perform the same steps. However, note that the port names are different on the EXP700 than on the EXP810.

Note: For an illustration of how to connect an EXP810 in a DS4800 Storage Subsystem drive loop configuration at the:

- End (bottom) of a drive loop, see Figure 28 on page 78.
- Top (beginning) of a drive loop, see Figure 32 on page 84.

Connecting new storage expansion enclosures at the end (bottom) of a drive loop

The cabling instructions illustrated in Figure 38 on page 101, Figure 39 on page 102, and Figure 40 on page 103 describe cabling a DS4000 EXP700 Storage Expansion Enclosure to the end (bottom) of a redundant drive loop of a functioning DS4300 Storage Subsystem (model 60X or 60U). Again, IBM recommends that you add storage expansion enclosures to an existing drive loops only in this manner.

See also “DS4000 Storage Subsystem drive loop schemes” on page 27.

- ___ Step 1. Insert the small form-factor pluggables (SFPs) or gigabit interface converters (GBICs) into only those ports you intend to use. Do not leave GBICs or SFPs inserted into port slots without connecting them to other ports using cables.
- ___ Step 2. Extend one of the drive loops (that is, drive loop A) in a DS4000 Storage Subsystem redundant drive loop pair by connecting the OUT port of the last storage expansion enclosure to the IN port of the new storage expansion enclosure as shown in Figure 38 on page 101.

Note: The port name on an EXP810 is not labeled IN. See Figure 28 on page 78 for details.

Attention: Carefully reconfigure only one drive loop at a time, making sure that the drive loop that you modify is properly connected and in optimal state before you attempt to reconfigure another drive loop. Take this precaution to prevent the arrays from being inadvertently failed by the DS4000 Storage Subsystem controllers. This happens when two or more drives in the arrays cannot be reached through either drive loop in the redundant drive loop pair.

- ___ Step 3. Power on the newly added storage expansion enclosure unit.
- ___ Step 4. Wait a few seconds; verify that the port bypass LEDs of all of the ports in drive loop A, now extended to the new storage expansion enclosure, are not lit. Using the DS4000 Storage Manager Client Subsystem Management window, verify that the new storage expansion enclosure is added and displayed in the Logical/Physical view of the window. Correct any errors before proceeding to step 5. For port bypass:
 - ___ a. Verify that the SFPs and GBICs or fibre cables are in good condition.
 - ___ b. Remove and reinsert SFPs, GBICs and fibre cables.
 - ___ c. Make sure the new drive expansion enclosure speed switch is set to the same speed as the existing drive expansion enclosures and the DS4000 Storage Subsystem speed setting.
 - ___ d. Verify that the ESM is good by physically removing and swapping it with the other ESM in the same drive expansion enclosure. For enclosure ID conflict, set the drive expansion enclosure ID switch to values unique from the current settings in the existing drive expansion enclosures and storage server.

Call the IBM Help Center in your geography for assistance if the problems persist.

- ___ Step 5. In the other drive loop (that is, drive loop B) in a DS4000 Storage Subsystem redundant drive loop pair, remove the connection from the storage subsystem drive loop port to the OUT port of the last storage

expansion enclosure and connect it to the OUT port of the new drive enclosure as shown in Figure 39 on page 102.

Note: The port name on an EXP810 is not labeled OUT. See Figure 28 on page 78 for details.

- ___ Step 6. Wait a few seconds; verify that the port bypass LEDs of the two ports in the connection between the storage subsystem drive loop port and the OUT port of the new drive enclosure are not lit. Using the DS4000 Storage Manager Client Subsystem Management window, verify that the **new** drive enclosure does not indicate the drive enclosure lost redundancy path error. See the preceding step 4 on page 99 for possible corrective actions, if needed.

Note: The existing storage expansion enclosures will be shown with drive enclosure lost redundancy path errors until you establish the fibre channel cabling connection described in step 7.

- ___ Step 7. In drive loop B, cable the new drive enclosure's IN port to the OUT port of the last enclosure in the already functioning storage expansion enclosure drive loop as shown in Figure 40 on page 103.
- ___ Step 8. Wait a few seconds; verify that the port bypass LEDs of all of the ports in drive loop B to which you have added a new connection are not lit. Using the DS4000 Storage Manager Client Subsystem Management window, verify that all of the drive enclosures in the DS4000 redundant drive loop pair to which the new enclosure was added does not report the drive enclosure lost redundancy path error.

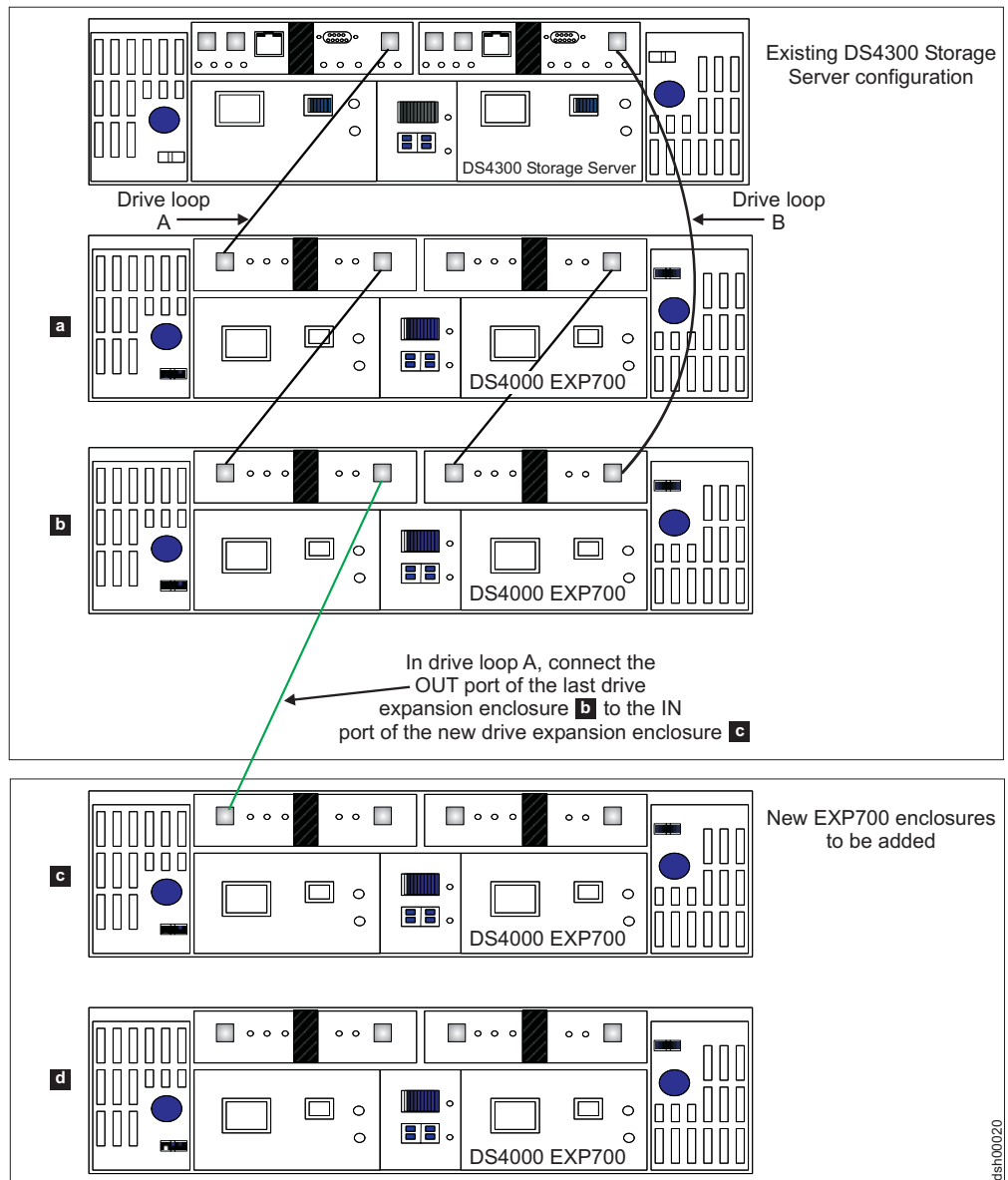

Figure 38. Cabling a single drive enclosure to the end of a functioning drive loop (step 1 of 3)

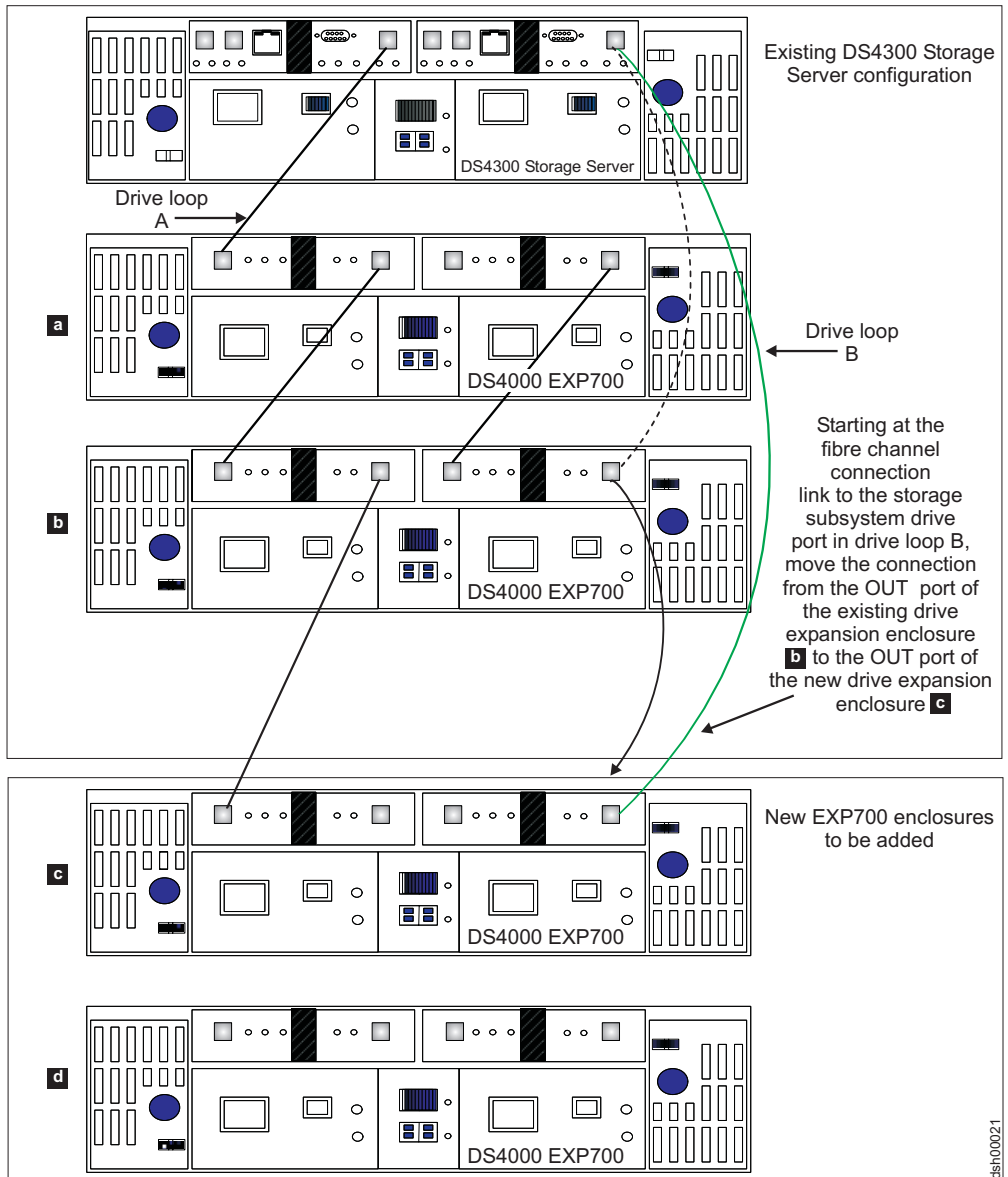

Figure 39. Cabling a single drive enclosure to the end of a functioning drive loop (step 2 of 3)

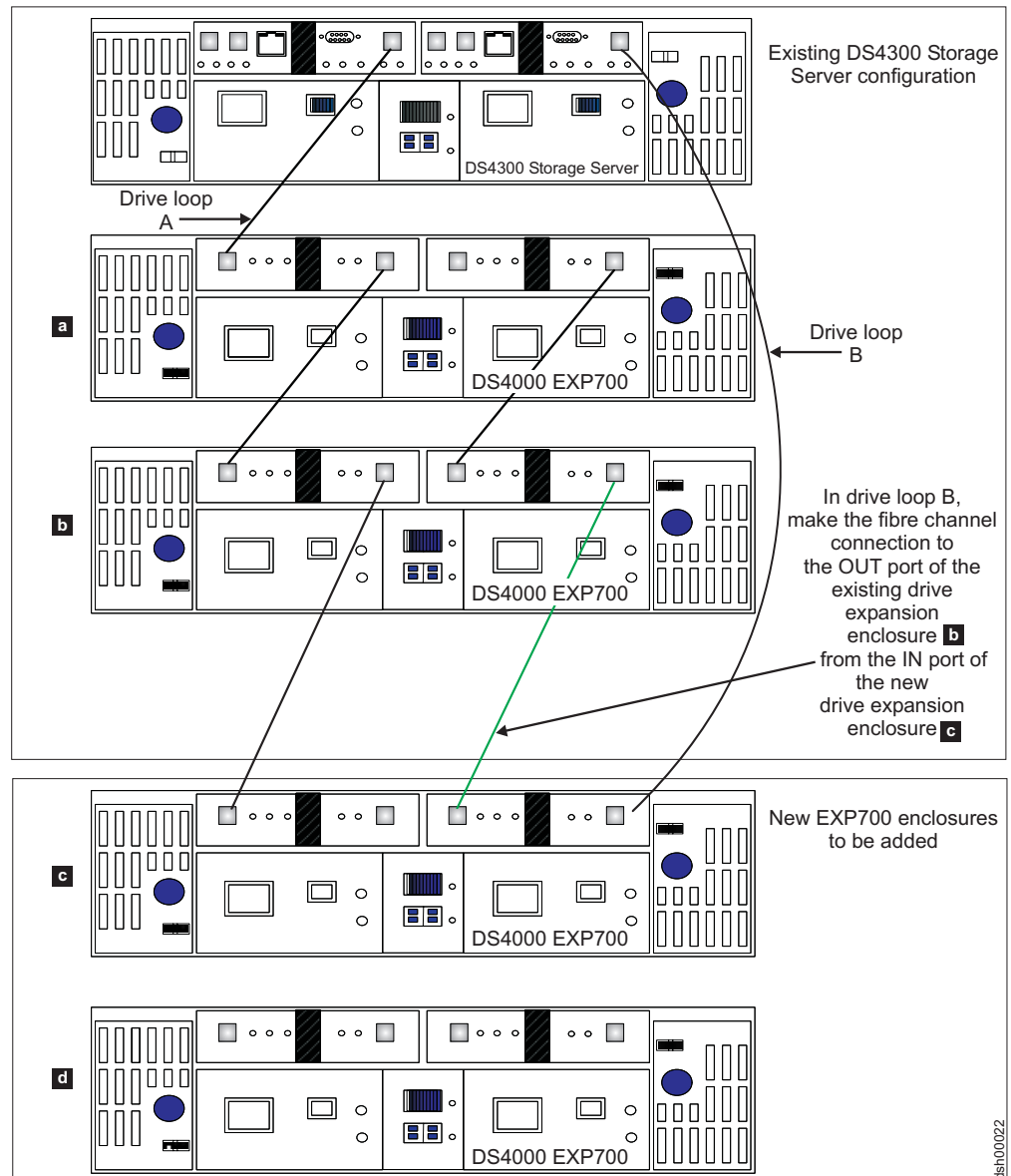

Figure 40. Cabling a single drive enclosure to the end of a functioning drive loop (step 3 of 3)

Connecting new storage expansion enclosures at the beginning (top) of a drive loop

It is possible to add new storage expansion enclosures to either the beginning (top) or end (bottom) of a functioning storage expansion enclosure drive loop. The cabling instructions illustrated in Figure 41 on page 106, Figure 42 on page 107, and Figure 43 on page 108 describe cabling a DS4000 EXP700 Storage Expansion Enclosure to the beginning (top) of a redundant drive loop of a functioning DS4300 Storage Subsystem (model 60X or 60U). IBM does not recommend that you add storage expansion enclosures in this manner, especially if there is insufficient rack space to allow the methodical, uncluttered, and uniform fibre channel cabling of such new enclosures. Without proper planning, disadvantages of adding expansion enclosures in this manner include cable management issues that contribute to avoidable troubleshooting difficulties. (For the diagram of a properly planned addition of a new expansion enclosure at the beginning (top) of a functioning storage expansion enclosure drive loop, see Figure 35 on page 88.)

See “DS4000 Storage Subsystem drive loop schemes” on page 27.

- ___ Step 1. Insert the small form-factor pluggables (SFPs) or gigabit interface converters (GBICs) into only those ports you intend to use. Do not leave GBICs or SFPs inserted into port slots without connecting them to other ports using cables.
- ___ Step 2. Extend one of the drive loops (that is, drive loop B) in a DS4000 Storage Subsystem redundant drive loop pair by connecting the IN port of the first (existing) storage expansion enclosure to the OUT port of the new storage expansion enclosure as shown in Figure 41 on page 106.

Note: The port name on an EXP810 is not labeled OUT. See Figure 32 on page 84 for details.

Attention: Carefully reconfigure only one drive loop at a time, making sure that the drive loop that you modify is properly connected and in optimal state before you attempt to reconfigure another drive loop. Take this precaution to prevent the arrays from being inadvertently failed by the DS4000 Storage Subsystem controllers. This happens when two or more drives in the arrays cannot be reached through either drive loop in the redundant drive loop pair.

- ___ Step 3. Power on the newly added storage expansion enclosure unit.
- ___ Step 4. Wait a few seconds; verify that the port bypass LEDs of all of the ports in drive loop B, now extended to the new storage expansion enclosure, are not lit. Using the DS4000 Storage Manager Client Subsystem Management window, verify that the new storage expansion enclosure is added and displayed in the Logical/Physical view of the window. Correct any errors before proceeding to step 5. For port bypass:
 - ___ a. Verify that the SFPs and GBICs or fibre cables are in good condition.
 - ___ b. Remove and reinsert SFPs, GBICs and fibre cables.
 - ___ c. Ensure that the new drive expansion enclosure speed switch is set to the same speed as the existing drive expansion enclosures and the DS4000 Storage Subsystem speed setting.
 - ___ d. Verify that the ESM is good by physically removing and swapping it with the other ESM in the same drive expansion enclosure. For enclosure ID conflict, set the drive expansion enclosure ID switch to values unique from the current settings in the existing drive expansion enclosures and storage server.

Call the IBM Help Center in your geography for assistance if the problems persist.

- ___ Step 5. In the other drive loop (that is, drive loop A) in a DS4000 Storage Subsystem redundant drive loop pair, remove the connection from the DS4000 Storage Subsystem drive loop port to the IN port of the first storage expansion enclosure and connect it to the IN port of the new drive enclosure as shown in Figure 42 on page 107.

Note: The port name on an EXP810 is not labeled IN. See Figure 32 on page 84 for details.

- ___ Step 6. Wait a few seconds; verify that the port bypass LEDs of the two ports in the connection between the storage subsystem drive loop port and the IN port of the new drive enclosure are not lit. Using the DS4000 Storage Manager Client Subsystem Management window, verify that the **new** drive enclosure does not indicate the drive enclosure lost

redundancy path error. See the preceding step 4 on page 104 for possible corrective actions, if needed. Until you establish the fibre channel cabling connection described in step 7, the existing storage expansion enclosures will appear in the Storage Manager Client Subsystem Management window with drive enclosure lost redundancy path errors.

- ___ Step 7. In drive loop A, cable the new drive enclosure's OUT port to the IN port of the first enclosure in the already functioning storage expansion enclosure drive loop as shown in Figure 43 on page 108.
- ___ Step 8. Wait a few seconds; verify that the port bypass LEDs of all of the ports in drive loop A to which you have added a new connection are not lit. Using the DS4000 Storage Manager Client Subsystem Management window, verify that all of the drive enclosures in the DS4000 redundant drive loop pair to which the new enclosure was added does not report the drive enclosure lost redundancy path error.

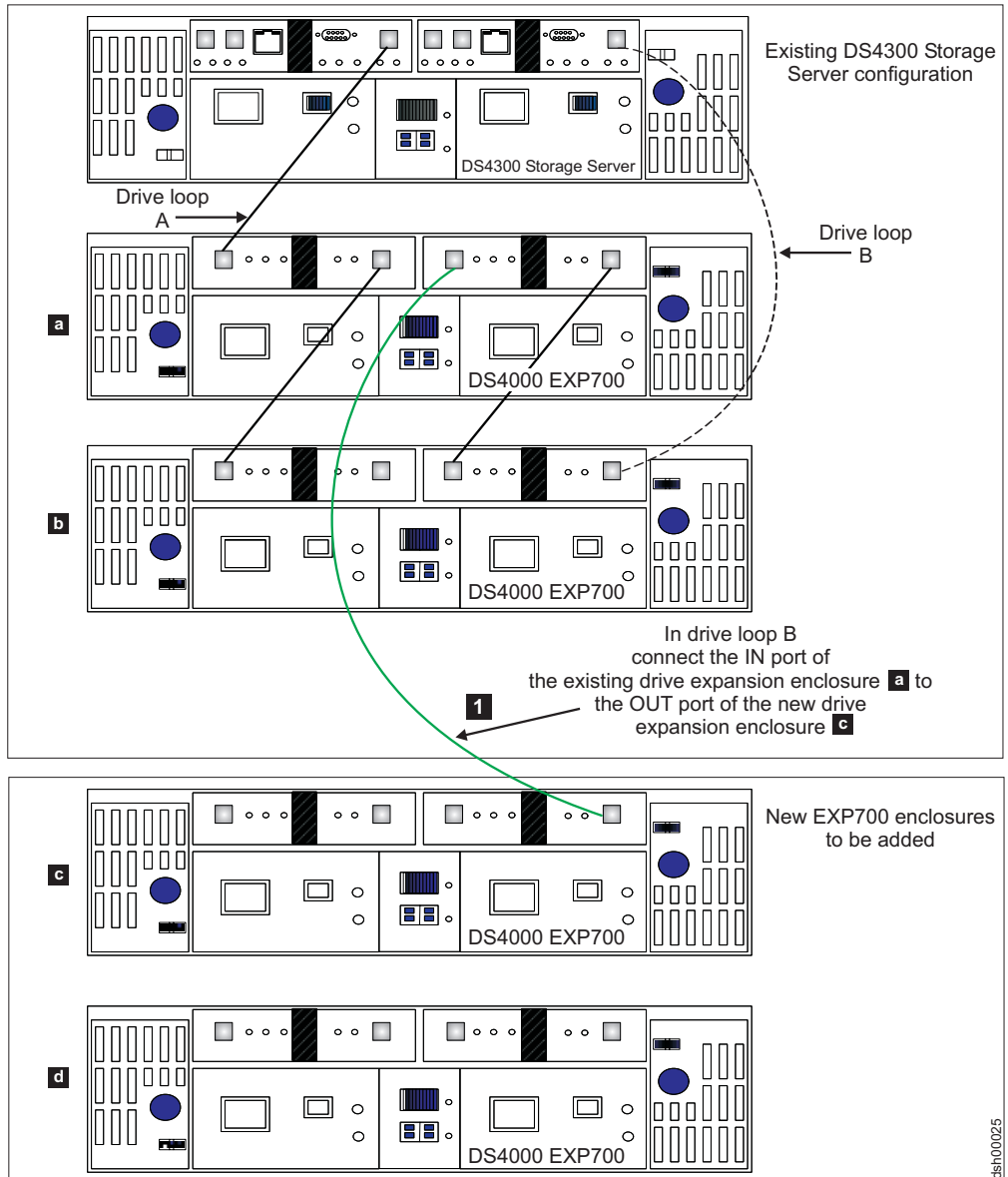

Figure 41. Cabling a single drive enclosure to the beginning of a functioning drive loop (step 1 of 3)

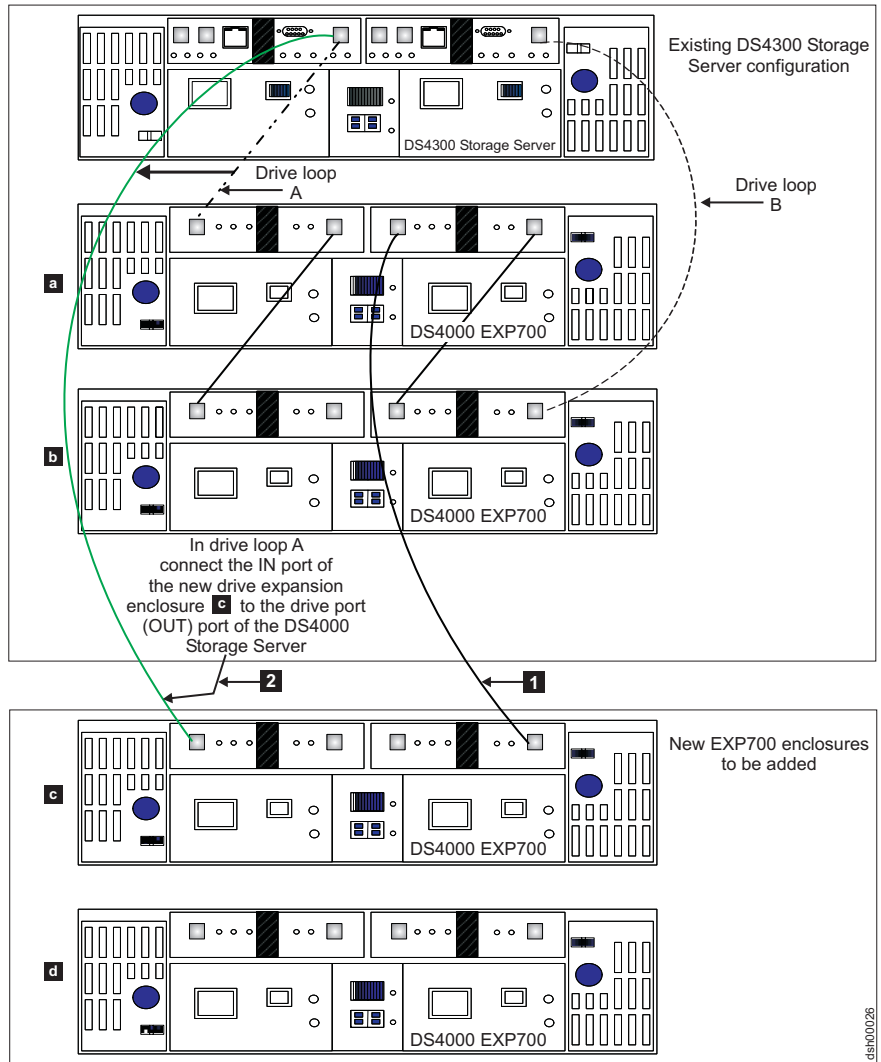

Figure 42. Cabling a single drive enclosure to the beginning of a functioning drive loop (step 2 of 3)

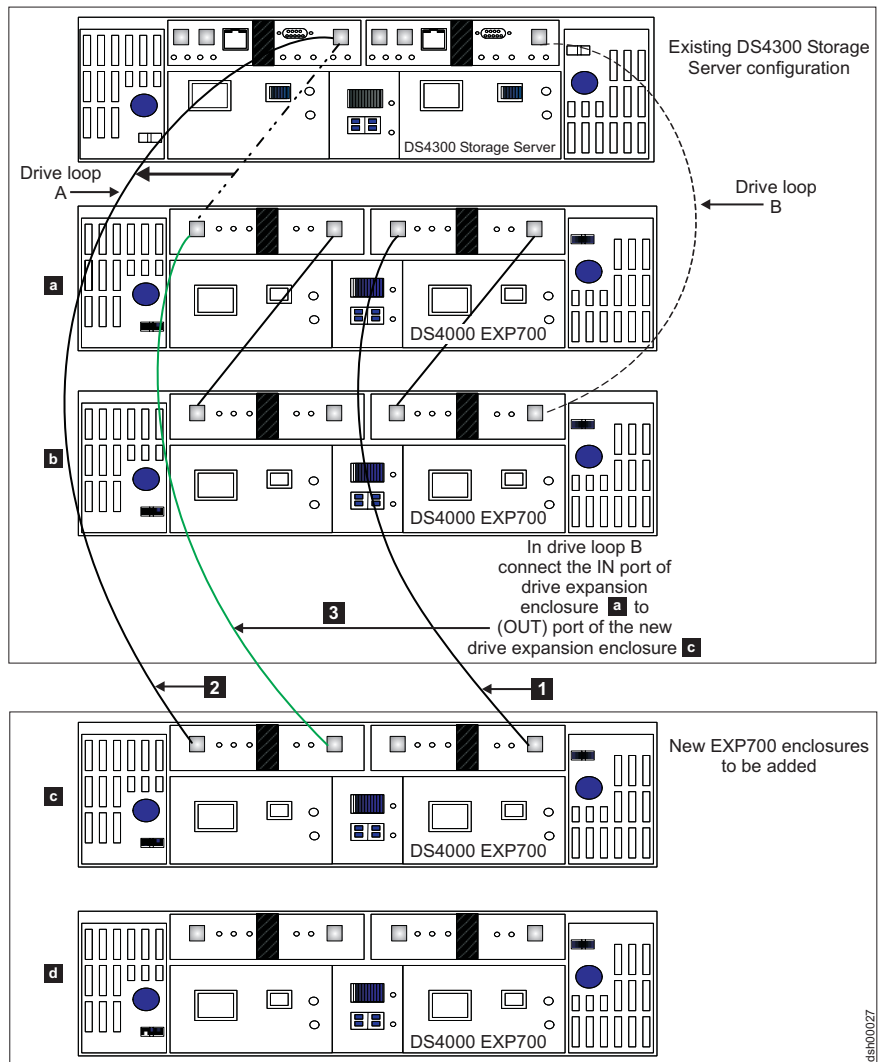

Figure 43. Cabling a single drive enclosure to the beginning of a functioning drive loop (step 3 of 3)

Activity 7: Inserting hard drives and placing logical drives online

Note: When migrating hard drives from multiple DS4000 Storage Subsystems to a single DS4000 Storage Subsystem, move all of the hard drives from the first DS4000 Storage Subsystem as an independent “set” to the destination DS4000 Storage Subsystem. Before moving hard drives as a set from subsequent DS4000 Storage Subsystems, ensure that all of the hard drives from the previous set have been successfully transferred to the destination DS4000 Storage Subsystem. If you do not transfer hard drives as “sets” to the destination DS4000 Storage Subsystem, the newly relocated array may not appear in the Subsystem Management window.



- ___ Step 1. Insert the drives into the empty drive slots in the new enclosure in pairs. Wait (up to 5 minutes) until each drive pair has fully spun up and displayed in the DS4000 Storage Subsystem Management window before inserting the next drive pair.
- ___ Step 2. For each additional enclosure that you intend to migrate to the functioning drive loop pair, perform Activity 5: Installing and setting

storage expansion unit IDs and speeds step 1 on page 97 through step 3 on page 98, Activity 6: Cabling, powering on, and verifying storage expansion unit operation step 1 on page 99 through step 4 on page 99, and step 1 on page 108 of this activity. (See Figure 33 on page 86.) When you have completed adding enclosures, proceed to step 3.

___ Step 3. As the DS4000 Storage Subsystem recognizes the drives, it reads and displays the array and logical drive information on the drives in the Logical/Physical view of the DS4000 Storage Subsystem Management window. The storage subsystem places the array in offline state until it recognizes that you have inserted all of the drives that comprise the array.

___ Step 4. Once you insert all of the drives and the DS4000 Storage Subsystem recognizes them, change the state of the arrays or logical drives to the online state by right-clicking on the array name in the Storage Subsystem window and clicking **Place → Online**.

If any of the following conditions persist, contact the IBM Help Center in your geography for assistance.

- The empty drive slot icon () displayed for the drive slot into which you inserted the migrating drive.
- The Failed unconfigured drive icon () or the Failed configured drive icon () displayed for the drive slot into which you inserted the migrating drive.
- Array configuration data on the drives you have added is incomplete.
- You cannot bring the array online.

Attention: Do not initialize a drive that you want to keep (by right-clicking its icon and selecting **Initialize** from the pull-down menu) if it contains configuration or user data. Initializing any of the drives in a defined array causes all hard drives that comprise an array to return to the Unconfigured Capacity storage pool, deleting their array definitions from the DS4000 Storage Subsystem configuration. The user data on such drives is lost.

Result: Once the arrays are online, they are ready for you to configure and map to host servers. You might also then recreate flashcopies and remote mirror relationships.

___ Step 5. Use the DS4000 Storage Manager program to view the storage partitioning definitions and make any necessary corrections.

___ Step 6. The DS4000 Storage Subsystem that the drives are migrated from will display the logical drives that are defined in these drives as “missing LUNs.” In order to remove these “missing LUNs” entries, right-click on each entry and select **Delete** from the pull-down menu.

Chapter 7. Upgrading a storage subsystem in a functioning configuration

Note: When migrating hard drives from multiple DS4000 Storage Subsystems to a single DS4000 Storage Subsystem, move all of the hard drives from the first DS4000 Storage Subsystem as an independent 'set' to the destination DS4000 Storage Subsystem. Before moving hard drives as a 'set' from subsequent DS4000 Storage Subsystems, ensure that all of the hard drives from the previous 'set' have been successfully transferred to the destination DS4000 Storage Subsystem. If you do not transfer hard drives as 'sets' to the destination DS4000 Storage Subsystem, the newly relocated arrays/logical drives that are defined in these drives might not appear in the Subsystem Management window.

This procedure details the steps that are required to upgrade a DS4000 Storage Subsystem in a functioning DS4000 configuration. Where either an identical or newer DS4000 Storage Subsystem model is involved, this upgrade involves only the replacement of the DS4000 storage controller to be upgraded. DS4000 storage expansion enclosures that had been attached to drives containing configuration data will be connected to the new DS4000 Storage Subsystem. The upgraded (original) DS4000 Storage Subsystem being replaced will be either scrapped or returned to operation (redeployed) at a later date with new drives and/or new storage expansion enclosures.

Table 27 on page 113 associates each DS4000 Storage Subsystem with its supported replacements.

Important:

IBM Support is available to supply assistance and guidance to those who choose to upgrade a DS4000 Storage Subsystem.

Preliminary considerations: Storage Subsystem upgrade

While upgrading a DS4000 Storage Subsystem in a functioning configuration, remain aware of these important considerations:

- Observe proper ESD handling procedures when handling electronic equipment. See "Handling static-sensitive devices" on page 51 for additional information.
- IBM assigns premium feature entitlements only to specific DS4000 Storage Subsystems. In order to enable premium features in a replacement DS4000 Storage Subsystem configuration that had been enabled in an original DS4000 Storage Subsystem configuration, you must purchase appropriate entitlements for the replacement DS4000 Storage Subsystem. In addition, IBM assigns host kits only to specific DS4000 Storage Subsystems. You must also purchase the appropriate host kits for new DS4000 Storage Subsystems.
- See the appropriate *DS4000 Storage Controller's Installation and User's Guide* for information on the proper power on and power off sequences.

Note: The remainder of this topic pertains to the original DS4000 Storage Subsystem that is designated for replacement as either the original or old DS4000 Storage Subsystem.

This task requires that you shut down the DS4000 Storage Subsystem configuration. In addition, after the upgrade, premium features previously enabled in

the original DS4000 Storage Subsystem along with the enable-by-default premium features in the new DS4000 Storage Subsystem will automatically be placed in Out-of-Compliance state. Full data availability is retained, but you must generate new premium feature SAFE keys in order to re-enable premium features. Because IBM assigns premium feature entitlements only to specific DS4000 Storage Subsystems, you must purchase the appropriate entitlement for the new DS4000 Storage Subsystem. You can generate new SAFE keys by contacting the IBM Help Center in your geography. Be sure to have the necessary proof of purchase. Alternately, you can also generate new SAFE keys by using instructions located at the following Web site:

www.storage.ibm.com/pfeatures.html/

The new DS4000 Storage Subsystem controller identifies itself using a new Worldwide Name (WWN) that is different from the WWN used by the original DS4000 Storage Subsystem controller. For this reason, additional tasks might be required after the upgrade for any host applications or drivers that rely on the WWNs to identify logical drives defined in a given DS4000 Storage Subsystem. See your application program's documentation, your driver's user guide, or related documentation for detailed instructions on how to update the WWN of the DS4000 Storage Subsystem in the application or driver. Additionally, review the readme file and the related *IBM TotalStorage DS4000 Storage Manager Installation and Support Guide* for information about any preparation tasks required in addition or operating system-specific restrictions. *IBM TotalStorage DS4000 Storage Manager Installation and Support Guides* are located at the following Web site:

www.ibm.com/servers/storage/support/disk/

Attention: Depending on your existing DS4000 Storage Subsystem configuration, you might not be able to migrate all of your drives and storage expansion enclosures to a new DS4000 Storage Subsystem configuration. For example, you cannot migrate 1 Gbps EXP500 drive expansion enclosures from a FASTT500 Storage Subsystem to a DS4300 Storage Subsystem or you cannot migrate a EXP700 drive expansion enclosures to the DS4800 Storage Subsystem before upgrading them to EXP710 drive expansion enclosures first. See Table 11 on page 5 and Table 27 on page 113 for additional information on DS4000 Storage Subsystem and storage expansion enclosure compatibility.

Contact your IBM technical support representative if you have questions regarding the compatibility of drives and drive expansion enclosures in an existing DS4000 Storage Subsystem configuration with a new DS4000 Storage Subsystem configuration.

If you are planning to consolidate drive expansion enclosures from multiple DS4000 Storage Subsystem configurations into a single configuration with a new DS4000 Storage Subsystem, perform the DS4000 Storage Subsystem replacement using drive expansion enclosures (and drives) from a given DS4000 Storage Subsystem configuration first. After the DS4000 Storage Subsystem migration has been successfully completed, use the procedure describe in Chapter 6 to migrate the drive expansion enclosures from the rest of the DS4000 Storage Subsystem configurations to the new DS4000 Storage Subsystem.

Table 27 on page 113 associates each DS4000 Storage Subsystem with its supported replacements. Select **View** → **Rotate View** → **Clockwise** to optimize the appearance of this chart.

Table 27. DS4000 storage Subsystems by their supported replacements

DS4000 Storage Subsystem	Supported replacement DS4000 Storage Subsystem										
	DS4100 (Single Ctlr)	DS4100 (Base)	FAST200	FAST500	DS4300 (Single Ctlr)	DS4300 (Base model)	DS4300 (Turbo option)	DS4400	DS4500	DS4800	
DS4100 (Single Ctlr)	✓ ⁶	✓ ⁶									
DS4100 (Base)		✓ ⁶									
FAST200			✓	✓				✓			
FAST500 ²				✓		✓ ^{7,9}	✓ ^{7,9}	✓			
DS4300, Single Ctlr ³					✓		✓				
DS4300 (Base) ^{4,8}						✓	✓	✓	✓	✓ ^{7,10,11,12}	
DS4300 (Turbo) ^{5,8}						✓	✓	✓	✓	✓ ^{7,10,11,12}	
DS4400				✓		✓ ⁷	✓ ⁷	✓	✓	✓ ^{10,11,12}	
DS4500				✓		✓ ⁷	✓ ⁷	✓	✓	✓ ^{10,11,12}	
DS4800						✓	✓	✓	✓	✓	✓

Table 27. DS4000 storage Subsystems by their supported replacements (continued)

<ol style="list-style-type: none"> 1. IBM does not currently support replacement of SATA or fibre channel controllers with one another. Contact your IBM support representative for assistance with this issue should the need arise. 2. Set the DS4000 EXP700 storage expansion enclosure's speed switch to 1 Gbps when migrating from 2 Gbps configurations to a FAStT500 Storage Subsystem 1 Gbps configuration. 3. Single controller model (6LU/6LX) 4. Base model (60U/60X) 5. Model with Turbo option (60U/60X) 6. You must run the SMcli command: <pre>set storageSubsystem redundancyMode=duplex;</pre> 7. Migration to a DS4300 Storage Subsystem configuration from a FAStT500, DS4400, DS4500, or DS4800 storage subsystem configuration with more than eight drive expansion enclosures will require more than one DS4300 Storage Subsystem. See Table 9 on page 1. 8. DS4300 (Base model) and DS4300 (with Turbo option) Storage Subsystem configurations do not accommodate DS4000 EXP500 drive expansion enclosures. Do not migrate the EXP500 enclosures in FAStT500, DS4400, or DS4500 Storage Subsystem configurations to DS4300 (Base model) or DS4300 (with Turbo option) Storage Subsystem configurations. 9. You can migrate only EXP700 storage expansion enclosures from a FAStT500 Storage Subsystem to a DS4300 Storage Subsystem configuration. When you do so, you must set the EXP700 storage expansion enclosure's speed switch to 2 Gbps. 10. Migration to non-DS4800 Storage Subsystem requires the drive enclosures be operating at 2 Gbps FC speed. 11. The DS4800 Storage Subsystem does not support EXP700 drive expansion enclosures. The EXP700 drive expansion enclosures must be upgraded to EXP710 in the existing DS4000 Storage Subsystem configuration before migrating it to the DS4800 Storage Subsystem. 12. You cannot replace the DS4800 Storage Subsystem with a non-DS4800 storage subsystem if the existing DS4800 configuration has EXP810s in the drive channels.

Preliminary considerations: Firmware behavior during subsystem upgrade

This section describes technical considerations regarding basic DS4000 Storage Subsystem controller firmware behavior during a DS4000 Storage Subsystem upgrade. It covers firmware behavior during system upgrade, where a new DS4000 Storage Subsystem connects to functioning drives and storage expansion enclosures, as well as firmware behavior during system redeployment, where the original (old) DS4000 Storage Subsystem serves as a logically distinct entity, optionally, using some of the drives from the original system.

DS4000 configuration behavior after upgrade and DS4000 Storage Subsystem replacement

The new DS4000 Storage Subsystem that powers up in a functioning storage expansion enclosure configuration as part of the DS4000 Storage Subsystem upgrade process impacts the following areas of the DS4000 Storage Subsystem identification and premium features:

1. Worldwide Name (WWN):

The worldwide names that were used by the original DS4000 Storage Subsystem prior to the upgrade are not returned when the upgrade is complete. Rather, the new DS4000 Storage Subsystem begins to advertise itself using WWNs that are based on an embedded unique identifier from its controller blades. This statement applies to both the port WWNs and the node WWNs. Consequently, any hosts that were aware of the logical drives in the original DS4000 Storage Subsystem based on the original DS4000 Storage Subsystem's WWN values will likely be confused. The data volumes that resided behind the previously known WWNs now reside behind a seemingly new device with different WWNs.

2. Storage Array Identifier (SAI or SA Identifier):

The storage array identifier, or SA Identifier, is the identification value used by the DS4000 Storage Manager host software (SMclient) to uniquely identify managed storage subsystems. The DS4000 Storage Manager SMclient program maintains SA Identifier records of previously discovered storage subsystems in the host resident file, which allows it to retain discovery information in a persistent fashion. This identifier is stored on DACstore, and persists across reboots, power cycles, and so on. The new DS4000 Storage Subsystem that powers up in a functioning storage expansion enclosure configuration as part of the DS4000 Storage Subsystem upgrade process continues to use the SA Identifier of the original DS4000 Storage Subsystem.

3. SAFE Premium Feature Identifier (SAFE ID) and Premium Feature Enable Status:

The new DS4000 Storage Subsystem retains the SAFE ID of the original DS4000 Storage Subsystem. It also retains all of the features previously enabled on the original DS4000 Storage Subsystem. The feature states, however, are set to the Out-of-Compliance state. As a result, the system sends alert notices and establishes a Needs Attention condition. Also, any features that are marked in the new controller's NVSRAM for automatic enablement are enabled, though their feature states are also set to Out-of-Compliance. You must re-enable the premium features by using premium feature SAFE key files. Because IBM assigns premium feature entitlements only to specific DS4000 Storage Subsystems, you must purchase the appropriate entitlements for the new DS4000 Storage Subsystem to enable all of the premium features previously enabled on the original DS4000 Storage Subsystem.

Redeployed DS4000 configuration behavior in an original (replaced) DS4000 Storage Subsystem

Important:

IBM Support is available to supply assistance and guidance to those who choose to redeploy a replaced DS4000 Storage Subsystem.

When you redeploy DS4000 Storage Subsystem hardware in another DS4000 Storage Subsystem's configuration, identification and premium features of the redeployed system behave somewhat differently from information described in "DS4000 configuration behavior after upgrade and DS4000 Storage Subsystem replacement" on page 115. This section describes those relevant behavioral differences.

- Worldwide Name (WWN):

The worldwide names that were used by the original DS4000 Storage Subsystem are retained on the redeployed system. These values are based on an embedded unique identifier from the original DS4000 Storage Subsystem controller blades, and are stored in the NVSRAM on each controller board within the controller blade. Assuming that both controllers remain fully optimal after the redeployment, they recognize the stored value and continue to use it. Consequently, any hosts that were aware of the original DS4000 Storage Subsystem, based on its WWN values, will likely be confused. The logical drives that used to reside behind the previously-known WWNs no longer reside there, because they are now part of the new DS4000 Storage Subsystem, which has a different WWN.

- Storage Array Identifier or SA Identifier:

If you return one or more drives that were originally moved from a DS4000 Storage Subsystem back to the original DS4000 Storage Subsystem configuration before it is redeployed, it is possible that the SA Identifier that was used on the original DS4000 Storage Subsystem system will also be reused in the redeployed DS4000 Storage Subsystem configuration. Whether this occurs depends on the specific selection of transported drives. If certain conditions are met, however, the redeployed unit adopts the same SA Identifier that was retained by the new DS4000 Storage Subsystem. Otherwise, or in cases in which only new drives are used in the redeployed configuration, the redeployed DS4000 Storage Subsystem generates a new (and unique) SA Identifier that does not conflict with the one that was retained by the upgraded unit.

If both the new and the redeployed DS4000 Storage Subsystem have the same SA Identifier, serious problems will result when you start the DS4000 Storage Manager SMclient program. Since there will be two DS4000 Storage Subsystems with the same SA Identifier, the DS4000 Storage Manager SMclient program will respond by arbitrarily selecting either the new or the redeployed DS4000 Storage Subsystem. The storage subsystem that the DS4000 Storage Manager SMclient program arbitrarily selects will be manageable, and the other storage subsystem will be unmanageable.

- SAFE Premium Feature Identifier (SAFE ID)

Premium Feature Enable status:

If you return any drives from an original DS4000 Storage Subsystem, along with the original DS4000 Storage Subsystem controllers, to a redeployed DS4000 configuration, the SAFE ID of the original DS4000 Storage Subsystem will be retained, and all enabled features will remain fully enabled and compliant.

If you do not move any drives from an original DS4000 Storage Subsystem, it generates a new SAFE ID when redeployed, enabling none of the premium features from the original system. This new SAFE ID prevents the system from using any previously-acquired SAFE key files and re-enabling any premium features. In cases where the original DS4000 Storage Subsystem was pre-loaded with NVSRAM codes to enable certain premium features, NVSRAM codes are cleared from the DS4000 Storage Subsystem when redeployed and powered on for the first time. Therefore, premium features that were enabled as standard features do not reactivate on the redeployed system. The system retains full data availability, but you must generate new premium feature SAFE keys in order to re-enable premium features. You can generate new SAFE keys by contacting the IBM Help Center in your geography. Be sure to have the necessary proof of purchase. Alternately, you can also generate new SAFE keys by using instructions located at the following Web site:

www.storage.ibm.com/pfeatures.html/

- **Controller IP addresses:**

When the DS4000 Storage Subsystem controllers were assigned static IP addresses, the IP addresses were stored in the NVSRAM of the controller board as well as the DACstore on the disks. If the new (replacement) DS4000 Storage Subsystem controllers were assigned the same IP addresses as the original (replaced) DS4000 Storage Subsystem controllers, network problem will arise when the original (replaced) DS4000 Storage Subsystem is eventually redeployed. The problem will occur because two devices have the same IP address in the Ethernet network. The best practice is to assign new unique IP addresses to new (replacement) DS4000 Storage Subsystem controllers instead of using the same IP addresses as the DS4000 controllers that they replace.

Upgrading storage subsystems in functioning DS4000 configurations

Before you perform the following upgrade procedure, review and perform the steps detailed in Chapter 2, “Prerequisites to adding capacity and hard drive migration,” on page 41.

Complete the following activities to upgrade your DS4000 Storage Subsystem:

Activity 1: Preliminary activities

Perform the following steps before you disconnect storage expansion enclosures from an original DS4000 Storage Subsystem that is being replaced to ensure a successful DS4000 Storage Subsystem upgrade.

- ___ Step 1. Verify that the original DS4000 Storage Subsystem’s controller firmware and NVSRAM are at the levels shown in Table 25 on page 43.
- ___ Step 2. Verify that the firmware of the ESMs in the storage expansion enclosures is at the levels shown in Table 26 on page 45.
- ___ Step 3. Disable or delete any flashcopies of the logical drives.
- ___ Step 4. Delete any remote mirror relationships.
- ___ Step 5. If the arrays (logical drives) are not in optimal state, perform the steps necessary to bring the arrays (logical drives) into their optimal state before you attempt their migration. See the *DS4000 Problem Determination Guide* associated with your particular DS4000 hardware model or “Bringing storage subsystems and drive loops into optimal state” on page 49 for additional information on how to make this determination.

- ___ Step 6. If the drive enclosures are not in optimal state, perform the steps necessary to bring them to optimal state before attempting migration. Perform the following steps to verify that the drive loops are in optimal state:
 - ___ Step a. Physically trace the actual cable connections making sure that connections are properly modified and that the cable connectors are firmly inserted into the SFPs or GBICs.
 - ___ Step b. Verify that the following LEDs are not lit or briefly flashed in the modified drive loop:
 - ESM fault
 - port bypass
 - ID conflict
 - ___ Step c. Verify that the controller drive loop LED remains lit. If the controller drive loop LED becomes unlit momentary, there are problems in the drive loop and the LIPs are generated by the DS4000 Storage Subsystem controller.
 - ___ Step d. In the DS4000 Storage Manager Client Subsystem Management window, verify that there are no loss of ESM path redundancy errors in the drives expansion enclosures that are not migrated.

Do not modify the second drive loop in a redundant drive loop pair until you are sure that the first modified drive loop is operating optimally. See the *DS4000 Problem Determination Guide* associated with your particular DS4000 hardware model or “Bringing storage subsystems and drive loops into optimal state” on page 49 for additional information on how to make this determination.
- ___ Step 7. Perform a full backup of the original DS4000 Storage Subsystem and schedule it for down time. This is necessary because you must power down the DS4000 Storage Subsystem configuration during the upgrade procedure.
- ___ Step 8. Save the DS4000 Storage Subsystem profile of the original DS4000 Storage Subsystem configuration in a location other than that in which the logical drives are defined in the original DS4000 Storage Subsystem configuration.
- ___ Step 9. Stop all programs, services or processes in the host servers that access the logical drives defined in the migrated hard drives. Ensure that there are not any running background programs, services or processes that write data to the logical drives. (For example, Microsoft MSCS service periodically writes to the “Quorum” disk.)
- ___ Step 10. Unmount the file systems to flush I/O from the server cache to disks.

Notes:

- a. In a Microsoft Windows environment, remove the drive letter or the mount points of the mapped LUNs instead of unmounting the file systems.
 - b. Consult documentation associated with your particular operating system for detailed information regarding the Unmount procedure.
- ___ Step 11. Place the arrays defined on the DS4000 Storage Subsystem in offline state. In the Storage Subsystem Management window, right-click on the name of the array and select **Place → Offline**.

- ___ Step 12. Retrieve proofs of purchase for both the original and new DS4000 Storage Subsystems and for the additional premium feature entitlements on the new and original DS4000 Storage Subsystems. IBM support personnel will require this information to regenerate premium feature SAFE key files that were enabled in the original DS4000 Storage Subsystem for use on the new DS4000 Storage Subsystem.

Activity 2: Powering off the original DS4000 Storage Subsystem

Power down the original DS4000 Storage Subsystem and remove it from the DS4000 configuration. Do not redeploy this DS4000 Storage Subsystem in the same management domain as its upgrade (replacement) DS4000 Storage Subsystem until you regenerate its SA identifier using the instructions in “Redeploying the original (replaced) DS4000 Storage Subsystem” on page 121.

Note: See the appropriate *DS4000 Storage Controller's Installation and User's Guide* for details on the correct power off sequence.

Activity 3: Installing new DS4000 Storage Subsystems and setting minihub speed

Install the new DS4000 Storage Subsystem. For DS4400 and DS4500 storage servers, set the drive minihub speed switch to the speed of the storage expansion enclosure ports to which they are connected.

Note: The DS4300 drive loop port operates only at 2 Gbps. If you migrate storage expansion enclosures from a 1 Gbps fibre channel environment to a 2 Gbps fibre channel environment, do not automatically change the storage expansion enclosure speed settings from 1 Gbps to 2 Gbps. Before you do, verify that each fibre channel drive involved is capable of 2 Gbps operation and that you have installed the latest firmware enabling them to work properly in a 2 Gbps fibre channel environment.

Important:

If the new DS4000 Storage Subsystem is either a FASTT200 or DS4300 Storage Subsystem, set the FASTT200 or DS4300 enclosure ID to a value unique from other EXP storage expansion enclosures in the fibre channel drive loop. These IDs are normally set to “0” at the factory.

Activity 4: Making connections

Insert the SFPs or GBICs into the DS4000 Storage Subsystem drive port slots and make the connections from the DS4000 Storage Subsystem to the storage expansion enclosures. For detailed information, see the appropriate *DS4000 Storage Controller's Installation and User Guide*.

Ensure that all of the DS4000 storage expansion enclosures are set to the correct fibre channel speed for the drive loop of the new DS4000 Storage Subsystem.

Activity 5: Powering on the expansion unit and setting IP addresses

- ___ Step 1. Verify that all of the storage expansion enclosures are powered on and in optimal state by examining the expansion enclosure LED states. Then, power on the new DS4000 Storage Subsystem. Using the DS4000 Storage Manager client program, verify that the DS4000 Storage Subsystem is operational and that all of the drives are

recognized and in optimal state. See the *DS4000 Problem Determination Guide* associated with your particular DS4000 hardware model or “Bringing storage subsystems and drive loops into optimal state” on page 49 for additional information on how to make this determination.

Notes:



- a. Your storage subsystem will identify the new DS4000 Storage Subsystem as the machine type it replaced until you download the appropriate NVSRAM file for the new storage subsystem. For example, if you replace a FAStT500 with a DS4500, the DS4500 will be reported as a FAStT500 until you download the appropriate NVSRAM file for the DS4500.
 - b. See the appropriate *DS4000 Storage Controller's Installation and User Guide* for information on the proper power on sequence.
- ___ Step 2. If the new DS4000 Storage Subsystem is managed out-of-band, perform the steps for setting the IP addresses for new DS4000 Storage Subsystem controllers defined in the *IBM TotalStorage DS4000 Storage Manager Installation and Support Guide* associated with your operating system environment. *DS4000 Storage Manager Installation and Support Guides* are located at the following Web site:
www.ibm.com/servers/storage/support/disk/

Changing DS4000 Storage Subsystem IP addresses

- ___ Step 1. Open the Storage Manager client program's Enterprise Management window.
- Note:** The new DS4000 Storage Subsystem will have the same IP addresses as the DS4000 Storage Subsystem previously removed.
- ___ Step 2. Select the entry of the DS4000 Storage Subsystem that you want to manage.
- ___ Step 3. Right click and select **Manage Device** from the pop-up menu. The DS4000 Storage Manager Client Subsystem Management window opens.
- ___ Step 4. In the Logical/Physical view of the window, select **Controller → Change → Network Configuration**. The Change Network Configuration window opens.
- ___ Step 5. Select the **Slot A** tab.
- ___ Step 6. Select the radio button labeled **Specify Configuration Setting**.
- ___ Step 7. Type in the new IP address, subnet mask, and gateway information.
- ___ Step 8. Click **OK**.
- ___ Step 9. Select the **Slot B** tab.
- ___ Step 10. Select the radio button labeled **Specify Configuration Setting**.
- ___ Step 11. Type in the new IP address, subnet mask, and gateway information.
- ___ Step 12. Click **OK** to enable the IP address changes.
- ___ Step 13. Close the DS4000 Storage Manager Client Subsystem Management window.
- ___ Step 14. Select the entry of the DS4000 Storage Subsystem whose IP address you just changed. Right click.
- ___ Step 15. Select **Remove Device** from the pop-up menu.
- ___ Step 16. Click **Yes** to confirm removal of each device.

- ___ Step 17. Select **Edit → Add Device**. The Add Device window opens.
- ___ Step 18. Type in the name or new IP address of controller A and close the window.
- ___ Step 19. Type in the name or new IP address of controller B and close the window.

Activity 6: Downloading firmware and NVSRAM and returning arrays online

- ___ Step 1. Use the DS4000 Storage Manager client program to download the firmware and the NVSRAM for the new DS4000 Storage Subsystem.
- ___ Step 2. Return the offline arrays to online state by right-clicking on the array and selecting **Place → Online**. If any of the following conditions persist, contact the IBM Help Center in your geography for assistance:
 - The empty drive slot icon () displayed for the drive slot into which you inserted the migrating drive.
 - The Failed unconfigured drive icon () or the Failed configured drive icon () displayed for the drive slot into which you inserted the migrating drive.
 - Array configuration data on the drives you have added is incomplete.
 - You cannot bring the array online.

Activity 7: Generating and applying premium feature SAFE key files

Generate the new premium feature SAFE key files using the new DS4000 Storage Subsystem Feature Enable Identifier. Apply premium feature SAFE keys to remove Out-of-Compliance errors on enabled premium features.

Result: You are now able to recreate flashcopies and remote mirror relationships, if required.

Redeploying the original (replaced) DS4000 Storage Subsystem

As a safety measure, force generation of a new SA Identifier when you redeploy an original (replaced) DS4000 Storage Subsystem. Use the controller shell commands to generate a new SA Identifier. To gain access to the controller shell, you will require a null modem cable and a terminal emulation program that is capable of sending a BREAK signal. The setting for the terminal emulation session is 8-N-1 (8 data bits, no parity bit and 1 stop bit). Once you enter the controller shell, use the following command sequence to force the controller to generate a new SA Identifier:

```
1d </Debug
symbolGenerateNewSAIdentifier
```

Note: It is necessary for you to run this command sequence on only one controller. Then, reset both DS4000 Storage Subsystem controllers and proceed with the normal DS4000 Storage Subsystem installation and configuration process.

Accessing the DS4000 Storage Subsystem controller shell

The following steps describe how to access the DS4000 Storage Subsystem controller shell using the terminal emulation program of your choice. One example

of such a terminal emulation program for which IBM neither makes nor implies a warranty, HyperTerminal, Private Edition; version 6.3 or higher, is available for your consideration at the following Web site:

www.hilgraeve.com

A generic version of steps involved in accessing the DS4000 Storage Subsystem controller shell using the terminal emulation program of your choice follows:

- ___ Step 1. Stop all I/O on the DS4000 Storage Subsystem.
- ___ Step 2. Connect a null modem serial cable from one of the DS4000 Storage Subsystem controller communications (COM) ports to a system with an available terminal emulator.
- ___ Step 3. Open the terminal emulation program of your choice, such as the HyperTerminal, Private Edition program and from the menu bar, click **File → Properties → Configure**. Establish the following property settings:
 - Bits per second: 57600
 - Data bits: 8
 - Parity: None
 - Stop Bit: 1
 - Flow Control: None
- ___ Step 4. Connect to the DS4000 Storage Subsystem controller shell by sending a BREAK signal. (If you are using the HyperTerminal, Private Edition program, press the Ctrl and BREAK keys simultaneously to send the BREAK signal.)
- ___ Step 5. Repeat step 4 until the following message displays:
"Press the space bar for baud rate within 5 seconds."
- ___ Step 6. Press the space bar within the time limit to establish the correct baud rate setting.
- ___ Step 7. Send another BREAK signal. The following message is displayed:
"Press within 5 seconds: ESC for SHELL, BREAK for baud rate."
- ___ Step 8. Press the ESC key within the time limit to access the controller shell.
- ___ Step 9. When prompted, type the following password:
infiniti
- ___ Step 10. You are now accessing the DS4000 Storage Subsystem controller shell.

Important:

Be careful when entering commands in the DS4000 Storage Subsystem controller shell. Improper use of DS4000 Storage Subsystem controller shell commands could result in loss of configuration data.

Notices

This publication was developed for products and services offered in the U.S.A.

IBM may not offer the products, services, or features discussed in this document in other countries. Consult your local IBM representative for information on the products and services currently available in your area. Any reference to an IBM product, program, or service is not intended to state or imply that only that IBM product, program, or service may be used. Any functionally equivalent product, program, or service that does not infringe any IBM intellectual property right may be used instead. However, it is the user's responsibility to evaluate and verify the operation of any non-IBM product, program, or service.

IBM may have patents or pending patent applications covering subject matter described in this document. The furnishing of this document does not give you any license to these patents. You can send license inquiries, in writing, to:

*IBM Director of Licensing
IBM Corporation
North Castle Drive
Armonk, NY 10504-1785
U.S.A.*

INTERNATIONAL BUSINESS MACHINES CORPORATION PROVIDES THIS PUBLICATION "AS IS" WITHOUT WARRANTY OF ANY KIND, EITHER EXPRESS OR IMPLIED, INCLUDING, BUT NOT LIMITED TO, THE IMPLIED WARRANTIES OF NON-INFRINGEMENT, MERCHANTABILITY OR FITNESS FOR A PARTICULAR PURPOSE. Some jurisdictions do not allow disclaimer of express or implied warranties in certain transactions, therefore, this statement may not apply to you.

This information could include technical inaccuracies or typographical errors. Changes are periodically made to the information herein; these changes will be incorporated in new editions of the publication. IBM may make improvements and/or changes in the product(s) and/or the program(s) described in this publication at any time without notice.

Any references in this publication to non-IBM Web sites are provided for convenience only and do not in any manner serve as an endorsement of those Web sites. The materials at those Web sites are not part of the materials for this IBM product, and use of those Web sites is at your own risk.

IBM may use or distribute any of the information you supply in any way it believes appropriate without incurring any obligation to you.

Trademarks

The following terms are trademarks of International Business Machines Corporation in the United States, other countries, or both:

FlashCopy
IBM
IBMLink

Netfinity
ServerProven®
TotalStorage

Intel® is a trademark of Intel Corporation in the United States, other countries, or both.

Java and all Java-based trademarks and logos are trademarks or registered trademarks of Sun Microsystems, Inc. in the United States, other countries, or both.

Other company, product, or service names may be trademarks or service marks of others.

Important notes

Processor speeds indicate the internal clock speed of the microprocessor; other factors also affect application performance.

CD-ROM drive speeds list the variable read rate. Actual speeds vary and are often less than the maximum possible.

When referring to processor storage, real and virtual storage, or channel volume, KB stands for approximately 1000 bytes, MB stands for approximately 1 000 000 bytes, and GB stands for approximately 1 000 000 000 bytes.

When referring to hard disk drive capacity or communications volume, MB stands for 1 000 000 bytes, and GB stands for 1 000 000 000 bytes. Total user-accessible capacity may vary depending on operating environments.

Maximum internal hard disk drive capacities assume the replacement of any standard hard disk drives and population of all hard disk drive bays with the largest currently supported drives available from IBM.

Maximum memory may require replacement of the standard memory with an optional memory module.

IBM makes no representation or warranties regarding non-IBM products and services that are ServerProven, including but not limited to the implied warranties of merchantability and fitness for a particular purpose. These products are offered and warranted solely by third parties.

IBM makes no representations or warranties with respect to non-IBM products. Support (if any) for the non-IBM products is provided by the third party, not IBM.

Some software may differ from its retail version (if available), and may not include user manuals or all program functionality.

Electronic emission notices

This section gives the electronic emission notices or statements for the United States and other countries or regions.

Federal Communications Commission (FCC) statement

Note: This equipment has been tested and found to comply with the limits for a Class A digital device, pursuant to Part 15 of the FCC Rules. These limits are designed to provide reasonable protection against harmful interference when the equipment is operated in a commercial environment. This equipment generates, uses, and can radiate radio frequency energy and, if not installed and used in accordance with the instruction manual, may cause harmful interference to radio

communications. Operation of this equipment in a residential area is likely to cause harmful interference, in which case the user will be required to correct the interference at his own expense.

Properly shielded and grounded cables and connectors must be used in order to meet FCC emission limits. Properly shielded and grounded cables and connectors must be used in order to meet FCC emission limits. IBM is not responsible for any radio or television interference caused by using other than recommended cables and connectors or by using other than recommended cables and connectors or by unauthorized changes or modifications to this equipment. Unauthorized changes or modifications could void the user's authority to operate the equipment.

This device complies with Part 15 of the FCC Rules. Operation is subject to the following two conditions: (1) this device may not cause harmful interference, and (2) this device must accept any interference received, including interference that may cause undesired operation.

Chinese class A compliance statement

Attention: This is a class A statement. In a domestic environment, this product might cause radio interference in which case the user might be required to take adequate measures.

中华人民共和国“A类”警告声明

声明

此为A级产品，在生活环境中，该产品可能会造成无线电干扰。在这种情况下，可能需要用户对其干扰采取切实可行的措施。

Industry Canada Class A emission compliance statement

This Class A digital apparatus complies with Canadian ICES-003.

Avis de conformité à la réglementation d'Industrie Canada

Cet appareil numérique de la classe A est conforme à la norme NMB-003 du Canada.

Australia and New Zealand Class A statement

Attention: This is a Class A product. In a domestic environment this product may cause radio interference in which case the user may be required to take adequate measures.

United Kingdom telecommunications safety requirement

Notice to Customers

This apparatus is approved under approval number NS/G/1234/J/100003 for indirect connection to public telecommunication systems in the United Kingdom.

European Union EMC Directive conformance statement

This product is in conformity with the protection requirements of EU Council Directive 89/336/EEC on the approximation of the laws of the Member States relating to electromagnetic compatibility. IBM cannot accept responsibility for any

failure to satisfy the protection requirements resulting from a nonrecommended modification of the product, including the fitting of non-IBM option cards.

This product has been tested and found to comply with the limits for Class A Information Technology Equipment according to CISPR 22/European Standard EN 55022. The limits for Class A equipment were derived for commercial and industrial environments to provide reasonable protection against interference with licensed communication equipment.

Attention: This is a Class A product. In a domestic environment this product may cause radio interference in which case the user may be required to take adequate measures.

Taiwan Class A warning statement

警告使用者：
這是甲類的資訊產品，在
居住的環境中使用時，可
能會造成射頻干擾，在這
種情況下，使用者會被要
求採取某些適當的對策。

Japanese Voluntary Control Council for Interference (VCCI) statement

この装置は、情報処理装置等電波障害自主規制協議会（VCCI）の基準に
基づくクラスA情報技術装置です。この装置を家庭環境で使用すると電波妨害を
引き起こすことがあります。この場合には使用者が適切な対策を講ずるよう要求
されることがあります。

Glossary

This glossary provides definitions for the terminology and abbreviations used in IBM TotalStorage DS4000 publications.

If you do not find the term you are looking for, see the *IBM Glossary of Computing Terms* located at the following Web site:

www.ibm.com/ibm/terminology

This glossary also includes terms and definitions from:

- *Information Technology Vocabulary* by Subcommittee 1, Joint Technical Committee 1, of the International Organization for Standardization and the International Electrotechnical Commission (ISO/IEC JTC1/SC1). Definitions are identified by the symbol (I) after the definition; definitions taken from draft international standards, committee drafts, and working papers by ISO/IEC JTC1/SC1 are identified by the symbol (T) after the definition, indicating that final agreement has not yet been reached among the participating National Bodies of SC1.
- *IBM Glossary of Computing Terms*. New York: McGraw-Hill, 1994.

The following cross-reference conventions are used in this glossary:

See Refers you to (a) a term that is the expanded form of an abbreviation or acronym, or (b) a synonym or more preferred term.

See also

Refers you to a related term.

Abstract Windowing Toolkit (AWT). A Java graphical user interface (GUI).

accelerated graphics port (AGP). A bus specification that gives low-cost 3D graphics cards faster access to main memory on personal computers than the usual peripheral component interconnect (PCI) bus. AGP reduces the overall cost of creating high-end graphics subsystems by using existing system memory.

access volume. A special logical drive that allows the host-agent to communicate with the controllers in the storage subsystem.

adapter. A printed circuit assembly that transmits user data input/output (I/O) between the internal bus of the

host system and the external fibre-channel (FC) link and vice versa. Also called an I/O adapter, host adapter, or FC adapter.

advanced technology (AT[®]) bus architecture. A bus standard for IBM compatibles. It extends the XT™ bus architecture to 16 bits and also allows for bus mastering, although only the first 16 MB of main memory are available for direct access.

agent. A server program that receives virtual connections from the network manager (the client program) in a Simple Network Management Protocol-Transmission Control Protocol/Internet Protocol (SNMP-TCP/IP) network-managing environment.

AGP. See *accelerated graphics port*.

AL_PA. See *arbitrated loop physical address*.

arbitrated loop. One of three existing fibre-channel topologies, in which 2 - 126 ports are interconnected serially in a single loop circuit. Access to the Fibre Channel-Arbitrated Loop (FC-AL) is controlled by an arbitration scheme. The FC-AL topology supports all classes of service and guarantees in-order delivery of FC frames when the originator and responder are on the same FC-AL. The default topology for the disk array is arbitrated loop. An arbitrated loop is sometimes referred to as a Stealth Mode.

arbitrated loop physical address (AL_PA). An 8-bit value that is used to uniquely identify an individual port within a loop. A loop can have one or more AL_PAs.

array. A collection of fibre-channel or SATA hard drives that are logically grouped together. All the drives in the array are assigned the same RAID level. An array is sometimes referred to as a "RAID set." See also *redundant array of independent disks (RAID)*, *RAID level*.

asynchronous write mode. In remote mirroring, an option that allows the primary controller to return a write I/O request completion to the host server before data has been successfully written by the secondary controller. See also *synchronous write mode*, *remote mirroring*, *Global Copy*, *Global Mirroring*.

AT. See *advanced technology (AT) bus architecture*.

ATA. See *AT-attached*.

AT-attached. Peripheral devices that are compatible with the original IBM AT computer standard in which signals on a 40-pin AT-attached (ATA) ribbon cable followed the timings and constraints of the Industry Standard Architecture (ISA) system bus on the IBM PC AT computer. Equivalent to integrated drive electronics (IDE).

auto-volume transfer/auto-disk transfer (AVT/ADT).

A function that provides automatic failover in case of controller failure on a storage subsystem.

AVT/ADT. See *auto-volume transfer/auto-disk transfer*.

AWT. See *Abstract Windowing Toolkit*.

basic input/output system (BIOS). The personal computer code that controls basic hardware operations, such as interactions with diskette drives, hard disk drives, and the keyboard.

BIOS. See *basic input/output system*.

BOOTP. See *bootstrap protocol*.

bootstrap protocol (BOOTP). In Transmission Control Protocol/Internet Protocol (TCP/IP) networking, an alternative protocol by which a diskless machine can obtain its Internet Protocol (IP) address and such configuration information as IP addresses of various servers from a BOOTP server.

bridge. A storage area network (SAN) device that provides physical and transport conversion, such as fibre channel to small computer system interface (SCSI) bridge.

bridge group. A bridge and the collection of devices connected to it.

broadcast. The simultaneous transmission of data to more than one destination.

cathode ray tube (CRT). A display device in which controlled electron beams are used to display alphanumeric or graphical data on an electroluminescent screen.

client. A computer system or process that requests a service of another computer system or process that is typically referred to as a server. Multiple clients can share access to a common server.

command. A statement used to initiate an action or start a service. A command consists of the command name abbreviation, and its parameters and flags if applicable. A command can be issued by typing it on a command line or selecting it from a menu.

community string. The name of a community contained in each Simple Network Management Protocol (SNMP) message.

concurrent download. A method of downloading and installing firmware that does not require the user to stop I/O to the controllers during the process.

CRC. See *cyclic redundancy check*.

CRT. See *cathode ray tube*.

CRU. See *customer replaceable unit*.

customer replaceable unit (CRU). An assembly or part that a customer can replace in its entirety when any of its components fail. Contrast with *field replaceable unit (FRU)*.

cyclic redundancy check (CRC). (1) A redundancy check in which the check key is generated by a cyclic algorithm. (2) An error detection technique performed at both the sending and receiving stations.

dac. See *disk array controller*.

dar. See *disk array router*.

DASD. See *direct access storage device*.

data striping. See *striping*.

default host group. A logical collection of discovered host ports, defined host computers, and defined host groups in the storage-partition topology that fulfill the following requirements:

- Are not involved in specific logical drive-to-LUN mappings
- Share access to logical drives with default logical drive-to-LUN mappings

device type. Identifier used to place devices in the physical map, such as the switch, hub, or storage.

DHCP. See *Dynamic Host Configuration Protocol*.

direct access storage device (DASD). A device in which access time is effectively independent of the location of the data. Information is entered and retrieved without reference to previously accessed data. (For example, a disk drive is a DASD, in contrast with a tape drive, which stores data as a linear sequence.) DASDs include both fixed and removable storage devices.

direct memory access (DMA). The transfer of data between memory and an input/output (I/O) device without processor intervention.

disk array controller (dac). A disk array controller device that represents the two controllers of an array. See also *disk array router*.

disk array router (dar). A disk array router that represents an entire array, including current and deferred paths to all logical unit numbers (LUNs) (hdisks on AIX). See also *disk array controller*.

DMA. See *direct memory access*.

domain. The most significant byte in the node port (N_port) identifier for the fibre-channel (FC) device. It is not used in the fibre channel-small computer system interface (FC-SCSI) hardware path ID. It is required to be the same for all SCSI targets logically connected to an FC adapter.

DRAM. See *dynamic random access memory*.

Dynamic Host Configuration Protocol (DHCP). A protocol defined by the Internet Engineering Task Force that is used for dynamically assigning Internet Protocol (IP) addresses to computers in a network.

dynamic random access memory (DRAM). A storage in which the cells require repetitive application of control signals to retain stored data.

ECC. See *error correction coding*.

EEPROM. See *electrically erasable programmable read-only memory*.

EISA. See *Extended Industry Standard Architecture*.

electrically erasable programmable read-only memory (EEPROM). A type of memory chip which can retain its contents without consistent electrical power. Unlike the PROM which can be programmed only once, the EEPROM can be erased electrically. Because it can only be reprogrammed a limited number of times before it wears out, it is appropriate for storing small amounts of data that are changed infrequently.

electrostatic discharge (ESD). The flow of current that results when objects that have a static charge come into close enough proximity to discharge.

environmental service module (ESM) canister. A component in a storage expansion enclosure that monitors the environmental condition of the components in that enclosure. Not all storage subsystems have ESM canisters.

E_port. See *expansion port*.

error correction coding (ECC). A method for encoding data so that transmission errors can be detected and corrected by examining the data on the receiving end. Most ECCs are characterized by the maximum number of errors they can detect and correct.

ESD. See *electrostatic discharge*.

ESM canister. See *environmental service module canister*.

EXP. See *storage expansion enclosure*.

expansion port (E_port). A port that connects the switches for two fabrics.

Extended Industry Standard Architecture (EISA). A bus standard for IBM compatibles that extends the Industry Standard Architecture (ISA) bus architecture to 32 bits and allows more than one central processing unit (CPU) to share the bus. See also *Industry Standard Architecture*.

fabric. A Fibre Channel entity which interconnects and facilitates logins of N_ports attached to it. The fabric is responsible for routing frames between source and destination N_ports using address information in the

frame header. A fabric can be as simple as a point-to-point channel between two N_ports, or as complex as a frame-routing switch that provides multiple and redundant internal pathways within the fabric between F_ports.

fabric port (F_port). In a fabric, an access point for connecting a user's N_port. An F_port facilitates N_port logins to the fabric from nodes connected to the fabric. An F_port is addressable by the N_port connected to it. See also *fabric*.

FAST MSJ. See *FAST Management Suite Java*.

FAST Management Suite Java (FAST MSJ). A diagnostic and configuration utility that can be used on Linux, Microsoft Windows, and Novell NetWare host systems. In Linux, it is also used with the QLRemote agent to define preferred and non-preferred paths for logical drives.

FC. See *fibre channel*.

FC-AL. See *arbitrated loop*.

feature enable identifier. A unique identifier for the storage subsystem, which is used in the process of generating a premium feature key. See also *premium feature key*.

fibre channel (FC). A set of standards for a serial input/output (I/O) bus capable of transferring data between two ports at up to 100 Mbps, with standards proposals to go to higher speeds. FC supports point-to-point, arbitrated loop, and switched topologies.

Fibre Channel-Arbitrated Loop (FC-AL). See *arbitrated loop*.

Fibre Channel Protocol (FCP) for small computer system interface (SCSI). A high-level fibre-channel mapping layer (FC-4) that uses lower-level fibre-channel (FC-PH) services to transmit SCSI commands, data, and status information between a SCSI initiator and a SCSI target across the FC link by using FC frame and sequence formats.

field replaceable unit (FRU). An assembly that is replaced in its entirety when any one of its components fails. In some cases, a field replaceable unit might contain other field replaceable units. Contrast with *customer replaceable unit (CRU)*.

FlashCopy. A premium feature for DS4000 that can make an instantaneous copy of the data in a volume.

F_port. See *fabric port*.

FRU. See *field replaceable unit*.

GBIC. See *gigabit interface converter*

gigabit interface converter (GBIC). A transceiver that performs serial, optical-to-electrical, and

electrical-to-optical signal conversions for high-speed networking. A GBIC can be hot swapped. See also *small form-factor pluggable*.

Global Copy. Refers to a remote logical drive mirror pair that is set up using asynchronous write mode without the write consistency group option. This is also referred to as "Asynchronous Mirroring without Consistency Group." Global Copy does not ensure that write requests to multiple primary logical drives are carried out in the same order on the secondary logical drives as they are on the primary logical drives. If it is critical that writes to the primary logical drives are carried out in the same order in the appropriate secondary logical drives, Global Mirroring should be used instead of Global Copy. See also *asynchronous write mode, Global Mirroring, remote mirroring, Metro Mirroring*.

Global Mirroring. Refers to a remote logical drive mirror pair that is set up using asynchronous write mode with the write consistency group option. This is also referred to as "Asynchronous Mirroring with Consistency Group." Global Mirroring ensures that write requests to multiple primary logical drives are carried out in the same order on the secondary logical drives as they are on the primary logical drives, preventing data on the secondary logical drives from becoming inconsistent with the data on the primary logical drives. See also *asynchronous write mode, Global Copy, remote mirroring, Metro Mirroring*.

graphical user interface (GUI). A type of computer interface that presents a visual metaphor of a real-world scene, often of a desktop, by combining high-resolution graphics, pointing devices, menu bars and other menus, overlapping windows, icons, and the object-action relationship.

GUI. See *graphical user interface*.

HBA. See *host bus adapter*.

hdisk. An AIX term representing a logical unit number (LUN) on an array.

host. A system that is directly attached to the storage subsystem through a fibre-channel input/output (I/O) path. This system is used to serve data (typically in the form of files) from the storage subsystem. A system can be both a storage management station and a host simultaneously.

host bus adapter (HBA). An interface between the fibre-channel network and a workstation or server.

host computer. See *host*.

host group. An entity in the storage partition topology that defines a logical collection of host computers that require shared access to one or more logical drives.

host port. Ports that physically reside on the host adapters and are automatically discovered by the DS4000 Storage Manager software. To give a host computer access to a partition, its associated host ports must be defined.

hot swap. To replace a hardware component without turning off the system.

hub. In a network, a point at which circuits are either connected or switched. For example, in a star network, the hub is the central node; in a star/ring network, it is the location of wiring concentrators.

IBMSAN driver. The device driver that is used in a Novell NetWare environment to provide multipath input/output (I/O) support to the storage controller.

IC. See *integrated circuit*.

IDE. See *integrated drive electronics*.

in-band. Transmission of management protocol over the fibre-channel transport.

Industry Standard Architecture (ISA). Unofficial name for the bus architecture of the IBM PC/XT™ personal computer. This bus design included expansion slots for plugging in various adapter boards. Early versions had an 8-bit data path, later expanded to 16 bits. The "Extended Industry Standard Architecture" (EISA) further expanded the data path to 32 bits. See also *Extended Industry Standard Architecture*.

initial program load (IPL). The initialization procedure that causes an operating system to commence operation. Also referred to as a system restart, system startup, and boot.

integrated circuit (IC). A microelectronic semiconductor device that consists of many interconnected transistors and other components. ICs are constructed on a small rectangle cut from a silicon crystal or other semiconductor material. The small size of these circuits allows high speed, low power dissipation, and reduced manufacturing cost compared with board-level integration. Also known as a *chip*.

integrated drive electronics (IDE). A disk drive interface based on the 16-bit IBM personal computer Industry Standard Architecture (ISA) in which the controller electronics reside on the drive itself, eliminating the need for a separate adapter card. Also known as an Advanced Technology Attachment Interface (ATA).

Internet Protocol (IP). A protocol that routes data through a network or interconnected networks. IP acts as an intermediary between the higher protocol layers and the physical network.

Internet Protocol (IP) address. The unique 32-bit address that specifies the location of each device or workstation on the Internet. For example, 9.67.97.103 is an IP address.

interrupt request (IRQ). A type of input found on many processors that causes the processor to suspend normal processing temporarily and start running an interrupt handler routine. Some processors have several interrupt request inputs that allow different priority interrupts.

IP. See *Internet Protocol*.

IPL. See *initial program load*.

IRQ. See *interrupt request*.

ISA. See *Industry Standard Architecture*.

Java Runtime Environment (JRE). A subset of the Java Development Kit (JDK) for end users and developers who want to redistribute the Java Runtime Environment (JRE). The JRE consists of the Java virtual machine, the Java Core Classes, and supporting files.

JRE. See *Java Runtime Environment*.

label. A discovered or user entered property value that is displayed underneath each device in the Physical and Data Path maps.

LAN. See *local area network*.

LBA. See *logical block address*.

local area network (LAN). A computer network located on a user's premises within a limited geographic area.

logical block address (LBA). The address of a logical block. Logical block addresses are typically used in hosts' I/O commands. The SCSI disk command protocol, for example, uses logical block addresses.

logical partition (LPAR). (1) A subset of a single system that contains resources (processors, memory, and input/output devices). A logical partition operates as an independent system. If hardware requirements are met, multiple logical partitions can exist within a system. (2) A fixed-size portion of a logical volume. A logical partition is the same size as the physical partitions in its volume group. Unless the logical volume of which it is a part is mirrored, each logical partition corresponds to, and its contents are stored on, a single physical partition. (3) One to three physical partitions (copies). The number of logical partitions within a logical volume is variable.

logical unit number (LUN). An identifier used on a small computer system interface (SCSI) bus to distinguish among up to eight devices (logical units) with the same SCSI ID.

loop address. The unique ID of a node in fibre-channel loop topology sometimes referred to as a loop ID.

loop group. A collection of storage area network (SAN) devices that are interconnected serially in a single loop circuit.

loop port. A node port (N_port) or fabric port (F_port) that supports arbitrated loop functions associated with an arbitrated loop topology.

LPAR. See *logical partition*.

LUN. See *logical unit number*.

MAC. See *medium access control*.

management information base (MIB). The information that is on an agent. It is an abstraction of configuration and status information.

man pages. In UNIX-based operating systems, online documentation for operating system commands, subroutines, system calls, file formats, special files, stand-alone utilities, and miscellaneous facilities. Invoked by the **man** command.

MCA. See *micro channel architecture*.

media scan. A media scan is a background process that runs on all logical drives in the storage subsystem for which it has been enabled, providing error detection on the drive media. The media scan process scans all logical drive data to verify that it can be accessed, and optionally scans the logical drive redundancy information.

medium access control (MAC). In local area networks (LANs), the sublayer of the data link control layer that supports medium-dependent functions and uses the services of the physical layer to provide services to the logical link control sublayer. The MAC sublayer includes the method of determining when a device has access to the transmission medium.

Metro Mirroring. This term is used to refer to a remote logical drive mirror pair which is set up with synchronous write mode. See also *remote mirroring*, *Global Mirroring*.

MIB. See *management information base*.

micro channel architecture (MCA). Hardware that is used for PS/2 Model 50 computers and above to provide better growth potential and performance characteristics when compared with the original personal computer design.

Microsoft Cluster Server (MSCS). MSCS, a feature of Windows NT[®] Server (Enterprise Edition), supports the connection of two servers into a cluster for higher availability and easier manageability. MSCS can automatically detect and recover from server or

application failures. It can also be used to balance server workload and provide for planned maintenance.

mini hub. An interface card or port device that receives short-wave fiber channel GBICs or SFPs. These devices enable redundant fibre channel connections from the host computers, either directly or through a fibre channel switch or managed hub, over optical fiber cables to the DS4000 Storage Server controllers. Each DS4000 controller is responsible for two mini hubs. Each mini hub has two ports. Four host ports (two on each controller) provide a cluster solution without use of a switch. Two host-side mini hubs are shipped as standard. See also *host port*, *gigabit interface converter (GBIC)*, *small form-factor pluggable (SFP)*.

mirroring. A fault-tolerance technique in which information on a hard disk is duplicated on additional hard disks. See also *remote mirroring*.

model. The model identification that is assigned to a device by its manufacturer.

MSCS. See *Microsoft Cluster Server*.

network management station (NMS). In the Simple Network Management Protocol (SNMP), a station that runs management application programs that monitor and control network elements.

NMI. See *non-maskable interrupt*.

NMS. See *network management station*.

non-maskable interrupt (NMI). A hardware interrupt that another service request cannot overrule (mask). An NMI bypasses and takes priority over interrupt requests generated by software, the keyboard, and other such devices and is issued to the microprocessor only in disastrous circumstances, such as severe memory errors or impending power failures.

node. A physical device that allows for the transmission of data within a network.

node port (N_port). A fibre-channel defined hardware entity that performs data communications over the fibre-channel link. It is identifiable by a unique worldwide name. It can act as an originator or a responder.

nonvolatile storage (NVS). A storage device whose contents are not lost when power is cut off.

N_port. See *node port*.

NVS. See *nonvolatile storage*.

NVSRAM. Nonvolatile storage random access memory. See *nonvolatile storage*.

Object Data Manager (ODM). An AIX proprietary storage mechanism for ASCII stanza files that are edited as part of configuring a drive into the kernel.

ODM. See *Object Data Manager*.

out-of-band. Transmission of management protocols outside of the fibre-channel network, typically over Ethernet.

partitioning. See *storage partition*.

parity check. (1) A test to determine whether the number of ones (or zeros) in an array of binary digits is odd or even. (2) A mathematical operation on the numerical representation of the information communicated between two pieces. For example, if parity is odd, any character represented by an even number has a bit added to it, making it odd, and an information receiver checks that each unit of information has an odd value.

PCI local bus. See *peripheral component interconnect local bus*.

PDF. See *portable document format*.

performance events. Events related to thresholds set on storage area network (SAN) performance.

peripheral component interconnect local bus (PCI local bus). A local bus for PCs, from Intel, that provides a high-speed data path between the CPU and up to 10 peripherals (video, disk, network, and so on). The PCI bus coexists in the PC with the Industry Standard Architecture (ISA) or Extended Industry Standard Architecture (EISA) bus. ISA and EISA boards plug into an IA or EISA slot, while high-speed PCI controllers plug into a PCI slot. See also *Industry Standard Architecture*, *Extended Industry Standard Architecture*.

polling delay. The time in seconds between successive discovery processes during which discovery is inactive.

port. A part of the system unit or remote controller to which cables for external devices (such as display stations, terminals, printers, switches, or external storage units) are attached. The port is an access point for data entry or exit. A device can contain one or more ports.

portable document format (PDF). A standard specified by Adobe Systems, Incorporated, for the electronic distribution of documents. PDF files are compact; can be distributed globally by e-mail, the Web, intranets, or CD-ROM; and can be viewed with the Acrobat Reader, which is software from Adobe Systems that can be downloaded at no cost from the Adobe Systems home page.

premium feature key. A file that the storage subsystem controller uses to enable an authorized premium feature. The file contains the feature enable identifier of the storage subsystem for which the

premium feature is authorized, and data about the premium feature. See also *feature enable identifier*.

private loop. A freestanding arbitrated loop with no fabric attachment. See also *arbitrated loop*.

program temporary fix (PTF). A temporary solution or bypass of a problem diagnosed by IBM in a current unaltered release of the program.

PTF. See *program temporary fix*.

RAID. See *redundant array of independent disks (RAID)*.

RAID level. An array's RAID level is a number that refers to the method used to achieve redundancy and fault tolerance in the array. See also *array, redundant array of independent disks (RAID)*.

RAID set. See *array*.

RAM. See *random-access memory*.

random-access memory (RAM). A temporary storage location in which the central processing unit (CPU) stores and executes its processes. Contrast with *DASD*.

RDAC. See *redundant disk array controller*.

read-only memory (ROM). Memory in which stored data cannot be changed by the user except under special conditions.

recoverable virtual shared disk (RVSD). A virtual shared disk on a server node configured to provide continuous access to data and file systems in a cluster.

redundant array of independent disks (RAID). A collection of disk drives (*array*) that appears as a single volume to the server, which is fault tolerant through an assigned method of data striping, mirroring, or parity checking. Each array is assigned a RAID level, which is a specific number that refers to the method used to achieve redundancy and fault tolerance. See also *array, parity check, mirroring, RAID level, striping*.

redundant disk array controller (RDAC). (1) In hardware, a redundant set of controllers (either active/passive or active/active). (2) In software, a layer that manages the input/output (I/O) through the active controller during normal operation and transparently reroutes I/Os to the other controller in the redundant set if a controller or I/O path fails.

remote mirroring. Online, real-time replication of data between storage subsystems that are maintained on separate media. The Enhanced Remote Mirror Option is a DS4000 premium feature that provides support for remote mirroring. See also *Global Mirroring, Metro Mirroring*.

ROM. See *read-only memory*.

router. A computer that determines the path of network traffic flow. The path selection is made from several paths based on information obtained from specific protocols, algorithms that attempt to identify the shortest or best path, and other criteria such as metrics or protocol-specific destination addresses.

RVSD. See *recoverable virtual shared disk*.

SAI. See *Storage Array Identifier*.

SA Identifier. See *Storage Array Identifier*.

SAN. See *storage area network*.

SATA. See *serial ATA*.

scope. Defines a group of controllers by their Internet Protocol (IP) addresses. A scope must be created and defined so that dynamic IP addresses can be assigned to controllers on the network.

SCSI. See *small computer system interface*.

segmented loop port (SL_port). A port that allows division of a fibre-channel private loop into multiple segments. Each segment can pass frames around as an independent loop and can connect through the fabric to other segments of the same loop.

sense data. (1) Data sent with a negative response, indicating the reason for the response. (2) Data describing an I/O error. Sense data is presented to a host system in response to a sense request command.

serial ATA. The standard for a high-speed alternative to small computer system interface (SCSI) hard drives. The SATA-1 standard is equivalent in performance to a 10 000 RPM SCSI drive.

serial storage architecture (SSA). An interface specification from IBM in which devices are arranged in a ring topology. SSA, which is compatible with small computer system interface (SCSI) devices, allows full-duplex packet multiplexed serial data transfers at rates of 20 Mbps in each direction.

server. A functional hardware and software unit that delivers shared resources to workstation client units on a computer network.

server/device events. Events that occur on the server or a designated device that meet criteria that the user sets.

SFP. See *small form-factor pluggable*.

Simple Network Management Protocol (SNMP). In the Internet suite of protocols, a network management protocol that is used to monitor routers and attached networks. SNMP is an application layer protocol. Information on devices managed is defined and stored in the application's Management Information Base (MIB).

SL_port. See *segmented loop port*.

SMagent. The DS4000 Storage Manager optional Java-based host-agent software, which can be used on Microsoft Windows, Novell NetWare, HP-UX, and Solaris host systems to manage storage subsystems through the host fibre-channel connection.

SMclient. The DS4000 Storage Manager client software, which is a Java-based graphical user interface (GUI) that is used to configure, manage, and troubleshoot storage servers and storage expansion enclosures in a DS4000 storage subsystem. SMclient can be used on a host system or on a storage management station.

SMruntime. A Java compiler for the SMclient.

SMutil. The DS4000 Storage Manager utility software that is used on Microsoft Windows, HP-UX, and Solaris host systems to register and map new logical drives to the operating system. In Microsoft Windows, it also contains a utility to flush the cached data of the operating system for a particular drive before creating a FlashCopy.

small computer system interface (SCSI). A standard hardware interface that enables a variety of peripheral devices to communicate with one another.

small form-factor pluggable (SFP). An optical transceiver that is used to convert signals between optical fiber cables and switches. An SFP is smaller than a gigabit interface converter (GBIC). See also *gigabit interface converter*.

SNMP. See *Simple Network Management Protocol* and *SNMPv1*.

SNMP trap event. (1) (2) An event notification sent by the SNMP agent that identifies conditions, such as thresholds, that exceed a predetermined value. See also *Simple Network Management Protocol*.

SNMPv1. The original standard for SNMP is now referred to as SNMPv1, as opposed to SNMPv2, a revision of SNMP. See also *Simple Network Management Protocol*.

SRAM. See *static random access memory*.

SSA. See *serial storage architecture*.

static random access memory (SRAM). Random access memory based on the logic circuit known as flip-flop. It is called static because it retains a value as long as power is supplied, unlike dynamic random access memory (DRAM), which must be regularly refreshed. It is however, still volatile, meaning that it can lose its contents when the power is turned off.

storage area network (SAN). A dedicated storage network tailored to a specific environment, combining

servers, storage products, networking products, software, and services. See also *fabric*.

Storage Array Identifier (SAI or SA Identifier). The Storage Array Identifier is the identification value used by the DS4000 Storage Manager host software (SMClient) to uniquely identify each managed storage server. The DS4000 Storage Manager SMClient program maintains Storage Array Identifier records of previously-discovered storage servers in the host resident file, which allows it to retain discovery information in a persistent fashion.

storage expansion enclosure (EXP). A feature that can be connected to a system unit to provide additional storage and processing capacity.

storage management station. A system that is used to manage the storage subsystem. A storage management station does not need to be attached to the storage subsystem through the fibre-channel input/output (I/O) path.

storage partition. Storage subsystem logical drives that are visible to a host computer or are shared among host computers that are part of a host group.

storage partition topology. In the DS4000 Storage Manager client, the Topology view of the Mappings window displays the default host group, the defined host group, the host computer, and host-port nodes. The host port, host computer, and host group topological elements must be defined to grant access to host computers and host groups using logical drive-to-LUN mappings.

striping. Splitting data to be written into equal blocks and writing blocks simultaneously to separate disk drives. Striping maximizes performance to the disks. Reading the data back is also scheduled in parallel, with a block being read concurrently from each disk then reassembled at the host.

subnet. An interconnected but independent segment of a network that is identified by its Internet Protocol (IP) address.

sweep method. A method of sending Simple Network Management Protocol (SNMP) requests for information to all the devices on a subnet by sending the request to every device in the network.

switch. A fibre-channel device that provides full bandwidth per port and high-speed routing of data by using link-level addressing.

switch group. A switch and the collection of devices connected to it that are not in other groups.

switch zoning. See *zoning*.

synchronous write mode. In remote mirroring, an option that requires the primary controller to wait for the

acknowledgment of a write operation from the secondary controller before returning a write I/O request completion to the host. See also *asynchronous write mode*, *remote mirroring*, *Metro Mirroring*.

system name. Device name assigned by the vendor's third-party software.

TCP. See *Transmission Control Protocol*.

TCP/IP. See *Transmission Control Protocol/Internet Protocol*.

terminate and stay resident program (TSR program). A program that installs part of itself as an extension of DOS when it is executed.

topology. The physical or logical arrangement of devices on a network. The three fibre-channel topologies are fabric, arbitrated loop, and point-to-point. The default topology for the disk array is arbitrated loop.

TL_port. See *translated loop port*.

transceiver. A device that is used to transmit and receive data. Transceiver is an abbreviation of transmitter-receiver.

translated loop port (TL_port). A port that connects to a private loop and allows connectivity between the private loop devices and off loop devices (devices not connected to that particular TL_port).

Transmission Control Protocol (TCP). A communication protocol used in the Internet and in any network that follows the Internet Engineering Task Force (IETF) standards for internetwork protocol. TCP provides a reliable host-to-host protocol between hosts in packet-switched communication networks and in interconnected systems of such networks. It uses the Internet Protocol (IP) as the underlying protocol.

Transmission Control Protocol/Internet Protocol (TCP/IP). A set of communication protocols that provide peer-to-peer connectivity functions for both local and wide-area networks.

trap. In the Simple Network Management Protocol (SNMP), a message sent by a managed node (agent function) to a management station to report an exception condition.

trap recipient. Receiver of a forwarded Simple Network Management Protocol (SNMP) trap. Specifically, a trap receiver is defined by an Internet Protocol (IP) address and port to which traps are sent. Presumably, the actual recipient is a software application running at the IP address and listening to the port.

TSR program. See *terminate and stay resident program*.

uninterruptible power supply. A source of power from a battery that is installed between a computer system and its power source. The uninterruptible power supply keeps the system running if a commercial power failure occurs, until an orderly shutdown of the system can be performed.

user action events. Actions that the user takes, such as changes in the storage area network (SAN), changed settings, and so on.

worldwide port name (WWPN). A unique identifier for a switch on local and global networks.

worldwide name (WWN). A globally unique 64-bit identifier assigned to each Fibre Channel port.

WORM. See *write-once read-many*.

write-once read many (WORM). Any type of storage medium to which data can be written only a single time, but can be read from any number of times. After the data is recorded, it cannot be altered.

WWN. See *worldwide name*.

zoning. (1) In Fibre Channel environments, the grouping of multiple ports to form a virtual, private, storage network. Ports that are members of a zone can communicate with each other, but are isolated from ports in other zones. (2) A function that allows segmentation of nodes by address, name, or physical port and is provided by fabric switches or hubs.

Index

A

access controller shell 121
add
 new hard drives 53
 single drive enclosure
 final connection 76, 82, 86, 87, 102, 107
 first connection 74, 80, 100, 105
 second connection 75, 81, 101, 106
 storage expansion enclosures 69
 license requirement 1
 used hard drives 54
AppWare 43
array
 cannot bring online 64
 configuration data for drives incomplete 64
 RAID-level modification 49
 redundancy checking 49
 return online 121
arrays, migrating 64
attention 54, 55, 64, 70, 90, 93, 96, 109
automatically reset controllers 54, 55, 85, 91

B

backup
 logical drives 60, 95
 storage subsystem data 41, 118
bag or container, ESD 111
beginning of drive loop, connect storage expansion enclosures 79, 103
BootWare 43
bottom of drive loop, connect storage expansion enclosures 73, 99

C

cable
 connections 75, 76, 81, 82, 86, 87, 101, 102, 106, 107
 EXP500 to EXP700 9
 EXP700 to EXP500 9
 EXP710 to EXP810 17
 new storage expansion enclosures 72
 trace connections 96, 118
cabling, incorrect 27
cannot bring array online 64
catastrophic failure 50
change fibre channel speed settings 9
change storage server IP address 120
check drive firmware level 48
check for configuration data 55
 on newly discovered drives 91
Class A electronic emission notice 124
clear configuration data 86
compliant state 116
Concepts Guide xxv
concurrent firmware download 46

configuration
 behavior after replacement 115
 data, clear 86
configuration data 59
configure drives 55
container or bag, ESD 111
controller
 blade, embedded unique identifier 116
 drive loop LED 96, 118
 firmware download during I/O 46
 firmware version 41
 by machine type 43
 by model number 43
 by NVSRAM version 43
 current 44
 firmware, verify level 41, 44, 61, 94, 117
 reset automatically 54, 55, 85, 91
 shell, accessing 121
controller firmware 42
controller IP addresses 117
Copy Services Guide xxv
copyback, logical drive 49
customize storage partitioning information 61, 95

D

DACstore 115, 117
DCE 49
delete
 FlashCopy 95
 remote mirror relationships 95
 storage partition mappings 95
disable drive migration settings 54, 85
 become effective 55
DisableDriveMigration.scr script 56
documentation
 DS4000 Storage Manager xxv
 DS4000-related documents xxvi
 DS4100 Storage Server xxiii
 DS4300 Fibre Channel Storage Server xxii
 DS4400 Fibre Channel Storage Server xxi
 DS4500 Fibre Channel Storage Server xx
 DS4800 Storage Subsystem xxiv
download firmware with I/O 46
downloading drive firmware 46
drive displays as unconfigured 90
drive expansion enclosure weight 96
drive firmware
 downloading 46
drive firmware download 46
drive firmware levels, determining 37
drive firmware, level 48
drive ID and model, determining 38
drive loop
 optimal state 49
 pairs, maximum allowable 1
 speed change procedure 9
drive loop pairs, maximum 11

- drive loop schemes 27
 - drive loop state, determine 41
 - drive loops A and B 73, 74, 79, 80, 99, 100, 104, 105
 - drive migration
 - prerequisites 41
 - settings
 - disable 54, 85
 - enable 90
 - re-enable 54, 86
 - drives
 - CRU assembly 62
 - do not appear marked as Failed 64
 - do not display 64
 - maximum allowable 1
 - remove
 - configuration data 54
 - will not spin up 53, 59, 69
 - DS4000 Hardware Maintenance Manual xxvi
 - DS4000 Problem Determination Guide xxvi, 117
 - DS4000 Quick Start Guide xxvi
 - DS4000 Storage Manager
 - documents xxv
 - related documents xxvi
 - DS4000 Storage Manager publications 39
 - DS4000 Storage Subsystem
 - firmware 42
 - NVSRAM 42
 - profile 42
 - DS4000 support
 - Web site 44
 - DS4000/FAST product renaming xvii
 - DS4100 dual controller replacement with single controller 114
 - DS4100 single controller replacement with dual controller 114
 - DS4100 Storage Server library xxiii
 - DS4300
 - 1 Gbps fibre channel drives 69
 - enclosure IDs 71
 - Storage Subsystem firmware and NVSRAM 43
 - Turbo Storage Subsystem firmware and NVSRAM 43
 - DS4300 Fibre Channel Storage Server library xxii
 - DS4300 Storage Subsystem migration 114
 - DS4400 Storage Server library xxi
 - DS4400 Storage Subsystem firmware and NVSRAM 43
 - DS4500 Fibre Channel Storage Server library xx
 - DS4500 Storage Subsystem firmware and NVSRAM 43
 - DS4800 Storage Subsystem library xxiv
 - dual controller replacement with single controller 114
 - dual drive loop 1
 - DVE 49
 - dynamic
 - capacity expansion, DCE 49
 - volume expansion, DVE 49
- E**
- electronic emission Class A notice 124
 - Electronic emission notices
 - Australia and New Zealand Class A statement 125
 - European Union EMC Directive conformance statement 125
 - Federal Communications Commission (FCC) statement 124
 - Industry Canada Class A emission compliance statement 125
 - Japanese Voluntary Control Council for Interference (VCCI) statement 126
 - Taiwanese Class A warning statement 126
 - United Kingdom telecommunications safety requirement 125
 - electrostatic discharge (ESD) bags 63
 - electrostatic discharge (ESD) procedure 53
 - electrostatic discharge procedure 51
 - empty drive icon 64
 - emulation program, sample 121
 - EnableDriveMigration.scr script 55, 91
 - enclosure ID 32
 - end of drive loop, connect storage expansion enclosures 73, 99
 - environmental service module (ESM) firmware 9
 - errors
 - drive enclosure lost redundancy path 73, 74, 79, 80, 99, 100, 104, 105
 - loss of ESM path redundancy 96, 118
 - management event log (MEL) 41
 - out-of-compliance 121
 - ESD bag or container 97, 111
 - ESD procedures 51
 - ESM Fault LED 96, 118
 - ESM firmware
 - EXP500 44
 - EXP700 44
 - upgrade during I/O 42
 - version, current 44
 - version, upgrade 45
 - version, upgrade during I/O 46
 - ESM firmware levels, determining 37
 - event logs, interpreting 49
 - execute script 54, 55, 85, 91
 - EXP100
 - ID settings 33
 - EXP500
 - and EXP700 in a redundant drive loop pair 8
 - cabling 9
 - drive loop pair maximum 11
 - ESM firmware 44
 - ID settings 33
 - ID switch location 71, 97
 - maximum per drive loop pairs 11
 - EXP500 and EXP700 enclosure ID settings 35
 - EXP500 drive expansion enclosure accommodation 114
 - EXP700
 - 1 Gbps fibre channel drives 69
 - and EXP500 in a redundant drive loop pair 8
 - cabling 9
 - drive loop pair maximum 11
 - ESM firmware 44

- EXP700 (continued)
 - ID settings 34
 - ID switch location 71, 97
 - maximum per drive loop pairs 11
- EXP700 and EXP710 enclosure ID settings 35
- EXP700 migration to DS4300 114
- EXP710
 - cabling 17
- EXP810
 - cabling 17
- EXP810 and EXP710 enclosure ID settings 36
- expansion enclosure
 - ID setting 32
- expansion enclosure and storage server
 - compatibility 5
- expansion enclosure compatibility, mixed 4
- expansion enclosure speed setting 115, 119
- expansion enclosures
 - cabling mixed 9, 17
 - ESM firmware version 44
 - ID setting 71, 97, 119
 - LED state 119
 - migrate 93
 - speeds restriction 8
- expansion unit enclosure speed setting 98
- expansion unit firmware levels, determining 37
- external drive enclosure, benefits 3

F

- Failed icons 64
- false storage subsystem identification, example 120
- FAST/DS4000 product renaming xvii
- FAST200
 - enclosure IDs 71
 - HA Storage Server firmware and NVSRAM 43
 - Storage Subsystem firmware and NVSRAM 43
- FAST500 RAID Controller Enclosure firmware and NVSRAM 43
- FC Worldwide Name (WWN) 112
- FCC Class A notice 124
- fibre channel
 - connections cabling 75, 76, 81, 82, 86, 87, 101, 102, 106, 107
 - drive firmware 46
 - insert drives 53, 54, 59, 64, 69, 70, 85, 108
 - remove connection 73, 79, 99, 104
 - trace cable connections 96, 118
 - Worldwide Name (WWN) storage 112, 115, 116
- fibre channel controller replacement with SATA 114
- firmware
 - compatibility 42
 - controller 42
 - controller and NVSRAM levels 61, 94
 - controller, NVSRAM, and ESM levels 41
 - current 43
 - download 121
 - ESM, version by expansion enclosure 44
 - updates 44
 - verify controller and NVSRAM levels 117

- firmware and NVSRAM
 - DS4300
 - Storage Subsystem 43
 - Turbo Storage Subsystem 43
 - DS4400 Storage Subsystem 43
 - DS4500 Storage Subsystem 43
 - FAST200
 - HA Storage Subsystem 43
 - Storage Subsystem 43
 - FAST500 RAID Controller Enclosure 43
- firmware download with I/O 46
- firmware levels, determining 37
- FlashCopy
 - delete 61, 95, 117
 - recreate 64, 109, 121
- flush I/O 42, 118
- flush server-cached I/O 42
- force generation SA Identifier 121

G

- GBIC 72, 96, 118, 119
- generate
 - new premium feature SAFE keys 111, 121
 - SA Identifier 121
- gigabit interface converter 72, 96, 118, 119
- glossary 127
- grouping expansion enclosures 8

H

- handling static-sensitive devices 51
- hard drives
 - add new 53, 54
 - add storage expansion enclosures containing 69
 - add used 54
 - ID/Model Number 53, 59, 69
 - migrate 59
 - newly discovered 85
 - prerequisites 41
 - removal 62
 - will not spin up 53, 59, 69
- hardware installation process xix
- help
 - center 49
 - online 50
 - prevent data loss 50
- host group names, unique 61, 95
- host kits, purchase 115
- host names, unique 61, 95
- host ports, unique 61, 95
- HyperTerminal, Private Edition 121

I

- I/O, flush 42, 118
- IBM
 - Help Center, contact 49
 - IBM Safety Information xxvi
 - IBMSAN.CDM multi-path software 45

- icon
 - empty drive 64
 - Failed 64, 109, 121
 - Subsystem Management window 64, 109, 121
- ID
 - conflict LED 96, 118
 - switch location 71
- ID settings 33
- ID/model number, hard drive 53, 59, 69
- identify
 - 1 Gbps FC drives 53, 59, 69
 - firmware updates 44
- ignore
 - configuration data setting 54
 - configuration information 85
- impact of new storage subsystem
 - on identification 115
 - on premium features 115
- IN port 73, 74, 79, 80, 99, 100, 104, 105
- incorrect cabling schemes 27
- initialize a drive 109
- insert drives 85, 108
- insert fibre channel drives 64
- insert SATA drives 64
- installation planning xix
- installation process xix
- intermix expansion enclosures 8
- intermixed enclosure ID settings 35, 36
- intermixing EXP500s and EXP700s 9
- intermixing EXP700s and EXP710s 11
- intermixing storage expansion enclosures 3
- IP address, change 120
- IP addresses 117

L

- LED
 - controller drive loop 96, 118
 - expansion enclosure states 119
 - ID conflict 96, 118
 - port bypass 96, 118
- license requirements 1
- Linux failover adapter driver
 - multi-path software 45
- listing
 - DisableDriveMigration.scr script file 56
 - EnableDriveMigration.scr script file 55
- load script 54, 55, 91
- logical drive
 - backup 60, 95
 - copyback 49
 - creation, FlashCopy 49
 - creation, VolumeCopy 49
 - dynamic capacity expansion 49
 - flashcopies, delete 61
 - reconstruction 49
 - segment size modification 49
 - sparing 49
 - synchronization, remote mirror 49
 - verify name 61
- Loop Initialization Primitive (LIP) 96

- loss of ESM path redundancy error 96, 118

M

- machine type 1722
 - Model 60U 1, 43
 - Model 60X 1, 43
 - Model 6LU 1, 43
 - Model 6LX 1, 43
- machine type 1740
 - Model 1RU 45
 - Model 1RX 45
- machine type 1742
 - Model 1RU 1, 43
 - Model 1RX 1, 43
 - Model 90U 1, 43
 - Model 90X 1, 43
- machine type 3542
 - Model 1RU 1, 43
 - Model 1RX 1, 43
 - Model 2RU 1, 43
 - Model 2RX 1, 43
- machine type 3552
 - Model 1RU 1, 43
 - Model 1RX 1, 43
- machine type 3560
 - Model 1RU 45
 - Model 1RX 45
- management event log errors 41
- map drives 55
- maximum
 - allowable drives 1
 - drive expansion enclosures 11
 - drives per redundant drive loop pair 11
 - storage expansion enclosures 11
- MEL errors 41
- menu option
 - Advanced → Reset Controller 54, 55, 91
 - Array → Check Redundancy 49
 - Execute 85, 91
 - Script 55, 91
 - File → Load Script 54, 55, 85, 91
 - Initialize 64
 - Place → Offline 61, 96, 118
 - Place → Online 64, 109
 - Tools → Verify and Execute 54, 55, 85, 91
- migrate drives 46
- migrate hard drives 59
- migrate storage expansion enclosures with drives 93
- migrating arrays 64
- migrating from 2 Gbps to 1 Gbps configuration 114
- migration to DS4300 Storage Subsystem 114
- minihub speed, set 119
- mix expansion enclosures 8
- mixed configuration
 - EXP500 to EXP700 cabling 9
 - EXP700 to EXP500 cabling 9
 - EXP710 to EXP810 cabling 17
- model and product ID, determining 38

- model number
 - DS4000 EXP500
 - 1RU 45
 - 1RX 45
 - DS4000 EXP700
 - 1RU 45
 - 1RX 45
 - DS4000 EXP710
 - 710 45
 - DS4100
 - 100 43
 - DS4300
 - 60U 1, 43
 - 60X 1, 43
 - DS4300 Single Controller
 - 6LU 1, 43
 - 6LX 1, 43
 - DS4300 Turbo
 - 60U 1, 43
 - 60X 1, 43
 - DS4400
 - 1RU 1, 43
 - 1RX 1, 43
 - DS4500
 - 90U 1, 43
 - 90X 1, 43
 - FAST200
 - 1RU 1, 43
 - 1RX 1, 43
 - 2RU 1, 43
 - 2RX 1, 43
 - FAST500
 - 1RU 1, 43
 - 1RX 1, 43
- move drives 46
- multi-path software
 - IBMSAN.CDM 45
 - Linux failover adapter driver 45
 - RDAC 45

N

- Needs Attention
 - condition 115
 - state 49
- new storage subsystem impact 115
- notes, important 124
- notices
 - electronic emission 124
 - FCC, Class A 124
- null modem serial cable 121
- NVSRAM
 - clear codes 116
 - codes pre-loaded 116
 - DS4000 Storage Subsystem 42
 - stores IP addresses 117
 - verify level 41, 44, 94, 117
 - version, by controller firmware version 43
- NVSRAM and controller firmware
 - DS4300
 - Storage Subsystem 43

- NVSRAM and controller firmware (*continued*)
 - DS4300 (*continued*)
 - Turbo Storage Subsystem 43
 - DS4400 Storage Subsystem 43
 - DS4500 Storage Subsystem 43
 - FAST200
 - HA Storage Subsystem 43
 - Storage Subsystem 43
 - FAST500 RAID Controller Enclosure 43

O

- offline state 64, 96, 108, 118
- online help xix, 50
- online state 64, 109, 121
- optimal state 41, 49, 60, 61, 64, 70, 93, 95, 96, 117, 119
- orientation
 - hard drives 63
- OUT port 73, 74, 79, 80, 99, 100, 104, 105
- out-of-band storage server IP addresses 120
- out-of-compliance state 111, 115

P

- place drive online 108
- port bypass LED 73, 74, 79, 80, 96, 99, 100, 104, 105, 118
- post-replacement configuration behavior 115
- post-upgrade configuration behavior 115
- power on
 - drive expansion enclosure 9
 - storage expansion enclosure 9
 - storage server 9
- premium feature
 - enable status 115, 116
 - generate new SAFE keys 111, 121
 - IBM assigns entitlements 115
 - identifier 115
 - impact of new storage subsystem on 115
 - re-enable 115
- premium features
 - enabled as standard 116
- prerequisites
 - adding capacity 41
 - drive migration 41
- prevent
 - data loss 50, 55, 90
 - shock 32, 63, 96
- procedure
 - access controller shell 121
 - add new hard drives 53
 - add storage expansion enclosures 69
 - disable drive migration settings 54
 - electrostatic discharge (ESD) 53
 - enable drive migration settings 55
 - flush server-cached I/O 42
 - migrate hard drives 59
 - migrate storage expansion enclosures with drives 93
 - redeploy original (replaced) storage server 121

- procedure *(continued)*
 - save a module profile report 50
 - save a storage subsystem profile 50
 - unmount file systems 42
 - upgrade
 - storage subsystem 111, 117
- product ID and model, determining 38
- profile
 - DS4000 Storage Subsystem 50
- proofs of purchase 111, 116, 118
- publications, DS4000 Storage Manager 39
- purchase
 - entitlements 1, 111, 115
 - host kits 111, 115

Q

- Quorum disk 118

R

- RAID-level modification 49
- re-enable
 - drive migration settings 54
 - premium features 111, 115
- Read_Link_Status
 - function 41, 49
- readme file 46, 70, 93, 112
- recommended cabling scheme 27
- reconstruction, logical drive 49
- Recovery Guru 41
- redeploy original (replaced) storage server 121
- redistributing data 64
- redundancy checking 49
- redundant disk array controller [RDAC]
 - multi-path software 45
- redundant drive loop pair 1, 11
- remote mirror
 - logical drive synchronization 50
- relationships
 - delete 95, 117
 - recreate 109, 121
 - remove 61
- remove
 - configuration data 54
 - connection 73, 79, 99, 104
 - drive expansion enclosure 96
 - drives 60, 96
 - hard drives 62
 - out-of-compliance errors 121
 - remote mirror relationships 61, 95
 - storage components 53, 59, 69, 93
 - storage expansion enclosure 96
 - storage subsystem 117, 119
- renaming xvii
- reordering data 64
- replacement subsystems 112
- reset
 - controllers 55, 85, 121
 - automatically 85
 - controllers automatically 91

- reset *(continued)*
 - storage subsystem setting 54, 55
- restore a storage subsystem configuration 50

S

- SA Identifier 115
 - force generation 121
- SAFE
 - ID 115
 - key 118
 - Premium Feature Identifier 115
- safety information iii
- SAI 115
- SATA
 - insert drives 59, 64, 108
 - Worldwide Name (WWN) storage 115, 116
- SATA controller replacement with fibre channel 114
- Saving a module profile report and state capture information to help prevent data loss 50
- schedule upgrades 46, 70, 93, 118
- script
 - DisableDriveMigration.scr 56
 - editor window 55, 85, 91
 - EnableDriveMigration.scr 55
 - execute 54, 55, 85, 91
 - load 54, 55, 85, 91
- set drive expansion enclosure ID 97
- set enclosure ID 32
- set minihub speed 119
- set storage expansion enclosure ID 97
- setting
 - out-of-band storage server IP addresses 120
- settings
 - disable drive migration
 - become effective 55
 - drive migration
 - disable 54, 85
 - enable 90
 - re-enable 54, 86
 - expansion enclosure speed 119
 - fibre channel speed 9
- SFP 72, 96, 118, 119
- shutdown
 - drive expansion enclosure 9
 - storage expansion enclosure 9
 - storage server 9
- single controller replacement with dual controller 114
- small form-factor pluggable 72, 96, 118, 119
- SMclient 115
- software compatibility
 - Web site 45
- software installation process xix
- sparing, logical drive 49
- speed restriction
 - drive expansion enclosure 8
 - storage expansion enclosure 8
- speed settings
 - drive loop 9
 - expansion enclosure 119

- state
 - compliant 116
 - expansion enclosure LED 119
 - Needs Attention 49
 - offline 60, 64, 96, 108, 118
 - online 64, 109, 121
 - optimal 41, 49, 54, 60, 61, 64, 70, 93, 95, 96, 117, 119
 - out-of-compliance 111, 115
- static IP address
 - storage 117
- static-sensitive devices, handling 51
- storage
 - components removal 93
 - DS4000 Storage Subsystem profile 42, 51
 - static IP address 117
 - Worldwide Name (WWN) 115, 116
- Storage Array Identifier 115
- storage expansion enclosure weight 96
- storage expansion enclosures, intermixing 3
- Storage Manager
 - installation and support guide 45, 50, 70, 93, 112, 120
 - installation CD 54, 55, 85, 91
- Storage Manager version 8.x drive firmware,
 - download 48
- Storage Manager version 9.1x drive firmware
 - download 46
- Storage Manager version 9.1x drive firmware,
 - download 46
- storage partition mappings
 - delete 95
- storage partitioning definitions, view 64, 109
- storage pool, unconfigured capacity 109
- storage server
 - configuration migration 50
 - controller firmware behavior after upgrade 115
 - controller firmware version 43
 - physical configuration, alter 53, 59, 69, 93
 - status 49
 - upgrade NVSRAM version 43
- storage server and expansion enclosure
 - compatibility 5
- storage server firmware levels, determining 37
- storage subsystem
 - configuration behavior after
 - redeployment 116
 - upgrade and replacement 115
 - false identification example 120
 - identification 115
 - optimal state 49
 - redeploy 121
 - restore configuration 50
- storage subsystem profile
 - restore 50
 - save 42, 50
 - storage 42, 50
- storage subsystem replacements 112
- striping data 64
- Subsystem Management window icon 64
- subsystem replacements, DS4000 112

- supported replacements, DS4000 112
- suspend I/O from hosts during drive firmware
 - upgrade 46
- switches
 - ID 71
- synchronization
 - remote mirror logical drive 50

T

- technical background on storage server controller
 - firmware behavior 115
- terminal emulation program, sample 121
- top of drive loop, connect storage expansion
 - enclosures 79, 103
- trace cable connections 96, 118

U

- unconfigured capacity storage pool 109
- United States electronic emission Class A notice 124
- United States FCC Class A notice 124
- unmount file systems 42, 61, 95, 118
- upgrade
 - drive firmware 46
 - ESM firmware 45
 - schedule 43, 46, 70, 93, 118
 - storage subsystem 117
 - important considerations 111
 - in functioning configuration 111, 117
- used hard drives 54

W

- Web site 50
 - DS4000 documentation 39
 - DS4000 support 44
 - software compatibility 45
 - support 50
- weight of drive expansion enclosure 96
- window
 - Client Subsystem Management 50, 73, 74, 79, 80, 96, 99, 100, 104, 105, 118
 - Enterprise Management 54, 55, 85, 90
 - Load Script file selection 54, 55, 85, 91
 - Read_Link_Status 49
 - Reset Controller 54, 55, 85, 91
 - script editor 54, 55, 85, 91
 - Storage Subsystem Management 49, 54, 55, 60, 64, 85, 91, 96, 108, 118, 121
- WWN 112, 115, 116

Readers' comments — we would like to hear from you.

IBM TotalStorage DS4000
Hard Drive and Storage Expansion Enclosure Installation and Migration Guide

Publication No. GC26-7704-03

Overall, how satisfied are you with the information in this book?

	Very Satisfied	Satisfied	Neutral	Dissatisfied	Very Dissatisfied
Overall satisfaction	<input type="checkbox"/>	<input type="checkbox"/>	<input type="checkbox"/>	<input type="checkbox"/>	<input type="checkbox"/>

How satisfied are you that the information in this book is:

	Very Satisfied	Satisfied	Neutral	Dissatisfied	Very Dissatisfied
Accurate	<input type="checkbox"/>	<input type="checkbox"/>	<input type="checkbox"/>	<input type="checkbox"/>	<input type="checkbox"/>
Complete	<input type="checkbox"/>	<input type="checkbox"/>	<input type="checkbox"/>	<input type="checkbox"/>	<input type="checkbox"/>
Easy to find	<input type="checkbox"/>	<input type="checkbox"/>	<input type="checkbox"/>	<input type="checkbox"/>	<input type="checkbox"/>
Easy to understand	<input type="checkbox"/>	<input type="checkbox"/>	<input type="checkbox"/>	<input type="checkbox"/>	<input type="checkbox"/>
Well organized	<input type="checkbox"/>	<input type="checkbox"/>	<input type="checkbox"/>	<input type="checkbox"/>	<input type="checkbox"/>
Applicable to your tasks	<input type="checkbox"/>	<input type="checkbox"/>	<input type="checkbox"/>	<input type="checkbox"/>	<input type="checkbox"/>

Please tell us how we can improve this book:

Thank you for your responses. May we contact you? Yes No

When you send comments to IBM, you grant IBM a nonexclusive right to use or distribute your comments in any way it believes appropriate without incurring any obligation to you.

Name

Address

Company or Organization

Phone No.



Fold and Tape

Please do not staple

Fold and Tape



NO POSTAGE
NECESSARY
IF MAILED IN THE
UNITED STATES

BUSINESS REPLY MAIL

FIRST-CLASS MAIL PERMIT NO. 40 ARMONK, NEW YORK

POSTAGE WILL BE PAID BY ADDRESSEE

International Business Machines Corporation
Information Development
Dept. GZW
9000 South Rita Road
Tucson, Arizona
U.S.A. 85744-0001



Fold and Tape

Please do not staple

Fold and Tape



Printed in USA

GC26-7704-03

