

This camera manual library is for reference and historical purposes, all rights reserved.

This page is copyright by mike@butkus.org M. Butkus, N.J.

This page may not be sold or distributed without the expressed permission of the producer

I have no connection with any camera company

If you find this manual useful, how about a donation of \$3 to: M. Butkus, 29 Lake Ave., High Bridge, NJ 08829-1701 and send your E-mail address too so I can thank you. Most other places would charge you \$7.50 for a electronic copy or \$18.00 for a hard to read Xerox copy. These donations allow me to continue to buy new manuals and maintain these pages. It'll make you feel better, won't it?

If you use Pay Pal, use the link below. Use the above address for a check, M.O. or cash. Use the E-mail of butkusmi@ptd.net for PayPal.



[back to my "Orphancameras" manuals /flash and light meter site](#)

Only one "donation" needed per manual, not per multiple section of a manual !

The large manuals are split only for easy download size.

D Differential Mode

Functions:

Automatic exposure with aperture priority, pre-selected film speed and calculated shutter speed.

Features:

Continuous metering of the light value.

Locking and storing of the light value in a selected moment.

Continuous indication of the difference between the stored and the presently metered light value.

Adjustment of the stored light value ± 5 EV-steps in 1/3 EV-step increments.

How to Use the "D" Mode

The Differential **D** Mode is very convenient when you want to find out the contrast range of a subject. By locking and storing the light values on one subject part and then moving the metering area about the subject, the display continuously shows the contrast difference between the initially metered part and the present location of the metering area. The stored light value remains for any number of exposures until intentionally replaced or adjusted.

Suggested procedure:

1. Pre-set the film speed. With a E- (or TCC-) magazine set the film speed dial (page 36). With a standard magazine use the **Pr** mode to insert and store the film speed (page 41).
2. Pre-set the desired aperture.
3. Set the Mode Selector Dial at **D** and aim

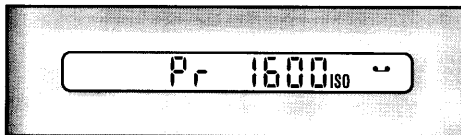
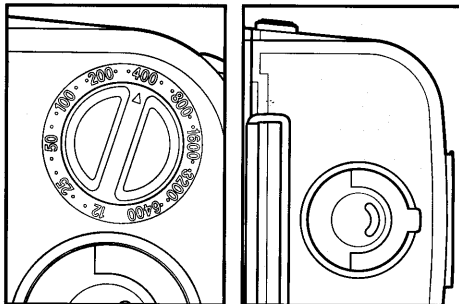
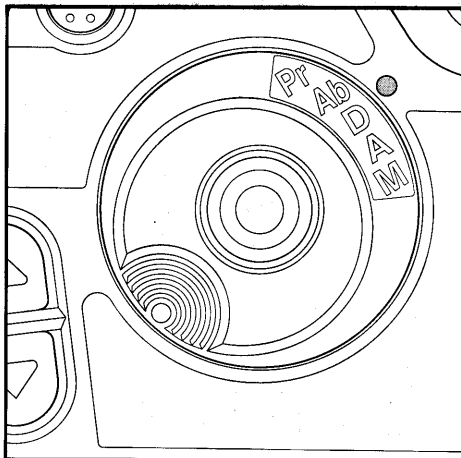

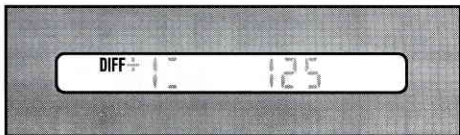
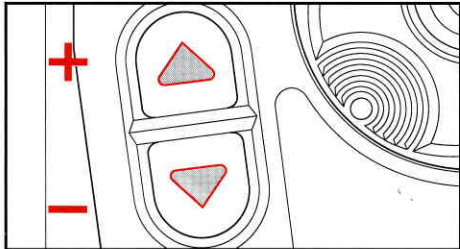
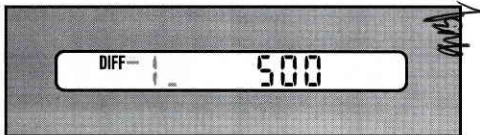
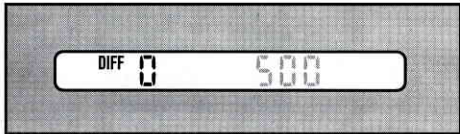
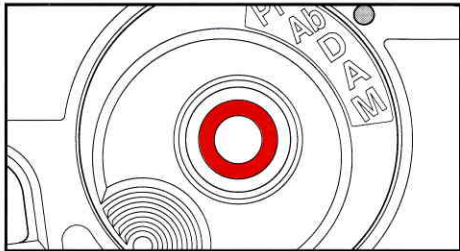

- the camera to place the metering area on a selected subject part.
4. Depress the AE-lock button to start the metering system. The viewfinder display shows the symbol "DIFF", the figure "0" and the shutter speed (calculated from the pre-set aperture, the ISO setting and the metered light level) continuously changing the speed as the metering area is moved to brighter or darker subject parts.
 5. Release the AE-lock button to lock the exposure value and the shutter speed on a selected "reference" subject part considered to have the desired "normal" brightness. As the metering area is moved to other subject parts the display continuously shows the brightness difference in + or - EV between the reference part and the present location of the metering area with an accuracy of 1/3 EV-step.
 6. Use the adjustment buttons to adjust the exposure up or down to the desired level with 1/3 EV increments. You can display the pre-set aperture by depressing the exposure release button to the pressure point, and you can change it if required. The shutter speed adjusts automatically to the new aperture setting, keeping the exposure unchanged.
 7. Depress the exposure release button fully to make an exposure.
 8. Rewind the camera to cock the shutter and advance the film to the next frame with the previous exposure values and adjustments maintained.

NOTE: The metering system can also be started by depressing the exposure release button. It then recalls the latest stored exposure value including any adjustment.

All settings remain unchanged until they are erased and the system unlocked by depressing the AE-lock button or by removing the battery.

A Automatic Mode

Function:

Automatic exposure with aperture priority, pre-selected film speed and automatically calculated shutter speed.

Features:

Continuous metering of the light value.
Locking and storing of the light value at a selected moment by keeping the exposure button at the pressure point.
Permanent adjustment of the continuous or stored light value ± 5 EV-steps in 1/3 step increments.

The Automatic Mode **A** differs from the Automatic Bracketing Mode **Ab** (page 44) by disabling the bracketing facility and making light value readings at each single exposure. Thus, in a sequence, the shutter speed may change from one exposure to the next, despite the fact that the exposure button is kept depressed during the sequence.

The viewfinder display is identical to the **Ab** mode.

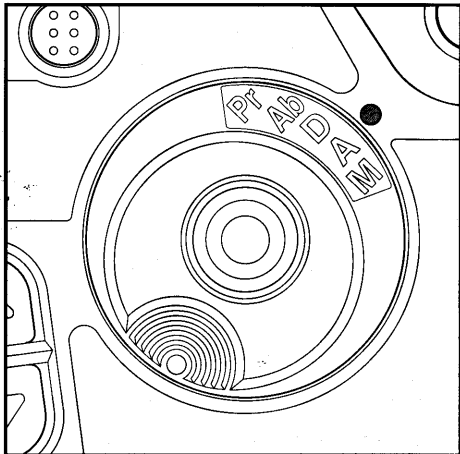

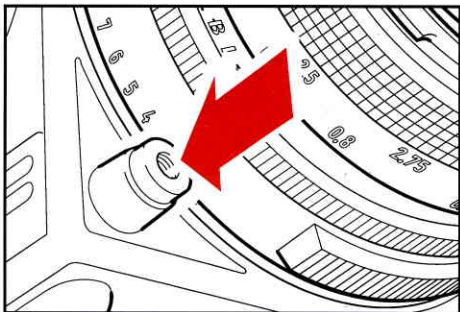
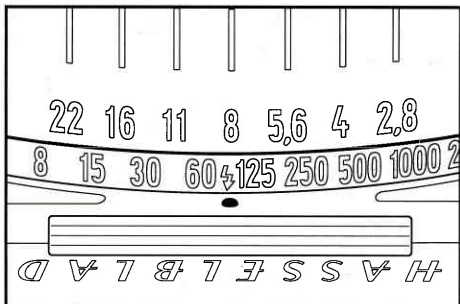
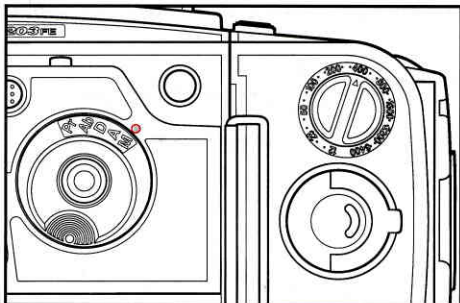

M Manual Mode

Normal exposure, reference function off.

Functions:

Manual pre-setting of aperture as well as shutter speed.

Features:

Completely manually controlled exposure.
 Continuous metering of the light value.
 Continuous indication of the difference in EV between the pre-set exposure and the exposure calculated by the camera's CPU.

How to Use the "M" Mode

The M Mode is completely manual. The metering system is working, but it does not change the shutter speed (the aperture is always pre-set manually). The display indicates the calculated "normal" exposure for the metered subject part, but the exposure will be executed according to the manual settings made.

Suggested procedure:

1. Pre-set the film speed with the film speed dial on the E- (or TCC-) magazine or using the Pr mode with a standard magazine. (This point may be omitted but is required for a correct indication on the viewfinder display).
2. Set the Mode Selector Dial at **M**.
3. Set the aperture and the shutter speed manually.

4. Depress the exposure release or the pre-release button to the pressure point. The metering system starts and the viewfinder display shows the symbol "M" for Manual Mode and the pre-set aperture and shutter speed.

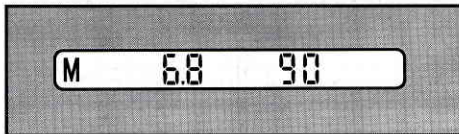

5. Release the exposure button. Instead of the aperture value the display starts showing the difference in EV-steps between the set exposure and the calculated "normal" exposure for the present subject part with an accuracy of 1/3 EV-step, continuously changing the indication as the metering area is moved about the subject.

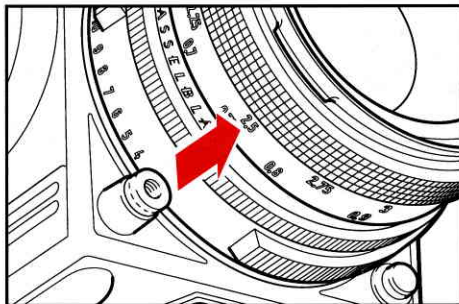

6. The normal function of the adjustment buttons is disabled in the "M" mode. To change the exposure values, e.g. to adjust the exposure to 0 difference for a certain subject area, change the aperture or the shutter setting (or both) until the difference indication on the display reads within $0 \pm 1/3$

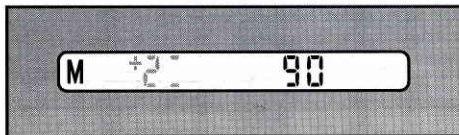

7. Depress the exposure release button for an exposure with the set values, independent of the meter readings.

8. Rewind the camera to cock the shutter and advance the film for the next frame. All settings remain until you change them manually.

NOTE: The metering system could be started by depressing the AE-lock button as well. In that case the display starts by showing the difference as per p.5 above.

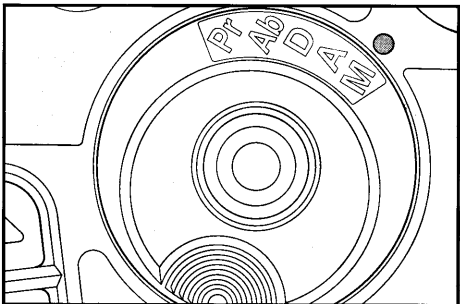
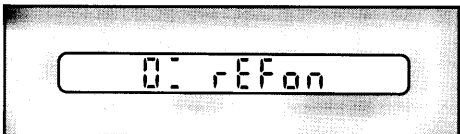
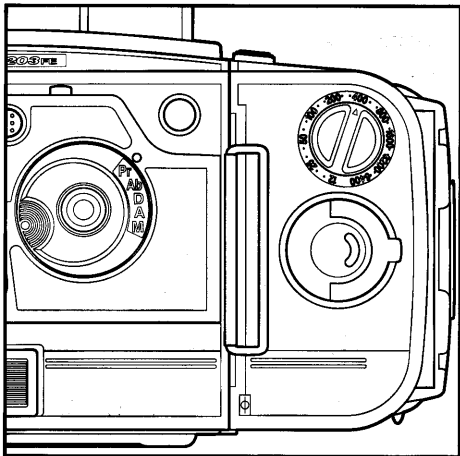

M (ref) Manual Mode, reference

Normal exposure, reference function on.

Functions:

Manual pre-setting of aperture as well as shutter speed.

Pre-programming of acceptable exposure variation and optional warning function.

Features:

Fully manually controlled exposure.

Continuous metering of the light value.

Continuous indication of the difference in EV between the determined, set, and stored exposure and the presently required one.

Warning indication when the ambient conditions require an exposure outside the pre-programmed acceptable variation.

How to Use the "M (ref)" Mode

The **M(ref)** Mode is completely manual, but the metering system is still working. It detects any change in the ambient conditions but does not change the shutter speed (the aperture is always pre-set manually). You decide the proper exposure for the actual subject yourself, using the camera's metering system or any other means, and enter that exposure manually by setting the aperture and shutter speed.

That exposure is then stored in the metering system as your **reference level**, indicated as **0** (zero) on the display (p. 6 below). Any deviation from that reference level is then indicated in EV on the display, but the exposure will be executed according to the settings you have made manually.

Suggested procedure:

1. Pre-set the film speed with the film speed dial on the E- (or TCC-) magazine or using the Pr mode with a standard magazine. Also use Pr mode to switch on the reference function and set the acceptable exposure variation range.
2. Set the Mode Selector Dial at **M**.
3. Determine the appropriate exposure. Set the aperture and shutter speed accordingly, or use the procedure described in p.6 on page 53.
4. Depress the exposure release or the pre-release button to the pressure point to start the metering system. The viewfinder display shows the symbol "M" for Manual Mode, the difference in EV between the pre-set and the calculated exposures for the present subject part with an accuracy of 1/3 EV-step, continuously changing the indication as the metering area is moved about the subject, and the shutter speed setting.
5. Release the button. The display now continuously shows the difference in EV to any previously stored value, and the sign "ref".
6. Press the AE-lock to store the pre-set exposure value as **your reference level**. The display now shows **0** for "no difference", and the sign "ref".

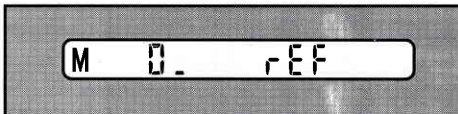
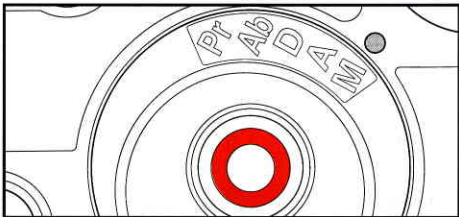
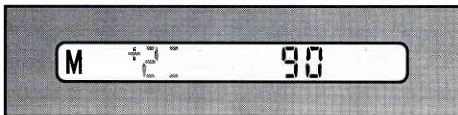
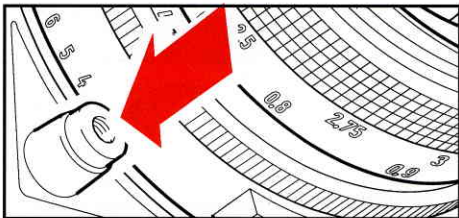
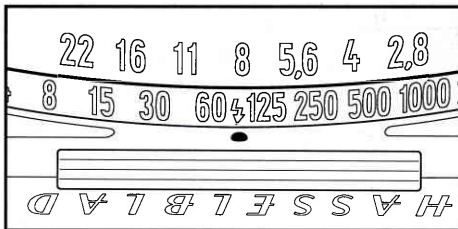

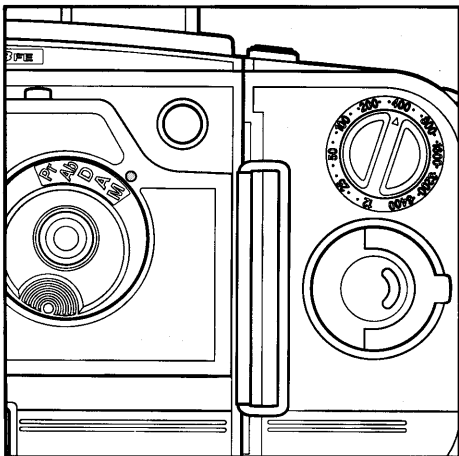
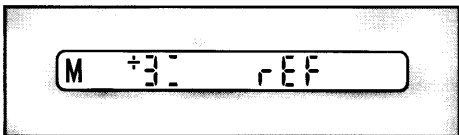
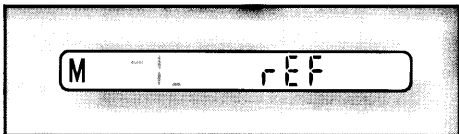

7. Release the AE-lock. When conditions, e.g. lighting or camera settings change, the display continuously shows the difference in EV to the reference level. If an exposure variation range has been set, the display starts flashing when the difference is outside that range.
8. Depress the exposure release button to the pressure point. The display changes to the same state as in p.4 above.
9. Depress the exposure release button for an exposure with the pre-set values, independent of the meter readings.
10. Rewind the camera to cock the shutter and advance the film for the next frame. All settings remain until they are changed manually.

NOTE: The metering system could be started by depressing the AE-lock button as well. In that case the system starts as described in p.6 above.

M (L.E.) Manual Mode

Long exposure, metering system disabled.

Functions:

Manual pre-setting of aperture as well as shutter speed.

Features:

Completely manually controlled exposure. Shutter speeds from 1 second thru 34 minutes (see page 22).

Indication of aperture and shutter speed.

How to Use the "M (L.E.)" Mode

The **M (L.E.)** mode is completely manual. The metering system is disabled. The display indicates the manual settings.

Suggested procedure:

1. Set the Mode Selector Dial at **M**.
2. Depress the exposure release button or the AE-lock button to start the camera
3. Depress both adjustment buttons at the same time to select "long exposure"
4. Determine the appropriate exposure and set the aperture and the shutter speed manually. The display shows the letters "**M**" and "**L.E.**" to indicate the long exposure function and the selected shutter speed in minutes and seconds.
5. Depress the exposure release or the pre-release button to the pressure point. The display changes to show the pre-set aperture and shutter speed.
6. Depress the exposure release button all the way in for an exposure with the set values.
7. Rewind the camera to cock the shutter and advance the film for the next frame. All settings remain until you change them manually. The long exposure function remains active until 4 seconds after the camera auto switch-off.

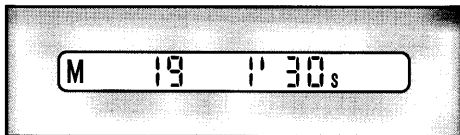
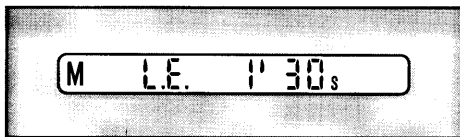
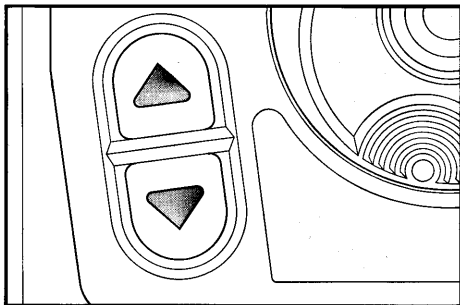

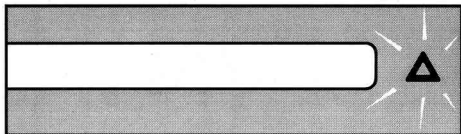

Warning Functions

Whenever the camera settings could result in an exposure error the red warning triangle flashes.

Permanent Warnings

The permanent warning functions are built into the system and cannot be changed or disabled.

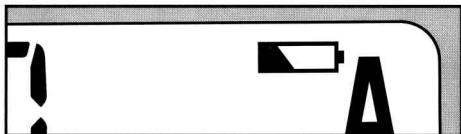

Battery Capacity Warning

When the battery voltage drops below a certain point, the battery symbol is displayed for at least two seconds and the warning triangle flashes twice.

NOTE: Battery recovery may cause the battery symbol to disappear after the two seconds.

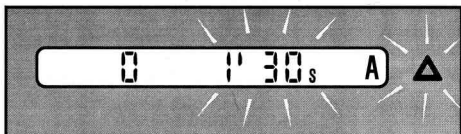

Shutter Speed Warning

When the calculated shutter speed is slower than 90 s or faster than 1/2000 s the shutter speed indication and the red warning triangle start flashing.



Light Meter Range Warning

When the light value falls below or above the range of the light meter the indication "Lo" or "Hi" resp. appears in the left hand part of the display. If no other light value is stored the warning triangle flashes.

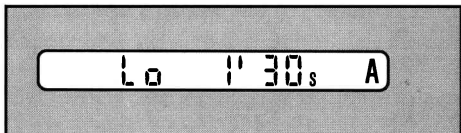

Flash Photography Warnings

In dedicated flash photography the indication "Hi FLASH" or "Lo FLASH" is displayed together with the flashing warning triangle and display backlighting if the flash was too bright or if it was insufficient. This warning is on for 2 seconds after the exposure.

If the pre-set film speed exceeds the range for the automatic flash control (ISO 25 – 1000) the indication "FLASH Er" is displayed when the exposure button is depressed to the pressure point

Reference Warning

The difference indication flashes when the pre-set limit is exceeded.

This optional warning function can be set, changed or disabled by you (Pr5, page 44).

Flash Photography

Dedicated Flash Unit

The flash control function in the 203FE works behind the selected mode of operation, which basically remains unchanged. The film speed range for the flash function is ISO 25 – 1000. When a dedicated flash unit, such as the Hasselblad Profash 4504, or another unit complying with the European SCA-standards is connected to the dedicated flash socket (page 14) – directly or through a suitable adapter – and switched on, the green flash symbol in the viewfinder automatically lights up when the flash is charged and operative. If a plus or minus flash metering adjustment has been entered, the r.h. plus/minus sign also appears in the display.

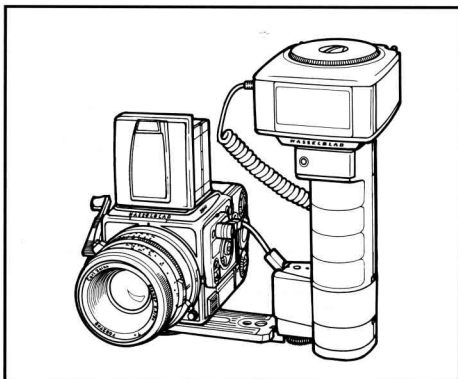

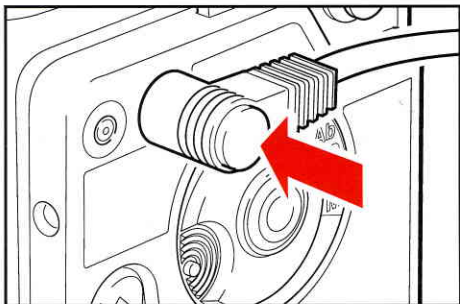
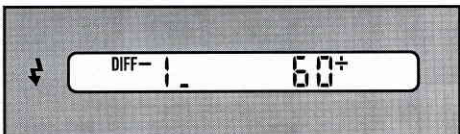
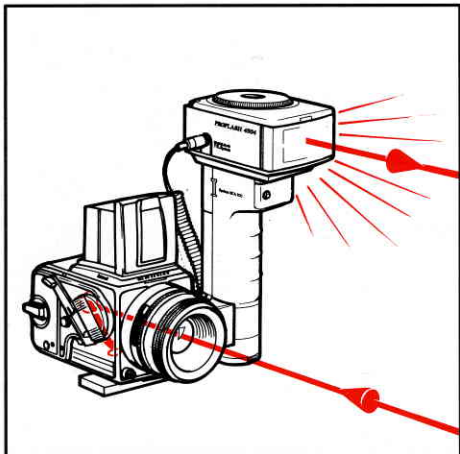

Your 203FE controls the flash duration by TTL/OTF metering (TTL = **T**hrough **T**he **L**ens; OTF = **O**ff **T**he **F**ilm), i.e. it meters the light reflected off the film and terminates the flash when the exposure is correct.

There is of course also the possibility to connect the flash unit to the PC socket, but then you no longer have the advantage of letting the camera system control the flash and the exposure.

The camera continues to operate in the selected mode with the calculated or pre-set shutter speed.

If an automatic mode is desired for the camera the **D** mode is recommended. Meter the selected subject area, lock the metered value and make the desired adjustments. Then adjust the aperture or use the adjustment keys **until the shutter speed figure stops flashing** to be sure that the shutter speed will be slower than 1/90 s. Note that even the displayed 1/90 s could be flashing!

NOTE: If the shutter speed is faster than 1/90 s the shutter speed display flashes and no sync signal is generated to trigger the flash.

How to Use the Dedicated Flash

A. Flash set at TTL Mode

For the operation of the flash unit see the flash unit Instruction Manual.

Functions:

- Fully automatic exposure control through TTL/OTF metering.
- Exposure with pre-set aperture and shutter speeds slower than 1/90 s.

- Pre-set flash exposure adjustment -3 to $+1$ EV through Pr mode (page 42) indicated by the r.h. minus alt. plus sign.
- Display warning when the pre-set or calculated shutter speed is faster than $1/90$ s.
- Display warning when the pre-set film speed is outside the range (ISO 25 -1000)
- Viewfinder indications when the flash unit is charged and ready to flash.
- Viewfinder warning at over- and underexposure or disabled flash triggering.

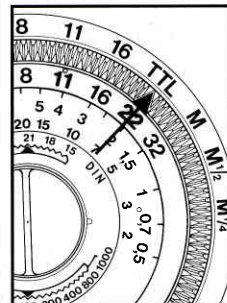
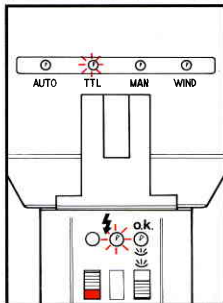
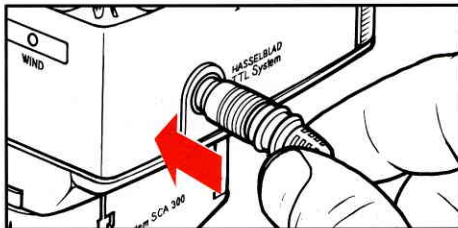

Suggested procedure:

1. Attach and connect the flash according to the Flash Manual. With the Hasselblad Proflash 4504 connect the Hasselblad TTL-cable between the dedicated flash socket in the camera body (page 29) and the TTL socket in the flash unit.
(The PC connector of the Proflash 4504 is inoperative but can be "parked" in the PC-socket.)
2. Set the flash unit at TTL or corresponding mode and switch it on. Start the camera. When the flash unit is charged and ready to flash the green flash symbol (see page 18) lights up in the viewfinder. If a flash power adjustment has been entered, also the r.h. plus/minus sign appears in the display.
3. In manual mode, pre-set the aperture and set the shutter speed not to exceed $1/90$ s. In automatic mode follow the recommended procedure on page 60!

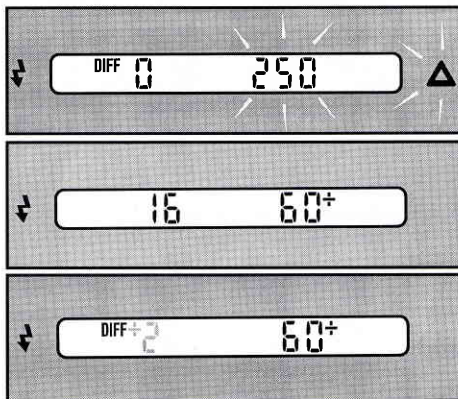

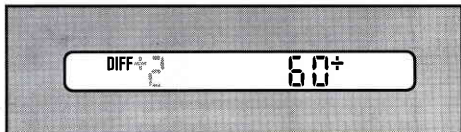
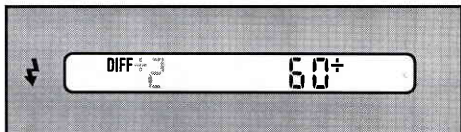
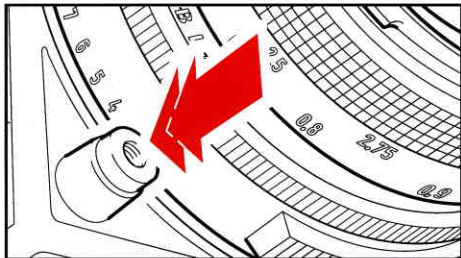
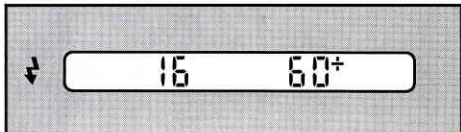
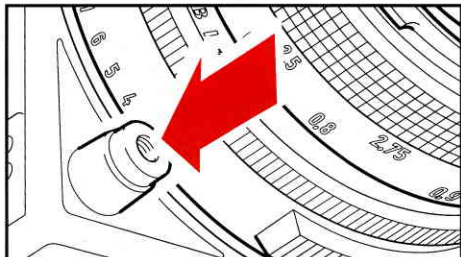

4. Depress the exposure button to the pressure point. The camera is working in the selected mode. When the exposure button is depressed to the pressure point the display appearance is according to that mode except for the described flash indications.

5. Depress the exposure button fully to make the exposure and trigger the flash. The control circuits in the camera cut the flash when the exposure is correct.

Release the exposure button. If the flash was powerful enough to produce a correct exposure but did not use up all the power the flash symbol stays on and the display returns to its normal appearance.

Did it use up most of the power the flash symbol turns off while the flash unit is recharging and lights up again when it is fully recharged.

WARNINGS (page 58):

The sign “**Hi FLASH**” appears on the display when the flash was **too bright**, e.g. if the flash-to-subject distance is short, the camera aperture large, the film fast or any combination of these. The remedies are to move the flash away from the subject (use a lens with longer focal length), reduce the aperture, change to a slower film.

The sign “**Lo FLASH**” appears when the flash was **insufficient** to give a correct exposure, e.g. if the flash-to-subject distance is too long, the aperture is too small, the film too slow. The remedies are shorter flash-to-subject distance, larger aperture or faster film. It also appears at shutter speed faster than 1/90 s when the flash triggering was disabled when the exposure was released.

In both cases the suggested remedies could be combined in any desired way.

Both warnings appear for two seconds after the flash exposure together with a flashing display backlighting, which also is visible from the outside in the display backlighting window.

6. Rewind the camera to cock the shutter and advance the film to the next frame.

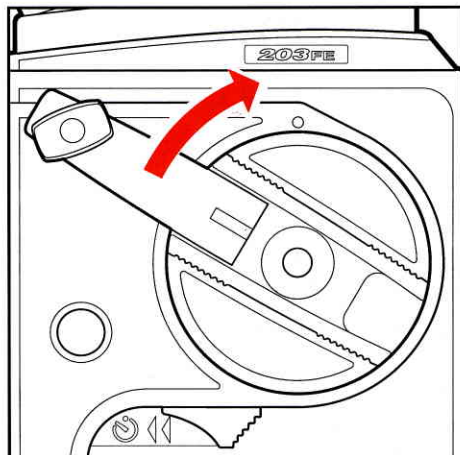
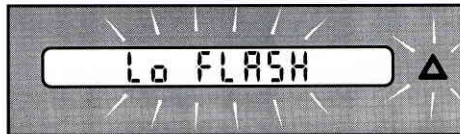
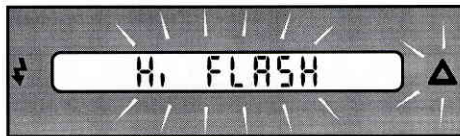

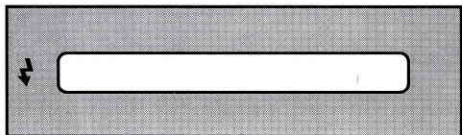
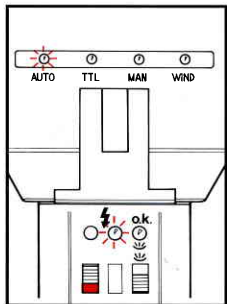
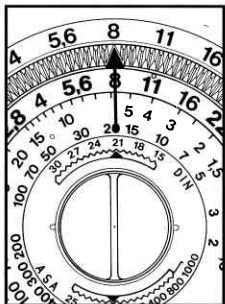
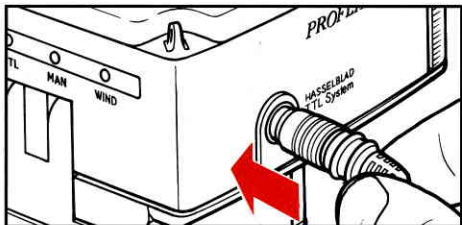
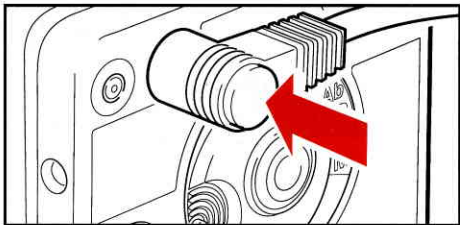

B. Flash set at Automatic Mode

The flash unit should be set for its own built-in automatic control (see the flash unit instructions).

Functions:

- Automatic exposure control through the built-in system in the flash unit.
- Exposure with pre-set aperture and shutter speed determined by the selected operating mode.
- Viewfinder indication when the flash unit is charged and ready to flash.
- Viewfinder warning at over- and under-exposure and disabled flash triggering.

Suggested procedure:

1. Attach and connect the flash according to the Flash Manual. With the Hasselblad Proflash 4504, connect the TTL-cable between the dedicated flash socket in the camera body (page 29) and the TTL socket in the flash unit.
(The PC connector of Proflash 4504 is inoperative but can be "parked" in the PC-socket.)
2. Set the flash unit to Automatic or corresponding mode, set the film speed on the flash unit's dial and switch it on. When the flash unit is charged and ready to flash, the green flash symbol (page 18) lights up in the viewfinder.

3. Select and pre-set the lens aperture for the desired depth-of-field and set the flash dial at the corresponding aperture value

or

set the flash-to-subject distance on the flash dial, read the corresponding aperture value on that dial and pre-set the camera aperture at the same value.

4. Depress the exposure release or the pre-release button to the pressure point to start the camera. The camera operates in the selected mode and the display shows the corresponding indications.

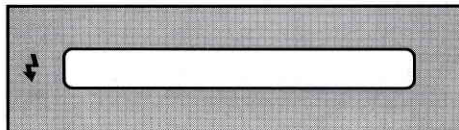
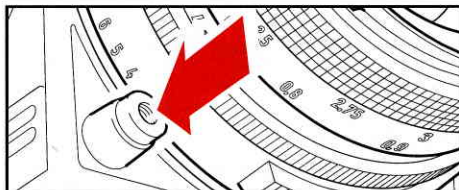
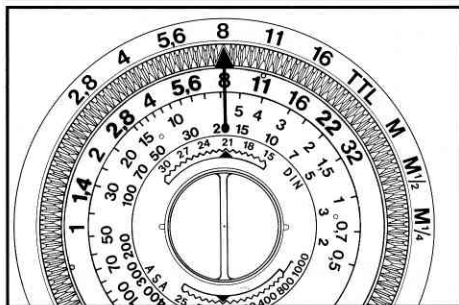
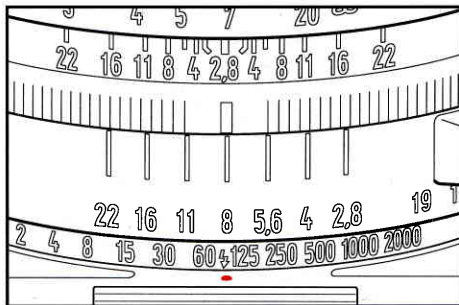

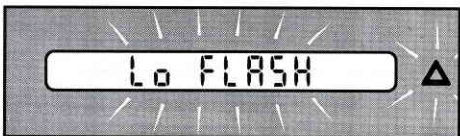
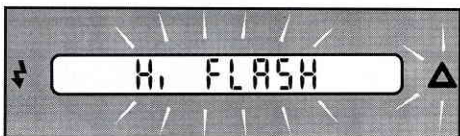
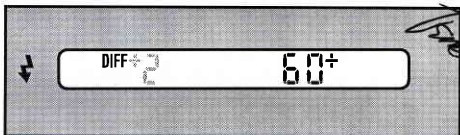
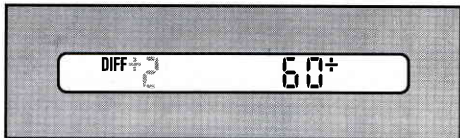
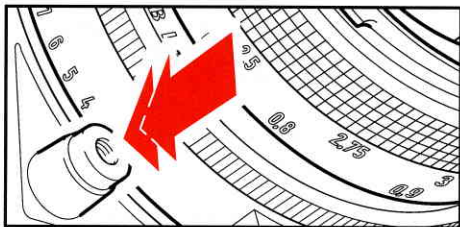

- Depress the exposure release button fully to make the exposure and trigger the flash. The control circuits in the flash unit cut the flash when the exposure is correct. If the flash was powerful enough to produce a correct exposure and did not use up all the energy the flash symbol stays on. Did it use up most of the energy the flash symbol turns off while the flash unit is recharging and lights up again when it is fully recharged.

WARNINGS (page 58):

The sign "**Hi FLASH**" appears on the display when the flash was **too bright**, e.g. if the flash-to-subject distance is short, the camera aperture large, the film fast or any combination of these. The remedies are to move the flash away from the subject (use a lens with longer focal length), reduce the aperture, change to a slower film.

The sign "**Lo FLASH**" appears when the flash was **insufficient** to give a correct exposure, e.g. if the flash-to-subject distance is too long, the aperture is too small, the film too slow. The remedies are shorter flash-to-subject distance, larger aperture or faster film. It also appears at shutter speeds faster than 1/90 s when the flash triggering was disabled.

Both warnings appear together with a flashing display backlighting for two seconds after the flash exposure.

- Rewind the camera to cock the shutter and advance the film to the next frame.

C. Flash set at Manual Mode

The flash unit should be set for manual control (see the flash unit instructions).

Functions:

Exposure with pre-set aperture and shutter speed determined by the operating mode.

Viewfinder indication when the flash unit is charged and ready to flash.

Viewfinder warning at over- and under-exposure and disabled flash triggering.

Suggested procedure:

1. Attach and connect the flash according to the Flash Manual.

With the Hasselblad Proflash 4504 connect the TTL-cable between the dedicated flash socket on the camera body (page 29) and the TTL socket on the flash unit.

(The PC connector of Proflash 4504 is inoperative but can be "parked" in the PC-socket.)

2. Set the flash unit to Manual or corresponding mode and switch it on. When the flash unit is charged and ready to flash, the green flash symbol (page 18) lights up in the viewfinder.

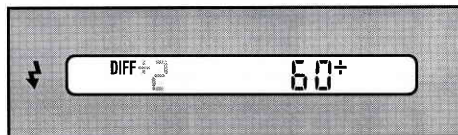
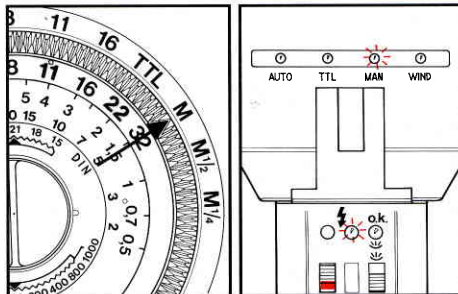
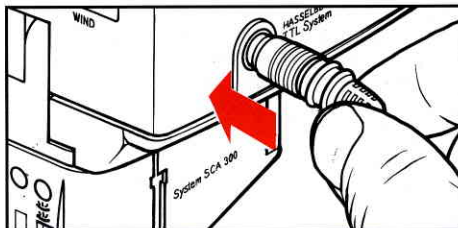
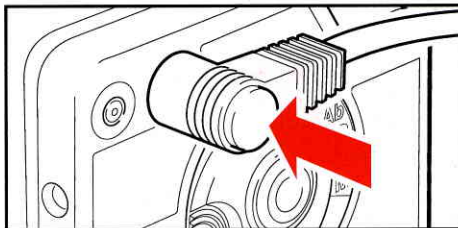

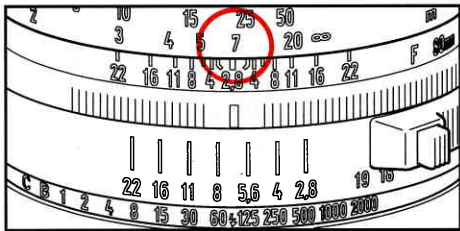

3. Estimate the flash-to-subject distance or measure it by focusing the lens and reading the distance from the focusing scale.

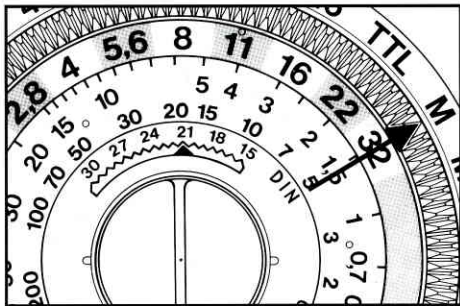

4. Determine the aperture setting using the aperture calculator on the flash unit or the Guide Number (see the flash unit manual).

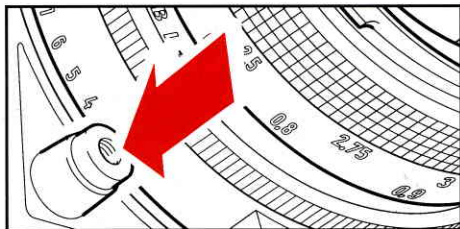

5. Depress the exposure release or the pre-release button to the pressure point to start the camera. The display indicates the aperture setting and the shutter speed. Is the Mode Selector Dial set at **Ab**, **A** or **M** the symbols **A** or **M** are also shown but other symbols are not.

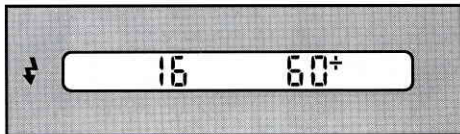

6. Depress the exposure release button fully to release the exposure and trigger the flash. In Manual mode the flash normally uses full power.

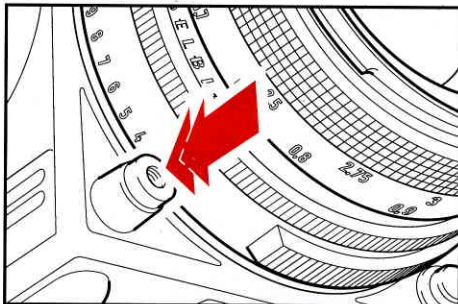

The flash symbol turns off while the flash unit is recharging and lights up again when it is fully recharged.

WARNINGS (page 58):

The sign "**Hi FLASH**" appears on the display when the flash was **too bright**, e.g. if the flash-to-subject distance is shorter than estimated or the subject brighter than normal. The remedy is to reduce the aperture.

The sign "**Lo FLASH**" appears when the flash was **insufficient** to give a correct exposure, e.g. if the flash-to-subject distance is longer than estimated or the subject darker than normal. The remedy is to use a larger aperture. It also appears at shutter speed faster than 1/90 s when the flash triggering was disabled.

Both warnings appear together with a flashing display backlighting for two seconds after the flash exposure.

7. Rewind the camera to cock the shutter and advance the film to the next frame.

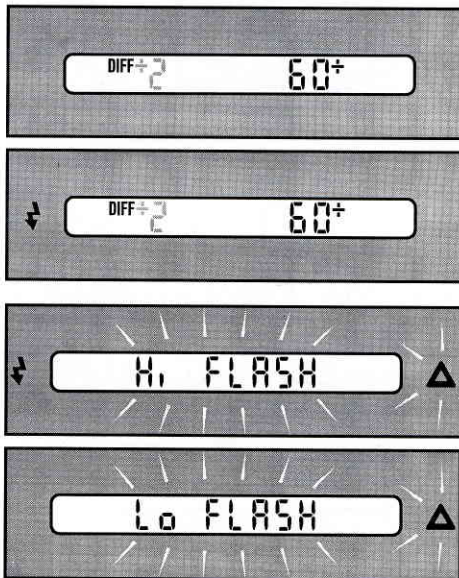

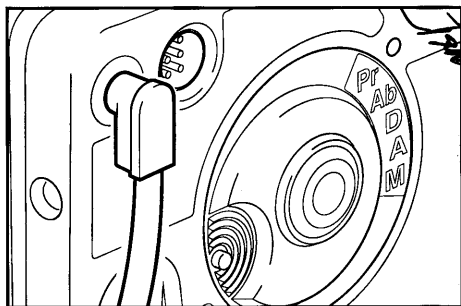
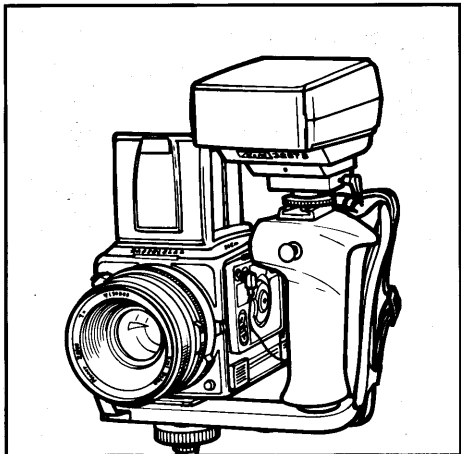

Non-dedicated Flash Units

With a non-dedicated flash unit you can not take advantage of the sophisticated TTL/OTF flash metering and control system in the 203FE and the viewfinder information supplied by this system. You then have to rely on the control system of the flash itself or your own aperture calculations. Always refer to the Flash Instruction Manual for flash settings and Guide Number!

The non-dedicated flash unit should be connected to the PC-socket next to the TTL socket on the left hand side of the camera body through a conventional synchronization cord, usually supplied with the flash unit.

The metering system and the viewfinder display in the camera will work normally in all operating modes as if no flash was connected, i.e. the flash symbol in the viewfinder will **not** light up when the flash is ready.

NOTE: The fastest shutter speed for full flash synchronization is 1/90 s corresponding to the flash symbol on the shutter speed ring. At faster speeds the PC-terminal is disconnected and the flash is not triggered. Use the camera's **M** mode and the 1/90 s shutter speed to ensure that the flash will fire.

Since the metering system automatically calculates and sets the correct shutter speed in the modes **Ab**, **A** and **D** you must monitor the viewfinder display closely to check that the shutter speed is 1/90 s or slower before making the exposure. Change the pre-set aperture or use the adjustment buttons to change the shutter speed if necessary.

How to use a Non-dedicated Flash Unit

Suggested procedure:

1. Connect the flash to the PC-socket on the camera body and switch it on.
2. Pre-set the desired aperture.
3. Use the camera as described in any desired operating mode, observing the shutter in the modes **Ab**, **A** and **D**. Pre-set the shutter speed 1/90 s (flash symbol) in **M** mode.

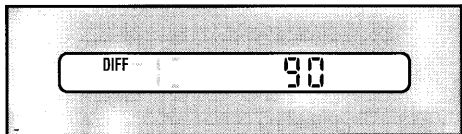
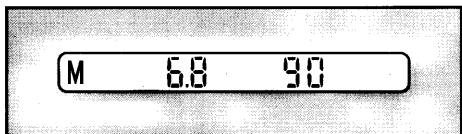
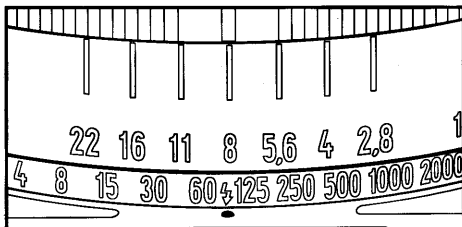

203FE with other Hasselblad Lenses

You can use the Hasselblad F-, CF- and C-lenses on your 203FE without fear of damaging camera or lens. Since these lenses do not have the electronics required by the metering system, there will be a few minor limitations in the camera functions. In this section you will find information on the F-lenses and how to use them on your 203FE. How to use the CF- and C-lenses is described in Appendix A, page 83.

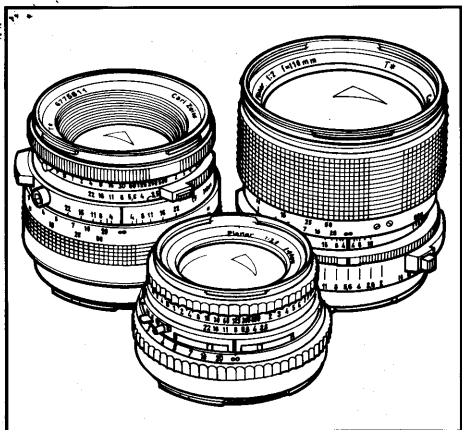

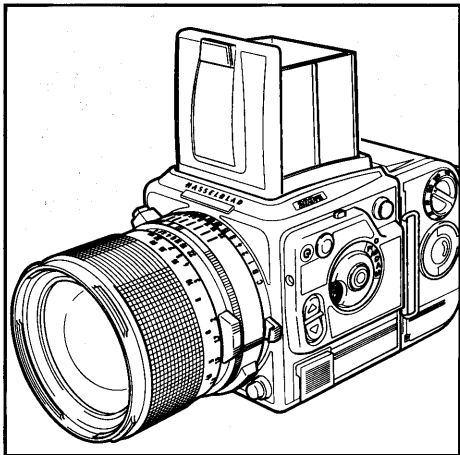
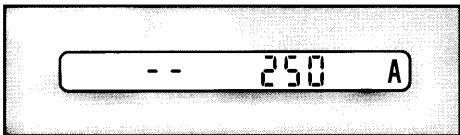
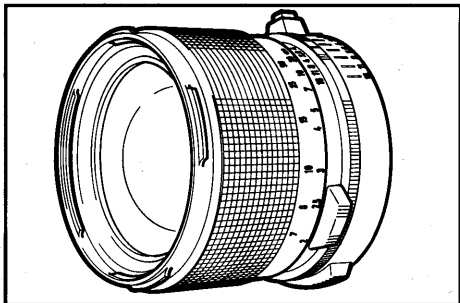

F-Lenses

The F-lenses are optically, mechanically and operationally identical with the corresponding FE-lenses but are not equipped with their internal electronics and external identifications. The instructions for the FE-lenses are generally applicable also to the F-lenses (page 31).

NOTE: With an F-lens on the camera the aperture value does not appear in the viewfinder display when the exposure or pre-release button is depressed. Instead the display shows two dashes (—).

How to use the 203FE with an F-lens

Like all Hasselblad lenses the F-lenses are normally opened up to the largest aperture in viewing position but can be stopped down manually to the pre-set aperture. Since no information on the pre-set aperture is transferred to the metering system in the camera body the shutter speed calculated by the system relates to the actual lens aperture. To get a correctly calculated shutter speed you have to stop down the lens to the pre-set aperture before you make the exposure. With the extra-ordinary brightness of the Acute-Matte focusing screen there are usually no difficulties to focus with a stopped-down lens.

Suggested procedure:

1. Pre-set the film speed as previously described.
 2. Pre-set the desired aperture value.
 3. Set the Mode Selector Dial at the desired mode of operation.
-
4. Stop down the lens by pushing the preview knob down until it locks (page 32).
 5. Follow the instructions for the selected mode of operation.

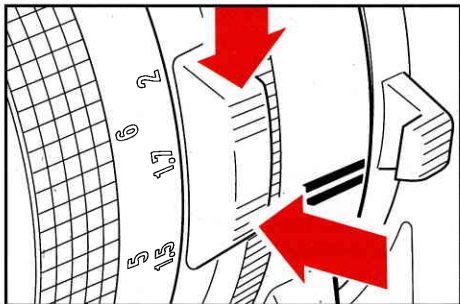
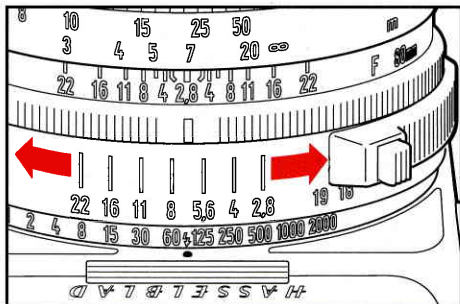

Flash photography with F-lenses

The overall similarity between the FE- and F-lenses makes the flash photography procedures almost identical. The only difference is that the aperture value does not appear on the viewfinder display.

Dedicated Flash Unit

The TTL/OTF flash control system makes no difference between the FE- and F-lenses as it always operates when the lens is stopped down during the exposure.

How to use the Dedicated Flash

The procedures are identical to those described for the FE-lenses in all flash and camera modes of operation (pages 56-63).

Non-dedicated Flash Unit

The information and procedure described for the use of a non-dedicated flash unit together with a FE-lens (page 66) is in all parts applicable with an F-lens.

Accessories

All accessories originally designed for the 203FE are marked with the blue twin lines. The mark is always located on that side which is to the left when the accessory is attached to the camera to make it easily identified.

Other accessories are so called "general accessories". These accessories do not have the blue twin lines but can still be used on the 203FE without restrictions.

A third group of accessories can be used but will cause certain limitations to the TCC functions.

Finally there is a fourth group of accessories that cannot in any way be used on the 203FE.

Accessory Mounts

The quick coupling plate on the bottom of the camera body (pages 25 and 72) fits to the handy and reliable Hasselblad tripod quick coupling and to the flash gun bracket.

On the front of the lenses are external and internal bayonet mounts for filters, close-up lenses and lens shades. The viewfinder mount on top of the camera body accepts various focusing screens and viewfinders. Underneath the winding crank is a bayonet mount for the Hasselblad Winder.

Major FE Accessories

A selection of the most important FE accessories is described below. For a complete review of the Hasselblad system refer to the Hasselblad Product Catalog.

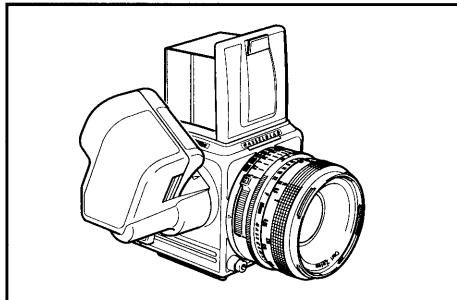

Winder

The TCC Winder motorizes the 203FE for a maximum frame rate of 1,3 fps.

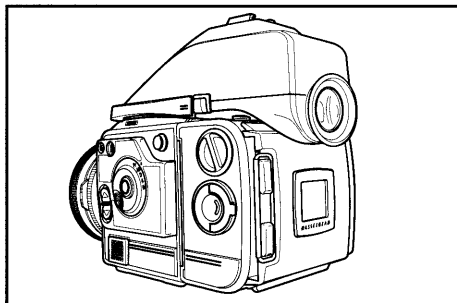

Viewfinders

Besides the focusing hood which is delivered with the camera body you have a choice of a magnifying hood and prism viewfinders with and without exposure meters.

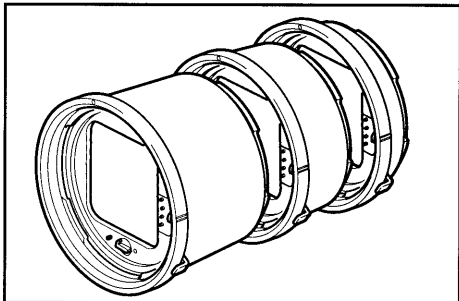

E-type Extension Tubes

For close-up and macro photography the E-type extension tubes have all connections, both mechanical and electrical, between camera body and lens.

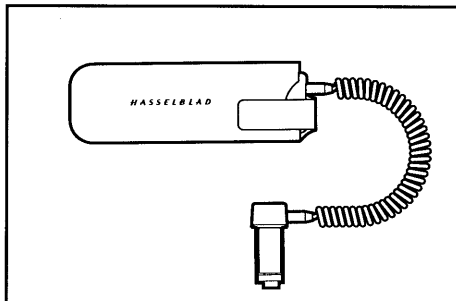

External Battery Cassette

The external battery cassette connector replaces the original battery cassette in the battery compartment. It provides additional power and the extension cord allows you to keep the batteries warm in your pocket when you are using the 203FE in cold conditions.

General Accessories

The range of general Hasselblad accessories that can be used on the 203FE without affecting the metering functions includes different focusing screens, lens shades and filter adapters. There is also the Hasselblad Winder and the Hasselblad Proflash 4504 dedicated flash unit. Other dedicated flash units can be connected through flash adapters, such as the Hasselblad SCA 390 and SCA 590.

Other Accessories

These accessories can be used but will result in certain limitations to the metering system. The F and CF lenses belong to this group, as

do the bellows and the PC-Mutar. Also some of the discontinued accessories such as the C lenses belong here.

Finally there is a group of accessories which cannot be used on your 203FE, such as the other viewfinders, the grips and the accessories designed to be attached to the accessory rail on the other Hasselblad reflex models.

The Hasselblad System Chart

Overleaf you will find the accessory chart that indicates the different groups of accessories in the Hasselblad System. Refer to the Hasselblad Product Catalog for complete information on the entire Hasselblad System.

Hasselblad System Chart

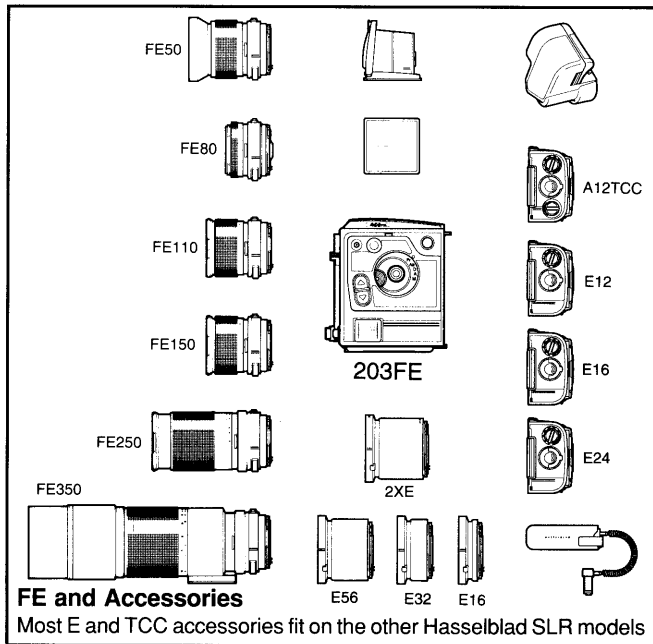

FE and Accessories

Most E and TCC accessories fit on the other Hasselblad SLR models

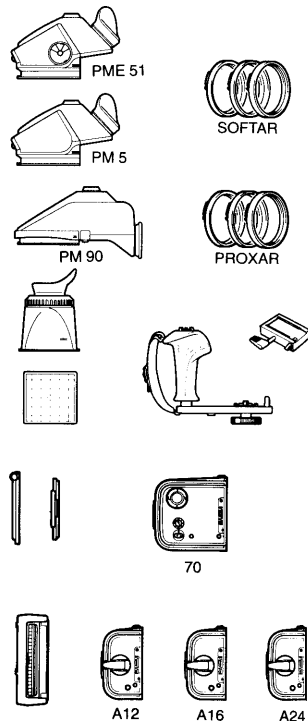

General Accessories

Can be used on the 203FE without affecting the metering function

Other Accessories

Cause limitations to the metering function when used on the 203FE

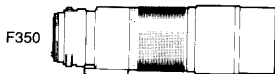
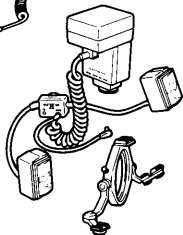
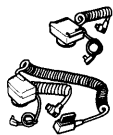
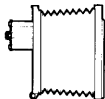
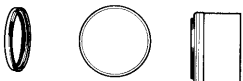
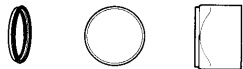
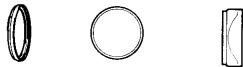

F350



F250



F150



F110



F50

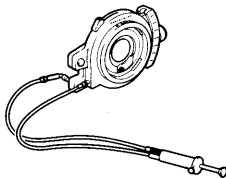
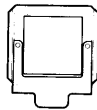
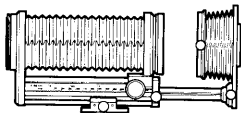

8



CF30



CF105

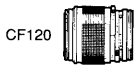

CF120



CF135



CF40
FLE



CF50
FLE

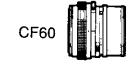

CF60



CF80



CF100



CF150

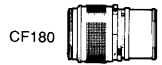

CF180

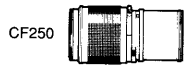

CF250



CF250 SA



CF350

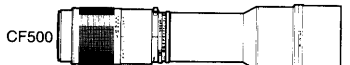

CF500

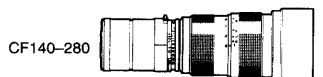

CF140-280

Troubleshooting

Your Hasselblad 203FE is built for long and trouble-free service, especially when you follow the advices on maintenance and care (page 82). Should you encounter any operational difficulties the troubleshooting chart below may help you to resolve them.

| PROBLEM | POSSIBLE CAUSE | REMEDY |
|---|---|---|
| The camera can not be activated in any way. | The battery is removed or completely exhausted. The battery is reversed. The camera was not rewound after the last exposure. | Install or replace the battery. Insert the battery according to the labelling on the battery cassette. Wind the camera with one full turn of the winding crank. |
| The camera cannot be activated by depressing the AE lock. | The AE lock has been depressed for more than 16 seconds. | Activate the camera by depressing the exposure release button. |
| The exposure release button cannot be depressed. | The camera was not rewound after the last exposure. The magazine slide is in the magazine. The roll of film is finished (frame counter at end). | Rewind the camera with one full turn of the winding crank. Remove the magazine slide completely. Insert a new film or change to a fully loaded magazine (or w/o film remove and re-insert film holder). |
| The viewfinder image is dark but the display is bright. | The lens front cover is on. | Remove the lens front cover. |

| PROBLEM | POSSIBLE CAUSE | REMEDY |
|--|---|---|
| The viewfinder image is dark but the display is bright. | <p>The camera is pre-released.</p> <p>The camera has a C lens or a CF lens in C setting attached and was not rewound after the last exposure.</p> | <p>Complete the camera release or depress the double exposure button and wind the camera with one full turn of the winding crank.</p> <p>Rewind the camera with one full turn of the winding crank.</p> |
| The lens cannot be attached. | <p>The lens is released.</p> <p>The camera body is pre-released or released.</p> | <p>Cock the lens.</p> <p>Release and/or rewind the camera with one full turn of the winding crank.</p> |
| The lens cannot be detached. | The camera is pre-released or released. | Release and/or rewind the camera with one full turn of the winding crank. |
| The magazine cannot be detached. | The magazine slide is not completely inserted. | Push the magazine slide in until it positively stops. |
| The flash symbol does not light up when a dedicated flash unit is connected. | <p>The flash unit is not switched on or is not fully charged and ready to be fired.</p> <p>The connection between flash unit and camera is defective.</p> | <p>Switch on the flash unit and/or wait until it is fully charged.</p> <p>Check the connections according to the flash unit's manual.</p> <p>Replace the TTL sync cord.</p> |

Faulty and Error Indications on the Viewfinder Display (All parts have system mark)

| PROBLEM | POSSIBLE CAUSE | REMEDY |
|---|---|--|
| The display signs appear reversed. | The viewfinder is not properly installed. | Push the viewfinder firmly forwards until it stops. |
| Aperture indication is “- -” | Defective contact between lens and camera body. | Detach the lens. Clean all four contact surfaces on the lens and on the camera body with a lint-free cloth or suede. DO NOT touch the contact surfaces with your fingers! |
| The magazine symbol appears when a TCC magazine is attached. | Defective contact between magazine and camera body. | Detach the magazine. Clean all four contact surfaces on the magazine and on the camera body with a lintfree cloth or suede. DO NOT touch the contact surfaces with your fingers! |
| The display indicates “Err 1”, “Err 2” or “Err 12 4”, possibly together with A or M . | Electronic system error. | Bring the camera to an authorized “Hasselblad Service Center”. Explain the look of the display to the service technician. |

NOTE: If there is a contact failure between the lens and the camera body you can still use your equipment according to the instruction for the F lens (page 72–73). Contact failure between the magazine and the camera body could be overrun by selecting **Pr** mode and entering the film speed manually (page 41).

Technical Specifications and Equipment, 203FE

Camera Design: Medium format single lens reflex camera with built-in TTL selective meter electronically connected to FE lenses and E magazines. Interchangeable lenses, film magazines, viewfinders and focusing screens.

Shutter: Electronically controlled mechanical focal plane shutter with release solenoid system. Horizontally running textile curtains. Shutter speed range B, 90 s – 1/2000 s; in Manual Mode up to 34 minutes. Fully mechanical C setting for lenses with built-in leaf shutters. Flash synchronization from B up to 1/90s.

Lens Mount: Hasselblad bayonet mount for FE, F, CF and C lenses. Contacts for data-bus communication with the FE lenses.

Viewfinder: Focusing hood with 4 x magnifier, interchangeable with magnifying hood and prism viewfinders with and without exposure meter. TCC viewfinders only acceptable. Acute-Matte focusing screen interchangeable with other Hasselblad focusing screens. Illuminated flash and warning symbols.

Operation Display: LCD display in viewfinder with all relevant exposure and operational data and switch-controlled low light illumination.

Camera Winding & Film Advance: Manual single turn winding crank. Simultaneous shutter cocking and film advance. The crank is interchangeable with the Hasselblad motor winder for up to 1.3 frames/second.

Exposure Meter: TTL metering at full aperture with FE lenses. High sensitivity silicon photocell. Selective meter area approximately 20% of the image area. Metering range EV 0.5 to EV 21.5 at ISO 100/21° and f/2,8. Active time 16 s after release of any operational button.

more>

Exposure Functions: Aperture priority automatic exposure, automatic flash control and full manual control. Exposure compensation ± 5 EV in 1/3 EV increments. AE-lock.

Operating Modes: Programming Mode, Automatic Bracketing Mode, Differential Mode, Automatic Mode and Manual Mode.

Film Speed Range: ISO 12/12° to ISO 6400/39°, selected with film speed dial on E and TCC magazines or entered in programming mode.

Flash Control: Center weighted TTL/OTF flash exposure meter. Full dedicated flash control with inhibited flash triggering at shutter speed faster than 1/90 s. Flash control film speed range ISO 25 – 1000.

Selftimer: Default delay 10 s. Delay programmable in 12 steps from 2 s to 60 s.

Battery: 6V, type PX28L, 4G-13 or equivalent lithium type.

Tripod Mount: Quick coupling plate and 1/4" socket thread.

External Dimensions: Camera body only see page 81. With focusing hood, lens Planar FE 2,8/80 and magazine E 12: 185L x 117W x 110H mm (7 9/32 x 4 5/8 x 4 11/32 in.)

Weight: 1660 g with focusing hood, lens Planar FE 2,8/80, E12 magazine and battery. Body alone: 745 g.

The camera body (chrome finish P/N 10561, black finish P/N 10574), comes with focusing hood, focusing screen, winding crank, shoulder strap, front and rear protective covers.

For comprehensive information on accessories please refer to the Hasselblad Product Catalog.

Camera Body Dimensions

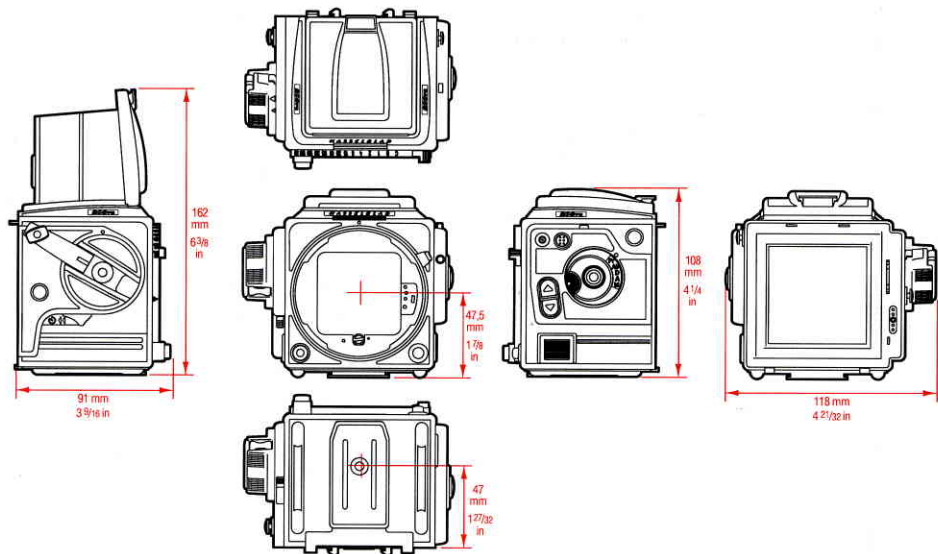

Hasselblad reserve the right to change the specifications without prior notice.

Hasselblad 203FE is covered by several Swedish and foreign patents.

Camera Care, Service and Guarantee

Camera Care.

Your Hasselblad camera is designed to withstand the rigours of professional use in most environments. In order to avoid the possibility of damage, however, the camera should be protected from the following.

Extremes of temperature. High temperatures can have an adverse effect on both the film and the camera. Do not keep your camera in places where it may get hot, such as in direct sunlight or above a radiator. In tropical environments fungus growth can be prevented by keeping your equipment in an area where the air is circulating. Frequent rapid and severe temperature changes can cause problems such as corrosion of electrical contacts, and should be avoided. When in extremely cold temperatures, cameras and especially lenses should be protected as much as possible.

Dust and grit. Prevent dirt of any kind from getting into your camera. When taking photographs in coastal areas for example, the camera should be protected from sand and salt water spray.

You can blow away dust on the lens glass, magnifier of focusing screen, or wipe it off gently with a soft cloth if necessary. Smears on the lens glass should be removed with a high quality lens cleaning solution on a soft, clean tissue. Be careful not to scratch the lens or touch any of the glass surfaces with your fingers. The surface of the mirror

is coated and should be blown clean but not be wiped. Lens cleaning solvents or other chemicals should not be used on the focusing screen.

Impact. Your camera can be damaged by severe physical shocks. You should take care not to leave it where it can fall or be knocked to the ground, or roll about.

Service. Faultless camera performance is essential to the professional photographer. Therefore it is advisable to check that your camera is functioning correctly before an important assignment. You should also return your camera to a "Hasselblad Authorized Service Center" for periodical checking and preventive maintenance. If your camera is used constantly and intensively, exposing hundreds of rolls of film per week, checkups every six months are recommended.

Hasselblad Service Centers have the expert staff and specialized equipment necessary to ensure that your camera remains in perfect working order.

Guarantee. Provided that you bought your camera from an authorised Hasselblad outlet, it is covered by an international guarantee for one year. The guarantee document and a registration card are supplied with the camera. Keep the guarantee document carefully, but fill in the registration card and return it to your Hasselblad distributor.

APPENDIX A

Hasselblad 203FE with CF- and C-lenses

The CF- and the older C-lenses differ from the FE- and F-lenses through their built-in leaf shutter with shutter speeds from 1 to 1/500 s and B. Both types have flash synchronization on all shutter speeds. The CF-lenses also have an additional shutter setting F to let the lens be used together with the focal plane shutter and the instant return mirror

NOTE: Avoid using the 203FE with a C-lens in temperature conditions below 0°C (32°F)..

CF-lenses

With a CF-lens on your 203FE you can choose to use the focal plane shutter with all its advantages and full automation or to disengage the focal plane shutter and benefit from the advantages of lens' built-in leaf shutter with battery independence and a wider choice of flash synchronization on faster shutter speeds.

NOTE: When you need shutter speeds of 1/250 s or faster while using a CF-lens, you are under certain conditions recommended to set the lens shutter at F (see page 84) and use the camera's focal plane shutter

CF-lens design and functions

The setting rings and scales on the CF-lenses are arranged differently from those on the F-lenses. Counted from the camera body and forwards the rings are:

- Focusing ring with focusing distance scale in feet (orange) and meters (white).
- Common index line and depth-of-field scale.
- Aperture ring with aperture scale and EV index (orange).
- Shutter speed ring with shutter speed scale, EV scale (orange) and F lock button (green).

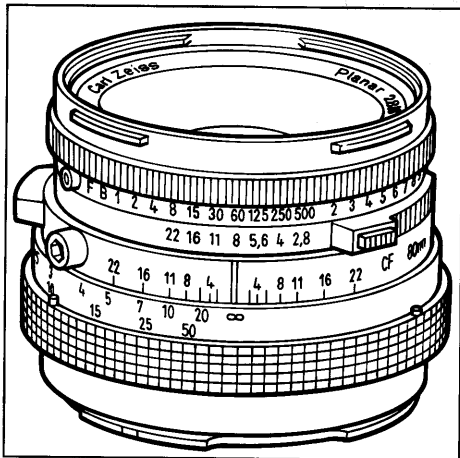

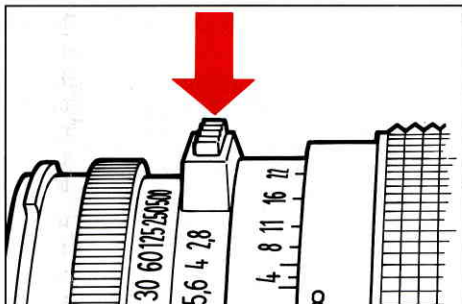

EV Interlock Button

Depressing the EV interlock button interlocks the shutter speed and aperture rings to make it possible to change the combined speed/aperture setting without changing the EV.

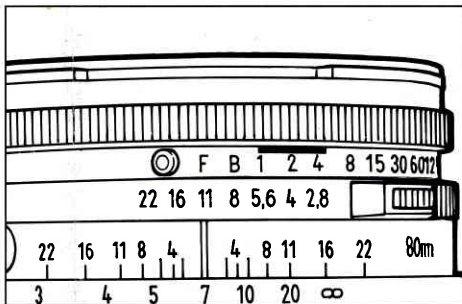

Depth-of-field Preview Knob

The Depth-of-field Preview knob location and operation is identical to the FE- and F-lenses (page 32).

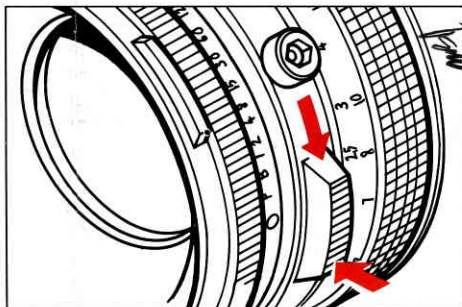

F-setting

Depress the small green F-lock button to the left of the green F on the shutter speed ring. Keep it depressed while turning the ring to align the F with the index line. Release the button to lock the ring in the F position. The F setting locks the shutter wide open without interfering with the aperture function. With this setting the lens works exactly as an F-lens (page 69).

How to use the CF-lens

A. Lens in F mode (leaf shutter open)

Suggested procedure:

1. Turn the shutter speed ring to the F setting.
2. Operate the camera as described for the F-lens

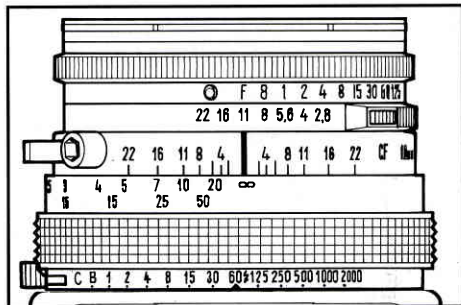

B. Lens in C mode (leaf shutter working)

When using the built-in leaf shutter in the CF-lens the focal plane shutter in the camera body must be disengaged. By setting the camera's shutter speed ring in the C position (page 22, 23) the focal plane shutter is turned into an auxiliary shutter, only used to protect the film from inadvertent exposure.

NOTE: The leaf shutter remains closed after the exposure, leaving the viewfinder screen dark until the camera is rewound.

Suggested procedure:

1. Check that the lens' shutter speed ring is **not** set at F.
2. Keep the lens catch button depressed while turning the **camera's** shutter speed ring to align the **C** at the end of the scale with the red index mark.
3. Release the lens catch button to lock the shutter speed ring in the **C** setting.

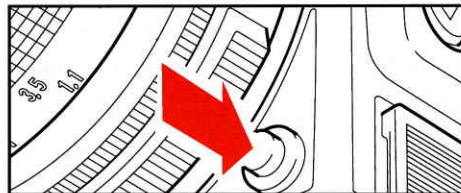
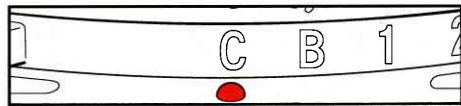
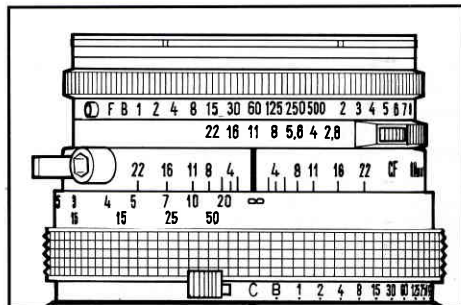

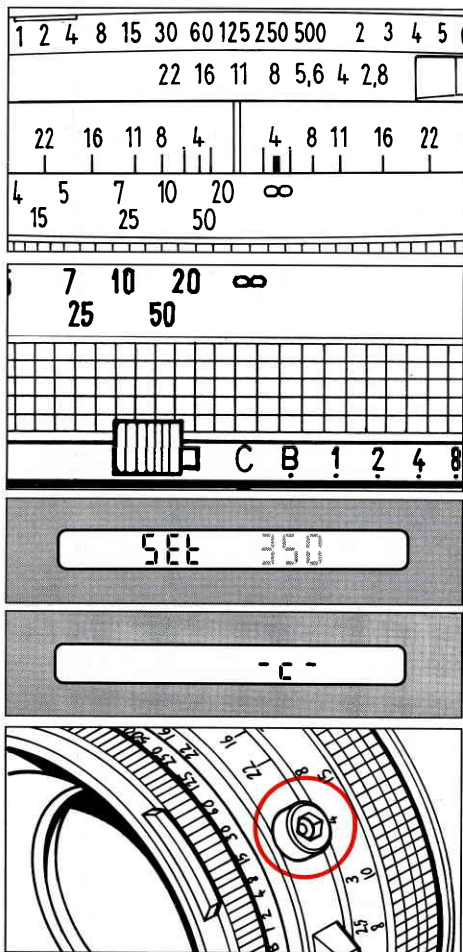

4. Pre-set the desired aperture and shutter speed on the **lens scales**.
5. Press the exposure button to make an exposure with the pre-set values.
6. Rewind the camera to get the viewfinder image back, advance the film to the next frame and to cock the lens shutter.

NOTE: If the selected camera mode is **Ab, D** or **A** the display indicates the proper shutter speed to be set on the lens' shutter, provided that the lens has been stopped down manually to the preselected f-stop. In the **M** mode, setting the camera's shutter speed ring at **C** turns off the entire metering system. The viewfinder display shows only (-c-) for the shutter speed when the exposure or pre-release button is depressed. The AE-lock button is inoperative.

Flash photography with CF-lens

The CF-lenses have a built-in X-type flash synchronization at all shutter speeds. Flash connection is the PC socket located on the **left hand side of the lens**, close to the depth-of-field scale.

Lens in F mode

Dedicated and non-dedicated Flash Units

The procedures are identical to the corresponding procedures for the F-lens (page 71).

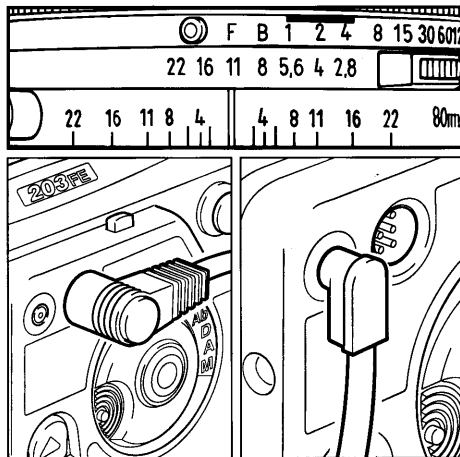

Lens in C mode

Dedicated Flash Unit

Although the metering system is turned off in C mode the TTL/OTF system is still working to control the dedicated flash unit directly – as with the Hasselblad Proflash 4504 – or through a suitable adapter. However, since the focal plane shutter is not working as a shutter the triggering of the flash must come from the shutter in the CF-lens. The green “ready” flash symbol works and the “Hi FLASH” and “Lo FLASH” warning indications may appear in the viewfinder when the exposure button is released.

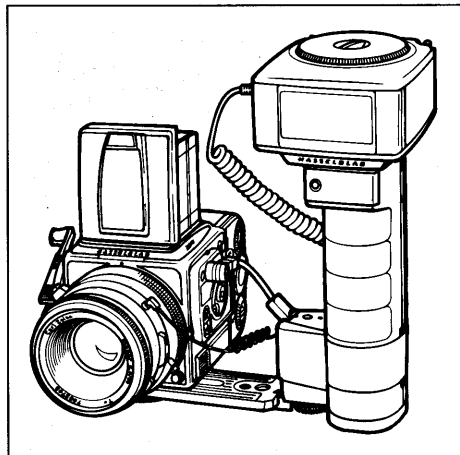

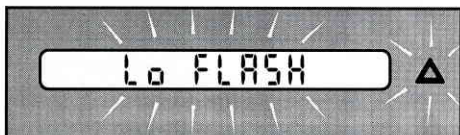
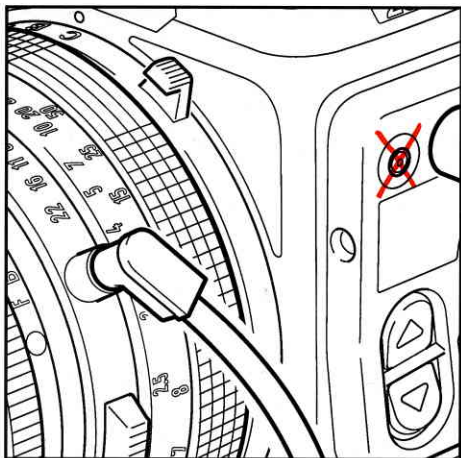

How to use the Dedicated Flash

(Camera shutter speed set at C)

Suggested procedure:

1. Attach the flash to the camera if desired.
2. Connect the TTL-cord according to the flash instruction.
3. Connect the PC-connector to the PC-socket on the CF-lens, **not** to the PC-socket in the camera body.
4. Set the flash unit in the desired mode of operation and switch it on. The green flash symbol in the viewfinder lights up when the flash is ready to fire.
5. Select shutter speed and pre-set aperture on the lens.
6. Press and release the exposure button to make an exposure, observing the viewfinder display for warning indications.
7. Rewind the camera to get the viewfinder image back, cock the shutter and advance the film to the next frame.

NOTE: When used at full power some electronic flash units have a flash duration longer than 1/500 s. To take advantage of the full flash power in such cases and to avoid "Lo FLASH" warning and under-exposure you are recommended to use shutter speeds of 1/125 s or slower.

Non-dedicated Flash Units

The non-dedicated flash unit should be connected to the PC-socket on the lens only. The exposure is controlled either by the flash itself or by aperture value settings calculated from the guide number of the flash (see the flash manual). There will be no indications or warnings in the viewfinder.

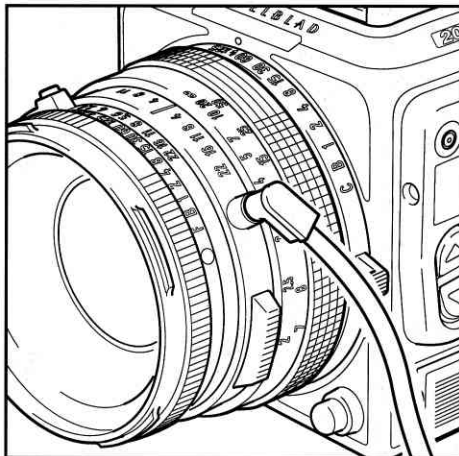

How to use the Non-dedicated Flash Unit.

(Camera shutter speed ring set at C).

Suggested procedure:

1. Attach the flash to the camera if desired.
2. Connect the synch cord to the PC-socket on the CF-lens, **not** to the PC-socket in the camera body.
3. Set the flash unit at the desired mode and switch it on.
4. Select and pre-set aperture and shutter speed (preferably 1/125 s or slower).
5. Press the exposure button to make an exposure.
6. Rewind the camera to get the viewfinder image back, cock the shutter and advance the film to the next frame.

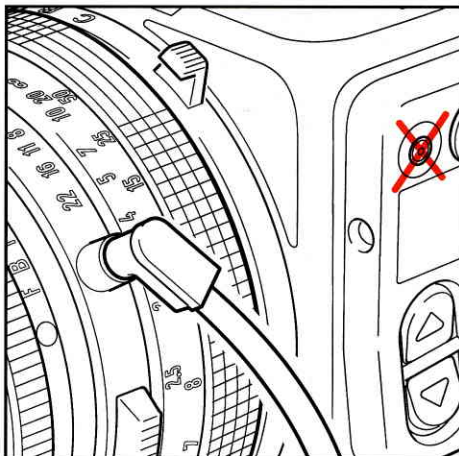

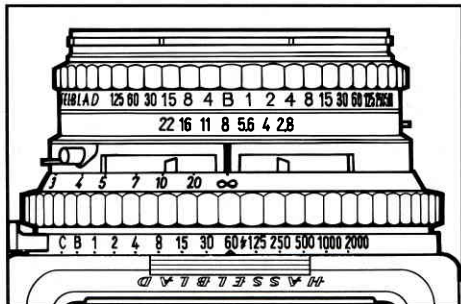
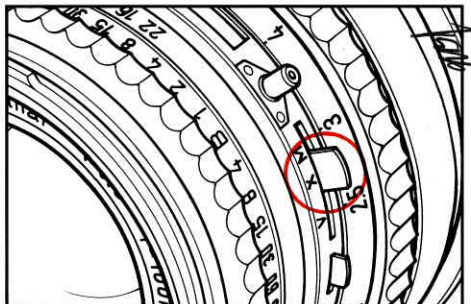
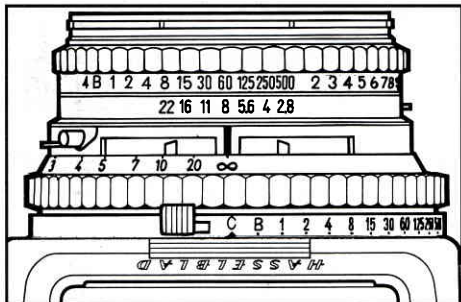

C-lenses

The older C-lenses (production terminated in 1982) look different but are in most respects identical to the CF-lenses. There are, however, four major differences:

1. There is no F-setting on the shutter.
2. The shutter speed and aperture rings are normally interlocked.
3. There are two different flash synchronization modes.
4. There is a built-in mechanical selftimer.

How to use the C-lens

Avoid using the focal plane shutter together with a C-lens. If it cannot be avoided follow the procedure below:

1. Set the lens shutter at **B**.
2. Pre-set the desired aperture.
3. Set the camera shutter at the desired shutter speed.
4. Press the exposure button to make an exposure.
5. Rewind the camera to get the viewfinder image back, cock the shutter and advance the film to the next frame.

Lens in C mode

The procedure is identical with the CF-lens procedure (page 85).

Flash photography with the C-lens

Using the camera's focal plane shutter

With the lens shutter set at B the lens can be used as an F-lens.

Dedicated and Non-dedicated Flash Units

Follow the corresponding procedures for the F-lens (page 71).

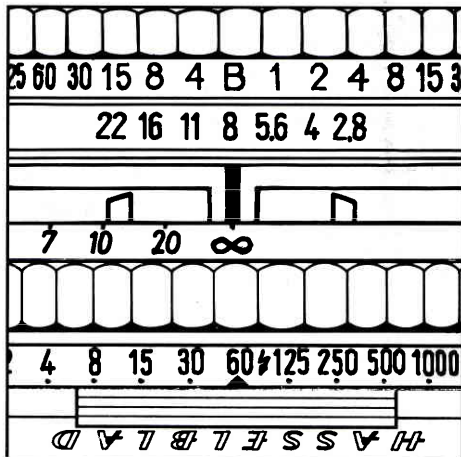

Using the C-lens' leaf shutter

Make sure that the flash mode selector is set at X.

Dedicated and Non-dedicated Flash Units

Follow the corresponding procedures for the CF-lens (page 87).

