

This camera manual library is for reference and historical purposes, all rights reserved.

This page is copyright by mike@butkus.org M. Butkus, N.J.

**This page may not be sold or distributed without the expressed
permission of the producer**

I have no connection with any camera company

If you find this manual useful, how about a donation of \$3 to: M. Butkus, 29 Lake Ave., High Bridge, NJ 08829-1701 and send your E-mail address too so I can thank you. Most other places would charge you \$7.50 for a electronic copy or \$18.00 for a hard to read Xerox copy. These donations allow me to continue to buy new manuals and maintain these pages. It'll make you feel better, won't it?

If you use Pay Pal, use the link below. Use the above address for a check, M.O. or cash. Use the E-mail of butkusmi@ptd.net for PayPal.



[back to my "Orphancameras" manuals /flash and light meter site](#)

Only one "donation" needed per manual, not per multiple section of a manual !

The large manuals are split only for easy download size.

HASSELBLAD

SWC/M

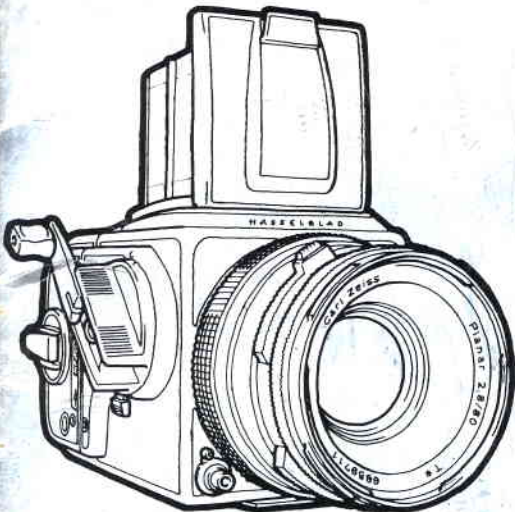

500C/M

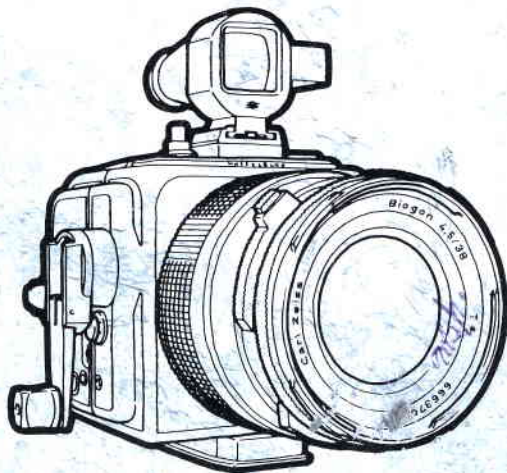

Instruction Manual

Guarantee

If within one year from date of original purchase, this Hasselblad photographic product fails to function because of defects in materials or workmanship, Victor Hasselblad Aktiebolag will, at its option, either repair or replace the product, provided the purchaser returns the product to a Hasselblad authorized service station and submits proof of date of original purchase.

Service and maintenance

Cameras and lenses put to heavy-duty professional use should be serviced by an authorized Hasselblad service center at regular intervals. The lubrication in cameras and lenses that are unused for long periods, (6 months or more) can dry out. This may lead to increased wear, and a poorer operation. To avoid drying, operate stored equipment from time to time, exposing a couple of times at each shutter speed. In this way the lubrication will be distributed in the mechanism and the equipment will be kept in good condition.

Copyright © 1985, Victor Hasselblad AB.

All rights reserved. No part of this material may be reproduced, stored in a retrieval system, or transmitted, in any form or by any means, electronic, mechanical, photocopy, recording, or otherwise, without the prior written permission of the Company.



Hasselblad 500C/M

The Hasselblad 500C/M is a medium format single-lens reflex camera featuring lens, magazine, viewfinder, and focusing screen interchangeability.

The extensive Hasselblad system of accessories provides unlimited photographic scope. It is a system capable of taking your photography to inner, or outer space, and almost anywhere in between.

The rugged dependability of the Hasselblad 500C/M is already a legend, but it is a precision instrument, and as such it requires skill and know-how in its operation in order to yield the best photographic result.

Please take a little time to read the contents of this instruction manual. Follow the picture sequence for the best initial operation of your 500C/M. Full operating potential is described – enabling you to make the very most of your new camera.

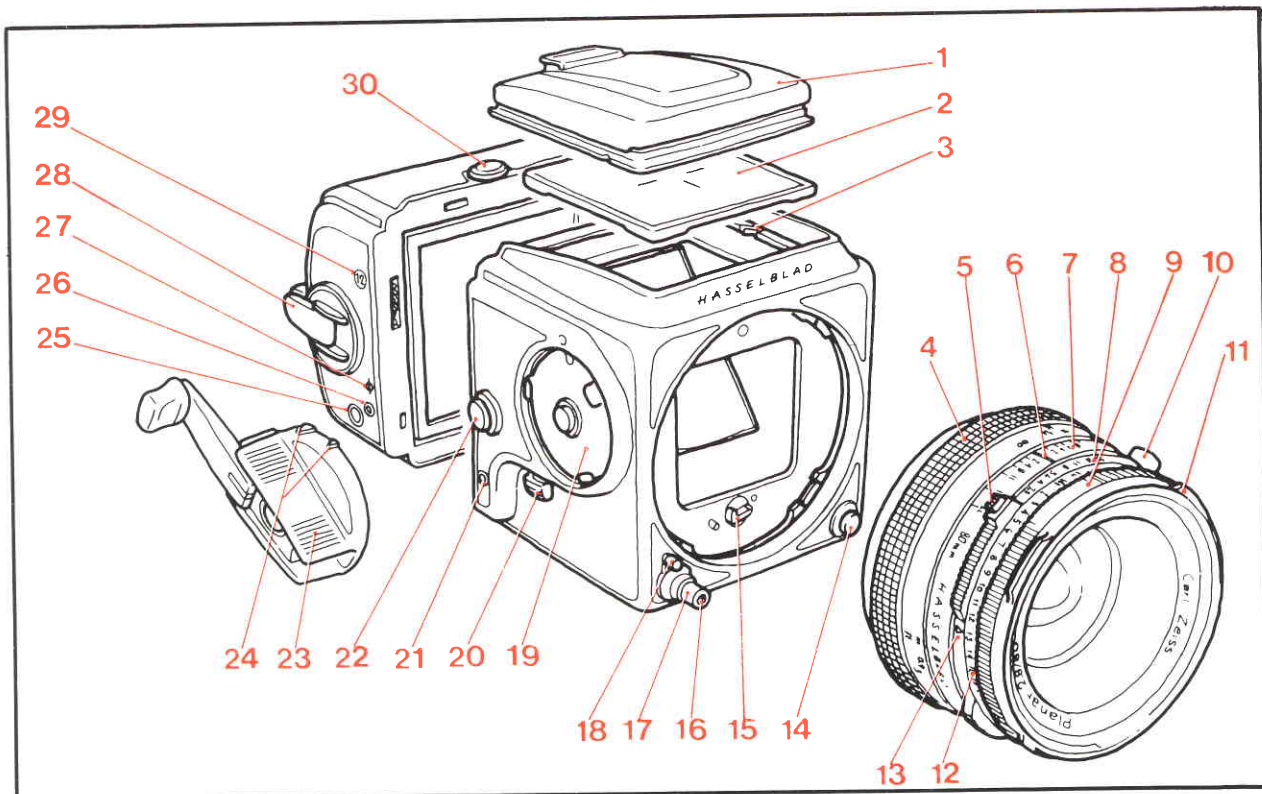

- | | | |
|--|---|-------------------------------|
| 1. Focusing hood | 10. PC flash terminal | 20. Pre-release button |
| 2. Focusing screen | 11. External and internal lens accessory mounts | 21. Shutter status indicator |
| 3. Screen retaining clip | 12. Exposure value scale | 22. Strap lug |
| 4. Lens focusing ring with distance scale | 13. Exposure value index | 23. Winding crank |
| 5. Button for cross-coupling of shutter speed and aperture rings | 14. Lens lock release button | 24. Winding crank index |
| 6. Central index | 15. Main drive axle | 25. Frame counter |
| 7. Depth-of-field scale | 16. Threaded cable release socket | 26. Magazine status indicator |
| 8. Aperture ring with aperture scale | 17. Main camera release button | 27. Film plane indicator |
| 9. Shutter speed selector ring | 18. Time exposure catch | 28. Film winding crank |
| | 19. Winding crank bayonet | 29. Magazine designation |
| | | 30. Magazine catch |

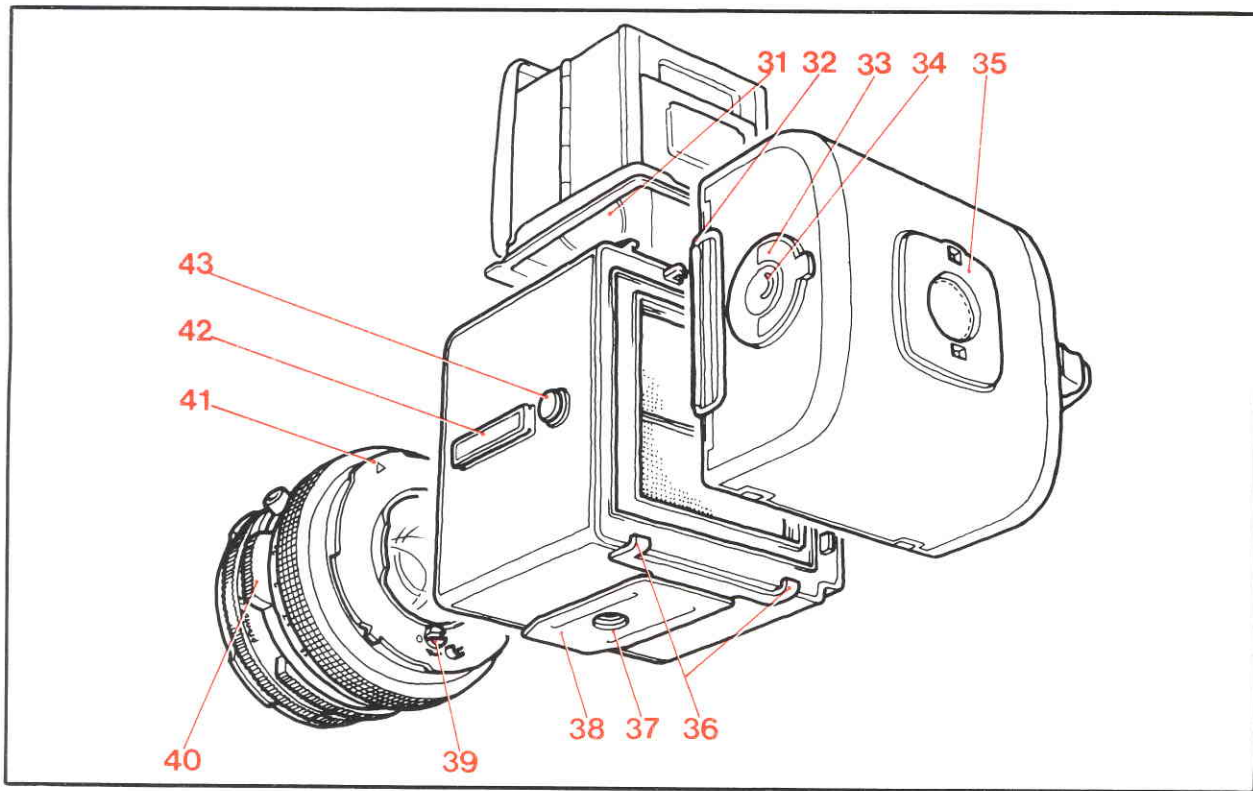

- 31. Focusing hood magnifier
- 32. Magazine slide
- 33. Roll holder key
- 34. Film consumption indicator
- 35. Film speed and type indicator

- 36. Magazine support hooks
- 37. 3/8" tripod socket
- 38. Quick coupling plate
- 39. Lens drive axle
- 40. Depth-of-field preview button

- 41. Lens locating index
- 42. Accessory rail
- 43. Strap lug

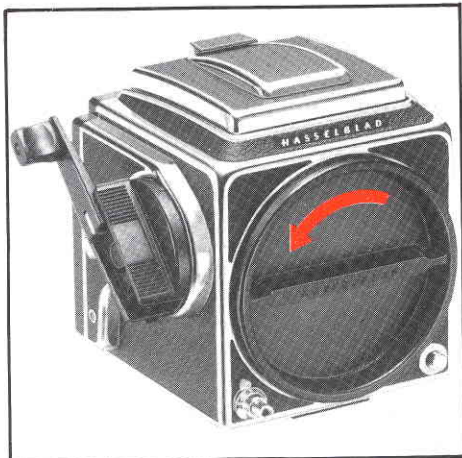

Front protective cover

Turn the cover (bayonet fitting) in the direction of the arrow and remove.

NOTE: The front protective cover may only be removed when the camera is cocked (fully wound).



Rear protective cover

Depress the catch and swing back the cover. Lift the cover off the magazine support hooks.

Opening the focusing hood

Lift the lid firmly at the rear edge, and swing it up to the vertical position.

The built-in magnifier

The magnifier flips up into the viewing position when the oval button is moved in the direction of the arrow.

To re-fold the magnifier simply press it down with a fingertip until it locks back into the lid.

The magnifier may be changed for a correction lens. See page 13.

Closing the focusing hood

"Pinch" in the side plates at the hinge points, and fold down the lid.

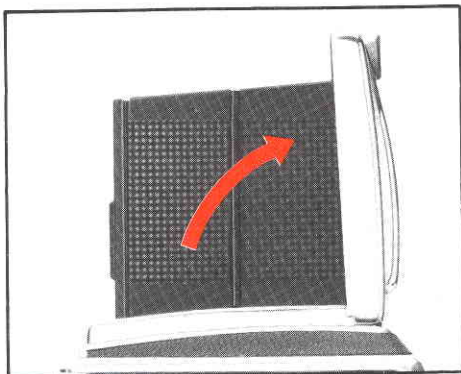

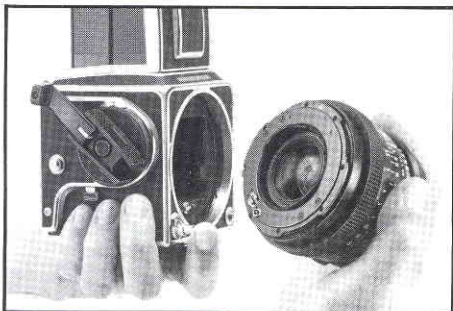

Lenses

Since the early 1950's Hasselblad lenses have been manufactured by Carl Zeiss in West Germany. The Hasselblad 500C/M uses CF and C lenses made by Carl Zeiss.

With the exception of "F" type lenses all Hasselblad lenses manufactured since 1957 can be used with the 500C/M. **F-lenses can only be used with the Hasselblad 2000 series cameras.**

Attaching a Hasselblad lens

Make sure the camera is fully cocked. The picture shows the correct relation between the camera's drive axle and the red index.

Ensure that the lens is cocked. The slot on the drive axle must be aligned with the adjacent red dot, as shown in the picture. If this is not the case, insert a coin in the drive axle slot and turn it **in the direction of the arrow** until it locks.

Align the red index on the lens bayonet with the corresponding index on the body bayonet.

Insert the lens and rotate it clockwise. A faint click can be heard as the lens lock drops into place. The lens will now turn no further and is fully locked on.

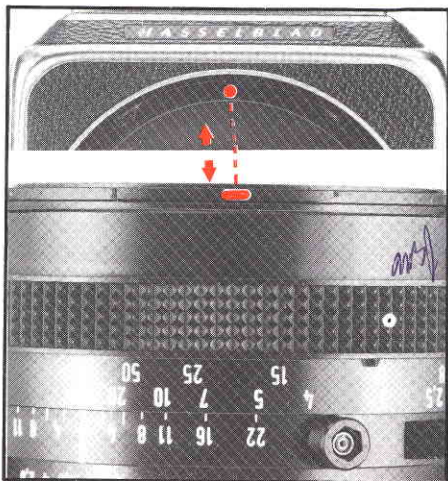
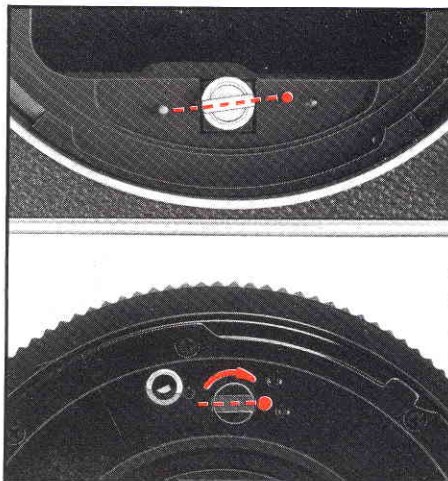



Diaphragm

CF lenses have an automatic diaphragm that stops down to the working aperture immediately prior to exposure.

Shutter speeds

The shutter speed selector ring is the ring located closest to the front of the lens. The desired shutter speed is set against the main lens index.

The white scale shows the shutter speeds, and the orange scale the exposure values.

The green F setting is only used when the lens is attached to a Hasselblad camera in the 2000 series. The F setting disconnects the leaf shutter in the lens which then allows a 2000 series camera to function in the focal plane shutter (F) mode. Diaphragm operation is not effected. The F setting can only be made after depressing the green detent button.



Exposure values

The aperture and shutter speed combination set opposite the central lens index determines exposure. Every combination of shutter speed/aperture has an equivalent exposure value (EV).

Cross-coupled shutter speed/aperture

When the cross-coupling button is depressed, the lens aperture ring and shutter speed ring are locked together and rotate simultaneously. In this manner, speed/aperture combinations may be altered without changing the exposure value (EV).

Should you for example wish to change from $f/8$ to $f/11$, the shutter speed ring will automatically be moved to a correspondingly slower shutter speed. The reverse is also true. A change in shutter speed will bring about a corresponding compensation of the aperture setting.

Focusing and depth of field

The lens is focused with the focusing ring (the rubberized ring closest to the camera body). Rotate the ring until the viewfinder image is sharp.

The distance between the subject and the film plane is read off the focusing ring's distance scale opposite the central index. The distance in meters is shown in white numerals, and the distance in feet is in orange numerals.

Objects closer or further away than the selected distance can be sharp, within certain limits. The borders for this field of sharp focus, i.e. depth of field, vary with the f/stop.

A small f/stop yields wide depth of field.

A large f/stop yields narrow depth of field.

The depth of field available at any given f/stop can be read off the depth-of-field scale located on both sides of the central index.

Viewing depth of field

Depth of field may be viewed by stopping down the diaphragm to the required aperture, and viewing the resulting image on the ground glass.

To stop down the diaphragm, simply slide the manual preview button downwards until it locks into the preview position.

To release the button, and reopen the diaphragm, press in the lower section of the button.

Infrared photography

Infrared (IR) rays (wavelengths longer than 800 nanometers) are refracted to a focal plane somewhat behind the focal plane of the visible light images formed on the focusing screen. To compensate for this discrepancy, proceed as follows:

Focus as usual on the focusing screen. Then rotate the focusing ring until the distance set is opposite the red IR index.

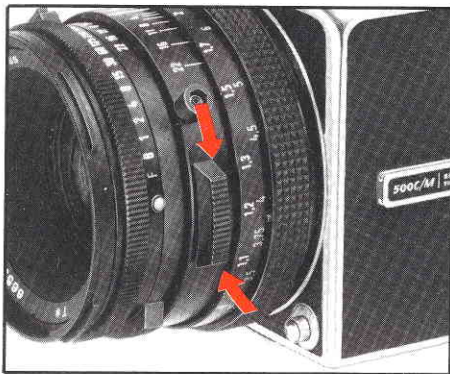

Lens removal

Depress the lens release button and rotate the lens counter-clockwise about one fifth of a turn to remove it.

Note. Lens removal is only possible if the camera is cocked (fully wound), and not in the pre-released mode.

Film magazines

Attaching the magazine

Ensure that the magazine slide is fully inserted, and that the indicator is white. If the status indicator does not show a white signal then refer to the instruction on page 9.

Locate the magazine on the lower support hooks – see that it is fully seated on the supports.

Slide the magazine catch to the right and hold it there whilst swinging the magazine forward into contact with the camera's rear plate. Release the magazine catch, ensuring that it returns to the locked position on the left side.

Remove the magazine slide and the camera is ready to shoot.

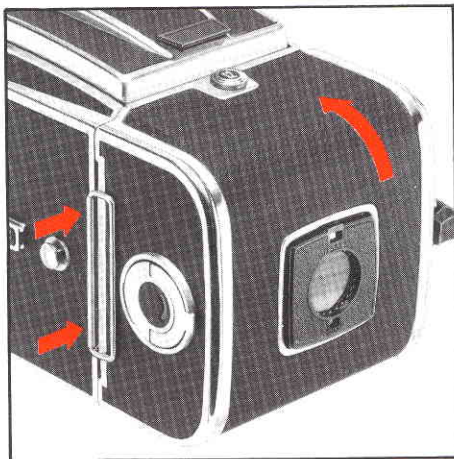

Removing the magazine

Ensure that the camera is cocked (fully wound on).

The magazine and camera indicator windows should both display white. (If the magazine indicator window shows a red signal then follow the instructions on the next page.)

Insert the magazine slide into the magazine.

Slide the magazine catch to the right.

Swing back the magazine, and lift it off the lower supports.

The magazine cannot be removed without inserting the magazine slide. The slide protects the film from fogging. Note also that the camera cannot be fired when a magazine, with slide inserted, is attached to the camera.

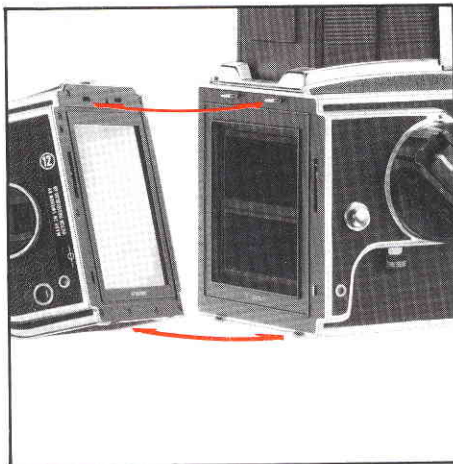

The magazine and camera indicator windows

The indicator signals on the right side of the camera and magazine show if the particular unit is ready to fire (white) or if it has been fired (red). The golden rule is, that when attaching a magazine to a camera, the signal colours should match – white to white, or red to red. There are only two incorrect combinations. This is how to rematch the signals.

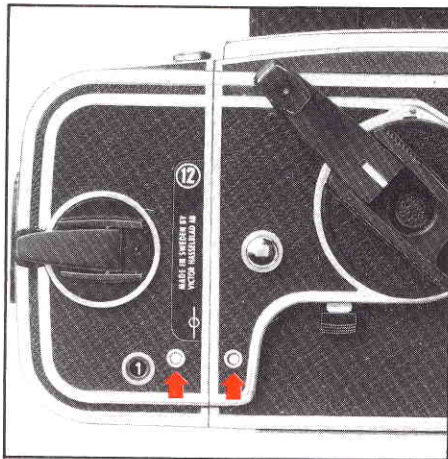

Red magazine – white camera

Remove the magazine from the camera.

Fire the camera – its signal will change to red.

Attach the magazine.

Rewind the camera with one full turn of the winding crank.

Both signals will now display white.

White magazine – Red camera

Remove the magazine from the camera.

Wind on the camera with one full turn of the winding crank. The camera status signal will change to white.

Replace the magazine. Both signals will now display white.

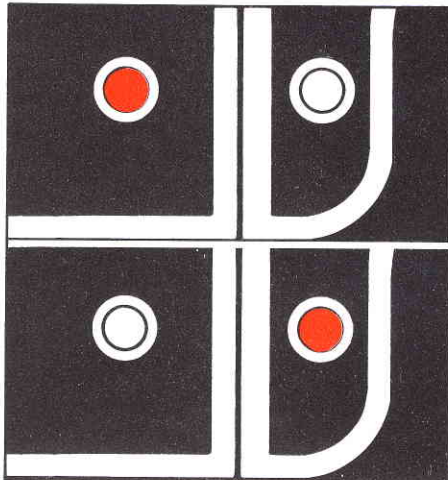

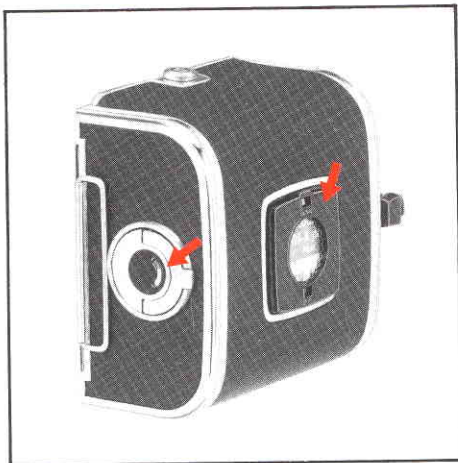

Load status and film type indicators

In the center of the roll holder key is a crescent shaped indicator that displays white when the film is loaded into the magazine, and progressively changes to red as the film is wound on. A completely red signal indicates that either the final frame is exposed, or that the magazine is empty.

The film indicator at the rear of the magazine can be set to the sensitivity of the film in use – in ASA or DIN.

The indicator hinges out to accept the lid of a film carton informing the user of film type, as well as sensitivity.

Loading the magazine

The magazine may be loaded on, or off the camera. If the magazine is to be loaded off the camera then the magazine slide must be inserted, and have its flat side towards the rear of the magazine. This facilitates removal of the roll holder for loading.

- 1) Fold out the roll holder key.
- 2) Turn the key **counter-clockwise** and withdraw the roll holder.
- 3) Place an empty spool under the spool clamp bar – closest to the splined knob. Insert a roll of film under the other end of the bar, ensuring that it is turned the same way as in the picture. Be careful to remove **all** the paper tape that surrounds a new roll of film.
- 4) Turn the roll holder key **clockwise** so that the film clamp opens. Pull 3 to 4 in. of paper backing off the film roll and slide the edge under the clamp.
- 5) Insert the tongue of the backing paper into the slot in the take-up spool.
- 6) Turn the splined knob **clockwise** until the arrow on the paper backing is opposite the triangular index on the spool clamp bar.
- 7) Turn the roll holder key **counter-clockwise** and insert the roll holder into the magazine – jiggling it a little if it does not click into place. Lock the roll holder into the magazine by turning the key **clockwise**.
- 8) Fold out the film crank and rotate it **clockwise** about ten turns until it stops. Refold the crank.

Number 1 will now be displayed in the frame counter window and the magazine is loaded – ready for use.

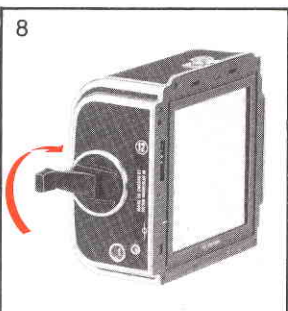
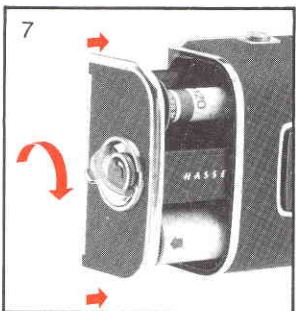
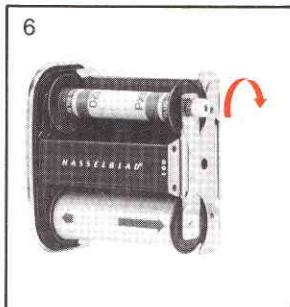
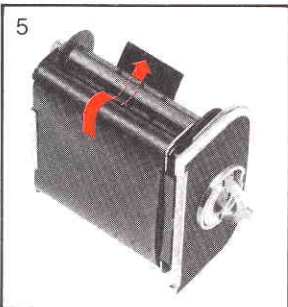
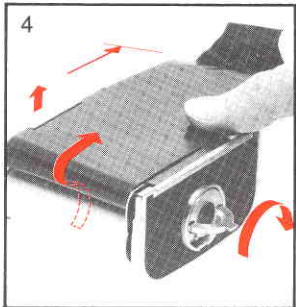
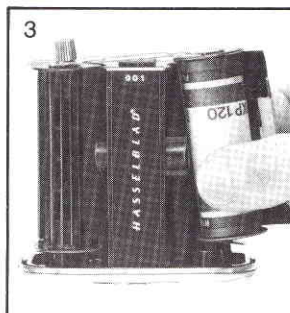
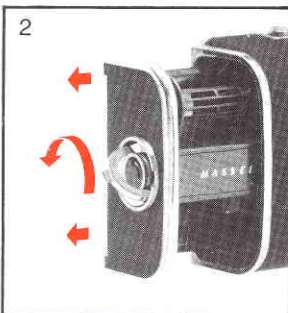
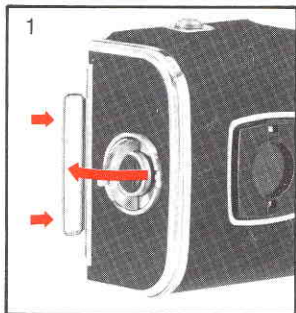

Removing film from the magazine

When the last frame has been exposed, and wound on, the magazine is blocked for further release.

Wind off the film by folding out the film winding crank, and rotating it clockwise until the film is felt to clear the spool.

The roll holder may now be withdrawn from the magazine and the exposed film removed.

General

The magazine's film winder crank is only blocked at frame 1. A partially exposed film may be wound off at any frame thereafter.

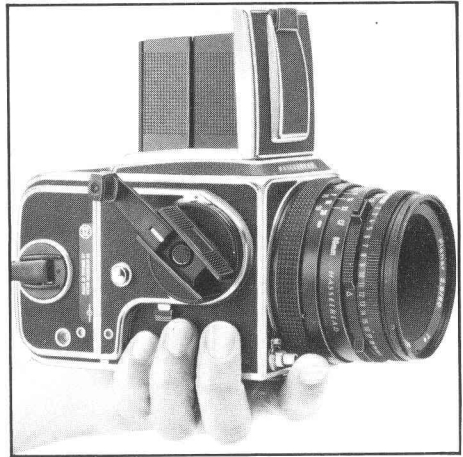

Left hand grip

The accompanying picture shows the best way to hold the camera whilst shooting.

The camera is cradled in the left hand with the left index finger on the release button.

This leaves the right hand free for rewinding, focusing, exposure settings and change of lens or magazine.

Make a habit of the left hand grip!

Focus and shoot

Remove the magazine slide from the magazine. A safety interlock now prevents magazine removal. The release button (previously blocked) is freed ready for exposure.

Rotate the focusing ring on the lens until the subject is sharp in the viewfinder.

Depress the shutter release button to fire the camera.

Exposure

As a general rule for all exposure with the time exposure lock at the O setting, the shutter release must be kept depressed until the built-in leaf shutter has opened and closed fully. This is especially important at shutter speeds from 1 s to 1/15 s.

If pressure on the release is relaxed too soon, the auxiliary shutter will terminate the exposure prematurely.

The auxiliary shutter, which consists of two blinds, can be seen through the rear opening of the camera body.

Warning signal

There is a red marking on the shutter speed scale opposite the 1, 1/2, and 1/4 s. This is to warn against possible exposure errors. The auxiliary shutter remains open as long as pressure is maintained on the shutter release.

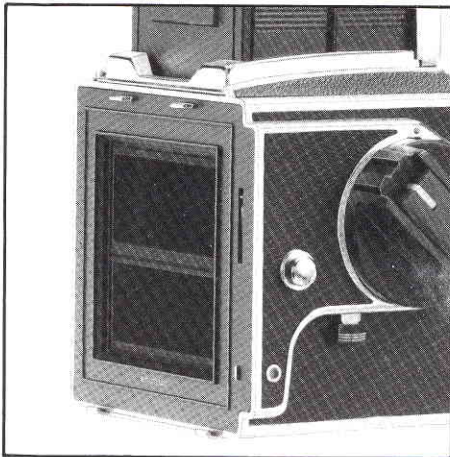

Double exposure

Proceed as follows when multiple exposures are desired on the same frame:

Depress the main release button and make the initial exposure.

Insert the magazine slide and remove the magazine.

Rewind the camera with one full revolution of the winding crank.

Replace the magazine and remove the slide.

The unit is now ready to make a second exposure on the same frame.

Additional exposures may be made in the same manner.

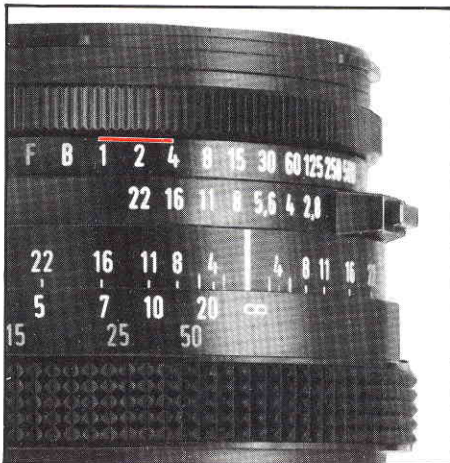

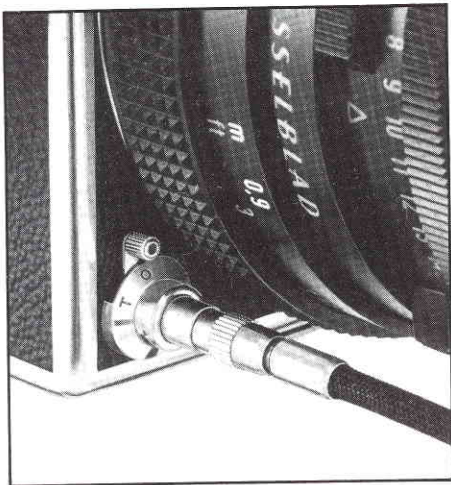

Time exposure lock

The time exposure lock has two settings: O (= disengaged) and T (= depressed shutter release locks in the depressed position until the lock is returned to the O setting).

The T setting can thus be used for time exposure when the shutter is set at B.

Film cannot be advanced until the lock is reset to O.

The setting cannot be used in operation with a cable release.

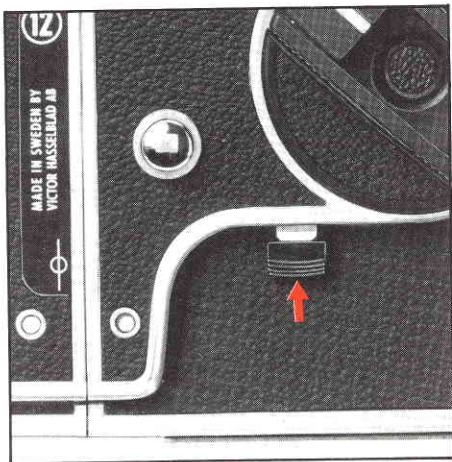

Pre-release

To reduce the low level of camera-induced shake to a minimum, the camera can be pre-released by pressing the pre-release button. This is what happens when the pre-release button is pressed: the mirror flops up, then lens stops down to the preset working aperture, the auxiliary shutter opens, and the shutter closes (but remains cocked).

When the shutter release is pressed, only the operation of the shutter remains. Since the image on the focusing screen disappears in a pre-released camera, a sports viewfinder is a good way to keep track of moving subjects.

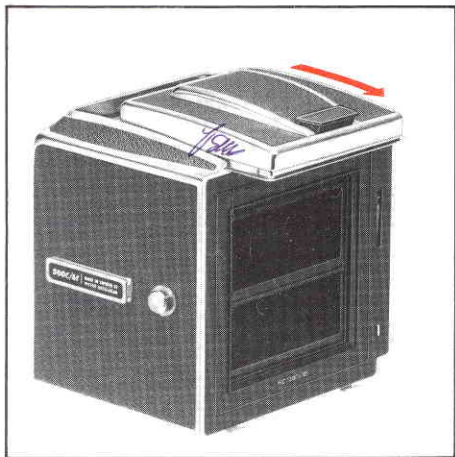

Change of focusing hood or viewfinder

The film magazine must be detached before the focusing hood or other viewfinder can be removed.

Remove the hood by sliding it to the rear in its guide slots.

Slide the replacement finder into the slots and push it forward.

Attach a magazine to the camera.

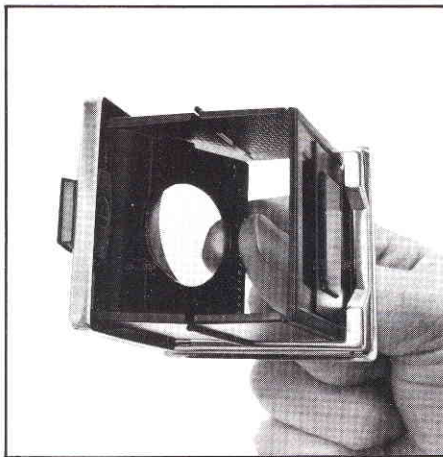

Changing the magnifier

The focusing hood has an easily interchangeable magnifier, if you should need to compensate for eyesight variations.

Magnifiers with correction factors from +3 to -4 are available, and are easily interchanged by following these instructions:

Remove the focusing hood from the camera and open it by lifting the lid firmly at the rear edge.

Bring the magnifier to the viewing position by moving the oval button in the direction of the arrow.

Push the magnifier half way back down to its folded position.

Grip the lower edge of the magnifier between thumb and forefinger (through the underside of the hood), and pull firmly.

Insertion of the replacement magnifier is the reverse of the above procedure.

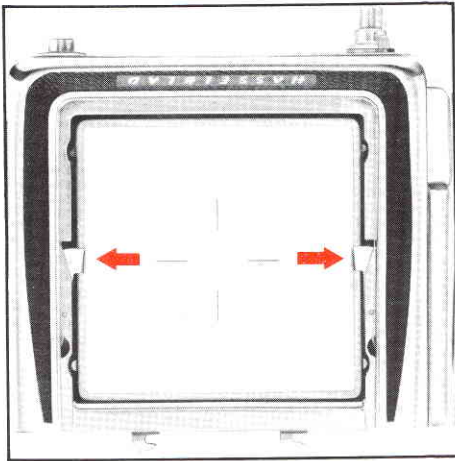

Changing the focusing screen

The screen is quickly interchangeable without the requirement of special tools.

Detach the magazine and viewfinder.

Slide the screen latches to the side.

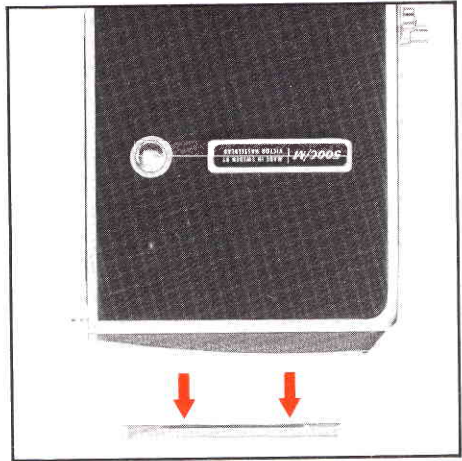

Cup your hand over the screen, and invert the camera.

The screen will now drop into your hand.

Insert the replacement screen, ensuring that the smooth flat side of the frame is uppermost, and that all four corners are seated on the support pins.

It is not necessary to return the screen latches. This is done automatically when the viewfinder is replaced.

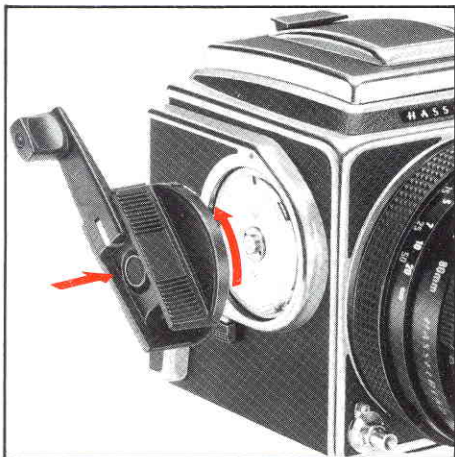

The winding crank

One complete revolution of the winding crank re-cocks the camera and lens, it also transports the film one frame.

Removing the winding crank

It is preferable that the camera be fully wound-on during removal, and especially during replacement of the crank.

Depress the latch button in the center of the winding crank and turn off the crank – **counter clockwise**.

Attaching the winding crank

Locate the winding crank against the camera's winding crank bayonet with the crank index opposite the camera index. Push in the crank lightly and turn it in a clockwise direction until it locks on.



Flash synchronization

The Hasselblad 500C/M uses lenses from the Hasselblad CF series. These lenses have built-in leaf shutters with speeds from 1 to 1/500s. Flash synchronization occurs at full shutter opening via the PC flash terminal.

Electronic flash units can be used at all shutter speeds, 1–1/500.

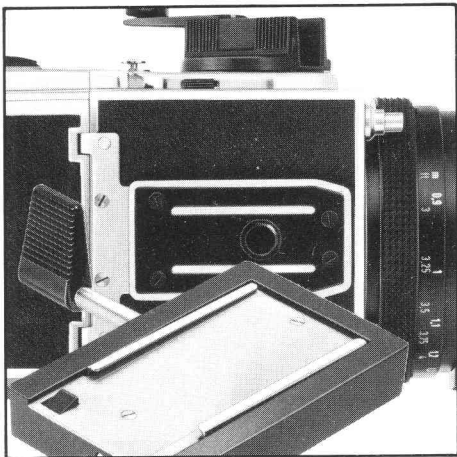

Accessory mounts

On the underside of the camera is a 3/8" tripod socket. The socket is located in the center of a quick coupling plate that accepts pistol grips, and flash gun brackets. A special attachment is available for tripods that will receive, and lock on to, the camera's quick coupling plate.

In front of the strap lug on the left side of the camera is an accessory rail for the Hasselblad sports finder, spirit level, and adjustable flash shoe.

The lenses accept filters and lens shades via internal and external bayonet mounts.



Strap lugs

Strap attachment

Place the main body of the strap clip over one of the camera's strap lugs. Press down on the tip of the clip and pull back so that the strap lug slips into the opening at the tip of the clip.

Strap removal

Lift the clip locking plate and slide the clip forward. The clip will then slide off the strap lug.

Accessories

A wide range of accessories is available for almost every photographic purpose.

Please see the Hasselblad Product Catalog for further information.

Hasselblad SWC/M

The Hasselblad SWC/M is a wide-angle camera with a permanently attached lens and an optical viewfinder.

The uncompromising design of the 38 mm f/4.5 Zeiss Biogon CF yields a 90° diagonal angle of view and displays exceptional distortion correction. Spirit level alignment is viewed at eye level via a prism mounted on the optical viewfinder.

Through the lens viewing is possible via a focusing screen adapter, and any one of the many Hasselblad viewfinders.

The Hasselblad SWC/M consists of three main components:

The camera body with its permanently attached Biogon lens, the detachable optical viewfinder, and the interchangeable film magazine, which also fits the other Hasselblad cameras.

Operating instructions for the lens and magazine are covered under the 500C/M section of this instruction manual.



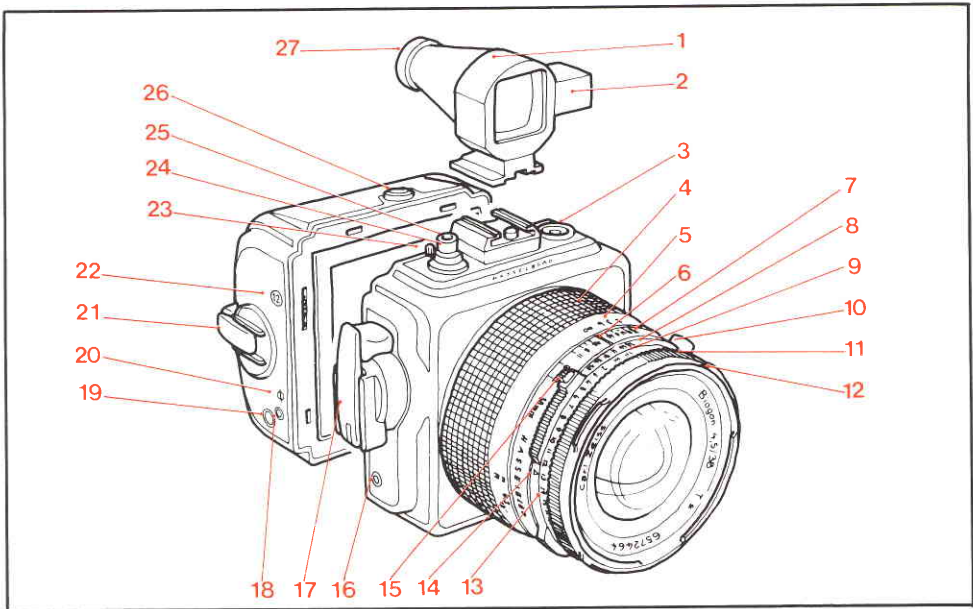

- | | | |
|--------------------------------------|---|-----------------------------------|
| 1. Viewfinder | 10. PC flash terminal | 19. Frame counter |
| 2. Reflector prism for spirit level | 11. Shutter speed ring | 20. Film plane indicator |
| 3. Spirit level | 12. External and internal lens accessory mounts | 21. Film winding crank |
| 4. Focusing ring | 13. Exposure value scale | 22. Magazine designation |
| 5. Distance scale (feet and meters) | 14. Exposure value index | 23. Time exposure lock |
| 6. Central index | 15. Button for cross-coupling of shutter speed and aperture rings | 24. Shutter release button |
| 7. Depth-of-field scale | 16. Shutter status indicator | 25. Threaded cable release socket |
| 8. Aperture ring with aperture scale | 17. Winding crank | 26. Magazine catch |
| 9. Shutter speed scale | 18. Magazine status indicator | 27. Protective rubber ring |

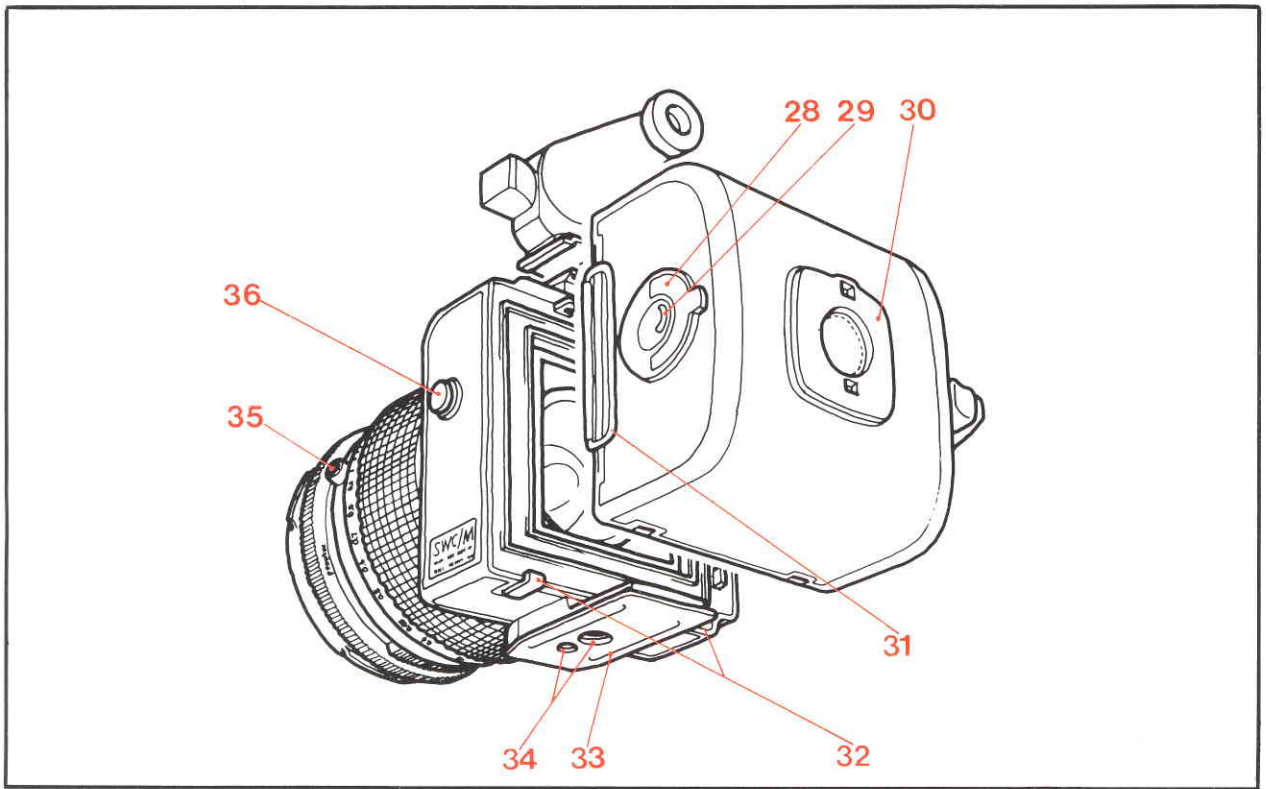

- | | |
|-----------------------------------|------------------------------------|
| 28. Roll holder key | 33. Quick coupling plate |
| 29. Film consumption indicator | 34. Tripod sockets – 3/8" and 1/4" |
| 30. Film speed and type indicator | 35. PC flash terminal |
| 31. Magazine slide | 36. Strap lug |
| 32. Magazine support hooks | |

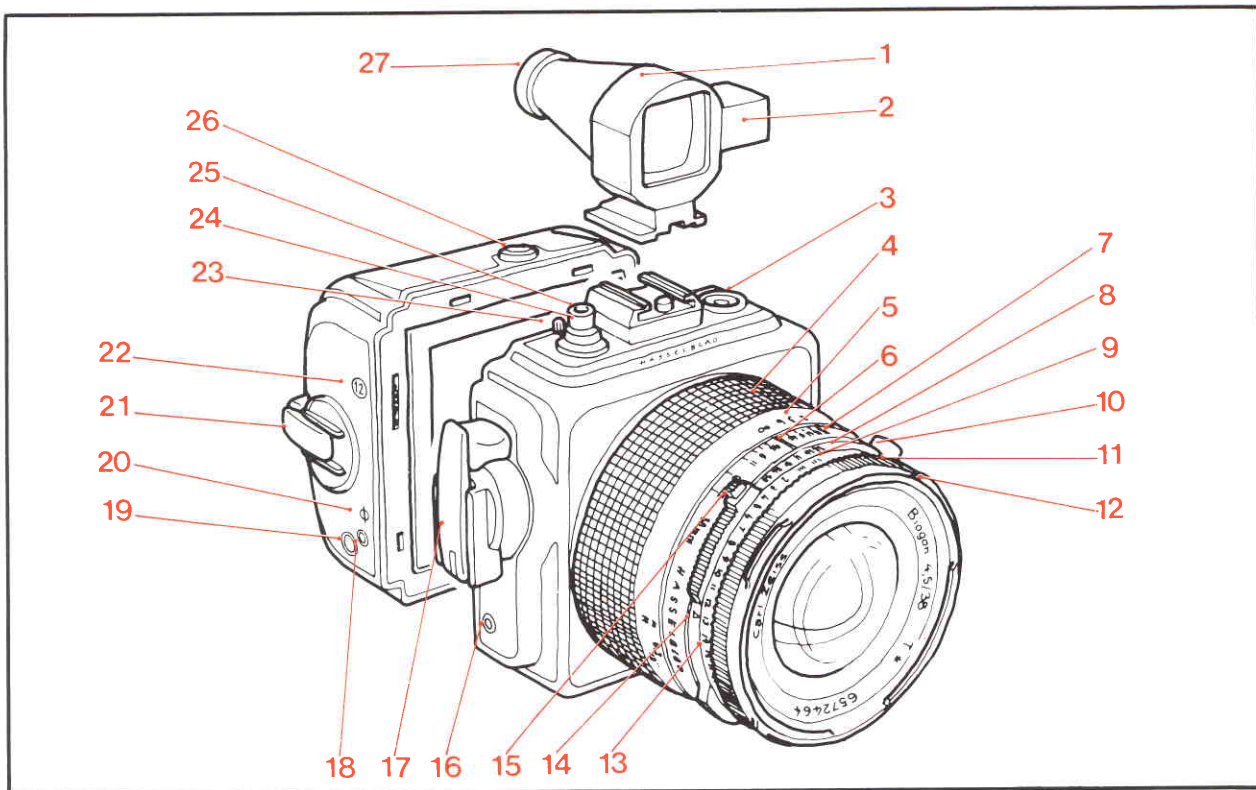

- | | | |
|--------------------------------------|---|-----------------------------------|
| 1. Viewfinder | 10. PC flash terminal | 19. Frame counter |
| 2. Reflector prism for spirit level | 11. Shutter speed ring | 20. Film plane indicator |
| 3. Spirit level | 12. External and internal lens accessory mounts | 21. Film winding crank |
| 4. Focusing ring | 13. Exposure value scale | 22. Magazine designation |
| 5. Distance scale (feet and meters) | 14. Exposure value index | 23. Time exposure lock |
| 6. Central index | 15. Button for cross-coupling of shutter speed and aperture rings | 24. Shutter release button |
| 7. Depth-of-field scale | 16. Shutter status indicator | 25. Threaded cable release socket |
| 8. Aperture ring with aperture scale | 17. Winding crank | 26. Magazine catch |
| 9. Shutter speed scale | 18. Magazine status indicator | 27. Protective rubber ring |



How to hold the SWC/M

Cradle the lens in your left hand with your thumb and index finger curled around the focusing ring. The right hand steadies the grip, while the right index finger rests on the shutter release.

Exposure

The Hasselblad SWC/M has a top mounted shutter release button. When making an exposure depress the shutter release smoothly.

Note. In order to release the camera the shutter must be cocked and the magazine slide removed.

The release button is threaded to accept a standard cable release.

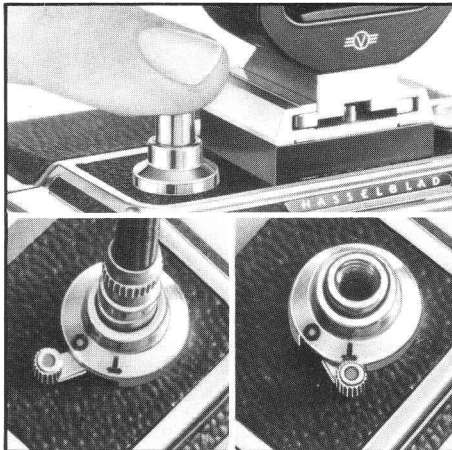

Time exposure lock.

The time exposure lock has two settings:

O = Normal setting

T = Release button locks after being depressed and remains locked until the lever is returned to the O setting.

The T setting is used for time exposures when the lens is set at B.

The film cannot be advanced with the crank until the exposure lock is returned to the O setting.

Note. This locking function will not operate when a cable release is attached.

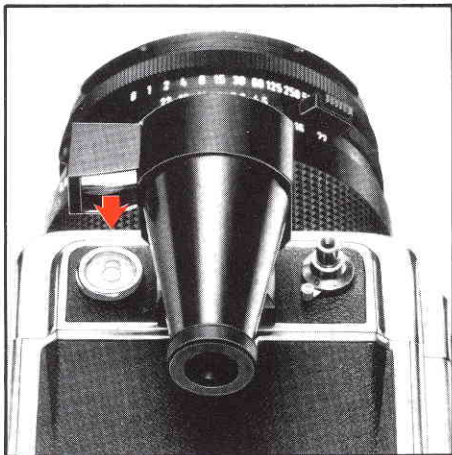

Viewfinder

The optical finder shows the picture area, and a simultaneous view – via the prismatic reflector – of the spirit level. The reflector makes it possible to keep a continuous check on the spirit level during hand held use of the camera.

The finder has the same angle of view as the lens but takes in a slightly larger field because of the finders location behind the lens:

Top of the field: 6 ins larger.

Bottom of field: finder and lens coincide.

Sides of fields: 3 ins wider on each side.

This is the case regardless of the lens to subject distance.

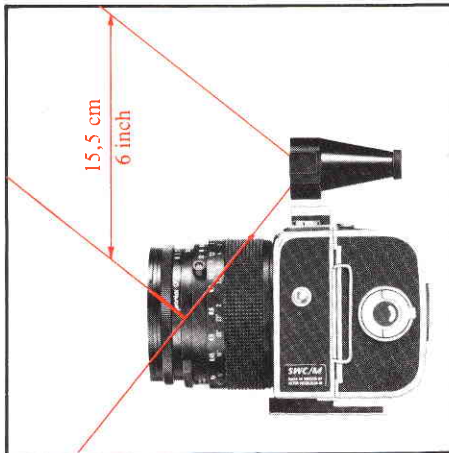

Lens

The lens is fixed and is not interchangeable with other Hasselblad lenses.

Operating instructions are covered under the lens section of the 500C/M instructions in this manual.

Magazines

The SWC/M accepts all Hasselblad magazines with the exception of the Polaroid 80 magazines.

For operating instructions please refer to the magazine section of the 500C/M instructions in this manual.



Magazine for Polaroid film

When a magazine for Polaroid film is used with the SWC/M the film crank cannot complete its wind.

In order to cock the camera proceed as follows:

Fold out the crank.

Attach a magazine for Polaroid film.

Make an exposure.

Move the crank up and down with a pumping motion until it stops.

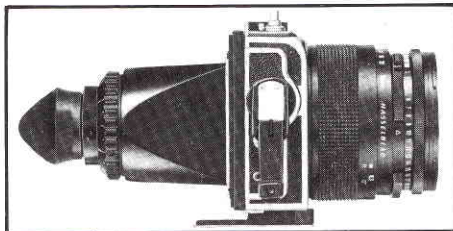

The focusing screen adapter 41025

The focusing screen adapter is used when an exact check on depth of field or image composition is necessary. It is attached to the camera in the same way as a magazine.

The focusing screen adapter accepts all Hasselblad viewfinders and focusing hoods.

Viewing via the focusing screen adapter 41025

Set the shutter at B.

Set the lens at the maximum aperture.

Set the time exposure lock at T.

When viewing is completed, return the time exposure lock to O which closes the shutter.

Cock the shutter and remove the focusing screen.