

This camera manual library is for reference and historical purposes, all rights reserved.

This page is copyright by mike@butkus.org M. Butkus, N.J.

**This page may not be sold or distributed without the expressed
permission of the producer**

I have no connection with any camera company

If you find this manual useful, how about a donation of \$3 to: M. Butkus, 29 Lake Ave., High Bridge, NJ 08829-1701 and send your E-mail address too so I can thank you. Most other places would charge you \$7.50 for a electronic copy or \$18.00 for a hard to read Xerox copy. These donations allow me to continue to buy new manuals and maintain these pages. It'll make you feel better, won't it?

If you use Pay Pal, use the link below. Use the above address for a check, M.O. or cash. Use the E-mail of butkusmi@ptd.net for PayPal.



[back to my "Orphancameras" manuals /flash and light meter site](#)

Only one "donation" needed per manual, not per multiple section of a manual !

The large manuals are split only for easy download size.

HASSELBLAD GUIDE

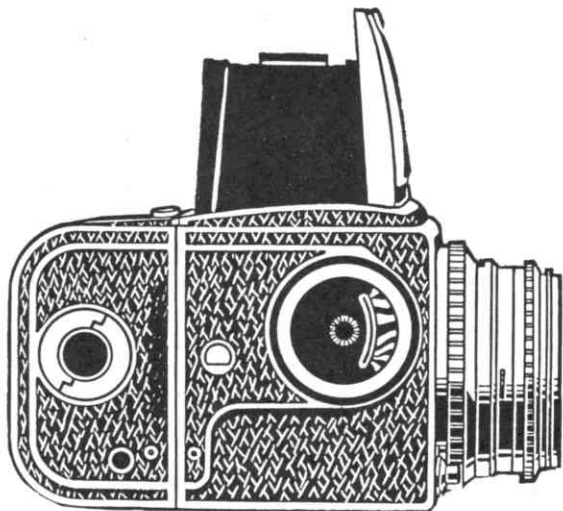

HASSELBLAD 1600 F
HASSELBLAD 1000 F
HASSELBLAD 500 C
HASSELBLAD 500 EL
HASSELBLAD SUPER-WIDE
HASSELBLAD SUPER-WIDE C

COMPLETE
CORRECT
THE CAMERA GUIDE



This is a *Camera Guide*. It deals with one make of camera, but it is not boosting it. The *Camera Guide* is a Focal Press publication. It is not sponsored or censored by manufacturers, or dependent on them in any way. The *Camera Guide* is as scrupulous in fully describing the camera and advising on its use as the very best type of manufacturer's book of instructions. It is, however, more critical than they could be. No *Camera Guide* will attempt to camouflage the limitations of a camera or make efforts to sell an endless chain of accessories. It is straightforward, practical and devoted to the questions of how to take the best photographs with a particular camera, rather than to praise of it. The *Camera Guide* is compiled by an author who has had long experience in handling the equipment in question. It represents at the same time the gist of all available literature collected by the *Focal Press Circle of Photographers* and filtered through their considered judgment.

First Edition: October 1962
Second Edition: February 1966
Third Edition: July 1969

REPRINTED November, 1988 by A
PHOTOGRAPHERS PLACE, 133 Mercer
Street, New York, NY 10012, U.S.A.

HASSELBLAD GUIDE

How to Use
The Hasselblad 500C, 500EL,
1600F, 1000F, Super Wide and Super Wide C

Third Edition

By W. D. EMANUEL



THE FOCAL PRESS
London and New York

CONTENTS

	<i>Page</i>	<i>Page</i>	
The Hasselblad System	4	The Self-timer	45
Hasselblad Evolution	7	Using an Exposure Meter	45
The Hasselblad Picture Size	8	Shutter Speeds and Movement	49
The Square Shape	8	Aperture and Depth of Field	50
Handling the Hasselblad	10	Zone Focusing	52
Holding	10	Working in Hot Climates	53
Carrying	12	Flash with the Hasselblad	54
Viewing and Focusing	12	Flash with Compur Shutter Models	56
Waist-level and Eye-level Viewing	13	Flash with Focal Plane Shutter Models	56
Focusing Technique	14	Exposure Guide Numbers	57
Shooting	15	Synchro-Sunlight	57
The Interchangeable Film Magazine	16	The Interchangeable Lenses	58
Magazine Models	16	Wide-angle Lens	58
Fitting to, and Removal from, the Camera	18	Telephotography	58
Loading the Magazine	20	Focusing and Viewing	60
Unloading	22	Facts and Figures	61
Early Magazines	22	Conversion of Feet and Inches into Metric Units	61
Changing Partly Exposed Magazines	22	Focal Plane Flash Synchronization	62
Deliberate Double Exposures	23	Daylight Exposure Values	62
Quick-winding Crank	23	Filters for Black-and-white Film	63
220 Film	23	Filters for Black-and-white and Colour Film	63
Films and Filters	26	Light Balancing Filters for Reversal Colour Film	64
Black-and-white Film	26	Colour Temperatures and Light Sources	64
Colour Film	28	Light Balancing Filters Data	64
Colour Reversal Film	29	Filter Equivalents	65
Colour Negative Film	30	Minimum Focusing Range without Accessories	65
Colour Film Speeds	30	Focusing Ranges with the 80-mm. Planar and Proxars	65
The Choice of Colour Film	31		
Filters for Black-and-white Film	31		
Filters for Colour Film	41		
The Polarizing Filter	41		
Exposure	42		
Aperture and Speed	42		
Choosing the Combination	43		
Time Exposures	44		

THE HASSELBLAD SYSTEM

<i>Page</i>	<i>Page</i>
Close-up Ranges with the 60-mm. Distagon <i>f</i> 4, the 80-mm. Planar <i>f</i> 2.8, the 150-mm. Sonnar <i>f</i> 4, and the 250-mm. Sonnar <i>f</i> 5.6 67-68	Focusing Ranges with the Extension Bellows 69 Shutter Speeds to Arrest Movement 69 Conversion of Film Speed Systems 70 Colour Films 70 Black-and-white Films 71

The green section between pages 24 and 25

The Hasselblad 500C Shooting 2 - Special Controls 4	2
The Hasselblad 500EL Shutter Release Methods 7 - B and T Exposures 8 - Alternative Release Methods 8 - Remote-control Release by Radio 8 - The Hasselblad 500EL Batteries 8	7
The Hasselblad 1600F and 1000F Shooting 10 - Special Controls 12	10
The Hasselblad Super Wide C and Super Wide Shooting 13 - Special Controls 14	13
Hasselblad Lenses and Finders Lenses for the Hasselblad 500C 18 - Changing the Lenses of the 500C 21 - The Lenses for the Hasselblad F Models 21 - The Super Wide-angle Lens 22 - Changing the 1000F and 1600F Lenses 22 - Lens Hoods 22 - Filter Attachments 24 - Interchangeable Finder and Focusing Attachments 24 - The Ground Glass Adapter 25	18
Close-up Equipment Proxar Lenses 26 - Extension Tubes 26 - Extension Bellows 28 - Assembling the Extension Bellows 28 - Using the Extension Bellows 28 - The Transparency Copy Holder 30 - The Microscope Adapter 30 - The Microscope Shutter 30	26
Miscellaneous Accessories The Rapid Winding Crank 32 - The Winding Knob with Exposure Meter 32 - Exposure Meter Attachment 32 - The Exposure Meter Wrist Strap 34 - Flash Holder Attachment 34 - The Quick Focusing Handle 34 - The Quick Tripod Coupling 34 - The Pistol Grip with Release 34 - The Flash Gun Bracket 34 - The Spirit Level 36 - The Checked Screen 36 - The Cut Film Adapter 36 - Loading the Cut Film Holder 36 - Attaching the Adapter to the Camera 38 - Polaroid Back for the Hasselblad 500c 38 - Command Unit 38 - Underwater Equipment 38	32

© Focal Press Ltd., 1969

SBN 240 44966 5

Printed and bound in Great Britain by Staples Printers Limited at their Rochester, Kent, establishment

The Hasselblad single-lens reflex camera is one of the very few models of this type designed for $2\frac{1}{4} \times 2\frac{1}{4}$ in. size pictures on standard 120 roll film. It is extremely versatile in its application through a system of interchangeable film backs for different picture sizes and types of film. Its interchangeable focusing hood permits both waist-level and eye-level reflex focusing. The interchangeable lens system offers wide-angle normal and tele views.

Basically an instrument for all general photographic work, it can be adapted through a wide range of accessories for any specialized field, such as press, portrait, fashion, nature, advertising, architecture, industry, medicine, photocopying, macrophotography and photomicrography.

Despite its versatility, the Hasselblad is essentially simple to handle, even in the hands of the average amateur photographer. The body houses the reflex mirror with ground glass screen, and a simple auxiliary shutter which acts also as capping device for the film while aperture and shutter are open for viewing and focusing. On the front of the body is the bayonet lens mount flange, accepting a range of interchangeable lenses (each with its own shutter), and the release button with lock for long time exposures.

The rear of the body takes interchangeable film magazines which click into position with a special locking catch.

The top incorporates the ground glass reflex screen with a Fresnel-type field lens. Above this is a groove accepting a folding finder hood with built-in magnifier for critical focusing. This is interchangeable with a hooded focusing magnifier or an eye-level pentaprism. The base of the body incorporates a plate designed as a quick change tripod attachment slide and features both Continental and international tripod bushes.

One side wall of the body has a shoe for fitting a sports finder, flash contact for the auxiliary shutter, and flash cable bearer. The other side carries the film transport knob which also sets the shutter and which is interchangeable

THE HASSELBLAD SYSTEM

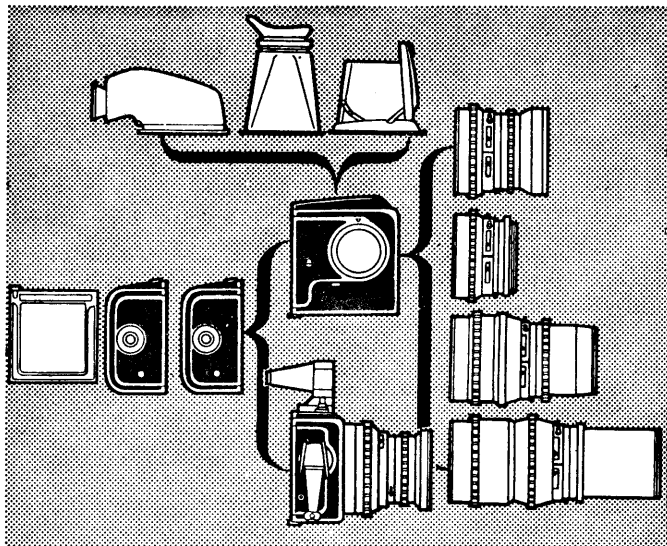

The Hasselblad is part of a comprehensive camera system, built up on the unit principle. The basic components are the camera body, the film cassettes and the alternative body of the Super Wide (shown in black). These are used with a number of interchangeable units, covering on the one hand alternative lenses complete with shutter units (right), and on the other alternative finder units for waist-level and eye-level viewing (top) as well as roll film magazines and single sheet film cassettes (left). Further accessories include close-up gear such as the extension bellows and extension tubes, various other lens attachments to facilitate focusing, cable releases, etc.

against a knob with built-in exposure meter or quick transport crank. This side also incorporates a quick-release button for the camera back, and shutter position signal. On either side of the camera body is a carrying strap holder.

The detachable film magazine incorporates its own automatic film counter and film-type indicator. Inside the shell it houses a removable film holder with pressure plate unit. A removable sheath closes the film aperture light-tight. There are three types of magazine, one for 12 exposures $2\frac{1}{2} \times 2\frac{1}{2}$ in. (6×6 cm.), one for 16 exposures $1\frac{1}{8} \times 2\frac{1}{8}$ in. (4×6.5 cm.), and one for 16 exposures $1\frac{1}{8} \times 1\frac{1}{8}$ in. (4×4 cm.) on a standard roll of 120 film.

Several magazines may be used with one camera for different types or speeds of film or different picture sizes.

Built-in safety devices prevent accidental exposures while the magazine sheath is in position, and also lock the shutter release after the last frame in the magazine has been exposed. For single exposures a sheet adapter can be used.

Ten interchangeable lenses are available for the Hasselblad with focal lengths ranging from 40 to 500 mm. Each lens has a bayonet filter mount and its own built-in Synchro Compur shutter, which is changed with the lens. The shutter carries an exposure value scale, a manual and spring-loaded automatic pre-selector iris system, and an automatic depth of field indicator. The speeds range from 1 to 1/500 sec. and B, with XM flash synchronization and self-timer.

A driving shaft couples the shutter to the camera body and links up with a similar shaft on the camera body itself. Turning the film transport tensions the shutter, opens the diaphragm and opens the shutter blades for focusing and viewing. At the same time the auxiliary shutter in the back of the camera body is closed. On pressing the release, the shutter blades close, the diaphragm closes down to the pre-selected opening, the auxiliary shutter opens, the mirror flies up and the shutter blades open for the exposure.

The standard lens is the 80-mm. ($3\frac{1}{8}$ -in.) Zeiss Planar f/2.8, seven-element, four component symmetrical anastigmat which combines a wide aperture with excellent correction of

the various aberrations. It has an angle of view of 52° and a focusing range of 3 ft. to infinity.

A wide range of accessories adapts the Hasselblad camera to almost any specialized field of photography. These include, for close-up work, Proxar lenses, extension bellows, a transparency copy holder, microscope adapter, micro shutter and lens mount adapter for attaching special lenses. A sheet film adapter with single sheet film holder and film cutter are available to permit the use of sensitive materials other than roll film. A magnifying hood, eye-level pentaprism, prism sports finder and sports frame finder provide alternative focusing and viewing methods. The rapid winding crank, film transport knob with exposure meter, quick tripod coupling, quick focusing handle, camera grip etc., increase the speed or convenience of operation.

The Hasselblad Super Wide is an extreme wide-angle camera. It can be considered as a lens permanently fixed to a shallow non-reflex body, using the normal Hasselblad roll or sheet film backs. The lens is a 38-mm. (1½-in.) Zeiss Biogon *f* 4.5, an outstanding eight-element, five-component, wide-angle anastigmat with a 90° angle of view. It focuses from 12 in. to infinity. This is built into a Synchro-Compur shutter. The body carries a rapid winding crank, quick coupling tripod base, and release button mounted on top. A ground glass adapter back, grooved to accept the magnifying hood, is available for composing, precision focusing, photo-copying and close-up shots. A brilliant optical finder is provided for hand-held shots.

Hasselblad Evolution

●THE HASSELBLAD 1600F, introduced in 1948, follows on the whole the description on pages 4-7 but has a focal plane shutter with speeds from 1 sec. to 1/1600 sec., built into the camera body. The lenses therefore are without shutters. The film transport knob is fixed. The standard lens is the 80-mm. Kodak Ektar *f* 2.8 with manual pre-set iris. The camera base has no quick-mounting facility.

●THE HASSELBLAD 1000F replaced the 1600F in 1952. It still has a focal plane shutter, but with speeds from 1 sec. to 1/1000 sec., and is generally improved in precision. Originally it came with the 80-mm. Kodak Ektar *f* 2.8, later on with the 80-mm. Zeiss Tessar *f* 2.8.

THE HASSELBLAD 500C, introduced 1957, follows the description on pages 4-7.

THE HASSELBLAD 500EL, introduced in 1965, is basically a 500C but has a built-in electric motor to advance the film and cock the shutter automatically for remote operation of the camera.

●THE HASSELBLAD SUPER WIDE, introduced in 1954, is similar to the specification on page 7, but has a Compur shutter and film transport knob. The lens has a manual pre-set iris. The camera base has no quick-mounting facility.

THE HASSELBLAD SUPER WIDE C superseded the Super Wide model in 1959 and is as described on page 7.

In the course of the years, minor improvements were made within each model, which do not, however, affect manipulation. Models marked ● are now discontinued.

The Hasselblad Picture Size

The 2¼ × 2¼ in. film is not a miniature size by modern standards. Contact prints made of these negatives are large enough to be appreciated as proofs, but enlargements are of course more effective. Whilst, however, the 24 × 36 mm. miniature negative needs a 12 times linear enlargement to yield a 12 × 15 in. exhibition print, the 2¼ × 2¼ in. negative produces the same size of print with only 6½ times enlargement. Thus the Hasselblad negative is not as a rule subjected to an extreme degree of enlarging.

The Square Shape

The Hasselblad negative has a square shape. The view of the lens is a circle and this circle is best utilized by the square—but this in itself is a purely technical consideration. Essential, however, from a practical point of view, is the fact that the square, representing the simplest geometrical pattern (next to the circle), lends itself easily to placing and framing almost any subject matter. With the square picture the camera hold is the same for every shot. Should the square shape prove unsatisfactory with a particular subject it is still possible to print only a portion of the negative, without sacrificing more of the subject than a rectangular picture shape would have done from the outset.

HASSELBLAD EVOLUTION

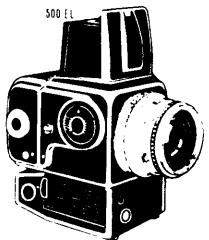
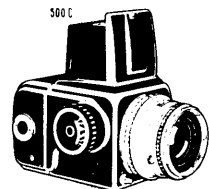
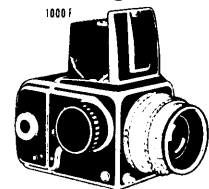
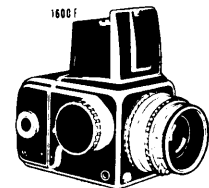

The Hasselblad cameras evolved along two parallel lines. On the one hand there are the normal models, starting with the 1600F (first introduced in 1948) and followed by the 1000F in 1952. These cameras, with focal plane shutter, were replaced by the 500C in 1957 which underwent minor changes, in particular in the design of the standard waist-level hood. The 500EL, introduced in 1965, is a 500C with built-in electric motor.

The Super Wide series started with the original Super Wide in 1954, which was superseded by a modified model C in 1959.

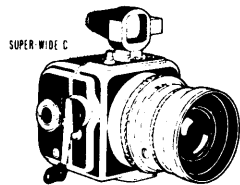
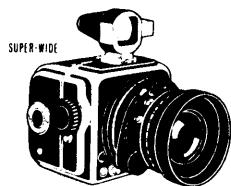

HANDLING THE HASSELBLAD

In order to simplify the description and handling of the Hasselblad camera without being confused by different features of individual models, this Guide is divided into a general section which applies to all Hasselblad models and a section of green pages to cover the individual requirements and differences in handling of each model.

For convenience a symbolic reference system is also used in the general section. Wherever the sign ■ appears, further details will be found in the camera pages of the green section for each camera. The sign ● refers to lens and ●● to accessory details in the green section. The appropriate pages are marked accordingly in the bottom left- or right-hand corner.

Holding

Naturally the camera should be held as steady as possible as the slightest camera shake, even if not seen in the negative, will become visible in the enlargement.

There are various ways of holding the camera. The basic method is to carry the camera on its strap—which should be passed round the back of the neck. Hold the camera in the left hand with the index finger of the left hand on the release button. The right hand remains free for transporting the film, setting shutter speed, aperture and focus. Pulling the camera down against its strap will help considerably to steady it at the time of exposure.

When the magnifying hood is used, press the eye against the eyepiece. Insert both hands from below through the carrying strap (adjust its length to suit); this provides additional steadying support.

Virtually the same holding position can be adapted when using the camera at eye-level with either the sports frame finder or the pentaprism.

To release the shutter, press the release button with the ball of the index finger. Use finger pressure only, and keep the hand and its grip on the camera steady. The actual pressure should be slow and smooth. The slower the exposure time, the smoother must be the release.

HOLDING AND CARRYING

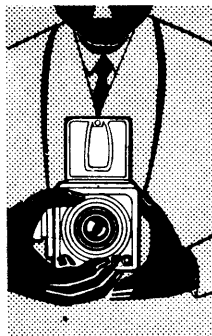

For eye-level shooting, the pentaprism (*above left*) fits on top of the camera in place of the waist-level hood. Hold the camera up to the eye, looking directly through the eyepiece at the back. With the sports finder (*above right*) turn the camera sideways so that the sports finder is on top in its shoe on the side of the camera (*above right*).

The normal hold consists in supporting the camera round the neck with the carrying strap, and steadying it with the left hand. The left index finger is on the release button, while the right hand focuses the lens. The right hand also operates the winding knob after every exposure.

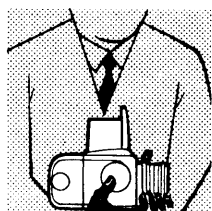
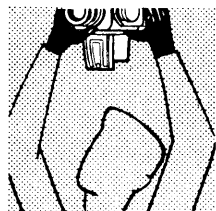
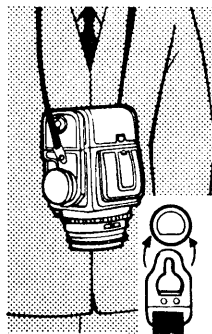

Two special holds for unusual occasions. To shoot over the heads of a crowd, hold the camera upside down above your head and look up into the finder hood (*above left*). To get unobserved shots of people turn the camera round sideways (*above right*) so that the lens points past your left arm. You see what is going on by looking down into the finder, although you are facing at right angles to the shooting direction of the camera.

When not actually shooting, let the camera hang on its carrying strap, lens downwards. The strap is held in position on clipping the fitting at the end of the strap over the strap button at each side of the camera body (*inset*).

For slow exposures in the hand, it is advisable to rest the elbows or at least to lean the body against some support in order to avoid shaking. In this way, 1/15, 1/8 and even 1/4 sec. can be risked without incurring camera shake.

Such a support is also desirable for faster exposures, as various movements take place inside the camera after pressing the release button. A slightly unsteady hold may thus easily lead to blurred pictures.

The use of a tripod or other solid support is necessary when taking time exposures and it is also recommended for speeds from 1/15 to 1 sec. It is useful even for normal instantaneous shots (1/30 to 1/125 sec.) where circumstances permit.

Carrying

To be ready for quick action, it is best to carry the camera on its shoulder strap round the neck so that it lies on your chest, lens downwards. Lifting it up then takes a split second.

For convenience and protection, carry the Hasselblad in its ever-ready case. It is then only necessary to open the flap to get the camera ready for use.

The camera neck strap itself goes through the ever-ready case.

Viewing and Focusing

You can view and focus only after the shutter has been wound. This operation brings down the mirror into its viewing position to reflect the image from the lens on to the ground glass screen. So you know that when the image is visible, the film is also advanced for the next shot (the film transport is coupled with the shutter tensioning mechanism).

The image appears in natural size, free from parallax. A Fresnel-type field lens ensures even illumination right into the corners of the screen.

The lens is used at full aperture for focusing. This shows up the difference between a perfectly sharp and slightly unsharp image to the greatest degree; at a smaller lens stop

it is not so easy to adjust the lens exactly to its sharpest setting. Such critical focusing also leads to emphasis of the main subject by good definition—thereby separating it from its background. This is the first decisive step from the casual snapshot to a real picture. The focusing screen is the most efficient means of photographic education. Unlike any other viewfinder it presents a two-dimensional, full-size preview of the photograph as it will look later. The man who cannot be taught to “see” photographically by the ground glass of a camera will never learn to do so.

To open the hood, push its catch to the right. The hooding of the finder keeps stray light from the screen, and so makes the images appear brighter. To close the hood first fold down both sides, followed by the back and finally the front.

Although you are likely to hold the camera reasonably level, make sure that vertical and horizontal lines of the picture run parallel to the cross engraved on the screen. You can tilt the camera intentionally, but see that the effect does not look like an accidental tilt.

The picture on the screen appears upright, but reversed left to right. Movements are also reversed left to right; to follow moving subjects you therefore have to turn the camera against the apparent subject movement.

Waist-level and Eye-level Viewing

With the camera held at chest or waist level for reflex viewing you see many popular subjects—children, animals, people sitting down—from a more natural viewpoint than when looking down from eye-level. More natural, that is, for the subject, for the camera gets down automatically to the subject level. Informal portraits, candid studies, can be got quietly and without fuss.

For unobserved shots hold the camera at right-angles, with the lens pointing to the left or right instead of straight ahead. To take pictures over the heads of a crowd or to obtain a higher viewpoint, hold the camera above your head, viewing up into the reflex screen.

The camera is used at eye-level with the pentaprism and

the prism sports viewfinders, where the image appears upright and the right way round. These are therefore the finder units to choose when the cameras should be used at eye-level for viewing and focusing, particularly when following moving objects with the camera.

The sports frame finder serves the same purpose as the pentaprism and prism sports finder, but does not permit reflex focusing at the same time. This is therefore primarily intended for sports, landscape, or other distant subjects, or for shots where you pre-focus on a subject that remains at the same distance from the camera.

A separate frame viewfinder for Sonnar 150 and 250 lenses snaps on the lens hood.

Focusing Technique

The best way to arrive at critical definition is to turn the focusing mount of the lens slowly to and fro while observing the subject to be focused on the ground glass. As you turn the mount, the image becomes more and more sharp up to a certain point, beyond which it will again lose definition. At this “beyond” stage, turn the mount back again, narrowing down the degree of movement until you arrive at the point of best definition.

The Hasselblad has a magnifier built into the focusing hood to determine the point of best definition. To bring it into action push the hood opening catch *fully* to the right. When closing the hood, fold the magnifier back first.

The orthodox way of focusing with the ground glass screen may be adopted for taking photographs of subjects that are fairly stationary. A different method of focusing is required when taking subjects in motion. Set the lens to a distance at which the subject will be in a given moment, or focus at some spot which it actually has to pass, and press the release button when the subject is reaching the pre-focused point.

With subjects liable to react self-consciously (e.g. children) set the lens to a suitable distance, and then approach the

subject, exposing as soon as the screen image appears sharp.

Alternatively, focus at some object which is at the same distance from the camera as the subject, but in a different direction. When you have found the range swing round to press the release button as soon as the subject slips into the field of view of the finder.

Shooting

Practise the following operations first with the empty camera with its film magazine in position until you can do them practically automatically.

1. **Wind the film transport.** This advances the film and film counter, tensions the shutter, opens the aperture (in C models) and brings down the mirror ready for the next exposure.
2. **Open reflex hood to focus** for a preview of the picture you want to take.
3. **Set the exposure.** Adjust the shutter for the right amount of light for the subject conditions (see page 32).
4. **Select the aperture-speed combination** you want to use; smaller apertures for greater depth of field (page 48) or faster speed to arrest movement (page 47).
5. **Determine the exact picture area and focus.**
6. **Release the shutter gently.**

THE INTERCHANGEABLE FILM MAGAZINE

One of the most important features of the Hasselblad camera is the interchangeable film magazine. This is the film holder which is loaded and unloaded independently of the rest of the camera. The use of film magazines permits film changing at any time.

Each magazine has a casing of stainless steel. The ends of the case are aluminium, polished and chrome plated to resist wear and scratching. The spool holder is aluminium alloy. The pressure plate is precision turned and has a black anodized surface.

Magazine Models

THE STANDARD MAGAZINE is in two versions—the A12 and the 12. Both take 120 roll film, giving 12 pictures $2\frac{1}{4} \times 2\frac{1}{4}$ in., with automatic stop after 12 exposures. The A12 also has automatic stop at first frame and can be loaded faster.

THE 16 MAGAZINE takes 16 pictures $1\frac{1}{2} \times 2\frac{1}{4}$ in., still on size 120 roll film, but with the picture area masked down. This offers a certain film economy, especially when using colour film. The film counter on the magazine counts exposures up to No. 16. A ground glass screen mask is also supplied with the magazine, with markings to show the limits of the $1\frac{1}{2} \times 1\frac{1}{2}$ in. super-slide size. This gives a guide to arranging a picture for subsequent trimming down to a miniature slide format for mounting in 2×2 in. slide holders.

THE 16S MAGAZINE is similar to the 16 magazine, but the film aperture is masked down to $1\frac{1}{8} \times 1\frac{1}{8}$ in. A ground glass screen mask is supplied with it. This magazine directly yields transparencies of the correct size for mounting in 2×2 in. slide frames.

THE ROLLFILM MAGAZINE

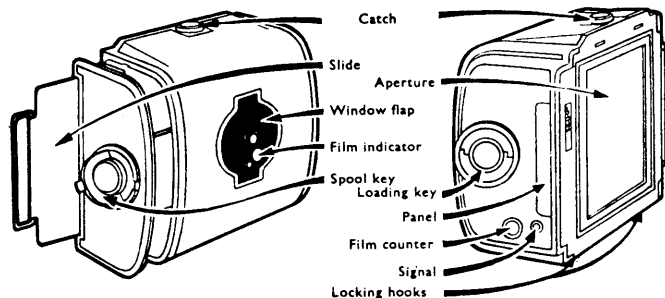

The catch secures the magazine to the camera body. The pullout slide closes the film aperture light-tight when the magazine is removed from the body. The window flap opens the rear window for advancing the film to the first exposure. It is fitted with a film type and speed indicator. The spool key unlocks the spool holder for loading. The loading key serves to wind up the film to the first exposure, also a film plane mark. The film counter shows the number of frames exposed, and is coupled with the transport mechanism of the camera. The signal indicates whether the film in the film plane has been exposed. The locking hooks engage the bottom of the camera body when attaching the magazine.

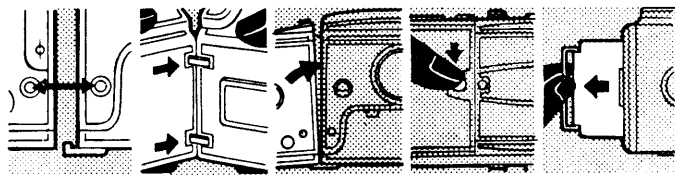

Fitting the magazine. Check that the signal on the camera and magazine correspond (left), then hook the bottom of the magazine to the camera body (centre left), push the magazine against the camera back (centre), and secure the catch (centre right). Then pull out the slide (right); the camera is now ready to shoot.

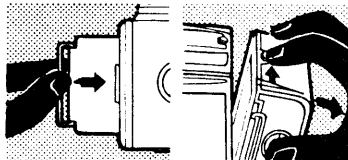

Removing the magazine. First always insert the slide to close the film aperture light-tight (right), then press the catch to release the magazine from the body (far right).

All these magazines may be used with the '220' film, see page 23.

THE MAGAZINE 70 is designed to take up to 15 ft. of cassette-loaded 70-mm. film for up to seventy $2\frac{1}{4} \times 2\frac{1}{2}$ in. negatives. The magazine is of similar design to the others with film plane markings, film signal, counter and film type indicator. It is intended for the professional, press and also amateur photographer who has to take large numbers of photographs at one sitting.

70-mm. film is supplied in 100 and 300 ft. rolls from which cassettes can be loaded with any length up to 16 ft. Ready loaded cassettes are also available.

Fitting to, and Removal from, the Camera

Let us start with the magazine attached to the camera.

Before the magazine can be removed, the sheath has to be in place on the front of the magazine, protecting any film in it from being exposed to the light. As a safety feature, the magazine cannot be removed from the camera body until the sheath is completely inserted into the magazine. To insert the sheath slide it into the slot on top and push down fully. The bent-over part of the sheath (which acts as a finger hold) should always be towards the front of the magazine for easier loading.

To remove the magazine, press the catch on the top to the right, let the magazine drop back, and lift it out from the two catches on the camera body.

When a magazine is freshly loaded and the automatic counter set to No. 1, the signal on the right is white, indicating that an unexposed frame is in position in the magazine.

Before you attach the magazine to the camera, the corresponding signal on the right-hand side of the body (behind and before the transport knob) should also be white, indicating that the film transport has been wound and the camera, too, is ready for exposure. If the signal on the camera is red, simply wind the transport knob before attaching the magazine.

LOADING

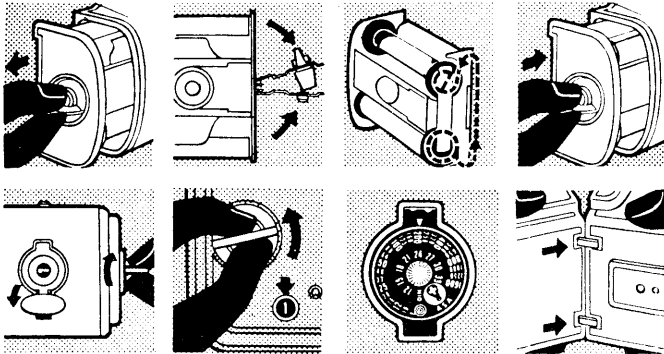

Top row: Unlock the spool holder key (left) and pull out the spool holder. Open the spool holder arms (centre left), insert the full film spool and thread the backing paper round to the empty take-up spool (centre right). Insert the loaded spool holder into the magazine and lock (right).

Lower row: Wind the loading key to bring No. 1 into the centre of the film window at the back (left), then turn the key anti-clockwise and fold down (centre left). Set the film indicator in the rear flap (centre right). The magazine is then ready for attaching to the camera (right).

UNLOADING

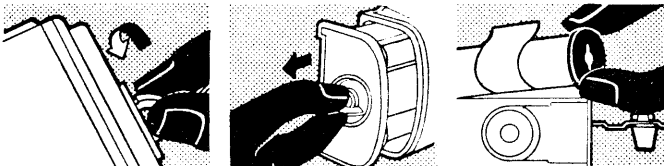

Unloading. Wind off the end of the backing paper with the loading key (left), then remove the spool holder by unlocking the spool key and withdrawing the holder (centre). Finally remove the full film spool and seal (right).

If the last frame still in the film aperture of the magazine is already exposed, the magazine signal is red. The camera signal then also has to be red before you attach the magazine. If the camera signal should be white, simply release the shutter to make the signal colours match. This boils down to the rule that both signals have to indicate the same colour (either red or white) before the magazine is attached.

To attach the magazine to the camera, lower its front edge into the two hooks at the rear base of the camera, and push the magazine against the camera body while pressing its locking catch to the right. Once the magazine makes full contact with the camera body, move the catch to the left. After pulling out the sheath, the camera is ready for use.

Loading the Rollfilm Magazine

- 1. Remove the spool holder.** First release the catch in the centre of the left-hand side (opposite to the side of the signal) and turn it anti-clockwise. Pull out the spool holder.
- 2. Prepare the spool holder** by turning the spool holder catch clockwise to open the film clamp and open up both spool holder arms.
- 3. Load the film.** Insert the empty take-up spool into the holder with the milled knob. Place the full film spool into the opposite holder. Remove the seal and pull out approximately 4 in. of paper, the black side of the paper facing you. (The spool must be inserted so that the backing paper comes off from underneath.) Keep the thumb pressed against the spool to prevent the film from unwinding itself. Draw the free paper across the front of the pressure plate but *under* the film clamp. Hold the paper in position by turning the spool holder catch anti-clockwise. Now fix the paper end into the slot of the take-up spool. Take up the slack by turning the milled knob protruding from the take-up spool chamber.
- 4. Insert the loaded spool holder** into the magazine shell (make sure that its sheath is in position), and turn the

release catch clockwise. This has the double action of locking the spool holder in position and releasing the clamped-down paper.

5. **Set the first exposure.** Open the film window cover in the back of the magazine and turn the winding knob until No. 1 appears in the rear window. The winding key is the key in the right-hand side of the magazine, i.e. the same side as the signal window and the film counter window. Now turn the film winder anti-clockwise as far as it will go. Always keep the film window cover closed—except when getting the magazine ready for the first exposure.

This causes No. 1 to appear in the automatic film counter window on the winder side of the magazine. Always set the counter window to No. 1 immediately; if this is overlooked you will get uneven spacing between the individual negatives and possibly lose the last exposure.

6. **Set the film indicator.** This is advisable even if only one magazine is used, and becomes essential when you work with several types of film. The film indicator is on the back of the magazine. On it you can set the speed of the film in ASA and DIN (white figures on black) and also the type of material. The latter you set in the cut-out by turning the milled centre button.

The various symbols are as follows:

- red star with + sign = daylight colour reversal film;
- red star with — sign = daylight or universal colour negative film;
- red bulb with + sign = artificial light colour reversal film;
- red bulb with — sign = artificial light colour negative film;
- divided black and white circle = black-and-white film.

7. **Attach the loaded magazine to the camera** (see page 18). However, there is no need to remove the magazine from

the camera at all for reloading, as all the steps are equally possible while the magazine is on the camera.

The metal panel indicating the film plane on the outside of the magazine (a circle with a vertical line through it) may be used for pencil notes, e.g. exposure, developing or subject data. The notes can be removed with a damp cloth or india rubber.

Unloading the Rollfilm Magazine

After all exposures have been made, the shutter release on the camera is automatically blocked. So you cannot accidentally take pictures without film. The film counter window in the side of the magazine always shows the number of exposures. When this reaches No. 12 (or No. 16 with the 16-exposure magazine), unload the film.

There is no need to remove the magazine from the camera for unloading.

1. **Wind off the film end.** Turn the winding key until the paper end disappears in the film window in the back of the magazine (open the cover to check) and the film is completely wound on to the take-up spool.
2. **Remove the spool holder** as described for loading.
3. **Remove the full spool of film** from the spool holder. Seal the end down to prevent accidental unrolling.
4. **Re-insert the spool holder** into the magazine (as described for loading, step No. 4), or reload with film.

Early Magazines

Magazines of serial numbers below 20000 are of a somewhat different construction and will not fit the Hasselblad 500C or Super Wide C. The current magazines will fit all models.

These early magazines can be recognized by the exposure counter window which is below the film transport key. On the current ones the film counter is close to the signal window. Also the film window cover on the back has no film type and speed indicator.

Early magazines have no automatic release lock to prevent exposures beyond the last film frame.

The only difference in handling arises after turning the film transport key to bring No. 1 into the film window in the back of the magazine. On the early models the key is then turned anti-clockwise a number of

turns (in place of a quarter turn as on the current model) until it comes to a definite stop, when No. 1 appears in the film counter window on the side.

Changing Partly Exposed Magazines

One of the main features of the Hasselblad system is the ease of changing from one magazine to another after any number of exposures. The procedure is as follows.

1. **Turn the film transport of the camera.** This tensions the shutter and advances the film, setting both signals to white. (While not essential, this is a strongly recommended procedure.)
2. **Insert the sheath into the magazine.**
3. **Remove the magazine** from the camera (see page 18).
4. **Attach the alternative magazine** (see page 18).

Deliberate Double Exposures

While the construction of the camera automatically prevents two exposures on one film frame, deliberate double exposures are possible. The procedure, after the first exposure, is as follows:

1. **Remove the magazine.**
2. **Tension the shutter** without magazine attached to the camera.
3. **Attach the magazine again.**
4. **Release the shutter.**

Quick Winding Crank

This special crank for film magazines is attached to the loading key of the magazine and permits quick winding forward to the first frame and equally on winding off film after the last exposure.

220 Film

Primarily designed for the professional user, 220 film permits 24 exposures $2\frac{1}{4} \times 2\frac{1}{4}$ in. square in the standard Hasselblad magazine on observing the following points:

As the new 220 film is without backing paper the light leaking through the film window must be shut out by a light-tight plug which is fitted on to the film window, from inside the magazine, with the number "220" facing outwards or by fixing black tape across the film window. The 220 film has an arrow going across the first paper section; it has no numbering but there is a dotted line about 6 in. before the crosswise arrow. To obtain the most even spacing between negative frames the appropriate instructions (below) should be used in accordance with the serial number of the magazine employed.

Magazine Serial No. 001-19999

1. Thread the film in the usual manner on to the Hasselblad spool-holder. The protecting paper is drawn forward so that the dotted line comes to the centre of the receiving spool.
2. After the spool-holder is inserted in the magazine, set the exposure-counter at 1.
3. Wind the film forwards 7 complete turns (14 half-turns).
4. Expose 12 frames (no stop).
5. Reset the exposure counter to 1.
6. Expose another 12 frames (no stop).

Magazine Serial No. 20000-64399

1. Thread the film in the usual manner on to the Hasselblad spool-holder. The protecting paper is drawn forward so that the dotted line comes to the centre of the receiving spool.
2. After the spool-holder is inserted in the magazine, set the exposure-counter to 1.
3. Wind the film forwards 10 complete turns (20 half-turns) or until the frame number 8 begins to appear in the exposure-counter window.
4. Reset the exposure-counter to 1.
5. Expose 12 frames (until stop).

(continued on page 25 after the green page section)

THE HASSELBLAD: MODEL BY MODEL

These green pages deal with the individual Hasselblad cameras in detail.

The Hasselblad 500C	2	Close-up Equipment	25
Shooting	2	Proxar Lenses	25
Special Controls	4	Extension Tubes	25
		Extension Bellows	26
The Hasselblad 500EL	7	Assembling the Extension Bellows	26
Shutter Release Methods B and T Exposures	7	Using the Extension Bellows	26
Alternative Release Methods	8	The Transparency Copy Holder	28
Remote Control Release by Radio	8	The Microscope Adapter	28
Hasselblad 500EL Batteries	8	The Microscope Shutter	28
		Miscellaneous Accessories	32
The Hasselblad 1600F and 1000F	10	The Rapid Winding Crank	32
Shooting	10	The Winding Knob with Exposure Meter	32
Special Controls	12	Exposure Meter Attachment	32
		The Exposure Meter Wrist Strap	33
The Hasselblad Super Wide C and Super Wide	13	Flash Holder Attachment	33
Shooting	13	The Quick Focusing Handle	33
Special Controls	14	The Quick Tripod Coupling	33
Hasselblad Lenses and Finders	18	The Pistol Grip with Release	33
Lenses for the Hasselblad 500C	18	The Flash Gun Bracket	33
Changing the Lenses of the 500C	20	The Spirit Level	33
The Lenses for the Hasselblad F Models	21	The Checked Screen	36
The Super Wide-angle lens	22	The Cut Film Adapter	36
Changing the 1000F and 1600F Lenses	22	Loading the Cut Film Holder	36
Lens Hoods	22	Attaching the Adapter to the Camera	38
Filter Attachments	22	Polaroid Back for the Hasselblad 500c	38
Interchangeable Finder and Focusing Attachments	22	Command Unit	38
The Ground Glass Adapter	24	Underwater Equipment	38

THE HASSELBLAD 500C

The Hasselblad 500C is the standard camera of this series, with interchangeable lenses, and finder systems, interchangeable winding knob and interchangeable roll film magazine backs.

Each lens comes in its own Synchro-Compur shutter giving automatic speeds of $1, \frac{1}{2}, \frac{1}{4}, \frac{1}{8}, 1/15, 1/30, 1/60, 1/125, 1/250, 1/500$ sec., and B for time exposures. The shutter is synchronized for flash bulbs and electronic flash at all speeds, and incorporates a delayed-action release and an exposure value scale. The lenses have automatic and manual pre-selector iris control and automatic depth of field indicators.

In addition an auxiliary shutter is built into the back of the camera body. It consists of two movable blades, which remain closed as long as the mirror is in the lower position and the reflex ground glass screen image is visible. It prevents the light from falling on the film when focusing or changing lenses, since this can only be done when the mirror is lowered and the shutter open.

This shutter can also be used as an auxiliary shutter with exposures of 1/25 sec. or longer, when the camera is used with the extension bellows for macro-photography or photomicrography, or with special lenses without their own shutters. This shutter has its own flash contact (see page 54).

The standard lens of this model is the 80-mm. Zeiss Planar f2.8. Alternative lenses cover focal lengths from 60 to 500 mm. (●).

FOR CLOSE-UP WORK Proxar lenses, extension tubes, extension bellows and a transparency copy holder are available.

OTHER ACCESSORIES INCLUDE: magazines, the sheet film adapter, the magnifying hood, eye-level pentaprism, sports finders, rapid winding crank, winding knob with exposure meter, quick tripod coupling, lens mount adapter, microscope adapter, microscope shutter, filters, lens hood, diffusion discs, quick focusing handles, camera grip, spirit level, flash bracket, squared screen, and ever-ready and outfit cases.

Shooting

1. Wind the film transport by turning the transport knob one turn to a full stop. This advances the film to the next frame, lowers the mirror, and tensions the shutter. It further sets the signal on the camera indicating that the shutter is tensioned (white), sets the signal on the attached magazine to show that the film is advanced (white), and opens the shutter and iris diaphragm.

If you cannot turn the film transport knob, this may be due to:
(a) the last film frame being exposed, leaving no number in the film window;

(b) using the shutter at the B setting and not resetting the time catch to its original position (see below: Time exposure); or

THE HASSELBLAD 500C

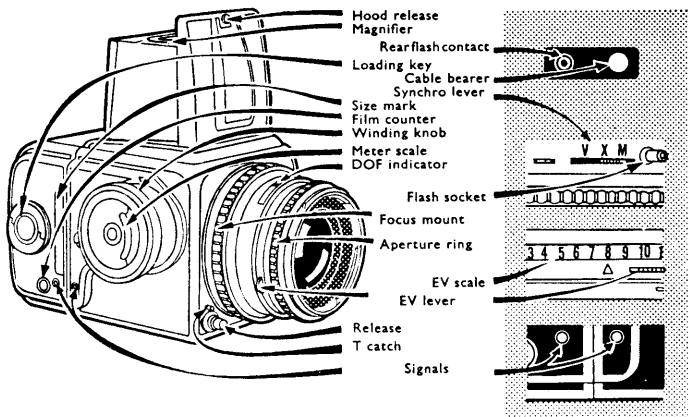

The hood release opens the focusing hood and the magnifier. The rear flash contact serves for synchronizing the auxiliary focal plane shutter in the back of the camera. The loading key advances the film for the first exposure. The synchronizing lever sets the synchronization and the self-timer. The size mark indicates the type of magazine in use. The film counter shows a number of exposures taken. The winding knob advances the film and tensions the shutter, it also incorporates the exposure meter. The depth of field indicator is coupled with the aperture ring of the lens. The focusing mount sets the lens to the correct distance. The exposure value scale and exposure value lever select the exposure value. The aperture ring also sets aperture-speed combinations. The release incorporates a catch to hold it down for time exposures. The signal in the side of the camera magazine indicates whether the frame has been exposed or the film advanced.

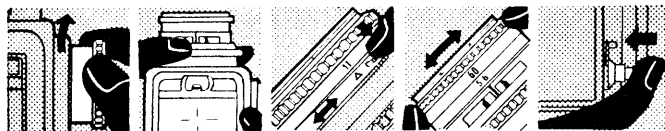

Shooting with the 500C. From left to right: Wind the film transport; view and focus the image on the screen; set the exposure value; select a suitable aperture-speed combination; press the release to expose.

- (c) pressing the quick release button without actually taking the exposure (see below: Quick release); or
 (d) trying to wind on before the shutter, particularly when set to a slow exposure, e.g. 1 sec., has fully run down.

2. **Open the reflex hood** for a preview of the picture you intend to take.
3. **Set the exposure value.** The shutter rim carries a range of numbers engraved in red from 2 to 18. These are exposure values for correct exposure. Each exposure value represents a range of shutter-speed aperture combinations of equivalent exposure. To set the exposure value, slightly push back the serrated lever on the rim behind the exposure values and move the triangular mark beside the lever to the appropriate exposure value (obtained from exposure tables or a meter) on the scale. Intermediate exposure values, e.g. 10½, 11½, etc., can also be set.
4. **Select the aperture-speed combination** by turning the milled shutter ring. Aperture and speed scales here move together. The figures opposite each other represent alternative combinations corresponding to the exposure value set. Again only the aperture and speed actually opposite the black central index line on top of the shutter are the ones in use. To set apertures and speeds separately (e.g. for flash shots) adjust first the shutter speed and then the aperture on the exposure value setting ring.
5. **Focus** the image on the reflex screen and determine the exact field to be photographed.
6. **Release** the shutter gently. Keep the release button depressed for the duration of the exposure. This is of some importance when using slow speeds; if you let the release button go earlier, the auxiliary shutter stops the exposure.

Special Controls

FOR TIME EXPOSURES set the index of the shutter speed ring to B (= brief time).

The green figures represent full seconds corresponding to the aperture value opposite them at a given exposure value. If you want to use one of these apertures, note the time opposite it. Set the aperture separately by depressing the exposure value lever and turning the aperture ring. (Leave the shutter speed ring at B.) Then expose for the time which was previously opposite that aperture value.

For time exposures always use the cable release. This screws into the centre of the body release on the camera body. For long time exposures, where it is inconvenient to keep the release depressed, a time catch can be brought into action. The time catch is the small lever with red spot in its top. Push this lever to the T position; the shutter will, on releasing, remain open until this catch is pushed back to the O position.

THE AUXILIARY SHUTTER. The main function of this is to protect the film from light when focusing, changing lenses, etc. It can also be used as a shutter at 1/25 sec. when working with special lenses

SPECIAL HASSELBLAD 500C CONTROLS

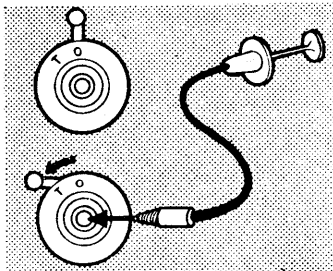

For time exposures (with the shutter set to B) the time catch on the release keeps the shutter open after pressing the release. For this purpose move the catch to the position T before releasing. Preferably make time exposures with a cable release; this screws into the release button. The shutter closes again on moving the time catch to the position O.

The quick-release button below the winding knob (left) reduces the time delay in shooting. Pressing the button closes the camera shutter, opens the auxiliary shutter, lifts the mirror and presets the aperture. Pressing the normal release button (right) then only releases the shutter—and does so at once. When using the quick-release button, the image is not however visible on the focusing screen, and a separate sports finder must be used.

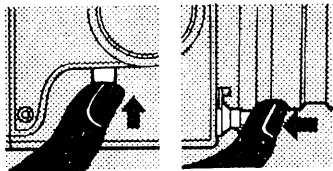

Left: To use the self-timer set the synchronizing lever to the position V, while pressing the locking catch next to it. This must be done after tensioning the shutter. The time catch must also be set to T. On pressing the release the shutter opens after a delay of about 8 seconds.

Below: To change the winding knob (for example to fit the plain winding knob instead of the exposure meter knob or vice-versa) press the catch on the rim and turn the knob anti-clockwise (left), then lift off. To attach the knob, place it in position with its red circle opposite the red triangular mark on the body (centre), then turn clockwise to engage the bayonet lock (right). The solid red mark must now be opposite the red triangle.

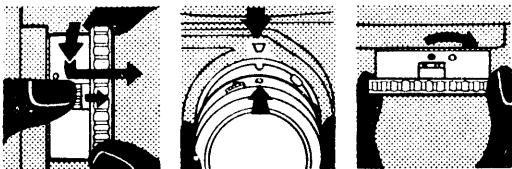

lacking a shutter, in macrophotography and photomicrography. It has its own flash contact in the side wall of the camera body. The flash cable is connected to this contact. The shutter is X-synchronized and can therefore be used with electronic flash and normal "M"-type flash bulbs.

THE DELAYED-ACTION RELEASE built into the Synchron-Compur releases any speed set from 1 sec. to 1/500 sec. with $8\frac{1}{2}$ sec. delay. It is brought into action by moving the green level on the left of the shutter to V while pressing the small protruding lock at the left at the same time. Set the time catch on the camera release to T. After the self-timer exposure, reset the time catch to O, otherwise you cannot transport the film.

FLASH SETTINGS. For X- or M-synchronization, set the green lever on the left part of the shutter to X or M, while depressing the small protruding lock at the left. The cable bearer can be connected to the body of the camera. This is a hook with a ball at its end. The ball is pushed into the recess beside the auxiliary shutter flash contact of the camera body. The protruding hook holds the flash cable to secure it to the flash plug.

CHANGING THE WINDING KNOB. The film transport and shutter tensioning knob of the Hasselblad 500C is interchangeable and can be replaced by a knob with exposure meter, or crank, etc.

Removing the knob is best done after winding it ready for an exposure. Push the catch on the rim of the knob away from the camera body with the thumb of your right hand, while turning the knob anti-clockwise. This action releases it from its bayonet base.

To attach the knob, position the circular red mark on its rim opposite the red triangular mark on the camera body. Then turn the knob clockwise. When the triangular mark points to the solid red mark on the knob, the latter is secure.

RAPID EXPOSURE. To reduce the time between releasing and the instant of exposure—normally 1/10 sec.—to the absolute minimum, press the quick release button which is situated just below and to the left of the film transport knob. (It does *not* need to be held down.) This closes the camera shutter, opens the auxiliary shutter, lifts the mirror and sets the aperture to the pre-selected value. The picture on the ground glass is no longer visible. On pressing the normal release button to take the picture, only the between-lens shutter operates, cutting down the interval from releasing to the instant of exposure to 1/60 sec.

Once you have operated the quick release button, you must still release the shutter before you can turn the winding knob.

The quick release button is therefore useful for sports and action shots. The subject must of course be observed through a sports or frame finder.

THE HASSELBLAD 500EL

The Hasselblad 500EL is basically a Hasselblad 500C, but it has an electric motor drive built into its base. This motor undertakes the mechanical tasks of advancing the film and cocking the shutter, giving the photographer greater freedom to concentrate on the actual photographic work, focusing and exposing. The motor is powered by one or two rechargeable batteries, each giving 1,000 exposures per charge.

The camera uses the same lenses and shutter, finder and magazine unit as the Model 500C. As it is best used with the magazine giving 70 pictures, it is usually supplied as the 500EL/70.

Shutter Release Methods

The shutter release of the Hasselblad 500EL can be operated in the following ways:

1. By release knob on the camera in the conventional way.
2. With the remote control cable at varying distances from the camera of up to 100 ft. or, with an amplifier, up to 200 yards.
3. By remote control radio signal without cable connection.
4. Automatically with an electric timer for programmed exposure at fixed intervals.
5. Automatically to take a series of rapid sequence shots.

Additionally, there are five different ways of making exposures. The chosen method is set on the selector scale on the side wall of the camera. The effect of these settings is:

1. **With the indicator set to "O"** (=normal setting), the film is advanced after exposure, the shutter is cocked and the mirror returns to the focusing position.
2. **With the indicator set to "S"** (=speed setting), the reaction time between release and exposure is reduced to a minimum because with this setting, the mirror is lifted, the auxiliary shutter is opened and the diaphragm is slipped down to the pre-set value beforehand.
3. **With the indicator set to "SR"** (=speed repeat setting), the result is the same as with the "S" setting above, but the camera remains at this setting after exposure.
4. **With the indicator set to "A"** (=automatic setting), the camera continues to make exposures as an exposure signal is given and the magazine exposure counter shows that it contains unexposed film. The exposure signal can be given, for example, by a release cord. The time between each exposure is approximately 1 sec. The exposure values from 1-1/15th sec. should be avoided but if they have to be used, it is important that the release button remains depressed until the between-lens shutter completes the exposure. Otherwise the auxiliary shutter will close and interrupt the exposure.
5. **With the indicator set to "AS"** (=automatic speed setting), the result is the same as at the automatic setting above, except that the camera remains at the "S" setting after the exposure signal.

B and T Exposures

Exposure times between 1 sec. and 1 minute, which are to be released by means of the release button or remotely by radio or cord, should have the shutter set to "B". For time exposures in excess of 1 minute, the shutter should be opened by moving the lever to "T" (with the shutter set to "B"). To close the shutter, set the time lever back to the "O" setting. This advances the film and cocks the shutter. To save the batteries use the time lever for exposures in excess of 1 minute and also when making exposures with the self-timer.

Alternative Release Methods

There are two releases on the camera front and one on the side. Normal exposures are made with a release button, which can be attached to either of the two front sockets.

To work away from the camera, release cords measuring 1 ft., 10 ft. or 20 ft. can be connected to either of the two front sockets. When using these cords, the release button need not be removed and can be used as an alternative release.

The side socket is used to recharge batteries in the camera with the recharge unit and also in conjunction with the release cord SK150 when making exposures at greater distances from the camera, e.g. with the 100 ft. connecting lead.

Programmed exposure with fixed intervals from one frame every 2 seconds to one frame every 60 hours can be obtained with the timer. This is connected to the side socket of the camera. The timer is electric and runs off a mains supply.

Remote-control Release by Radio

A receiver is mounted to the camera accessory shoe and takes power from the camera batteries. A tone transmitter operating on a 27 mc/s radio control band is employed to send a release signal to the camera. (In Britain, Post Office authority is required to operate this equipment).

The Hasselblad 500EL Batteries

The electric motor is powered by one or two rechargeable nickel cadmium batteries. With one battery, 1,000 exposures can be made on each charge. With two batteries, 2,000 exposures are possible before recharging.

The recharging unit Model I is supplied with the camera and is designed to recharge one or two batteries in the camera. The recharging time for each battery is 14 hours. A recharging unit Model II is available, intended for charging batteries in the camera or in the Hasselblad battery box. It is equipped with adjustable timer which automatically stops the charging after the pre-set time has elapsed.

THE HASSELBLAD 500EL

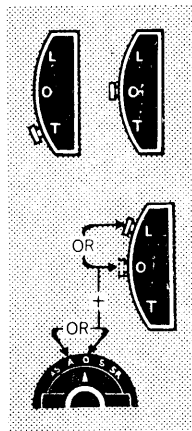
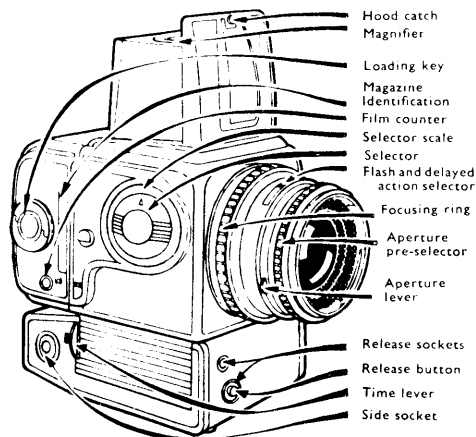

The 500EL is basically a 500C, but it has additional controls. The *time lever*, shown at right above, is used for exposures from 1 second to 1 minute and when making exposures with the self-timer. Moving the lever to T (with the shutter set to B) opens the shutter. Moving the lever to O closes the shutter, advances the film and re-cocks the shutter. When changing lenses, the time lever must be set to L or O and the selector scale (see below) set to A or O.



The selector scale on the 500EL. The figures used here correspond to those on page 7 of this section: 1. Normal setting. 2. Speed setting. 3. Speed repeat setting. 4. Automatic setting. 5. Automatic speed setting.

THE HASSELBLAD 1600F AND 1000F

These models use interchangeable lenses and finder systems, and interchangeable roll film backs. They are fitted with a stainless steel focal plane shutter. The lenses therefore do not have their own shutter. The shutter is synchronized for flash bulbs and electronic flash.

All the interchangeable lenses, except 250 mm., are fitted with a manual pre-selector iris and all have a depth of field indicator.

The standard lens is the 80-mm. Ektar *f*2.8; the later models of the 1000F are fitted with the 80-mm. Zeiss Tessar *f*2.8. Alternative lenses cover focal lengths from 135 to 250 mm.

THE MODEL 1600F has shutter speeds from 1 sec. to 1/1600 sec. and B.

THE MODEL 1000F has shutter speeds from 1 sec. to 1/1000 sec. and B.

FOR CLOSE-UP WORK extension tubes, extension bellows and transparency copy holder are available.

OTHER ACCESSORIES INCLUDE: Magazines, the sheet film adapter, the magnifying hood, eye-level pentaprism, sports finders, quick tripod coupling, filters, lens hood, flash gun bracket, squared screen and ever-ready and outfit cases.

Shooting

1. **Wind the film transport** by turning the transport knob one turn to a full stop. This advances the film to the next frame, lowers the mirror, and tensions the shutter. It further sets the signal on the camera indicating that the shutter is tensioned (white), and sets the signal on the attached magazine to show that the film is advanced (white). If you cannot turn the film transport knob, this may be due to the last film frame being exposed, leaving no number in the film window. This occurs with magazines above Serial No. 20,000.
2. **Open the reflex hood** for a preview of the picture you intend to take.
3. **Set the shutter speed.** Pull out the film transport knob and turn it clockwise (on 1600F you can turn either way) to bring the required speed (engraved on the knob) opposite the red triangular mark on the camera body. Then let knob spring back. This can be done after operating the transport knob.
4. **Set the aperture.** Slide the trigger handle protruding near the front of the lens to the left and turn the aperture setting ring to the aperture you want to use.
5. **Focus** by turning the front serrated lens ring while observing the screen, and determine the exact field to be photographed.
6. **Stop down and release.** As soon as you are ready to take the picture slide the trigger on the lens mount to the right as far as it will go. The lens is now stopped down to the aperture you had preselected (see above, No. 4). The red rectangle on the aperture ring will then

THE HASSELBLAD 1000F AND 1600F

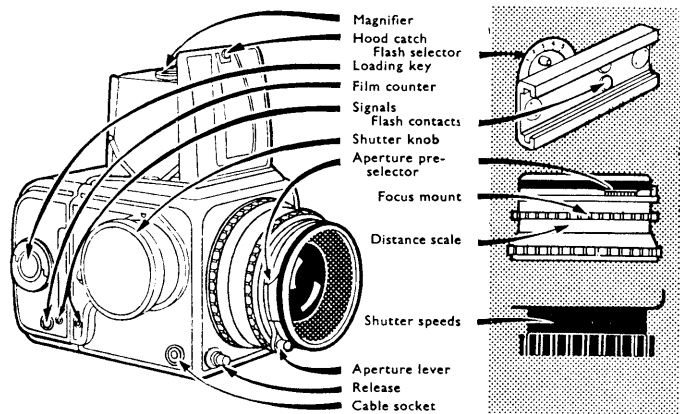

The hood catch opens both the hood and the magnifier. The flash selector sets the appropriate synchronization for different types of flash. The loading key advances the film to the first exposure. The film counter indicates the number of frames exposed. The signals on the camera and magazine show the state of operation of both. The flash contacts in the finder shoe connect to outlets on the slide in adaptors. The shutter knob advances the film and tensions the shutter, as well as setting the shutter speed. The aperture preselector presets the required lens opening. The focusing mount, next to the distance scale sets the lens to the appropriate distance. The shutter speeds are marked on the barrel of the shutter knob. The aperture lever or trigger stops down the lens immediately before the exposure to the preselected value.

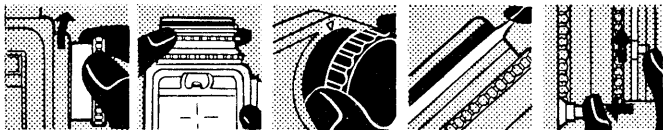

Shooting with the F models. From left to right: Wind the film and tension the shutter; view the subject on the screen and focus the lens; set the shutter speed; preselect the lens aperture; close down the lens to the preselected value and press the release.

joint to the red dot on the aperture scale. Now release the shutter gently by pressing the button.

Special Controls

FOR TIME EXPOSURES set the shutter speed indicator to B (= brief time). On releasing, the shutter will remain open as long as the release button is pressed down and closes as soon as the pressure on the release is removed.

For time exposures always use a cable release. This screws into the release socket on the bottom front corner of the winder side of the camera body. Unscrew the dust cover with the tip of the index finger. For long time exposures, where it is inconvenient to keep the release depressed, a cable release with time lock is useful. After depressing the plunger, engage the catch or tighten the locking screw to keep the shutter open. Disengage the time catch to close the shutter.

FLASH SETTINGS. For flash the special flash connection or the frame finder with flash connection is required. This goes into the accessory shoe on the side of the camera body, and carries two flash sockets. Push in the attachment as far as it will go; it must click into position to establish the correct flash contact.

There are two models of this socket connection. One carries the now discontinued U.S.-type twin pins. The other has 3-mm. co-axial flash socket. Either type of socket has two outlets marked *flash* and *strobe* respectively. When using the U.S.-type twin-pin socket, the flash gun has to be insulated from the camera, to avoid short-circuits.

Above the accessory shoe fitting on the camera there is a pointer and a semi-circular plate engraved with numbers from 1 to 5. The pointer adjusts the flash synchronization for different types of flash bulbs.

The Hasselblad with focal plane shutter should only be used with focal plane flash bulbs which have a long flash duration. These are generally marked F.P. When working with flash bulbs, connect the flash cable to the outlet socket marked *Flash*. Then set the synchronization according to the table on page 59. If your first tests show that the negative is not evenly exposed, the synchronization can be adjusted. If the negative is thinner on the side with the two notches, move the pointer to the next higher figure; if it is thinner on the opposite side, set the pointer to the next lower figure.

When working with electronic flash, connect the flash cable to the socket marked *Strobe*. This bypasses the synchronization adjustment and its position is irrelevant. The shutter speed with electronic flash must be set to 1/25 sec. or slower.

Class M flash bulbs (non-focal plane types) can also be synchronized at 1/25 sec. by using the electronic flash socket.

The sports frame finder made for the F models occupies the accessory shoe space required by the flash socket. This finder, except its earliest version, is therefore so constructed that it contains in its base the flash sockets. Finders with U.S. or 3-mm. co-axial fittings are available.

THE HASSELBLAD SUPER WIDE C AND SUPER WIDE

These Hasselblad models are part of the Hasselblad system. While they are specialized cameras in their own right, they can also be considered as front attachments to the Hasselblad 500C, 1600 F or 1000F.

The Super Wide is an extreme wide-angle camera. With an angle of view of 90°, it offers a subject field four times larger than the standard 80-mm. lens with its angle of view of 52°. This feature is of greatest value when taking photographs in limited space indoors, and for architectural and industrial photography.

The lens is the 38-mm. Zeiss Biogon *f*4.5. It is an 8-element construction, focusing from 12 in. to infinity. The image is free from vignetting even at full aperture and the lens is fully corrected for distortion and colour rendering. It accepts Hasselblad type 63 (Series VIII) filters which are retained by a filter ring on the lens front.

The body is very shallow, as this camera has no reflex focusing system. Nor is that needed, as the extreme short focal length of the lens provides a very large depth of field. A spirit level is let into the camera top.

The Super Wide models use the interchangeable film back for standard Hasselblad roll film magazines and sheet film holder. The back also accepts the ground glass adapter and magnifying hood.

The top of the camera carries a removable optical direct vision viewfinder with prism to observe the spirit level.

The shutter is synchronized for flash bulbs and electronic flash and has a delayed-action release.

THE SUPER WIDE C has a Synchro-Compur shutter with speeds of 1, $\frac{1}{2}$, $\frac{1}{4}$, 1/8, 1/15, 1/30, 1/60, 1/125, 1/250, 1/500 sec. and B. The shutter is automatically tensioned on-advancing the film by the film winding crank. It carries an exposure value scale and automatic depth of field indicators. The base has fitting for instant tripod attachment. The release button is in the top of the camera body.

THE SUPER WIDE has a Compur shutter with speeds of 1, $\frac{1}{2}$, 1/5, 1/10, 1/25, 1/50, 1/100, 1/250, 1/500 sec. and B. The shutter has to be tensioned independently. A knob is fitted for film transport and a depth of field scale is opposite the distance scale. The release button is on the base of the camera front plate.

ACCESSORIES include the Super Wide viewfinder, flash gun bracket, magnifying hood, ground glass adapter, magazines, sheet film adapter, quick tripod coupling, filters, and cases.

Shooting

1. Wind the film transport one turn to a full stop.
- 2a. Set the exposure value on the Super Wide C. The shutter rim carries

a range of numbers engraved from 3 to 18. These are exposure values for correct exposure. Each exposure value represents a range of shutter speed-aperture combinations of equivalent effective exposure. To set the exposure value, slightly push back the serrated lever on the rim behind the exposure values and move the triangular mark beside the lever to the appropriate exposure value (obtained from exposure tables or a meter) on the scale. Intermediate exposure values, e.g. 10½, 11½, etc., can also be set.

- 2b. Set the exposure time and tension the shutter on the Super Wide. Turn the ring behind the front lens mount until its index points to the shutter speed required. The engraved numbers 1, 2, 5, 10, 25, 50, 100, 250, 500, indicate fractions of a second and stand, therefore, for $\frac{1}{2}$, 1/5, 1/10, 1/25 sec., etc. Then push up the shutter tensioning lever, which is situated between the aperture scale and the flash socket.
- 3a. Select the aperture-speed combination of the Super Wide C by turning the milled shutter ring. Aperture and speed scales here move together. The figures opposite each other represent alternative combinations corresponding to the exposure value set. Again only the aperture and speed actually opposite the black central index line on top of the shutter are the ones in use. To set apertures and speeds separately (e.g. for flash shots), adjust first the shutter speed and then the aperture on the exposure value setting ring.
- 3b. Set the Aperture on the Super Wide by moving the lever behind the aperture scale until its index points to the aperture selected.
4. Set the distance. Focus by turning the large milled ring on the rear of the lens mount to bring the required distance figure opposite the index.
5. View the subject through the finder. Watch the spirit level through the prism. Perfect alignment is essential to avoid distorted vertical and horizontal lines.
6. Release the shutter gently.

Special Controls

FOR TIME EXPOSURES set the index of the shutter speed ring to B (= brief time).

On the Synchro-Compur shutter of the Super Wide C the green figures represent full seconds corresponding to the aperture value opposite them at a given exposure value. If you want to use one of these apertures, note the time opposite it. Set the aperture separately by depressing the exposure value lever and turning the aperture ring. (Leave the shutter speed ring at B.) Then expose for the time which was previously opposite that aperture value.

For time exposures use a cable release to avoid camera shake. On the Super Wide C this screws into the centre of the body release. For

THE ORIGINAL SUPER WIDE

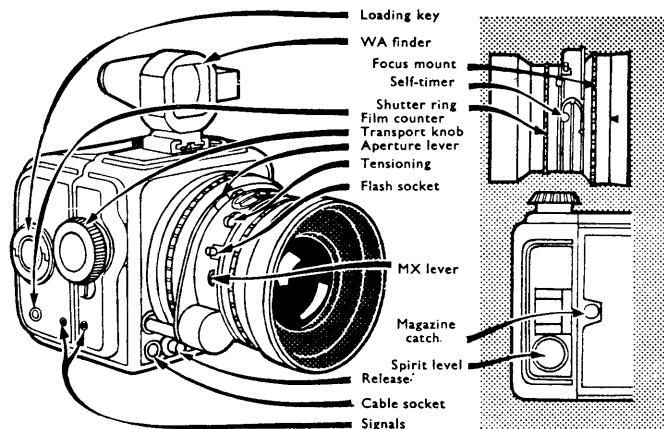

The loading key advances the film to the first exposure, after which the film counter in the side of the magazine indicates the number of exposures made. The wide angle finder incorporates a prism to show the spirit level. The self-timer on the shutter permits delayed releasing. The shutter speed ring sets the shutter speeds, and the aperture lever the apertures; these two are not interconnected. The transport knob advances the film, but the shutter must be tensioned separately with the tensioning lever. The flash socket takes standard co-axial plugs; the MX lever selects the type of synchronization. A cable release socket is mounted next to the release button. The signals on the camera and magazine indicate whether the picture has been exposed or the film needs advancing.

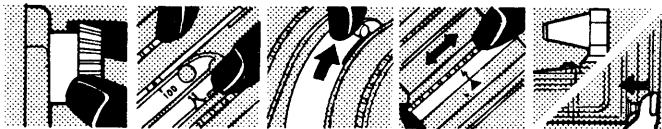

Shooting with the Super Wide. From left to right: Wind the film transport knob; set the aperture and shutter speed separately; tension the shutter; set the lens to the appropriate subject distance; view the subject through the finder and release the shutter.

HASSELBLAD LENSES AND FINDERS

Lenses for the Hasselblad 500C

Every interchangeable lens for the Hasselblad 500C camera has its own built-in Synchro-Compur shutter, automatic and manual aperture adjustment, automatic depth of field indicators, exposure value scales and delayed action.

The iris diaphragm on the latest versions of the Hasselblad 500C lenses has a special release lever to stop down the lens to its preselected aperture during viewing. This lever is on the shutter rim on the winding knob side of the camera when the lens is mounted on the Hasselblad, and protrudes between the words "Synchro" and "Compur" engraved on the shutter. Pressing the lever down closes the aperture; this provides a preview of the depth of field of the screen image. The latter is of course then correspondingly dimmer.

The iris then remains closed down to that value until you press the shutter release and tension the shutter again with the winding knob. If you want to open up the lens to full aperture again before shooting, set the aperture selector ring to the maximum aperture, and then to the required smaller aperture again. The iris now once more remains fully open until you release the shutter (or press the preview lever).

The series of lenses consists of:

THE 40-mm. ZEISS DISTAGON is an extra wide-angle lens with an angle of view of 88° consisting of ten elements, has a focusing range from 20 in. to infinity and apertures from $f/4$ to $f/32$. The lens accepts Hasselblad filters series 104.

THE 50-mm. ZEISS DISTAGON $f/4$ is a wide-angle lens with an angle of view of 75° (as compared with 52° of the standard lens). It consists of seven elements, has a focusing range from 20 in. to infinity and apertures $f/4$ to $f/22$. The lens accepts series 63 filters. This lens has replaced the 60-mm. lens.

THE 60-mm. ZEISS DISTAGON $f/4$ (up to 1961 it was supplied with aperture $f/5.6$) is a wide-angle lens. The angle of view of this lens is 67°. It consists of seven elements, has focusing range of 21 in. to infinity and apertures from $f/4$ (or $f/5.6$) to $f/22$. The lens accepts Hasselblad filters series 63.

THE 80-mm. ZEISS PLANAR $f/2.8$ is the standard lens of the Hasselblad 500C camera. It is a seven-element construction (originally six-element) with an angle of view of 52°, a focusing range from 3 ft. to infinity, and apertures from $f/2.8$ to $f/22$. The near focusing limit can be extended by Proxar lenses, extension tubes, and the extension bellows (●●). This lens accepts Hasselblad filters, series 50 with bayonet mount, and a series 80 bayonet lens hood. For infra-red film use a position 9.5 mm. to the right of the central distance indication line as the focusing index.

THE 100 mm. $f/3.5$ ZEISS PLANAR has a particularly flat field (for photogrammetric use), is a slightly longer than normal length lens

LENS CHANGING

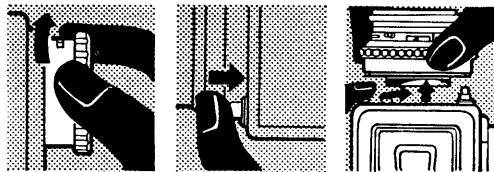

Removing the lens from the Hasselblad 500C. First tension the shutter (left), then depress the lens catch (centre), and turn the lens anti-clockwise and lift out of the camera (right).

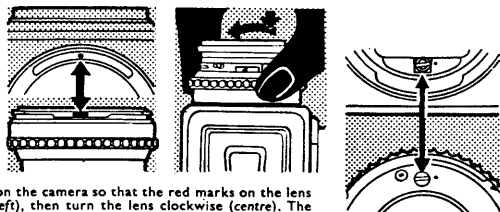

To fit the lens, mount on the camera so that the red marks on the lens and body are in line (left), then turn the lens clockwise (centre). The tensioning shafts on both the camera and the lens must have their groove lined up with the red dot before a lens can be fitted (right). This is automatically the case if the camera is always tensioned before a lens is removed or fitted.

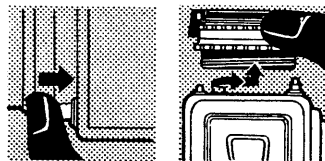

To remove the lens on the F models press the catch (left) and turn the lens anti-clockwise to lift out (right).

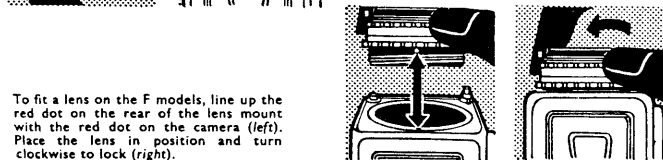

To fit a lens on the F models, line up the red dot on the rear of the lens mount with the red dot on the camera (left). Place the lens in position and turn clockwise to lock (right).

of seven-element construction, with an angle of view of 43° and a focusing range from 3 ft. to infinity and apertures from $f/3.5$ to $f/22$. Intended for use specially calibrated together with camera body and magazine 70.

THE 105 mm. $f/4.3$ ZEISS UV SONNAR. This is a seven-element construction with an angle of view of 40° and a focusing range from 6 ft. to infinity. Apertures from $f/4.3$ to $f/32$. Available to special order only with enhanced UV transmission for use with UV materials by scientists and technologists, especially when examining old or altered documents, etchings, tapestries, paintings, finger prints on various surfaces, etc.

THE 120-mm. ZEISS S-PLANAR $f/5.6$ is a long focus lens giving $1.5\times$ magnification as compared with the standard lens. It is a six-element construction and has an angle of view of 36° . The focusing range extends from 3 ft. to infinity and apertures are $f/5.6$ to $f/32$. The lens accepts series 50 filters with bayonet mount. For near focusing distances extension tubes (●●) and extension bellows are available.

THE 150-mm. ZEISS SONNAR $f/4$ is the most universal long-focus lens, giving almost $2\times$ magnification as compared with the standard lens. It is a five-element construction, and has an angle of view of 29° . The focusing range extends from 5 ft. to infinity, and apertures from $f/4$ to $f/32$. For near focusing distances extension tubes (●●) and extension bellows are available. This lens accepts Hasselblad filters series 50 with bayonet mount and a 150/250 bayonet lens hood. For infra-red film use a position 4.2 mm. to the right from the central distance indication line as the focusing index.

THE 250-mm. ZEISS SONNAR $f/5.6$ is a tele lens for close-ups of distant subjects. It yields more than 3 times magnification as compared with the standard lens. It is a four-element construction, with an angle of view of 18° , and has a focusing range from 8 ft. to infinity. For nearer shots, extension tubes and the extension bellows can be used (●●). Apertures are adjustable from $f/5.6$ to $f/45$. This lens accepts Hasselblad filters series 50 with bayonet mount and the 150/250 bayonet lens hood. For infra-red film use a position 5.1 mm. to the right from the central distance indication line as the focusing index.

THE 500-mm. ZEISS TELE TESSAR $f/8$ is a tele lens for extreme magnification. Its main applications include special jobs in press, expedition and wild animal photography. It is the first extreme tele lens with Compur shutter and automatic aperture setting. It is a five-element tele construction; the distance from the front lens element to the film plane is only 380 mm. It yields a linear magnification of $6\frac{1}{2}$ times as compared with the standard lens, with an angle of view of 9° . The focusing range is from 28 ft. to infinity; the apertures are adjustable from $f/8$ to $f/64$. The lens accepts Hasselblad series 86 filters with threaded fitting and threaded lens hood. The latter is supplied with the lens.

Changing the Lenses of the 500C

The lenses have a bayonet mount with four retaining lugs, and one starting point only.

REMOVING THE LENS. The shutter has to be tensioned before the lens can be removed. Depress the lens catch in the right bottom corner of the front of the camera body, hold the entire lens mount with your right hand and turn it anti-clockwise by a one-fifth turn. Then lift off the camera body.

FITTING THE LENS. A lens can only be attached to the camera when its shutter is tensioned. Normally, winding the film transport knob tensions the shutter. With the lens removed from the camera, the groove on the tensioning shaft in the rear of the lens should then point to the red mark beside it. If the shutter was released while the lens was removed from the camera it must be re-tensioned before the lens can be inserted. The simplest way of tensioning the shutter is to place the edge of a coin in the groove on the cocking shaft and turn clockwise.

The lens is in the correct position for attaching to the camera body when the red dot in the back of the lens is opposite the corresponding mark on the camera body. Push lens into the flange of the body and turn the whole lens clockwise until the catch on the bottom right-hand corner of the camera front clicks into position.

A LENS FLANGE designed for photographers who want to use the Hasselblad 500C lenses on their enlarger accepts the lens on one side, while the other one will fit most enlargers. To stop down the Hasselblad lens when on the enlarger, use the manual aperture setting lever.

The Lenses for the Hasselblad F Models

The interchangeable lenses for these camera models with a built-in focal plane shutter do not have their own shutters. They are fitted (except the 250-mm. lens) with a pre-select iris. This allows presetting of the aperture at which you want to work. You then focus at full aperture for maximum image brightness on the reflex screen (and minimum depth of focus for highest focusing accuracy). On flicking the aperture lever as far as it will go, the iris closes down to the pre-selected stop; you do not even have to take your eye from the screen. The lenses are fitted with depth of field indicators. The nearest focusing range of all lenses can be extended with extension tubes and the extension bellows (●●). All lenses accept series VII filter glasses which fit the front ring of the lens and are held in position by a retaining ring.

THE 60-mm. DISTAGON $f/5.6$ is a wide-angle lens of six elements, with an angle of view of 65° . It focuses from 20 in. to infinity, and carries aperture settings from $f/5.6$ to $f/22$.

THE 80-mm. EKTAR $f/2.8$, the standard lens of the earlier models, has four elements. Its angle of view is 51° and the focusing range from 20 in. to infinity. The lens is recessed so that no lens hood is needed.

THE 80-mm. ZEISS TESSAR $f/2.8$, the standard lens of the later models of Hasselblad 1000F, has the same specification as the Ektar above. The lens is recessed so that no lens hood is needed.

THE 135-mm. ZEISS SONNAR $f/3.5$ is a universal long-focus lens for distant shots. It yields a linear magnification of $1\frac{1}{3}$ times compared with the standard lens. The angle of view is 32° and the focusing range from 40 in. to infinity. It accepts a series VII lens hood.

THE 135-mm. EKTAR $f/3.5$ is similar to the 135-mm. Sonnar in application and performance.

THE 250-mm. ZEISS SONNAR $f/2.6$ has the same construction, specification and performance as the same lens for Hasselblad 500C. It takes, however, series IX filters with retaining ring. A lens hood is supplied with lens.

A 250-mm. ZEISS SONNAR $f/4$ was available for a limited time. The overall optical performance at wide apertures is not quite equal to that of the $f/5.6$ model. This lens uses the special Zeiss filters, which are placed between the lens and the lens hood. The latter comes with the lens.

The Super Wide-angle Lenses

THE 38-mm. BIOGON $f/4.5$ forms part of the Hasselblad Super Wide camera. It can in a way be considered as a lens unit usable with the magazines and other attachments of the Hasselblad system.

Changing the 1000F and 1600F Lenses

The lenses are fitted with a quick change mount.

To remove the lens, hold the milled ring at the base of the lens with your right hand. Press the lens lock release on the bottom corner on the right of the camera front and turn the lens by a third of a turn anti-clockwise as far as it will go. The lens can now be lifted away.

To attach the lens, line up the red dot on the rear rim of the lens mount with the red dot on the top of the lens flange on the camera body. Turn the lens clockwise until the lens lock clicks into position.

Lens Hoods

The lens hood protects the lens from light coming from outside the actual picture area. Without a hood, light from objects outside the actual picture area reaches the lens and reduces the picture brilliance. This applies not only to photographs taken against the light—when the lens hood becomes indispensable—but to sunshine in general, as well as to pictures in diffused light and indoors.

THE LENS HOODS FOR THE HASSELBLAD 500C lenses of focal length from 80 to 250 mm. carry a bayonet fitting to fit the bayonet front of the lens mount. Special models are made for the Biogon 38-mm. and Distagon 50-mm. lenses. They screw directly on to the lenses and take Hasselblad series 63 filters.

ALTERNATIVE FINDER UNITS



To remove the standard hood (left), first release the magazine and then slide the hood backwards out of its grooved fitting. Alternative finders, such as the magnifying hood (right) can then be slid in place.

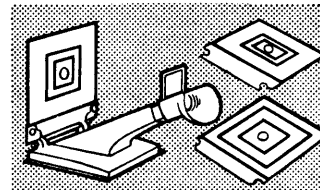
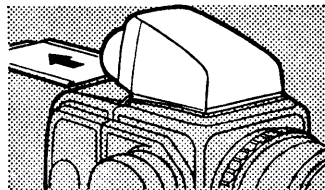

To fit the pentaprism, first remove the sheath from the bottom of the pentaprism which protects the optical glass surfaces. Mount the pentaprism on the top of the camera in the same way as the standard hood (left). Alternatively the prism frame finder (now discontinued) can be fitted on the top of the camera. This simultaneously provides a view of the focusing screen and a direct eye-level view through the frames of the finder. Interchangeable masks are available for the finder frame to indicate the fields of view with the different lenses (right).

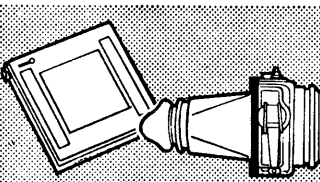
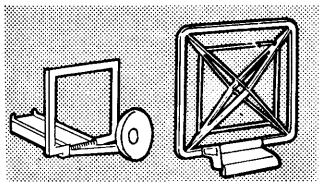

The sports viewfinder (left) fits into the shoe in the side of the camera. This finder again can be fitted with interchangeable masks for lenses of different focal length. A special version indicates the field of view for the Sonnar 150 and 250 lenses used with Hasselblads 500C/500EL and magazines A12, 12, 24 or 70.

The Super Wide C can also be used with a ground glass adaptor (right) to permit precise focusing on a ground glass screen. The adaptor fits in place of the film magazine, and can be used with the focusing magnifier for accurate judgement of the screen image.

A professional model in the form of a square bellows extending to about 4 in. (100-mm.) also screws directly into these lenses. For use on the 80- to 250-mm. lenses an adapter ring is included.

THE LENS HOODS FOR THE HASSELBLAD 1600F AND 1000F. The standard 80-mm. lens is recessed in its mount, so that the front acts as a lens hood. The square standard series VII hoods can, however, be added for maximum efficiency. For other lenses the size of lens hood required is given with the details for each lens.

Filter Attachments

Filters for black-and-white and colour photography, a polarizing filter and diffusion disc are available. The size required is indicated with the description of each lens.

Interchangeable Finder and Focusing Attachments

The standard reflex hood of the Hasselblad 500C, 1600F and 1000F can be removed. For this purpose the magazine has to be released. You can then slide the hood backwards out of its grooved fitting.

As an alternative there is available a magnifying hood, the eye-level pentaprisms, or the prism sports finder, which is now discontinued. These are pushed into the grooves above the ground glass screen from the back. Push the unit home until it clicks into place.

THE MAGNIFYING HOOD carries in its top a $2.5\times$ magnifier, which is adjustable by rotating the focusing holder. This provides a range of eyesight corrections equivalent to -3 to $+3.5$ dioptres to suit individual needs. The rubber eyepiece excludes extraneous light.

THE EYE-LEVEL PRISM FINDER has a soft rubber eyepiece with an extra groove to accept an eyesight correction lens. The eye of the prism finder carries a release button which permits changing of magazines, as with this finder in position the normal magazine release button is inaccessible. The finder provides a brilliant upright and right-way-round image, magnified $2\frac{1}{2}$ times, with camera at eye-level.

THE EYE-LEVEL PRISM FINDER NC-2 is similar to the above but has a sighting angle of 45° and gives a three-times magnification.

THE PRISM SPORTS FINDER fits into the grooves above the ground glass in place of the reflex hood. It is made of stainless steel and light alloy. It has two sighting apertures. The first is for looking straight ahead through the front frame to observe and follow the subject. The second eyepiece is directed down at approximately 25° into a tube. At the end of the latter there is a pentaprism above a small rectangular centre-section of the reflex ground glass screen. This permits focusing and control of the depth of field while the camera follows the subject.

The tube is adjustable and marked for parallax correction. The front frame has a spring-loaded holder for interchangeable masks. A mask for the $2\frac{1}{4}\times 2\frac{1}{4}$ in. negative size is supplied with the finder. Separate

masks for the 16 and 16S magazines are available. Each mask has in its centre a polarized disc which appears blacked out if the eye is not in a straight line with the front frame.

THE TIRAC SPORTS FINDER is a simplified version of the above sports finder. It is suitable for the model 500C. It has parallax correction but no reflex focusing prism, and it can be folded flat. The film fits into the accessory shoe. The metal frame is used as a mask for the standard 80-mm. Planar lens with the $2\frac{1}{2} \times 2\frac{1}{2}$ in. magazine. Masks for different picture sizes and lens fields slide into the grooved metal frame.

THE SPORTS FINDER F is of similar design to the Tirac, but for the 1600F and 1000F. The base contains the flash socket for either the U.S. or the standard 3-mm. co-axial flash plug.

THE FRAME FINDER TISFC shows the field of the 150-mm. and 250-mm. lenses and clips to the front of the lens hood.

The Ground Glass Adapter

A ground glass adapter can be attached to the back of the Super Wide models in the same way as a magazine. When working from a tripod, the ground glass screen permits visual observation of the image, for easy composition, alignment of vertical lines and control of depth of field. The screen is fitted with a Fresnel lens for brighter images.

The ground glass adapter can be combined with the magnifying hood or the standard reflex hood of any of the other Hasselblad models.

CLOSE-UP EQUIPMENT

The Hasselblad camera is particularly suitable for close-up photography as the actual picture is seen on the ground glass screen right up to the moment of exposure. This eliminates all parallax and focusing errors. Any of the Hasselblad lenses can be used for close-ups.

Without the aid of any attachments the 80-mm. Planar focuses down to 3 ft. At this distance the lens covers an area of $19\frac{1}{2} \times 19\frac{1}{2}$ in. With the 60-, 150- and 250-mm. lenses at their closest setting the field covered is even somewhat less (see table on page 63). If smaller areas are to be photographed, there are various close-up accessories.

Proxar Lenses

These are Zeiss close-up lenses in double bayonet mounts for series attachments (adding further a Proxar lens or/and a filter). They fit the front of the 80-mm. Planar f 2.8 lens. There are three types: Proxar 1.0 (focusing range $22\frac{3}{4}$ to $42\frac{1}{2}$ in.), Proxar 2.0 ($26\frac{1}{2}$ to $83\frac{1}{2}$ in.), and Proxar 0.5 ($17\frac{1}{4}$ to $24\frac{1}{2}$ in.) They can be used singly or in combination.

When working with close-up lenses, stop down the camera lens to at least f 4 or f 5.6, to avoid falling-off of definition towards the corners. No change of exposure time is required.

Extension Tubes

These go between the lens and the camera body. They increase the lens-to-film distance and thus enable the lens to focus on much closer distances.

FOR THE HASSELBLAD 500C two extension tubes are available. One is 21 mm. long (M21) and one 55 mm. (M55). They have bayonet front and rear fittings to suit the 500C body and lenses. A shaft passes through the extension tube to connect the camera lens with the mechanism of the body, thus permitting the same automatic aperture control as without extension tubes. They can be used in conjunction with any of the Hasselblad 500C lenses. For instance, with the 80-mm. lens and the M21 tube the focusing range covers subject-film distances from 40.2 to 48.5 cm.; with the 80-mm. lens and the M55 tube, from 31.9 to 32.6 cm.

With the standard 80-mm. Planar lens, extension tubes can also be used in conjunction with the Proxar lenses.

Before fitting the extension tubes fully wind the film transport, and remove the lens. Attach the tube first to the camera body, and then the lens to the tube. If two tubes are used, first fit the M21 to the camera body, the M55 tube to the M21 tube, and finally the lens to the front of the combination of tubes.

To remove the extension tube or tubes, first remove the lens from the extension tube, releasing it with the extension tube release button.

CLOSE UP GEAR

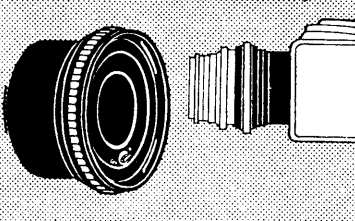

Extension tubes are available for the Hasselblad to go between the camera and the lens and shutter unit of the 500C. The tubes can be used with any of the lenses, and incorporate a coupling shaft to connect the shutter tensioning and automatic aperture control system of the lens to the camera mechanism. The tubes must thus be fitted in the same way as the lens, with the coupling shaft lined up with the red dot inside the tube.

Similar tubes, but without the coupling system are available for the F models.

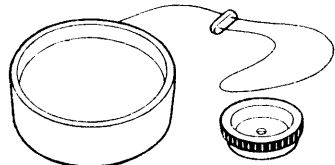

The linear mirror unit is used in photocopying when extremely accurate parallel alignment between the plane and subject is essential. It is accurate to within two minutes of arc.

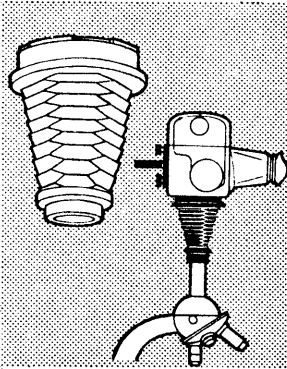

The micrometer adaptor (above) connects the Hasselblad directly with the eyepiece of the microscope for photomicrography.

A special microscope shutter is available to fit between the camera and the micro adaptor (left). This has no lens, and merely provides a means of controlling the exposure. Alternatively the rear auxiliary shutter of the camera can be used. A lens mount adaptor is also available for certain special lenses on the camera (right)

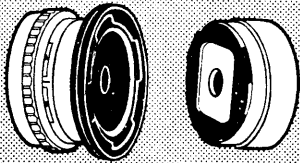

Then remove the extension tubes, one at a time, starting with the route tube.

FOR THE HASSELBLAD F MODELS two tubes are provided. One is 20 mm. long (No. 20) and one 40 mm. (No. 40). They are threaded to fit the camera body on one end and the lens on the other. They are suitable for all Hasselblad 1600F and 1000F lenses and can be used individually or in combination.

Extension Bellows

The extension bellows for the Hasselblad acts in the same way as the tubes but provides a valuable extension between 3 in. and 8 in. It is intended for large close-ups, macrophotography, and copying of small originals (e.g. postage stamps).

The bellows unit for the Hasselblad 500C has bayonet mounts for attachment to the camera and to take the lenses. It is supplied with a double cable release for the operation of the lens and the camera mechanism. The lens is tensioned manually with a setting arm in the lens mount on the bellows unit. A lens-hood front adapter is used in conjunction with the attachment. This adapter is essential when working with the transparency copy holder (see below).

The bellows unit for Hasselblad 1600F and 1000F is similar to that of the Hasselblad 500C, but it has a screw mount for the 1600F/1000F lenses and does not employ the double cable release. (The lens and camera mechanisms on these models are independent from each other.)

Assembling the Extension Bellows

1. Remove the front bellows-hood.
2. Screw the red cable of the twin cable release into the cable socket on the lower front, and the other cable into the corresponding one on the back of the bellows unit. (This applies only to the bellows for the model 500C.)
3. Remove the camera lens from the body. Fit it (with the red dot of the lens lined up with the red dot on the bellows unit) to the front of the unit. Mount the rear of the bellows (again lining up the red dots) on the camera body. (With the bellows unit for the Hasselblad F models, screw the lens to the bellows and the bellows to the camera.)
4. Slide the front hood into the front tube of the unit. But first loosen the locking screw on the side of the tube.
5. Clip the rear ring of the bellows hood to the front bayonet mount of the lens and tighten the retaining screw on the rear of the bellows hood unit.

Using the Extension Bellows

As the automatic tensioning system is disconnected when the bellows attachment is in use, the shutter requires tensioning after each exposure.

THE EXTENSION BELLOWS

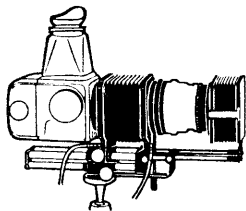

The camera mount connects directly to the body of the Hasselblad. The rear unit is movable and controls the extension of the bellows. Scales on the rails indicate the necessary exposure increase with the various lenses. The lens fits into the front mount on the bellows. A twin cable release is used with the bellows, to work the camera release and the release of the automatic lens aperture control respectively. The tripod mount moves the whole bellows unit forward and backward on the tripod, to permit accurate focusing without varying the bellows extension.

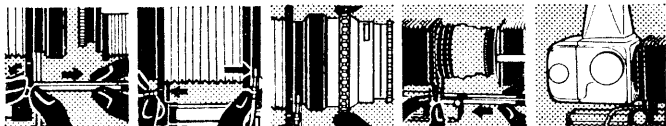

Assembling the bellows. Remove the front hood (left), fit the cable releases at the front and the rear of the bellows unit (centre left); mount the camera lens in the front mount (centre); replace the extension hood (centre right); and finally mount the camera on the rear mount (right).

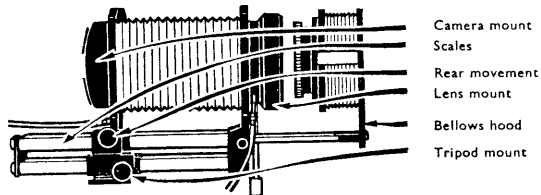

The extension bellows can also be used for copying transparencies with the aid of the transparency copy holder. This fits on the front of the extension hood and takes transparencies (or negatives) which are illuminated from behind by suitable light source.

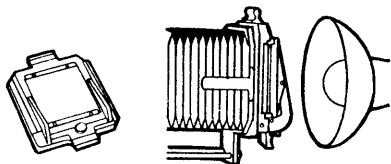

Turn the tensioning arm on the front of the attachment through one full turn. Tension the camera by the film transport knob. (On the Hasselblad F models the transport knob in any case tensions the shutter.) Focus with the lower knob on the left-hand side; set the range and scale with the upper knob. Either movement can be locked by the corresponding knobs on the right-hand side of the bellows unit.

The front bellows hood can be extended to the required shading effect by loosening its fixing screw and unclipping the hooks on both sides of the hood.

To expose, depress the cable release button until the auxiliary shutter opens. This means also that the lens shutter is closed and the aperture is set to the preselected opening. Wait with the final releasing until the camera has stopped vibrating and then release fully. Keep the release depressed until the shutter mechanism has run down, otherwise the auxiliary shutter (of the Hasselblad 500C) will close and break the exposure.

The Transparency Copy Holder

This is an attachment which is used in conjunction with the extension bellows and hood. It permits copying of colour negatives and transparencies. You can at the same time correct under-exposure, colour casts, too contrasty or flat colour transparencies. You can also duplicate colour copies or black-and-white ones. Finally, you can use the copy-holder for making colour separation negatives.

To use the copy holder, push it into the grooves on the front of the hood of the assembled extension bellows unit. Attach the support bracket to the bellows with its tripod screw. Release the ground glass screen by the catch on its base, insert the object to be copied and tighten the locking screw above the catch. Focus and set the degree of enlargement. Tighten the support bracket screws and expose.

The Microscope Adapter

This can be attached to the Hasselblad 500C to provide an effective, convenient connection between the camera and the microscope eyepiece. The microscope adapter can be connected either directly to the camera—in which case the exposure is made with the rear shutter in the camera body—or with the microscope shutter especially designed for photomicrography.

The Microscope Shutter

This is an XM-synchronized Synchro Compur shutter with speeds from 1 to 1/500 sec. and B. It is tensioned and released automatically and is used in conjunction with the microscope adapter. Use a cable release to avoid vibration. Alternatively, open the rear shutter before the exposure, by pressing the quick-release button. The exposure will then be made by the micro-shutter alone on pressing the release button on the camera.

If the extension bellows is fitted between the microscope shutter and the camera the magnification provided by the microscope lens can be adjusted continuously.

The extension bellows, like the microscope adapter, provides a completely vibrationless microscope attachment. If the focusing hood is used, the microscope image appears directly on the ground glass. The double cable release for the extension bellows then opens the rear auxiliary shutter immediately before the between-the-lens shutter, and so ensures a vibration-free exposure.

A LENS MOUNT ADAPTER is available to connect special lenses such as generally used for photomicrography to the Hasselblad 500C camera.

THE LINEAR MIRROR UNIT permits extremely accurate parallel alignment between film plane and subject in copying. It consists of a lens flange mirror attached in place of the lens of the Hasselblad 500C and a reflecting mirror placed at the subject plane.

A RINGLIGHT can be attached to all Hasselblad 500C lenses, except the 500-mm. It gives even, shadowless illumination in close-up work in research, medicine, technology, etc. It is fitted with cables to connect with Paffrath C Kemper electronic flash units.

MISCELLANEOUS ACCESSORIES

The Rapid Winding Crank

The film winding knob of the Hasselblad 500C is interchangeable, and can be replaced by a rapid winding crank. The crank consists of a knob base with bayonet fitting and a handle which can be folded over into the base and is swung outward for use. Cranking the handle advances the film and sets the shutter in one smooth and even movement, reducing the transport time. It is therefore useful for all quick-action work, particularly in sports photography. It is attached and removed in the same way as the winding knob (■).

The Winding Knob with Exposure Meter

Suitable for the Hasselblad 500C, this is a precision photo-electric exposure meter incorporated into a film winding knob. It can be fitted to the camera in place of the standard knob and removed from it in the same way as the normal knob (■). It can therefore be used on the camera, or for independent exposure readings. The meter is calibrated in exposure values from 1-20 and is fitted with an incident light blind which can be drawn over the photo cell and locked in position by the catch at its end. For normal reflected light measurement, the blind is pushed back.

To use the meter:

1. Set the film speed by turning the disc in the centre outside face of the meter with a coin until the ASA or DIN film speed marker points to the speed of the film to be used.
2. Point the meter at the subject.
3. Read off the exposure value and set it on the shutter. Trace from the black or white section against which the needle registers to the corresponding exposure value number on the outside rim of the meter. This is the value to be set.

Detach the exposure meter from the camera when working with the long focus lenses, as the lens branch of the latter may produce reflections which would make the exposure meter reading inaccurate.

CHECKING THE METER. When the cell is completely shielded from all light, the meter needle should point to the white line at the left-hand end of the scale. If it does not, it can be re-set to the zero position by turning the small adjustment screw on the meter rim below the cell.

Exposure Meter Attachment

This attachment can be clipped to the front of the lens hood and holds the exposure meter when using the rapid winding crank on the 500C. It also enables the user of the 500EL to use the exposure meter.

HASSELBLAD ACCESSORIES

The rapid winding crank fits on the camera in place of the normal winding knob, for quick film transport and shutter tensioning.

The exposure meter knob is a winding knob with the built-in exposure meter system. This comprises a meter cell with incident light diffuser, and the measuring instrument which directly reads in exposure values after being set to the appropriate film speed.

The exposure meter knob can also be fitted to a wrist strap as an alternative to mounting it on the camera. This makes separate meter readings more convenient.

Left: The quick focusing handle fits on the lens and carries a series of movable index markers for rapid adjustment of the focusing mount. When the appropriate index marker is on top, you know that the lens is set to a predetermined distance. Right: The camera grip fits the tripod bush in the base of the Hasselblad 500C, for convenient eye-level shooting. The release trigger on the grip directly connects to the camera release button.

Left: The quick tripod coupling permits instant attachment of the models 500C or Super Wide C, without the need for screwing the tripod into the bush in the camera. The coupling remains permanently on the tripod. The coupling can be used with older models by fitting an intermediate shoe.

Right: The camera grip with flash bracket consists of a handle, as well as a holder for a flash gun plus a cable release. It permits a steady hold of the camera with the left hand for eye-level shooting.

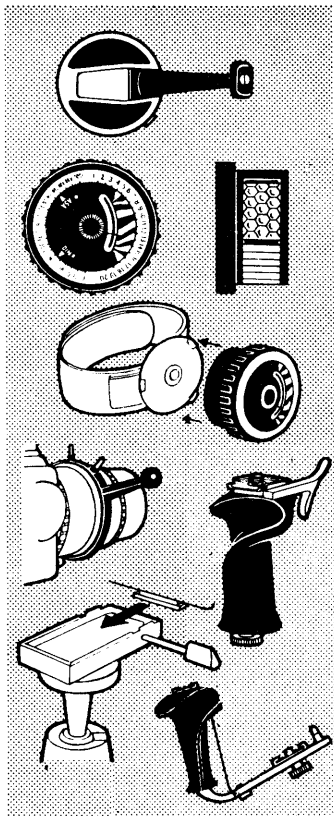

The Exposure Meter Wrist Strap

A wrist strap, now discontinued, with a bayonet fitting similar to that on the camera body holds the Hasselblad exposure meter. This is useful when the rapid winding crank is used on the camera, or when the meter is used separately, e.g. for incident light or close-up readings.

Flash Holder Attachment

The flash holder clips to the lens hood and simplifies use of flash bulbs and flash cubes. It offers additional ways of using the flash as its baseplate can be clicked into different positions.

The Quick Focusing Handle

Designed for extra-fast movement of the lens focusing mount, the handle is made from resilient plastic, and is equipped with three movable index markers and six coloured rubber sleeves. For use the ring is pressed over the focusing ring of the lens mount. The markers can be placed anywhere on the ring and the desired colour sleeves attached to act as focusing position signals.

The quick focusing handle Type I is suitable for the 50 and 60-mm. Distagon and 80-mm. Planar lenses of the Hasselblad 500C, while the Type II will fit the 120, 150 and 250-mm. lenses of the Hasselblad 500C.

The Quick Tripod Coupling

The quick tripod coupling consists of a base plate which is screwed on top of the tripod. The top of the base is grooved. To connect the Hasselblad 500C or Super Wide C, to the tripod, simply place the camera on the base and push it home. It is locked into position by a simple turn of the protruding handle on the base.

The quick tripod coupling can also be utilized by Hasselblad models 1600F and 1000F by attaching the shoe FUCUS to the camera.

The Pistol Grip with Release

For convenient holding of the Hasselblad 500C at eye level with the pentaprism or sports finder this grip can be fitted to the quick attachment shoe of the 500C. A release trigger on the grip connects to the camera release button. The grip is shaped for the left hand.

The Flash Gun Bracket

This attachment fulfils the function of the camera grip (described above) and is combined with a flash bracket to accept a flash gun or an electronic flash unit in a standard accessory shoe fitting (which is on

HASSELBLAD ACCESSORIES

Attachments for flash-holder (top) and exposure meter (bottom) clip on to the front of the lens hood. The flash attachment consists of a swivel plate with a standard accessory shoe to accommodate a small flash gun or flash cube. The attachment for the exposure meter takes the Hasselblad knob with exposure meter, enabling it to be used together with the rapid-wind crank on the 500C and providing a plate for it on the 500EL. The spirit level (centre) is particularly useful when short-focus lenses are used. It fits into the accessory socket on the left-hand side of the camera.

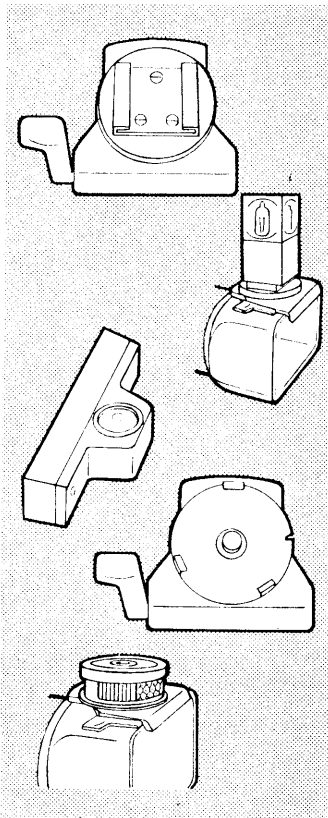

top of the handle). A cable release is fitted. The unit with camera and flash attached can be held at eye level by the grip. This unit is suitable for the Hasselblad 500C and Super Wide C with the quick tripod coupling. An adjustable flash shoe for the 500C model is designed to hold small flashguns and electronic flash units. It fits the accessory socket of the camera.

The Spirit Level

A spirit level attaches to the accessory socket on the side of the Hasselblad 500C body. The levelling can then be observed from above. This attachment is useful for architectural and other photographs where distortion of vertical lines has to be avoided.

The Checked Screen

This Plexiglass plate can be placed over the ground glass screen and is held in position by the focusing head. It is ruled with vertical and horizontal lines which outline the picture sizes of the 16 and 16S magazines. It is intended to help in the composition of the picture and in aligning vertical and horizontal subjects.

The Cut Film Adaptor

The cut film adaptor is usable on all Hasselblad camera models. It permits taking single exposures on $2\frac{1}{2} \times 2\frac{1}{2}$ in. cut film or plates to utilize the wide range of emulsions available in these forms.

The cut film adaptor is stainless steel outside, and decasting inside; locks and catches are chrome-plated brass. The film holder is nickel-silver treated. It is of course advisable to have a number of holders.

The film holder accepts $2\frac{1}{2} \times 2\frac{1}{2}$ in. film or plates. As this size is not generally available, cut film has to be cut down to the proper size. For this purpose a special film cutter is available. To use the film cutter, place a $2\frac{1}{2} \times 3\frac{1}{2}$ in. sheet of film under the cover guard in the cutter so that it touches the two stop plates. (This must be done in total darkness.) The notched edge of the film should be turned inwards. Press the guillotine knife down to trim to the correct size.

Loading the Cut Film Holder

Load the holder in the dark room or in complete darkness with $2\frac{1}{2} \times 2\frac{1}{2}$ in. (6.5 x 6.5 cm.) cut film. Place the film in the film frame with the emulsion side towards the frame. Fold the frame against the backing plate and press down so that the sheath can be pushed into position. Make sure that the sheath is pushed in all the way. The velvet light trap shuts out all light.