

Repair and Support System

F4/F4S



Nikon | NIKON CORPORATION
Tokyo, Japan

August 1989
Printed in Japan

F4 TROUBLE DIAGNOSTIC SYSTEM

1. The difference between the Trouble Diagnostic Systems for the F-401 (N4004) and F-801 (N8008), and that for the F4 is as follows:

The usage of the F4 Trouble Diagnostic System is totally different from that of the F-401 (N4004) and the F-801 (N8008).

In the Trouble Diagnostic System for the F-401 (N4004) and the F-801 (N8008), trouble diagnostic procedures and inspections based on communications have been included in the program file on the floppy disk provided. While in the Trouble Diagnostic System for the F4, the program file on the floppy for the previous models has been divided into following two forms:

Configuration of the F4 Trouble Diagnostic System

Item	Medium	Contents
(1) F4 check flowchart	Paper material	Trouble diagnostic procedures
(2) F4 Trouble Diagnostic System	Floppy disk	Inspections based on communications: 1. Sequence errors 2. Film advance mode 3. Reading out EEPROM data 4. Exposure data 5. Checking of each motor driving 6. Block operations

2. Usage of the F4 Trouble Diagnostic System
 - (1) Usually you will find pertinent items from the Trouble Diagnostic Check Flowchart in the first place. The Trouble Diagnostic Program is used only when inspection based on communication between personal computer and F4 camera is carried out. Inspection based on communication between computer and camera will be explained in the Trouble Diagnostic Check Flowchart.
 - (2) The F4 Trouble Diagnostic System has been designed to find out the cause of trouble found in the F4 body. Accordingly, nothing has been discussed on the trouble caused by accessories (viewfinder, data back, battery pack, etc.) in this system.

For instance, when receiving F4S (MB-21 attached) camera for repair, check to see first of all if the trouble is found in the MB-21 or not. Then utilize the F4 Trouble Diagnostic System.

F4/F4S
TROUBLE DIAGNOSTIC
CHECK FLOWCHART

CONTENTS

Item	No.	Phenomenon	Page
A.		Name and location of each press contact.	A1
B.		Malfunction of shutter prerelease operation	
	B-1:	Shutter prerelease operation does not work.	B1
	B-2:	Shutter prerelease timer is not turned OFF.	B3
	B-3:	Shutter prerelease timer is not turned OFF. Exposure value does not change.	B5
	B-4:	Shutter prerelease timer is not turned OFF, Malfunction of AF indicators.	B5
	B-5:	Shutter prerelease timer always holds for 0 second.	B6
	B-6:	Shutter can be released when shutter prerelease switch is ON.	B6
	B-7:	Shutter can be released continuously when shutter prerelease switch is ON.	B6
C.		Malfunction of shutter release operation	
	C-1:	Shutter cannot be released.	C1
	C-2:	Shutter cannot be released when film is not loaded and camera back is closed.	C2
	C-3:	Shutter can be released while camera back is open.	C2
	C-4:	Shutter is released when power (battery) is turned ON.	C2
D.		Malfunction of sequence operation	
	D-1:	Sequence error.	D1
	D-1-1:	ERROR DATA (128). Voltage of DC-DC converter is lower than guaranteed value.	D2
	D-1-2:	ERROR DATA (64). Sequence error of rear shutter curtain.	D3
	D-1-3:	ERROR DATA (32). Main CPU hang-up. (Microprocessor is dead.)	D5
	D-1-4:	ERROR DATA (8). Mechanical charging error.	D5

G-12:	Shutter speed remains at 1/250(X) sec.	G8
G-13:	Metering accuracy is incorrect.	G9
G-14:	Metering value is incorrect.	G10
G-15:	Aperture value (F-Fo) is incorrect.	G10
G-16:	Full aperture value (Fo) is incorrect.	G10
G-17:	Film speed value is incorrect.	G11
G-18:	DX-coded value is incorrect.	G11
G-19:	Exposure compensation value is incorrect.	G12
G-20:	AE-L button is defective.	G12
G-21:	Always in minimum aperture value.	G13
G-22:	Always in full aperture value.	G15
G-23:	Aperture control is unstable.	G15
G-24:	Exposure value of aperture and shutter speed controls differ by 1EV or more.	G15

H. Malfunction of AF operation

H-1:	Focus aid operation is unable.(Focus indicators do not appear.)	H1
H-2:	AF lens does not operate.	H2
H-3:	Unstable AF lens operation.	H3
H-4:	AF lens performs scanning operation only when shutter prerelease switch is ON.	H3
H-5:	Subject is not in focus on focusing screen though in-focus indicator appears.	H4
H-6:	List of trouble due to disconnection of lens contacts (7 portions).	H5

I. Malfunction of display

I-1:	Malfunction of LCD and LED displays at body side.	I1
I-2:	Malfunction of focus indicators.	I2
I-3:	Malfunction of exposure compensation indicator.	I3
I-4:	List of trouble due to poor press contact between main FPC and display FPC.	I4

1. 圧接部の名称について Name and location of each press contact.

F4ボディの各圧接部の名称は、F4故障診断チェックフローチャート中では以下のように表しています。
 (各FPC、ユニットごとに色付けをするとより各部が判り易くなります。)
 A name of each press contact of F4 body is expressing as follows
 in F4 repair and support flow chart .
 (Every part becomes easy to understand by applying a color every
 each FPC and a unit.)

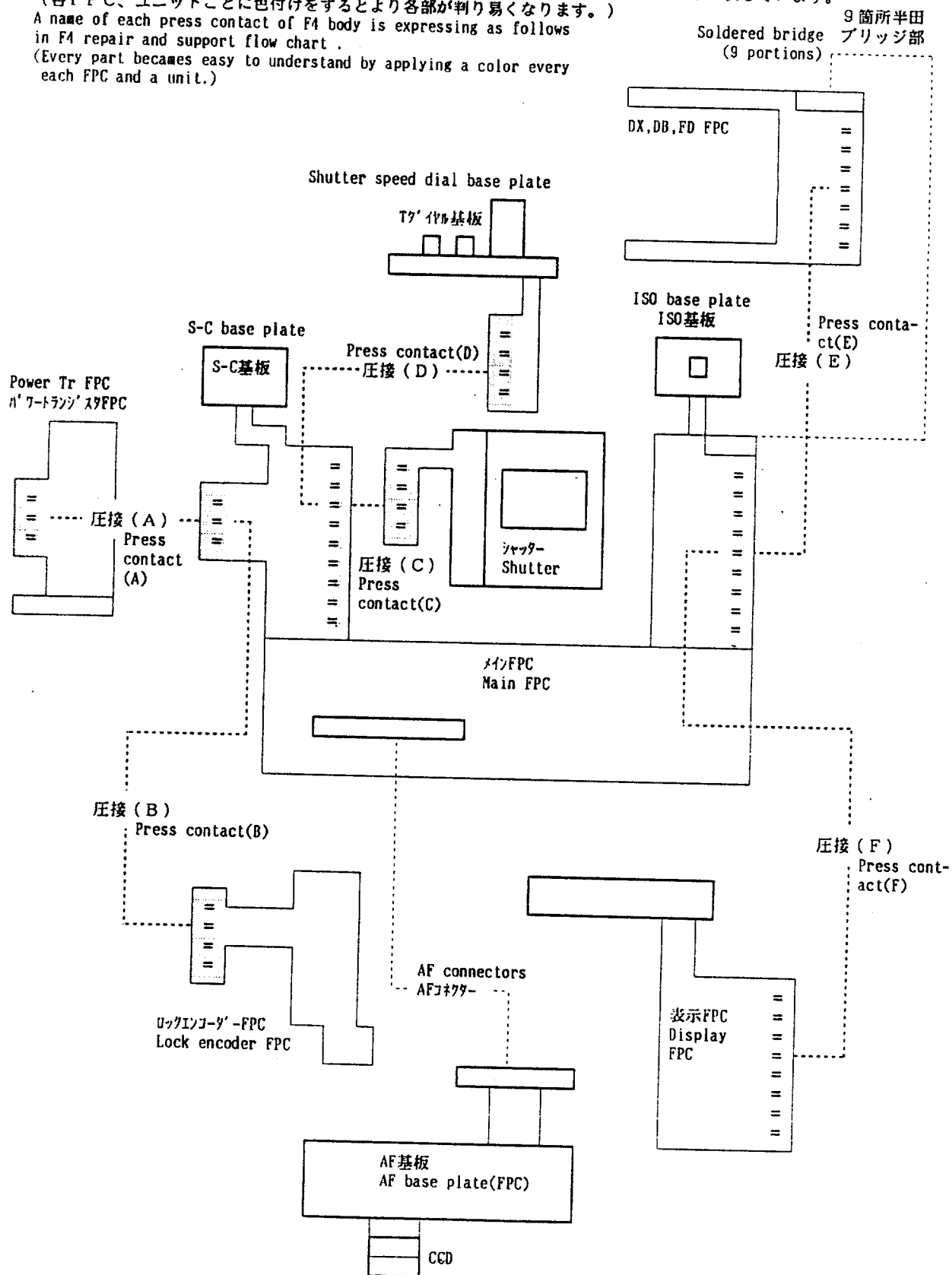

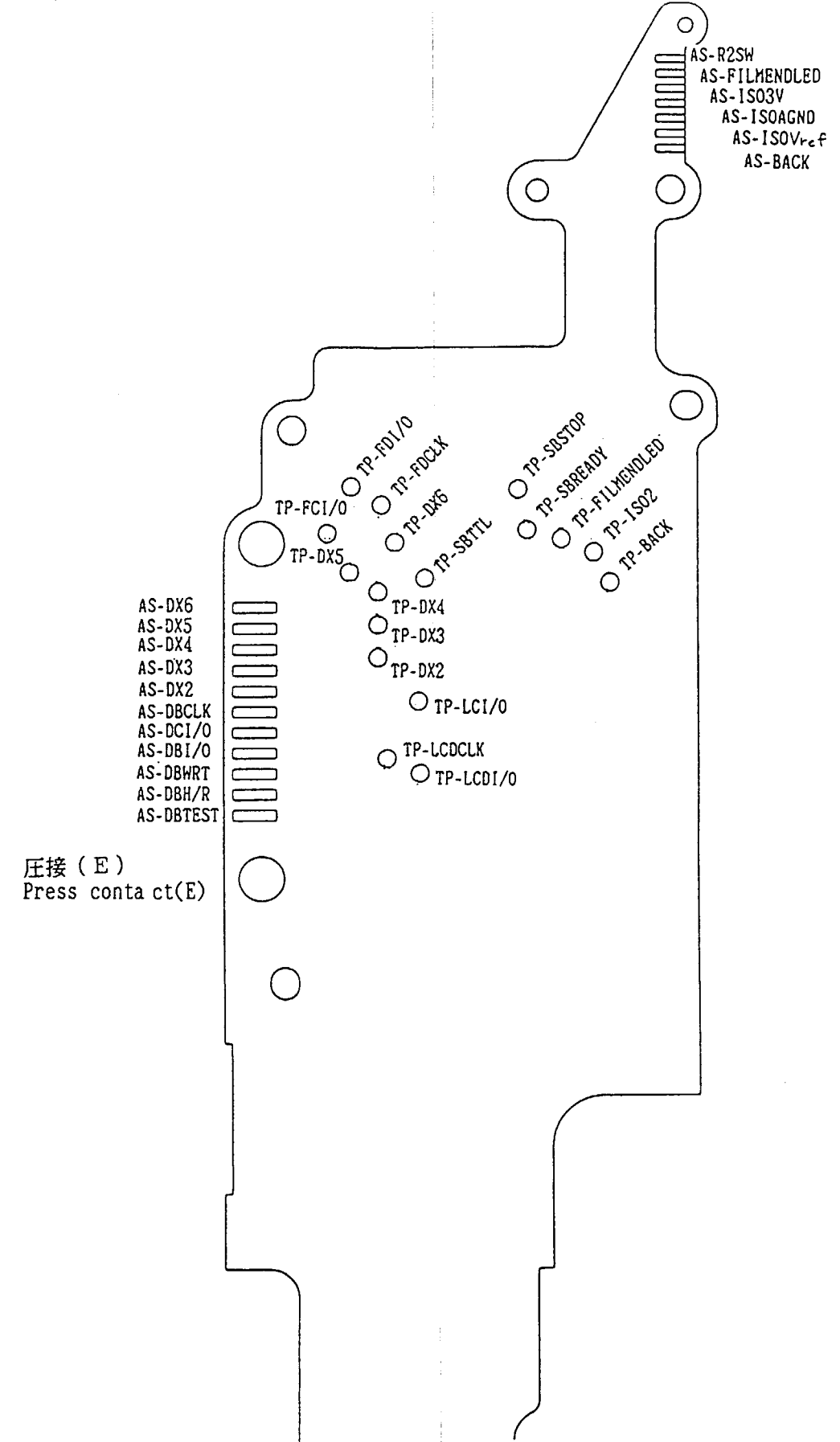
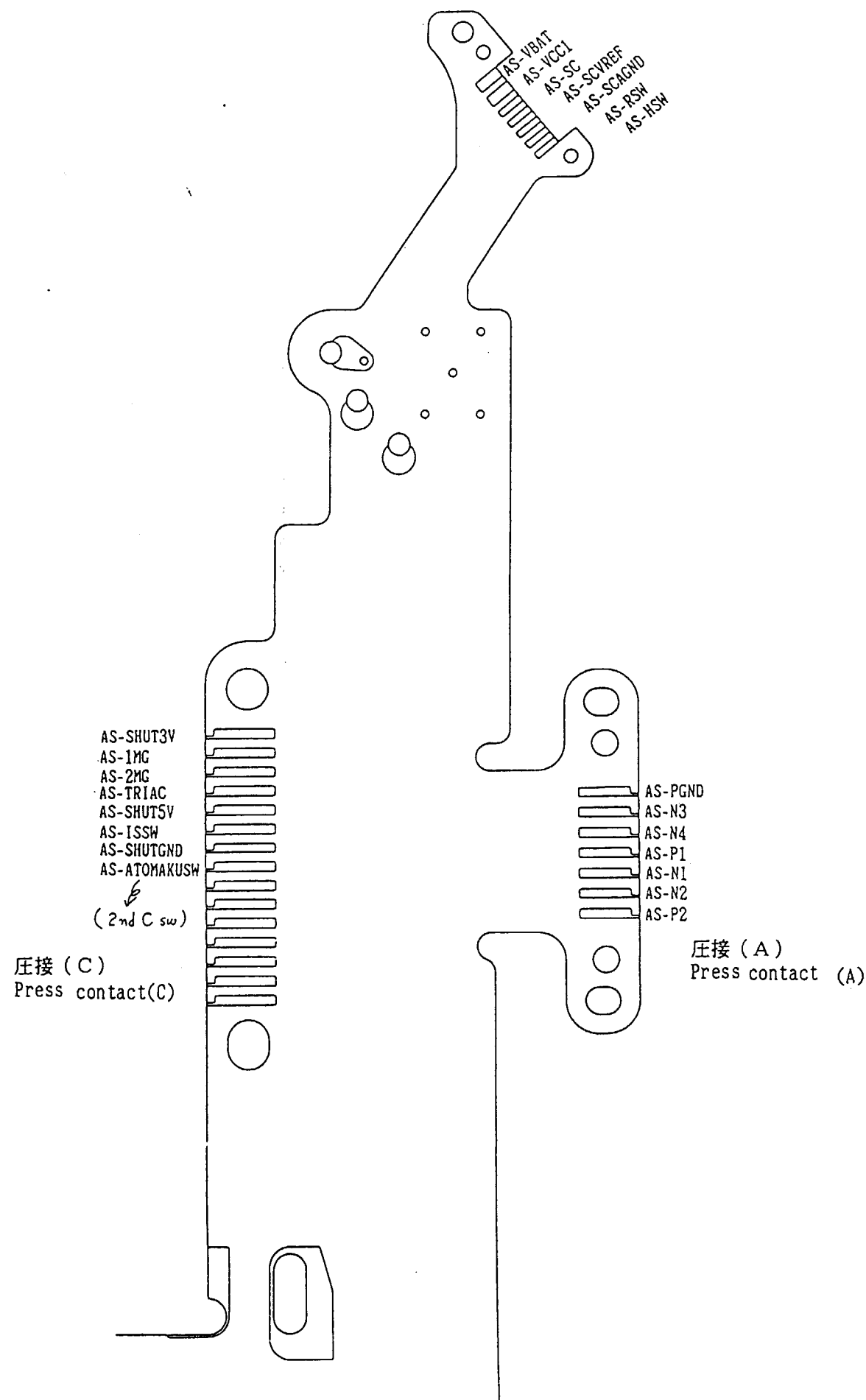

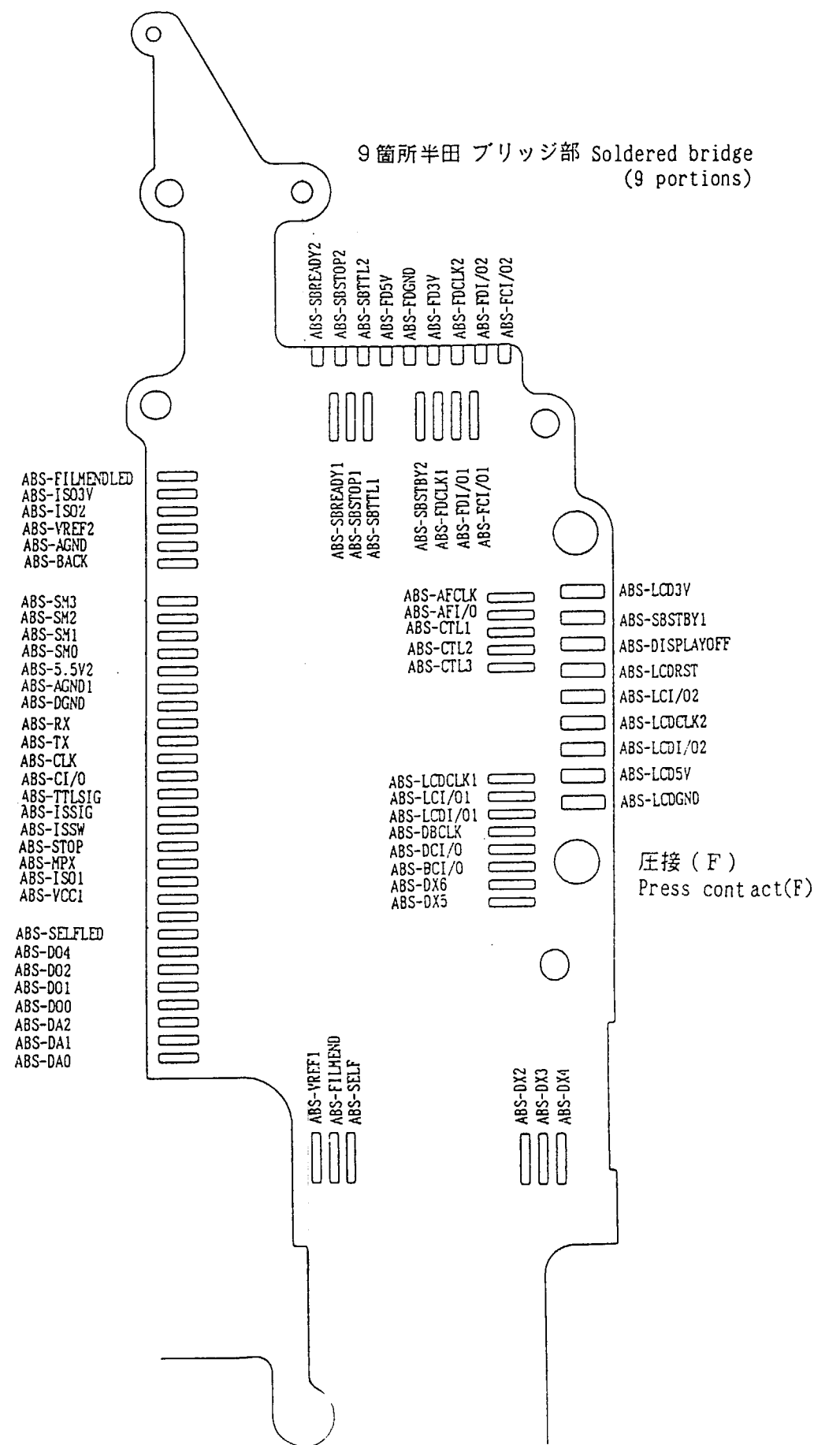
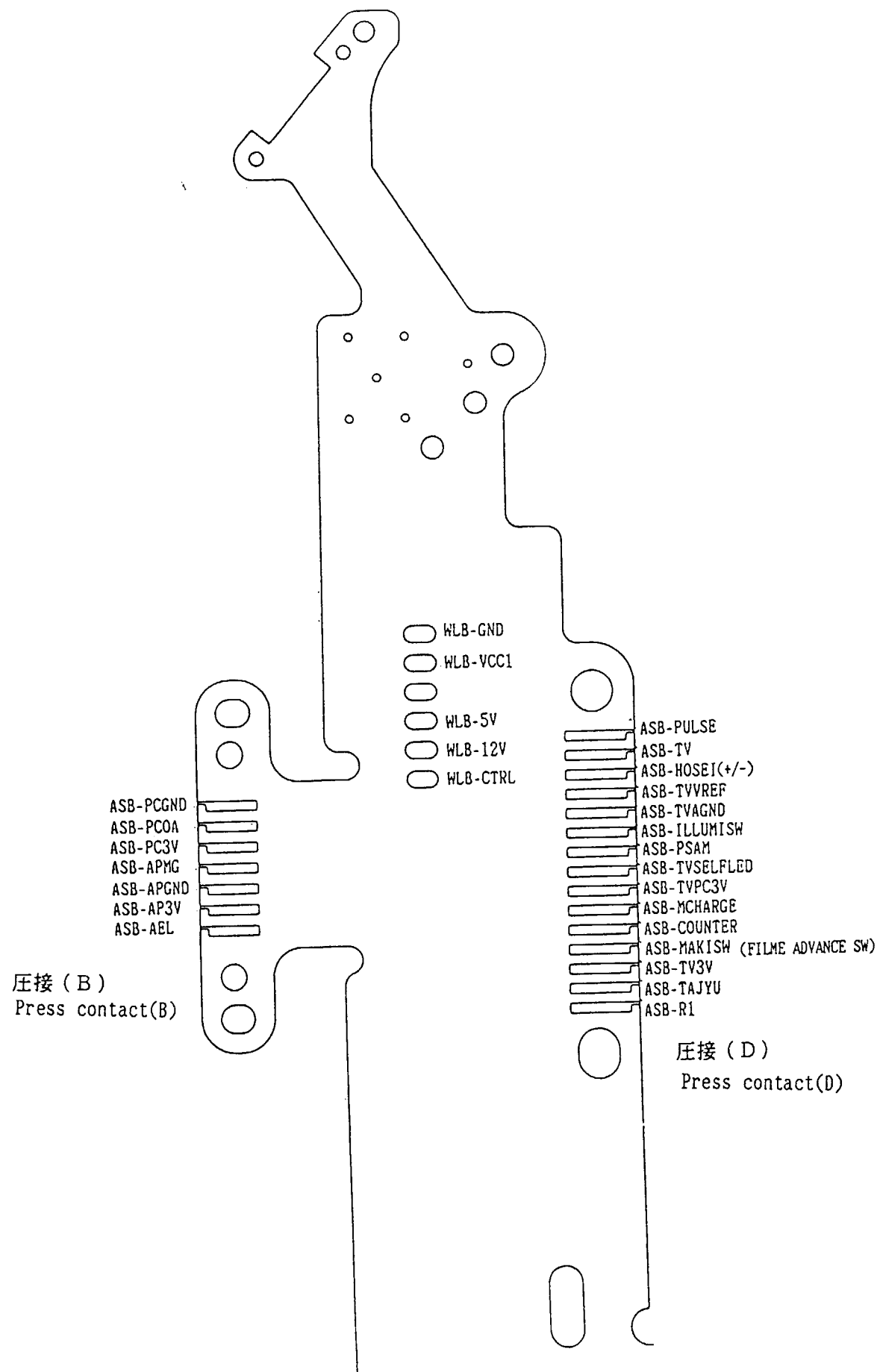

Shutter speed dial base plate FPC

シャッター基板 FPC

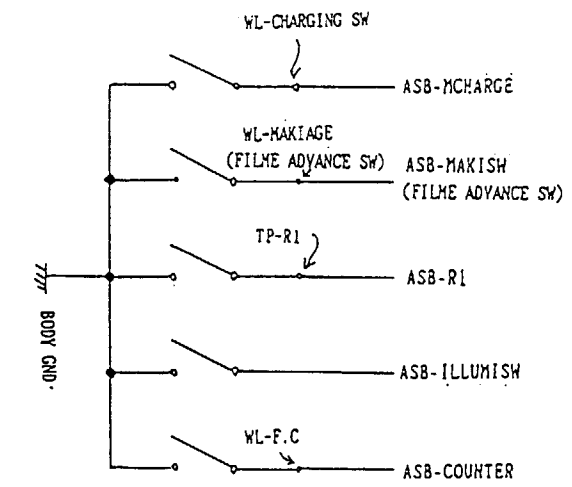
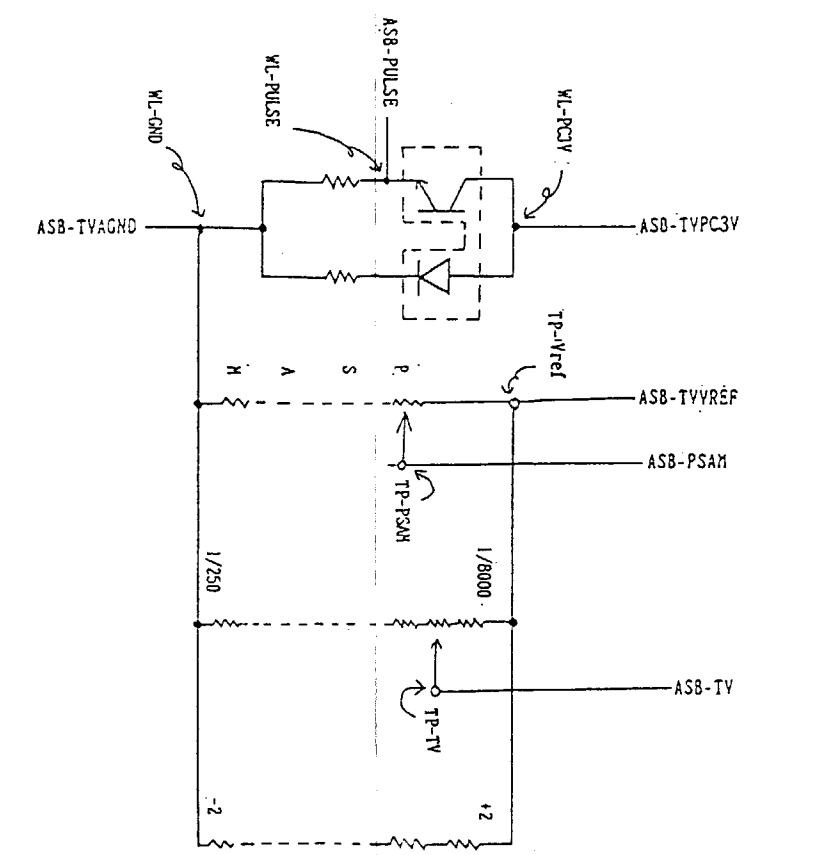
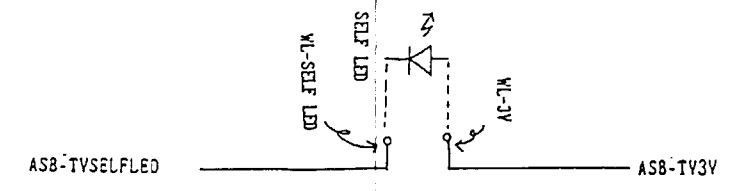
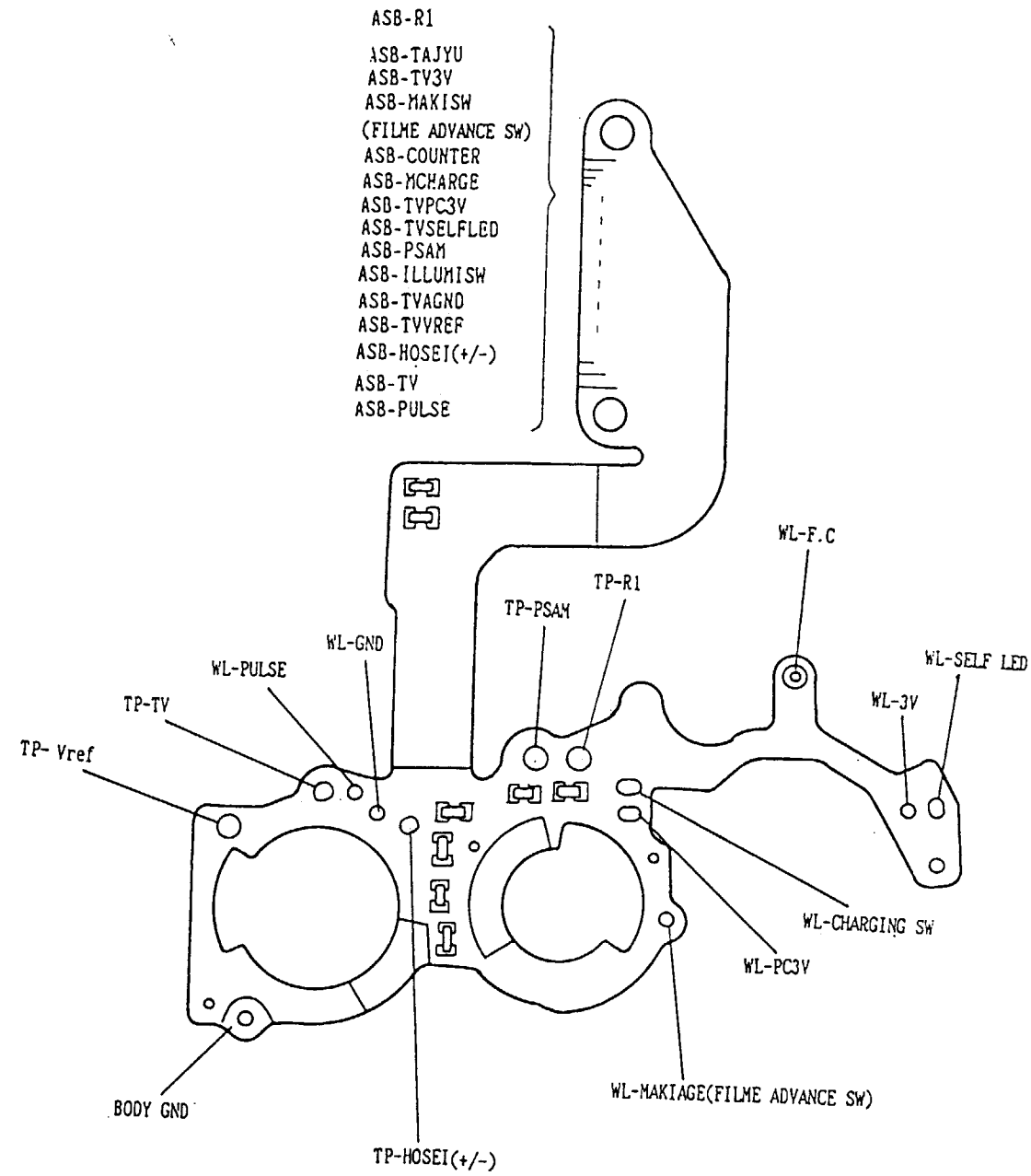

	Phenomenon	Cause
B-1	Shutter prerelease operation does not work. (No display appears and camera does not operate when shutter prerelease switch is ON.)	<ol style="list-style-type: none"> 1. Contamination is present in shutter prerelease switch. Soldered portion in shutter prerelease switch is detached. 2. Cord (blue) is pinched. (Short-circuit to the body) 3. Soldered portion in battery contacts is detached. 4. Contamination is present in brush of S-C dial. 5. DC-DC converter is defective. 6. Main FPC

** Check to see if there is short-circuit in the circuits by connecting a DC regulated power supply to the camera before starting trouble diagnostic operation.

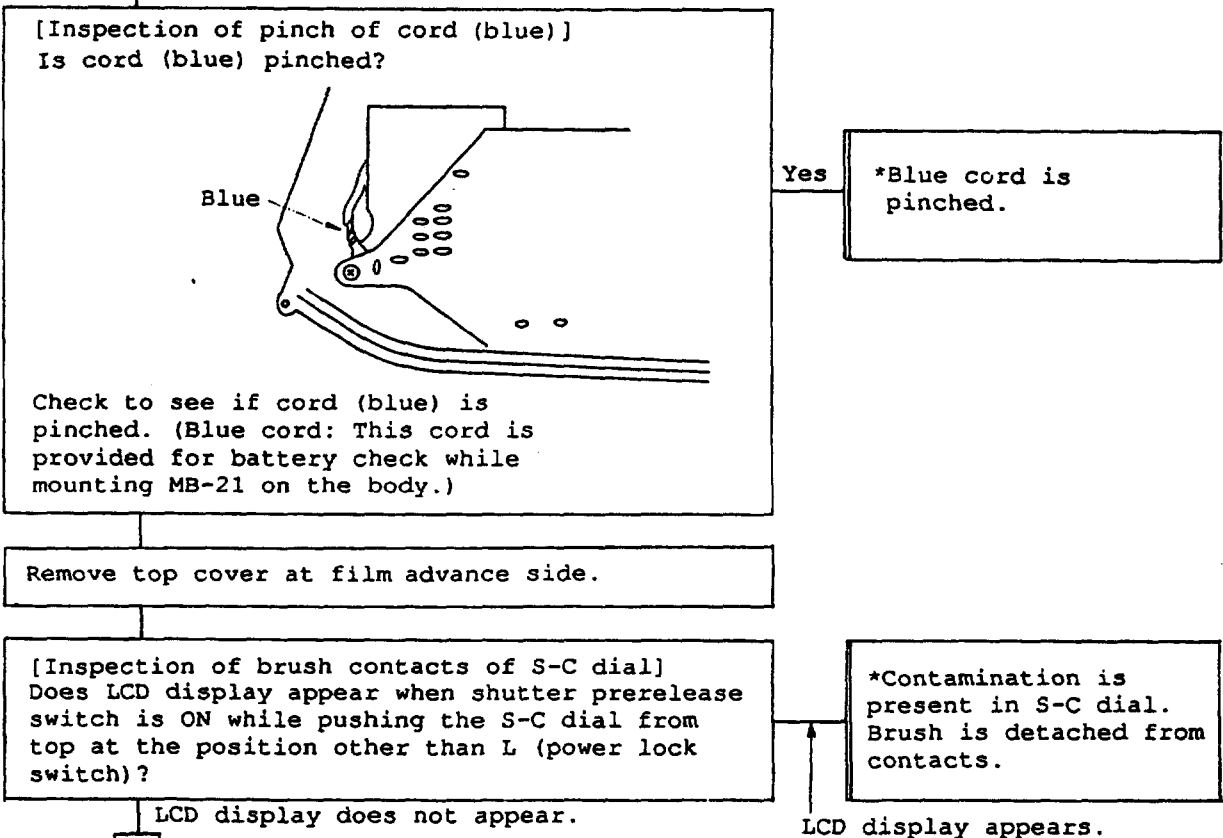
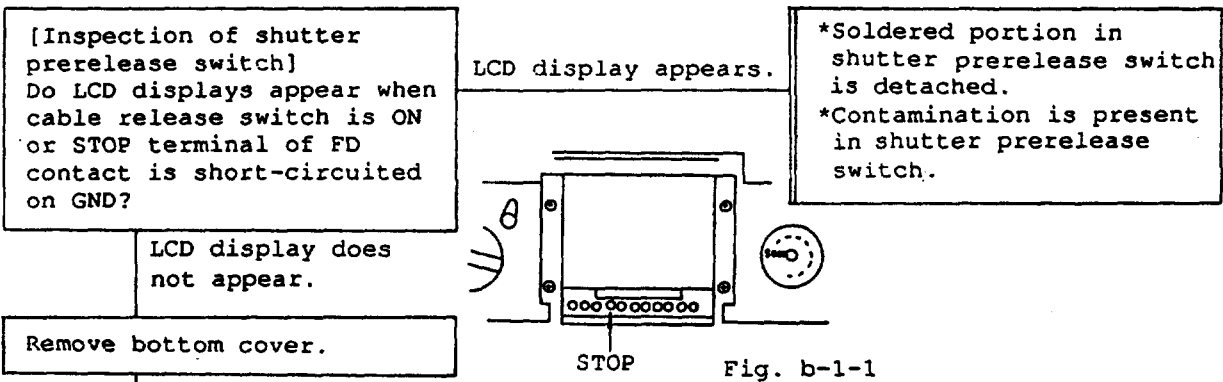

a

Raise S-C dial.

[Inspection of soldered portion of battery contacts and main FPC]
Try to solder battery contacts again.

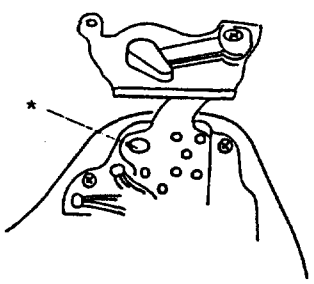

*Soldered portion of battery contacts is defective.

LCD display appears.

LCD display does not appear.

Remove front body.

[Inspection of DC-DC converter]
Remove five cords (red, black, yellow, brown, orange) of DC-DC converter from main FPC and connect them as follows.

DC regulated power supply	DC-DC converter
+	Red
-	Black
	Yellow
6V	Brown
	Orange

← 5.5V
← 12V

Measure voltage of brown cord (5.5V) and orange cord (12V) with a voltmeter.

*DC-DC converter is defective.

Voltage (5.5V, 12V) is not output.

Voltage (5.5V, 12V) is output.

*Main FPC is defective.

	Phenomenon	Cause
B-2	Shutter prerelease timer is not turned OFF.	<ol style="list-style-type: none"> 1. Short-circuit in shutter prerelease switch. 2. Short-circuit in cable release switch. 3. Short-circuit between DC-DC converter cord (yellow) and GND. 4. Main FPC is defective.

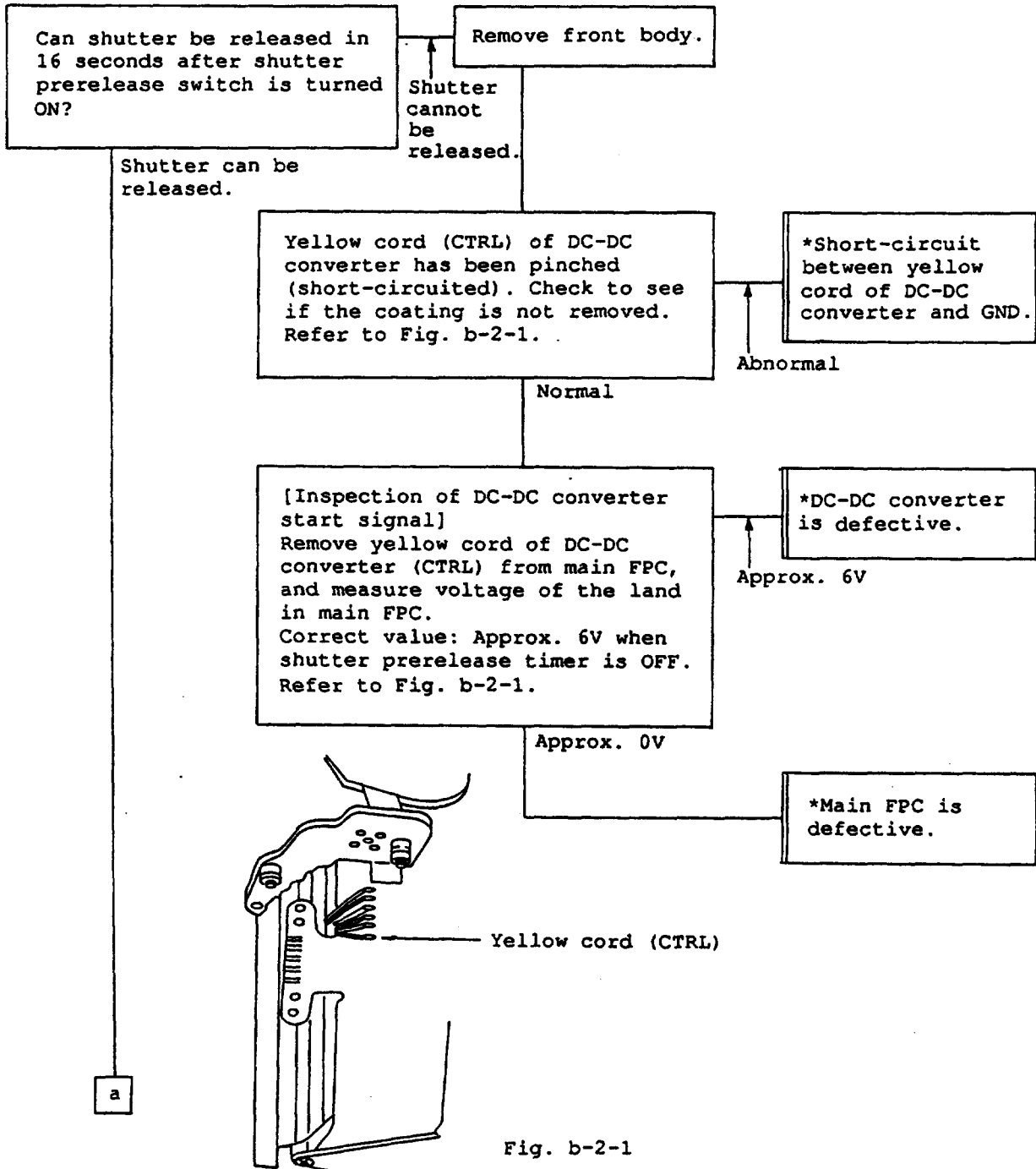

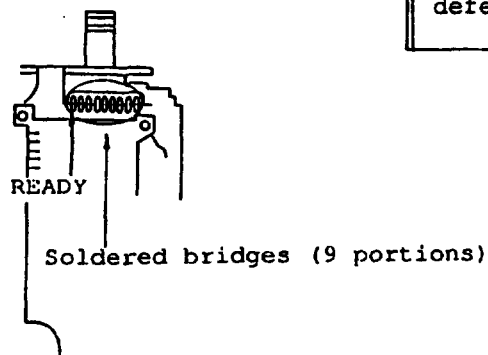
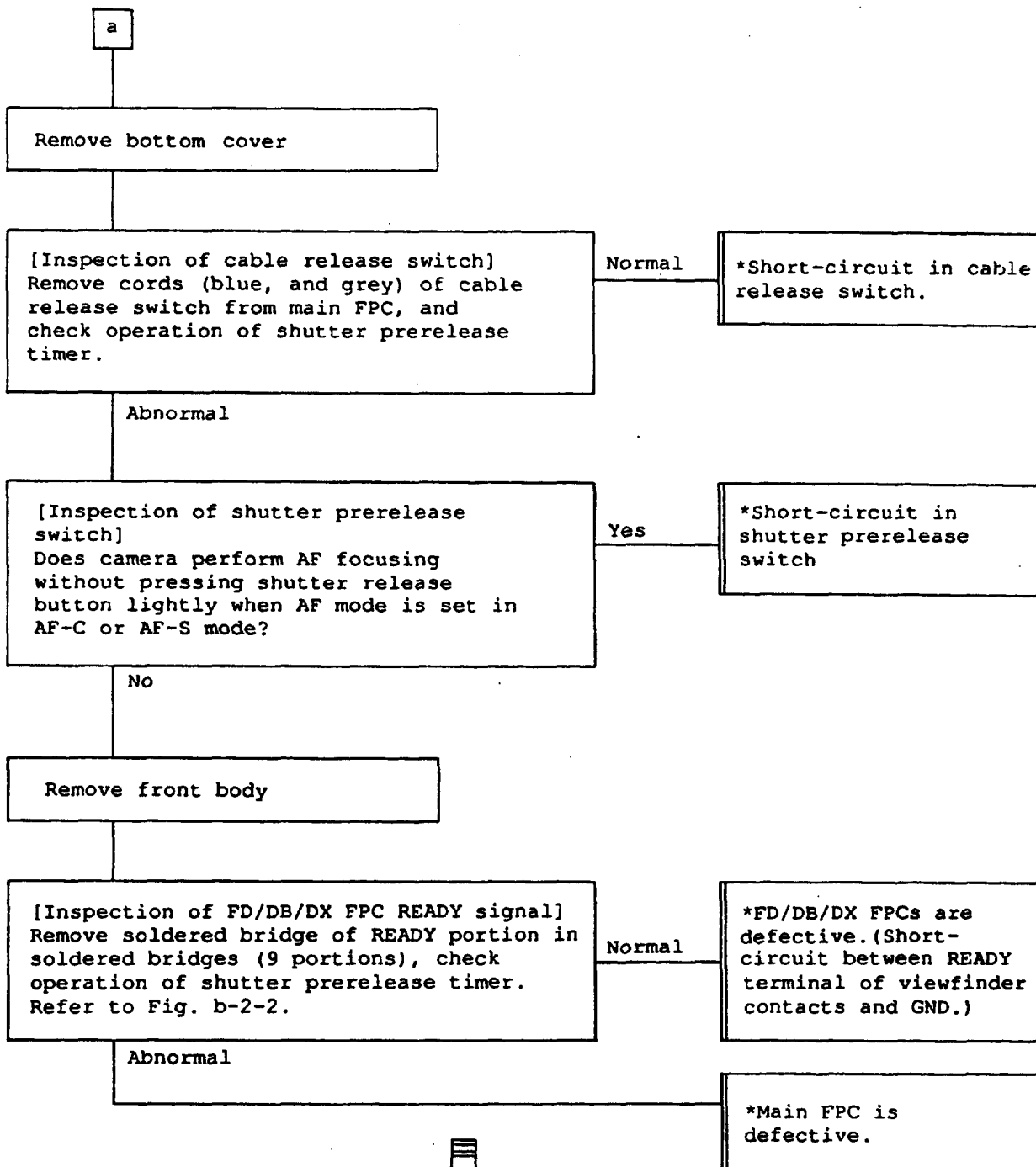
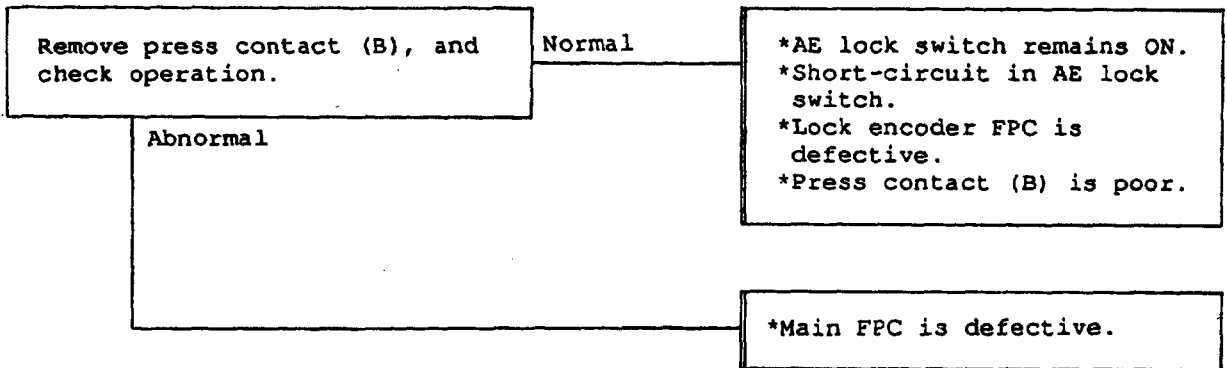
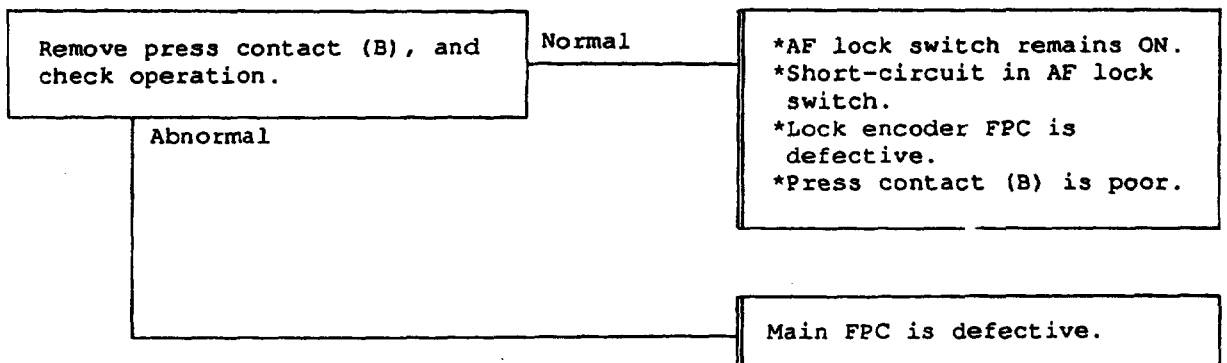

Fig. b-2-2

	Phenomenon	Cause
B-3	<p>Shutter prerelease timer is not turned OFF. Exposure value does not change.</p> <p>For example: Shutter speed does not change even when the subject is in bright or dark environment if exposure mode selector is set to A and aperture dial is set to f5.6.</p>	<ol style="list-style-type: none"> 1. Main FPC is defective. 2. Lock encoder FPC is defective. 3. AE lock switch remains ON.



	Phenomenon	Cause
B-4	<p>Shutter prerelease timer is not turned OFF. Malfunction of AF indicators.</p> <p>For example: AF indicators does not appear in AF-S and AF-C modes, and AF indicators appear in AF-M mode.</p>	<ol style="list-style-type: none"> 1. Main FPC is defective. 2. Lock encoder FPC is defective. 3. AF lock switch remains ON.



	Phenomenon	Cause
B-5	Shutter prerelease timer always holds for 0 seconds.	<ol style="list-style-type: none"> 1. Battery power for customer's camera is insufficient. (Power has been exhausted.) 2. Main FPC is defective. 3. AF base plate is defective. 4. Screw on battery contact base plate is missing.

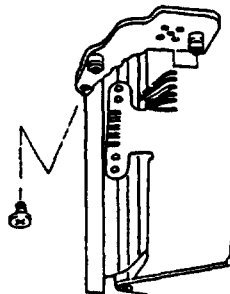
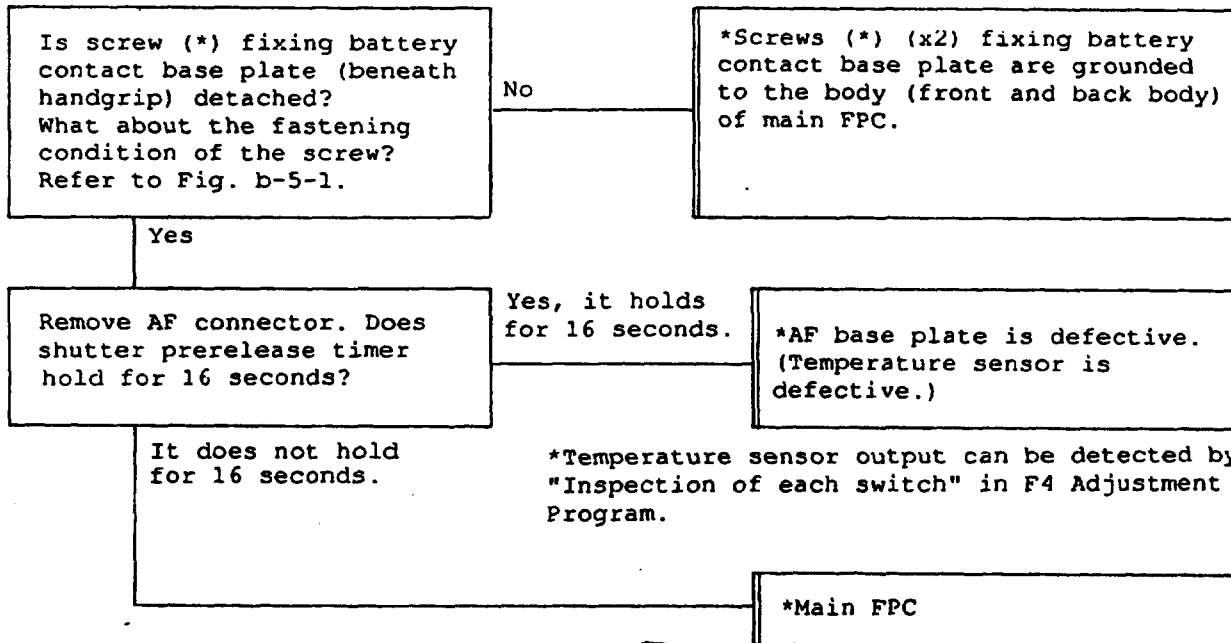

Fig. b-5-1

	Phenomenon	Cause
B-6	Shutter can be released when shutter prerelease switch is ON.	1. Short-circuit between shutter prerelease switch and shutter release switch.

	Phenomenon	Cause
B-7	Shutter can be released continuously when shutter prerelease switch is ON. (Shutter curtain does not open, film is not advanced.)	<ol style="list-style-type: none"> 1. Shutter release Mg. mechanism does not work properly or shutter release Mg. is defective. 2. Malfunction of shutter release vertical shaft operation. 3. Malfunction of shutter release mechanism on film advance base plate. 4. Main FPC is defective.

	Phenomenon	Cause
C-1	Shutter cannot be released.	1. Trouble due to abnormal operation found in other items. 2. Main FPC is defective.

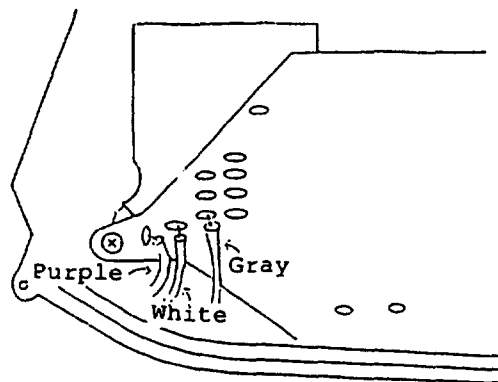
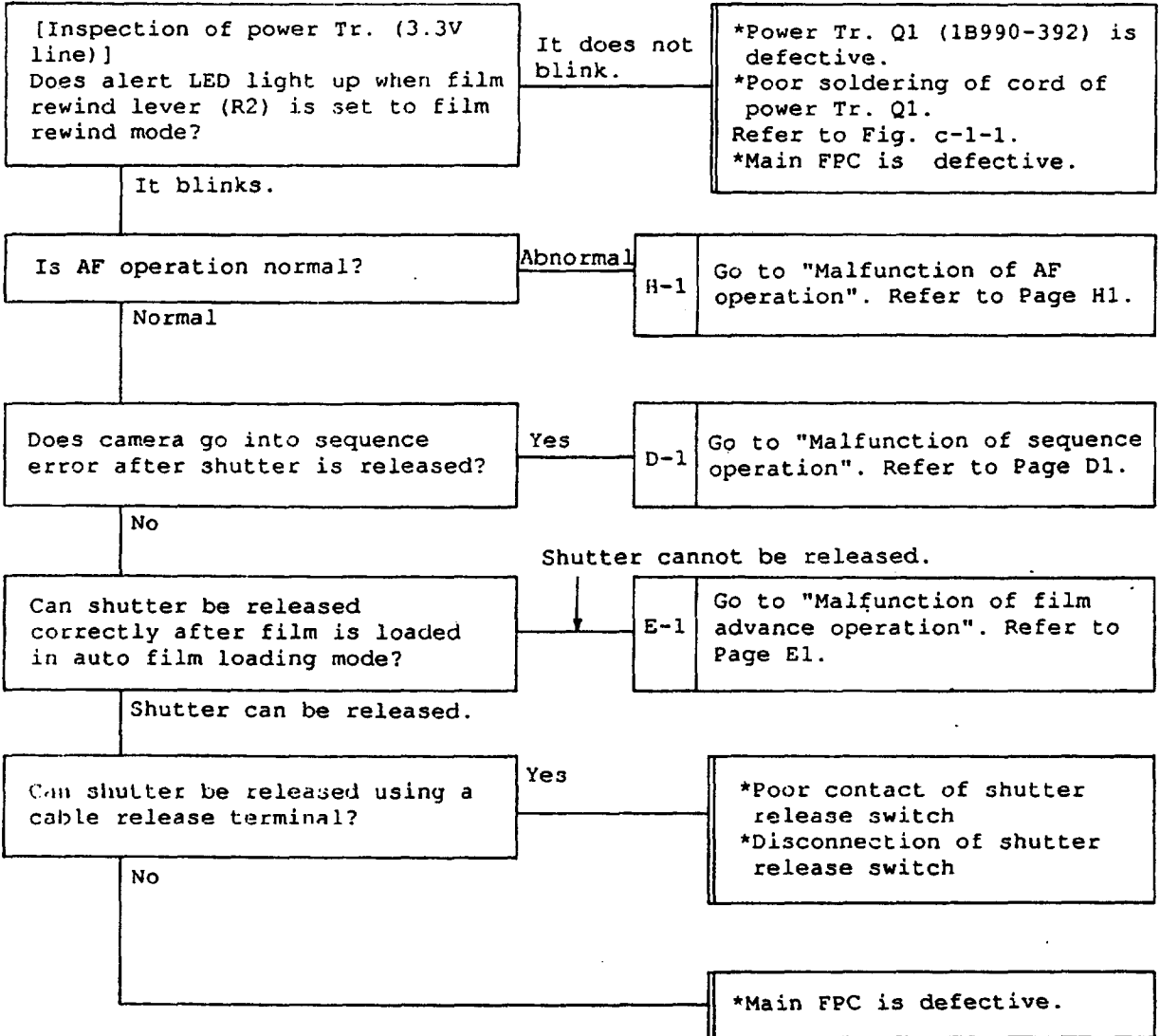

Fig. c-1-1

	Phenomenon	Cause
C-2	Shutter cannot be released when film is not loaded and camera back is closed. Alert LED lights up (film advance error) and generates rattling sound (when shutter is released. Both shutter release and film advance operations work properly when camera back is closed and film is loaded. But if film rewind operation is performed, film rewind operation remains not to stop.	1. Film detection switch is open.

	Phenomenon	Cause
C-3	Shutter can be released while camera back is open.	1. Camera back remains opened. 2. Frame counter switch remains OFF. (LCD frame count does not return to 0.)

	Phenomenon	Cause
C-4	Shutter is released when power (battery) is turned ON.	1. Short-circuit between gray cord of cable release switch and GND. 2. Short-circuit between shutter release switch and GND.

The following are actual phenomenon of trouble attributable to above two causes.

(1) Film advance and shutter release.

Film advance modes:

In CH, CL or CS mode, shutter release operation goes on continuously in each mode when power is switched ON. (Shutter release operation does not stop.) In S or self-timer mode, shutter is released once in each mode. Following shutter release operation cannot be performed unless power is turned OFF once.

Auto film loading: Shutter cannot be released after film is loaded using auto film loading mode. Turn power OFF once to perform the above mentioned operation.

(2) Shutter control: Normal

(3) Shutter prerelease timer: It does not turn OFF.

	Phenomenon	Cause
D-1	Sequence error	<p>You can perform Trouble Diagnostic operation in either one of the following two methods.</p> <ol style="list-style-type: none"> 1. You can check sequence error by using Trouble Diagnostic Program and find out the cause of the trouble. 2. Read out values written in EEPROM (address 30) using adjustment program and proceed trouble diagnostic operation by referring the contents to be mentioned in the following pages.

**Be sure to rewrite the data written in EEPROM (address 30) to "0" before you return camera to customer.

	Phenomenon	Cause
D-1-1	Voltage of DC-DC converter is lower than guaranteed value. EEPROM (30) -> ERROR DATA (128)	<ol style="list-style-type: none"> 1. Battery power for customer's camera is insufficient. (Power has been exhausted.) 2. Film advance and rewind mechanisms do not work properly.

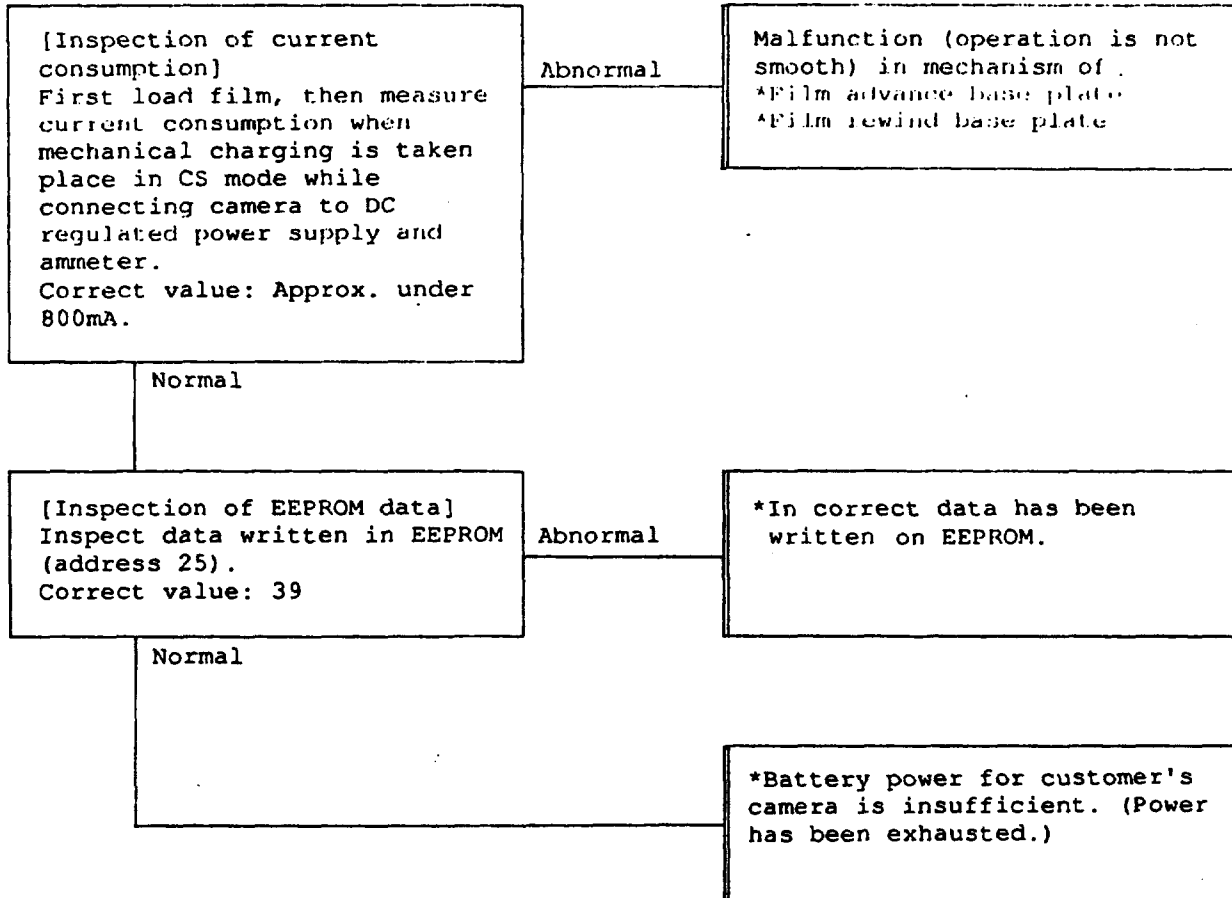

	Phenomenon	Cause
D-1-2	Sequence error of rear shutter curtain. EEPROM (30) -> ERROR DATA (64). *Sequence error warning appears. (Alert LED blinks.)	1. Poor contact of press contact (D) 2. Shutter is defective. 3. Shutter release Mg. is defective. 4. Main FPC is defective.

Note: Rear curtain and mechanical charging switches are inserted in parallel to circuit.

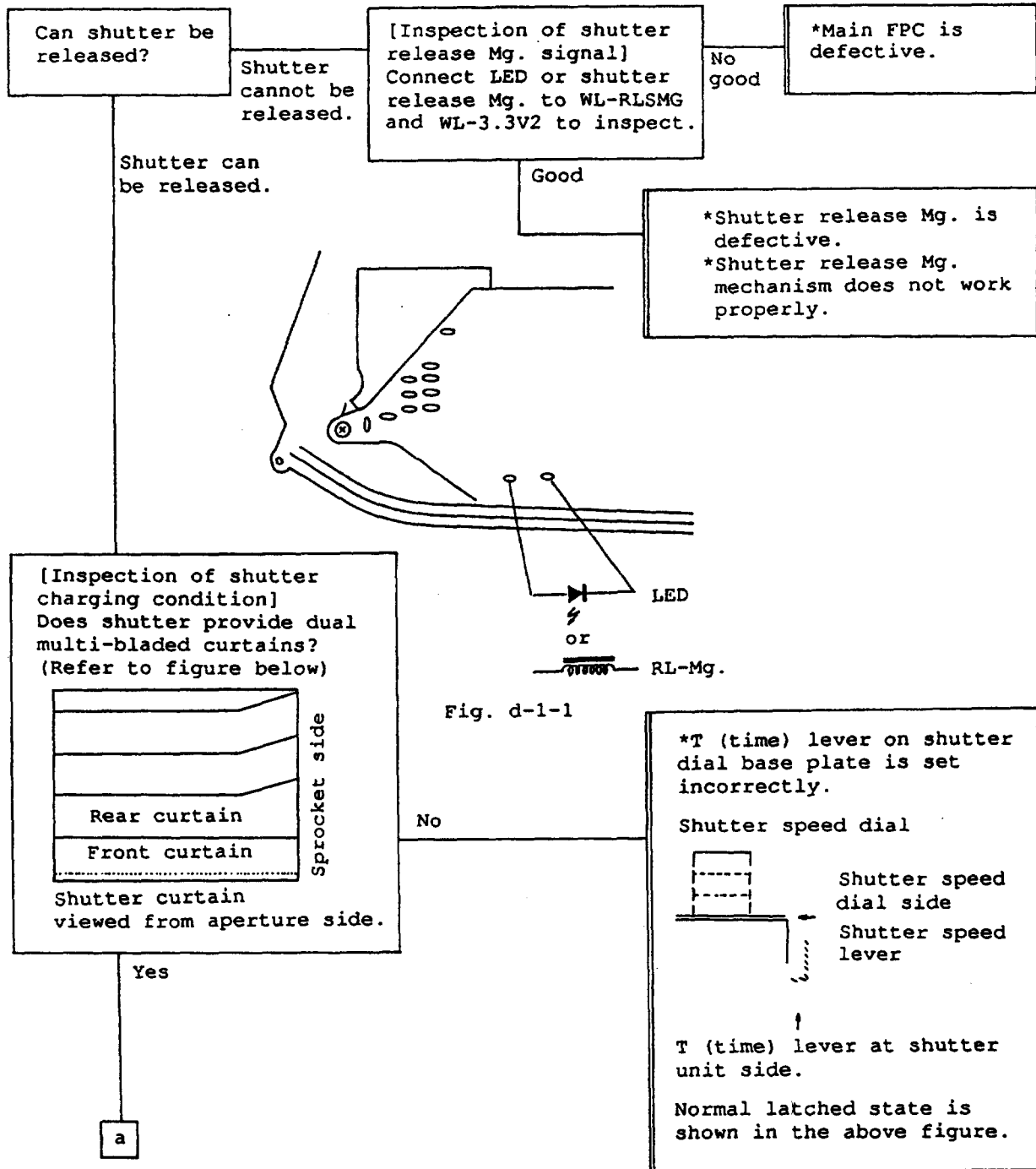

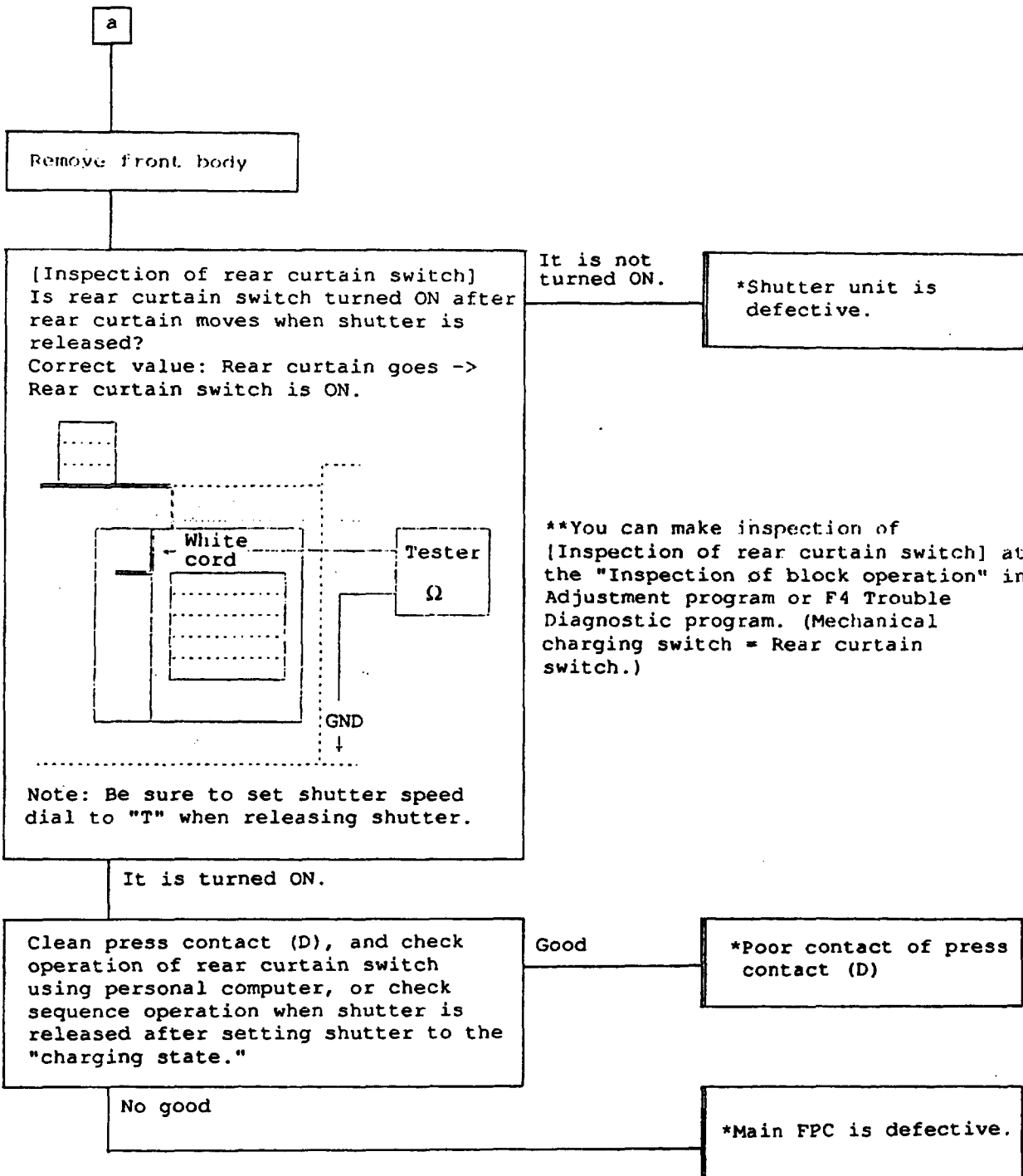

How to set shutter to "charging state."
Method 1: Rotate the charging cam up to charging completion position by raising shutter speed dial base plate after removing screws.

Method 2: Apply 3V power on mechanical charging motor (yellow, black cords).

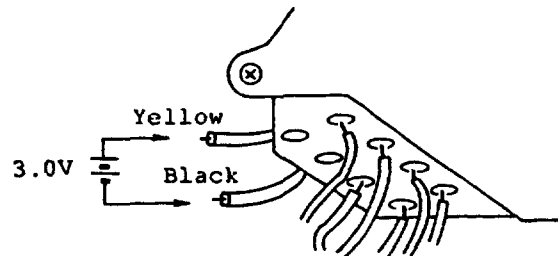

	Phenomenon	Cause
D-1-3	Main CPU hang-up. (Microprocessor is dead.) EEPROM (30) -> ERROR DATA(32).	No cause of this trouble is known since this trouble has ever been occurred by now. Send Nikon detailed report on customer's specifics such as: *Location of shooting, *Type of film loaded, *Type of battery installed, *Accessories used, *Environment when trouble occurred (ex. in shutter release operation, in film advance or film rewinding operation, and others).

	Phenomenon	Cause
D-1-4	Mechanical charging error. EEPROM (30) -> ERROR DATA (8). *Sequence error warning appears. (Alert LED blinks)	1. Mechanism in film advance base plate is defective. 2. Poor press contact (A) 3. Power transistor FPC is defective. 4. Main FPC is defective.

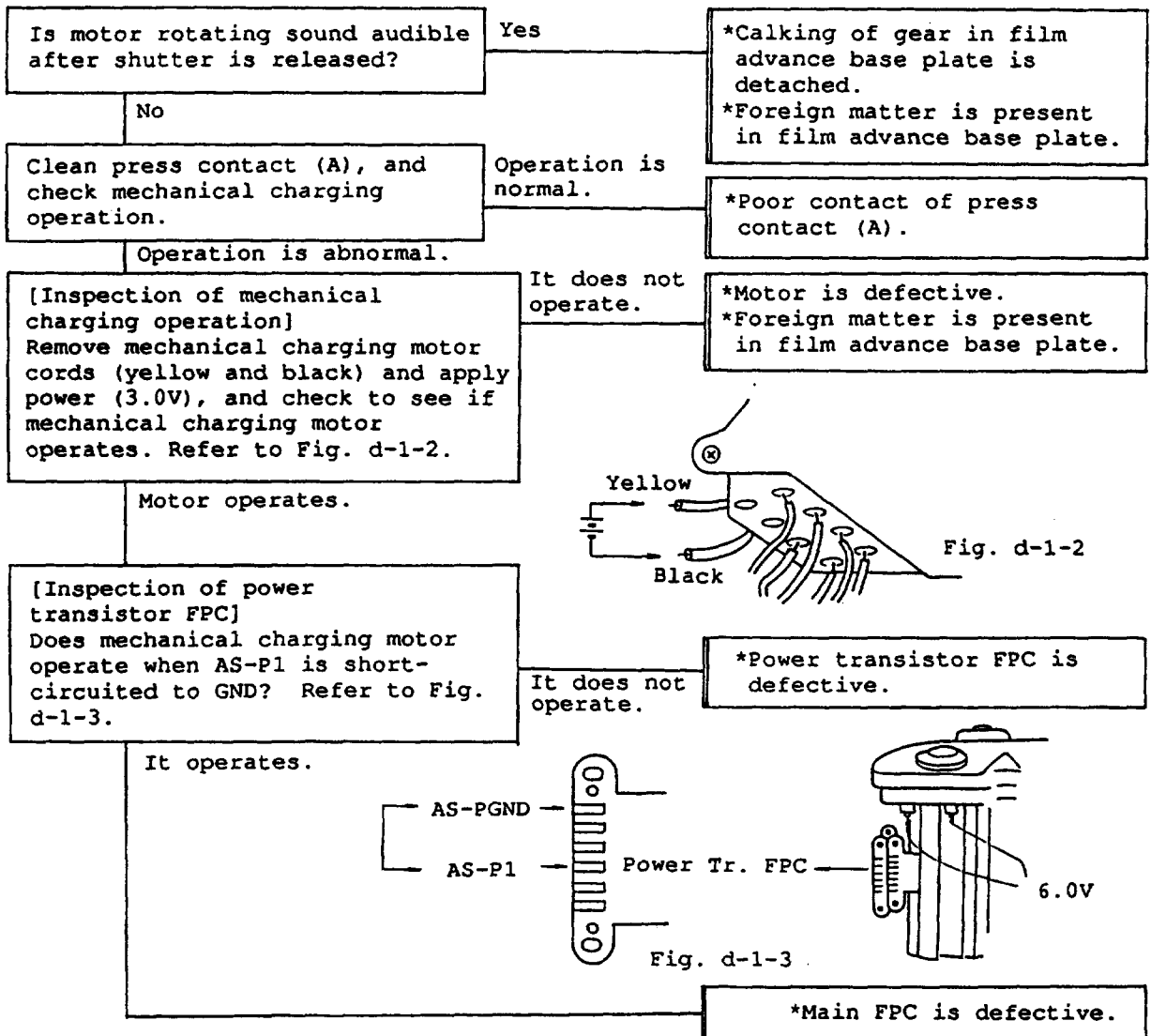

	Phenomenon	Cause
D-1-5	X close error. EEPROM (30) -> ERROR DATA (4) *Sequence error warning appears. (Alert LED blinks.)	1. Shutter unit is defective.

Note: X close error does not occur with back body alone. (Data cannot be written in EEPROM.)

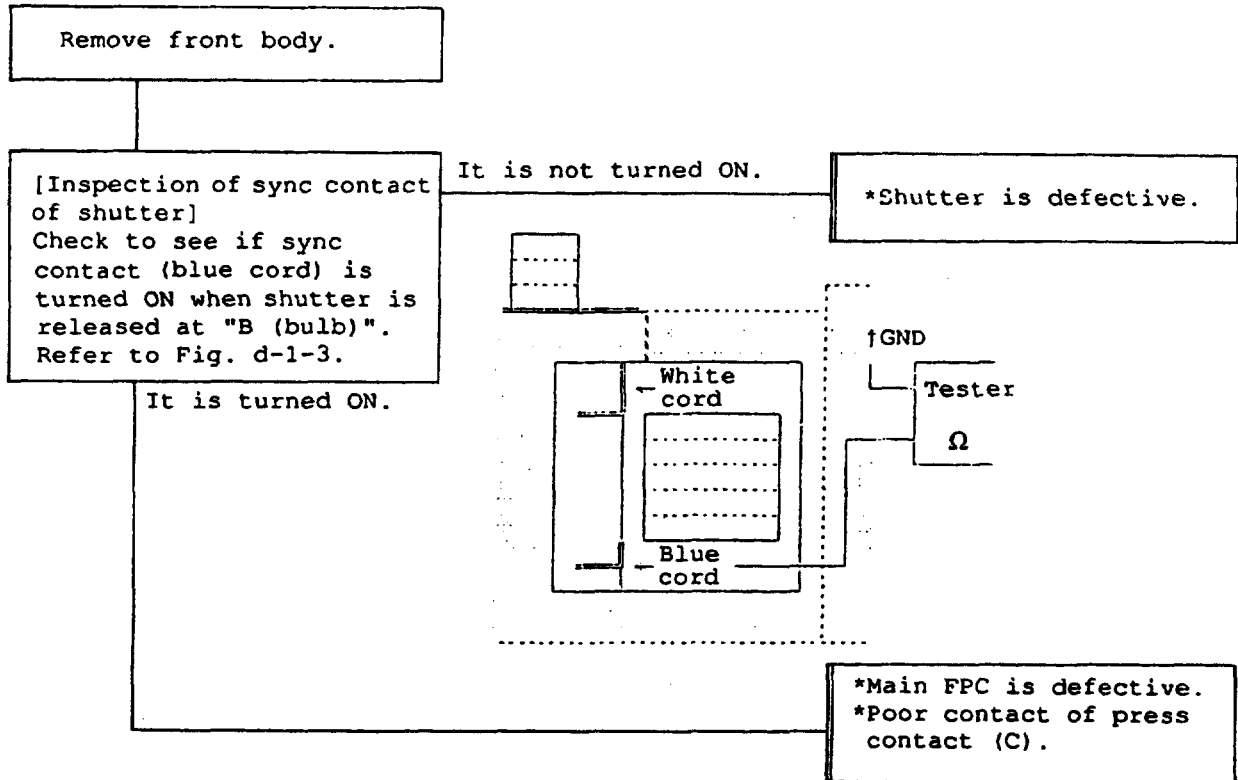

	Phenomenon	Cause
D-1-6	No expected aperture pulse is output. EEPROM (30) -> ERROR DATA (2) *Sequence error warning does not appear.	<ol style="list-style-type: none"> 1. Aperture P.I gear spring tension is insufficient. 2. Poor contact of press contact (B). 3. Poor soldering of aperture P.I. 4. Aperture P.I. is defective. 5. Mechanical operation of mirror box I base plate is improper. 6. 3.4 lever (aperture lever) is bent.

	Phenomenon	Cause
D-1-7	Aperture stop down error. EEPROM (30) -> ERROR DATA (1) *Sequence error warning appears. (Alert LED blinks.)	<ol style="list-style-type: none"> 1. Aperture P.I. gear spring tension is insufficient. 2. Poor soldering of aperture P.I. 3. Mechanical operation of mirror box I base plate is improper.

	Phenomenon	Cause
D-2	Mirror does not move up completely. Shutter curtain does not open. Camera goes into sequence error. Rear curtain sequence error EEPROM (30) -> 64	1. Poor contact of press contact (D). 2. Charging switch is not turned ON. 3. Disconnection of shutter speed dial FPC. 4. Main FPC is defective.

Remove top cover at film advance side.

[Inspection of charging switch]
Check to see if mechanical charging operation stops or not when shutter prerelease switch is ON and land of charging switch cord (gray) is short-circuited to GND. Refer to Fig. d-2-1.

It does not stop.

*Charging switch is not turned ON. Contamination is present. Soldered portion is detached.

It stops.

Charging switch (gray)

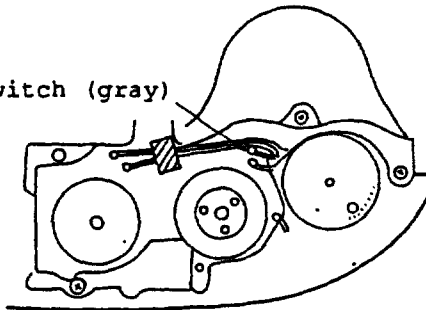

Fig. d-2-1

Remove front body.

[Inspection of press contact (D), main FPC]
Clean press contact (D), and check operation after reassembling.

Operation is normal.

*Poor contact of press contact (D).

Operation is abnormal.

[Inspection of shutter speed dial FPC]
Check continuity of charging switch line. Refer to Fig. d-2-2.

No continuity.

*Disconnection of shutter speed dial FPC

Continuity

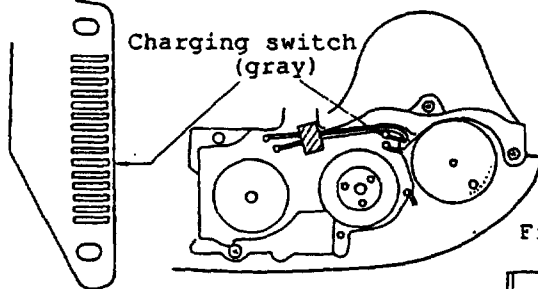
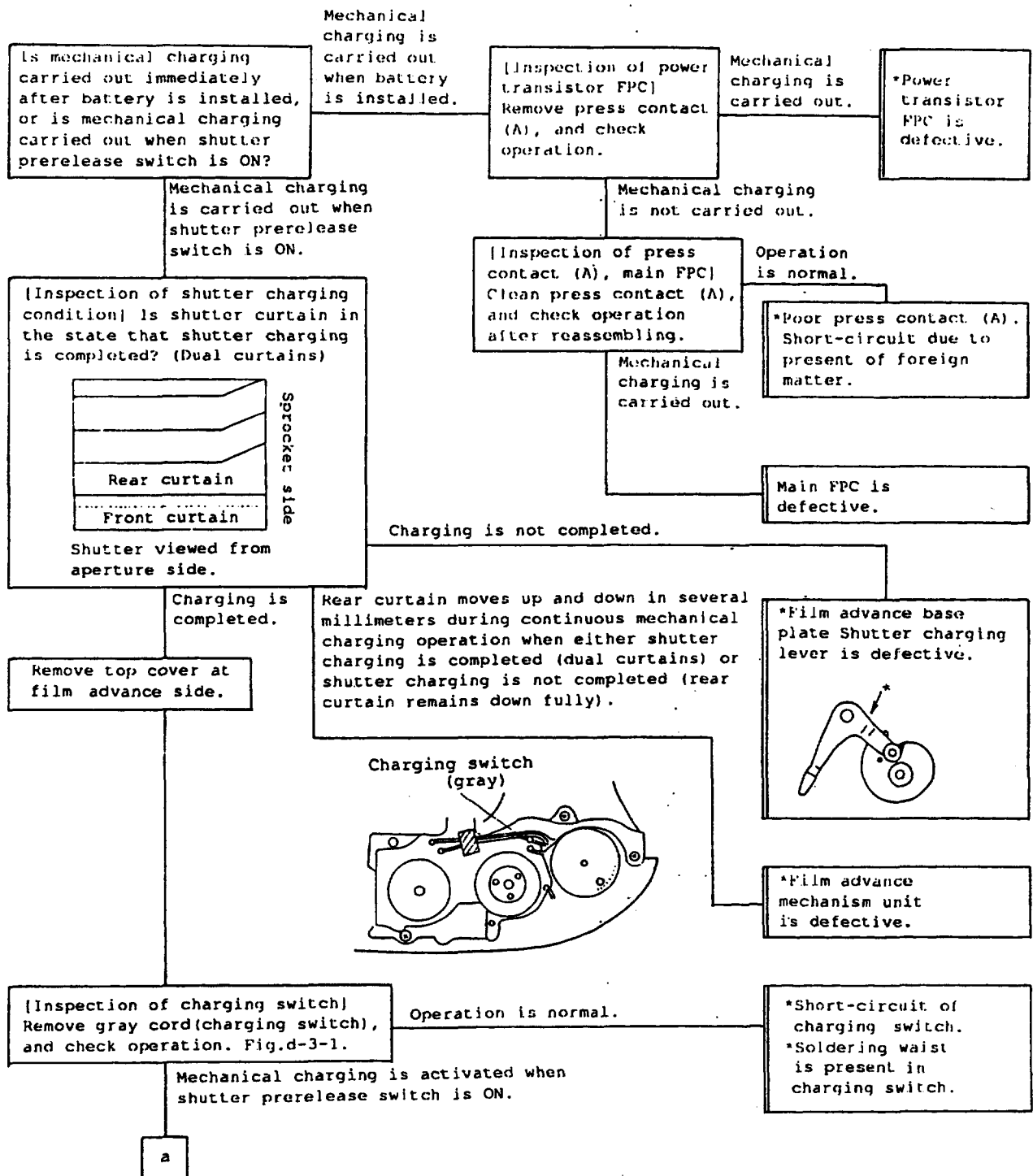

Fig. d-2-2

*Main FPC is defective.

	Phenomenon	Cause
D-3	Mechanical charging does not stop. (Mirror does not move, shutter does not open.)	<ol style="list-style-type: none"> 1. Charging switch is defective. 2. Shutter is defective. 3. Mechanical operation of film advance base plate is improper. 4. Power transistor FPC is defective. 5. Main FPC is defective.



a

Remove front body.

[Inspection of rear curtain switch]
 Shutter charging should have been completed.
 Remove press contact (C), and check rear curtain switch (white cord).
 Correct value: Shutter charging is completed -> Infinite resistance (rear curtain switch is OFF).

Note: Be sure to set shutter speed dial to "T" when releasing shutter.

*Shutter is defective. (short-circuit of rear curtain switch)

Abnormal 0Ω (rear curtain switch is ON)

Normal

[Inspection of press contact (C), main FPC] Clean press contact (C), and check operation after reassembling.

Operation is normal.

*Poor contact of press contact (C). Short-circuit due to presence of foreign matter.

Continuous mechanical charging is activated when shutter prerelease switch is ON.

*Main FPC is defective.

	Phenomenon	Cause
D-4	AF filter remains operating when shutter prerelease switch is ON or film rewind motor remains operating.	1. Film rewind vertical shaft gear is damaged. 2. Operation of AF filter change over driving base plate is improper. 3. Poor contact of AF filter switch. 4. Poor contact of AF connector. 5. AF base plate is defective.

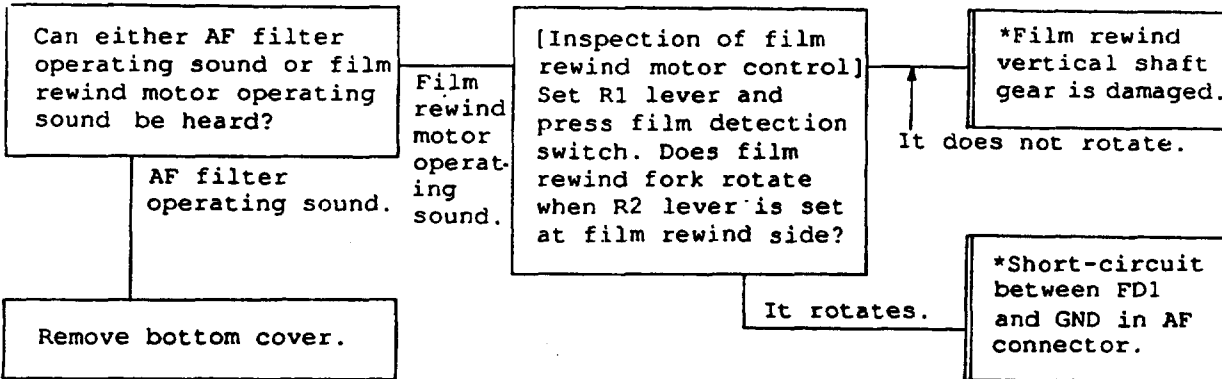

[Inspection of AF filter switch] Is AF filter switch cords (yellow and green) switched over properly when AF filter switching lever is moved toward arrow "a" and "b"? (Table) Normal

	"a" direction (AF filter)	"b" direction (general filter)
Yellow cord	0 Ω	Infinity
Green cord	Infinity	0 Ω

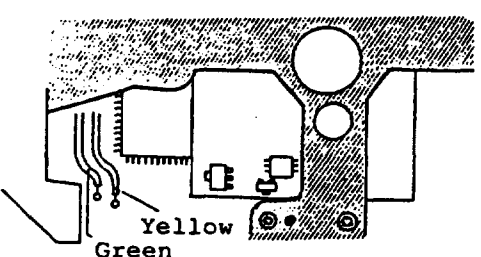

You can see AF base plate (yellow, green cords) when bottom main FPC is raised.

Abnormal

*Malfunction of AF filter driving base plate

*Poor contact of AF filter switch. Switch ON stroke is defective and switch is contaminate.

Inspection of AF filter driving base plate (correct one): When you remove front body and push AF filter select lever lightly with tweezers, the AF filter select lever slides by itself due to tension of spring built-in AF filter driving base plate.

Film rewind side | Mirror box | Film advance side

a — [Diagram] — b

AF filter select lever AF base plate

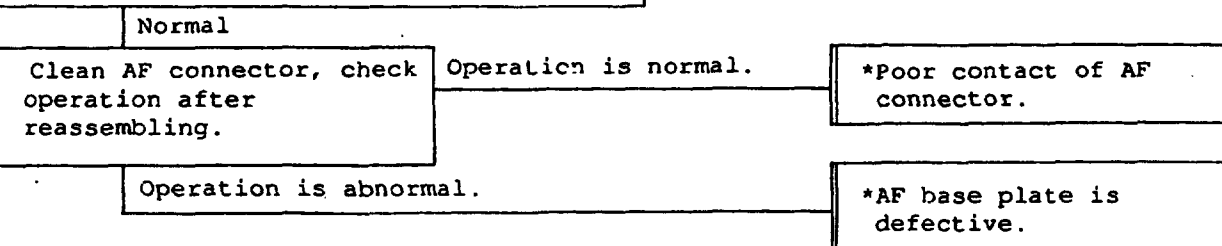

	Phenomenon	Cause
D-5	Operation stops when mirror moves up. Shutter prerelease switch cannot be turned ON afterward (or power cannot be ON).	1. Oscillator is defective. (8MHz oscillator for main CPU)

	Phenomenon	Cause
E-1	Preliminary film advance does not work.	1. Poor contact of frame counter switch 2. Poor contact of camera back switch

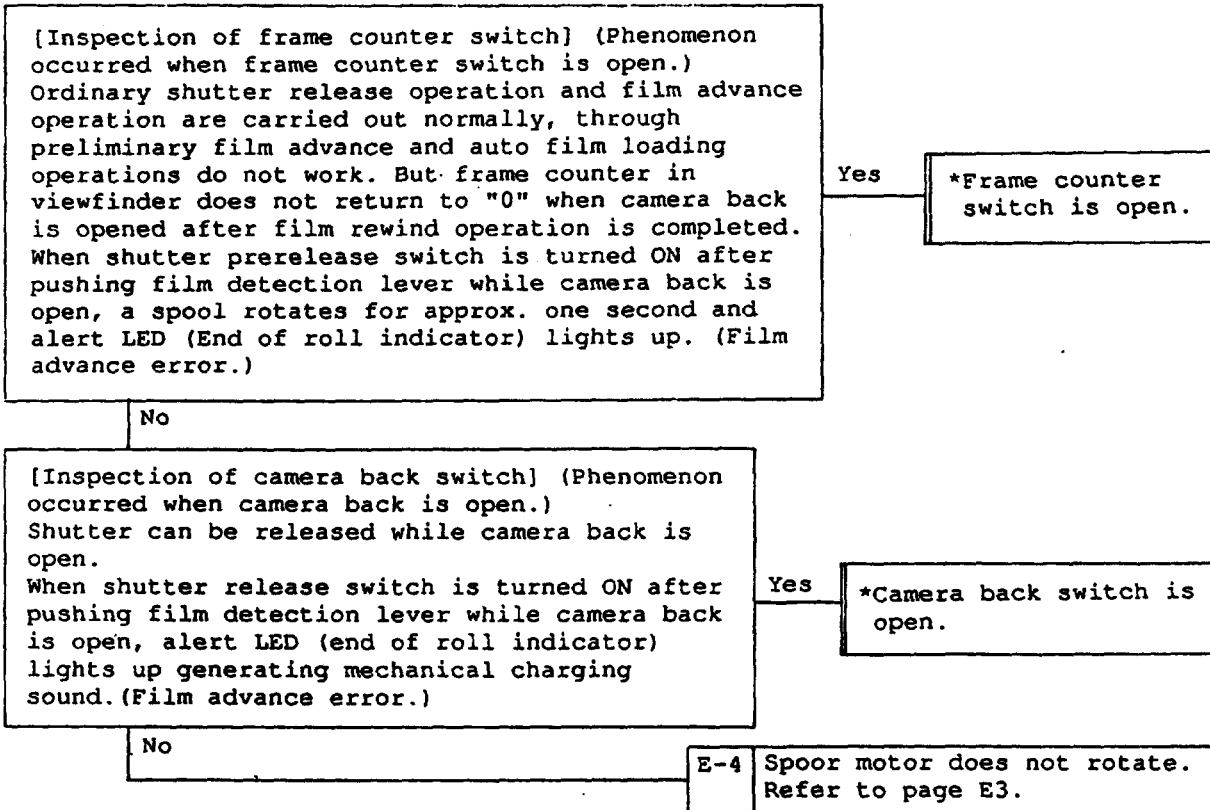

	Phenomenon	Cause
E-2	Auto film loading does not work.	1. Poor contact of frame counter switch.

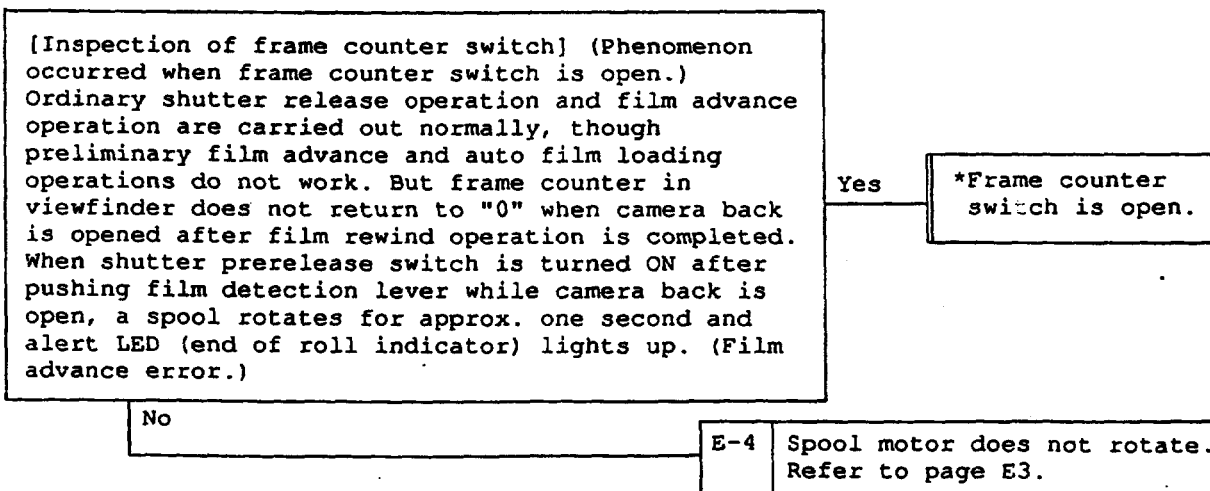

	Phenomenon	Cause
E-3	Film advance error. (End of roll indicator (red LED) lights up.)	1. Poor contact of frame counter switch. 2. Poor contact of camera back switch.

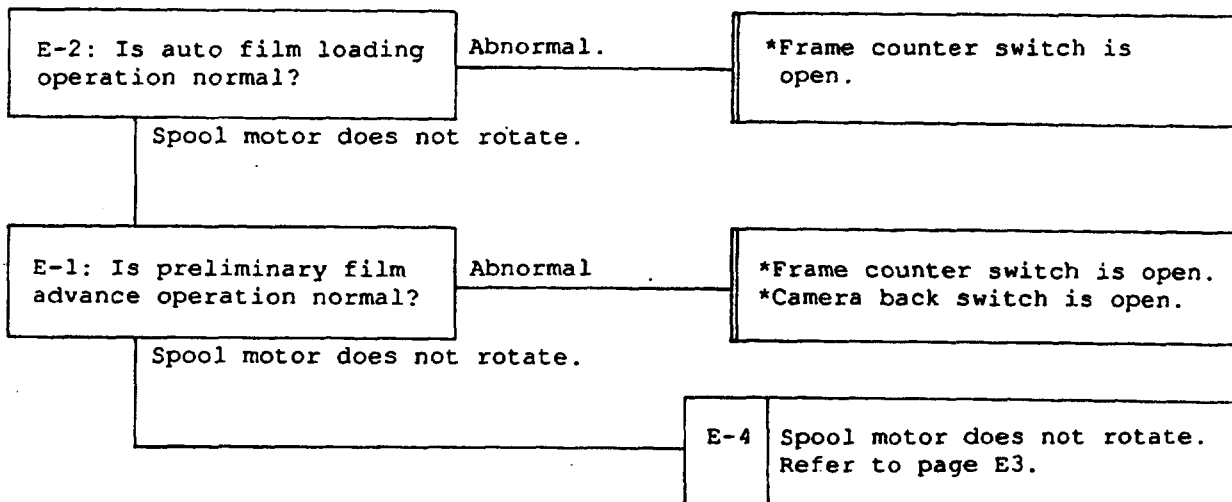

	Phenomenon	Cause
E-4	Spool motor does not rotate.	1. Poor contact of AF connector. 2. Poor contact of film advance completion switch. 3. Poor contact of press contact (D) 4. Power transistor FPC is defective. 5. Main FPC is defective. 6. AF FPC is defective.

Make inspection in the order of [A:*] ~ [D:***] in case of the trouble "Spool motor does not rotate."

[A: Inspection of AF connector]

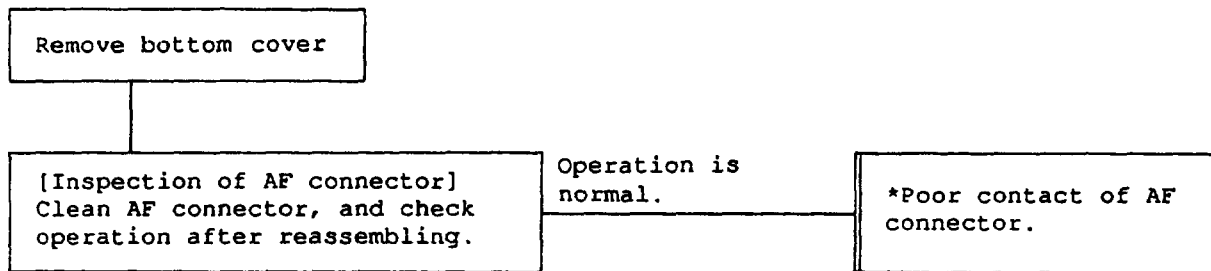

[B: Inspection of film advance completion switch]

[Inspection of film advance completion switch]
*With a personal computer: it is possible to ON/OFF inspection of film advance completion switch using adjustment program.

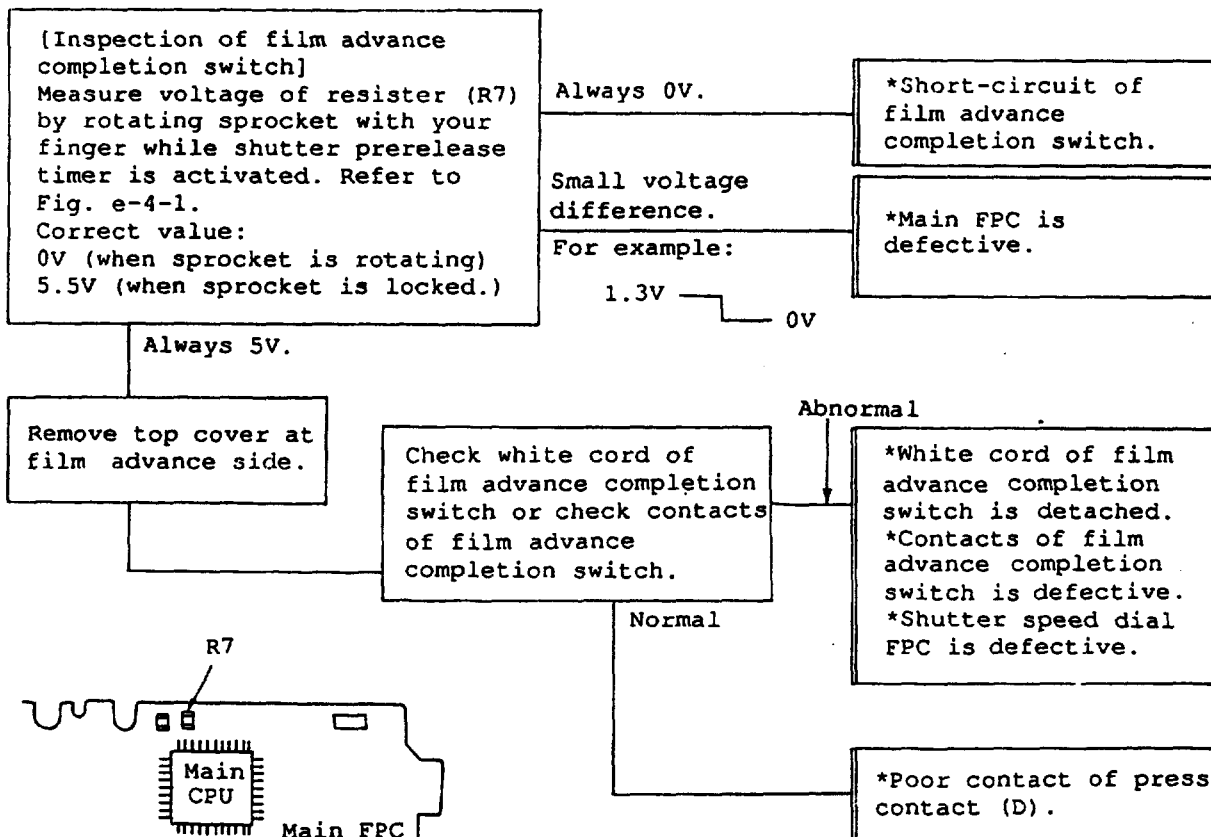

[C: Inspection of power transistor FPC, spool motor]

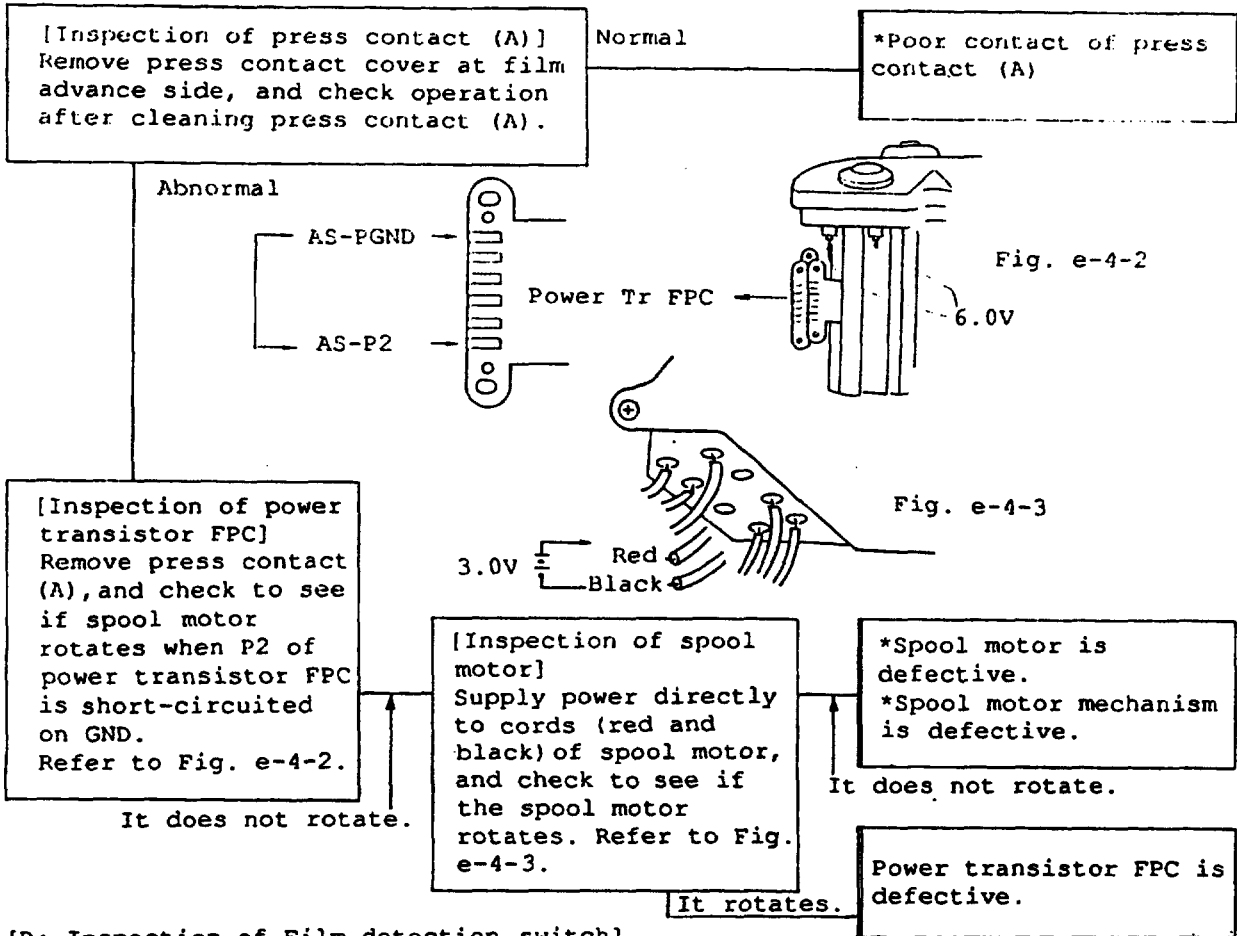

[D: Inspection of Film detection switch]

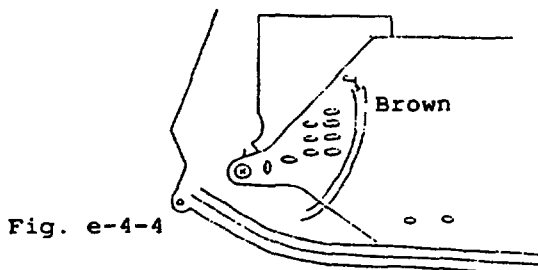
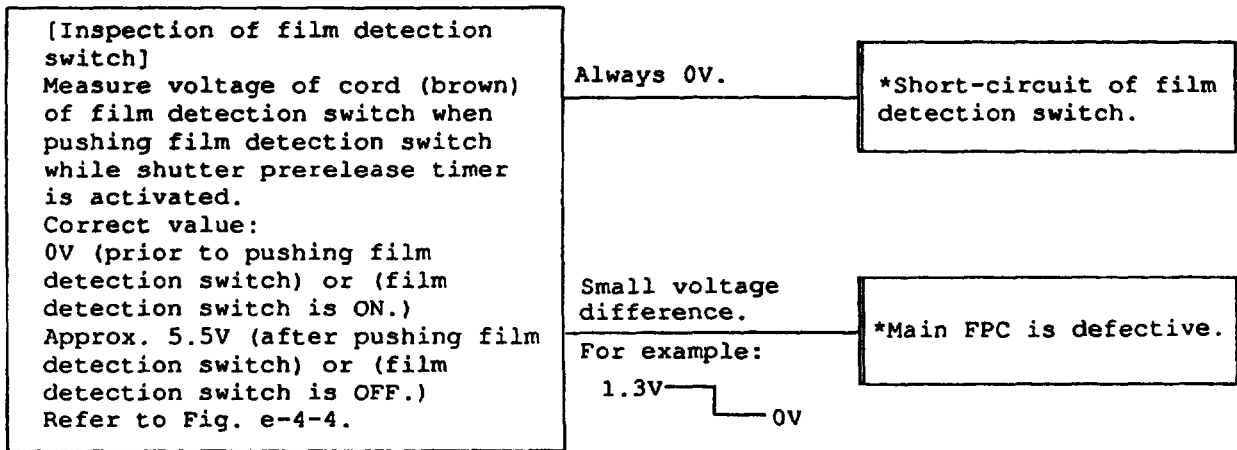

[E: Inspection of main FPC]

[Inspection of main FPC spool motor driving output]
Set camera back switch OFF or set frame counter "1" or more, measure voltage between P1 and GND of main FPC while shutter release switch is ON.
Correct value:
5.5V (shutter release switch is OFF.)
0V (after shutter release switch is ON)
Refer to Fig. e-4-5.

Remains 5.5V.

*Main FPC is defective.

Normal

Check again carefully to see if you have missed the inspection.

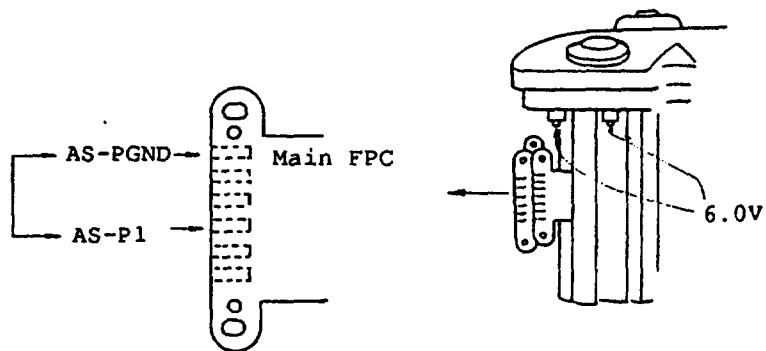

Fig. e-4-5

	Phenomenon	Cause
F-1	Film is not rewound automatically.	<ol style="list-style-type: none"> 1. Damage of film rewind vertical shaft gear. 2. Poor contact of press contact (D). 3. Poor contact of R1 switch. 4. Poor contact of R2 switch. 5. Shutter speed dial base plate is defective. (Shutter speed dial FPC is disconnected.) 6. Power transistor FPC is defective. 7. Main FPC is defective.

Can strange sound or idling sound in film rewind motor be heard after set in power film rewind mode. **Yes** → *Film rewind vertical shaft gear is damaged.

No
 Check ON/OFF operations of R1, R2, film detection switches using personal computer.
 Film detection switch is defective. **E-1** → Go to "Malfunction of film advance operation".

R2 switch is defective.
 Remove top cover at film rewind side.
 Check soldering of R2 switch.
 Poor soldering → *Poor soldering of R2 switch.
 Good soldering → *Main FPC is defective.

Remove top cover at film advance side.

[Inspection of R1 switch] Use tester to check ON/OFF operation of R1 switch. Refer to Fig. f-1-1.
 Abnormal → Hold up shutter speed dial, clean R1 switch, and check operation.
 Normal → *Poor contact of R1 switch.

Abnormal → *Shutter speed dial base plate is defective. (Shutter speed dial FPC is disconnected.)

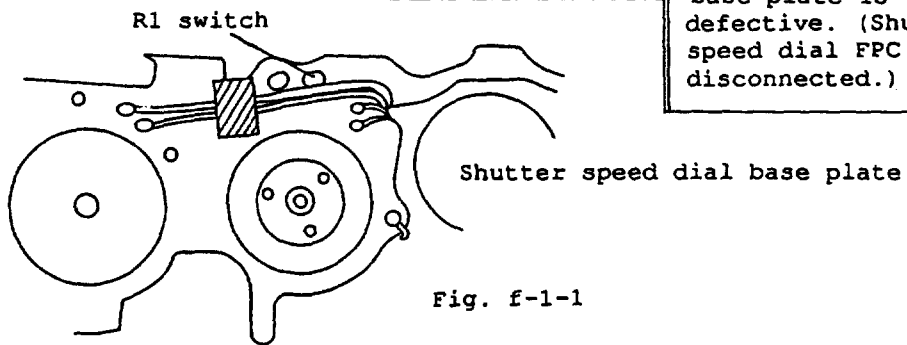

Fig. f-1-1

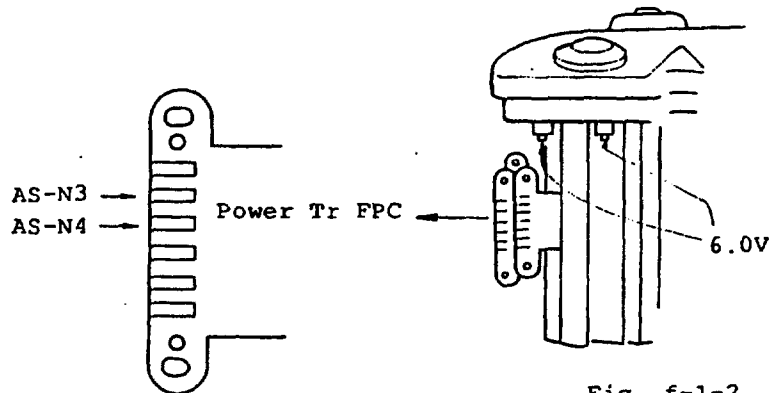
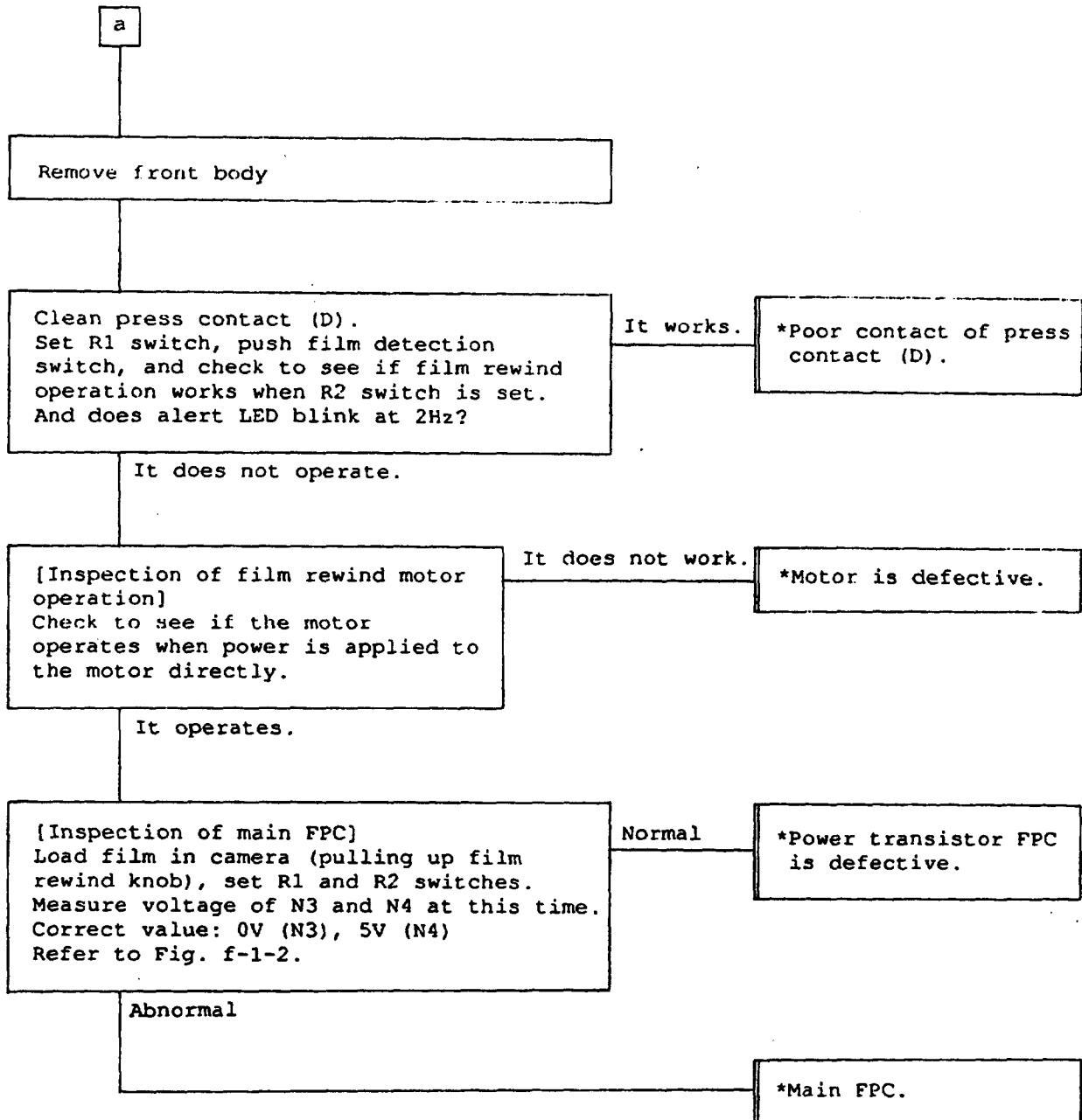
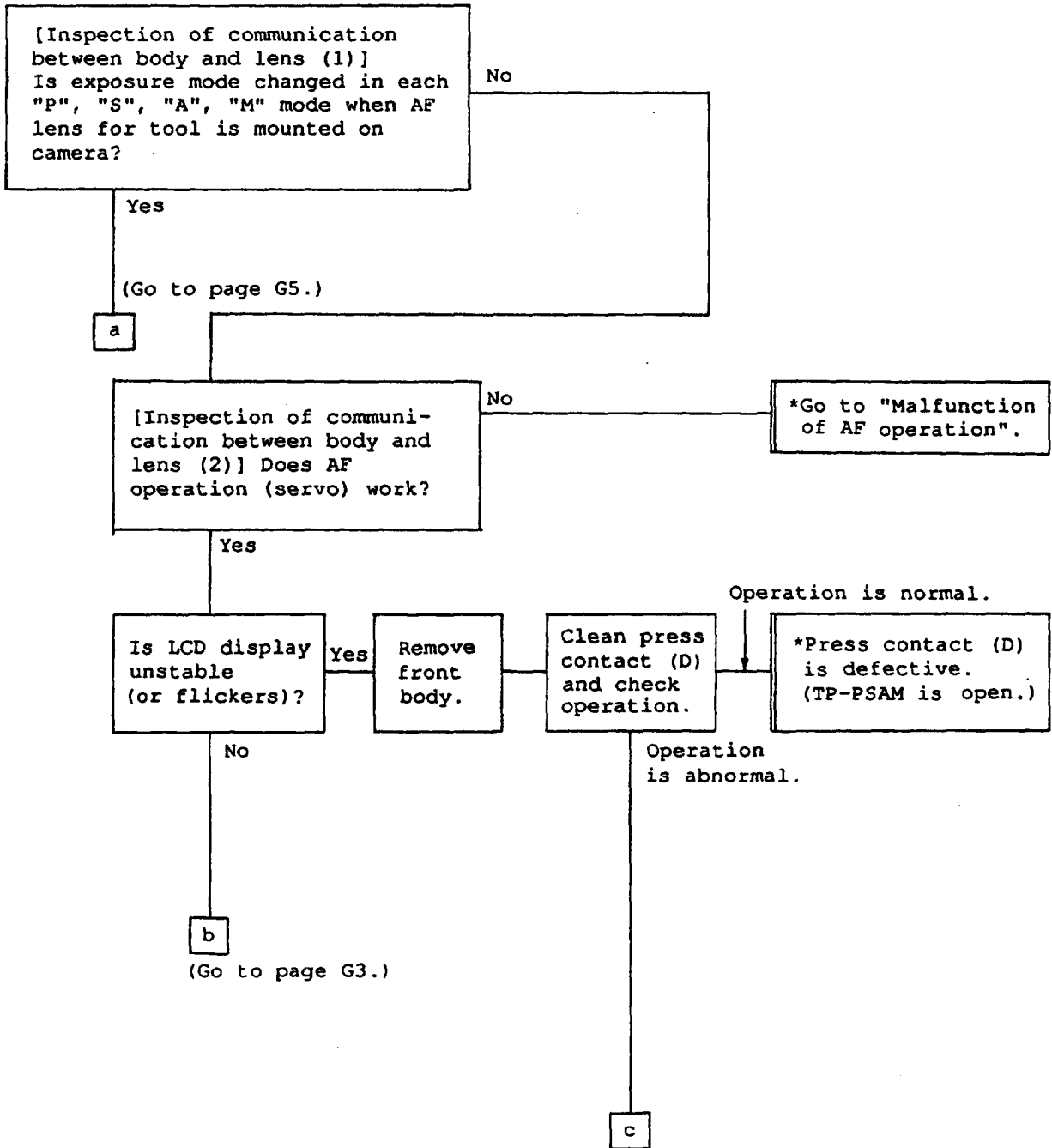
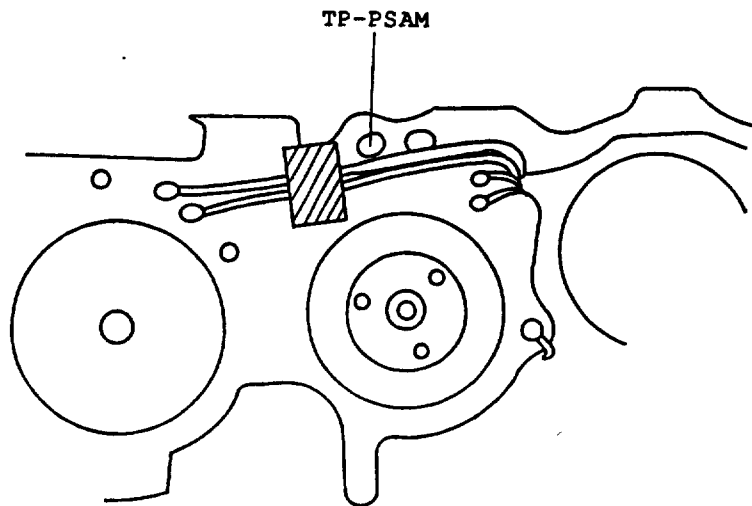
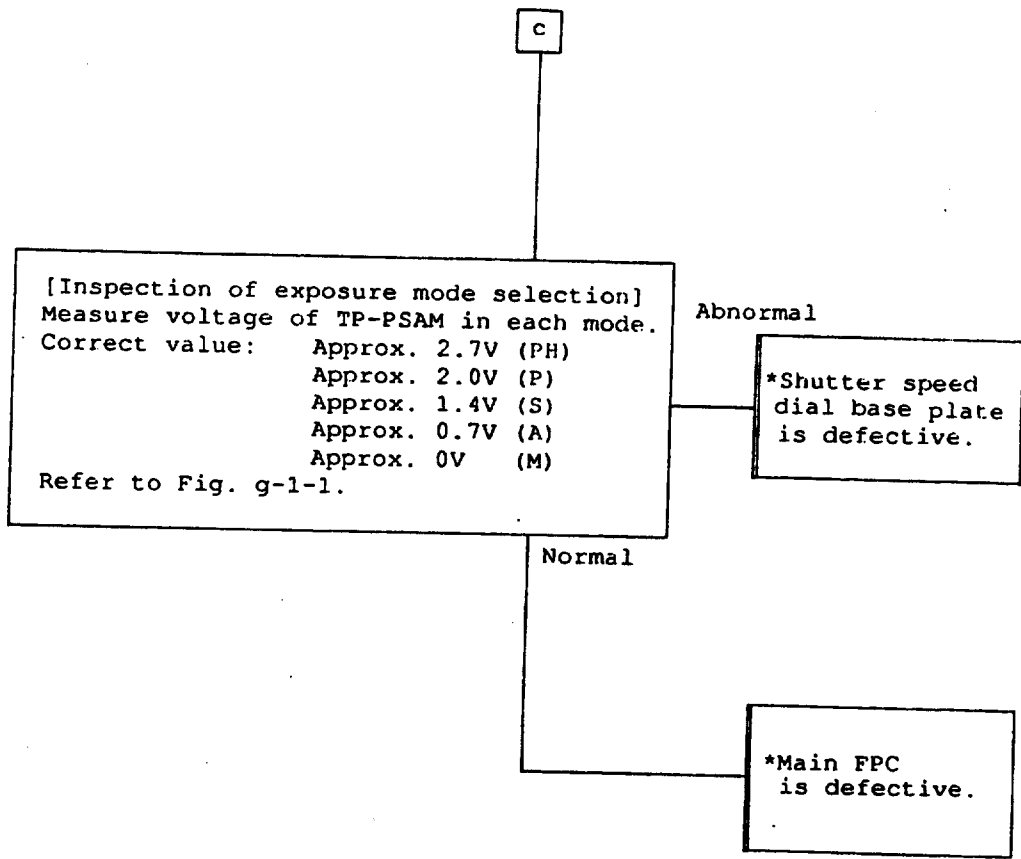

Fig. f-1-2

	Phenomenon	Cause
G-1	Exposure control is abnormal.	1. Poor contact of press contact (D). 2. Shutter speed dial base plate is defective. 3. Main FPC is defective.





Shutter speed dial base plate

Fig. g-1-1

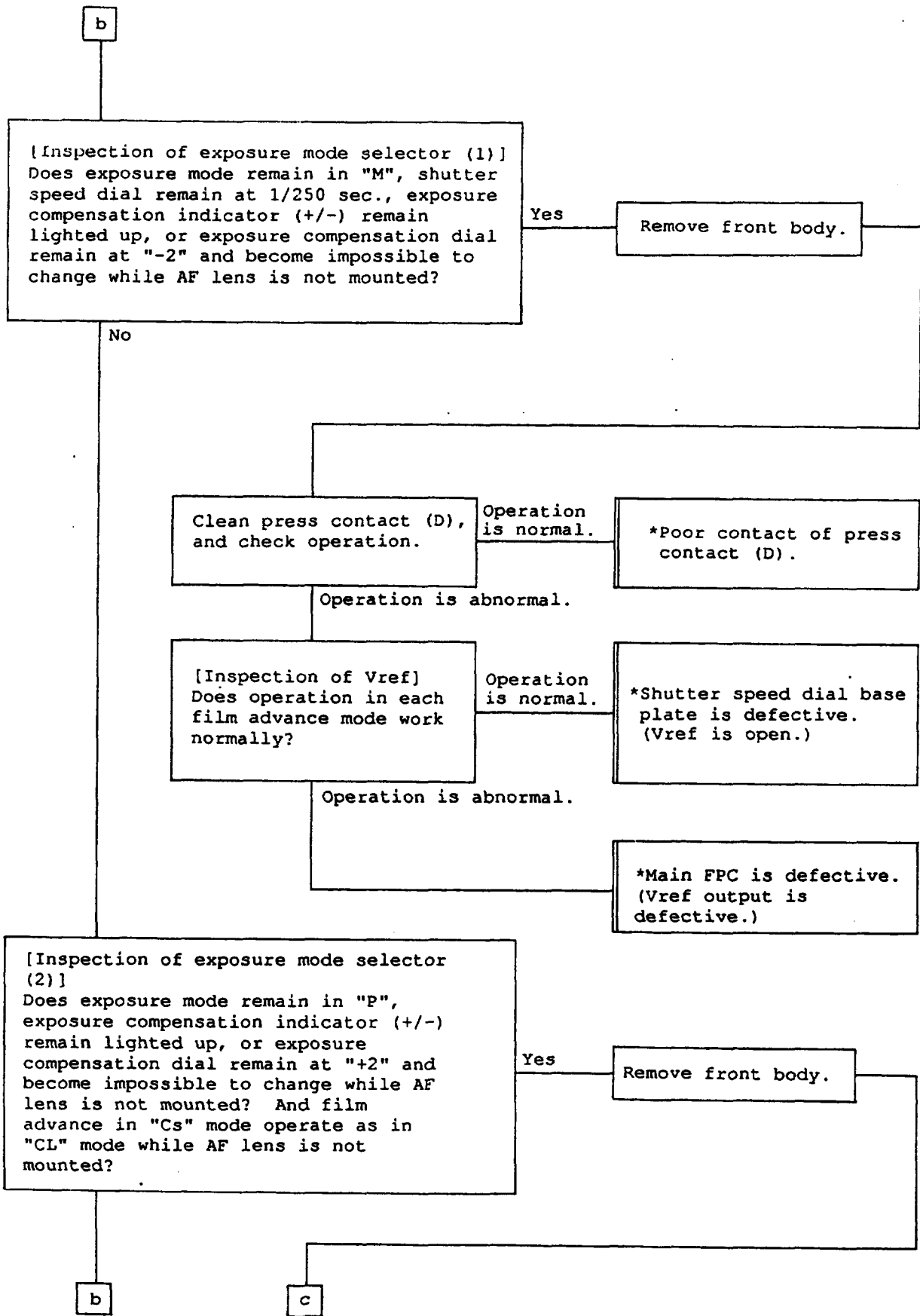

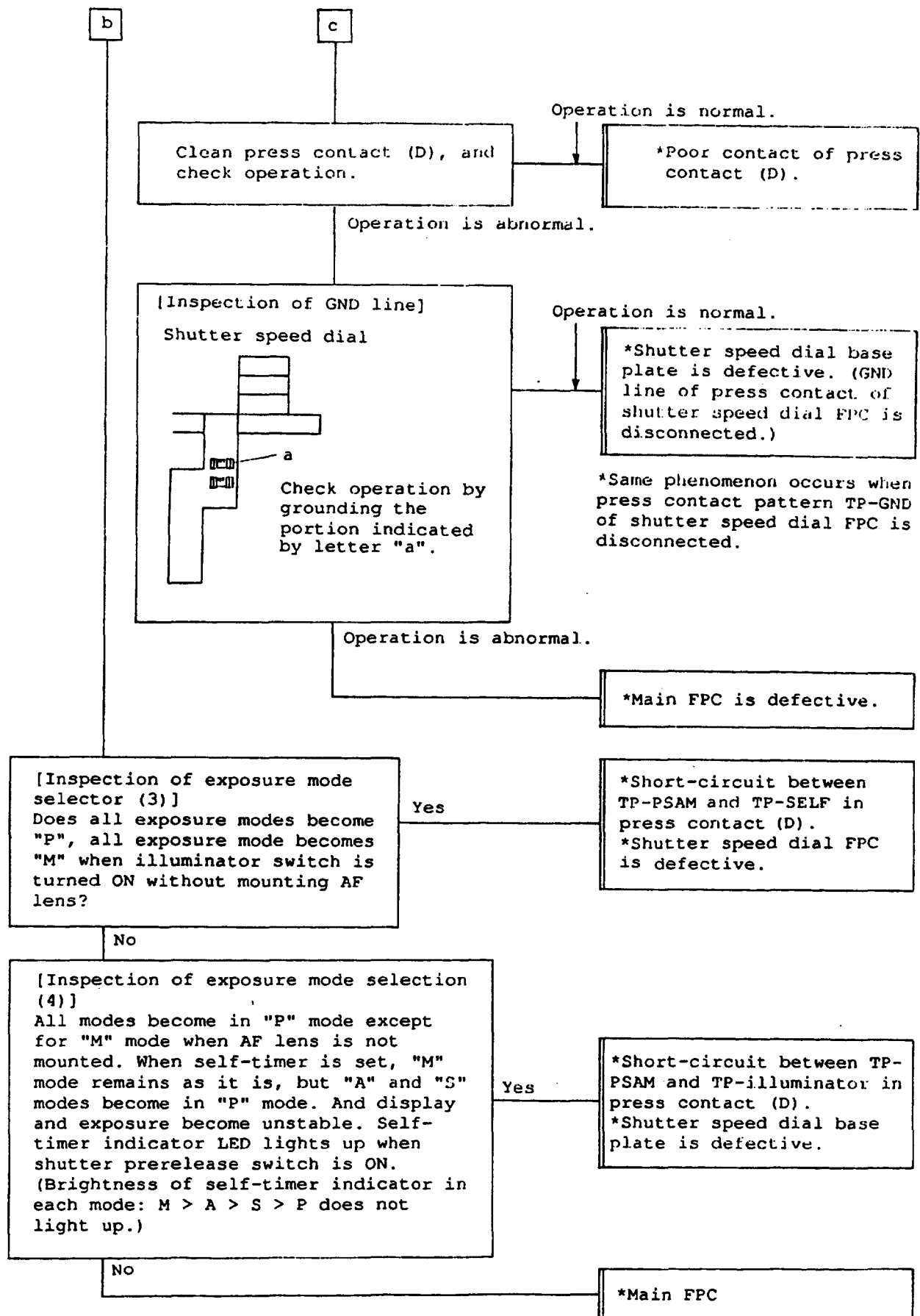

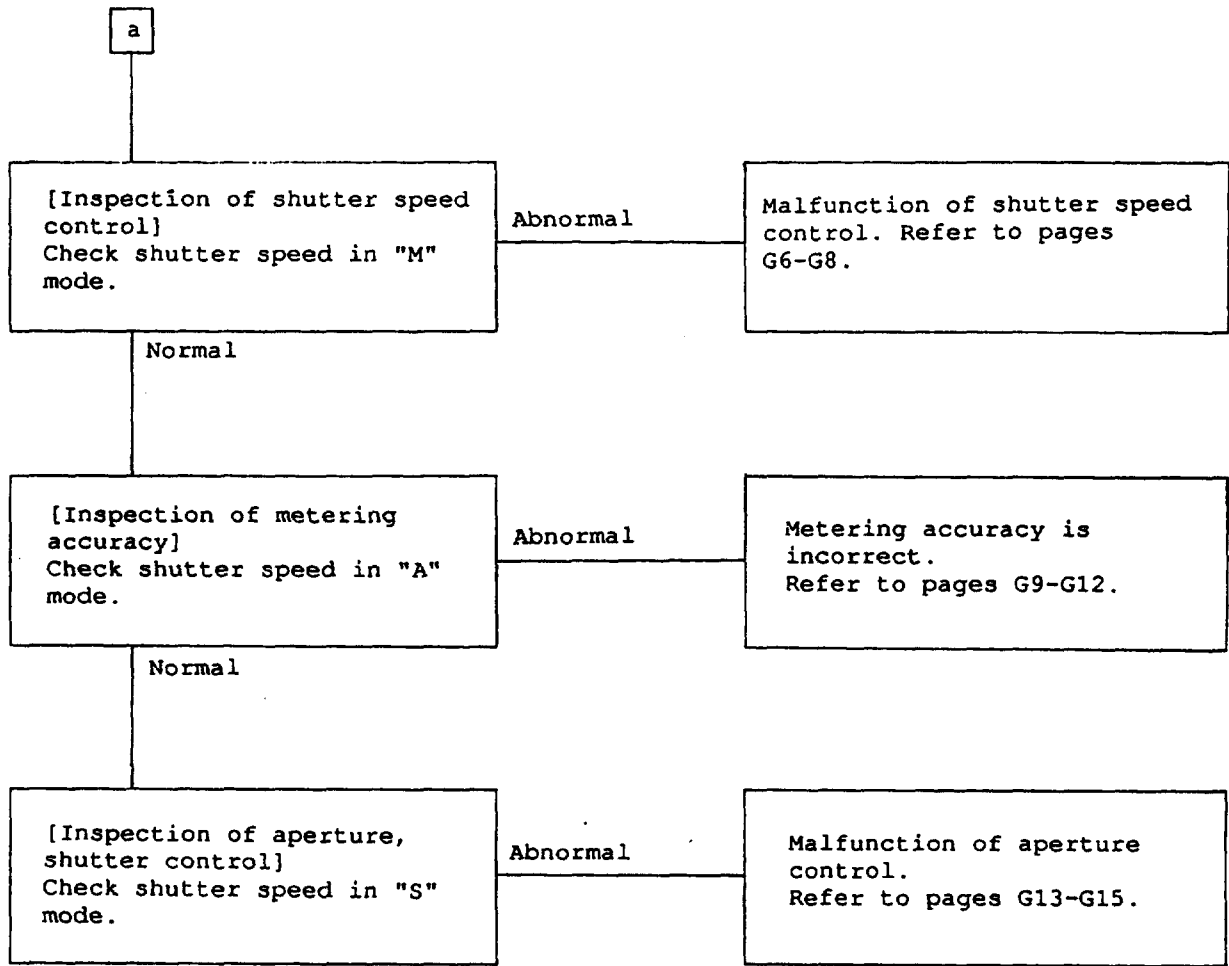

	Phenomenon	Cause
G-2	Shutter speed setting is unstable.	1. Shutter is defective. 2. 3. 4.

	Phenomenon	Cause
G-3	No adjustment of high shutter speed accuracy (1/8000, 1/4000 sec.) is possible.	1. Shutter is defective. 2. Data on EEPROM (11) is incorrect. 3. 4.

	Phenomenon	Cause
G-4	Shutter curtain does not open sometimes.	1. Shutter is defective. 2. 3. 4.

	Phenomenon	Cause
G-5	Shutter curtain does not open.	1. Shutter is defective. 2. Poor press contact (D) 3. Main FPC is defective. 4.

*If the same trouble occurs even when shutter is replaced (press contact (D) is cleaned), main FPC is defective.

	Phenomenon	Cause
G-6	Shutter bound.	1. Shutter is defective. 2. 3.

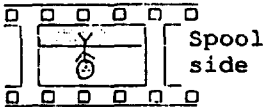
	Phenomenon	Cause
G-7	Shade appears on frame (upper part). Film cartridge side.  Spool side	1. Shutter is defective.

Notes on suffix:

E, F:

No measures have been taken. (It is possible that rear curtain does not return or focusing screen is shaded.)

G, H, JH, JHG, ...L:

Measures have been taken temporary. It is less possible that rear curtain does not return or focusing screen is shaded. If it occurs, send the defective shutter back to Nikon with a reporting sheet.)

K, and after:

Measures have been taken. (If trouble has occurred, send defective shutter back to Nikon with a reporting sheet.)

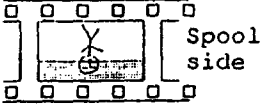
	Phenomenon	Cause
G-8	Shade appears on frame, underexposure (lower part). Film cartridge side  Spool side	1. Charging cam is defective.

	Phenomenon	Cause
G-9	All shutter speeds of 1/125 sec. or higher are set to 1/60 sec.	1. Shutter is defective. 2. Poor press contact (D) 3. Main FPC is defective. 4.

	Phenomenon	Cause
G-10	Some of shutter speeds on dial do not change when shutter speed dial is rotated.	1. Shutter speed dial base plate is defective. 2. Poor press contact (D) 3. Main FPC is defective. 4.

	Phenomenon	Cause
G-11	Shutter speed remains at 1/8000 sec.	1. Poor press contact (D) 2. Shutter speed dial base plate is defective. 3. Main FPC is defective. 4.

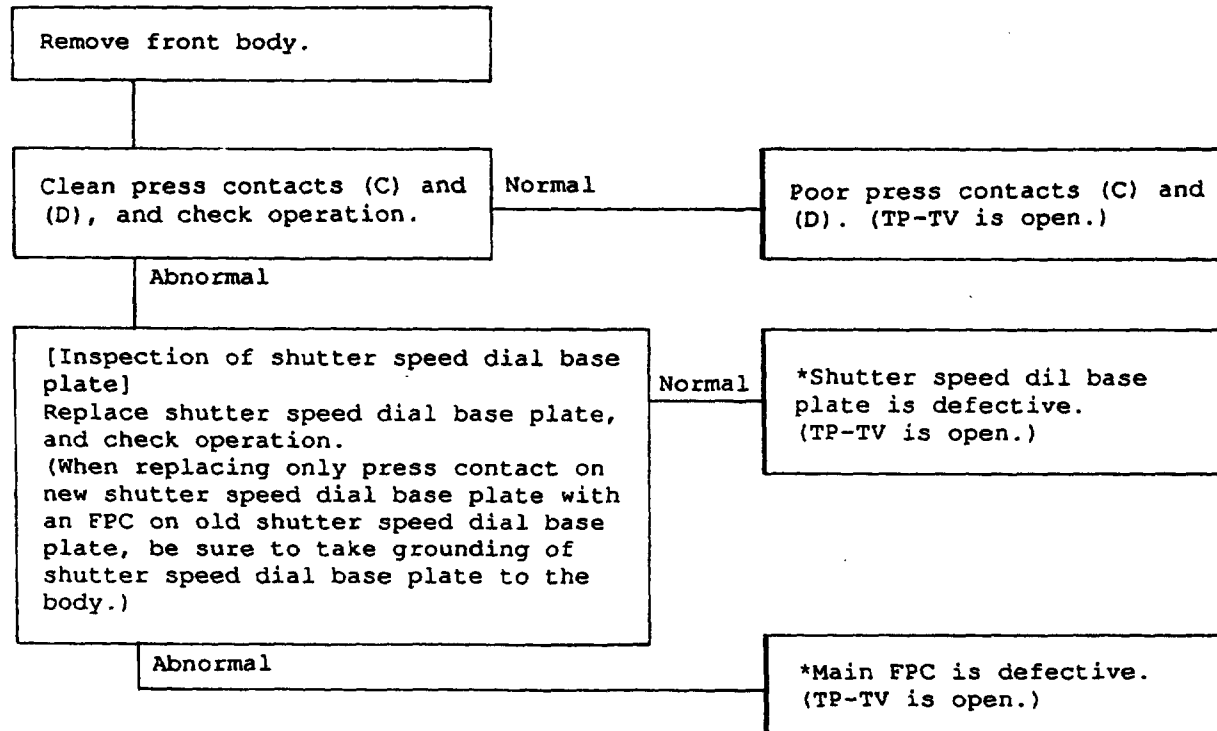

	Phenomenon	Cause
G-12	Shutter speed remains at 1/250 (X) sec.	1. Shutter speed dial base plate is defective. 2. Poor press contact (D) 3. Main FPC is defective. 4.

Remove front body.

Clean press contacts (C) and (D), and check operation.

Normal

*Poor press contacts (C) and (D).
(Vref is disconnected.)
(Short-circuit of TP-TV.)

Abnormal

[Inspection of shutter speed dial base plate]
 Replace shutter speed dial base plate, and check operation.
 (When replacing only press contact on new shutter speed dial base plate with an FPC on old shutter speed dial base plate, be sure to take grounding of shutter speed dial base plate to the body.)

Normal

*Shutter speed dial base plate is defective.
(Vref is disconnected.)
(Short-circuit of TP-TV.)

Abnormal

*Main FPC is defective.
(Vref is disconnected.)
(Short-circuit of TP-TV.)

	Phenomenon	Cause
G-13	Metering accuracy is incorrect. *Only spot metering accuracy is incorrect.	1. Main FPC is defective. 2. 3.

Example: Exposure display shows 1/250 sec. though shutter speed dial shows 1/30 sec.

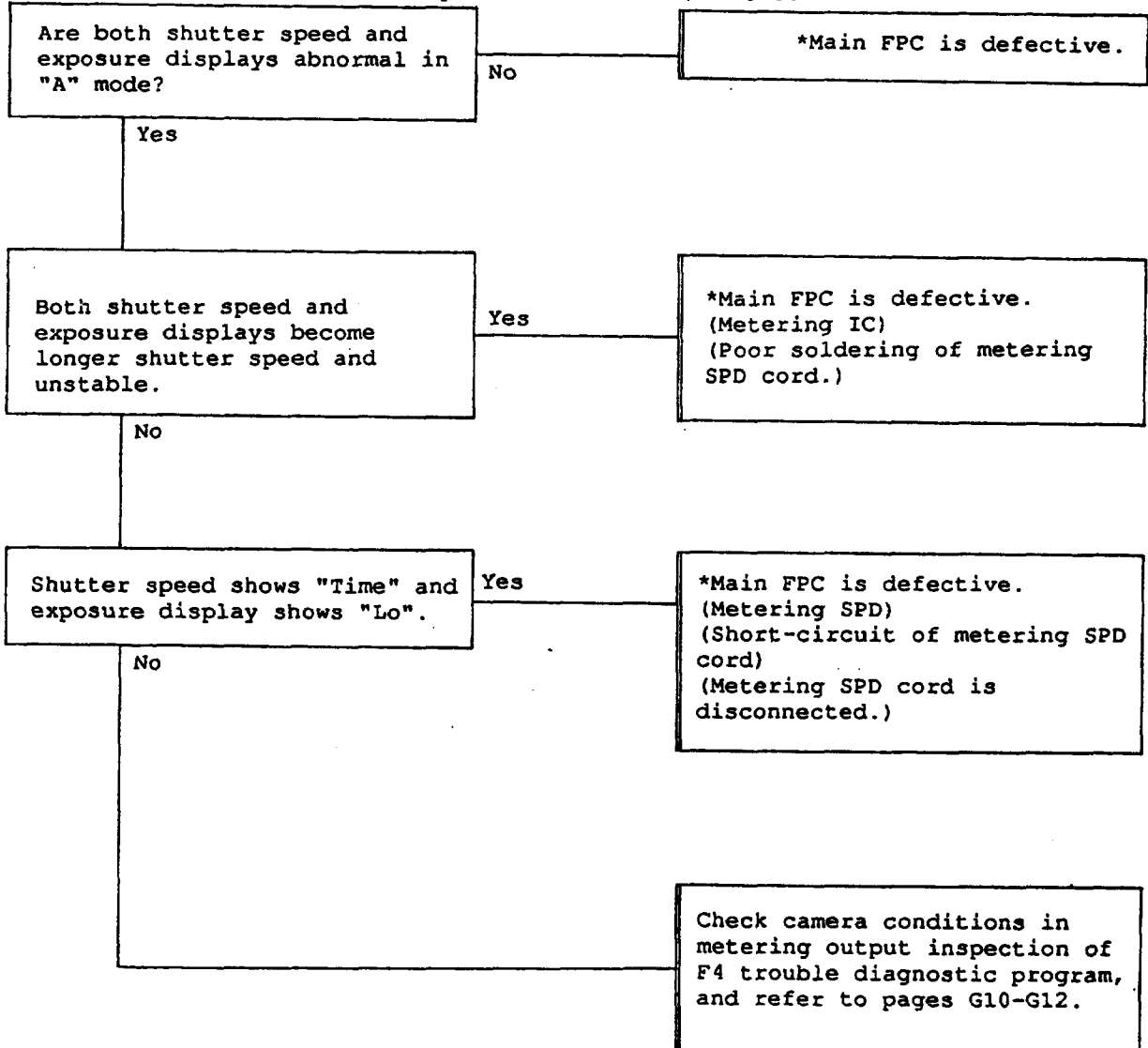

	Phenomenon	Cause
G-14	Metering value is incorrect.	<ol style="list-style-type: none"> 1. Main FPC is defective. 2.

	Phenomenon	Cause
G-15	Aperture value (F-Fo) is incorrect.	<ol style="list-style-type: none"> 1. F-Fo base plate is defective. 2. Poor contact of F-Fo pulley (brush). 3. Main FPC is defective.

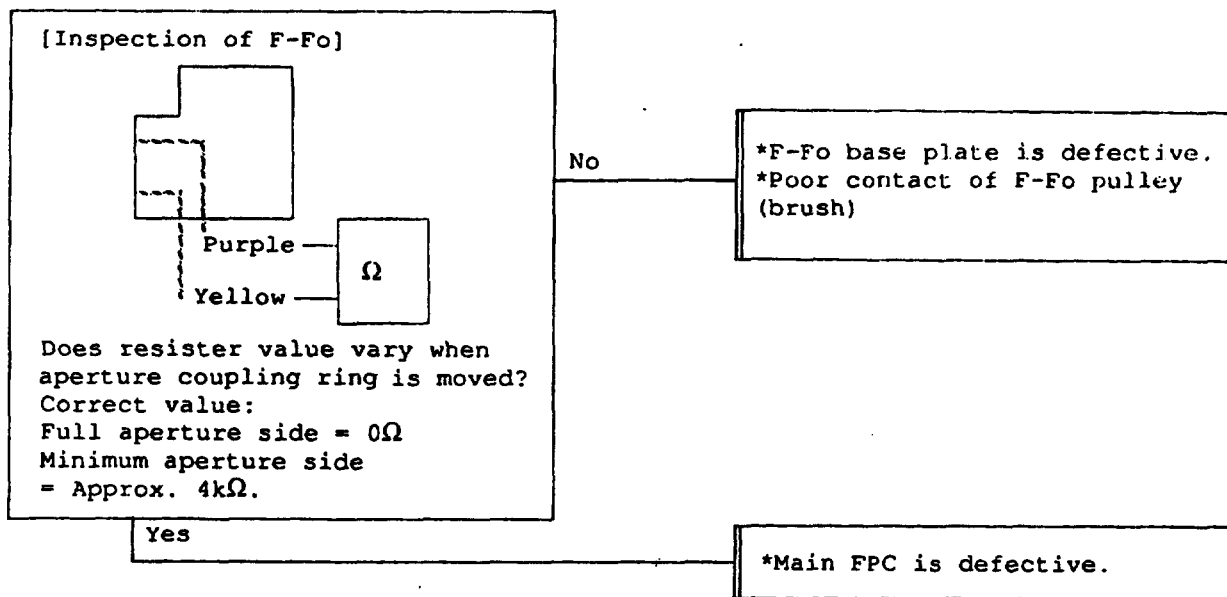

	Phenomenon	Cause
G-16	Full aperture value (Fo) is incorrect.	<ol style="list-style-type: none"> 1. Fo base plate is defective. 2. Poor contact of Fo brush

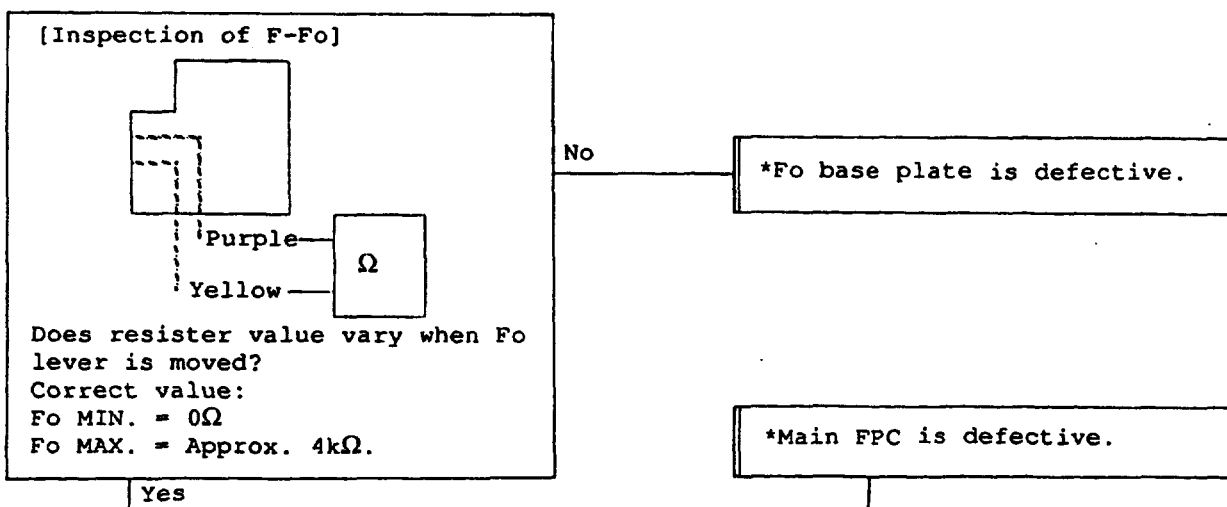

	Phenomenon	Cause
G-17	Film speed value is incorrect.	<ol style="list-style-type: none"> 1. Poor contact of film speed dial brush. 2. Short-circuit or disconnection of circuit patterns in film speed dial. 3. Main FPC is defective.

	Phenomenon	Cause
G-18	DX-coded value is incorrect.	<ol style="list-style-type: none"> 1. Poor contact of DX pins. 2. Poor contact between DX pins and DX FPC. 3. Film cartridge is defective. 4. Poor press contact (E). 5. Main FPC is defective.

Remove front cover.

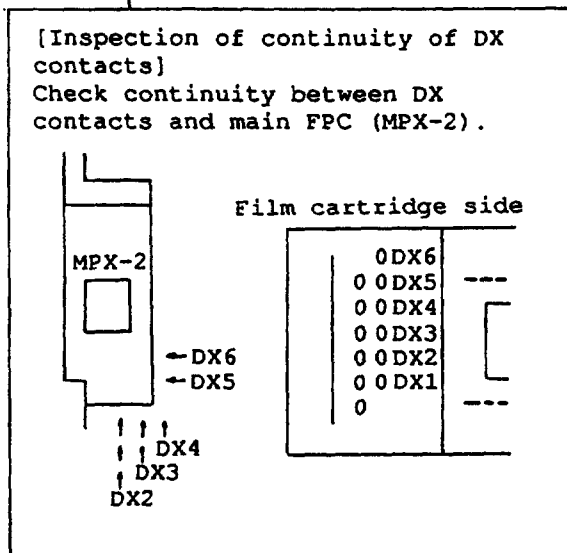

Normal

*Main FPC is defective.

Abnormal

Clean press contact (E), and repeat [Inspection of continuity of DX contacts] operation.

Normal

*Poor contact of press contact (E).

Abnormal

*DX, DB, FD FPC are defective.

	Phenomenon	Cause
G-19	Exposure compensation value is incorrect.	<ol style="list-style-type: none"> 1. Shutter speed dial base plate is defective. 2. Poor contact of press contact (D). 3. Main FPC is defective.

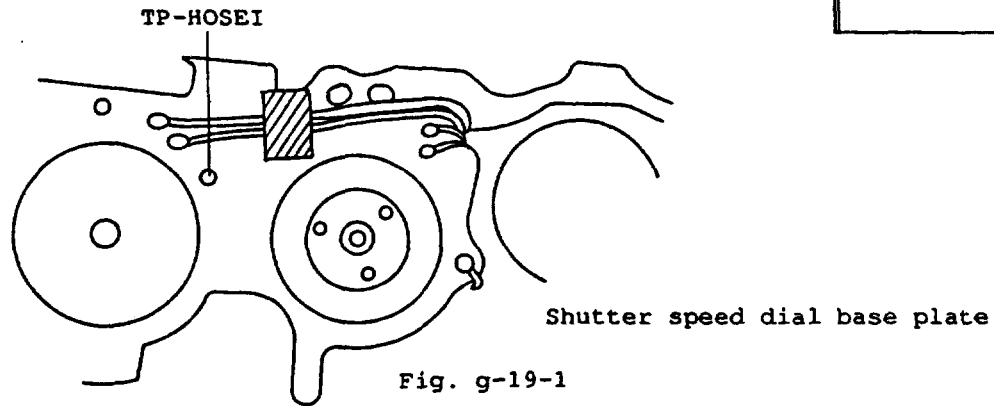
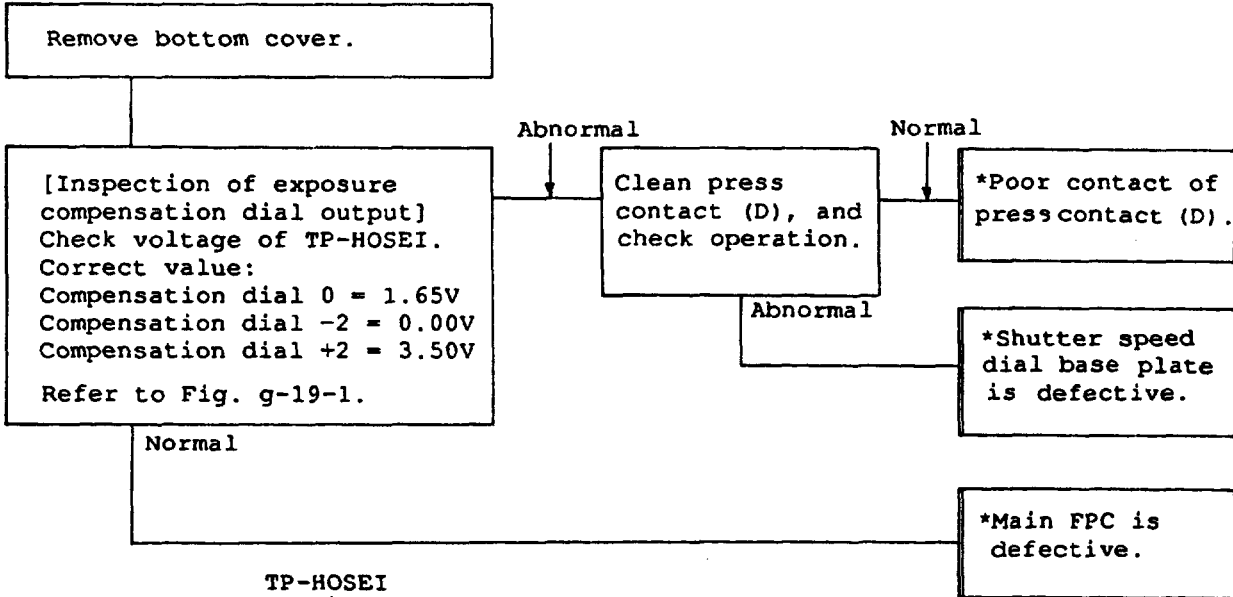

	Phenomenon	Cause
G-20	AE-L button is defective.	<ol style="list-style-type: none"> 1. Lock encoder FPC is defective. 2. AE-L switch is defective. 3. Main FPC is defective.

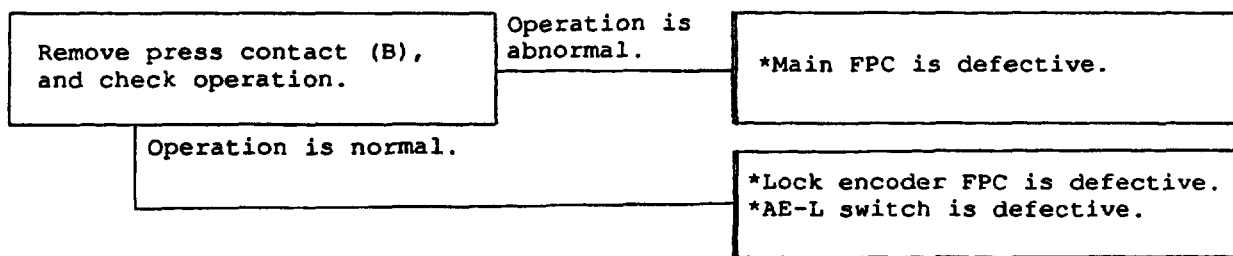

	Phenomenon	Cause
G-21	Always in minimum aperture value.	<ol style="list-style-type: none"> Poor contact of AF connector. Poor contact of press contact (B). Aperture P.I is defective. Aperture Mg. is defective. Tension of aperture gear speed-up spring is defective. Mirror box mechanism is defective. Main FPC is defective.

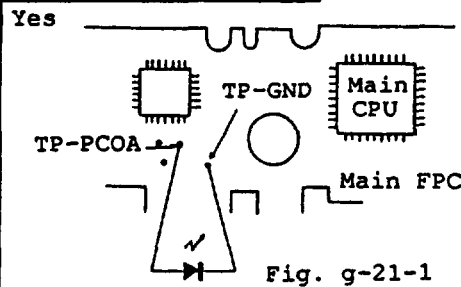
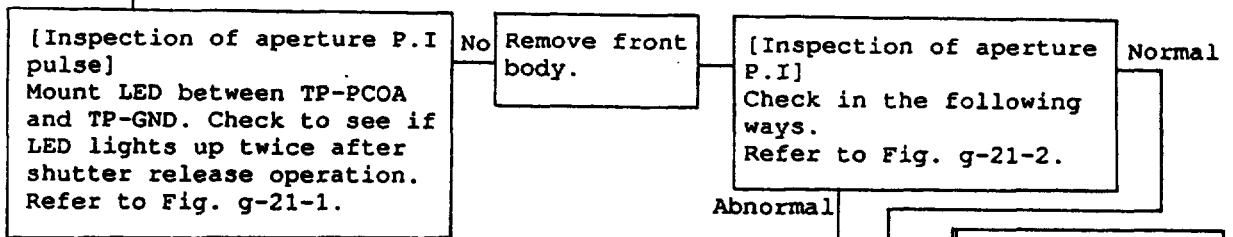
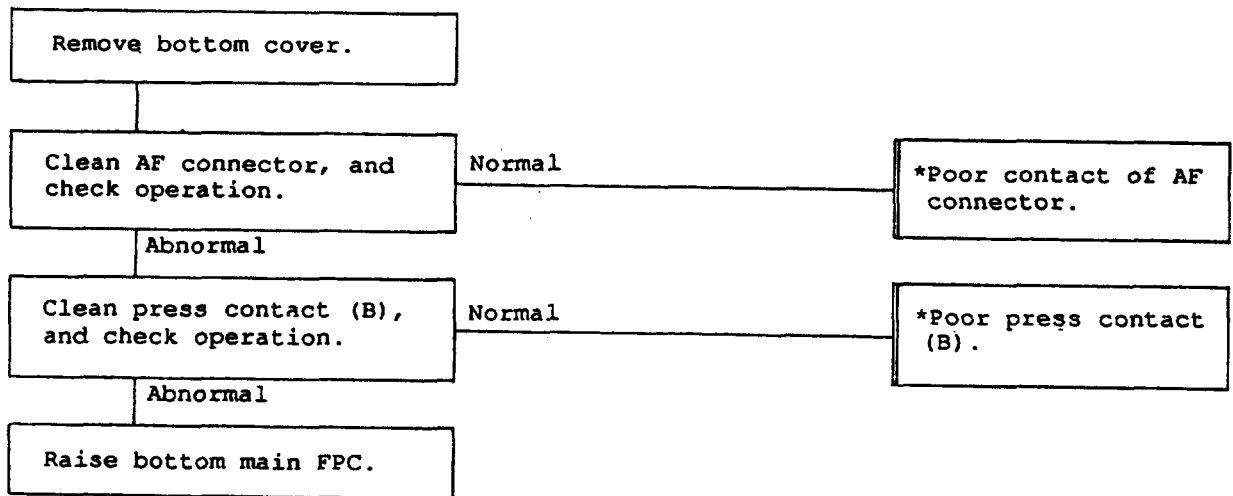

[Inspection of aperture P.I]
Connect cords as shown in Fig. g-21-2, and check to see if LED lights up when aperture lever is moved. LED blinks: Normal. LED does not blink: Abnormal.

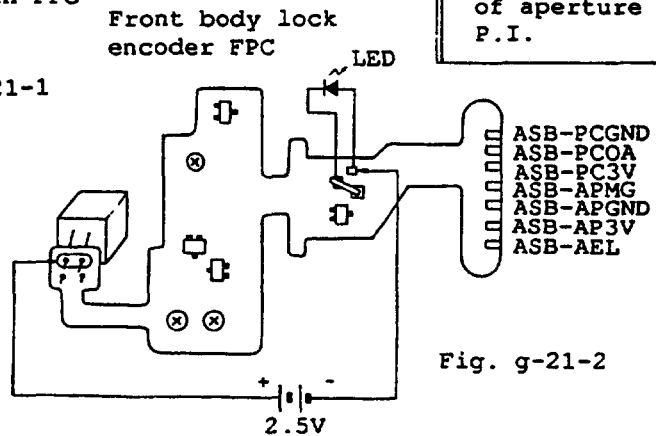

a

a

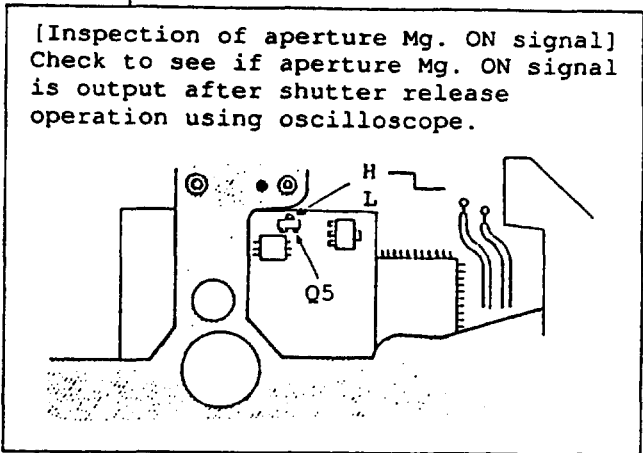

No signal is output.

*Main FPC is defective.

Signal is output.

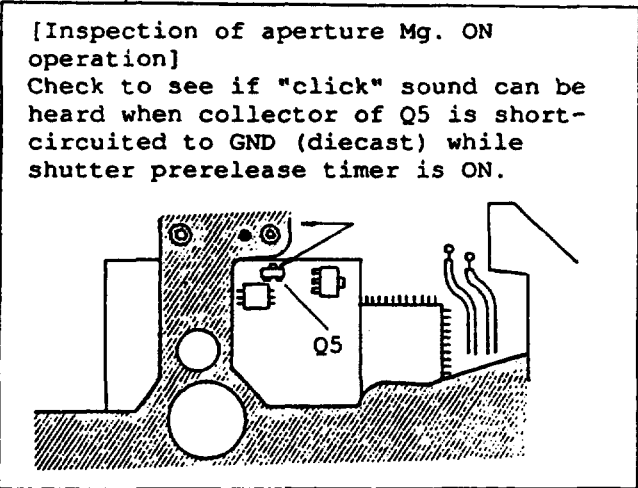

No sound can be heard.

*Aperture Mg. is defective.

Sound can be heard.

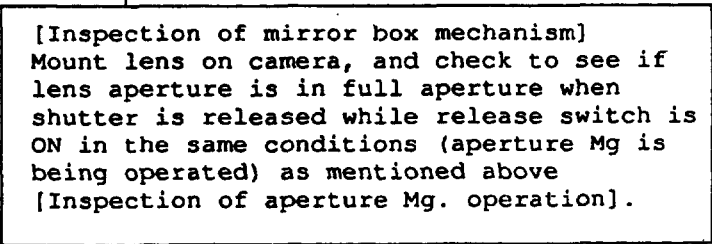

Not in full aperture.

*Mirror box mechanism is defective.

In full aperture.

*Tension of aperture speed-up gear spring is defective. (270° normally).

	Phenomenon	Cause
G-22	Always in full aperture value.	<ol style="list-style-type: none"> 1. Poor contact of AF connector. 2. Mirror box mechanism is defective. 3. Aperture Mg. is defective. 4.

	Phenomenon	Cause
G-23	Aperture control is unstable.	<ol style="list-style-type: none"> 1. Poor contact of AF connector. 2. Mirror box mechanism is defective. 3. Poor soldering of aperture P.I. 4.

	Phenomenon	Cause
G-24	Exposure value of aperture and shutter speed controls differ by 1EV or more.	<ol style="list-style-type: none"> 1. Tension of aperture speed-up gear spring is defective. 2. 3. 4.

	Phenomenon	Cause
H-1	Focus aid operation is unable. (Focus indicators x▶●◀ do not appear.)	<ol style="list-style-type: none"> Poor contact of AF connector or it is contaminated. Disconnection or detachment of soldering of orange cord. AF base plate is defective. DC-DC converter is defective. Main FPC is defective.

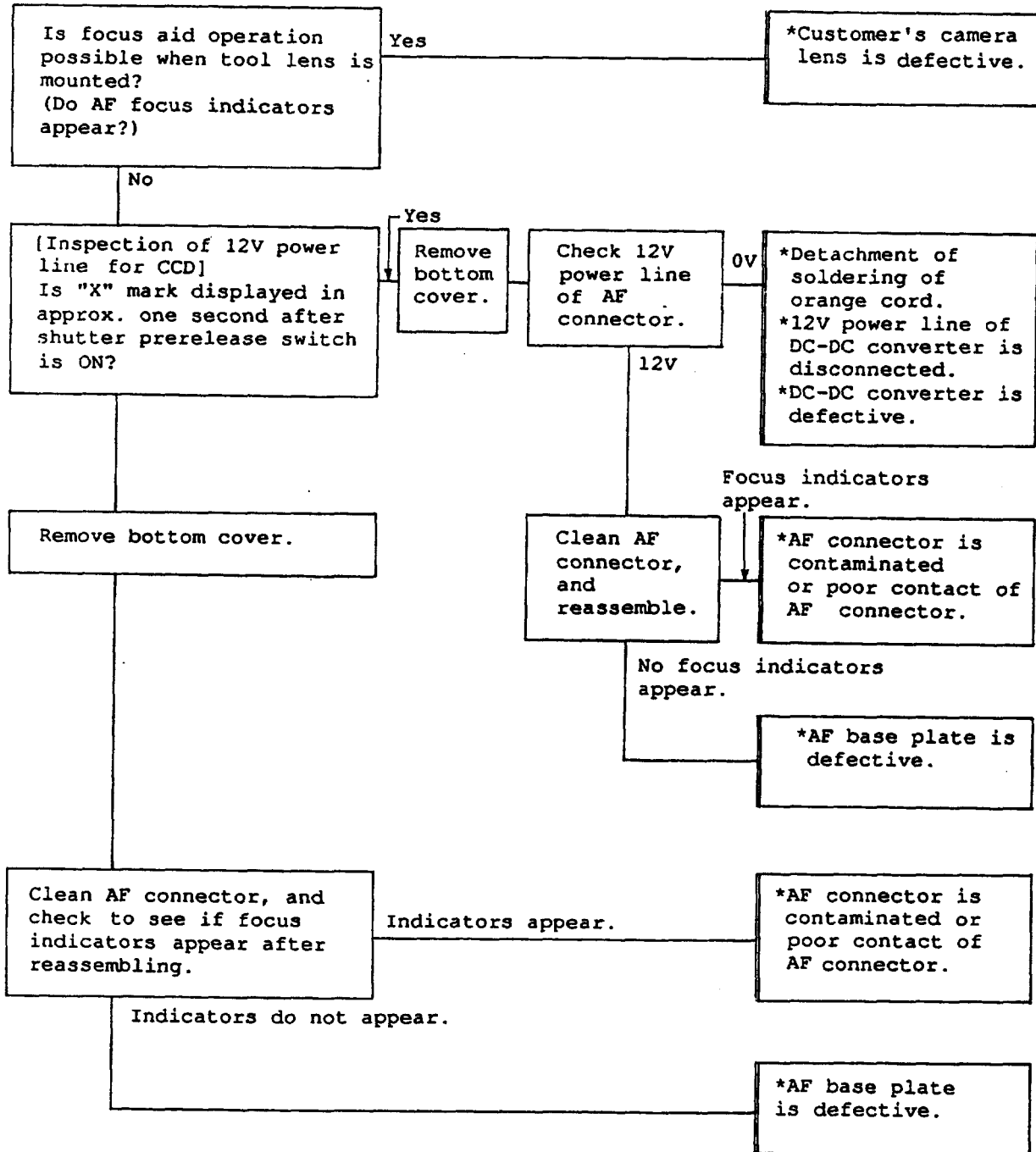

	Phenomenon	Cause
H-2	AF lens does not operate.	1. AF base plate is defective. 2. AF driving portion (including AF motor.) is defective. 3. Main FPC is defective.

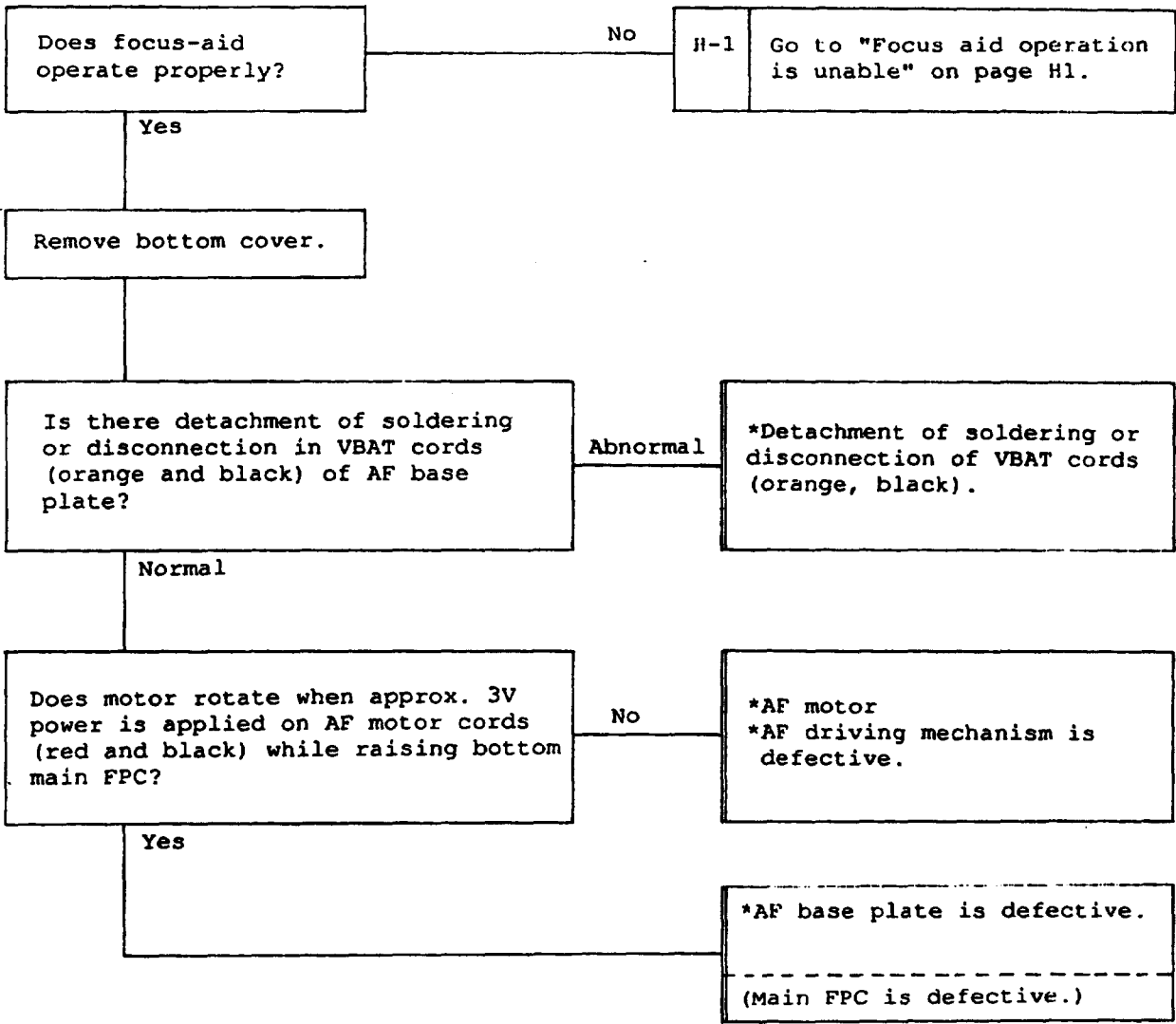

	Phenomenon	Cause
H-3	Unstable AF lens operation.	<ol style="list-style-type: none"> 1. Foreign matter is present on AF filter or AF sensor. 2. Poor soldering of AF PI. Operation of AF PI mechanism is improper. 3. AF base plate is defective.

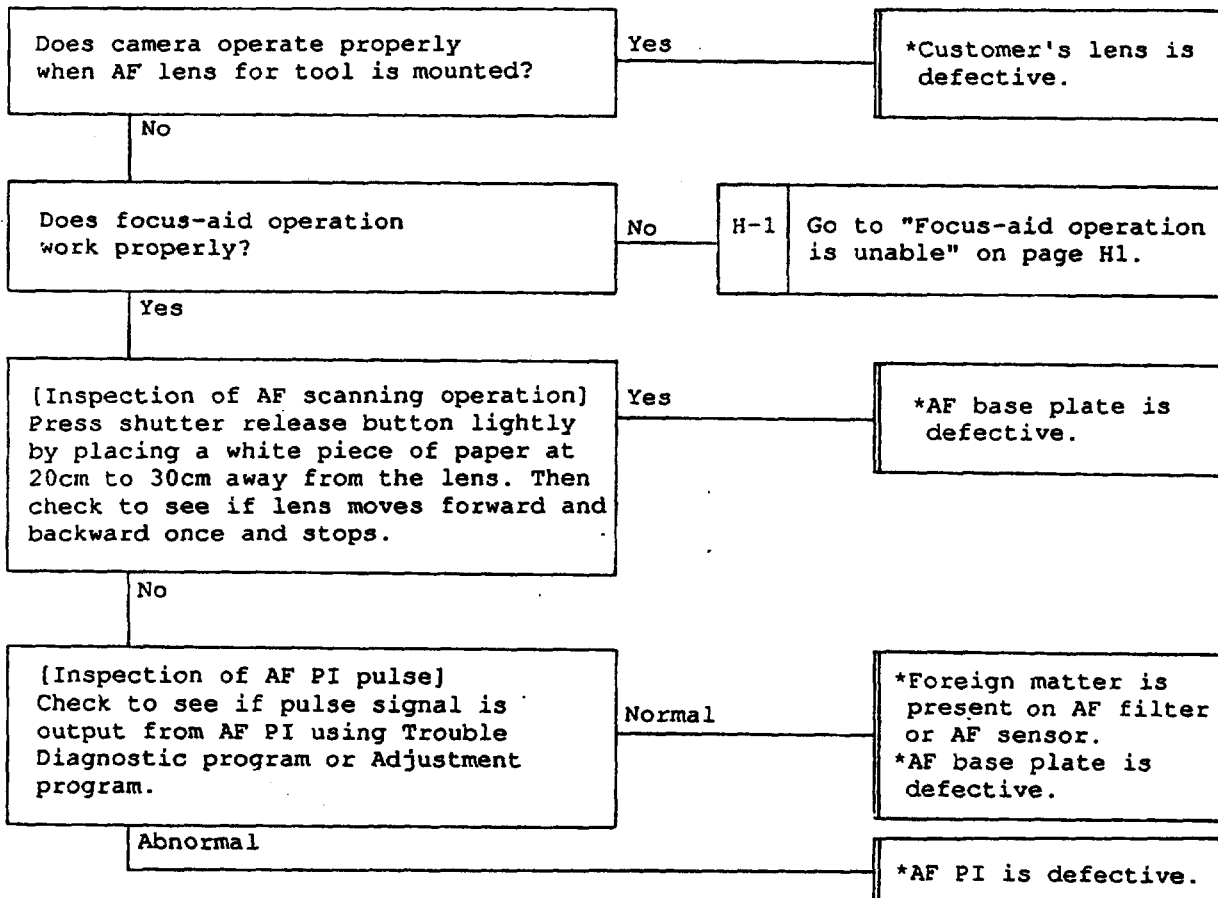

Note: The way of AF operation may vary depending on the size or location of foreign matter.
 Example: When a relatively large piece of foreign matter is present on the AF filter, the lens may operate little by little and come into focus.

	Phenomenon	Cause
H-4	AF lens performs scanning operation only when shutter prerelease switch is ON.	<ol style="list-style-type: none"> 1. Foreign matter is present on AF filter or AF sensor. 2. Poor soldering of AF.PI. Mechanical operation of AF.PI is improper. 3. AF base plate is defective.

AF scanning operation:
 Usually AF lens moves from infinity to near and near to infinity once immediately after shutter prerelease switch is turned ON when nothing has been detected on AF sensor (or not in focus).

	Phenomenon	Cause
H-5	Subject is not in focus on focusing screen though in-focus indicator appears.	<ol style="list-style-type: none"> 1. Foreign matter is present on AF filter or AF sensor. 2. Angle of 45° between main and sub mirrors is incorrect. 3. Body back is defective. 4. AF adjustment is improper. 5. Customer's lens is defective.

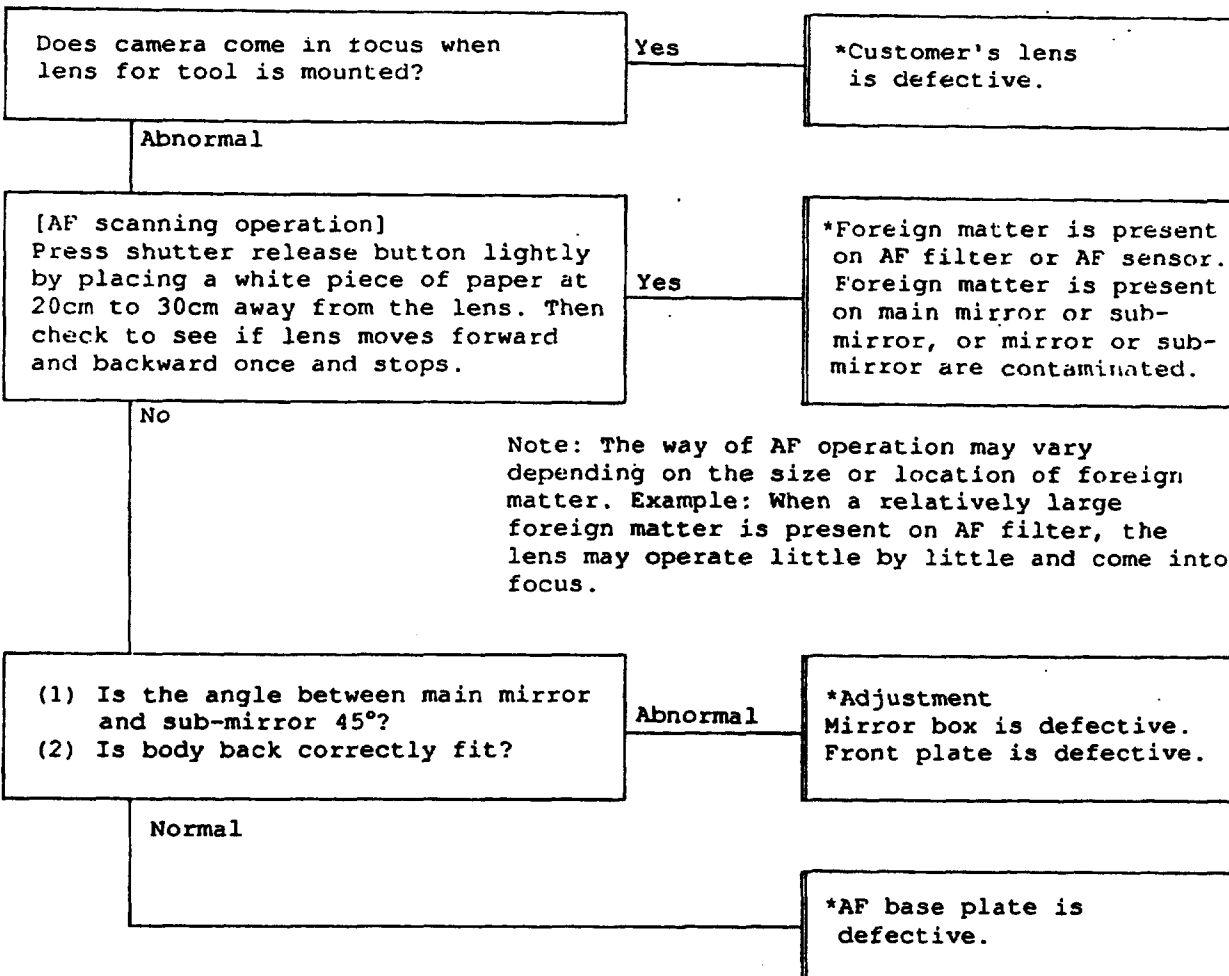

H-6	List of trouble due to disconnection of lens contacts (7portions).
-----	--

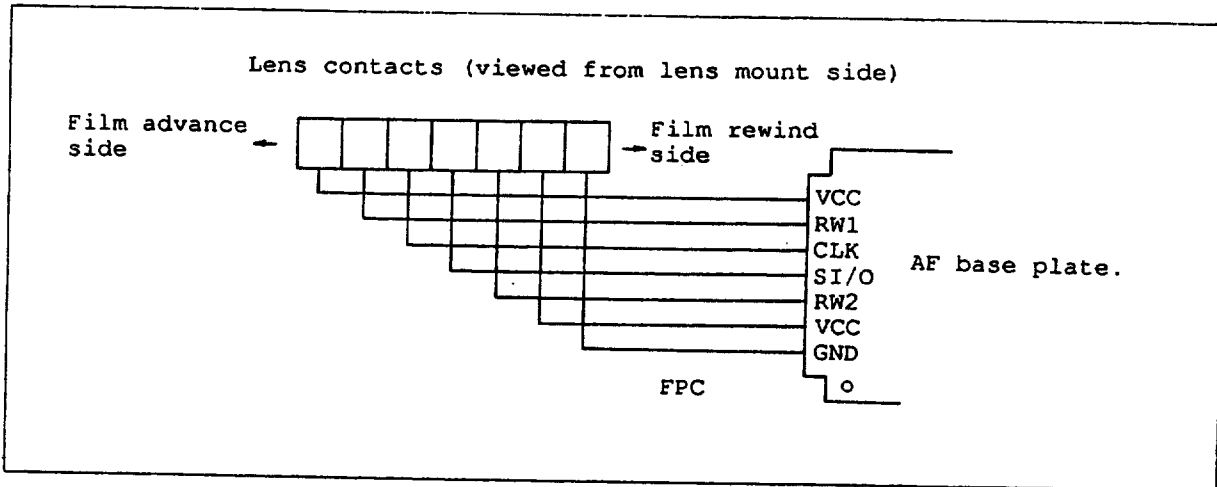

Terminal No.	Terminal name	Phenomenon (AF lens)		Phenomenon (AF lens for F3)
A	VCC	Focus aid is possible. AF does not work. No communication with flash.	Does not change to "P" and "S" modes. (Remains in "A" mode.)	Does not work.
B	RW1	Focus aid is possible. AF does not work. No communication with flash.	Does not change to "P" and "S" modes. (Remains in "A" mode.)	No trouble can be detected.
C	CLK (Wide -> Tele)	Focus aid is possible. AF does not work. No communication with flash.	Does not change to "P" and "S" modes. (Remains in "A" mode.)	In Wide -> Tele mode, lens moves but does not focus. In Tele -> Wide mode, lens does not move. Focus aid is possible.
D	SI/O (Tele -> Wide)	Focus aid is possible. AF does not work. No communication with flash.	Does not change to "P" and "S" modes. (Remains in "A" mode.)	In Tele -> Wide mode, lens moves but does not focus. In Wide -> Tele mode, lens does not move. Focus aid is possible.
E	RW2	No trouble can be detected.		Does not work.
F	VCC (relative distance)	No trouble can be detected.		Does not work.
G	GND	Focus aid is possible. AF does not work. No communication with flash.	Does not change to "P" and "S" modes. (Remains in "A" mode.)	Does not work.

	Phenomenon	Cause
I-1	Malfunction of LCD and LED displays at body side. This corresponds to the trouble in display at body side only. Find cause of trouble using each check flow when metering and AF accuracy operations are abnormal.	<ol style="list-style-type: none"> 1. Poor contact of press contact (F). 2. Display FPC is defective. 3. Main FPC is defective. 4.

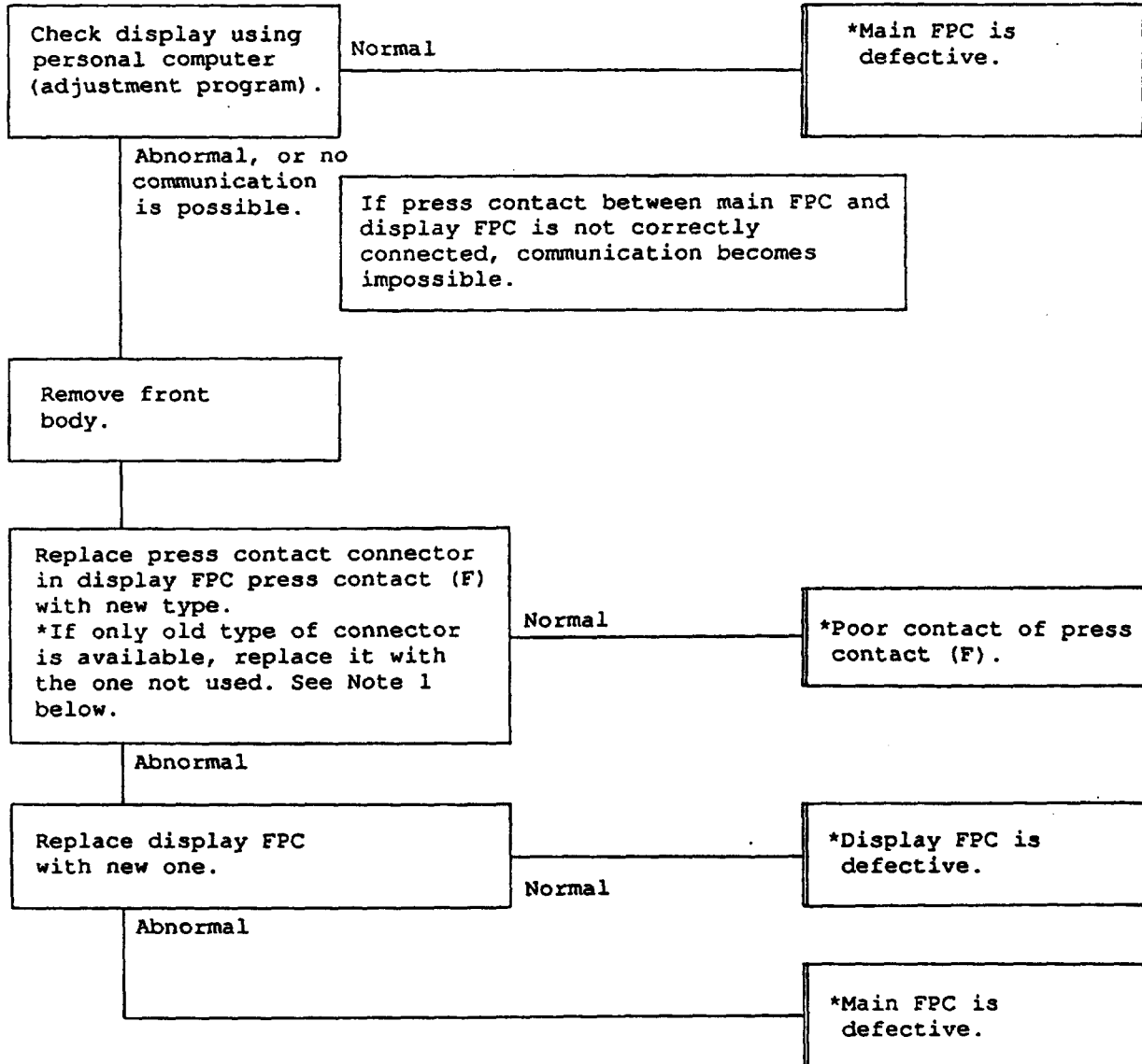

Note 1: Take special care for handling connector used in old type of display press contact for it is very sensitive. Replace old type of connector with new one as much as possible.

	Phenomenon	Cause
I-2	Malfunction of LED focus indicators. (No indicator appears, or indicators flicker.)	1. Poor contact of press contact (F) in display FPC. 2. Poor contact of AF connector. 3. AF base plate is defective. 4. Main FPC is defective.

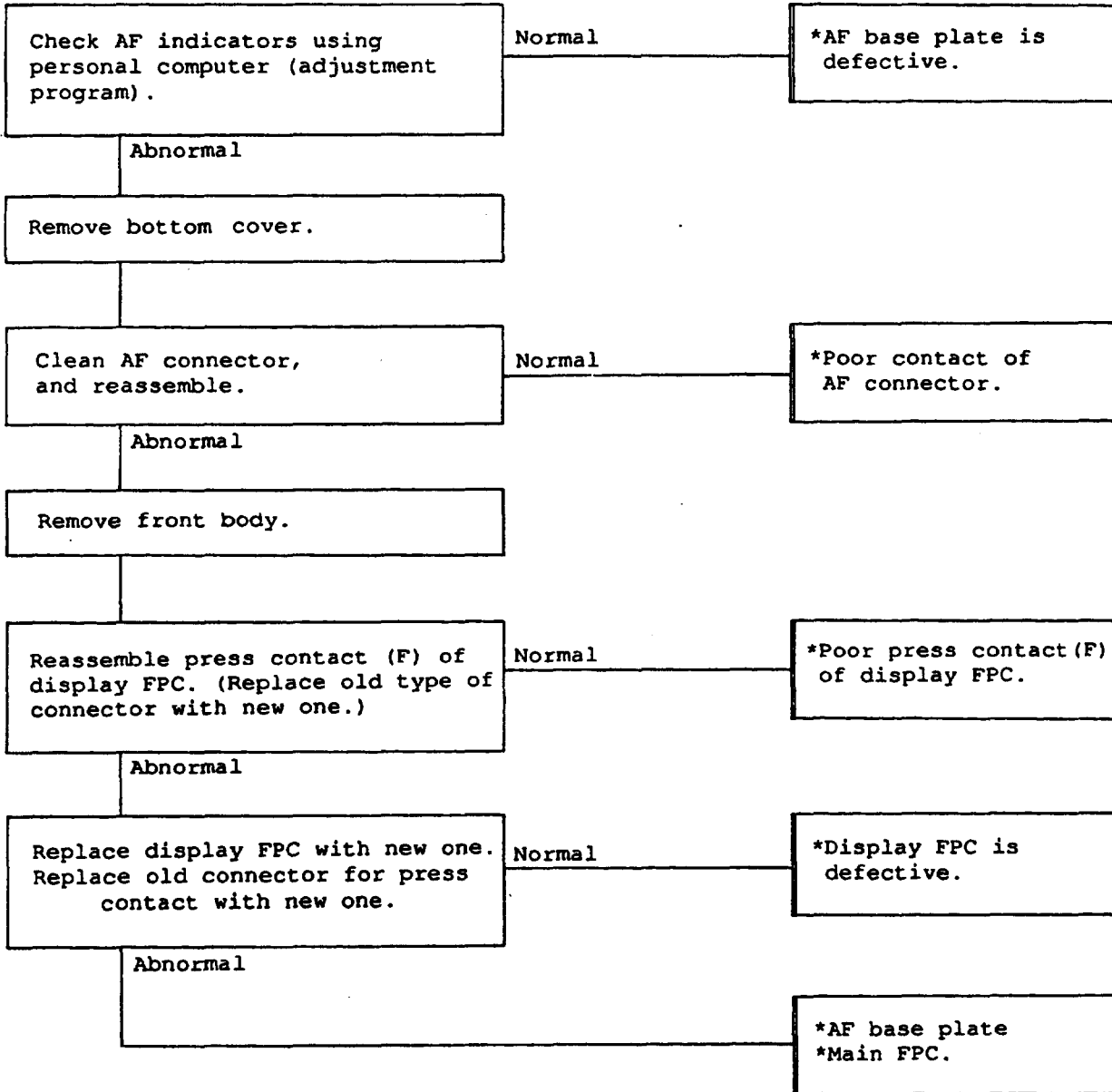

	Phenomenon	Cause
I-3	Malfunction of exposure compensation indicator (+/-). It does not light up. It remains lit It lights up but is unstable.	1. Poor contact of press contact (F). 2. Poor contact of press contact (D). 3. Shutter speed dial base plate is defective. 4. Display FPC is defective. 5. Main FPC is defective.

If LED lights up due to gap of exposure compensation dial at position 0, replace the dial.

Remove front body.

[Inspection of press contact (F)]
Replace old type of connector with new one. Clean press contact of new type of connector, and reassemble it.

Normal

*Poor contact of press contact (F).

Abnormal

Check display using personal computer (adjustment program). Is exposure compensation indicator (+/-) turned ON/OFF properly?

No

Replace display FPC and check the operation.

Normal

*Display FPC is defective.

Abnormal

*Main FPC is defective.

Yes

Clean press contact (D), check operation after reassembling.

Normal

*Poor press contact (D)

Abnormal

Does voltage vary from approx. 3.3V to 0V when land voltage inspection compensation dial in shutter speed dial (HOSEI) is rotated by +2 to -2?

No

*Shutter speed dial base plate is defective.

Yes

It varies.

*Poor press contact (D).

Does voltage vary from approx. 3.3V to 0V when land voltage inspection compensation dial in main FPC (HOSEI) is rotated by +2 to -2?

No

Clean press contact (D) again, and reassemble it.

It does not vary.

*Shutter dial is defective.
*Main FPC is defective.

It varies.

*Main FPC is defective.

I-4	List of trouble due to poor press contact between main FPC and display FPC. Conditions: Lens; AF50mm f/1.4, with no viewfinder, and illuminator switch being ON. Replace old type of press contact with new one as much as possible.
-----	--

Display at body side.  LCD display LED display *LCD display with no viewfinder mounted. *Illuminator *AF indicator *Exposure compensation display *Flash ready-light display	Name of land of press contact. 1: LCD, 3V 2: SB.STBY1 3: DISPLAY. OFF 4: LCD.RST 5: LC.I/O2 6: LCD.CLK2 7: LCD.I/O2 8: LCD.5V 9: LCD.GND	
---	---	--

Phenomenon when each land at press contact becomes disconnected (open).						
	LCD display	LED display	Illuminator	Shutter release	AF operation	Others
1: LCD.3V	Normal	No display appears.	Does not light up.	Normal	Normal	
2: SB.STBY1	Normal	Normal	Normal	Normal	Normal	Not applicable without viewfinder and flash.
3: DISPLAY OFF	Display does not go out when mirror moves up.	Display does not go out when mirror moves up.	Does not go out when mirror moves up.	Normal	Normal	
4: LCD.RST	No display appears.	No display appears.	Does not light up.	Normal	Normal	
5: LC.I/O2	No display appears.	No display appears.	Does not light up.	Normal	Normal	
6: LCD.CLK2	No display appears.	No display appears.	Does not light up.	Normal	Normal	
7: LCD.I/O2	Both LCD/LED and illuminator light up but unstable and flicker.			Normal	Normal	
8: LCD.5V	No display appears.	No display appears.	Does not light up.	Normal	Normal	
9: LCD.GND	No display appears.	No display appears.	Does not light up.	Normal	Normal	

*In case of short-circuit between each land of press contact and next land.						
	LCD display	LED display	Illuminator	Release	AF operation	Others
1: LCD.3V - SB.STBY1	Normal	Normal	Normal	Normal	Normal	Normal without viewfinder and flash.
2: SB.STBY1 - DISPLAY OFF	Normal prior to shutter release operation. After shutter release operation, mirror moves up and ready-light LED lights up.			Normal	Normal	
3: DISPLAY OFF - LCD.RST	Normal prior to shutter release operation. After shutter release operation, display and illuminator go out and shutter release operation become impossible.			Impossible	Normal	
4: LCD.RST - LC.I/02	No display appears.	No display appears.	Does not light up.	Impossible	Impossible	Power is applied and holds for 16 seconds.
5: LC.I/02 - LCD.CLK2	No display appears.	No display appears.	Does not light up.	Normal	Normal	
6: LCD.CLK2 - LCD.I/02	No display appears.	No display appears.	Does not light up.	Normal	Normal	
7: LCD.I/02 - LCD.5V	Both LCD and LED display light up. (All segments of LCD and LED light up.)			Normal	Normal	
8: LCD.5V - LCD.GND	No display appears.	No display appears.	Does not light up.	Impossible	Impossible	Current flows instantly when shutter prerelease switch is turned ON, but it does not hold for 16 seconds.

	Phenomenon	Cause
L-1	Flash does not fire when using sync terminal.	<ol style="list-style-type: none"> 1. Shutter (sync contact) is defective. 2. Poor press contact (C). 3. Triac base plate is defective. 4. Main FPC is defective.

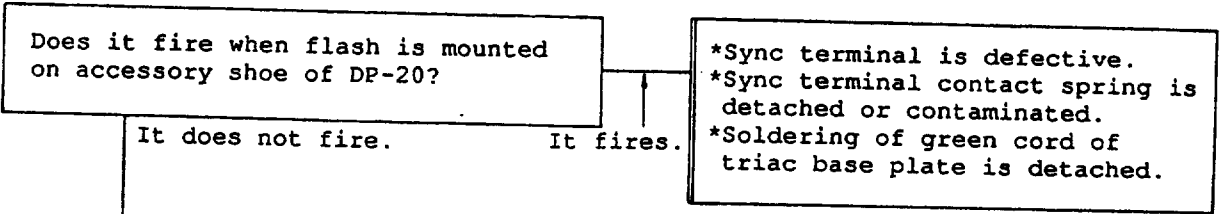

Remove front cover.

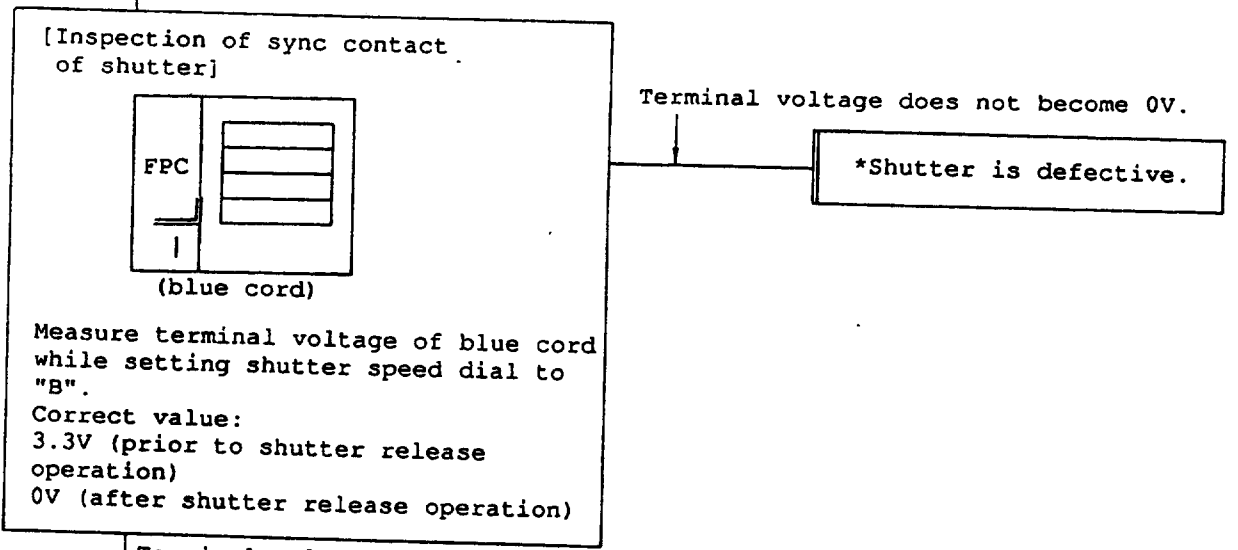

Terminal voltage becomes 0V after shutter release operation.

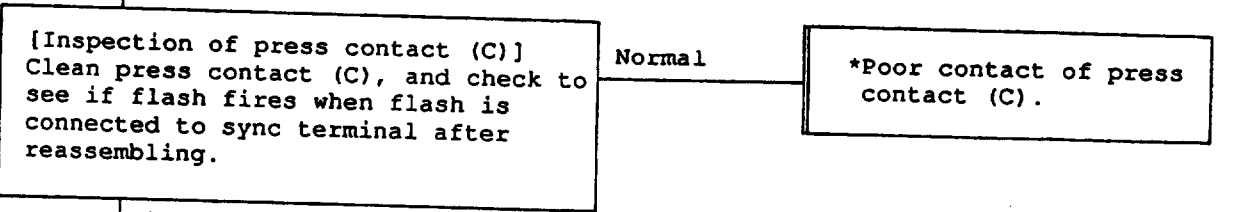

Abnormal

a

a

[Inspection of triac base plate] Check to see if flash fires when yellow cord from triac base plate is short-circuited to 3.3V power line after connecting flash to sync terminal.

It does not fire.

*Triac base plate is defective.

It fires.

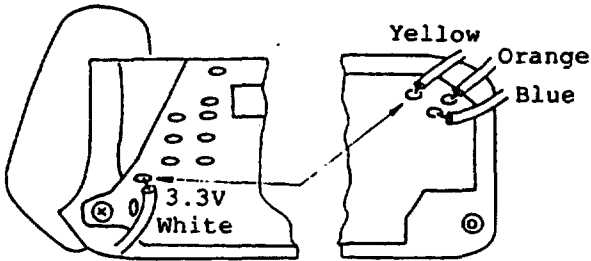
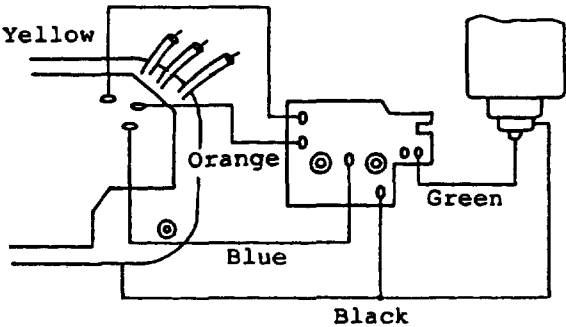

Fig. 1-1-1

*Main FPC is defective.

[Inspection of triac base plate] can be performed by attaching triac base plate (correct parts) externally as shown in the figure below and check flash firing.



Make sure that there are old and new combinations in main FPC and triac base plate. Refer to Technical Information bulletin (Ref. No.: F4-890026).	
If you mounted old and new combinations reversely (without making any corrective measures), the following trouble occurs.	
1. Old FPC + New triac base pate	2. New FPC + Old triac base plate
Current flow display (250mA) does not appear when shutter prerelease switch is turned ON. Shutter can not be released.	Rear curtain sync flash even in T (time) mode (with SB-24 mounted.)

Z-1	List of trouble due to disconnection of each pin of 24-pin AF connector. Conditions: DP-20 and AF50 F/1.4 lens are mounted.
-----	---

No.	Land name	Phenomenon
1.	AF-GND:	*No trouble can be found.
2.	AF-ASV:	*In AF-S and M modes, exposure and AF indicators do not appear. Shutter release operation is impossible. *All are in "A" mode except AF-C and exposure mode "M". AF indicator does not appear. Shutter release operation is possible. *AF filter change over operation is repeated slowly for 16 seconds after auto film loading.
3.	AF-ABLE:	*In AF-M mode and focus aid operations are possible. Shutter can be released. *In AF-S and C modes, lens vibrates slightly and goes in focus. Shutter release operation is possible. *AF filter change over operation is done little by little and stops. *Exposure display is normal.
4.	RLS-ABLE:	*In AF-M mode, focus aid and shutter release operations are possible. *In AF-S mode, Shutter can be released even when subject is not in focus. (Sometimes shutter can not be released.) *AF-C mode is normal.
5.	AF-RESET:	*Exposure display is normal. *All are in "A" mode except exposure mode "M". *Auto film loading is impossible, shutter cannot be released. (Shutter can be released when film is not loaded.) (During shooting, shutter release and film rewind operations become impossible.)
6.	AF-R.SW Sig:	*No trouble can be found.
7.	AF-H.Sing:	*In AF-M mode, focus aid and shutter release operations are possible. *In AF-S mode, no AF indicator appears and shutter release operation is impossible. *In AF-C mode, no AF indicator appears and shutter release operation is possible. (Either one of focus indicators lights up during shutter release operation.)
8.	AF.R.Sig:	*No trouble can be found.
9.	FD-1:	*AF filter change over operation does not work after auto film loading. *Others are in normal.
10.	AF-D.GND:	No trouble can be found.
	L.E.A.:	*All are in "A" mode except exposure mode "M". *AF indicator does not appear. *In AF-M mode, shutter release operation are not possible. *In AF-S, C mode, shutter release operation are possible. *No auto film loading is possible.
12.	FD.O:	*After auto film loading, film rewind motor rotation does not stop.
13.	CTL3:	*AF indicator does not appear. *Lens does not operate. *All are in "A" mode except exposure mode "M". *Auto film loading is impossible. *Shutter cannot be released. (Shutter can be released when film is not loaded.)

14.	FILTER:	*No trouble can be found.
15.	LD:	*No trouble can be found.
16.	AF-DSV:	*No trouble can be found.
17.	DC:	*All are in "A" mode except exposure mode "M". (Others are in normal.)
18.	AF-3V:	*In AF-M mode, focus aid and shutter release operation are possible. *In AF-S, C modes, hunting occurs at in focus position. (Sometimes shutter release operation is possible.) *Volume of scanning is insufficient.
19.	AF-12V:	*AF indicator remains to show "X" and does not change. *In AF-M mode, shutter can be released. *In AF-S mode, shutter cannot be released. *In AF-C mode, there is time lag from shutter release switch is ON until shutter is released. Shutter cannot be released by pressing shutter release button slightly.
20.	AF-CLK:	*AF indicator does not appear. *Lens does not operate. *Shutter can be released. *All are in "A" mode except exposure mode "M". *Film is loaded, auto film loading is impossible. Shutter cannot be released. (During shooting, above phenomenon occurs and film rewind becomes impossible.)
21.	CTL1:	*All are in "A" mode except exposure model "M". *No other trouble can be found.
22.	AF-1/O:	*AF indicator does not appear. *Lens does not operate. Shutter can be released. All are in "A" mode except exposure mode "M". *Film is loaded, auto film loading is impossible. Shutter can be released.
23.	CTL2:	*No trouble can be found.
24.	(NC):	

- * When either one of following pins is disconnected, the trouble can be detected through communication inspection to front body.
Pin 2, 5, 13, 20, or 22
- * In AF connector at AF base plate side in some of the initially produced bodies, double coated adhesive tape has been used as an adhesive agent. In this body, the connector may become disconnected because the tape protrudes out of the connector. Fully clean the connector using alcohol, and insert in the 24-pin connector at main FPC side.
If double coated adhesive tape is found in 24-pin connector at main FPC side, replace the 24-pin connector.

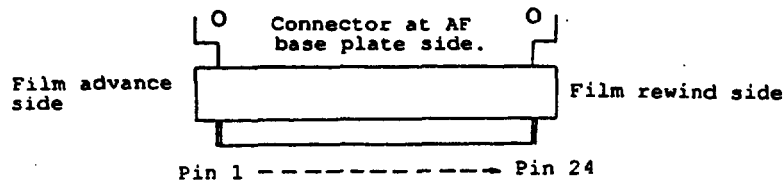

Z-2	List of trouble due to disconnection of cords around film advance base plate.
1.	Charging switch (gray cord) remains ON or short-circuit to body.
Phenomenon	It performs continuous mechanical charging when shutter release button is pressed lightly.
2.	Charging switch is disconnected or not turned ON.
Phenomenon	Camera back opened: It performs continuous mechanical charging when shutter is released. Camera back closed: Mirror does not move smoothly during mirror moving up, and sequence error display appears after mirror moves down.
3.	Film advance completion switch (white cord) remains ON or short-circuit to body.
Phenomenon	External alert LED lights up when shutter release button is pressed lightly.
4.	Film advance completion switch is disconnected or is not turned ON.
Phenomenon	[Film loaded]: Spool motor does not rotate. (Auto film loading is impossible.) In mechanical charging only, blank exposures are repeated.
5.	Mechanical charging switch (gray cord) and P.I cord (pink cord) are short-circuited.
Phenomenon 1	[Film not loaded, or camera back opened or closed]: (1) Mechanical charging is performed little by little when shutter is released. (2) Spool motor does not rotate.
Phenomenon 2	[Film loaded]: (1) Auto film loading is impossible, spool motor alone rotates and advances film when shutter release button is pressed lightly, alert LED lights up at end of roll and spool motor stops. (2) Auto film rewinding is impossible.
6.	Either one of P.I cords (green, blue, pink) is detached. Either one of P.I cords (green, blue, pink) is short-circuited to each other. Either one of P.I cords (green, blue, pink) is short-circuited to GND.
Phenomenon	Cs mode becomes CH mode. Other operations are normal.

2-3	List of trouble due to poor soldering between main FPC and nine soldered portions of DB/FD/DX FPCs. Conditions: DP-20, SB-24, and AF zoom lens are mounted.
-----	--

List of trouble when each land of nine soldered bridges is disconnected (open).				
Inspection items	Body side	Viewfinder side	Flash side	Other
		LCD/LED display Display illuminator Shutter release AF operation Shutter speed	LCD display Display illuminator	Communication (zoom, aperture, film speed) Firing Light output measurement
<p>Check the cause of trouble carefully before starting repair procedures because the cause of trouble may be found in body, viewfinder, or flash.</p> <p>*List of trouble was made after having made inspection of each item of above items.</p> <p>*No description was made for the items in which no trouble was found. (Blank)</p> <p>("No trouble can be found" does not mean that operation is normal.)</p> <p>For example, no communication is made between body and flash in the list of trouble, you can confirm it by checking that LCD panel of flash (SB-24) does not change when operating film speed dial in body, zooming lens, or controlling aperture.</p>				

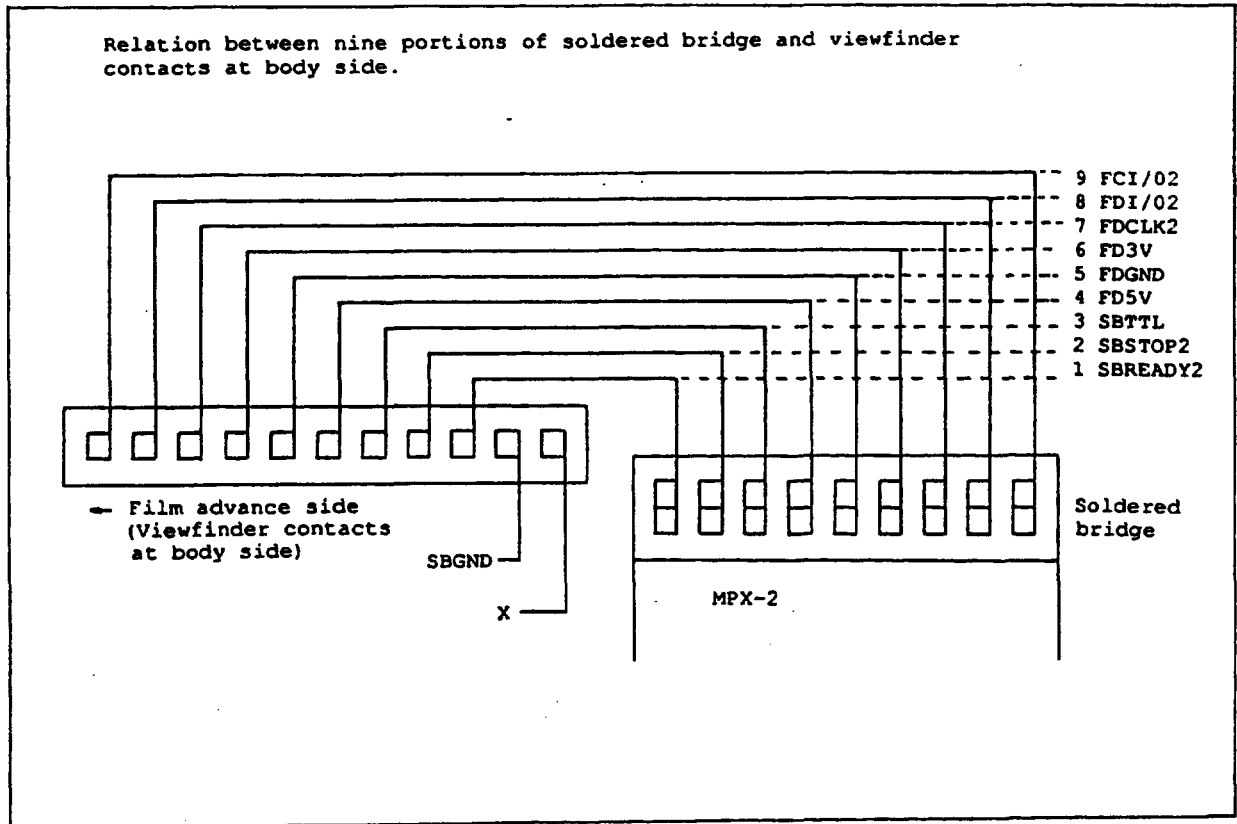

Land name	Phenomenon at body side	Phenomenon at viewfinder side	Phenomenon at flash side
SB READY2	Flash ready-light does not light up. Does not change over to sync shutter speed		No communication between flash and body.
SB STOP2			No communication between flash and body. Flash fires fully in TTL mode.
SB TTL			No communication between flash and body. TTL-BL is impossible.
FD 5V	Flash ready-light does not light up. Does not change over to sync shutter speed.	No display appears.	No communication between flash and body. Flash fires fully in TTL mode.
FD GND		No display appears.	
FD 3V	Shutter cannot be released. No LCD display appears. Illuminator does not light up. AF indicators and operation are normal.	No display appears. Illuminator does not light up.	No communication between flash and body.
FD CLK	LCD display is stable. FD detection indicators appear alternately.	No display appears. Illuminator does not light up.	
FD I/O		Metering mode does not change over.	
FC I/O		No display appears. Illuminator does not light up.	