

HASSELBLAD 201F

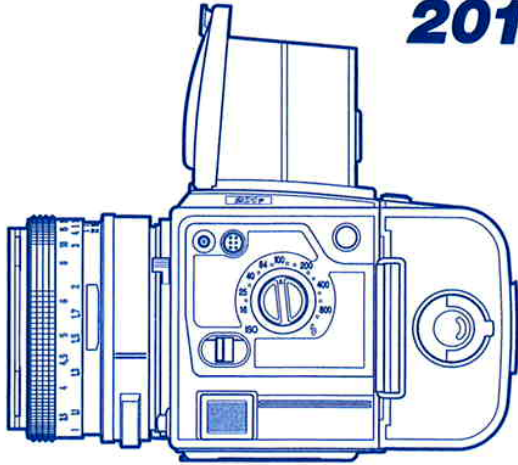

INSTRUCTION MANUAL

Hasselblad 201F Instruction Manual Contents

| | |
|--|---|
| 3 Hasselblad 201F Introduction | 16 The Right Hand Side |
| 4 Parts and Components | 16 Double Exposure |
| 6 Getting Started | 16 Mirror and Mechanism Pre-release |
| 6 Battery | 17 The Selftimer |
| 6 Cocking the Camera | 17 The Grip Cushion |
| 6 Front Protective Cover | 18 The Front |
| 6 Attaching the Lens | 18 The Shutter Speed Ring |
| 7 Removing the Lens | 18 Battery Check |
| 8 Rear Protective Cover | 19 Exposure Release Button |
| 8 Attaching the Magazine | 19 Cable Release |
| 9 Removing the Magazine | 19 Lens Catch |
| 9 The Magazine Status Indicator | 20 Rear Side & Focal Plane Shutter |
| 10 The Winding Crank | 21 The Bottom |
| 10 Removing the Winding Crank | 21 The Top |
| 10 Attaching the Winding Crank | 22 The Viewfinder System |
| 11 Strap and Strap Lugs | 22 Changing Focusing Hood/Viewfinder |
| 11 Attaching the Strap | 22 Changing the Magnifier |
| 11 Removing the strap | 23 Changing the Focusing Screen |
| 12 Focusing Hood and Magnifier | 24 Meter Prism Viewfinder Adjustments |
| 12 Opening the Focusing Hood | 26 The Left Hand Side |
| 12 The Built-in Magnifier | 26 The Film Speed Selector Dial |
| 12 Closing the Focusing Hood | 26 The Shutter Speed Ring Lock |
| 13 Focusing Screen and Viewfinder Image | 26 The Flash Connectors |
| 13 The Control Panel | 27 Lenses |
| 14 Flash Connectors | 27 FE Lenses |
| 14 The PC-socket | 28 FE Lens Functions |
| 14 The TTL Connector | 28 Setting the Aperture |
| 14 The Film Speed Selector Dial | 28 Focusing and Depth-of-field |
| 14 The Shutter Speed Ring Lock | 29 Depth-of-field Preview |
| 15 Left Hand Grip | 30 Infrared (IR) Photography |
| 15 Focusing and Exposure Release | 30 Exposure Value (EV) |
| 16 Operating Details | 31 Interlocked Shutter Speed/Aperture |
| | 31 Other Hasselblad Lenses |

Contents 1

32 Magazine Operation

- 32 Loading the Magazine
- 34 Magazine Load Status
- 34 Removing the Film
- 34 Film Tab Holder
- 34 Film Plane Index
- 35** Flash Photography
- 35 Automatic Flash Control
- 36 Viewfinder Signal
- 36 Ready Signal
- 36 Confirmation Signal
- 36 No Signal
- 36 Setting the Film Speed
- 37** How to use the Dedicated Flash
- 37 Flash in TTL-mode
- 39 Flash in other mode than TTL
- 39 Non-dedicated Flash Units
- 40** 210F with other Hasselblad Lenses
- 40 Flash photography with F-lenses
- 40 Dedicated Flash Unit
- 40 How to use the Dedicated Flash
- 40 Non-dedicated Flash Unit
- 41** Accessories
- 41 Accessory Mounts
- 41 Major Accessories
- 41 Winder
- 41 Viewfinders
- 42** Hasselblad 201F System Chart
- 44** Technical Specifications
- 46** Troubleshooting
- 48** Camera Body Dimensions
- 49** Camera Care, Service & Guarantee
- 50** APPENDIX A
- 50** Hasselblad 201F with CF- and C-lenses

- 50 CF-lenses
- 50 CF-lens design and functions
- 51 EV Interlock Button
- 51 Depth-of-field Preview Button
- 51 F-setting
- 52** How to use the CF-lens
- 53** Flash photography with CF-lens
- 53 Lens in F mode
- 53 Dedicated & Non-dedicated Flash Units
- 53 Lens in C mode
- 54 Dedicated Flash Unit
- 55 Non-dedicated Flash Units
- 56** C-lenses
- 57** Flash photography with the C-lens

Service and Maintenance

Although Hasselblad products are exceptionally reliable and durable, continuous and extensive professional use will require maintenance and overhaul at regular intervals at an authorized Hasselblad Service Center. Read more about maintenance and service on page 49!

Warranty

Provided that you purchased your equipment from an authorized Hasselblad dealer or distributor it is covered by an international warranty for one year from the date of delivery. Read more about the warranty on page 49!

Hasselblad 201F – Fast and Flexible

The Hasselblad 201F gives you access to the entire Hasselblad system of interchangeable photographic equipment, the world's major medium format camera system. The full range of highest quality lenses with focal lengths from 30mm to 500mm – and double that with the 2x converter; viewfinders with different angles of view, with or without light metering system; a number of focusing screens for all kinds of applications; film magazines for different film types and image formats and a host of other accessories.

The 1/1000s focal plane shutter lets you use the powerful FE-type* lenses, but it also has a setting for the CF-type lenses, which have a built-in leaf shutter for full flash synchronization at all speeds up to 1/500s.

And above all the Hasselblad 201F also provides a built-in TTL/OTF dedicated flash sensor system. If you are using the Hasselblad Profash 4504 you simply connect it to the camera, enter the film speed with the film speed dial, point and shoot. Other dedicated flash units will require an adapter, such as the Hasselblad SCA 390 or SCA 590 adapters, also available within the Hasselblad system, between the flash and the 201F.

The Hasselblad system, that has been taken to the ends of the earth and beyond – into deep space, carries the name of the man

who first envisioned it to satisfy his own exacting standards and diverse requirements: Dr. Victor Hasselblad, himself an accomplished photographer.

Being a photographer first and businessman second he would never sacrifice quality for ease of production. To this day Hasselblad products are painstakingly crafted with this principle in mind, forming a range of equipment for maximum of flexibility and optimum of photography in any application.

Lenses

Since the early 1950's Hasselblad lenses – with few exceptions only – have been manufactured to the highest quality requirements by Carl Zeiss in Germany. All Hasselblad lenses manufactured since 1957 can be used with the 201F.

This Instruction Manual describes in detail how to operate the Hasselblad 201F. Read it carefully to avoid mistakes and to get access to the Hasselblad potential. Exploiting that potential is limited by your own imagination only!

*) Former designation: F/TCC

Introduction 3

2 Contents

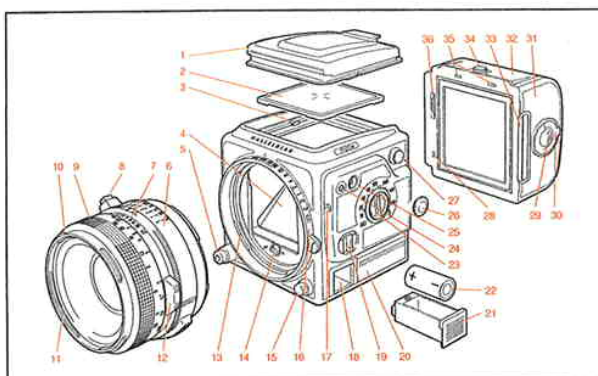

201F Parts and Components

- | | | |
|-------------------------------------|------------------------------|----------------------------------|
| 1 Focusing hood | 13 Lens mount | 25 TTL Dedicated flash connector |
| 2 Acute-Matte* focusing screen | 14 Drive shaft | 26 TTL flash connector cover |
| 3 Focusing screen catch | 15 Lens catch button | 27 Strap lug |
| 4 Viewfinder mirror | 16 Shutter speed ring | 28 Indicator trigger slot |
| 5 Shutter release button | 17 Selftimer indicator light | 29 Film load indicator |
| 6 Aperture ring | 18 Battery compartment | 30 Film holder key |
| 7 Depth-of-field scale | 19 Shutter speed ring lock | 31 Film holder |
| 8 Shutter/aperture interlock button | 20 Grip cushion | 32 Film magazine |
| 9 Focusing ring | 21 Battery cassette | 33 Magazine slide |
| 10 Lens front bayonet, extensor | 22 Battery | 34 Film magazine catch |
| 11 Lens front bayonet, mirror | 23 Film speed selector dial | 35 Magazine hook slot |
| 12 Depth-of-field preview knob | 24 PC flash socket | 36 Magazine gear |

* Acute Matte designed by MINOLTA

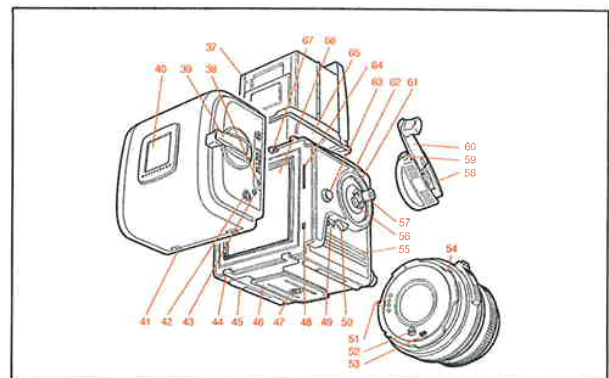

- | | | |
|------------------------------|------------------------------------|--------------------------|
| 37 Focusing hood | 48 Magazine indicator trigger | 59 Winding crank catch |
| 38 Film plane indication | 49 Selftimer indication | 60 Winding crank |
| 39 Film winding crank | 50 Mirror release/selftimer button | 61 Winder bayonet mount |
| 40 Film tab holder | 51 TCC connectors | 62 Winding crank index |
| 41 Magazine support slot | 52 Lens drive shaft | 63 Strap lug |
| 42 Frame counter | 53 Lens drive shaft catch | 64 Magazine driving gear |
| 43 Magazine status indicator | 54 Lens bayonet plate | 65 Magnifier |
| 44 Magazine support | 55 Grip cushion | 66 Shutter curtain |
| 45 Camera support | 56 Winder coupling | 67 Magazine hooks |
| 46 Quick coupling slide | 57 Double exposure button | |
| 47 Tripod thread 1/4" | 58 Winding crank hub | |

NOTE: The positions of components are described in the text in relation to the camera as you see it when taking a photograph, i.e. the lens is on the front, the viewfinder is on the top, the winding crank is on the right hand side, and the control panel is on the left hand side.

4 Parts and Components

Parts and Components 5

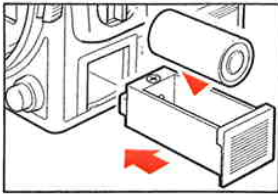

Getting Started

This section describes how you prepare your Hasselblad 201F for use. You will find comprehensive detail information how to operate the camera in the section starting on page 16. Follow the instructions step by step to avoid jamming or damaging the equipment. Always keep the rear protective cover on to protect the shutter curtain when the magazine is detached!

Battery

The battery compartment and cassette is located in the lower forward corner on the left hand side of the camera body. Pull out the cassette and install the battery – 6V type PX28 (UCAR 537) – according to the marking on the cassette. Push the cassette all the way back into the compartment.

Cocking the Camera

Cock the camera after installing the battery. Fold out the winding crank on the right hand side, press the button in the center of the crank and rotate it clockwise one turn until it locks (Cf. page 16, Double exposure).

Front Protective Cover

The front protective cover is attached to a bayonet mount. Rotate it as indicated by the arrow in the illustration and lift it out of the mount.

Attaching the Lens

Remove the lens' rear protective cover by rotating it clockwise and lifting it off the lens. Check that both the camera and the lens are

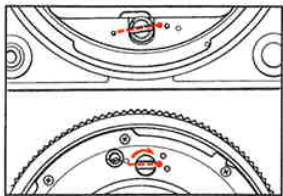
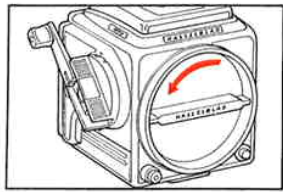

6 Getting started

cocked. The lower illustration on page 6 shows the proper position of the drive shafts against the index marks for the camera drive shaft (top) and the lens drive shaft (bottom). You will find that holding the camera body in your left hand and the lens in your right hand as shown in the illustration is the easiest way to attach the lens.

When you have aligned the red index on the lens bayonet with that on the camera body as shown in the illustration, the lens will fit easily into the bayonet mount. You can then rotate it clockwise until it stops with a faint click as the lens catch locks it in place.

Removing the Lens

Depress the lens catch button, rotate the lens counter-clockwise and lift it out of the bayonet mount.

NOTE: You can only attach and remove the lens when the camera is cocked (fully wound) and not in pre-released mode (see page 16).

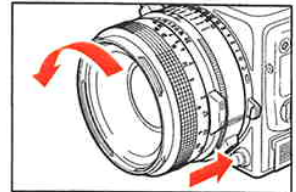
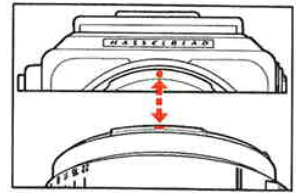
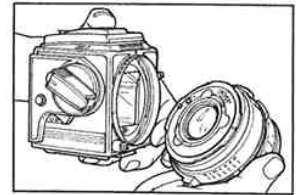

Getting started 7

Rear Protective Cover

Depress the catch, tilt the cover backwards and lift it off.

Always attach the rear protective cover to protect the shutter curtain when you detach the magazine!

Attaching the Magazine

Ensure that the magazine slide is fully inserted and that the magazine status indicator is white. If the indicator is red, then follow the instructions on page 9. Rest the magazine on the magazine supports with the support lugs properly engaging the recesses in the magazine bottom. Carefully swing the magazine towards the camera body, checking that the magazine hooks fit into the slots in the magazine. Push the magazine gently but firmly against the hooks while sliding the magazine catch to the right.

Release the button when the magazine makes contact with the camera body and then push the button to the left to ensure that it has reached the locked position. Remove the slide to positively lock the magazine to the camera body.

Removing the Magazine

It is advisable to have the camera fully wound and the magazine status indicator showing white. If the indicator shows red, then follow the instructions below.

Insert the magazine slide fully and with the hinge towards the front of the camera. Slide the magazine catch to the right, tilt the magazine back and lift it off the supports.

NOTE: The magazine cannot be removed without inserting the magazine slide. The camera cannot be operated when a magazine with the slide inserted is attached to the camera.

The Magazine Status Indicator

The status indicator on the right hand side of the magazine shows **white** when the magazine is ready to operate and **red** when the film has not been advanced after the exposure. Do not attach a magazine showing white to a camera that is not rewound! Wind the camera first or you will lose one frame. Do not attach a magazine showing red to a fully wound camera! That could result in a double exposure. If the status indicator shows red, release the camera (page 15) before attaching the magazine. Then, winding the camera advances the film one frame.

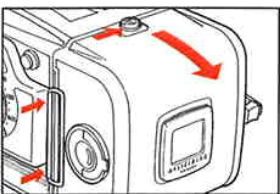
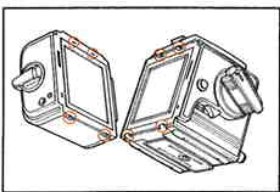
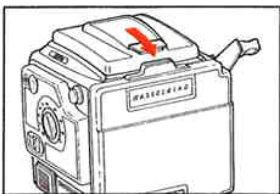

8 Getting started

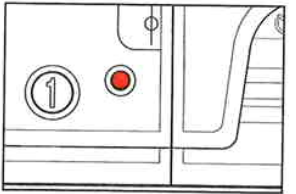
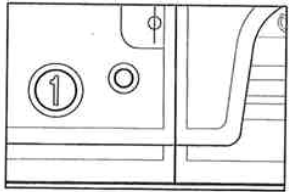
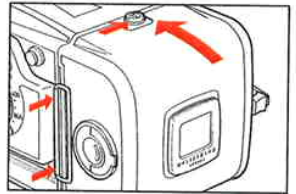

Getting started 9

The Winding Crank

One full revolution of the winding crank cocks the camera and lens mechanisms and advances the film to the next frame.

Undereath the crank are the drive shaft and the bayonet mount for the Hasselblad Winder (page 41), which can be attached after removing the crank. It is recommended that the camera is fully wound when the crank is removed or replaced.

Removing the Winding Crank

To remove the crank, push the catch lever on the rear of the crank hub downwards while rotating the crank counter-clockwise. Then pull it straight out from the shaft.

Attaching the Winding Crank

On the side of the crank hub are one large and one small triangular index mark. Attach the crank to the shaft with the smaller mark aligned with the red dot located immediately above the mount.

While pushing the crank against the camera body rotate it clockwise until the larger mark is aligned with the red dot.

Strap and Strap Lugs

The 201F is delivered with a medium wide shoulder strap, which is packed separately. You will find other types of straps in the Hasselblad Product Catalog. All straps have special clips for easy attaching them to and removing them from the camera body.

Attaching the Strap

Place the main body of the strap clip over the strap lug on the camera (see figure). Press the tip of the clip towards the camera while pulling the strap to slide the clip over the lug to the locked position.

Removing the strap

Lift the locking plate of the clip high enough to let it pass over the top of the lug. Push the clip in the direction opposite to the strap to slide it off the lug.

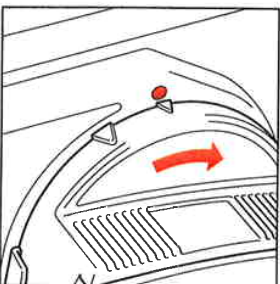
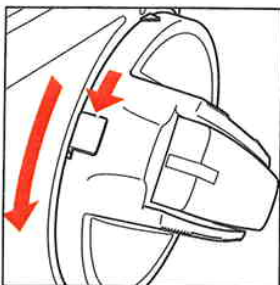

10 Getting started

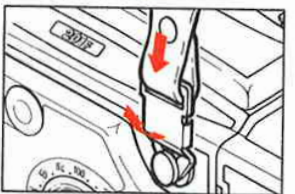
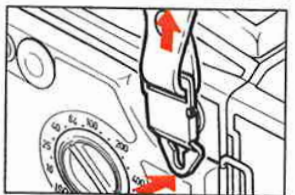
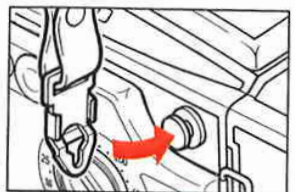

Getting started 11

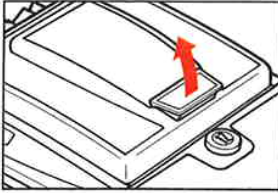

Focusing Hood and Magnifier

Opening the Focusing Hood

Lift the lid with a firm grip on the tab at its rear edge and swing it up to a vertical position. The hood unfolds automatically and locks in open position.

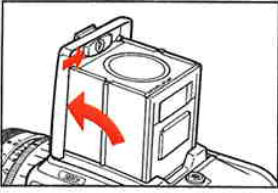

The Built-in Magnifier

Use the built-in 4.5x magnifier to enlarge the viewfinder image, e.g. for more accurate focusing. To unfold it, push the oval catch inside the lid to the right, as indicated in the illustration.

To fold the magnifier down, simply push it back towards the lid until it locks.

The magnifier can easily be exchanged for one with a suitable correction lens to match your individual eyesight (see page 22).

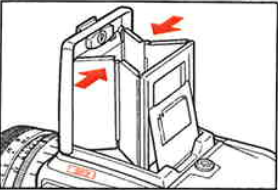

Closing the Focusing Hood

"Pinch" the side plates at the hinge points and fold the hood back down.

12 Getting started

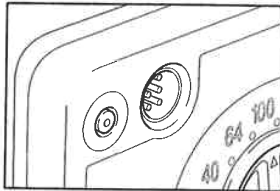

Flash Connectors

The flash connectors are located in the upper forward corner of the control panel. The smaller one is a standard PC-socket and the larger one with a protective cover is a 6-pin TTL connector for dedicated flash units.

The PC-socket

Non-dedicated flash units and certain adapters should be connected to this socket.

The TTL Connector

A dedicated flash unit connected to this 6-pin outlet directly or through a suitable adapter will be fully controlled by the flash control circuit in the camera.

You will find further information on flash photography on pages 33-37, 38, 51-53, 55.

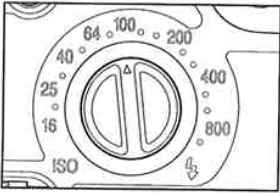

The Film Speed Selector Dial

Use the film speed selector dial to set the actual film speed for the dedicated flash control function.

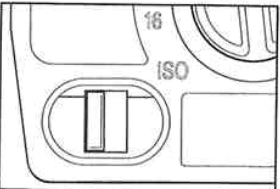

The Shutter Speed Ring Lock

Push the locking button forwards to lock the shutter speed ring at any marked or intermediate click stop setting. Pull it backwards to release the ring for a change of setting.

14 Getting started

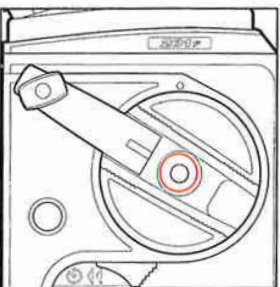

Operating Details

The Right Hand Side

On the right hand side of the camera body are the winding crank (see page 10) and the combined pre-release and selftimer button.

Double Exposure

You can make double (or multiple) exposures by rewinding the camera without advancing the film. This is possible by depressing the double exposure button in the center of the crank hub and slightly turning the crank clockwise at the same time. You can then release the button and complete the winding until the crank locks.

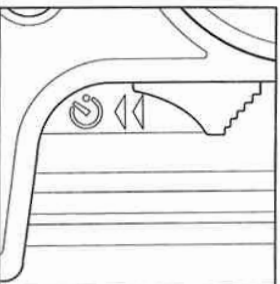

Mirror and Mechanism Pre-release

The viewfinder mirror shows the entire image without vignetting. By pre-releasing certain camera functions and lifting up the mirror you can avoid camera vibrations, reduce the sound level and shorten the time delay between the exposure button actuation and the exposure. This is done by pressing the pre-release button once. To reset the mechanism and lower the mirror again you simply perform the operation for a double exposure as described above.

16 The Right Hand Side

Focusing Screen and Viewfinder Image

The Hasselblad 201F is equipped with the Acute-Matte focusing screen featuring superior brightness and the highest resolution among the Hasselblad focusing screens. The center of the screen is indicated by a hairline cross.

See page 23 on how to change the focusing screen.

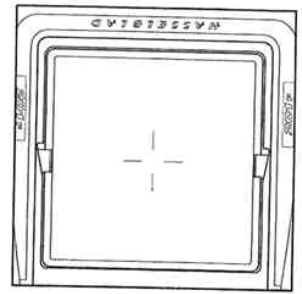

The Control Panel

The control panel occupies a major part of the left hand side of the camera body. It includes the controls for certain functions of the 201F, such as:

- The Flash Connectors
- The Film Speed Selector Dial
- The Shutter Speed Ring Lock
- The Selftimer Indicator Light

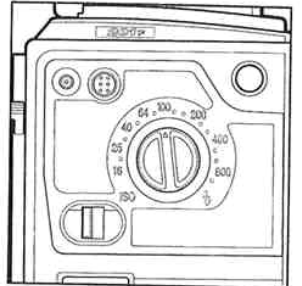

Getting started 13

Left Hand Grip

Holding the 201F in your left hand, as shown in the illustration, is the most convenient grip. You can reach the exposure release button with your index finger and the shutter speed ring lock with your thumb. Your right hand is free for focusing, setting the aperture, operating the crank or for changing lens or magazine.

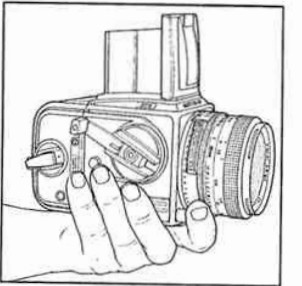

Focusing and Exposure Release

Turn the focusing ring (page 28) until the image of the subject appears sharp in the viewfinder. Depress the exposure release button to release the shutter.

After releasing the exposure button you can rotate the winding crank one full turn until it locks to rewind the camera, cock the shutter and advance the film one frame.

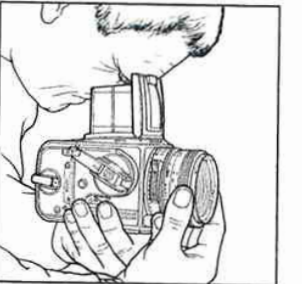

Getting started 15

The Selftimer

Pressing the pre-release button a second time starts the selftimer function. This is indicated by a flashing red light on the camera body to the left of the lens mount. The standard selftimer delay is 10 s.

Pressing the selftimer button a third time reduces the selftimer delay to 2 s, which is very useful to avoid blur due to camera vibrations, especially at slow shutter speeds. At the beginning the light flashes twice per second, but when two seconds remain of the delay time or after the third pressing of the button it increases to four times per second and changes to a continuous light the last half second. You can interrupt the selftimer function at any time by pressing the pre-release button a fourth time or by a "blind" rewind as for a double exposure.

The selftimer function is inoperative when the shutter speed ring is set in positions B or C (page 18).

The Grip Cushion

A rubber cushion along the lower edge of the right hand side provides a safe and comfortable grip.

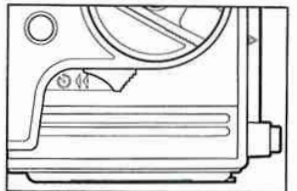
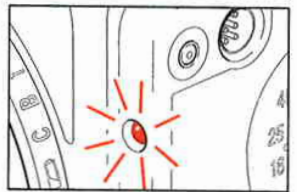
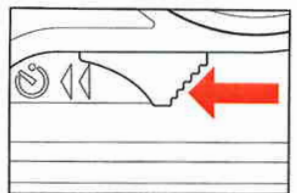

The Right Hand Side 17

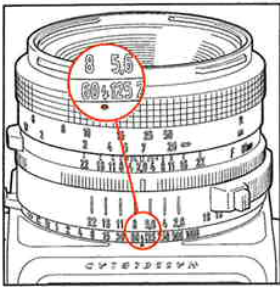

The Front

The Shutter Speed Ring

The shutter speed ring controlling the focal plane shutter in the 201F has click stop settings with marked speeds from 1 s to 1/1000 s as well as **B**, **C**, and a battery check symbol. Between the marked settings are click stops for intermediate speeds. One of these settings is marked with a flash symbol for 1/90 s, which is the fastest shutter speed for electronic flash synchronisation with the focal plane shutter (page 20). The setting marked **C** is used together with CF and C lenses only (Appendix A, pages 48-55).

NOTE: If you require a shutter speed slower than 1 s you have to set the speed ring at **B** and measure the exposure time yourself.

Battery Check

The battery check is actuated by turning the shutter speed ring beyond the **C** to the spring-loaded non-locking end position at the battery symbol. An acceptable battery power level is then indicated in the viewfinder by the same red light as for the flash indications (page 36). The light remains on as long as the shutter speed ring is kept in the check position. Conserve battery power by avoiding excessive use of the battery check function.

If the indicator light already is on to indicate a connected dedicated flash, the light intensity increases when the battery check function is activated.

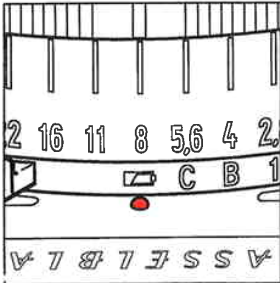

18 The Front

Exposure Release Button

The exposure release button is located in the lower right hand corner of the front, within comfortable reach of the left hand index finger when the "left hand grip" is applied (page 15). Pressing the button triggers the exposure cycle:

1. The mirror folds up and darkens the viewfinder.
2. The lens diaphragm closes down to the preselected f-stop.
3. The shutter curtains travel across the image opening in the rear of the camera body to expose the film.
4. The mirror folds down again to restore the viewfinder image.
5. The rewind crank is released.

NOTE: The exposure button is locked when the magazine slide is in the magazine.

Cable Release

When using shutter speeds slower than 1/30 s you are recommended to mount the camera on a tripod and use a cable release, attached to the threaded mount in the center of the exposure release button. The cable release and the exposure button have identical functions.

Lens Catch

In the lower left hand corner of the front is the lens catch button. To remove the lens you have to keep the button depressed while rotating the lens clockwise as seen from behind.

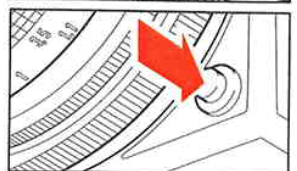
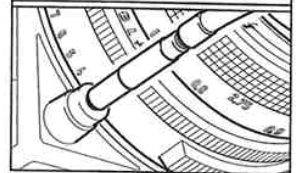
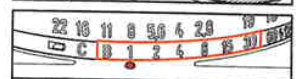
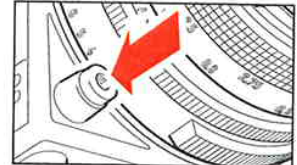

The Front 19

The Rear of the Camera and the Focal Plane Shutter

Avoid leaving the rear of the camera and the shutter curtains unprotected! Attach the rear protective cover whenever the magazine is detached!

The opening in the rear of the camera is normally covered by the shutter curtain. The 201F has a mechanically powered but electronically controlled focal plane shutter with two textile curtains running from left to right across the opening. The running time for the curtains is 1/90 s, i.e. at that and all slower speeds the entire image area is open during the exposure.

Caution: Whether the shutter is cocked or released, one of the shutter curtains is always exposed in the opening. When the rear of the camera is not covered by a magazine or a protective cover great care should be taken when handling it. The curtains are very sensitive to damage.

Do not touch the curtains!

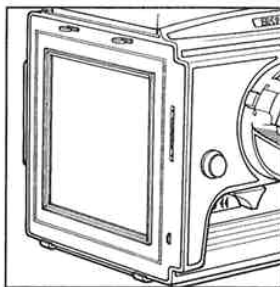

20 The Rear & The Shutter

To the right of the shutter opening are the magazine driving gear and the trigger for the magazine status indicator (page 9). At the bottom edge of the rear of the camera are the magazine supports and close to the top are the magazine hooks – the means serving to hold the magazine to the camera body (page 8).

The Bottom

At the bottom of the camera are the quick coupling plate, the tripod thread and two ridges, supporting the camera when placed on a flat surface. The quick coupling plate fits the Hasselblad accessories, such as the tripod quick coupling and the flash bracket. The tripod thread is 1/4" and accepts the retaining screws of the flash rail and the flash bracket.

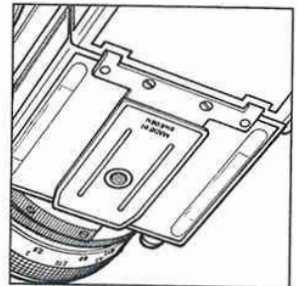

The Top

The entire top of the camera is covered by the viewing components (page 12). The camera body is supplied with the collapsible focusing hood, which also serves as a protective cover for the focusing screen.

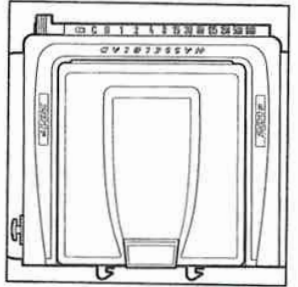

The Bottom & The Top 21

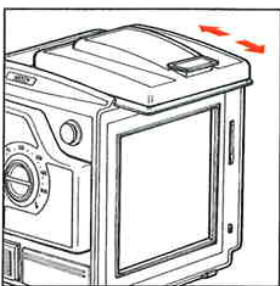

The Viewfinder System

Changing Focusing Hood or Viewfinder

To remove the focusing hood for the purpose of attaching any other viewfinder in the Hasselblad system, detach the magazine (or the rear protective cover). Fold down the focusing hood to protect it from damage and remove it by sliding it to the rear in its guide slots. Slide the replacement viewfinder into the slots and push it forward until it stops. When fully inserted the viewfinder is retained in position by a spring-loaded ball latch until you have reattached the magazine or protective cover.

Changing the Magnifier

The standard magnifier normally provides a comfortable viewing of the focusing screen for most users. If necessary, however, the standard magnifier plate with lens can be changed for a plate with a correction lens to compensate for individual eyesight. Correction lenses are available with powers ranging from +3 to -4 dioptres.

Change the magnifier as follows:

1. Remove the focusing hood from the camera body and open it by lifting the lid.
2. Release the magnifier by pushing the catch to the left. Push the magnifier halfway down, seize the lens plate from underneath and pull it out of the holder.
3. Keep the plate holder halfway down and insert the replacement lens plate with the printed side up. Fold the hood down and put it back on the camera.

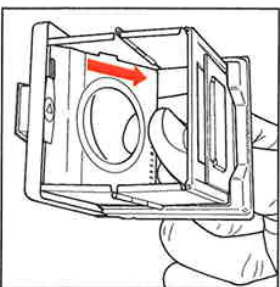

22 The Viewfinder System

Changing the Focusing Screen

Your 201F is equipped with the exceptionally bright and sharp Acute-Matte focusing screen.

If you wish to replace the focusing screen with any of the other focusing screens in the Hasselblad System simply follow the procedure below:

1. Detach the magazine and the viewfinder.
2. Push the two screen latches to the side into their recesses.
3. Place your hand over the screen and invert the camera. The screen will now drop into your hand.
4. Insert the replacement screen with the smooth side up and the sharp-edged corners down. Ensure that all four corners of the screen are positively seated on their supports. You need not return the screen latches. This is done automatically when the viewfinder is replaced.

NOTE: Should the screen refuse to drop out by itself, ensure that the camera is fully wound, remove the lens and check that the mirror is in the down position. Put a finger through the lens mount and push gently at the screen from underneath, preferably with a soft cloth between the finger and the screen.

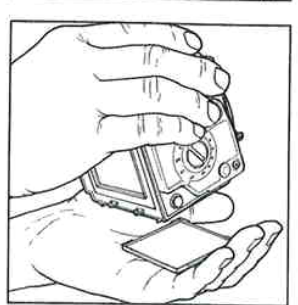
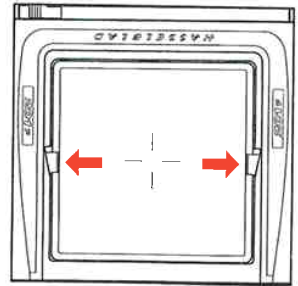

The Viewfinder System 23

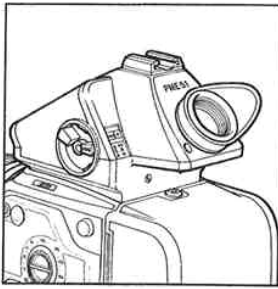

Hasselblad Meter Prism Viewfinder Adjustments

The Hasselblad Meter Prism Viewfinders meter the light level on the focusing screen. They are calibrated at the factory to give an accurate reading with one particular type of screen. If that focusing screen is replaced with another type which gives a different light level under the same ambient conditions, the meter has to be adjusted to compensate for the difference.

The PME, PME3, PME5 and PME51 are basically the same design but are differently adjusted from the factory. The PME3, PME5 and PME51 are adjusted to the brighter Acute-Matte screen in the 201F camera while the previous PME is adjusted to the lower light level of the Ground-glass screen (Cat. No. 42161) and other comparable screens, such as Split image (42188), Microprism & split image (42218), or Grid & microprism (42250). The Plain glass screen (42200) is not suitable for TTL metering.

The viewfinder types are identified by the marks PME 3, PME 5 or PME 51 respectively on the rear of the viewfinder body above the eyepiece.

The PME has no marking.

The recommended procedures of compensation for alternative usage of the meter viewfinders are shown in the charts on the opposite page.

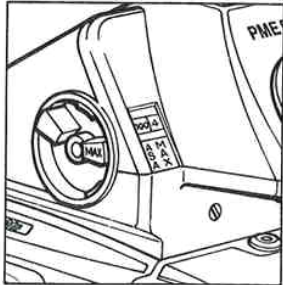

A. Acute-Matte focusing screen combined with:

| Viewfinder model | Action required to obtain a correct EV |
|------------------|---|
| PME3/PME5/PME51 | No action required |
| PME | REDUCE the ASA/ISO setting to half the film speed value as indicated on the film package or INCREASE the MAX lens aperture setting one full step or REDUCE the EV reading one full step when setting it on the lens' EV scale |

B. Ground-glass or similar focusing screen combined with:

| Viewfinder model | Action required to obtain a correct EV |
|------------------|--|
| PME3/PME5/PME51 | INCREASE the ASA/ISO setting to twice the film speed value as indicated on the film package or REDUCE the MAX lens aperture setting one full step or INCREASE the EV reading one full step when setting it on the lens' EV scale |
| PME | No action required |

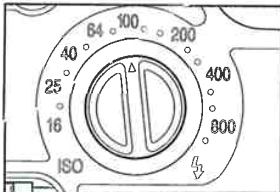

The Left Hand Side

The Film Speed Selector Dial

The film speed selector dial is effective in connection with dedicated flash photography only. See the chapter "Flash Photography" (pages 35-39) for detail information.

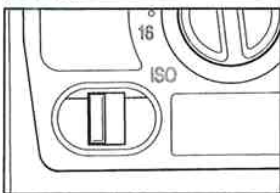

The Shutter Speed Ring Lock

Slide the lock button forwards to lock the shutter speed ring at any full or intermediate speed setting including B and C. In the locked position a red warning flag is exposed next to the button. Unlock the shutter speed ring by sliding the button rearwards.

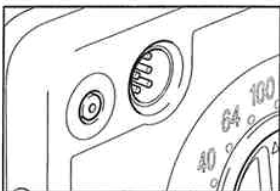

The Flash Connectors

The larger six-pin TTL-connector provides automatic control of dedicated flash units. The Hasselblad Profflash 4504 can be connected directly to the 201F but other dedicated flash units may require a suitable adapter, such as the Hasselblad SCA-adapter 390 or 590, between the unit and the camera. The smaller connector is a common PC-socket for any kind of flash unit. You can find further instructions on flash photography with the 201F on pages 35-39.

Lenses

The Hasselblad lenses manufactured since 1957 can be separated in two major groups, each with two subgroups:

- Lenses with a built-in leaf shutter:
 - C lenses (discontinued)
 - CF lenses
- Lenses without shutter:
 - F lenses (discontinued)
 - FE (formerly F/TCC) lenses

All these lenses can be used on the 201F, but the F and FE lenses are exclusively designed for use on focal plane shutter cameras such as the 201F.

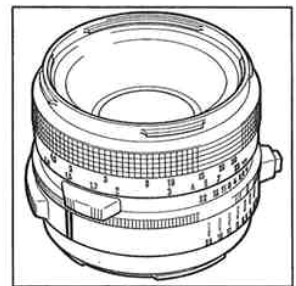

FE Lenses

The Hasselblad FE lenses, which have no built-in shutter, can easily be identified by their system sign: the twin blue lines on the left hand side of the aperture ring. Another sign, visible only when the lens is detached from the camera body, are the four contact pins in the bayonet plate at the rear of the lens. They are used for the data transmission between the lens electronics and the electronic system in the 205TCC camera body. The contact surfaces of these pins are sensitive to contamination and should not be touched with your fingers. Attach the protective cover after removing the lens from the camera and never set the lens down on the unprotected bayonet plate!

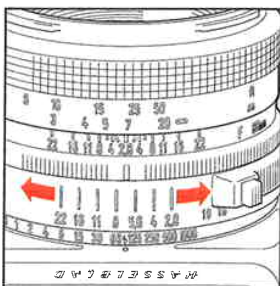
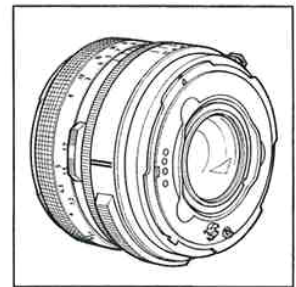

FE Lens Functions

Setting the Aperture

The aperture ring is the one closest to the shutter speed ring on the camera body. Use it to preset the selected f-stop. The full f-stops marked on the ring have click stops, but there are also click stops for each intermediate half f-stop. The preset aperture value can be read against the heavy index line on the grooved ring in front of the aperture ring. The aperture ring has two grooved grips for handling convenience. One of these grips has a push-button which is used to interlock the aperture ring and the shutter speed ring on the 201F to retain the EV-value (see page 31).

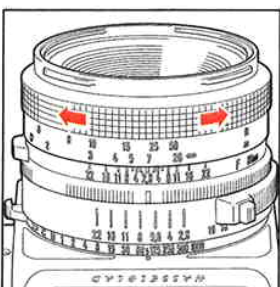

Focusing and Depth-of-field

The focusing ring is the rotating ring with a knurled rubber grip closest to the front of the lens. It has two scales for the focusing distance – the white meter scale and the orange inch/foot scale. Rotate the focusing ring until the image of your subject is absolutely sharp on the focusing screen.

The depth-of-field scale repeats the aperture values on both sides of the heavier index line between ring with the index line and the focusing ring. When the image is focused on the screen you can read the focusing distance opposite the index line in the depth-of-field scale. The depth-of-field limits can be read opposite the left and right values corresponding to the preset aperture value. The illustration depicts the depth-of-field for the preset aperture value of 8.

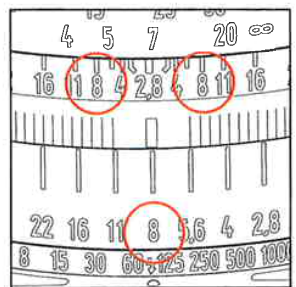

Depth-of-field Preview

The lens is normally opened to the largest aperture to provide the brightest possible viewfinder image with the most shallow depth-of-field. You can stop down the lens diaphragm to the preset aperture by pushing down the depth-of-field preview knob until it locks. To reopen it depress the lower end of the knob.

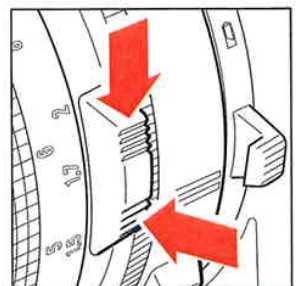

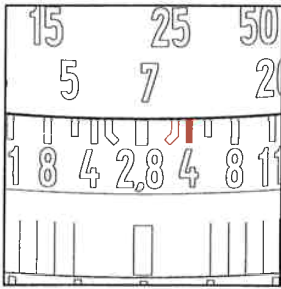

Infrared (IR) Photography
 Infrared light with wavelengths beyond 800 nm are refracted by the lens to an image plane further away from the lens than the image plane for visible light. When photographing with IR light you have to compensate for this difference by setting the focusing distance opposite the red IR index to the right of the common index line. Follow this procedure:

1. Focus as usual on the focusing screen.
2. Mark or memorize the distance on the focusing scale opposite the common index line.
3. Rotate the focusing ring to set this distance opposite the IR index.

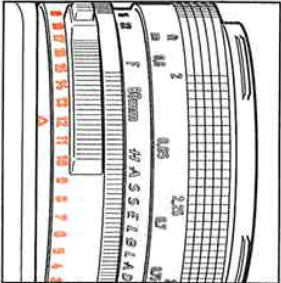

Exposure Value (EV)
 The orange scale on the right hand side indicates the exposure value for the set aperture/shutter speed combination. You read the value opposite the orange triangular index on the shutter speed ring. Use the scale to set the exposure as it can be read from exposure meters such as the PME51.

30 FE Lens Functions

Interlocked shutter speed/aperture
 If you want to change the shutter speed or the aperture without changing the EV you can interlock the shutter speed and aperture setting rings by holding down the grooved interlock button in the grip to the right of the aperture scale. When rotated the rings move together to the required speed or f-stop setting.

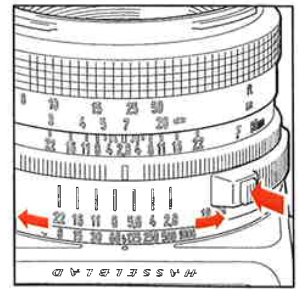

Other Hasselblad Lenses
 How to use other Hasselblad lenses on your 201F is described on pages 40 and in Appendix A.



FE Lens Functions 31

Magazine Operation

Loading the Magazine (figures 1 - 8)
 You can load the magazine with film when it is either on or off the camera. Off the camera you have to ensure that the magazine slide is inserted with its flat side towards the rear. Follow the procedure below to load a film. Paragraph numbers refer to the corresponding figure.

- cw**=clockwise; **ccw**=counter-clockwise
- 1. Fold out the film holder key.
- 2. Turn the key **ccw** and withdraw the film holder (magazine insert).
- 3. Place an empty take-up spool under the grooved knob of the spool clamp bar. Insert a roll of film under the other end of the bar, turned as in the picture. Remove all of the paper band surrounding the roll!
- 4. Turn the film holder key **cw** to open the film clamp. Pull 8-10 cm (3-4 in.) of paper backing off the film roll. Slide the side edge under the clamp.
- 5. Insert the tongue of the backing paper into the slot in the take-up spool.
- 6. Turn the grooved knob **cw** to align the arrow on the paper with the triangular index on the bar, **but no further**.
- 7. Turn the film holder key **ccw**. Insert the film holder into the magazine. Ensure that it is correctly positioned. Turn the film holder key **cw** to lock the film holder in the magazine.
- 8. Fold out the film winding crank. Rotate it **cw** about ten turns until it stops. Turn it **ccw** and fold it in.

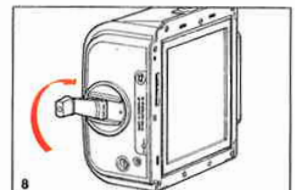
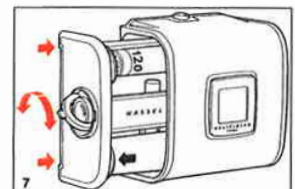
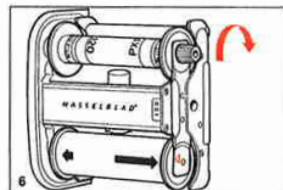
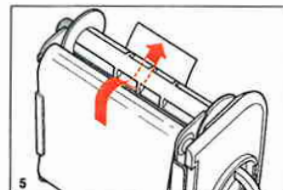
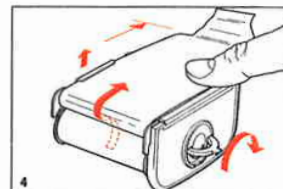
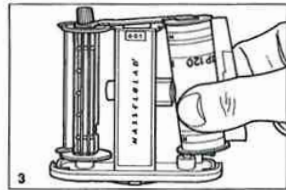
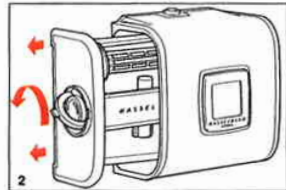
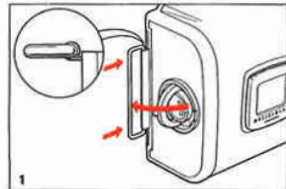

Number 1 will now be displayed in the frame counter window indicating that the loaded magazine is ready for use. The film winding crank is blocked at frame 1 only. It can be used to wind up a partially exposed film at any frame after that. The frame counter is automatically reset when the film holder is withdrawn from the magazine.

32 Magazine operation

Magazine operation 33

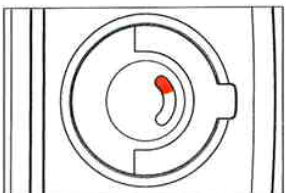

Magazine Load Status
 In the center of the film holder key there is a crescent-shaped indicator window that shows white when the magazine is freshly loaded. It gradually changes to red as the film is wound through. An all red indicator shows that the film is used up or that the magazine is empty.

Removing the Film
 When the film has been advanced after the last frame, the magazine blocks the camera against further exposure release. To remove the exposed film, fold out the film winding crank and rotate it clockwise until you can feel that the film is leaving the supply spool. Withdraw the film holder from the magazine and remove the film.

Film Tab Holder
 The end tab of the film pack can be inserted in the holder on the back of the magazine as a reminder of the kind of film that has been loaded into the magazine.

Film Plane Index
 The film plane index on the right hand side of the magazine body indicates the position of the film plane. It can be used to for accurate determination of the subject-to-film distance, which is important in close-up photography.

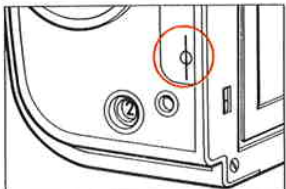
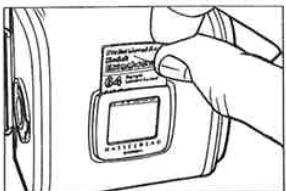

34 Magazine operation

Flash Photography

Automatic Flash Control
 When a dedicated flash unit, such as the Hasselblad Proflash 4504, or any other unit complying with the European SCA-standards, is connected to the TTL flash socket (page 26,37) – directly or through a suitable adapter – the built-in sensor and flash control circuits in your 201F controls the flash duration by TTL/OTF metering (TTL=Through The Lens; OTF=Off The Film). This means that it meters the light reflected off a central portion of the film surface, and terminates the flash when the exposure is correct, according to the film speed you have selected with the film speed dial (page 26, 36). The flash control circuit and the flash adapter, when used, is powered from the flash unit and consumes no energy from the camera battery.

Any electronic flash unit including the dedicated flash types can be connected to the PC socket. Then, however, you no longer have the advantage of letting the camera system control the flash and the exposure when you are using a dedicated flash unit.

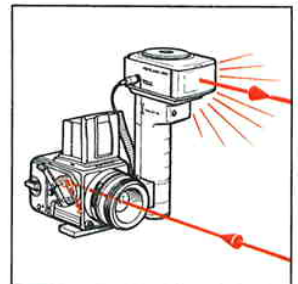
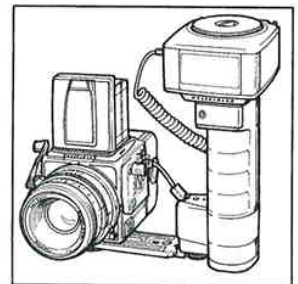

Flash Photography 35

Viewfinder Signal

The flash operation signal is combined with the battery check indicator (page 18).

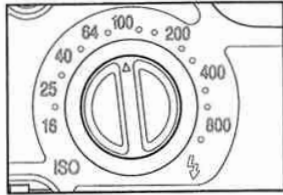
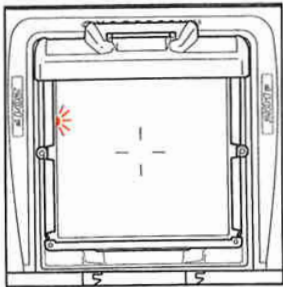

| | | | | | | | | |
|---------|----|----|----|----|-----|-----|-----|-----|
| ISO/ASA | 16 | 25 | 40 | 64 | 100 | 200 | 400 | 800 |
| DIN | 13 | 14 | 15 | 16 | 17 | 18 | 19 | 20 |

36 Flash Photography

It is operative as flash signal only when a dedicated flash is connected to the TTL socket.

The signal has three different states of indication; a ready signal, an exposure confirmation signal and no signal.

Ready Signal

A fixed red light indicates that the flash unit is fully charged and ready to operate.

Confirmation Signal

A flashing red light that appears during a little longer than a second immediately after the exposure confirms that the light output was sufficient for a proper exposure. After the confirmation signal the indicator remains dark until the ready signal reappears, indicating that the flash unit is operative again.

No signal

Absence of the confirmation signal indicates that the light output from the flash unit was insufficient for a correct exposure.

Setting the Film Speed

The film speed is set with the ISO selection dial. The setting range is ISO 16 – 1000. The equivalent DIN numbers are shown in the table below. Certain films, e.g. Polaroid, need compensation for differences in reflection. Such compensation is made by changing the film speed setting. The amount of compensation has to be determined by experiment.

3. Select and preset the aperture for the desired depth-of-field. Preset the shutter speed at 1/90 s (or slower if required).

NOTE: The flash is not triggered at selected shutter speeds faster than 1/90 s to avoid unexpected exposure failures. Shutter speeds slower than 1/90 s are operative and may result in unwanted mixed-light exposures when the flash and the camera are used in TTL mode.

4. Depress the exposure release button to make the exposure and trigger the flash. The control circuits in the camera cut the flash when the exposure is correct. If the flash was powerful enough to produce a correct exposure but did not use up all the power, the viewfinder signal turns to the "ready" state directly after the flashing confirmation signal. If it did use up most of the power, the signal turns off after the confirmation while the flash unit is recharging and lights up again when it is fully recharged.

WARNING: Absence of the confirmation signal indicates underexposure. The remedy is to move closer to the subject, select a larger aperture, use a faster film or any combination of these actions.

5. Rewind the camera to cock the shutter and advance the film to the next frame.

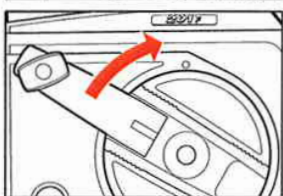
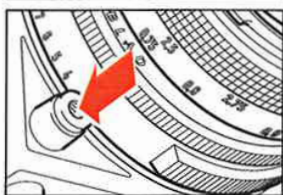
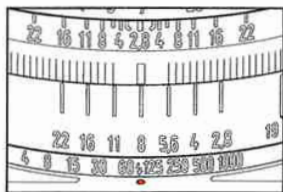

38 Flash Photography

How to Use the Dedicated Flash

Flash in TTL-mode

For the operation of the flash unit please refer to the flash unit Instruction Manual.

Camera Functions:

- Fully automatic exposure control through TTL/OTF metering.
- Exposure with preset aperture and shutter speed of 1/90 s or slower.
- Automatic disabling of flash triggering when the preset shutter speed is faster than 1/90 s.
- Viewfinder indication:
 - when the flash unit is charged and ready to flash,
 - when the exposure was correct,
 - when the exposure was insufficient.

Suggested procedure:

1. Set the film speed with the Film Speed Dial. Attach and connect the flash unit according to the flash unit Manual. With the Hasselblad Prof flash 4504 connect the Hasselblad TTL-cable between the TTL socket in the camera body (page 26) and the TTL socket in the flash unit. The PC cable connector is inoperative but can be "parked" in the PC-socket.

2. Set the flash unit at TTL or corresponding mode and switch it on. When the flash unit is charged and ready to flash, the indicator in the viewfinder lights up with a fixed red light.

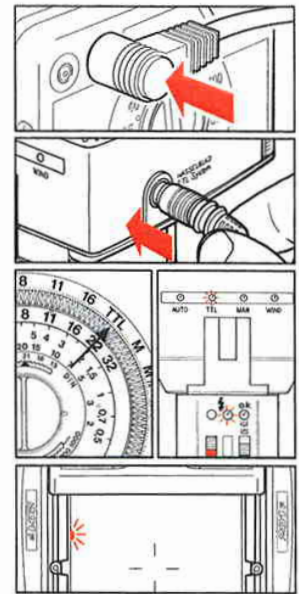

Flash Photography 37

Flash in other mode than TTL

A dedicated flash unit, connected to the TTL socket and set in any other mode than TTL, will not be controlled by the camera but will still trigger the "ready" and "confirmation" indications in the viewfinder. The flash function and the viewfinder indications, however, are regardless of the film speed setting on the camera.

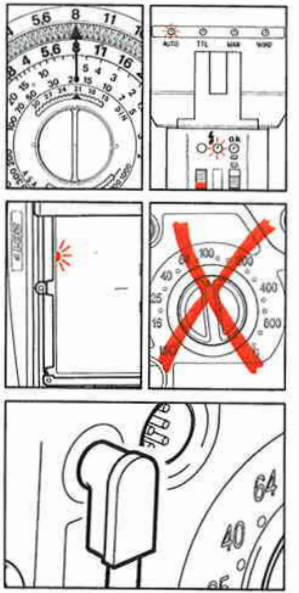

Flash Photography 39

Non-dedicated Flash Units

Any kind of electrically powered flash unit connected to the PC-socket will only be triggered but not controlled by the camera. The viewfinder signals will not be operating. The PC-socket is inoperative at shutter speed settings faster than 1/90 s to avoid exposure failures.

NOTE: High power studio flash units may in some cases have a flash duration longer than 1/90 s. When using such equipment you are recommended to set the shutter speed at 1/60 s or slower to avoid uneven exposure due to shutter curtain movement.

201F with other Hasselblad Lenses

You can use the Hasselblad F-, CF- and C-lenses on your 201F camera body without fear of damaging neither camera nor lens.

The F-lenses are optically, mechanically and operationally identical with the corresponding FE-lenses. The instructions for the FE-lenses are in all parts applicable on the F-lenses.

How to use the CF- and C- lenses is described in Appendix A, page 48.

Flash photography with F-lenses

The overall similarity between the FE- and F-lenses makes the flash photography procedures identical.

Dedicated Flash Unit

The TTL/OTF flash control system makes no difference between the FE- and the F-lenses as it always operates when the lens is stopped down during the exposure.

How to use the Dedicated Flash

The procedures are identical to those described for the FE-lenses in the different flash modes of operation (pages 37-39).

Non-dedicated Flash Unit

The information on and procedure described for the use of a non-dedicated flash unit together with a FE-lens (page 39) is in all parts applicable with an F-lens.



40 Other Hasselblad lenses

Accessories

All accessories included in the present Hasselblad Product Catalog and most discontinued older accessories can be used on the 201F when not specifically noted otherwise.

Accessory Mounts

The quick coupling plate on the bottom of the camera body (page 21) fits the handy and reliable Hasselblad tripod quick coupling and the flash gun bracket.

On the front of the lenses are external and internal bayonet mounts for filters, close-up lenses and lens shades. The viewfinder mount on top of the camera body accepts various focusing screens and viewfinders. Underneath the winding crank is a bayonet mount for the Hasselblad Winder.

Major Accessories

A couple of the most important accessories is described below. For a complete review of the Hasselblad system refer to the Hasselblad Product Catalog.

Winder

The Hasselblad Winder replaces the winding crank and motorizes the 201F for a maximum frame rate of 1,3 fps.

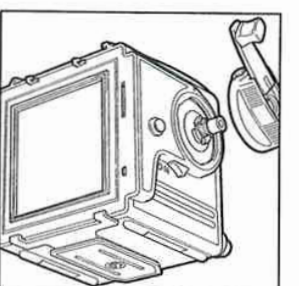

Viewfinders

Besides the focusing hood which is delivered with the camera body you have a choice of a magnifying hood and a range of prism viewfinders with and without built-in exposure meters.

The Hasselblad 201F System Chart

The accessory chart on the following pages indicates the wide range of accessories available within the Hasselblad System. Please refer to the Hasselblad Product Catalog for full information on the complete Hasselblad Camera System.

The Hasselblad 201F System Chart

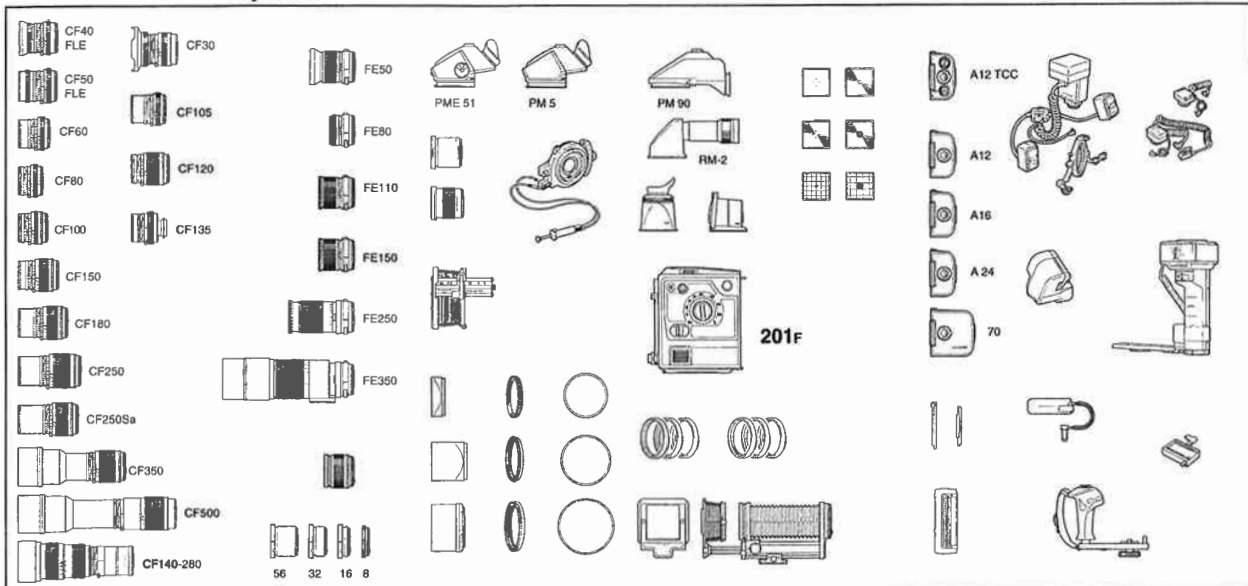

42 Hasselblad System Chart

Hasselblad System Chart 43

Technical Specifications and Equipment, 201F

Camera design: Medium format single lens reflex camera with built-in flash exposure control. Full image size mirror. Max. film size 6 x 6 cm (2 1/4 x 2 1/4 in) . Interchangeable lenses, film magazines, viewfinders, and focusing screens.

Shutter: Electronically controlled mechanical focal-plane shutter with release solenoid system. Horizontally running textile curtains. Shutter speed range 1s - 1/1000s and B. Fully mechanical C setting for lenses with built-in leaf shutters. Flash synchronization at all speeds from B to 1/90s.

Lens mount: Hasselblad bayonet mount for FE, F, CF and C lenses.

Viewfinder: Focusing hood with 4.5x magnifier, interchangeable with magnifying hood and prism viewfinders with or without exposure meter. Acute-Matte focusing screen interchangeable with other Hasselblad focusing screens. Illuminated flash indication.

Camera winding & Film advance: Manual single turn winding crank. Simultaneous shutter cocking and film advance. The crank is interchangeable with the motorized Hasselblad Winder for a frame rate of up to 1.3 fps.

Flash control: Center weighted TTL/OTF flash exposure meter powered from flash unit. Low center metering area. Full dedicated flash control with shutter speeds from B to 1/90 s. Inhibited flash triggering at shutter speeds faster than 1/90 s.

Film speed range: ISO 16/13° - 1000/31° for dedicated flash control. Selected with film speed dial on camera body.

Selftimer: Default delay 10s, optional delay 2s selected with selftimer button. Flashing selftimer indication light.

Battery: 6V, type PX28, UCAR 537, 4G-13 or equivalent Lithium type.

Tripod mount: Quick coupling plate and 1/4" and 3/8" socket thread.

External dimensions: Camera body only: See page 46. With focusing hood, Planar FE 2.8/80mm lens with front cover, and film magazine A12: 188L x 117W x 108H mm (7 1/2 x 4 5/8 x 4 1/4 in).

Weight: 1650 g with focusing hood, Planar FE 2.8/80, A12 film magazine and battery. Camera body alone: 750 g.

The camera body (Cat. Nos.: chrome finish 10529, black finish 10532) comes with focusing hood, focusing screen, winding crank, shoulder strap, front and rear protective covers.

For comprehensive information please refer to the Hasselblad Product Catalog.

Hasselblad reserves the right to change te specifications without prior notice.

44 Technical Specification

Technical Specification 45

Troubleshooting

Your Hasselblad 201F is built for long and troublefree service, especially when you follow the advices on maintenance and care on page 49. Should you encounter any operational difficulties the troubleshooting chart below may help you to resolve them.

| PROBLEM | POSSIBLE CAUSE | REMEDY |
|--|---|---|
| When the exposure release button is depressed only the mirror lifts and there is no battery check indication in the viewfinder | The battery is missing | Insert a fresh battery as described on page 6, depress the double exposure button and rewind the camera |
| | The battery is exhausted | Insert a fresh battery as described on page 6, depress the double exposure button and rewind the camera |
| The exposure release button cannot be depressed | The magazine slide is still in the magazine | Remove the magazine slide completely |
| | The film is finished | Load a new film or change to a new loaded magazine |
| | The camera is not rewound | Rewind the camera with one full turn of the winding crank |
| There is no image on the focusing screen | The camera is pre-released | Complete the camera release or depress the double exposure button, and rewind the camera |
| | The lens front cover is on | Remove the cover |
| | The camera has a C-lens or a CF-lens in C position on and is released | Rewind the camera with one full turn of the winding crank |

46 Troubleshooting

| PROBLEM | POSSIBLE CAUSE | REMEDY |
|---|---|--|
| The lens cannot be attached | The lens is released | Cock the lens |
| | The camera body is released or pre-released | Complete the camera release or depress the double exposure button, and rewind the camera |
| The lens cannot be detached | The camera body is released or pre-released | Complete the camera release or depress the double exposure button, and rewind the camera |
| The magazine cannot be detached | The magazine slide is not completely inserted | Push the magazine slide in until it positively stops |
| The shutter speed ring cannot be moved | The shutter speed ring lock is engaged | Disengage the shutter speed ring lock |
| The flash is not triggered when the camera is released | The selected shutter speed is faster than 1/90 s. | Select a shutter speed of 1/90 s or slower |
| The flash "ready" signal does not light up when a dedicated flash unit is connected | The flash unit is not switched on or is not fully charged to be operative | Switch on the flash unit and/or wait until it is fully charged |
| | The connection between flash unit and camera is defective | Check the connections according to the flash unit's manual Replace the TTL sync cord |
| The "confirmation" signal does not appear after a dedicated flash exposure | The flash unit's batteries are too exhausted to recharge the unit. | Replace the flash unit's batteries with fresh ones |

Troubleshooting 47

Camera Body Dimensions

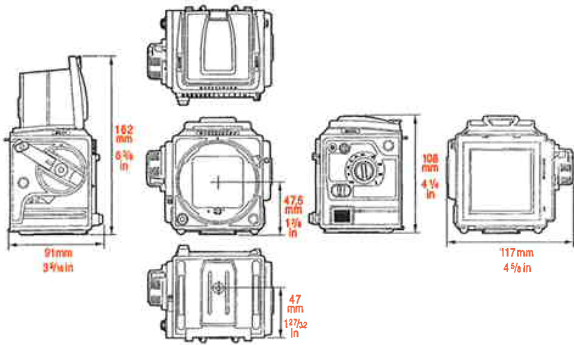

48 Camera dimensions

APPENDIX A

Hasselblad 201F with CF- and C-lenses

The CF- and the older C-lenses differ from the FE- and F-lenses through their built-in leaf shutter with shutter speeds from 1s to 1/500s and B. Both types have full flash synchronization on all shutter speeds. The CF-lenses also have an additional shutter setting F to let the lens be used together with the focal plane shutter and the instant return mirror.

NOTE: Avoid using the 201F with a C-lens in temperature conditions below 0°C (32°F)

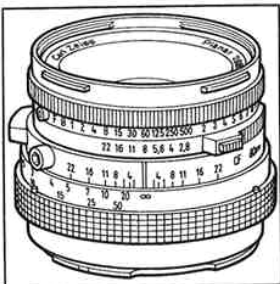

50 APPENDIX A: CF-lenses

CF-lenses

With a CF-lens on your 201F you can choose to use the focal plane shutter with all its advantages or to disengage the focal plane shutter and benefit from the advantages of lens' built-in leaf shutter with full flash synchronization on all shutter speeds.

NOTE: When you need shutter speeds of 1/250s or faster while using a CF-lens, you are under certain conditions recommended to set the lens shutter at F (see page 51) and use the camera's focal plane shutter.

CF-lens design and functions

The setting rings and scales on the CF-lenses are arranged differently from those on the FE-lenses. Counted from the camera body and forwards the rings are:

- Focusing ring with focusing distance scale in meters (white) and feet (orange).
- Common index line and depth-of-field scale.
- Aperture ring with aperture scale and EV index (orange).
- Shutter speed ring with shutter speed scale, EV scale (orange) and F lock button (green).

How to use the CF-lens

A. Lens in F mode (leaf shutter open)

Suggested procedure:

1. Turn the shutter speed ring to the F setting.
2. Operate the camera as described for the FE-lens (page 28).

B. Lens in C mode (leaf shutter working)

When using the built-in leaf shutter in the CF-lens the focal plane shutter in the camera body must be disengaged. By setting the camera's shutter speed ring in the C position (page 18) the focal plane shutter is turned into an auxiliary shutter, used only to protect the film from inadvertent exposure.

NOTE: The leaf shutter remains closed leaving the viewfinder screen dark until the camera is rewound.

Suggested procedure:

1. Check that the lens' shutter speed ring is not set at F.
2. Turn the camera's shutter speed ring to align the C at the end of the scale with the red index mark.
3. Lock it there by engaging the shutter speed ring lock (page 26).
4. Preset the desired aperture and shutter speed on the lens scales.

52 APPENDIX A: CF-lenses

Camera Care, Service and Guarantee

Camera Care.

Your Hasselblad camera is designed to withstand the rigours of professional use in most environments. In order to avoid the possibility of damage, however, the camera should be protected from the following.

Extremes of temperature. High temperatures can have an adverse effect on both the film and the camera. Do not keep your camera in places where it may get hot, such as in direct sunlight or above a radiator. In tropical environments fungus growth can be prevented by keeping your equipment in an area where the air is circulating. Frequent rapid and severe temperature changes can cause problems such as corrosion of electrical contacts, and should be avoided. When in extremely cold temperatures, cameras and especially lenses should be protected as much as possible.

Dust and grit. Prevent dirt of any kind from getting into your camera. When taking photographs in coastal areas for example, the camera should be protected from sand and salt water spray. You can blow away dust on the lens glass, magnifier of focusing screen, or wipe it off gently with a soft cloth if necessary. Smears on the lens glass should be removed with a high quality lens cleaning solution on a soft, clean tissue. Be careful not to scratch the lens or touch any of the glass surfaces with

your fingers. The surface of the mirror is coated and should be blown clean but not be wiped. Lens cleaning solvents or other chemicals should not be used on the focusing screen.

Impact. Your camera can be damaged by severe physical shocks. You should take care not to leave it where it can fall or be knocked to the ground, or roll about.

Service. Faultless camera performance is essential to the professional photographer. Therefore it is advisable to check that your camera is functioning correctly before an important assignment. You should also return your camera to a "Hasselblad Authorized Service Center" for periodical checking and preventive maintenance. If your camera is used constantly and intensively, exposing hundreds of rolls of film per week, checkups every six months are recommended.

Hasselblad Service Centers have the expert staff and specialized equipment necessary to ensure that your camera remains in perfect working order.

Guarantee. Provided that you bought your camera from an authorised Hasselblad outlet, it is covered by an international guarantee for one year. The guarantee document and a registration card are supplied with the camera. Keep the guarantee document carefully, but fill in the registration card and return it to your Hasselblad distributor.

Care, Service & Guarantee 49

EV Interlock Button

Depressing the EV interlock button interlocks the shutter speed and aperture rings to make it possible to change the shutter speed/aperture setting while retaining the EV value.

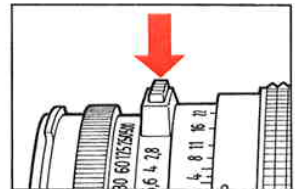

Depth-of-field Preview Knob

The Depth-of-field preview knob location and operation is identical to the FE- and F-lenses (page 29).

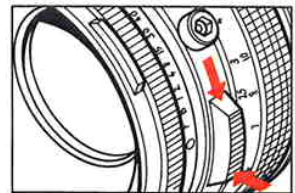

F-setting

Depress the small green F-lock button located to the left of the green F on the shutter speed ring. Keep it depressed while turning the ring to align the F with the index line. Release the button to lock the ring in the F position.

The F setting locks the shutter wide open without interfering with the aperture function. With this setting the lens works exactly as an FE- or F-lens (page 28).

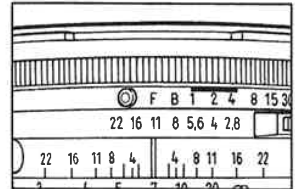

APPENDIX A: CF-lenses 51

5. Press the exposure button to make an exposure with the preset values.

NOTE: In temperature conditions below 0°C (32°F) the leaf shutter may react slower than normal. Be sure to keep the release button depressed until the leaf shutter has completed the exposure function!

6. Rewind the camera to get the viewfinder image back, advance the film to the next frame and to cock the lens shutter.

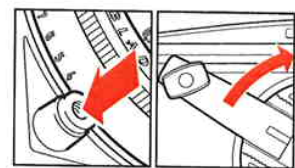

Flash photography with CF-lens

The CF-lenses have a built-in X-type flash synchronization at all shutter speeds. Flash connection is the PC socket located on the left hand side of the lens, close to the depth-of-field scale.

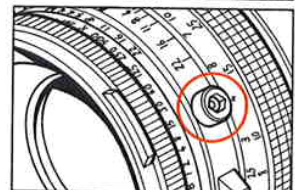

Lens in F mode

Dedicated and non-dedicated Flash Units

The procedures are identical to the corresponding procedures for the FE-lens (page 37).

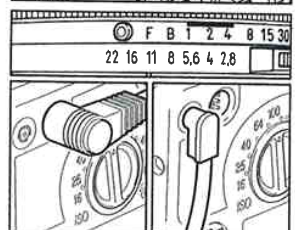

APPENDIX A: CF-lenses 53

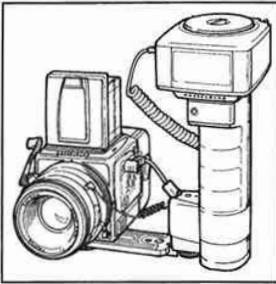

Lens in C mode

Dedicated Flash Unit

The TTL/OTF system is working also in C-mode to control the dedicated flash unit directly – as with the Hasselblad Proflash 4504 – or through an suitable adapter. However, since the focal plane shutter is not working as a shutter, the triggering of the flash must come from the shutter in the CF-lens. The red "ready" signal and flashing "confirmation" indication appear in the viewfinder as described on page 36.

How to use the Dedicated Flash
(Camera shutter speed set at C)

Suggested procedure:

1. Attach the flash to the camera (if desired),
2. Connect the TTL-cord according to the flash instruction.
3. Connect the PC-connector to the PC-socket on the CF-lens, **not to the PC-socket in the camera body.**
4. Set the flash unit in the desired mode of operation and switch it on. The red "ready" signal in the viewfinder lights up when the flash is ready to be fired.
5. Select shutter speed and preset aperture on the lens.
6. Press and release the exposure button to make an exposure, observing the viewfinder display for the "confirmation" indication.
7. Rewind the camera to get the viewfinder image back, cock the shutter and advance the film to the next frame.

NOTE: When used at full power some electronic flash units have a flash duration longer than 1/500 s. To take advantage of the full flash power in such cases and to avoid underexposure you are recommended to use shutter speeds of 1/125 s or slower.

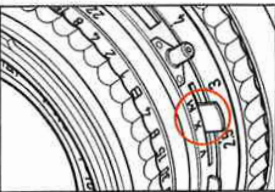

C-lenses

The older C-lenses (production terminated in 1982) look different but are in most respects identical to the CF-lenses. There are, however, certain major differences:

1. There is no F-setting on the shutter.
2. The shutter speed and aperture rings are normally interlocked.
3. There are two different flash synchronization modes.
4. There is a built-in mechanical selftimer.

How to use the C-lens

Avoid using the focal plane shutter together with a C-lens. If it cannot be avoided follow the procedure below:

1. Set the lens shutter at B.
2. Preset the desired aperture.
3. Set the camera shutter at the desired shutter speed.
4. Press the exposure button to make an exposure and **keep it depressed until the focal plane shutter has closed.** This is very important at slow shutter speeds.
5. Rewind the camera to get the viewfinder image back, cock the shutter and advance the film to the next frame.

Camera in C mode

The lens is permanently working in C-mode. The procedure is identical with the CF-lens in C-mode procedure (page 54).

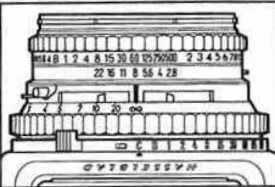
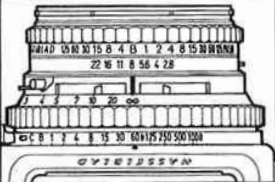

Non-dedicated Flash Units

The non-dedicated flash unit should be connected to the PC-socket on the lens only. The exposure is controlled either by the flash itself or by aperture value settings calculated from the guide number of the flash (see the flash manual). There will be no indications in the viewfinder.

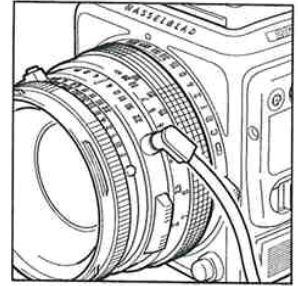

How to use the Non-dedicated Flash Unit.

(Camera shutter speed set at C).

Suggested procedure:

1. Attach the flash to the camera (if desired),
2. Connect the sync cord to the PC-socket on the CF-lens, **not to the PC-socket in the camera body.**
3. Set the flash unit at the desired mode and switch it on.
4. Select and preset aperture and shutter speed (preferably 1/125 s or slower).
5. Press the exposure button to make an exposure.
6. Rewind the camera to get the viewfinder image back, cock the shutter and advance the film to the next frame.

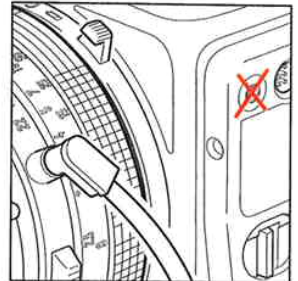

Flash photography with the C-lens

Using the camera's focal plane shutter

With the lens shutter set at B the lens can be used as an F-lens.

Dedicated and Non-dedicated Flash Units

Follow the procedures for the F-lens (page 40).

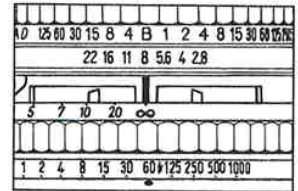

Using the C-lens' leaf shutter

Make sure that the flash mode selector is set at X.

Dedicated and Non-dedicated Flash Units

Follow the corresponding procedures for the CF-lens (page 53).

