

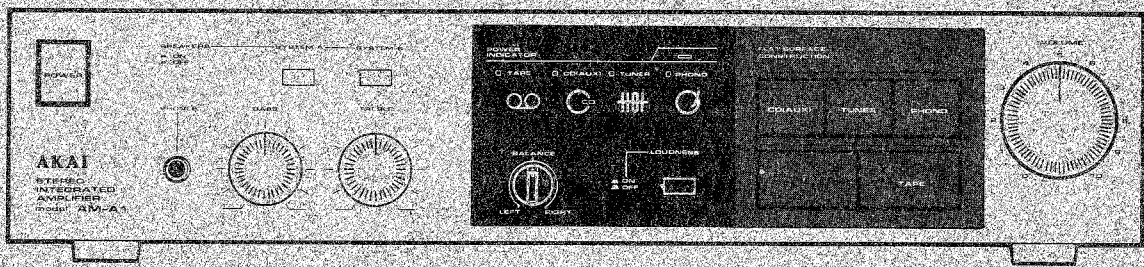

For more Hi-Fi manuals and set-up information
please visit www.hifiengine.com

AKAI SERVICE MANUAL



STEREO INTEGRATED AMPLIFIER

MODEL **AM-A1**

ABBREVIATIONS FOR SERVICE MANUAL MODEL AM-A1

ABBREVIATION	EXPLANATION
FTC	Federal Trade Commission
G-EQ	Graphic Equalizer
IHF	Institute High Fidelity (Standard)
RIAA	Recording Industry Association of America
SW	Switch

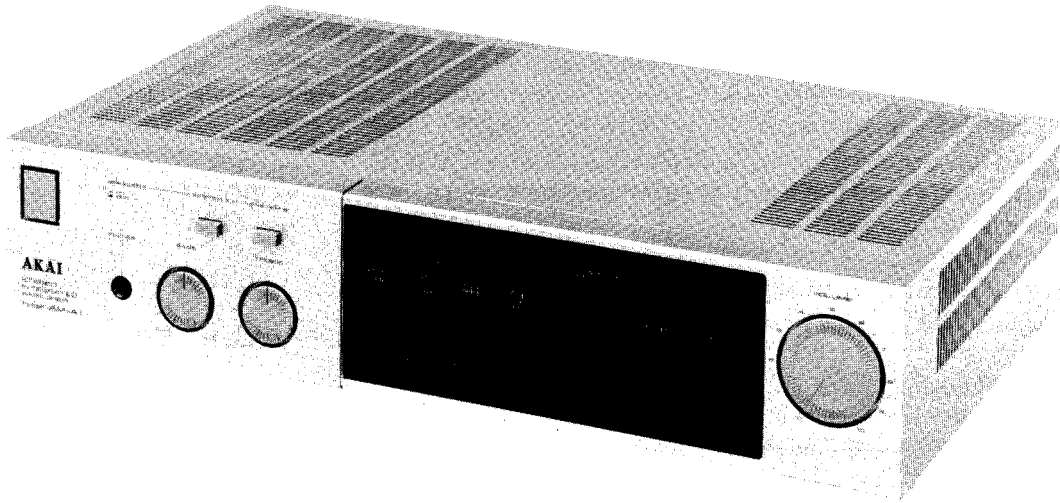

STEREO INTEGRATED AMPLIFIER
MODEL AM-A1

SECTION 1	SERVICE MANUAL	3
SECTION 2	PARTS LIST	9

SAFETY INSTRUCTIONS

SAFETY CHECK AFTER SERVICING

Confirm the specified insulation resistance between power cord plug prongs and externally exposed parts of the set is greater than 10 Mohms, but for equipment with external antenna terminals (tuner, receiver, etc.) and is intended for **C** or **A**, specified insulation resistance should be more than 2.2 Mohms (ground terminals, microphone jacks, headphone jacks, line-in-out jacks etc.)

PRECAUTIONS DURING SERVICING

1. Parts identified by the **△** symbol parts are critical for safety.
Replace only with parts number specified.
2. In addition to safety, other parts and assemblies are specified for conformance with such regulations as those applying to spurious radiation. These must also be replaced only with specified replacements.
Examples: RF converters, tuner units, antenna selector switches, RF cables, noise blocking capacitors, noise blocking filters, etc.
3. Use specified internal wiring. Note especially:
 - 1) Wires covered with PVC tubing
 - 2) Double insulated wires
 - 3) High voltage leads
4. Use specified insulating materials for hazardous live parts. Note especially:
 - 1) Insulation Tape
 - 2) PVC tubing
 - 3) Spacers (Insulating Barriers)
 - 4) Insulation sheets for transistors
 - 5) Plastic screws for fixing microswitch (especially in turntable)
5. When replacing AC primary side components (transformers, power cords, noise blocking capacitors, etc.), wrap ends of wires securely about the terminals before soldering.

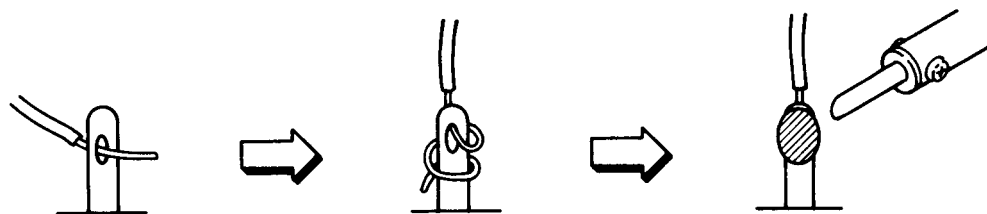

6. Observe that wires do not contact heat producing parts (heatsinks, oxide metal film resistors, fusible resistors, etc.).
7. Check that replaced wires do not contact sharp edged or pointed parts.
8. Also check areas surrounding repaired locations.
9. Use care that foreign objects (screws, solder droplets, etc.) do not remain inside the set.

VOLTAGE CONVERSION

Models for Canada USA, Europe, UK and Australia are not equipped with this facility. Each machine is preset at the factory according to destination, but some machines can be set to 110V, 120V, 220V, or 240V as required. If your machine's voltage can be converted:

Before connecting the power cord, turn the **VOLTAGE SELECTOR** located on the rear panel with a screwdriver until the correct voltage is indicated.

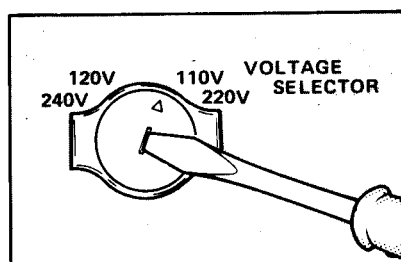

SECTION 1

SERVICE MANUAL

TABLE OF CONTENTS

I. SPECIFICATIONS	4
II. DISMANTLING OF UNIT	5
III. CONTROLS	6
IV. PLINCIPAL PARTS LOCATION	7
V. ADJUSTMENT	8
VI. PC BOARD TITLE AND IDENTIFICATIONS	8

For basic adjustments, measuring methods, and operating principles, refer to GENERAL TECHNICAL MANUAL.

I . SPECIFICATIONS

POWER AMPLIFIER SECTION

RATED POWER OUTPUT 40Hz to 20kHz	8 ohms 25W/0.3%	4 ohms 25W/0.3%
POWER OUTPUT (by FTC) 40Hz to 20kHz	8 ohms 28W/0.3%	4 ohms 28W/0.3%
1kHz	30W/0.3%	30W/0.3%
MUSIC POWER (BOTH CHANNEL)	100W	
POWER BANDWIDTH (IHF -3dB, 8 ohms)	5Hz to 40kHz (0.5%)	
S/N (IHF-A)		
PHONO	72dB	
CD (AUX)	95dB	
RESIDUAL NOISE (8 ohms)	0.5mV	
CHANNEL SEPARATION (IHF, 1kHz)	55dB	
DAMPING FACTOR (1kHz, 8 ohms)	30	
REQUIRED SPEAKER IMPEDANCE	A or B : 4 to 16 ohms A + B : 8 to 16 ohms	

PRE AMPLIFIER SECTION

INPUT SENSITIVITY/IMPEDANCE		
PHONO	2mV/47kohms	
CD (AUX)	150mV/47kohms	
TAPE	150mV/47kohms	
OUTPUT LEVEL/IMPEDANCE		
TAPE REC	150mV/1kohms	
FREQUENCY RESPONSE		
PHONO (RIAA DEVIATION)	±0.5dB	
CD (AUX)	5Hz to 80kHz (-3dB)	
TONE CONTROL		
BASS	±8dB	
TREBLE	±8dB	
LOUDNESS CONTROL (VOLUME SET AT -30dB POSITION)	100Hz/+9dB 10kHz/+5dB	
PHONO MAX. INPUT LEVEL	150mV	
POWER REQUIREMENTS	120V, 60Hz for USA & Canada 220V, 50Hz for Europe except UK 240V, 50Hz for UK & Australia 110/120/220/240V, 50/60Hz switchable for other countries	
DIMENSIONS	440 (W) × 98 (H) × 255 (D) mm (17.3 × 3.9 × 10 inches)	
WEIGHT	5.45kg(11.99 lbs)	

* For improvement purposes, specifications and design are subject to change without notice.

II. DISMANTLING OF UNIT

In case of trouble, etc. necessitating dismantling, please dismantle in the order shown in the photographs. Reassemble in reverse order.

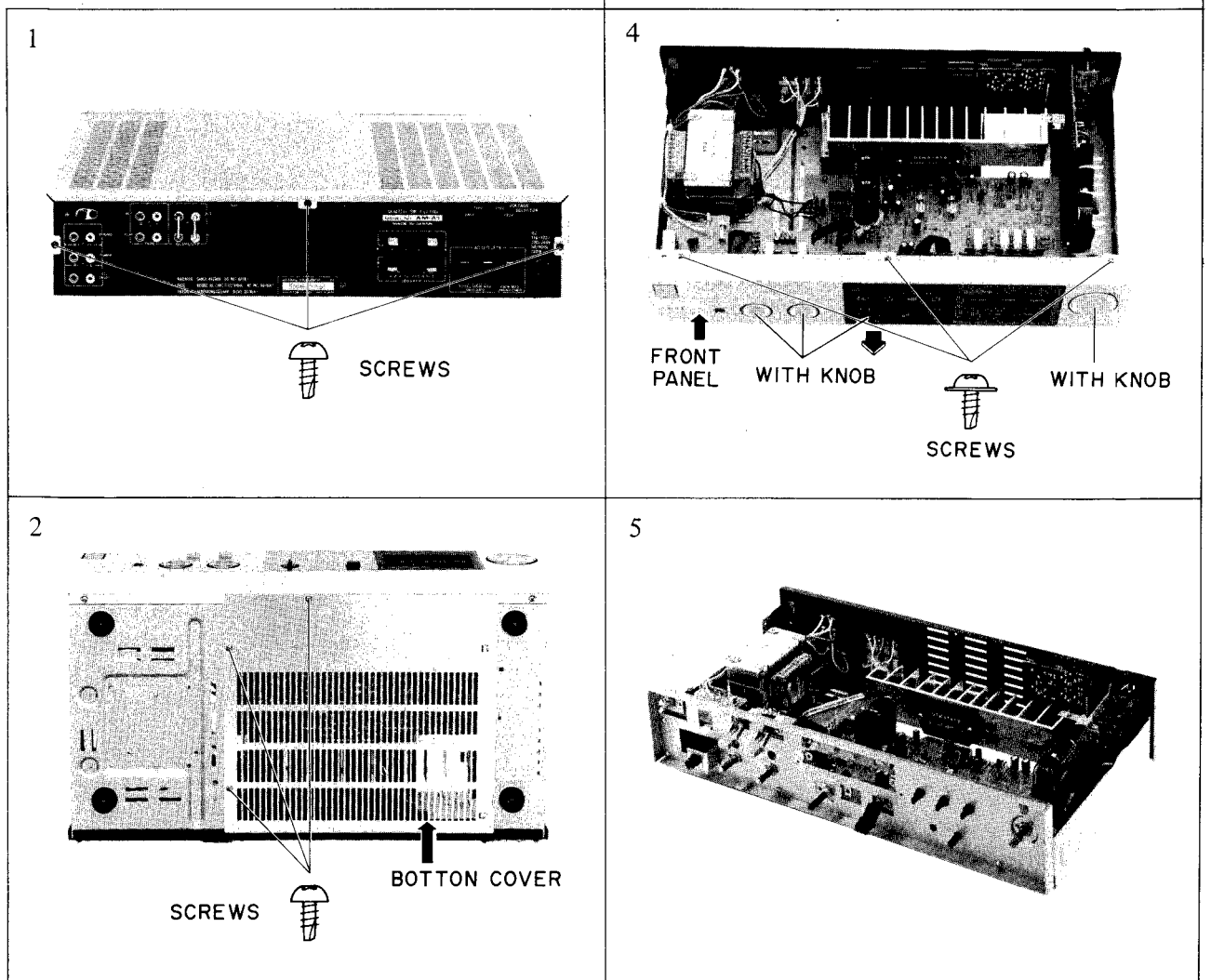

III. CONTROLS

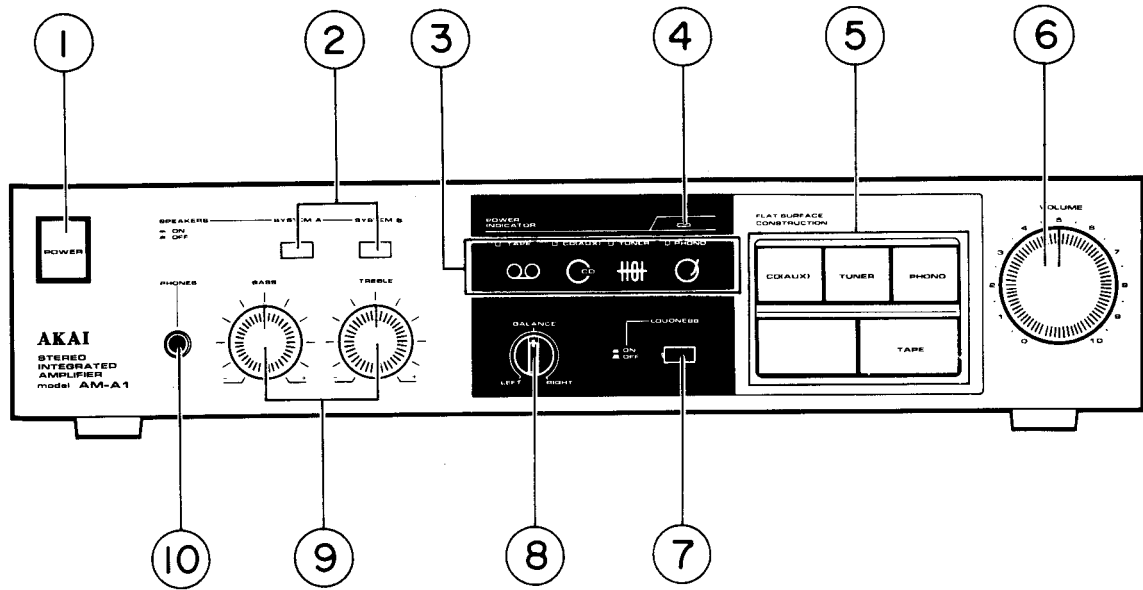

Fig. 3-1

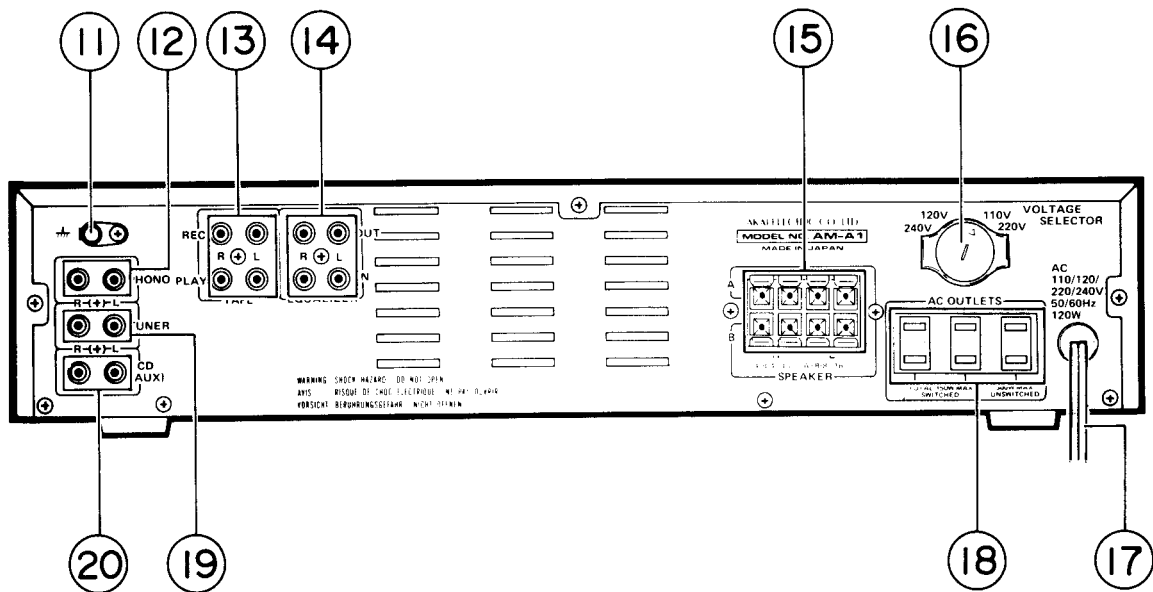

Fig. 3-2

- | | |
|---|--|
| <ol style="list-style-type: none"> 1. POWER SWITCH 2. SPEAKER SELECTOR BUTTONS (SYSTEM A AND SYSTEM B) 3. INPUT SOURCE INDICATORS 4. POWER INDICATOR 5. INPUT SOURCE SELECTOR BUTTONS (PHONO, TUNER, CD (AUX) AND TAPE) 6. VOLUME CONTROL 7. LOUDNESS SWITCH 8. BALANCE CONTROL 9. TONE CONTROLS | <ol style="list-style-type: none"> 10. HEADPHONE JACK 11. GROUND TERMINAL 12. PHONO JACKS 13. TAPE JACKS (REC AND PLAY) 14. EQUALIZER JACKS (IN AND OUT) 15. SPEAKER TERMINALS 16. VOLTAGE SELECTOR SWITCH (U MODEL ONLY) 17. AC POWER CORD 18. AC OUTLETS (U,C,A MODELS ONLY) 19. TUNER JACKS 20. CD (AUX) JACKS |
|---|--|

IV. PRINCIPAL PARTS LOCATION

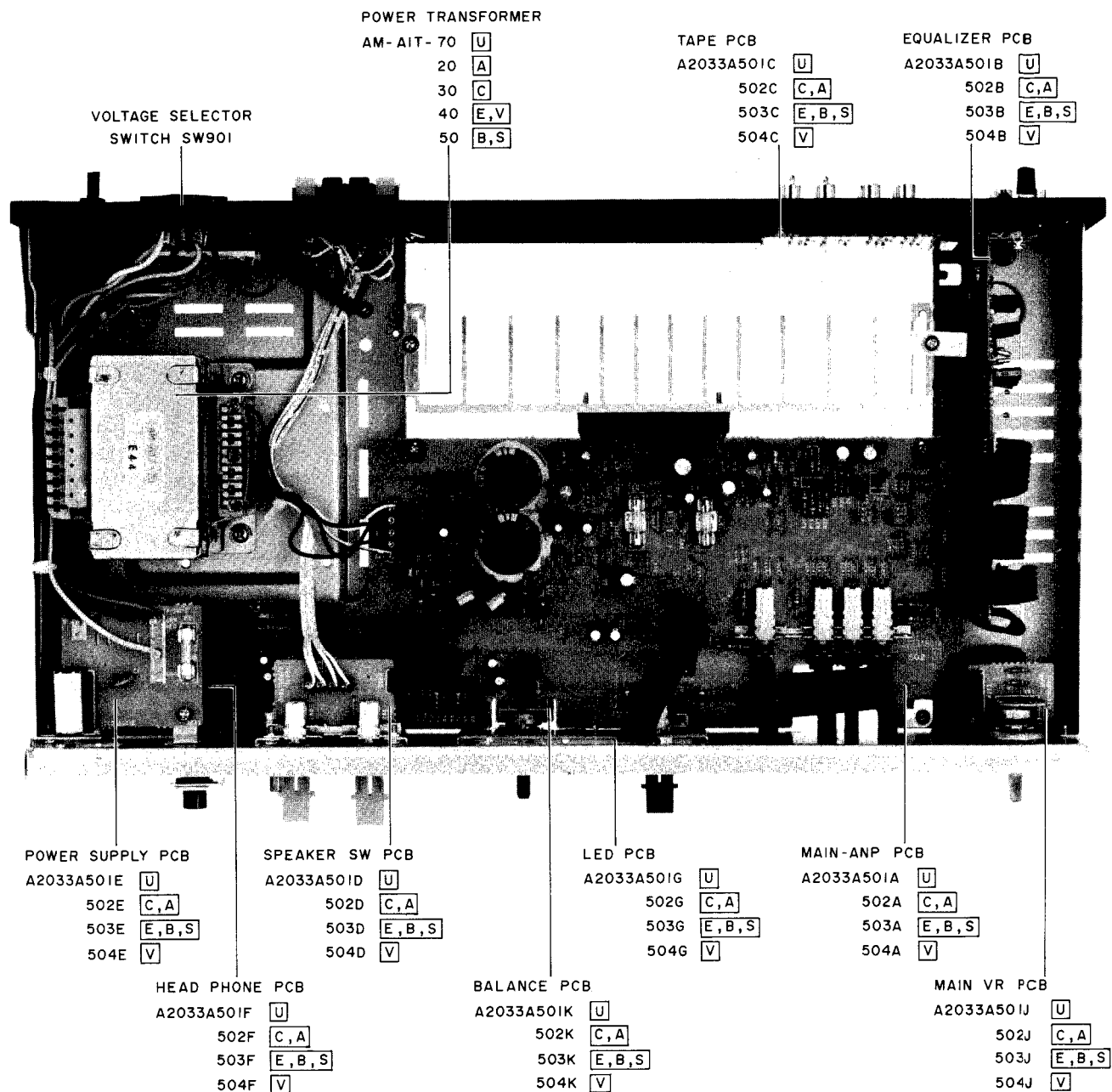

Fig. 4-1 Top View (U model)

V. ADJUSTMENT

No Adjustment is Necessary for this model.

VI. PC BOARD TITLE AND IDENTIFICATIONS

PC BOARD TITLE	PC BOARD NUMBER	REMARKS
MAIN AMP PC BOARD	A2033A501A	U
	502A	C, A
	503A	E, B, S
	504A	V
EQUALIZER PC BOARD	A2033A501B	U
	502B	C, A
	503B	E, B, S
	504B	V
TAPE PC BOARD	A2033A501C	U
	502C	C, A
	503C	E, B, S
	504C	V
SPEAKER SW PC BOARD	A2033A501D	U
	502D	C, A
	503D	E, B, S
	504D	V
POWER SUPPLY PC BOARD	A2033A501E	U
	502E	C, A
	503E	E, B, S
	504E	V
HEADPHONE PC BOARD	A2033A501F	U
	502F	C, A
	503F	E, B, S
	504F	V
LED PC BOARD	A2033A501G	U
	502G	C, A
	503G	E, B, S
	504G	V
FILTER PC BOARD	A2033A504H	V
SPEAKER TERMINAL PC BOARD	A2031D5070	V
MAIN VR PC BOARD	A2033A501J	U
	502J	C, A
	503J	E, B, S
	504J	V
BALANCE PC BOARD	A2033A501K	U
	502K	C, A
	503K	E, B, S
	504K	V

SECTION 2

PARTS LIST

TABLE OF CONTENTS

RECOMMENDED SPARE PARTS	11
1. PC BOARD BLOCK	12
2. MAIN AMP PC BOARD	12
3. EQUALIZER PC BOARD	13
4. TAPE PC BOARD	13
5. LED PC BOARD	13
6. SPEAKER SWITCH PC BOARD	13
7. MAIN VR PC BOARD	13
8. BALANCE PC BOARD	13
9. SPEAKER TERMINAL PC BOARD	13
10. HEAD PHONE PC BOARD	13
11. POWER SUPPLY PC BOARD	13
12. FILTER PC BOARD (V ONLY)	13
13. ASSEMBLY BLOCK	14
14. FINAL ASSEMBLY BLOCK	15
INDEX	16

Resistor and Capacitor which is not listed in this parts list, please refer to
COMMON LIST FOR SERVICE PARTS.

ATTENTION

1. When placing an order for parts, be sure to list the parts no., model no., and description. There are instances in which if any of this information is omitted, parts cannot be shipped or the wrong parts will be delivered.
2. Please be careful not to make a mistake in the parts no. If the parts no. is in error, a part different from the one ordered may be delivered.
3. Because parts number and parts unit supply in the Preliminary Parts List may be partially changed, please use this parts list for all future reference.

HOW TO USE THIS PARTS LIST

1. This Parts List shows the parts that are considered necessary for repairs. Other parts, such as resistors and capacitors, are shown in the "Common List for Service Parts". Select and order such parts from the "Common List for Service Parts".
2. The Recommended Spare Parts shows those parts in the Parts List which are considered particularly important for service.
3. Parts not shown in the Parts List and "Common List for Service Parts" will not be supplied in principle.
4. How to read list

a) Mechanism Block

b) P.C Board Block

2. HEAD BASE BLOCK

REF. NO.	PARTS NO.	DESCRIPTION
2-1x	BH-T2023A320A	HEAD BASE BLOCK GX-F66R
2-2	HP-H2206A010A	HEAD R/P PR4-8FU C
2-3	ZS-477876	PAN20x03STL CMT
2-4	ZS-536488	BID20x08STL CMT
2-5	ZG-402895	CS ANGLE ADJUST SPRING

SP (Service Parts) Classification

A small "x" indicates the inability to show that particular part in the Photo or Illustration.

This number corresponds with the individual parts index number in that figure

This number corresponds with the Figure Number

6. SYS. CON. P.C BOARD BLOCK

REF. NO.	PARTS NO.	DESCRIPTION
6-1	BA-T2034A070A	PC SYS CON BLK GX-F44R
6-IC1	EI-324536	IC HD14049BP
6-IC2	EI-336801	IC MB8841-564M
6-IC3	EI-331661	IC SN7405N
6-IC4	EI-336725	IC M54527P
6-TR1to4	ET-200985	TR 2SC2603 F,G
6-TR5to28	ET-554657	TR 2SA733A P,Q
6-D1	ED-318292	D SILICON H 1S2473T-77 T26
6-D2to4	ED-308952	D GERMA V 1K34A-LR F07
6-D5to10	ED-318292	D SILICON H 1S2473T-77 T26
6-X1	EI-318384	OSC X'TAL NC-18C 3.579545MHZ

SP (Service Parts) Classification

This reference numbers corresponds with symbol numbers of Schematic Diagrams.

5. Both the kind of part and installation position can be determined by the Parts Number. To determine where a parts number is listed, utilize Parts Index at end of Parts List. It is necessary first of all to find the Parts Number. This can be accomplished by using the Reference Number listed at right of parts number in the Parts Index.

WARNING

△ INDICATES SAFETY CRITICAL COMPONENTS FOR CONTINUED SAFETY, REPLACE SAFETY CRITICAL COMPONENTS ONLY WITH MANUFACTURE'S RECOMMENDED PARTS

AVERTISSEMENT

△ IL INDIQUE LES COMPOSANTS CRITIQUES DE SÉCURITÉ. POUR MAINTENIR LE DEGRÉ DE SÉCURITÉ DE L'APPAREIL, NE REMPLACER QUE DES PIÈCES RECOMMANDÉES PAR LE FABRICANT

RECOMMENDED SPARE PARTS

Because, if the parts listed below are on hand, almost any repair can be accomplished, we suggest that you stock these Recommended Spare Parts Items.

REF. NO.	PARTS NO.	DESCRIPTION
1	BT-352429	△ TRANS POWER AM-A1T-20 (A)
2	BT-352428	△ TRANS POWER AM-A1T-30 (C)
3	BT-352430	△ TRANS POWER AM-A1T-40 (E,V)
4	BT-352431	△ TRANS POWER AM-A1T-50 (B,S)
5	BT-352426	△ TRANS POWER AM-A1T-70 (U)
6	ED-349656	D LED AY5505S
7	ED-337391	D LED GL5NG6 GRN
8	ED-200213	D SILICON DBA40C-K15 200/2.6A
9	ED-301911	D SILICON H DS448
10	ED-306320	D ZENER H HZ15 2
11	ED-324013	D ZENER H HZ20 2
12	ED-329056	D ZENER H HZ22 2
13	EF-602550	△ FUSE SEMKO T 250V 1.25A (E,V,B,S)
14	EF-601964	△ FUSE SEMKO T 250V 1.60A (E,V,B,S)
15	EF-690996	△ FUSE SEMKO T 250V 4.00A (E,V,B,S)
16	EF-306951	△ FUSE TSC A 250V 2.50A (U)
17	EF-326639	△ FUSE TSC A 250V 3.15A (U)
18	EF-306954	△ FUSE TSC 125V 2.00A (C)
19	EF-306956	△ FUSE TSC 125V 2.50A (C,A)
20	EF-346139	△ FUSE TSC 125V 5.00A (C,A)
21	EI-337228	IC M5218L0
22	EI-344764	IC M5218P-21
23	EI-352644	IC STK4141-2
24	ER-328278	△ R FUSE ERD2FC 1/4W 10R0G
25	ER-200746	△ R FUSE ERD2FC 1/4W 1000G
26	ES-349070	△ SW SELECTOR YKS11-0002 02-4 (U) (SW901)
27	ES-352624	SW PUSH ESB-62838 2 THROW
28	ES-352619	SW PUSH ESB-62840 4 THROW
29	ES-352620	SW PUSH ESB-62922 02-2 S
30	ES-337902	SW PUSH SDLD1P 01-1
31	ET-349882	TR 2SA1283 D,E
32	ET-349883	TR 2SC3243 D,E
33	EV-352622	VR ROTARY 16P10×1T W105
34	EV-352621	VR ROTARY 16P20× B104
35	EV-352623	VR ROTARY 16P20×3Q C104

SYMBOL FOR DESTINATION

- A : AAL (U.S.A.)
- B : UK (England)
- C : CSA (Canada)
- E : CEE (Europe)
- S : SAA (Australia)
- U : U/T (Universal Area)
- V : VDE (West Germany)

1. PC BOARD BLOCK

REF. NO.	PARTS NO.	DESCRIPTION
MAIN PC BOARD BLOCK		
1-1A	BA-A2033A020A	PC MAIN BLK AM-A1 (U)
1-1B	BA-A2033A020B	PC MAIN BLK AM-A1 (C,A)
1-1C	BA-A2033A020C	PC MAIN BLK AM-A1 (E,B,S)
1-1D	BA-A2033A020D	PC MAIN BLK AM-A1 (V)
1-1E	BA-A2033A020E	PC MAIN BLK AM-A1 (A)

NOTE: MAIN PC BOARD BLOCK CONSISTS OF FOLLOWING PC BOARDS.

- A MAIN AMP PC BOARD
- B EQUALIZER PC BOARD
- C TAPE PC BOARD
- D SPEAKER SWITCH PC BOARD
- E POWER SUPPLY PC BOARD
- F HEAD PHONE PC BOARD
- G LED PC BOARD
- H FILTER PC BOARD
- I MAIN VR PC BOARD
- J BALANCE PC BOARD

2. MAIN AMP PC BOARD

REF. NO.	PARTS NO.	DESCRIPTION
2-IC1	EI-337228	IC M5218L0
2-IC2	EI-352644	△ IC STK4141-2
2-TR1	ET-349883	△ TR 2SC3243 D,E
2-TR2	ET-349882	△ TR 2SA1283 D,E
2-D2,		
4	ED-324013	△ D ZENER H HZ20 2
2-D5	ED-200213	△ D SILICON DBA40C-K15 200/2.6A
2-D6	ED-301911	D SILICON H DS448
2-D7	ED-329056	D ZENER H HZ22 2
2-SW1	ES-352619	SW PUSH ESB-62840 4THROW
2-SW2	ES-352620	SW PUSH ESB-62922 02-2 S
2-VR1,		
2	EV-352623	VR ROTARY 16P20×3Q C104
2-L1	EO-336902	COIL DET 2 106AK-026 1R0K
2-FR1	ER-328278	△ R FUSE ERD2FC 1/4W 10R0G
2-FR2	ER-200746	△ R FUSE ERD2FC 1/4W 1000G
2-R21	ER-325269	△ R CB H S10 FS RDS 1/4W 222J
2-R22	ER-308875	△ R CB H S15 FS RDS 1/2W 100J
2-R24	ER-333355	△ R CB H S10 FS RDS 1/4W 103J
2-R25	ER-308028	△ R OMF H S15 FS 1W 181J
2-R26	ER-308875	△ R CB H S15 FS RDS 1/2W 100J
2-R27		
	to 31 ER-333654	△ R CB H S15 FS RDS 1/2W 332J
2-R32	ER-333376	△ R CB H S10 FS RDS 1/4W 162J
2-R33	ER-327198	△ R CB H S10 FS RDS 1/4W 122J
2-R34	ER-325269	△ R CB H S10 FS RDS 1/4W 222J
2-R35	ER-302241	△ R CB H S10 FS RDS 1/4W 4R7J
2-R36	ER-353214	R CB H RD 1/2W 103J
2-R37	ER-333376	△ R CB H S10 FS RDS 1/4W 162J
2-R38	ER-327198	△ R CB H S10 FS RDS 1/4W 122J
2-R39	ER-325269	△ R CB H S10 FS RDS 1/4W 222J
2-R40	ER-302241	△ R CB H S10 FS RDS 1/4W 4R7J
2-R41	ER-353214	R CB H RD 1/2W 103J
2-R44	ER-328082	R CB H S10 FS RDS 1/4W 332J
2-C27	EC-326583	C MMY V CUT CF921 473K 400DC

3. EQUALIZER PC BOARD

REF. NO.	PARTS NO.	DESCRIPTION
3-IC1	EI-344764	IC M5218P-21
3-D1	ED-306320	D ZENER H HZ15 2
3-L1	EO-338420	COIL FIX 2 FL12R202E 202K (V)
3-L2,3	EO-336934	COIL FIX 1 LAL03KH 2R2M (V)
3-R7	ER-322331	△ R CB H S10 FS RDS 1/4W 821J
3-J1	EJ-344370	PIN J YKC21-0081 P 6P

4. TAPE PC BOARD

REF. NO.	PARTS NO.	DESCRIPTION
4-L1		
to 6	EO-336934	COIL FIX 1 LAL03KH 2R2M (V)
4-J1,2	EJ-343365	PIN J YMC21-0063 P 4P

5. LED PC BOARD

REF. NO.	PARTS NO.	DESCRIPTION
5-D1	ED-349656	D LED AY5505S
5-D2 to 4	ED-337391	D LED GL5NG6 GRN
5-D5	ED-349656	D LED AY5505S

6. SPEAKER SWITCH PC BOARD

REF. NO.	PARTS NO.	DESCRIPTION
6-SW3	ES-352624	SW PUSH ESB-62838 2 THROW

7. MAIN VR PC BOARD

REF. NO.	PARTS NO.	DESCRIPTION
7-VR1	EV-352621	VR ROTARY 16P20x B104

8. BALANCE PC BOARD

REF. NO.	PARTS NO.	DESCRIPTION
8-VR1	EV-352622	VR ROTARY 16P10x1T W105

9. SPEAKER TERMINAL PC BOARD

REF. NO.	PARTS NO.	DESCRIPTION
9-L1	EO-342936	COIL BALUN
9-TM902	EJ-349401	TERMINAL LEVER YKD21-0027 8P

10. HEAD PHONE PC BOARD

REF. NO.	PARTS NO.	DESCRIPTION
10-L1	EO-336934	COIL FIX 1 LAL03KH 2R2M (V)
10-J1A	EJ-343380	PHONE J 3P HLJ0541-040 6.3 (EXCEPT BL)
10-J1B	EJ-355012	PHONE J 3P HLJ0541-010 6.3 (BL)

11. POWER SUPPLY PC BOARD

REF. NO.	PARTS NO.	DESCRIPTION
11-SW1	ES-337902	△ SW PUSH SDDL1P 01-1
11-C1A	EC-320548	△ C CE V F 103Z 250AC (U)
11-C1B	EC-338411	△ C CE V FZ 103P 400AC (C,A)
11-C1C	EC-338496	△ C CE V FZ 472P 400AC (E,V,B,S)

12. FILTER PC BOARD (V ONLY)

REF. NO.	PARTS NO.	DESCRIPTION
12-L1	EO-338409	COIL LF FKOB160MH02 250UH (V)

ASSEMBLY BLOCK

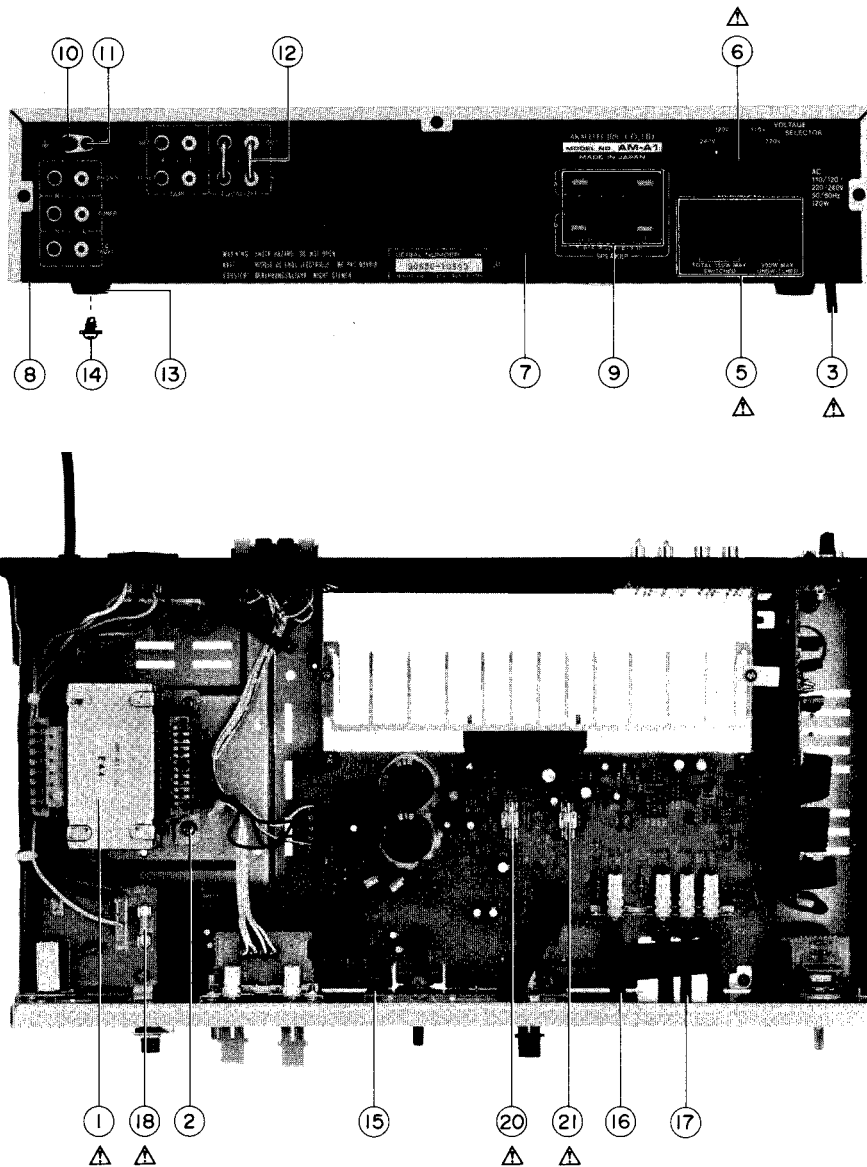

13. ASSEMBLY BLOCK

REF. NO.	PARTS NO.	DESCRIPTION	REF. NO.	PARTS NO.	DESCRIPTION
13-1A	BT-352426	△ TRANS POWER AM-A1Y-70 (U)	13-5A	EJ-337405	△ SOCKET OUTLET S2T733T164 JUC 3x2P (U) (J901)
13-1B	BT-352428	△ TRANS POWER AM-A1T-30 (C)	13-5B	EJ-352642	△ SOKET OUTLET S2T733T114T (C,A) (J901)
13-1C	BT-352429	△ TRANS POWER AM-A1T-20 (A)	13-6	ES-349070	△ SW SELECTOR YKS11-0002 02-4 (U)
13-1D	BT-352430	△ TRANS POWER AM-A1T-40 (E,V)	13-7A	SP-349930J	PANEL REAR AM-A1 (U)
13-1E	BT-352431	△ TRANS POWER AM-A1T-50 (B,S)	13-7B	SP-349930K	PANEL REAR AM-A1 (C,A)
13-2	ZS-346732	△ ST BID40x08STL CMT CUP	13-7C	SP-349930L	PANEL REAR AM-A1 (E,V)
13-3A	EW-354515	△ AC CORD 2 CORES KP-700A, VFF-CB U/T (U)	13-7D	SP-349930M	PANEL REAR AM-A1 (B,S)
13-3B	EW-349427	△ AC CORD 2 CORES KP-8W, SPT-2 UC (C)	13-8	ZS-308846	T2BR30x08STL BZN PROJECTION
13-3C	EW-349428	△ AC CORD 2 CORES KP-8W, SPT-1 UC (A)	13-9A	EJ-351485	TERMINAL PUSH YKD21-0148A S 8P (EXCEPT V)
13-3D	EW-354625	△ AC CORD 2 CORES KP-419C, LTCE- 2F E (E)	13-9B	EJ-349401	TERMINAL LEVER YKD21-0027 8P (V)
13-3E	EW-354513	△ AC CORD 2 CORES KP-419C, LTCE- 2F EV (V)	13-10	EJ-329610	TERMINAL W/SCREW UB-0067 L 1P
13-3F	EW-354512	△ AC CORD 2 CORES LTBS-2F CB B (B)	13-11	ZS-308846	T2BR30x08STL BZN PROJECTION
13-3G	EW-354514	△ AC CORD 2 CORES KP-560, LTSA2F-CB S (S)	13-12	EJ-348218	PLUG SHORT PIN P2138
13-4X	EZ-631945	STRAIN RELIEF SR-4N 4 (C,A)	13-13	SA-202118	FOOT
			13-14	ZS-498273	T2BR30x08STL CMT PW080
			13-15	ZW-698308	RV NYL30x055 BL
			13-16	TA-349937	JOINT (B)

FINAL ASSEMBLY BLOCK

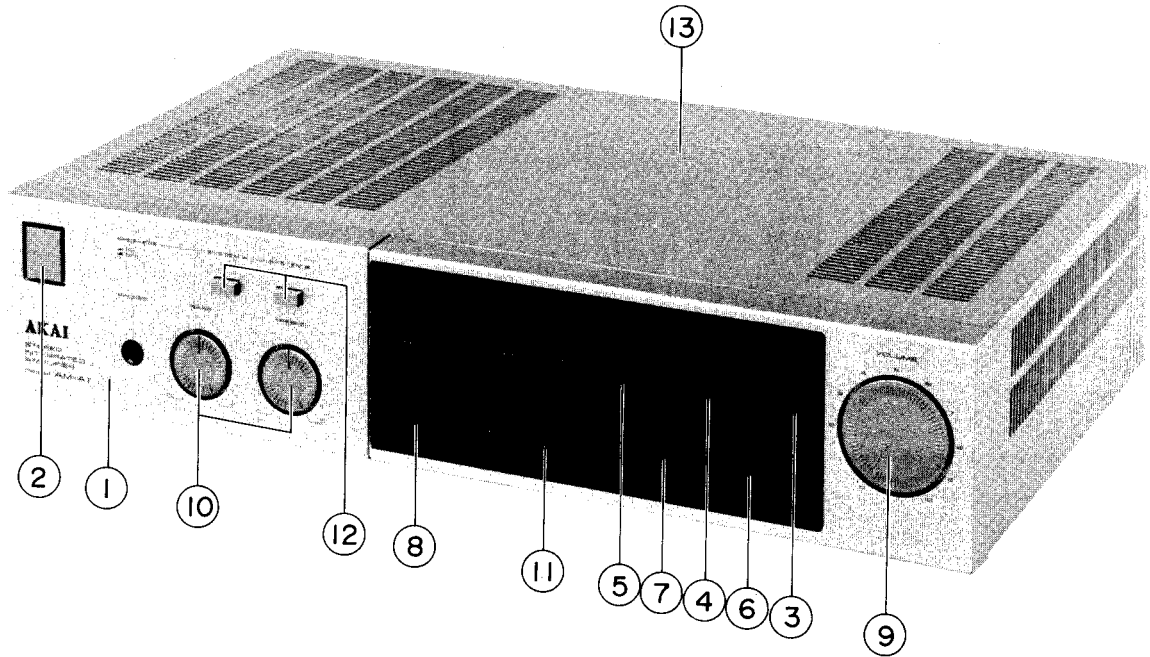

14. FINAL ASSEMBLY BLOCK

REF. NO.	PARTS NO.	DESCRIPTION
13-17	TA-349938	JOINT (C)
13-18A	EF-326639	△ FUSE TSC A 250V 3.15A (U) (F1)
13-18B	EF-306956	△ FUSE TSC 125V 2.50A (C,A) (F1)
13-18C	EF-602550	△ FUSE SEMKO T 250V 1.25A (E,V,B,S) (F1)
13-19A	EF-346139	△ FUSE TSC 125V 5.00A (C,A) (F3)
13-19B	EF-690996	△ FUSE SEMKO T 250V 4.00A (E,V,B,S) (F3)
13-20A	EF-306951	△ FUSE TSC A 250V 2.50A (U) (F4)
13-20B	EF-306954	△ FUSE TSC 125V 2.00A (C) (F4)
13-20C	EF-306956	△ FUSE TSC 125V 2.50A (A) (F4)
13-20D	EF-601964	△ FUSE SEMKO T 250V 1.60A (E,V,B,S) (F4)
13-21A	EF-306951	△ FUSE TSC A 250V 2.50A (U) (F5)
13-21B	EF-306954	△ FUSE TSC 125V 2.00A (C) (F5)
13-21C	EF-306956	△ FUSE TSC 125V 2.50A (A) (F5)
13-21D	EF-601964	△ FUSE SEMKO T 250V 1.60A (E,V,B,S) (F5)
13-22X	ZW-305013	RV POP 32 (A)

REF. NO.	PARTS NO.	DESCRIPTION
14-1	BD-A2033A030A	PANEL FRONT BLK AM-A1
14-1P	BD-A2033A030B	PANEL FRONT BLK AM-A1-P
14-1B	BD-A2033A030C	PANEL FRONT BLK AM-A1-B
14-2	SK-343017C	KNOB POWER (2)
14-2P	SK-343017B	KNOB POWER-P
14-2B	SK-343017F	KNOB POWER-B
14-3	SK-349943A	KNOB (C-1) (EXCEPT BL)
14-3B	SK-349943D	KNOB (C-1)-B (BL)
14-4	SK-349943B	KNOB (C-2) (EXCEPT BL)
14-4B	SK-349943E	KNOB (C-2)-B (BL)
14-5	SK-349943C	KNOB (C-3) (EXCEPT BL)
14-5B	SK-349943F	KNOB (C-3)-B (BL)
14-6	SK-349941C	KNOB (D-3) (EXCEPT BL)
14-6B	SK-349941D	KNOB (D-3)-B (BL)
14-7	SK-349946	KNOB (E) (EXCEPT BL)
14-7B	SK-349946B	KNOB (E)-B (BL)
14-8	SK-332591A	KNOB VOLUME (A) (EXCEPT BL)
14-8B	SK-332591E	KNOB VOLUME (A-5) (BL)
14-9	SK-345375G	KNOB VOLUME (E)
14-9P	SK-345375D	KNOB VOLUME (B)-P
14-9B	SK-35375K	KNOB VOLUME (H) (BL)
14-10	SK-349939A	KNOB (A)
14-10P	SK-349939B	KNOB (A)-P
14-10B	SK-349939C	KNOB (A)-B (BL)
14-11	SK-349940A	KNOB (B-1)
14-12	SK-349940B	KNOB (B-2)
14-12P	SK-349940C	KNOB (B-3)
14-12B	SK-349940A	KNOB (B-1) (BL)
14-13	SP-349925A	COVER UPPER
14-13P	SP-349925B	COVER UPPER-P
14-13B	SP-349925C	COVER UPPER-B

NOTE: SYMBOL FOR COLOR VARIATION

NON : STANDARD COLOR

P : PEARL SHADOW

B or BL : BLACK

INDEX

PARTS NO.	REF. NO.	PARTS NO.	REF. NO.	PARTS NO.	REF. NO.	PARTS NO.	REF. NO.	PARTS NO.	REF. NO.
BA-A2033A020A	1-1A	ER-327198	2-R38						
BA-A2033A020B	1-1B	ER-328082	2-R44						
BA-A2033A020C	1-1C	ER-328278	2-FR1						
BA-A2033A020D	1-1D	ER-333355	2-R24						
BA-A2033A020E	1-1E	ER-333376	2-R32						
BD-A2033A030A	14-1	ER-333376	2-R37						
BD-A2033A030B	14-1P	ER-333654	2-R28						
BD-A2033A030C	14-1B	ER-333654	2-R27						
BT-352426	13-1A	ER-333654	2-R29						
BT-352428	13-1B	ER-333654	2-R30						
BT-352429	13-1C	ER-333654	2-R31						
BT-352430	13-1D	ER-353214	2-R36						
BT-352431	13-1E	ER-353214	2-R41						
EC-320548	11-C1A	ES-337902	11-SW1						
EC-326583	2-C27	ES-349070	13-6						
EC-338411	11-C1B	ES-352619	2-SW1						
EC-338496	11-C1C	ES-352620	2-SW2						
ED-200213	2-D5	ES-352624	6-SW3						
ED-301911	2-D6	ET-349882	2-TR2						
ED-306320	3-D1	ET-349883	2-TR1						
ED-324013	2-D2	EV-352621	7-VR1						
ED-324013	2-D4	EV-352622	8-VR1						
ED-329056	2-D7	EV-352623	2-VR1						
ED-337391	5-D2	EV-352623	2-VR2						
ED-337391	5-D3	EW-349427	13-3B						
ED-337391	5-D4	EW-349428	13-3C						
ED-349656	5-D1	EW-354512	13-3F						
ED-349656	5-D5	EW-354513	13-3E						
EF-306951	13-21A	EW-354514	13-3G						
EF-306951	13-20A	EW-354515	13-3A						
EF-306954	13-21B	EW-354625	13-3D						
EF-306954	13-20B	EZ-631945	13-4x						
EF-306956	13-20C	SA-202118	13-13						
EF-306956	13-21C	SK-332591A	14-8						
EF-306956	13-18B	SK-332591E	14-8B						
EF-326639	13-18A	SK-343017B	14-2P						
EF-346139	13-19A	SK-343017C	14-2						
EF-601964	13-20D	SK-343017F	14-2B						
EF-601964	13-21D	SK-345375D	14-9P						
EF-602550	13-18C	SK-345375G	14-9						
EF-690996	13-19B	SK-345375K	14-9B						
EI-337228	2-IC1	SK-349939A	14-10						
EI-344764	3-IC1	SK-349939B	14-10P						
EI-352644	2-IC2	SK-349939C	14-10B						
EJ-329610	13-10	SK-349940A	14-11						
EJ-337405	13-5A	SK-349940A	14-12B						
EJ-343365	4-J1	SK-349940B	14-12						
EJ-343365	4-J2	SK-349940C	14-12P						
EJ-343380	10-J1A	SK-349941C	14-6						
EJ-344370	3-J1	SK-349941D	14-6B						
EJ-348218	13-12	SK-349943A	14-3						
EJ-349401	9-TM902	SK-349943B	14-4						
EJ-349401	13-9B	SK-349943C	14-5						
EJ-351485	13-9A	SK-349943D	14-3B						
EJ-352642	13-5B	SK-349943E	14-4B						
EJ-355012	10-J1B	SK-349943F	14-5B						
EO-336902	2-L1	SK-349946	14-7						
EO-336934	3-L2	SK-349946B	14-7B						
EO-336934	3-L3	SP-349925A	14-13						
EO-336934	4-L3	SP-349925B	14-13P						
EO-336934	4-L4	SP-349925C	14-13B						
EO-336934	4-L5	SP-349930J	13-7A						
EO-336934	4-L6	SP-349930K	13-7B						
EO-336934	4-L1	SP-349930L	13-7C						
EO-336934	4-L2	SP-349930M	13-7D						
EO-336934	10-L1	TA-349937	13-16						
EO-338409	12-L1	TA-349938	13-17						
EO-338420	3-L1	ZS-308846	13-8						
EO-342936	9-L1	ZS-308846	13-11						
ER-200746	2-FR2	ZS-346742	13-2						
ER-302241	2-R35	ZS-498273	13-14						
ER-302241	2-R40	ZW-305013	13-22x						
ER-308028	2-R25	ZW-698308	13-15						
ER-308875	2-R22								
ER-308875	2-R26								
ER-322331	3-R7								
ER-325269	2-R21								
ER-325269	2-R34								
ER-325269	2-R39								
ER-327198	2-R33								

AKAI

MODEL AM-A1

PC BOARD SCHEMATIC DIAGRAM

1. SCHEMATIC DIAGRAM OF ICs 2
2. AM-A1 NO.840801A BLOCK DIAGRAM 2
3. AM-A1 NO.840802A SCHEMATIC DIAGRAM 3
4. MAIN AMP PC BOARD A2033A501A(U)(2ED), A2033A502A(C,A),
A2033A503A(E,B,C), A2033A504A(V) 4
5. EQUALIZER PC BOARD A2033A501B(U), A2033A502B(C,A),
A2033A503B(E,B,S), A2033A504B(V) 4
6. OTHER PC BOARDS 5

STK4141-II

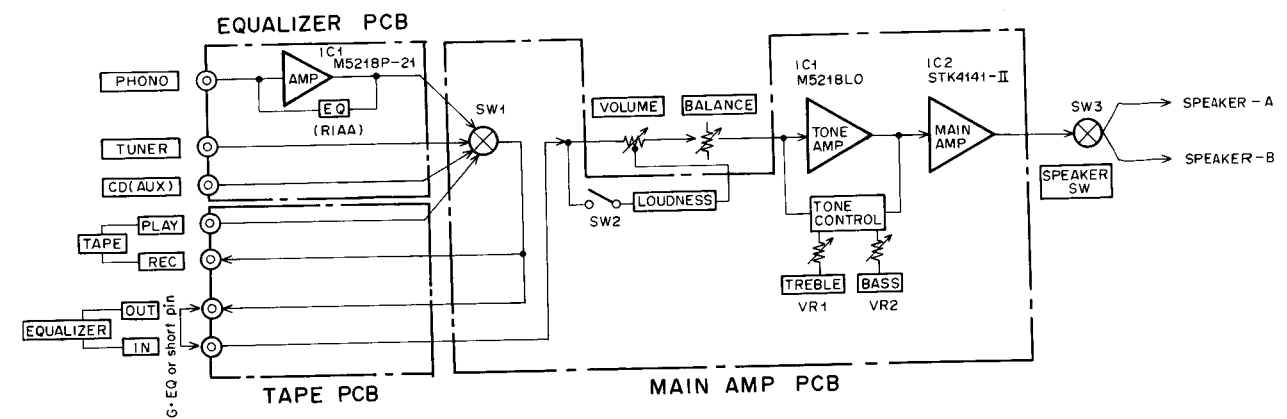
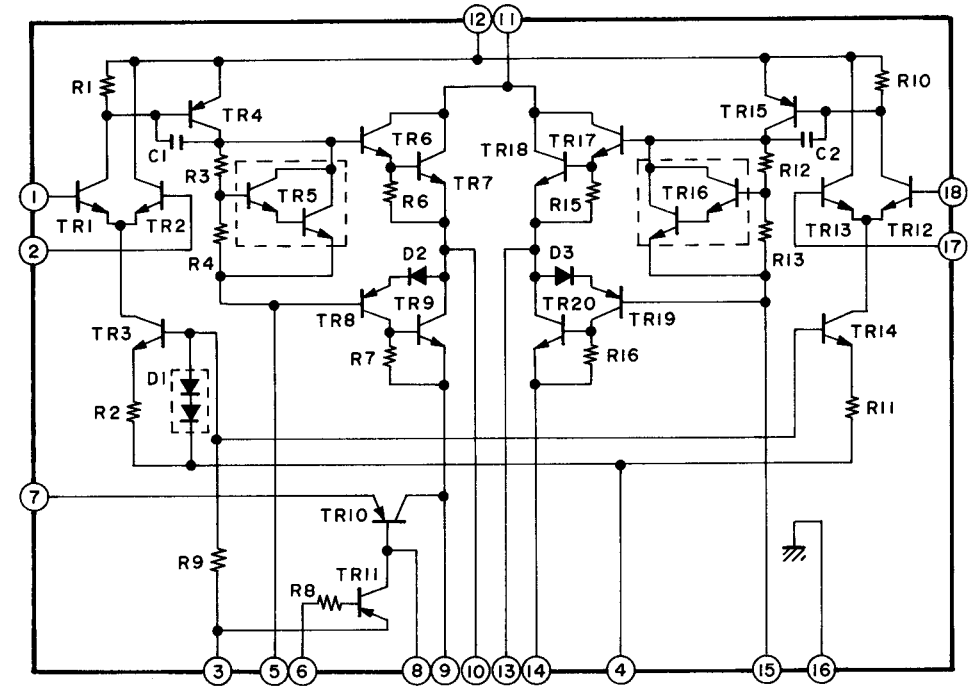

AM-A1
BLOCK DIAGRAM
NO. 840801A

AM-A1

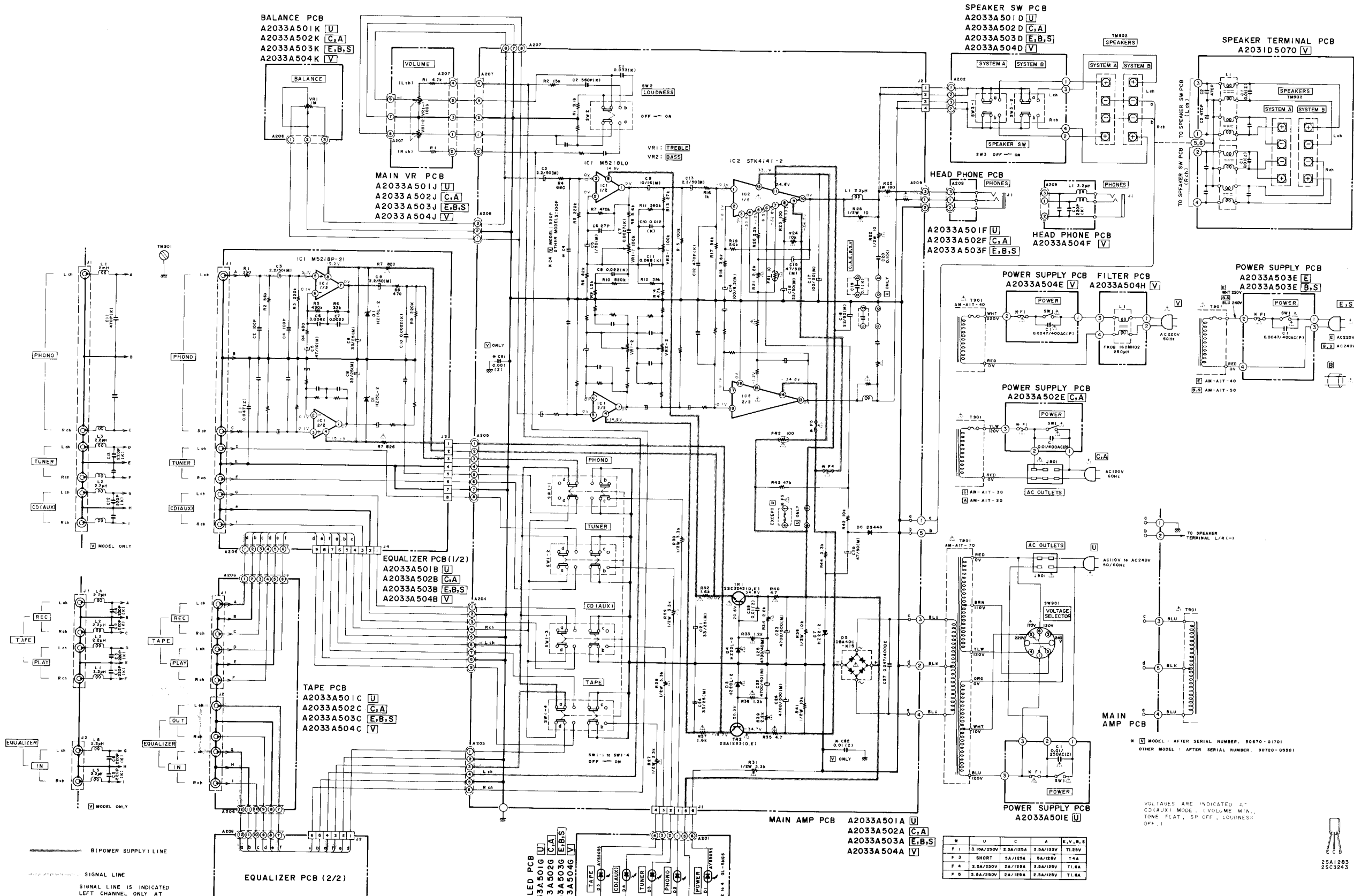

(POWER SUPPLY) LINE
 SIGNAL LINE
 SIGNAL LINE IS INDICATED LEFT CHANNEL ONLY AT PHONO MODE.

LED PCB
 A2033A501G [U]
 A2033A502G [C,A]
 A2033A503G [E,B,S]
 A2033A504G [V]

MAIN AMP PCB
 A2033A501A [U]
 A2033A502A [C,A]
 A2033A503A [E,B,S]
 A2033A504A [V]

F	U	C	A	E,V,R,S
F 1	3.15A/250V	2.5A/125A	2.5A/125V	T1.25V
F 3	SHORT	5A/125A	5A/125V	T 4A
F 4	2.5A/250V	2A/125A	2.5A/125V	T1.6A
F 5	2.5A/250V	2A/125A	2.5A/125V	T1.6A

H MODEL: AFTER SERIAL NUMBER, 90670-01701
 OTHER MODEL: AFTER SERIAL NUMBER, 90720-09501

VOLTAGES ARE INDICATED AT CD(AUX) MODE. (VOLUME MIN., TONE FLAT, SP OFF, LOUDNESS OFF.)

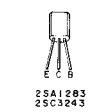

55A1283
 25C3243

WARNING: A INDICATES SAFETY CRITICAL COMPONENTS. (C) CONTINUED SAFETY. REPLACE SAFETY CRITICAL COMPONENTS ONLY WITH MANUFACTURER'S RECOMMENDED PARTS.
 AVERTISSEMENT: A INDICQUE LES COMPOSANTS CRITIQUES DE SECURITE. POUR MAINTENIR LE DEGRE DE SECURITE DE L'APPAREIL, NE REMPLACEZ QUE DES PIECES RECOMMANDEES PAR LE FABRICANT.

NOTE
 UNLESS OTHERWISE SPECIFIED ALL RESISTORS IN OHMS (1/4W/1%) ALL CAPACITORS IN MF (50WV/1J)

AM-A1
SCHEMATIC DIAGRAM
 No. 840802A

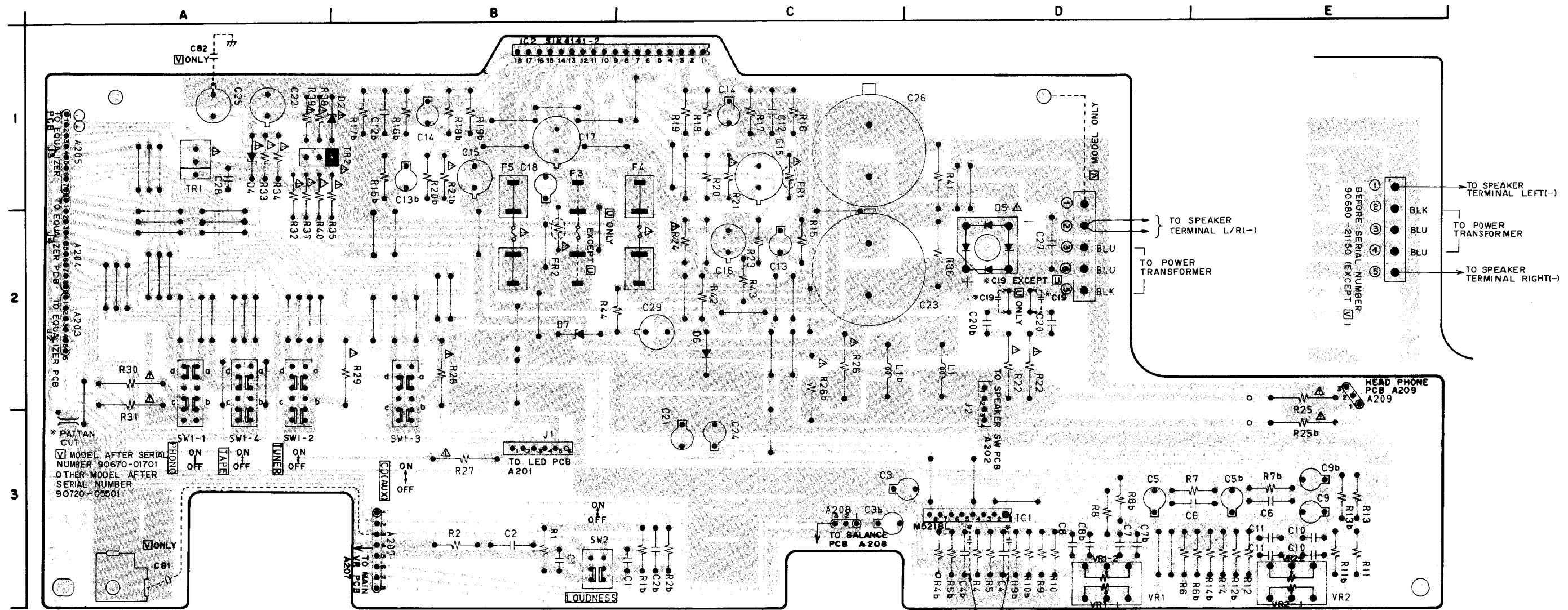

MAIN AMP PCB A2033A501A (2ED)
 502A C,A
 503A E,B,C
 504A

For model only, the Capacitor C4 is divided on pattern side and parts side before July production lot. (Serial number : 90670-02100)

- LOCATION OF COMPONENTS
- IC
 - IC1-----D3
 - IC2-----B1,C1
 - TR
 - TR1,2-----A1
 - TERMINAL
 - J1-----B3
 - J2-----D2,D3
 - A203, A204--A2
 - A205-----A1
 - A207-----B3
 - A208-----C3
 - A209-----E2
 - ①-----D1
 - ②to⑤-----D2

- TR1 2SC3243(D, E)
- TR2 2SA1283(D, E)

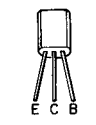

2SA1283
2SC3243

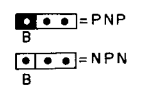

WARNING: INDICATES SAFETY CRITICAL COMPONENTS FOR CONTINUED SAFETY. REPLACE SAFETY CRITICAL COMPONENTS ONLY WITH MANUFACTURER'S RECOMMENDED PARTS.
 AVERTISSEMENT: IL INDIQUE LES COMPOSANTS CRITIQUES DE SÉCURITÉ. POUR MAINTENIR LE DEGRÉ DE SÉCURITÉ DE L'APPAREIL, NE REMPLACER QUE DES PIÈCES RECOMMANDÉES PAR LE FABRICANT

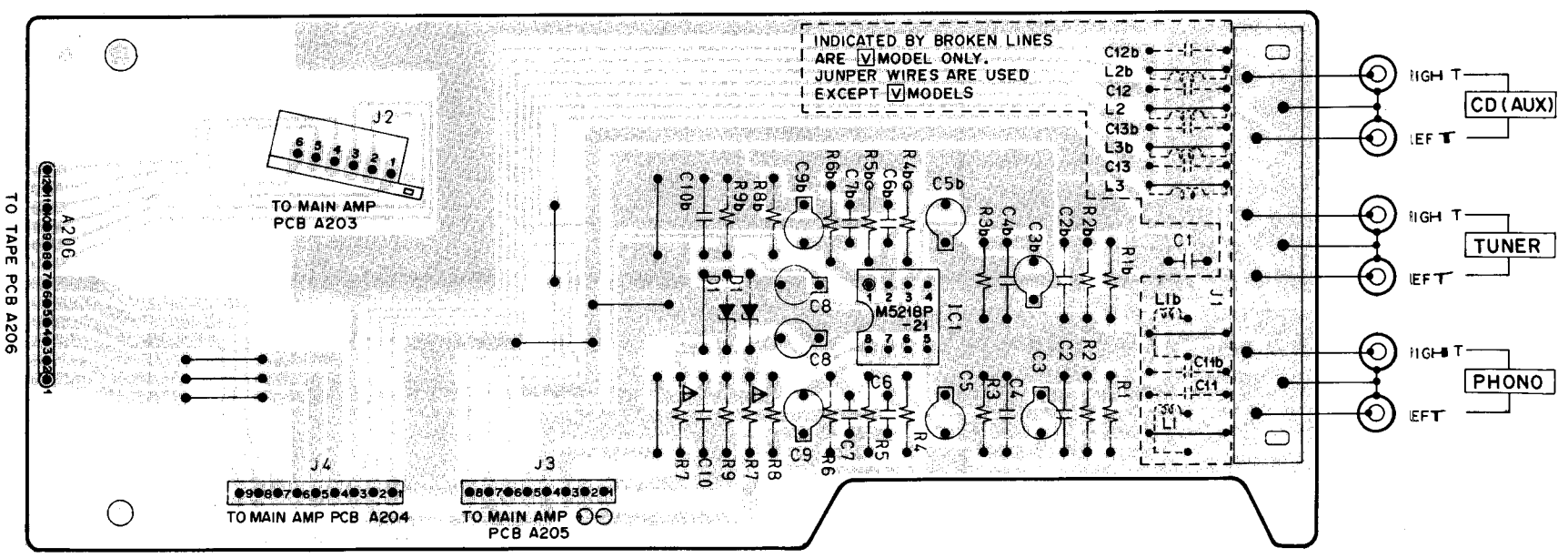

EQUALIZER PCB A2033A501B
 A502B C,A
 A503B E,B,S
 A504B

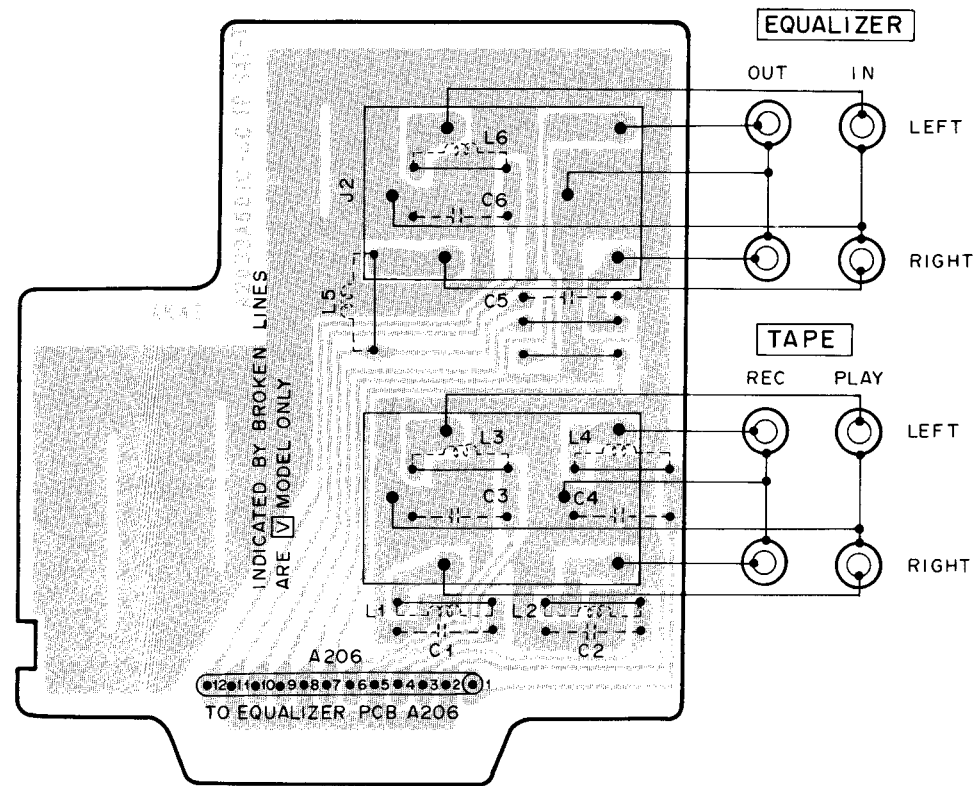

TAPE PCB A2033 A501C [U]
 A502C [C,A]
 A503C [E,B,S]
 A504C [V]

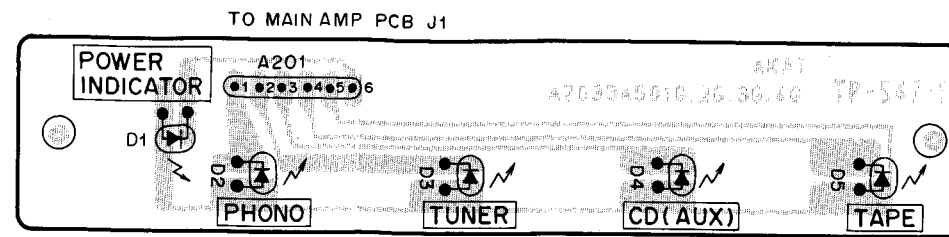

LED PCB A2033 A501G [U]
 A502G [C,A]
 A503G [E,B,S]
 A504G [V]

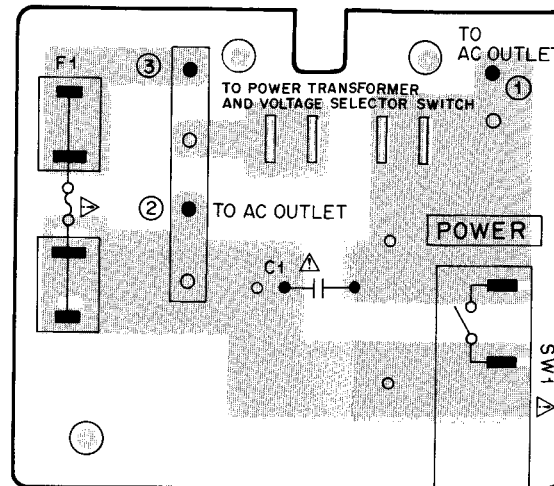

POWER SUPPLY PCB A2033A501E [U]

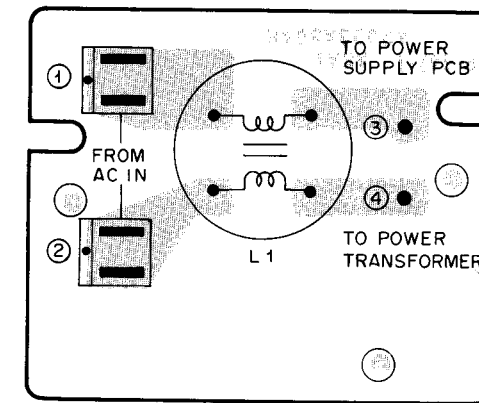

FILTER PCB A2033A504H [V]

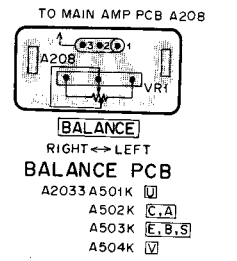

BALANCE
 RIGHT ↔ LEFT
BALANCE PCB
 A2033 A501K [U]
 A502K [C,A]
 A503K [E,B,S]
 A504K [V]

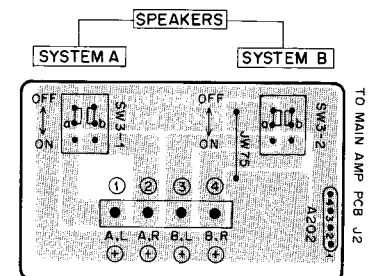

SPEAKER SW PCB
 A2033A501D [U]
 A502D [C,A]
 A503D [E,B,S]
 A504D [V]

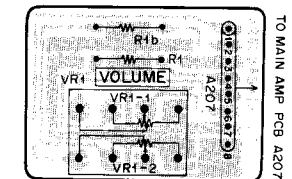

MAIN VR PCB
 A2033 A501J [U]
 A502J [C,A]
 A503J [E,B,S]
 A504J [V]

WARNING: ⚠ INDICATES SAFETY CRITICAL COMPONENTS. FOR CONTINUED SAFETY, REPLACE SAFETY CRITICAL COMPONENTS ONLY WITH MANUFACTURER'S RECOMMENDED PARTS.
 AVERTISSEMENT: ⚠ IL INDIQUE LES COMPOSANTS CRITIQUES DE SÉCURITÉ. POUR MAINTENIR LE DEGRÉ DE SÉCURITÉ DE L'APPAREIL, NE REMPLACER QUE DES PIÈCES RECOMMANDÉES PAR LE FABRICANT.

INDICATED BY BROKEN LINES ARE [V] MODEL ONLY

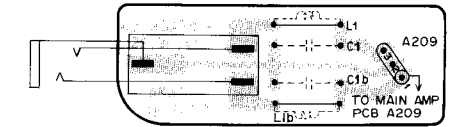

HEAD PHONE PCB
 A2033A501F [U]
 A502F [C,A]
 A503F [E,B,S]
 A504F [V]

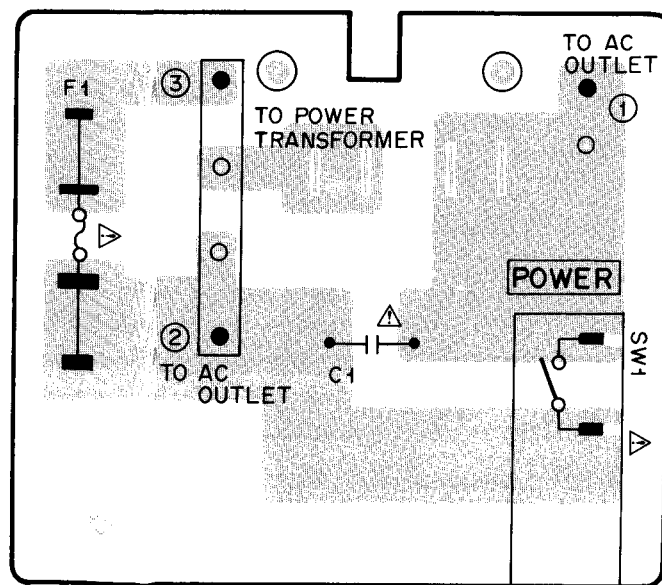

POWER SUPPLY PCB
 A2033A502E [C,A]

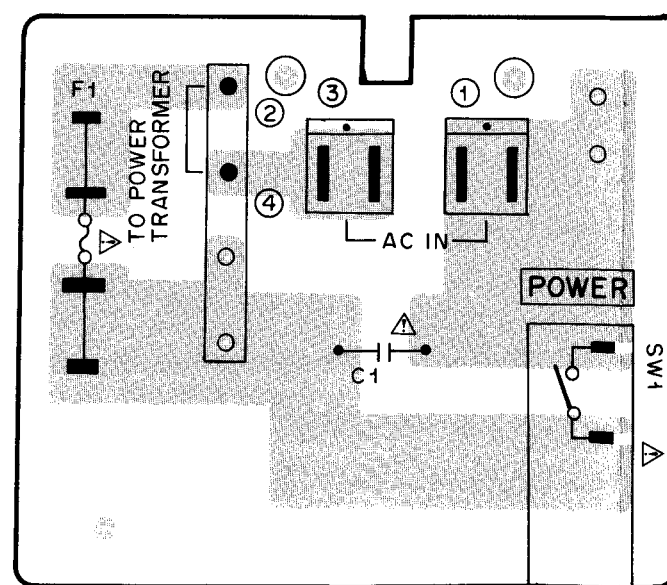

POWER SUPPLY PCB
 A2033A503E [E,B,S]

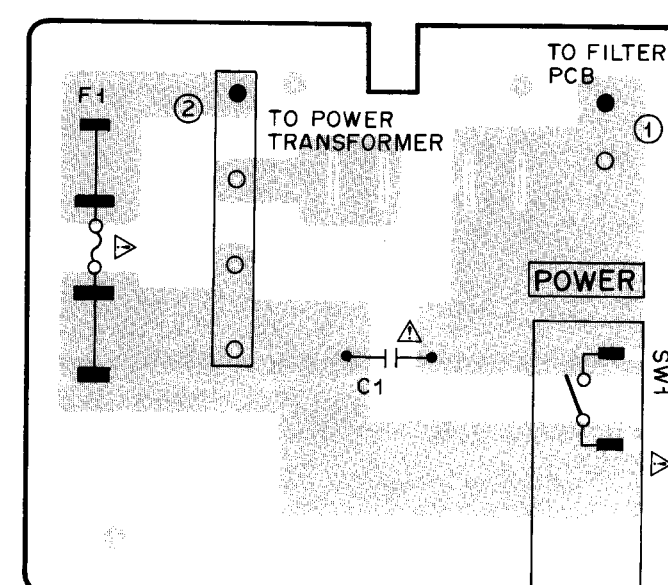

POWER SUPPLY PCB
 A2033A504E [V]

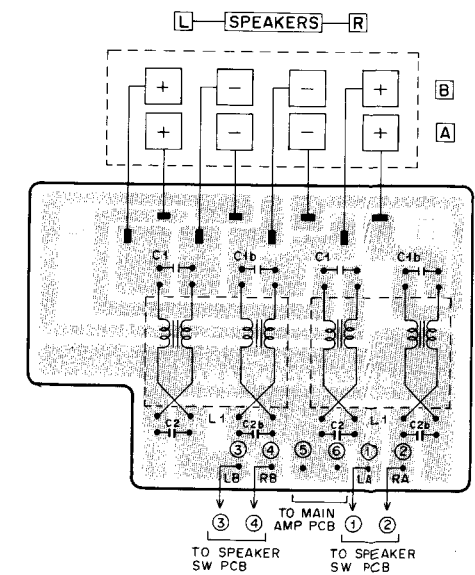

SPEAKER TERMINAL PCB
 A2031D5070