

SX-2500

FVW



INSTALLATION, OPERATION AND SERVICE MANUAL

Including PARTS LIST, CIRCUIT DIAGRAMS,
TROUBLE SHOOTING AND MOUNTING TEMPLATE.

PIONEER®

FEATURES

TUNING SECTION

AUTOMATIC TUNING

The "AUTO TUNING" SWITCHES allow the dial pointer to scan the dial, stopping and centering on an FM station. To get the next station, just press the switch and the lit pointer travels to it automatically without dialing.

MANUAL TUNING

If the "AUTO TUNING" SWITCHES are not in use, tuning is manual. The 2 tuning meters make this quick and accurate

FM CIRCUITRY

The FRONT END employs FET and two-stage radio frequency amplifier, for higher signal-to-noise ratio.

The IF STAGE includes a crystal filter and 4 IC's to provide excellent limiting, selectivity and capture ratio.

EASY TO USE

The FM MUTING knob provides a variable degree of muting, depending on the number of stations you want to scan.

The FM STEREO STATION button, when pressed, causes the pointer to pass by stronger FM mono stations and stop only at FM stereo.

REMOTE CONTROL

With the remote control attachment you can operate the tuning and volume controls of the SX-2500 from distances up to 20 feet. This is one of the most convenient features of this advanced tuner.

AUDIO SECTION

200 WATTS MUSIC POWER

The high power of the SX-2500 will drive even very low-efficiency speakers with ease, and eliminates clipping.

STEP TONE CONTROLS

The "step" treble and bass knobs let you set ideal tonal balance quickly.

3-STAGE EQUALIZER CIRCUIT

This is a professional circuit that provides higher dynamic range and lower distortion.

HIGHLY VERSATILE

The SX-2500 incorporates an 8-pin socket for a step-up transformer unit Pioneer PP-402 for a moving coil cartridge; a switch for separate use of pre- and main amplifiers; outputs for 2 stereo systems; a PHONO 1 and PHONO 2 button, and connections for 2 tape recorders or decks, permitting even tape-to-tape dubbing.

STYLING

The SX-2500 is a handsome unit, with a smoked glass dial face and indicators that light up to indicate various function modes and tuning.

LINE VOLTAGE SELECTION AND FUSE

SWITCHING LINE VOLTAGE SETTING AND FUSE

To remove the fuse, turn the fusecap located on the line voltage selector switch in the direction indicated by the arrow. Then remove the fuse plug from the unit.

Put the fuse plug back so that the proper line voltage marking can be seen through the cut on the edge of the plug. Whenever the position of the selector switch is changed, check the rating of the fuse.

A 1.5-ampere is to be used for either 220V or 240V operation and a 3-ampere fuse for 110V, 120V or 130V operation.

If the rating of the fuse is correct, replace cap.

FUSE REPLACEMENT

If the fuse blows, remove the fuse cap and replace the fuse with a new one.

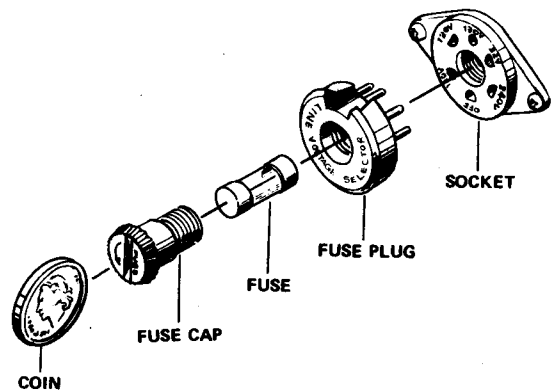

Take off the fuse cap by turning it with a coin, in the direction indicated by the arrow.

Fig. 1

STEREO SYSTEM

The SX-2500 is general-purpose stereo amplifier. Connect it to the speaker systems (two or four), turntable, tape recorder, etc., which are separately available.

INSTALLATION

When installing your stereo system, check the following points.

- The area should be well-ventilated, and free from dampness and dust.
- The units should not be exposed to direct sunlight.
- The units should not be placed near radiators or other heating units.
- The place should be substantial and roomy enough for the installation, when installing the unit on a shelf.

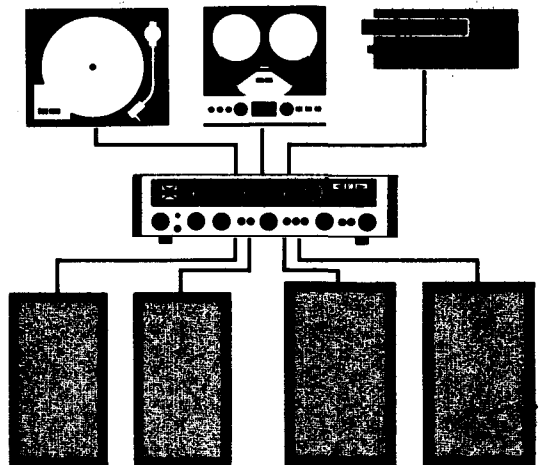

Fig. 2

A WORD ABOUT ROOM ACOUSTICS

The quality of reproduced sound varies according to the size and shape of the room, the materials of walls, floor and ceiling and the amount and arrangement of furniture. Too harsh or "bright" a sound usually results from too many hard reflecting surfaces, and/or too low a ceiling. This condition is improved by having ample carpet area or covering the wall (especially that facing the speakers) with a thick curtain.

On the other hand, too many absorbing surfaces will tend to "soak up" the sound, resulting in a certain "deadness". Furniture may be rearranged to provide irregular reflection of the sound. In any event, the true stereo effect is lost if the two speaker systems are placed too far apart. This may be corrected by angling them slightly toward each other or reducing the distance between them.

CONNECTING THE SPEAKER SYSTEM

- To connect a speaker, take a furnished speaker connector plug and connect it to the leads of the speaker as in Fig. 3. Be sure the polarity is correct.
- When the plugs have been connected to speakers, connect the plugs of the left and right channel speakers to the SPEAKER OUTPUT A Terminal.
- When using two speaker systems with the SX-2500, connect the second speaker system to SPEAKER OUTPUT B Terminals.

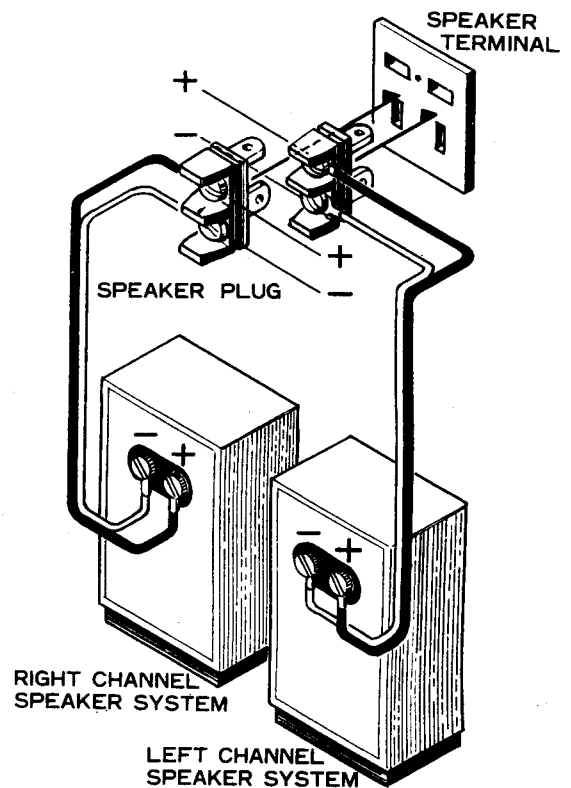

Fig. 3

LINE VOLTAGE SELECTION AND FUSE

SWITCHING LINE VOLTAGE SETTING AND FUSE

To remove the fuse, turn the fusecap located on the line voltage selector switch in the direction indicated by the arrow. Then remove the fuse plug from the unit.

Put the fuse plug back so that the proper line voltage marking can be seen through the cut on the edge of the plug. Whenever the position of the selector switch is changed, check the rating of the fuse.

A 1.5-ampere is to be used for either 220V or 240V operation and a 3-ampere fuse for 110V, 120V or 130V operation.

If the rating of the fuse is correct, replace cap.

FUSE REPLACEMENT

- If the fuse blows, remove the fuse cap and replace the fuse with a new one.

STEREO SYSTEM

The SX-2500 is general-purpose stereo amplifier. Connect it to the speaker systems (two or four), turntable, tape recorder, etc., which are separately available.

INSTALLATION

When installing your stereo system, check the following points.

- The area should be well-ventilated, and free from dampness and dust.
- The units should not be exposed to direct sunlight.
- The units should not be placed near radiators or other heating units.
- The place should be substantial and roomy enough for the installation, when installing the unit on a shelf.

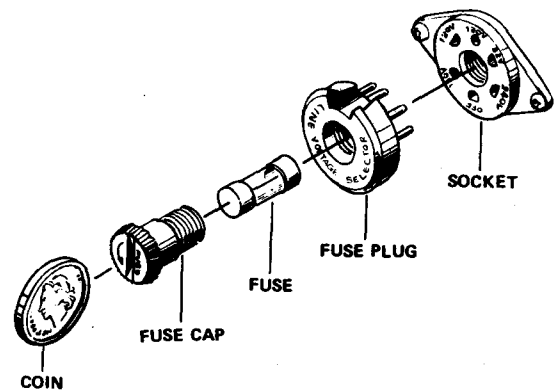

Take off the fuse cap by turning it with a coin, in the direction indicated by the arrow.

Fig. 1

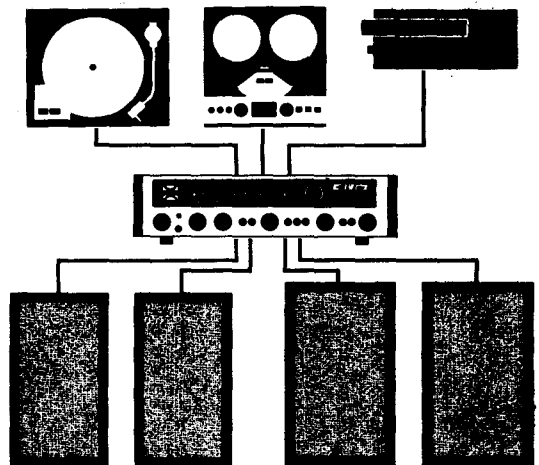

Fig. 2

A WORD ABOUT ROOM ACOUSTICS

The quality of reproduced sound varies according to the size and shape of the room, the materials of walls, floor and ceiling and the amount and arrangement of furniture. Too harsh or "bright" a sound usually results from too many hard reflecting surfaces, and/or too low a ceiling. This condition is improved by having ample carpet area or covering the wall (especially that facing the speakers) with a thick curtain.

On the other hand, too many absorbing surfaces will tend to "soak up" the sound, resulting in a certain "deadness". Furniture may be rearranged to provide irregular reflection of the sound. In any event, the true stereo effect is lost if the two speaker systems are placed too far apart. This may be corrected by angling them slightly toward each other or reducing the distance between them.

CONNECTING THE SPEAKER SYSTEM

- To connect a speaker, take a furnished speaker connector plug and connect it to the leads of the speaker as in Fig. 3. Be sure the polarity is correct.
- When the plugs have been connected to speakers, connect the plugs of the left and right channel speakers to the SPEAKER OUTPUT A Terminal.
- When using two speaker systems with the SX-2500, connect the second speaker system to SPEAKER OUTPUT B Terminals.

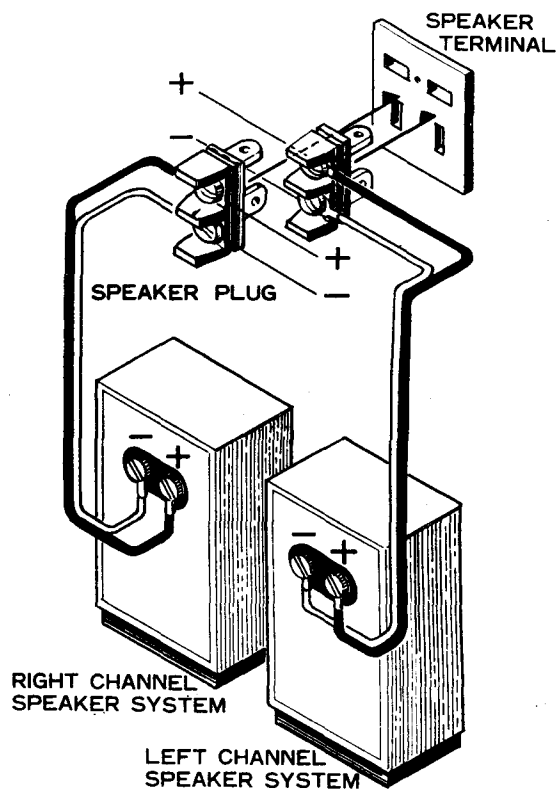

Fig. 3

ANTENNA AND GROUND CONNECTION

ANTENNAS

When using MODEL SX-2500 at place of low field strength or distant from the station, select the most suitable FM and AM antenna as follows, and the efficiency of any antenna depends on its height more than its length.

FM ANTENNA

- Reception is easier if the building is primarily of wood and is near the FM station in this case, use the accessory T-type indoor antenna.

Unfold the horizontal section of the antenna to its full length, and determine the best direction for the antenna while actually receiving an FM broadcast program.

- When using MODEL SX-2500 at a relatively long distance from the station, or within a building or home with relatively thick walls, or vicinity of tall buildings, erect an outdoor FM antenna, and connect it to the FM antenna terminals as in Fig. 5.

There are various FM antennas, consisting of 3 to 7 elements.

Select the best antenna by consulting a nearby RADIO, TV or HI-FI store.

AM ANTENNA

- If your house is located in area relatively close to the AM station, the ferrite loopstick antenna provided on the back of MODEL SX-2500 will be sufficient for reception of AM programs.

The antenna is directional, and it should be moved about while listening to a station and set at the position which provides the best reception.

- If the loopstick antenna does not provide sufficient sensitivity for reception and static is noticeable, put the furnished antenna wire on the wall and connect one end of the wire to the AM antenna terminal.
- If you want reception from a distant AM station, you may have to set up an outdoor AM antenna. In such a case, connect one end of the AM outdoor antenna to the AM antenna terminal.

NOTE: A standard AM outdoor antenna can be formed by purchasing insulated wire from an electric appliance store and installing it 25 feet(7.5m) above the ground for a horizontal length of 50 feet(15m), with a feeder line 30 feet(10m) long. These antenna dimensions need not be so precise, should not be too low, to attain good results.

GROUNDING

The MODEL SX-2500 will provide stable performance whether grounded or not. In rare cases, however, grounding may help. If so, connect a wire from the GND terminal to a water pipe or metal balcony, fastening it firmly. Never use a gas-pipe as a ground.

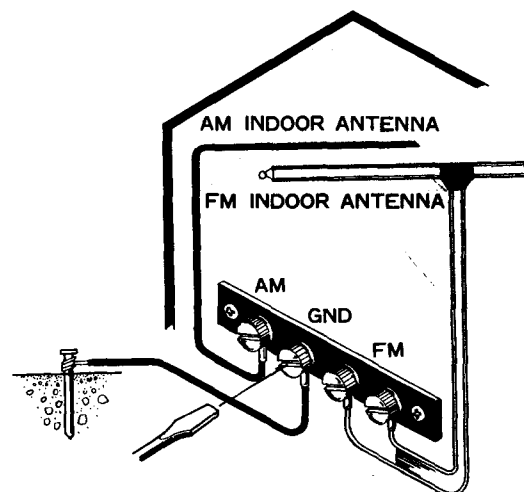

Fig. 4

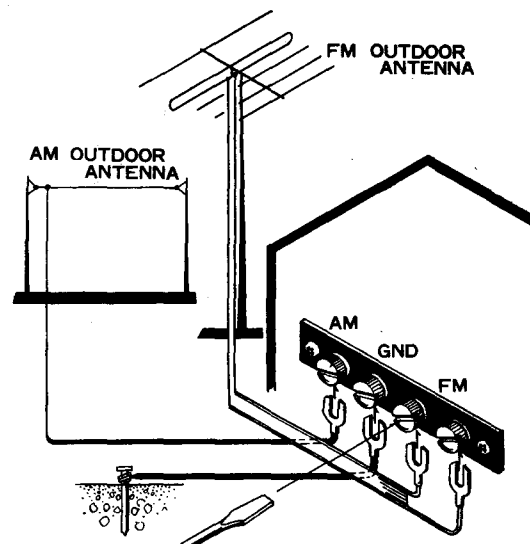

Fig. 5

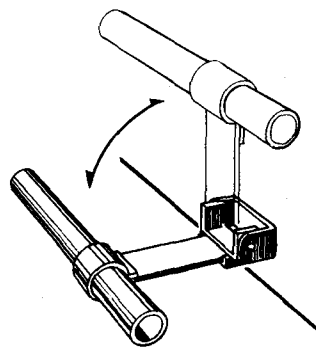

Fig. 6

CONNECTING THE TURNTABLE

- The turntables or changers to be used is equipped with a magnetic type cartridge, connect the output of the turntable to the MAG terminals of PHONO 1 on the rear panel; if equipped with a ceramic cartridge, to the CER terminals of PHONO 2.

Connect the left channel output cord of the turntable to the upper terminal, and the right channel output cord to the lower terminal.

When using a monophonic turntable, its output cord may be connected to either upper or lower terminal.

- To use two turntables or changers both having a magnetic type cartridge.

Connect one to the PHONO 1 MAG terminals and the other to the PHONO 2 MAG terminals.

NOTE: 1. When desiring to use a turntable equipped with a moving-coil(MC) cartridge, use a Pioneer's Model PP-402 MC Transformer, separately available.

2. The output cords of some turntable are provided with plugs which do not fit the input jacks of MODEL SX-2500. In such a case, replace the plugs with the pin plugs contained in the accessories bag.

CONNECTING THE TAPE DECK OR TAPE RECORDER

- The tape deck or tape recorder to be connected to MODEL SX-2500 should have a record/playback pre-amplifier built-in, such as Pioneer's MODEL T-500F, T-600F.
- The tape recorder to be connected should have output terminals (LINE OUTPUT jacks for external amplifier), or tape monitor terminals.

CONNECTIONS FOR RECORDING

- Connect the LINE INPUT terminals of the tape deck to the TAPE REC terminals on the rear panel. For this connection, use the cords furnished with the tape deck. The upper terminal is for the left channel, and the lower one is for the right channel.

If the tape deck is monophonic, connect it to the upper terminal.

CONNECTIONS FOR PLAYBACK OR RECORDING MONITOR

- Connect the LINE OUTPUT or TAPE MONITOR terminals of the tape deck to the TAPE MON terminals. Use of the terminals is similar to that for the connection for recording described above.

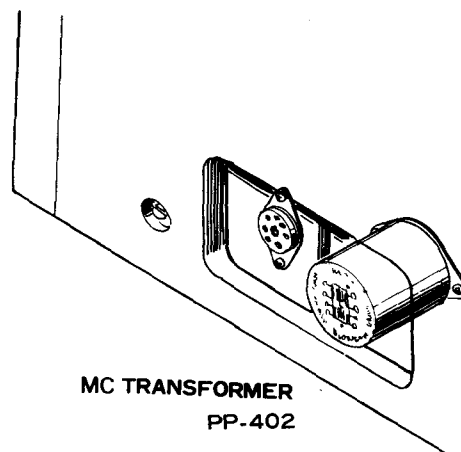

MC TRANSFORMER
PP-402

Fig. 7

CONNECTIONS FOR RECORDING AND PLAYBACK

If the tape deck is equipped with a record/playback connector of the DIN type, connect the connector to the TAPE REC/P.B. connector by using a DIN cable that is available separately.

In this case, connections as described in "CONNECTIONS FOR RECORDING" and "CONNECTIONS FOR PLAYBACK" above are unnecessary.

Use with two tape decks(or tape recorder)

When using two tape decks (or tape recorder) at the same time, connect the second tape deck (or tape recorder) to TAPE "B" REC and TAPE "B" MON.

If you want to record the same signal with the tape deck (or tape recorder) simultaneously, set the TAPE MON "A" SWITCH to "OFF".

Use the TAPE MON "B" "ON-OFF" switch when you want to monitor the recording.

Should the TAPE MON "A" SWITCH be set to "ON" during recording, a "click" may be recorded in the second tape deck.

It is important to keep the TAPE MON "A" SWITCH in "OFF" position.

Dubbing recorded tape

With another clean or erased tape for dubbing recorded tape, use the tape deck(or tape recorder) connected to the TAPE REC "B" terminal.

The signals to be transferred are supplied from the tape deck(or tape recorder) connected to the TAPE REC "A" and TAPE MON "A" terminals.

Keep the TAPE MON "A" switch set to "OFF" during recording, and use the TAPE MON "B" switch "ON-OFF" for monitoring.

ig. 7

CONNECTION DIAGRAM

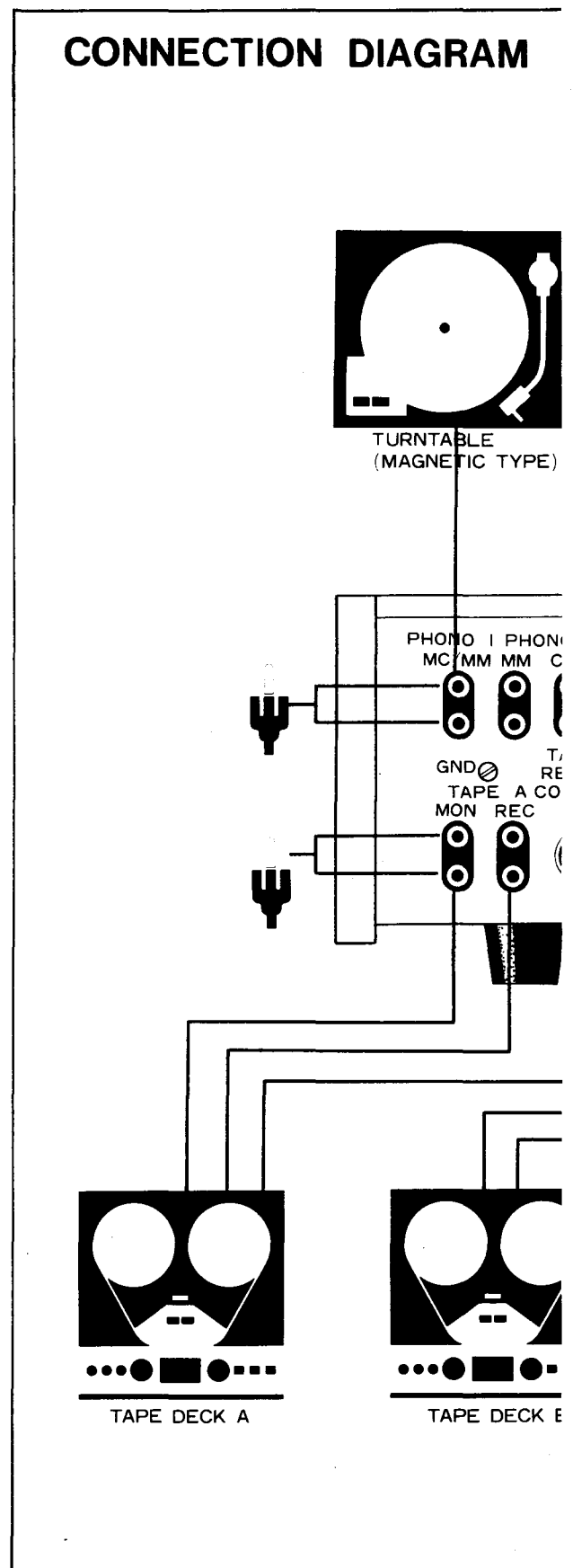

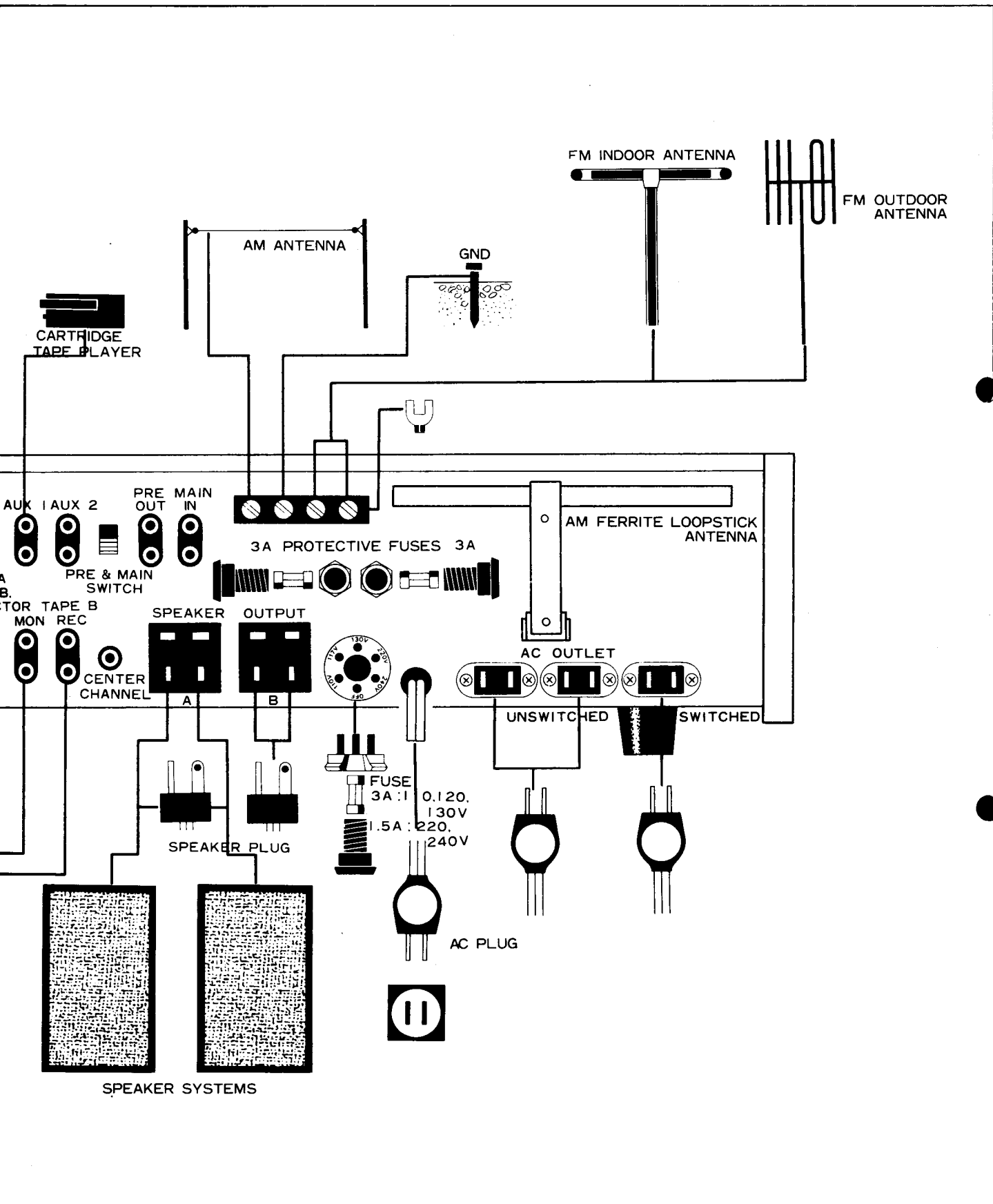

FM STEREO STATION SWITCH

When tuning only FM stereo stations, set the switch to "ON".
The FM stereo indicating lamp will light when an FM stereo broadcast is tuned in.

LOCAL STATION SWITCH

When automatically tuning AM or FM stations, noise due to near radio stations will not allow the dial pointer to tune to stations.
When automatically tuning AM or FM stations far away from you, set the switch to "OFF".
When manually tuning FM stations, the LOCAL STATION switch "ON" functions to eliminate interstation noise.

FM MUTING

This knob is for adjustment of dial pointer sensitivity in "AUTO TUNING". In listening to near stations, turn the knob to the right so that the dial pointer is not affected by noise.

PHONO 1,2 SWITCH

This switch is selected two turntables.
PHONO1 When using turntable connected PHONO1 terminals.
PHONO2 When using turntable connected PHONO2 terminals.

MPX NOISE FILTER SWITCH

This switch is used to eliminate high frequency noise when receiving an FM stereo station.

SELECTOR SWITCH

The switch for selecting the program source.
AM: For reception of an AM program.
FM MONO: For reception of an FM monophonic program.
FM AUTO: For automatically selective reception of stereo or monophonic FM program.
PHONO: For playing a record by using the turntable connected PHONO 1 or PHONO 2 terminals selected with "PHONO" switch.
AUX 1: For using cartridge tape player connected to the AUX 1 terminals.
AUX 2: For reproducing the TV audio output, or operating other equipment connected to the AUX 2 terminals.

VOLUME CONTROL

Turned clockwise, the volume will increase; turned counterclockwise, it will decrease.

BALANCE CONTROL

This knob is used for adjusting the stereophonic balance. When the volume of the right channel speaker is smaller, turn the knob clockwise toward right; when left channel volume is smaller counterclockwise toward left.

LOUDNESS CONTOUR

When playing at low volume, turn the switch on, this will boost the bass and treble for a more natural balance.
For normal listening levels, it is recommended to keep the switch at "OFF".

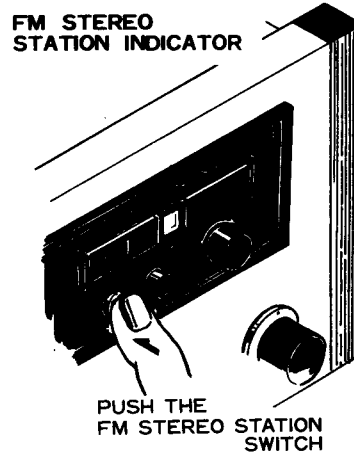

Fig. 10

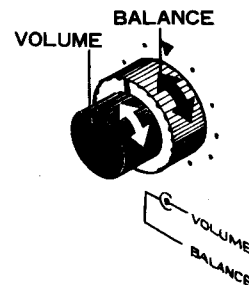

Fig. 11

THINGS TO CHECK BEFORE OPERATION

- Set the SPEAKERS switch to the "A" position after checking the following:
 1. The BALANCE knob is in the center position.
 2. The VOLUME knob is in the MIN position (turned fully counterclockwise).
 3. The TAPE MONITOR A. B switches are set to OFF position.
 4. The MODE switch is in the STEREO position.

LISTENING TO FM OR AM

RECEPTION OF FM

Manual Tuning

1. Set the SELECTOR switch to the FM AUTO position.
2. Set the LOCAL STATION switch to the ON position. (Keep the switch turned OFF, if the field strength is low.)
3. While observing the deflection of meters, tune the receiver to the desired station by adjusting the TUNING knob.

The best radio reception is attained when the pointer of the signal meter is deflected to the right, and the pointer of the FM tuning meter is at the center. When the tuned-in station is broadcasting a stereo program, the FM stereo indicator lights, and MODEL SX-2500 operates automatically for stereo broadcast reception. If the received program is monophonic, the indicator does not light, and the equipment operates for monophonic broadcast reception.
4. When the desired station has been tuned in, turn the VOLUME control gradually clockwise for the desired volume. Adjust the BASS and TREBLE controls as desired.

Automatic Tuning

1. Set the SELECTOR switch to "FM AUTO".
2. Set the LOCAL STATION switch to "ON" and turn the FM MUTING knob to the right.

In a fringe area, however, set the LOCAL STATION switch to "OFF", and turn the FM MUTING knob to the left.
3. Press lightly either the (<) or (>) button.
 - When tuning only FM stereo stations, first set the FM STEREO STATION switch to "ON", and then press one of the AUTO TUNING switches.

You can also tune automatically. (Refer to the paragraph, "Automatic Tuning".)

NOTE: In a fringe area or where reception is noisy, turning the SELECTOR switch to "FM MONO" will usually eliminate the noise. In this case, however, stereo broadcasting will be reproduced as monophonic.

RECEPTION OF AM

Manual Tuning

1. Set the SELECTOR switch to the AM position.
2. While observing the deflection of meters, tune the receiver to the desired station by adjusting the TUNING knob. The best radio reception is attained when the pointer of the signal meter is deflected to the right, and the pointer of the tuning meter is at the center.
3. When the desired station has been tuned in, adjust the VOLUME, BASS and TREBLE controls for desired volume and tone.

NOTE: If good reception cannot be attained by step 1 through 3 above, the antenna may be the cause. Refer to the "ANTENNA AND GROUND CONNECTION" on page 4. When the broadcasting station is very near, a highly distorted sound may result from the high field strength.

If this occurs, shorten or remove the antenna connected to the AM antenna terminal for the best radio reception.

Automatic Tuning

1. Set the SELECTOR switch to "AM".
2. Press either the (<) or (>) button under "AUTO TUNING".
3. If the dial pointer stops at an unwanted station, press either the (<) or (>) button again.
4. Adjust tone and volume.

NOTE: Set the LOCAL STATION switch to "OFF" in a fringe area, and "ON" in areas near stations.

If reception is noisy, refer to the paragraph, "CONNECTING ANTENNA AND GROUND".

RECORDING AND PLAYBACK WITH TAPE DECK

RECORDING

The same signal as that reproduced from speaker terminals are always present at the TAPE REC. terminals. According to the program source desired, set the SELECTOR switch and MODE switch, referring to the sections "LISTENING TO FM OR AM", and "LISTENING TO RECORDS".

The signal does not concern the VOLUME, BASS or TREBLE controls of Model SX-2500. Adjust the recording level with the controls provided on the tape deck or tape recorder.

NOTE: When using a monophonic tape recorder, set the MODE switch to the L+R position, and a monophonic signal will be supplied to the recorder. In this case, the sound reproduced by the speakers will be monophonic.

PLAYBACK

1. Set the TAPE MONITOR A switch to ON, in this time the SELECTOR switch does not matter.
2. Adjust the VOLUME, BASS and TREBLE controls for the desired volume and tone.

TAPE MONITOR

When using a 3-head tape deck (or tape recorder) for recording, you can monitor the program material as follows;

1. Set the TAPE MONITOR A switch to ON, and the recorded signal will be monitored.
2. Set the TAPE MONITOR A switch to OFF and the signal about to be recorded will be monitored.

NOTE: For normal listening to radio or phonograph, the TAPE MONITOR A and B switch should be set to OFF.

You can easily check the condition of the tape or of the recording and playback heads by quickly switching between the TAPE MONITOR's ON and OFF positions.

If there is a noticeable difference in the quality of the signals, you should check the recorder or the tape itself.

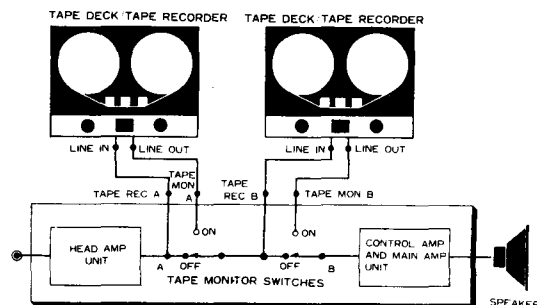

Fig. 12

LISTENING TO RECORDS

1. Set the SELECTOR switch to PHONO.
To use the turntable connected to the PHONO 1 terminals, set the PHONO 1, 2 switch to PHONO 1, for that connected to PHONO 2, set to PHONO 2.
2. If the record is monophonic, set the MODE switch to either L or R.
3. Adjust the VOLUME, BASS and TREBLE controls.

NOTE: When using the turntable with a moving-coil(MC) cartridge, connect a matching transformer model PP-402, separately available, to the socket(8P) of your SX-2500.

In general, since a jumper plug is to be connected to the socket(8P), care should be paid for connecting after pulling out the jumper plug. Refer to Fig. 7 .

When handling the PHONO 1 , 2 switch, keep the volume at minimum.

REMOTE CONTROL

For remote control of FM or AM "AUTO" tuning and volume adjustment, connect the REMOTE CONTROL UNIT to the REMOTE socket on the front panel, and connect the CdS UNIT to the 7P socket on the right side. Figs. 13 and 14.

AUTOMATIC TUNING

- Refer to "Automatic Tuning" on AM and FM reception.

VOLUME CONTROL

- Turn the VOLUME knob of the SX-2500 down to the left as possible, and use the VOLUME knob of the REMOTE CONTROL UNIT to control the VOLUME.

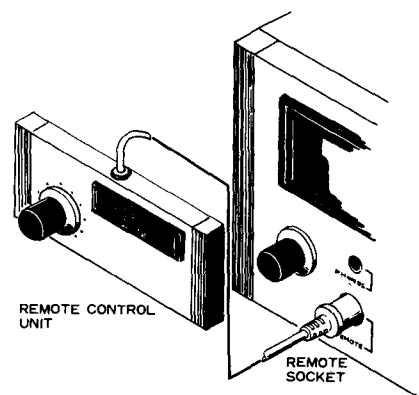

Fig.13

OTHER USES OF THE SX-2500

MULTI-AMPLIFIER SYSTEM

A multi-amplifier system can be composed by using a two- or three-division band-pass filter and one or two stereo power amplifiers besides Model SX-2500.

- Set the PRE & MAIN switch to the "SEPARATED" position (upper position).
- Connect the PRE-AMP OUTPUT terminals to the input terminals of the dividing band-pass filter, and the MAIN-AMP INPUT terminals to the output terminals of one of the dividing band-pass filters.
- Connect the input of the other stereo power amplifiers to the output terminals of the other dividing band-pass filters.

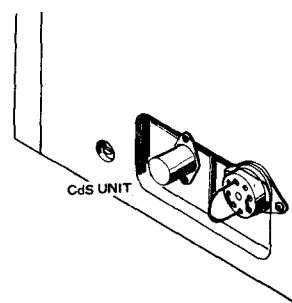

Fig.14

INTEGRATED STEREO SYSTEMS

By connecting one or more of PIONEER's Model IS-60, IS-70 or IS-80 units, which are separately available, to the PRE-AMP OUTPUT terminals for both left and right channels, respectively, an integrated stereo system having minimum sound distortion can be composed. Also, a PA system for use in large area can be made by using several power systems with Model SX-2500.

3-D STEREO SYSTEMS

A 3-D stereo system can be produced by connecting a power amplifier equipped with a low-pass filter ($f \leq 250\text{Hz}$) to the CENTER CHANNEL OUTPUT terminal.

SPECIFICATIONS

SEMICONDUCTORS

Tuner Section

ICs	5
FETs	3
Transistors	34
Diodes	35

AUDIO SECTION

FETs	2
Transistors.....	36
Diodes	18
Thermistors	2

AUDIO SECTION

Music Power Output	8 Ω 208 watts total (IHF rating) 4 Ω 340 watts total
Continuous Power Output (Each channel driven)	8 Ω 84w/84w (1kHz) H.D. 0.5% 4 Ω 120w/120w (1kHz)H.D. 0.5%
Continuous Power Output (Both channel driven)	8 Ω 72w + 72w (1kHz) H.D. 0.5% 4 Ω 90w + 90w (1kHz) H.D. 0.5%
Harmonic Distortion	Less than 0.5% (at 1kHz, Continuous Power Output)
Damping Factor	40 (at 8 Ω , 1kHz)
Frequency Response	20 Hz to 70 kHz, \pm 2dB
Power Bandwidth	8 Hz to 40 kHz (IHF rating)
Hum and Noise	PHONO MAG More than 80 dB AUX More than 100 dB
Sensitivity and Impedance (at 1kHz, continuous power output)	PHONO MAG 2.7mV, 50k Ω PHONO CER/CRYSTAL 60mV, 100k Ω AUX 200mV, 100k Ω TAPE MONITOR 200mV, 100k Ω PHONO 1 (MC) 110 μ V, 30 Ω with PP-402
Output Jacks and Terminals	MAIN INPUT 500mV, 120k Ω Speakers (A,B) 4 to 16 ohms Stereo Headphone Jack TAPE Recording Jacks TAPE REC/P.B. Connector (DIN type) REMOTE CONTROL Connector (4P) M.C Transformer Connector (8P)
Equalization Curves	PHONO RIAA
BASS Control	+12dB, -9dB (at 100Hz)
TREBLE Control	+9dB, -12dB (at 10kHz)
Filters	LOW Cut 8dB (at 50 Hz) HIGH Cut 10dB (at 20kHz)
Loudness Contour	Switchable to ON-OFF +13dB (at 50Hz), +6dB (at 10kHz), with VOLUME control set at -40dB.

FM TUNER SECTION

Frequency Range	87.5MHz to 108MHz
IHF Sensitivity	1.6 μ V (at 98MHz)
Capture Ratio	1.0 dB (at 98MHz)
Selectivity	65 dB (at 98MHz)
Image Rejection	90 dB (at 98MHz)
Signal to Noise Ratio	More than 70 dB (IHF rating)
Antenna Input	300 ohms balanced, 75 ohms unbalanced

FM MPX SECTION

Channel Separation	40 dB (at 1kHz)
Harmonic Distortion	0.5% (at 1kHz)

AM TUNER SECTION

Frequency Range	525 kHz to 1,605 kHz
IHF Sensitivity	8 μ V
Image Rejection	83 dB (at 1,000 kHz)
Antenna Input	Built-in ferrite loopstick antenna

MISCELLANEOUS

Power Requirements	110, 120, 130, 220 and 240 volts (switchable) 50 - 60 Hz
Power Consumption	220 VA
Dimensions (Overall)	19 1/8" 486 mm (width) 5 3/4" 146 mm (height) 15 1/8" 384 mm (depth)
Weight	Without package 33 lb /15 kg With package 40 lb 2 oz/18.2 kg

NOTE:

Specifications and the design subject to possible modification without notice due to improvements.

DIAL CORD STRINGING

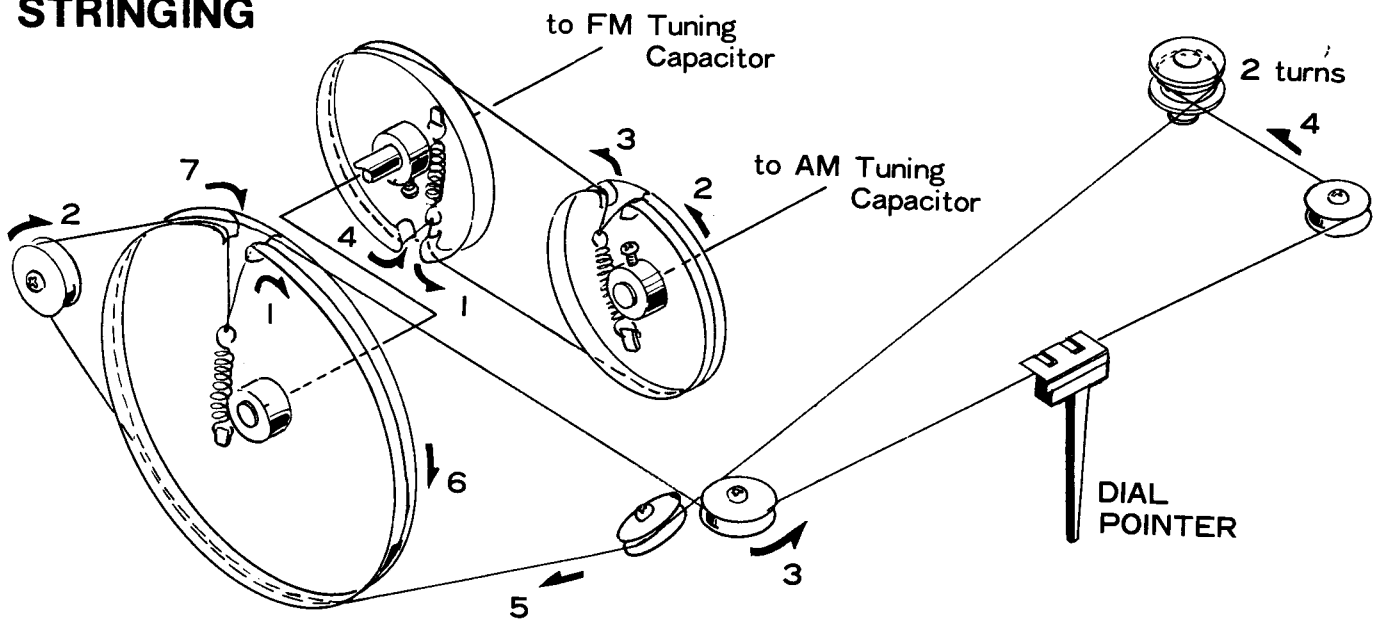

ALIGNMENT OF MPX SECTION

Position of Switch: SELECTOR FM AUTO

Volume Control Setting: Fully Counterclockwise
 Input Signal: Main (L+R) 40.5KHz Deviation (60%)
 19KHz Pilot 7.5KHz Deviation (10%)

STEPS	Circuit to be adjusted	Input		Connect VTVM	Alignment	
		Connections	Signal		Adjust	Remarks
1	Separation	MPX SG to FM Antenna terminal	Sub (L-R)	AC VTVM REC terminal L or R	L ₁	Adjust for maximum deflection.
2			L or R		VR ₁	Adjust for minimum deflection of the other channel.

ALIGNMENT OF AM SECTION

*VTVM and oscilloscope should be connected in parallel at the output.

Position of Switch: SELECTOR..... AM

Volume Control Setting: Fully Counterclockwise

Step	Input			Dial Setting	Output Equipment Connections	Alignment	
	Equipment Connections	Frequency	Level			Adjust	Remarks
1	Sweep Generator 12	455kHz	60dB	Point of no interference as near as 1605kHz	VTVM Oscilloscope 8	T3 T4 T5	Adjust for maximum sensitivity and symmetrical characteristics.
2	Signal Generator Antenna Terminal through dummy	600kHz	30dB	600kHz	VTVM Oscilloscope 8	T2	Adjust for maximum deflection.
3		1400kHz		1400kHz		CT3	
4	Repeat steps 2 and 3 several times.						
5	Signal Generator Antenna Terminal through dummy	600kHz	30dB	600kHz	VTVM Oscilloscope 8	T1, Ferrite Antenna (Adjusting core)	Adjust for maximum deflection.
6		1400kHz		1400kHz		CT1 CT2	
7	Repeat steps 5 and 6 several times.						

ALIGNMENT INSTRUCTIONS

ALIGNMENT OF FM SECTION

Disconnect IF lead of Front end unit from the IN terminal of IF unit

Position of Switch: SELECTOR.....FM MONO

Volume Level Control Setting: Fully Counterclockwise

STEPS	Input		Level	Dial Setting	Output		Alignment		
	Equipment Connections	Frequency			Equipment Connections	Adjust	Remarks		
1	Sweep Generator	10.7MHz	40dB		Oscilloscope	T ₁ T ₂		Adjust for maximum sensitivity and symmetrical characteristics	
2	IN		80dB		MET				Check symmetry of characteristic curve
3	Remove electrolytic capacitor C ₂₆ (4.7μF) from detector circuit								
4	Sweep Generator	10.7MHz	40dB		Oscilloscope OUT	T ₃		Adjust the primary core of T ₃ so that slope of straight portion of "S" curve will become the steepest and adjust the secondary core so that the center of "S" curve will coincide with the center of the marker	
5	Connect IF terminal or Front end unit to IN terminal of IF unit								
6	FM Antenna terminal	10.7MHz	40dB	Point of no interference as near as 87MHz	Oscilloscope MET	T ₁ of Front end T ₁ T ₂		Adjust for maximum sensitivity and symmetrical characteristics	
7	Sweep Generator		80dB						Check symmetry of characteristic curve
8			40dB						T ₃
9	Connect electrolytic C ₂₆ (4.7μF) back to where it was								
10	Signal Generator FM Antenna terminal	90MHz	20dB (400Hz, 30%)	90MHz	VTVM Oscilloscope OUT		L ₇	Adjust for maximum deflection	
11		106MHz		106MHz					CT ₄
12	Repeat STEPS 10 and 11 several times								
13	Signal Generator FM Antenna	90MHz	20dB (400Hz, 30%)	90MHz	VTVM Oscilloscope OUT	L ₁ L ₄ L ₅		Adjust for maximum deflection	
14	Terminal	106MHz		106MHz					CT ₂ CT ₂ CT ₃
15	Repeat STEPS 13 and 14 several times								

PARTS LAYOUT

TOP VIEW

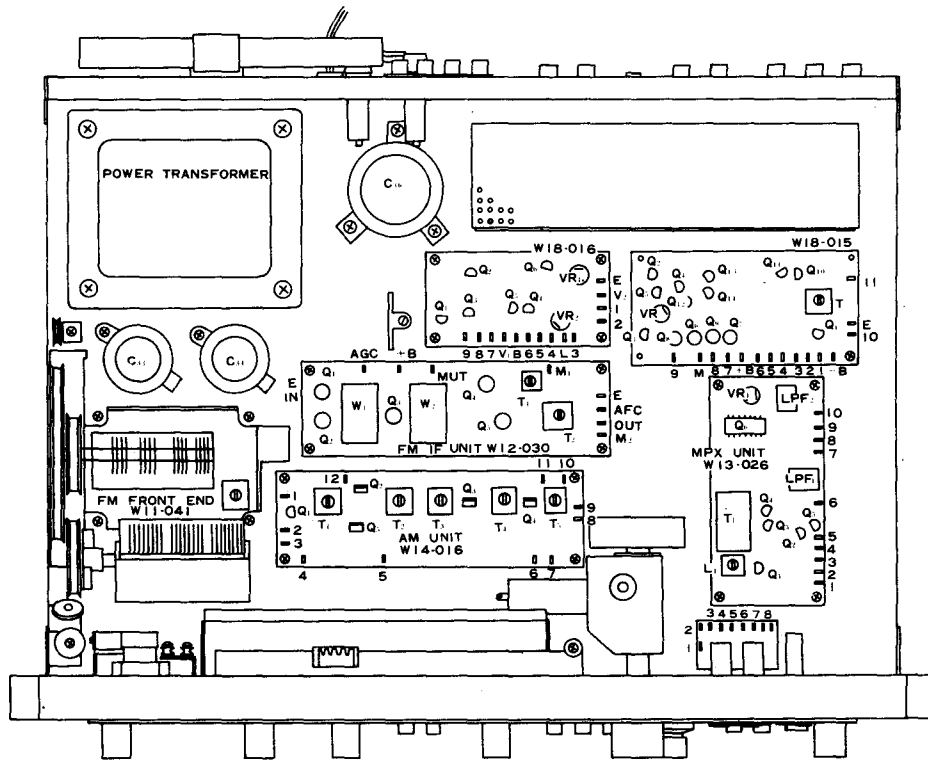

BOTTOM VIEW

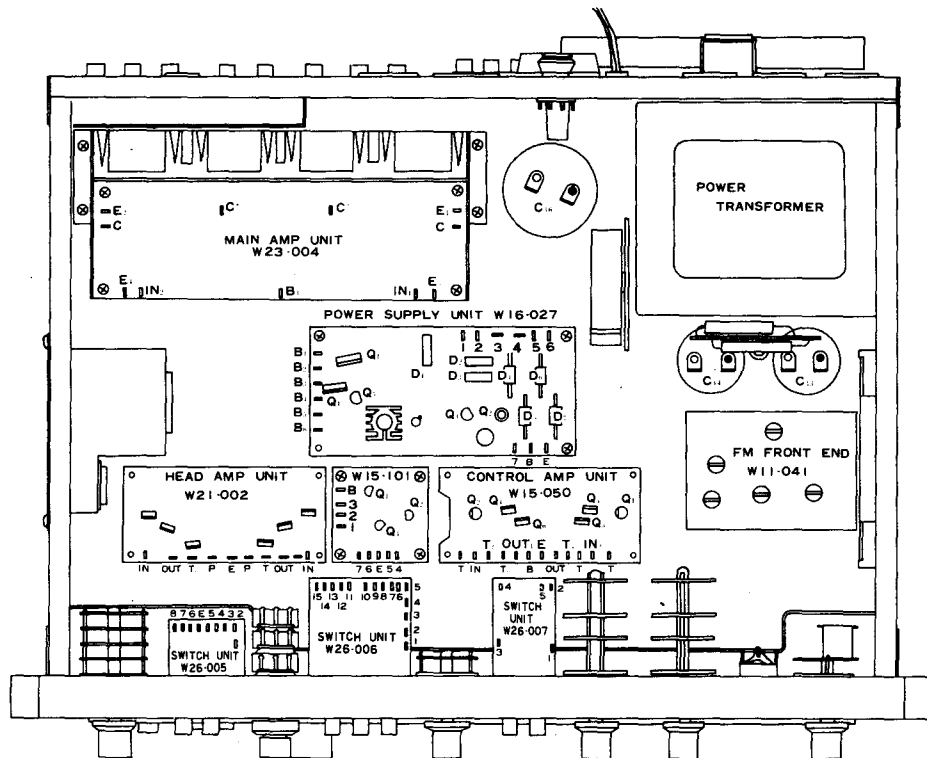

PARTS LIST

CAPACITORS

IN μF UNLESS OTHERWISE NOTED

p: μpF

Symbol	Description	Part No.
C1	Ceramic 0.01 50V	CKDYZ 103K 50
C2	Ceramic 0.01 50V	CKDYZ 103K 50
C3	Mylar 0.05 50V	CQMA 503K 50
C4	Mylar 0.05 50V	CQMA 503K 50
C5	Styrol 1800p 50V	CQSA 182K 50
C6	Styrol 1800p 50V	CQSA 182K 50
C7	Styrol 1000p 50V	CQSA 102K 50
C8	Styrol 1000p 50V	CQSA 102K 50
C9	Styrol 1800p 50V	CQSA 182K 50
C10	Styrol 1800p 50V	CQSA 182K 50
C11	Mylar 0.025 50V	CQMA 253K 50
C12	Mylar 0.025 50V	CQMA 253K 50
C13	Mylar 0.015 50V	CQMA 153K 50
C14	Mylar 0.015 50V	CQMA 153K 50
C15	Mylar 0.03 50V	CQMA 303K 50
C16	Mylar 0.03 50V	CQMA 303K 50
C17	Mylar 0.05 50V	CQMA 503K 50
C18	Mylar 0.05 50V	CQMA 503K 50
C19	Styrol 820p 50V	CQSA 821K 50
C20	Styrol 820p 50V	CQSA 821K 50
C21	Styrol 820p 50V	CQSA 821K 50
C22	Styrol 820p 50V	CQSA 821K 50
C23	Styrol 1200p 50V	CQSA 122K 50
C24	Styrol 1200p 50V	CQSA 122K 50
C25	Mylar 2000p 50V	CQMA 202K 50
C26	Mylar 2000p 50V	CQMA 202K 50
C27	Mylar 0.012 50V	CQMA 123K 50
C28	Mylar 0.012 50V	CQMA 123K 50
C29	Mylar 0.012 50V	CQMA 123K 50
C30	Mylar 0.012 50V	CQMA 123K 50
C31	Mylar 0.012 50V	CQMA 223K 50
C32	Mylar 0.022 50V	CQMA 223K 50
C33	Electrolytic 2200 50V	C52-045-A
C34	Electrolytic 2200 50V	C52-045-A
C35	Electrolytic 100 100V	CETG 100MF 100V
C36	Electrolytic 4700 100V	C52-086-0
C37	Ceramic 0.011 D.C.1.4kv	C43-003-0
C38	Ceramic 0.011 D.C.1.4kv	C43-003-0
C39	Ceramic 0.011 D.C.1.4kv	C43-003-0
C40	Mylar 1000p 50V	CQMA 102K 50
C41	Mylar 1000p 50V	CQMA 102K 50
C42	Mylar 0.047 50V	CQMA 473K 50
C43	Mylar 0.047 50V	CQMA 473K 50
C44	Electrolytic 1000 25V	CETG 1000MF 25V

RESISTORS

IN Ω , $\frac{1}{2}\text{W}$ UNLESS OTHERWISE NOTED

k:k Ω , M:M Ω

Symbol	Description	Part No.
R1	Carbon film 100k	RF1PS 100K-K,NL
R2	Carbon film 100k	RF1PS 100K-K,NL
R3	Carbon film 1M	RF1PS 1M-K,NL
R4	Carbon film 1M	RF1PS 1M-K,NL
R5	Carbon film 150k	RF1PS 150K-K,NL
R6	Carbon film 150k	RF1PS 150K-K,NL
R7	Carbon film 15k	RF1PS 15K-K
R8	Carbon film 33k	RF1PS 33K-K
R9	Carbon film 100k	RF1PS 100K-K
R10	Carbon film 1k	RF1PS 1K-K
R11	Carbon film 27k	RF1PS 27K-K

R12	Carbon film 27k	RF1PS 27K-K
R13	Carbon film 1.8k	RF1PS 1R8K-K
R14	Carbon film 1.8k	RF1PS 1R8K-K
R15	Carbon film 120k	RF1PS 120K-K
R16	Carbon film 120k	RF1PS 120K-K
R17	Carbon film 330k	RF1PS 330K-K
R18	Carbon film 330k	RF1PS 330K-K
R19	Carbon film 470k	RF1PS 470K-K
R20	Carbon film 470k	RF1PS 470K-K
R21	Carbon film 180k	RF1PS 180K-K
R22	Carbon film 180k	RF1PS 180K-K
R23	Carbon film 15k	RF1PS 15K-K
R24	Carbon film 15k	RF1PS 15K-K
R25	Carbon film 1.8k	RF1PS 1R8K-K
R26	Carbon film 1.8k	RF1PS 1R8K-K
R27	Carbon film 100k	RF1PS 100K-K
R28	Carbon film 100k	RF1PS 100K-K
R29	Carbon film 22k	RF1PS 22K-K
R30	Carbon film 22k	RF1PS 22K-K
R31	Carbon film 82k	RF1PS 82K-K
R32	Carbon film 82k	RF1PS 82K-K
R33	Wire wound 150 4W	RM4P 150-K
R34	Wire wound 150 4W	RM4P 150-K
R35	Carbon film 100k	RF1PS 100K-K
R36	Carbon film 10k	RF1PS 10K-K

POTENTIOMETERS

Symbol	Description	Part No.
VR1	500k Ω 4-gang, VOLUME and BALANCE	C88-009-0
VR2	30k Ω , MUTING	C81-013-0

SWITCHES

Symbol	Description	Part No.
S1	INPUT SELECTOR Switch	S13-039-A
S2	MODE SELECTOR Switch	S14-035-0
S3	BASS CONTROL Switch	S16-046-0
S4	TREBLE CONTROL Switch	S16-047-0
S5	PRE & MAIN Switch	S41-025-0
S6	OUTPUT SELECTOR & POWER Switch	S11-022-A
	LINE VOLTAGE SELECTOR	S11-018-0
	AUTO TUNING REVERSE Switch	S48-003-A
	Spring Switch	S48-002-A

COILS AND TRANSFORMER

Symbol	Description	Part No.
L1	Choke Coil	T24-030-0
L2	Heater Choke Coil	T24-026-0
	AM Ferrite Loopstick Antenna	T42-024-
	Power Transformer	T52-186-B

MISCELLANEOUS

Symbol	Description	Part No.
	FM Front end	W11-041-0
	FM IF Unit	W12-030-0
	AM Unit	W14-016-0
	MPX Unit	W13-026-0
	AUTO TUNING Unit	W18-015-0

INDICATOR Unit	W18-016-O
MUTING Unit	W15-101-O
HEAD AMP Unit	W21-002-O
CONTROL AMP Unit	W15-050-A
POWER SUPPLY Unit	W16-027-O
PROTECTOR Unit	W18-029-O
SWITCH Unit	W26-004-A
SWITCH Unit	W26-005-O
SWITCH Unit	W26-006-O
SWITCH Unit	W26-007-O
MAIN AMP Unit	W23-004-C
Front Panel Ass'y	W21-371-C
Dial Pulley	W42-009-B
Dial Pulley (small)	M42-054-O
Dial Pulley for Tuning Capacitor (large)	M42-027-C
Dial Pulley for Tuning Capacitor (small)	M42-056-C
Pulley (small)	M42-056-A
AM Ferrite Loopstick Antenna Holder	W72-002-B
Foot	M61-017-O
AUTO TUNING Mechanism Ass'y	M42-058-O
Dial Glass	A33-124-A
Meter Frame	A61-216-O
Signal Meter	A91-009-D
FM Tuning Meter	A91-008-D
Lamps Box	M15-327-A
Switch frame	A66-026-A
Button for AUTO TUNING switch	A18-003-A
Knob for LOW, HIGH FILTER, TAPE MONITOR A, B, LOUDNESS, MPX NOISE FILTER, PHONO SELECTOR, FM STEREO STATION and LOCAL STATION switch	A19-085-O
Knob for FM MUTING	A12-204-A
Knob for TUNING	A12-146-D
Knob for BASS and TREBLE	A12-244-D
Knob for SPEAKERS, MODE and SELECTOR	A12-217-O
Knob for VOLUME	A12-168-O
Knob for BALANCE	A13-016-A
6p Input Terminal	K22-013-C
4P Input Terminal	K21-010-D
1P Input Terminal	K21-005-C
4P Antenna Terminal	K11-018-O
Pilot Lamp for Dial Glass	E22-021-O
Pilot Lamp for Program Indicator	E22-025-O
Pilot Lamp for AUTO TUNING Button	E22-029-O
Pilot Lamp for Meter	E22-002-O
Pilot Lamp for STEREO STATION Indicator	E22-015-A
Dial Pointer	A31-095-O
Fuse 1.5A	E21-012-O
AM Tuning Capacitor	C64-030-O
Compound Part for REC Terminal	W52-004-O
7P Socket for Cds. Unit	K23-007-O
Spare A.C Outlet	K82-011-O
Speaker Socket	K73-003-B
Headphone Jack	K72-026-O
Pilot Lamp (for Dial Glass) Socket	K91-005-A
Pilot Lamp (for Meter) Socket	K41-002-B
Connector 5P	K93-003-B
Fuse Holder	K96-007-O
4P Connector for REMOTE CONTROL	K85-020-O
8P Socket for PP-402	K24-002-A
8P Plug	K71-030-O
Short Pin Plug	K71-028-O
Smooth Nylon	E32-022-B
Dial Spring	E31-064-B
Rubber Cushion	E31-151-O
Rubber Cushion	E31-152-O
Cord Band	E32-016-O
Dial Cord String (1.5m)	
Boss for Printed Circuit Board	B21-008-O
Screw for GND Terminal	B11-012-A

Screw to fix Wooden Case	B11-017-A
Washer M11	M22-009-O
Washer M9	M45-086-O
Nut M11	M71-004-O
Nut M9	M71-005-O
A.C Power Cord	D11-003-E
Instruction Manual	R12-068-O
Accessory Parts kit (A-5)	E11-060-O
Accessory Parts kit (B-9)	E11-075-O
FM Indoor Antenna	D52-013-O
AM Indoor Antenna	D53-002-A
Wooden Case	M52-130-C
Packing Case	H15-114-O
Packing Cloth Bag	H14-023-O
Pad (Upper)	H11-065-O
Pad (Under)	H11-066-O

FM IF UNIT(W12-030) CAPACITORS

Symbol	Description	Part No.
C1	Ceramic 0.01	50V CKDYZ 103P 50
C2	Ceramic 0.01	50V CKDYZ 103P 50
C3	Ceramic 0.01	50V CKDYZ 103P 50
C4	Ceramic 0.01	50V CKDYZ 103P 50
C5	Ceramic 0.01	50V CKDYZ 103P 50
C6	Ceramic 1000p	50V CKDYZ 102P 50
C7	Mylar 0.1	50V CQMA 104M 50
C8	Ceramic 0.01	50V CKDYZ 103P 50
C9	Ceramic 0.01	50V CKDYZ 103P 50
C10	Ceramic 0.01	50V CKDYZ 103P 50
C11	Ceramic 0.01	50V CKDYZ 103P 50
C12	Ceramic 0.01	50V CKDYZ 103P 50
C13	Ceramic 0.01	50V CKDYZ 103P 50
C14	Mylar 0.1	50V CQMA 104M 50
C15	Ceramic 0.01	50V CKDYZ 103P 50
C16	Ceramic 5p	50V CCDSL 050D 50
C17	Ceramic 100P	50V CCDSL 101K 50
C18	Ceramic 0.01	50V CKDYZ 103P 50
C19	Ceramic 0.01	50V CKDYZ 103P 50
C20	Ceramic 0.01	50V CKDYZ 103P 50
C21	Ceramic 0.01	50V CKDYZ 103P 50
C22	Ceramic 0.01	50V CKDYZ 103P 50
C23	Ceramic 300p	50V CCDSL 301K 50
C24	Electrolytic 1	50V CSYA 010M 50
C25	Electrolytic 4.7	16V CEMX 4R7MF16V
C26	Electrolytic 4.7	16V CEMX 4R7MF16V
C27	Ceramic 0.01	50V CKDYZ 103P 50
C28	Ceramic 15p	50V CCDSL 150K 50
C29	Ceramic 0.01	50V CKDYZ 103P 50

RESISTORS

Symbol	Description	Part No.
R1	Carbon film 820	RF $\frac{1}{2}$ VS 820-K
R2	Carbon film 1.5	RF $\frac{1}{2}$ VS 1R5K-K
R3	Carbon film 4.7	RF $\frac{1}{2}$ VS 4R7K-K
R4	Carbon film 1.2	RF $\frac{1}{2}$ PS 1R2K-K
R5	Carbon film 820	RF $\frac{1}{2}$ PS 820-K
R6	Carbon film 820	RF $\frac{1}{2}$ PS 820-K
R7	Carbon film 33	RF $\frac{1}{2}$ PS 33-K
R8	Carbon film 33	RF $\frac{1}{2}$ PS 33K-K
R9	Carbon film 33	RF $\frac{1}{2}$ PS 33-K
R10	Carbon film 820	RF $\frac{1}{2}$ PS 820-K
R11	Carbon film 33	RF $\frac{1}{2}$ PS 33K-K
R12	Carbon film 33	RF $\frac{1}{2}$ PS 33K-K
R13	Carbon film 100	RF $\frac{1}{2}$ PS 100-K

R14	Carbon film	220k	RF $\frac{1}{2}$ PS 220K-K
R15	Carbon film	22k	RF $\frac{1}{2}$ PS 22K-K
R16	Carbon film	820	RF $\frac{1}{2}$ PS 820-K
R17	Carbon film	82k	RF $\frac{1}{2}$ VS 82K-K
R18	Carbon film	15k	RF $\frac{1}{2}$ VS 15K-K
R19	Carbon film	1k	RF $\frac{1}{2}$ VS 1K-K

C25	Electrolytic	100	16V	CEMX 100MF 16V
C26	Ceramic	47p	50V	CKDSL 470K 50
C27	Ceramic	0.02	25V	CKDYZ 203P 25

DIODES AND TRANSISTORS

Symbol	Description	Part No.
D1	1S188 FM-1 Diode	
D2	1S188 FM-1 Diode	
D3	1S188 FM-1 Diode	
D4	1S188 FM-1 Diode	
D5	1S188 FM-1 Diode	
D6	1S188 FM-1 Diode	
D7	1S188 FM-1 Diode	
Q1	2SC710-R Transistor	
Q2	LM703L-BL IC	
Q3	LM703L-BL IC	
Q4	LM703L-BL IC	
Q5	LM703L-BL IC	

COIL AND TRANSFORMERS

Symbol	Description	Part No.
T1	Choke Coil	T24-028-A
T2	Transformer	T73-029-0
L1	IF Transformer for Det.	T74-003-0

COMPOUND PARTS

Symbol	Description	Part No.
W1	Crystal filter	W53-042-0
W2	Crystal filter	W53-042-0
W3	for Detector Circuit	W53-040-0

AM UNIT (W14-016)

CAPACITORS

Symbol	Description	Part No.
C1	Ceramic 0.04 25V	CKDYZ 403P 25
C2	Electrolytic 10 10V	CEMX 10MF 10V
C3	Ceramic 0.04 25V	CKDYZ 403P 25
C4	Ceramic 0.04 25V	CKDYZ 403P 25
C5	Electrolytic 22 25V	CEMX 22MF 25V
C6	Ceramic 0.04 25V	CKDYZ 403P 25
C7	Ceramic 0.04 25V	CKDYZ 403P 25
C8	Ceramic 0.04 25V	CKDYZ 403P 25
C9	Ceramic 0.04 25V	CKDYZ 403P 25
C10	Mylar 0.01 50V	CQMA 103K 50
C11	Styrol 410p 50V	CQSA 411K 50
C12	Ceramic 0.04 25V	CKDYZ 403P 25
C13	Electrolytic 10 50V	CEMX 10MF 50V
C14	Ceramic 0.02 25V	CKDYZ 203P 25
C15	Ceramic 0.04 25V	CKDYZ 403P 25
C16	Ceramic 0.04 25V	CKDYZ 403P 25
C17	Ceramic 0.04 25V	CKDYZ 403P 25
C18	Ceramic 47p 50V	CKDSL 470K 50
C19	Ceramic 0.04 25V	CKDYZ 403P 25
C20	Mylar 4700p 50V	CQMA 472K 50
C21	Mylar 4700p 50V	CQMA 472K 50
C22	Electrolytic 0.47 50V	CEMX R47MF 50V
C23	Electrolytic 220 6V	CEMX 220MF 6V
C24	Ceramic 0.04 25V	CKDYZ 403P 25

RESISTORS

Symbol	Description	Part No.
R1	Carbon film 22k	RF $\frac{1}{2}$ PS 22K-K
R2	Carbon film 15k	RF $\frac{1}{2}$ PS 15K-K
R3	Carbon film 470	RF $\frac{1}{2}$ PS 470-K
R4	Carbon film 100	RF $\frac{1}{2}$ PS 100-K
R5	Carbon film 2.2k	RF $\frac{1}{2}$ PS 2R2KK
R6	Carbon film 10k	RF $\frac{1}{2}$ PS 10K-K
R7	Carbon film 3.3k	RF $\frac{1}{2}$ PS 3R3KK
R9	Carbon film 1k	RF $\frac{1}{2}$ PS 1K-K
R10	Carbon film 1k	RF $\frac{1}{2}$ PS 1K-K
R11	Carbon film 4.7k	RF $\frac{1}{2}$ PS 4R7K-K
R12	Carbon film 27k	RF $\frac{1}{2}$ PS 27K-K
R13	Carbon film 1k	RF $\frac{1}{2}$ PS 1K-K-K
R14	Carbon film 68	RF $\frac{1}{2}$ PS 68-K-K
R15	Carbon film 4.7k	RF $\frac{1}{2}$ PS 4R7K-K
R16	Carbon film 100k	RF $\frac{1}{2}$ PS 100K-K
R17	Carbon film 27k	RF $\frac{1}{2}$ PS 27K-K
R18	Carbon film 1k	RF $\frac{1}{2}$ PS 1K-K
R19	Carbon film 150k	RF $\frac{1}{2}$ PS 150K-K
R20	Carbon film 4.7k	RF $\frac{1}{2}$ PS 4R7K-K
R21	Carbon film 4.7k	RF $\frac{1}{2}$ PS 4R7K-K
R22	Carbon film 22k	RF $\frac{1}{2}$ PS 22K-K
R23	Carbon film 470	RF $\frac{1}{2}$ PS 470-K
R24	Carbon film 470	RF $\frac{1}{2}$ PS 470-K
R25	Carbon film 100	RF $\frac{1}{2}$ PS 100-K
R26	Carbon film 3.3k	RF $\frac{1}{2}$ PS 3R3K-K
R27	Carbon film 6.8k	RF $\frac{1}{2}$ PS 6R8K-K
R28	Carbon film 100	RF $\frac{1}{2}$ PS 100-K
R29	Carbon film 3.9k	RF $\frac{1}{2}$ PS 3R9K-K
R30	Carbon film 4.7k	RF $\frac{1}{2}$ PS 4R7K-K

COILS AND TRANSFORMERS

Symbol	Description	Part No.
T1	MW RF Coil	T41-008-0
T2	MW OSC Coil	T43-007-0
T3	AM IFT	T71-025-A
T4	AM IFT	T71-025-A
T5	AM IFT	T72-017-0

DIODES AND TRANSISTORS

Symbol	Description	Part No.
D1	1S188 FM-1 Diode	
D2	1S188 FM-1 Diode	
D3	1S188 FM-1 Diode	
D4	1S188 FM-1 Diode	
Q1	2SC382 Transistor	
Q2	2SC460-B Transistor	
Q3	2SC460-B Transistor	
Q4	2SC460-B Transistor	
Q5	2SC460-B Transistor	

MPX UNIT (W13-026) CAPACITORS

Symbol	Description			Part No.
C1	Electrolytic	2.2	50V	CEMX 2R2MF 50V
C2	Electrolytic	10	10V	CEMX 10MF 10F
C3	Styrol	3300p	50V	C15-011-0
C4	Electrolytic	3.3	25V	CEMX 3R3MF 25V
C5	Mylar	2200p	50V	CQMA 222K 50
C6	Mylar	2200p	50V	CQMA 222K 50
C7	Mylar	2200p	50V	CQMA 222K 50
C8	Electrolytic	0.47	50V	CEMX R47MF 50V
C9	Electrolytic	0.47	50V	CEMX R47MF 50V
C10	Mylar	1500p	50V	CQMA 152K 50
C11	Mylar	1500p	50V	CQMA 152K 50
C12	Ceramic	300p	50V	CCDSL 301K 50

RESISTORS

Symbol	Description			Part No.
R1	Carbon film	6.8k		RF $\frac{1}{2}$ PS 6R8K-K
R2	Carbon film	4.7k		RF $\frac{1}{2}$ PS 4R7K-K
R3	Carbon film	39k		RF $\frac{1}{2}$ PS 39K-K
R4	Carbon film	4.7k		RF $\frac{1}{2}$ PS 4R7K-K
R5	Carbon film	47k		RF $\frac{1}{2}$ PS 47K-K
R6	Carbon film	47		RF $\frac{1}{2}$ PS 47-K
R7	Carbon film	2.2k		RF $\frac{1}{2}$ PS 2R2K-K
R8	Carbon film	15k		RF $\frac{1}{2}$ PS 15K-K
R9	Carbon film	100		RF $\frac{1}{2}$ PS 100-K
R10	Carbon film	300		RF $\frac{1}{2}$ PS 330-K
R11	Carbon film	33k		RF $\frac{1}{2}$ PS 33K-K
R12	Carbon film	10k		RF $\frac{1}{2}$ PS 10K-K
R13	Carbon film	10k		RF $\frac{1}{2}$ PS 10K-K
R14	Carbon film	150		RF $\frac{1}{2}$ PS 150-K
R15	Carbon film	53k		RF $\frac{1}{2}$ PS 33K-K
R16	Carbon film	32.7k		RF $\frac{1}{2}$ PS 2R7K-K
R17	Carbon film	1.2k		RF $\frac{1}{2}$ PS 1R2K-K
R18	Carbon film	2.7k		RF $\frac{1}{2}$ PS 2R7K-K
R19	Carbon film	1.2k		RF $\frac{1}{2}$ PS 1R2K-K
R20	Carbon film	10k		RF $\frac{1}{2}$ PS 10K-K
R21	Carbon film	10k		RF $\frac{1}{2}$ PS 10K-K
R22	Carbon film	1k		RF $\frac{1}{2}$ PS 1K-K
R23	Carbon film	15k		RF $\frac{1}{2}$ PS 15K-K
R24	Carbon film	15k		RF $\frac{1}{2}$ PS 15K-K
R26	Carbon film	330		RF $\frac{1}{2}$ PS 330-K
R27	Carbon film	1k		RF $\frac{1}{2}$ PS 1K-K
R28	Carbon film	33k		RF $\frac{1}{2}$ PS 33K-K
R29	Carbon film	33k		RF $\frac{1}{2}$ PS 33K-K

DIODES AND TRANSISTORS

Symbol	Description	Part No.
D1	1S188 FM-1 Diode	
D2	1S188 FM-1 Diode	
Q1	2SC870 F or E Transistor	
Q2	2SC711-F or E Transistor	
Q3	2SC711-F or E Transistor	
Q4	2SC711-F or E Transistor	
Q5	2SC711-F or E Transistor	
Q6	CA3054 IC	

COILS AND TRANSFORMER

Symbol	Description	Part No.
L1	19kHz Coil	T75-023-0
LPF1	38kHz Filter	T75-015-A
LPF2	38kHz Filter	T75-015-A
T1	MPX Transformer	T75-026-0

POTENTIOMETER

Symbol	Description	Part No.
VR1	330 Ω Semi-fixed	C92-058-0

AUTO TUNING UNIT (W18-015) CAPACITORS

Symbol	Description			Part No.
C1	Ceramic	330p	50V	CCDSL 331K 50
C2	Ceramic	0.04	50V	CKDYZ 403Z 50
C3	Ceramic	0.04	50V	CKDYZ 403Z 50
C4	Ceramic	0.04	50V	CKDYZ 403Z 50
C5	Ceramic	330p	50V	CKDYZ 331K 50
C6	Ceramic	680p	50V	CKDYZ 681K 50
C7	Ceramic	680p	50V	CKDYZ 681K 50
C8	Ceramic	0.04	50V	CKDYZ 403Z 50
C9	Ceramic	0.01	50V	CKDYZ 103Z 50
C10	Ceramic	0.04	50V	CKDYZ 403Z 50
C11	Ceramic	1000p	50V	CKDZ5P 102K 50
C12	Ceramic	0.04	50V	CKDYZ 403Z 50
C13	Ceramic	1000p	50V	CKDZ5P 102K 50
C14	Ceramic	0.04	50V	CKDYZ 403Z 50
C15	Electrolytic	10	16V	CEMX 10MF 16V
C16	Electrolytic	1	25V	CEMX 1MF 25V
C17	Electrolytic	2.2	35V	CEMX 2R2MF 35V

RESISTORS

Symbol	Description			Part No.
R1	Carbon film	33k		RF $\frac{1}{2}$ PS 33K-K
R2	Carbon film	27k		RF $\frac{1}{2}$ PS 27K-K
R3	Carbon film	3.3k		RF $\frac{1}{2}$ PS 3R3K-K
R4	Carbon film	560		RF $\frac{1}{2}$ PS 560-K
R5	Carbon film	680		RF $\frac{1}{2}$ PS 680-K
R6	Carbon film	33k		RF $\frac{1}{2}$ PS 33K-K
R7	Carbon film	22k		RF $\frac{1}{2}$ PS 22K-K
R8	Carbon film	22k		RF $\frac{1}{2}$ PS 22K-K
R9	Carbon film	4.7k		RF $\frac{1}{2}$ PS 4R7K-K
R10	Carbon film	12k		RF $\frac{1}{2}$ PS 12K-K
R11	Carbon film	100k		RF $\frac{1}{2}$ PS 100K-K
R12	Carbon film	22k		RF $\frac{1}{2}$ PS 22K-K
R13	Carbon film	150		RF $\frac{1}{2}$ PS 150-K
R14	Carbon film	2.2k		RF $\frac{1}{2}$ PS 2R2K-K
R15	Carbon film	22		RF $\frac{1}{2}$ PS 22-K
R16	Carbon film	47		RF $\frac{1}{2}$ PS 47-K
R17	Carbon film	10		RF $\frac{1}{2}$ PS 10-K
R18	Carbon film	22		RF $\frac{1}{2}$ PS 22-K
R19	Carbon film	150		RF $\frac{1}{2}$ PS 150-K
R20	Carbon film	2.2k		RF $\frac{1}{2}$ PS 2R2K-K
R21	Carbon film	22k		RF $\frac{1}{2}$ PS 22K-K
R22	Carbon film	100k		RF $\frac{1}{2}$ PS 100K-K
R23	Carbon film	2.2k		RF $\frac{1}{2}$ PS 2R2K-K
R24	Carbon film	22k		RF $\frac{1}{2}$ PS 22K-K
R25	Carbon film	22k		RF $\frac{1}{2}$ PS 22K-K

R26	Carbon film	1k	RF $\frac{1}{2}$ PS 1K-K
R27	Carbon film	22k	RF $\frac{1}{2}$ PS 22K-K
R28	Carbon film	3.3k	RF $\frac{1}{2}$ PS 3R3K-K
R29	Carbon film	22k	RF $\frac{1}{2}$ PS 22K-K
R30	Carbon film	22	RF $\frac{1}{2}$ PS 22-K
R31	Carbon film	1.8k	RF $\frac{1}{2}$ PS 1R8K-K
R32	Carbon film	22k	RF $\frac{1}{2}$ PS 22K-K
R33	Carbon film	22k	RF $\frac{1}{2}$ PS 22K-K
R34	Carbon film	390	RF $\frac{1}{2}$ PS 390-K
R35	Carbon film	10k	RF $\frac{1}{2}$ PS 10K-K
R36	Carbon film	10k	RF $\frac{1}{2}$ PS 10K-K
R37	Carbon film	22k	RF $\frac{1}{2}$ PS 22K-K
R38	Carbon film	10k	RF $\frac{1}{2}$ PS 10K-K
R39	Carbon film	22k	RF $\frac{1}{2}$ PS 22K-K
R40	Carbon film	22k	RF $\frac{1}{2}$ PS 22K-K
R41	Carbon film	10k	RF $\frac{1}{2}$ PS 10K-K

POTENTIOMETER

Symbol	Description	Part No.
VR	330 Ω Semi-fixed	C92-058-O

TRANSFORMER

Symbol	Description	Part No.
T ₁	AM IFT	T72-021-O

INDICATOR UNIT (W18-016)

CAPACITORS

Symbol	Description	Part No.
C ₁	Electrolytic 0.22 25V	CEMX R22MF 25V
C ₂	Electrolytic 0.22 25V	CEMX R22MF 25V
C ₃	Electrolytic 0.47 50V	CEMX R47MF 50V
C ₄	Electrolytic 2.2 16V	CEMX 2R2MF 16V
C ₅	Electrolytic 2.2 16V	CEMX 2R2MF 16V

RESISTORS

Symbol	Description	Part No.
R ₁	Carbon film 39k	RF $\frac{1}{2}$ PS 39K-K
R ₂	Carbon film 470k	RF $\frac{1}{2}$ PS 470K-K
R ₃	Carbon film 33k	RF $\frac{1}{2}$ PS 33K-K
R ₄	Carbon film 330k	RF $\frac{1}{2}$ PS 330K-K
R ₅	Carbon film 10k	RF $\frac{1}{2}$ PS 10K-K
R ₆	Carbon film 2.2k	RF $\frac{1}{2}$ PS 2R2K-K
R ₇	Carbon film 33k	RF $\frac{1}{2}$ PS 33K-K
R ₈	Carbon film 10k	RF $\frac{1}{2}$ PS 10K-K
R ₉	Carbon film 4.7k	RF $\frac{1}{2}$ PS 4R7K-K
R ₁₀	Carbon film 10k	RF $\frac{1}{2}$ PS 10K-K
R ₁₁	Carbon film 15k	RF $\frac{1}{2}$ PS 15K-K
R ₁₂	Carbon film 6.8k	RF $\frac{1}{2}$ PS 6R8K-K
R ₁₃	Carbon film 100	RF $\frac{1}{2}$ PS 100-K
R ₁₄	Carbon film 10k	RF $\frac{1}{2}$ PS 10K-K
R ₁₅	Carbon film 22k	RF $\frac{1}{2}$ PS 22K-K
R ₁₆	Carbon film 220	RF $\frac{1}{2}$ PS 220-K
R ₁₇	Carbon film 82	RF $\frac{1}{2}$ PS 82-K
R ₁₈	Carbon film 33k	RF $\frac{1}{2}$ PS 33K-K

DIODES AND TRANSISTORS

Symbol	Description	Part No.
D ₁	1S188 FM-1 Diode	
D ₂	1S188 FM-1 Diode	
D ₃	1S188 FM-1 Diode	
Q ₁	2SC870-E Transistor	
Q ₂	2SC870-E Transistor	
Q ₃	2SC870-E Transistor	
Q ₄	2SC870-E Transistor	
Q ₅	2SC870-E Transistor	
Q ₆	2SC868Y-3 Transistor	

POTENTIOMETERS

Symbol	Description	Part No.
VR ₁	10K Ω B Semi-fixed	C92-049-O
VR ₂	100k Ω B Semi-fixed	C92-047-O

MUTING UNIT (W15-101)

CAPACITORS

Symbol	Description	Part No.
C ₁	Electrolytic 100 10V	CEMX 100MF 10V
C ₂	Electrolytic 47 10V	CEMX 47MF 10V
C ₃	Electrolytic 2.2 35V	CEMX 2R2MF 35V
C ₄	Electrolytic 2.2 35V	CEMX 2R2MF 35V
C ₅	Electrolytic 10 10	CEMX 10MF 10V
C ₆	Electrolytic 10 10V	CEMX 10MF 10V
C ₇	Ceramic 56p 50V	CCDSL 560K 50
C ₈	Ceramic 56p 50V	CCDSL 560K 50

RESISTORS

Symbol	Description	Part No.
R ₁	Carbon film 5.6k	RF $\frac{1}{2}$ PS 5R6K-K
R ₂	Carbon film 1.8k	RF $\frac{1}{2}$ PS 1R8K-K
R ₃	Carbon film 100k	RF $\frac{1}{2}$ PS 100K-K
R ₄	Carbon film 2.2k	RF $\frac{1}{2}$ PS 2R2K-K
R ₅	Carbon film 2.7k	RF $\frac{1}{2}$ PS 2R7K-K
R ₆	Carbon film 220k	RF $\frac{1}{2}$ PS 220K-K
R ₇	Carbon film 4.7k	RF $\frac{1}{2}$ PS 4R7K-K
R ₈	Carbon film 10k	RF $\frac{1}{2}$ PS 10K-K
R ₉	Carbon film 220k	RF $\frac{1}{2}$ PS 220K-K
R ₁₀	Carbon film 330k	RF $\frac{1}{2}$ PS 330K-K
R ₁₁	Carbon film 330k	RF $\frac{1}{2}$ PS 330K-K
R ₁₂	Carbon film 2.7k	RF $\frac{1}{2}$ PS 2R7K-K
R ₁₃	Carbon film 2.7k	RF $\frac{1}{2}$ PS 2R7K-K
R ₁₄	Carbon film 47k	RF $\frac{1}{2}$ PS 47K-K
R ₁₅	Carbon film 47k	RF $\frac{1}{2}$ PS 47K-K

DIODES AND TRANSISTORS

Symbol	Description	Part No.
D ₁	1S188 FM-1 Diode	
D ₂	1S188 FM-1 Diode	
D ₃	1S188 FM-1 Diode	
D ₄	1S188 FM-1 Diode	
Q ₁	2SC870-E Transistor	
Q ₂	2SC870-E Transistor	
Q ₃	2SC870-E Transistor	

SWITCH UNIT(W26-004)

Symbol	Description	Part No.
	Demi-switch	S31-029-O

HEAD AMP UNIT(W21-002) CAPACITORS

Symbol	Description	Part No.
C1	Electrolytic 22 10V	CEMX 22MF 10V
C2	Electrolytic 22 10V	CEMX 22MF 10V
C3	Electrolytic 4.7 10V	CEMX 4R7MF10V
C4	Electrolytic 4.7 10V	CEMX 4R7MF10
C5	Electrolytic 10 25V	CEMX 10MF 25V
C6	Electrolytic 10 25V	CEMX 10MF 25V
C7	Ceramic 100p 50V	CCDSL 101K 50
C8	Ceramic 100p 50V	CCDSL 101K 50
C9	Ceramic 330p 50V	CCDSL 301K 50
C10	Ceramic 330p 50V	CCDSL 301K 50
C11	Mylar 0.012 50V	CQMA 123K 50
C12	Mylar 0.012 50V	CQMA 123K 50
C13	Mylar 3300p 50V	CQMA 302K 50
C14	Mylar 3300p 50V	CQMA 302K 50
C15	Electrolytic 220 25V	CEMX 220MF 25

RESISTORS

Symbol	Description	Part No.
R1	Carbon film 1k	RF1PS 1K-K
R2	Carbon film 1k	RF1PS 1K-K
R3	Carbon film 56k	RF1PS 56K-K
R4	Carbon film 56k	RF1PS 56K-K
R5	Carbon film 1M	RF1PS 1M-K
R6	Carbon film 1M	RF1PS 1M-K
R7	Carbon film 390	RF1PS 390-K
R8	Carbon film 390	RF1PS 390-K
R9	Carbon film 470k	RF1PS 470K-K
R10	Carbon film 470k	RF1PS 470K-K
R11	Carbon film 56k	RF1PS 56K-K
R12	Carbon film 56k	RF1PS 56K-K
R13	Carbon film 330k	RF1PS 330K-K
R14	Carbon film 330k	RF1PS 330K-K
R15	Carbon film 3.3k	RF1PS 3R3K-K
R16	Carbon film 3.3k	RF1PS 3R3K-K
R17	Carbon film 4.7k	RF1PS 4R7K-K
R18	Carbon film 4.7k	RF1PS 4R7K-K
R19	Carbon film 10k	RF1PS 10K-K
R20	Carbon film 10k	RF1PS 10K-K
R21	Carbon film 47k	RF1PS 47K-K
R22	Carbon film 47k	RF1PS 47K-K
R23	Carbon film 270k	RF1PS 270K-K
R24	Carbon film 270k	RF1PS 270K-K
R25	Carbon film 22k	RF1PS 22K-K
R26	Carbon film 22k	RF1PS 22K-K
R27	Carbon film 2.2k	RF1PS 2R2K-K
R28	Carbon film 2.2k	RF1PS 2R2K-K
R29	Carbon film 12k	RF1PS 12K-K
R30	Carbon film 12k	RF1PS 12K-K

TRANSISTORS

Symbol	Description	Part No.
Q1	2SC458LG-B	
Q2	2SC458LG-B	
Q3	2SC458LG-B	
Q4	2SC458LG-B	
Q5	2SC458LG-B	
Q6	2SC458LG-B	

CONTROL AMP UNIT(W15-050) CAPACITORS

Symbol	Description	Part No.
C1	Electrolytic 0.1 25V	CSYA 0R1M 25
C2	Electrolytic 0.1 25V	CSYA 0R1M 25
C3	Electrolytic 30 6V	CEMX 30MF 6V
C4	Electrolytic 30 6V	CEMX 30MF 6V
C5	Ceramic 39p 50V	CCDSL 390K 50
C6	Ceramic 39p 50V	CCDSL 390K 50
C7	Electrolytic 30 6V	CEMX 30MF 6V
C8	Electrolytic 30 6V	CEMX 30MF 6V
C9	Ceramic 470p 50V	CCDSL 471K 50
C10	Ceramic 470p 50V	CCDSL 471K 50
C11	Electrolytic 10 25V	CEMX 10MF 25V
C12	Electrolytic 10 25V	CEMX 10MF 25V
C13	Electrolytic 10 25V	CEMX 10MF 25V
C14	Electrolytic 10 25V	CEMX 10MF 25V
C15	Electrolytic 50 25V	CEMX 50MF 25V

RESISTORS

Symbol	Description	Part No.
R1	Carbon film 1k	RF1PS 1k-K
R2	Carbon film 1k	RF1PS 1K-K
R3	Carbon film 4.7M	RF1PS 4R7M-K
R4	Carbon film 4.7M	RF1PS 4R7M-K
R5	Carbon film 4.7k	RF1PS 4R7K-K
R6	Carbon film 4.7k	RF1PS 4R7K-K
R7	Carbon film 1k	RF1PS 1K-K
R8	Carbon film 1k	RF1PS 1K-K
R9	Carbon film 39k	RF1PS 39K-K
R10	Carbon film 39k	RF1PS 39K-K
R11	Carbon film 8.2k	RF1PS 8R2K-K
R12	Carbon film 8.2k	RF1PS 8R2K-K
R13	Carbon film 1.8k	RF1PS 1R8K-K
R14	Carbon film 1.8k	RF1PS 1R8K-K
R15	Carbon film 10k	RF1PS 10K-K
R16	Carbon film 10k	RF1PS 10K-K
R17	Carbon film 6.8k	RF1PS 6R8K-K
R18	Carbon film 6.8k	RF1PS 6R8K-K
R19	Carbon film 120k	RF1PS 120K-K
R20	Carbon film 120k	RF1PS 120K-K
R21	Carbon film 330	RF1PS 330-K
R22	Carbon film 330	RF1PS 330-K

TRANSISTORS

Symbol	Description	Part No.
Q1	2SK17-Y FET	
Q2	2SK17-Y FET	
Q3	2SC369-GR Transistor	
Q4	2SC369-GR Transistor	
Q5	2SC369-GR Transistor	
Q6	2SC369-GR Transistor	

POWER SUPPLY UNIT (W16-027) CAPACITORS

Symbol	Description	Part No.
C1	Ceramic 0.01 D.C 1.4kV	C43-003-0
C2	Electrolytic 330 25V	CEMX 330MF 25V
C3	Electrolytic 100 25V	CEMX 100MF 25V
C4	Electrolytic 100 25V	CEMX 100MF 25V
C5	Ceramic 0.01 D.C 1.4kV	C43-003-0
C6	Electrolytic 220 10V	CEMX 220MF 10V
C7	Electrolytic 220 10V	CEMX 220MF 10V
C8	Ceramic 0.01 D.C 1.4kV	C43-003-0
C9	Ceramic 0.01 D.C 1.4kV	C43-003-0
C10	Ceramic 0.01 D.C 1.4kV	C43-003-0
C11	Ceramic 0.01 D.C 1.4kV	C43-003-0
C12	Electrolytic 100 50V	CEMX 100MF 50V
C13	Ceramic 100p 50V	CCDSL 101K 50

RESISTORS

Symbol	Description	Part No.
R1	Carbon film 150	RF $\frac{1}{2}$ PS 150-K
R2	Wire wound 33 1W	RO1 33-K
R3	Carbon film 820	RF $\frac{1}{2}$ PS 820-K
R4	Wire wound 33 1W	RO1 33-K
R5	Carbon film 1.5k	RF $\frac{1}{2}$ PS 1R5K-K
R6	Carbon film 22	RF $\frac{1}{2}$ PS 22-K
R7	Carbon film 2.7k	RF $\frac{1}{2}$ PS 2R7K-K
R8	Carbon film 820	RF $\frac{1}{2}$ PS 820-K
R9	Carbon film 4.7k	RF $\frac{1}{2}$ PS 4R7K-K
R10	Carbon film 1.2k	RF $\frac{1}{2}$ PS 1R2K-K
R11	Carbon film 4.7k	RF $\frac{1}{2}$ PS 4R7K-K
R12	Carbon film 33k	RF $\frac{1}{2}$ PS 33K-K
R13	Wire wound 560 1W	RO1 560-K
R14	Carbon film 15k	RF $\frac{1}{2}$ PS 15K-K
R15	Carbon film 3.9k	RF $\frac{1}{2}$ PS 3R9K-K
R16	Carbon film 33k	RF $\frac{1}{2}$ PS 33K-K
R17	Carbon film 150k	RF $\frac{1}{2}$ PS 150K-K
R18	Carbon film 18k	RF $\frac{1}{2}$ PS 18K-K

DIODES AND TRANSISTORS

Symbol	Description	Part No.
D1	1S1850 Diode	
D2	1S1850R Diode	
D3	1S1850 Diode	
D4	SR3AM-8 Diode	
D5	SR3AM-8 Diode	
D6	SR3AM-8 Diode	
D7	SR3AM-8 Diode	
D8	1S338 Diode	
D9	1S338 Diode	
Q1	2SC1061 Transistor	
Q2	2SC971 Transistor	
Q3	2SC870 Transistor	
Q4	2SC1061 Transistor	
Q5	2SC870 Transistor	
Q6	2SC627 Transistor	
Q7	2SC485 Transistor	
Q8	2SC968 Transistor	

OTHER

Symbol	Description	Part No.
	Heat Sink	M14-043-0

PROTECTOR UNIT (W18-029) CAPACITORS

Symbol	Description	Part No.
C1	Mylar 0.012 50V	CQMA 123K 50
C2	Mylar 0.1 50V	CQMA 104K 50
C3	Electrolytic 22 25V	CEMX 22MF 25V

RESISTORS

Symbol	Description	Part No.
R1	Carbon film 3.3k	RF $\frac{1}{2}$ PS 3R3K-K
R2	Carbon film 4.7k	RF $\frac{1}{2}$ PS 4R7K-K
R3	Carbon film 68 Ω	RF $\frac{1}{2}$ PS 68K-K
R4	Carbon film 8.2k	RF $\frac{1}{2}$ PS 8R2K-K
R5	Carbon film 680k	RF $\frac{1}{2}$ PS 680K-K
R6	Carbon film 33k	RF $\frac{1}{2}$ PS 33K-K
R7	Carbon film 3.9k	RF $\frac{1}{2}$ PS 3R9K-K
R8	Carbon film 56k	RF $\frac{1}{2}$ PS 56K-K
R9	Carbon film 8.2k	RF $\frac{1}{2}$ PS 8R2K-K
R10	Carbon film 68k	RF $\frac{1}{2}$ PS 68K-K
R11	Carbon film 10k	RF $\frac{1}{2}$ PS 10K-K
R12	Carbon film 1.5k	RF $\frac{1}{2}$ PS 1R5K-K
R13	Carbon film 1.5k	RF $\frac{1}{2}$ PS 1R5K-K

DIODES AND TRANSISTORS

Symbol	Description	Part No.
D1	1N 60 Diode	
D2	1N 60 Diode	
D3	1N 60 Diode	
D4	1N60 Diode	
Q1	2SC373 Transistor	
Q2	2SC373 Transistor	
Q3	2SC373 Transistor	
Q4	2SC373 Transistor	

POTENTIOMETER

Symbol	Description	Part No.
VR ₁	5k-B Semi-fixed	C92-031-0

SWITCH UNIT (W26-005) CAPACITOR

Symbol	Description	Part No.
C ₁	Styrol 2200p 50V	CQSA 222K 50

SWITCH UNIT (W26-006) CAPACITORS

Symbol	Description	Part No.
C ₁	Mylar 0.01 50V	CQMA 103M 50
C ₂	Mylar 0.01 50V	CQMA 103M 50
C ₃	Ceramic 82p 50V	CCDSL 820K 50
C ₄	Ceramic 82p 50V	CCDSL 820K 50

RESISTORS

Symbol	Description	Part No.
R ₁	Carbon film 3.3k	RF $\frac{1}{2}$ PS 3R3K-K
R ₂	Carbon film 3.3k	RF $\frac{1}{2}$ PS 3R3K-K
R ₃	Carbon film 27k	RF $\frac{1}{2}$ PS 27K-K
R ₄	Carbon film 27k	RF $\frac{1}{2}$ PS 27K-K
R ₅	Carbon film 68k	RF $\frac{1}{2}$ PS 68K-K
R ₆	Carbon film 68k	RF $\frac{1}{2}$ PS 68K-K

SWITCH UNIT (W26-007) CAPACITORS

Symbol	Description	Part No.
C ₁	Mylar 0.1 50V	CQMA 104M 50
C ₂	Mylar 0.1 50V	CQMA 104M 50
C ₃	Mylar 0.01 50V	CQMA 103M 50
C ₄	Mylar 0.01 50V	CQMA 103M 50

RESISTORS

Symbol	Description	Part No.
R ₁	Carbon film 4.7k	RF $\frac{1}{2}$ PS 4R7K-K
R ₂	Carbon film 4.7k	RF $\frac{1}{2}$ PS 4R7K-K
R ₃	Carbon film 18k	RF $\frac{1}{2}$ PS 18K-K
R ₄	Carbon film 18k	RF $\frac{1}{2}$ PS 18K-K

MAIN AMP UNIT (W23-004) CAPACITORS

Symbol	Description	Part No.
C ₁	Electrolytic 1 50V	CEMX 1MF 50V
C ₂	Electrolytic 1 50V	CEMX 1MF 50V
C ₅	Ceramic 100p 50V	CCDSL 101K 50
C ₆	Ceramic 100p 50V	CCDSL 101K 50
C ₇	Electrolytic 4.7 50V	CEMX 4R7MF 50V
C ₈	Electrolytic 4.7 50V	CEMX 4R7MF 50V
C ₉	Electrolytic 47 35V	CEMX 47MF 35V
C ₁₀	Electrolytic 47 35V	CEMX 47MF 35V
C ₁₁	Electrolytic 100 50V	CEMX 100MF 50V
C ₁₂	Electrolytic 100 50V	CEMX 100MF 50V
C ₁₅	Electrolytic 100 3V	CEMX 100MF 3V
C ₁₆	Electrolytic 100 3V	CEMX 100MF 3V
C ₁₇	Ceramic 220p 50V	CCDSL 221K 50
C ₁₈	Ceramic 220p 50V	CCDSL 221K 50
C ₂₁	Mylar 0.1 50V	CQMA 104K 50
C ₂₂	Mylar 0.1 50V	CQMA 104K 50

RESISTORS

Symbol	Description	Part No.
R ₁	Carbon film 1M	RF $\frac{1}{2}$ PS 1M-K
R ₂	Carbon film 1M	RF $\frac{1}{2}$ PS 1M-K
R ₃	Carbon film 820k	RF $\frac{1}{2}$ PS 820K-K
R ₄	Carbon film 820k	RF $\frac{1}{2}$ PS 820K-K
R ₅	Carbon film 220k	RF $\frac{1}{2}$ PS 220K-K
R ₆	Carbon film 220k	RF $\frac{1}{2}$ PS 220K-K
R ₇	Carbon film 10k	RF $\frac{1}{2}$ PS 10K-K
R ₈	Carbon film 10k	RF $\frac{1}{2}$ PS 10K-K
R ₉	Carbon film 3.3k	RF $\frac{1}{2}$ PS 3R3K-K
R ₁₀	Carbon film 3.3k	RF $\frac{1}{2}$ PS 3R3K-K
R ₁₁	Carbon film 150	RF $\frac{1}{2}$ PS 150-K
R ₁₂	Carbon film 150	RF $\frac{1}{2}$ PS 150-K
R ₁₃	Carbon film 100k	RF $\frac{1}{2}$ PS 100K-K
R ₁₄	Carbon film 100k	RF $\frac{1}{2}$ PS 100K-K
R ₁₅	Carbon film 10k	RF $\frac{1}{2}$ PS 10K-K
R ₁₆	Carbon film 10k	RF $\frac{1}{2}$ PS 10K-K
R ₁₇	Carbon film 2.2k $\frac{1}{2}W$	RF $\frac{1}{2}$ PS 2R2K-K
R ₁₈	Carbon film 2.2k $\frac{1}{2}W$	RF $\frac{1}{2}$ PS 2R2K-K
R ₁₉	Carbon film 82k	RF $\frac{1}{2}$ PS 82K-K
R ₂₀	Carbon film 82k	RF $\frac{1}{2}$ PS 82K-K
R ₂₁	Carbon film 3.3k	RF $\frac{1}{2}$ PS 3R3K-K
R ₂₂	Carbon film 3.3k	RF $\frac{1}{2}$ PS 3R3K-K
R ₂₃	Carbon film 6.8k $\frac{1}{2}W$	RF $\frac{1}{2}$ PS 6R8K-K
R ₂₄	Carbon film 6.8k $\frac{1}{2}W$	RF $\frac{1}{2}$ PS 6R8K-K
R ₂₅	Carbon film 470	RF $\frac{1}{2}$ PS 470-K
R ₂₆	Carbon film 470	RF $\frac{1}{2}$ PS 470-K
R ₂₉	Carbon film 330	RF $\frac{1}{2}$ PS 330-K
R ₃₀	Carbon film 330	RF $\frac{1}{2}$ PS 330-K
R ₃₁	Carbon film 68	RF $\frac{1}{2}$ PS 68-K
R ₃₂	Carbon film 68	RF $\frac{1}{2}$ PS 68-K
R ₃₃	Carbon film 330	RF $\frac{1}{2}$ PS 330-K
R ₃₄	Carbon film 330	RF $\frac{1}{2}$ PS 330-K

R35	Carbon film	100	½W	RF½PS 100-K
R36	Carbon film	100	½W	RF½PS 100-K
R37	Carbon film	10	½W	RF½PS 10-K
R38	Carbon film	10	½W	RF½PS 10-K
R39	Carbon film	100	½W	RF½PS 100-K
R40	Carbon film	100	½W	RF½PS 100-K
R41	Wire wound	0.3	3W	RS3B OR3-K
R42	Wire wound	0.3	3W	RS3B OR3-K
R43	Wire wound	0.3	3W	RS3B OR3-K
R44	Wire wound	0.3	3W	RS3B OR3-K
R45	Carbon film	15k		RF½PS 15K-K
R46	Carbon film	15k		RF½PS 15K-K
R47	Carbon film	15k		RF½PS 15K-K
R48	Carbon film	15k		RF½PS 15K-K
R49	Wire wound	10	3W	RM2P 10-K
R50	Wire wound	10	3W	RM2P 10-K

POTENTIOMETERS

Symbol	Description	Part No.
VR1	100k-B Semi-fixed	C92-047-O
VR2	100k-B Semi-fixed	C92-047-O
VR3	220-B Semi-fixed	C92-060-O
VR4	220-B Semi-fixed	C92-060-O

DIODES AND TRANSISTORS

Symbol	Description	Part No.
D1	1N60 Diode	
D2	1N60 Diode	
D3	VB-11 Varistor	
D4	VB-11 Varistor	
Q1	2SC458LG Transistor	
Q2	2SC458LG Transistor	
Q3	2SC627-1 Transistor	
Q4	2SC627-1 Transistor	
Q5	2SC984-C Transistor	
Q6	2SC984-C Transistor	
Q7	2SC484-Y Transistor	
Q8	2SC484-Y Transistor	
Q9	2SA484-Y Transistor	
Q10	2SA484-Y Transistor	
Q11	2SC1079 Transistor	
Q12	2SC1079 Transistor	
Q13	2SC1079 Transistor	
Q14	2SC1079 Transistor	

OTHERS

Symbol	Description	Part No.
	Heat Sink	M14-048-D
	Miniature Heat Sink	M14-060-O
	Socket for Power Transistor	K31-018-O

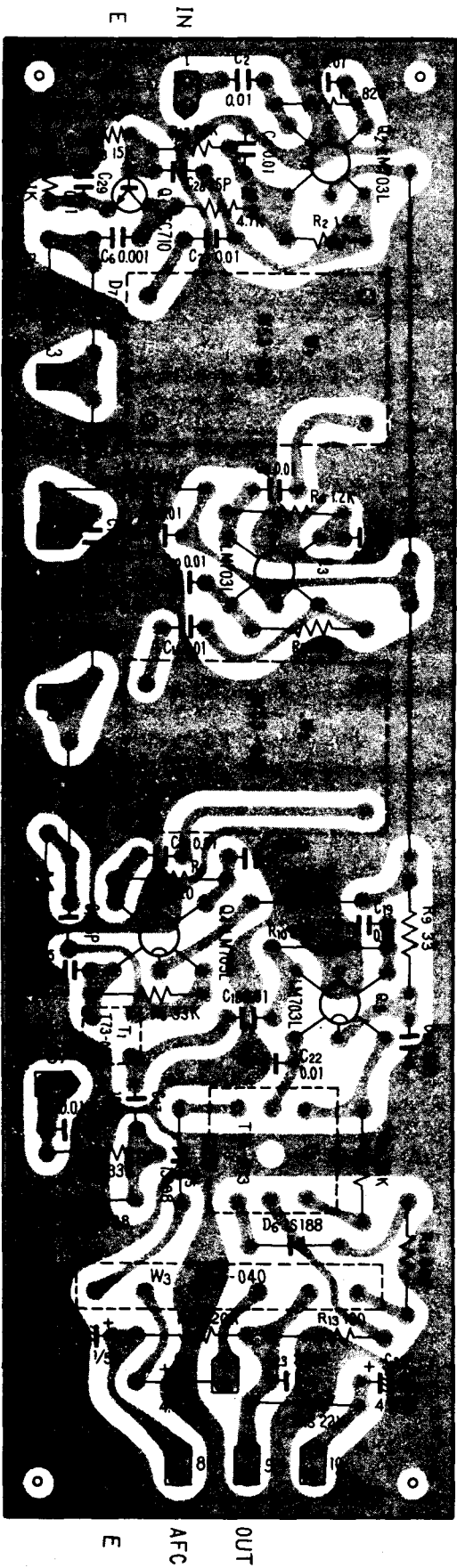
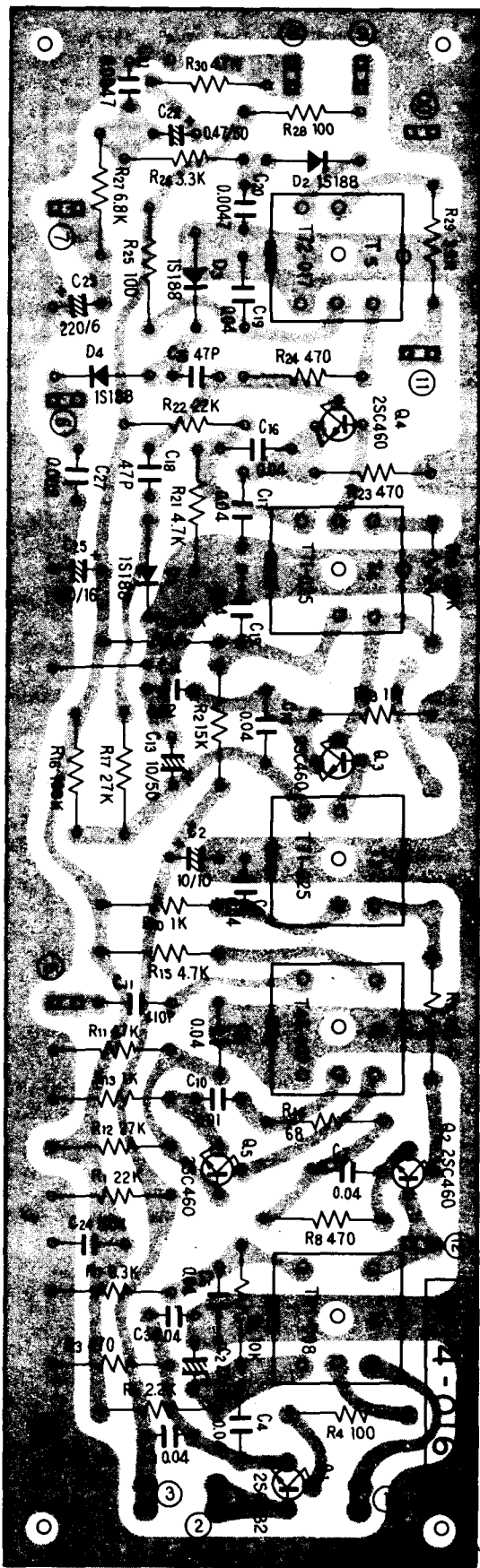

AGC B MUT

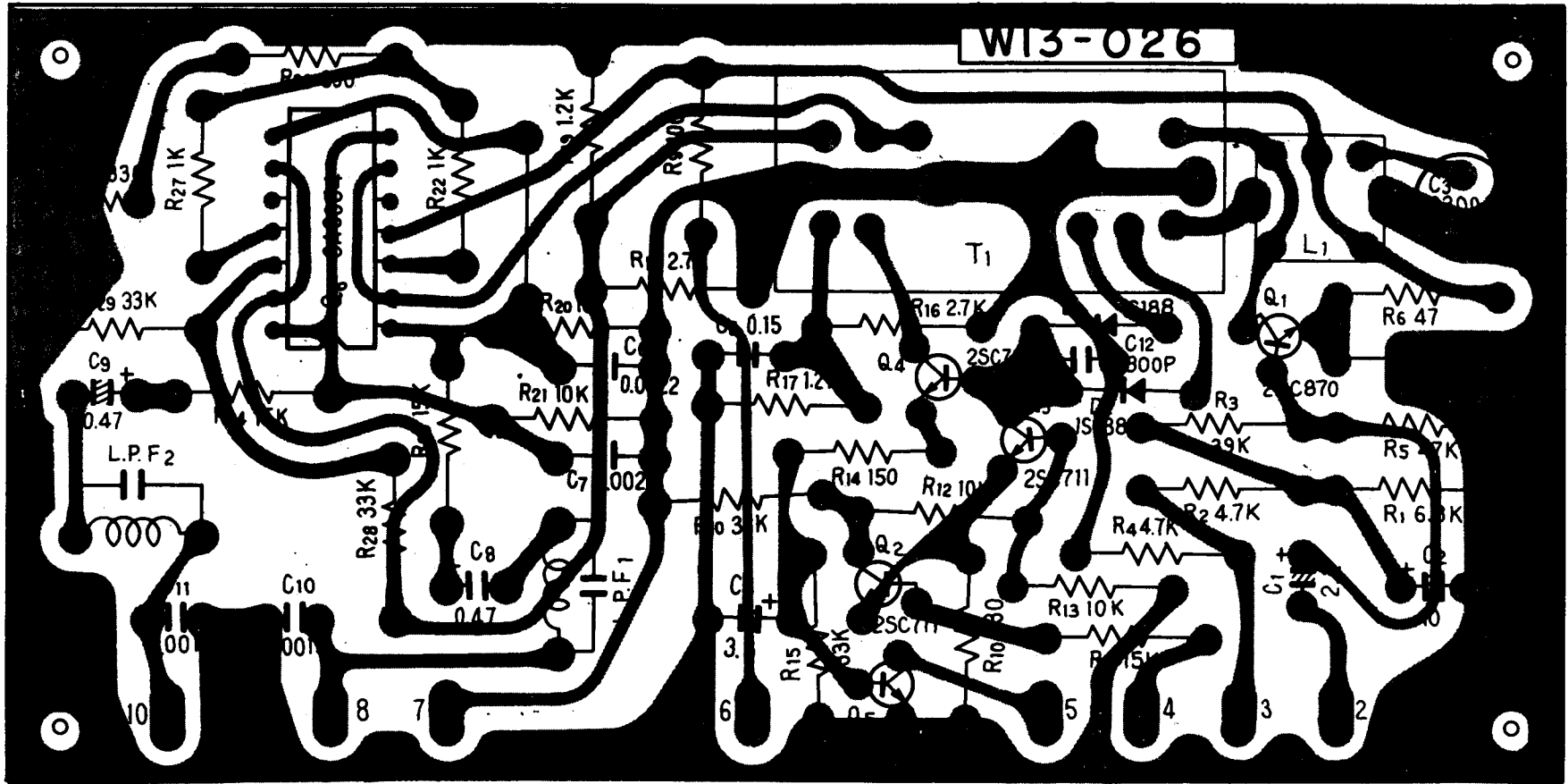

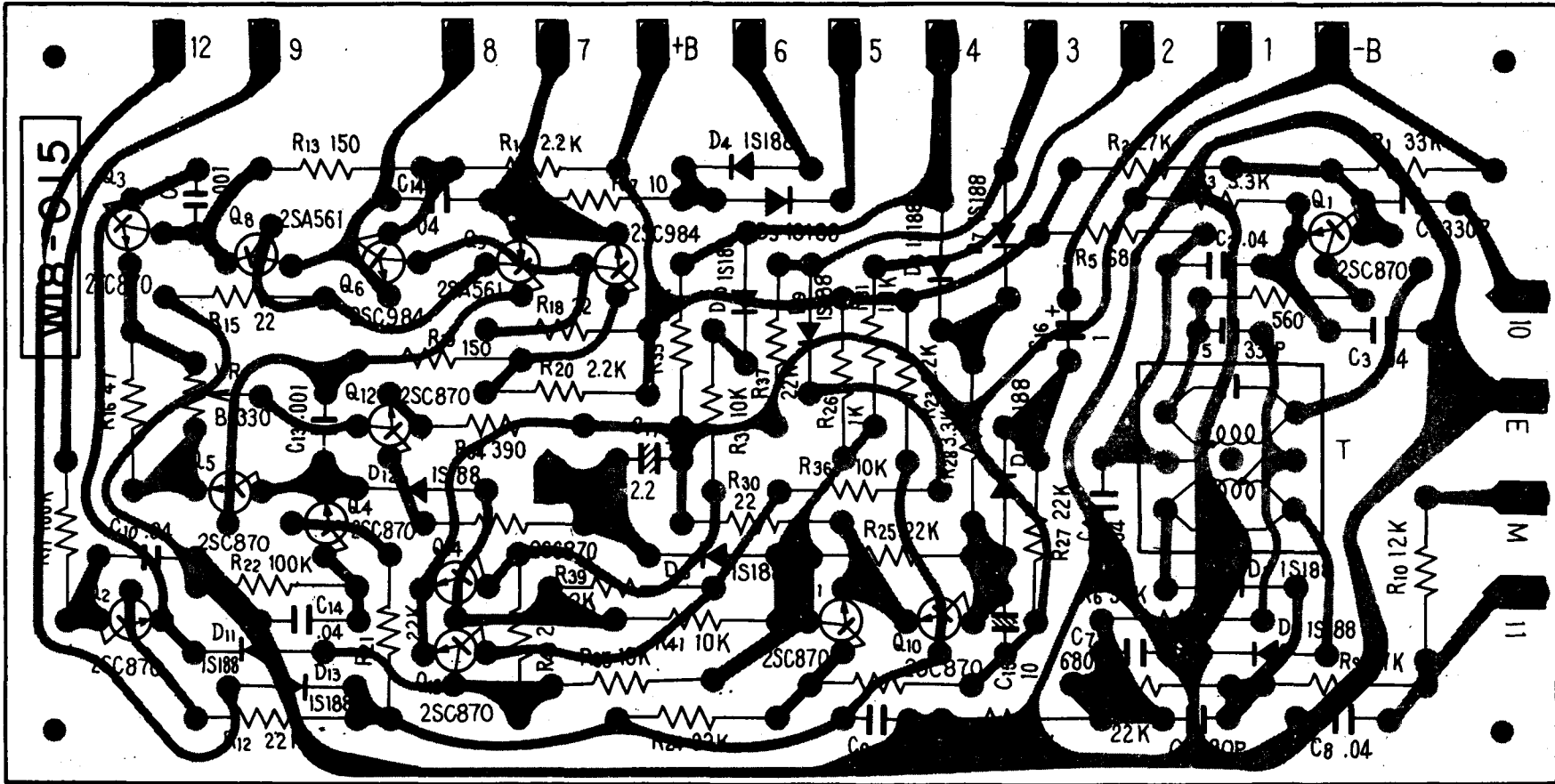

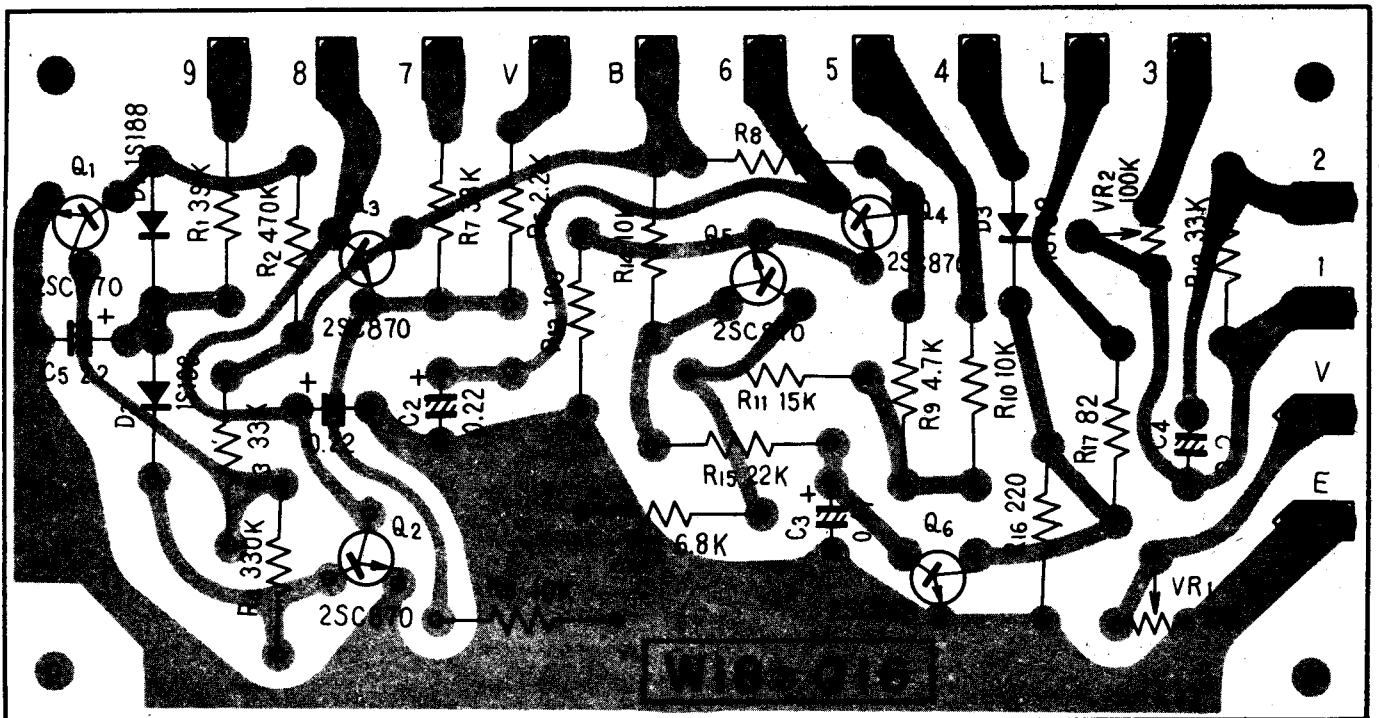
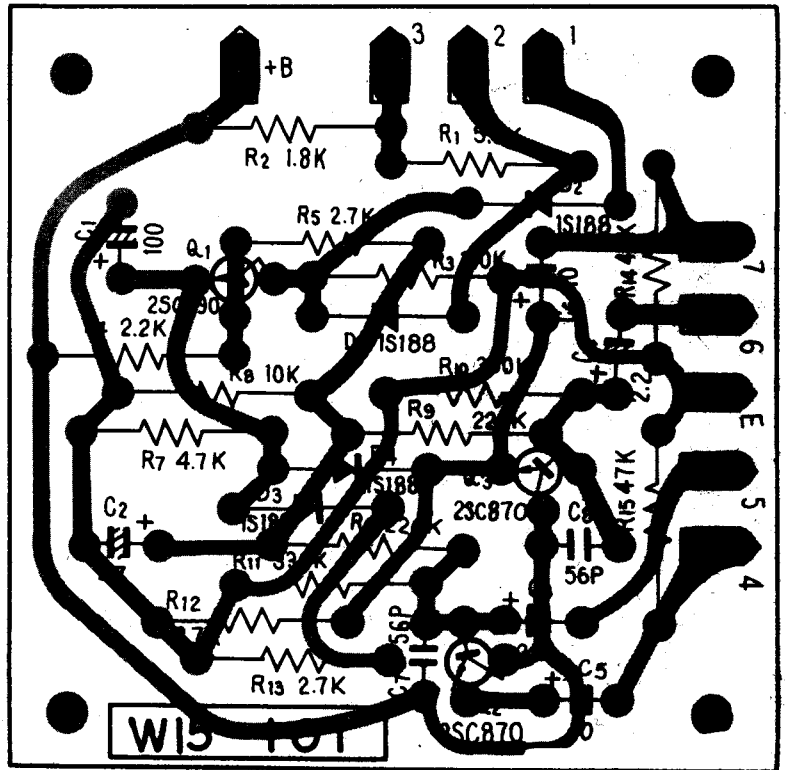

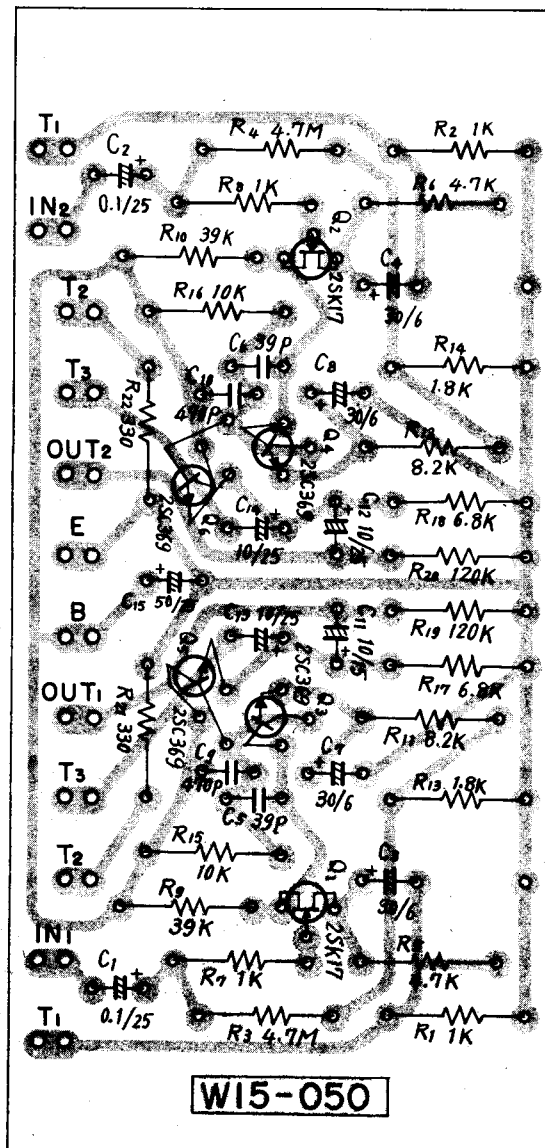
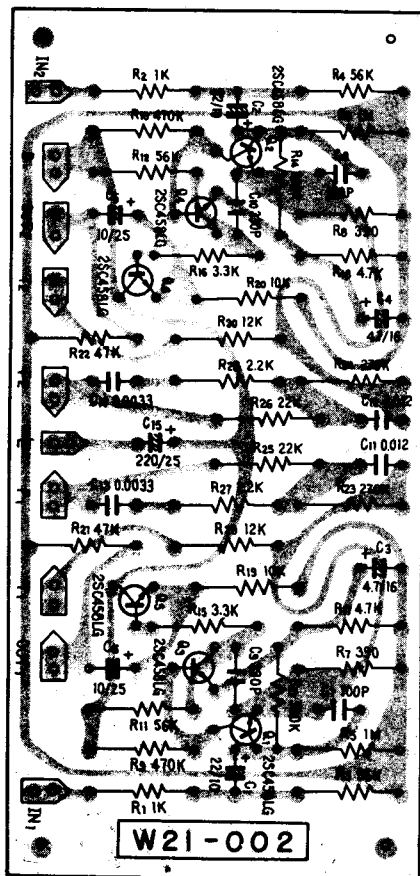
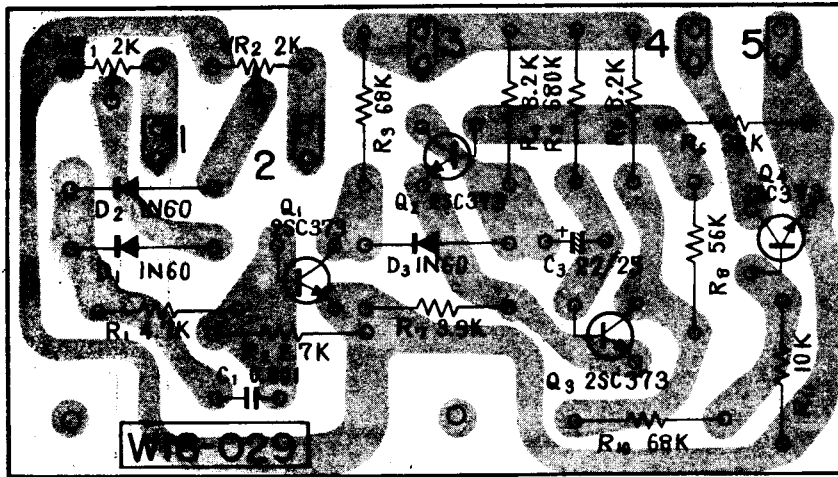

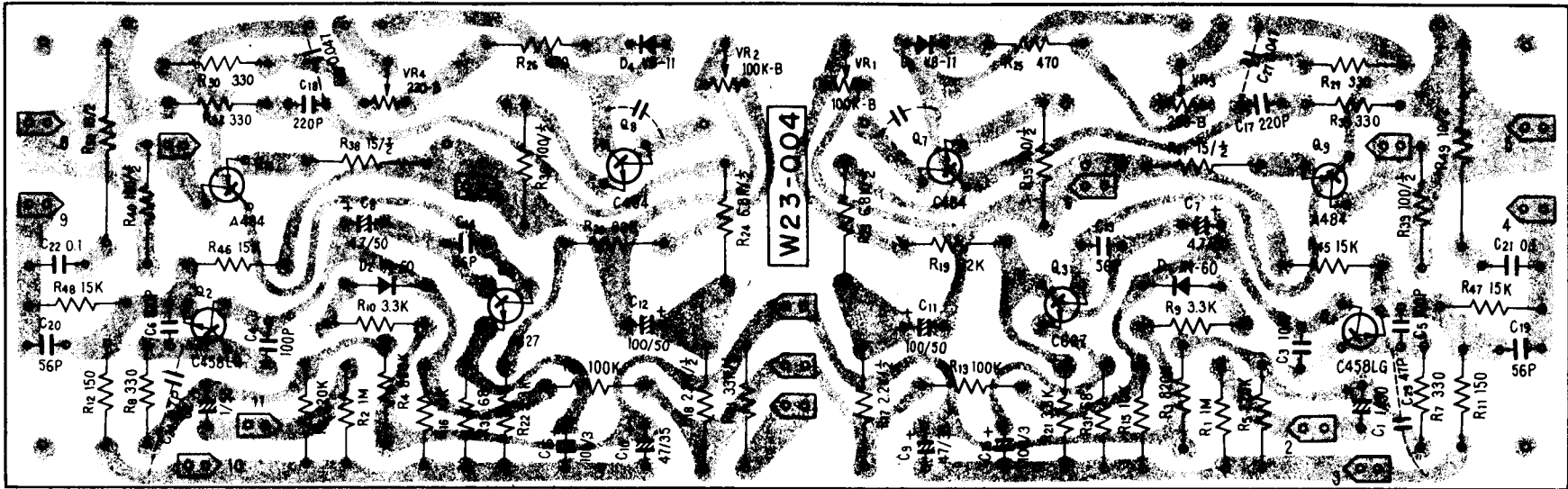
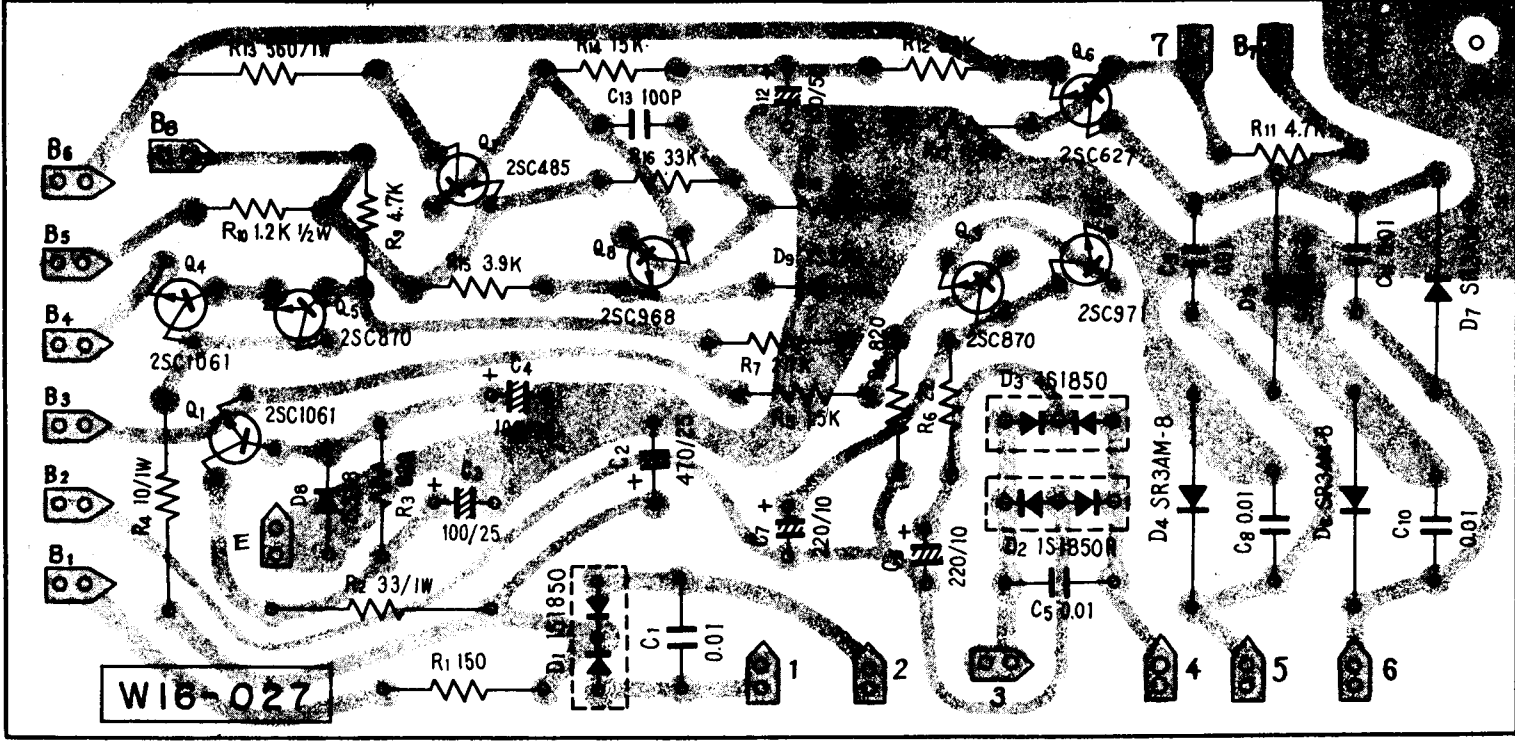

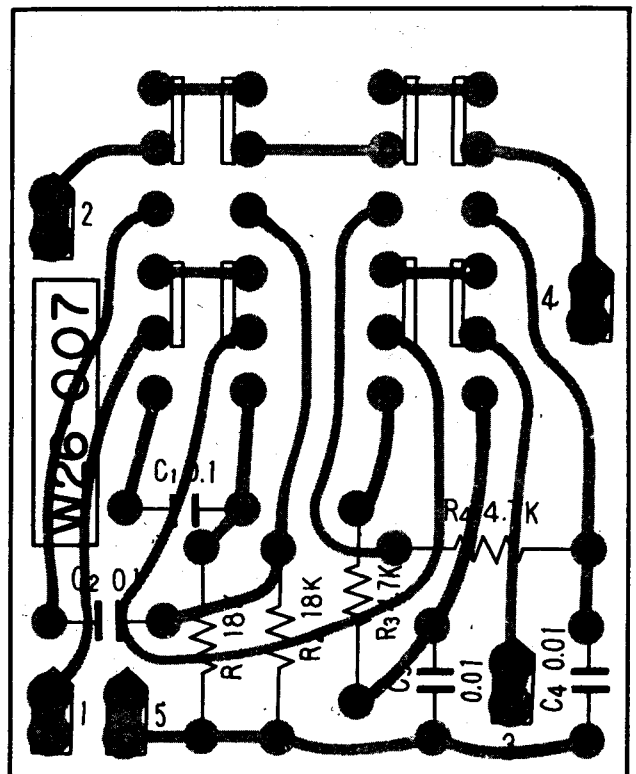
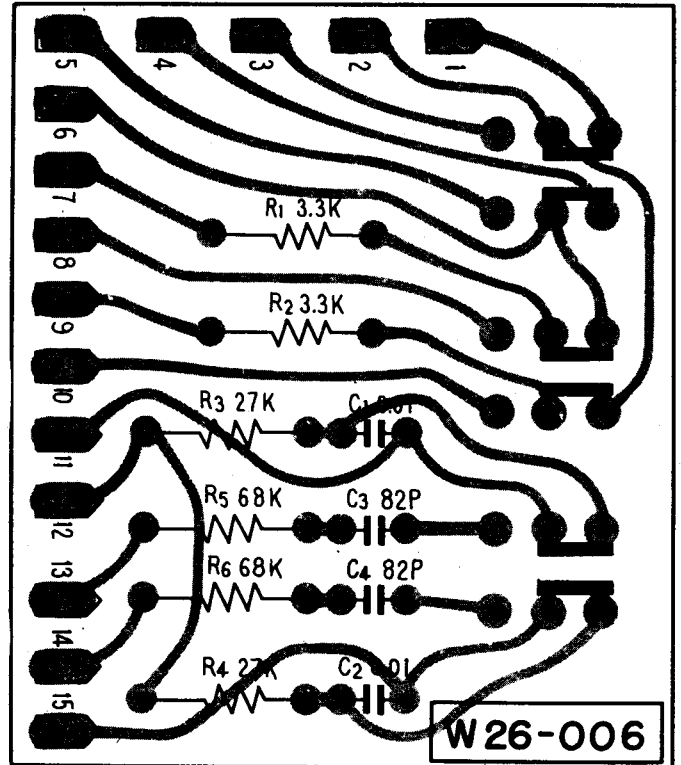
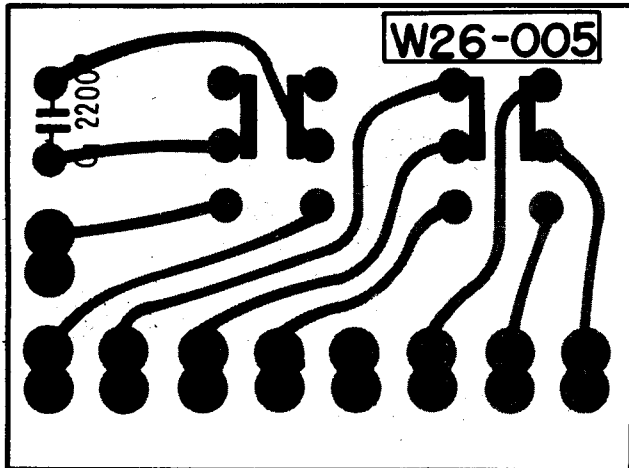
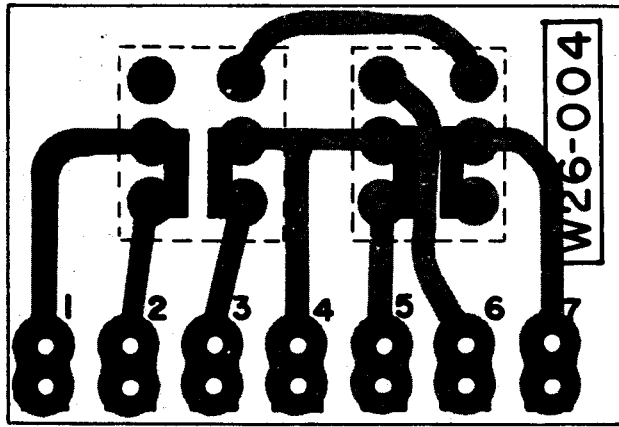

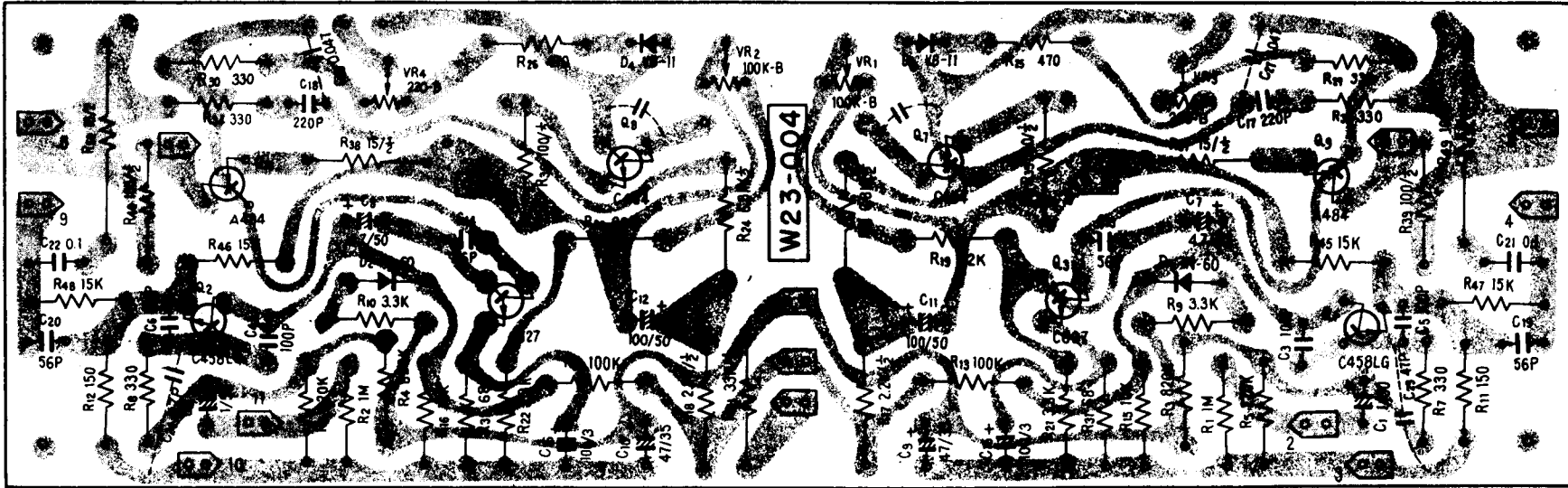
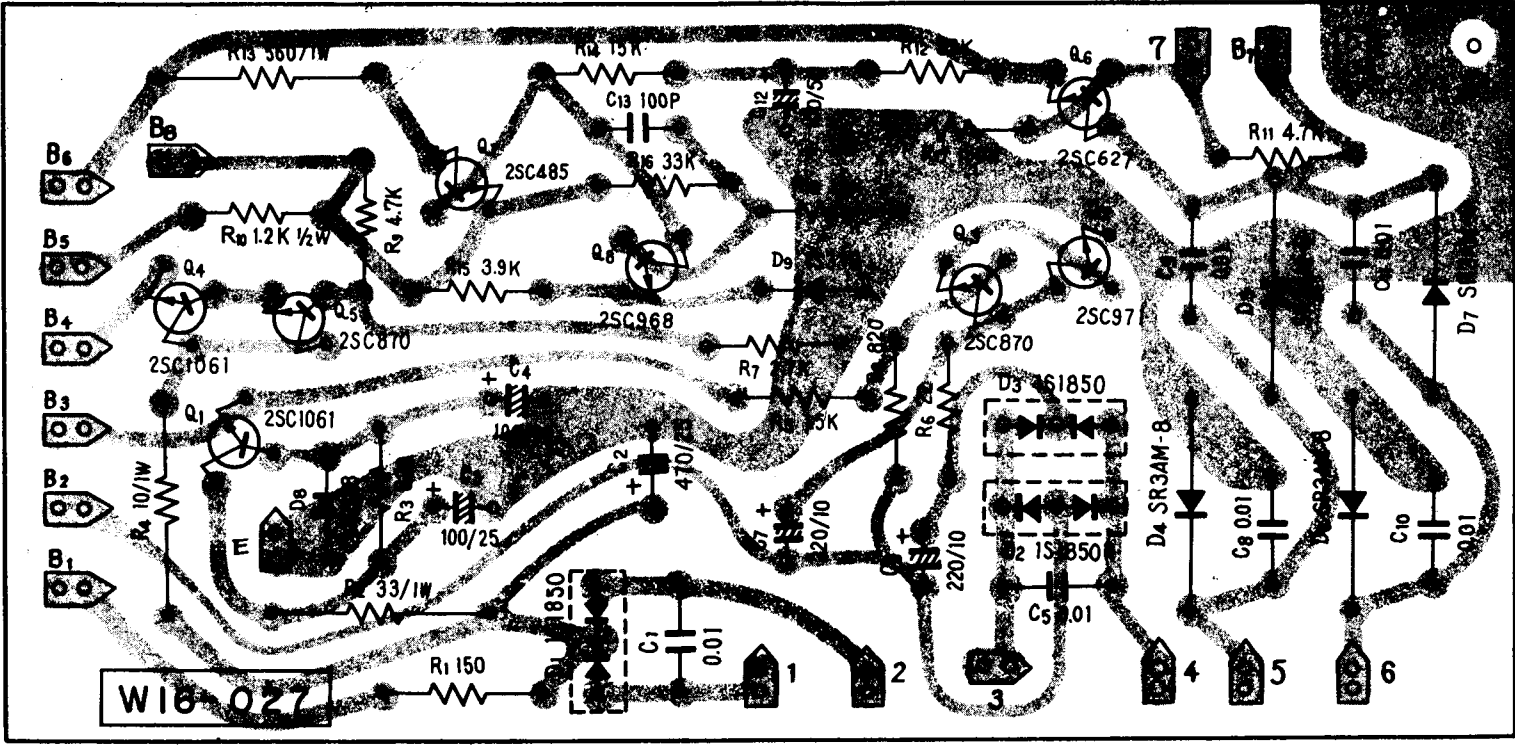

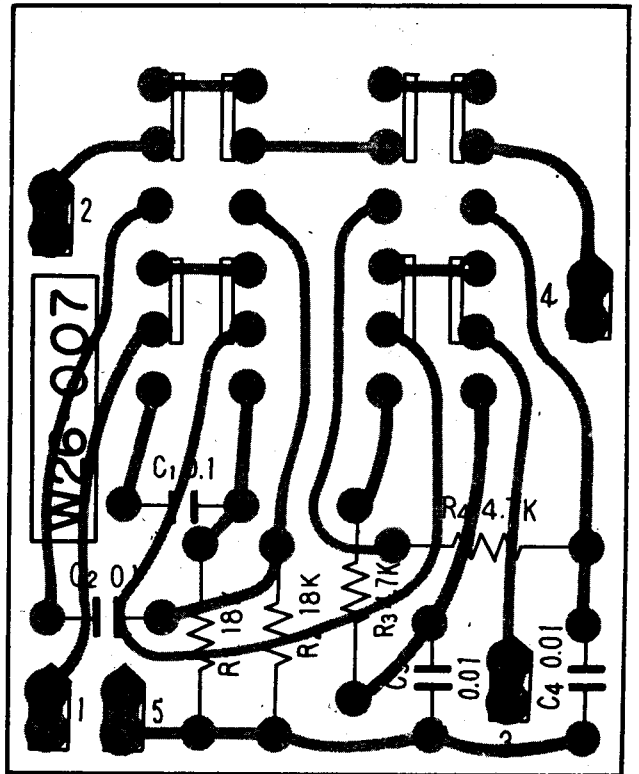
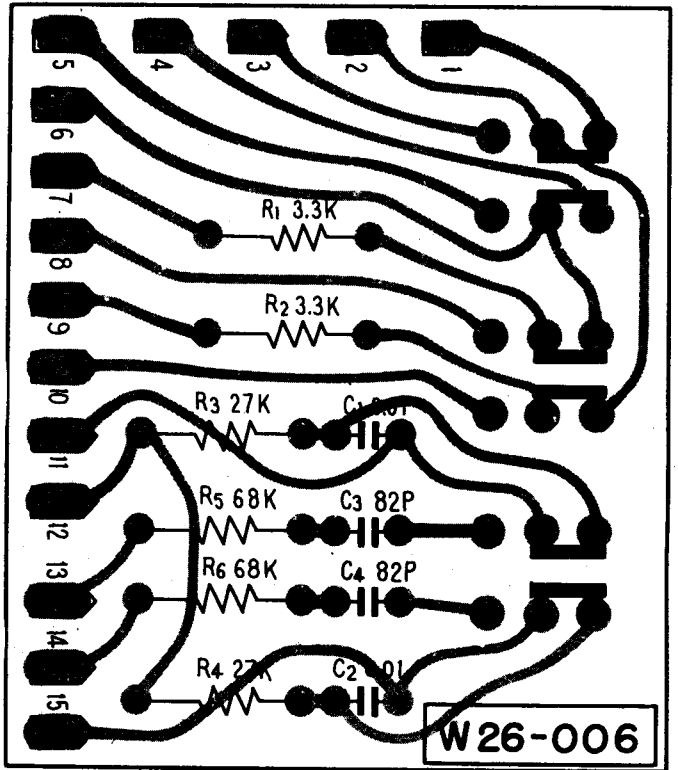
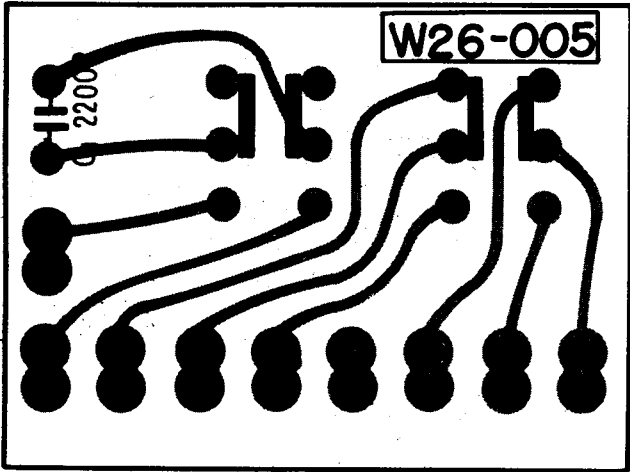
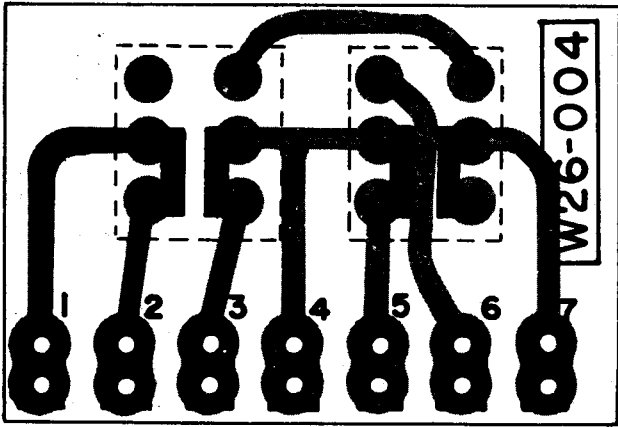

CONDITIONS FREQUENTLY MISTAKEN FOR MALFUNCTION

Noise: There are a variety of noises relating to the operation of a hi-fi unit. These are generally divided into two types; (1) the unit is faulty (a transistor or part has deteriorated) and (2) an external source is adding to the unit.

When a hi-fi unit produces an unpleasant noise, it is often assumed that the unit is faulty, but statistical records indicate that the majority of noises produced in hi-fi acoustic units result

from external sources of noise: Due to the inherent high sensitivity and the high fidelity in reproduction, the unit amplifiers and reproduces extraneous noises, into definite output noise. If your receiver produces a noise, check according to the following table and trace out the source of noise for the appropriate corrective action.

	Symptom	Suspected Source of Noise	Diagnosis and Remedy
When Listening to Broadcast	Continuous or intermittent noise like jiiiii or zzzzz.	<ul style="list-style-type: none"> ●Static(lightning) ●Fluorescent lamp, motor, or thermostat may be in use in house or in the vicinity of the house. 	In many cases, it is very difficult to remove the source of noise. In order to make the radio input larger than the noise level, set up a good outdoor antenna and make a complete grounding.
	When a station is tuned in, hum is mixed in the program.	<ul style="list-style-type: none"> ●Poor fluorescent lamp, motor, or electric heater may be in use in house or near the house. 	Reversing the line plug may occasionally alleviate this noise problem. Usually it is very difficult to eliminate the noise.
	Static noise (in particular, when automobiles run close to the house).	<ul style="list-style-type: none"> ●White noise generated from automobile engines. ●Radio frequency sewing machine or welding machine being used near your house. 	In an area surrounded by hills or high buildings, the FM input signals are very weak. Thus the noise limiter in the circuit loses its function. Set up an FM outdoor antenna having many reflector elements.
	Reception of FM stereo program contains more noise than FM mono program.	<ul style="list-style-type: none"> ●Note that the service area covered by an FM stereo broadcast is about 50% of that of a regular mono broadcast. 	Increasing FM input signal may alleviate this problem. Use an exclusive FM outdoor antenna instead of the indoor T-type antenna.
When Playing Records	Hum or buzz. When switched to radio reception, the noise disappears.	<ul style="list-style-type: none"> ●Poor connection of shielded wire. (a). ●Jack connection is loose. (b) ●Line cord or fluorescent lamp is near the shielded wire. (c) ●Poor grounding. (d) ●HAM transmitting station or TV transmitting station is near your house. (e) 	Correct the conditions stated in (a), (b), (c) or (d). In case of (e), report it to an official activity.
	Output tone quality is poor and mixed with noise. Treble is not clear.	<ul style="list-style-type: none"> ●Stylus is worn out. (a) ●Record is worn out. (b) ●Dust adheres to stylus. (c) ●Stylus is improperly mounted. (d) ●Stylus pressure is not proper. (e) ●The TREBLE level is too high. 	Check (a) through (e) and correct the condition. Lower the TREBLE level.

Watch for the following conditions; these are also apt to be mistaken for malfunction.

	Symptom	Suspected Source of Noise	Diagnosis and Remedy
	Power is not turned on although the power switch is set to ON.	<ul style="list-style-type: none"> ●Fuse blows. (a) ●Line plug is loose. (b) 	Check (a) and (b) and correct the condition.
	In playing a record, increasing the volume causes howling.	<ul style="list-style-type: none"> ●Distance between the turntable and the speakers is too short. ●The place on which the turntable or speakers are set is unstable. 	Change the distance or rearrange the installation increase of the unit and speakers. (Installing the turntable on a firm, solid stand may alleviate this problem.) Do not enhance the BASS sound level excessively.

PIONEER ELECTRONIC CORPORATION

15-5, 4-Chome, Ohmori-nishi, Ohta-ku, Tokyo, Japan

U.S. PIONEER ELECTRONICS CORPORATION

178 Commerce Road, Carlstadt New Jersey 07072 U. S. A.

PIONEER ELECTRONIC (EUROPE) N.V.

Frankrijklei 64-68, 2000 Antwerp, Belgium

Printed in Japan
< R12-068-0 >

<71A03Y05S>