

ALAN

9001

MANUAL SERVICE



CTE INTERNATIONAL s.r.l.

Via Sevardi 7, 42010

Mancasale (RE) - ITALY

Ufficio vendite CB: Tel. 0522-509420 - Fax 509422

Assistenza clienti : Tel. 0522-509535 - fax 509534

cod. 603251

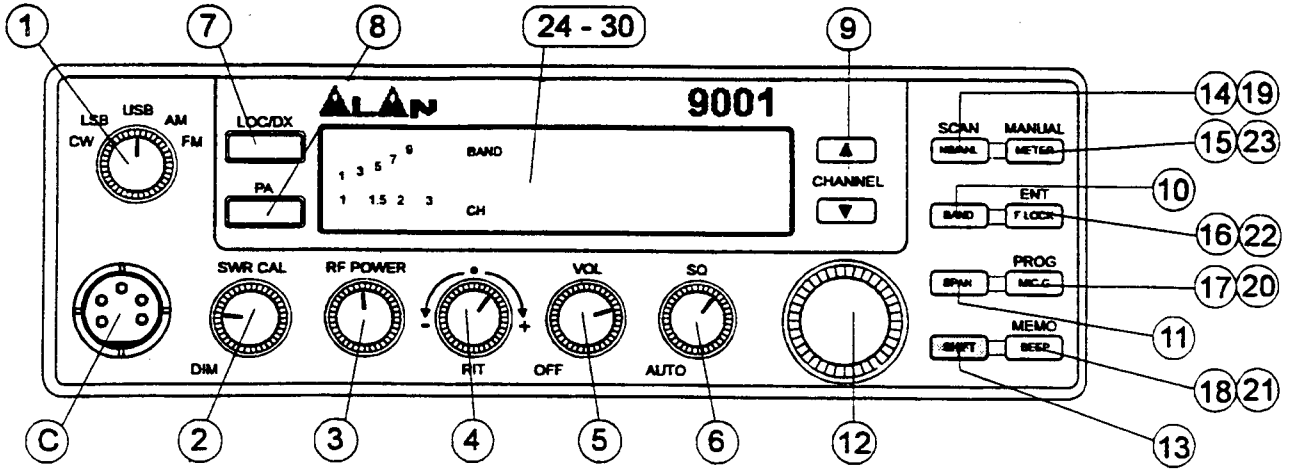

Front panel

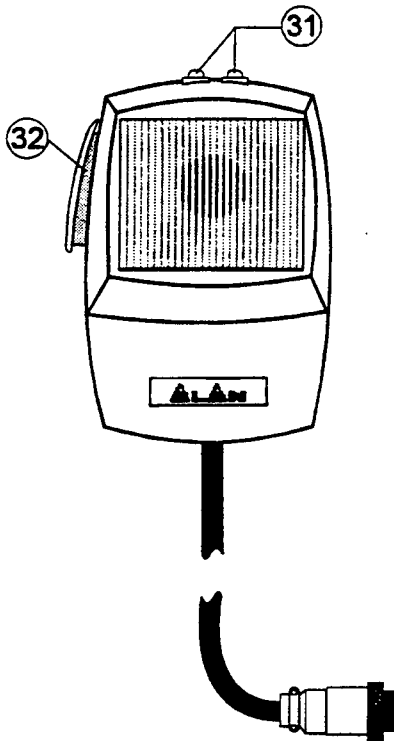

Microphone

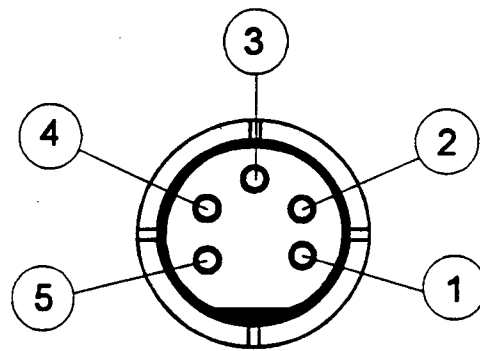

Connector on front panel

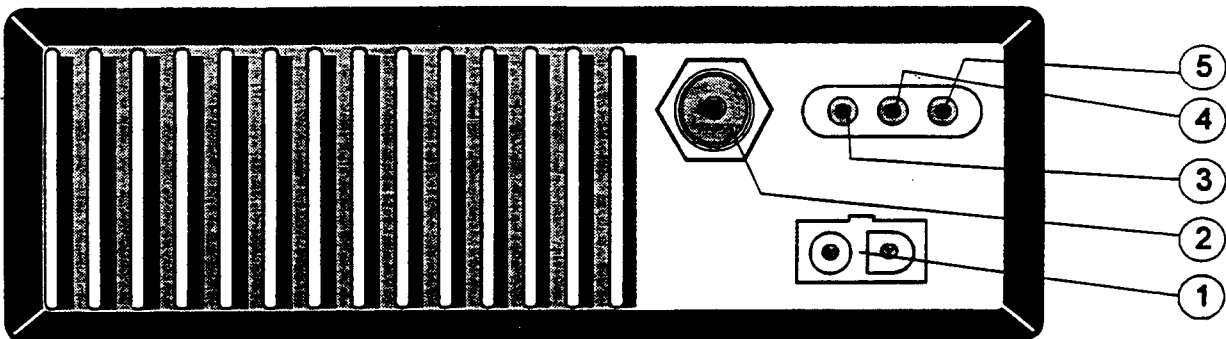

Back Panel

Controls and Functions

- Direct Control Switches -



1. **Mode Switch-** This control is used to select the desired transmit mode. The modes available are: CW,, LSB, USB, AM and FM.



2. **Dim/SWR/CAL Control-** This control is used to adjust the calibration of the SWR meter while in SWR CAL mode. Turning this control fully CCW (Counter Clock Wise) until it clicks dims the display backlighting.



3. **RF Power Control-** This control enables you to adjust RF power continuously over the range of about 1 watt through 10 watt in AM or FM mode, about 10 watt through 25 watt in CW mode.

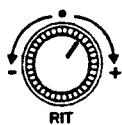

4. **RIT Control-** The receiver incremental tuning control is used to fine tune to the received signal. This is used in USB and LSB modes to obtain maximum clarity of reception, and in CW mode to control the pitch of the beat note. The RIT Control can tune the receive frequency about + 2.3 KHz. This control will not affect the transmit frequency, or the frequency display, but will change the receive frequency.



5. **On/Off/Volume Control-** This control is used to turn the unit on or off and to adjust the volume.

OFF



6. **Squelch Control-** The Squelch control is used to adjust the squelch function, which eliminates the "rushing" sound between transmission. Turning the squelch control CCW until it clicks enables the auto squelch, eliminating the need to manually adjust the squelch.

AUTO



7. **LOC/DX SWITCH-** This is used to vary the RF input to the receiver. This control is used to help eliminate strong, adjacent signals.

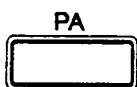

8. **PA SWITCH-** Pressing this switch enables the PA Mode, if an external PA speaker is installed. When in PA mode, the normal transmit functions of the radio are disabled, but the receive audio is routed through the PA speaker.



CHANNEL



9. **CHANNEL-** Pressing these controls will step up or down to the next 10 KHz channel in the currently selected band segment. The currently selected channel is displayed next to the frequency display.



10. **BAND SWITCH-** Pressing this control will select one of the four band segments. Band segments are: 28.0000 - 28.9999, c: 29.0000 - 29.4999, and d: 29.5000 - 29.6999 MHz. The currently selected band segment is displayed left - hand side the band display.



11. **SPAN SWITCH -** This control is used to select either 10KHz, 1KHz, or 100Hz steps for the VFO. The currently selected step is indicated by a line under the relevant digit on the Frequency Display.

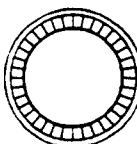

12. **VFO CONTROL-** The Variable Frequency Oscillator control is used to select the desired transmit and receive frequency. Tuning continuous throughout the entire range of the TS - 5010 with no need to select band segments.



13. **SHIFT SWITCH-** This switch is used to select the second function mode which is written in same color as SHIFT switch. The currently selected second function mode is displayed "SHIFT" on the liquid crystal display.

DUAL FUNCTION CONTROL SWITCHES

Pressing this switch followed by SHIFT button makes second function mode.

- FIRST FUNCTION MODE SWITCHES -

Pressing this switch makes function mode as indicated on the button.



14. **NB/ANL SWITCH-** Pressing this switch enables the built in noise reducing functions. There are: noise blanker only, both noise blanker and automatic noise limiter, and automatic noise limiter only. Each time the NB/ANL switch is pushed, the next function is selected.



15. **METER SWITCH-** This switch is used to select the operating mode for the multifunction meter. The meter modes are: S/RF, Modulation, SWR Calibration setting, and SWR. Each time the Meter switch is pushed, the next mode is selected. See the operation section for more information on meter usage. The currently selected mode is displayed around the meter.



16. **F. LOCK SWITCH-** Pressing the Frequency Lock button will disable all frequency determining controls on the front panel, to prevent accidental changes of frequency.



17. **MIC GAIN SWITCH-** Pressing this switch activates the built - in microphone attenuator. This feature is designed to be used when operating the TS - 5010 in high ambient noise environments.



18. **BEEP SWITCH-** Pressing this control will cause a short beep tone to be transmitted whenever you release the PTT switch on the microphone.

- SECOND FUNCTION MODE SWITCHES -

Pressing this switches followed by the SHIFT Switch makes them work.



19. **SCAN SWITCH-** The Scan control is used to scan up to 50 channels in each band segment. See the section on operation for more information on using the Scan Control.



20. **PROGRAM SWITCH-** This switch is used to program operating. See the section on operation for more information on using the program operation.



21. **MEMORY SWITCH-** This switch is used to set up memory channel what you want to program, to pick up the memory channel you programed and for memory channel scanning. See the section on operation for more information on using the program operation and the scan control.

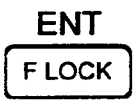

22. **ENTER SWITCH-** This switch is used to program frequencies in memory. See the section on operation for more information on using the program operation.



23. **MANUAL SWITCH-** This Switch is used to return the unit to first function mode from second function mode.

- THE DISPLAY -

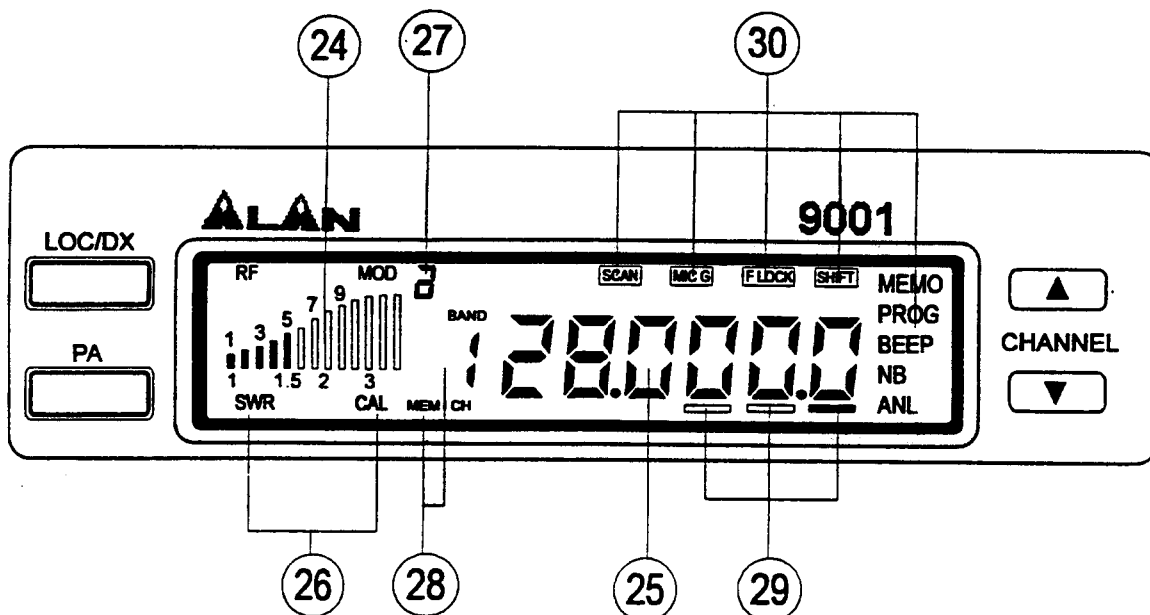

- 24. **MULTIFUNCTION METER-** This meter can display S/RF, Modulation, SWR Cal, or SWR. See the section on operation for more information on using the multifunction Meter.
- 25. **FREQUENCY DISPLAY-** The Frequency Display displays the currently selected transmit and receive frequency.
- 26. **METER MODE DISPLAY-** Displays the currently selected meter operating mode.
- 27. **BAND SEGMENT DISPLAY-** Shows the currently selected band segment.
- 28. **CHANNEL and MEMORY CHANNEL DISPLAY-** Gives the selected channel and memory channel number.
- 29. **VFO STEP INDICATOR-** Displays the currently selected VFO step. (The Fig. shows 100Hz step selected).
- 30. **FUNCTION INDICATORS-** Illuminates when activated functions are indicated.

- THE MICROPHONE -

- 31. **Remote Control Channel SWITCHES-** You can step up or down by one 10KHz channel within the current band segment using these controls. See the section on operation for more information.
- 32. **PTT SWITCH-** The Push to Talk switch is used to control the transmit and receive of your ALAN 9001 Press to transmit, and release to receive.

- FRONT PANEL CONNECTOR -

The microphone included with the **ALAN 9001** is a 500 Ohm dynamic microphone, with channel up and down switches. The view of the connector is facing the TS-5010 front panel. The pin connections are as follows:

Pin	Connection
1 & 2	Microphone
3 & 2	PTT Switch
4 & 2	Channel up Switch
5 & 2	Channel down Switch
2	Common Ground

REAR PANEL CONNECTORS

1. Power Connector

The power cord included with the **ALAN 9001** is color cord. The red wire goes to +13.8V DC nominal and the black wire goes to ground. The **ALAN 9001** is designed for operation with a negative ground system only. The view of the power connector is facing the rear panel of the **ALAN 9001**

2. Antenna Connector

The antenna connects to an ordinary SO - 239 Female RF connector on the rear panel. The RF output impedance is 50 .
WARNING: Standing Wave Ratios in excess of 2:1 may cause transmitter damage.

3. Key Connector

This is used for Morse Code operation. To operate this mode, connect a CW key to this jack and place the Mode switch in the CW position.

4. PA SP Connector

An 8 Ohm 4W PA speaker may be connected to this connector for PA operation. Press the PA switch for this operation.

5. EXT SP Connector

When the external speaker is connected to this connector, the built - in speaker will be disabled.

INSTALLATION

- Tranceiver Mounting -

Plan the location of the tranceiver and microphone bracket before starting the installation. Select a location that is convenient for operation and does not interfere with the driver or passenger in the vehicle. The radio should be secured to a solid surface, using the mounting bracket and self - tapping screws supplied.

- Mobile Antenna -

The antenna is a very important factor affecting transmission and reception. It is for this reason that we strongly recommend that you install only a quality antenna in your new **ALAN 9001** system. You have purchased a superior quality tranceiver, don't diminish its performance by installing an inferior antenna.

Only a properly matched antenna system will allow maximum power transfer from the 50 transmission line to the radiating element. Our business departement is qualified to assist you in the selection of the proper antenna to meet your application requirements.

For automobile installations, a quarter wave whip antenna may be used with good effect. The most efficient and practical installation is to mount it on the rear deck or fender top midway between the rear window and bumper.

A short base loaded whip antenna is more convenient to install, but the efficiency is less than a quarter wave whip.

Fore marine installations, consult your dealer for information regarding an adequate grounding system and prevention of electrolysis.

WARNING: Standing Wave Ratios in excess of 2:1 may cause transmitter damage.

- Ground information -

Most newer U.S. and foreign made cars and small trucks use a 13.8V DC nominal negative ground system, while some older cars and large trucks use a positive ground system. A negative ground system is generally identified by the negative (-) battery terminal being connected to the vehicle frame or engine block, but if you cannot determine the polarity of your vehicle or are unsure, contact your vehicle dealer for definite information.

WARNING: Your **ALAN 9001** is designed for operation on a 13.8V DC nominal, negative ground system only. Operation on other voltages or polarities may cause fires, tranceiver damage, and/or other hazards.

- POWER CORD CONNECTION -

The red lead (with the inline fuse) of the supplied power cord is to be connected to a "hot" (positive) wire, and the black lead to ground. As the **ALAN 9001** draws appreciable current during transmitting, you may wish to connect the positive lead directly to the battery, or to a main supply wire.

OPERATION

- SELECTING A FREQUENCY -

VFO Operation

Selecting an operating using the **▲▲▲ 9001**'s built - in VFO is easy. Make sure that the F.Lock key is NOT depressed and then simply rotate the dial to the desired operating frequency. The VFO will step in either 10KHz, or 100Hz increments. The step increment is indicated by a line under one of the 3 rightmost digits of the frequency display. To change the VFO step, press the Span button until the desired step is indicated by the black line. When using the VFO, you do not need to manually select the band segment, as this is done automatically, so that the tuning range is continuous throughout the entire operating frequency range.

Channel Select Operation

You may also select the operating frequency using the Channel and buttons on the front panel or the microphone. The channel select buttons will select any 10KHz channel in a band segment (50 channels in a; 28.0000 to 28.4900, b;28.5000 to 28.9900, c;29.0000 to 29.4900, and 20 channels in d;29.5000 to 29.6900 MHz). The 10KHz channel frequencies are pre-programmed and cannot be changed. When stepping up or down, the unit will tune to the nearest 10 KHz channel, NOT to the dial frequency + or - 10KHz. When you reach channel 50 (channel 20 in segment d), pressing the Channel button again will step to channel 1, conversely when you are on channel 1, pressing the Channel button will step to channel 50 (channel 20 in segment d).

To select a band segment, press the Band button until the desired band segment letter is displayed. It is displayed, on the display, above the channel number.

If you press and hold down the channel button, the **▲▲▲ 9001** will continuously step up through the pre - programmed channels. In the same manner, pressing the Channel key will also do this.

- RECEIVE SCANNING -

The receive scanning functions of your **▲▲▲ 9001** make it easy to find active frequencies. You can scan 50 channels in segment a, b, or c, and 20 channels in segment d. Scanning is always from the lower frequency to higher frequencies, and always in 10KHz steps.

Scanning Operation

To begin scanning, press the Scan button followed by SHIFT button. If there is a transmission on the current frequency (the squelch is broken open), pressing the Scan button will just step one channel up. If the squelch is NOT broken, scanning will begin. The unit will scan through the selected band segment until it encounters a signal strong enough to break (open) the squelch. It will then stop on that frequency for the duration of the transmission. When the transmission stops, the **▲▲▲ 9001** will wait approximately 1.5 seconds before resuming the scan cycle, to allow you to hear a return transmission on that channel. If you take no further action, the scan will resume. If you want to communicate, press the PTT switch directly on the microphone within these 1.5 seconds, then your **▲▲▲ 9001** can transmit on the channel that has been stopped for transmission while scanning. To exit from scan mode while still scanning, press the Manual button.

During Scanning Operation, you can use memory channel scanning with pressing MEMO button.

Refer programming mode of section on operation for details of memory channel.

- CW OPERATION -

Using CW mode with the **▲▲▲ 9001** is easy. Just select your operating frequency, place the mode switch in CW, and you're ready to transmit CW if you have connected an external key to the key connector on the rear of the unit. (See the section on rear panel connectors for information on connecting a CW key).

To use CW mode with an external key, select an operating frequency, place the mode switch in CW, and you are now ready to operate as semibreak - in CW mode. (If you leave the key up for more than 1 second, the receiver is enabled). The **▲▲▲ 9001** has a built-in sidetone oscillator for your convenience. The **▲▲▲ 9001** will NOT transmit in CW mode unless an external key is connected and in key down condition.

To adjust the pitch of the received CW note, you can use either the VFO or RIT to tune it as desired. (Note: Adjusting the RIT will NOT affect the frequency display).

- USB/LSB/FM OPERATION -

Using the **▲▲▲ 9001** for voice communication as either USB, LSB, AM or FM modes is simple. Simply select your desired operating frequency, turn the mode switch to the desired type of operation, and the PTT switch controls the transmit and receive. To fine tune the receive signal in USB or LSB, you can use either the VFO or RIT controls. (Note: Using the RIT control to fine tune the receive frequency will NOT affect the frequency display).

The Mic Gain control can (and should) be used when you are transmitting from a high ambient noise environment. Pressing The Mic Gain control reduces the output from the microphone. Press the Mic Gain control again to restore it to normal operating condition.

- NOISE BLANKER AND AUTOMATIC NOISE LIMITER -

The Noise Blanker and Automatic Noise Limiter has been designed specifically to reduce the pulsive noise. You can select NB only, ANL only, or both of them. Every time you press the NB/ANL button, the next function will be selected. When you reach the end of the functions, it will start over with the first. They effectively eliminate interference generated by vehicle ignition systems.

F.LOCK

The Frequency Lock function is used to lock the frequency determining controls against accidental changes. To lock the frequency controls, press the F.Lock button. To unlock the frequency controls, press F.Lock again.

BEEP CONTROL

The Beep control enables and disables a short "beep" tone that is transmitted whenever you release the PTT switch (except in CW mode). This is especially useful when transmitting in USB or LSB mode, as it lets the station that you are working know that you have stopped transmitting. Press the Beep button to enable the beep tone, and press it again to disable it.

MULTIFUNCTION METER

The Multifunction Meter built - in to your **AA-9001** provides a number of useful functions. These are:

- S/RF Meter
- MOD Meter
- SWR CAL Meter
- DWR Meter

Every time you press the Meter button, the next function will be selected. When you reach the end of the functions, it will start over with the first.

S/RF METER

The S/RF meter function provides a visual indication of relative received signal strength and relative transmit power. To use the S/RF function, press the Meter button until "RF" is displayed over the meter display. The meter automatically switches function depending on whether you are transmitting or receiving (S mode). When receiving, the meter reverts to the "S" function.

MOD METER

This function gives you an indication of the strength of your modulation when transmitting. There is no function for this meter when receiving signals. To use the MOD function, press the Meter button until "MOD" is displayed over the meter display.

SWR CAL METER

This mode of the multifunction meter is used to calibrate the meter for the SWR function. To use this mode, first place the unit in CW, AM, or FM modes. Then, press the Meter button until the small triangle and "CAL" are visible under the meter. Press the PTT switch on the microphone or hold down the CW key (if connected), and adjust the meter using the SWR CAL control until it indicates up to the small triangle. When you have done this, you are ready to check the SWR using the procedure under "SWR Meter".

NOTE: Don't forget that all transmissions must be properly identified, and remember to listen on the frequency before transmitting.

SWR METER

After you have calibrated the SWR meter using the SWR CAL function (in the previous section) you are ready to check the SWR of your **AA-9001** and antenna system. Press the Meter button until "SWR" is displayed under the meter. At this point, pressing the PTT switch on the microphone, or holding down the CW key (if connected) to transmit will cause the meter to display the Standing Wave Ratio.

NOTE: If you are in LSB or USB modes and using voice, you will not see a steady SWR indication, since there is no carrier transmitted in these modes. To see a steady SWR indication, you must be in CW, AM, or FM Modes when transmitting.

WARNING: Standing Wave Ratios in excess of 2:1 may cause transmitter damage.

PA MODE

To use the PA mode of your **ALAN 9001**, you must first connect an external PA speaker to the PA.SP. connector on the unit (See the section on the rear panel connectors for more information). With a PA speaker connected, just pressing the PA button will enable the PA mode.

PROGRAMMING MODE

TS - 5010 has 10 memory channels, you can have them memorize frequencies which you selected.

- How to program -

1. Press SHIFT button first, and PROG button, then you can see PROG on the LCD display
2. Press MEMO button then you can see memory channel number on the LCD display. You can select numbers from 0 to 9, every pressing the MEMO button changes numbers on the LCD display.
3. Put frequency number which you selected on the LCD display.
4. Press the ENTER button.

- How to pick up memory channel -

Press SHIFT button first, and press MEMO button until you find out channel number which you want.

- How to change frequency number -

Refer "How to program", and do it again, but when you are in paragraph 3. mentioned above put different frequency number.

- Memory Channel Scanning operation -

Press the SHIFT button first, the MEMO button and SCAN button, then it starts MEMORY CHANNEL SCANNING. To exit from memory channel scanning mode while still scanning, press the MANUAL button.

SPECIFICATIONS

General

Frequency Range	Band a	28.0000 - 28.4999 MHz
	Band b	28.5000 - 28.9999 MHz
	Band c	29.0000 - 29.4999 MHz
	Band d	29.5000 - 29.6999 MHz
Microphone	500 Ω Dynamic, w/PTT and Channel Up & Down	
Speaker	8 Ohm, 5W Max	
Operating Modes	CW, USB, LSB, AM, FM	
Display	Backlit LCD	
Display Items	Frequency, Channel No., Memory channel No. , Meter, Meter Mode, Function Mode, Band, VFO Span	
Size	200(W) x 265(D) x 60(H)mm (7.89"(W) x10.43"(D) x 2.36"(H))	

Transmitter

Frequency Stability	+ 300Hz Nominal. (@ 25°C, 5 Minutes after power on)
Output Power	CW 25W Nominal USB/LSB 25W PEP Nominal AM/FM 10W Nominal
Spurious Harmonic Emissions	-50dB Nominal, all modes
Carrier Suppression	-55dB Nominal, USB/LSB Modes
Unwanted Sideband Suppression	-45dB Nominal, USB/LSB Modes
Power Consumption (No Modulation, PTT Depressed)	AM/FM, 3.1A Nominal USB/LSB 1A Nominal
(Max Modulation)	CW 4.6A Nominal (Key Down)
Microphone Input	AM/FM/USB/LSB 3.3A Nominal
CW Key Voltage/Current	1.3mV Nominal for 50% AM Modulation 8V DC, 10mA

Receiver

Sensitivity for 10dB S/N	AM 1 μ V Nominal CW/USB/LSB 0.3 μ V Nominal
Sensitivity for 20dB S/N	FM 1 μ V Nominal
Adjacent Channel Selectivity	60dB Nominal (10KHz Spacing)
Max. Audio Output	4.5W Nominal
RF Gain Range	20dB Nominal
RIT Range	+ 2.3KHz Nominal
"S" Meter Sensitivity @ S9	100 μ V Nominal
Image Rejection Ratio	65dB Nominal
Power Consumption, No Signal	430mA Nominal
Power Consumption, Max Audio	770mA Nominal

TROUBLE - SHOOTING

If your **ALAN 9001** is not performing up to your expectations, please try these simple steps. If you still cannot get satisfactory results after reading this manual and following the trouble - shooting steps, please contact our business department.

Trouble	Check
Unit will not turn on No Power	<ol style="list-style-type: none">1. Check power cord and all connections2. Check power cord fuse3. Check vehicle electrical system4. Check unit grounding
Poor Reception	<ol style="list-style-type: none">1. Check & adjust squelch2. Check antenna3. Check antenna cable4. Check antenna connectors5. Check operating mode of radio
Weak Transmission	<ol style="list-style-type: none">1. Check antenna2. Check antenna cable3. Check antenna connectors4. Check operating mode of radio5. Check antenna SWR6. Check antenna grounding7. Check for corrosion on connectors

ALIGNMENT
No. 5010-03A
APPROVED BY
ISSUED ON 20, Aug. 1993
ISSUED BY

ADJUSTMENTS AND INSPECTIONS FOR EACH VFO PCB

1. Adjust the core of coils(L503,504,506,517 and 518) to the lowest position.
Adjust semi-fixed resistor VR501,502 to the center (12:00 position).

2. PLL Adjustment ① (LOCK Voltage Adjustment)

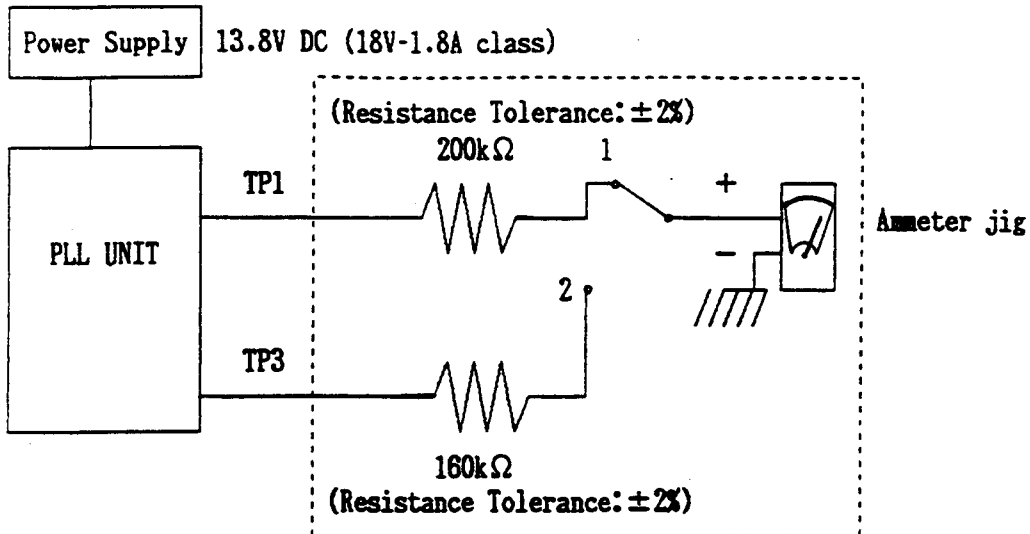

- ① Set the switch of the Ammeter jig at 1 position, adjust L502 to $25\mu\text{A}$ reading on the DC Ammeter.
- ② Set the switch of the Ammeter jig at 2 position, adjust L515 to $25\mu\text{A}$ reading on the DC Ammeter.

3. PLL Adjustment ② (Balance Adjustment)

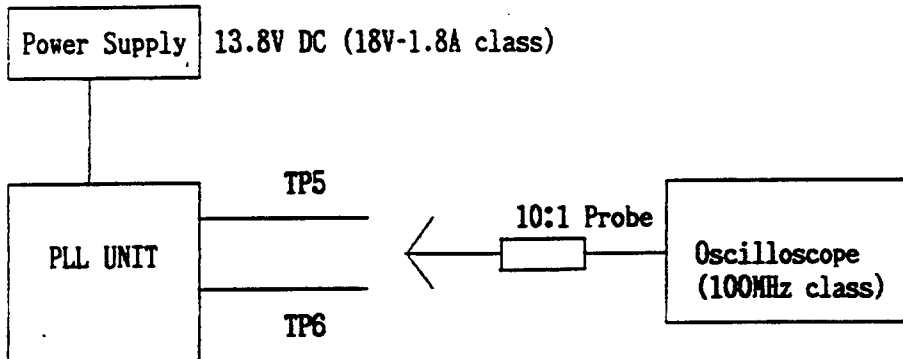

- ① Adjust VR501 to obtain the best waves watching the TP6.
- ② Adjust VR502 to obtain the best waves watching the TP5.

4. LOCK Voltage Inspection

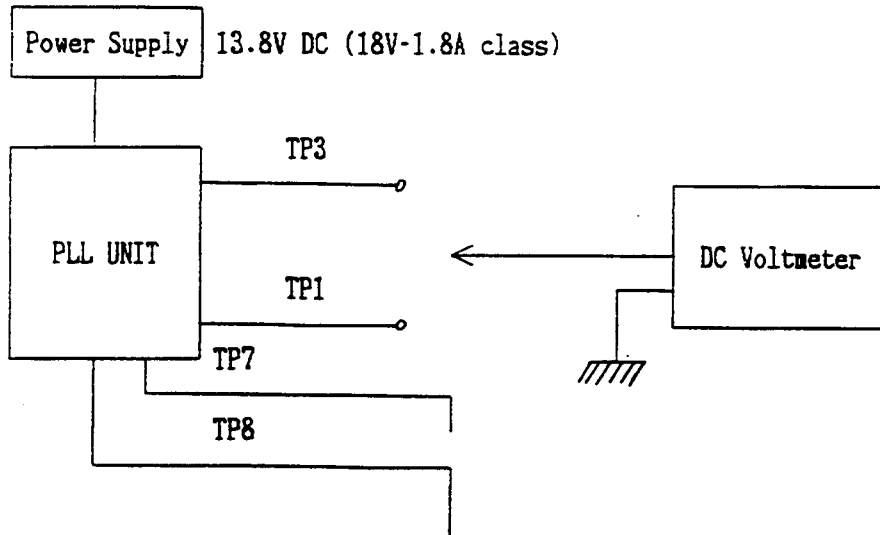

Check the Voltage of TP3 and TP1, and adjust them within the value mentioned below.

No.of Band (1 Ch.)	TP3 Voltage (V)	TP1 Voltage (V)
a	4.0 ±0.5	5.0 ±0.5
b	4.3 ±0.5	5.0 ±0.5
c	4.6 ±0.5	5.0 ±0.5
d	4.9 ±0.5	5.0 ±0.5
e	3.1 ±0.5	2.5 ±0.5
f	3.4 ±0.5	2.5 ±0.5
g	3.7 ±0.5	2.5 ±0.5
h	5.0 ±0.5	5.0 ±0.5
C	3.2 ±0.5	2.5 ±0.5

Operate the adjustment mentioned below after assembly of PLL UNIT.

5. Frequency Adjustment

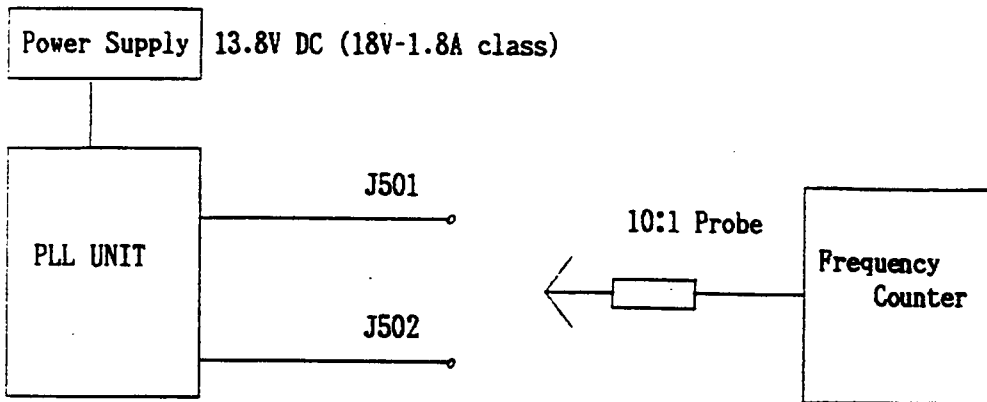

- ① Set RIT Volume(VR1003) to the center(12:00 position), and adjust L516 to make the output frequency of J501 at $10.240\text{MHz} \pm 10\text{Hz}$.
- ② Set at 1Ch of a-band and adjust L501 to make the output frequency of J502 at $38.695\text{MHz} \pm 100\text{Hz}$.
- ③ Connect the counter to TP1 and adjust frequency at following modes.

Mode	Remarks
1 USB	Adjust L108 to set the frequency at $10.6975\text{MHz} \pm 100\text{Hz}$
2 LSB	Adjust L109 to set the frequency at $10.6925\text{MHz} \pm 100\text{Hz}$
3 CW	Adjust L107 to set the frequency at $10.695\text{MHz} \pm 100\text{Hz}$

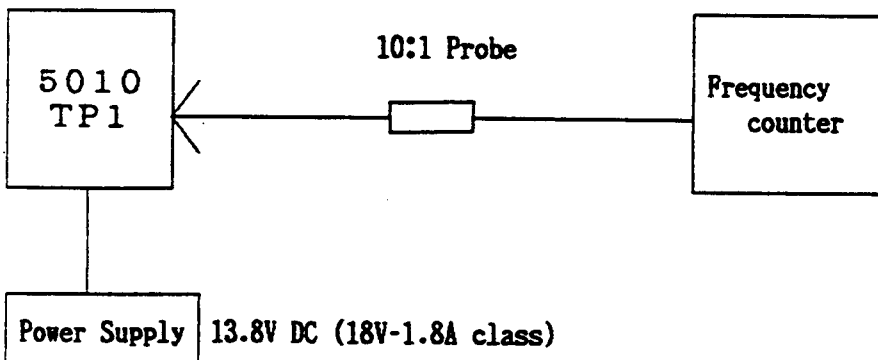

6. TX Frequency Adjustment

Set at 1Ch of a-band and set it at transmission mode, and adjust VR108 to make the TX frequency at $38.695 \pm 100\text{Hz}$.

ALIGNMENT OF TRANSMITTER PORTION

1. Test Equipment Required

Power Supply : 13.8V (more than 10A)

AF SSG AM, FM(1KHz), SSB(2 Signal modulations 500Hz and 2,400Hz)

Oscilloscope, RF Power Meter(CW/PEAK SW:PEAK), AF VTVM, Dummy Load(50 Ω)

FM Linear Detector, DC Ammeter

2. Preparation for Alignment

Semi Fixed Resistor

VR104, VR112 : Clockwise

VR113 : Counter Clockwise

LOC/DX SW : DX

MIC GAIN Mode : OFF

PA SW : OFF

RF Power Volume : Max.

Frequency: 28.000MHz

3. Alignment Procedure

Step	Preset to	Adjustment	Remarks
1	Mode:USB No Mod.	VR112	Remove the PCB(PB-101) from Main PCB. Connect a DC Ammeter (+) to TP101 (-) to TP102. Adjust VR112 for 60mA reading on the DC Ammeter.
2	Mode:USB No Mod.	VR113	Connect the DC Ammeter (+) to TP101, (-) to TP103. Adjust VR113 for 60mA reading on the DC Ammeter.
3	Mode:USB MIC Input: See Remarks 2 SIG.Mod.	L124	Disconnect the DC Ammeter. Reinstall the PB-101 to the Main PCB. Connect an RF Power Meter to the ANT.Jack. Connect an Oscilloscope and an FM Linear Detector across a Trombone to the RF Power Meter. Adjust L124 for maximum reading on the RF Power Meter. During this step, set the AF Oscillator so that the output is less than 8W. Repeat this step twice.
4	Mode:USB 30mV RMS 2 SIG.Mod.	VR103	Adjust VR103 for 25W PEP reading on the RF Power Meter.
5	Mode:USB or LSB No Mod.	VR105	Adjust VR105 so that the carrier leakage at USB and LSB become minimum and almost equal. The Oscilloscope reading has to be less than 500mV P-P.
6	Mode:CW No Mod.	VR104	Connect a SW to Key Jack. Change the CW/PEAK SW on the RF Power Meter to CW position. When turn on the SW, adjust VR104 for 25W reading on the RF Power Meter.
7	Mode:AM No Mod.	VR111	Adjust VR111 for 10W reading on the RF Power Meter.

Step	Preset to	Adjustment	Remarks
8			Repeat step6 and step7 once again.
9	Mode:AM No Mod.		Confirm that the difference of power is less than 1W between 26.500MHz and 30.190MHz.
10	Mode:AM No Mod. Meter:CAL		Set the frequency at 28.000MHz, adjust SWR Volume to light on to the CAL position on the Meter.
11	Mode:AM No Mod. Meter:SWR		SWR Meter has to indicate less than "1" .
12	Mode:AM No Mod. Meter:RF	VR109	Adjust VR109 so that "9" LCD just lights on.
13	Mode:AM 1KHz, 30mV RMS Mod.	VR110	Adjust VR110 to obtain the 85% negative reading on the Oscilloscope.
14	Mode:AM 1KHz, 1mV RMS Mod. Meter:MOD	VR107	Adjust VR107 so that "9" LCD just lights on.
15	Mode:FM 1KHz, 30mV RMS Mod. HPF 50Hz LPF 3KHz	VR106	Adjust VR106 for ± 3 KHz deviation on the FM Linear Detector.
16	Mode:CW Vol.:Max.	VR115	Connect an AF VTVM across a Dummy Load (8Ω) at the EXT.Speaker. When turn on the SW, adjust VR115 for 1.0V RMS reading on the AF VTVM.

TEST EQUIPMENT CONNECTION : Refer to attached drawing.

INSPECTION OF TRANSMITTER PORTION

Step	Preset to	Remarks
1	Mode:USB 30mV RMS Mod. (2 Tones)	Set the CW/PEAK SW on the RF Power Meter to the PEAK position. When it is in transmission operation, RF Power has to be between 24.0W and 26.0W.
2	Mode:CW No Mod.	Set the CW/PEAK SW on the RF Power Meter to the CW position. When the Key Jack is switched on, RF Power has to be between 24.0W and 26.0W.
3	Mode:AM No Mod.	When it is in transmission operation, RF Power has to be between 9.0W and 11.0W.
4	Mode:AM No Mod. Meter:RF	When it is in transmission operation, RF Meter indicates between "8" and "10" .
5	Mode:AM 30mV RMS Mod. (1KHz,Single Tone)	When it is in transmission operation, Modulation has to be between 80% and 90%.
6	Mode:AM Meter: MOD 1mV RMS Mod. (1KHz,Single Tone)	When it is in transmission operation, MOD Meter indicates between "8" and "10" .
7	Mode:FM 2.2mV RMS Mod. (1KHz,Single Tone) HPF 50Hz, LPF 3KHz	When it is in transmission operation, Linear Detector reading has to be between ± 1 KHz and ± 2 KHz of Deviation.
8	Mode:CW Vol.Max.	When the Key Jack is switched on, the Output of AF VTVM across a Dummy Load(8Ω) at the EXT Speaker has to be between 0.9V RMS and 1.1V RMS.
9	PA SW:ON MIC Input:1.4mV	The Output of PA Speaker Dummy Load(8Ω) has to be between 1.6V RMS and 2.5V RMS

ALIGNMENT OF RECEIVER PORTION

1. Test Equipment Required

- Power Supply : 13.8V
- Speaker Dummy Load : 8Ω (at the EXT Speaker)
- SSG
 - Frequency : 28.000MHz
 - Modulation Frequency : 1KHz

2. Preparation for Alignment

- LOC/DX SW : DX
- PA SW : OFF
- NB ANL Mode : ALL OFF
- Squelch : Min. (Auto SQ OFF)
- RIT Volume : Connect the counter to TP2.
 - When you turn fully RIT Volume clockwise and counter clockwise, local frequency has to be varied more than $38,895\text{MHz} \pm 2\text{KHz}$.
 - After above operation, adjust the volume to the center.

Standard Modulation : AM 30%, FM $\pm 1.5\text{KHz DEV}$

3. Alignment Procedure

Step	Preset to	Adjustment	Remarks
1	Mode:AM SSG RF Output: See Remarks SSG: 1KHz 30% Mod.(AM)	L101,102, 103,104, 106	Alignment of sensitivity. Adjust coils for maximum reading on the AF VTVM (During this step, set the SSG attenuator so that the standard output is less than $0.5W(2V/8\Omega)$). Adjust them lastly with SSG RF output set at $1\mu V$.
2	SSG RF Output:1mV	VR101	Alignment of Squelch. Set the Output of SSG to $66 \pm 2\text{dB}$ and squelch volume to maximum. Adjust VR101 so that the squelch just breaks. (Adjust VR101 to indicate Audio Signal Wave to be appeared on the Osilloscope.)
3	SSG:100 μV No Mod. Meter:RF	VR102	Alignment of S-meter. Set the output of SSG to $100\mu V$. Adjust VR102 so that "9" LCD just lights on.
4	Mode:FM SSG RF Output:1mV SSG:1KHz ($\pm 1.5\text{KHz DEV(FM)}$)	L801	Adjust the volume so that the output of EXT. Speaker dummy 8Ω end does not exceed $0.5W(2V/8\Omega)$, then adjust L801 for maximum reading on the AF VTVM.
5	Mode:AM NB ANL Mode:NB SSG RF Output:1mV SSG: 1KHz 30% Mod.(AM)	L401	Adjust L401 for maximum reading at TP401.

NOTE:As to Steps 4 and 5, adjust them with each PCB before assembling with the main PCB.
TEST EQUIPMENT CONNECTION : Refer to attached drawing

INSPECTION OF RECEIVER PORTION

Step	Preset to	Remarks
1	Mode:FM SSG:±1.5KHz DEV(FM) RF Output:1 μV	S/N ratio has to be more than 20dB.
2	Change Freq. to 26.500MHz	S/N ratio has to be more than 20dB.
3	Change Freq. to 30.190MHz	S/N ratio has to be more than 20dB.
4	Mode:AM SSG:1KHz 30% Mod.(AM) RF Output:1 μV Freq.:28.000MHz	S/N ratio has to be more than 10dB.
5	Change Freq. to 26.500MHz	S/N ratio has to be more than 10dB.
6	Change Freq. to 30.190MHz	S/N ratio has to be more than 10dB.
7	Freq.:28.000MHz LOC/DX SW:LOC RF Output:20 μV	S/N ratio has to be less than 10dB.
8	Mode:USB SSG:No Mod. RF Output:0.3 μV Freq.:28.001MHz Meter:RF LOC/DX SW:DX	When the SSG RF output is switched on and off, S/N ratio has to be more than 10dB. When the RF output is switched off, RF Meter must not be lit on.
9	Change Mode to LSB Change Freq. to 27.999MHz	When the SSG RF output is switched on and off, S/N ratio has to be more than 10dB. When the RF output is switched off, RF Meter must not be lit on.
10	Change Mode to CW	When the SSG RF output is switched on and off, S/N ratio has to be more than 10dB. When the RF output is switched off, RF Meter must not be lit on.
11	Mode:AM SSG:No Mod. RF Output:100 μV Freq.:28.000MHz Meter:RF	RF Meter indicates between "8" and "10" .

Step	Preset to	Remarks
1 2	Mode:AM SSG:1KHz 30% Mod.(AM) RF Output:1 μ V SQ Volume:Auto	Audio Signal Wave must not be produced on the Oscilloscope.
1 3	Mode:AM SSG:1KHz 30% Mod.(AM) RF Output:3 μ V SQ Volume:Auto	Audio Signal Wave has to be shown on the Oscilloscope.
1 4	Mode:AM SSG:1KHz 30% Mod.(AM) RF Output:3 μ V SQ Volume:Auto NB check jig:on	Press the NB/ANL Key to select NB mode, then the pulse noise of Audio Output has to be decreased. After confirmation, press NB/ANL Key three times to make the mode back to ordinary condition. Turn off the NB check jig.
1 5	Mode:AM SSG:1KHz 30% Mod.(AM) SQ Volume:TIGHT (Clockwise, Max.) RF Output:400 μ V	Audio Signal Wave must not be produced on the Oscilloscope.
1 6	Mode:AM SSG:1KHz 30% Mod.(AM) SQ Volume:TIGHT (Clockwise, Max.) RF Output:2mV	Audio Signal Wave has to be shown on the Oscilloscope.

SPECIFICATION OF TRANSMITTER PORTION

	Item	Unit	Specification
1	Frequency Stability (5 Minutes after switch on)	Hz	-300 < , < +300
2	Output Power at FM or AM (No Mod., RF Max.) (No Mod., RF Min.)	W	9.0 < , < 11.0
		W	0.1 < , < 1.5
	Output Power at USB or LSB (30mV Mic In)	W (PEP)	24.0 < , < 26.0
	Output Power at CW (RF Max.) (RF Min.)	W W	24.0 < , < 26.0 3.0 < , < 15.0
3	Suprious Harmonic (at all mode)	dB	< -46.0
4	Carrier Suppresion at USB or LSB	dB	< -46.0
5	Power Consumption at FM or AM (No Mod.)	A	< 3.5
	Power Consumption at USB or LSB (No Mod.) (Max. Mod.)	A	< 1.5
		A	< 3.5
	Power Consumption at CW	A	< 5.0
6	Mod. Sensitivity at AM (50% Mod.) (85% Mod.)	mV	1.0 < , < 2.0
		mV	2.0 < , < 3.0
	Mod. Sensitivity at FM (± 1.5 KHz DEV.) HPF 50Hz, LPF 3KHz	mV	1.5 < , < 3.0
7	PA Mic Sensitivity(2V RMS output across 8 Ω dummy load)	mV	1.1 < , < 1.6

SPECIFICATION OF RECEIVER PORTION

	Item	Unit	Specification
1	S/N 20dB Sensitivity at FM (DX)	μ V	< 1.0
2	S/N 20dB Sensitivity at FM (LOC)	μ V	1.0 < , < 4.0
3	S/N 10dB Sensitivity at AM (DX)	μ V	< 1.0
4	S/N 10dB Sensitivity at AM (LOC)	μ V	4.0 < , < 10.0
5	S/N 10dB Sensitivity at USB or LSB	μ V	< 0.5
6	S meter "S9" Sensitivity at FM or AM	μ V	50 < , < 200
7	Audio Distortion at 2V RMS Output (at all mode)	%	< 5.0
8	Audio Output at 10% THD	V	4.0 <
9	SQ Sensitivity at Auto (FM or AM)	μ V	1.0 < , < 3.0
10	SQ Sensitivity at TIGHT (FM or AM)	μ V	400 < , < 2,000
11	Image Rejection Ratio	dB	60 <
12	Adjucent Channel Selectivity +10KHz	dB	55 <
	-10KHz	dB	55 <
13	Power Consumption at no signal	mA	< 450
14	Power Consumption at Audio MAX.	mA	< 800

NB/FM PCB ADJUST

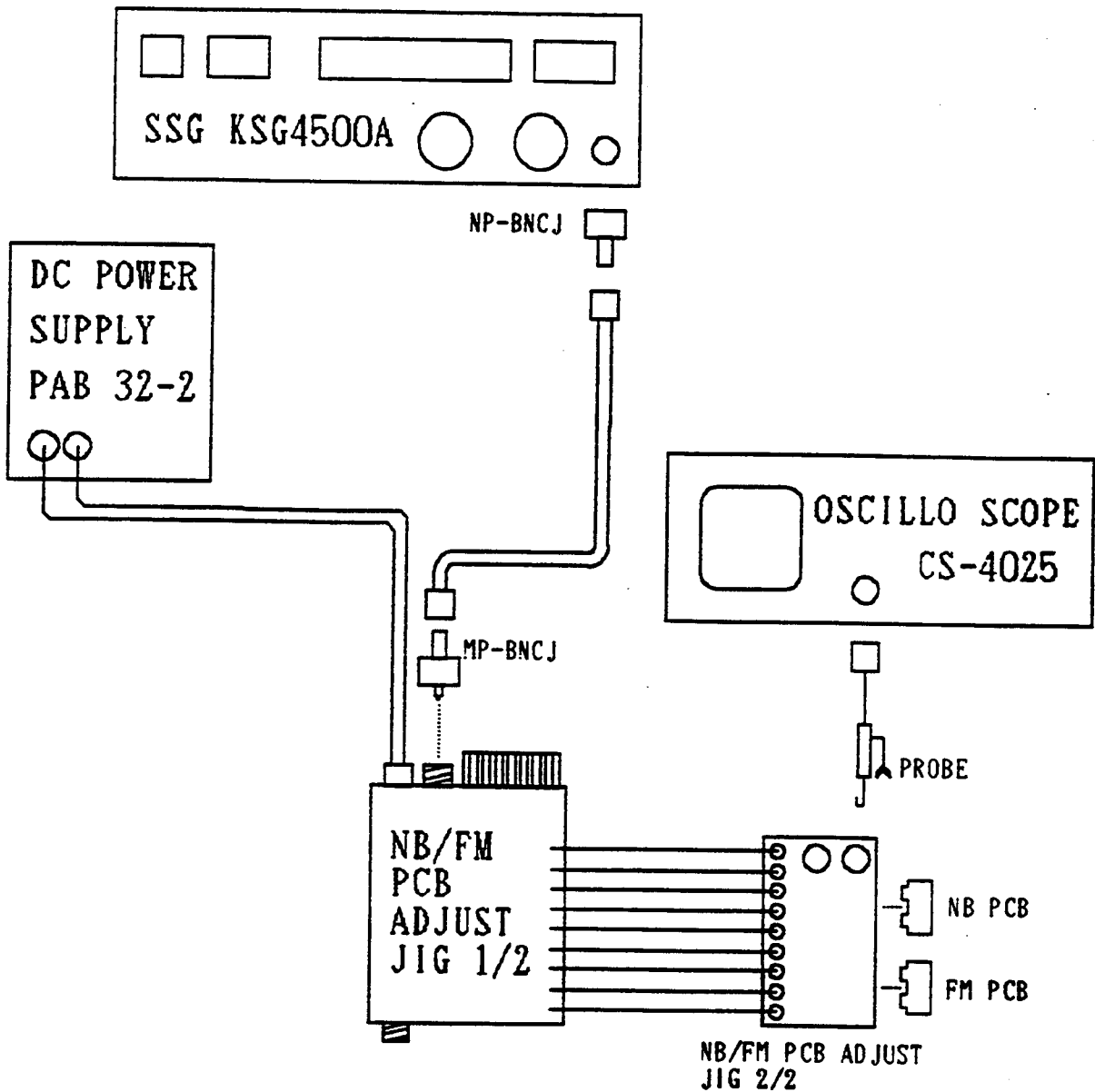

CONNECTOR	Q' TY	CABLE & ETC	Q' TY	CABLE & ETC	Q' TY
MP-BNCJ	1	BNCP-BNCP 1m	1	CLIP-CLIP	0
N-PP	0	BNCP-BNCP1.5m	0	CLIP-BANANA	1
NP-BNCJ	1	BNC-BANANA	1	BANANA-BANANA	0
		BNC-CLIP	1	SP PLUG-CLIP	1
		MIC PLUG-CLIP	0	DC POWER CABLE	1
		CERAMIC DRIVER	1	DRIVER FOR VR	1

RX PRE-ADJUST

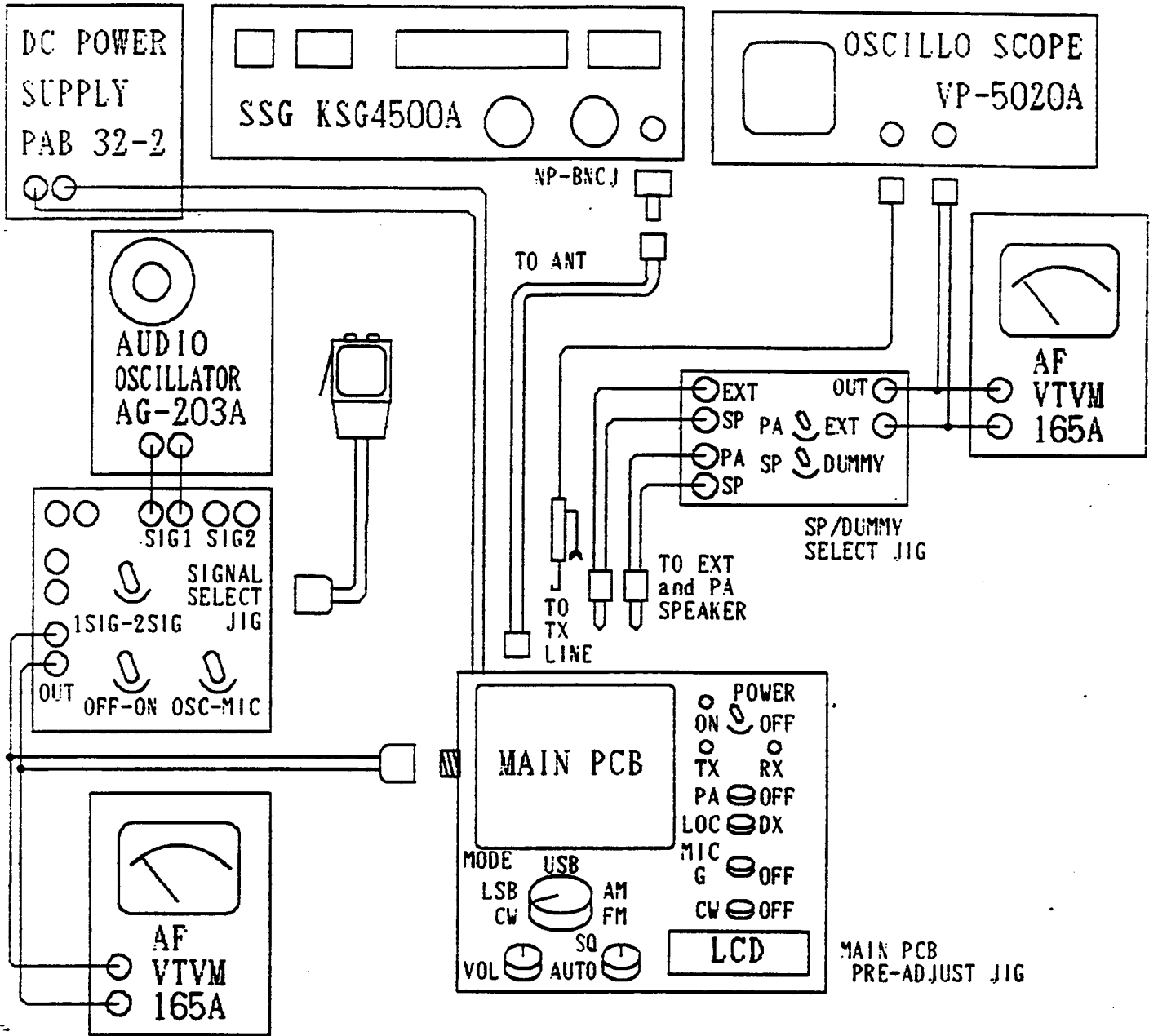

CONNECTOR	Q'TY	CABLE & ETC	Q'TY	CABLE & ETC	Q'TY
MP-BNCJ	0	BNCP-BNCP 1m	1	CLIP-CLIP	0
N-PP	0	BNCP-BNCP1.5m	0	CLIP-BANANA	0
NP-BNCJ	1	BNCP-BANANA	0	BANANA-BANANA	3
		BNCP-CLIP	1	SP PLUG-CLIP	2
MICROPHONE	1	MIC PLUG-CLIP	1	DC POWER CABLE	1
		CERAMIC DRIVER	1	DRIVER FOR VR	1

LCD UNIT CHECK

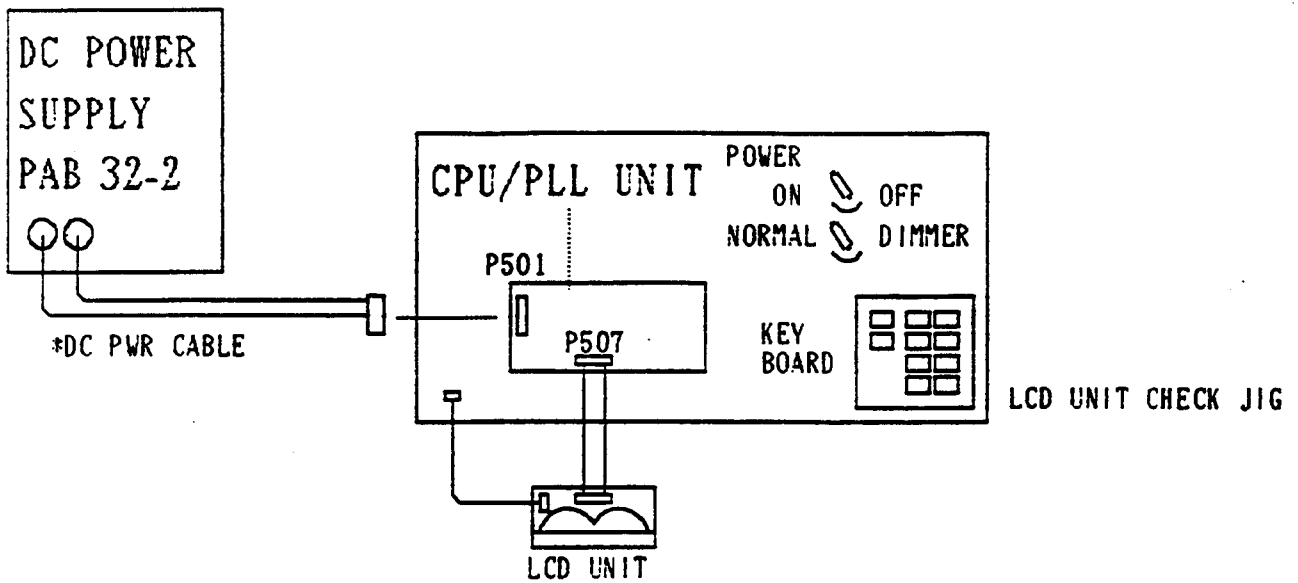

*MODIFY WIRES ASSEMBLED WA-0170104

CONNECTOR	Q' TY	CABLE & ETC	Q' TY	CABLE & ETC	Q' TY
MP-BNCJ	0	BNCP-BNCP 1m	0	CLIP-CLIP	0
N-PP	0	BNCP-BNCP1.5m	0	CLIP-BANANA	0
NP-BNCJ	0	BNCP-BANANA	0	BANANA-BANANA	0
		BNCP-CLIP	0	SP PLUG-CLIP	0
		MIC PLUG-CLIP	0	DC POWER CABLE	1
		CERAMIC DRIVER	0	DRIVER FOR VR	0

FRONT CHASSIS CHECK

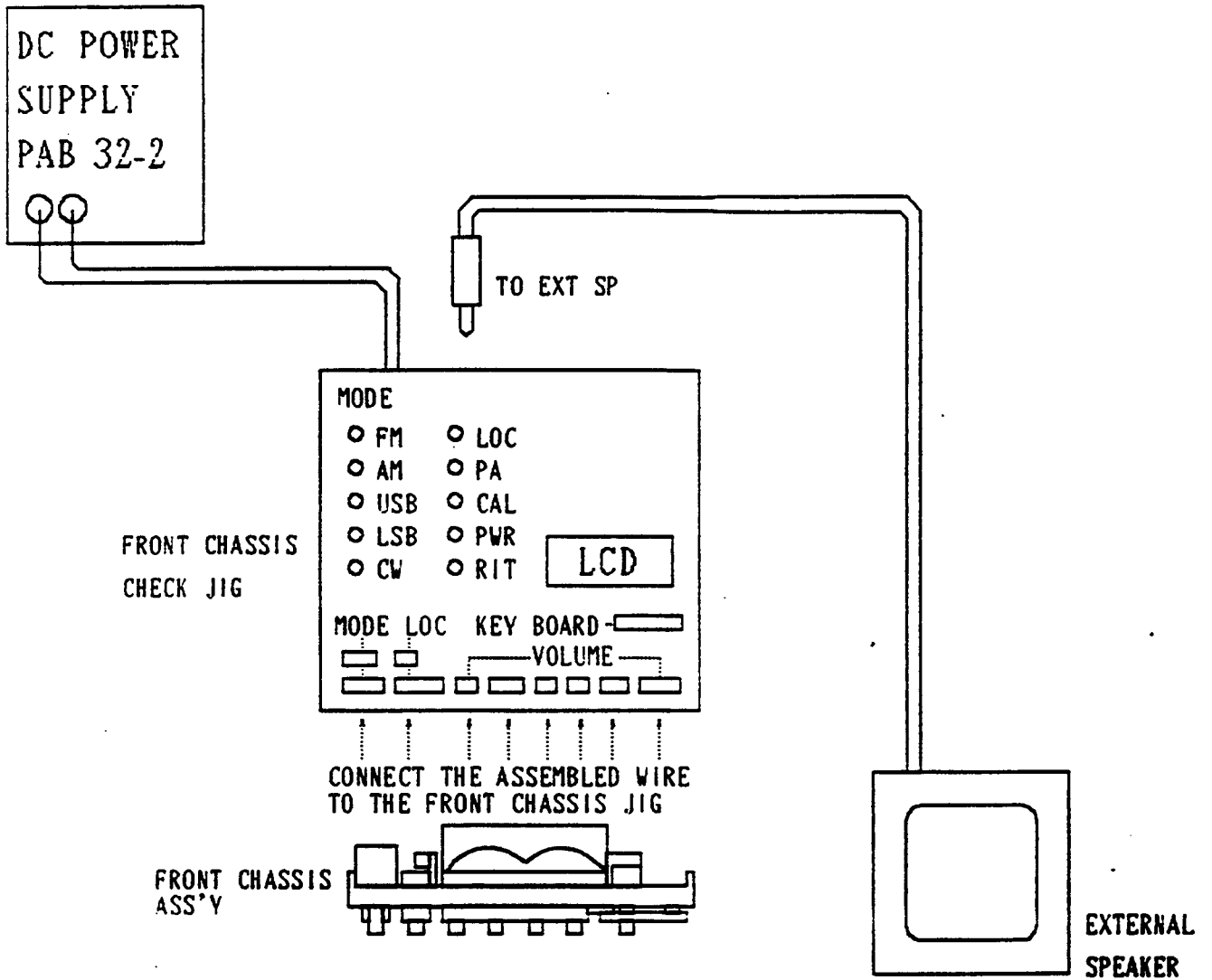

CONNECTOR	Q'TY	CABLE & ETC	Q'TY	CABLE & ETC	Q'TY
MP-BNCJ	0	BNCP-BNCP 1m	0	CLIP-CLIP	0
N-PP	0	BNCP-BNCP1.5m	0	CLIP-BANANA	0
NP-BNCJ	0	BNCP-BANANA	0	BANANA-BANANA	0
		BNCP-CLIP	0	SP PLUG-CLIP	1
		MIC PLUG-CLIP	0	DC POWER CABLE	1
		CERAMIC DRIVER	0	DRIVER FOR VR	0

CPU/PLL UNIT ADJUST

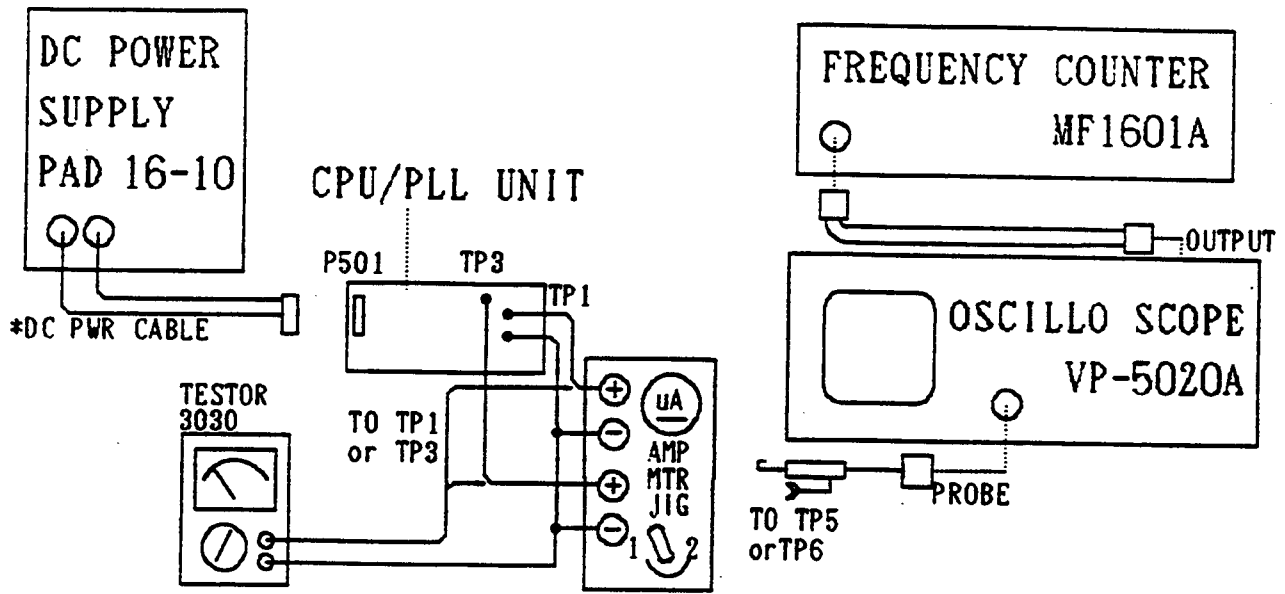

*MODIFY WIRES ASSEMBLED WA-0170104

CONNECTOR	Q' TY	CABLE & ETC	Q' TY	CABLE & ETC	Q' TY
MP-BNCJ	0	BNCP-BNCP 1m	1	CLIP-CLIP	0
N-PP	0	BNCP-BNCP1.5m	0	CLIP-BANANA	3
NP-BNCJ	0	BNCP-BANANA	0	BANANA-BANANA	0
		BNCP-CLIP	0	SP PLUG-CLIP	0
		MIC PLUG-CLIP	0	DC POWER CABLE	1
		CERAMIC DRIVER	1	DRIVER FOR VR	1

TX ADJUST

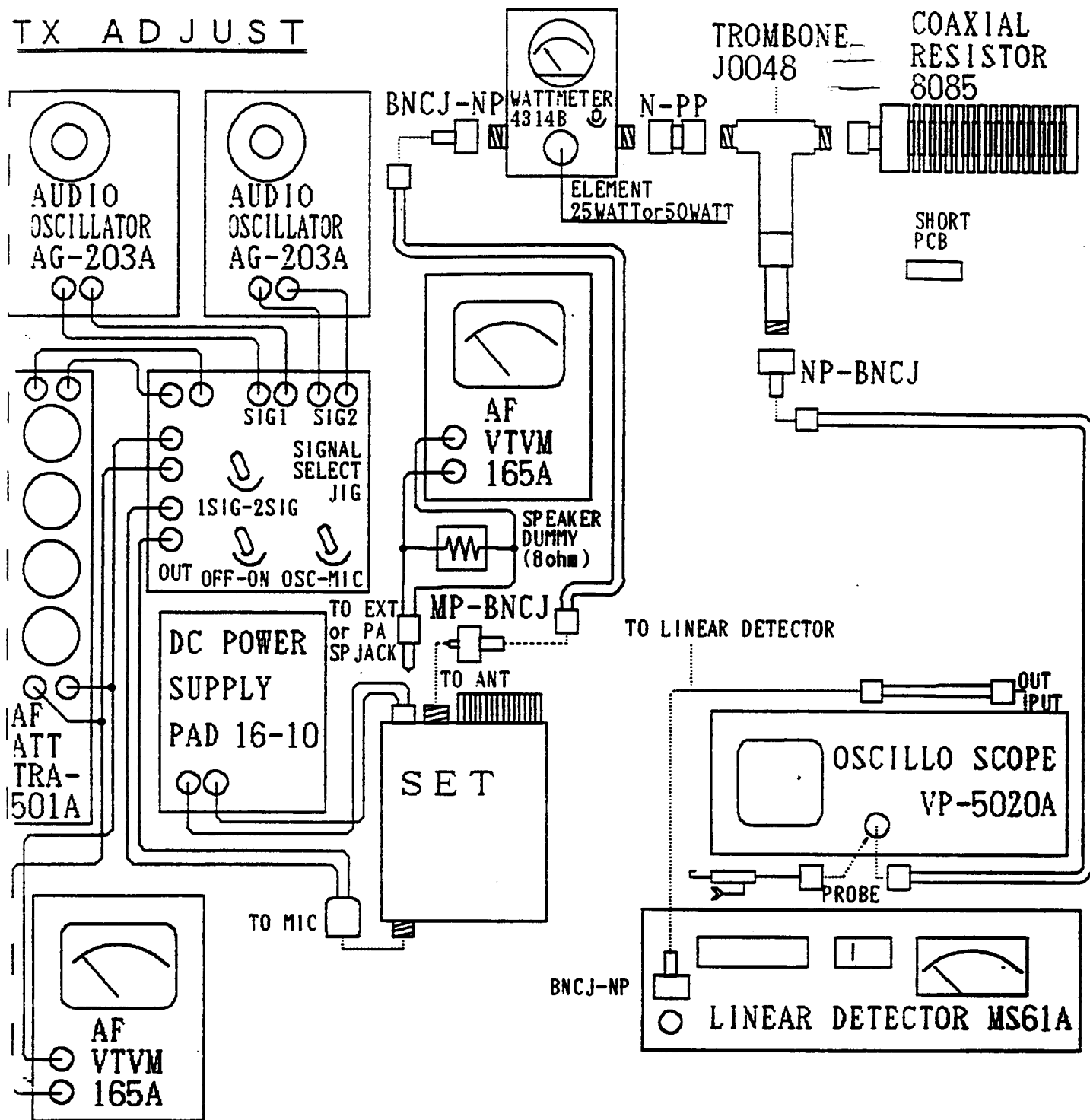

CONNECTOR	Q' TY	CABLE & ETC	Q' TY	CABLE & ETC	Q' TY
MP-BNCJ	1	BNCP-BNCP 1m	2	CLIP-CLIP	0
N-PP	1	BNCP-BNCP 1.5m	1	CLIP-BANANA	2
NP-BNCJ	2	BNCP-BANANA	0	BANANA-BANANA	4
		BNCP-CLIP	0	SP PLUG-CLIP	1
		MIC PLUG-CLIP	1	DC POWER CABLE	1
		CERAMIC DRIVER	1	DRIVER FOR VR	1

RX ADJUST

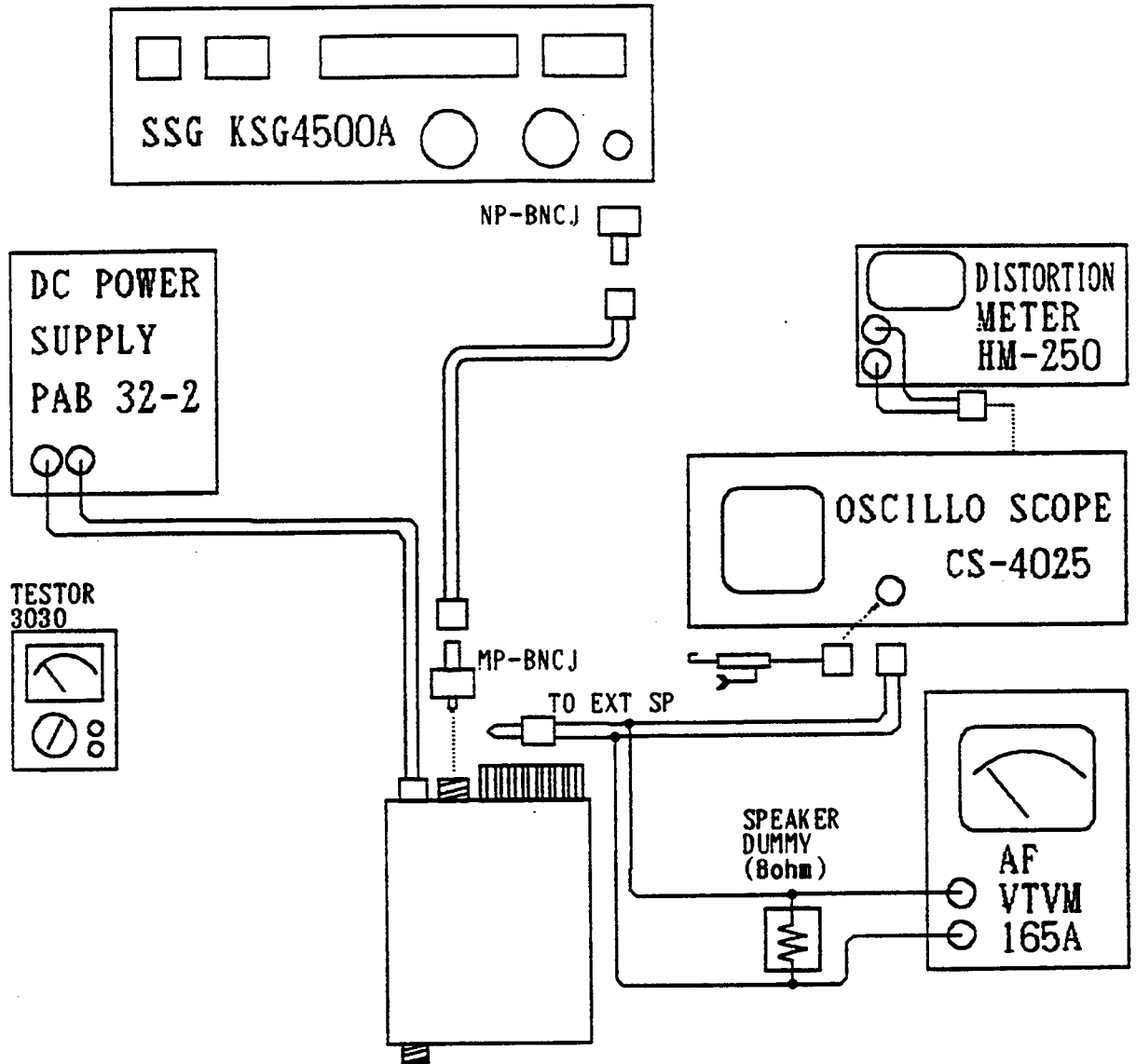

CONNECTOR	Q' TY	CABLE & ETC	Q' TY	CABLE & ETC	Q' TY
MP-BNCJ	1	BNCP-BNCP 1m	0	CLIP-CLIP	0
N-PP	0	BNCP-BNCP 1.5m	1	CLIP-BANANA	0
NP-BNCJ	1	BNCP-BANANA	1	BANANA-BANANA	0
		BNCP-CLIP	1	SP PLUG-CLIP	1
		MIC PLUG-CLIP	0	DC POWER CABLE	1
		CERAMIC DRIVER	1	DRIVER FOR VR	1

TX INSPECTION

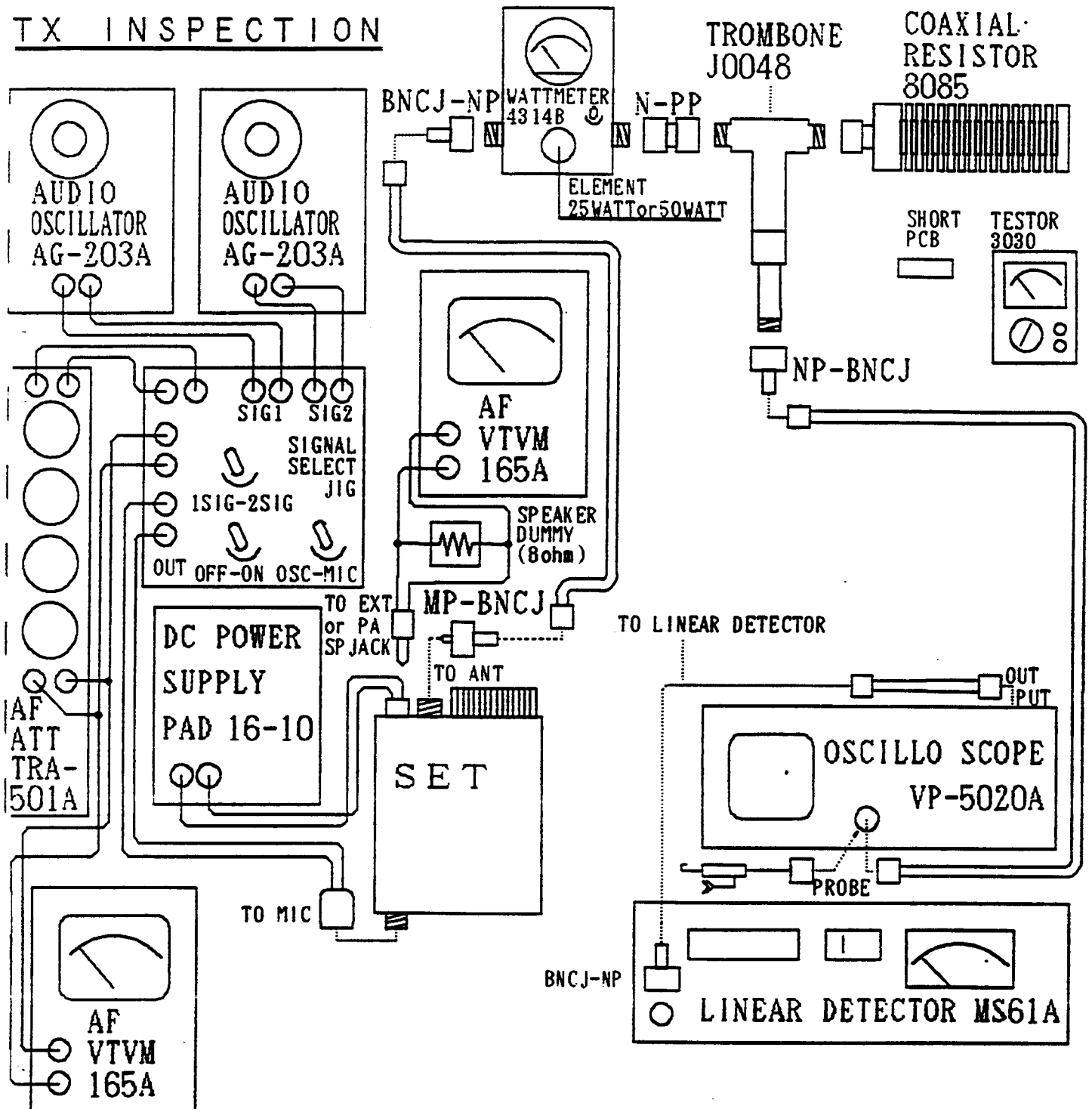

CONNECTOR	Q' TY	CABLE & ETC	Q' TY	CABLE & ETC	Q' TY
MP-BNCJ	1	BNCP-BNCP 1m	2	CLIP-CLIP	0
N-PP	1	BNCP-BNCP 1.5m	1	CLIP-BANANA	2
NP-BNCJ	2	BNCP-BANANA	0	BANANA-BANANA	4
		BNCP-CLIP	0	SP PLUG-CLIP	1
		MIC PLUG-CLIP	1	DC POWER CABLE	1
		CERAMIC DRIVER	1	DRIVER FOR VR	1

RX INSPECTION

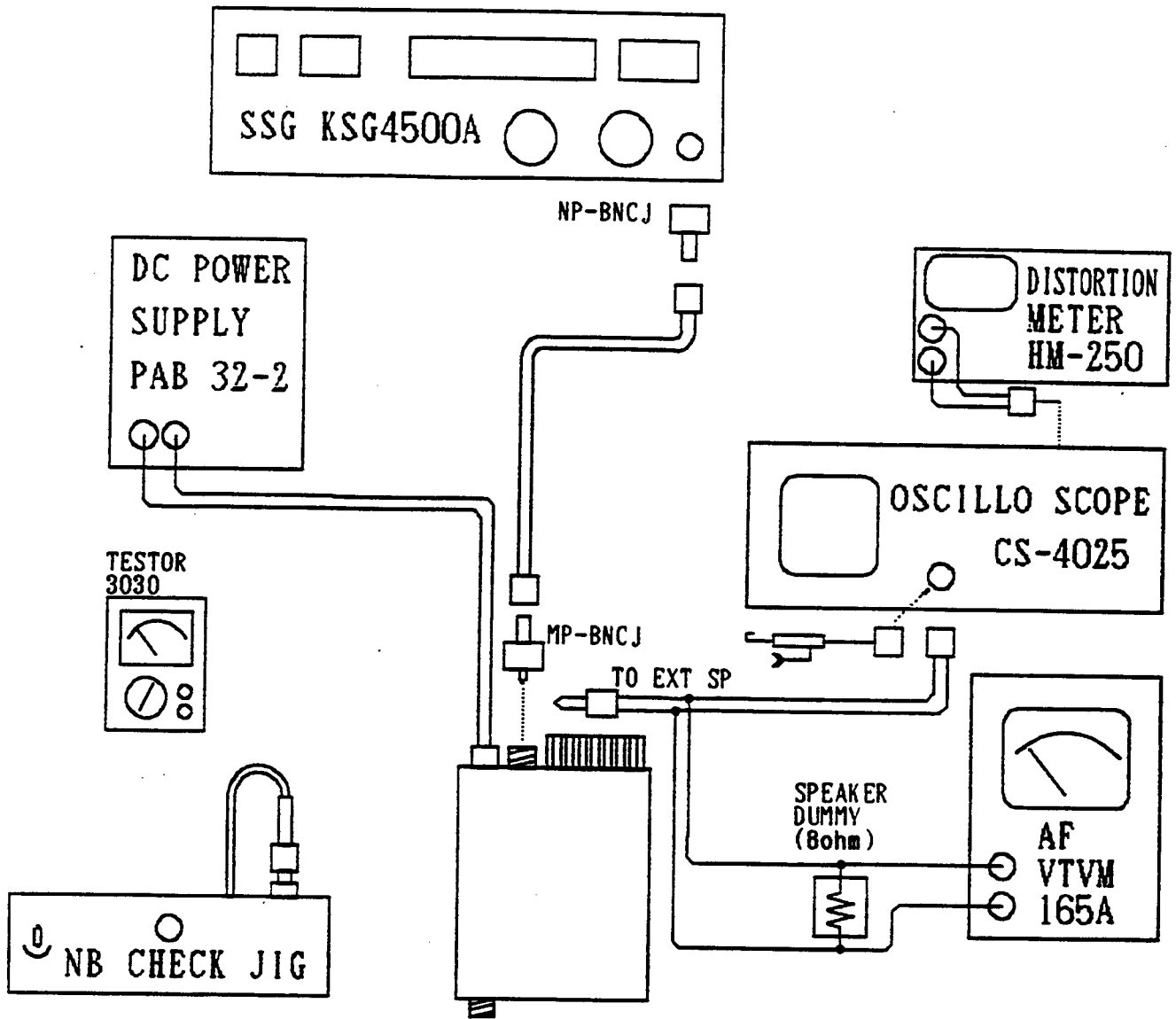

CONNECTOR	Q' TY	CABLE & ETC	Q' TY	CABLE & ETC	Q' TY
MP-BNCJ	1	BNCP-BNCP 1m	0	CLIP-CLIP	0
N-PP	0	BNCP-BNCP1.5m	1	CLIP-BANANA	0
NP-BNCJ	1	BNCP-BANANA	1	BANANA-BANANA	0
		BNCP-CLIP	1	SP PLUG-CLIP	1
		MIC PLUG-CLIP	0	DC POWER CABLE	1
		CERAMIC DRIVER	1	DRIVER FOR VR	1

2C TX INSPECTION

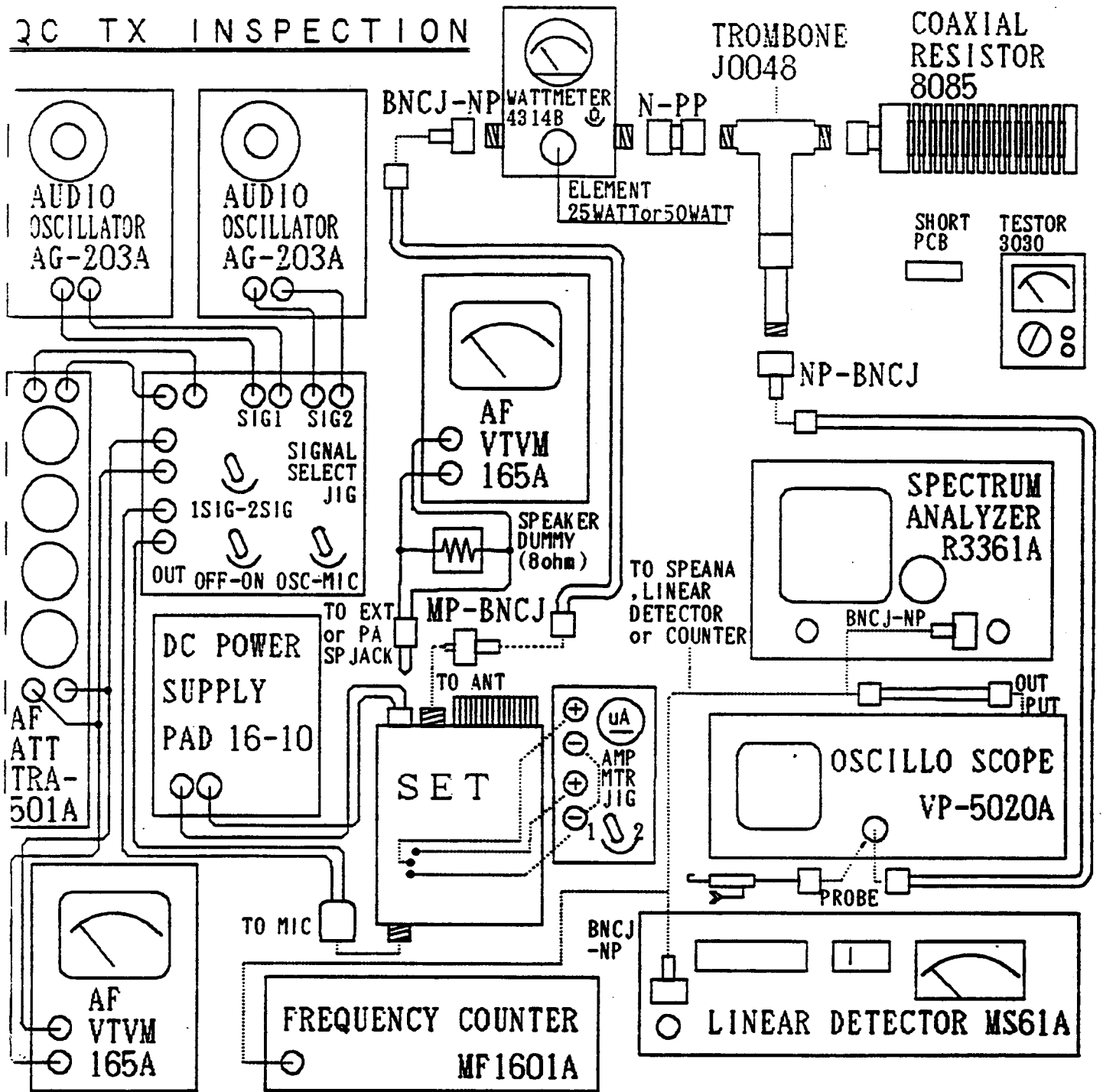

CONNECTOR	Q' TY	CABLE & ETC	Q' TY	CABLE & ETC	Q' TY
MP-BNCJ	1	BNCP-BNCP 1m	2	CLIP-CLIP	0
N-PP	1	BNCP-BNCP 1.5m	1	CLIP-BANANA	2
NP-BNCJ	3	BNCP-BANANA	0	BANANA-BANANA	4
		BNCP-CLIP	0	SP PLUG-CLIP	1
		MIC PLUG-CLIP	1	DC POWER CABLE	1
		CERAMIC DRIVER	1	DRIVER FOR VR	1

QC RX INSPECTION

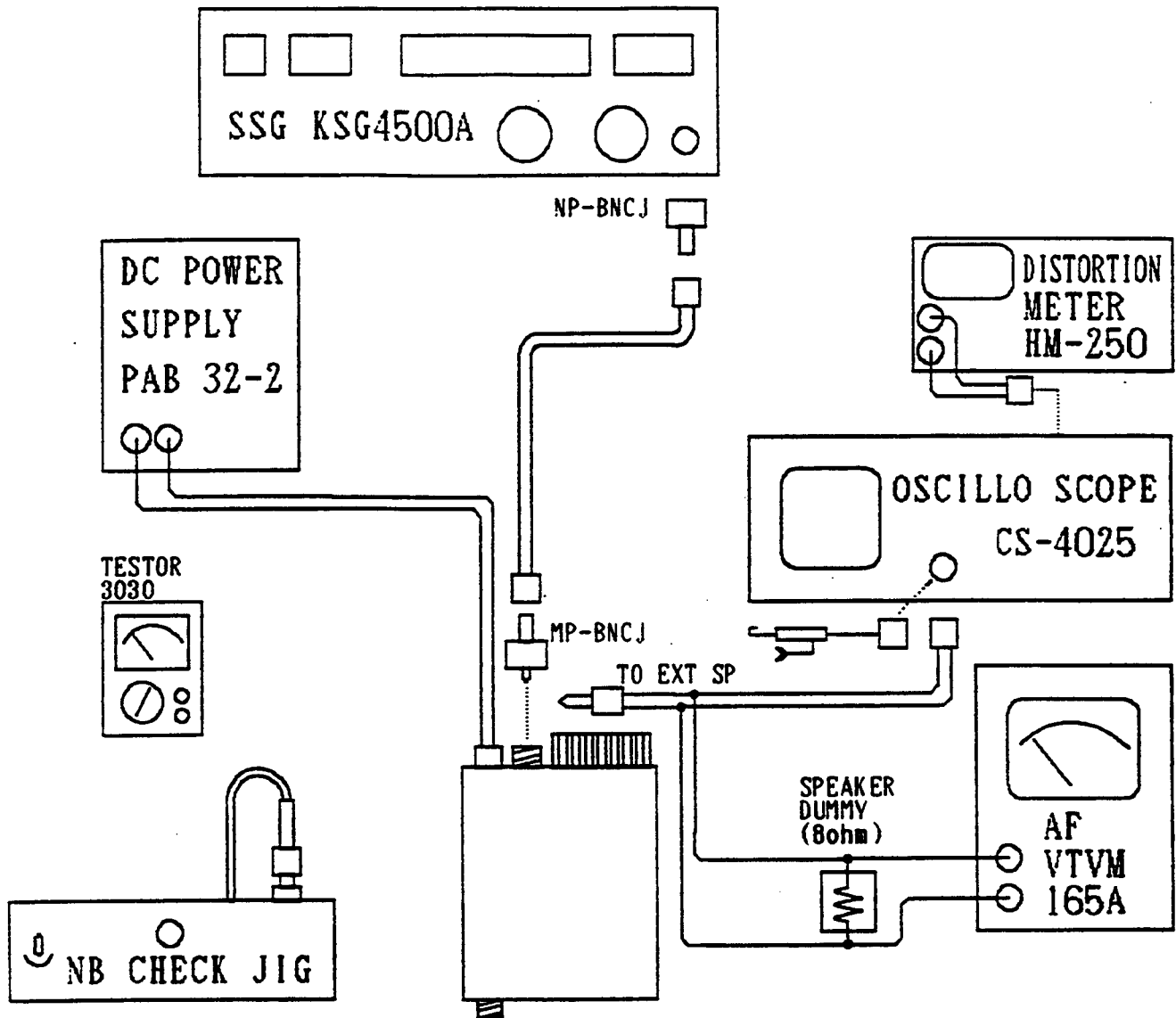

CONNECTOR	Q' TY	CABLE & ETC	Q' TY	CABLE & ETC	Q' TY
MP-BNCJ	1	BNCP-BNCP 1m	0	CLIP-CLIP	0
N-PP	0	BNCP-BNCP1.5m	1	CLIP-BANANA	0
NP-BNCJ	1	BNCP-BANANA	1	BANANA-BANANA	0
		BNCP-CLIP	1	SP PLUG-CLIP	1
		MIC PLUG-CLIP	0	DC POWER CABLE	1
		CERAMIC DRIVER	1	DRIVER FOR VR	1

REPAIR TX

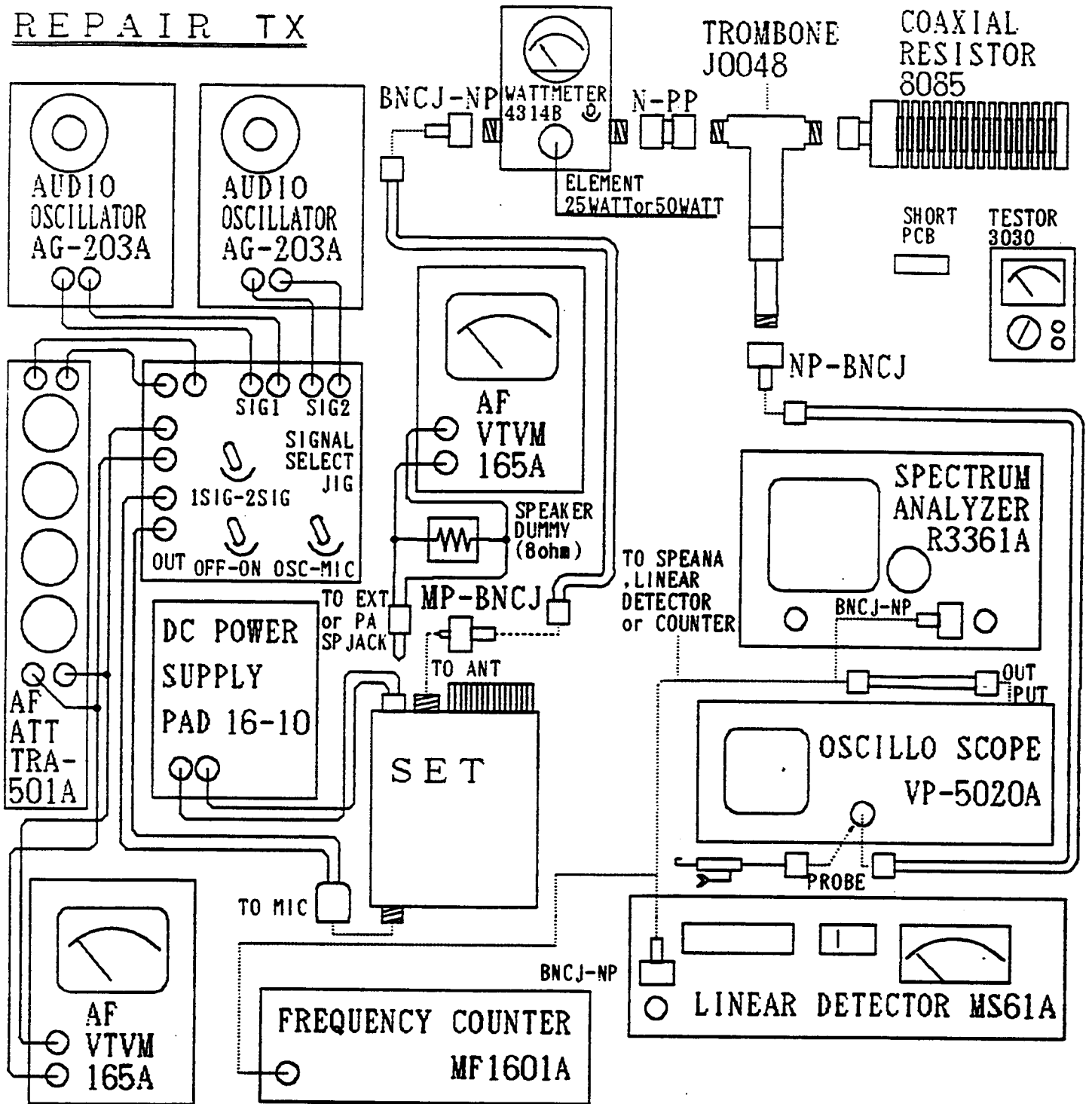

CONNECTOR	Q'TY	CABLE & ETC	Q'TY	CABLE & ETC	Q'TY
MP-BNCJ	1	BNCP-BNCP 1m	2	CLIP-CLIP	0
N-PP	1	BNCP-BNCP 1.5m	1	CLIP-BANANA	2
NP-BNCJ	3	BNCP-BANANA	0	BANANA-BANANA	4
		BNCP-CLIP	0	SP PLUG-CLIP	1
		MIC PLUG-CLIP	1	DC POWER CABLE	1
		CERAMIC DRIVER	1	DRIVER FOR VR	1

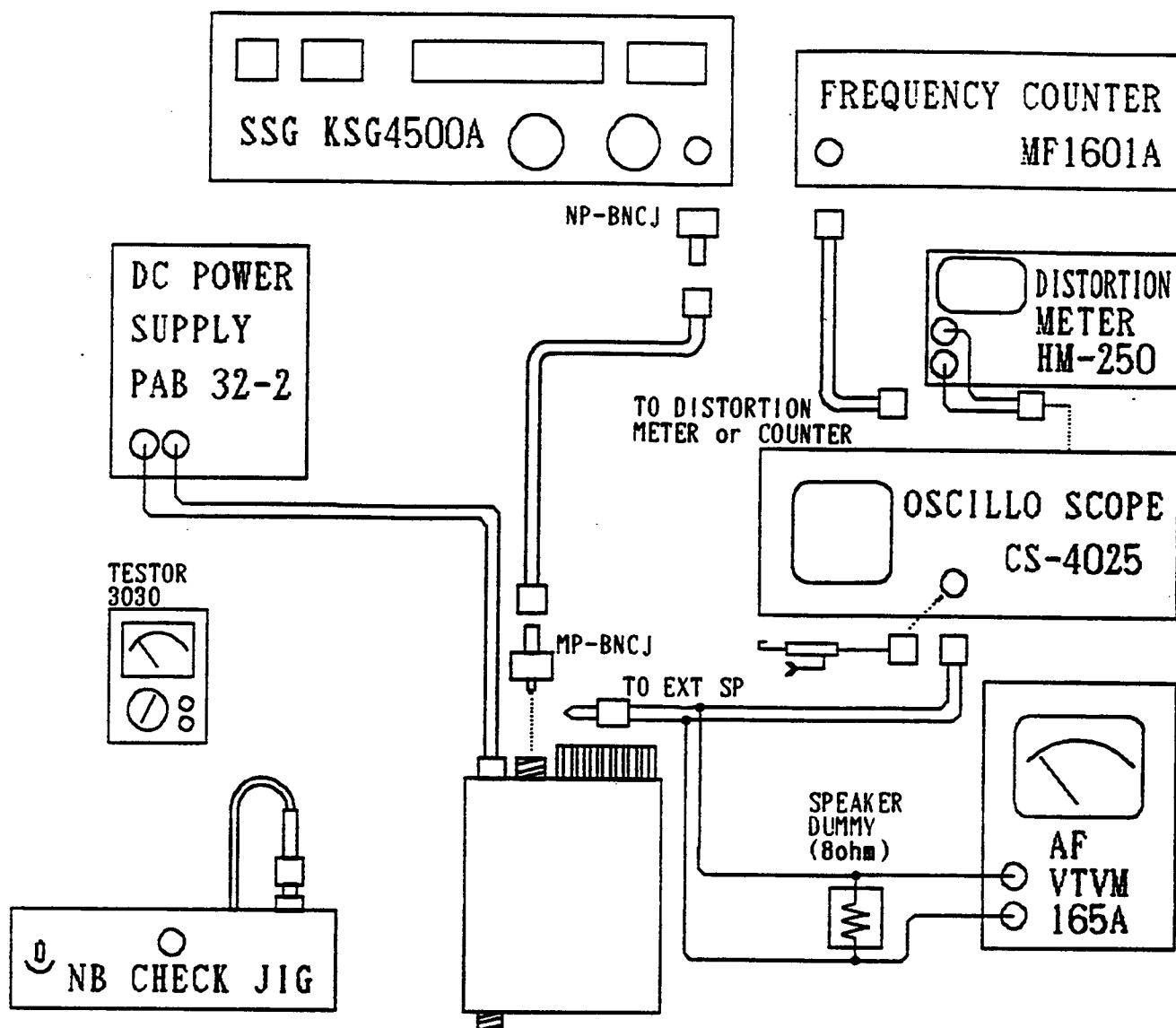
REPAIR RX

CONNECTOR	Q'TY	CABLE & ETC	Q'TY	CABLE & ETC	Q'TY
MP-BNCJ	1	BNCP-BNCP 1m	1	CLIP-CLIP	0
N-PP	0	BNCP-BNCP1.5m	1	CLIP-BANANA	0
NP-BNCJ	1	BNCP-BANANA	1	BANANA-BANANA	0
		BNCP-CLIP	1	SP PLUG-CLIP	1
		MIC PLUG-CLIP	0	DC POWER CABLE	1
		CERAMIC DRIVER	1	DRIVER FOR VR	1

QC FINAL FUNCTION

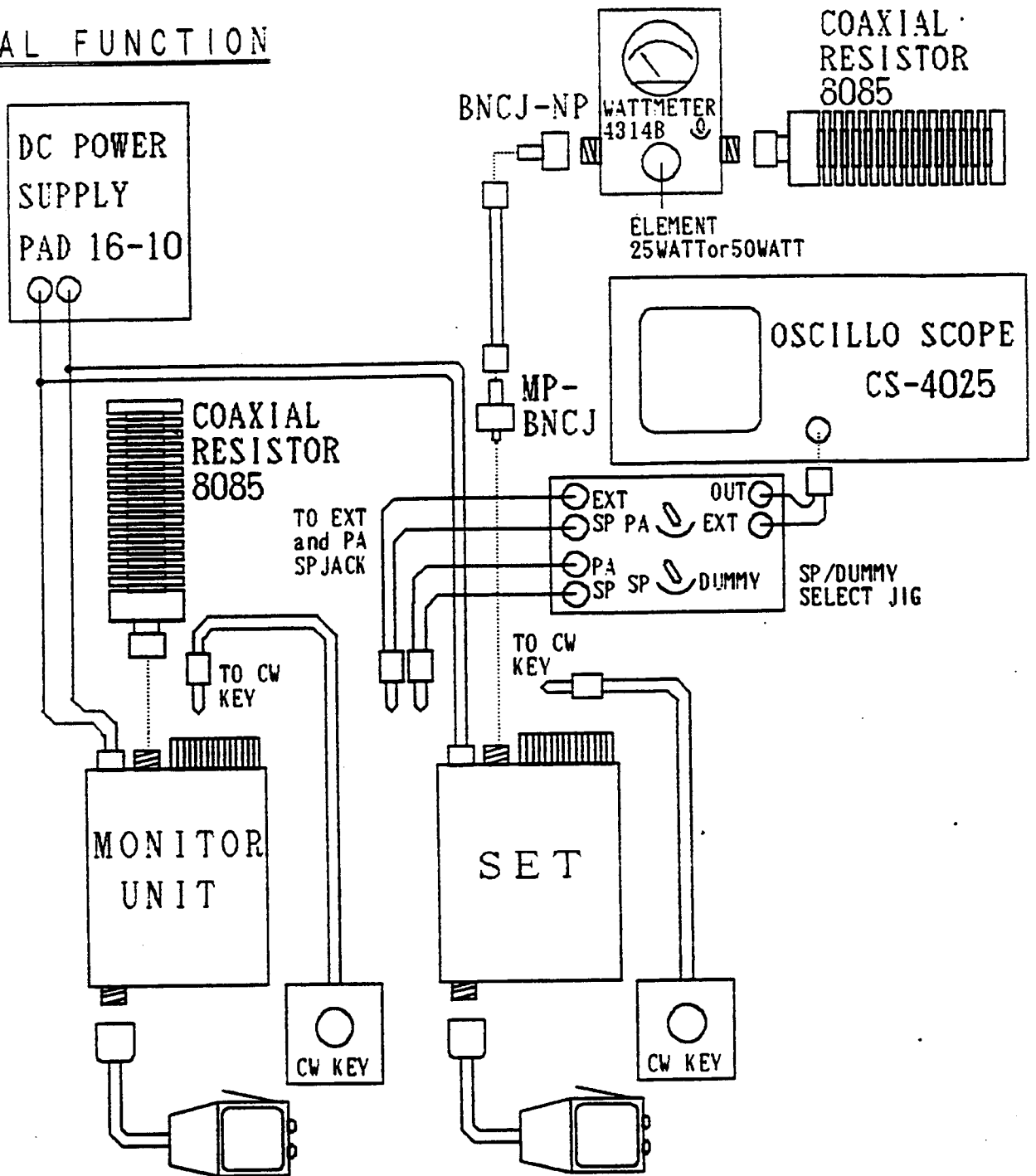

CONNECTOR	Q'TY	CABLE & ETC	Q'TY	CABLE & ETC	Q'TY
MP-BNCJ	1	BNCP-BNCP 1m	1	CLIP-CLIP	0
N-PP	0	BNCP-BNCP 1.5m	0	CLIP-BANANA	0
NP-BNCJ	1	BNCP-BANANA	1	BANANA-BANANA	0
		BNCP-CLIP	0	SP PLUG-CLIP	4
MICROPHONE	2	MIC PLUG-CLIP	0	DC POWER CABLE	2
		CERAMIC DRIVER	0	DRIVER FOR VR	0

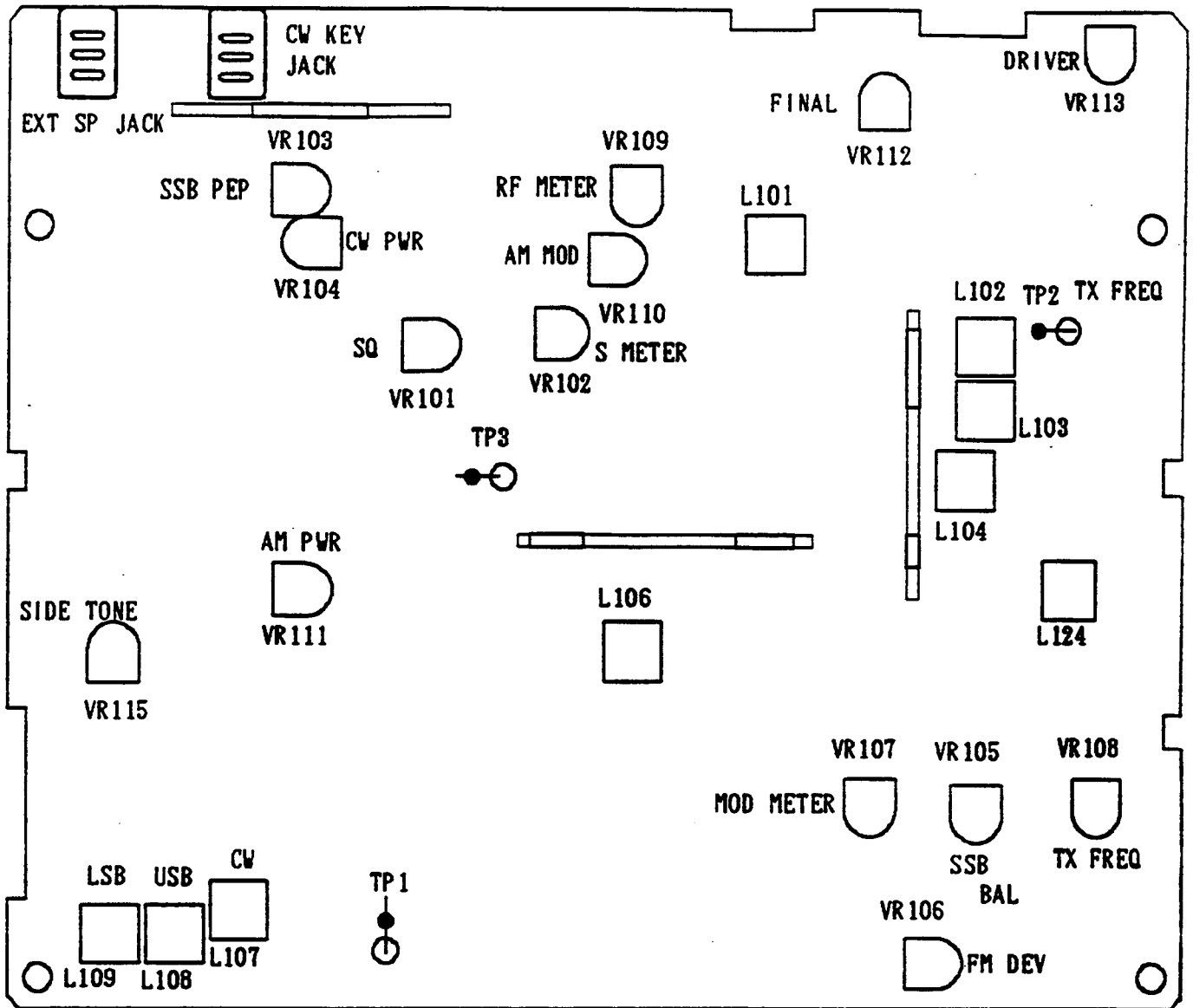





























VOLTAGE CHART



REF. NO.	TX/RX	FUTURE	(AM)			FM			SSB(U/L)			CW
			<E	C	B>	E	C	B	E	C	B	
Q401		NB							0.9	7	1.5	
Q402		NB							0	2.3	0.7	
Q403		NB							1.5	6.9	2.3	
Q404		NB							0.9	7.2	0	
Q405		NB							0	4.2	0	
Q406		NB							6.5	0	4.4	
Q407		NB							0	0	0	
Q801		FM				0.9	3.7	1.5				

PIN NO.	IC501 L78M08CV	IC502 L78M05CV	IC503 IC4066BP	IC504 M51953BL	IC506 SM5152A1	IC507 NJM2203D	IC508 NJM2203D
1.	13.5	13.5	0 0	4.8 4.8	2 2	3.4 3.4	3.4 3.4
2.	0	0.5	0 0.5	0 0	2.5 2.5	0 0	0 0
3.	8	5.5	0 0	0 0	4.7 4.7	7.8 7.8	7.8 7.8
4.			0 0.5	1 1	3.8 3.8	5.2 5.2	5.5 5.5
5.			0 0	4.8 4.8	0 0	0 0	0 0
6.			5 5		2.4 2.4	0 0	0 0
7.			0 0		0 0	0 0	0 0
8.			0 0.5		0 0	0 0	0 0
9.			0 0.5		0 0	0 0	0 0
10.			0 3			0 0	0 0
11.			0 0.5			0.8 0.8	0.8 0.8
12.			0 0			0.2 0.2	0.2 0.2
13.			0 0			0.8 0.8	0.8 0.8
14.			4.7 5			0.2 0.2	0.2 0.2
15.						0 0	0 0
16.						3.5 3.5	3.5 3.5
17.							
18.							
			↑ ↑ RX TX	↑ ↑ RX TX	↑ ↑ RX TX	↑ ↑ RX TX	↑ ↑ RX TX
AM			AM	AM	AM	AM	AM

PIN NO.	IC509		IC510		IC511	
	M54460L		PLLO305A		NJM3404AS	
1.	0	0	4.8	4.8	7.8	7.8
2.	0	0	0	0	4	4
3.	0	0	4.8	4.8	3.8	3.8
4.	1.5	1.5	4.8	4.8	3.8	3.8
5.	1.5	1.5	4.8	4.8	0	0
6.	4.8	4.8	0	0	3.8	3.8
7.	2.8	2.8	0	0	3.8	3.8
8.	1	1	4.8	4.8	4.8	4.8
9.			2	2	7.8	7.8
10.			0	0		
11.			0	0		
12.			0	0		
13.			4	4		
14.			0	0		
15.			2	2		
16.			2.4	2.4		
17.			2.2	2.2		
18.			0	0		
	↑	↑	↑	↑	↑	↑
	RX	TX	RX	TX	RX	TX
AM MODE						



	B (G)		C (D)		E (S)		REMARKS
Q501 2SA1162	4.8	4.8	0	0	4.8	4.8	
Q502 2SC2712	0	0	4.8	4.8	0	0	
Q503 2SC3121	3	3	7.2	7.2	4.5	4.5	
Q504 2SC3121	2.2	2.2	7.7	7.7	1.7	1.7	
Q505 2SC3121	4.2	4.2	7.7	7.7	4.2	4.2	
Q506 2SK302Y	0	0	7	7	0.5	0.5	
Q507 2SC2413	4	4	5	5	3.4	3.4	
Q508 2SK302	0	0	7	7	0.5	0.5	
Q509 2SC3121	4.5	4.5	7.7	7.7	3.9	3.9	
Q510 2SK302	0	0	7.3	7.3	0.3	0.3	
	↑	↑	↑	↑	↑	↑	
	RX	TX	RX	TX	RX	TX	
AM MODE							



IC 701 IR 2429		
1	 2.6V 0V 33Hz	 2.6V 0V 33Hz
2	 2.6V 0V 33Hz	 2.6V 0V 33Hz
3	 2.6V 0V 33Hz	 2.6V 0V 33Hz
4	 2.6V 0V 33Hz	 2.6V 0V 33Hz
5	 2.6V 0V 33Hz	 2.6V 0V 33Hz
6	 2.6V 0V 33Hz	 2.6V 0V 33Hz
7	 2.6V 0V 33Hz	 2.6V 0V 33Hz
8	 2.6V 0V 33Hz	 2.6V 0V 33Hz
9	 2.6V 0V 33Hz	 2.6V 0V 33Hz
10	 2.6V 0V 33Hz	 2.6V 0V 33Hz
11	 2.6V 0V 33Hz	 2.6V 0V 33Hz
12	 2.6V 0V 33Hz	 2.6V 0V 33Hz
13	 2.6V 0V 33Hz	 2.6V 0V 33Hz
14	 2.3V 0V 33Hz	 2.3V 0V 33Hz

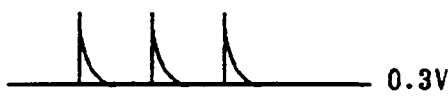
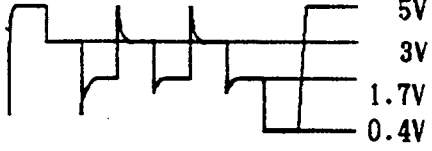
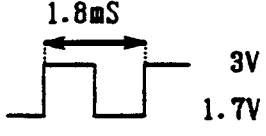
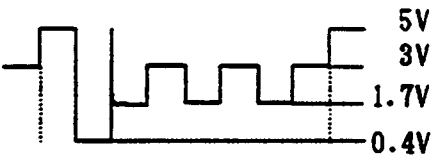
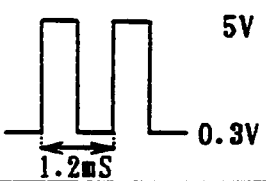
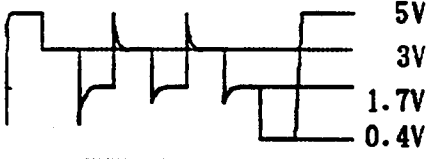
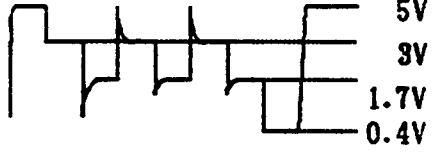
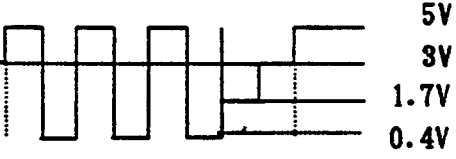
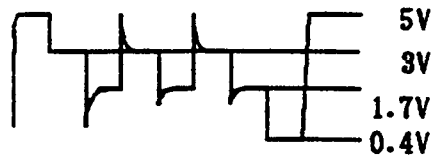
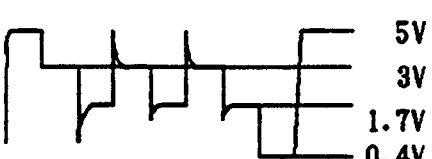
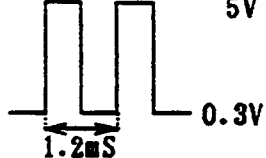
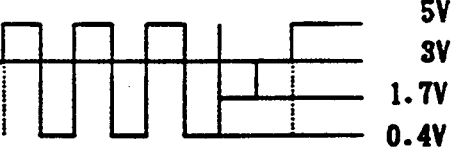
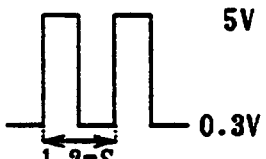
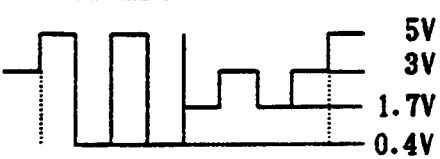

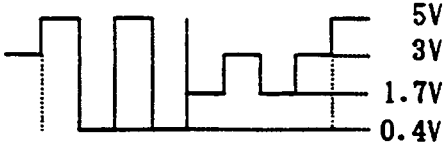
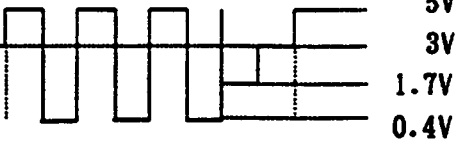
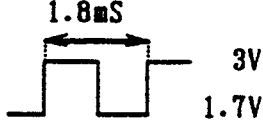
IC 701 IR 2429		
15	3.7V	3.7V
16	1.1V	1.1V
17	4.2V	4.2V
18	4.2V	4.2V
19	0.8V	0.8V
20	0V	0V
21	0V	0.8V
22	0V	0V
	 RX	 TX
	(AM MODE)	

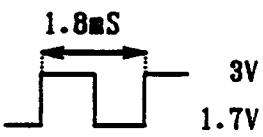
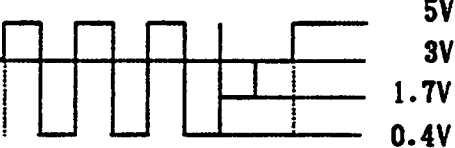
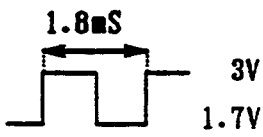
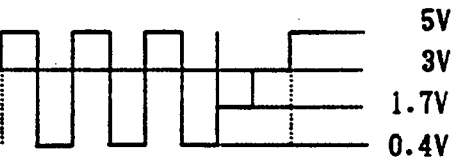
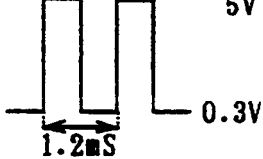
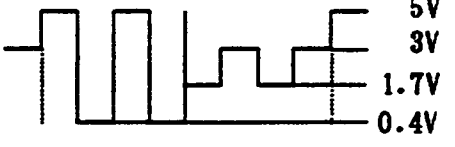
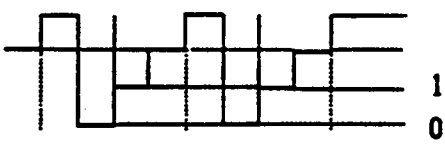
IC 702			
PIN NO.		PIN NO.	
1	<p>5V 3V 1.7V 0.4V</p>	10	<p>5V 0.3V 1.2ms</p>
2	<p>5V 0.3V 1.2ms</p>	11	<p>5V 3V 1.7V 0.4V</p>
3	<p>5V 0.3V 1.2ms</p>	12	<p>5V 3V 1.7V 0.4V</p>
4	<p>1.8ms 3V 1.7V</p>	13	<p>4.8V 0.2V ABOUT 70KHz</p>
5	<p>5V 0.3V 1.2ms</p>	14	2.2V
6	<p>5V 0.3V 1.2ms</p>	15	<p>5V 0V ABOUT 110KHz</p>
7	<p>5V 0.3V 1.2ms</p>	16	<p>5V 0V</p>
8	<p>5V 0.3V 1.2ms</p>	17	<p>5V 3V 2V</p>
9	<p>5V 0.3V 1.2ms</p>	18	<p>1.7V</p>

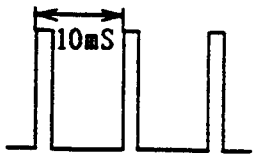
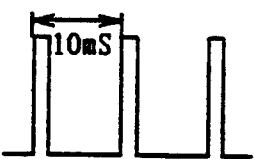
IC 702			
PIN NO.		PIN NO.	
19	 0.3V	33	 5V 3V 1.7V 0.4V
20	0V	34	 1.8mS 3V 1.7V
21	5V		
22	5V		
23	5V		
24	5V	35	 5V 3V 1.7V 0.4V
25	0V		
26	5V		
27	5V		
28	2.2V	36	 5V 1.2mS
29	 5V 3V 1.7V 0.4V		
30	 5V 3V 1.7V 0.4V	37	 5V 3V 1.7V 0.4V
31	 5V 3V 1.7V 0.4V		
32	 5V 3V 1.7V 0.4V	38	 5V 1.2mS
		39	 5V 3V 1.7V 0.4V
		40	 5V 1.2mS
		41	 5V 3V 1.7V 0.4V

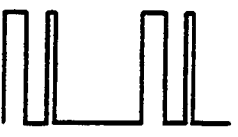
IC 702			
PIN NO.			
42	2.2V	49	5V
43		50	
44		51	
45		52	
46		53	
47		54	
48		55	
		56	2.2V

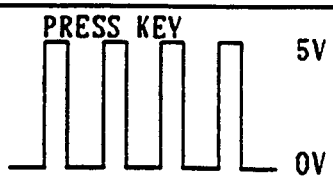
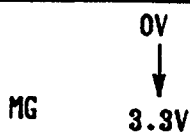
IC505 MICROCOMPUTER			
PIN NO.		PIN NO.	
1	5V LCD CHANGE	17	
2	5V LCD CHANGE		
3	5V LCD CHANGE		
4	5V	18	5V
5	5V	19	5V
6	0V	20	5V
7	0V	21	5V
8	0V	22	5V
9	5V	23	5V
10	0V	24	5V
11	0V	25	5V
12	0V	26	5V
13	0V	27	0V
14		28	0V LCD CHANGE
15		29	0V LCD CHANGE
		30	0V LCD CHANGE
		31	0V LCD CHANGE
16		32	5V

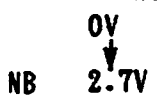
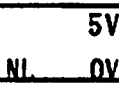
IC505			
PIN NO.			PIN NO.
33	KT 0V		51
34	MT 5V		52
35	0V		
36	MG 0V		53
37	BP 0V		54
38	NB 0V		55
39	NL 5V		56
40	0V		57
41	0V		58
42	0V		59
43	0V		60
44	0V		61
45	5V		62
46	SQ 4.7V	SQ OPEN 0.4V SQ CLOSE 4.7V	63
47	4.7V		64
48	5V		
49	0V		
50	5V		

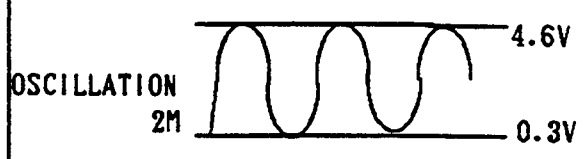
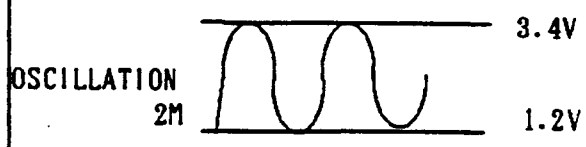

THE PROCESS OF RX PRE-ADJUSTMENT

1. Preparation

SP/Dummy Select Jig PA/EXT SW : EXT

SP/Dummy SW : Dummy

Signal Select Jig 1 Sig/2 Sig SW : 1 Sig

OFF/ON SW : OFF

OSC/MIC SW : OSC

Mode SW : AM, PA SW : OFF, LOC/DX SW : DX, MIC G : OFF, VOL : center position,

SQ : Turn fully counter clockwise (Note : Auto SQ is at OFF position)

Step	Preset to	Remarks
1	TX/RX SW:TX	TX LED has to light on.
2	TX/RX SW:RX	RX LED has to light on.
3	Mode:AM SSG RF Output: See Remarks SSG: 1KHz 30% Mod.(AM)	Alignment of sensitivity. Adjust coils for maximum reading on the AF VTVM(During this step, set the SSG attenuator so that the standard output is less than $0.5W(2V/8\Omega)$). Adjust them lastly with SSG RF output set at $1\mu V$.
4	SSG RF Output:1mV	Alignment of squelch. Set the output of SSG to $66\pm 2dB$ and squelch volume to maximum. Adjust VR101 so that the squelch just breaks. (Adjust VR101 to indicate audio signal wave to be appeared on the Oscilloscope.)
5	SSG:100 μV No Mod. Meter:RF	Alignment of S-meter. Set the output of SSG to $100\mu V$. Adjust VR102 so that "9" LCD just lights on.
6	Mode:CW SSG RF Output:OFF No Mod. SQ Volume:Min. (Auto SQ:OFF)	During the CW key is pressed, side tone signal is given to EXT. Speaker output, transmission signal wave has to be shown on the Oscilloscope. When the CW key is released, transmission output is stopped at once without any delay.

Step	Preset to	Remarks
7	Meter:Mod. 1KHz 10mV RMS Mod. Sig. Select Jig OFF/ON SW:ON	When the Mode SW is changed, MOD Meter and transmission output should be set as follows at each Mode. Nothing is given from EXT. Speaker output. CW : MOD Meter doesn't move, and transmitting output isn't produced. LSB : MOD Meter moves, and a few seconds later transmitting output is produced. USB : MOD Meter moves, and a few seconds later transmitting output is produced. (At LSB and USB Mode, if MIC input is decreased, transmitting output is also decreased, and at last it stops.) AM : MOD Meter doesn't move, and transmitting output is produced. FM : MOD Meter moves, and transmitting output is produced. (At FM Mode, the carrier of transmitting output doesn't have modulation like it has at AM Mode.)
8	Mode:FM 1KHz 1mV RMS Mod. Sig. Select Jig OFF/ON SW:ON SP/Dummy Select Jig PA/EXT. SW:PA	When the PA SW is switched on, Audio output has to be shown on the Oscilloscope. Then when the MIC G. SW is switched on, audio output has to decrease more than 6dB. After confirmation, turn off the PA and MIC G SW, change the PA/EXT. SW to EXT. position.
9	Mode:FM No Mod. Sig. Select Jig OFF/ON SW:OFF	When the LOC/DX SW is changed to LOC position, noise level of EXT. Speaker output has to decrease more than 6dB.

INSPECTION PROCESS OF LCD UNIT

1. Preparation

Power SW : OFF, Normal/Dimmer SW : Dimmer

Step	Preset to	Remarks
1	Power SW:ON	LCD indicates as follows: a BAND 1CH 28.000.0
2	Push Channel△	LCD indicates as follows: a BAND 2CH 28.010.0
3	Push Channel▽	LCD indicates as follows: a BAND 1CH 28.000.0
4	Push NB/ANL 4 times	LCD indicates and changes at each push as follows: Nothing → NB → NB → → Nothing ANL ANL
5	Push BAND 4 times	LCD indicates and changes at each push as follows: a BAND 1CH 28.000.0 ↓ b BAND 1CH 28.500.0 ↓ c BAND 1CH 29.000.0 ↓ d BAND 1CH 29.500.0 ↓ a BAND 1CH 28.000.0
6	Push SPAN 3 times	LCD indicates and changes at each push as follows: (Note : Each push changes the position of underline.) a BAND 1CH 28.00 <u>0</u> .0 ↓ a BAND 1CH 28.0 <u>0</u> 0.0 ↓ a BAND 1CH 28.00 <u>0</u> .0 ↓ a BAND 1CH 28.000. <u>0</u>
7	Push SHIFT, and Push MANUAL	When the SHIFT is pushed, "SHIFT" LCD has to light on, and then the MANUAL is pushed, "SHIFT" LCD has to light off.
8	Push METER 4 times	Meter on the LCD indicates and changes at each push as follows: "RF" → "MOD" → "CAL" → "SWR" → "RP"

Step	Preset to	Remarks
9	Push FLOCK twice	When the FLOCK is pushed once, "FLOCK" LCD has to light on. When it is pushed again, "FLOCK" LCD has to light off.
10	Push MIC G twice	When the MIC G is pushed once, "MIC G" LCD has to light on. When it is pushed again, "MIC G" LCD has to light off.
11	Push BEEP twice	When the BEEP is pushed once, "BEEP" LCD has to light on. When it is pushed again, "BEEP" LCD has to light off.
12	Normal/Dimmer SW: Normal	The lamp becomes bright.
13	Normal/Dimmer SW: Dimmer	The lamp lights weakly.
14	Power:OFF	Change the LCD unit to next unit.

INSPECTION PROCESS OF FRONT CHASSIS

1. Preparation

Mode SW : CW, LOC/DX SW : DX, PA SW : OFF, VOL : center position

SWR CAL, RF POWER, RIT and SQ Volume : Turn fully all of these SW's counter clockwise.

Step	Preset to	Remarks
1	Change the Mode SW as follows: CW→LSB→USB→AM→FM	Mode LED on the jig has to light on in order of following: CW→LSB→USB→AM→FM
2	Push LOC/DX SW twice	LOC LED has to light on at the first push, and at the second push it has to light off.
3	Push PA SW twice	PA LED has to light on at the first push, and at the second push it has to light off.
4	Turn fully the SWR CAL Volume clockwise.	LCD has to get bright, then CAL LED has to light on.
5	Turn fully the RF POWER Volume clockwise.	PWR LED has to light on.
6	Turn fully the RIT Volume clockwise.	RIT LED has to light on.
7	Turn the SQ Volume clockwise to cancel the state of Auto SQ.	Receiving noise has to be released from the EXT. Speaker.
8	Turn fully the SQ Volume clockwise.	Receiving noise from the EXT. Speaker becomes nil.
9	Turn the frequency selection knob clockwise	Frequencies on LCD display are to be increased.
10	Turn the frequency selection knob counter clockwise.	Frequencies on LCD display are to be decreased.
11	Push these keies on the Key Board in order of following: ChannelΔ → Channel▽→ →NB/ANL(4times)→BAND→ →SPAN→ SHIFT→ METER→ → FLOCK (twise) → → MIC G (twise) → → BEEP (twise)	Key tone has to be released from the EXT. Speaker with every push.

INSPECTION PROCESS OF QC FINAL FUNCTION

1. Preparation

SP/Dummy Select Jig PA/EXT SW : EXT
 SP/Dummy SW : Dummy

Monitor Unit and Set

Mode SW: CW, LOC/DX : DX, PA : OFF, METER : RF, SWR CAL Volume : DIM,
 RF POWER Volume : Turn fully clockwise, RIT and VOL Volume : center position
 SQ Volume : Turn fully counter clockwise, and keep the Auto SQ switched off.
 RF Power meter element : 50W, CW/PEAK SW : CW, Frequency : a BAND 1CH 28.000.0MHz
 (Caution : When the mode is changed, it should be simultaneously done on both
 the monitor unit and the set.)

Step	Preset to	Remarks
1	Mode: CW No Mod.	RF METER must not light on. When the key jack of the set is switched on, RF Power has to be between 24.0W and 26.0W. The side tone for the monitor should be appeared at the audio output of the unit. When RIT Volume of the monitor unit is rotated to the left or right, receiving noise to be heard through the internal speaker.
2	Mode: CW No Mod.	The key jack of the monitor unit is switched on. When RIT Volume of the set is adjusted clockwise or counter clockwise, receiving waves should be seen on the Oscilloscope. While it is shown, the indication of RF meter should be more than 9.
3	Mode: LSB CW/PEAK SW: PEAK	RF Meter must not light on. Pushing PTT SW, input the voice into the microphone. Under the condition, the Power Meter should be activated in accordance with the strength of the voice and the voice should be heard through the speaker of the monitor unit.
4	Mode: LSB CW/PEAK SW: PEAK	Pushing PTT SW of the monitor unit, input the voice into the microphone. Under the condition, the audio output of the set should be appeared on the Oscilloscope.
5	Mode: USB CW/PEAK SW: PEAK	RF Meter must not light on. Pushing PTT SW, input the voice into the microphone. Under the condition, the Power Meter should be activated in accordance with the strength of the voice and the voice should be heard through the speaker of the monitor unit.

Step	Preset to	Remarks
6	Mode:USB CW/PEAK SW:PEAK	Pushing PTT SW of the monitor unit, input the voice into the microphone. Under the condition, the audio output of the set should be appeared on the Oscilloscope.
7	Mode:AM CW/PEAK SW:CW	Push PTT SW of the monitor unit. Under the condition, RF Power has to be between 9.0W and 11.0W.
8	Mode:AM Meter:MOD	Pushing PTT SW of the set, input the voice into the microphone. Under the condition, the MOD Meter should be activated in accordance with th strength of the voice and the voice should be heard through the speaker of the monitor unit.
9	Mode:FM Meter:MOD	Change SP/Dummy select jig to SP, then change LOC/DX SW of the set to LOC. Under the condition, noise level of EXT. Speaker output has to be decreased. After confirming the above, SP/Dummy select jig can be switched to Dummy and LOC/DX SW can be switched to DX.
10	Mode:FM Meter:CAL	Set SQ volume at auto SQ position. The audio output noise of the set should be disappeared.
11	Mode:FM Meter:CAL	Turn SQ volume clockwise and fix it when the audio output noise becomes nil. Pushing PTT SW of the monitor unit, input the voice into the microphone. Then, the voice should be heard at the audio output of the Speaker Dummy.
12	Mode:FM Meter:CAL	Push PTT SW of the set and turn SWR/CAL volume clockwise until the meter is reached to the CAL position.
13	Mode:FM Meter:SWR	When Meter is switched to SWR, Meter has to indicate less than 1.
14	Mode:FM Meter:RF PA SW:PA	Set the PA/EXT. SW of the SP/Dummy select jig at PA. Pushing PTT SW of the set, input the voice into the microphone. The audio output from the SP/Dummy end should be appeared on Oscilloscope. After confirming the above PA/EXT. SW of the SP/Dummy select jig can be switched to EXT.
15	Mode:FM Meter:RF	When the frequency selection knob is turned clockwise, the frequency indication on the LCD should be increased accordingly.

Step	Preset to	Remarks
16	Mode:FM Meter:RF	When the frequency selection knob is turned counter clockwise, the frequency indication on the LCD should be decreased accordingly.
17	Push Channel Δ	LCD indicates as follows: a BAND 2CH 28.010.0
18	Push Channel ∇	LCD indicates as follows: a BAND 1CH 28.000.0
19	Push NB/ANL 4 times	LCD indicates and changes at each push as follows: Nothing \rightarrow NB \rightarrow NB \rightarrow \rightarrow Nothing ANL ANL
20	Push BAND 4 times	LCD indicates and changes at each push as follows: a BAND 1CH 28.000.0 \downarrow b BAND 1CH 28.500.0 \downarrow c BAND 1CH 29.000.0 \downarrow d BAND 1CH 29.500.0 \downarrow a BAND 1CH 28.000.0
21	Push SPAN 3 times	LCD indicates and changes at each push as follows: (Note : Each push changes the position of underline.) a BAND 1CH 28.000. <u>0</u> \downarrow a BAND 1CH 28.00 <u>0</u> .0 \downarrow a BAND 1CH 28.00 <u>0</u> .0 \downarrow a BAND 1CH 28.000. <u>0</u>
22	Push SHIFT, and Push MANUAL	When the SHIFT is pushed, "SHIFT" LCD has to light on, and then the MANUAL is pushed, "SHIFT" LCD has to light off.
23	Push METER 4 times	Meter on the LCD indicates and changes at each push as follows: "RF" \rightarrow "MOD" \rightarrow "CAL" \rightarrow "SWR" \rightarrow "RF"

Step	Preset to	Remarks
2 4	Push FLOCK twice	When the FLOCK is pushed once, "FLOCK" LCD has to light on. When it is pushed again, "FLOCK" LCD has to light off.
2 5	Push MIC G twice	When the MIC G is pushed once, "MIC G" LCD has to light on. When it is pushed again, "MIC G" LCD has to light off.
2 6	Push BEEP twice	When the BEEP is pushed once, "BEEP" LCD has to light on. When it is pushed again, "BEEP" LCD has to light off.

PART NAME	PART NO.	QTY	PART NAME	PART NO.	QTY
1 FRONT PANEL	T1-00542	1	36 ROUND NUT	MIC CONN ACC.	1
2 KNOB	T4-00543A	6	37 SPRING WASHER	MIC CONN ACC.	2
3 KNOB CH.	T4-00544A	1	38 MIC CONN.	5S-L-D107	1
4 PUSH BUTTON	T4-00545	2	39 LUG TERMINAL	MIC CONN ACC.	2
5 LAMP HOLDER	T3-00546	1	40 CAP FOR LAMP	AG-4212-02Y2.5	2
6 REAR CHASSIS	T2-00547	1	41 IC	HA17808W	1
7 FRONT CHASSIS ASSY	T3-00548	1	42 SPEAKER	77R01-1	1
8 SIDE CHASSIS	T3-00549	2	43 JACK ANT.	M-RM-L102	1
9 PCB HOLDER	T3-00550	1	44 NUT HEX.	JACK ANT. ACC	1
10 SHIELD PLATE (A)	T3-00551	1	45 WIRES ASS'Y	WA-0170101	1
11 TOP COVER	T2-00553	1	46 DIODE	NVS-03	2
12 BOTTOM COVER	T2-00554	1	47 BUSHING	YY-172	2
13 BRACKET (L)	T4-00558	1	48 TRANSISTOR	MRF477	1
14 BRACKET (R)	T4-00559	1	49 TRANSISTOR	2SC2166-C	1
15 SCRW MOUNT	T4-00561	4	50 INSULATION	YY-027	1
16 DISPLAY PLATE	T4-00562	1	51 BIND HD SCREW	M2 x 12 NI	2
17 LCD PLATE	T4-00563	1	52 BIND HD SCREW	M2.6 x 4 NI	2
18 SPACER	T4-00564A	4	53 BIND HD SCREW	M3 x 5 NI	19
19 RUBBER KEY	T3-00569	1	54 BIND HD SCREW	M3 x 6 BNI	12
20 REAR LABEL	T4-00573	1	55 BIND HD SCREW	M3 x 8 NI	2
21 SER. NO. LABEL	T4-00574	1	56 FLAT HD SCREW	M3 x 6 NI	8
22 LUG TERMINAL	T4-00638	2	57 P TIGHT BIND HD	Ø2.6 x 6 NI	2
23 KNOB SPRING	HAKUTO 6600	7	58 P TIGHT BIND HD	Ø3 x 8 NI	1
24 MIC. HANGER	MIC ACC. C-1	1	59 FLANGE NUT	M3 ZMC	4
25 BLIND	T4-00640	1	60 TAPPING PAN HD	Ø4 x 8 NI	2
26 KEY PCB	PB-0171400	1	61 TAPPING PAN HD	Ø5 x 10 NI	4
27 MODE PCB	PB-0171300	1	62 FLAT WASHER	Ø5 NI	4
28 MIC CONN PCB	PB-0171200	1	63 STAR WASHER	Ø5 NI	4
29 PA, LOC SW PCB	PB-0171100	1			
30 LCD PCB	PB-0170700	1			
31 CONTROL PCB	PB-0171000	1			
32 CPU/PLL PCB	PB-0170500	1			
33 MAIN PCB	PB-0170100	1			
34 NUT HEX.	VOL ACC.	7			
35 FLAT WASHER	VOL ACC.	7			

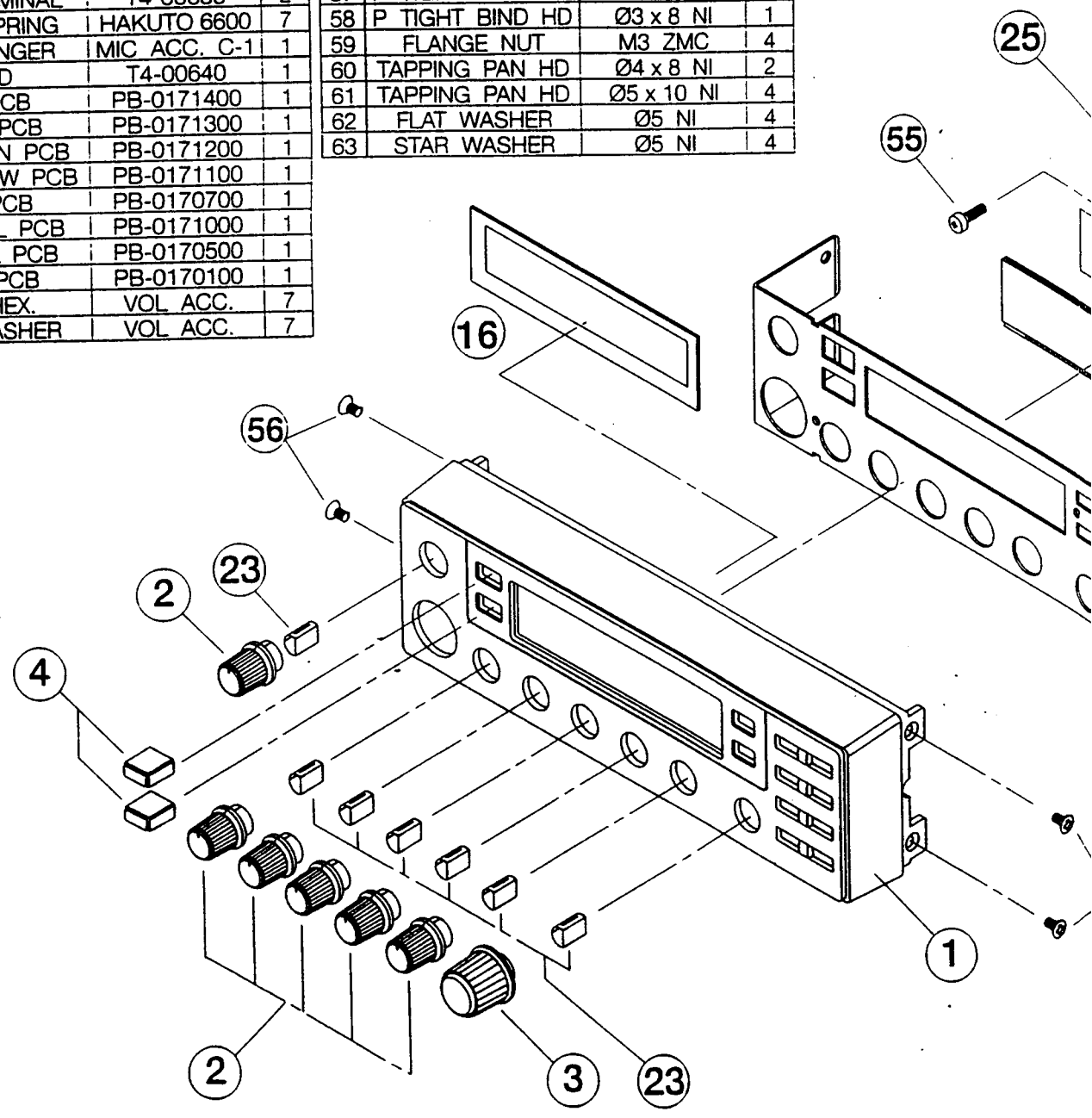

PART NAME	PART NO.	QTY
ROUND NUT	MIC CONN ACC.	1
SPRING WASHER	MIC CONN ACC.	2
MIC CONN.	5S-L-D107	1
LUG TERMINAL	MIC CONN ACC.	2
CAP FOR LAMP	AG-4212-02Y2.5	2
IC	HA17808W	1
SPEAKER	77R01-1	1
JACK ANT.	M-RM-L102	1
NUT HEX.	JACK ANT. ACC.	1
WIRES ASS'Y	WA-0170101	1
DIODE	NVS-03	2
BUSHING	YY-172	2
TRANSISTOR	MRF477	1
TRANSISTOR	2SC2166-C	1
INSULATION	YY-027	1
BIND HD SCREW	M2 x 12 NI	2
BIND HD SCREW	M2.6 x 4 NI	2
BIND HD SCREW	M3 x 5 NI	19
BIND HD SCREW	M3 x 6 BNI	12
BIND HD SCREW	M3 x 8 NI	2
FLAT HD SCREW	M3 x 6 NI	8
P TIGHT BIND HD	Ø2.6 x 6 NI	2
P TIGHT BIND HD	Ø3 x 8 NI	1
FLANGE NUT	M3 ZMC	4
TAPPING PAN HD	Ø4 x 8 NI	2
TAPPING PAN HD	Ø5 x 10 NI	4
FLAT WASHER	Ø5 NI	4
STAR WASHER	Ø5 NI	4

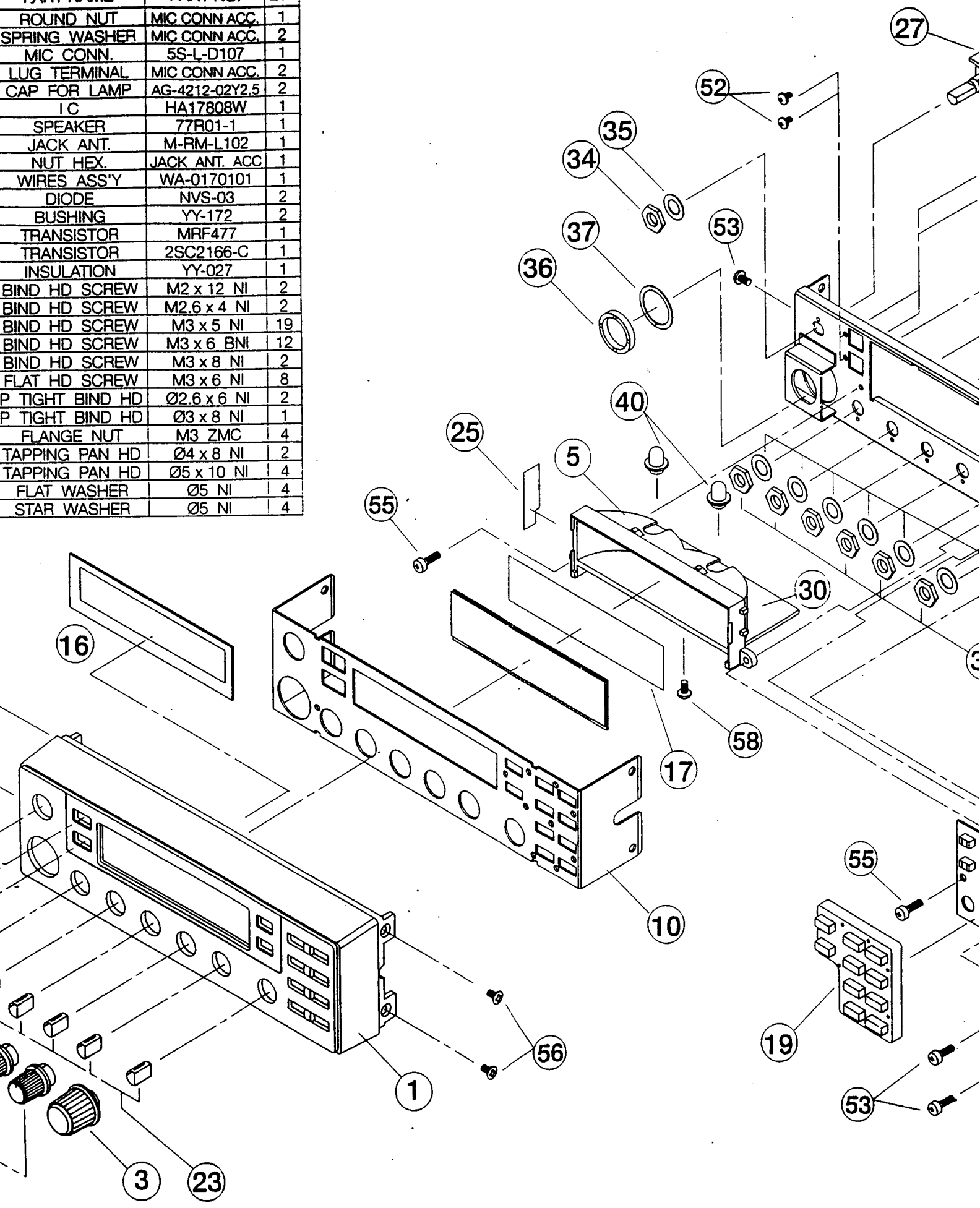

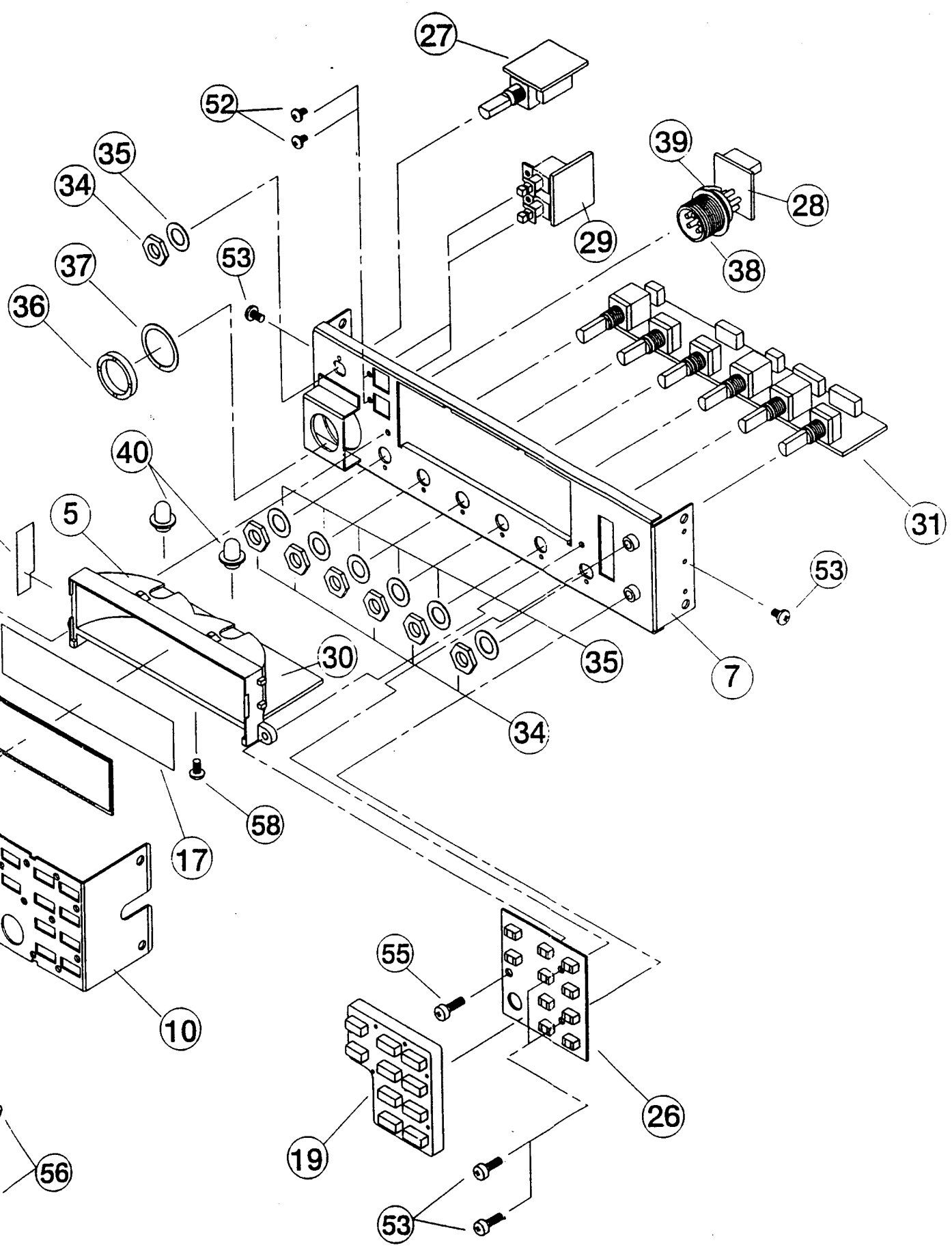

MOBILE TRANSCEIVER MODEL :
EXPLODED VIEW DIAGRAM - FRONT PARTS
July / 1994

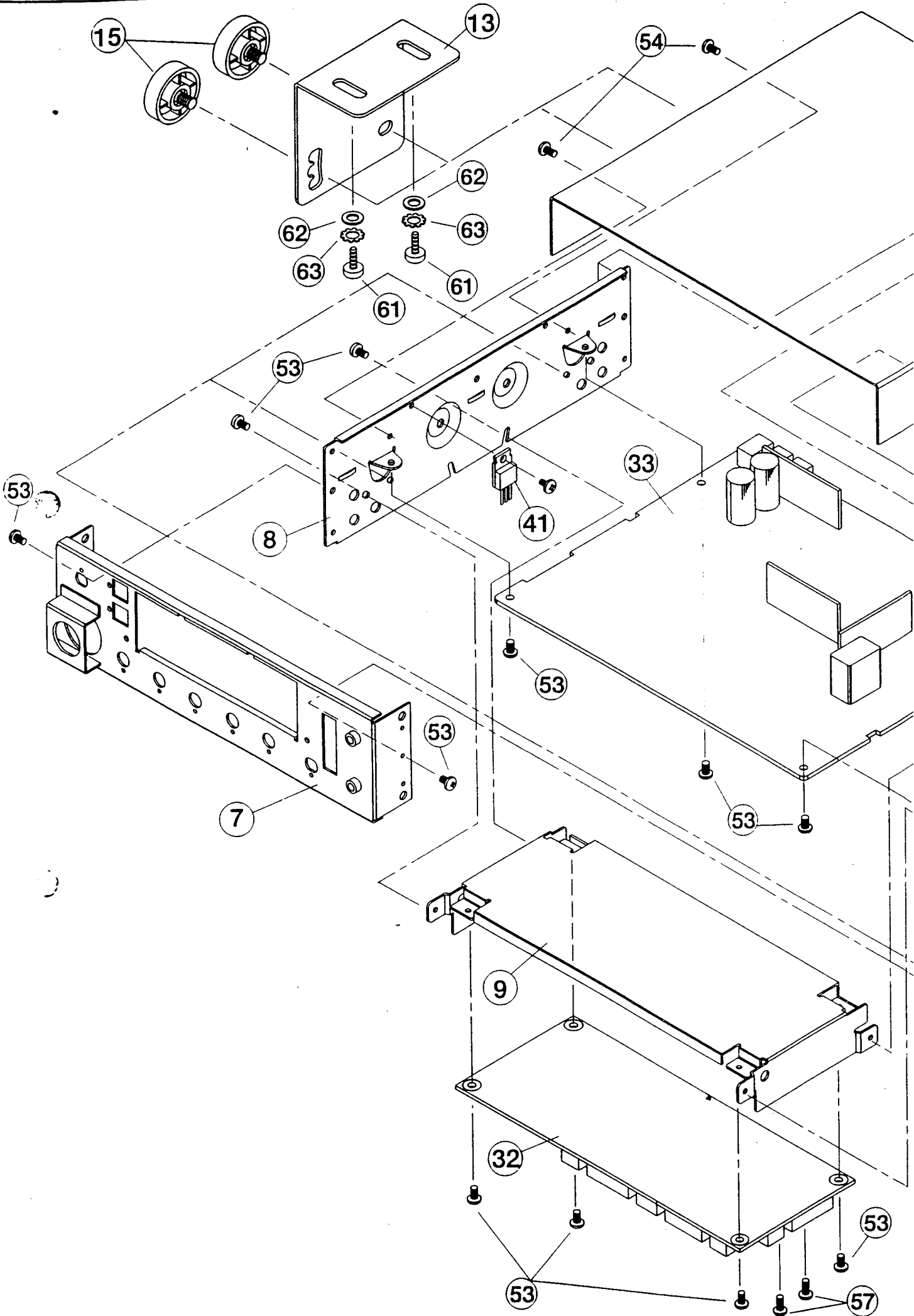

2B

2C

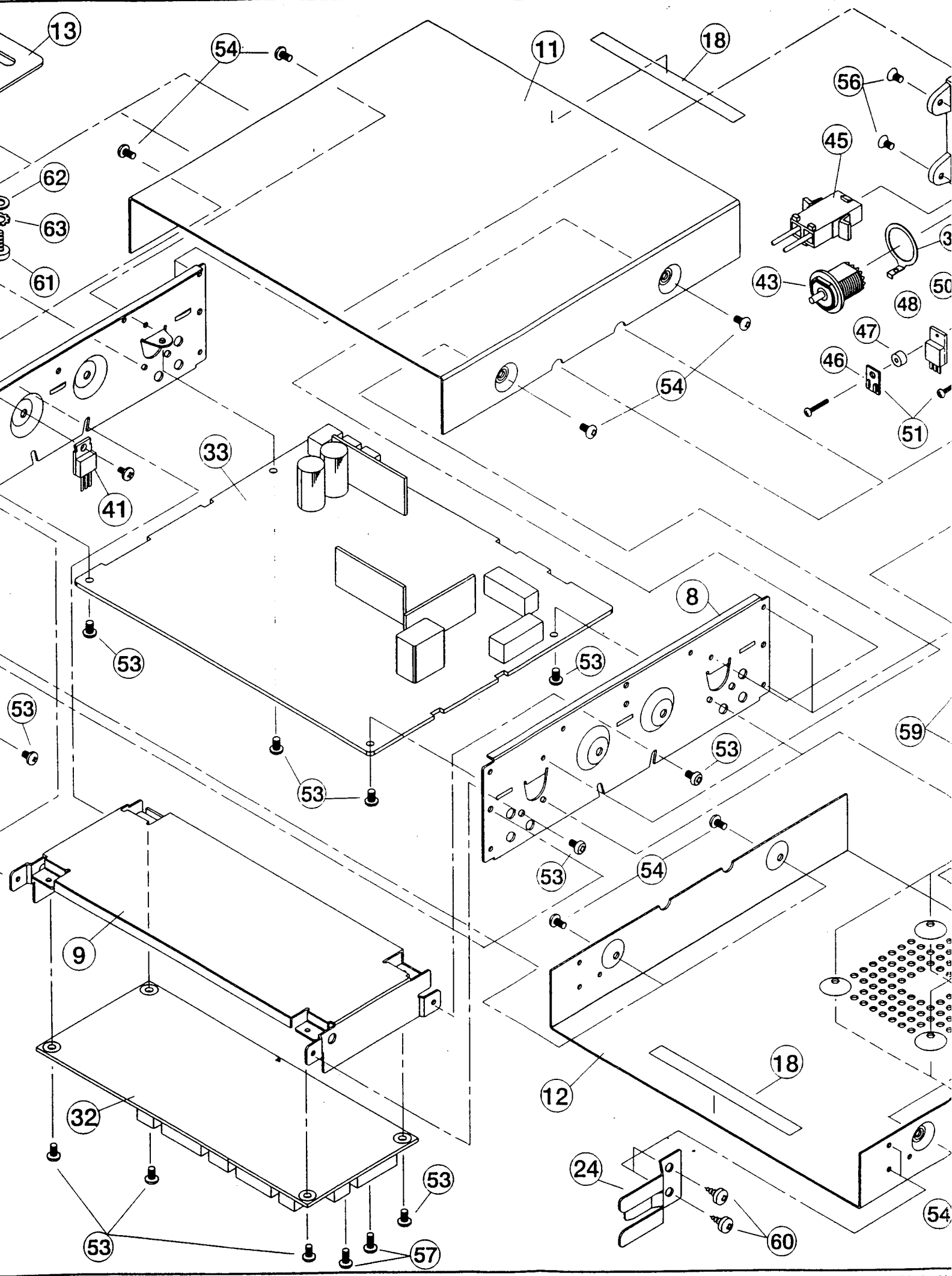

20

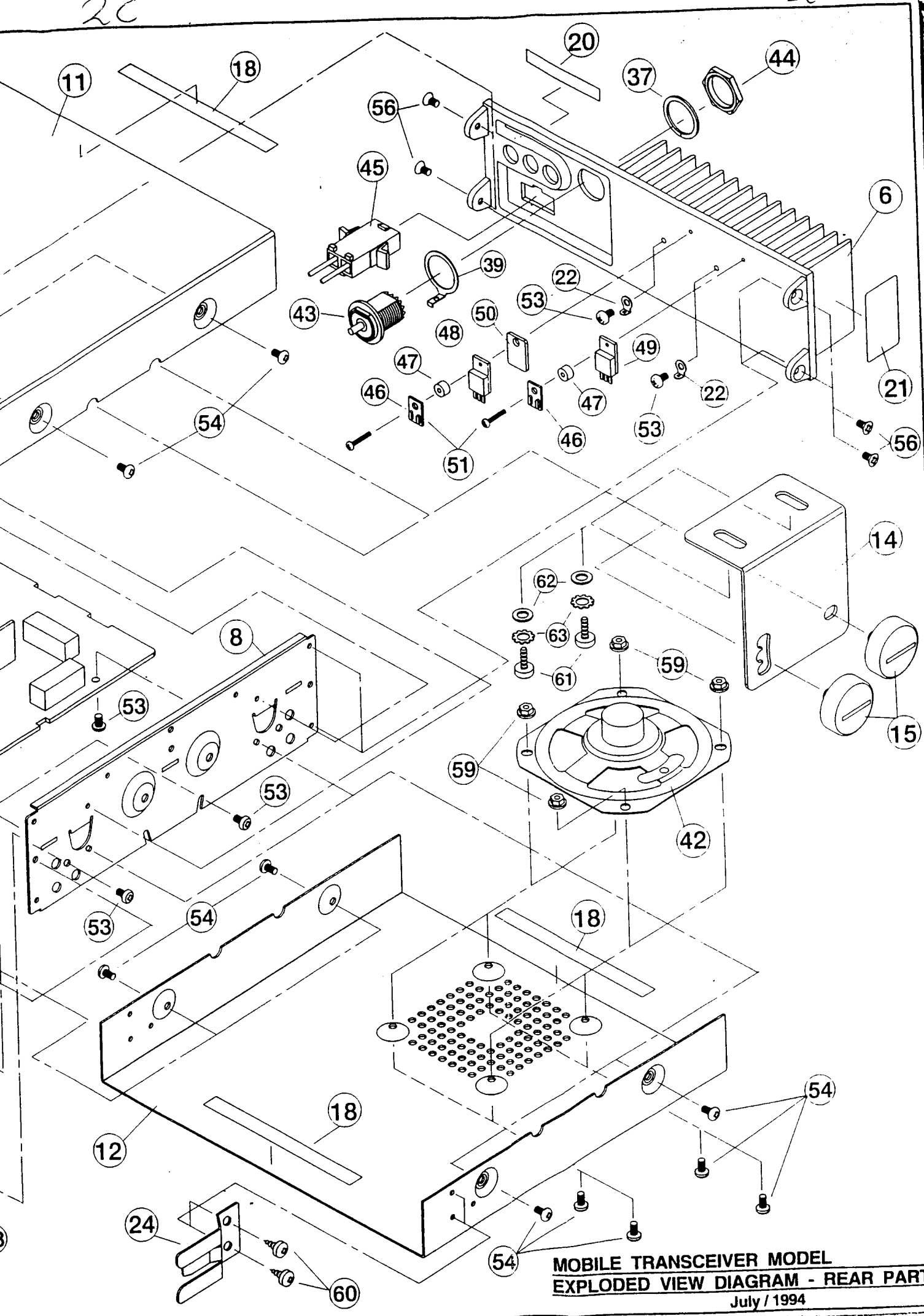

**MOBILE TRANSCEIVER MODEL
EXPLODED VIEW DIAGRAM - REAR PARTS**

July / 1994

4A

4B

