

DR-M03R / DR-03T

Service Manual

CONTENTS

SPECIFICATIONS

GENERAL.....	2
TRANSMITTER.....	2
RECEIVER.....	2

CIRCUIT DESCRIPTION

1) Receiver System.....	3,4
2) Transmitter System.....	4
3) PLL Synthesizer Circuit.....	4,5
4) CPU and Peripheral Circuit.....	5,6
5) Power Supply Circuit.....	6
6) M38268MCA082GP#U0 (XA1170A).....	7-9

SEMICONDUCTOR DATA

1) NJM7808FA (XA0102).....	10
2) TC4S66F (XA0115).....	10
3) TC4W53FU (XA0348).....	10
4) TA31136FN (XA0404).....	11
5) LA4425A (XA0410).....	11
6) BR24L32FJ (XA0604Z).....	12
7) S-80845ALMP (XA0620).....	12
8) NJM78M05DL1A (XA0947).....	12
9) MB15A01PFV1 (XA1010).....	13
10) LM2904PWR (XA1103).....	14
11) LM2902PWR (XA1106).....	14
12) TA78DS10F (XA1249).....	14
13) Transistor, Diode and LED Outline Drawing...	15
14) RD16HHF1 (XE0056).....	16
15) LCD Connection (TTR3626UPFDHN).....	17

EXPLODED VIEW

1) Top and Front View.....	18
2) Bottom View.....	19
3) LCD Assembly.....	20

PARTS LIST

CPU Unit.....	21
MAIN Unit.....	21-24
PA Unit.....	24
Mechanical Parts.....	24
Packing Parts.....	25
ACCESSORIES.....	25
ACCESSORIES (SCREW SET).....	25

ADJUSTMENT

1) Adjustment Spot.....	26
2) VCO and RX Adjustment Specification..	27
3) TX Adjustment Specification.....	27
4) RX Test Specification.....	28
5) TX Test Specification.....	28

PC BOARD VIEW

1) CPU Unit Side A (UP0584).....	29
2) CPU Unit Side B (UP0584).....	29
3) MAIN / PA Unit Side A (UP0584).....	30
4) MAIN / PA Unit Side B (UP0584).....	30

SCHEMATIC DIAGRAM

1) CPU Unit.....	31
2) MAIN Unit.....	32

BLOCK DIAGRAM

1) DR-M03R / DR-03T.....	33
--------------------------	----

SPECIFICATIONS

■ General

	DR-M03R	DR-03T
Frequency coverage	28.000 ~ 29.700MHz (RX, TX)	
Operating mode	FM 16K0F3E	
Frequency resolution	5 , 8.33 , 10 , 12.5 , 15 , 20 , 25 , 30 , 50 kHz	
Number of memory Channels	100	
Antenna impedance	50ohm unbalanced	
Power requirement	13.8V DC +/- 15% (11.7 ~ 15.8 V)	
Ground method	Negative ground	
Current drain	Receive	0.6 A (max.)
	Transmit	0.4 A (Squelched)
		Approx. 3.0 A max.
Operating temperature	-10 °C ~ 60°C	
Frequency stability	+/- 7ppm	
Dimensions	142 (w) x 40 (h) x 174 (d) mm (142 x 40 x 188 mm for projection included)	
Weight	Approx. 1.0 Kg	

■ Transmitter

Output power	Hi	10 W
	Mid	5 W
	Low	1 ~ 4 W
Modulation system	Variable reactance frequency modulation	
Maximum deviation	Frequency	+/- 5kHz
		+/- 2.5kHz
Spurious emission	- 50 dB	
Adjacent channel power	- 60 dB	
Noise and hum ratio	- 40 dB	- 34 dB
Microphone impedance	2kohm	

■ Receiver

Sensitivity	- 12 dBu for 12 dB SINAD	
Receiver circuit	Double conversion super-heterodyne	
Intermediate frequency	1st 10.7 MHz 2nd 450kHz	
Squelch sensitivity	- 16 dBu	
Adjacent channel selectivity	- 65 dB	
Inter-modulation rejection ratio	60 dB	
Spurious and image rejection ratio	70 dB	
Audio output power	2.0 W (8ohm , 10 % THD)	

! NOTE : All specifications are subject to change without notice or obligation.

CIRCUIT DESCRIPTION

1) Receiver System

The receiver system is a double super-heterodyne system with a 10.7MHz first IF and a 450kHz second IF.

1. Front End

The received signal at any frequency in the 28.000MHz to 29.695MHz range is passed through the low-pass filter (L115, L114, L113, C204, C203, C202, C216 and C215) and tuning circuit (L105 and D105), and amplified by the RF amplifier (Q107). The signal from Q107 is then passed through the tuning circuit (L104, L103, L102, and variable capacitor D104, D103, D102) and converted into 10.7MHz by the mixer (Q106). The tuning circuit, which consists of L105, variable capacitor D105, L104, L103, L102, variable capacitor D104, D103 and D102, is controlled by the tracking voltage from the VCO. The local signal from the VCO is passed through the buffer (Q145), and supplied to the source of the mixer (Q106). The radio uses the upper side of the super-heterodyne system.

2. IF Circuit

The mixer mixes the received signal with the local signal to obtain the sum of and difference between them. The crystal filter (XF101A, XF101B) selects 10.7 MHz frequency from the results and eliminates the signal of the unwanted frequencies. The first IF amplifier (Q105) then amplifies the signal of the selected frequency.

3. Demodulation Circuit

After the signal is amplified by the first IF amplifier (Q105), it is input to pin16 of the demodulator IC (IC108). The second local signal of 11.15MHz (shared with PLL IC reference oscillation), which is oscillated the external oscillator X601, is input through pin 1 of IC108. Then, these two signals are mixed by the internal mixer in IC108 and the result is converted into the second IF signal with a frequency of 450kHz. The second IF signal is output from pin 3 of IC108 to the ceramic filter (FL101), where the unwanted frequency band of that signal is eliminated, and the resulting signal is sent back to the IC108 through pin 5. The second IF signal input via pin 5 is demodulated by the internal limiter amplifier and quadrature detection circuit in IC 108, and output as an audio signal through pin 9.

4. Audio Circuit

The audio signal from pin 9 of IC 108 is amplified by the audio amplifier (IC120:A), and switched by the signal switch IC (IC111) and then input it to the de-emphasis circuit.

And is compensated to the audio frequency characteristics in the de-emphasis circuit (R203, R207, R213, R209, C191, C218, C217) and amplified by the AF amplifier (IC120:B). The signal is then input to volume (VR1). The adjusted signal is sent to the audio power amplifier (IC117) through the pin 1 to drive the speaker.

5. Squelch Circuit

The detected output which is outputted from pin 9 of IC108 is inputted to pin 8 of IC108 after it was been amplified IC120:A and it is outputted from pin 7 after the noise component was been eliminated from the composed band pass filter in the built in amplifier of the IC, then the signal is rectified by the internal diode in IC108 to convert into DC component. The adjusted voltage level at VR101 is delivered to the comparator of the CPU.

The voltage is led to pin 2 of CPU and compared with the setting voltage. The squelch will open if the input voltage is lower than the setting voltage. During open squelch, pin 30 (SQC) of the CPU becomes "L" level, AF control signal is begin controlled and sounds is outputted from speaker.

2) Transmitter System

1. Modulator Circuit

The audio signal is converted to an electrical signal by the microphone, and input it to the microphone amplifier (Q6). Amplified signal which passes through mic-mute control IC109 is adjusted to an appropriate mic-volume by means of mic-gain adjust VR106.

IC114:D and C consists of two operational amplifiers; one amplifier (pin 12, 13 and 14) is composed of pre-emphasis and IDC circuit and the other (pin 8, 9 and 10) is composed of a splatter filter. The maximum frequency deviation is obtained by VR107. And input to the signal switch (IC113) (9600 bps packet signal input switch) and input to the anode of the variable capacitor of the VCO, to change the electric capacity in the oscillation circuit. This produces the frequency modulation.

2. Power Amplifier Circuit

The transmitted signal is oscillated by the VCO, amplified by the younger amplifier (Q115 and Q103), and input to the final power amplifier (Q701). The signal is then amplified by the final power amplifier (Q701) and led to the antenna switch (D110) and low-pass filter (L113, L114, L115, C215, C216, C202, C203 and C204), where unwanted high harmonic waves are reduced as needed, and the resulting signal is supplied to the antenna.

3. APC Circuit

Part of the transmission power from the low-pass filter is detected by D111, converted to DC. The detection voltage is passed through the APC circuit (IC114:B), then it controls the APC voltage supplied to final power amplifier Q701 to fix the transmission power.

3) PLL Synthesizer Circuit

1. PLL

The dividing ratio is obtained by sending data from CPU (IC1) to pin 10 and sending clock pulses to pin 9 of the PLL IC (IC116). The oscillated signal from the VCO is amplified by the buffer (Q134 and Q135) and input to pin 8 of IC116. Each programmable divider in IC116 divides the frequency of the input signal by N according to the frequency data, to generate a comparison frequency of 5 or 6.25 kHz.

2. Reference Frequency Circuit

The reference frequency appropriate for the channel steps is obtained by dividing the 11.15 MHz reference oscillation (X601) by 4250 or 3400, according to the data from the CPU (IC1). When the resulting frequency is 5 kHz, channel step of 5, 8.33, 10, 15, 20, 25, 30 and 50 kHz are used. When it is 6.25 kHz, the 12.5 kHz channel step is used.

3. Phase Comparator Circuit

The PLL (IC116) uses the reference frequency, 5 or 6.25 kHz. The phase comparator in the IC116 compares the phase of the frequency from the VCO with that of the comparison frequency, 5 or 6.25 kHz, which is obtained by the internal divider in IC116.

4. PLL Loop Filter Circuit

If a phase difference is found in the phase comparison between the reference frequency and the VCO output frequency, the charge pump output (pin 5) of IC116 generates a pulse signal, which is converted DC voltage by the PLL loop filter and input to the input to the variable capacitor of the VCO unit for oscillation frequency control.

5. VCO Circuit

A Colpitts oscillation circuit driven by Q131 directly oscillates the desired frequency. The frequency control voltage determine in the CPU (IC1) and PLL circuit is input to the variable capacitor (D123). This change the oscillation frequency, which is amplified by the VCO buffer (Q134, Q145) and output from the VCO area.

4) CPU and Peripheral Circuits

1. LCD Display Circuit

The CPU turns ON the LCD via segment and common terminals with 1/4 the duty and 1/3 the bias, at the frame frequency is 64 Hz.

2. Reset and Backup

When the power from the DC cable increases from Circuits 0 V to 2.5 V or more, "H" level reset signal is output from the reset IC (IC4) to pin 33 of the CPU (IC1), causing the CPU to reset. The reset signal , however, waits at 100, and dose not enter the CPU until the CPU clock (X1) has stabilized.

3. S (Signal) Meter Circuit

The DC potential of IF IC is input to pin 1 of the CPU (IC1), converted from an analog to a digital signal, and displayed as the S-meter signal on the LCD.

4. DTMF Encoder

The CPU (IC1) is equipped with an internal DTMF encoder. The DTMF signal is output from pin 10, through R35, R34 and VR109 (for level adjustment), and then through the microphone amplifier (IC114:D), and is sent to the variable capacitor of the VCO for modulation. At the same time, the monitoring tone passes through the AF circuit and is output from the speaker.

5. Tone Encoder

The CPU (IC1) is equipped with an internal tone encoder. The tone signal (67.0 to 250.3 Hz) is output from pin 9 of CPU to the variable capacitor (D123) of the VCO for modulation.

6. DCS Encoder

The CPU (IC1) is equipped with an internal DCS code encoder. The code (023 to 754) is output from pin 9 of CPU to the variable capacitor (D601) of the PLL reference oscillator. When DCS is ON, DCS MUTE circuit (Q126-ON, Q133-ON, Q132-OFF) works. The modulation activates in X601 side only.

7. CTCSS, DCS Decoder

The voice band of the AF output signal from pin 1 of IC120:A is cut by sharp active filter IC104:A, B and C (VCVS) and amplified, then led to pin 4 of CPU. The input signal is compared with the programmed tone frequency code in the CPU. The squelch will open when they match. During DCS, Q108 is ON, C419 is working and cut off frequency is lowered.

5) Power Supply Circuit

When power supply is ON, there is a "L" signal being inputted to pin 39 (PSW) of CPU which enables the CPU to work. Then, "H" signal is outputted from pin 41 (C5C) of CPU and drives ON the power supply switch control Q8 and Q7 which turns the 5VS ON. 5VS turns ON the PLL IC (IC116), main power supply switch Q127 and Q122, AF POWER IC117 and the 8V of AVR (IC115). During reception, pin 29 (R5) of CPU outputs "H" level, Q124 is ON, and the reception circuits supplied by 8 V. While during transmission, pin 28 (T5) of CPU outputs "L" level which is reverse by Q11 so that the output in Q128 will be "H" level, Q123 is ON, and the transmission circuit is supplied by 8 V. Or, in the case when the condition of PLL is UNLOCK, "H" level is outputted from pin 7 of PLL IC (IC116), UNLOCK switch Q129 is ON, transmission switch Q128 is OFF which makes the transmission to stop.

6) M38268MCL082GP#U0 (XA1170A)

CPU

Terminal Connection
(TOP VIEW)

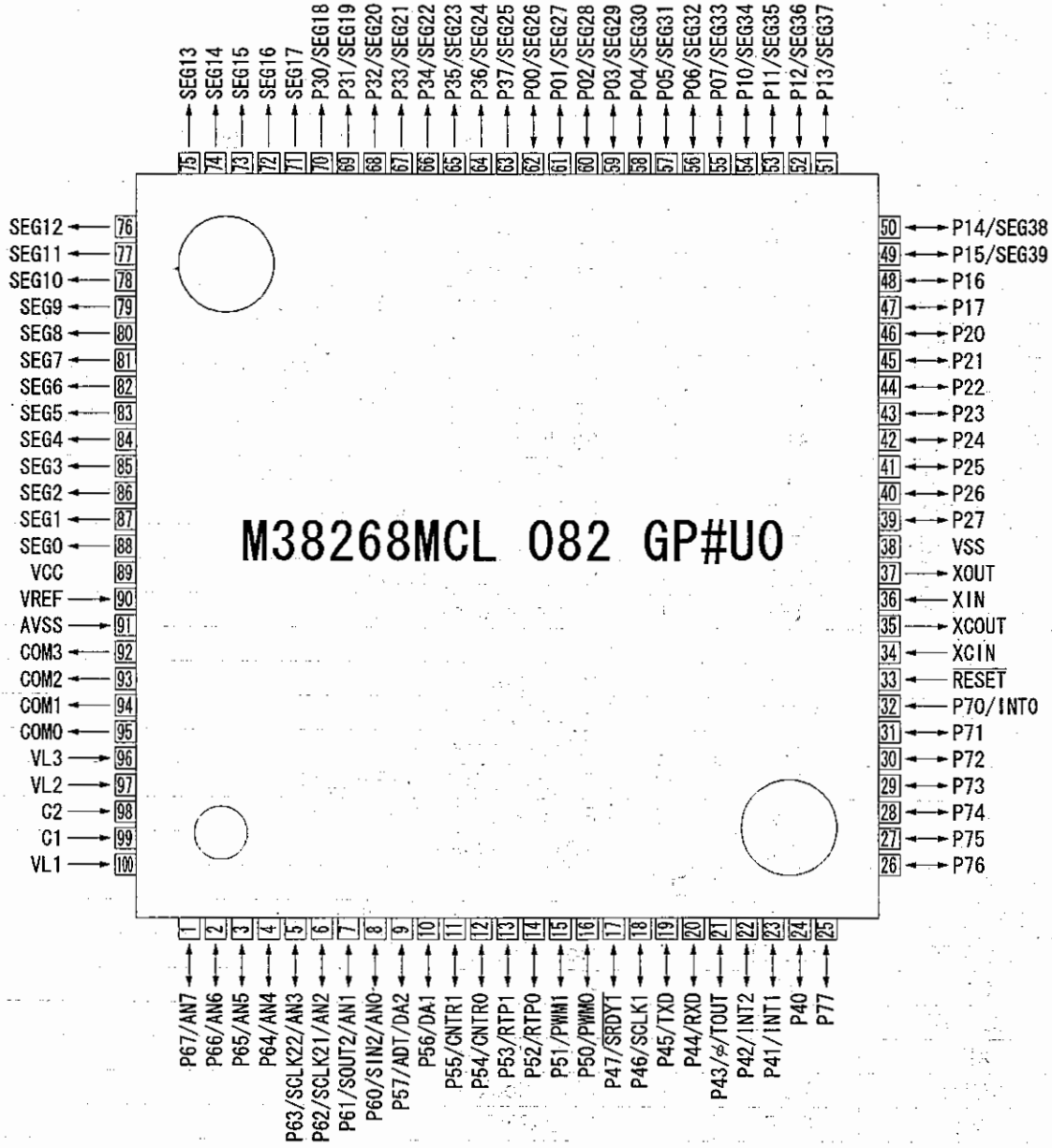

No.	Terminal	Signal	I/O	Description
1	P67/AN7	SMT	I	S-meter input
2	P66/AN6	SQL	I	Noise level input for squelch
3	P65/AN5	BP5	I	Band plan 5
4	P64/AN4	TIN	I	CTCSS tone input / DCS code input
5	P63/SCLK22/AN3	BP1	I	Band plan 1
6	P62/SCLK21/AN2	BP2	I	Band plan 2
7	P61/SOUT2/AN1	DCSW	O	DCS signal mute
8	P60/SIN2/AN0	RE2	I	Rotary encoder input
9	P57/ADT/DA2	TOUT	O	CTCSS tone output / DCS tone output
10	P56/DA1	DOUT	O	DTMF output
11	P55/CNTR1	SCL	O	Serial clock for EEPROM
12	P54/CNTR0	TBST	O	Tone burst output
13	P53/RTP1	BP4	I/O	Band plan 4
14	P52/RTP0	MUTE	I/O	Microphone mute / Security alarm SW
15	P51/PWM1	CLK	O	Serial clock output for PLL
16	P50/PWM0	DATA	I/O	Serial data output for PLL / PLL unlock signal input
17	P47/SRDY1	TSTB	I/O	Trunking board detection / Strobe signal to trunking board
18	P46/SCLK1	STB	O	Strobe for PLL IC
19	P45/TXD	UTX	O	UART data transmission output
20	P44/RXD	RTX	I	UART data reception output
21	P43/□/TOUT	BEEP	I/O	Beep tone / Band plan 3
22	P42/INT2	SEC	I	Security voltage input
23	P41/INT1	RE1	I	Rotary encoder input
24	P40			
25	P77	PTT	I	PTT input
26	P76	SSTB	O	Security mode
27	P75	W/N	O	Wide Narrow SW
28	P74	T5	O	TX power ON / OFF output
29	P73	R5	O	RX power ON / OFF output
30	P72	SQC	O	SQL ON / OFF
31	P71			
32	P70/INT0	BU	I	Backup signal detection input
33	RESET	RESET	I	Reset input
34	XCIN	Xcin	-	-
35	XCOUT	Xcout	-	-
36	XIN	Xin	-	Main clock input
37	XOUT	Xout	-	Main clock output
38	VSS	GND	-	CPU GND
39	P27	PSW	I	Power switch input
40	P26	SDA	O	Serial data for EEPROM
41	P25	C5C	O	C5V power ON / OFF output
42	P24	MID	O	Tx middle power
43	P23	LOW	O	Tx low power
44	P22	EXP	O	Trunking / Packet data SW
45	P21	SW6	I	Key sw 6 (SQL)
46	P20	SW5	I	Key sw 5 (CALL)
47	P17	SW4	I	Key sw 4 (TSQ)
48	P16	SW3	I	Key sw 3 (MHz)
49	P15/SEG39	SW2	I	Key sw 2 (V/M)
50	P14/SEG38	SW1	I	Key sw 1 (FUNC)

No.	Terminal	Signal	I/O	Description
51	P13/SEG37	DOWN	I	Mic down input
52	P12/SEG36			
53	P11/SEG35			
54	P10/SEG34	UP	I	Mic up input
55	P07/SEG33	S33	O	LCD segment signal
56	P06/SEG32	S32	O	
57	P05/SEG31	S31	O	
58	P04/SEG30	S30	O	
59	P03/SEG29	S29	O	
60	P02/SEG28	S28	O	
61	P01/SEG27	S27	O	
62	P00/SEG26	S26	O	
63	P37/SEG25	S25	O	
64	P36/SEG24	S24	O	
65	P35/SEG23	S23	O	
66	P34/SEG22	S22	O	
67	P33/SEG21	S21	O	
68	P32/SEG20	S20	O	
69	P31/SEG19	S19	O	
70	P30/SEG18	S18	O	
71	SEG17	S17	O	
72	SEG16	S16	O	
73	SEG15	S15	O	
74	SEG14	S14	O	
75	SEG13	S13	O	
76	SEG12	S12	O	
77	SEG11	S11	O	
78	SEG10	S10	O	
79	SEG9	S9	O	
80	SEG8	S8	O	
81	SEG7	S7	O	
82	SEG6	S6	O	
83	SEG5	S5	O	
84	SEG4	S4	O	
85	SEG3	S3	O	
86	SEG2	S2	O	
87	SEG1	S1	O	
88	SEG0	S0	O	
89	VCC	VDD	-	CPU power terminal
90	VREF	Vref	-	AD converter power supply
91	AVSS	Avss	-	AD converter GND
92	COM3	COM3	O	LCD COM3 output
93	COM2	COM2	O	LCD COM2 output
94	COM1	COM1	O	LCD COM1 output
95	COM0	COM0	O	LCD COM0 output
96	VL3	VL3	-	LCD power supply
97	VL2	VL2	-	LCD power supply
98	C2	I	-	-
99	C1	C1	-	-
100	VL1	VL1	I	LCD power supply

SEMICONDUCTOR DATA

1) NJM7808FA (XA0102)

8V (1A) Voltage Regulator

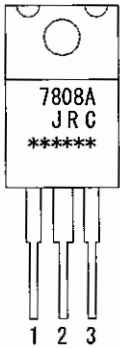

- 1. INPUT
- 2. COMMON
- 3. OUTPUT

2) TC4S66F (XA0115)

Bilateral Switch

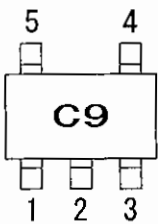

- 1. IN / OUT
- 2. OUT / IN
- 3. VSS
- 4. CONT
- 5. VDD

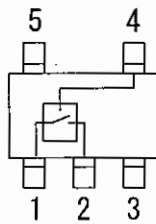

CONT	Function (IN-OUT)
L	Disconnect (Hi Z)
H	Connect (290ohm typ.)

3) TC4W53FU (XA0348)

Multiplexer / De-multiplexer

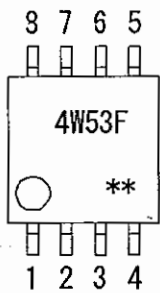

- 1. COMMON
- 2. INH
- 3. VEE
- 4. VSS
- 5. A
- 6. ch 1
- 7. ch 0
- 8. VDD

Control input		ON channel
INH	A	
L	L	ch 0
L	H	ch 1
H	*	NONE

* Don't care

4) TA31136FN (XA0404)

Narrow Band FM IF IC

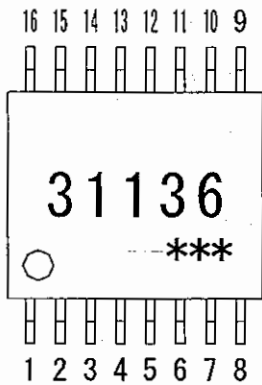

- | | |
|------------|------------|
| 1. OSC IN | 9. AF OUT |
| 2. OSC OUT | 10. QUAD |
| 3. MIX OUT | 11. IF OUT |
| 4. Vcc | 12. RSSI |
| 5. IF IN | 13. N-DET |
| 6. DEC | 14. N-REC |
| 7. FIL OUT | 15. GND |
| 8. FIL IN | 16. MIX IN |

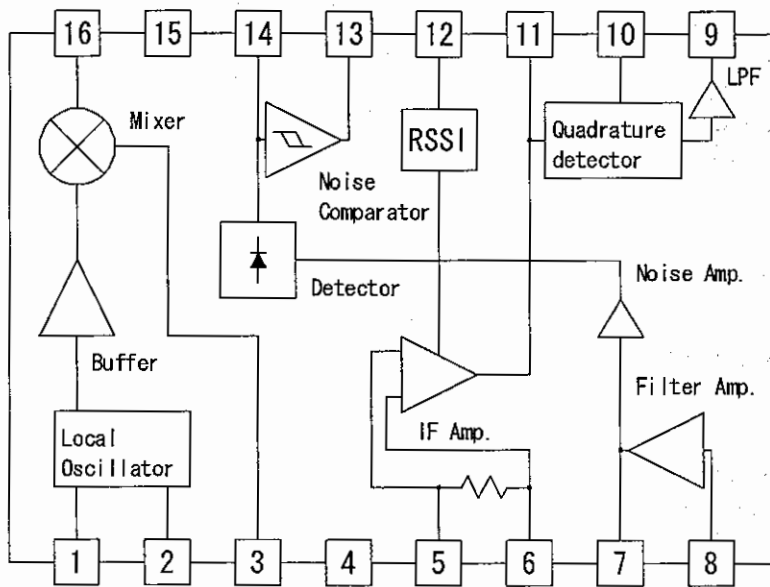

5) LA4425A (XA0410)

5W Audio Power Amplifier

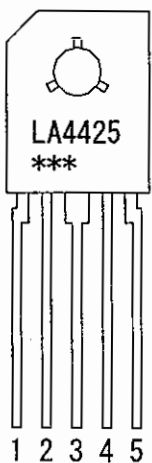

1. Input
2. Small signal GND
3. Large signal GND
4. Output
5. Vcc

Test Circuit

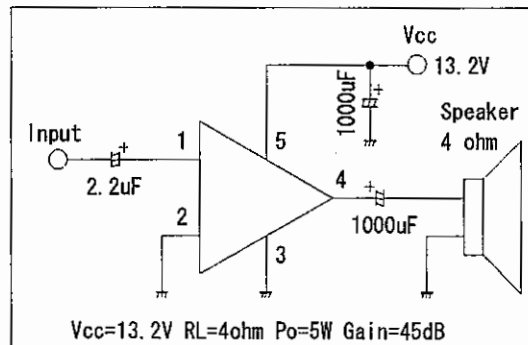

6) BR24L32FJ (XA0604Z)

32K-Bit EEPROM

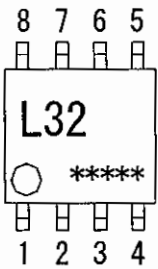

1. A0
2. A1
3. A2
4. Vss
5. SDA
6. SCL
7. WP
8. Vcc

Name	Function
A0...A2	User Configurable Chip Select
Vss	Ground
SDA	Serial Address / Data / I/O
SCL	Serial Clock
WP	Write Protect Input
Vcc	+2.5 ~ 6.0V Power Supply

7) S-80845ALMP (XA0620)

4.5V Voltage Detector

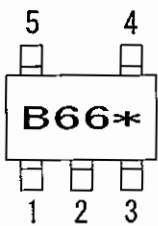

1. GND
2. Vin
3. Vout
4. NC
5. NC

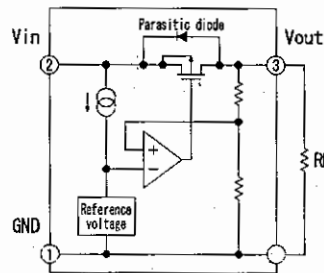

8) NJM78M05DL1A (XA0947)

5V (500mA) Voltage Regulator

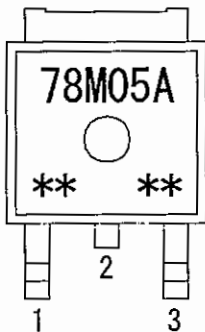

1. Input
2. GND
3. Output

9) MB15A01PFV1 (XA1010)

PLL Synthesizer

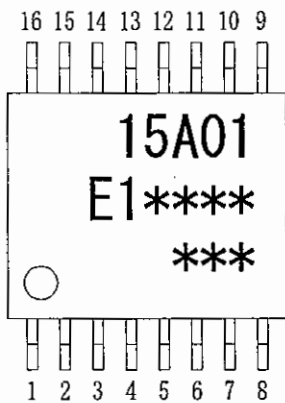

- | | |
|------------|--------------|
| 1. OSC IN | 9. Clock |
| 2. OSC OUT | 10. Data |
| 3. Vp | 11. LE |
| 4. Vcc | 12. FC |
| 5. Do | 13. N. C. |
| 6. GND | 14. fout |
| 7. LD | 15. ϕP |
| 8. fin | 16. ϕR |

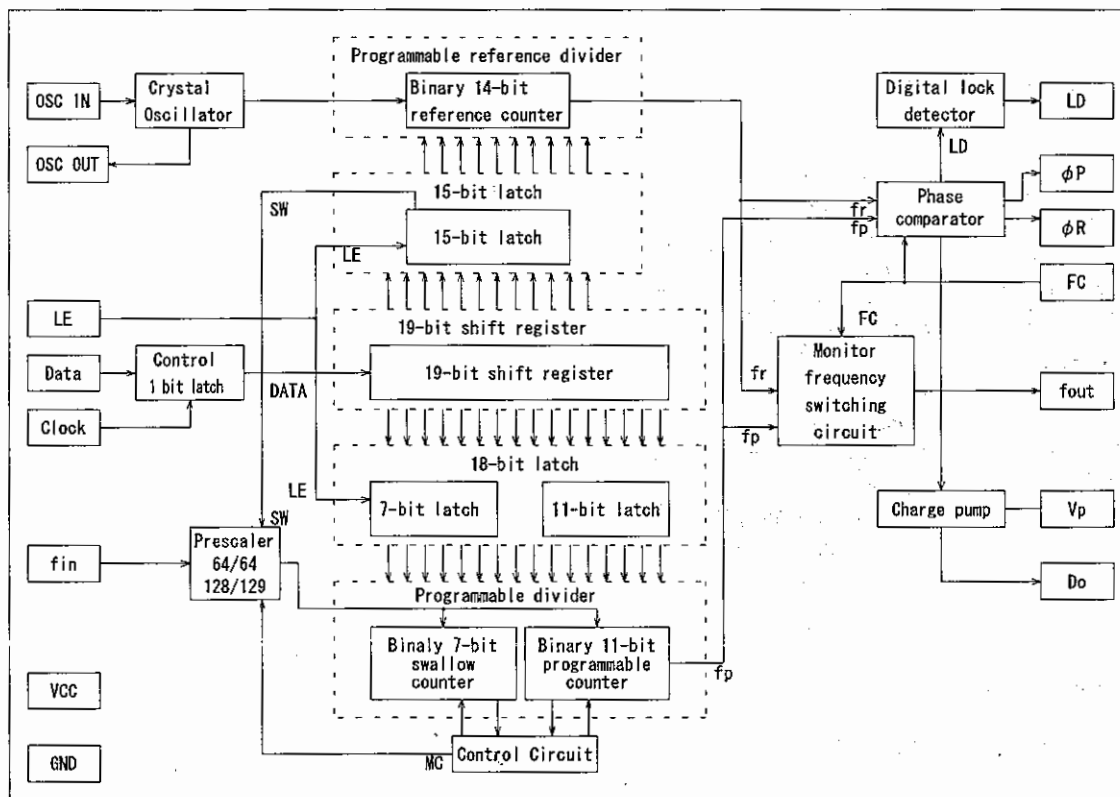

($V_{cc} = 2.7$ to $3.5V$, $T_a = -40^{\circ}C$ to $+85^{\circ}C$)

Parameter	Symbol	Condition	Min.	Typ.	Max.	Unit
Power supply voltage	V_{cc}	-	2.7	3.0	3.5	V
Power supply current	I_{cc}	2500MHz $V_{cc}=V_p=3.75V$		6.5		mA
LPF supply voltage	V_p	-	V_{cc}	-	6.0	V
Local oscillator input level	V_{fin}	-	-10		+6	dBm
Local oscillator input frequency	f_{in}	-	10		1100	MHz
Xin input level	V_{xin}	-	0.5		-	Vp-p
Xin input frequency	F_{xin}	-	-	12	23	MHz

10) LM2904PWR (XA1103)

Dual Operational Amplifiers

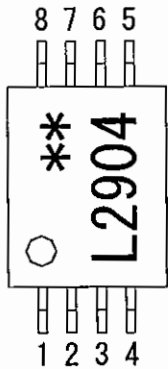

1. Output A
2. Inverting Input A
3. Non-inverting Input A
4. GND
5. Non-inverting Input B
6. Inverting Input B
7. Output B
8. Vcc

11) LM2902PWR (XA1106)

Quad Operational Amplifiers

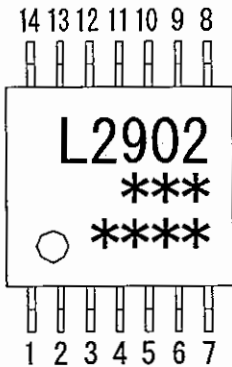

1. Output A
2. Inverting Input A
3. Non-inverting Input A
4. Vcc
5. Non-inverting Input B
6. Inverting Input B
7. Output B
8. Output C
9. Inverting Input C
10. Non-inverting Input C
11. GND
12. Non-inverting Input D
13. Inverting Input D
14. Output D

12) TA78DS10F (XA1249)

10V (30mA) Voltage Regulator

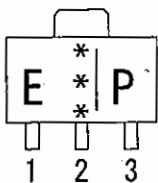



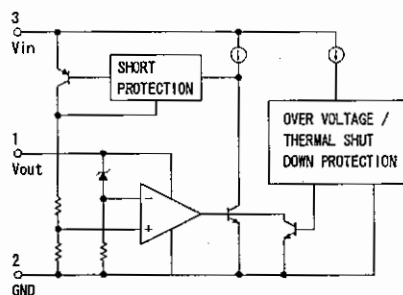



























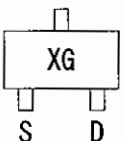

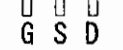

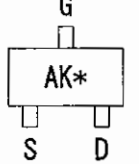





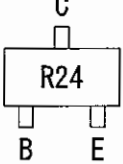

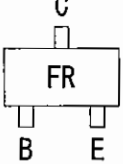

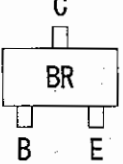

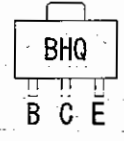
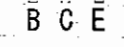
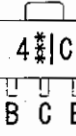
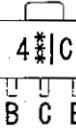
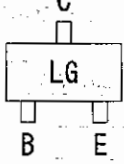

1. OUTPUT
2. COMMON
3. INPUT

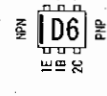
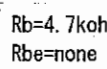
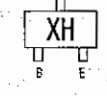
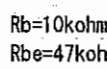

13) Transistor, Diode and LED Outline Drawing

Top View

MI407 XD0013	DA204U XD0130	1SV268 XD0301	DAN235E XD0320	SVC347S XD0380	VDZ5.1B XD0402	S3V60 XD0414
 	 	 	 	 	 	 
1SS383 XD0426	JDV2S14 XD0427	1SS383 XD0461	1SS406 XD0462	2SK880GR XE0021	2SK3074 XE0044	3SK293 XE0053
 	 	 	 	 	 	 
2SK2539 XE0066	FA1111C XL0069	FA1111C XL0077	2SC3356T1 XT0030	2SA1576A XT0094	2SC4081 XT0095	2SC4915 XT0178
 	 	 	 	 	 	 
2SB1386 XT0190	2SA2070 XT0223	2SC4738 XT0224	RN1104 XU0195	EMD6 XU0209	RN1107FV XU0210	RN2107FV XU0211
 	 	 	  Rb=47kohm Rbe=47kohm	  Rb=4.7kohm Rbe=none	  Rb=10kohm Rbe=47kohm	  Rb=10kohm Rbe=47kohm
RN1711 XU0226						
  Rb=10kohm Rbe=none						

14) RD16HHF1 (XE0056)

Nch MOS FET

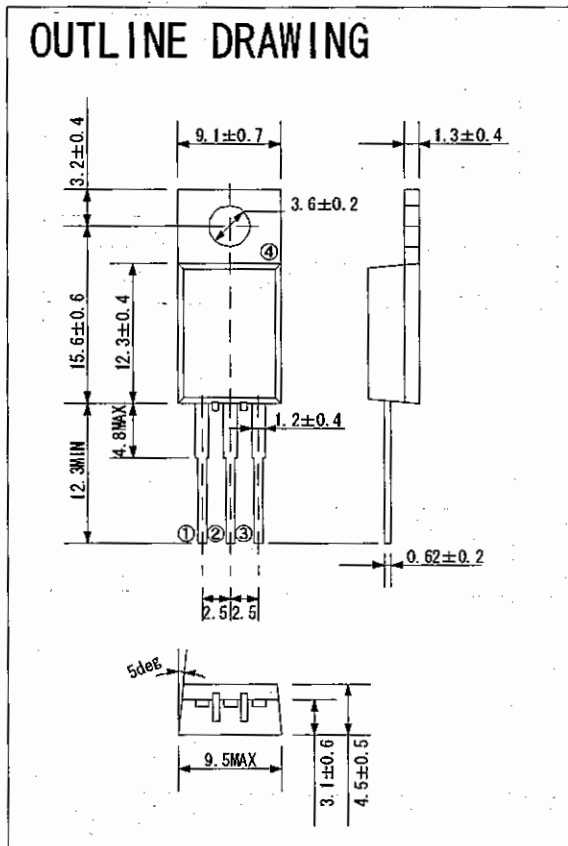

- PIN
- ① GATE
 - ② SOURCE
 - ③ DRAIN
 - ④ FIN (SOURCE)

ABSOLUTE MAXIMUM RATING (Tc = 25 °C, unless otherwise noted)

Symbol	Parameter	Conditions	Ratings	Unit
VDSS	Drain to source voltage	Vgs = 0V	50	V
VGSS	Gate to source voltage	Vds = 0V	+/- 20	V
Pch	Channel dissipation	Tc = 25 °C	56.8	W
Pin	Input Power	Zg = Zl = 50 Ω	0.8	W
ID	Drain to source Current	-	5	A
Tch	Channel temperature	-	150	°C
Tstg	Storage temperature	-	-40 to +150	°C
Rth j-c	Thermal resistance	Junction to case	2.2	°C/W

ELECTRICAL CHARACTERISTICS (Tc = 25 °C, unless otherwise noted)

Symbol	Parameter	Conditions	Limits			Unit
			Min	Typ	Max	
IDSS	Zero gate voltage drain current	VDS = 17V, VGS = 0V	-	-	10	μ A
IGSS	Gate to source leak current	VGS = 10V, VDS = 0V	-	-	1	μ A
VTH	Gate threshold voltage	VDS = 12V, IDS = 1mA	1.7	-	7.7	V
Pout	Output Power	f = 30MHz, VDD = 12.5V	16	19	-	W
η D	Drain Efficiency	Pin = 0.4W, Idq=0.5A	55	65	-	%
	Load VSWR Tolerance	VDD = 15.2V, PO = 16W (Pin Control) f = 30MHz, Idq = 0.5A, Zg = 50 Ω Load VSWR = 20:1 (ALL Phase)	No degradation			-

15) LCD Connection (TTR3626UPFDHN)

SEG

SEG33
SEG32
SEG31
SEG30
SEG29
SEG28
SEG26
SEG25
SEG24
SEG23
SEG22
SEG21
SEG20
SEG19
SEG18
SEG17
SEG16
SEG15
SEG14
SEG13
SEG12
SEG11
SEG10
SEG9
SEG8
SEG7
SEG6
SEG5
SEG4
SEG3
SEG2
SEG1
SEG0

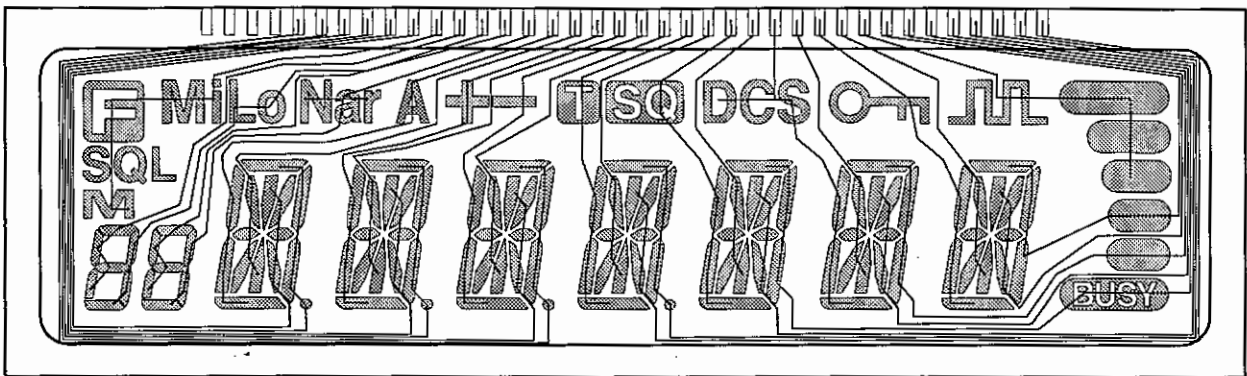

COM

COM3
COM2
COM1
COM0

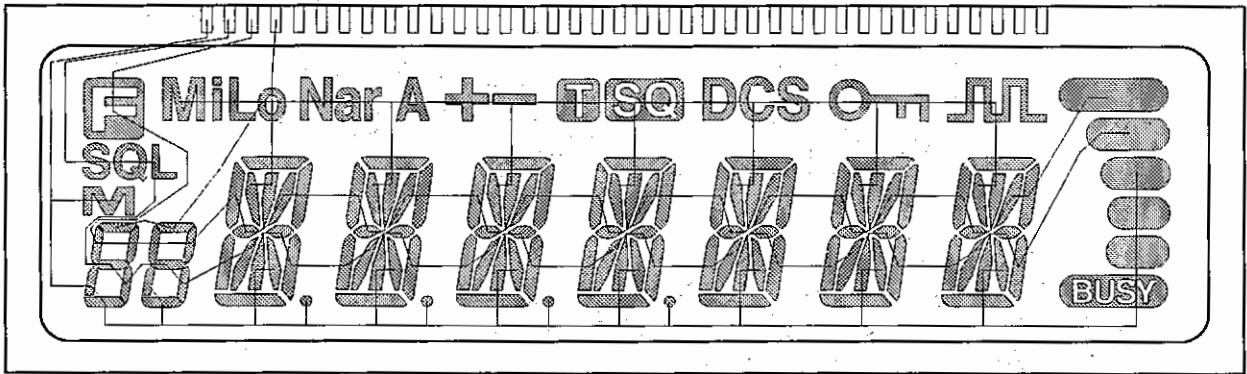

2) Top and Front View

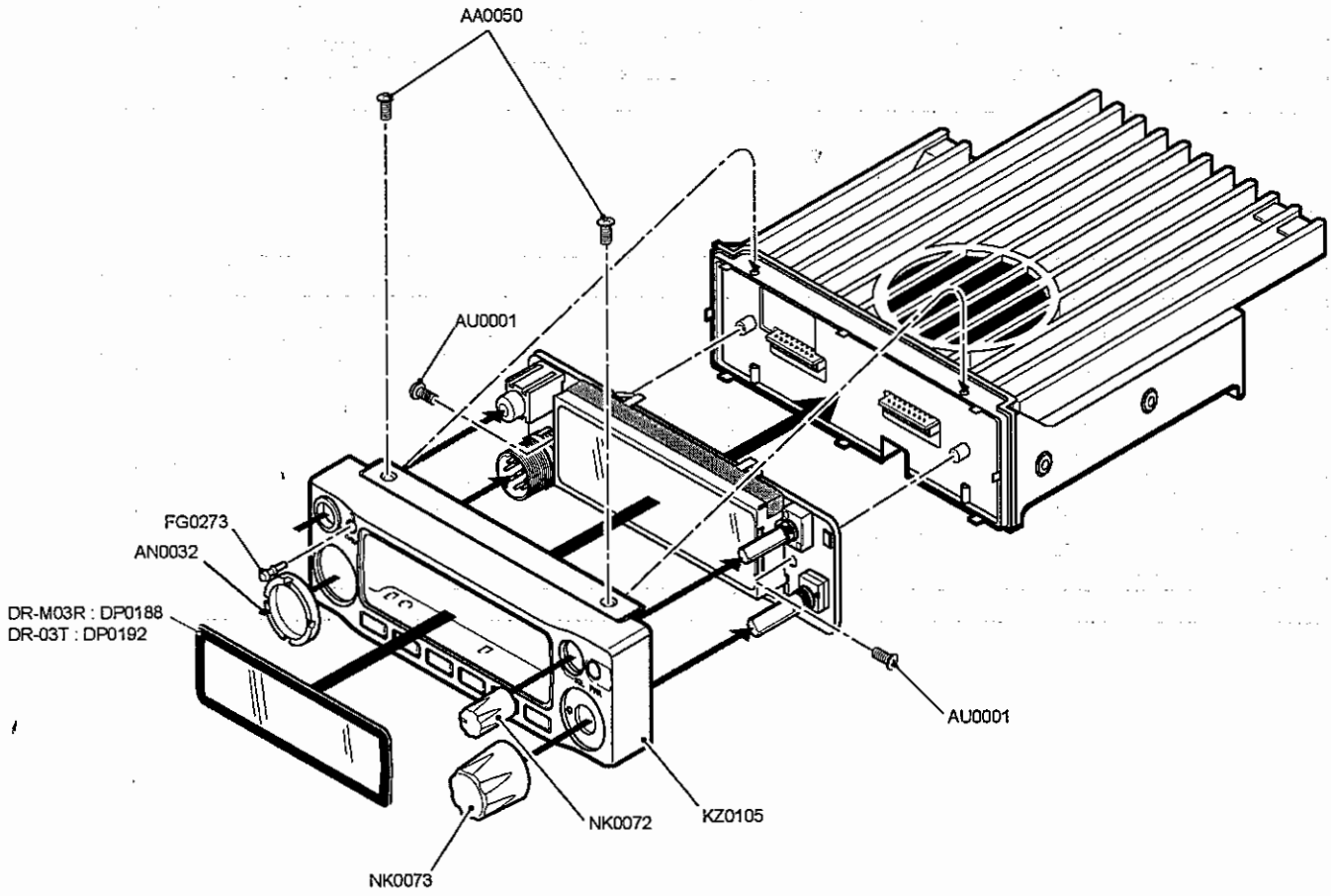

3) Bottom View

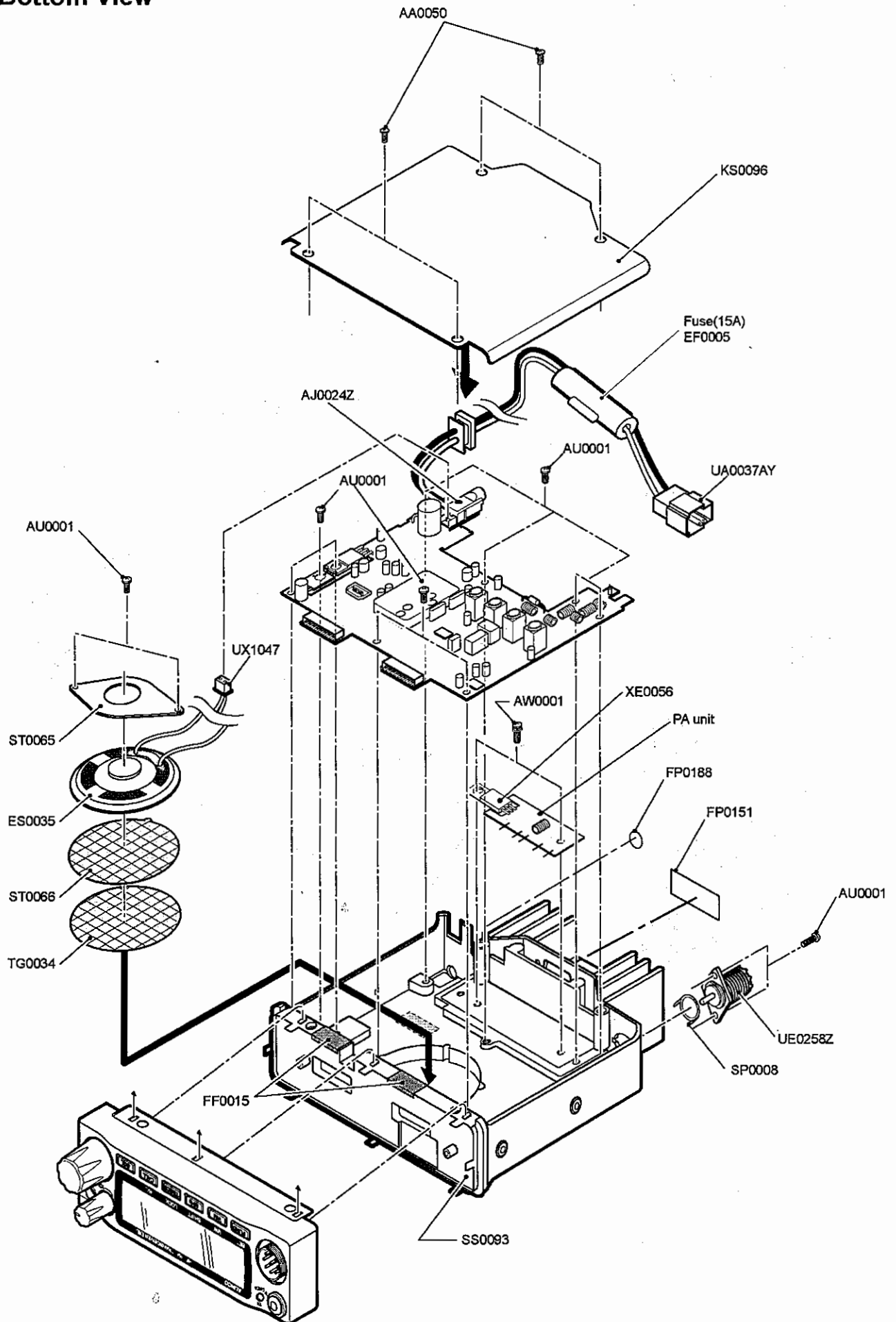

EXPLODED VIEW

1) LCD Assembly

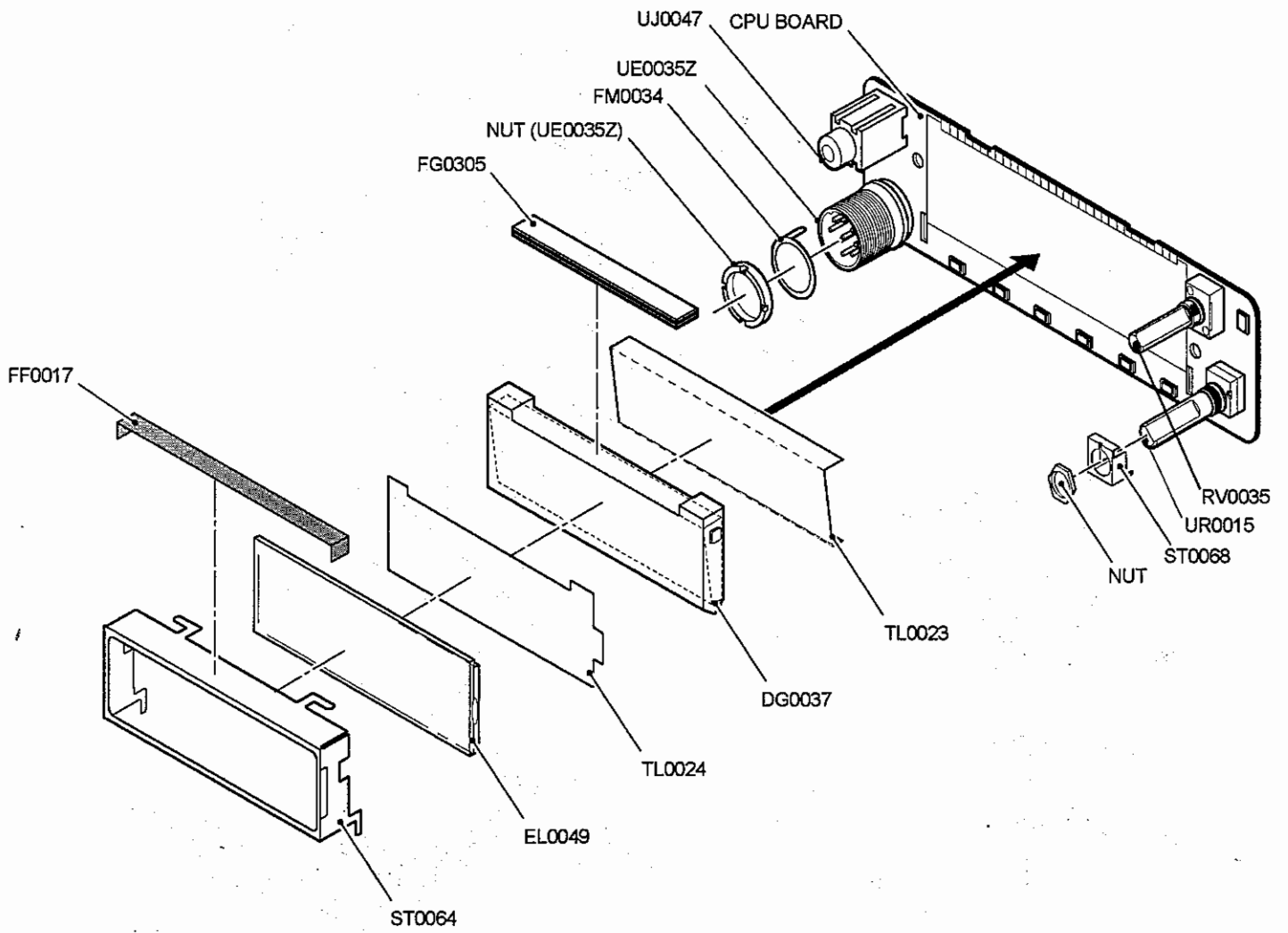

PARTS LIST

CPU Unit

Ref No.	Part No.	Description	Parts Name	Qty.	
				DR-M03R	DR-03T
C1	CU3554	Chip C.	GRM155B11A104KA01D	1	1
C2	CU3554	Chip C.	GRM155B11A104KA01D	1	1
C3	CU3549	Chip C.	GRM155B11C153KA01D	1	1
C4	CU3549	Chip C.	GRM155B11C153KA01D	1	1
C5	CU3554	Chip C.	GRM155B11A104KA01D	1	1
C6	CU3523	Chip C.	GRM1552C1H101JD01D	1	1
C7	CU3523	Chip C.	GRM1552C1H101JD01D	1	1
C8	CU3543	Chip C.	GRM155B11H392KA01D	1	1
C9	CU3554	Chip C.	GRM155B11A104KA01D	1	1
C10	CU3543	Chip C.	GRM155B11H392KA01D	1	1
C11	CU3543	Chip C.	GRM155B11H392KA01D	1	1
C12	CU3553	Chip C.	GRM155B11A473KA01D	1	1
C13	CS0049	Chip tantalum	TMCSA1C105MTRF	1	1
C14	CU3514	Chip C.	GRM1552C1H180JZ01D	1	1
C15	CU3514	Chip C.	GRM1552C1H180JZ01D	1	1
C16	CU3535	Chip C.	GRM155B11H102KA01D	1	1
C17	CS0424	Chip tantalum	TMCSA1C106MTRF	1	1
C18	CU3535	Chip C.	GRM155B11H102KA01D	1	1
C19	CU3554	Chip C.	GRM155B11A104KA01D	1	1
C20	CU3547	Chip C.	GRM155B11C103KA01D	1	1
C21	CU3547	Chip C.	GRM155B11C103KA01D	1	1
C22	CU3535	Chip C.	GRM155B11H102KA01D	1	1
C23	CU3547	Chip C.	GRM155B11C103KA01D	1	1
C24	CU3535	Chip C.	GRM155B11H102KA01D	1	1
C25	CU3535	Chip C.	GRM155B11H102KA01D	1	1
C26	CU3535	Chip C.	GRM155B11H102KA01D	1	1
C27	CU3535	Chip C.	GRM155B11H102KA01D	1	1
CN1	UE0291	Connector	17R-JE(LF)(SN)	1	1
CN2	UE0291	Connector	17R-JE(LF)(SN)	1	1
CN3	UE0035Z	Mic Connector	MIC FM214-8SMPY(Z)	1	1
D1	XL0069	Chip LED	FA1111C-TR	1	1
D2	XL0077	Chip LED	FA1111C-732-TR	1	1
D3	XL0077	Chip LED	FA1111C-732-TR	1	1
D4	XL0069	Chip LED	FA1111C-TR	1	1
D5	XL0077	Chip LED	FA1111C-732-TR	1	1
D6	XL0077	Chip LED	FA1111C-732-TR	1	1
D8	XD0426	Chip Diode	1SS387	1	1
D9	XD0462	Chip Diode	1SS406(TPH3,F)	1	1
D11	XL0077	Chip LED	FA1111C-732-TR	1	1
D17	XD0462	Chip Diode	1SS406(TPH3,F)	1	1
IC1	XA1170A	IC	M38268MCA-082GP#U0	1	1
IC2	XA0604Z	IC	BR24L32FJ-WE2	1	1
IC4	XA0620	IC	S80845CLMC-B66-T2G	1	1
IC6	XA0348	IC	TC4W53FU(TE12L)	1	1
JK1	UJ0047	Jack	HSJ2013-01-120	1	1
JP3	MACL04GG	Wire	#30AH1-040-H1	0	1
LCD1	EL0049	LCD	LCD DR135	1	1
Q4	XU0210	Chip	RN1107MFV(TPL3)	1	1
Q6	XT0095	Chip	2SC4081 T106R	1	1
Q7	XT0223	Chip	2SA2070(TE12L,F)	1	1
Q8	XU0210	Chip	RN1107MFV(TPL3)	1	1
Q10	XU0210	Chip	RN1107MFV(TPL3)	1	1
Q11	XU0211	Chip	RN2107MFV(TPL3)	1	1
Q12	XU0211	Chip	RN2107MFV(TPL3)	1	1
R1	RK3554	Chip R.	ERJ2GEJ223X	1	1
R4	RK3554	Chip R.	ERJ2GEJ223X	1	1
R5	RK3550	Chip R.	ERJ2GEJ103X	1	1
R6	RK3550	Chip R.	ERJ2GEJ103X	1	1
R7	RK3026	Chip R.	MCR03EZPJ101	1	1
R8	RK3026	Chip R.	MCR03EZPJ101	1	1
R10	RK3032	Chip R.	MCR03EZPJ331	1	1
R11	RK3546	Chip R.	ERJ2GEJ472X	1	1
R14	RK3548	Chip R.	ERJ2GEJ682X	1	1
R19	RK3562	Chip R.	ERJ2GEJ104X	1	1
R20	RK3546	Chip R.	ERJ2GEJ472X	1	1
R22	RK3538	Chip R.	ERJ2GEJ102X	1	1
R25	RK3550	Chip R.	ERJ2GEJ103X	1	1
R26	RK3550	Chip R.	ERJ2GEJ103X	1	1
R27	RK3550	Chip R.	ERJ2GEJ103X	1	1
R28	RK3538	Chip R.	ERJ2GEJ102X	1	1
R29	RK3538	Chip R.	ERJ2GEJ102X	1	1
R30	RK3538	Chip R.	ERJ2GEJ102X	1	1
R32	RK3544	Chip R.	ERJ2GEJ332X	1	1
R33	RK3534	Chip R.	ERJ2GEJ471X	1	1
R34	RK3547	Chip R.	ERJ2GEJ562X	1	1
R35	RK3552	Chip R.	ERJ2GEJ153X	1	1
R36	RK3562	Chip R.	ERJ2GEJ104X	1	1
R37	RK3549	Chip R.	ERJ2GEJ822X	1	1
R38	RK3551	Chip R.	ERJ2GEJ123X	1	1
R39	RK3558	Chip R.	ERJ2GEJ473X	1	1
R40	RK3562	Chip R.	ERJ2GEJ104X	1	1
R41	RK3526	Chip R.	ERJ2GEJ101X	1	1
R42	RK3550	Chip R.	ERJ2GEJ103X	1	1
R43	RK3550	Chip R.	ERJ2GEJ103X	1	1
R44	RK3026	Chip R.	MCR03EZPJ101	1	1
R45	RK3550	Chip R.	ERJ2GEJ103X	1	1

Ref No.	Part No.	Description	Parts Name	Qty.	
				DR-M03R	DR-03T
R48	RK3538	Chip R.	ERJ2GEJ102X	1	1
R50	RK3570	Chip R.	ERJ2GEJ474X	1	1
R51	RK3538	Chip R.	ERJ2GEJ102X	1	1
R52	RK3538	Chip R.	ERJ2GEJ102X	1	1
R53	RK3562	Chip R.	ERJ2GEJ104X	1	1
R54	RK3550	Chip R.	ERJ2GEJ103X	1	1
R55	RK3574	Chip R.	ERJ2GEJ105X	1	1
R56	RK3550	Chip R.	ERJ2GEJ103X	1	1
R57	RK3566	Chip R.	ERJ2GEJ224X	1	1
R58	RK3534	Chip R.	ERJ2GEJ471X	1	1
R59	RK3526	Chip R.	ERJ2GEJ101X	1	1
R60	RK3034	Chip R.	MCR03EZPJ471	1	1
R61	RK3574	Chip R.	ERJ2GEJ105X	1	1
R62	RK3550	Chip R.	ERJ2GEJ103X	1	1
R63	RK3526	Chip R.	ERJ2GEJ101X	1	1
R64	RK3549	Chip R.	ERJ2GEJ822X	1	1
R65	RK3526	Chip R.	ERJ2GEJ101X	1	1
R66	RK3550	Chip R.	ERJ2GEJ103X	1	1
R67	RK3526	Chip R.	ERJ2GEJ101X	1	1
R68	RK3550	Chip R.	ERJ2GEJ103X	1	1
R70	RK3562	Chip R.	ERJ2GEJ104X	1	1
R71	RK3574	Chip R.	ERJ2GEJ105X	1	1
R72	RK3550	Chip R.	ERJ2GEJ103X	1	1
R73	RK3032	Chip R.	MCR03EZPJ331	1	1
R74	RK3526	Chip R.	ERJ2GEJ101X	1	1
R76	RK3532	Chip R.	ERJ2GEJ331X	1	1
R79	RK3538	Chip R.	ERJ2GEJ102X	1	1
R80	RK3538	Chip R.	ERJ2GEJ102X	1	1
R85	RK3546	Chip R.	ERJ2GEJ472X	1	1
R87	RK3554	Chip R.	ERJ2GEJ223X	1	1
R88	RK3550	Chip R.	ERJ2GEJ103X	1	1
R89	RK3568	Chip R.	ERJ2GEJ473X	1	1
R90	RK3558	Chip R.	ERJ2GEJ473X	1	1
R98	RK3501	Chip R.	ERJ2GE0R00X	1	1
RE1	UR0015	Dial	RH90N74E20-A90770	1	1
SW1	UU0042	Switch	SKQYAAE010	1	1
SW2	UU0042	Switch	SKQYAAE010	1	1
SW3	UU0042	Switch	SKQYAAE010	1	1
SW4	UU0042	Switch	SKQYAAE010	1	1
SW5	UU0042	Switch	SKQYAAE010	1	1
SW6	UU0042	Switch	SKQYAAE010	1	1
SW7	UU0042	Switch	SKQYAAE010	1	1
VR1	RV0035	Variable R.	EVUF2JFK4B14	1	1
X1	XQ0131	Xtal	CSA310 3.686400MHZ	1	1
	DG0037		LCD LIGHT DR135	1	1
	FF0017	Cloth	BLIND CLOTH DR570	1	1
	FG0305		LCD RUB.CONNECT. 135	1	1
	FM0034		MIC GND PLATE	1	1
	FP0034		MIC SPACER DR110	1	1
	FP0234		MIC SPACER A DR135	1	1
	ST0064		LCD HOLDER DR135	1	1
	ST0068		DIAL FITTING DR135	1	1
	TL0023		REFLECTION DR135	1	1
	TL0024		DIFFUSION SHEET 135	1	1
	YZ0042		CEMENT G17 / 1G	1	1

MAIN Unit

Ref No.	Part No.	Description	Parts Name	Qty.	
				DR-M03R	DR-03T
C101	CU3535	Chip C.	GRM155B11H102KA01D	1	1
C103	CU3535	Chip C.	GRM155B11H102KA01D	1	1
C104	CU3047	Chip C.	C1608JB1H103KT-NS	1	1
C105	CS0439	Chip tantalum	TMCSA0J476MTRF	1	1
C107	CU3554	Chip C.	GRM155B11A104KA01D	1	1
C108	CU3547	Chip C.	GRM155B11C103KA01D	1	1
C109	CE0339	Electrolytic C.	16ME10SWB+TS-ALC	1	1
C110	CU3547	Chip C.	GRM155B11C103KA01D	1	1
C111	CU3554	Chip C.	GRM155B11A104KA01D	1	1
C112	CU3554	Chip C.	GRM155B11A104KA01D	1	1
C113	CU3047	Chip C.	C1608JB1H103KT-NS	1	1
C114	CU3547	Chip C.	GRM155B11C103KA01D	1	1
C115	CU3003	Chip C.	C1608CH1H020CT-NS	1	1
C116	CU3019	Chip C.	C1608CH1H470JT-NS	1	1
C117	CU3547	Chip C.	GRM155B11C103KA01D	1	1
C120	CU3522	Chip C.	GRM1552C1H820JD01D	1	1
C122	CU3504	Chip C.	GRM1553C1H3R0CZ01D	1	1
C123	CU3513	Chip C.	GRM1552C1H150JZ01D	1	1
C129	CU3547	Chip C.	GRM155B11C103KA01D	1	1
C130	CU0108	Chip C.	LMK212B1J05KGG-T	1	1
C132	CU3535	Chip C.	GRM155B11H102KA01D	1	1
C135	CU3547	Chip C.	GRM155B11C103KA01D	1	1
C136	CU3011	Chip C.	C1608CH1H100DT-NS	1	1
C137	CU3517	Chip C.	GRM1552C1H330JZ01D	1	1
C139	CU3535	Chip C.	GRM155B11H102KA01D	1	1

Ref No.	Part No.	Description	Parts Name	Qty.
C140	CU3535	Chip C.	GRM155B11H102KA01D	1
C143	CU3554	Chip C.	GRM155B11A104KA01D	1
C144	CU3535	Chip C.	GRM155B11H102KA01D	1
C145	CU3523	Chip C.	GRM1552C1H101JD01D	1
C146	CE0364	Electrolytic C.	16ME47SWB+TS	1
C148	CU3535	Chip C.	GRM155B11H102KA01D	1
C149	CU3535	Chip C.	GRM155B11H102KA01D	1
C151	CU3535	Chip C.	GRM155B11H102KA01D	1
C152	CE0339	Electrolytic C.	16ME10SWB+TS-ALC	1
C154	CU3535	Chip C.	GRM155B11H102KA01D	1
C155	CU3505	Chip C.	GRM1552C1H4R0CZ01D	1
C157	CU3535	Chip C.	GRM155B11H102KA01D	1
C158	CU3535	Chip C.	GRM155B11H102KA01D	1
C159	CU3511	Chip C.	GRM1552C1H100JZ01D	1
C161	CU3535	Chip C.	GRM155B11H102KA01D	1
C163	CU3535	Chip C.	GRM155B11H102KA01D	1
C164	CU3535	Chip C.	GRM155B11H102KA01D	1
C165	CU3559	Chip C.	GRM155B30J105KE18D	1
C166	CE0420	Electrolytic C.	16ME22SZ	1
C169	CU3527	Chip C.	GRM1552C1E221JD01D	1
C170	CU3554	Chip C.	GRM155B11A104KA01D	1
C173	CU3537	Chip C.	GRM155B11H152KA01D	1
C174	CU3527	Chip C.	GRM1552C1E221JD01D	1
C175	CU3535	Chip C.	GRM155B11H102KA01D	1
C177	CU3035	Chip C.	C1608JB1H102KT-NS	1
C178	CU3047	Chip C.	C1608JB1H103KT-NS	1
C179	CU3554	Chip C.	GRM155B11A104KA01D	1
C180	CU3535	Chip C.	GRM155B11H102KA01D	1
C182	CU3535	Chip C.	GRM155B11H102KA01D	1
C183	CU3023	Chip C.	C1608CH1H101JT-NS	1
C184	CK0002	Ceramic C.	HE60SJYF103Z	1
C185	CS0232	Chip tantalum	TMCMA1A475MTRF	1
C186	CU3535	Chip C.	GRM155B11H102KA01D	1
C187	CU3535	Chip C.	GRM155B11H102KA01D	1
C188	CU3535	Chip C.	GRM155B11H102KA01D	1
C189	CU3523	Chip C.	GRM1552C1H101JD01D	1
C190	CU3547	Chip C.	GRM155B11C103KA01D	1
C191	CU3552	Chip C.	GRM155B11A333KA01D	1
C193	CK0002	Ceramic C.	HE60SJYF103Z	1
C196	CU3523	Chip C.	GRM1552C1H101JD01D	1
C199	CE0339	Electrolytic C.	16ME10SWB+TS-ALC	1
C200	CU3035	Chip C.	C1608JB1H102KT-NS	1
C201	CU4019	Chip C.	GRM31M2C2H470JV01L	1
C202	CU9037	Chip C.	C3216CH2J181JT	1
C203	CU9036	Chip C.	C3216CH2J151JT	1
C204	CU4020	Chip C.	GRM31M2C2H560JV01L	1
C205	CU3035	Chip C.	C1608JB1H102KT-NS	1
C206	CE0339	Electrolytic C.	16ME10SWB+TS-ALC	1
C207	CU3003	Chip C.	C1608CH1H020CT-NS	1
C208	CU3001	Chip C.	C1608CH1H0R5CT-NS	1
C209	CU3547	Chip C.	GRM155B11C103KA01D	1
C210	CU3006	Chip C.	C1608CH1H050CT-NS	1
C211	CU3006	Chip C.	C1608CH1H050CT-NS	1
C212	CE0364	Electrolytic C.	16ME47SWB+TS	1
C213	CU3035	Chip C.	C1608JB1H102KT-NS	1
C214	CU3535	Chip C.	GRM155B11H102KA01D	1
C215	CU4025	Chip C.	GRM31MR72H221KY21L	1
C216	CU9036	Chip C.	C3216CH2J151JT	1
C217	CU3551	Chip C.	GRM155B11C223KA01D	1
C218	CU3551	Chip C.	GRM155B11C223KA01D	1
C219	CU3035	Chip C.	C1608JB1H102KT-NS	1
C220	CU3035	Chip C.	C1608JB1H102KT-NS	1
C224	CU3023	Chip C.	C1608CH1H101JT-NS	1
C225	CU3035	Chip C.	C1608JB1H102KT-NS	1
C226	CU3035	Chip C.	C1608JB1H102KT-NS	1
C227	CU0108	Chip C.	LMK212BJ105KG-T	1
C228	CU3535	Chip C.	GRM155B11H102KA01D	1
C229	CU3553	Chip C.	GRM155B11A473KA01D	1
C230	CU3535	Chip C.	GRM155B11H102KA01D	1
C231	CU3535	Chip C.	GRM155B11H102KA01D	1
C232	CU3535	Chip C.	GRM155B11H102KA01D	1
C233	CU3535	Chip C.	GRM155B11H102KA01D	1
C235	CU3523	Chip C.	GRM1552C1H101JD01D	1
C236	CU3523	Chip C.	GRM1552C1H101JD01D	1
C237	CU3535	Chip C.	GRM155B11H102KA01D	1
C238	CU3554	Chip C.	GRM155B11A104KA01D	1
C239	CU3535	Chip C.	GRM155B11H102KA01D	1
C241	CU3522	Chip C.	GRM1552C1H820JD01D	1
C242	CU3551	Chip C.	GRM155B11C223KA01D	1
C243	CE0339	Electrolytic C.	16ME10SWB+TS-ALC	1
C244	CE0339	Electrolytic C.	16ME10SWB+TS-ALC	1
C245	CS0237	Chip tantalum	TMCMA1A475MTRF	1
C246	CU3543	Chip C.	GRM155B11H392KA01D	1
C248	CU3547	Chip C.	GRM155B11C103KA01D	1
C249	CU3538	Chip C.	GRM155B11H182KA01D	1
C250	CU3526	Chip C.	GRM1552C1E181JD01D	1
C253	CU3551	Chip C.	GRM155B11C223KA01D	1
C254	CU3059	Chip C.	C1608JF1H104ZT-NS	1
C255	CE0364	Electrolytic C.	16ME47SWB+TS	1
C256	CU3059	Chip C.	C1608JF1H104ZT-NS	1
C257	CE0339	Electrolytic C.	16ME10SWB+TS-ALC	1

Ref No.	Part No.	Description	Parts Name	Qty.
C258	CU0108	Chip C.	LMK212BJ105KG-T	1
C260	CE0339	Electrolytic C.	16ME10SWB+TS-ALC	1
C261	CU3535	Chip C.	GRM155B11H102KA01D	1
C262	CU3535	Chip C.	GRM155B11H102KA01D	1
C263	CS0424	Chip tantalum	TMCMA1C106MTRF	1
C264	CU3531	Chip C.	GRM155B11H471KA01D	1
C268	CU3535	Chip C.	GRM155B11H102KA01D	1
C269	CU3535	Chip C.	GRM155B11H102KA01D	1
C270	CU3047	Chip C.	C1608JB1H103KT-NS	1
C272	CS0237	Chip tantalum	TMCMA1A475MTRF	1
C273	CS0237	Chip tantalum	TMCMA1A475MTRF	1
C274	CU3535	Chip C.	GRM155B11H102KA01D	1
C275	CU3547	Chip C.	GRM155B11C103KA01D	1
C276	CS0220	Chip tantalum	TMCMA1C225MTRF	1
C277	CE0343	Electrolytic C.	16ME1000HC+T	1
C278	CU3535	Chip C.	GRM155B11H102KA01D	1
C279	CU3547	Chip C.	GRM155B11C103KA01D	1
C281	CU3543	Chip C.	GRM155B11H392KA01D	1
C282	CU3511	Chip C.	GRM1552C1H100JZ01D	1
C283	CU3547	Chip C.	GRM155B11C103KA01D	1
C284	CU3543	Chip C.	GRM155B11H392KA01D	1
C285	CU3535	Chip C.	GRM155B11H102KA01D	1
C286	CU3027	Chip C.	C1608CH1H221JT-NS	1
C287	CS0235	Chip tantalum	TMCMA1V334MTRF	1
C289	CU3535	Chip C.	GRM155B11H102KA01D	1
C290	CU3535	Chip C.	GRM155B11H102KA01D	1
C293	CU3535	Chip C.	GRM155B11H102KA01D	1
C294	CU3035	Chip C.	C1608JB1H102KT-NS	1
C297	CU3535	Chip C.	GRM155B11H102KA01D	1
C300	CU3527	Chip C.	GRM1552C1E221JD01D	1
C301	CU3523	Chip C.	GRM1552C1H101JD01D	1
C302	CU3523	Chip C.	GRM1552C1H101JD01D	1
C303	CU3523	Chip C.	GRM1552C1H101JD01D	1
C305	CU3547	Chip C.	GRM155B11C103KA01D	1
C306	CU3554	Chip C.	GRM155B11A104KA01D	1
C307	CU3547	Chip C.	GRM155B11C103KA01D	1
C308	CE0353	Electrolytic C.	16ME470HC	1
C309	CU3551	Chip C.	GRM155B11C223KA01D	1
C310	CU3523	Chip C.	GRM1552C1H101JD01D	1
C312	CU3031	Chip C.	C1608JB1H471KT-NS	1
C321	CS0220	Chip tantalum	TMCMA1C225MTRF	1
C323	CU3035	Chip C.	C1608JB1H102KT-NS	1
C324	CU3535	Chip C.	GRM155B11H102KA01D	1
C325	CU3547	Chip C.	GRM155B11C103KA01D	1
C326	CU3535	Chip C.	GRM155B11H102KA01D	1
C327	CS0235	Chip tantalum	TMCMA1V334MTRF	1
C328	CU0108	Chip C.	LMK212BJ105KG-T	1
C331	CU3535	Chip C.	GRM155B11H102KA01D	1
C333	CU3535	Chip C.	GRM155B11H102KA01D	1
C401	CU3549	Chip C.	GRM155B11C153KA01D	1
C402	CU3550	Chip C.	GRM155B11C183KA01D	1
C403	CU3552	Chip C.	GRM155B11A333KA01D	1
C404	CU3559	Chip C.	GRM155B30J105KE18D	1
C405	CU3541	Chip C.	GRM155B11H332KA01D	1
C406	CU3545	Chip C.	GRM155B11E682KA01D	1
C407	CU3540	Chip C.	GRM155B11H272KA01D	1
C408	CU3544	Chip C.	GRM155B11E562KA01D	1
C409	CU3536	Chip C.	GRM155B11H122KA01D	1
C410	CU3539	Chip C.	GRM155B11H222KA01D	1
C412	CU0108	Chip C.	LMK212BJ105KG-T	1
C413	CU3541	Chip C.	GRM155B11H332KA01D	1
C414	CU3542	Chip C.	GRM155B11H392KA01D	1
C415	CU3545	Chip C.	GRM155B11E682KA01D	1
C417	CU3548	Chip C.	GRM155B11C123KA01D	1
C418	CU3547	Chip C.	GRM155B11C103KA01D	1
C419	CU3548	Chip C.	GRM155B11C123KA01D	1
C420	CE0339	Electrolytic C.	16ME10SWB+TS-ALC	1
C421	CU3035	Chip C.	C1608JB1H102KT-NS	1
C422	CS0220	Chip tantalum	TMCMA1C225MTRF	1
C423	CU3059	Chip C.	C1608JF1H104ZT-NS	1
C427	CU3559	Chip C.	GRM155B30J105KE18D	1
C428	CU0110	Chip C.	C2012JB1A475KT-NS	1
C503	CU3523	Chip C.	GRM1552C1H101JD01D	1
C521	CU3513	Chip C.	GRM1552C1H150JZ01D	1
C522	CU3013	Chip C.	C1608CH1H150JT-NS	1
C523	CU3513	Chip C.	GRM1552C1H150JZ01D	1
C601	CU3515	Chip C.	GRM1552C1H220JZ01D	1
C603	CU3504	Chip C.	GRM1553C1H3R0CZ01D	1
C607	CU3514	Chip C.	GRM1552C1H180JZ01D	1
C613	CU3515	Chip C.	GRM1552C1H220JZ01D	1
CN101	UE0369	Connector	AXN49301616	1
CN102	UE0293	Connector	17PS-JE	1
CN103	UE0293	Connector	17PS-JE	1
CN104	UA0037AY	Wire	R-B2.X0.2M PLUG 15A	1
CN106	UE0043	Connector	PI22A02M	1
D102	XD0427	Chip Diode	JDV2S14E(TPH3,F)	1
D103	XD0427	Chip Diode	JDV2S14E(TPH3,F)	1
D104	XD0427	Chip Diode	JDV2S14E(TPH3,F)	1
D105	XD0427	Chip Diode	JDV2S14E(TPH3,F)	1
D106	XD0402	Chip Diode	VDZT2R 5.1B	1
D107	XD0130	Chip Diode	DA204U T106	1

Ref No.	Part No.	Description	Parts Name	Qty.
D108	XD0130	Chip Diode	DA204U T106	1
D109	XD0301	Chip Diode	1SV268-TD	1
D110	XD0013	Diode	XB15A407A2G8N MI407	1
D111	XD0461	Chip Diode	1SS383(TE85L,F)	1
D112	XD0461	Chip Diode	1SS383(TE85L,F)	1
D114	XD0320	Chip Diode	DAN235E-TL	1
D118	XD0130	Chip Diode	DA204U T106	1
D119	XD0426	Chip Diode	1SS387	1
D121	XD0414	Diode	S3V60-5000	1
D123	XD0380	Chip Diode	SVC347S-TL	1
D126	XD0402	Chip Diode	VDZT2R 5.1B	1
D130	XD0426	Chip Diode	1SS387	1
D402	XD0426	Chip Diode	1SS387	1
D601	XD0427	Chip Diode	JDV2S14E(TPH3,F)	1
FL101	XC0052	Ceramic Filter	ALFYM450G-K	1
IC101	XA0947	IC	NJM78M05DL1ATE1#ZZZ	1
IC104	XA1106	IC	LM2902PWR	1
IC108	XA0404	IC	TA31136FNG(EL)	1
IC109	XA0115	IC	TC4S66F(TE85R,F)	1
IC111	XA0115	IC	TC4S66F(TE85R,F)	1
IC112	XA1249	IC	TA78DS10F(TE12L,F)	1
IC113	XA0115	IC	TC4S66F(TE85R,F)	1
IC114	XA1106	IC	LM2902PWR	1
IC115	XA0102	IC	NJM7808FA-#ZZZB	1
IC116	XA1010	IC	MB15A01PFV1GBNDEFE	1
IC117	XA0410	IC	LA4425A-E	1
IC120	XA1103	IC	LM2904PWR	1
JK102	UJ0024Z	Jack	LGY6501-0900FC	1
L101	QC0048	Coil Lnductor	NLV32T-100J-PFS	1
L102	QA0169	Coil	50MHZ COIL	1
L103	QA0169	Coil	50MHZ COIL	1
L104	QA0169	Coil	50MHZ COIL	1
L105	QA0169	Coil	50MHZ COIL	1
L111	QKA95G	Coil	MR5.0 9.5T 0.6	1
L113	QKA85G	Coil	MR5.0 8.5T 0.6	1
L114	QKA95G	Coil	MR5.0 9.5T 0.6	1
L115	QKA75G	Coil	MR5.0 7.5T 0.6	1
L116	QC0043	Coil Lnductor	NLV32T-2R2J-PFS	1
L118	QC0365	Coil Lnductor	SP0406-180K-6	1
L119	QC0819	Coil Lnductor	C2012C-R39J	1
L120	QC0819	Coil Lnductor	C2012C-R39J	1
L121	QC0296	Coil Lnductor	NLV25T-4R7J-PFS	1
L123	QA0167	Coil	VCO COIL	1
L125	QC0043	Coil Lnductor	NLV32T-2R2J-PFS	1
L129	QC0082	Coil Lnductor	NLV32T-470J-PFS	1
Q103	XE0044	Chip FET	2SK3074 TE12L	1
Q104	XT0095	Chip	2SC4081 T106R	1
Q105	XT0178	Chip	2SC4915-O(TE85L,F)	1
Q106	XE0053	Chip FET	3SK293TE85L	1
Q107	XE0053	Chip FET	3SK293TE85L	1
Q108	XU0210	Chip	RN1107MFV(TPL3)	1
Q109	XT0224	Chip	2SC4738F-GR(T5L,F)	1
Q110	XT0224	Chip	2SC4738F-GR(T5L,F)	1
Q111	XT0094	Chip	2SA1576A T106R	1
Q112	XT0095	Chip	2SC4081 T106R	1
Q115	XT0030	Chip	2SC3356-T1B(R,S)	1
Q116	XT0190	Chip	2SB1386 T100Q	1
Q117	XT0095	Chip	2SC4081 T106R	1
Q121	XU0226	Chip	RN1711(TE85L,F)	1
Q122	XT0190	Chip	2SB1386 T100Q	1
Q123	XT0223	Chip	2SA2070(TE12L,F)	1
Q124	XU0209	Chip	EMD6T2R	1
Q125	XE0021	Chip FET	2SK880GRTE85L	1
Q126	XU0210	Chip	RN1107MFV(TPL3)	1
Q127	XT0095	Chip	2SC4081 T106R	1
Q128	XU0210	Chip	RN1107MFV(TPL3)	1
Q129	XU0195	Chip	RN1104(TE85L,F)	1
Q131	XE0066	Chip FET	2SK2539-TB-E	1
Q132	XU0210	Chip	RN1107MFV(TPL3)	1
Q133	XU0210	Chip	RN1107MFV(TPL3)	1
Q134	XT0178	Chip	2SC4915-O(TE85L,F)	1
Q135	XT0178	Chip	2SC4915-O(TE85L,F)	1
Q144	XT0095	Chip	2SC4081 T106R	1
Q145	XT0178	Chip	2SC4915-O(TE85L,F)	1
Q401	XU0210	Chip	RN1107MFV(TPL3)	1
Q402	XU0211	Chip	RN2107MFV(TPL3)	1
R101	RK3552	Chip R.	ERJ2GEJ153X	1
R102	RK3552	Chip R.	ERJ2GEJ153X	1
R103	RK3552	Chip R.	ERJ2GEJ153X	1
R105	RK3530	Chip R.	ERJ2GEJ221X	1
R106	RK3556	Chip R.	ERJ2GEJ333X	1
R107	RK3538	Chip R.	ERJ2GEJ102X	1
R108	RK3550	Chip R.	ERJ2GEJ103X	1
R109	RK3526	Chip R.	ERJ2GEJ101X	1
R110	RK3526	Chip R.	ERJ2GEJ101X	1
R112	RK3526	Chip R.	ERJ2GEJ101X	1
R113	RK3530	Chip R.	ERJ2GEJ221X	1
R114	RK3540	Chip R.	ERJ2GEJ152X	1
R116	RK3534	Chip R.	ERJ2GEJ471X	1
R117	RK3562	Chip R.	ERJ2GEJ104X	1
R118	RK3526	Chip R.	ERJ2GEJ101X	1

Ref No.	Part No.	Description	Parts Name	Qty.
R119	RK2012	Chip R.	ERJ12YJ470U	1
R125	RK3538	Chip R.	ERJ2GEJ102X	1
R128	RK3562	Chip R.	ERJ2GEJ104X	1
R129	RK3550	Chip R.	ERJ2GEJ103X	1
R130	RK3562	Chip R.	ERJ2GEJ104X	1
R131	RK3562	Chip R.	ERJ2GEJ104X	1
R132	RK3547	Chip R.	ERJ2GEJ562X	1
R133	RK3501	Chip R.	ERJ2GEOR00X	1
R134	RK3553	Chip R.	ERJ2GEJ183X	1
R136	RK3534	Chip R.	ERJ2GEJ471X	1
R143	RK3524	Chip R.	ERJ2GEJ680X	1
R144	RK3542	Chip R.	ERJ2GEJ222X	1
R147	RK3550	Chip R.	ERJ2GEJ103X	1
R148	RK3538	Chip R.	ERJ2GEJ102X	1
R149	RK3562	Chip R.	ERJ2GEJ104X	1
R151	RK3550	Chip R.	ERJ2GEJ103X	1
R152	RK3558	Chip R.	ERJ2GEJ473X	1
R153	RK3562	Chip R.	ERJ2GEJ104X	1
R155	RK3551	Chip R.	ERJ2GEJ123X	1
R156	RK3560	Chip R.	ERJ2GEJ683X	1
R157	RK3562	Chip R.	ERJ2GEJ104X	1
R158	RK3526	Chip R.	ERJ2GEJ101X	1
R160	RK3552	Chip R.	ERJ2GEJ153X	1
R161	RK3552	Chip R.	ERJ2GEJ153X	1
R162	RK3522	Chip R.	ERJ2GEJ470X	1
R163	RK3526	Chip R.	ERJ2GEJ101X	1
R164	RK3025	Chip R.	MCR03EZPJ820	1
R165	RK3574	Chip R.	ERJ2GEJ105X	1
R166	RK3562	Chip R.	ERJ2GEJ104X	1
R167	RK3564	Chip R.	ERJ2GEJ154X	1
R168	RK3554	Chip R.	ERJ2GEJ223X	1
R170	RK3546	Chip R.	ERJ2GEJ472X	1
R171	RK3552	Chip R.	ERJ2GEJ153X	1
R172	RK3552	Chip R.	ERJ2GEJ153X	1
R173	RK3526	Chip R.	ERJ2GEJ101X	1
R178	RK3544	Chip R.	ERJ2GEJ332X	1
R179	RK3534	Chip R.	ERJ2GEJ471X	1
R180	RK3534	Chip R.	ERJ2GEJ471X	1
R181	RK3534	Chip R.	ERJ2GEJ471X	1
R183	RK3568	Chip R.	ERJ2GEJ334X	1
R184	RK3526	Chip R.	ERJ2GEJ101X	1
R185	RK3570	Chip R.	ERJ2GEJ474X	1
R186	RK3562	Chip R.	ERJ2GEJ104X	1
R187	RK3558	Chip R.	ERJ2GEJ473X	1
R188	RK3552	Chip R.	ERJ2GEJ153X	1
R189	RK3538	Chip R.	ERJ2GEJ102X	1
R190	RK3538	Chip R.	ERJ2GEJ102X	1
R191	RK3538	Chip R.	ERJ2GEJ102X	1
R193	RK3538	Chip R.	ERJ2GEJ102X	1
R195	RK3570	Chip R.	ERJ2GEJ474X	1
R196	RK3538	Chip R.	ERJ2GEJ102X	1
R200	RK3570	Chip R.	ERJ2GEJ474X	1
R202	RK3522	Chip R.	ERJ2GEJ470X	1
R203	RK3556	Chip R.	ERJ2GEJ333X	1
R204	RK3526	Chip R.	ERJ2GEJ101X	1
R205	RK0069	Chip R.	ERJ6GEYJ104V	1
R206	RK3523	Chip R.	ERJ2GEJ560X	1
R207	RK3552	Chip R.	ERJ2GEJ153X	1
R208	RK3545	Chip R.	ERJ2GEJ392X	1
R209	RK3561	Chip R.	ERJ2GEJ823X	1
R210	RK3538	Chip R.	ERJ2GEJ102X	1
R211	RK2012	Chip R.	ERJ12YJ470U	1
R212	RK4026	Chip R.	ERJ12YJ101U	1
R213	RK3549	Chip R.	ERJ2GEJ822X	1
R214	RK3550	Chip R.	ERJ2GEJ103X	1
R215	RK3554	Chip R.	ERJ2GEJ223X	1
R216	RK3050	Chip R.	MCR03EZPJ103	1
R217	RK3050	Chip R.	MCR03EZPJ103	1
R219	RK3538	Chip R.	ERJ2GEJ102X	1
R220	RK4034	Chip R.	ERJ12YJ471U	1
R222	RK3550	Chip R.	ERJ2GEJ103X	1
R223	RK3526	Chip R.	ERJ2GEJ101X	1
R224	RK3526	Chip R.	ERJ2GEJ101X	1
R225	RK3545	Chip R.	ERJ2GEJ392X	1
R226	RK3038	Chip R.	MCR03EZPJ102	1
R227	RK3501	Chip R.	ERJ2GEOR00X	1
R228	RK3538	Chip R.	ERJ2GEJ102X	1
R229	RK3547	Chip R.	ERJ2GEJ562X	1
R230	RK3546	Chip R.	ERJ2GEJ472X	1
R231	RK3550	Chip R.	ERJ2GEJ103X	1
R232	RK3526	Chip R.	ERJ2GEJ101X	1
R233	RK3538	Chip R.	ERJ2GEJ102X	1
R234	RK3556	Chip R.	ERJ2GEJ333X	1
R235	RK3558	Chip R.	ERJ2GEJ473X	1
R236	RK3551	Chip R.	ERJ2GEJ123X	1
R237	RK3526	Chip R.	ERJ2GEJ101X	1
R238	RK3562	Chip R.	ERJ2GEJ104X	1
R239	RK3550	Chip R.	ERJ2GEJ103X	1
R241	RK3550	Chip R.	ERJ2GEJ103X	1
R242	RK3522	Chip R.	ERJ2GEJ470X	1
R243	RK3538	Chip R.	ERJ2GEJ102X	1

Ref No.	Part No.	Description	Parts Name	Qty.
R244	RK3568	Chip R.	ERJ2GEJ334X	1
R245	RK3538	Chip R.	ERJ2GEJ102X	1
R247	RK3538	Chip R.	ERJ2GEJ102X	1
R249	RK3570	Chip R.	ERJ2GEJ474X	1
R251	RK3550	Chip R.	ERJ2GEJ103X	1
R253	RK3557	Chip R.	ERJ2GEJ393X	1
R254	RK3557	Chip R.	ERJ2GEJ393X	1
R255	RK3546	Chip R.	ERJ2GEJ472X	1
R256	RK3526	Chip R.	ERJ2GEJ101X	1
R258	RK3557	Chip R.	ERJ2GEJ393X	1
R259	RK3550	Chip R.	ERJ2GEJ103X	1
R261	RK3554	Chip R.	ERJ2GEJ223X	1
R262	RK3569	Chip R.	ERJ2GEJ394X	1
R264	RK3538	Chip R.	ERJ2GEJ102X	1
R266	RK3550	Chip R.	ERJ2GEJ103X	1
R267	RK3522	Chip R.	ERJ2GEJ470X	1
R269	RK3562	Chip R.	ERJ2GEJ104X	1
R270	RK3547	Chip R.	ERJ2GEJ562X	1
R271	RK4034	Chip R.	ERJ12YJ471U	1
R272	RK3542	Chip R.	ERJ2GEJ222X	1
R274	RK3550	Chip R.	ERJ2GEJ103X	1
R275	RK3552	Chip R.	ERJ2GEJ153X	1
R276	RK3526	Chip R.	ERJ2GEJ101X	1
R278	RK3531	Chip R.	ERJ2GEJ271X	1
R279	RK3046	Chip R.	MCR03EZPJ472	1
R281	RK3041	Chip R.	MCR03EZPJ182	1
R282	RK3550	Chip R.	ERJ2GEJ103X	1
R283	RK3038	Chip R.	MCR03EZPJ102	1
R284	RK3526	Chip R.	ERJ2GEJ101X	1
R286	RK3534	Chip R.	ERJ2GEJ471X	1
R287	RK3546	Chip R.	ERJ2GEJ472X	1
R288	RK3550	Chip R.	ERJ2GEJ103X	1
R289	RK3539	Chip R.	ERJ2GEJ122X	1
R290	RK3554	Chip R.	ERJ2GEJ223X	1
R292	RK3526	Chip R.	ERJ2GEJ101X	1
R293	RK3526	Chip R.	ERJ2GEJ101X	1
R294	RK3539	Chip R.	ERJ2GEJ122X	1
R296	RK3568	Chip R.	ERJ2GEJ334X	1
R299	RK3549	Chip R.	ERJ2GEJ822X	1
R300	RK3534	Chip R.	ERJ2GEJ471X	1
R301	RK3546	Chip R.	ERJ2GEJ472X	1
R302	RK3524	Chip R.	ERJ2GEJ680X	1
R304	RK3562	Chip R.	ERJ2GEJ104X	1
R307	RK3550	Chip R.	ERJ2GEJ103X	1
R309	RK3550	Chip R.	ERJ2GEJ103X	1
R310	RK3526	Chip R.	ERJ2GEJ101X	1
R311	RK3550	Chip R.	ERJ2GEJ103X	1
R312	RK3550	Chip R.	ERJ2GEJ103X	1
R313	RK3550	Chip R.	ERJ2GEJ103X	1
R315	RK3544	Chip R.	ERJ2GEJ332X	1
R320	RK3542	Chip R.	ERJ2GEJ222X	1
R322	RD0108	Jumper	J1/6ZC	1
R325	RK3566	Chip R.	ERJ2GEJ224X	1
R337	RK3570	Chip R.	ERJ2GEJ474X	1
R339	RK3550	Chip R.	ERJ2GEJ103X	1
R340	RK3550	Chip R.	ERJ2GEJ103X	1
R346	RK3534	Chip R.	ERJ2GEJ471X	1
R347	RK3550	Chip R.	ERJ2GEJ103X	1
R348	RK3547	Chip R.	ERJ2GEJ562X	1
R401	RK3553	Chip R.	ERJ2GEJ183X	1
R402	RK3551	Chip R.	ERJ2GEJ123X	1
R403	RK3542	Chip R.	ERJ2GEJ222X	1
R404	RK3562	Chip R.	ERJ2GEJ104X	1
R405	RK3563	Chip R.	ERJ2GEJ124X	1
R406	RK3559	Chip R.	ERJ2GEJ563X	1
R407	RK3562	Chip R.	ERJ2GEJ104X	1
R408	RK3558	Chip R.	ERJ2GEJ473X	1
R409	RK3560	Chip R.	ERJ2GEJ683X	1
R410	RK3557	Chip R.	ERJ2GEJ393X	1
R411	RK3562	Chip R.	ERJ2GEJ104X	1
R412	RK3562	Chip R.	ERJ2GEJ104X	1
R413	RK3550	Chip R.	ERJ2GEJ103X	1
R414	RK3566	Chip R.	ERJ2GEJ224X	1
R415	RK3558	Chip R.	ERJ2GEJ473X	1
R416	RK3550	Chip R.	ERJ2GEJ103X	1
R417	RK3568	Chip R.	ERJ2GEJ334X	1
R418	RK3560	Chip R.	ERJ2GEJ683X	1
R419	RK3550	Chip R.	ERJ2GEJ103X	1
R420	RK3574	Chip R.	ERJ2GEJ105X	1
R421	RK3566	Chip R.	ERJ2GEJ224X	1
R422	RK3562	Chip R.	ERJ2GEJ104X	1
R423	RK3550	Chip R.	ERJ2GEJ103X	1
R429	RK3501	Chip R.	ERJ2GE0R00X	1
R431	RK3558	Chip R.	ERJ2GEJ473X	1
R506	RK3562	Chip R.	ERJ2GEJ104X	1
R507	RK3538	Chip R.	ERJ2GEJ102X	1
R508	RK3546	Chip R.	ERJ2GEJ472X	1
R521	RK2012	Chip R.	ERJ12YJ470U	1
R522	RK4026	Chip R.	ERJ12YJ101U	1
R523	RK3001	Chip R.	MCR03EZPJ000	1
R524	RK3518	Chip R.	ERJ2GEJ220X	1

Ref No.	Part No.	Description	Parts Name	Qty.
R601	RK3538	Chip R.	ERJ2GEJ102X	1
R609	RK3550	Chip R.	ERJ2GEJ103X	1
R611	RK3550	Chip R.	ERJ2GEJ103X	1
R613	RK3574	Chip R.	ERJ2GEJ105X	1
R615	RK3574	Chip R.	ERJ2GEJ105X	1
R621	RK3548	Chip R.	ERJ2GEJ682X	1
R629	RK3538	Chip R.	ERJ2GEJ102X	1
R637	RK3556	Chip R.	ERJ2GEJ333X	1
SH101	TS0172	Case	VCO CASE DR620	1
TC601	CT0050	Trimmer C.	TZY22100A001R00	1
VR101	RH0233	Trimmer R.	RH02B1C15X(100K OHM)	1
VR102	RH0231	Trimmer R.	RH02B1C54X(47K OHM)	1
VR103	RH0233	Trimmer R.	RH02B1C15X(100K OHM)	1
VR104	RH0231	Trimmer R.	RH02B1C54X(47K OHM)	1
VR106	RH0231	Trimmer R.	RH02B1C54X(47K OHM)	1
VR107	RH0225	Trimmer R.	RH02B1C53X(4.7K OHM)	1
VR108	RH0233	Trimmer R.	RH02B1C15X(100K OHM)	1
VR109	RH0231	Trimmer R.	RH02B1C54X(47K OHM)	1
X101	XK0003	Discriminator	CDBL8450KCA07-B0	1
X601	XQ0188	Xtal	DSX321G 11.150MHZ	1
XF101	XF0004Z	Xtal Filter	HC49U 10.7MHZ	1
	FG0320	SP Cushion	SP CUSHION DR135	1
	TZ0056	Dumper	SILICON DUMPER 49U	2
	UP0584	P.C.BOARD	DRM03R INTEGRATED	1

PA Unit

Ref No.	Part No.	Description	Parts Name	Qty.
C702	CU4023	Chip C.	GRM31M2C2H101JV01L	1
C703	CU9037	Chip C.	C3216CH2J181JT	1
C704	CU3047	Chip C.	C1608JB1H103KT-NS	1
C705	CU3047	Chip C.	C1608JB1H103KT-NS	1
C706	CU3059	Chip C.	C1608JF1H104ZT-NS	1
C707	CU3047	Chip C.	C1608JB1H103KT-NS	1
C708	CU3035	Chip C.	C1608JB1H102KT-NS	1
L701	QC0128	Coil Lnductor	NLV32T-R33J-PFS	1
L702	QK0112A	Coil	COIL QK0112A	1
Q701	XE0056	Chip FET	RD16HHF1-01	1
TP701	YZ0144	Wire	1.0 X 1mm	7
TP702	YZ0144	Wire	1.0 X 1mm	7
TP703	YZ0144	Wire	1.0 X 1mm	7
TP704	YZ0144	Wire	1.0 X 1mm	7
TP705	YZ0144	Wire	1.0 X 1mm	7
	YZ0042		CEMENT G17 / 1G	1

Mechanical Parts

Ref No.	Part No.	Description	Parts Name	Qty.	
				DR-M03R	DR-03T
	ES0035	Speaker	57-8BC-35 ROHS	1	1
	UX1047	Wire	WIRE DR130	1	1
	AA0050	Screw	OH M2.6+6 FE/B.ZN	6	6
	AN0032	Nut	MIC NUT	1	1
	AU0001	Screw	PH/S B26+8 FEN	15	15
	AW0001	Screw	PH/D6 3+8 FEN	2	2
	DP0188	LCD Panel	LCD PANEL DRM03R	1	0
	DP0192	LCD Panel	LCD PANEL DR03T	0	1
	FF0015	Cloth	BLIND CLOTH DR110	3	3
	FG0273	Rubber	ON AIR KEY RUBBER	1	1
	FP0151	Panel	REAR PANEL DR135	1	1
	FP0188	Panel	JACK PANEL DR135	1	1
	KS0096	Bottom Case	BOTTOM CASE DR135	1	1
	KZ0105	Front Case	FRONT ASSY. DR135	1	1
	NK0072	Knob	VOL KNOB DR135	1	1
	NK0073	Knob	DIAL KNOB DR135	1	1
	SP0008	GND Terminal	GND TERM XM601	1	1
	SS0093	Chassis	CHASSIS DR135	1	1
	ST0065	SP Holder	SP HOLDER DR135	1	1
	ST0066	SP Fitting	SP FITTING DR135	1	1
	TG0034	SP Himeron	SP HIMERON DR135	1	1
	UE0258Z	ANT	FM-M.D.R-4(Z)	1	1
	YZ0131	Tape	#9110 12X1mm	30	30

Packing Parts

Ref No.	Part No.	Description	Parts Name	Qty.	
				DR-M03R	DR-03T
	DS0446	Label	NITTO MODEL PLATE(S)	1	1
	HK0668	Package	PACKAGE DRM03R	1	0
	HK0674	Package	PACKAGE DR03T	0	1
	HM0218Z	Carton Box	MASTER CARTON DR135	1	1
	HU0099Z	P.MTL/Carton	FRONT INNER DR605	1	1
	HU0159Z	P.MTL/Carton	INNER DR135T	1	1
	HU0161Z	P.MTL/Carton	INNER 5 PCS	2	2
	PR0288	Label	SCREW STKR DX70	2	2
	PR0478	Label	SERIAL SEAL	1	1
	PR0513	Label	NITTO 13X13 LABEL(W)	5	5
	PR0514	Label	EPSON 10X49 LABEL(W)	2	2

ACCESSORIES

Ref No.	Part No.	Description	Parts Name	Qty.	
				DR-M03R	DR-03T
	ADFM78	Bracket	BRACKET DR130	1	1
	ADUA38	Power Cable	R-B2.0X3M RECEPT.15A	1	1
	AJ0025	Screw	PH T3.5+10 FE/N 1	2	2
	EBC-7	Mic Hanger	MIC HANGER	1	1
	EHM53B	Microphone	MICROPHON EMS53B	1	0
	EHM57D	Microphone	MICROPHON EMS57D	0	1
	HP0009	Plastic Bag	PLA.BAG 5X125X250	1	1
	HP0016	Plastic Bag	5X75X90	1	1
	HP0035	Plastic Bag	E.BAG 5X200X250	1	1
	PF0137		ADD SHEET DR03T	0	1
	PH0015		WARRANTY CEAT EXPO	0	1
	PK0125	Diagram	SCHEMATIC DR03T	0	1
	PS0530A	Manual	INSTRUCTION DR135LH	1	1
	YZ0138	Tape	TAPE EBC7	1	1

ACCESSORIES (SCREW SET)

Ref No.	Part No.	Description	Parts Name	Qty.	
				DR-M03R	DR-03T
	AA0013	Screw	BH M5+20 FE/ZN	4	4
	AE0012	Nut	HEX/H/D M4+8 FE/3BBC	4	4
	AJ0003	Screw	BH T5+20 FE/ZN 1	4	4
	AN0002	Nut	HEX N5X0.8 FE/ZN	4	4
	AZ0009	Washer	SW 5X9.2X1.3 FE/ZN	4	4
	AZ0010	Washer	SW 5X12X0.8 FE/ZN	4	4
	EF0005	Fuse	FGBO 15A	2	2
	FM0079Z	Spanner	SPANNER DR130	1	1
	HP0006	Plastic Bag	5X90X170	1	1
	YZ0121	Tape	TAPE 10MM	2	2

ADJUSTMENT

1) Adjustment Spot

Power Supply Voltage 13.8V

Output of SSG is all EMF indication.

If without instruction, SSG output is MOD 1KHz DEV 3.5KHz/DEV. (DR-M03R)

If without instruction, SSG output is MOD 1KHz DEV 1.75KHz/DEV. (DR-03T)

Standard modulation is also based above.

Speaker load is 8 ohm and output is 50 ~ 100 mV.

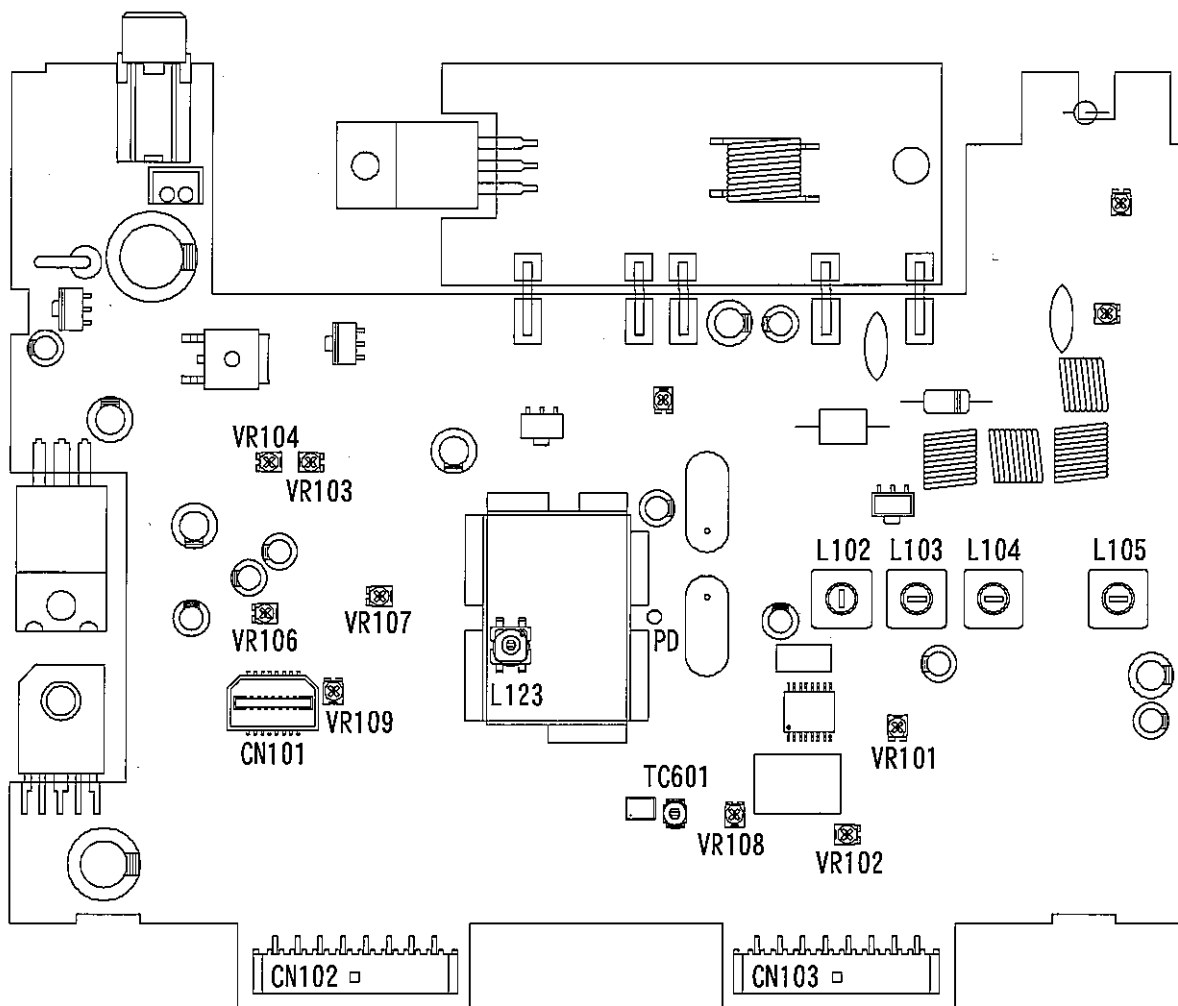

2) VCO and RX Adjustment Specification

ITEM	CONDITION	UNIT	ADJ. SPOT	ADJUSTING MTRHOD
Adjustment Frequency	29.00MHz TX	MAIN	TC601	Adjust so that Tx Frequency becomes within 29.00MHz +/- 100Hz
VCO Adjustment	29.00MHz RX	MAIN	L123	Adjust so that PD voltage becomes 6.0 +/- 0.1V
Rx Signal Sensitivity Adjustment	29.05MHz 26.05MHz 29.05MHz 39.05MHz	MAIN	L105, L104 L103, L102	Repeatedly adjust so that the Rx sensitivity becomes in maximum/. Confirm: At -8dBu SINAD more than 12dB At -9dBu SINAD more than 12dB At 10dBu SINAD more than 12dB
Squelch Adjustment	29.05MHz SSG OFF Indicate 01	MAIN	VR101	Adjust so that the squelch stops at perfectly close location
S Meter Adjustment	29.05MHz SSG 20dBu	MAIN	VR102	Adjust so that all the indicator appears

3) TX Adjustment Specification

ITEM	CONDITION	UNIT	ADJ. SPOT	ADJUSTING MTRHOD
HI POWER Adjustment	29.00MHz HI POWER	MAIN	VR103	Adjust to 11.0 +/- 0.5W
MID POWER Adjustment	29.00MHz MID POWER	MAIN	VR104	Adjust to 5.0 +/- 0.5W
LOW POWER Confirmation	29.00MHz LOW POWER	MAIN		Confirm if it becomes 1- 4W
Maximum Deviation Adjustment	29.00MHz MOD 1KHz 40mVemf	MAIN	VR107	4.5 +/- 0.1KHz/DEV (DR-M03R) 2.2 +/- 0.1KHz/DEV (DR-03T)
Mic Gain Adjustment	29.00MHz MOD 1KHz 4mVemf	MAIN	VR106	3.0 +/- 0.1KHz/DEV (DR-M03R) 1.5 +/- 0.1KHz/DEV (DR-03T)
CTCSS Modulation Level Confirmation	29.00MHz 88.5Hz	MAIN		800 +/- 200Hz/DEV (DR-M03R) 400 +/- 200Hz/DEV (DR-03T) 3KHz LPF ON
DCS Modulation Level Adjustment	29.00MHz 255 Code	MAIN	VR108	800 +/- 50Hz/DEV (DR-M03R) 600 +/- 100Hz/DEV (DR-03T) 3KHz LPF ON
1750Hz Modulation Level Adjustment	29.00MHz 1750Hz	MAIN	VR109	3.0 +/- 0.1KHz/DEV (DR-M03R) 1.5 +/- 0.1KHz/DEV (DR-03T)
DTMF Modulation Level Confirmation	29.00MHz DTMF 1 Press the V/M key during TX	MAIN		3.0 +/- 0.5KHz/DEV (DR-M03R) 1.5 +/- 0.5KHz/DEV (DR-03T)

4) RX Test Specification

TEST ITEM	CONDITION	ADJ. STANDARD	TEST STANDARD	NOTE
RX Signal Sensitivity	26.05MHz 29.05MHz 39.95MHz	Less than -8dBu Less than -9dBu Less than 10dBu	Less than -7dBu Less than -8dBu Less than 10dBu	12dB SINAD
RX Distortion	29.05MHz	Less than 4%	Less than 5%	SSG Output 30dBu
RX S/N	29.05MHz	More than 40dB (M03R) 34dB (03T)	More than 38dB (M03R) 32dB (03T)	SSG Output 30dBu 0.3 ~ 3KHz BPF OFF
Squelch Sensitivity	29.05MHz Indication 02	Squelch Open	Squelch Open	SSG Output -10dBu
		Squelch Close	Squelch Close	SSG Output OFF
S Meter	29.05MHz	All appears at 20dBu	All appears at 25dBu	Decrease SSG level and decrease S Meter level
AF Output	29.05MHz	More than 2W	More than 2W	SSG Output 30dBu
CTCSS Sensitivity	29.05MHz	Open at 500Hz/DEV (M03R) 250Hz/DEV (03T)	Open at 500Hz/DEV (M03R) 250Hz/DEV (03T)	SSG Output 0dBu 88.5Hz
DCS Sensitivity	29.05MHz	Opens when Test Equipment is in TX	Opens when Test Equipment is in TX	255 Code
Drain Current	29.05MHz	Less than 0.65A	Less than 0.65A	Max volume
Power off Current	29.05MHz	Less than 10mA	Less than 10mA	Power off
Howling	29.05MHz	Don't occur	Don't occur	SSG Output 60dBu Mod off, Max volume

5) TX Test Specification

TEST ITEM	CONDITION	ADJ. STANDARD	TEST STANDARD	NOTE
Tx Output HI POWER	28.00MHz	11 +/- 0.5W	11 +/- 2W	
	29.00MHz		11 +/- 1W	
	29.68MHz		11 +/- 2W	
Tx Output MID POWER	29.00MHz	5 +/- 0.5W	5 +/- 1W	
Tx Output LOW POWER	29.00MHz	1 - 4W	1 - 4W	
Drain Current	29.00MHz	Less than 2.5A	Less than 2.8A	
Frequency Deviation	29.00MHz	Within +/- 0.1KHz	Within +/- 0.5KHz	
Spurious	28.00MHz	More than 55dB	More than 50dB	MID and LOW standard power is also the same as of HI power level
	29.00MHz	More than 55dB	More than 50dB	
	29.68MHz	More than 55dB	More than 50dB	
Modulation Level*	29.00MHz	3.0 +/- 0.1KHz/DEV	3.0 +/- 0.2KHz/DEV	MIC in 1KHz 4mVemf
		4.5 +/- 0.1KHz/DEV	4.5 +/- 0.2KHz/DEV	MIC in 1KHz 40mVemf
		1.5 +/- 0.1KHz/DEV	1.5 +/- 0.2KHz/DEV	MIC in 1KHz 4mVemf
		2.2 +/- 0.1KHz/DEV	2.2 +/- 0.2KHz/DEV	MIC in 1KHz 40mVemf
CTCSS Modulation Level*	29.00MHz	800 +/- 200Hz/DEV	800 +/- 200Hz/DEV	88.5Hz
		400 +/- 200Hz/DEV	400 +/- 200Hz/DEV	3KHz LPF ON
DCS Modulation Level*	29.00MHz	800 +/- 50Hz/DEV	800 +/- 200Hz/DEV	255 Code
		600 +/- 100Hz/DEV	600 +/- 200Hz/DEV	3KHz LPF ON
1750Hz Modulation Level*	29.00MHz	3.0 +/- 0.1KHz/DEV	3.0 +/- 0.5KHz/DEV	
		1.5 +/- 0.1KHz/DEV	1.5 +/- 0.5KHz/DEV	
DTMF Modulation Level*	29.00MHz	3.0 +/- 0.5KHz/DEV	3.0 +/- 0.5KHz/DEV	Press the V/M key during TX
		1.5 +/- 0.5KHz/DEV	1.5 +/- 0.5KHz/DEV	
Modulation Distortion	29.00MHz	Less than 3%	Less than 4%	
TX S/N	29.00MHz	More than 40dB (DR-M03R) 34dB (DR-03T)	More than 38dB (DR-M03R) 32dB (DR-03T)	0.3 ~ 3KHz BPF ON

* Modulation Level, CTCSS, DCS, 1750Hz, DTMF : Upper line DR-M03R , Lower line DR-03T

PC BOARD VIEW

1) CPU Unit SIDE A DR-M03R / DR-03T (UP0584)

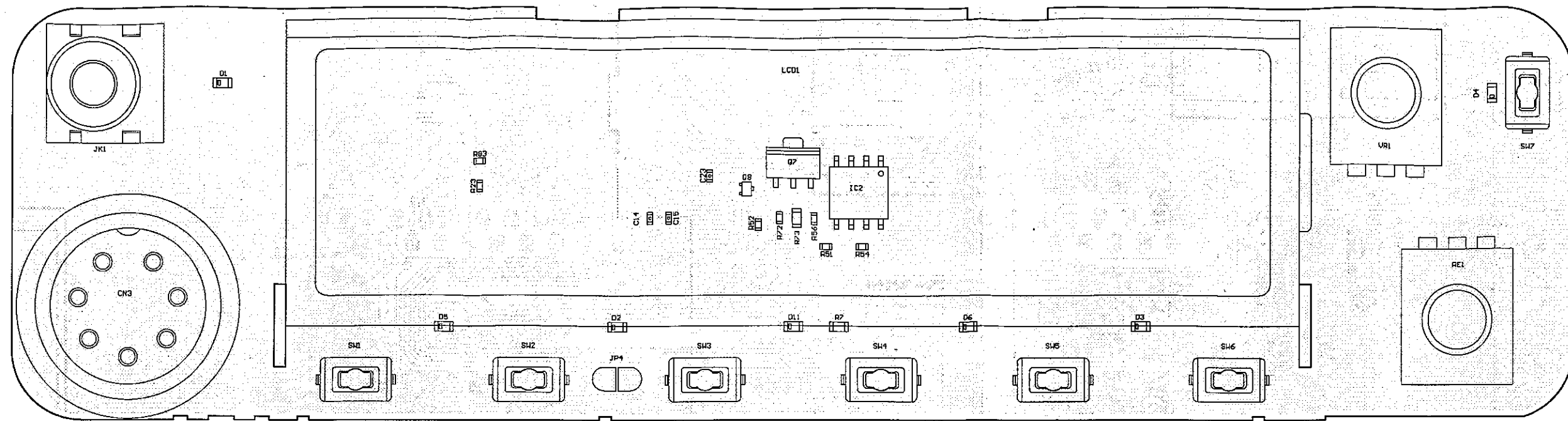

2) CPU Unit SIDE B DR-M03R / DR-03T (UP0584)

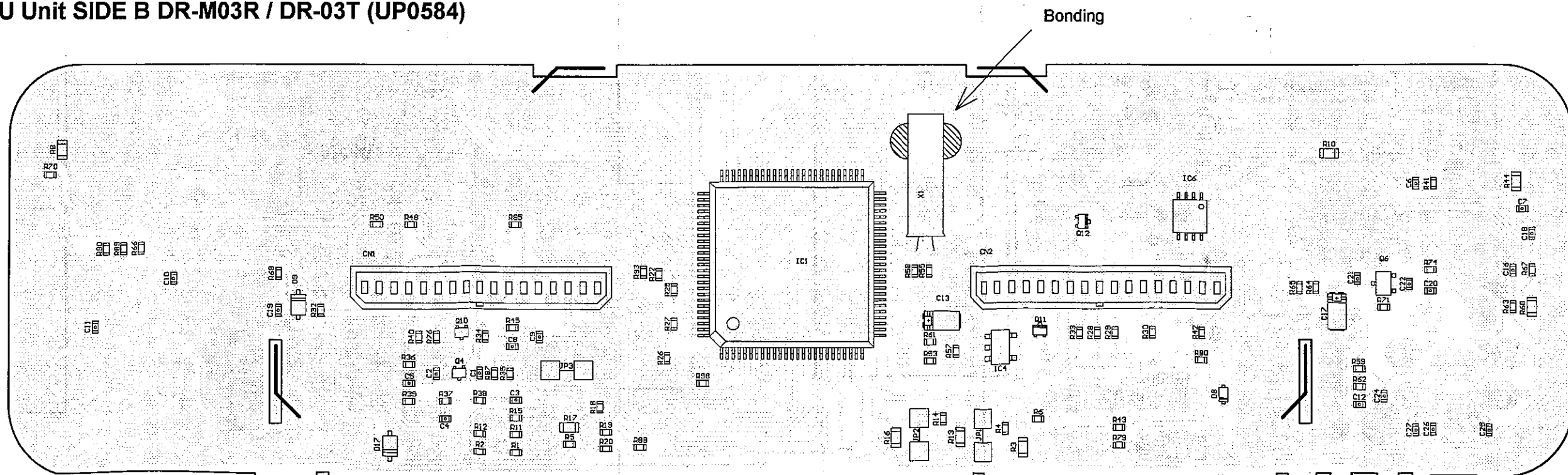

SCHEMATIC DIAGRAM

1) CPU Unit DR-M03R / DR-03T

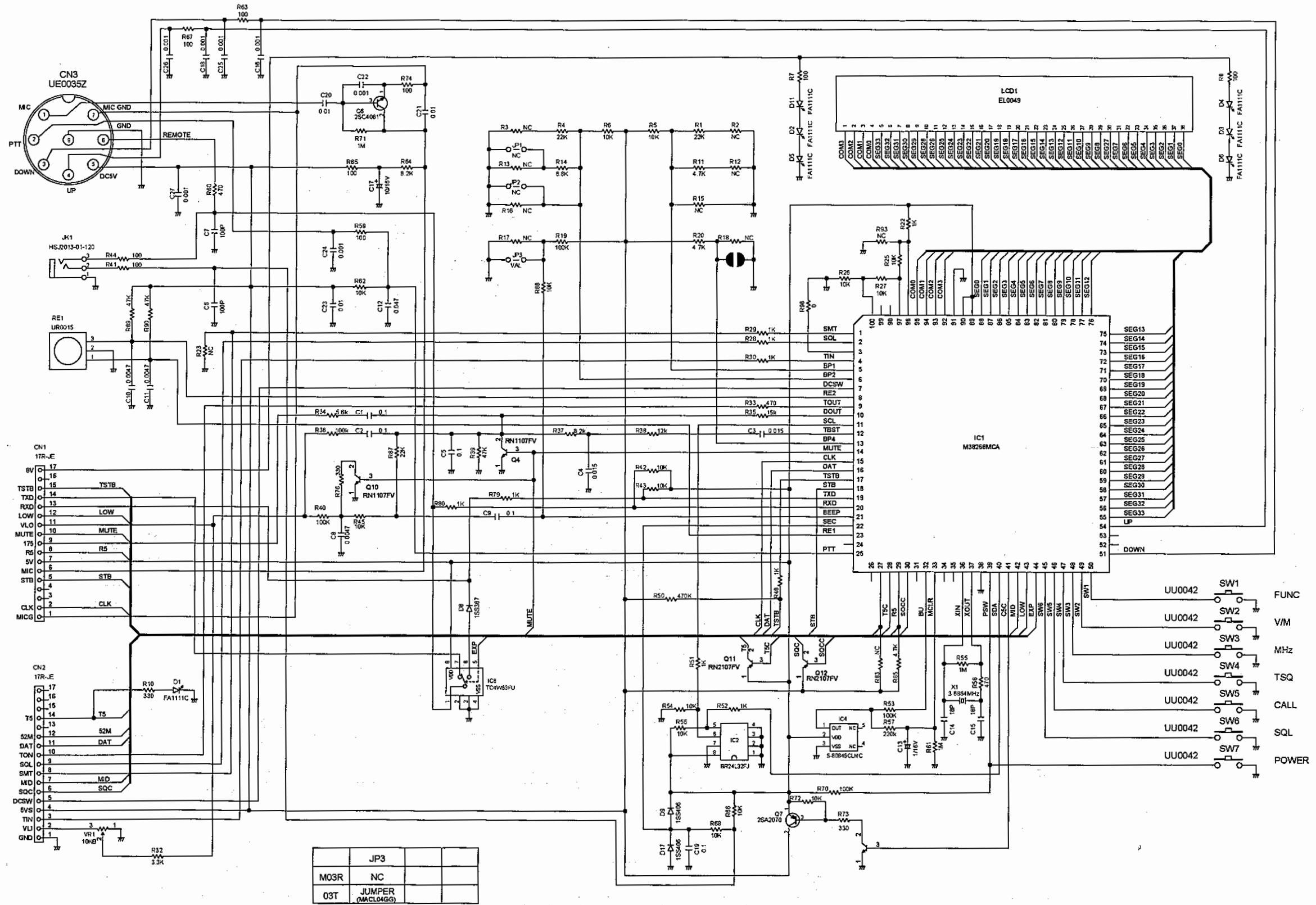

ALINCO, INC.

Head Office: Shin-Dai Building 9th Floor
2-6, 1-Chome, Dojimahama, Kita-ku, Osaka 530-0004, JAPAN
Phone: +81-6-4797-2136 Fax: +81-6-4797-2157
E-mail: export@alinco.co.jp

Dealer/Distributor