

DR-1200T

Service Manual

● SPECIFICATIONS	1
● PARTS LIST	2~5
● CABINET PARTS LOCATION	6
● ADJUSTMENT	7
● BLOCK DIAGRAM	8
● CONTROL PC BOARDS	9
● VHF MAIN PC BOARDS	10, 11
● APC PC BOARDS	12
● MIC PC BOARDS	12
● SQL PC BOARDS	12
● LOCK SW PC BOARDS	13
● IF PC BOARDS	13
● 144 DRIVE PC BOARDS	13
● LIBAT PC BOARDS	14
● 144 VCO PC BOARDS	14
● PA PC BOARDS	15
● TONE SQUELCH PC BOARDS	16



ALINCO ELECTRONICS INC.

■ SPECIFICATIONS

■ General

Frequency Coverage	144.0~148.0 MHz
Antenna Impedance	50 ohms unbalanced
Power Supply Requirement	13.8 Volts D.C.
Current Drain at 13.8 V	Receiving abt. 0.5 A Transmitting abt. 5A(Hj) abt. 2.5A(Lo)
Dimension	140 mm (W)×40 mm (H)×170 mm (D) (5½"×2"×6¾")
Weight	Approx. 1.1 kgs. (2.64 lbs.)

■ Transmitter

Output Power	High: 25 Watts Low: Approx. 5 Watts
Emission Mode	16F3
Modulation System	Variable Reactance F.M.
Max. Frequency Deviation	±5 kHz
Spurious Emission	60 dB below carrier
Microphone	Electret Condenser Microphone
Operating Mode	Simplex Duplex ±600 kHz, 1.6 MHz, 5 MHz, 7.6 MHz or odd splits from receive frequency
DTMF Encoder	Built-in (U.S. Version)

■ Receiver

Receiving System	Superhetrodyne, dual conversion
Modulation Acceptance	16F3
Intermediate Frequency	10.7 MHz/455 kHz
Sensitivity	12 dB SINAD less than 0.16 μV
Selectivity	More than ±6 kHz at -6 dB Less than ±12 kHz at -60 dB
Audio Power Output	abt. 2 W (8 ohms-10% Distortion)
Speaker Impedance	8 ohms

*Subject to change without notice.

Ref. No.	Part Code	Part Name and Number	Ref. No.	Part Code	Part Name and Number	Ref. No.	Part Code	Part Name and Number
C40	CU8038	Chip C, 3216Y5V1E105Z	C130	CS0064	Chip Tantal TMC1A155TR	R78	RK0056	Chip R, 2125MCR10223J
C41	CU8028	Chip C, 2125B1H103K	C131	CU0004	Chip C, C2012CH1H030C	R79	RK0052	Chip R, 2125MCR10103J
C42	CE0064	Chemical C, 10 V MS947	C132	CU8016	Chip C, C2012B1H102K	R80	RK0018	Chip R, 2125MCR10101J
C43	CU8028	Chip C, 2125B1H103K	C133	CS0060	Chip Tantal, TMCSA1E474MTR	R82	RK0052	Chip R, 2125MCR10103J
C44	CE0151	Chemical C, 10 V SSP 470	R1	RK0059	Chip R, MCR10J333	R83	RK0031	Chip R, 2125MCR10681J
C45	CS0049	Chip Tantal TMC 1C105	R2	RK0069	Chip R, MCR10J104	R84	RK0035	Chip R, 2125MCR10102J
C46	CE0064	Chemical C, 10 V MS947	R3	RK0069	Chip R, MCR10J104	R85	RK0062	Chip R, 2125MCR10473J
C47	CU8016	Chip C, 2125B1H102K	R4	RK0018	Chip R, 2125MCR10101J	R86	RK0105	Chip R, 2125MCR102R2J
C48	CU8028	Chip C, 2125B1H103K	R5	RK0011	Chip R, 2125MCR10470J	R87	RK0062	Chip R, 2125MCR10473J
C49	CU8028	Chip C, 2125B1H103K	R6	RK0025	Chip R, 2125MCR10331J	R88	RK0057	Chip R, 2125MCR10273J
C50	CU8028	Chip C, 2125B1H103K	R7	RK0011	Chip R, 2125MCR10470J	R89	RK0018	Chip R, 2125MCR10101J
C53	CU8028	Chip C, 2125B1H103K	R8	RK0052	Chip R, 2125MCR10103J	R90	RK0038	Chip R, 2125MCR10182J
C54	CU0076	Chip C, 2125CH1H200J	R9	RK0062	Chip R, 2125MCR10473J	R91	RK0020	Chip R, 2125MCR10151J
C55	CU0043	Chip C, 2125CHC221K	R10	RK0011	Chip R, 2125MCR10470J	R95	RK2010	Chip R, 2125MCR10330E
C56	CU0071	Chip C, 2125CH1H101J	R11	RK0062	Chip R, 2125MCR10473J	R96	RK0069	Chip R, 2125MCR10104J
C57	CU0071	Chip C, 2125CH1H101J	R12	RK0035	Chip R, 2125MCR10102J	R97	RK0052	Chip R, 2125MCR10103J
C59	CQ0007	Film C, 50 V F2M473K	R13	RK0001	Chip R, 2125MCR10100J	R98	RK0069	Chip R, 2125MCR10104J
C60	CU0071	Chip C, 2125CH1H101J	R14	RK0074	Chip R, 2125MCR10274J	R100	RK0045	Chip R, 2125MCR10472J
C61	CU0051	Chip C, C2012CH1H471K	R15	RK0018	Chip R, 2125MCR10101J	R102	RK0045	Chip R, 2125MCR10472J
C62	CU8019	Chip C, 2125B1H182K	R16	RK0038	Chip R, 2125MCR10182J	R105	RK0056	Chip R, 2125MCR10223J
C63	CU8028	Chip C, 2125B1H103K	R17	RK0062	Chip R, 2125MCR10473J	R106	RK0057	Chip R, 2125MCR10273J
C64	CS0049	Chip Tantal, TMCSA1C105MTR	R18	RK0052	Chip R, 2125MCR10103J	R107	RK0081	Chip R, 2125MCR10564J
C65	CU8016	Chip C, 2125B1H102K	R19	RK0018	Chip R, 2125MCR10101J	R108	RK0039	Chip R, 2125MCR10222J
C66	CS0049	Chip Tantal, TMCSA1C105MTR	R20	RK0028	Chip R, 2125MCR10471J	R109	RK0035	Chip R, 2125MCR10102J
C67	CU8028	Chip C, 2125B1H103K	R21	RK0018	Chip R, 2125MCR10101J	R110	RK0069	Chip R, 2125MCR10104J
C68	CQ0008	Film C, 50V2M683K	R23	RK0038	Chip R, 2125MCR10182J	R111	RK0069	Chip R, 2125MCR10104J
C69	CS0049	Chip Tantal, TMCI105	R25	RK0059	Chip R, 2125MCR10333J	R112	RK0069	Chip R, 2125MCR10104J
C70	CE0199	Chemical C, 16 V MS7100	R26	RK0035	Chip R, 2125MCR10102J	R113	RK0062	Chip R, 2125MCR10473J
C72	CU0066	Chip C, 2125CH1H330J	R27	RK0045	Chip R, 2125MCR10472J	R114	RK0035	Chip R, 2125MCR10102J
C73	CU8016	Chip C, 2125B1H102K	R28	RK0056	Chip R, 2125MCR10223J	R115	RK0035	Chip R, 2125MCR10102J
C74	CU0066	Chip C, 2125CH1H330J	R29	RK0052	Chip R, 2125MCR10103J	R116	RK0035	Chip R, 2125MCR10223J
C75	CU8028	Chip C, 2125B1H103K	R30	RK0057	Chip R, 2125MCR10273J	R118	RK0107	Chip R, 2125MCR10000
C76	CU0011	Chip C, 2125CH1H100D	R31	RK0035	Chip R, 2125MCR10102J	R124	RK0107	Chip R, 2125MCR10000
C77	CU8016	Chip C, 2125B1H102K	R33	RK0069	Chip R, 2125MCR10104J	R127	RK0056	Chip R, 2125MCR10223J
C78	CU0011	Chip C, 2125CH1H100D	R34	RK0039	Chip R, 2125MCR10222J	R128	RK0057	Chip R, 2125MCR10104J
C79	CU8028	Chip C, 2125B1H103K	R36	RK0038	Chip R, 2125MCR10182J	R129	RK0008	Chip R, 2125MCR10330J
C80	CU0051	Chip C, C2012CH1H471K	R37	RK0052	Chip R, 2125MCR10103J	R130	RK0052	Chip R, 2125MCR10103J
C81	CU8016	Chip C, 2125B1H102K	R38	RK0038	Chip R, 2125MCR10182J	R131	RK0052	Chip R, 2125MCR10103J
C84	CU8028	Chip C, 2125B1H103K	R39	RK0035	Chip R, MCR10J102	R132	RK0056	Chip R, 2125MCR10223J
C85	CU8028	Chip C, 2125B1H103K	R40	RK0052	Chip R, 2125MCR10103J	R134	RK0025	Chip R, MCR10J331
C86	CU8038	Chip C, 3216Y5V1E105Z	R41	RK0038	Chip R, MCR10J182	R137	RK0035	Chip R, 2125MCR10102J
C87	CU8034	Chip C, 2125B1E333K	R42	RK0035	Chip R, MCR10J102	R138	RK0069	Chip R, MCR10J104
C88	CE0064	Chemical C, 10 V MS947	R43	RK0001	Chip R, MCR10J100	R139	RK0069	Chip R, MCR10J104
C89	CE0064	Chemical C, 10 V MS947	R44	RK0045	Chip R, 2125MCR10472J	IC1	XA0082	IC, MC7808CT
C90	CE0064	Chemical C, 10 V MS947	R45	RK0062	Chip R, 2125MCR10473J	IC2	XA0078	IC, MS4959P
C91	CE0151	Chemical C, 10 V SSP470	R46	RK0062	Chip R, 2125MCR10473J	IC4	XA0079	IC, MPC1241H
C92	CU8042	Chip C, CM21W5R104K25AT	R47	RK0062	Chip R, 2125MCR10473J	VR1	RH0063	VR, VM6CK-PV-1S102B
C93	CE0163	Chemical C, 16 V SSP1000	R48	RK0062	Chip R, 2125MCR10473J	VR2	RH0044	VR, VM6CK-PV-1S103B
C94	CU8028	Chip C, C2012B1H103K	R49	RK0062	Chip R, 2125MCR10473J	VR3	RH0044	VR, VM6CK-PV-1S103B
C95	CU8016	Chip C, C2012B1H102K	R50	RK0048	Chip R, 2125MCR10682J	VR4	RH0046	VR, VM6CK-PV-1S503B
C96	CE0125	Chemical C, 25 V MS74R7	R51	RK0076	Chip R, 2125MCR10334J	VR5	RH0046	VR, VM6CK-PV-1S503B
C97	CE0030	Chemical C, 16 V MS710	R52	RK0044	Chip R, 2125MCR10392J	VR6	RH0044	VR, VM6CK-PV-1S103B
C98	CU8016	Chip C, C2012B1H102K	R53	RK0076	Chip R, 2125MCR10334J	VR7	RH0045	VR, VM6CK-PV-1S303B
C100	CU8016	Chip C, C2012B1H102K	R54	RK0044	Chip R, 2125MCR10392J	VR9	RH0021	VR, H0651A 10KB
C101	CE0030	Chemical C, 16 V MS710	R55	RK0056	Chip R, 2125MCR10223J	FL1	XF0004	X, Fil, 10.7M15A49/T
C102	CU8016	Chip C, C2012B1H102K	R56	RK0039	Chip R, 2125MCR10222J	FL2	XC0001	Ceramic Fil, CFW455F
C103	CE0199	Chemical C, 16 V MS7100	R58	RK0018	Chip R, 2125MCR10101J	X1	XQ0037	X1al HC-49/u 12.8 MHz
C104	CU8028	Chip C, C2012B1H103K	R59	RK0056	Chip R, 2125MCR10223J	X2	XQ0033	X1al HC-49/u 10.245 MHz
C105	CU8016	Chip C, C2012B1H102K	R60	RK0052	Chip R, 2125MCR10103J	TH1	XS0004	Thermistor TD5A150D
C106	CU8016	Chip C, C2012B1H102K	R61	RK0035	Chip R, MCR10J102	TC1	CT0015	Trimmer C, CV05A0601
C107	CU8016	Chip C, C2012B1H102K	R62	RK0052	Chip R, 2125MCR10103J	TC3	CT0025	Trimmer C, ECRLA020E12A
C108	CU8016	Chip C, C2012B1H102K	R63	RK0062	Chip R, 2125MCR10473J	TC4	CT0025	Trimmer C, ECRLA020E12A
C110	CU8025	Chip C, C2012B1H562K	R64	RK0040	Chip R, 2125MCR10272J	D1	XD0103	D, ISS226TE85L
C111	CU8025	Chip C, C2012B1H562K	R65	RK0040	Chip R, 2125MCR10272J	D2	XD0041	D, DAP202KT96
C112	CU8003	Chip C, C2012F1E104Z	R66	RK0050	Chip R, 2125MCR10822J	D3	XD0040	D, DAN202KT96
C113	CU8028	Chip C, C2012B1H103K	R67	RK0052	Chip R, MCR10J103	D4	XD0040	D, DAN202KT96
C115	CU0069	Chip C, C2012CH1H680J	R68	RK0052	Chip R, 2125MCR10103J	D5	XD0104	Zener 02C26.2YTE85L
C117	CU0060	Chip C, C2012CH1H470J	R69	RK0052	Chip R, 2125MCR10103J	D6	XD0041	D, DAP202KT96
C118	CU0067	Chip C, C2012CH1H390J	R70	RK0045	Chip R, 2125MCR10472J	D7	XD0070	D, ISS265
C120	CS0033	Chip Tantal TMC1A225TR	R71	RK0056	Chip R, 2125MCR10223J	D8	XD0070	D, ISS265
C121	CU8016	Chip C, 2125B1H102K	R72	RK0052	Chip R, 2125MCR10103J			
C122	CU8016	Chip C, 2125B1H102K	R73	RK0052	Chip R, MCR10J103			
C123	CU0071	Chip C, 2125CH1H101J	R74	RK0018	Chip R, 2125MCR10101J			
C124	CU0071	Chip C, 2125CH1H101J	R75	RK0035	Chip R, 2125MCR10102J			
C125	CU0071	Chip C, 2125CH1H101J	R76	RK0018	Chip R, 2125MCR10101J			
C126	CU0071	Chip C, 2125CH1H101J	R77	RK0035	Chip R, 2125MCR10102J			
C129	CU0051	Chip C, C2012CH1H471K						

Ref. No.	Part Code	Part Name and Number
D9	XD0041	D, DAP202KT96
D10	XD0058	D, ISS181
D11	XD0100	Vari cap, ISV164T1
D12	XD0100	Vari cap, ISV164T1
D13	XD0100	Vari cap, ISV164T1
D16	XD0078	D, DAN235KT96
D17	XD0040	D, DAN202KT96
D18	XD0040	D, DAN202KT96
D19	XD0080	D, RB400DT96
D20	XD0080	D, RB400DT96
D21	XD0100	D, 1SV164
D22	XD0100	D, 1SV164
	TS0020B	VCO Case
	TS0021	COIL Case
Q1	XE0013	Chip FET, 3SK184STX
Q2	XE0012	Chip FET, 3SK131V12T1
Q3	XT0059	Chip TR, 2SC3082KT96Q
Q4	XT0077	Chip TR, 2SC3326ATE85L
Q5	XT0061	Chip TR, 2SB1132T100Q
Q6	XT0061	Chip TR, 2SB1132T100Q
Q7	XU0018	Digital TR, DTC124EKT96
Q8	XU0018	Digital TR, DTC124EKT96
Q9	XT0037	Chip TR, 2SC2412KT96R
Q11	XT0081	Chip TR, 2SC2714Y
Q13	XT0037	Chip TR, 2SC2412KT96R
Q14	XT0037	Chip TR, 2SC2412KT96R
Q15	XT0038	Chip TR, 2SA1037KT96R
Q16	XT0030	Chip TR, 2SC3356T1
Q17	XT0030	Chip TR, 2SC3356T1
Q19	XT0020	TR, 2SC2538
Q20	XT0064	TR, 2SD1761E
Q21	XT0037	Chip TR, 2SC2412KT96R
Q22	XT0037	Chip TR, 2SC2412KT96R
Q23	XT0037	Chip TR, 2SC2412KT96R
Q24	XU0012	Digital TR, DTC114EKT96
L1	QA0038	Coil, 144MRF
L2	QA0038	Coil, 144MRF
L3	QA0053	Coil, 144M
L4	QA0053	Coil, 144M
L5	QA0054	Coil, 144M
L6	QA0037	Coil, 144MTC
L7	QA0039	Coil, 10R7MIF
L8	QA0039	Coil, 10R7MIF
L10	QA0041	Coil, 455KIF
L11	QL0007	Choke coil, 1R6mHR6A
L12	QC0045	Chip L, NL322522T3R3M
L13	QC0045	Chip L, NL322522T3R3M
L14	QC0034	Chip L, NL322522T3R3M
L16	QK0042	Coil, 3x5x0.6
CN101	UE0043	PI22A02M
CN102	UE0009	B2BEH
CN103	UE0017	B3BEH
CN104	UE0009	B2BEH
CN105	UE0017	B3BEH
CN106	UE0009	B2BEH
CN107	UE0044	PI22A09M
CN108	UE0045	PI22A11M
CN110	UE0043	PI22A02M
CN111	UE0043	PI22A0M
CN112	UE0041	TMP-J01X-V6
CN113	UE0041	TMP-J01X-V6
TP1	UE0043	PI22A02M
TP2	UE0047	R9 * 10
TP3	UE0047	R9 * 10
	TX0030A	Crystal Sheet
W17	UX1024	Wire
PA Unit		
C1	CE0044	Chemical C, 16VMS5 10M
C2	CE0044	Chemical C, 16VMS5 10M
C3	CC5002	Ceramic C, HM60SJSJL100J

Ref. No.	Part Code	Part Name and Number
C4	CC5020	Ceramic C, HM60SJSJL180J
C5	CC5025	Ceramic C, HM60SJSJL180J
C6	CC5020	Ceramic C, HM60SJSJL180J
C7	CC5023	Ceramic C, HM60SJSJL390J
C8	CC0102	Ceramic C, CC451HCH010
C9	CC5003	Ceramic C, HM60SJSJL303J
C10	CC0102	Ceramic C, CC451HCH010
C11	CC5021	Ceramic C, HM60SJSJL220J
C12	CU8016	Chip C, 2125B1H102K
C13	CU8016	Chip C, 2125B1H102K
C14	CU8016	Chip C, 2125B1H102K
C15	CU8016	Chip C, 2125B1H102K
C16	CU8016	Chip C, 2125B1H102K
C17	CK0003	Ceramic C, 50V102Z
C19	CU0009	Chip C, 2125CH1H080
L1	QK0044	Coil, 3x9.5x0.5
L2	QK0031	Coil, 3x6T
L3	QK0041	Coil, 3x4x0.8
L4	QK0044	Coil, 3x9.5x0.5
L5	QK0041	Coil, 3x4x0.8
L6	QK0041	Coil, 3x4x0.8
L7	QK0051	FL4H 1R0
L8	QK0046	Coil, 2.2x2.25T
R1	RD1008	R, R50x151J
R2	RD0054	R, R20x153J
VR1	RH0048	VR, TM64K2(PH)101B
D1	XD0107	D, G3B
D2	XD0106	PWD, UM9401
D3	XD0014	PWD, M1308
D4	XD0096	D, IS2472
D5	XD0096	D, IS2472
IC1	XA0016	IC, M57737
TP1	UE0047	R9 x 10
No2	MBDJ07CC	Wire #26B05-070-05
W4	UX1013	Wire
W7	UX1016	Wire
W8	UX1017	Wire
W9	UX1018	Wire
W15	UX1022	Wire
W16	UX1022	Wire
Control Unit		
C1	CU0071	Chip C, 2125CH1H101J
C2	CE0057	Chemical C, 6.3 V MS9 330M
C3	CU8016	Chip C, 2125B1H102K
C4	CU8028	Chip C, 2125B1H103K
C5	CE0033	Chemical C, 10 V MS5 10M
C6	CU8016	Chip C, 2125B1H102K
C7	CU8016	Chip C, 2125B1H102K
C8	CU8016	Chip C, 2125B1H102K
C9	CU8016	Chip C, 2125B1H102K
C10	CU8016	Chip C, 2125B1H102K
C11	CU8016	Chip C, 2125B1H102K
C12	CU8016	Chip C, 2125B1H102K
C13	CU8016	Chip C, 2125B1H102K
C14	CU8016	Chip C, 2125B1H102K
C19	CU8016	Chip C, 2125B1H102K
C20	CU8016	Chip C, 2125B1H102K
C21	CU8024	Chip C, 2125B1H472K
C24	CU0071	Chip C, 2125CH1H101J
C25	CU0071	Chip C, 2125CH1H101J
C26	CU0071	Chip C, 2125CH1H101J
C27	CU0071	Chip C, 2125CH1H101J
C28	CU8016	Chip C, 2125B1H102K
C29	CU8016	Chip C, 2125B1H102K
C30	CU8016	Chip C, 2125B1H102K
C31	CU8016	Chip C, 2125B1H102K
C32	CU8016	Chip C, 2125B1H102K

Ref. No.	Part Code	Part Name and Number
C33	CU8016	Chip C, C2012B1H102K
C34	CU8016	Chip C, 2125B1H102K
C35	CU8016	Chip C, 2125B1H102K
PL1	EP0008	Lamp, BQ031-40608A
PL2	EP0008	Lamp, BQ031-40608A
PL3	EP0008	Lamp, BQ031-40608A
PL4	EP0007	Lamp, BQ031-40604A
PL5	EP0007	Lamp, BQ031-40604A
PL6	XL0024	LED, TLG223
VR1	RV0010	Vol, EVU-F2AF20B54
VR2	RV0009	Vol, EVU-F2AF20B14
IC1	XA0186	IC, MB88543PF-G-290M
IC2	XA0189	IC, MSM82C43GS-VK
IC3	XA0033	IC, VPC393G-T
IC4	XA0073	F-IC, MN1280-T
IC5	XA0074	F-IC, AN8006
D1	XD0061	Chip D, DA204KT96
D2	XD0040	Chip D, DAN202KT96
D6	XD0040	Chip D, DAN202KT96
Q1	XU0015	Digital TR DTC144TKT96
Q4	XT0099	TR, 2SA1736TE12L
R1	RK0052	Chip R, 2125MCR10103J
R2	RK0018	Chip R, 2125MCR10101J
R3	RK0067	Chip R, 2125MCR10823
R4	RK0054	Chip R, 2125MCR10153
R5	RK0071	Chip R, 2125MCR10154
R6	RK0067	Chip R, 2125MCR10823
R7	RK0059	Chip R, 2125MCR10333
R8	RK0035	Chip R, 2125MCR10102J
R9	RK0062	Chip R, 2125MCR10473
R10	RK0062	Chip R, 2125MCR10473
R11	RK0045	Chip R, 2125MCR10472J
R12	RK0062	Chip R, 2125MCR10473J
R13	RK0062	Chip R, 2125MCR10473J
R14	RK0062	Chip R, 2125MCR10473J
R15	RK0062	Chip R, 2125MCR10473J
R16	RK0062	Chip R, 2125MCR10473J
R17	RK0062	Chip R, 2125MCR10473J
R18	RK0062	Chip R, 2125MCR10473J
R19	RK0062	Chip R, 2125MCR10473J
R20	RK0062	Chip R, 2125MCR10473J
R21	RK0062	Chip R, 2125MCR10473J
R22	RK0062	Chip R, 2125MCR10473J
R23	RK0062	Chip R, 2125MCR10473J
R24	RK0062	Chip R, 2125MCR10473J
R25	RK0062	Chip R, 2125MCR10473J
R26	RK0062	Chip R, 2125MCR10473J
T27	RK0070	Chip R, 2125MCR10124
R28	RK0070	Chip R, 2125MCR10124
R29	RK0062	Chip R, 2125MCR10473J
R30	RK0070	Chip R, 2125MCR10124J
R31	RK0070	Chip R, 2125MCR10124J
R32	RK0107	Chip R, 2125MCR10000J
R33	RK0062	Chip R, 2125MCR10473J
R34	RK0070	Chip R, 2125MCR10124J
R35	RK1035	Chip R, 3216MCR10102J
R38	RK0062	Chip R, 2125MCR10473J
R39	RK0086	Chip R, 2125MCR10105J
R40	RK1039	Chip R, 3216MCR222J
R41	RK0038	Chip R, 2125MCR10182J
R42	RK0038	Chip R, 2125MCR10182J
R43	RK0038	Chip R, 2125MCR10182J
R44	RK0038	Chip R, 2125MCR10182J
R45	RK0038	Chip R, 2125MCR10182J
R46	RK1039	Chip R, 3216MCR10222J
R47	RK0107	Chip R, MCR10J000
R48	RK0035	Chip R, 2125MCR10102J
R49	RK0035	Chip R, 2125MCR10102J
R50	RK0035	Chip R, 2125MCR10102J
R53	RK0035	Chip R, 2125MCR10102J
R54	RK0035	Chip R, 2125MCR10102J

Ref. No.	Part Code	Part Name and Number	Ref. No.	Part Code	Part Name and Number	Ref. No.	Part Code	Part Name and Number
SW1	UQ0011	Push, ESB-64801	C16	CU0033	Chip C, C2012CH1H220J			
SW2	UQ0011	Push, ESB-64801	C17	CU0060	Chip C, 2125CH1H470J			
SW3	UQ0013	Push, EVQ-QEC-04K	C20	CU0037	Chip C, C2012CH1H121K			
SW4	UQ0013	Push, EVQ-QEC-04K	C21	CU8016	Chip C, 2125CH1H102K			
SW5	UQ0013	Push, EVQ-QEC-04K	C23	CE0198	Chemical C, 10 V MS5 100M			
SW6	UQ0013	Push, EVQ-QEC-04K						
SW7	UQ0013	Push, EVQ-QEC-04K	TC1	CT0021	Trimmer C, ECRJA010A 12W			
SW8	UQ0013	Push, EVQ-QEC-04K	TC2	CT0021	Trimmer C, ECRJA010A 12W			
SW9	UQ0013	Push, EVQ-QEC-04K						
SW10	UQ0013	Push, EVQ-QEC-04K	L1	QC0045	Chip L, NL322522T3R3M			
SW11	UQ0013	Push, EVQ-QEC-04K	L2	OK0041	QKRM304008			
SW12	UQ0013	Push, EVQ-QEC-04K	L3	QC0045	Chip L, NL322522T3R3M			
			L5	OK0047	QKRM223505			
RENC1	UR0002	EVQ-WQGF 1524B	L6	QC0039	Chip L, NL322522T1R0M			
No3	MYCL09AA	Wire #30Y02-090-02	R1	RK0018	Chip R, 2125MCR10101J			
No6	MPDJ20AA	Wire #26P02-200-02	R2	RK0056	Chip R, 2125MCR10223J			
W1	UX1010	Wire	R3	RK0052	Chip R, 2125MCR10103J			
W2	UX1011	Wire	R4	RK0018	Chip R, 2125MCR10101J			
W10	UX1019	Wire	R5	RK0011	Chip R, 2125MCR10470J			
W11	UX1020	Wire	R6	RK0027	Chip R, 2125MCR10391J			
LCD1	EL0013	LCD DR112	R7	RK0089	Chip R, 2125MCR10104J			
	DG0003A	LCD Light	R8	RK0052	Chip R, 2125MCR10103J			
	FG0033	LCD Connector	R9	RK0037	Chip R, 2125MCR10152J			
	FM0031	LCD Folder	R10	RK0067	Chip R, 2125MCR10823J			
	FP0034	LCD MIC Spacer	R11	RK0073	Chip R, 2125MCR10224J			
	FM0034	MIC Earth Plate	R12	RK0011	Chip R, 2125MCR10470J			
			R13	RK0021	Chip R, 2125MCR10181J			
			R14	RK0048	Chip R, 2125MCR10682J			
			R15	RK0045	Chip R, MCR10J472			
			R17	RK0045	Chip R, MCR10J472			
Drive Unit			D1	XD0040	Chip D, DAN202KT96			
C3	CU8028	Chip C, 2125MCR10103K	D2	XD0100	Chip D, 1SV164			
C4	CU8028	Chip C, 2125MCR10103K	D3	XD0101	Chip D, 1SV166T1			
C5	CU8016	Chip C, 2125MCR10102K	D4	XD0101	Chip D, 1SV166T1			
C6	CU0066	Chip C, C2012CH1H330J	D5	XD0100	Chip D, 1SV164			
C7	CU8028	Chip C, 2125MCR10103K		UE0046	SB10P-HVQ-CT			
C8	CU8028	Chip C, 2125MCR10103K	Q1	XT0075	Chip TR, 2SC2757T1			
C9	CU8028	Chip C, 2125MCR10103K	Q2	XE0010	Chip FET, 2SK508K52T1			
C10	CU8016	Chip C, 2125MCR10102K	Q3	XT0037	Chip TR, 2SK508K52T1			
C11	CS0049	Chip Tantal, TMC1C105TR	Q4	XE0011	Chip FET, 2SK508K51T1			
C12	CU0003	Chip C, 2125MCR10020C						
L1	QC0063	Chip L, NL322522T-047M						
Q4	XT0059	Chip TR, 2SC3082KT96Q						
Q5	XT0071	Chip TR, 2SC3837KT96N						
R7	RK0018	Chip R, MCR10J101						
	UE0042	Terminal, 022 (1.0) S						
R8	RK0035	Chip R, 2125MCR10102J						
R10	RK0014	Chip R, 2125MCR10680J						
R11	RK0038	Chip R, 2125MCR10182J						
R12	RK0028	Chip R, 2125MCR10471J						
R13	RK0010	Chip R, 2125MCR10390J						
R14	RK0005	Chip R, 2125MCR10220J						
R16	RK0025	Chip R, 2125MCR10331J						
R17	RK0045	Chip R, 2125MCR10472J						
R19	RK0056	Chip R, 2125MCR10223J						
VCO Unit								
C1	CU8016	Chip C, 2125CH1H102K						
C2	CU8016	Chip C, 2125CH1H102K						
C3	CU0004	Chip C, 2125CH1H030C						
C4	CU8028	Chip C, 2125CH1H103K						
C5	CU0011	Chip C, C2012CH1H100D						
C6	CU0011	Chip C, 2125CH1H100D						
C7	CU0033	Chip C, 2125CH1H820J						
C8	CU0064	Chip C, 2125CH1H220J						
C9	CU0001	Chip C, 2125CH1H0R5C						
C10	CU0033	Chip C, 2125CH1H820J						
C11	CU8016	Chip C, 2125CH1H102K						
C12	CU0004	Chip C, 2125CH1H030C						
C13	CU8028	Chip C, 2125CH1H103K						
C14	CU0064	Chip C, C2012CH1H220J						
C15	CU0033	Chip C, C2012CH1H220J						

■ CABINET PARTS LOCATION

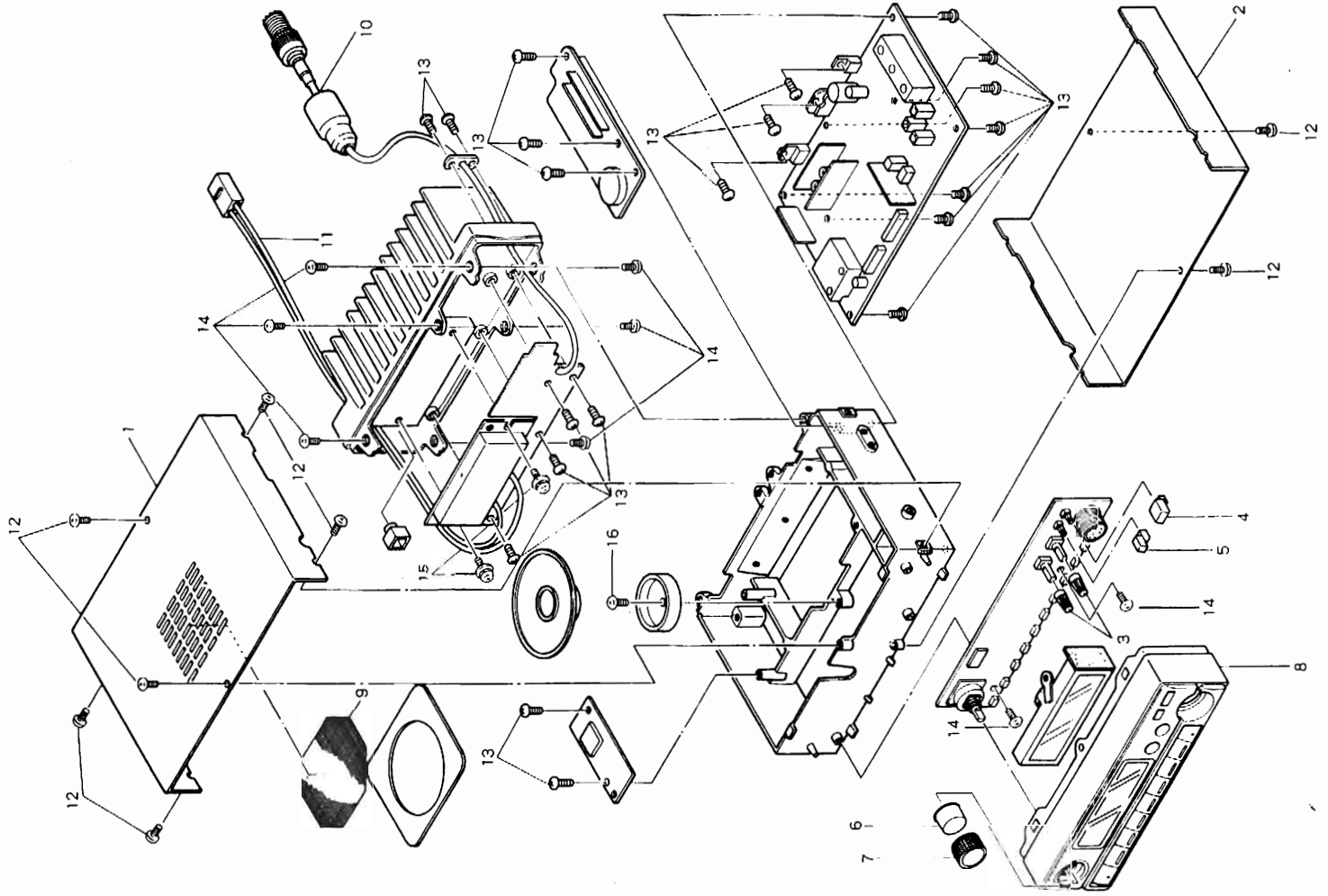

Ref. No.	Part Name and Number	Part Code	Part Name and Number
Mechanical Parts			
1	Upper Case	KU0084	Screws
2	Lower Case	KS0039	
3	Vol Knob	NK0010	
4	Power Knob	NP0015	
5	Hi/LO Knob	NP0016	
6	Dial Knob	NK0009	
8	Front Panel	KM0055	
9	SP Sheet	FF0013	
10	Coaxial Cable	UE0141	
11	DC Power Cable	UA0002	
12	M2.6 x 5	AA0031	
13	2.6 x 6 (tap)	AJ0015	
14	M2 x 4	AA0027	
15	M3 x 8	AD0001	
16	3 x 8 (tap)	AJ0005	

■ ADJUSTMENT

Item	Adjustment point	Adjustment method
VCO P/D Voltage (RX)	TC2 (VCO Box)	Adjust TC2 so that the voltage of TP3 is 2.3V on the receiving mode at 144.00MHz.
VCO P/D Voltage (TX)	TC1 (VCO Box)	Adjust TC1 so that the voltage of TP3 is 2.0V on the transmission mode at 144.00MHz.
Frequency	TC2 (Main Board)	Set the unit in the transmission mode at 145.00MHz and adjust TC2.
Power output	VR6 (Hi)	On "HI" position, turn VR6 for 25W output at 145.00MHz.
	VR7 (Lo)	On "LO" position, turn VR7 for 5W output at 145.00MHz.
RF Power Meter	VR4	Turn VR4 so that three segments will light on "LO" position.
Deviation	VR3	Input a signal of 1KHz/25mV into the MIC jack and adjust VR3 so that you obtain 4.9KHz/Dev in the transmission mode.
MIC Gain	VR2	Input a signal of 1KHz/4mV into the MIC jack and adjust VR2 so that you obtain 4.0KHz/Dev in the transmission mode.
Discrimination Adjustment	L-10	Enter SSG input 1KHz/MOD \pm 3.5KHz/Dev 60dB μ . Adjust to maximize the output wave.
Sensitivity	L1-5, L-6-8	Enter SSG input 1KHz MOD \pm 3.5KHz/Dev. At 145.00MHz, adjust to maximize 12dB SINAD sensitivity.
Subaudible Tone Deviation	VR1 (Tone squelch board)	On the "ENC" mode at 146.00MHz, turn VR1 so that the deviation is 0.7KHz.
S-Meter (SG output: 3dB μ EMF)	VR1	Turn VR1 so that the <input type="checkbox"/> begins to light.
Squelch Sensitivity (SG output: -6dB μ EMF)	VR9	Turn the squelch control fully clockwise and turn VR9 so that the squelch will be closed at the SG output of -6dB μ .

Upper Side View

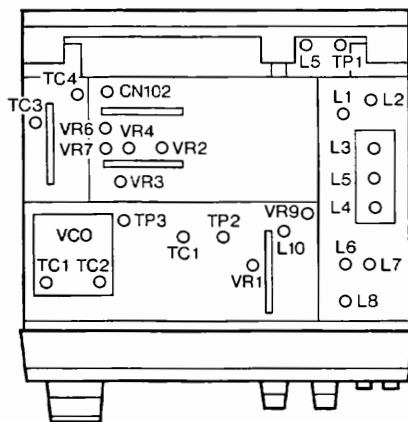

■ BLOCK DIAGRAM

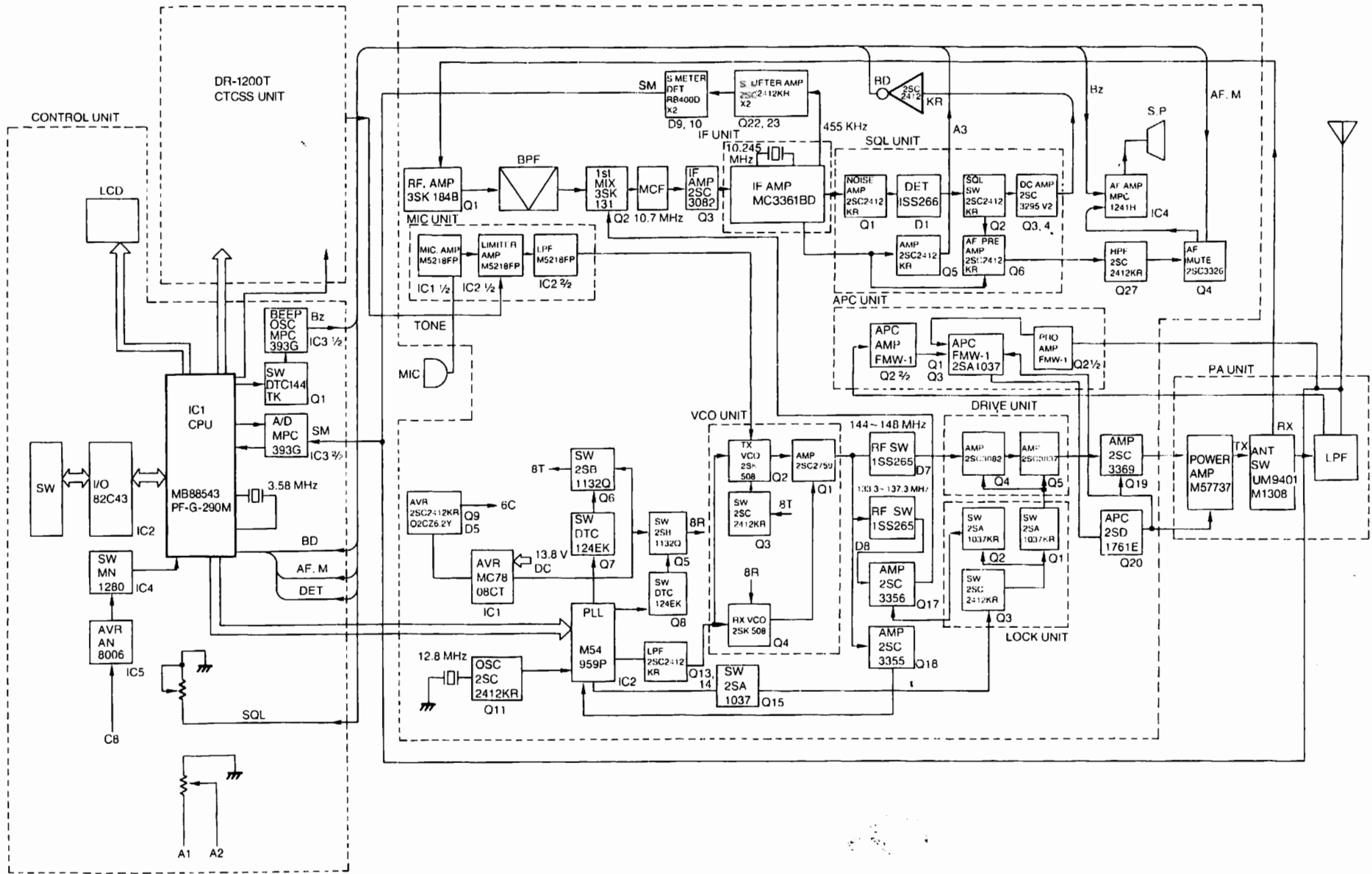

■ CONTROL PC BOARDS

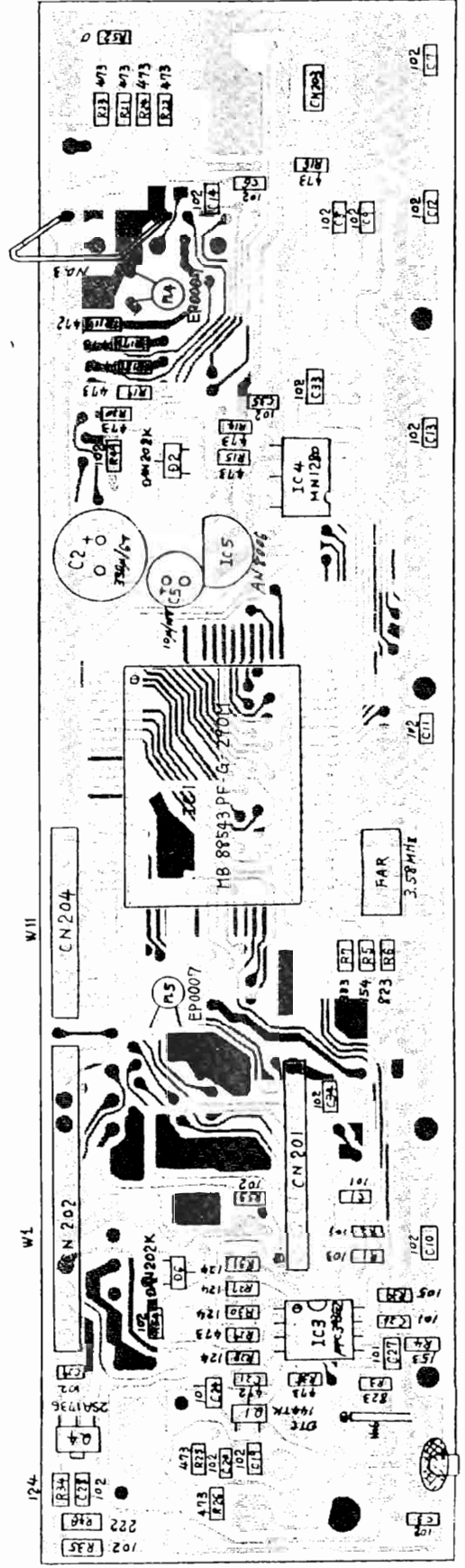
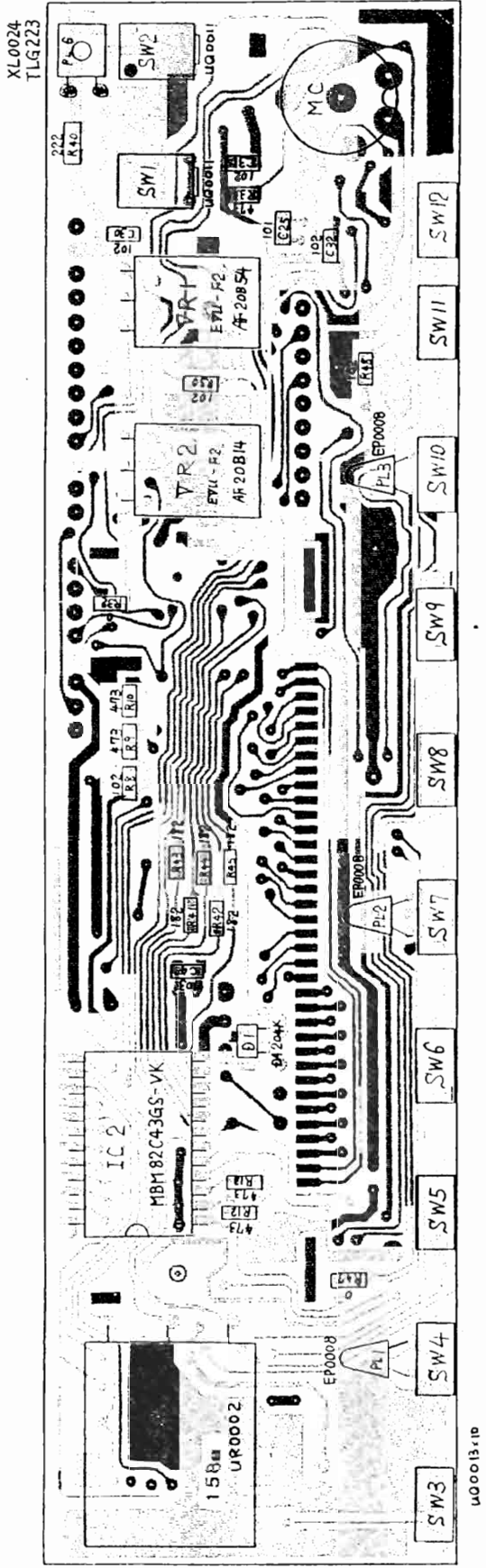

■ VHF MAIN PC BOARDS

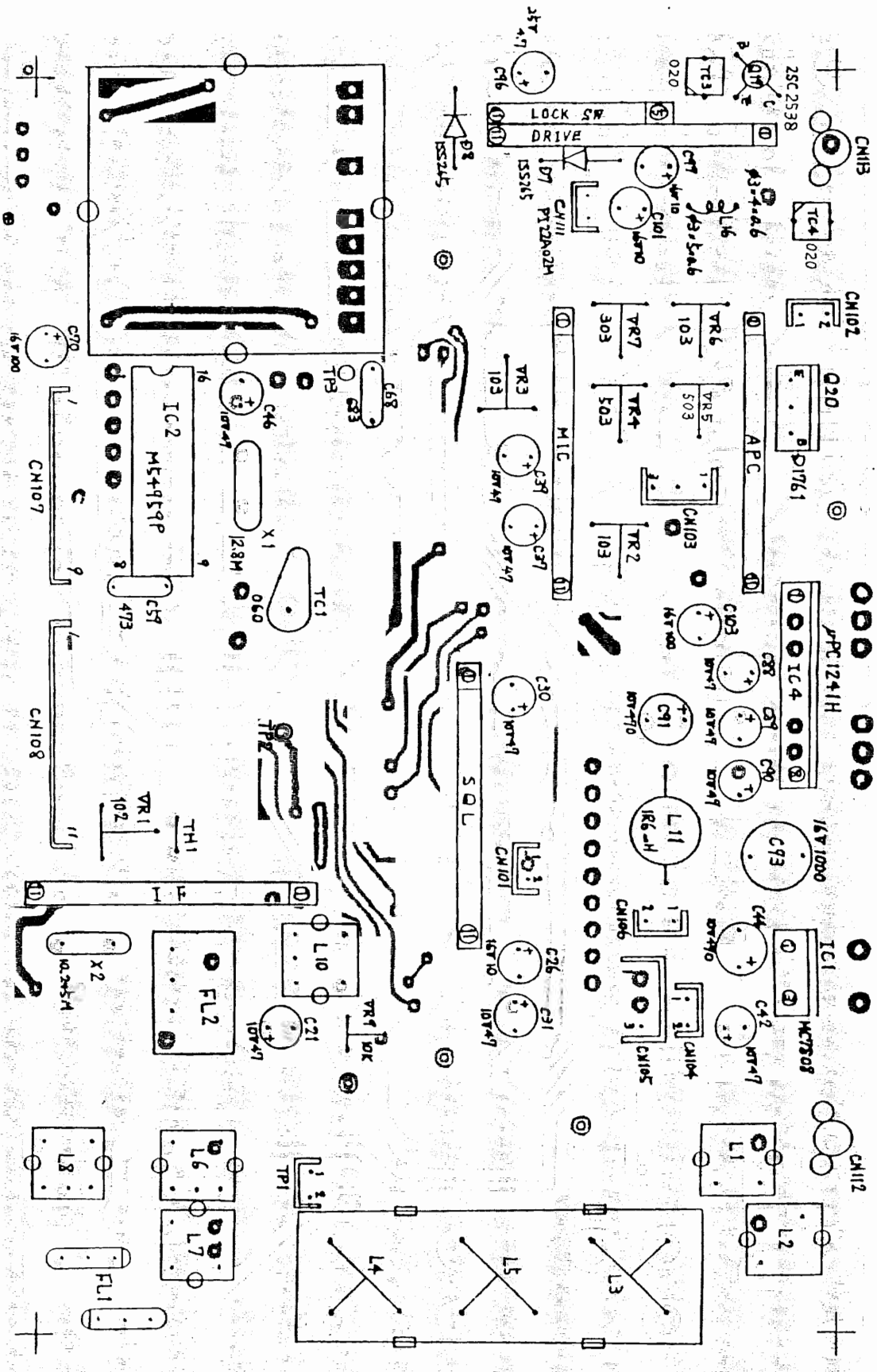

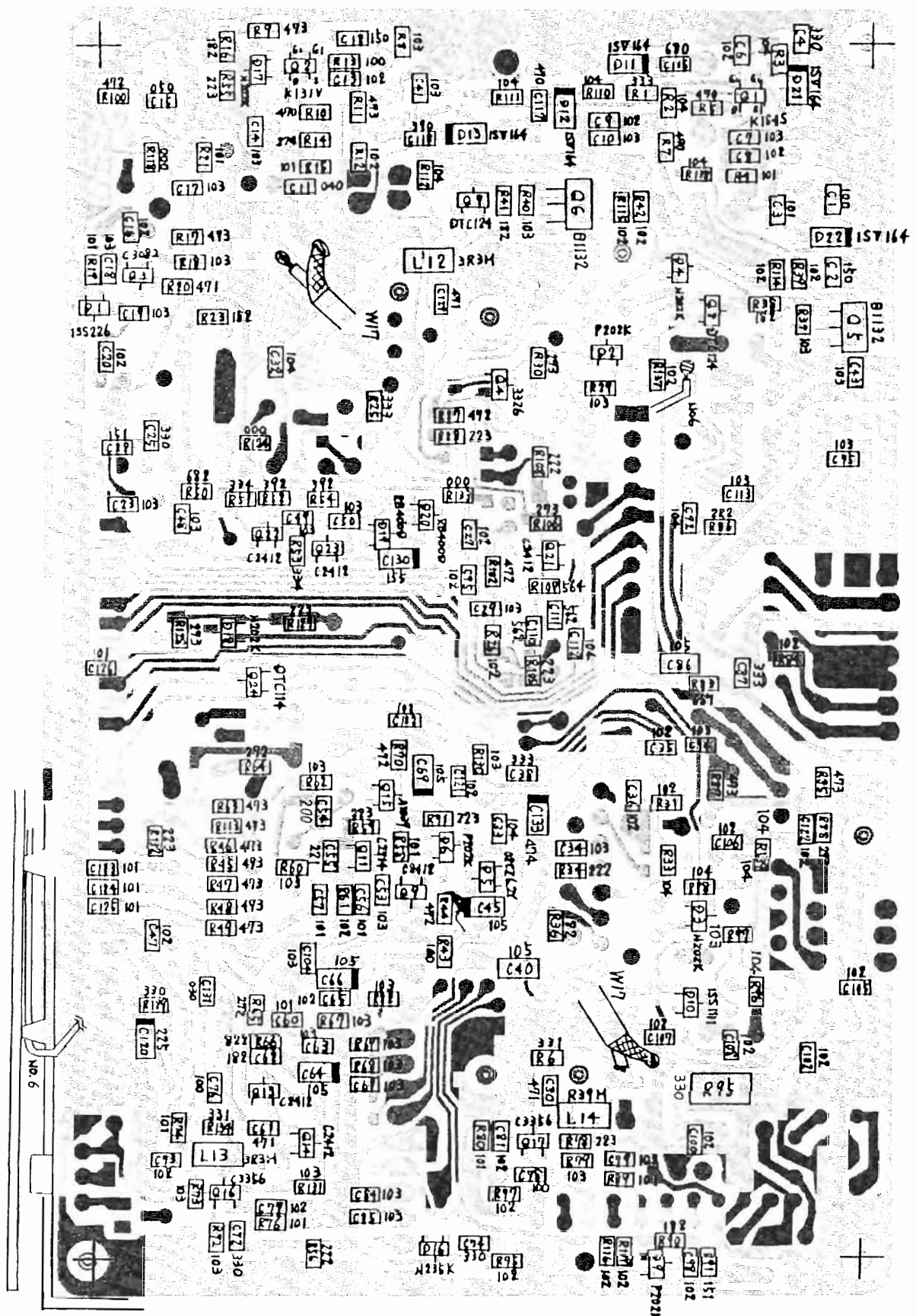

NO. 6

■ APC PC BOARDS

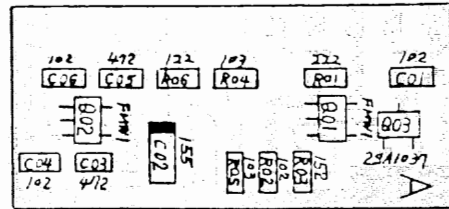
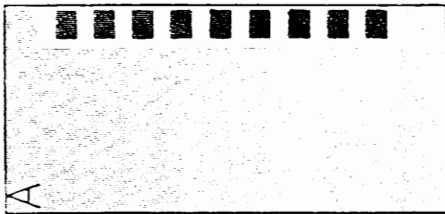

■ MIC PC BOARDS

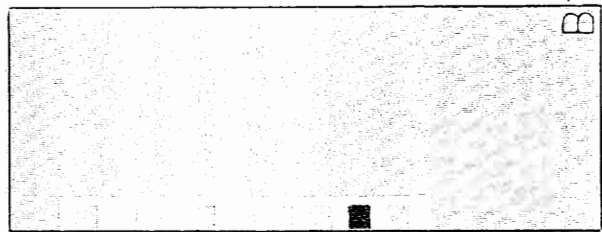
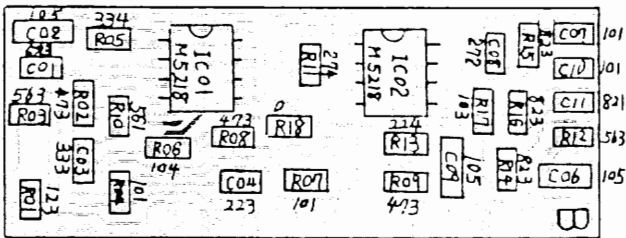

■ SQL PC BOARDS

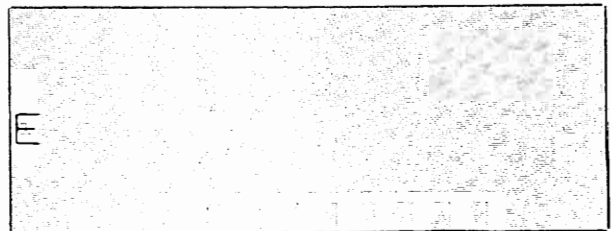
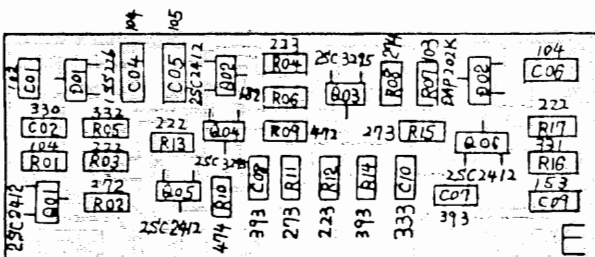

■ LOCK SW PC BOARDS

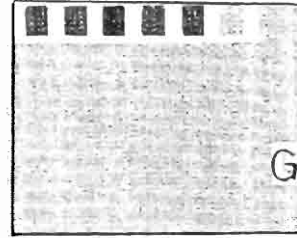
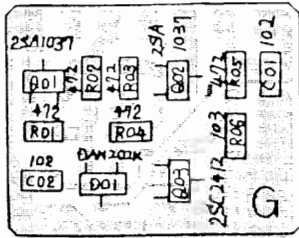

■ IF PC BOARDS

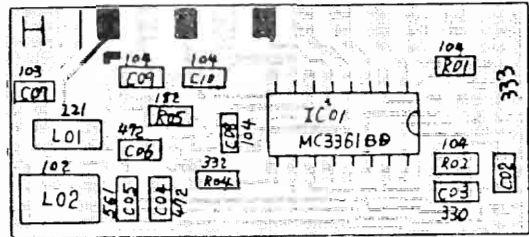

■ 144 DRIVE PC BOARDS

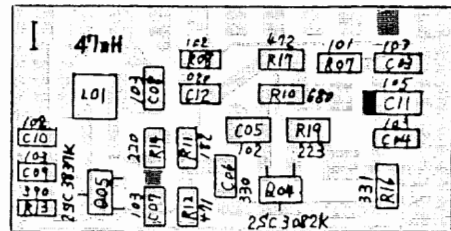
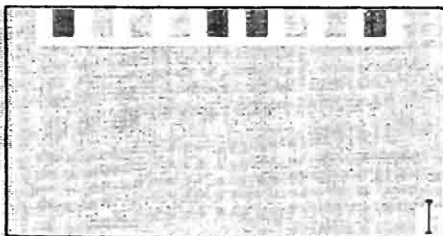

LIBAT PC BOARDS

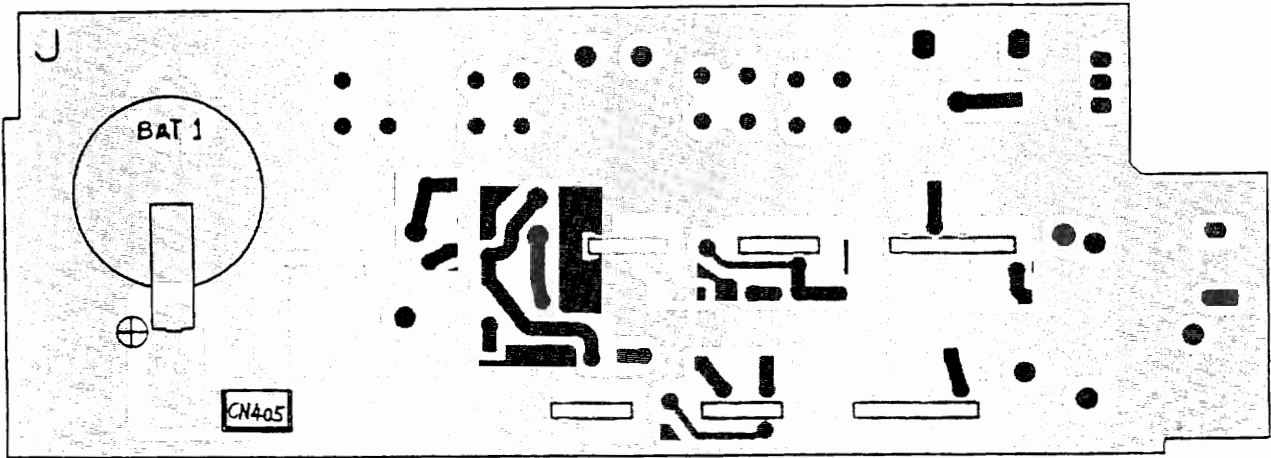

144 VCO PC BOARDS

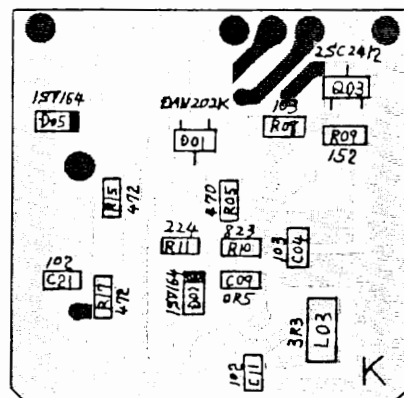
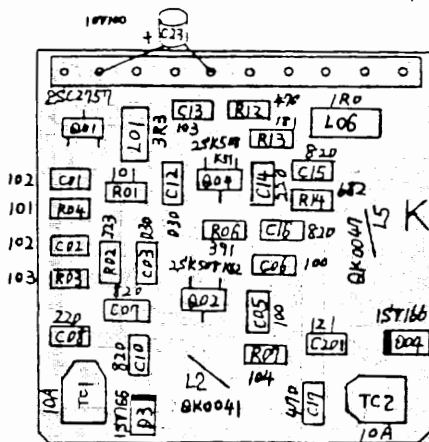

■ PA PC BOARDS

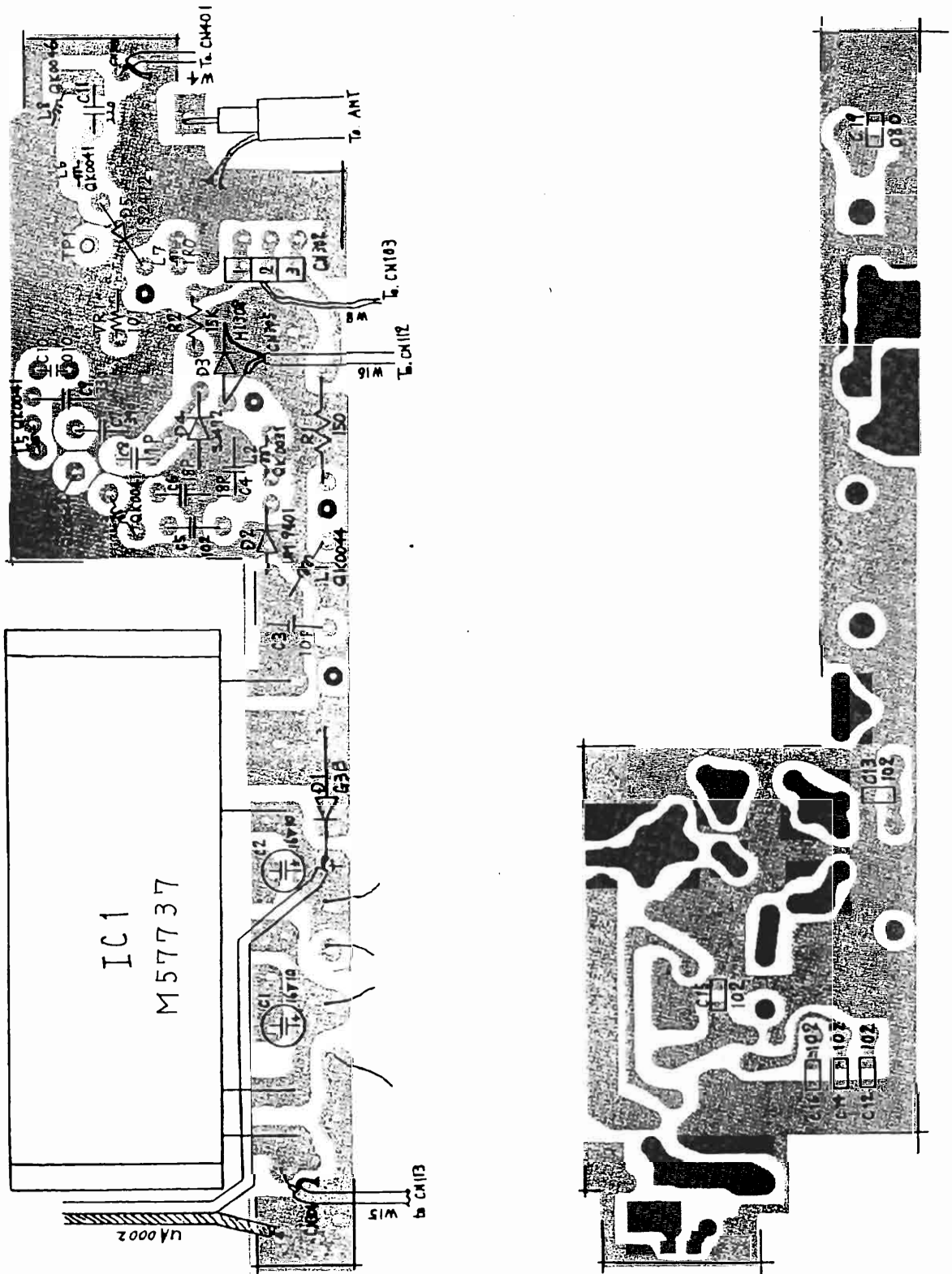



ALINCO ELECTRONICS INC.

Head Office : "TWIN 21" MID Tower Building 23F
1-61, 2-Chome, Shiromi, Higashi-ku, Osaka No. 540, Japan

Factory : 1-1-1, Mishimae, Takatsuki, Osaka No. 569, Japan

Dealer/Distributor