

ALINCO

VHF / FM MOBILE TRANSCEIVER

DR-150 T E

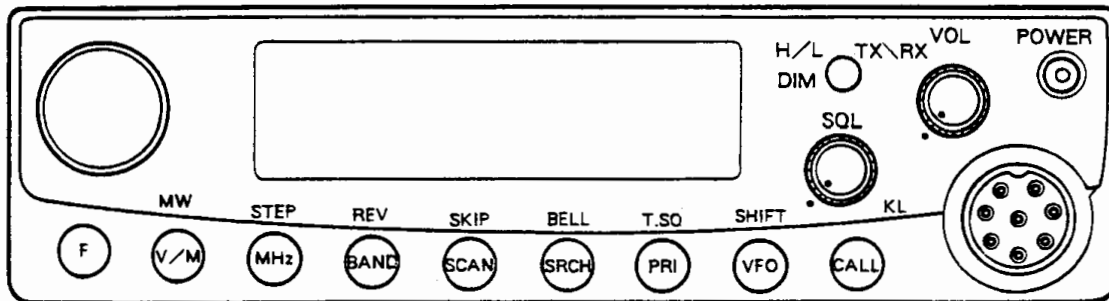

Instruction Manual

Thank you for buying this **ALINCO** transceiver. This instruction manual contains important safety and operating instructions. Please read it carefully before using the transceiver.

Table of Contents

1

Before Operating the Transceiver

Accessories	5
Installation	6
Specification	7

2

Panel Description

1. Front panel.....	8
2. Display	10
3. Rear panel	11
4. Microphone.....	11

3

Basic Operation

1. Receiving.....	12
2. Transmitting.....	14
3. Operating modes	15
4. Main and sub band operation	16

4

Advanced Functions

1. Memory channels	17
Calling up a memory channel	17
Temporarily changing a memory channel frequency (temporary mode).....	18
Programming a memory channel	18
Clearing a memory/reclaiming a memory	19
Transferring a memory to VFO	20
Operating in memory channel indication mode.....	20
2. Call channel	21
Calling up a call channel	21
Changing the call channel's frequency	21

3. Channel scope	22
VFO channel scope	22
Memory channel scope	24
Channel scope operation with the DTMF equipped microphone (EMS-12)	25
4. Scans	26
Setting a scan type	26
Band scan	27
Programmed scan	27
Memory scan	29
5. Sweep scan	30
Band sweep scan	30
Programmed sweep scan	30
Memory sweep scan	31
6. Priority watch.....	32
Priority watch while waiting on 2 channels.....	32
7. Other functions.....	33
S-meter squelch function	33
Setting the squelch timer	34
Shift and split settings (using different frequencies for transmit and receive).....	35
Reverse (transmit and receive frequencies are exchanged)	36
Setting the tone encoder	37
Changing tuning steps	38
Key lock	38
Bell function ON/OFF	39
Adjusting the display brightness	39
Beep tones ON/OFF	40
Setting the transmit time-out timer	40
RF attenuator ON/OFF	41
Sending a tone burst signal	41
Changing the CALL/TONE key function	41
Receive LITZ signal (DR-150T only).....	42
AM receiving	42

8. Cloning	43
9. Resetting the CPU	43
Full reset	44
VFO reset	44
Memory reset	44

5 Selective calling

General	45
1. Tone squelch	46
Tone scan	47
2. DSQ	48
Setting DSQ mode	48
Programming DSQ codes	49
Setting DSQ mode with a DTMF equipped microphone	50
Programming DSQ codes with a DTMF equipped microphone	50
Communicating in code squelch mode	51
Communicating in group pager mode	52
Communicating in private pager mode	53
Changing the rate of transmission of DTMF codes	54
Adjusting the DTMF code burst time	54
Transmitting DTMF codes manually	54
3. Auto-dialing	55
Programming transmit codes into memory	55
Correcting a code that you have entered	56
Confirming a received DTMF code	56
Transmitting a code using auto-dialing	57
Inhibiting auto-dialing (clearing DIAL)	57

6 Remote control operation

Operating procedure for microphone remote control	58
Entering a frequency directly	60

7 Packet operation

General	61
1. 1200 bps packet operation	62
2. 9600 bps packet operation	63

8 Maintenance

Troubleshooting	64
-----------------------	----

1

2

3

4

5

6

7

8

N O T I C E

This equipment has been tested and found to comply with the limits pursuant to Part 15 of the FCC Rules. These limits are designed to provide reasonable protection against harmful interference in a residential installation. This equipment generates, uses, and can radiate radio frequency energy, and if not installed and used in accordance with the instructions, may cause harmful interference to radio communications. However, there is no guarantee that interference will not occur in a particular installation. If this equipment does cause harmful interference to radio or television reception, which can be determined by turning the equipment off and on, the user is encouraged to try to correct the interference by one or more of the following measures.

- *Reorient or relocate the receiving antenna.*
- *Increase the separation between the equipment and receiver.*
- *Connect the equipment into an outlet on a circuit different from that which the receiver is connected.*
- *Consult the dealer or an experienced radio/TV technician for help.*

● ACCESSORIES ●

Carefully unpack your transceiver and you will find the Standard Accessories included:

■ Standard Accessories

1. Hand Microphone (Condenser Type).
2. Mobile Mounting Bracket.
3. Installation Hardware. (4 Black screws 4 Screws 1 Spanner)
(4 Sets Bolt/Nut 2 Fuse)
4. DC Power Cord.

Optional accessories are available, as listed below, at your Authorized ALINCO Dealer. We strongly recommend that you purchase the appropriate accessories to get full features and performance from you radio.

■ Optional Accessories

1. EJ-20U Tone Squelch Decoder Unit

● INSTALLATION ●

Mobile Antenna Installation:

50 Ohm coaxial cable is required for all antenna installations. Mobile antennas require an appropriate mounting base for proper installation and operation. Please refer to the antenna manufacturer's manual for the proper installation and mounting information. After installing your antenna, insure that you have the proper matching and best possible SWR reading. High SWR or improper matching can cause severe damage to your unit.

Caution:

High RF environments can cause severe damage to your unit. Ensure that you are not in a High RF environment when operating the DR-150T/DR-150E.

■ MOBILE INSTALLATION

1. Location

The transceiver may be installed in any position* in your car, where the controls and microphone are easily accessible and safe operation of the vehicle or the performance of the set will not be interfered with. (*Local regulation may apply)

Refer to the diagrams for installation of the Mounting Bracket:

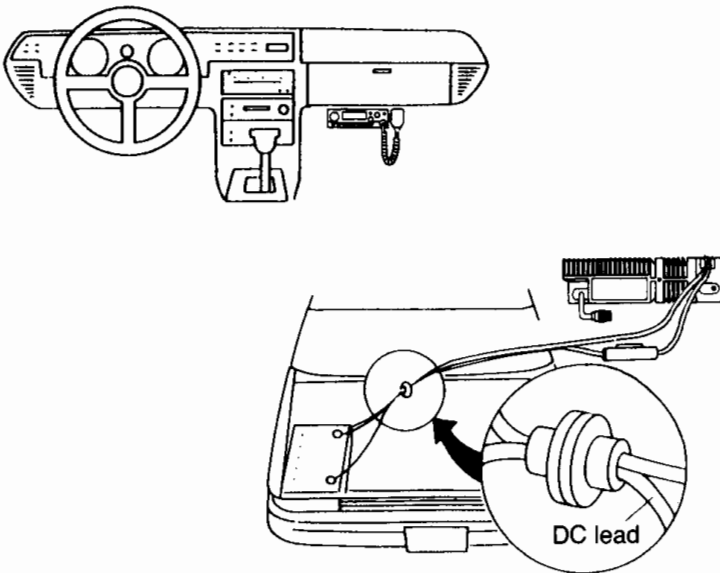

2. Power Requirements

The transceiver can be operated from any regulated 12 or 13.8 V negative ground source.

For mobile use, power connections should be made directly to the battery to minimize the possible ignition noise pickup.

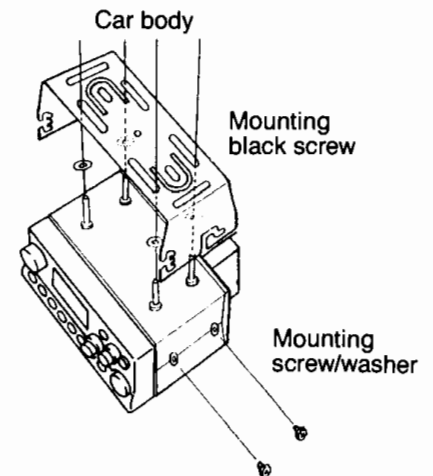

■ BASE STATION INSTALLATION

For fixed base operation, a 13.8 V D.C. Power Supply capable of providing at least 15 A continuously is required.

Connect the red lead of the power cable to the Positive (+) terminal, and the black lead to the Negative (-) terminal of the D.C. Power Supply.

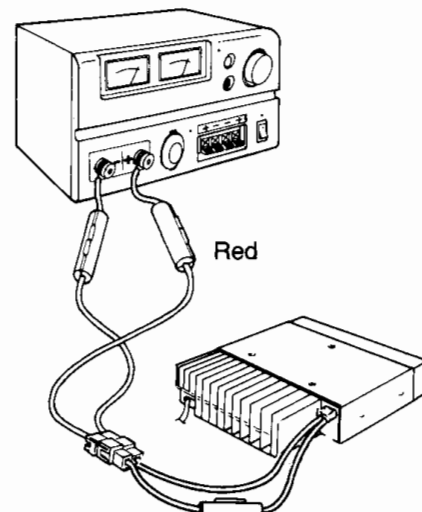

● SPECIFICATIONS ●

1

MODEL	DR-150T	DR-150E
GENERAL		
Freq. range	Tx : 144.000-147.995MHz FM Rx : 108.000-173.995MHz FM/AM Rx : 440.000-449.995MHz FM/AM	Tx : 144.000-145.995MHz FM Rx : 144.000-145.995MHz FM Rx : 430.000-439.995MHz FM
Operation mode	F2E, F3E (FM) A3E (AM) Receive only	
Ant. impedance	50 ohms	
Supply voltage	13.8V DC	
Current consumption	Transmit (High) 10A / Receive 0.6A	
Freq. stability	± 10 ppm max.	
Dimensions	140mm(W) × 40mm(H) × 129mm(D)	
Weight	approx. 800g (body only)	
Microphone	EMS-12 (DTMF mic.)	EMS-5A (plain mic.)
TRANSMITTER		
Power output (approx.)	High 50W / Mid 25W / Low 10W	
Modulation system	Reactance modulation	
Spurious emission	not more than - 60dB	
Max. deviation	± 5kHz	
Distortion at 60% modulation	not more than 3%	
Mic. impedance	2.2K ohms	
RECEIVER		
Receiving system	Double conversion superheterodyne	
I.F.	First: 45.1MHz / Second: 455kHz	
Sensitivity (12dB SINAD)	2m band: - 16dB μ or better, 70cm band: - 10dB μ or better	
Selectivity	- 6dB: 12kHz or more, -60dB: 28kHz or less	
Squelch sensitivity	- 20dB μ or better	
AF output	1.5W	
AF output imp.	8 ohms	

Specifications are subject to change without notice or obligation.
Specifications guaranteed in the amateur band only.

Operating temperature - 10°C ~ + 60°C

2

Panel Description

1. Front panel

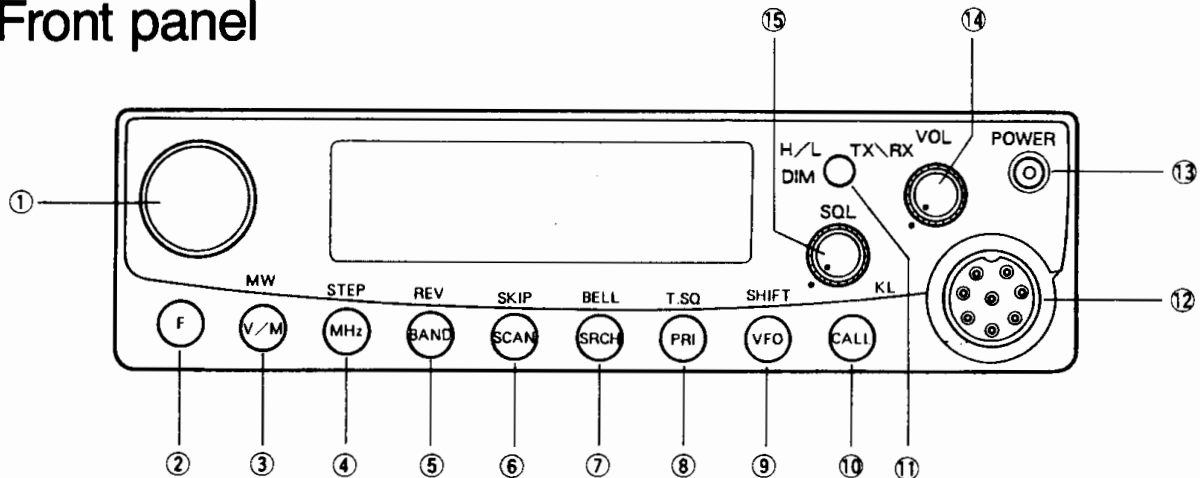

● Primary functions

No.	Name	Function	Page
1	Dial	Rotating the dial changes the frequency, memory channel and other various settings.	13
2	F	Push this key to activate secondary functions of other keys. FUNC appears when this key is pushed for less than 0.5 sec.; FUNC appears and flashes when this key is pushed for more than 0.5 sec.	-
3	V/M / MW	Toggles between VFO (A or B) and memory modes.	15
4	MHz / STEP	Changes the VFO frequency in 1 MHz steps (up or down)	13
5	BAND / REV	Toggles between the main and sub bands	16
6	SCAN / SKIP	In VFO and memory modes, starts and stops scan. During tone operation, starts tone scan.	26
7	SRCH / BELL	In VFO and memory modes, starts and stops channel scope operation.	22
8	PRI / T.SQ	Starts and stops priority watch.	32
9	VFO / SHIFT	In VFO mode, toggles between A and B. In memory mode, when pushed for less than 0.5 sec., enters temporary memory mode; when pushed or more than 1 sec., starts memory shift operation.	15 18 20
10	CALL / KL (DR-150T) TONE / KL (DR-150E)	DR-150T: selects call mode. Push a second time to return to the previous indication. DR-150E: Push and hold to transmit a 1750 Hz tone burst signal for repeater access.	15 41
11	H/L / DIM	Selects one of three output power levels.	14
	TX / RX	Lights green while receiving; lights red while transmitting.	12
12	Microphone connector		-
13	POWER	Turns the power ON/OFF.	12
14	VOL	Adjusts the audio output.	12
15	SQL	Adjusts the squelch setting.	12

● **Secondary functions after F is pushed for less than 0.5 sec (FUNC appears).**

No.	Name	Function	Page
1	Dial	Sets the S-meter squelch level	33
2	F	Cancels the FUNC indication.	–
3	V/M / MW	Programs memory information.	18
4	MHz / STEP	Changes the tuning step.	38
5	BAND / REV	Exchanges the receive and transmit frequencies.	36
6	SCAN / SKIP	In memory mode, toggles a skip setting ON and OFF.	29
7	SRCH / BELL	Toggles the bell function ON and OFF.	39
8	PRI / T.SQ	Activates tone operation; also used to set a tone frequency.	37
9	VFO / SHIFT	Sets offset direction, frequency and split operation.	35
10	CALL / KL (DR-150T) TONE / KL (DR-150E)	Toggles the lock function ON and OFF.	38
11	H/L / DIM	Selects one of two levels of display backlighting.	39

● **Functions after pushing the F key for more than 0.5 sec (FUNC appears and flashes).**

No.	Name	Function	Page
1	Dial	Sets the squelch timer.	34
2	F	Cancels the FUNC indication.	–
3	V/M / MW	Clears a memory channel or restarts an operation.	19
4	MHz / STEP	DR-150T only: toggles between AM and FM operation.	42
5	BAND / REV	Sets the time-out timer.	40
6	SCAN / SKIP	Selects a scan type.	26
8	PRI / T.SQ	Selects DSQ mode. Also used to set and send a DSQ code.	47
9	VFO / SHIFT	Initializes VFO data.	43
10	CALL / KL	Toggles beep tones ON and OFF.	40
11	H/L / DIM	Toggles the main band attenuator ON and OFF.	41

● **Functions pressed while turning power ON.**

No.	Name	Function	Page
2	F	All reset.	43
3	V/M / MW	Memory channel reset.	43
4	MHz / STEP	Selects memory channel indication mode.	20
5	BAND / REV	(DR-150T only) Toggles LITZ function ON/OFF.	42
6	SCAN / SKIP	Changes the DTMF code burst time.	53
8	PRI / T.SQ	Changes the DTMF first digit transmission speed.	53
10	CALL / KL (DR-150T) TONE / KL (DR-150E)	Selects the call channel or toggles tone burst ON and OFF.	41
11	H/L / DIM	Selects cloning mode.	

2. Display

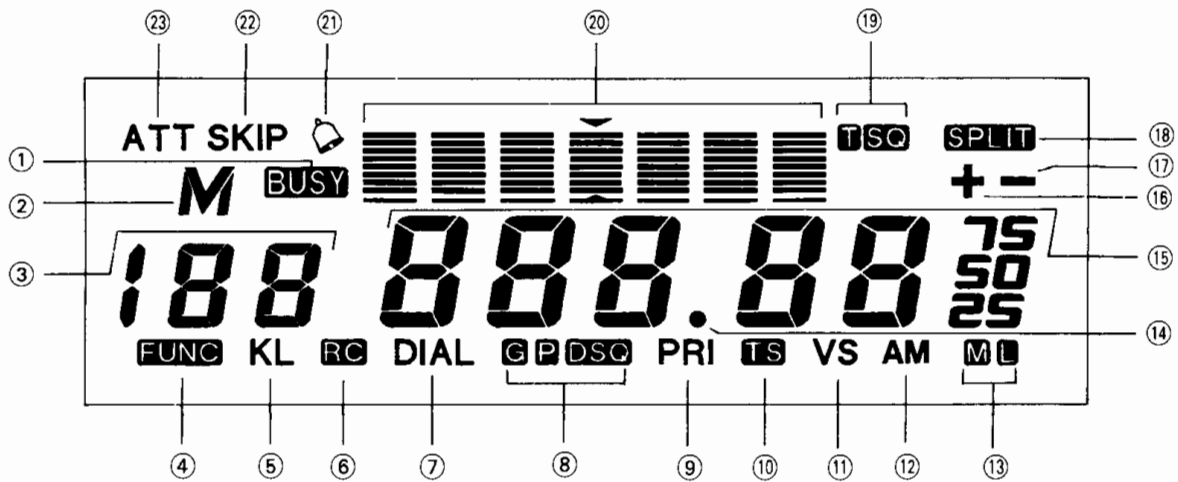

- | | |
|--|--|
| <p>① BUSY Appears while receiving a signal.</p> <p>② M V Indicates VFO mode is selected.
M Indicates memory mode is selected.</p> <p>③ 188 In VFO mode, indicates VFO A or B. In memory mode, indicates memory channel number.</p> <p>④ FUNC Appears when F is pushed for less than 0.5 sec.; appears and flashes when F is pushed for more than 0.5 sec. Pushing another key during either of these conditions activates a function per page 9.</p> <p>⑤ KL Appears when the lock function is activated.</p> <p>⑥ RC Appears when REMOTE is selected on the DTMF Mic; flashes when C is entered (optional for DR-150E).</p> <p>⑦ DIAL Flashes when the auto dial function is activated (optional for DR-150E).</p> <p>⑧ G P DSQ Appears when the DSQ function is activated.</p> <p>⑨ PRI Appears during priority watch. Flashes when receiving the priority channel for an extended period.</p> <p>⑩ TS Appears during timer scan (disappears during busy scan).</p> <p>⑪ VS Appears during empty scan (disappears during normal scan).</p> | <p>⑫ AM Appears during AM reception.</p> <p>⑬ ML Indicates the output power (high power is selected when neither is indicated).</p> <p>⑭ . MHz decimal point for receive/transmit frequency. Flashes during scanning and priority watch pause.</p> <p>⑮ 888.88 Indicates frequency, offset frequency, tone frequency and various other settings.</p> <p>⑯ + Indicates plus duplex is selected.</p> <p>⑰ - Indicates minus duplex is selected.</p> <p>⑱ SPLIT Appears during split mode operation.</p> <p>⑲ T SQ Appears while the tone encoder or tone squelch is activated.</p> <p>⑳ ■■■■■■ S-meter during receive; R/F meter during transmit. During channel scope operation, indicates the receive level of each signal.</p> <p>㉑ 🔔 Indicates the bell function is activated; flashes when you are being called.</p> <p>㉒ SKIP Indicates skip memories during scanning.</p> <p>㉓ ATT Appears when the RF attenuator is ON.</p> |
|--|--|

3. Rear panel

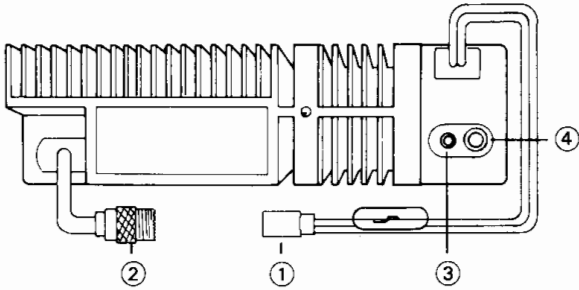

- ① **Power connector**
Connect the supplied power cord here. Red indicates the positive terminal; black indicates the negative terminal. Use a 13.8 V DC power source only.
- ② **Antenna connector**
Connect a 50 ohm antenna here.
- ③ **9600 bps packet terminal**
When operating 9600 bps packet, connect your TNC here. (p. 61 ~ p. 63)

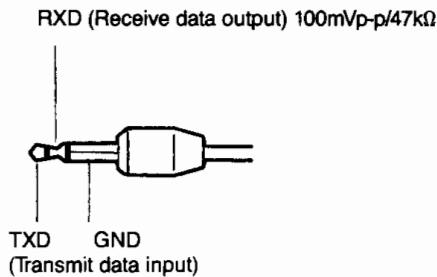

- ④ **External speaker terminal**
For connection of an external speaker. When an external speaker is connected, audio is output from this terminal. Also, connect here for 1200 bps packet operation. (p. 61 ~ p. 62)

4. Microphone

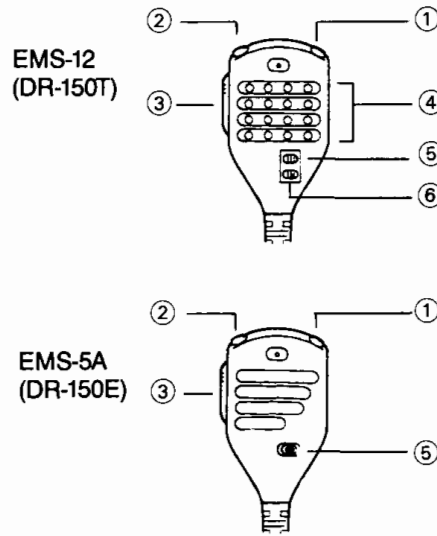

- ① ② **UP/DOWN key**
Increments/decrements the frequency, memory channel and various other indications. Push and hold to change continuously. Pushing and holding for more than 0.5 sec. starts a scan. In this case, push PTT to stop the scan.
- ③ **PTT**
Push and hold to transmit. Can also be used to end other setting operations in progress.
- ④ **DTMF key**
Used for remote control commands and entering frequency.
- ⑤ **UP/DOWN lock switch**
When this switch is activated, the UP/DOWN key is inhibited.
- ⑥ **REMOTE/DTMF switch**
Select REMOTE for remote control operation; select DTMF for DTMF code reception.

Microphone pin assignments

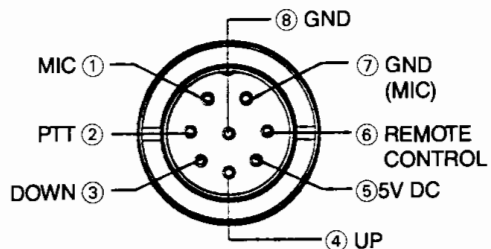

3

Basic Operation

1. Receiving

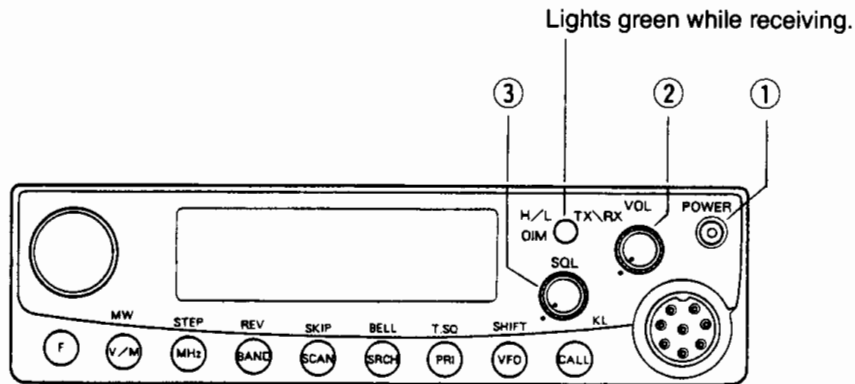

1. Power ON

Push **POWER**.

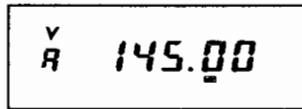

■ Push **POWER** a second time to turn the power OFF.

2. Adjusting the audio volume

Rotate the **VOL** knob.



Clockwise rotation increases the volume.

Counterclockwise rotation decreases the volume.

3. Adjusting the squelch

Rotate the **SQL** knob.

Rotate the SQL counterclockwise until noise is emitted, then rotate SQL counterclockwise until the noise is just muted. If the SQL is rotated too far counterclockwise weak signals will not be received.

■ An S-meter squelch function is also available. (p. 33)
(Noise squelch is the normal setting).



Indications during receive

1. The scope indication (S-meter) shows 8 levels of reception sensitivity.
2. TX/RX lights green while receiving.



■ When the UP/DOWN key is pushed for longer than 0.5 sec., scan starts. To stop the scan, push PTT.

■ Receive frequency range (MHz)

DR-150T	DT-150E
108.000 ~ 173.995	144.000 ~ 145.995

4. Selecting a frequency

Rotate the **DIAL** or push the **UP/DOWN** key on the microphone.

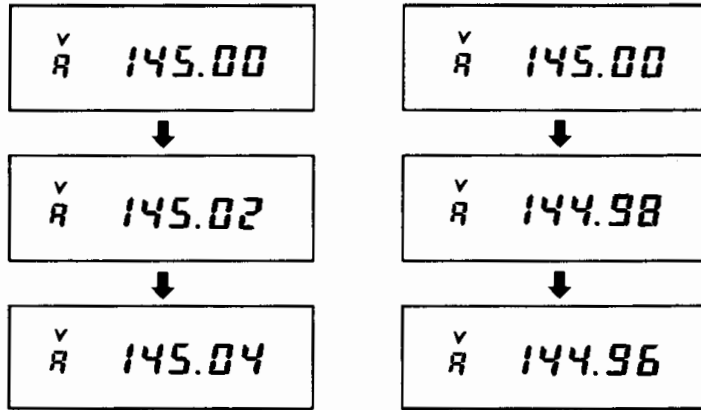
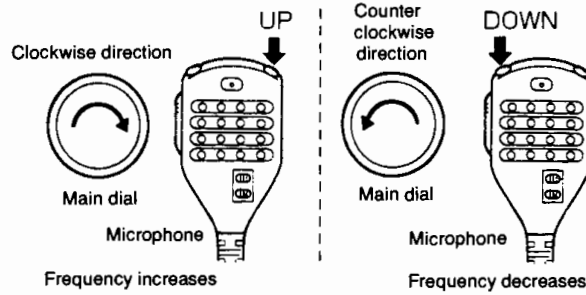

3

5. Changing the MHz digit only

① Push the MHz key.

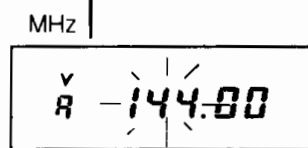
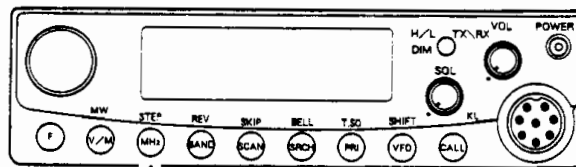

MHz digit flashes.

② Rotate the **DIAL** or push the **UP/DOWN** key to set the desired MHz digit. Only the MHz digit is affected.

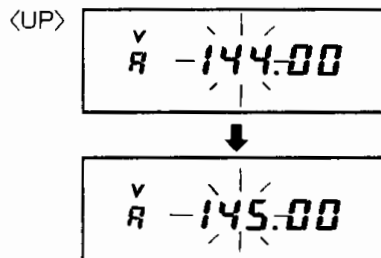

The MHz digit stops flashing.

When finished, push MHz, PTT or F. Also, this operation is finished if no keys or switches are pushed for 5 sec.

2. Transmitting

■ Transmit frequency range (MHz)

DR-150T	DR-150E
144.000 ~147.995	144.000 ~145.995

■ The factory default setting is HI power.

1. Selecting a frequency for transmit

Set a transmit frequency in the same manner as a receive frequency (page 13).

2. Selecting an output power

Push the H/L key.

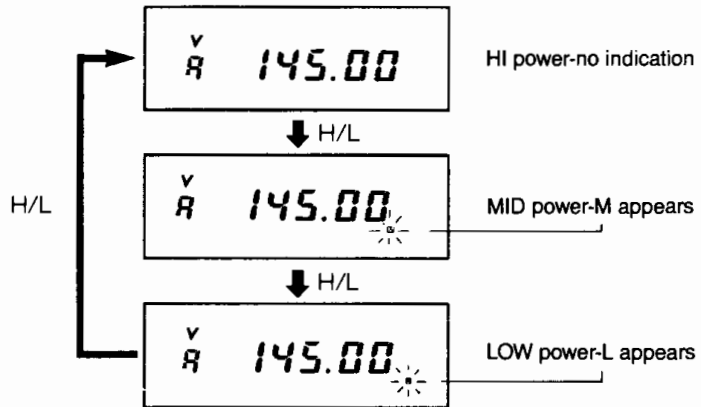
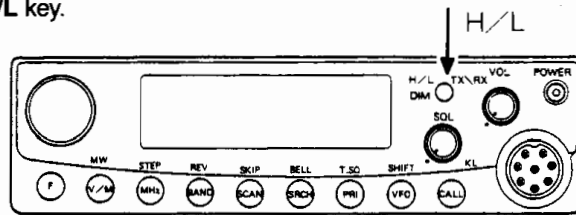

3

Note

- Do not interfere with other stations while transmitting.
- When trying to transmit outside of the allowed frequency range, "OFF" appears and transmit is inhibited.

■ During transmit, output power is indicated by the RF meter.



3. Transmitting

Push PTT on the microphone.

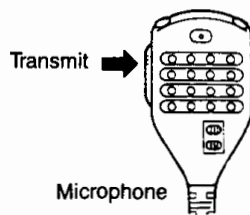

When TX LED lights red (indicating transmit condition) speak into the microphone.

Release PTT to receive.

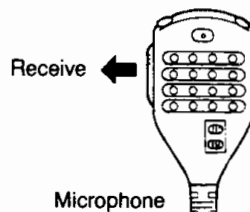

TX LED turns OFF. When a signal is received, it lights green.

3. Operating modes

This transceiver has 3 operating modes (VFO mode, memory mode and call mode).

Changing modes

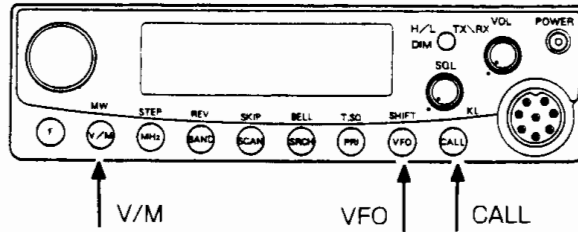

VFO mode

When initially applying power, VFO mode is selected and rotating the **DIAL** or pushing the microphone's **UP/DOWN** key changes the frequency. VFO A and VFO B are available. Push **VFO** to toggle between the two. When selecting VFO mode from another mode, whichever was selected last, VFO A or VFO B, is selected.

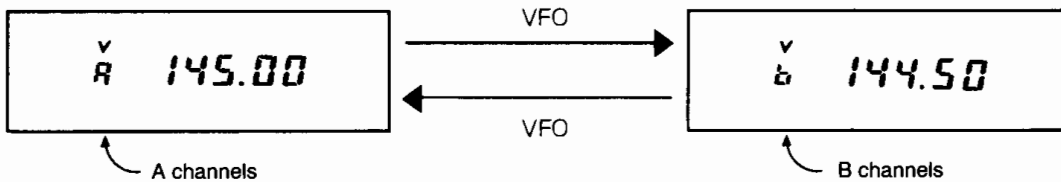

V/M

V/M

CALL

When VFO mode has been selected prior to CALL mode.

V/M or Call

Memory mode

Programmed memory channels can be selected in this mode. Rotating the **DIAL** or pushing the **UP/DOWN** key changes the selected memory channel number.

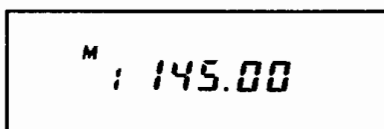

Memory number

(For details see page 17).

When operating memory mode prior to call mode.

V/M or CALL

CALL

CALL mode

This mode is used to receive or transmit on the programmed call channel.

Note DR-150E: This key operates as the **TONE** key on page 41. The call channel can be selected only when this key is allocated to the **CALL** key.

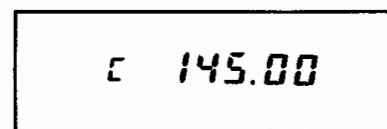

Call channel

(For details, see page 21).



4. Main and sub band operation

This transceiver can receive and transmit on the main band, or receive only on the sub band.

Model	Main band		Sub band	
	Receive	Transmit	Receive	Transmit
DR-150T	108.000 ~ 173.995	144.000 ~ 147.995	440.000 ~ 449.995	×
DR-150E	144.000 ~ 145.995	144.000 ~ 145.995	430.000 ~ 439.995	×

Note When pushing the PTT on the sub band, "OFF" appears and transmit is inhibited.

Changing bands

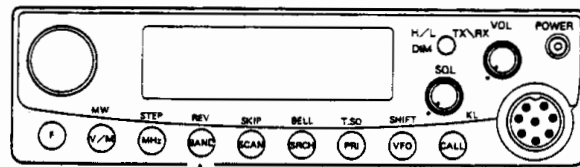

- ① Select VFO mode.
- ② Push **BAND**. Each push of this key selects the main and sub bands alternately.

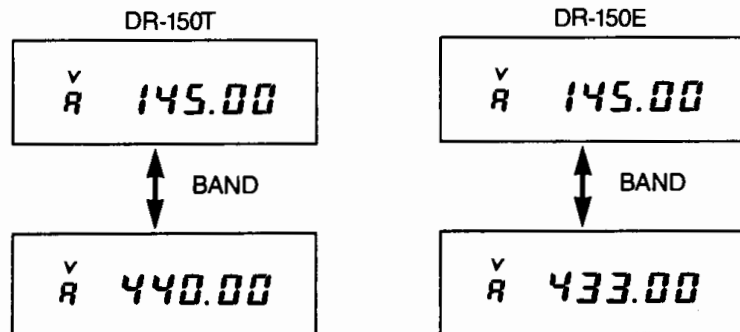

4

Advanced Functions

1. Memory channels

This transceiver has 100 memory channels, plus programmed scan edges and call channels, providing tremendous operating versatility. Program often used frequencies and settings into memory channels for quick and easy recall.

Memory types and default settings from the factory

Memory number	Contents	Initial value	
		DR-150T	DR-150E
ch 1	Regular memory channels	145.000	145.000
ch 2 ~ 100		Not programmed	
U	Programmed scan edge upper limit	173.995	145.995
L	Programmed scan edge lower limit	108.000	144.000
C	Call channel	145.000	(145.000)*

Programmable memory contents

- ① receive frequency
- ② offset direction
- ③ offset frequency
- ④ tone setting
- ⑤ tone encoder frequency
- ⑥ tone decoder frequency
- ⑦ DSQ setting

*See pages 21 and 41.

Calling up a memory channel

Before selecting a memory channel, memory mode must be selected.

- When selecting memory mode for the first time, memory channel 1 is selected by default.

1. Select memory mode (not necessary if memory mode is already selected).

While in VFO mode, push **V/M**.

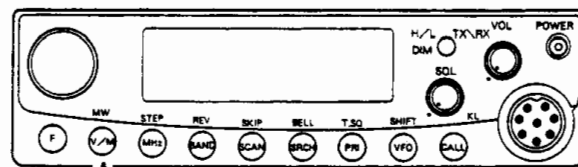

M : 145.00

M and the memory channel number are indicated in memory mode.

- Only memories already programmed appear (by default, these are ch 1, the upper and lower scan edges and call channel only).

2. Selecting a memory channel

Rotate the **DIAL** or push the **UP/DOWN** keys.

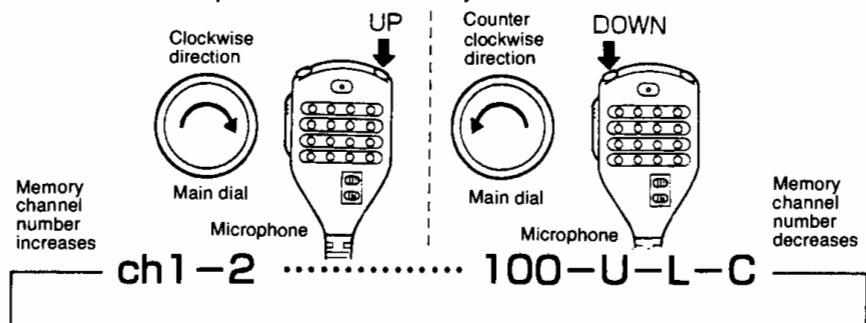

Temporarily changing a memory channel frequency (temporary mode)

When in temporary mode, the frequency changes according to the tuning steps set in VFO mode.

- The MHz key can be used to change the MHz digit of the frequency only.
- Settings other than frequency can be changed in the same manner as in regular memory mode.

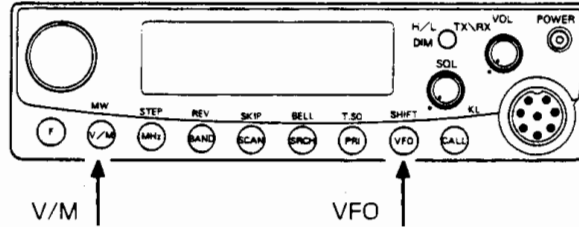

- ① Push **VFO**, then release it within 1 sec.

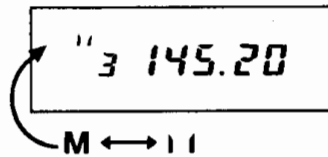

Temporary adjust mode is selected and **M** and **1** appear.

- ③ Rotate **DIAL** or push the **UP/DOWN** key to change the frequency. Frequency changes according to the tuning step selected in VFO A or VFO B, whichever was previously selected.

Push **V/M** to exit.

Display returns to the previously selected memory channel's programmed data.

Programming a memory channel

The current operating conditions can be programmed into a specific memory. Programming can be accomplished from the modes listed below.

- VFO mode
- memory mode
- temporary memory mode
- call mode

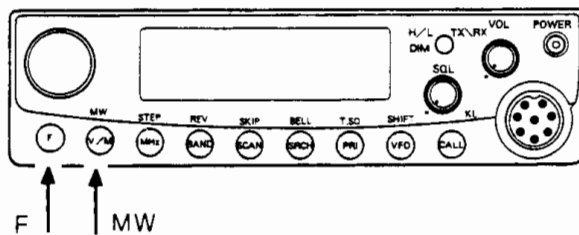

- ① Push **F** and release it within 0.5 sec.
FUNC appears.

- ② Push **MW**.

M and a memory number appear.

The last programmed memory is selected. If the memory channel has been changed since programming, the next higher unwritten memory channel is automatically selected; if no empty memory channel can be found in this direction, the transceiver searches in the lower direction until an unwritten channel is found. In no unwritten channel is found, then the previously programmed memory or previously used memory is found.

- While selecting a memory, the flashing memory number stops flashing.

Caution

- When a memory with no flashing M is selected, the previously programmed data is erased.
- Skip setting**
Upper and lower scan edges and the call channel are programmed with the skip setting ON. Ch 1 to 100 are programmed with the skip setting OFF (see page 29).

- Rotate **DIAL** or push the **UP/DOWN** key on the microphone to select a memory. Any memory channels can be selected. Frequency and other indications do not change.

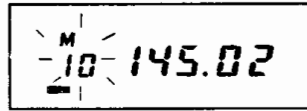

◀ Unwritten memory indication M and the memory number flash

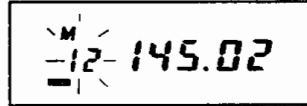

◀ Programmed memory indication M (not flashing) memory number does flash

- Push **MW**.
A beep sounds indicating the memory is programmed. **FUNC** disappears and the display returns to the previous indication.

Push **PTT** or **F** to exit the programming condition. If no operation is performed within 5 sec., the programming condition is automatically terminated.

Clearing a memory/reclaiming a memory

When selecting a memory, memories without a flashing M are cleared, memories with a flashing M are reclaimed.

Note

- The following memories cannot be cleared or reclaimed (ch 1, U, L, C).
- Reclaimed memories with no programmed data are automatically programmed with the VFO default data.

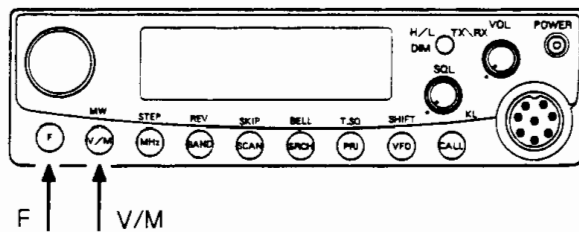

- While in memory mode, push **F** for more than 0.5 sec. **FUNC** flashes.
- Push **V/M(MW)**.
Memory number flashes.

Clearing

- By rotating **DIAL** or pushing the **UP/DOWN** key on the microphone, select a memory with an "M" that is not flashing.
- Push **V/M(MW)**.
The selected memory is cleared and the next lower memory is selected.

Reclaiming

- By rotating **DIAL** or pushing the **UP/DOWN** key on the microphone, select a memory with a flashing "M".
- Push **V/M(MW)**.
The selected memory is reclaimed.

Transferring a memory to VFO

- While in memory mode push VFO for more than 1 sec.

When **VFO** is pushed, temporary adjust memory mode is selected. Continue pushing VFO for more than 1 sec. to transfer the currently selected memories data to VFO A or VFO B (whichever was selected last). VFO mode is automatically selected.

- While in call mode or temporary memory mode, push VFO for more than 1 sec.

Push VFO for more than 1 sec. to transfer the data in the call channel or temporary memory to VFO. VFO mode is automatically selected.

Operating in memory channel indication mode (Channelized mode)

In this mode, only programmed memory numbers are indicated. VFO mode and call mode cannot be selected from this mode.

Note

The following operations cannot be performed in memory channel indication mode.

- Selecting VFO or call mode (p. 15)
- Memory programming (p. 18)
- Channel scope (p. 24)
- Programmed scan (p. 28)
- Priority watch (p. 32)
- Reverse (p. 36)
- Selecting a tuning step (p. 38)
- Reset (p. 43)

Shift split operation, tone operation and DSQ operation can be performed, however, their settings cannot be changed.

- ① While pushing **MHz**, turn power ON.

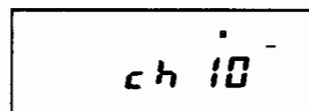
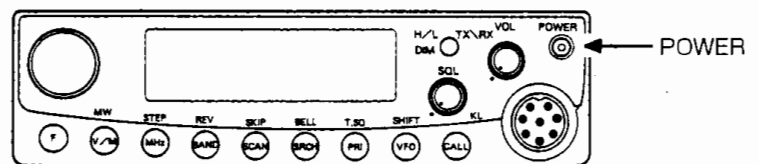

Frequency indication disappears and only the memory channel number is indicated.

- ② Use the **DIAL** or **UP/DOWN** key on the microphone to select a programmed memory channel.

Repeat step 1 above to exit memory channel indication mode (frequency indication reappears).

2. Call channel

This mode is used for operation on the call channel.

The call channel is indicated as channel C; data can be changed in the same manner as memory channels. It is convenient to program your most often used frequency into the call channel for instant recall.

DR-150E: The call channel can be called up only when the TONE key has been assigned the call function. (p. 41)

Calling up the call channel (Call mode)

- The factory default frequency for the call channel is 145.000 MHz.

In VFO or memory mode, push **CALL**.
(DR-150E: refer to page 41 to assign the call key)

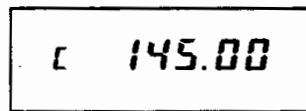
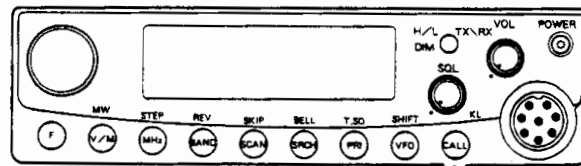

C appears and call mode is selected.

In call mode, pushing **CALL** selects the previously selected mode.

Changing the call channel's frequency

When wanting to change the contents of the call channel, memory channel C must be indicated.

- When setting data other than the frequency in call mode, the setting is temporary. When selecting a memory channel other than C from call mode, the data in the call channel is transferred to the specified memory.

- In call mode, pushing VFO for more than 1 sec. transfers the call channel's contents to VFO.

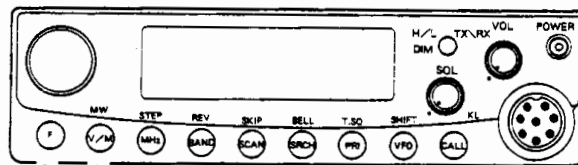

- ① Set new Call data in VFO or temporary memory mode.
- ② Push **F** for less than 0.5 sec.
FUNC appears.
- ③ Push **MW**.
- ④ Rotate **DIAL** or push the microphone's **UP/DOWN** key.
- ⑤ Push **MW**.
A beep sounds and the call frequency is changed.

Note

Memory C cannot be cleared.

3. Channel Scope

The Channel Scope function allows you to monitor received signal levels around a specific receiving frequency. This allows you to easily see activity around a signal thus catching signals you otherwise might have missed.

< Normal receive >

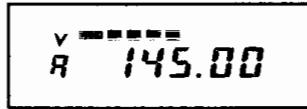

< Channel Scope >

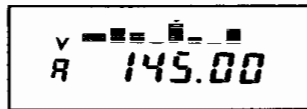

The center receive level indicator is marked with an (▼) and each of the 7 indicators shows the receive strength on a scale of 1 to 4.

- The indicating center receive frequency is called the center frequency or center channel.
- The Channel Scope operation works in the following sequence:

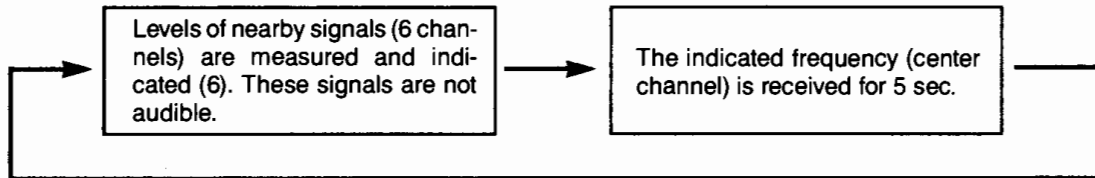

While signals are being measured on non-center channels, the center channel's audio is not audible.

4

There are two types of channel scope as follows.

- VFO channel scope adjacent frequencies receive levels are indicated according to the set tuning step.
- Memory channel scope adjacent memory channels receive levels are indicated.

VFO Channel Scope

- In call mode or temporary memory mode, push SRCH to set the indicated frequency to the center frequency for VFO channel scope operation.
- During reverse operation, the center frequency and the 3 upper and lower receive frequencies are also reversed.

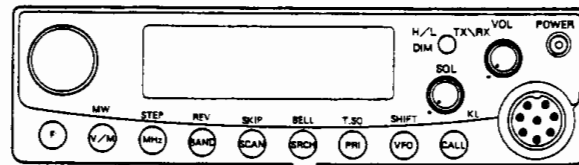

SRCH ↑

Start In VFO mode, push **SRCH**.
Channel scope mode and receive are selected.
Every 5 sec., according to the set tuning step, 3 frequencies on both sides of the center frequency are checked.

Stop Push **SRCH**.

■ Scope indication levels



■ Scope indication does not appear for channels outside of the band range. (Example below: DR-150T)

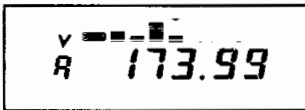
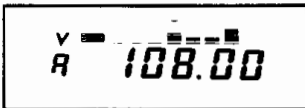

■ Push the MHz key to change the center frequency in units of 1 MHz (page 13). The scope indication changes with the new center frequency.

■ In call mode the center frequency cannot be changed.

1. What do the VFO scope level indications mean?

Example: tuning step is 20 kHz.

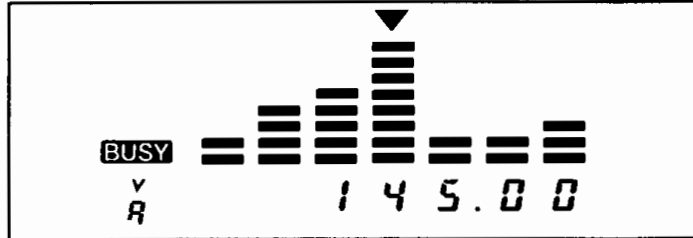
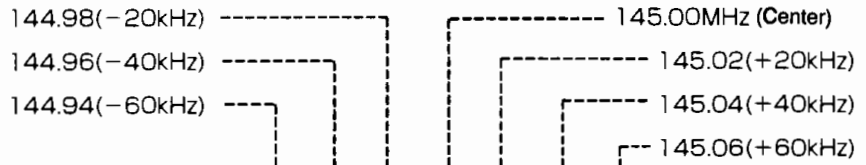

The 3 signals above and below the center frequency are checked every 5 sec.

2. Changing the center frequency

Rotate **DIAL** or push the **UP/DOWN** keys.

The center frequency changes according to the selected tuning step and the 7 signal level indicators also change accordingly.

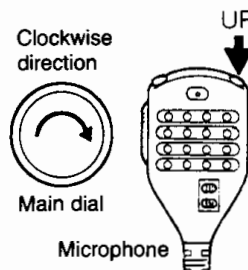

Center frequency increases

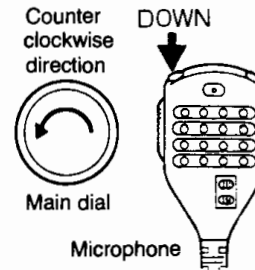
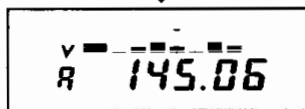
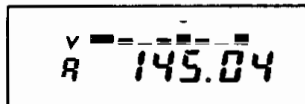

Center frequency decreases

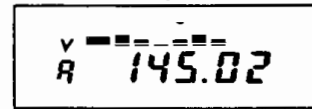
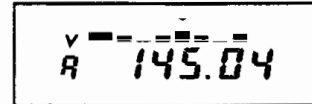

Transmitting during channel scope operation (VFO/memory modes)

During the Channel Scope operation, pushing **PTT** interrupts the channel scope receiving sequence and transmits on the center channel. At this time the channel scope indicator disappears and the RF meter appears to indicate the transmitted power output. When the transmission is finished, the Channel Scope operation resumes.

Memory Channel Scope

All programmed memories (including scan edges and the call channel) can be indicated on the Channel Scope.

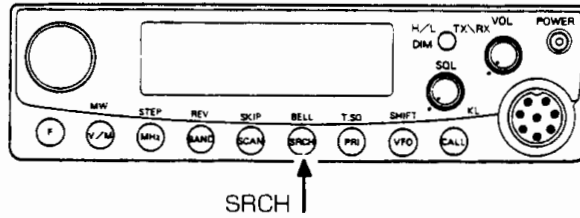

Start In memory mode, push **SRCH**. Channel Scope mode and receive are selected. The center channel is received and every 5 sec., the signal levels for the 3 channels above and below are measured.

Stop Push **SRCH**.

■ Refer to page 23 for details concerning the scope indication levels.

■ When the center channel is at the upper (ch. c) or lower (ch. 1) limits of the programmed memories, the scope indications levels are blank to the right or left of the center frequency, respectively.

<When ch. C is the center >
100 U L C

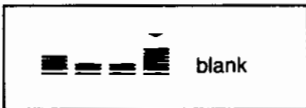

<When ch. 1 is the center >
1 2 3 4

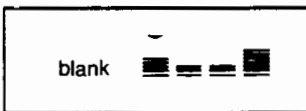

■ When less than 7 channels are programmed, side(s) of the center frequency would contain blanked levels.

Note

When the center channel is set to reverse, the center channel receives the reverse frequency, however, other channels are not received in reverse mode.

1. What do the memory scope level indications mean?

Example: M5, M6 are not yet programmed.

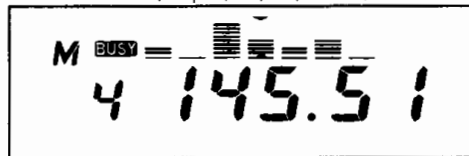
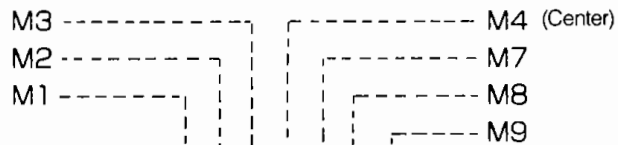

New receive levels above and below the center frequency are measured every 5 sec.

2. Changing the center channel

Rotate **DIAL** or push the microphone's **UP/DOWN** key.

When the center channel is moved up or down, the 7 receive signal levels are changed by one channel accordingly.

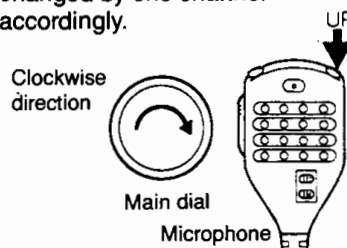

Memory channel increases

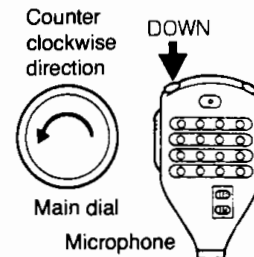
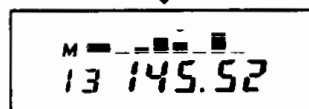
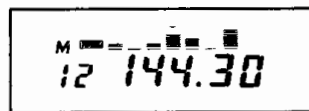

Memory channel decreases

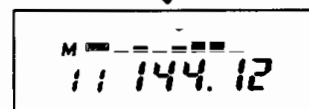
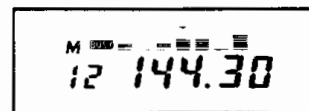

Channel Scope operation with the DTMF equipped microphone (EMS-12)

(For DR-150E: the optional EMS-12 DTMF microphone must be attached. The operation relates to both for VFO and memory scope operation.)

Caution

Before each operation, check to make sure that the REMOTE/DTMF switch is set to REMOTE.

■ The 5 sec. receive mode is resumed when the power is turned ON, or the Channel Scope operation is started, or sweep scan (p. 30) is executed.

1. Starting and stopping the scope function

Start Push "c" and "0" on the DTMF microphone.

Stop Repeat the above step.

2. Changing the center channel receive period (5 sec./0 sec.)

During channel scope operation, push "c" and "6" on the DTMF microphone.

This alternates the center channel receive period.

After the new receive period is indicated for 1 sec., frequency indication returns.

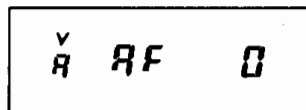

◀ 0 sec. receive
Scope levels of the center frequency and other channels are updated continuously. No receive audio.

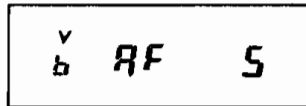

◀ 5 sec. receive
Every 5 sec., new receive levels are measured for the channels around the center frequency. Receive audio from the center channel.

3. Receiving in single start mode

During the Channel Scope operation push "c" and "7" on the DTMF microphone.

After this command the 7 signal levels are measured once. From then on only the center frequency indicator changes.

Push "c" and "7" to measure all 7 signals again.

Exit Push "c" and "6."
Single start mode is exited and 5 sec. receive is resumed.

4. Scanning

Scan searches for signals over a frequency range or in memory channels. The following scan types are available.

- Band scan Searches for signals over the entire band range.
- Programmed scan Searches for signals over a band between 2 user-defined frequencies (U is the upper scan edge and L is the lower scan edge).
- Memory scan Searches programmed memories.

Setting a scan type

Scan stops and resumes according to 4 scan resume conditions. Also, during priority watch, signals received on the priority channel have an influence (page 32).

■ Scan types can be selected while scanning.

■ Timer scan is the factory default.

■ During tone squelch (page 46) or DSQ (page 47) operation, received tones or codes (even if they are not matched) temporarily stop scanning. However, received signals for unmatched tones and codes are not audible. During empty scan, tones or codes are not checked for agreement.

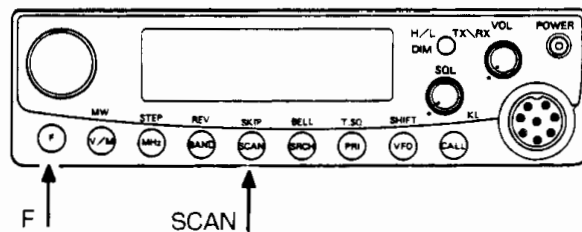

- ① Push **F** for more than 0.5 sec.
FUNC flashes.
- ② Push **SCAN**.
Each push of this key changes the scan type.

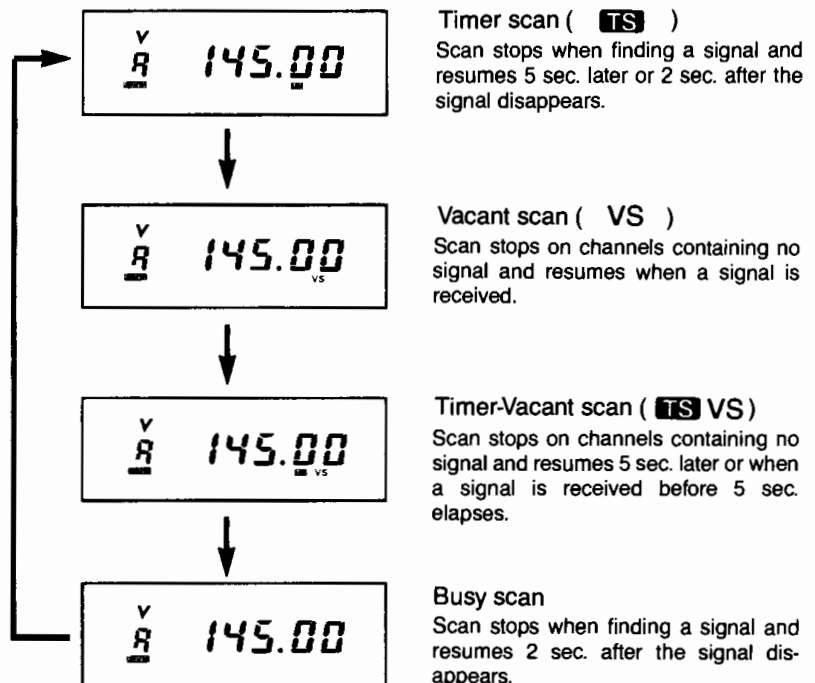

Exit Push **PTT** or **F**. Also, if no operation is performed within 5 sec., the scan programming mode is automatically exited.

Band scan

Scan searches through the entire band range according to the selected tuning step.

■ Scan proceeds to the upper limit (lower limit in the case of down scan) then returns to the lower limit (upper limit) and begins again.

■ Scan stops and resumes according to the set scan resume condition.

■ Scan direction indication

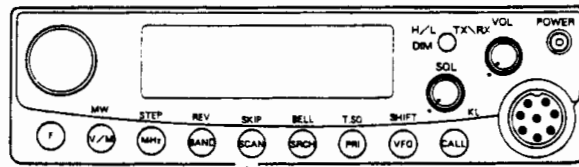
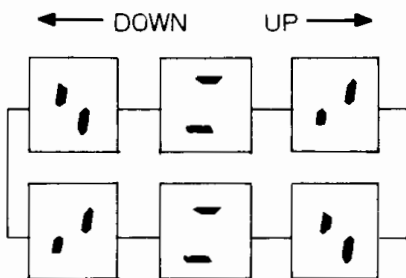

SCAN

Start In VFO mode, push and hold **SCAN** for less than 1 sec.; or push the microphone's **UP/DOWN** key for 0.5 sec. or more.

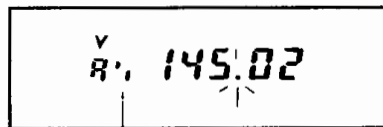

Scan direction indication

UP direction indicator

DOWN direction indicator

The decimal point flashes and scan proceeds according to the selected tuning step.

Scan proceeds in an UP or DOWN direction and the direction is indicated to the right of A/B.

Stop Push **PTT** or **SCAN**.

Programmed scan

Scan proceeds between memory L and U.

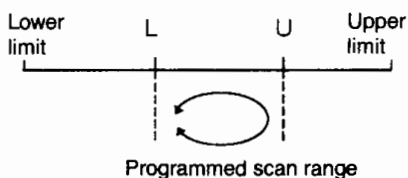

Note

- The factory default settings for memories L and U are the lower and upper limits for the main band. Program desired frequencies into these memories before activating the programmed scan.
- When the presently displayed band and the band set for programmed scan are different, the band set for programmed scan is selected when activating programmed scan.

1. Programming the scan range into memory

Refer to page 18 and program a lower limit into memory L and an upper limit into memory U.

If the following 2 points are not observed, programmed scan will not operate (invalid beep will sound):

- L and U must be set for the same band.
- L must be set to a lower value than U (Setting to the same frequency is not allowed).

--- continued to page 28.

Note

The upper and lower scan edges (U and L) must be programmed correctly in order for programmed scan to proceed.

■ Scan stops and resumes again according to the set scan resume condition (page 26).

■ Up scan proceeds from memory U (or if the down scan from L) to memory L (U) and then starts over again.

2. Programmed scan from VFO mode

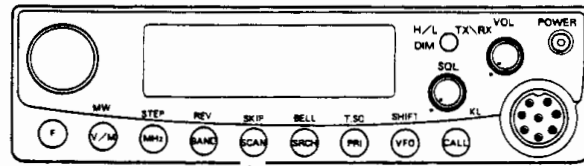

Start In VFO mode, push **SCAN** for more than 1 sec.

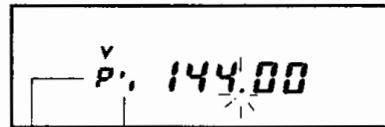

Scan proceeds from memory L frequency in the UP direction according to the set tuning steps.

The decimal point flashes during scanning and P and the scan direction appear instead of VFO A or B.

Stop Push **PTT** or **SCAN**.

3. Programmed scan from memory mode

Start In memory mode, push **SCAN** for more than 1 sec.

In temporary memory mode, scan proceeds in the DOWN direction when scan is started from memory U. When scan is started from a frequency other than memory U, scan jumps to memory L and proceeds in the UP direction according to the set tuning steps.

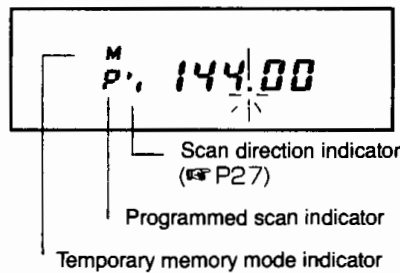

The decimal point flashes during scan, also the temporary memory mode indicators, **M** and **'**, appear one after another.

Stop Push **PTT** or **SCAN**.
The frequency on which the scan is stopped is selected in temporary memory mode.

4

■ Operation is performed in the same manner when in temporary memory mode.

Memory scan

Programmed memories are scanned.

Note

- More than 2 channels must be programmed, otherwise an invalid beep sounds and scan does not proceed.
- If SCAN is pushed for more than 1 sec., programmed scan (pages 27 ~ 28) is activated.
- Scan pauses and resumes according to the set scan resume condition.

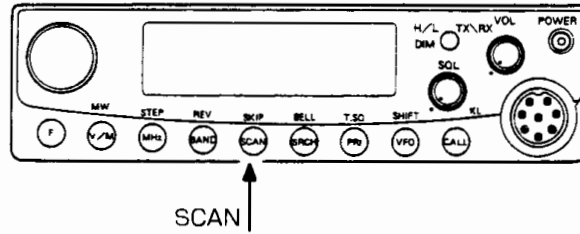

Start In memory mode, push and release **SCAN** within 1 sec., or push the **UP/DOWN** key for more than 0.5 sec.

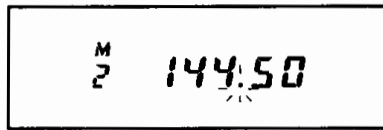

The decimal point flashes and programmed memories are scanned.

Scan proceeds in the UP or DOWN direction depending on the previous direction of tuning or scan.

Stop Push **PTT** or **SCAN**.

- Skip appears as a default setting for memory channels C, U and L. See the operation at right to cancel the skip setting.
- Memory channels are scanned from the lowest memory number (DOWN proceeds from the highest) to the highest memory (lowest) and then starts over again.

Setting non-scan (skip) channels

- ① Choose a channel in memory mode.
- ② Push and release **F** key within 0.5 sec. **FUNC** appears.
- ③ Push **SKIP**.

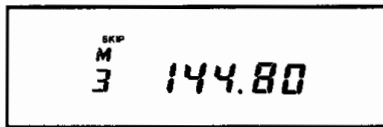

SKIP appears and the channel will be bypassed during scanning.

Exit Perform the same operation to exit from the skip setting (SKIP disappears).



Operation during scanning

- Rotate DIAL or push the microphone's UP/DOWN key to jump to the next channel and or change the direction of the scan.
- Scan type, S-meter squelch and squelch timer settings can be changed during scan.
- Push PRI to operate priority watch the same time as the scan.
- Push SRCH to start sweep scan (page 30).

5. Sweep scan

The sweep scan function measures and indicates receive signal levels during scan. When proceeding to a new channel the previous channel's receive level is indicated. Sweep scan can be operated in conjunction with any of the 3 scans; band, programmed, or memory scan.

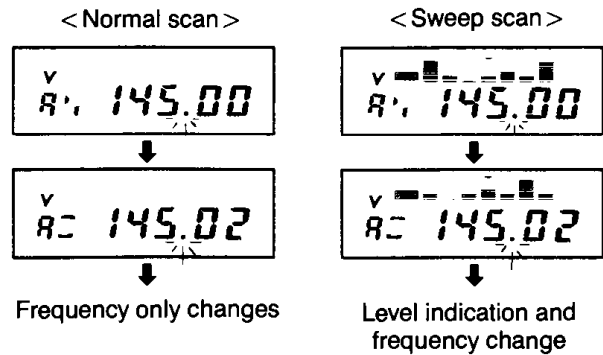

Band sweep scan

Sweep scan proceeds over the entire band according to the set tuning step.

■ For the sweep scan operation during tone squelch or DSQ operation, refer to page 26.

Start Perform the following operation while in VFO mode (order can proceed from ② to ① if desired).

- ① Push **SRCH**.
- ② Push and release **SCAN** within 1 sec., or push the microphone's **UP/DOWN** key for more than 0.5 sec.

Sweep scan proceeds in the same direction as the previously selected scan. The indicated frequency is received depending on the scan type (page 26).

Stop

- To return to channel scope operation..... Push **SCAN** or **PTT**.
- To return to regular scan operation..... Push **SRCH**.

What do the sweep scan levels mean?

Example: Scan proceeds in the UP direction (tuning steps are 20 kHz).

As scan proceeds UP, each frequency level is indicated in order. During sweep scan the decimal point flashes, and scan direction indicators appear.

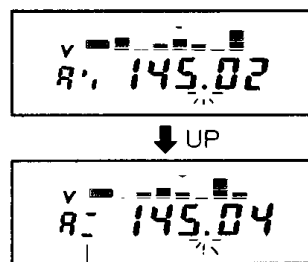

From the left

- 60kHz
- 40kHz
- 20kHz

▼: The displayed frequency

- + 20kHz
- + 40kHz
- + 60kHz

Scan direction indicators

■ The sweep scan direction can be changed using **DIAL** or the microphone's **UP/DOWN** keys.

■ Scan proceeds in the direction of the upper limit of the band (in the **DOWN** direction, the lower limit) and then starts over again.

■ The frequency level indicators are the same when scan proceeds in the **DOWN** direction.

Programmed sweep scan

Sweep scan proceeds between scan edges L and U according to the set tuning steps.

This scan is started in a different manner than band sweep scan, however, other operations are the same for both.

Start In VFO or memory mode, perform the following (the order can be changed from ② to ① if desired).

- ① Push **SRCH**.
- ② Push **SCAN** for more than 1 sec.

Scan proceeds in the UP direction when started from VFO mode; from memory mode, scan proceeds in the UP direction except when started from memory U, in which case scan proceeds in the DOWN direction. During sweep scan, P and scan direction indicators appear.

Memory sweep scan

Sweep scan proceeds through all programmed memories.

- For sweep scan operation during tone squelch or DSQ operation, refer to page 26.

Start Perform the following operation in memory mode (the order can be changed from, ② to ①, if desired).

- ① Push **SRCH**.
- ② Push and release **SCAN** within 1 sec., or push the **UP/DOWN** key for more than 0.5 sec.

Sweep scan proceeds in the same direction as the previously activated tuning or scan. Indicated frequencies are received according to the selected scan type (page 26).

Stop The same as for band scan.

- Rotate DIAL or push the UP/DOWN key to change the sweep scan direction.

- Scan proceeds from the lowest memory number (from the highest in the case of DOWN scan) to the highest (lowest) and then starts over again.

What do the sweep scan levels mean?

Example: scanning in the UP direction.
Level indications appear for each channel as scan proceeds channel by channel. The decimal point flashes during sweep scan.

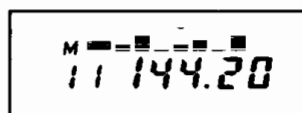

↓ UP

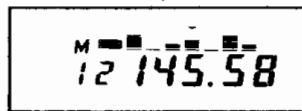

From the left -3
-2
-1

▼: The indicated memory channel

+1
+2
+3

Memories not indicated during sweep scan:

- Memories not yet programmed.
- Skip memories.

6. Priority watch

Priority watch waits on the displayed frequency and every 5 sec. checks a specified frequency for signals. The priority channel is paused on according to the scan type set (TS/VS). Priority watch can be started from VFO, memory or call mode providing 3 types of priority watch.

Type	5 sec.	Priority channel
VFO watch	VFO	Memory
Memory watch	Memory	VFO
Call watch	Call	VFO

Priority watch on 2 channels

Preparation

- ① Select the desired priority channel.
 - ② Select the receiving channel (5 sec. side according to the table above).
 - ③ Set the scan type (page 26).
- Priority watch pauses on the priority channel, then resumes according to the set condition.

Start

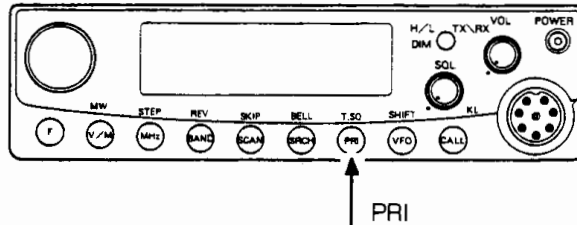

Push **PRI**.

When priority watch is started, the priority channel is checked every 5 sec. The watch pauses for a signal on the priority channel depending on the scan type set.

Example: VFO priority (timer scan set).

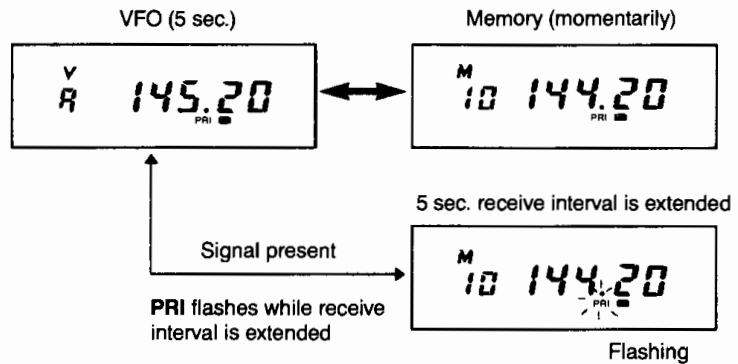

Stop

Push **PRI** while in the 5 sec. receive interval, or while receiving the priority channel, push **PTT** or **PRI**.

4

- When vacant scan (VS) is selected, watch pauses on the priority channel when no signal is present.
- When tone squelch or DSQ is activated, watch pauses on the priority channel only when a matched signal is received. When empty scan is selected, tone squelch and DSQ signals do not have to match for priority watch to pause.
- The previous mode is selected when priority watch is cancelled.

7. Other functions

S-meter squelch function

When the S-meter squelch function is set, only signals which are stronger than the selected S-meter level can unmute the squelch and thus be heard. This function is convenient when there is a lot of noise present and weak signals are not desired.

- The factory default setting is OFF. Once a squelch level is set the level can then be changed.
- After setting a squelch level, the normal S-meter indication appears and the squelch level flashes.
- This can be set during scan or priority watch. After setting S-meter squelch and an S-meter level, signals which do not reach the set level are treated as no signals.
- Scan does not stop for weak signals when S-meter squelch is set. However, during vacant scan weak signals can stop scanning.

Note

When DSQ or tone squelch is activated, receive signals which exceed the set S-meter level will not unmute the squelch unless they are matched.

Setting a squelch level during normal receive

- ① Push **F** and release within 0.5 sec.
- ② Rotate **DIAL** or push the microphone's **UP/DOWN** key to set the squelch level.

— OFF (no indication) – Level 1 – 2 – 3 7 —

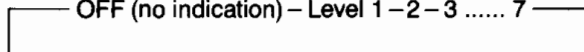

The flashing S-meter indicator shows the selected squelch level. Signals as strong as or stronger than the flashing S-meter level will unmute the squelch and audio can be heard. Adjust this to the desired level. Noise squelch is selected when all of the S-meter indicators disappear.

Example: Level 5 is set.

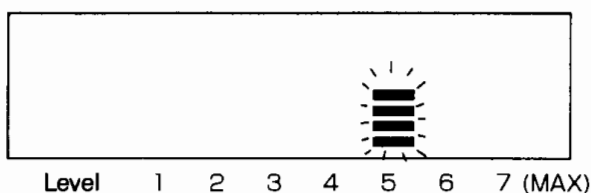

Squelch opens only for signals as strong as or stronger than level 5 and audio can be heard. At this time, S-meter appears at level 5.

- Exit** Push **PTT** or **F**. Also, if no operation is performed within 5 sec., the setting is exited and the S-meter level continues to flash.

Setting a squelch level during the Channel Scope operation

- ① During the Channel Scope operation, push **F** and release it within 0.5 sec. **FUNC** appears.

■ When setting the squelch level during Channel Scope, one of levels 3, 5, 6 or 7 is selected. If the squelch level has been set prior to activating the Channel Scope, audio is output according to the level before activating the Channel Scope.

■ The Channel Scope continues while setting a squelch level, however, scope indication does not appear, only the S-meter squelch flashes. After setting, the S-meter level (1 of 4) indication and the flashing squelch level both appear.

② Rotate **DIAL** or push the microphone's **UP/DOWN** key to set the squelch level.

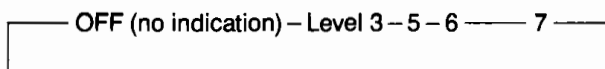

The flashing scope level position indicates 1 of 4 levels of S-meter squelch. When the center channel signal is stronger than the flashing level, the squelch unmutes and audio can be heard. If all the scope indicators disappeared, noise squelch is selected.

Example: Level 5 is set.

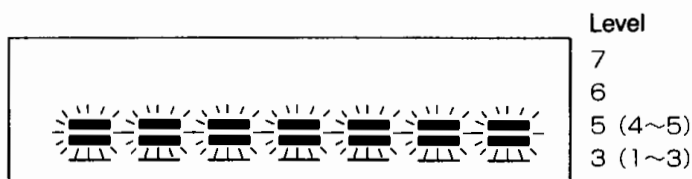

Squelch only unmutes when the received signal strength is as strong or stronger than level 5 on the center channel.

Exit Push **PTT** or **F**.
Also, if no operation is performed for 5 sec., the setting is automatically exited.

Setting the squelch timer

During mobile operation receive signal strength can often vary causing intermittent breaks in the audio. The squelch timer function helps prevent this from happening.

■ This function can be used during the Channel Scope, priority watch or scan operation.

■ The factory default setting is 50 msec.

① Push **F** for more than 0.5 sec.
FUNC flashes.

② Rotate **DIAL** or push the **UP/DOWN** key to set the squelch timer.

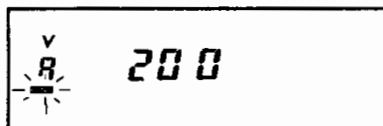

The currently set value is indicated (units: msec.).

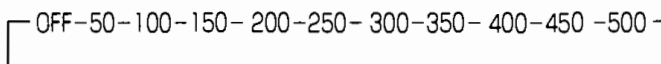

Cancel Push **PTT** or **F**.
Also, if no operation is performed for 5 sec., the setting is automatically cancelled.

Shift and split settings (using different frequencies for transmit and receive)

- **Shift setting** The transmit frequency can be shifted in a negative or positive direction from the receive frequency.
- **Split setting** Different operating modes are available for receive and transmit:
 - VFO mode In VFO A or B when **SPLIT** appears, push PTT to transmit on the previously received memory channel.
 - Memory mode In memory mode when **SPLIT** appears, push PTT to transmit on the previously received VFO A or B frequency.
 - Call mode In call mode when **SPLIT** appears, push PTT to transmit on the previously received VFO A or B frequency.

■ This setting can be performed on the main band only. (p. 16)

Out-of-band frequencies

- If a transmit frequency out-of-band is selected while - or + is flashing OFF will be indicated.
- When the transmit frequency is out-of-band and OFF appears, transmit is not possible.

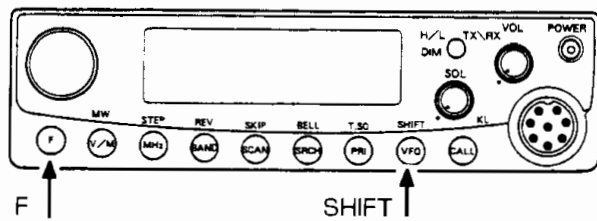

- ① Push **F** and release it within 0.5 sec. **FUNC** appears.
- ② Push **SHIFT**. Each push of this key toggles between shift and split operation.

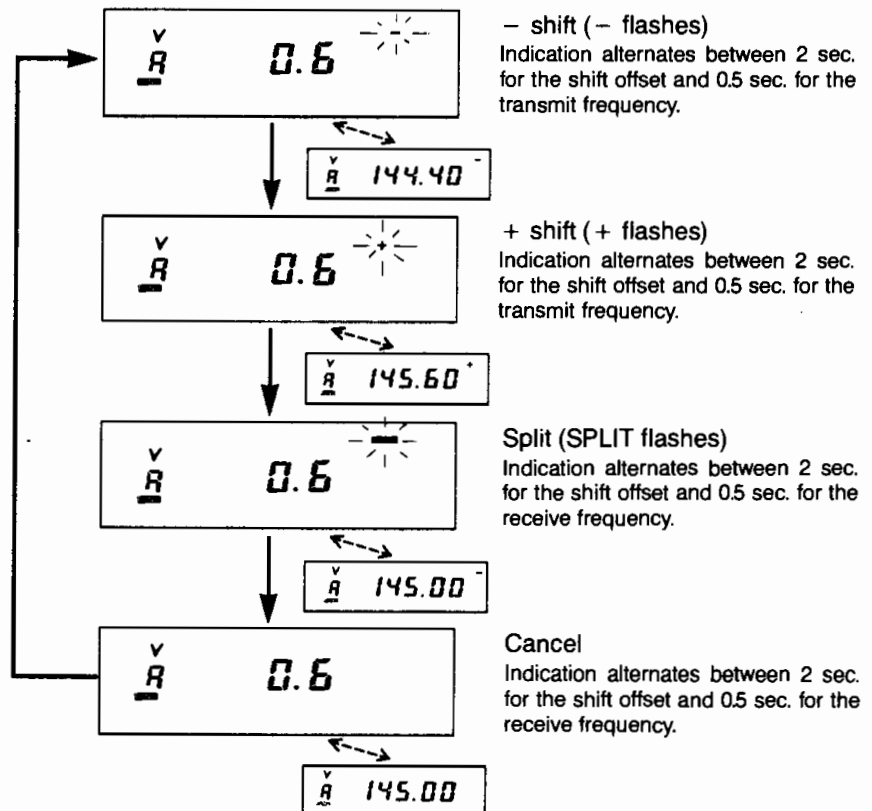

■ Factory default shift offset is 0.6 MHz (for both DR-150T and DR-150E)

■ Push MHz to change the shift offset in 1 MHz steps (page 13).

- ③ Rotate **DIAL** or push the microphone's **UP/DOWN** key to change the shift offset.
- The offset changes according to the tuning step set in VFO mode.
 - Shift offset range: 0 to 15.995 MHz

Exit Push **PTT** or **F**. Also, when no operation is performed for 5 sec., the setting is automatically exited.
-, + and **SPLIT** appear.

Reverse (transmit and receive frequencies are exchanged)

When - shift or + shift are set, the transmit and receive frequencies are exchanged.

Note

When reverse operation results in an out-of-band receive frequency, reverse operation will not proceed.

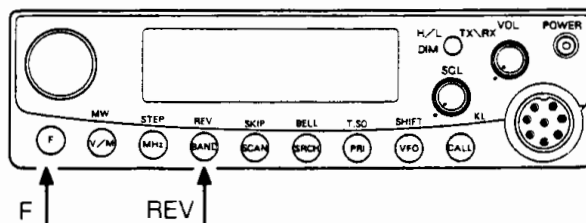

- ① Push **F** and release it within 0.5 sec.
FUNC appears.
- ② Push **REV**.
Receive and transmit frequencies are exchanged; shift direction indicator of normal shift flashes; and shift direction indicator of reverse shift appears.

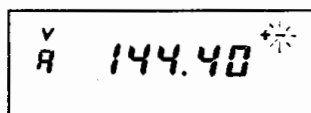

When reverse is selected during - shift
(- flashes, + appears but does not flash)

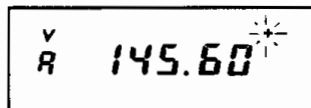

When reverse is selected during + shift
(+ flashes, - appears but does not flash)

Cancel Repeat the above operation.

Also, the reverse operation is cancelled by any of the following operations:

- Pressing the **VM** key
- Changing the frequency of VFO or memory channel.

Setting the tone encoder

Tone encoder comes standard. Tone decoder is an option (EJ-20U)

For details on the optional CTCSS (tone squelch) decoder unit (EJ-20U) see page 45.

When T appears, a subaudible tone is superimposed over your transmit signal. This has no effect on receive operation.

■ The factory default setting for the tone frequency is 88.5 Hz.

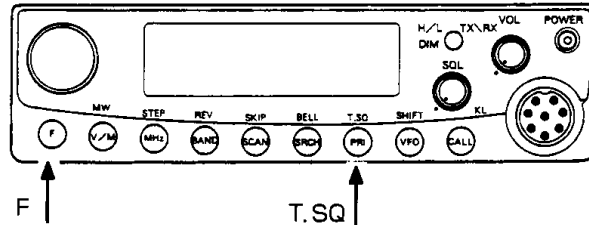

① Push **F** and release it within 0.5 sec.
FUNC appears.

② Push **T.SQ**.

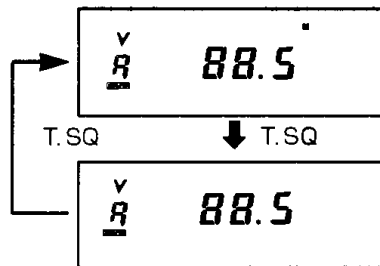

Tone encoder and tone frequency indicator **T** appear.

Cancel (Indicators disappear)

③ Rotate **DIAL** or push the microphone's **UP/DOWN** key to select a tone frequency.

(Unit: Hz)

67.0	69.3	71.9	74.4	77.0	79.7	82.5	85.4	88.5
91.5	94.8	97.4	100.0	103.5	107.2	110.9	114.8	118.8
123.0	127.3	131.8	136.5	141.3	146.2	151.4	156.7	159.8
162.2	165.5	167.9	171.3	173.8	177.3	179.9	183.5	186.2
189.9	192.8	196.6	199.5	203.5	206.5	210.7	218.1	225.7
229.1	233.6	241.8	250.3	254.1				

Exit Push **PTT** or **F**.

Also, if no operation is performed for 5 sec., the setting is automatically exited.

Changing tuning steps

Tuning steps are the amount the frequency changes for each click of the DIAL or each push of the UP/DOWN keys when tuning in VFO mode. This amount can be adjusted as desired.

- Changing the tuning step also affects the following:
 - Shift frequency setting
 - Scan
 - Channel scope
 - Sweep scan

- Tuning steps can be set separately for VFO A and VFO B.

Note

When the tuning step is changed from/to 12.5 or 25 kHz to/from another step, the frequency may be automatically changed to compensate for the changed tuning step.

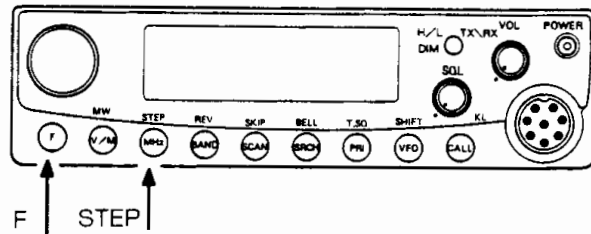

- ① In VFO mode, push **F** and release it in less than 0.5 sec.
FUNC appears.
- ② Push **STEP**.

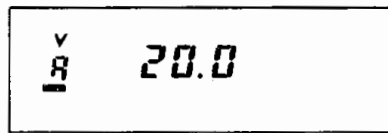

Tuning step setting mode is selected.

- ③ Rotate **DIAL** or push the **UP/DOWN** key to select the desired tuning step.

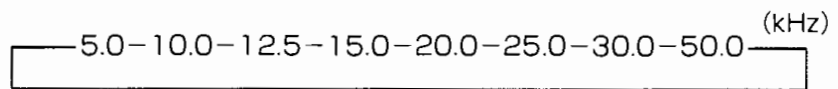

- Exit** Push **PTT** or **F**.
Also, when no operation is performed for more than 5 sec., setting mode is automatically exited.

Key lock function

Use the key lock function to prevent accidental changes in the frequency and function access.

- Except for the PTT, tone burst, and key-unlock, all other functions and key access are disabled during key lock.

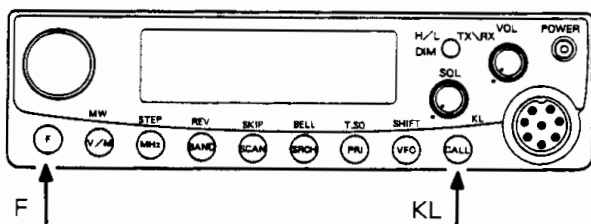

- ① Push **F** and release it in less than 0.5 sec.
- ② Push **KL**.

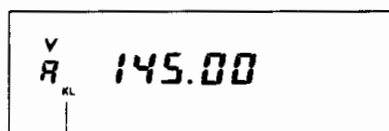

KL appears and the key lock function is activated. Only the **PTT** functions.

- Cancel** Repeat the above operation. (**KL** disappears)

Bell function ON/OFF

This function emits beep tones when being called by another station.

- This function is convenient when using the tone squelch or DSC functions.

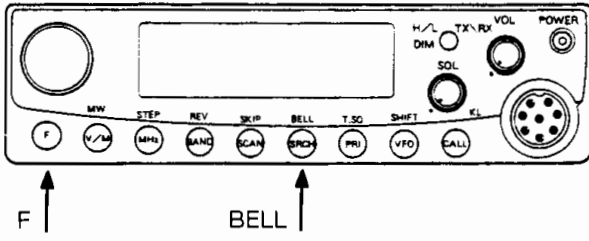

- ① Push **F** and release it within 5 sec.
FUNC appears.
- ② Push **BELL**.

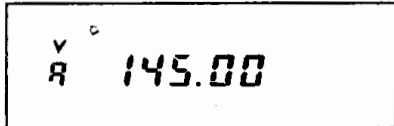

🔔 appears to indicate the bell function is activated.

Cancel Repeat the above operation.

Receiving a call when the bell function is activated....

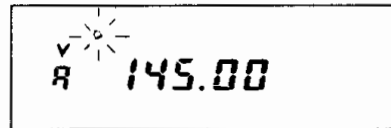

🔔 flashes and beep tones are emitted.

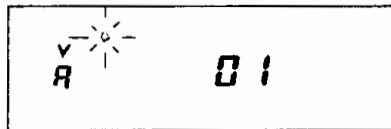

Once 🔔 flashes, the time from when the call is received is indicated in one minute intervals up to 23 hours and 59 minutes.

- If another call is received while the time is indicated, the time returns to 0 and starts counting over again.

Perform any operation to stop the flashing 🔔 and return to normal frequency indication.

Adjusting the display brightness

This transceiver's display has 2 levels of brightness.

- The default setting from the factory is on the brightest setting.

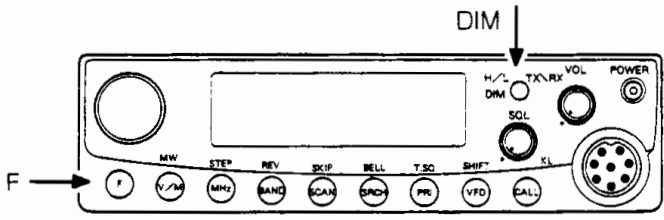

- ① Push **F** and release it within 0.5 sec.
FUNC appears.
- ② Push **DIM**.
The display brightness is toggled between the 2 available levels.

Beep tones ON/OFF

Confirmation beep tones sound after a key is pushed. These can be turned OFF if desired.

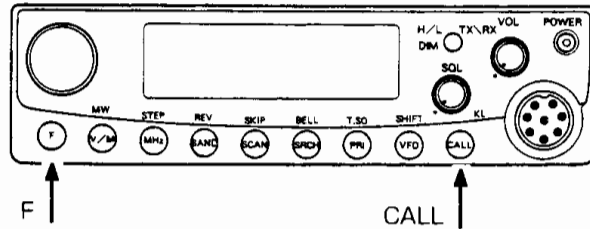

- ① Push **F** for more than 0.5 sec.
FUNC appears and flashes.
- ② Push **CALL**.
Beep tones are turned OFF.

Cancel Repeat the above operation (beep tones are turned back ON).

Setting the transmit time-out timer

This function automatically inhibits transmission after a specified period of uninterrupted transmit.

It is a good idea to set the time-out timer to prevent interference to other stations or excessive heat-up from accidental prolonged transmissions.

- The TOT can be set to 30-450 sec. 5 sec. before a transmission reaches the TOT, beeps sound and 5 sec. later transmission is inhibited.

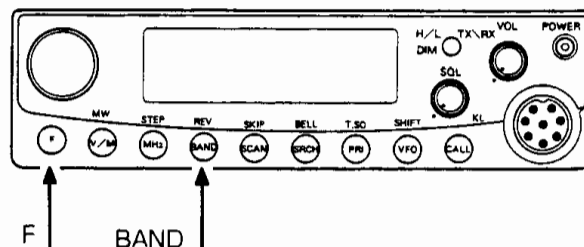

- ① Push and hold **F** for more than 0.5 sec.
FUNC flashes.
- ② Push **BAND**.

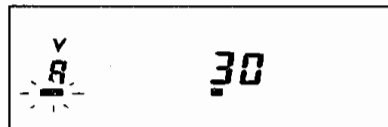

The current TOT is displayed (unit: sec.)

- ③ Rotate **DIAL** or push the **UP/DOWN** key to select the desired time-out time.

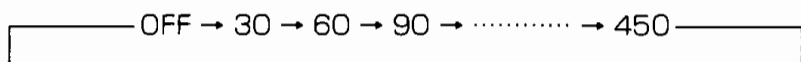

The time-out time can be selected from 30 sec. to 450 sec. in 30 sec. intervals.

Exit Push **PTT** or **F**.
Also, if no operation is performed for 5 sec., the time-out timer setting condition is automatically exited.

RF attenuator ON/OFF

The attenuator circuit prevents interference from strong adjacent signals. This function is convenient during crowded band conditions.

- This function works on the main band only.

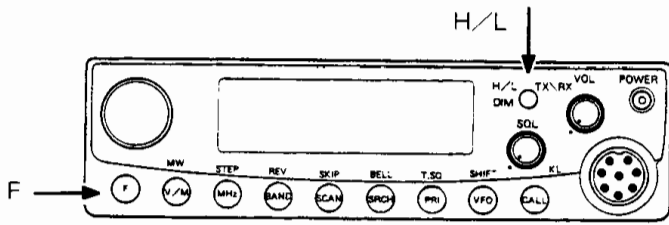

① Push and hold **F** for longer than 0.5 sec.
FUNC appears and flashes.

② Push **H/L**.

ATT
 V
 R 145.00

ATT appears and the RF attenuator is turned ON.

Cancel Perform the above operation again to turn the attenuator OFF (ATT disappears).

Sending a tone burst signal

For the DR-150E, when TONE is pushed, a 1750 Hz modulated tone is transmitted. Depending on the CALL and TONE key assignments, the DR-150T can also send a tone burst signal.

Note

Confirm whether or not the tone burst function is assigned to the CALL-TONE key.

- When **T** appears, a 1750 Hz tone burst signal is superimposed over the transmitted tone frequency.

Push **TONE** (while this key is pushed, a tone burst signal is transmitted).

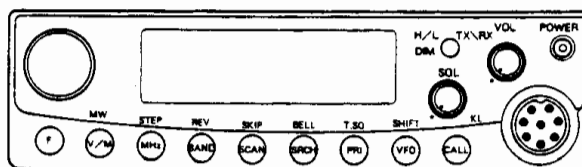

Also, the "c" and "3" keys on the DTMF microphone can be used to send a tone burst signal (page 58).
(The DTMF microphone is optional for the DR-150E)

Changing the CALL/TONE key function

This allows you to toggle the CALL/TONE key function between calling up the call channel and sending a tone burst signal.

While pushing the **CALL/TONE** key, turn power ON.

Each time this step is performed the CALL/TONE key function is changed and one of the following indications appears. Two seconds later the display indication returns to normal frequency indication.

CALL function is assigned



TONE function is assigned

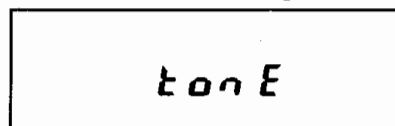

Receive LITZ signal

Your DR-150T has a capability to receive the LITZ signal which is used as an emergency or disaster communication alerting signal adapted by the ARRL (American Radio Relay League).

The LITZ signal is a continuous DTMF "0" tone sent for longer than 3 seconds.

Consult your repeater directory or contact your local club about the frequency information.

Here is how to receive the LITZ signal.

NOTE Slide the "REMOTE/DTMF" switch to the "DTMF" position.

1. Set the frequency for the LITZ signal.
2. Turn the power off.
3. Press and hold the "BAND/REV" key while the power is turned back on.
4. The display will indicate the "L-on" indicating the LITZ function is activated.
5. When the LITZ signal is received, the "Lit" icon will appear and blinking.
Also a S.O.S. of the Morse Code will be heard repeatedly until you will press any key.
6. Repeating step 1 to 4 will deactivate the LITZ function.

While pushing **BAND** turn power ON.

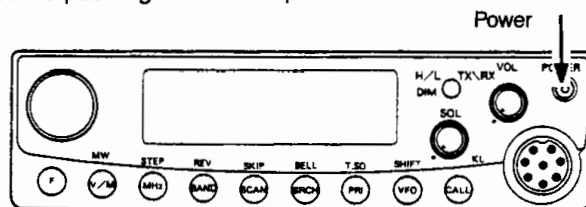

BAND

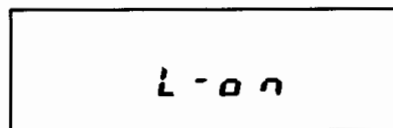

L-on appears for 2 sec. then the display returns to frequency indication and the transceiver enters LITZ reception mode.

Cancel Repeat the above operation to cancel the function.

When receiving the LITZ signal...

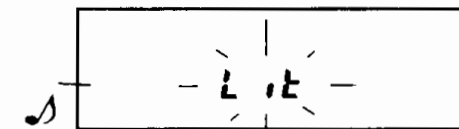

When this function is on and the LITZ signal is received, an alarm sounds and Lit flashes in the display.

Push any key to cancel the alarm and indication.

AM receive

This transceiver normally receives in FM mode, however, AM reception is also possible.

(Versions other than DR-150T must be modified in order to receive AM signals. After modification the transceiver is no longer covered under the warranty).

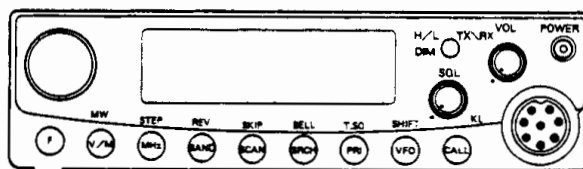

F MHz

① Push **F** for more than 0.5 sec.
FUNC flashes.

② Push **MHz**.

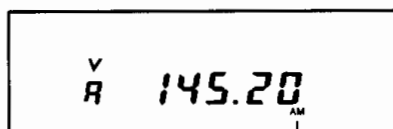

Appears

AM appears and the transceiver enters AM receive mode.

Cancel Perform the above operation again to cancel AM receive mode.

8. Cloning

VFO frequencies, memory information and other set data can be easily transferred to another DR-150T/E producing copy (or clone) of the information programmed into a transceiver (no cable is necessary). This is convenient for programming a group of transceivers with the same information.

Caution

- To prevent damage to the receiving side (slave) transceiver use low power on the transmitting side (master) transceiver when cloning and attach an attenuator.
- Cloning is possible only between DR-150T's, or between DR-150E's (not between DR-150T and DR-150E).
- Do not use the cloning function through a repeater.

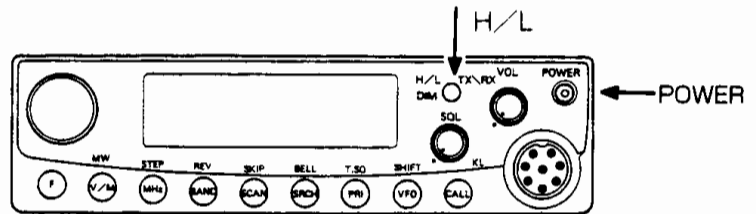

- ① Set the sending (master) and receiving (slave) transceivers to the same frequency.
- ② Set the sending (master) transceiver to low power and attach an attenuator.
- ③ Turn power OFF on both transceivers, then, while pushing **H/L** turn power back ON. Both transceivers are now in clone mode.

Sending side (master) Receiving side (slave)



- ④ Attach the microphone to the sending side (master) transceiver and push PTT for more than 1 sec. The transceiver starts sending data from register 129 and the receiving (slave) transceiver starts to receive. The display counts down the data as it is sent and when 0 is displayed cloning is complete (the entire process takes about 4 min.).

Sending side (master) Receiving side (slave)

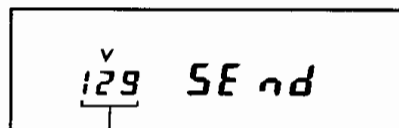

Amount of data left to be sent

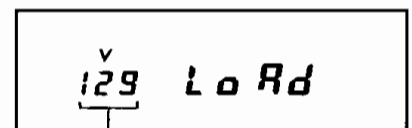

Amount of data left to be received

When cloning is complete the sending side (master) transceiver remains in clone mode and the receiving side (slave) transceiver enters normal operating mode.

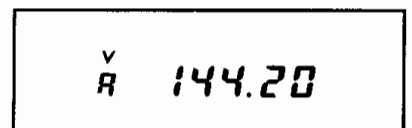

- ⑤ Push PTT on the sending side (master) transceiver to transfer data again; turn power OFF then ON again to return to normal operating mode.

Receiving side (slave) error

Pushing PTT or turning power OFF on the receiving side (slave) transceiver during cloning results in a cloning error.

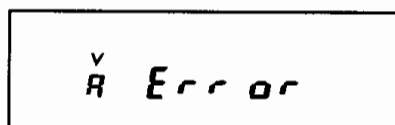

When a cloning error occurs, the receiving side (slave) transceiver reverts to the factory default settings and cloning must be started from the beginning again.

9. Resetting the CPU

Resetting the CPU returns all set data, memory information, etc. to the factory default settings. This transceiver has 3 CPU reset functions.

■ Resetting will not function properly if the F key is pushed before turning power OFF.

Reset the transceiver when erroneous data is displayed or when the transceiver does not seem to be functioning properly (page 64). In many cases this will restore operation to normal.

1. Full reset (all settings are returned to their initial values)

While pushing F turn power ON.

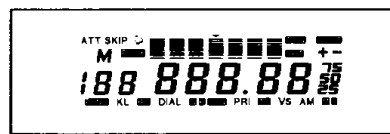
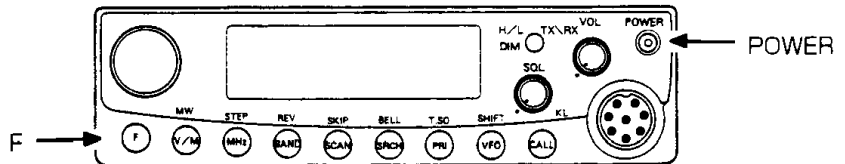

While pushing F the display shows all indications. When F is released indications return to normal (VFO A initial conditions are displayed).

2. VFO reset (VFO A and B settings only are returned to their initial values)

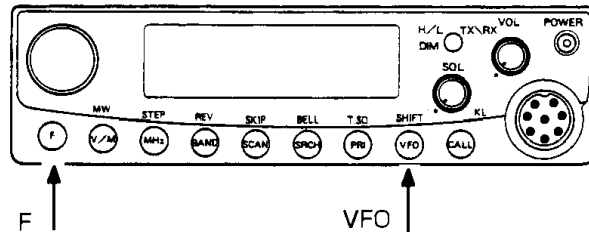

- ① In VFO mode push F for longer than 0.5 sec. **FUNC** flashes.
- ② Push VFO. V flashes.
- ③ Push VFO again. Indications return to the VFO initial values.

Factory default conditions

	DR-150T	DR-150E
VFO frequency	145.000MHz	145.000MHz
CALL frequency	145.000MHz	145.000MHz
Memory ch 1	145.000MHz	145.000MHz
Ch U	173.995MHz	145.995MHz
Ch L	108.000MHz	144.000MHz
Shift direction	None	None
Offset frequency	0.6MHz	0.6MHz
Tone setting	None	None
Tone frequency	88.5Hz	88.5Hz
DSQ	None	None
Tuning step	5kHz	12.5kHz
Output power	HI POWER	HI POWER
Key lock	OFF	OFF
Beep tones	ON	ON
TOT	OFF	OFF
Bell	OFF	OFF
ATT	OFF	OFF
Dimmer	Brightest	Brightest
CALL/TONE	CALL	TONE
LITZ	OFF	
AM/FM	FM	

3. Memory reset (memory channel contents are returned to their initial values)

While pushing V/M turn power ON.

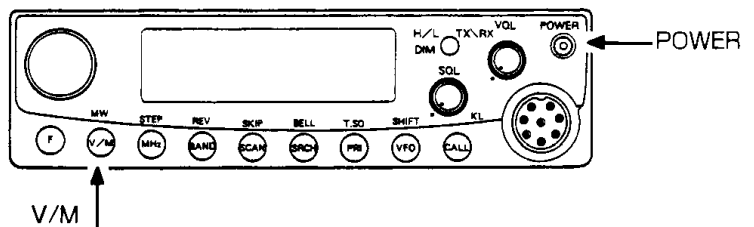

5

Selective Calling

Selective calling allows you to communicate with specific stations only. This is convenient because it allows quiet standby while waiting for calls.

Tone squelch (CTCSS) (Optional CTCSS (tone squelch) unit EJ-20U must be installed. For installation see diagram on the box of EJ-20U.)

When using tone squelch, only received signals which contain the same tone as yours will unmute the squelch and therefore be heard.

50 tone frequencies are available. p. 46 ~ 47

DTMF squelch (DSQ)

The DSQ (DTMF Squelch) Function sends a DSQ code (DTMF code) before voice transmission. If another transceiver has the same code set, its squelch opens and communication is possible. This function is very convenient for communicating with specific station(s) only. Moreover, when you receive a DSQ call, the display indicates that you are being called. p. 48 ~ 57

There are three DSQ modes:

(1) Code Squelch Mode

A three-digit code is sent and opens the squelch of stations having that code only. This is similar to tone squelch operation.

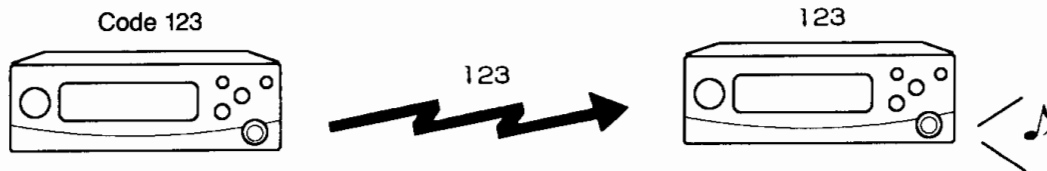

(2) Group Pager Mode

You can call a group of stations using the group code. An individual code is also sent so that the receiving stations know who called them.

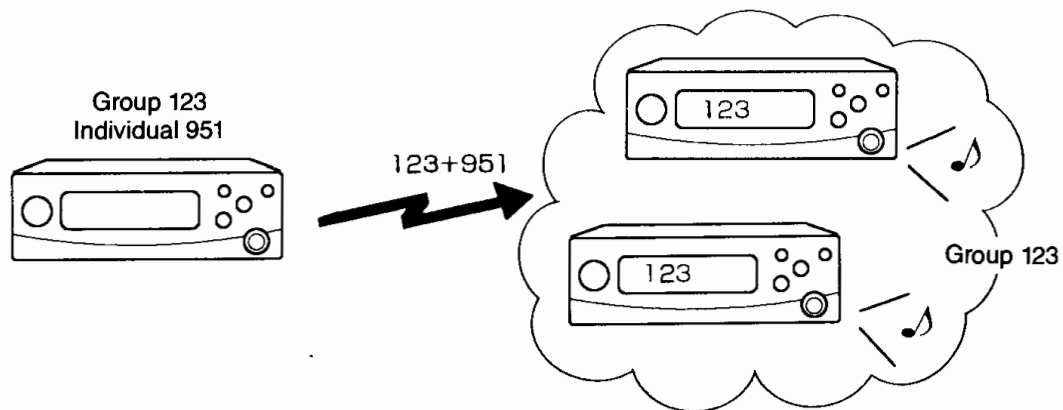

(3) Private Pager Mode

This mode is for calling a specific station only.

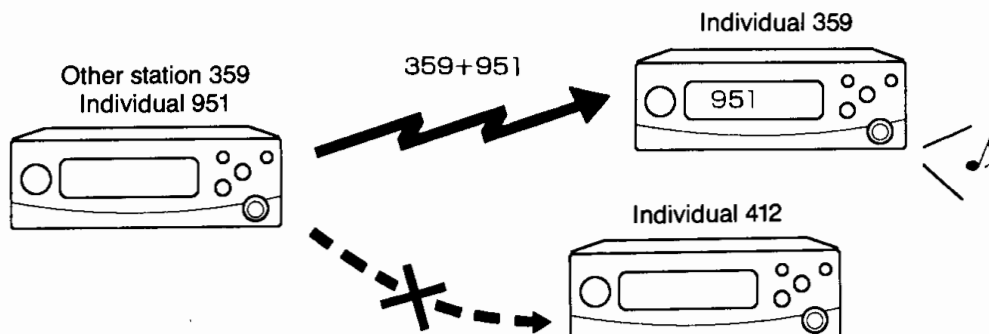

1. Tone squelch

Optional CTCSS (tone squelch) unit (EJ-20U) must be installed.

This section describes the CTCSS decoder setting. For the CTCSS encoder setting see p. 37.

Tone squelch allows quiet standby. Only received signals which contain the same tone frequency as your radio's decoder will unmute the squelch and can be heard.

Note

- When the encoder (T) frequency is changed, the decoder frequency (TSQ) automatically changes to the same value; however, when the decoder frequency is changed, the encoder frequency remains the same.
- When **T** and **SQ** indicators both disappear, the indicated frequency changes and the encoder and decoder frequencies both change to the same value.

1. Setting a tone squelch frequency

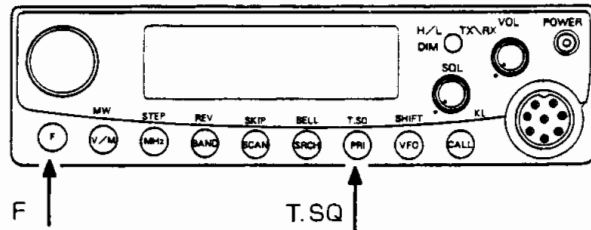

① Push **F** and release it within 0.5 sec.
FUNC appears.

② Push **T.SQ**. Each push of this key changes the tone setting.

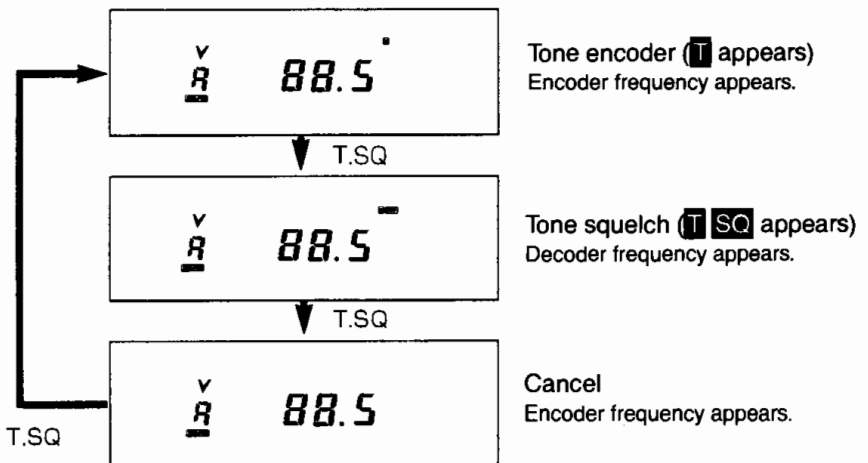

③ Rotate **DIAL** or push the **UP/DOWN** keys to select a decoder frequency.

(Unit: Hz)

67.0	69.3	71.9	74.4	77.0	79.7	82.5	85.4	88.5
91.5	94.8	97.4	100.0	103.5	107.2	110.9	114.8	118.8
123.0	127.3	131.8	136.5	141.3	146.2	151.4	156.7	159.8
162.2	165.5	167.9	171.3	173.8	177.3	179.9	183.5	186.2
189.9	192.8	196.6	199.5	203.5	206.5	210.7	218.1	225.7
229.1	233.6	241.8	250.3	254.1				

Exit Push **PTT** or **F**. Also, when no operation is performed for 5 sec. this setting is exited.

2. Transmitting

While **T SQ** appears, push **PTT**.
The set tone encoder frequency is superimposed over your transmission.

3. Receiving

While **T SQ** appears, only signals which match your transceiver's set tone decoder frequency unmutes the squelch and can be heard.

■ When **T SQ** appears, receiving unmatched signals will not be heard during scanning or priority watch. Tones have no effect on vacant scan.

■ Although signals with unmatched tones cannot be heard, all received signals light the LED green and are registered by the S-meter.

Tone scan

This function searches through the 50 tone frequencies in order and stops when detecting a matched tone frequency.

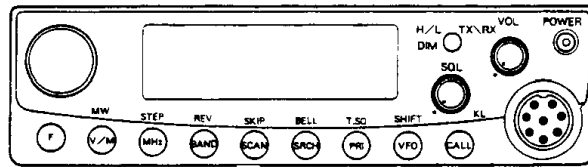

Start

While in tone setting mode (page 46) push **SCAN**.

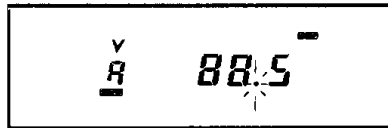

The decimal point flashes and scan proceeds in the UP direction.

- When the EJ-20U is not installed, an invalid beep sounds and this function does not operate.
- During tone scan, pushing PRI changes the tone setting.
- Once tone scan is activated, the tone setting mode will not be exited even if no operation is performed within 5 sec.

When a matched tone is detected, a beep sounds and tone scan automatically stops.

Stop

- Push **PTT, SCAN** Returns to normal tone setting mode.
- Rotate **DIAL**, push **UP/DOWN** key Tone frequency changes and transceiver returns to normal tone setting mode.
- Push **F** Tone setting mode is exited and display indicates frequency



Notes during tone scan operation

- Depending on the tone squelch (**T SQ**) setting, changing tone codes and audio output conditions differ:
 - When **T SQ** appears: The decoder frequency only changes. The encoder frequency does not change. During scanning, only when a signal with a matched tone is received, is audio output.
 - T** only or no indication appears: Encoder and decoder frequencies both change at the same time. During scanning, audio can be heard from any received signals, matched or unmatched.
- When operating tone scan during the Channel Scope or priority watch operation, the scope level measurement or priority watch receiving is temporarily paused.
- Tone scan may not function properly when CTCSS tone level or frequency on the transmitting radio is improper. For example, when operating through a repeater and the downlink CTCSS tone signal levels are low or intermittent, tone scan operation may not function properly.

2. DSQ

3 types of DSQ codes are used for communicating in DSQ mode as in the table at right.

DSQ codes are 3-digit numbers. Any one of memories 1 to 8, P or y may be used for Code squelch operation.

Code type	Description	DSQ Memory
Group code	There are eight codes available for common communication within groups. These codes are required for Group Pager Mode communications. These codes can be used in combination with code squelch operation.	1-8
Individual code	Specific individual private code. This code is necessary for receiving Private Pager calls.	P
Other station code	This is an individual code for private calling of a specific station.	y

Setting DSQ mode

Choose one of the three communication modes.

- DSQ codes can be programmed (page 49) while choosing one of the DSQ modes.

Note

- **DSQ** normally appears and does not flash. However, when the microphone's REMOTE/DTMF switch is set to REMOTE, **DSQ** flashes and DSQ codes cannot be received (optional for the DR-150E).
- When G DSQ is selected or when DSQ is cancelled, OFF may appear in place of the 3-digit codes. For details concerning the OFF indication, refer to page 49.

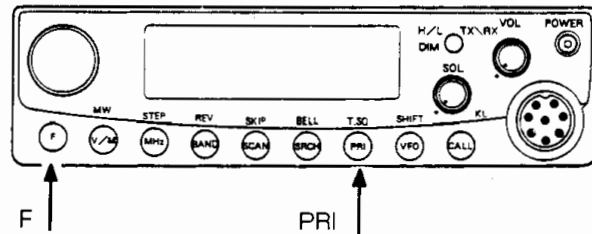

- ① Push **F** for more than 0.5 sec. **FUNC** flashes.
- ② Push **PRI**. Each push of this key alternates between the **G P** and **DSQ** indications.

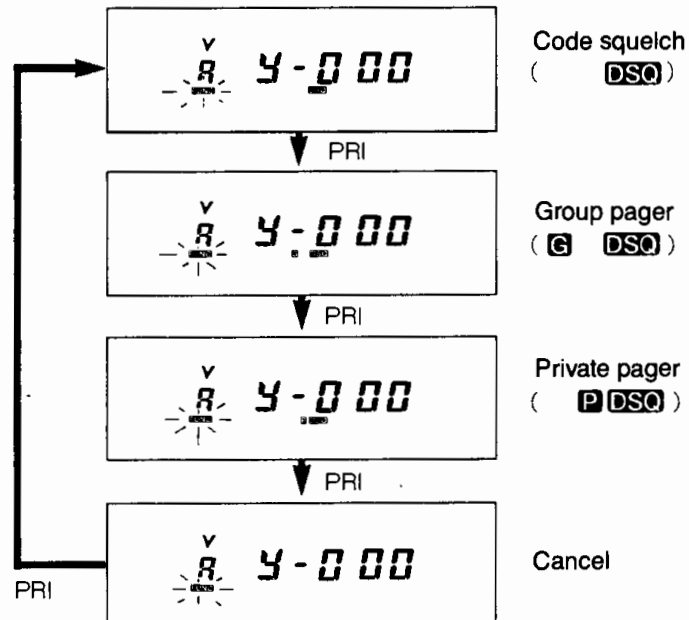

- ③ Rotate **DIAL** or push the **UP/DOWN** key to select a DSQ Memory (excluding **P DSQ** mode for which only the memory "y" is valid).

Exit Push **PTT** or **F**. Also, when no operation is performed for 5 sec. this condition is exited automatically.

Programming DSQ codes

DSQ codes must be programmed before communicating in DSQ mode.

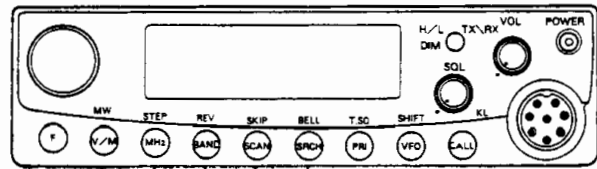

- SRCH (Monitor ON/OFF)
- SCAN (3rd digit flashes)
- BAND (2nd digit flashes)
- MHz (1st digit flashes)
- V/M (Code number flashes)

- ① While choosing DSQ mode, push **V/M**. DSQ code number flashes.
- ② Rotate **DIAL** or push the **UP/DOWN** keys to select a code number. y, P and 1 to 8 appear in order.
*By default, OFF appears in place of group codes 1 to 8. However, after performing step ③, OFF disappears and 000 appears in its place.
- ③ Push **MHz**, 1st digit flashes, then rotate **DIAL** or push the **UP/DOWN** key to set the first digit.

(Wild card code)

can be used as 0 to 9. When a code including # matches a received code, the # is replaced with the corresponding digit in the received code.

Note

When you try transmitting a code containing a wild card, the transceiver will enter the transmit condition, however, the code will not be sent.

0-1.....9-# (# Indication)

When entering P or y, # indication does not appear.

- ④ Push **BAND**, while the 2nd digit flashes, rotate **DIAL** or push the **UP/DOWN** key to set the second digit.
- ⑤ Push **SCAN**, while the 3rd digit flashes, rotate **DIAL** or push the **UP/DOWN** key to set the third digit.
- ⑥ When programming additional DSQ codes, push **V/M** and continue from step ② above.

Exit Push **PTT** or **F**.

Also, when no operation is performed for 5 sec., the condition is automatically exited.

OFF (monitor OFF)

When OFF appears instead of group codes (1 to 8), group pager calling (G DSQ) cannot be received. When communicating using code squelch (DSQ) OFF does not appear.

Setting/cancelling OFF

Push **SRCH**.
Each push toggles the setting.

■ Pushing **MHz**, **BAND** or **SCAN** while OFF appears cancels the setting and one of the digits of the 3-digit code flashes.

Setting DSQ mode with a DTMF microphone (EMS-12)

The EMS-12 is an option for the DR-150E.

- ① Set the microphone **REMOTE/DTMF** switch to **REMOTE**.
- ② Push "c" and "8" on the **DTMF** keypad.
This toggles DSQ mode (page 48).
After, each push of "8" changes the DSQ mode.
 - Rotate **DIAL** or push the **UP/DOWN** key to select a code.
 - **V/M, MHz, BAND** and **SCAN** can be used to set a code (page 49).

Exit Push **PTT** or **F**. Also, if no operation is performed for 5 sec., the condition is exited.
Return the microphone **REMOTE/DTMF** switch to the **DTMF** setting.

Programming DSQ codes using DTMF microphone (EMS-12)

The EMS-12 is an option for the DR-150E.

- ① Set the microphone **REMOTE/DTMF** switch to **REMOTE**.
- ② Push "c" and "9" on the **DTMF** keypad.

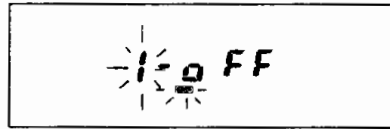

DSQ Memory number flashes and the DSQ code appears.

- ③ While the DSQ Memory number flashes rotate **DIAL** or push the **UP/DOWN** key to select a code number.
- ④ Enter a code using the **DTMF** keypad.
Example: To enter 546 into group memory number 2.

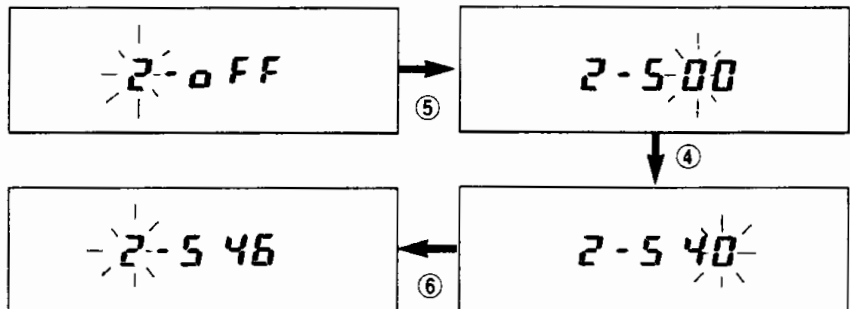

- **V/M, MHz, BAND** and **SCAN** change the flashing digit position.
- **DIAL** or the **UP/DOWN** key can be used to change the flashing code.
- y or P cannot be entered with #.
- For group codes 1 to 8 push **A** to indicate OFF/code, alternately.

Exit Push **PTT** or **F**. Also, if no operation is performed for 5 sec., the condition is exited.
Return the microphone **REMOTE/DTMF** switch to the **DTMF** setting.

■ For details concerning the OFF indication (monitor OFF) refer to page 49.

Communicating in code squelch mode (DSQ)

Select one of the DSQ codes (1 ~ 8, P or y) for receive and transmit. When receiving a 3-digit code that matches yours, squelch unmutes.

■ In code squelch mode, monitor OFF has no effect and all received codes are displayed.

Note

Make sure the microphone REMOTE/DTMF switch is in the DTMF position. (Optional for the DR-150E).

1. Preparation

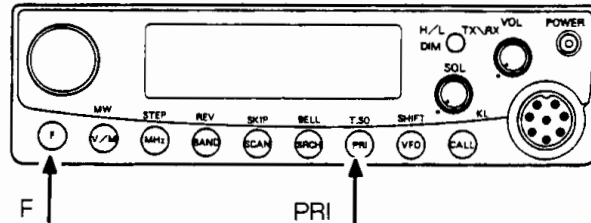

- ① Choose a code to use with your communicating partner in advance (page 48).
- ② Push **F** for longer than 0.5 sec. to display **FUNC.**
- ③ Push **PRI** to enter code squelch mode (**DSQ**).
- ④ Rotate **DIAL** or push the **UP/DOWN** keys to select a code.

Exit Push **PTT** or **F**. Also, if no operation is performed for 5 sec., the condition is exited.

2. Transmitting

Push **PTT**.

Transmit is selected and the 3-digit code is sent with the audible code tone.

3. Receiving

When receiving a 3-digit code that matches your selected group code the squelch unmutes.

- You are alerted with beeps.



Notes for DSQ operation

- After receiving a matched code that unmutes the squelch, and the signal disappears, communication with the other station remains possible for 3 sec.
- Adjust the squelch knob so that the S-meter does not appear while there is no signal.
- When receiving in DSQ mode, the microphone REMOTE/DTMF switch must be in the DTMF position. When in the REMOTE position, **DSQ** codes cannot be received and auto-dialing MO (see page 55) cannot be received (optional for the DR-150E).

Communicating in group pager mode (G DSQ)

The transmitting station sends group code and personal code, 7 digits in total; the receiving station's squelch unmutes when receiving the same group code as among that programmed into the receiving station's transceiver.

Note

If accidentally P, y, or OFF memory is selected:

1. The smallest numbered memory code that has no OFF setting will be selected.
2. When transmitting with all codes OFF, the OFF setting for group code 1 is cancelled.

1. Preparation

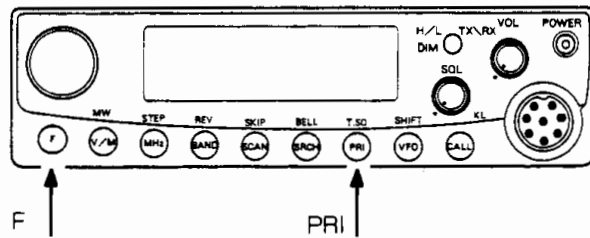

- ① All members of a group should decide on the group code to use and their individual codes in advance (page 48).
- ② Push **F** for more than 0.5 sec. to display **FUNC**.
- ③ Push **PRI** to enter group pager mode (**G DSQ**).
- ④ Rotate **DIAL** or push the **UP/DOWN** keys to select a group code.

Exit Push **PTT** or **F**. Also, if no operation is performed for 5 sec., the condition is exited.

2. Transmitting

Push **PTT**.

The 7 digits at right are transmitted.



Group code Individual code

3. Receiving

When receiving a matching group code, among DSQ memories 1~8 (not set to OFF), followed by *****, the squelch unmutes.

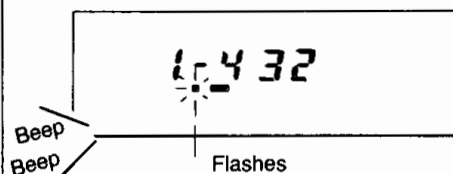

- An alert sounds for about 3 sec. and **G** flashes.
- The matched group code appears.

Perform any operation to stop the alert and return the display to frequency indication.

The transceiver searches for a matching group code in the order P, 1~8. However, even if a matching code is found, if the individual code (P) is found to match, the transceiver enters private pager mode (**P DSQ**) (page 53).

Note

Make sure the microphone REMOTE/DTMF switch is in the DTMF position. (Optional for the DR-150E).

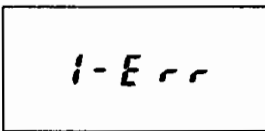

5

Communicating in private pager mode (P DSQ)

The transmitting station sends its own individual code as well as another station's individual code; when the receiving station receives a code that matches its individual code, the squelch unmutes.

1. Preparation

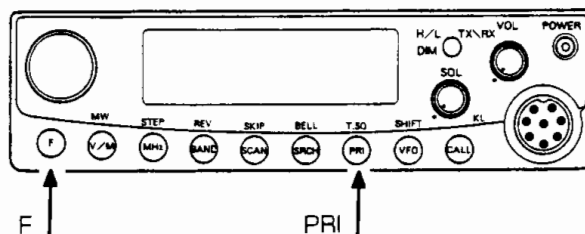

- ① Members wishing to communicate should decide on their own individual codes and learn the individual codes for other stations in advance (page 48).
- ② Push **F** for longer than 0.5 sec. to display **FUNC** and flashes.
- ③ Push **PRI** to enter private pager mode (**P DSQ**).

Exit Push **PTT** or **F**. Also, if no operation is performed for 5 sec., the condition is exited.

2. Transmitting

Push **PTT**.

The 7 digits displayed at right are transmitted.



Receiving station's individual code Your individual code

3. Receiving

When receiving a matching 3-digit code and *****, squelch opens.

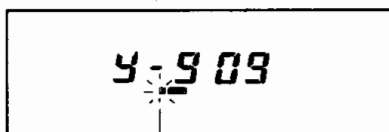

Beep
Beep

- Alert beeps sound for about 3 sec. and **P** flashes.
- The transmitting station's individual code appears.

Perform any other operation to stop the alert beeps and return the display for frequency indication.

When the received code does not match your individual code but does match a group code, **G DSQ** appears and the transceiver automatically selects group pager mode (page 52).

- The transmitting station's 3-digit individual code is programmed into memory of the receiving station.
- When no 3-digit code is received after the *****, squelch unmutes and an error message appears.

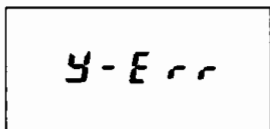

Note

Make sure the microphone REMOTE/DTMF switch is in the DTMF position (optional for the DR-150E).

Changing the rate of transmission of DTMF codes

Normally, after pushing PTT it takes about 450 msec. before a DTMF digit is transmitted. However, this can be increased to 750 msec. if desired.

While pushing **PRI**, turn power ON.

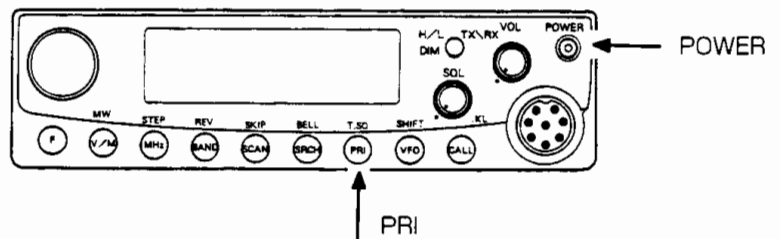

This operation toggles between 450 msec. and 750 msec. Two seconds after the transmission speed is displayed, the display returns to frequency indication.

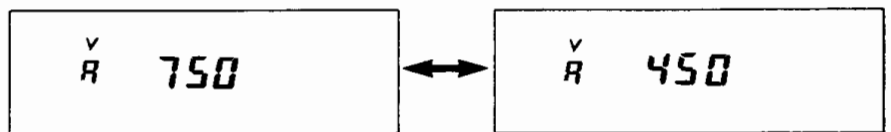

Adjusting the DTMF code burst time

The duration for each digit of DTMF transmission is normally 60 msec. However, this can be changed to 100 msec. if desired.

■ When other stations are having trouble receiving your DTMF codes, try changing your DTMF code burst time to 100 msec.

While pushing **SCAN**, turn power ON.

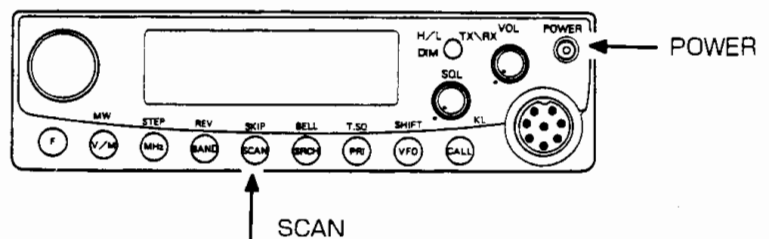

This operation toggles between 60 msec. and 100 msec. code burst values. Two seconds after the code burst time is displayed, the display returns to frequency indication.

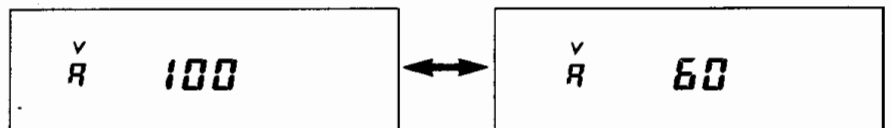

Transmitting DTMF codes manually

DTMF codes can be sent manually one digit at a time even if DSQ mode is not set (optional for the DR-150E).

- ① Set the microphone **REMOTE/DTMF** switch to the DTMF position.
- ② While pushing **PTT**, push **DTMF** keys (0 to 9, *, #) to manually transmit desired digits.

When transmitting more than one digit in succession, leave less than 3 sec. between transmitted digits.

3. Auto-dialing

Auto-dialing automatically sends DTMF codes which have been programmed into memory. This function is standard for the DR-150T and optional for the DR-150E (the optional EMS-12 DTMF microphone must be connected). The transceiver has 5 DTMF transmit memories and 1 DTMF receive memory. Up to 15 digits can be programmed into each memory.

Programming transmit codes into memory

■ When shipped from the factory, DTMF memories are not programmed and they appear blank in the display. When programmed, the memorized digits are displayed.

■ MO is the receive DTMF memory. Codes cannot be programmed into this memory.

■ When programming more than one memory, return to step ③.

■ Auto-dialing is possible only when DIAL appears.

■ Up to 15 digits can be programmed, including pauses.

① Set the microphone **REMOTE/DTMF** switch to the REMOTE position. **RC** appears.

② Push "c" and "5" on the **DTMF** keypad.



A memory number flashes and the transceiver enters dial code setting mode.

③ Push the **UP/DOWN** keys on the microphone to select a memory for programming. M1 to M5 are available.

④ Enter the desired code using the **DTMF** keypad (0 to 9, #, *, A to D).

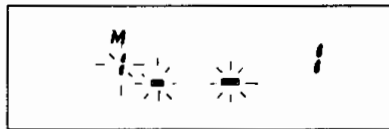

Entered digits appear on the far right and scroll to the left as other digits are entered. A maximum of 15 digits can be entered.

↓
12
↓
123

Finish Push **PTT** or **F**.
Setting the microphone **REMOTE/DTMF** switch to the **DTMF** position, or waiting for 5 sec. without performing another operation accomplishes the same.

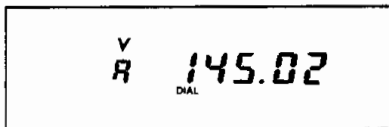

When the last memory has been programmed **DIAL** appears (excluding **MO**).

Programming a pause

Push **[*]** 2 times to enter a pause. **-** appears for a pause and 1 sec. pause is programmed between digits when transmitting.

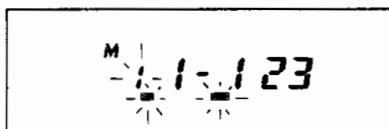

1 sec. pause appears between the transmission of 1 and the next digit.

H appears after pushing **[*]** once, **-** appears after the second push.

To enter 2 **[*]** characters:

- ① Push **[*]** 3 times, **- H** appears.
- ② Use the dial to move to the code before **-**, then push **[*]**.

Correcting a code that you have entered

- ① Rotate the **DIAL** to position the digit left of the digit you want to correct on the far right.

Example: you have now 123 # 354.

Clockwise rotation.

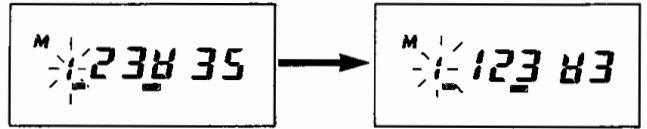
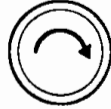

Counterclockwise rotation.

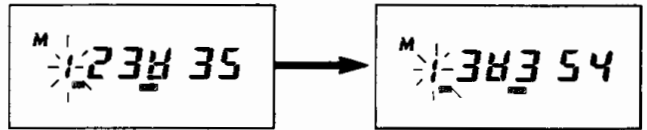
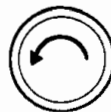

- ② Enter the correct code.
Example: Changing 123 # 354 to 123 # 754.

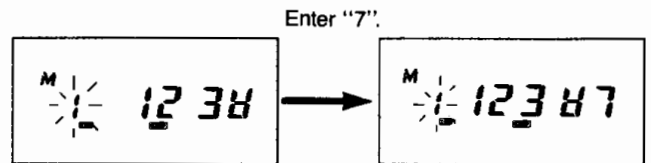

Clearing a code

Push **H/L** to clear the entire code.

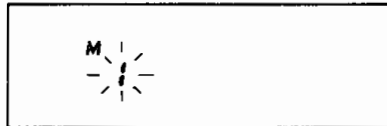

Code disappears.

Confirming a received DTMF code

By checking the special DTMF receive memory **MO**, you can check to see the 15 digits of the most recently received code.

Note

- When the **REMOTE/DTMF** switch is in the **REMOTE** position, DTMF codes cannot be received.
- When the power is turned **OFF**, the contents of **MO** are cleared.

- ① Select **MO** in dial code setting mode.
The last five digits of the received code are displayed.
- ② Rotate **DIAL** to check contents of the received code.
- ③ Push **H/L** to clear the memory.
- ④ Push **PTT** or **F** to exit.
Waiting for 5 sec. without performing another operation accomplishes the same.
- ⑤ In order to memorize the next received DTMF code, make sure that **REMOTE/DTMF** is set to **DTMF**.

Transmitting a code using auto-dialing

Note

- When selecting a memory that is not yet programmed or when selecting MO, this function cannot be used and DIAL does not appear.
- When DIAL does not appear, codes cannot be output.
- Codes can be sent regardless of the position of the REMOTE/DTMF switch.

1. Transmitting a specific memory

- ① Set the microphone **REMOTE/DTMF** switch to the REMOTE position.
- ② Enter "c" and "5" using the microphone **DTMF** keypad.
- ③ Select the desired auto-dialing memory using the microphone **UP/DOWN** key.
- ④ Push **PTT** to finish. Waiting for 5 sec. without performing another operation accomplishes the same. Make sure DIAL appears.
- ⑤ While pushing **PTT**, push the **DOWN** key on the microphone.

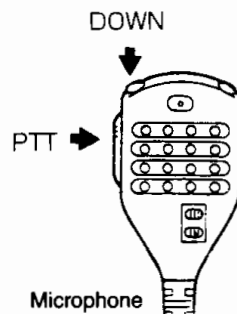

The selected DTMF memory is transmitted.

2. Transmitting DIAL memory M1

When DIAL appears, while pushing **PTT**, push the **UP** key on the microphone.

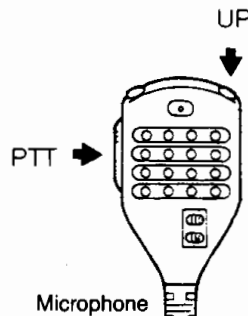

DTMF code M1 is transmitted.

Note

When M1 is not programmed codes cannot be transmitted.

Inhibiting auto-dialing (clearing DIAL)

Choose a memory that has not been programmed or MO then push "c" "5". DIAL disappears and auto-dialing is inhibited.

6

Remote Control Operation

Remote control functions are standard for the DR-150T only (available with the DR-150E only when the optional DTMF microphone (EMS-12) is connected).

Note

Remote control commands function only when the REMOTE/DTMF switch is in the REMOTE position.

Microphone remote control commands

Code	Corresponding key	Operation	Page
C1	VFO	VFO A/B and memory transfer	15-20
C2	V/M	Selects VFO/memory mode	15
C3	CALL/TONE	Select CALL mode/Sends a tone burst signal	21/41
C4	BAND	Toggles main and sub bands	16
C5	—	Sets an auto-dial code	55
C6	—	Changes the channel scope receive time	25
C7	—	Channel scope single start	25
C8	FUNC flashes PRI	DSQ mode setting	48
C9	FUNC flashes PRI → V/M	DSQ code setting	49
C0	SRCH	Starts/stops channel scope	25
CA	SCAN (more than 1 sec.)	Programmed scan	27
CB	FUNC appears REV	Reverse	36
CC	—	Cancels command entry	—
CD	PRI	Priority watch	32
C#	FUNC appears STEP	Sets a tuning step	38
C *	H/L	Changes the transmit output power	14

Operating procedure for microphone remote control

Note

When RC appears all transceiver keys are functional, however when RC flashes they are not functional.

When waiting longer than 5 sec. after entering a digit, the digit is cleared and **RC** appears again.

① Set the microphone **REMOTE/DTMF** key to the REMOTE position.
RC appears.

② Enter 'c' as the first digit.

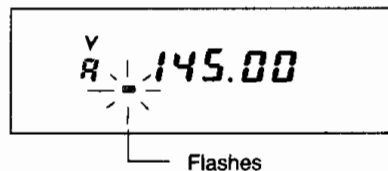

RC flashes

③ Enter the second digit within 5 sec.
The corresponding function is carried out.

Explanation of commands

- C1** Same function as the transceiver's VFO key (page 15). In VFO mode, toggles VFO A and B. In memory mode, selects temporary memory mode (page 18). Push "1" for 1 sec. to copy data to VFO. In CALL mode push "1" for 1 sec. to copy data to VFO.
- C2** Same function as the transceiver's V/M key (page 15). Toggles VFO and memory modes.
- C3** Same function as the transceiver's CALL (TONE) key. When the CALL key is assigned, selects CALL mode (page 21). When the TONE key is assigned, while pushing "3" a tone burst signal is transmitted (page 41).
- C4** Same function as the transceiver's BAND key (page 16). Toggles the main and sub bands.
- C5** Sets an auto-dial memory code. Also selects a transmit code (page 55).
- C6** During the Channel Scope operation, changes the center frequency receive time between 0 and 5 sec. When the Channel Scope starts, receive is initially set for 5 sec (page 25).
- C7** During the Channel Scope operation, sets receive for single start mode (page 25). After each of the 7 scope signals are displayed for once, receive continues on the center frequency.
- C8** Same function as pushing the PRI key on the transceiver when **FUNC** is flashing (page 48). Sets DSQ mode. After entering "c" and "8", each push of "8" changes the DSQ mode. Group codes can be selected, also codes can be entered using the transceiver's front panel.
- C9** When using the DTMF keys on the microphone, enters DSQ codes (page 49). Push PTT to finish entering.
- C0** Same function as the transceiver's SRCH key (page 22). Starts/stops the Channel Scope operation.
- CA** Same function as pushing SCAN for more than 1 sec. on the transceiver. Starts/stops programmed scan.
- CB** Same function as pushing REV on the transceiver when **FUNC** appears (page 36). Reverses the receive and transmit frequencies.
- CC** Cancels the command entered.
- CD** Same function as the PRI key on the transceiver. Starts/stops priority watch (page 32).
- C #** Same function as pushing the STEP key on the transceiver when **FUNC** appears (page 38). Changes the tuning step. Push PTT to exit.
- C*** Same function as the H/L key on the transceiver (page 14). Selects one of the 3 output power levels, H, M and L.

Note

During transmit or in any setting mode, remote control functions do not operate.

Entering a frequency directly

Frequencies can be entered directly while in VFO, memory or CALL mode.

Note

- When a sub-band frequency is entered while in the main-band, or a main-band frequency is entered while in the sub-band, the bands are automatically changed.
- If a frequency entered does not correspond with the set tuning step, there will be a frequency adjustment with the first frequency change after the entry.

- ① Set the microphone **REMOTE/DTMF** switch to the REMOTE position. **RC** appears.
- ② **DTMF** keys can be used to enter from the 100 MHz digit to the 10 kHz digit. Then the 1 kHz digit flashes for frequencies in which 1 kHz digits can be entered.

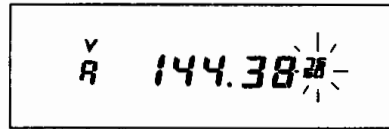

Push "A" to go back one digit.

Example: When entering "1" "4" "4" "3" "8", 50 and 75 flash. In this case "0", "5" or "7" can be used to enter the 1 kHz digit.

- ③ Enter the 1 kHz digit.

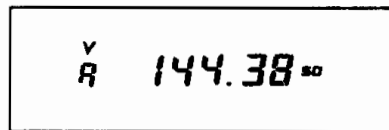

Example: Enter "5". 50 flashes and entry is complete.

When entry is completed, VFO mode is selected.

Clearing an entry

Push **PTT** or **F**.

Waiting for 5 sec. without performing another operation accomplishes the same and returns the display to the previous frequency indication.

DTMF microphone (EMS-12)

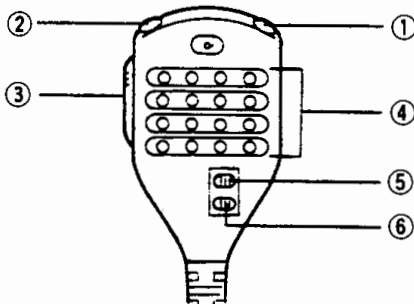

- ① ② **UP/DOWN** key
Change the frequency or memory channel.
- ③ **PTT**
Push and hold to transmit. When pushed during an operation, cancels the operation.
- ④ **DTMF Keyboard**
For remote control commands and frequency entry. During transmit, sends DTMF signals if the switch ⑥ is set to the DTMF position.
- ⑤ **Lock switch**
When in the locked position, the microphone UP/DOWN keys do not function.
- ⑥ **REMOTE/DTMF Switch**
Set to the **REMOTE** position to perform the remote control operations. For **DSQ** operation set to the **DTMF** position. When set to the **REMOTE** position during **DSQ** operation, **DSQ** flashes and **DSQ** codes or dial **MO** cannot be received.

7

Packet Operation

Packet operation is used for communicating data, rather than voice, using a personal computer, etc.

● Requirements for packet operation

- ① Antenna
- ② Regulated DC power source (for the DR-150)
- ③ Regulated DC power source (for a TNC)
- ④ TNC (Terminal Node Controller)
- ⑤ Personal computer

- Note**
- 2 power sources, one for the transceiver and one for the TNC, are required. Otherwise, noise between the transceiver, TNC and personal computer will cause interference.
 - Confirm your frequency and your communicating partners frequency. You may have to try several times to make a connection if the frequencies are not completely matched.

This transceiver can communicate at 1200 bps or 9600 bps. Set up is different depending on which speed you want to communicate at. Be sure to make the correct connections for the speed you want to communicate at.

TXD (transmit data) input sensitivity

	Input impedance	Normal modulation input	Corresponding equipment
1200bps	2.2kΩ	10mVp-p	Normal TNC or corresponding communications device
9600bps	47kΩ	2Vp-p	9600 bps modem/TNC

- Note**
- If you exceed the optimum data input level (1200 bps, 10 mVp-p/9600 bps, 2Vp-p) the S/N ratio will decrease and distortion may result in data loss.
 - When operating 9600 bps packet and your data input level exceeds approximately 3 Vp-p, the transceiver's limiter circuit may activate causing errors in transmission. In this case, turn the volume level on the TNC to its optimum level.
 - When exceeding speeds of 9600 bps, GMSK signals and line noise may reach a level that cause transmission errors. Also your occupied bandwidth may increase to the point where you interfere with other stations.

1. 1200 bps packet operation

1. Connecting equipment for packet operation

Connect the TNC, etc. to the microphone jack on the front of the transceiver and the speaker (SP) jack on the rear of the transceiver.

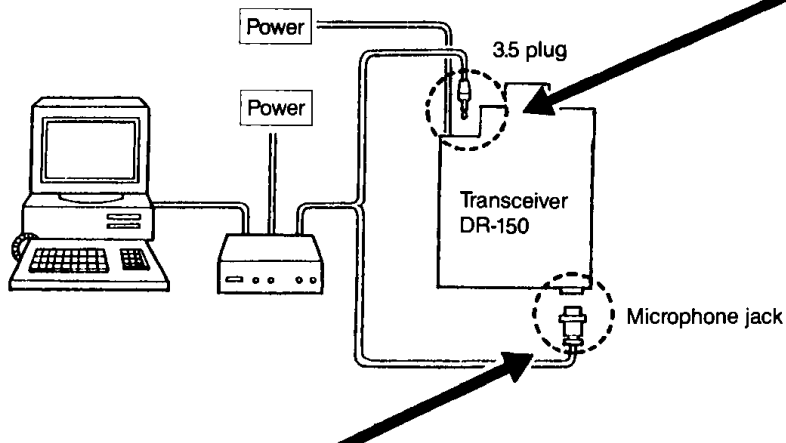

3.5 plug connection

Rear panel

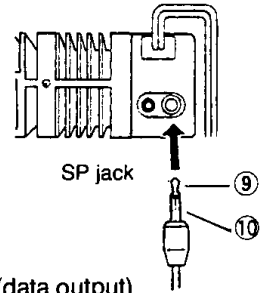

SP jack

- ⑨ AFO (data output)
After passing through the volume, receive signals are output.
- ⑩ GND for AFO

Microphone connector pin assignment

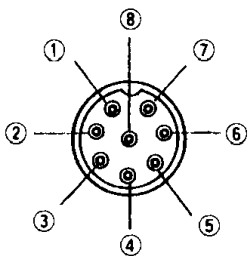

Set according to this diagram

- ① TXD (Transmit data input)
Connect the microphone input of the TNC
- ② PTT
Connect the PTT output
Transmit occurs when falls to L
- ③ NC
- ④ NC
- ⑤ NC
- ⑥ MC
- ⑦ DE (GND for TXD)
GND for TNC output
- ⑧ GND (GND for PTT)

Caution

- Do not connect the NC pins.

2. Packet operation

- ① Rotate the **SQL** control until the squelch is muted.
- ② Adjust the **VOL** level for packet input.

2. 9600 bps packet operation

1. Connections for packet operation

Connect your TNC to the microphone jack on the front panel of the transceiver and to the 9600 bps jack on the rear panel of the transceiver.

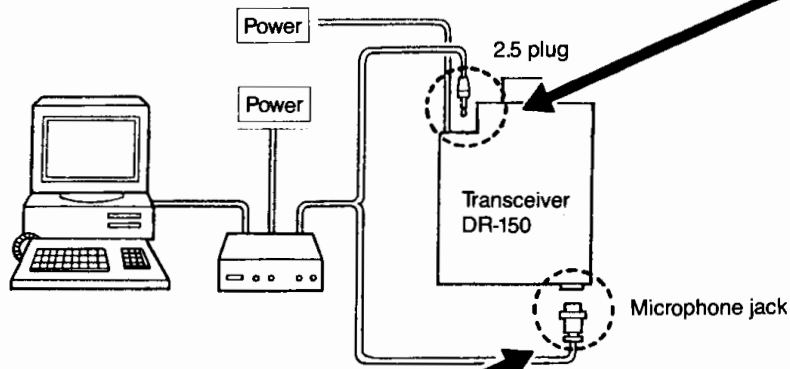

2.5 plug connections

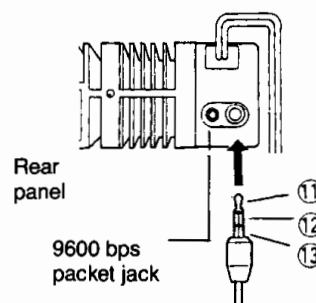

- ⑪ TXD (transmit data input)
Connect the TNC MIC output.
- ⑫ RXD (receive data output)
Discriminator output before de-emphasis.
Output level 100mVp-p/47kΩ
- ⑬ DE (GND for PKD)
GND for TNC output.

Microphone pin assignments

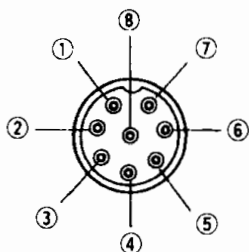

Set according to this diagram.

Caution

- Do not connect to the NC pins.

- ① NC
- ② PTT
Connect the PTT output.
When drops to L, transmit takes place.
- ③ NC
- ④ NC
- ⑤ NC
- ⑥ NC
- ⑦ NC
- ⑧ GND (GND for PTT)

2. Packet operation

Note

GMSK mode TNC's have been tested. However, for G3RUH and K9NG type check the TNC's output level since adjustments may be required due to low output.

- ① Rotate the **SQL** control to mute the transceiver.
- ② Adjust the **VOL** control to the appropriate level for packet operation.

● Troubleshooting ●

When the transceiver appears to be malfunctioning, check the points listed in the table below. In many cases resetting the transceiver's CPU will solve many problems (page 44). If the problem still persists, the transceiver may be in need of servicing.

Problem	Possible cause	Solution
Power is turned ON but nothing appears in the display.	a. Power has been connected with reverse polarity. b. Fuse is blown.	a. Connect the supplied DC cord correctly. The plus (+) terminal is red and the negative terminal (-) is black. b. Check for the cause of the blown fuse and remedy it; then replace the fuse with a new rated fuse.*
The display appears dark.	a. Voltage is too low. b. The dimmer is set to the dark setting.	a. The connected voltage should be 13.8 V DC. b. Set the dimmer to the bright setting.
No sound comes from the speaker and receiving is not possible.	a. VOL control is turned too far counterclockwise. b. Squelch is muted. c. Tone squelch is activated. d. DTMF squelch is activated. e. The microphone PTT switch is pushed and the transceiver is in transmit. f. S-meter squelch is activated.	a. Set the VOL control to obtain a suitable level of audio output. b. Rotate the SQL control counterclockwise. c. Turn tone squelch operation OFF. d. Turn DTMF squelch operation OFF. e. Release the PTT switch OFF as soon as possible. f. When you want to receive weak signals, turn the S-meter squelch function OFF.
Keys or dials cannot be operated.	The key lock function (KL appears) is activated.	Cancel the key lock function.
Programmed scan does not proceed.	The upper and lower memory channels, U and L, do not have proper frequencies set.	Program U and L with frequencies in the same band and make sure U's frequency is greater than L's frequency.
Transmit does not occur when PTT is pushed.	a. The microphone is not connected properly to the MIC jack. b. No antenna is connected.	a. Make sure the microphone is connected properly. b. Make sure an antenna is connected.

*Replacement fuses A fuse with the specified rating must be used.
The DC power cord fuse is 15 A.

ALINCO, INC.

Head office: "TWIN 21" MID Tower Building 23F

1-61, 2-Chome, Shiromi, Chuo-ku, Osaka 540 Japan

Phone: 06-946-8150 Fax: 06-946-8175 Telex: 63086

E-mail: 101243.1446@compuserve.com

U.S.A.: 438 Amapola Ave., Suite 130, Torrance, CA 90501-6201, U.S.A.

Phone: 310-618-8616 Fax: 310-618-8758

<http://www.alinco.com/>

Germany: Eschborner Landstrasse 55, 60489 Frankfurt am Main, Germany

Phone: 069-786018 Fax: 069-789-60766

Printed in Japan

Copyright © 1996 Alinco, Inc. Osaka, Japan

PS0208A