

ALINCO, INC.

Yodoyabashi Dai-bldg 13F

4-4-9 Koraibashi, Chuo-ku, Osaka 541-0043 Japan

Phone: +81-6-7636-2362 Fax: +81-6-6208-3802

<http://www.alinco.com>

E-mail: export@alinco.co.jp

CE 0700 

RoHS



DR-638HE: VHF/UHF FM amateur transceiver

144.000-145.995MHz/430.000-439.995MHz

Use of this device is authorized in all EU and EFTA member states(CH/ICE/LI/NOR).

Operator's license is required.

Copyright Alinco, Inc. PS0820/FNEH-NI

Printed in China

VHF/UHF FM Mobile Transceiver

DR-638H

Instruction Manual

Thank you for purchasing your new Alinco transceiver. Please read this manual carefully before using the product to ensure full performance, and keep this manual for future reference as it contains information on after-sales services. In case addendum or errata sheets are included with this product, please read those materials and keep them together with this instruction manual for future reference.

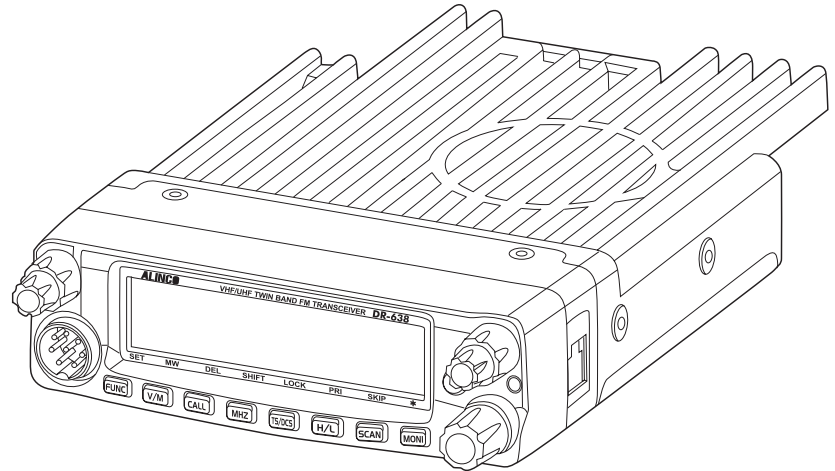

Introduction

Thank you very much for purchasing this excellent Alinco transceiver. Our products are ranked among the finest in the world. This radio has been manufactured with state of the art technology and it has been tested carefully at our factory. It is designed to operate to your satisfaction for many years under normal use.

Please read this manual completely from the first page to the last, to learn all the functions the product offers. It is important to note that some of the operations may be explained in relation to information in previous chapters. By reading just one part of the manual, you may risk not understanding the complete explanation of the function.

Before transmitting

There are many radio stations operating in proximity to the frequency ranges this product covers. Be careful not to cause interference when transmitting around such radio stations.

■ Lightning

Please note that no car provides adequate protection of its passengers or drivers against lightning. Therefore, Alinco will not take responsibility for any danger associated with using its radios or inside the car during lightning.

Conformity Symbols

CE 0700

RoHS

Tested to comply MIL-STD-810G

-Shock: Method 514.6/I,IV -Vibration: Method 516.6/I

CE Conformity Information

This device is in compliance with the essential requirements of R&TTE Directive 1999/5/EC.

A copy of the certificate by the notified body can be reviewed at <http://www.alinco.com/usa.html>.

DR-638HE

VHF/UHF FM Amateur Transceiver

144.000-145.995MHz/430.000-439.995MHz

CE 0700

This device is authorized for use in all EU and EFTA member states.

An operator's license is required for this device.

Manufacturer:

ALINCO, Inc. Electronics Division

Yodoyabashi Dai-bldg. 13F







4-4-9 Koraibashi, Chuo-ku,

Osaka 541-0043 Japan



Check with your local waste officials for details on recycling or proper disposal in your area.

To prevent any hazard during operation of Alinco's radio product, in this manual and on the product you may find symbols shown below. Please read and understand the meanings of these symbols before starting to use the product.

 Danger	This symbol is intended to alert the user to an immediate danger that may cause loss of life and property if the user disregards the warning.
 Alert	This symbol is intended to alert the user to a possible hazard that may cause loss of life and property if the user disregards the warning.
 Caution	This symbol is intended to alert the user a possible hazard that may cause loss of property or injure the user if the warning is disregarded.
	Alert symbol. An explanation is given.
	Warning symbol. An explanation is given.
	Instruction symbol. An explanation is given.

ALERT

■ Environment and condition of use:

-  Do not drive while handling the radio for your safety. It is recommended that you check local traffic regulations regarding the use of radio equipment while driving.
Some countries prohibit the operation of transceiver while driving.



Do not use this product in close proximity to other electronics devices, especially medical ones. It may cause interference to those devices.



Keep the radio out of the reach of children.



In case a liquid leaks from the product, do not touch it. It may damage your skin.
Rinse with plenty of cold water if the liquid contacted your skin.



Never operate this product in facilities where radio products are prohibited for use such as aboard aircraft, in airports, in ports, within or near the operating area of business wireless stations or their relay stations.



Use of this product may be prohibited or illegal outside of your country. Be informed in advance when you travel.



The manufacturer declines any responsibilities against loss of life and/or property due to a failure of this product when used to perform important tasks like life-guarding, surveillance, and rescue.



Do not use multiple radios in very close proximity. It may cause interference and/or damage to the product(s).



The manufacturer declines any responsibilities against loss of life and property due to a failure of this product when used with or as a part of a device made by third parties.



Use of third party accessory may result in damage to this product. It will void our warranty for repair.

WARNING

■ Handling this product:



Be sure to reduce the audio output level to minimum before using an earphone or a headset. Excessive audio may damage hearing.



Do not open the unit without permission or instruction from the manufacturer. Unauthorized modification or repair may result in electric shock, fire and/or malfunction.



Do not operate this product in a wet place such as shower room. It may result in electric shock, fire and/or malfunction.



Do not place conductive materials, such as water or metal in close proximity to the product. A short-circuit to the product may result in electric shock, fire and/or malfunction.



Do not touch the heatsink (on/around the unit mostly found on mobile-base units) as it may become very hot during/after the operation that may risk burn your skin.

■ About power-supply:



Use only appropriate, reliable and certified power supply of correct voltage and capacity.



Do not connect cables in reverse polarity. It may result in electric shock, fire and/or malfunction.



Do not plug multiple devices including the power-supply into a single wall outlet. It may result in overheating and/or fire.



Do not handle a power-supply with a wet hand. It may result in electric shock.



Securely plug the power-supply to the wall outlet. Insecure installation may result in short-circuit, electronic shock and/or fire.



Do not plug the power-supply into the wall outlet if the contacts are dirty and/or dusty.

Shortcircuiting and/or overheating may result in fire, electric shock and/or damage to the product.



Do not modify or remove fuse-assembly from the DC-cable. It may result in fire, electric shock and/or damage to the product.

■ In case of emergency:

In case of the following situation(s), please turn off the product, switch off the source of power, then remove or unplug the power-cord. Please contact your local dealer of this product for service and assistance. Do not use the product until the trouble is resolved. Do not try to troubleshoot the problem by yourself.

- When a strange sound, smoke and or strange odor comes out of the product.
- When the product is dropped or the case is broken or cracked.
- When a liquid penetrated inside.
- When a power-cord (including DC-cables, AC-cables and adapters) is damaged.



For your safety, turn off then remove all related AC-lines to the product and its accessories including the antenna if a thunderstorm is likely.



Turn off the unit, remove the mobile antenna from its base and keep it in the vehicle if a thunderstorm is likely.





Please read cautions regarding the lightning-protection on page 9 also.

■ Maintenance





Do not open the unit and its accessories. Please consult with your local dealer of this product for service and assistance.





 **CAUTION****■ Environment and condition of use:**

-  Do not use the product in proximity to a TV or a radio. It may cause interference or receive interference.
-  Do not install in a humid, dusty or insufficiently ventilated place. It may result in electric shock, fire and/or malfunction.
-  Do not install in an unstable or vibrating position. It may result in electric shock, fire and/or malfunction when/if the product falls to the ground.
-  Do not install the product in proximity to a source of heat and humidity such as a heater or a stove. Avoid placing the unit in direct sunlight.
-  Do not modify, dismantle, incinerate, or immerse the batteries that may be used in accessories you use with this product. Please check your local regulations for details on recycling option or disposal of the batteries in your area.

■ About transceiver

-  Do not connect devices other than specified ones to the jacks and ports on the product.
It may result in damage to the devices.
-  Turn off and remove the power-source (AC cable, DC cable, battery, cigar-cable, charger adapter etc) from the product when the product is not in use for extended period of time or in case of maintenance.
-  Use a clean, dry cloth to wipe off dirt and condensation from the surface of the product.
Never use thinner or benzene for cleaning.

■ About power-supply

-  Use only reliable power supply of specific DC output range and be mindful of the polarity of the cables and DC jack.
-  Always turn off the power supply when connecting or disconnecting the cables.
-  When using an external antenna, make sure that the antenna ground is not common with the ground of the power supply.
-  European users: When a transceiver is powered from an external DC power source (adapter, power supply, cigar-plug etc), make sure that this power supply has approval to the level of IEC/EN 60950-1.

CONTENTS

New and Innovative Features	1	High/Mid/Low Power Setting	13
Supplied Accessories/Optional Accessories	2	Frequency Reverse.....	13
Supplied Accessories	2	CTCSS/DCS setting.....	13
Initial Installation	3	Call channel recalling.....	13
Mobile installation	3	CTCSS/DCS Scan	13
DC Power Cable Connection.....	4	Dual Watch.....	14
Power supply voltage Display	6	Emergency Alarm.....	14
Antenna Connection	6	Channel/Frequency Scan	14
Accessories Connections.....	6	Channel Scan Skip	14
Front Panel Separation.....	7	Memory Channel Programming.....	14
Getting Acquainted	8	Search Scan Range Setting.....	14
Front panel.....	8	Channel Copy	15
Rear panel	9	Channel Delete	15
Display	9	Memory Banks operation	15
Microphone	10	PARAMETER SETTING MODE(SET MODE)	16
Basic Operations	11	Menu 01: APO (Automatic power off)	16
Switching the Power On/Off.....	11	Menu 02: Automatic offset	16
Adjusting the Volume	11	Menu 03: VFO Channel Step Setting.....	16
Squelch level setting.....	11	Menu 04: VFO Band lockout.....	16
Switch between VFO and memory mode	11	Menu 05: Beep Sound	17
Setting frequency	11	Menu 06: CPU Clock Frequency Setting	17
Setting channel	11	Menu 07: 2Tone Encode Select.....	17
Switch Between Main Band and Sub band.....	12	Menu 08: 5Tone Encode Select.....	17
Selecting the operating band	12	Menu 09: Add Optional Signaling.....	18
Receiving	12	Menu 10: Tone Encode Setup.....	18
Squelch Off/Squelch Off Momentary.....	12	Menu 11: Tone Decode Setup	18
Transmitting	12	Menu 12: Sub Band Display	19
Transmit DTMF/2TONE/5TONE signaling	13	Menu 13: DTMF Encode Pre-Loading Timing.....	19
		Menu 14: DTMF Encode Transmitting Time	19

CONTENTS

Menu 15: DTMF Encode Setup	19	Menu 52: Beep Volume control	26
Menu 16: Squelch Mode Setup.....	20	Menu 53: Talk Around	26
Menu 17: Compander	20	Menu 54: Microphone Speaker.....	26
Menu 19: Tone Burst Tones	20	Menu 55: Memory Banks Enquiry.....	27
Menu 20: Hyper	20	Menu 56: Memory Banks Linking.....	27
Menu 21: Keypad Lockout	21	Menu 64: Password Function	27
Menu 22: PTT Lockout.....	21	Microphone Operation	28
Menu 23: TOT Penalty	21	Send DTMF signaling	28
Menu 24: Frequency Reverse.....	21	Main/Sub band switching.....	28
Menu 25: SUB Band Mute	21	Function operation through PA-PD keys.....	28
Menu 26: Editing Memory Name	22	Cable Clone.....	30
Menu 27: Time-Out Timer(TOT).....	22	Resume Factory Default	30
Menu 28-31: Microphone PA,PB, PC,PD key setup	22	Programming Software Installing and Starting	31
Menu 32: RF Squelch	22	Utility Software in Windows system	31
Menu 33: Offset Direction	23	Maintenance.....	32
Menu 34: Scan Resume Condition	23	Trouble Shooting.....	32
Menu 35: Priority Channel Scan	23	Specifications	33
Menu 36: Offset Frequency	23	Appendix	34
Menu 37: Display Mode	24	51 groups CTCSS Tone Frequency(Hz).....	34
Menu 38: Busy Channel Lockout(BCLO).....	24	1024 groups DCS Code.....	34
Menu 39: DTMF Self ID Enquiry	24		
Menu 40: 5-TONE Self ID Enquiry.....	24		
Menu 41: VFO Frequency Linkage	25		
Menu 42: Wide/Narrow FM Mode.....	25		
Menu 44-46: LCD backlight	25		
Menu 47: Keypad backlight brightness.....	25		
Menu 48: Calling Record	25		
Menu 49: AM Function	26		
Menu 51: VHF External speaker port	26		

- ▼ 758 memory channels.
- ▼ 50 Watts of power output on the VHF band and 40 Watts on the UHF band.
- ▼ UU, UV, VU, VV operations.
- ▼ A large LCD with selectable backlit color, Keys and microphone keypads are also backlit and ensures comfortable operation in the dark.
- ▼ CTCSS, DCS, 2-tones, 5-tones and tone-bursts for repeater access and selective calling operations.
- ▼ Various scan functions including CTCSS/DCS Scan.
- ▼ Variety of signaling such as emergency alarm, ANI/DTMF, remote-kill/revive features.
- ▼ Compander function to decrease the background noise and enhance audio clarity.
- ▼ Wide and Narrow-FM modes supported. (25KHz/20KHz/12.5KHz)
- ▼ Theft alarm provides extra safety.

■ SUPPLIED ACCESSORIES

Carefully unpack to make sure the following items are found in the package in addition to this manual:

- Transceiver DR-638

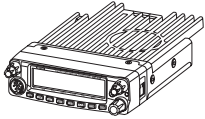

- Microphone EMS-77 (with DTMF keyboard)

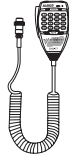

- Mobile Mounting Bracket

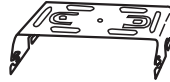

- DC Power Cable with Fuse Holder



- Hardware Kit for Bracket

Black screws (M4X8mm) 4PCS



Tapping screws (M5X8mm) 4PCS



S-Washer



- Spare Fuses

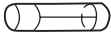

- User Manual



- Mic Hanger Unit

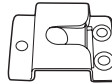

The standard accessories may vary slightly depending on the version you have purchased. Please contact your local authorized Alinco dealer should you have any questions. Alinco and authorized dealers are not responsible for any typographical errors there may be in this manual. Standard accessories may change without notice.

Warranty Policy: Please refer to any enclosed warranty information or contact your authorized Alinco dealer / distributor for the warranty policy.

- In order to operate this product, a properly tuned antenna, its feedline with connectors and fixing hardware are necessary. Please consult with your dealer for details.

3

Initial Installation

MOBILE INSTALLATION

The transceiver may be installed in any position in your car, where the controls and microphone are easily accessible and it does not interfere with the safe operation of the vehicle. If your vehicle is equipped with air bags, be certain your radio will not interfere with their deployment. If you are uncertain about where to mount the unit, contact your vehicle's dealer.

1. Install the mounting bracket in the vehicle using the supplied self-tapping screws (4pcs) and flat washers (4pcs).

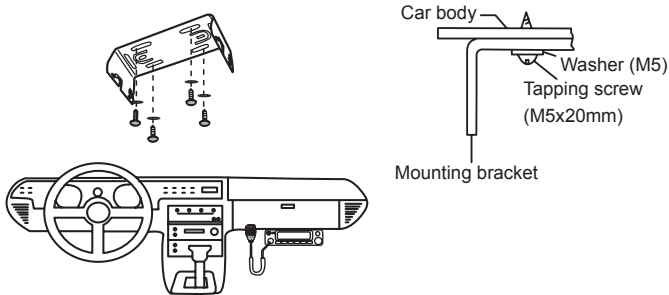

2. Position the transceiver, then insert and tighten the supplied hexagon SEMS screws.

- ▼ Double check that all screws are tightened to prevent vehicle vibration from loosening the bracket or transceiver.

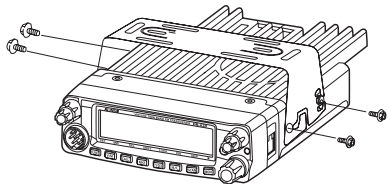

Use only the provided screws otherwise you risk damaging the circuit board, components or fall-off of the unit.

- ▼ Determine the appropriate angle of the transceiver, using the 3 screw hole positions on the side of the mounting bracket.

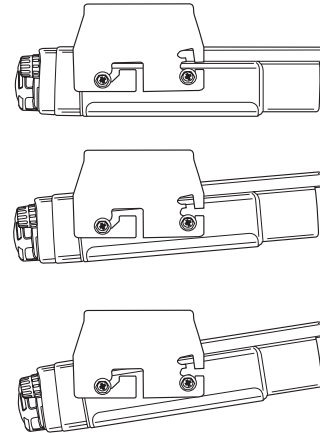

DC POWER CABLE CONNECTION

⚡ MOBILE OPERATION

The vehicle battery must have a nominal rating of 12V. Never connect the transceiver to a 24V battery. Be sure to use a 12V vehicle battery that has sufficient current capacity. If the current to the transceiver is insufficient, the display may darken during transmission, or transmitting output power may drop excessively.

1. Route the DC power cable supplied with the transceiver directly to the vehicle's battery terminals using the shortest path from the transceiver.
 - ▼ Never use the cigarette lighter socket as a DC source.
 - ▼ The entire length of the cable must be dressed so it is isolated from heat, moisture, and the engine secondary (high voltage) ignition system/cables.
2. After installing cable, in order to avoid the risk of damp, please use heat-resistant tap to tie together with fuse box. Don't forget to reinforce whole cable.
3. In order to avoid the risk of short circuit, please cut down connection with negative (-) of battery, then connect with radio.
4. Confirm the correct polarity of the connections, then attach the power cable to the battery terminals; red connects to the positive (+) terminal and black connects to the negative (-) terminal.
 - ▼ Never remove the fuse holders from the cable.

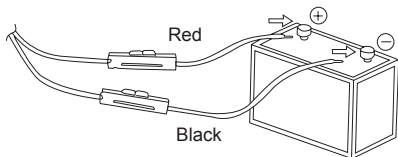

5. Reconnect any wiring removed from the negative terminal.
6. Connect the DC power cable to the transceiver's power supply connector.

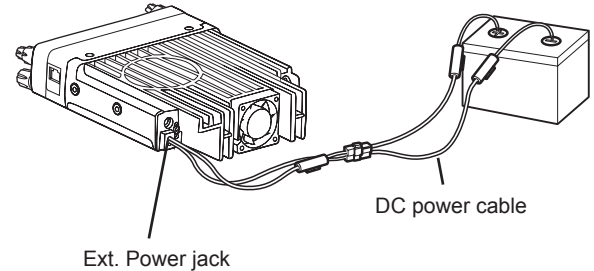

- ▼ Press the connectors firmly together until the locking tab clicks.

If the ignition-key on/off feature is desired (optional feature), use the optional EDC-43 (For Cigar-Plug connection) cable. Connect one of the cables between the ACC terminal or a Cigar-Plug that operates with the vehicle ignition or ACC switch on the vehicle and EXT POWER jack on the rear side of the unit.

7. When the ignition key is turned to ACC or ON (Start) position with the radio turned off, the power switch illuminates. The illumination will be turned off when the ignition key is turned to the off position. To turn on the unit, press the power switch manually while it is illuminated. (While ignition key is at ACC or ON position)
8. When the ignition key is turned to ACC or ON position with the radio's power switch on, the unit turns on automatically and the power switch will be lit. Turn the ignition key to OFF position or manually turn the power switch off to shut down the radio.
9. Use of ignition-key ON/OFF feature drains 5mAh of current from the battery as long as the EDC-43 is being connected.

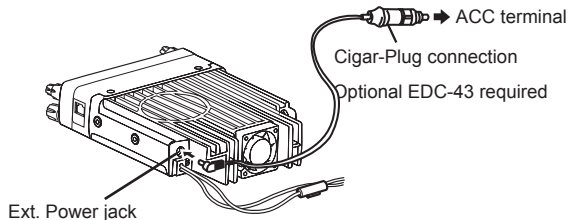

FIXED STATION OPERATION

In order to use this transceiver for fixed station operation, you will need a separate 13.8V DC power supply (not included). Please contact local dealer to require.

The current capacity of your power supply must be 12A or more.

1. Connect the DC power cable to the regulated DC power supply and ensure that the polarities are correct. (Red: positive, Black: negative).

- ▼ Never directly connect the transceiver to an AC outlet.
- ▼ Use the supplied DC power cable to connect the transceiver to a regulated power supply.
- ▼ Do not substitute a cable with smaller gauge wires.

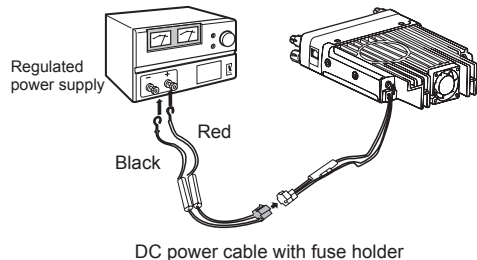

2. Connect the transceiver's DC power connector to the connector on the DC power cable.

- ▼ Press the connectors firmly together until the locking tab clicks.



NOTE

- ▼ Before connecting the DC power to the transceiver, be sure to switch the transceiver and the DC power supply OFF.
- ▼ Do not plug the DC power supply into an AC outlet until you make all connections.

REPLACING FUSES

If the fuse blows, determine the cause, then correct the problem. After the problem is resolved, replace the fuse. If newly installed fuses continue to blow, disconnect the power cable and contact your dealer for assistance.

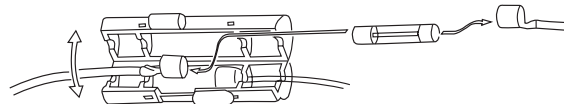

Fuse Location	Fuse Current Rating
Transceiver	15A
Supplied Accessory DC power cable	20A

Only use fuses of the specified type and rating, otherwise the transceiver could be damaged.



NOTE

If you use the transceiver for a long period when the vehicle battery is not fully charged, or when the engine is OFF, the battery may become discharged, and will not have sufficient reserves to start the vehicle. Avoid using the transceiver in these conditions.

POWER SUPPLY VOLTAGE DISPLAY

After connecting the transceiver to the power supply, long press the **(FUNC)** key, enter Menu 12: Sub Band Display menu, and select DC-IN, then it will appear current power supply voltage on the right side of Screen.

The display immediately changes as the voltage supply changes, It also displays voltage during transmission.

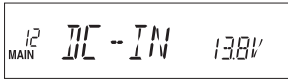

The range of displayed voltage is from 8V to 16V DC. Because the displayed value is estimated, please use a voltmeter when a more precise reading is desired.

ANTENNA CONNECTION

Before operating, install an efficient, well-tuned antenna. The success of your installation will depend on the type of antenna and its correct installation.

Use a 50Ω impedance antenna and low-loss coaxial feed-line that has a characteristic impedance of 50Ω, to match the transceiver input impedance. Coupling the antenna to the transceiver via feed-lines having an impedance other than 50Ω reduces the efficiency of the antenna system and can cause interference to nearby televisions, radio receivers and other electronic equipment.



Transmitting without first connecting an antenna or other matched load may damage the transceiver. Always connect the antenna to the transceiver before transmitting.

All fixed stations should be equipped with a lightning arrester to reduce the risk of fire, electric shock, and transceiver damage.

ACCESSORIES CONNECTIONS

EXTERNAL SPEAKER

If you plan to use the optional external speaker/s, There are 2 options. For a single speaker, plug into the 3.5mm SP Jack on the rear of the radio to hear both bands through one speaker. To use dual speakers, use the stereo plug it into the 3.5mm ST Jack on the rear of the radio to split the left and right bands between the 2 speakers.

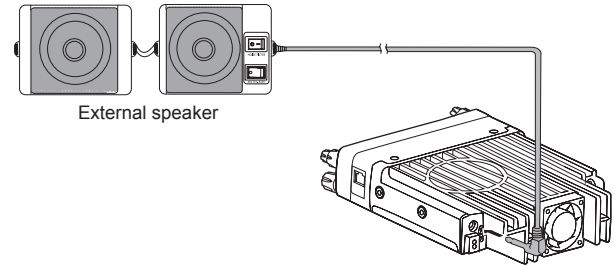

MICROPHONE

For voice communications, connect a provided microphone into the socket on the front of the main unit. Turn the ring firmly on the plug until it locks. Attach the supplied microphone hanger in an appropriate location using the screws included in the screw set.

Microphone connector

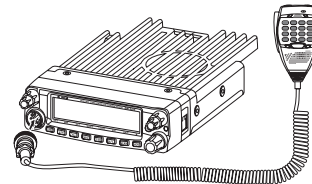

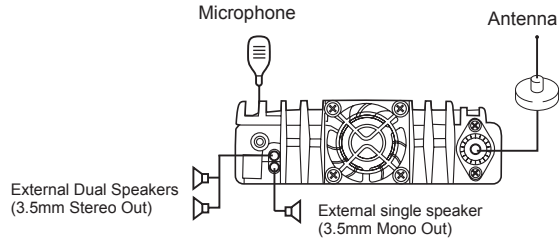

NOTE After installing your antenna, ensure that you have the best possible SWR reading.

7

IMPORTANT: RF Hazard Warning

The electro-magnetic exposure of this device may exceed the European standards of the hazard level when transmitting at the high-power setting while connected to a unity gain antenna at a distance of 63cm or less from the operator. Furthermore, the hazardous RF exposure level depends on the conditions of the combination of the antenna gain, distance from the operator, output setting and installation environment, therefore the operator may be exposed to stronger RF even at a distance of more than 63cm. For safety purpose, it is recommended that the antenna be installed outside of, and as far as possible from, the operator's area. Avoid using an excessively high-gained antenna in case the distance between the operator and the antenna is very limited. Always use the minimum necessary output power for communications.

FRONT PANEL SEPARATION

The main unit can be set with either side facing up. This can facilitate your ability to hear the speaker clearly. Position the front panel as you prefer.

1. Slide the front panel while keeping the tab pressed.

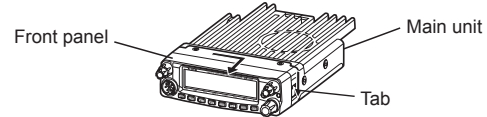

2. Turn the front panel, being careful to keep the cable free from kinks.

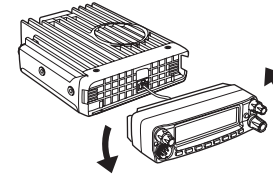

3. Match the catch in the main unit with the slot in the front panel and fit the front panel into the main unit.

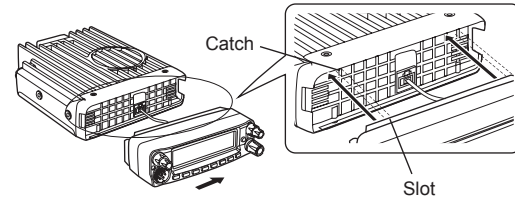

4. Slide the front panel until it locks securely in place.

NOTE By using the optional separation kit EDS-28, you can use the front panel and the main unit in separate positions. The instruction manual for remote placement is provided with the EDS-28.

FRONT PANEL

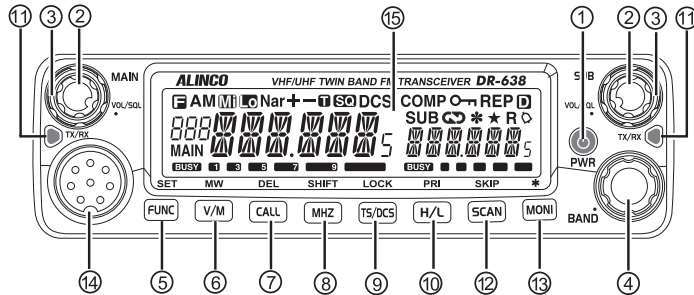

• Basic Functions

NO.	KEY	FUNCTION
1	PWR(Power)	Press it to power On/Off the transceiver.
2	Main AF knob Sub AF knob	Adjust Main band audio level.(Left) Adjust Sub band audio level.(Right)
3	Main SQL ring Sub SQL ring	Adjust Main band squelch level.(Left) Adjust Sub band squelch level.(Right)
4	Dial Knob	Rotate it to choose frequency/channel. Press it to set the left band as "Main Band". In function setup, it works as confirm key. In scan mode, rotate it to change scan directions.
5	FUNC/SET	Short press: Function Key Long press: Enter Function Menu setting
6	[V/M]	Short press: Switches between VFO mode and memory mode. Long press: Switch VFO working frequency

7	[CALL]	Short press: Switches to CALL channel. Long press: When channel setting DTMF/5 Tone, press this key can edit ANI code calling. (microphone input)
8	[MHZ]	Short press: Changes frequency step by 1MHz in VFO mode. Long press: Open the frequency reverse function.
9	[TS/DCS]	Short press: Sets CTCSS and DCS values. Long press: When channel setting CTCSS/DCS, long press this key to open CTCSS/DCS frequency scan.
10	[H/L]	Short press: Switches the output power in 4 levels. Long press: Open the emergency alarm function
11	LED indicators	I lluminates red while transmitting, green while receiving signals.
12	[SCAN]	Short press: Starts scanning. Long press: DTMF/2TONE/5TONE setting.
13	[MONI]	Long press: Opens squelch and cancels TSQ/DCS temporary.
14	MIC Connector	Connect the mic connector or data reading/writing, cloning.
15	LCD Display	Displays frequencies, channels and other operating parameters.

Functions which can be activated while  appears, after pressing the

 Key

1	MW	FUNC+V/M	Programs the data into the memory.
2	DEL	FUNC+CALL	Delete settings.
3	SHIFT	FUNC+MHZ	Changes shift directions.
4	LOCK	FUNC+TS/DCS	Blocks the keys and dial operation
5	PRI	FUNC+H/L	Enters to the Priority monitor.
6	SKIP	FUNC+SCAN	Sets scan skip channels
7	*	FUNC+MONI	Setting memory banks.



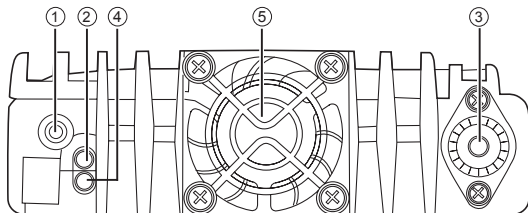

REAR PANEL

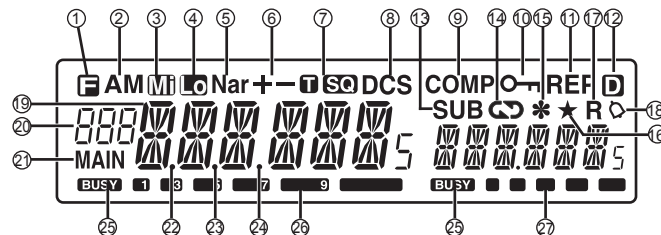

NO.	KEY	FUNCTION
1	Ext. Power Jack	To Connect optional cable for ignition key On/ Off function.
2	Ext. Dual Speakers	To connect external stereo speaker.
3	Antenna Connector	Connect a 50Ω antenna.
4	Ext. Single Speaker	To connect external mono speaker.
5	Fan	Automatically turns on at 45°C, and turns off when it cools down.

DISPLAY



NO.	KEY	FUNCTION
1		Appears when press FUNC key.
2	AM	Appears while in AM mode.
3	MI	Appears while using Middle output power.
4	LO	Appears while using low output power.
5	Nar	Appears while channel setting in narrow band.
6	+/-	Appears while channel setting in offset direction.
7		Appears while channel setting in CTCSS encoding and decoding
8	DCS	Appears while channel setting in DCS encoding and decoding.
9	COMP	Appears while channels setting in voice companding.
10		Appears while open key lock function.
11	REP	Not in use.
12	D	Not in use.
13	SUB	Appears while SUB band in Main side.
14		Not in use.

15	*	Appears while open grouping function.
16	★	Appears while Sub side in memory channel or Call channel mode.
17	R	Appears while Channels setting in frequency reverse function.
18	☐	Not in use.
19	□□□□□□□□□□	Appears channel frequency or channel name.
20	□□□	Appears channel number or grouping number.
21	MAIN	Appears while Main band.
22	P1	Appears when current channel is priority channel.
23	P2	Appears while channel setting in Scan skip.
24	P3	Flash while open Scan.
25	BUSY	Appears while main/sub receive squelch opened.
26	■■■■■	MAIN:Transmit power indicator/receive indicator.
27	■■■■■	SUB:Receive indicator.

MICROPHONE

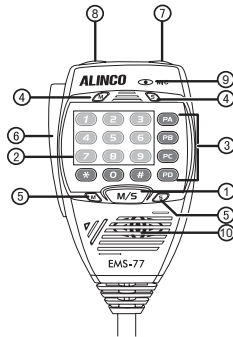

NO.	KEY	FUNCTION
1	M/S	Switches between Main and Sub bands.
2	Number Key	Input VFO frequency or DTMF dial out etc.
3	PA	Switches between VFO and Memory modes.
	PB	Changes CTCSS and DCS mode parameters.
	PC	Starts and stops scanning.
4	Band Indicator	Transmit preprogrammed DTMF, 2TONE, 5TONE code.
		The indicator light on for Main band.
5	TX/RX Indicator (Main/Sub)	Illuminates red while transmitting, green while receiving signals.
6	PTT	Push-TO-Talk key: Press this key to transmit.
7	UP	Increase frequency, channel number or setting value.
8	DOWN	Decrease frequency, channel number or setting value.
9	MIC	Speak here during transmission.
10	Speaker	When shut the speaker in the base, you can hear the calling by this speaker.

MIC Connector Diagram(in the front view of connector)

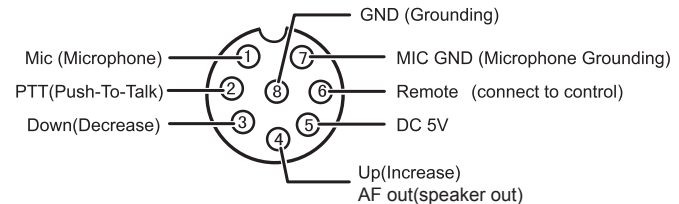

Important: The explanations herein are based on manufacturer's default setting.

SWITCHING THE POWER ON/OFF

POWER ON

Press  key to turn on. Appears "ALINCO DR-638" then displays current frequency or channel.

POWER OFF

Press  key for over 0.5 Second to turn off.

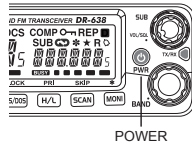

POWER

ADJUSTING THE VOLUME

Rotate the [VOL] knob of selected band clockwise to increase the audio level, counterclockwise to decrease.

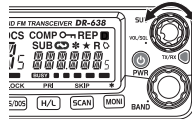



 Rotate the SQL ring counterclockwise to hear the white noise to set the audio NOTE level properly.

SQUELCH LEVEL SETTING

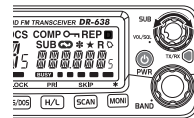

Rotate the [SQL] ring of selected band clockwise to increase the squelch level, counterclockwise to decrease.

A noise is heard at the minimum setting.



 Squelch is to cut the white-noise in stand-by state. NOTE Setting it too high may risk missing weaker signals but lower setting may open squelch often hearing more noise. You should set the levels of both MAIN and SUB bands before start operating.



SWITCH BETWEEN VFO AND MEMORY MODE

In standby, press  or  key to switch between VFO(Frequency)

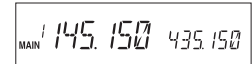



and Memory mode. When in memory mode, the memory channel number appears on the left side of memory frequency.

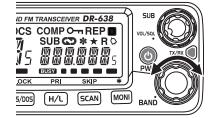

SETTING FREQUENCY

In VFO mode, turn the dial clockwise to increase frequency; Counterclockwise to decrease. Every click will increase or decrease frequency by one channel-step. To select MAIN and SUB band, press the dial. Press  key then turn the dial or  keys to change the frequency by 1MHz step.



 NOTE The microphone  key also able to adjust frequency. Press  key will increase(decrease) the frequency by one step size. Hold  key will adjust the frequency continuously.

INPUT FREQUENCY THROUGH MICROPHONE NUMBER KEY

In VFO mode, you can input the frequency by the numerical keys. Out-of-the-band frequencies are automatically rejected. For example, to input 145.320MHz, press 1,4,5,3,2,0 successively. When completed, a decimal point appears at the MHz order.

 NOTE When the Band lockout function is on, the operating ranges will be limited.

SETTING CHANNEL

In memory mode, you can select the frequency by turning the dial. Turn clockwise to increase, counterclockwise to decrease the channel numbers. To switch the MAIN/SUB band, press the dial. While a memory channel is shown in SUB band,  icon appears.

Pressing **[UP/DOWN]** keys on microphone also sets channels.

 **NOTE** The memory channels must be pre-programmed to operate in the memory mode. Empty channels numbers won't be displayed during operation and appears only during memory setting.

✘ INPUT CHANNEL THROUGH MICROPHONE NUMBER KEY

In memory mode, pressing 3 numerical keys recalls the desired memory channel. For example press 0,0,1 recalls channel 1. Press 0,3,0 for ch.30, and 5,1,2 for ch.512. If the input channel is not programmed in advance, an error beep sounds and returns to last channel operated. While pressing the key, **[CH-]** and entering numbers are shown on the display.

■ SWITCH BETWEEN MAIN BAND AND SUB BAND

At the default setting, both MAIN and SUB bands are displayed. The transmitting is possible only on the frequency/channel shown on the LEFT.



To transmit, press the dial to set the desired frequency or channel on the LEFT side of the display.



■ SELECTING THE OPERATING BAND

1. Select the MAIN band by pressing the dial so that MAIN appears on the left corner of the display. By pressing and holding the **[V/M]** key toggles the operating bands between 144-146MHz and 430-440MHz for receiving.
2. Select the SUB band so that SUB appears above the frequency display on the right. By pressing and holding the **[V/M]** key toggles the operating bands between 144-146MHz and 430-440MHz for receiving. Some restriction may apply depending on the versions.

Transmitting is prohibited outside of the specified frequency range. "OFF" appears when PTT is pressed in the RX-only frequency and alarming beep sounds.

 **NOTE** This transceiver can be set working on 2 UHF band or 2 VHF band.

■ RECEIVING

Both MAIN and SUB bands receive signals simultaneously. While receiving signals, the **BUSY** icon and signal strength icon will appear in the display, and audio sounds.



 **NOTE** You may risk missing weaker signals when the squelch level is set too high. If the Busy and signal strength icon are displayed but can't hear any audio, please check the selective calling(signaling) setting like Tone-squelch and DCS.

■ SQUELCH OFF/SQUELCH OFF MOMENTARY

Press and hold **[MONI]** key cancels the squelch and signaling setting temporary to monitor incoming signals of currently operating band. Release the **[MONI]** key to activate the squelch and signaling settings.

Pressing **[*]** key on the microphone functions same as above but holds squelch off until the **[*]** is pressed again.



■ TRANSMITTING

Before transmitting, monitor the frequency to make sure the channel is vacant and won't cause interference to others.

Hold [PTT] key to transmit, and speak at approximately 5cm/2 inches to the microphone in normal voice level. Too loud or too low voice level may cause trouble hearing at the receiving stations.



 **NOTE** Transmitting is possible only on the MAIN band. Operating setting can't be changed while transmitting.

■ TRANSMIT DTMF/2TONE/5TONE SIGNALING

If the current channel is with DTMF/2TONE/5TONE signaling, hold [PTT] and [UP] key will transmit selected Pre-programmed signaling.

■ HIGH/MID/LOW POWER SETTING

Press  key to choose output power from 4 different levels. Every press of the key toggles the setting as the chart below.

The setting is valid until next change in VFO mode, but it holds only temporarily in the memory mode and changing the channel or turning on/off the power will cancel the setting and recalls the original memory parameter of the output power setting.

HIGH	MID1	MID2	LOW
VHF(50W)	VHF(25W)	VHF(10W)	VHF(5W)
UHF(40W)	UHF(25W)	UHF(10W)	UHF(5W)

■ FREQUENCY REVERSE



In standby, hold  key for over 1 second to turn On/Off frequency reverse function. When reverse function is on, the TX frequency will change to RX frequency and RX frequency change to TX frequency.







The signaling will also be reversed if CTCSS/DCS signaling existed in this channel.



NOTE This function is valid only when current channel setup with offset frequency and offset direction

■ CTCSS/DCS SETTING

In standby, press  key or microphone  key can setting the CTCSS/DCS encoding and decoding for current channel.

1. Press  key, When the screen displays the CTCSS frequency and "T" icon, rotate band switch or MIC UP/DOWN keys to select CTCSS encoding which is desired to setting, press  key or [PTT] key to confirm and exit.
2. Double Press  key, When the screen displays the CTCSS frequency and "T SO" icon, rotate band switch or MIC UP/DOWN keys can sync setting the CTCSS encoding and decoding which is desired, press  key or [PTT] key to confirm and exit
3. Press  key three times, When the screen displays the DCS NO. and "DCS" icon, rotate band switch or MIC UP/DOWN keys can sync select the CTCSS encoding and decoding which is desired, press  key or [PTT] key to confirm and exit.

■ CALL CHANNEL RECALLING

Press  key to recall a preprogrammed channel. It is convenient to set the most frequently used channel in advance as a CALL channel for quicker operation. Repeat it to return to the last operating channel.

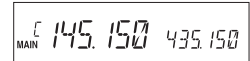



■ CTCSS/DCS SCAN

In standby, long press  key to enter CTCSS/DCS scan, when find matching CTCSS/DCS signal, the scan will pause in the scan pause way. In the CTCSS/DCS Scan status, rotate band switch or press the

MIC UP/DOWN key can change the scan direction.

 To enable this function, the channel shall be programmed with
NOTE CTCSS/DCS decode.

■ DUAL WATCH

In standby, Press  and while  icon is displayed on the screen, press  key to enter Dual Watch mode. The radio will scan the channel in every 5 seconds. When the radio receives matching signal, it pause scanning until the signaling disappear. Repeat above operation to exit Dual watch.

■ EMERGENCY ALARM

To start emergency alarm, press and hold  key until the transceiver displays **ALARM** and emit alarm. Re-power on the transceiver to exit alarm. This transceiver has 4 kind of alarm which can be setup by programming software.

■ CHANNEL/FREQUENCY SCAN

✕ FREQUENCY SCAN

In VFO mode, press the  or  key to start scanning.



During the scanning, turn the dial or press **[UP/DOWN]** keys to change the scanning direction. Press [PTT] or keys other than **[UP/DOWN]** to stop scanning.

✕ CHANNEL SCAN

In Memory mode, press the  or  key to start scanning.







During the scanning, turn the dial or press **[UP/DOWN]** keys to change the scanning direction. Press [PTT] or keys other than **[UP/DOWN]** to stop scanning.

■ CHANNEL SCAN SKIP

In Memory mode, turn the dial to choose the channel to skip during scanning. Press  and while  icon is displayed on the screen, press  key. A beep sounds twice and the channel is set as the skip channel and "P2" icon. Repeat it to cancel the setting, a beep is heard once and "P2" icon disappears.



■ MEMORY CHANNEL PROGRAMMING

1. In VFO mode, select the desired frequency by using the dial or numerical keys.
2. Press  key to display  and a memory channel number on the display.
3. Rotate the dial or press **[UP/DOWN]** keys to select a desired memory channel number.
4. While displaying the  and a number, press  key. MEN-IN appears on the display. While it's displayed, press and hold the  key again until a beep is heard and MEN-IN disappears. The memory channel is set. If  icon disappears during operation, simply press the  key again to resume.

14

■ SEARCH SCAN RANGE SETTING

Five different search scan ranges are programmable.

Set a pair of upper and lower limit frequencies in each L1/U1- L5/U5 memory channels to activate the function. L stands for the lower and U stands for the upper limit. The upper limit must exceed the lower limit frequency. Please refer above "MEMORY CHANNEL PROGRAMMING" section for how to memory frequencies.

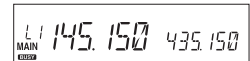

CHANNEL COPY

1. In memory mode, select the desired channel by using the dial or numerical keys.
2. Press **[FUNC]** key to display **[F]** and a memory channel number on the display.
3. Rotate the dial or press **[UP/DOWN]** keys to select a desired memory channel number.
4. While displaying the **[F]** and a number, press **[V/M]** key. **MEN-IN** appears on the display. Two beep is heard and then MEN-IN disappears channel copy completed. If **[F]** icon disappears during operation, simply press the **[FUNC]** key again to resume.

CHANNEL DELETE

1. In memory mode, select the desired channel by using the dial or numerical keys.
2. Press **[FUNC]** key to display **[F]** then press **[V/M]** key. **MENOUT** appears on the display. A beep is heard and the memory channel frequency disappears
3. Then rotate the dial or press **[UP/DOWN]** keys to confirm, channel delete completed. If **[F]** icon disappears during operation, simply press the **[FUNC]** key again to resume.

MEMORY BANKS OPERATION

The transceiver has 6 groups "A-F" and one no edit group.

Normal memory: 1 to 200 (200ch)

Bank A: CH 201 to 300 (100ch)

Bank B: CH 301 to 400 (100ch)

Bank C: CH 401 to 500 (100ch)

Bank D: CH 501 to 600 (100ch)

Bank E: CH 601 to 700 (100ch)

Bank F: CH 701 to 758 (58ch)

In memory mode, you can do the groups function according to the following instruction, the groups number show in the position of channel number. Normal memory: show "- -".

1. Press **[FUNC]** key to display **[F]** then press **[MONI]** key to enter the group mode.
2. Rotating the dial to choose the groups you want.
3. Press the **[MONI]** key again to confirm, "*" icon appears on the display, then the radio goes to the group that you choose.

If there is not channel in your choose group, it will return to the original channel.

4. Exit the groups mode: Press the **[FUNC]** then press **[MONI]** key in two times continuously, "*" icon disappears, the radio will back to the channel mode.

Parameter Setting Mode (SET MODE)

6

You can set the operating parameters and functions of DR-638 to best suite your demands.

1. Press and hold **[FUNC]** key until activating the function menu.
2. Rotate the dial or use **[UP/DOWN]** keys to select the desired menu.
3. Press the dial to enter to the parameter setting state and rotate it or use **[UP/DOWN]** keys to select the desired value.
4. Press the dial again to go back to the menu and set next parameters, or press **[PTT]** or **[FUNC]** key to set the new parameter and return to the operating mode.

■ MENU 01: APO (AUTOMATIC POWER OFF)

Once APO is activated, the transceiver will be automatically switched off when the pre-set time is elapsed.

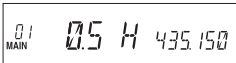
1. Press and hold **[FUNC]** key until activating the function menu. Rotate the dial or use **[UP/DOWN]** keys to select the menu 01 APO and press the dial. 
2. Rotate the dial or use **[UP/DOWN]** keys to select the value from 0.5 to 12 hours, or OFF for not using this function. 
3. Press **[PTT]** to set and exit or press the dial to set and continue.

■ MENU 02: AUTOMATIC OFFSET

This transceiver has automatic offset function. When this function is on, the transceiver will automatically transmitting with RX frequency \pm offset frequency.

1. Press and hold **[FUNC]** key until activating the function menu. Rotate the dial or use **[UP/DOWN]** keys to select the menu 02 ARS and press the dial. 

2. Rotate the dial or use **[UP/DOWN]** keys to select ON or OFF. 
3. Press **[PTT]** to set and exit or press the dial to set and continue.
4. When the ARS is ON, the transceiver will automatically turn on offset direction, the default offset for 144MHz range is 0.6MHz.



Frequency range	Offset Direction
145.200-145.495MHz	LCD displays "-"

■ MENU 03: VFO CHANNEL STEP SETTING

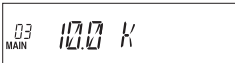
This menu appears only in the VFO mode.

1. Press and hold **[FUNC]** key until activating the function menu. Rotate the dial or use **[UP/DOWN]** keys to select the menu 03 STEP and press the dial. 
2. Rotate the dial or use **[UP/DOWN]** keys to select the value from 2.5K, 5K, 6.25K, 10K, 12.5K, 15K, 20K, 25K, 30K and 50KHz. 
3. Press **[PTT]** to set and exit or press the dial to set and continue.

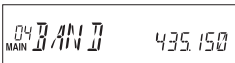
■ MENU 04: VFO BAND LOCKOUT

1. Press and hold **[FUNC]** key until activating the function menu. Rotate the dial or use **[UP/DOWN]** keys to select the menu 04 BAND and press the dial. 
2. Rotate the dial or use **[UP/DOWN]** keys to select the value from **ON**: Turn on VFO band lockout function. **OFF**: Turn off VFO band lockout function. 
3. The scanning or frequency setting through the dial or numerical keys

become available only within the current VFO frequency band.

- Press [PTT] to set and exit or press the dial to set and continue.

MENU 05: BEEP SOUND

- Press and hold **[FUNC]** key until activating the function menu. Rotate the dial or use **[UP/DOWN]** keys to select the menu 05 BEEP and press the dial.
- Rotate the dial or use **[UP/DOWN]** keys to select the value from

05 BEEP 435.150
MAIN

ON: Turn on Beep function.

OFF: Turn off Beep function.

OFF setting turns off the beep sounds.

05 BEEP ON 435.150
MAIN
- Press [PTT] to set and exit or press the dial to set and continue.

MENU 06: CPU CLOCK FREQUENCY SETTING

- Press and hold **[FUNC]** key until activating the function menu. Rotate the dial or use **[UP/DOWN]** keys to select the menu 06 CLKSFT and press the dial.

06 CLKSFT 435.150
MAIN
- Rotate the dial or use **[UP/DOWN]** keys to select the value from

06 SFT ON 435.150
MAIN

ON: Change CPU clock.

OFF: CPU clock frequency remain unchanged.
- When you hear a noise-interference always on a certain same channel even without connecting to the antenna, try setting it to ON parameter. If the noise is CPU clock related, it may be eliminated. This feature is not a noise-blanker.
- Press [PTT] to set and exit or press the dial to set and continue.

MENU 07: 2TONE ENCODE SELECT

- Press and hold **[FUNC]** key until activating the function menu. Rotate the dial or use **[UP/DOWN]** keys to select the menu 07 2T ENC and press the dial.

07 2T ENC 435.150
MAIN
- Rotate the dial or use **[UP/DOWN]** keys to select the value from 0-23, total 24 groups. If the 2TONE encode are programmed with name, the LCD will display the correspondent name.

07 2TONE00 435.150
MAIN
- Press [PTT] to set and exit or press the dial to set and continue.

 After choose the 2TONE encode group. Press [PTT] will transmit selected NOTE code.

MENU 08: 5TONE ENCODE SELECT

- Press and hold **[FUNC]** key until activating the function menu. Rotate the dial or use **[UP/DOWN]** keys to select the menu 08 5T ENC and press the dial.

08 5T ENC 435.150
MAIN
- Rotate the dial or use **[UP/DOWN]** keys to select the value from 0-99, total 100 groups. If the 5TONE encode are programmed with name, the LCD will display the correspondent name.

08 5TONE00 435.150
MAIN
- Press [PTT] to set and exit or press the dial to set and continue.

 After choose the 5TONE encode group. Press [PTT] will transmit selected NOTE code.

MENU 09: ADD OPTIONAL SIGNALING

1. Press and hold **[FUNC]** key until activating the function menu. Rotate the dial or use **[UP/DOWN]** keys to select the menu 09 TONDEC and press the dial.

09	MAIN	TONDEC	435.150
----	------	--------	---------
2. Rotate the dial or use **[UP/DOWN]** keys to select the value from :

DTMF: means DTMF signaling is added.
2TONE: means DTMF signaling is added.
5TONE: means DTMF signaling is added.
OFF: Turn off optional signaling

09	MAIN	TON DT	435.150
----	------	--------	---------

09	MAIN	TON 2T	435.150
----	------	--------	---------

09	MAIN	TON 5T	435.150
----	------	--------	---------

09	MAIN	TON OF	435.150
----	------	--------	---------
3. Press **[PTT]** to set and exit or press the dial to set and continue.
4. DTMF and 5Tone signaling can be applied for other advanced features such as ANI, **[PTT]** ID, group call, select call, remotely stun, remotely kill/Revive etc.

 **NOTE** The working of optional signaling shall be work associated with the squelch mode setup. (Refer to Squelch Mode setup in page 20)

MENU 10: TONE ENCODE SETUP

1. Press and hold **[FUNC]** key until activating the function menu. Rotate the dial or use **[UP/DOWN]** keys to select the menu 10 TXDCS and press the dial.

10	MAIN	TXDCS	435.150
----	------	-------	---------
2. Rotate the dial or use **[UP/DOWN]** keys to select the value from:

OFF: Turn off both CTCSS/DCS encode.
CTCSS: Set CTCSS encode.
DCS: Set DCS encode.

10	MAIN	CTC	435.150
----	------	-----	---------

10	MAIN	DCS	435.150
----	------	-----	---------

3. Press **[PTT]** to set and exit or press the dial to set and continue.

Available tones

CTCSS: 62.5-254.1Hz, and one self-define group, total 52 groups

DCS: 000N-777I, total 1024 groups

4. See the Appendix at the end of this booklet for more details.

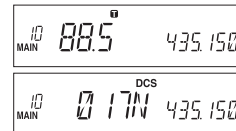

MENU 11: TONE DECODE SETUP

1. Press and hold **[FUNC]** key until activating the function menu. Rotate the dial or use **[UP/DOWN]** keys to select the menu 11 RXDCS and press the dial.

11	MAIN	RXDCS	435.150
----	------	-------	---------
2. Rotate the dial or use **[UP/DOWN]** keys to select the value from:

OFF: Turn off both CTCSS/DCS decode.
CTCSS: Set CTCSS decode.
DCS: Set DCS decode.

11	MAIN	CTC	435.150
----	------	-----	---------

11	MAIN	DCS	435.150
----	------	-----	---------
3. Press **[PTT]** to set and exit or press the dial to set and continue.

Available tones

CTCSS: 62.5-254.1Hz, and one self-define group, total 52 groups

DCS: 000N-777I, total 1024 groups

See the Appendix at the end of this booklet for more details.

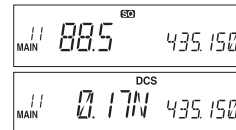

 **NOTE** The working of CTCSS/DCS decode shall be work associated with the squelch mode setup. (Refer to Squelch Mode setup in page 19)

■ MENU 12: SUB BAND DISPLAY

1. Press and hold **[FUNC]** key until activating the function menu. Rotate the dial or use **[UP/DOWN]** keys to select the menu 12 DSPSUB and press the dial.

12 MAIN DSPSUB 435.150

2. Rotate the dial or use **[UP/DOWN]** keys to select the value from:

FREQ: Displays sub band frequency.

DC-IN: Displays approximate DC voltage instead of sub band frequency.

OFF: Turns off to display the sub band frequency.

12 MAIN FREQ 435.150

12 MAIN DC-IN 138V

12 MAIN OFF

3. Press **[PTT]** to set and exit or press the dial to set and continue.
4. While OFF is selected, you can still switch between the MAIN and SUB bands.
5. This setting only hides the SUB band appearance, not turning off the SUB band functions.

■ MENU 13: DTMF ENCODE PRE-LOADING TIMING

1. Press and hold **[FUNC]** key until activating the function menu. Rotate the dial or use **[UP/DOWN]** keys to select the menu 13 DTMF D and press the dial.

13 MAIN DTMF D 435.150

2. Rotate the dial or use **[UP/DOWN]** keys to select the pre-Loading time value from:

100Ms/300Ms/600Ms/800Ms and 1000Ms (1 second)

13 MAIN 500MS 435.150

3. Press **[PTT]** to set and exit or press the dial to set and continue.

■ MENU 14: DTMF ENCODE TRANSMITTING TIME

1. Press and hold **[FUNC]** key until activating the function menu. Rotate the dial or use **[UP/DOWN]** keys to select the menu 14 DTMF S and press the dial.

14 MAIN DTMF S 435.150

2. Rotate the dial or use **[UP/DOWN]** keys to select the time for transmit a single DTMF encoding tone and the interval time value from 30Ms / 50Ms / 80Ms / 100Ms / 150Ms / 200Ms and 250Ms.

14 MAIN 50MS 435.150

3. Press **[PTT]** to set and exit or press the dial to set and continue.

■ MENU 15: DTMF ENCODE SETUP

1. Press and hold **[FUNC]** key until activating the function menu. Rotate the dial or use **[UP/DOWN]** keys to select the menu 15 DTMF W and press the dial.

15 MAIN DTMF W 435.150

2. Rotate the dial or use **[UP/DOWN]** keys to select the DTMF group.

15 MAIN 01- 435.150

3. Press **[FUNC]** key again to go back to DTMF. Pressing **[PTT]** will transmit with selected DTMF code (01-16: 16 groups of DTMF codes programmable). When the selected group is empty, the LCD displays [-----]. Press the dial so that the last bar starts flashing. Turn the dial to select desired first character or number for DTMF tone coding. Press the dial again to select the next. Press the **[FUNC]** key to complete and return to the DTMF group menu. Repeat for more coding.

15 MAIN 123456 435.150

15 MAIN 02- 435.150

4. Press **[FUNC]** key again to store values and exit code editing.
5. Press **[PTT]** to set and exit or press the dial to set and continue.

MENU 16: SQUELCH MODE SETUP

This parameter becomes available only when CTCSS/DCS or optional DTMF/5TONE/TONE signaling has been set.

1. Press and hold **[FUNC]** key until activating the function menu. Rotate the dial or use **[UP/DOWN]** keys to select the menu 16 SGN SQL and press the dial.

2. Rotate the dial or use **[UP/DOWN]** keys to select desired setting.

SQ: Normal squelch only without any selective calling functions.

CTSS/DCS: Like TSQ or DCS, CTCSS/DCS code is required to open the squelch.

CT*TO: Optional signaling such as DTMF and 5-tone is required to open the squelch.

TONE: CTCSS/DCS and an Optional signaling is required to open the squelch.

CT/TO: Opens squelch when matching either one of CTCSS/DCS or an optional signaling.

3. Press **[PTT]** to set and exit or press the dial to set and continue.

MENU 17: COMPANDER

Compander reduces background noise, but all users' radios must be equipped with compander and turned on the function.

1. Press and hold **[FUNC]** key until activating the function menu. Rotate the dial or use **[UP/DOWN]** keys to select the menu 17 COMP and press the dial.

2. Rotate the dial or use **[UP/DOWN]** keys to select the value:

ON: Turn on Compander function.

OFF: Turn off Compander function

3. Press **[PTT]** to set and exit or press the dial to set and continue.

MENU 19: TONE BURST TONES

Tone-burst tones are commonly used in Europe to activate repeaters.

1. Press and hold **[FUNC]** key until activating the function menu. Rotate the dial or use **[UP/DOWN]** keys to select the menu 19 TBST and press the dial.

2. Rotate the dial or use **[UP/DOWN]** keys to select desired setting.

1000: 1000Hz.

1450: 1450Hz.

1750: 1750Hz.

2100: 2100Hz.

3. Press **[PTT]** to set and exit or press the dial to set and continue.

To send the tone, press **[PTT]** then press **[down]** key. Once the repeater is open, sending TBT is not necessary.

MENU 20: HYPER

The radio can be setting two kinds of display mode, HYPER1 and HYPER2, Provide independent VFO, Call Channel, Group function setting.

1. Press and hold **[FUNC]** key until activating the function menu. Rotate the dial or use **[UP/DOWN]** keys to select the menu 20 HYPER and press the dial.
2. Rotate the dial or use **[UP/DOWN]** keys to select desired setting.

HYPER1: Super channel 1 display mode.

HYPER2: Super channel 2 display mode.

3. Press [PTT] to set and exit or press the dial to set and continue.

■ MENU 21: KEYPAD LOCKOUT

1. Press and hold **[FUNC]** key until activating the function menu. Rotate the dial or use **[UP/DOWN]** keys to select the menu 21 LOCK and press the dial.

2. Rotate the dial or use **[UP/DOWN]** keys to select the value:

ON: Turn on the key-lock. All keys operation are locked except **[FUNC]** key.

OFF: Turn off the key-lock.

3. Press [PTT] to set and exit or press the dial to set and continue.

■ MENU 22: PTT LOCKOUT

This function is to prohibit or restrict PTT operations.

1. Press and hold **[FUNC]** key until activating the function menu. Rotate the dial or use **[UP/DOWN]** keys to select the menu 22 LOCKT and press the dial.

2. Rotate the dial or use **[UP/DOWN]** keys to select the value:

ON: PTT lock.

OFF: PTT lock disabled.

3. Press **[FUNC]** key to set and exit or press the dial to set and continue.

■ MENU 23: TOT PENALTY

When transmission is shut down in the TOT mode, this function prohibits

another transmission during a selected TOT penalty period regardless of the [PTT] key being pressed. A beep sounds when the [PTT] key is pressed during the TOT penalty period.

1. Press and hold key until activating the function menu. Rotate the dial or use **[UP/DOWN]** keys to select the menu 23 TOTP and press the dial.

2. Rotate the dial or use **[UP/DOWN]** keys to select the value:

1-30 second, total of 30 setting parameters.

OFF: TOTP is turn off.

3. Press [PTT] to set and exit or press the dial to set and continue.

■ MENU 24: FREQUENCY REVERSE

1. Press and hold **[FUNC]** key until activating the function menu. Rotate the dial or use **[UP/DOWN]** keys to select the menu 24 REV and press the dial.

2. Rotate the dial or use **[UP/DOWN]** keys to select the value:

ON: Frequency Reverse is turn on, The TX and RX frequency will be exchanged, the CTCSS DCS signaling also will be exchanged if existed in current channel.

OFF: Turn off Frequency Reverse.

3. Press [PTT] to set and exit or press the dial to set and continue.

■ MENU 25: SUB BAND MUTE

1. Press and hold **[FUNC]** key until activating the function menu. Rotate the dial or use **[UP/DOWN]** keys to select the menu 25 MUTE and press the dial.

2. Rotate the dial or use **[UP/DOWN]** keys to select the value:

TX: When the Main band is transmitting, the sub band receive is mute.

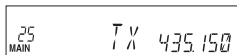

RX: When the Main band is receiving, the sub band receive is mute.



RX/TX: Suspends the sub band receive at any time.

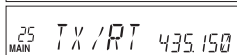

3. Press [PTT] to set and exit or press the dial to set and continue.

MENU 26: EDITING MEMORY NAME

1. Press and hold [FUNC] key until activating the function menu. Rotate the dial or use [UP/DOWN] keys to select the menu 26 NAME C and press the dial so that the last digit starts flashing. Up to 7 characters can be registered in each memory channel.
2. Turn the dial to select desired first character. Press the dial again to edit the next. Press [FUNC] key to store values and exit the setting menu.
3. Press PTT to set and exit or press the dial to set and continue.

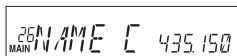

MENU 27: TIME-OUT TIMER(TOT)

The time-out timer limits the amount of continuously transmitting time. When the transmitting reaches the selected TOT value, the transmission will be automatically cut off and emits warning beep.

1. Press and hold [FUNC] key until activating the function menu. Rotate the dial or use [UP/DOWN] keys to select the menu 27 TOT and press the dial.

2. Rotate the dial or use [UP/DOWN] keys to select the value:

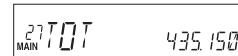

1-30 Minutes, total of 30 setting parameters.

OFF: TOT is turn off.



3. Press [PTT] to set and exit or press the dial to set and continue.



4-5 minutes is common and recommended.

MENU 28-31: MICROPHONE PA,PB, PC,PD KEY SETUP

1. Press and hold [FUNC] key until activating the function menu. Rotate the dial or use [UP/DOWN] keys to select the menu No.28-31 menu. The LCD displays "PG PA", "PG PB", "PG PC", "PG PD" and press the dial.
2. Rotate the dial or use [UP/DOWN] keys to select wanted value
3. Press [PTT] to set and exit or press the dial to set and continue.

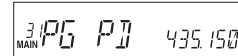
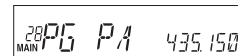

For Menu details, please refer to Page 28-29, Microphone Operation.

MENU 32: RF SQUELCH

The squelch opens only when the signal strength reaches to the selected S-meter reading.

1. Press and hold [FUNC] key until activating the function menu. Rotate the dial or use [UP/DOWN] keys to select the menu 32 RF SQL and press the dial.
2. Rotate the dial or use [UP/DOWN] keys to select the value:

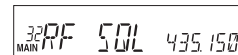

S-3: Squelch opens at 3 bars.

S-5: Squelch opens at 5 bars.

S-9: Squelch opens at 9 bars.

S-FULL: Squelch opens at FULL-scale reading only.

- Press [PTT] to set and exit or press the dial to set and continue.



when open, SQL ring adjustment is inefficiency.

MENU 33: OFFSET DIRECTION

- Press and hold [FUNC] key until activating the function menu. Rotate the dial or use [UP/DOWN] keys to select the menu 33 RPT MOD and press the dial.

- Rotate the dial or use [UP/DOWN] keys to select the value:

-: Minus offset, means transmitting frequency is lower than receiving frequency.

+: Plus offset, means transmitting frequency is higher than receiving frequency.

OFF: OFFSET is turn off. Transmitting frequency is the same as receiving frequency.

- Press [PTT] to set and exit or press the dial to set and continue.

MENU 34: SCAN RESUME CONDITION

- Press and hold [FUNC] key until activating the function menu. Rotate the dial or use [UP/DOWN] keys to select the menu 34 SCAN and press the dial.

- Rotate the dial or use [UP/DOWN] keys to select the value:

TIME: Pauses 5 seconds to receive the signal and resume scanning.

BUSY: Remains on the frequency until the signal is gone, then resume scanning after pausing 2 seconds.

SECEDE: Cancels scanning when a signal is received and stopped scanning.

- Press [PTT] to set and exit or press the dial to set and continue.

MENU 35: PRIORITY CHANNEL SCAN

Priority channels must be pre-programmed in P SCAN to set this parameter.

- Press and hold [FUNC] key until activating the function menu. Rotate the dial or use [UP/DOWN] keys to select the menu 35 SCAN M and press the dial.

- Rotate the dial or use [UP/DOWN] keys to select the value:

MEN: Scans all memory channels in the channel scanning mode.

MSN: Scans only Priority memory channels in the channel scanning mode.

- Press [PTT] to set and exit or press the dial to set and continue.

MENU 36: OFFSET FREQUENCY

The difference between the transmitting and receiving frequencies for repeater operation is called shift or offset frequency.

- Press and hold [FUNC] key until activating the function menu. Rotate the

dial or use **[UP/DOWN]** keys to select the menu 36 SHIFT and press the dial.

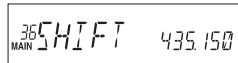

2. Rotate the dial or use **[UP/DOWN]** keys to select desired value between 0 and 100MHz.



3. Press [PTT] to set and exit or press the dial to set and continue.

■ MENU 37: DISPLAY MODE

1. Press and hold **[FUNC]** key until activating the function menu. Rotate the dial or use **[UP/DOWN]** keys to select the menu 37 DISPLAY and press the dial.

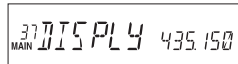

2. Rotate the dial or use **[UP/DOWN]** keys to select the mode:

FREQ: Displays channel number + frequency in memory mode and switches to VFO mode by pressing **[V/M]** key.



CH: Displays only memory channel numbers.



NAME: Displays channel number + name tags in memory mode and switches to VFO mode by pressing **[V/M]** key.



3. Press [PTT] to set and exit or press the dial to set and continue.

■ MENU 38: BUSY CHANNEL LOCKOUT(BCLO)

1. Press and hold **[FUNC]** key until activating the function menu. Rotate the dial or use **[UP/DOWN]** keys to select the menu 38 RELOCK and press the dial.

2. Rotate the dial or use **[UP/DOWN]** keys to select the mode:

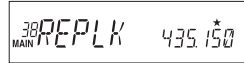

RLORP: Signaling BCLO, transmitting is inhibited when a signal with different CTCSS/DCS setting is being received.



RLOBU: Transmitting is inhibited when a signal of any kind is being received.



OFF: BCLO is disabled. Transmitting is allowed in any receiving status.

3. Press [PTT] to set and exit or press the dial to set and continue.

■ MENU 39: DTMF SELF ID ENQUIRY

1. Press and hold **[FUNC]** key until activating the function menu. Rotate the dial or use **[UP/DOWN]** keys to select the menu 39 DTMF ID and press the dial.

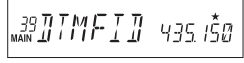

2. The DTMF self ID is shown on the display.

3. Press [PTT] to set and exit or press the dial to set and continue.

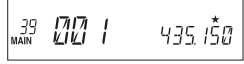

■ MENU 40: 5-TONE SELF ID ENQUIRY

1. Press and hold **[FUNC]** key until activating the function menu. Rotate the dial or use **[UP/DOWN]** keys to select the menu 40 5TONE ID and press the dial.



2. The 5-TONE self ID is shown on the display.

3. Press [PTT] to set and exit or press the dial to set and continue.



MENU 41: VFO FREQUENCY LINKAGE

1. Press and hold **[FUNC]** key until activating the function menu. Rotate the dial or use **[UP/DOWN]** keys to select the menu 41 VFOTR and press the dial.

41
MAIN VFOTR 435.150

2. Rotate the dial or use **[UP/DOWN]** keys to select the value:

ON: Turn on the Link. In VFO mode, both MAIN and SUB band frequencies changes by the same channel steps at dial or **[UP/DOWN]** operation.

41
MAIN ON 435.150

OFF: Turn off the Link.

3. Press **[PTT]** to set and exit or press the dial to set and continue.



This function is valid only when both bands operate in VFO mode.

MENU 42: WIDE/NARROW FM MODE

1. Press and hold **[FUNC]** key until activating the function menu. Rotate the dial or use **[UP/DOWN]** keys to select the menu 42 WINNAR and press the dial.

42
MAIN WINNAR 435.150

2. Rotate the dial or use **[UP/DOWN]** keys to select the mode:

WIDE: Wide bandwidth (25KHz)

MIDDLE: Middle bandwidth (20KHz)

NARROW: Narrow bandwidth (12.5KHz)

42
MAIN WIDE 435.150

42
MAIN MIDDLE 435.150

3. Press **[PTT]** to set and exit or press the dial to set and continue.

42
MAIN NARROW 435.150



The FM bandwidth must be set correctly in accordance with your local regulations. Incorrect setting may also cause poor audio quality.

MENU 44-46: LCD BACKLIGHT

1. Press and hold **[FUNC]** key until activating the function menu. Rotate the dial or use **[UP/DOWN]** keys to select themenu No. 44-46 menu The LCD displays "COL RED", "COLGRN", "COL BLU" and press the dial.

44
MAIN COL RED 435.150

45
MAIN COL GRN 435.150

2. Rotate the dial or use **[UP/DOWN]** keys to select wanted value. Each color (Red, Green, Blue) with 32 brightness levels.

46
MAIN COL BLU 435.150

3. Press **[PTT]** to set and exit or press the dial to set and continue.

44
MAIN COL RED 32 435.150

MENU 47: KEYPAD BACKLIGHT BRIGHTNESS

1. Press and hold **[FUNC]** key until activating the function menu. Rotate the dial or use **[UP/DOWN]** keys to select the menu 47 DIMMER and press the dial.

47
MAIN DIMMER 435.150

2. Rotate the dial or use **[UP/DOWN]** keys to select the value:

47
MAIN 32 435.150

Available value: 32 brightness levels.

3. Press **[PTT]** to set and exit or press the dial to set and continue.

MENU 48: CALLING RECORD

The transceiver offers enquiry of calling record.

1. Press and hold **[FUNC]** key until activating the function menu. Rotate the dial or use **[UP/DOWN]** keys to select the menu 48 NOTE and press the dial.

48
MAIN NOTE 435.150

2. Rotate the dial or use **[UP/DOWN]** keys to select the value:

48
MAIN CN 123 435.150

This transceiver is able to record 16 calling at most.

3. Press [PTT] to set and exit or press the dial to set and continue.

MENU 49: AM FUNCTION

1. Press and hold [FUNC] key until activating the function menu. Rotate the dial or use [UP/DOWN] keys to select the menu 49 AM and press the dial.

49 AM 456000
MAIN
2. Rotate the dial or use [UP/DOWN] keys to select the value:

AM ON 456000
MAIN

ON: Turn on AM function.
OFF: Turn off AM function.
3. Press [PTT] to set and exit or press the dial to set and continue.

 This function is only valid when the Main band frequency is VHF, the function is invalid when the right band is set as Main band.

MENU 51: VHF EXTERNAL SPEAKER PORT

When the function setup as external (EXT), an external Dual Track speaker must be connected in order to hear the calling on VHF. The calling from VHF and UHF are separated in 2 tracks.

1. Press and hold [FUNC] key until activating the function menu. Rotate the dial or use [UP/DOWN] keys to select the menu 51 VSPCONT and press the dial.

51 VSPCONT 435.150
MAIN
2. Rotate the dial or use [UP/DOWN] keys to select the value:

51 INT 435.150
MAIN

51 EXT 435.150
MAIN

INT: Internal speaker, VHF and UHF band share one speaker
EXT: External speaker, the calling on VHF is only audible through

the external Dual Track speaker.

3. Press [PTT] to set and exit or press the dial to set and continue.

MENU 52: BEEP VOLUME CONTROL

1. Press and hold [FUNC] key until activating the function menu. Rotate the dial or use [UP/DOWN] keys to select the menu 52 BP-VOL and press the dial.

52 BP-VOL 435.150
MAIN
2. Rotate the dial or use [UP/DOWN] keys to select the value:

52 HIGH 435.150
MAIN

LOW: BEEP volume is low.
HIGH: BEEP volume is high.
3. Press [PTT] to set and exit or press the dial to set and continue.

MENU 53: TALK AROUND

With this function on, the transceiver will not be able to communicate with another transceiver through a repeater.

1. Press and hold [FUNC] key until activating the function menu. Rotate the dial or use [UP/DOWN] keys to select the menu 53 TALK and press the dial.

53 TALK 435.150
MAIN
2. Rotate the dial or use [UP/DOWN] keys to select the value:

53 ON 435.150
MAIN

ON: Turn on Talk Around
OFF: Turn off Talk Around
3. Press [PTT] to set and exit or press the dial to set and continue.

MENU 54: MICROPHONE SPEAKER

1. Press and hold [FUNC] key until activating the function menu. Rotate the dial or use [UP/DOWN] keys to select the menu 54
- 54 MND SP 435.150
MAIN

HND SPK and press the dial.

2. Rotate the dial or use [UP/DOWN] keys to select the value:

HSPKOFF: Turn off microphone speaker.

HSPK ON: Turn on microphone speaker.

MSPKOFF: Turn off Main speaker.

3. Press [PTT] to set and exit or press the dial to set and continue.

54 HSPKOFF 435.150

54 HSPKON 435.150

54 MSPKOFF 435.150

MENU 55: MEMORY BANKS ENQUIRY

1. Press and hold [FUNC] key until activating the function menu. Rotate the dial or use [UP/DOWN] keys to select the menu 55 BAK -- and press the dial.
2. The memory bank is shown on the display.
3. Press [PTT] to set and exit or press the dial to set and continue.

55 BAK -- 435.150

55 F 435.150

MENU 56: MEMORY BANKS LINKING

Memory banks can be linked together for expanded scanning or viewing.

1. Press and hold [FUNC] key until activating the function menu. Rotate the dial or use [UP/DOWN] keys to select the menu 56 BALK and press the dial.
2. Rotate the dial or use [UP/DOWN] keys to select the value:

56 BALK 435.150

ON/OFF: Select ON to turn on Bank Linking, Off to turn off Bank Linking

Menu 57 Bank A Link ON /OFF

Menu 58 Bank B Link ON /OFF

Menu 59 Bank C Link ON /OFF

57 BALK A 435.150

Menu 60 Bank D Link ON /OFF

Menu 61 Bank E Link ON /OFF

Menu 62 Bank F Link ON /OFF

Menu 63 Bank CH Link ON /OFF

3. Press [PTT] to set and exit or press the dial to set and continue.

62 BALK F 435.150

63 BALK CH 435.150

MENU 64: PASSWORD FUNCTION

1. Press and hold [FUNC] key until activating the function menu. Rotate the dial or use [UP/DOWN] keys to select the menu 64 PASSWD and press the dial.
2. Rotate the dial or use [UP/DOWN] keys to select the value:
ON: Turn on password function.
OFF: Turn off password function.
3. Press [PTT] to set and exit or press the dial to set and continue.

64 PASSWD 435.150



When password function is on, correct password shall be input after power on. The password shall be programmed before using this function.

Microphone Operation

means plus offset, when the LCD displays "-", means minus offset.



This function is valid only when current channel set with offset frequency.

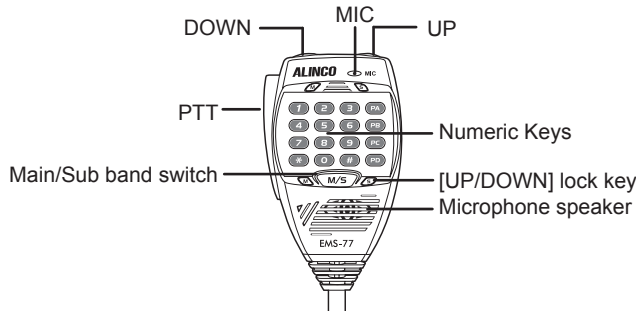

You can operate the transceiver by keypad or input desired frequency and channel through the EMS-77 microphone.

SEND DTMF SIGNALING

Hold the [PTT] key; input the desired DTMF signaling by the numeric keys.

MAIN/SUB BAND SWITCHING

At the default setting, both MAIN and SUB bands are displayed. The transmitting is possible only on the frequency/channel shown on the LEFT.

To transmit, press the [M/S] key to set the desired frequency or channel on the LEFT side of the display.

FUNCTION OPERATION THROUGH PA-PD KEYS

This function must be preprogrammed using the utility software in advance.

RPTR: OFFSET direction setup, in standby, press the key programmed as RPTR function will change the offset direction. When LCD displays "+",



PRI: Add or delete priority channel: In channel mode, press the key programmed as PRI function to set priority channel, when the LCD displays "P1", the current channel is set as priority channel. Repeat above operation, the "P1" icon disappear, the current channel is not set as priority channel.

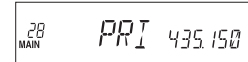

LOW: Output power setup, in standby, press the key programmed as LOW function will change the power level. When LCD displays HIGH, the transmitting power on current channel is high. When LCD displays MID1, the transmitting power on current channel is middle1, When LCD displays MID2, the transmitting power on current channel is middle 2. When LCD displays LOW, the transmitting power on current channel is low.



TONE: CTCSS/DCS code setup. In standby, press the key programmed as TONE function will be able to setup CTCSS/DCS code. When the LCD displays "T" and CTCSS frequency, press the [UP/DOWN] key to choose CTCSS encode. When the LCD displays "T SO" and CTCSS frequency, press the microphone [UP/DOWN] key to choose CTCSS decode. When the LCD displays "DCS" and DCS code, press the microphone [UP/DOWN] key to choose DCS code.



MHZ: In VFO mode, press the key programmed as MHZ function, the megabit digital in the LCD flashes, now rotate the dial or microphone [UP/DOWN] key to adjust frequency by 1MHz step.

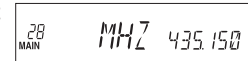

Microphone Operation

REV: In standby, press the key programmed as "REV" function to turn-on or turn off Frequency Revrse function.

28
MAIN REV 435.150

CALL: CALL channel switch, in standby press the key programmed as "CALL" function to switch between CALL channel and current channel.

28
MAIN CALL 435.150

MAIN: Main band switch, in standby press the key programmed as "MAIN" function to choose left band or right band as Main band.

28
MAIN MAIN 435.150

VFO/MR: Working mode switch, in standby, press the key programmed as "VFO/MR" function to switch between channel mode and frequency mode.

28
MAIN VFO/MR 435.150

SCAN: Scan function, in standby, press the key programmed as "SCAN" function to start channel scan or frequency scan.

28
MAIN SCAN 435.150

SQL OFF: Turn off Squelch, in standby, press the key programmed as "SQL OFF" function to turn off squelch, you can hear very weak signal, repeat the above function to turn on squelch.

28
MAIN SQL OFF 435.150

TBST: Transmit tone burst, in standby, press the key programmed as "TBST" function to transmit selected tone burst.

28
MAIN TBST 435.150

This function is use to wake sleeping repeater.

CALL OUT: Calling, in standby, press the key programmed as "CALL OUT" function to transmit pre-programmed DTMF, 2TONE, 5STONE code.

28
MAIN CALL OUT 435.150

COMP: Comander function in standby, press the key programmed as "COMP" to turn on or turn off Comander function.

28
MAIN COMP 435.150

SCR: Scrambler function, in standby, press the key programmed as "SCR" function to check Scrambler function. The optional scrambler groups (from 9 fixed groups and 2 self defined groups).

28
MAIN SCR 435.150

STONE DEC: Add Optional Signaling, in standby press the key programmed as "STONE DEC" function to choose DTMF(DT), 2TONE(2T), 5STONE(5T) or OFF.

28
MAIN STONE DEC 435.150

W/N: Wide or narrow band setup, in standby, press the key programmed as "W/N" function to choose Wide band, middle and narrow band.

28
MAIN W/N 435.150

TALK: In standby status, press programmed Talk key to enable and disable Talk around function.

28
MAIN TALK 435.150

OFF: No function.

This feature will copy the programmed data and parameters from the master unit to slave units. It copies the parameters and memory program settings.

1. Use optional cloning cable, connect the cable between the data jacks on both master and slave.
2. Press and hold **[H/L]** key to power on, then hold this key until the LCD displays "CLONE".

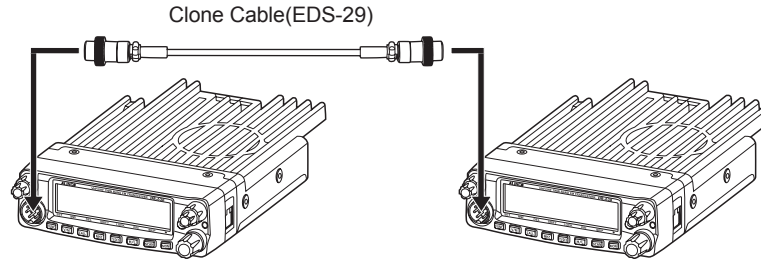

3. Press the dial, the Master unit and Slave unit both display "CLONE XX", "XX" stands for the data amount being cloned, when the Master unit displays "CLONE" again, the Slave unit re-power on, means the clone completed. Turn off the Slave unit, and change another slave unit. Then repeat step 3 to clone next radio.

CLONE

CLONE4

NOTE When the Master unit enter clone mode, repeater step 3 will be able to clone multi radios.
 If the data is not successfully transmitted, turn off both units, make sure the cable connection is correct and repeat the entire operation from the beginning.

RESUME FACTORY DEFAULT

If your radio seems to be malfunctioning because of wrong operation or setup, this function will be able to resume all setup and channels to factory default. Hold **[FUNC]** key while power on the radio, all channel and function setup will resume to factory default.

Note: The memory channels will be erased and can't recall after reset. Use of the utility software explained in the next page enables to store and recall memory data.



Programming Software Installing and Starting

UTILITY SOFTWARE IN WINDOWS SYSTEM

* ERW-12 driver installation

To use DR-638 setting utility software, a PC cable ERW-12 is necessary. Before using the ERW-12, a driver software should be installed.

Please visit <http://www.prolific.com.tw/> > Products Applications > Smart IO > Serial/parallel for the most updated driver software of the device used in the ERW-12 USB/serial conversion cable. The manufacturer of the device offers the driver and its complete instructions in English.

Unzip the downloaded file, unzip and click on the PL****Prolific_DriverInstaller_v*** to start installation.

* DR-638 utility software

NOTICE: Amateur radio version software is downloadable from ALINCO.com. The manufacturer distributes the Commercial-user version to the dealers through the authorized importers/distributors only. The dealers should consult with the distributor of your area for details.

To install, click on the DR638 Clone Utility ***.exe then follow the steps to complete the installation. After being completed, open the Device Manager menu of the Windows program to identify the assigned COM port ID of "Prolific USB-to-Serial port".

Connect the ERW-12 cable to the microphone connector of the DR-638, turn it on, then click on the DR_638** Icon to start the program. At first, the COM port setting window opens. Select the assigned COM port ID. After successfully selected the COM port, the utility window opens. You need to follow this instruction otherwise the ERW-12 doesn't recognize the DR-638.

The operation is fairly simple; please write/read a simple, dummy data several times to get used to the functions the program offers before actually edit the memory data.

When some parameters may be used, the radio becomes like a landmobile and user-reset is inhibited.

Please Consult your local dealers for technical support if necessary.

Alinco and ALINCO logo are registered trademarks of Alinco Incorporated, Japan in the United States, EU States, Russia, China and many other countries.

Windows is a registered trademark of Microsoft Corporation in the United States and other countries. All other trademarks are the properties of their respective holders.



■ TROUBLE SHOOTING

Problem	Possible Causes and Potential Solutions
(a) Power is on, nothing appears on Display.	Polarities of power connection are reversed. Connect red lead to positive terminal and black lead to negative terminal of DC power supply.
(b) Fuse is blown.	Check and solve problem resulting in blown fuse and replace fuse with new fuse.
(c) Display is too dim.	Set the LCD backlight parameter properly.
(d) No sound comes from speaker.	<ul style="list-style-type: none"> • Squelch is muted. Decrease squelch level. • Tone or CTCSS/DCS squelch is active. Turn CTCSS or DCS squelch off.
(e) Key and Dial do not function.	Key-lock function is activated. Cancel Key-lock function.
(f) Rotating Dial will not change memory channel.	Transceiver is in CALL mode. Change to the VFO or memory mode.
(g) PTT key is pressed but transmission does not occur.	<ul style="list-style-type: none"> • Microphone connection is poor. Connect microphone properly. • Antenna connection is poor. Connect antenna properly.

If a problem should occur, first try the troubleshooting procedure given above. If the problem persists, contact your nearest ALINCO dealer for technical assistances.



Specifications

General

Frequency Range	144~146MHz 430~440MHz
Number of Channels	758 channels
Channel Spacing	25KHz(Wide band) 20KHz(Middle band) 12.5KHz (Narrow band)
Phase-locked Step	2.5KHz、 5KHz、 6.25KHz、 10KHz、 12.5KHz、 15KHz、 20KHz、 25KHz、 30KHz、 50KHz
Operating Voltage	13.8V DC ±15%
Squelch	Carrier/CTCSS/DCS/5Tone/2Tone/DTMF
Frequency Stability	±2.5ppm
Operating Temperature	-20~+60°C
Dimensions(WxHxD)	139(W)x40(H)x212(D)mm
Weight	about 1.15kg

 Specifications are subject to change without notice due to advancements in technology.

Receiver

	Wide band	Narrow band
Sensitivity (12dB SINAD)	≤0.25μV	≤0.35μV
Adjacent Channel Selectivity	≥70dB	≥60dB
Audio Response	+1~-3dB(0.3~3KHz)	+1~-3dB(0.3~2.55KHz)
Hum & Noise	≥45dB	≥40dB
Audio distortion	≤5%	
Audio power output	> 2W@10%	

Transmitter

	Wide band	Narrow band
Power Output	50W/25W/10W/5W(VHF) 40W/25W/10W/5W(UHF)	
Modulation	16KΦF3E	11KΦF3E
Adjacent Channel Power	≥70dB	≥60dB
Hum & Noise	≥40dB	≥36dB
Spurious Emission	≥60dB	≥60dB
Audio Response	+1~-3dB(0.3~3KHz)	+1~-3dB(0.3~2.55KHz)
Audio Distortion	≤5%	

51 GROUPS CTCSS TONE FREQUENCY(HZ)

62.5	77.0	91.5	107.2	127.3	151.4	167.9	183.5	199.5	225.7	254.1	
67.0	79.7	94.8	110.9	131.8	156.7	171.3	186.2	203.5	229.1	Self Define	
69.3	82.5	97.4	114.8	136.5	159.8	173.8	189.9	206.5	233.6		
71.9	85.4	100.0	118.8	141.3	162.2	177.3	192.8	210.7	241.8		
74.4	88.5	103.5	123.0	146.2	165.5	179.9	196.6	218.1	250.3		

The self defined CTCSS tone supports non standard codes. The frequency shall be pre-programmed

1024 GROUPS DCS CODE

000	001	002	003	004	005	006	007
010	011	012	013	014	015	016	017
020	021	022	023	024	025	026	027
030	031	032	033	034	035	036	037
040	041	042	043	044	045	046	047
050	051	052	053	054	055	056	057
060	061	062	063	064	065	066	067
070	071	072	073	074	075	076	077
100	101	102	103	104	105	106	107
110	111	112	113	114	115	116	117
120	121	122	123	124	125	126	127
130	131	132	133	134	135	136	137
140	141	142	143	144	145	146	147
150	151	152	153	154	155	156	157
160	161	162	163	164	165	166	167
170	171	172	173	174	175	176	177
200	201	202	203	204	205	206	207
210	211	212	213	214	215	216	217
220	221	222	223	224	225	226	227
230	231	232	233	234	235	236	237
240	241	242	243	244	245	246	247
250	251	252	253	254	255	256	257
260	261	262	263	264	265	266	267
270	271	272	273	274	275	276	277
300	301	302	303	304	305	306	307
310	311	312	313	314	315	316	317
320	321	322	323	324	325	326	327
330	331	332	333	334	335	336	337

Appendix

340	341	342	343	344	345	346	347
350	351	352	353	354	355	356	357
360	361	362	363	364	365	366	367
370	371	372	373	374	375	376	377
400	401	402	403	404	405	406	407
410	411	412	413	414	415	416	417
420	421	422	423	424	425	426	427
430	431	432	433	434	435	436	437
440	441	442	443	444	445	446	447
450	451	452	453	454	455	456	457
460	461	462	463	464	465	466	467
470	471	472	473	474	475	476	477
500	501	502	503	504	505	506	507
510	511	512	513	514	515	516	517
520	521	522	523	524	525	526	527
530	531	532	533	534	535	536	537
540	541	542	543	544	545	546	547
550	551	552	553	554	555	556	557
560	561	562	563	564	565	566	567
570	571	572	573	574	575	576	577
600	601	602	603	604	605	606	607
610	611	612	613	614	615	616	617
620	621	622	623	624	625	626	627
630	631	632	633	634	635	636	637
640	641	642	643	644	645	646	647
650	651	652	653	654	655	656	657
660	661	662	663	664	665	666	667
670	671	672	673	674	675	676	677
700	701	702	703	704	705	706	707
710	711	712	713	714	715	716	717

720	721	722	723	724	725	726	727
730	731	732	733	734	735	736	737
740	741	742	743	744	745	746	747
750	751	752	753	754	755	756	757
760	761	762	763	764	765	766	767
770	771	772	773	774	775	776	777



N is positive code, I is negative code, total:1024 groups.