

ALINCO

COMMERCIAL HF SSB TRANSCEIVER

DX-701

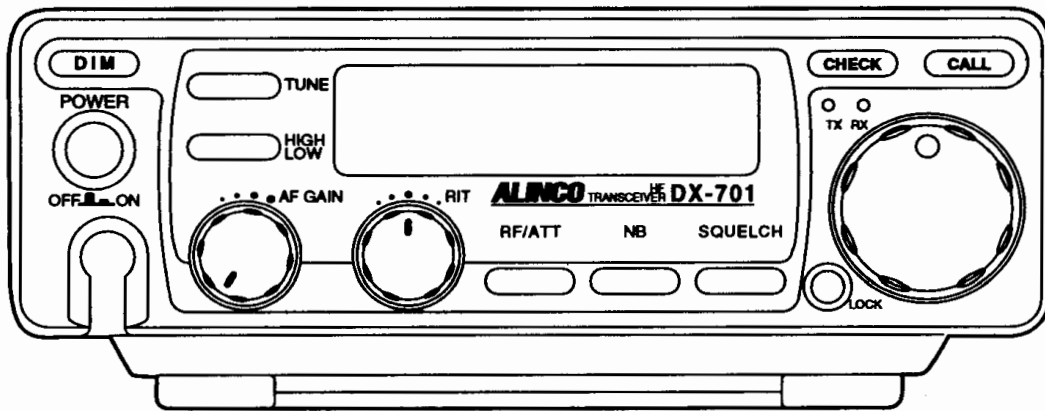

Instruction Manual

Thank you for purchasing this **ALINCO** transceiver. To obtain optimum performance from this transceiver, read this instruction manual thoroughly, and keep it for future reference.

PRECAUTIONS

- Do not open the transceiver case or touch no-user-serviceable components.

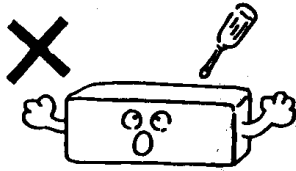

- Do not expose the transceiver to direct sunlight or to source of heat. Also, avoid using the transceiver in an extremely dusty or humid environment.

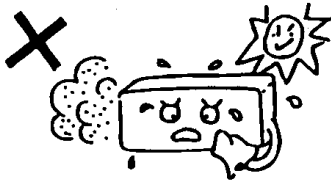

- Do not place anything which might spill over on top of the transceiver.



- For good ventilation, allow about 10 cm between the rear of the transceiver and the wall.

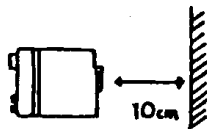

- If the transceiver causes harmful interference to VCR or TV reception, move the transceiver away from the appliance.

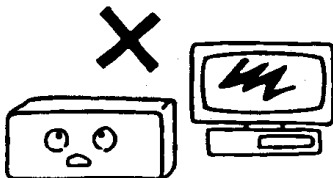

- Do not yank the power cable from its outlets. Also, do not rewire the power cable with other extension cables. Such handling may damage or short-circuit the cable.

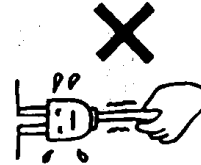

- Use a 13.8 V DC regulated power supply to operate this transceiver. The transceiver must be grounded.

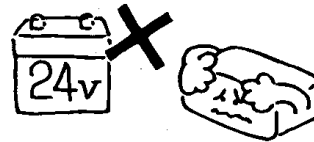

- Beware of moisture condensation. Moisture in the air will condense on the transceiver when you move it from a cold place to a warm place. Condensation will cause the unit to malfunction. If condensation forms on the unit, wipe or let dry.



- If the transceiver ever emits smoke or strange smells, immediately turn it off and unplug it. Then, contact your nearest ALINCO dealer.

■ Cleaning

Use a dry, silicone or soft cloth to clean the control panel and case.

- Do not use thinner, benzene, alcohol, or any solvent that might deform or discolor the transceiver.
- If any part of the transceiver excessively dirty, use a water-diluted neutral detergent to clean.

DOCUMENT CONVENTIONS

■ **Bold Typeface**

Indicates controls (keys, knob, etc.), terminals, and functions.

■ **Display Example**

Shows only the related indication.

■ **Icons**



Indicates a hazardous situation that, if not avoided, will result in death or serious injury.



Indicates a hazardous situation that, if not avoided, will result in serious damage to the unit.



Indicates an exception or note related to the procedure.



Provides helpful hint.



Indicates a reference page.

CONTENTS

PRECAUTIONS

DOCUMENT CONVENTIONS

1. FEATURES	5
2. SUPPLIED ACCESSORIES	5
3. INSTALLATION AND CONNECTION (FOR BASE STATION)	6
Connection Diagram	6
Connecting an Antenna	6
Connecting a Ground	6
Connecting the Microphone	7
Connecting an External Speaker	8
Connecting Headphones.....	8
Connecting a DC Regulated Power Supply	9
4. INSTALLATION AND CONNECTION (FOR MOBILE OPERATION).....	10
Connection Diagram	10
Connecting an Antenna	10
Installing the Transceiver	11
Connecting the Power Cable	13
Connecting an External Speaker	13
5. CONTROLS, TERMINALS, AND DISPLAY	14
Control Panel.....	14
LCD Display	15
Rear Panel	16
Other Components.....	17
Microphone	17
6. BASIC OPERATION	18
Reception.....	18
Transmission	18
7. USEFUL FUNCTIONS	19
CALL Channel.....	19
RIT Function	19
Squelch Selector	19
RF/ATT Function	19
Noise Blanker	20
CHECK Function	20
Dial Lock Function.....	20
Dimmer.....	20
External Antenna Tuner Control.....	20
8. TROUBLESHOOTING	21
9. OPTIONS	23
10. EXTERNAL ANTENNA TUNERS AVAILABLE	24
11. SPECIFICATIONS	26

1. FEATURES

- Easy-to-use, compact commercial HF transceiver
- General coverage from 1.8 MHz to 30 MHz in SSB and AM modes
- Detachable control panel (With the optional kit, the panel can be installed up to 1.5 m away from the transceiver body.)
- ± 0.5 PPM rock-solid frequency stability
- Built-in RF preamplifier and attenuator
- Continuous transmission within operating temperature range
- Automatic-antenna-tuner control

2. SUPPLIED ACCESSORIES

Check if these accessories are included in the shipping carton.

- DC power cable

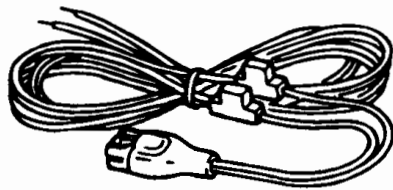

- Microphone

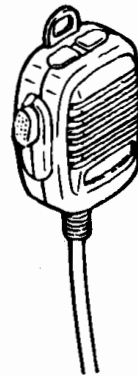

- Fuse

20A

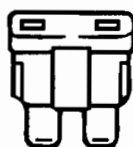

- Instruction manual (this manual)

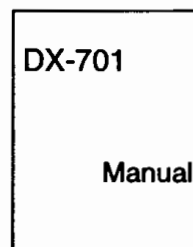

3. INSTALLATION AND CONNECTION (FOR BASE STATION)

Connection Diagram

This diagram shows the connections for a base station.

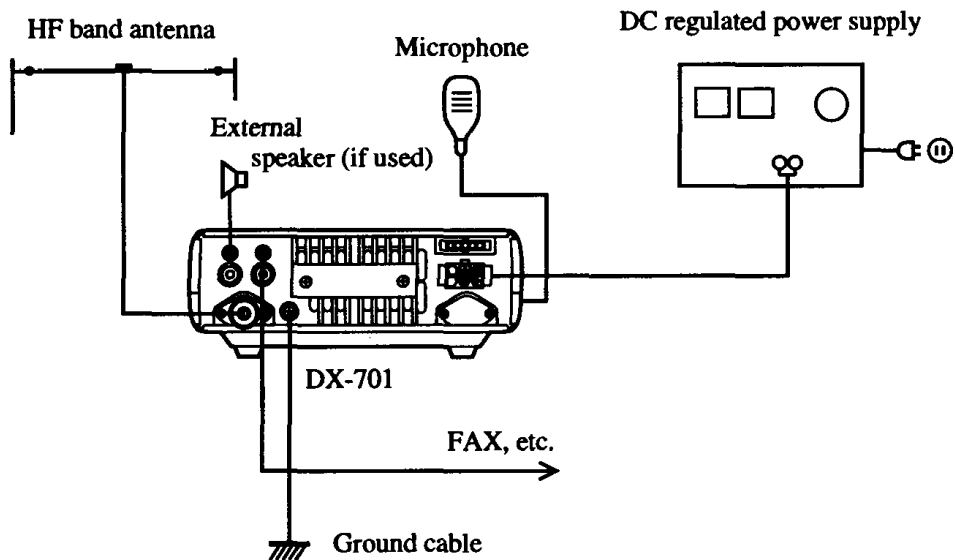

Connecting an Antenna

Use a properly-adjusted (low SWR) antenna to obtain optimum performance from the transceiver. A 50 impedance coaxial cable with UHF plugs is required for this connection.

Connecting a Ground

To prevent electric shock hazard and radio interference with other electronic appliances, bury a rod or copper plate under the ground and connect it to the transceiver **GND** terminal. Use a heavy gauge, short cable for this connection.



Warning: Do not ground the equipment on gas pipes, electrical conduits, or plastic water pipes.

Connecting the Microphone

1. Unlock the latches and detach the control panel from the body.

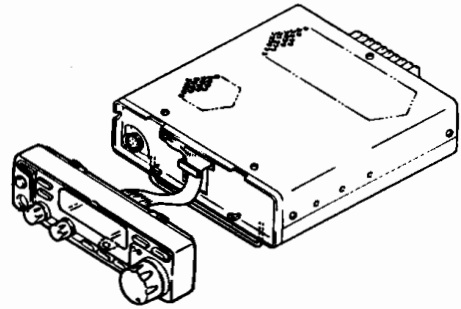
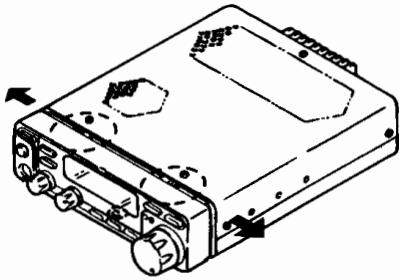

2. Plug the microphone into the microphone connector of the body.

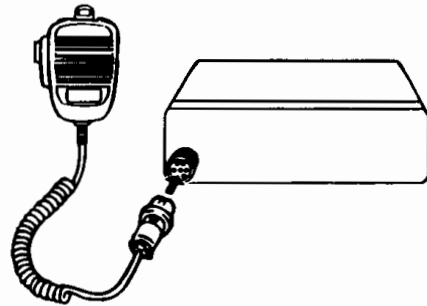

3. Tighten the screw on the connector to secure the connection.

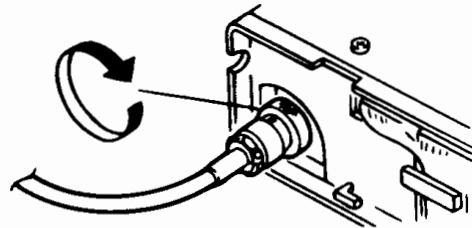

4. Let the microphone cord go through the notch hole in the control panel, and then attach the panel to the body.

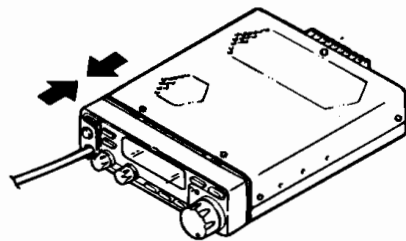
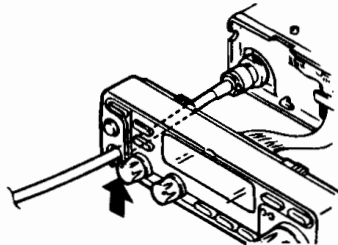

- First fit the lower part of the control panel into the body and press on the panel until hearing a click.

Connector pin assignment

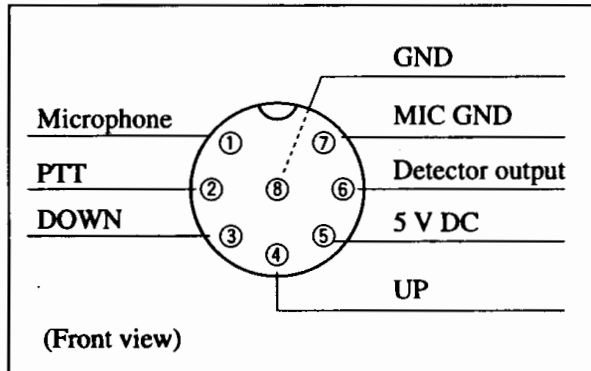

Connecting an External Speaker

Plug a 3 W or higher, 8 Ω speaker into the **EXT SP** or **AF OUT** jack on the rear panel. These jacks accept a 3.5 mm diameter mono plug.

Plug wiring

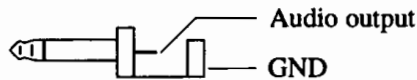

- Note:**
- When the **EXT SP** jack is plugged, the internal speaker turns off.
 - When the **AF OUT** jack is plugged, the internal speaker remains active.

Connecting Headphones

Plug 4 to 32 Ω headphones into the **EXT SP** or **AF OUT** jack on the rear panel. These jacks accept a 3.5 mm diameter resistor plug.

Resistor plug

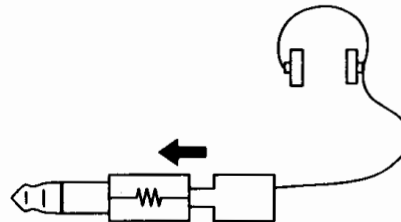

- Notes:**
- When the **EXT SP** jack is plugged, the internal speaker turns off.
 - When the **AF OUT** jack is plugged, the internal speaker remains active.
 - For stereo headphones, use a stereo/mono conversion plug to activate both channels.

Connecting a DC Regulated Power Supply

The DX-701 is designed to operate on a 13.8V DC regulated power supply. Use the supplied power cable to connect the transceiver and a DC power supply.

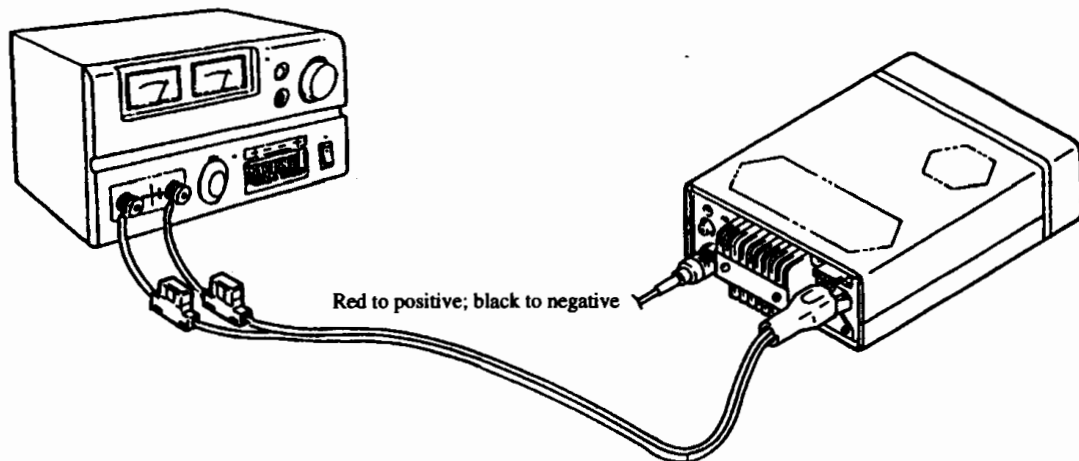

Warning: Before connecting, be sure to turn off the transceiver and DC power supply.

- Recommended DC regulated power supplies ➔ "9. OPTIONS"
 - DM-1350Z (Input 220V AC)
 - DM-1350T (Input 120V AC)
- Replacing the fuse
Use a 20A blade-type fuse.

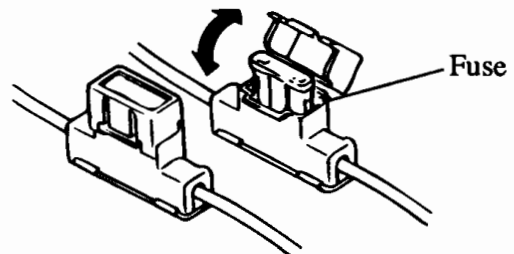

4. INSTALLATION AND CONNECTION (FOR MOBILE OPERATION)

Connection Diagram

This diagram shows the connections for mobile operation.

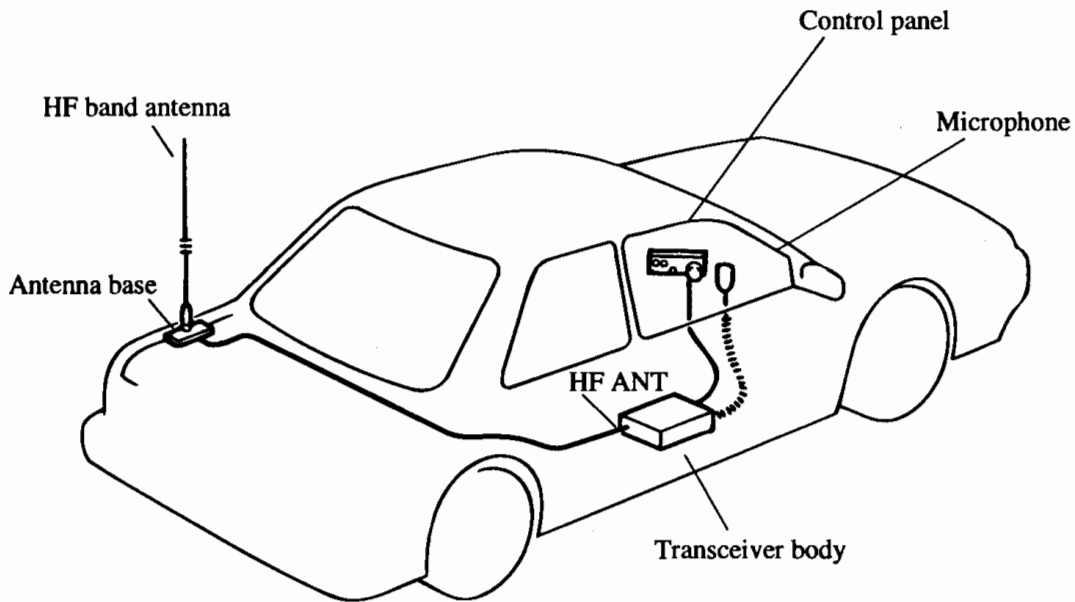

Connecting an Antenna

Use a properly-adjusted (low SWR) antenna to obtain optimum performance from this receiver.

1. Secure a commercially-available antenna base in a proper position on your car.
2. Ground the antenna base to the chassis.

⚠ Warning: A ground is indispensable for an HF band antenna.

3. Connect the antenna and transceiver using a 50 Ω impedance coaxial cable with UHF plugs.



Installing the Transceiver

With Control Panel Attached

1. Attach the optional mobile mount bracket (EBC-9) under the dashboard or in another convenient position.

 **Note:** Attach the bracket to a position where the controls and microphone are easily accessible and allow you to safely drive.

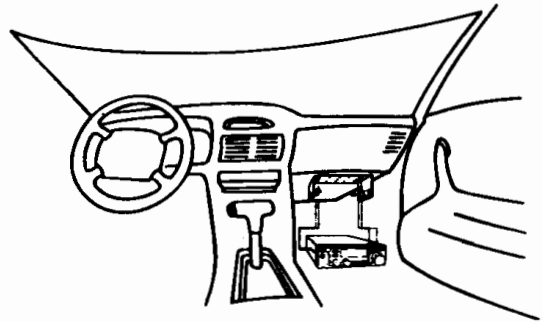

2. Install the transceiver in the bracket.

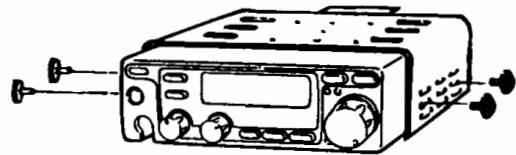

■ With Control Panel Detached

This transceiver can be separated into the control panel and body. Using the optional front control remote kit (EDS-4), front control angle bracket (EBC-8), and microphone extension cable (EDS-5), the panel can be installed in a position convenient for you when driving.

1. Detach the control panel from the body.

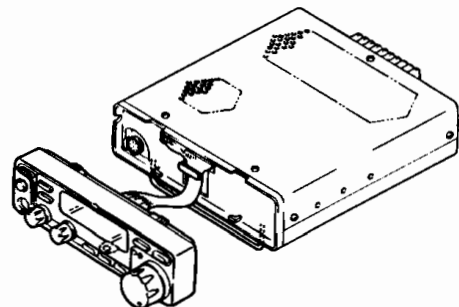

2. If necessary, connect the microphone extension cable to the body.

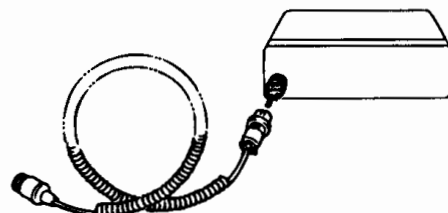

- 3.** Disconnect the two cables from the panel and body, and connect the remote cables of the optional kit instead.

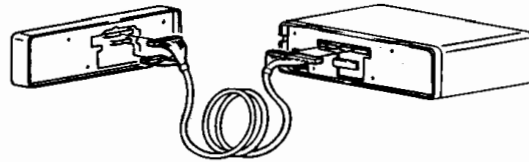

- 4.** Attach the covers of the optional kit to the panel and body.



- 5.** Using the front control angle bracket, install the control panel in a position where the controls are easily accessible.

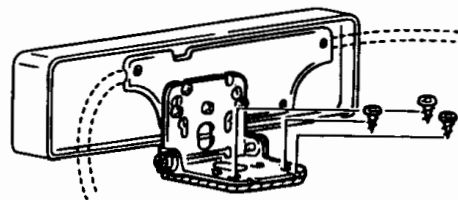

- 6.** Install the body in a proper position such as below a seat.



- 7.** Connect the microphone plug to the extension cable connector.

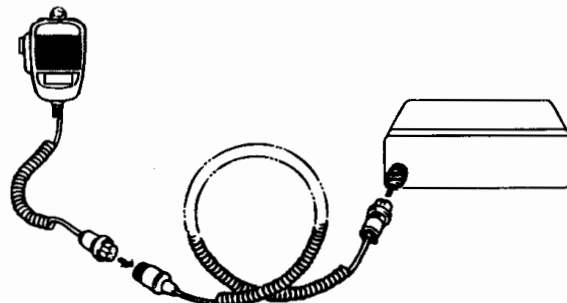

Tip: The control panel has screw holes in the bottom side. Using the holes, the panel can also be mounted on a commercially-available angle bracket for in-car TV sets or CD players.

Connecting the Power Cable

Caution: Use a 12 V car battery to operate the transceiver.

Connect the supplied power cable directly to the car battery.

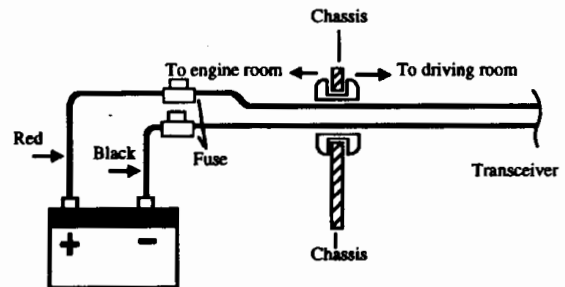

Note: If threading the cable through wiring coming in contact with the chassis.

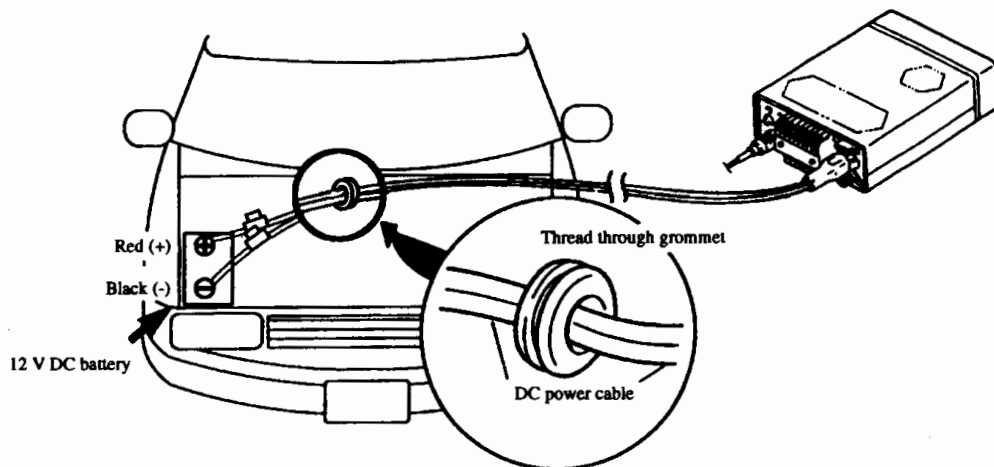

Caution:

- If using a 24 V car battery, be sure to convert the voltage to 12 V DC with a DC/DC converter.
- Do not connect the power cable to a cigarette lighter connector because the power supply is unstable.

Tip: The DX-701 is designed to filter ignition noise with a noise blanker (NB). However, if you pick up excessive ignition noise from your car, it is recommended to use a resistor spark plug.

Connecting an External Speaker

⇒ page 8

5. CONTROLS, TERMINALS, AND DISPLAY

Control Panel

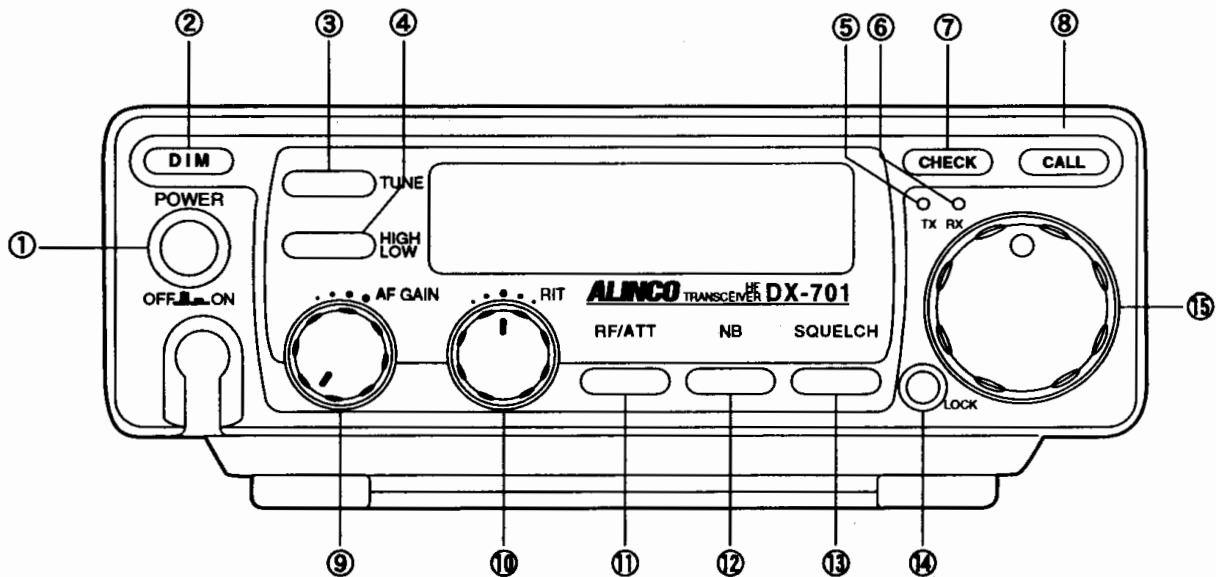

- ① **POWER** Turns the power on/off.
- ② **DIM** Changes the LCD brightness.
- ③ **TUNE** Activates an external antenna tuner for proper antenna matching.
- ④ **HIGH/LOW** Switches the output power between high and low.
- ⑤ **TX LED** Lights red when the **PTT** key on the microphone is pressed.
- ⑥ **RX LED** Lights green when signals are received or squelch is unmuted.
- ⑦ **CHECK** Unmutes squelch to check the transmission frequency.
- ⑧ **CALL** Accesses the call channel.
- ⑨ **AF GAIN** Adjusts the volume.
- ⑩ **RIT** Fine-tunes the reception frequency within a range of ± 1.4 kHz.
- ⑪ **RF/ATT** Adjusts the **RF** gain by switching between the preamplifier and attenuator.
- ⑫ **NB** Turns the noise blanker on/off.
- ⑬ **SQUELCH** Selects the squelch level from BUSY, 1, 2, 4, and 6.
- ⑭ **LOCK** Locks the main tuning dial.
- ⑮ **Dial** Changes the memory channel number (frequency).

Rear Panel

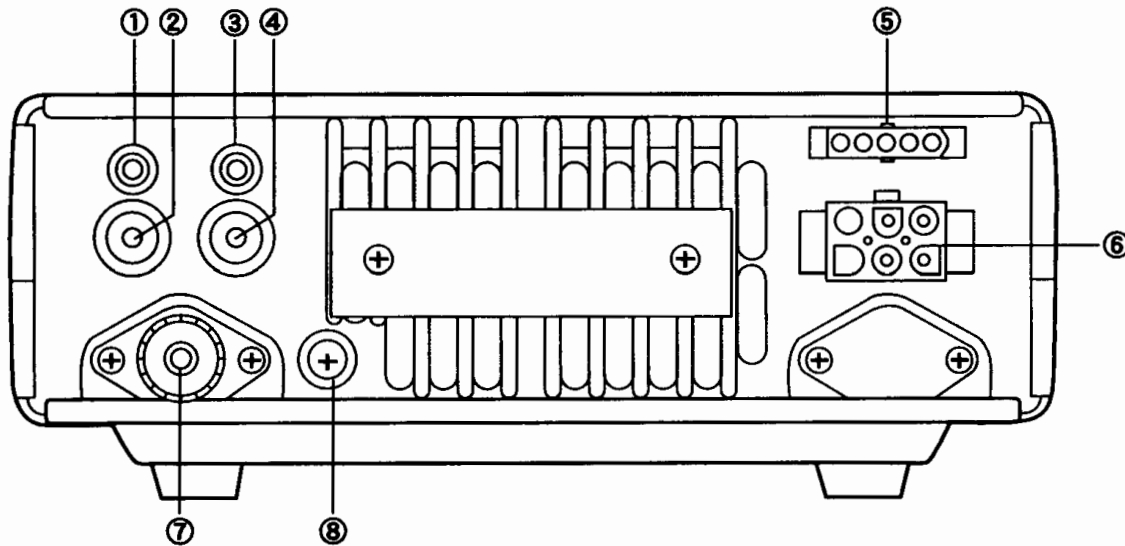

- | | |
|--------------------------|--|
| ① EXT SP jack | External speaker or headphones jack. When this jack is plugged, the internal speaker turns off. |
| ② RELAY jack | For connecting external equipment such as a linear amplifier. |
| ③ AF OUT jack | External speaker or headphones jack. When this jack is plugged, the internal speaker remains active. |
| ④ EXT ALC jack | ALC input for linear-amplifier (ALC input voltage: 0 to -3V DC). |
| ⑤ ACC connector | For connecting peripherals such as an external automatic antenna tuner. |
| ⑥ POWER connector | For connecting the supplied DC power cable (Input voltage: 13.8V DC \pm 15%). |
| ⑦ ANT connector | For connecting an HF band antenna. |
| ⑧ GND terminal | For connecting a grounding cable. |

Other Components

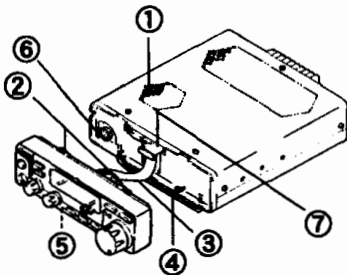

- ① Internal speaker
- ② Control panel latches
- ③ Control cable
- ④ Stand
- ⑤ Screw hole for the optional bracket
- ⑥ Microphone connector
- ⑦ Cable holder

Microphone

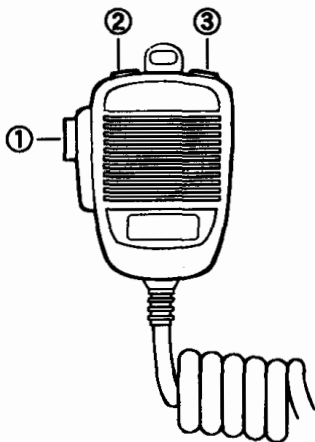

- ① **PTT** Push to transmit, and release to receive.
- ② **DOWN** Decreases the memory channel number.
- ③ **UP** Increases the memory channel number.

6. BASIC OPERATION

Reception

1. Press the **POWER** switch to turn the power on.
 - Turn the Dial clockwise to increase the memory channel number.
 - Turn it to decrease the number.
3. Press the **SQUELCH** key to select the proper squelch level.
 - The level is selectable from BUSY, 1, 2, 4, and 6.
 - The current level is shown on the S-meter.
4. Rotate the **AF GAIN** knob to adjust the volume.
 - Turn the knob clockwise to increase the volume.
 - Turn it counterclockwise to decrease the volume.

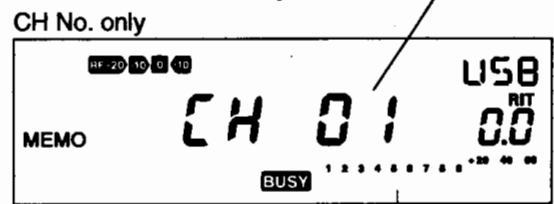
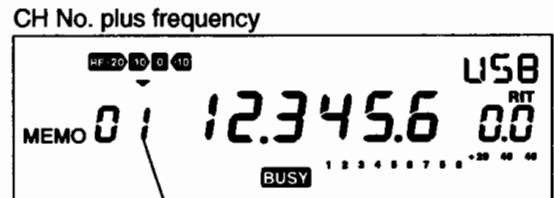

Indicates squelch level

Transmission

1. If necessary, rotate the Dial to select the desired memory channel.
2. If necessary, press the **HIGH/LOW** key to select the desired output power level.
 - **LOW** appears when the low level is selected.
 - **LOW** disappears when the high level is selected.
3. Push and hold the **PTT** key down and speak into the microphone.
 - The **TX** LED lights red and the S-meter indicates the current output power level.
 - The brightness of the **TX** LED changes according to the intensity of your voice.

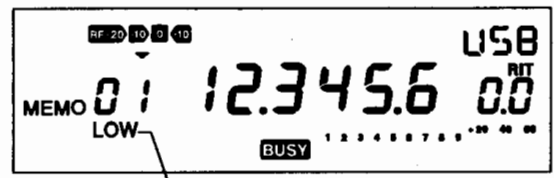

Appears when low level is selected

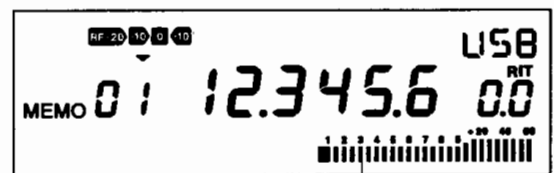

Indicates output power level



Note: On a reception-only channel, "OFF" is displayed.

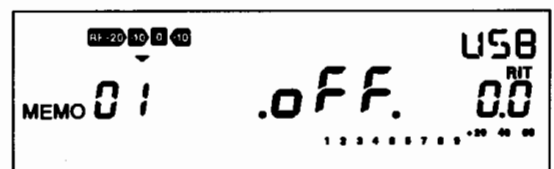

7. USEFUL FUNCTIONS

CALL Channel

The **CALL** channel is used to store most-often-used frequencies and settings for easy and quick recall.

Press the **CALL** key to recall the **CALL** channel.

- To return to a memory channel, press the **CALL** key again.

CH No. plus frequency



CH No. only

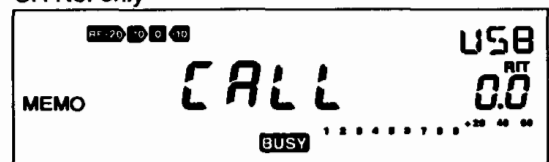

RIT Function

The **RIT** function fine-tunes the reception frequency within a range of ± 1.4 kHz. This change does not affect the transmission frequency.

Turn the **RIT** knob clockwise to increase the frequency in 25 Hz increment.

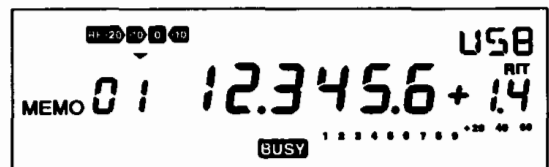

Turn the **RIT** knob counterclockwise to decrease the frequency in 25 Hz increment.

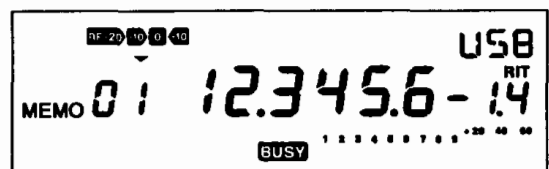

Squelch Selector

The squelch level is selectable from BUSY, 1, 2, 4, and 6.

Press the **SQUELCH** key to select the desired squelch level.

- The current level is shown on the S-meter.

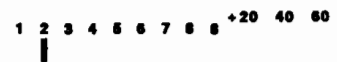

RF/ATT Function

The **RF/ATT** function adjusts the **RF** gain by switching between the preamplifier and attenuator.

Press the **RF/ATT** key to select one of the **RF** gain settings.

- Each time the **RF/ATT** key is pressed, one of the following icon will be displayed on the LCD:

RF -20 -10 0 <10 ..The 10 dB preamplifier is activated. Select this setting when receiving weak signals.

RF -20 -10 0This is the factory default setting.

RF -20 -10The -10 dB attenuator is activated. Select this setting when receiving strong local signals.

RF -20The -20 dB attenuator is activated. Select this setting when receiving very strong local signals or when you run into such signals near the received signal.

Noise Blanker

The noise blanker suppresses pulse noise like that from car ignition to clarify the received signal.

Press the **NB** key to turn on the noise blanker.

- **NB** appears on the LCD.
- To turn off the noise blanker, press the **NB** key again.

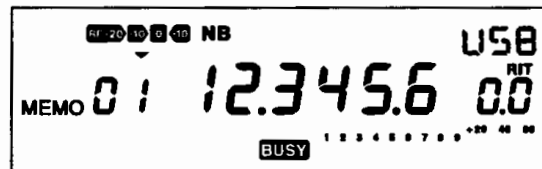

CHECK Function

The **CHECK** function unmutes squelch to check the transmission frequency.

Press the **CHECK** key.

- The **RX** LED lights green and the transmission frequency is received.

 *Note: On a reception-only channel, "oFF" is displayed.*

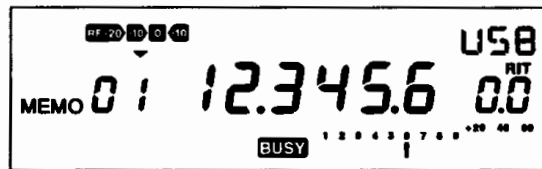

DIAL LOCK Function

The **DIAL LOCK** function locks the Dial to prevent accidental channel changes.

Press the **LOCK** key.

- **D-LOCK** appears on the LCD.
- To cancel this function, press the **LOCK** key again.

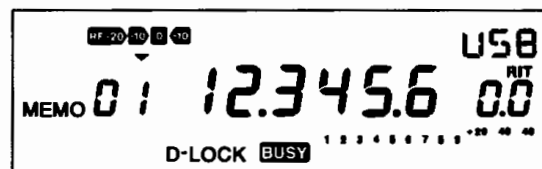

Dimmer

The dimmer changes the LCD brightness. It can be selected from five levels. At the lowest level, the LCD, **TX** LED, and **RX** LED go off.

Press the **DIM** key to select the desired brightness.

External Antenna Tuner Control

This function activates an external antenna tuner for proper antenna matching.

Press the **TUNE** key to activates an external antenna tuner.

- **TUNE** is displayed during tuning.

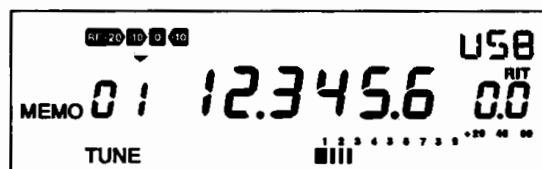

8. TROUBLESHOOTING

In all cases check that the cables connecting the front control panel and the body are connected properly.

Symptom	Possible Cause	Remedy
Power does not come on.	<ol style="list-style-type: none"> 1. DC power cable is incorrectly connected. 2. Fuse is blown. 3. Plug polarity is wrong. 4. Power switch of DC regulated power supply is off. 5. Voltage from the power supply is insufficient. 	<ol style="list-style-type: none"> 1. Correctly connect cable. 2. Replace fuse. 3. Correct polarity and replace fuse. 4. Turn power switch on. 5. Supply a regulated 13.8 V DC \pm 15%
Abnormal LCD display.	<ol style="list-style-type: none"> 1. Power supply voltage is low. To transmit at 100W output, the power supply must be capable of supplying 20 Amps continuously at 13.8 V DC. 	<ol style="list-style-type: none"> 1. ● Check that DC regulated power supply is used. ● Adjust the operating voltage within a range of 13.8 V DC \pm 15% (11.7 to 15.8 V DC). ● To transmit at 100W output, the power supply must be capable of supplying 20 Amps continuously at 13.8 V DC.
No sound from speaker.	<ol style="list-style-type: none"> 1. AF GAIN knob is turned fully counterclockwise. 2. PTT key of microphone is on. 3. External speaker cable is short-circuited or damaged. 4. Headphones or earphone is plugged into the EXT SP jack. 5. Squelch level is set too high. 	<ol style="list-style-type: none"> 1. Rotate AF GAIN knob to adjust volume. 2. Release PTT key. 3. Check cable. 4. Unplug headphones or earphone. 5. Press the SQUELCH key repeatedly.
Only strong signals are received.	<ol style="list-style-type: none"> 1. Squelch is muted. 2. ATT is on. 3. Defective antenna or short-circuited or damaged coaxial cable. 4. Antenna is not suitable for receive band. 	<ol style="list-style-type: none"> 1. Press the SQUELCH key to decrease the squelch level. 2. Press RF/ATT key to turn ATT off. 3. Check antenna, cable, and especially UHF plugs. 4. Connect correct antenna for receive band.

Symptom	Possible Cause	Remedy
No channel change when rotating the Dial	1. Dial is locked.	1. Press DIAL LOCK key to free dial.
No transmission or low output power	<ol style="list-style-type: none"> 1. Microphone is disconnected or poorly connected. 2. Antenna connection is poor or wrong. 3. Antenna matching is improper. 4. Microphone output level is low. 5. Power supply is of insufficient capacity. 	<ol style="list-style-type: none"> 1. Connect microphone correctly. 2. Check antenna connection. 3. Correct antenna matching. Connect correct antenna for operating bands. 4. Increase microphone gain. 5. Use a regulated 13.8 V DC power supply with a capacity of 20 Amps continuous duty. The cable for the power supply should be kept as short as possible, and away from co-ax if possible.
Linear amplifier does not activate.	<ol style="list-style-type: none"> 1. ALC is set to wrong level. 2. Connection between DX-701 and the Linear-amplifier is poor. 	<ol style="list-style-type: none"> 1. Adjust ALC level on your Linear-amp. 2. Check that relay-cable, ALC-cable, co-ax cable are all connected properly between DX-701 and the Linear-amp. Also check that DX-701's HF antenna terminal is connected with the HF Linear-amp.

9. OPTIONS

- DC regulated power supply
 - DM-1350Z(Input 220V AC)
 - DM-1350T(Input 120V AC)

- EBC-8 front control angle bracket

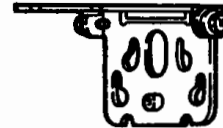

- EBC-9 mobile mount bracket

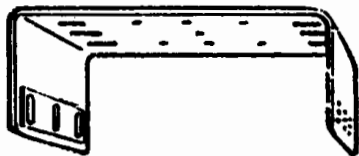

- EDS-4 front control remote kit

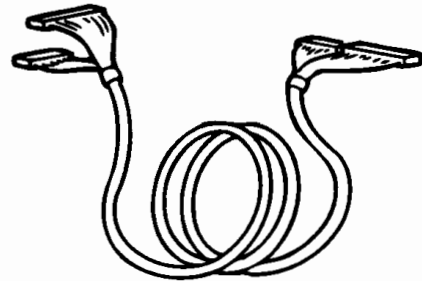

- EDS-5 microphone extension cable

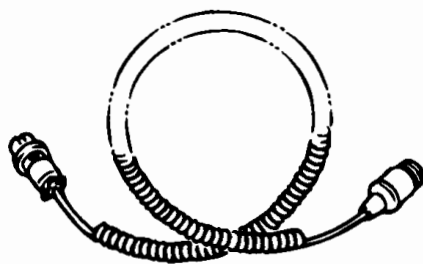

- ERW-5 interface cable

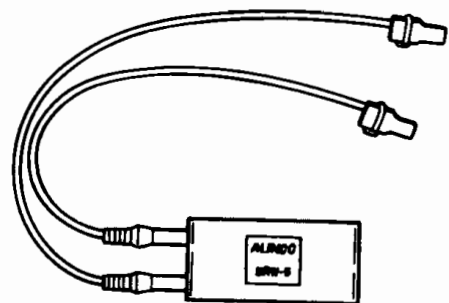

10. EXTERNAL ANTENNA TUNERS AVAILABLE

ALINCO EDX-1

■ Connection Example

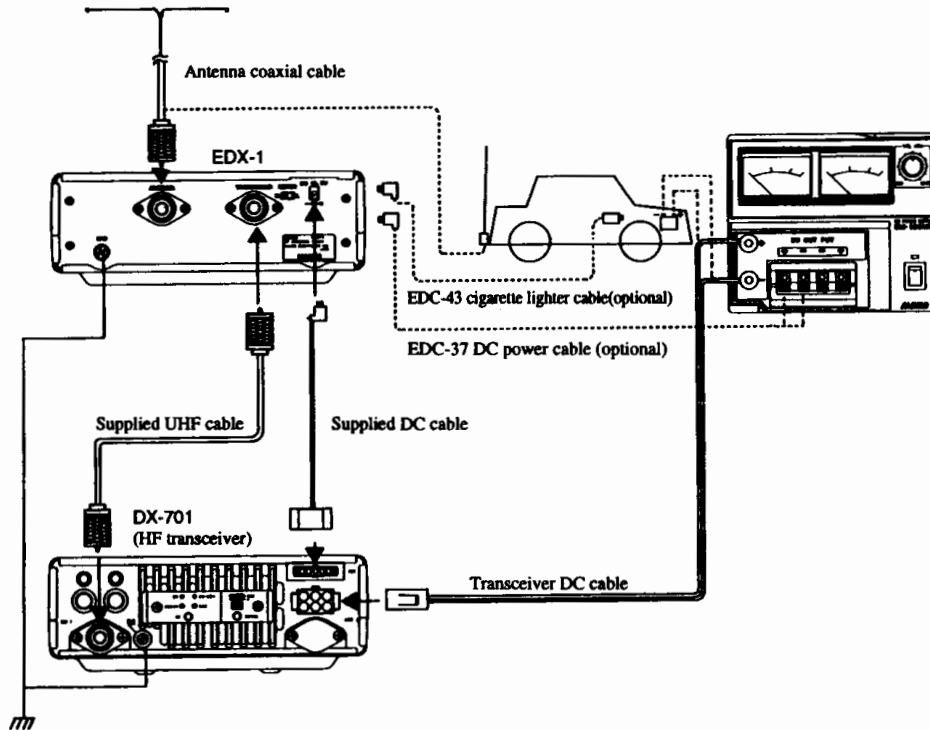

KENWOOD AT-50

■ Connection Example

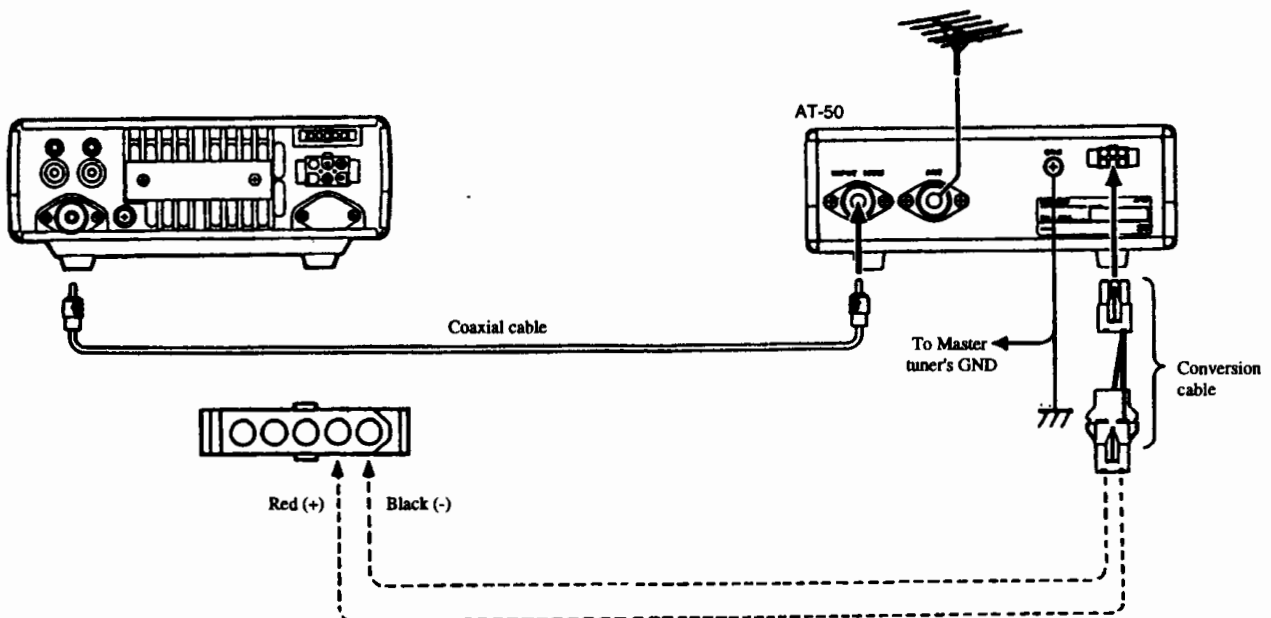

KENWOOD AT-300

■ Connection Example

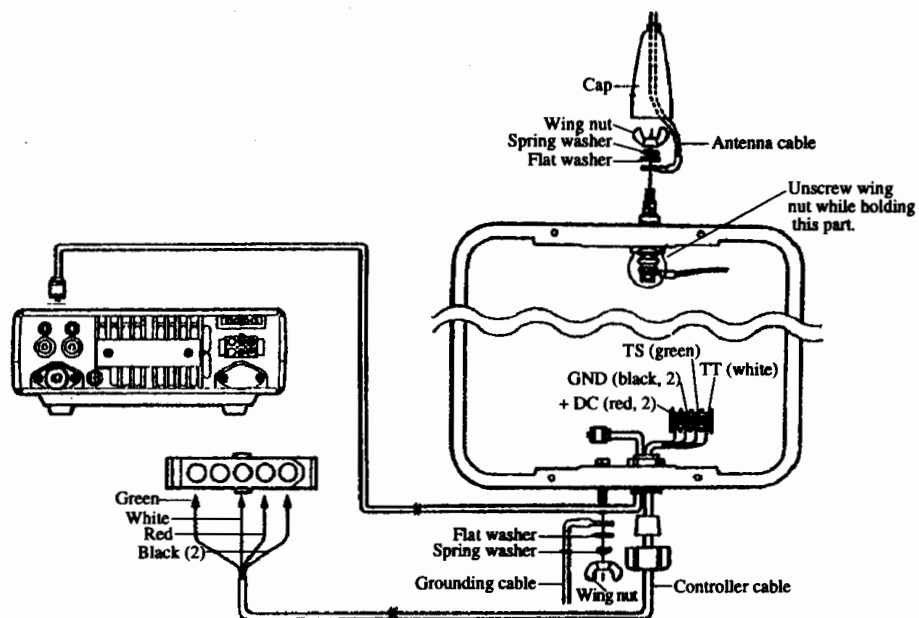

ICOM AH-3

■ Connection Example

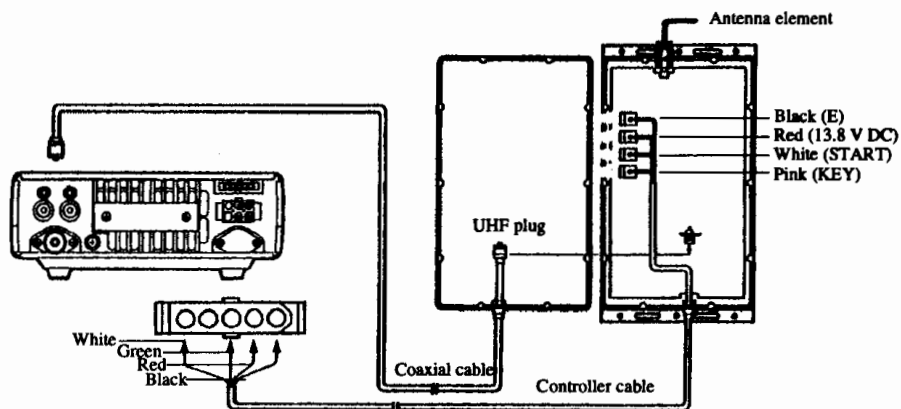

- Notes:**
- For details on how to connect an antenna tuner, see the instruction manual provided with it.
 - Names of products used in this manual are for identification purpose only and may be trademarks or registered trademarks of their respective company.

11. SPECIFICATIONS

■ General

Frequency coverage	Receiver: 0.5 to 29.9999 MHz continuously Transmitter: 1.6000 to 29.9999 MHz
Mode	J3E (USB, LSB), A3E (AM)
Usable temperature	-10 °C to +60 °C
Frequency stability	±0.5 PPM
Antenna impedance	50 Ω unbalanced
Power supply	13.8V DC ±15%
Number of memory	100 channels simplex or two-frequency simplex (TX RX split frequency memory)
Current drain (13.8V DC)	Transmission: 20 A Reception: 1.2 A
Dimensions	W178 × H58 × D228 mm (W7.0 × H2.3 × D9.0 inches) (Projections not included) W179 × H71 × D268 (W7.1 × H2.8 × D10.6 inches)
Weight	Approx. 2.7 kg (6.0 lb)

■ Transmitter

Output power	J3E (USB, LSB): 1.6 to 29.9999 MHz 100 W A3E (AM): 1.6 to 29.9999 MHz 40 W
Spurious emission	Less than -40 dB
Carrier suppression	More than 40 dB
Unwanted sideband	More than 50 dB (1 kHz)
Modulation system	SSB: balanced AM: Low power modulation
Microphone impedance	2 kΩ

■ Receiver

Sensitivity	J3E (1.8 to 30 MHz)	0dB μ EMF (1 μ V)	SINAD 12 dB
	(0.5 to 1.8 MHz)	+10dB μ EMF (3 μ V)	SINAD 12 dB
	A3E (1.8 to 30 MHz)	+12dB μ EMF (4.0 μ V)	SINAD 12 dB
	(0.5 to 1.8 MHz)	+20dB μ EMF (10 μ V)	SINAD 12 dB
Selectivity	J3E:	2.4 kHz/-6 dB, 4.5 kHz/-60 dB	
	A3E:	6 kHz/-6dB, 18 kHz/-60dB	
Intermediate frequency	1st:	71.75 MHz	2nd: 455 kHz
Spurious and image rejection ratio		More than 70 dB	
Audio output power		More than 2.0 W (8 Ω , 10%)	4W (4 Ω , 10%)
RIT variable range		\pm 1.4 kHz or \pm 0.2 kHz	



Note: Specifications are subject to change without notice.