

DR-135 / 435FX

Service Manual

CONTENTS

SPECIFICATIONS

| | |
|------------------|---|
| GENERAL..... | 2 |
| TRANSMITTER..... | 2 |
| RECEIVER..... | 2 |

CIRCUIT DISCRIPTION

| | |
|--|------|
| 1) Receiver System DR-135..... | 3,4 |
| 2) Transmitter System DR-135..... | 4 |
| 3) PLL Synthesizer Circuit DR-135..... | 4,5 |
| 4) Receiver System DR-435..... | 5,6 |
| 5) Transmitter System DR-435..... | 6,7 |
| 6) PLL Synthesizer Circuit DR-435..... | 7 |
| 7) CPU and Peripheral Circuit..... | 8 |
| 8) Power Supply Circuit..... | 8 |
| 9) M38268MCA075GP (XA1130)..... | 9-11 |

SEMICONDUCTOR DATA

| | |
|--|----|
| 1) NJM7808FA (XA0102)..... | 12 |
| 2) TC4S66F (XA0115)..... | 12 |
| 3) AN8010M (XA0119)..... | 12 |
| 4) TC4W53FU(XA0348)..... | 12 |
| 5) TA31136FN (XA0404)..... | 13 |
| 6) LA4425A (XA0410)..... | 13 |
| 7) BR24L32FJ (XA0604Z)..... | 14 |
| 8) S-80845ALMP (XA0620)..... | 14 |
| 9) S-816A50AMC (XA0925)..... | 14 |
| 10) NJM78M05DL1A(XA0947)..... | 14 |
| 11) LM2904PWR (XA1103)..... | 15 |
| 12) LM2902PWR (XA1106)..... | 15 |
| 13) MB15E07SR (XA1107)..... | 16 |
| 14) RA60H1317M1 (XA1108)..... | 17 |
| 15) S-AU82L (XA1142)..... | 18 |
| 16) Transistor, Diode and LED Outline Drawing... | 19 |
| 17) LCD Connection (TTR3626UPFDHN)..... | 20 |

EXPLODED VIEW

| | |
|----------------------------|----|
| 1) Top and Front View..... | 21 |
| 2) Bottom View..... | 22 |
| 3) LCD Assembly..... | 23 |

PARTS LIST

| | |
|------------------------------|-------|
| CPU Unit..... | 24 |
| MAIN Unit DR-135..... | 24-27 |
| MAIN Unit DR-435..... | 27-30 |
| Mechanical Parts..... | 30 |
| Packing Parts..... | 31 |
| ACCESSORIES | 31 |
| ACCESSORIES (SCREW SET)..... | 31 |

DR-135 ADJUSTMENT

| | |
|--|----|
| 1) Adjustment Spot..... | 32 |
| 2) VCO and RX Adjustment Specification.. | 33 |
| 3) TX Adjustment Specification..... | 33 |
| 4) RX Test Specification..... | 34 |
| 5) TX Test Specification..... | 35 |

DR-435 ADJUSTMENT

| | |
|--|----|
| 1) Adjustment Spot..... | 36 |
| 2) VCO and RX Adjustment Specification.. | 37 |
| 3) TX Adjustment Specification..... | 38 |
| 4) RX Test Specification..... | 39 |
| 5) TX Test Specification..... | 40 |

PC BOARD VIEW

| | |
|---|----|
| 1) CPU Unit Side A DR-135 (UP0538A).... | 41 |
| 2) CPU Unit Side B DR-135 (UP0538A).... | 41 |
| 3) CPU Unit Side A DR-435 (UP0545)..... | 42 |
| 4) CPU Unit Side B DR-435 (UP0545)..... | 42 |
| 5) MAIN Unit Side A DR-135 (UP0538A)... | 43 |
| 6) MAIN Unit Side B DR-135 (UP0538A).. | 43 |
| 7) MAIN Unit Side A DR-435 (UP0545).... | 44 |
| 8) MAIN Unit Side B DR-435 (UP0545).... | 44 |

SCHEMATIC DIAGRAM

| | |
|--------------------------|----|
| 1) CPU Unit DR-135..... | 45 |
| 2) CPU Unit DR-435..... | 46 |
| 3) MAIN Unit DR-135..... | 47 |
| 4) MAIN Unit DR-435..... | 48 |

BLOCK DIAGRAM

| | |
|----------------|----|
| 1) DR-135..... | 49 |
| 2) DR-435..... | 50 |

SPECIFICATIONS

■ General

| | | |
|--------------------|---------------------------------|--|
| Frequency coverage | DR-135 | DR-435 |
| FX | 136.000 ~ 173.995MHz (RX, TX) | 350.000 ~ 511.995MHz (RX) 400.000 ~ 489.995MHz (TX) |
| FXE | 144.000 ~ 145.995MHz (RX, TX) | 430.000 ~ 439.995MHz (RX, TX) |

| | | |
|---------------------------|---|---------------------|
| Operating mode | FM 16K0F3E (Wide mode) 8K50F3E (Narrow mode) | |
| Frequency resolution | 5 , 8.33 , 10 , 12.5 , 15 , 20 , 25 , 30 , 50 kHz | |
| Number of memory Channels | 100 | |
| Antenna impedance | 50ohm unbalanced | |
| Power requirement | 13.8V DC +/- 15% (11.7 ~ 15.8 V) | |
| Ground method | Negative ground | |
| Current drain | Receive | 0.6 A (max.) |
| | Transmit | 0.4 A (Squelched) |
| | Approx. 12.0 A max. | |
| Operating temperature | -10 °C ~ 60°C | |
| Frequency stability | +/- 5ppm | +/- 2.5 ppm |
| Dimensions | 142 (w) x 40 (h) x 174 (d) mm | |
| | (142 x 40 x 188 mm for projection included) | |
| Weight | Approx. 1.0 Kg | |

■ Transmitter

| | | | |
|-----------------------------|---|-------------|----------------------------|
| Output power | Hi | 50 W | 35 W |
| | Mid | 20 W | 20 W |
| | Low | Approx. 5 W | Approx. 5 W |
| Modulation system | Variable reactance frequency modulation | | |
| Maximum Frequency deviation | +/- 5kHz (Wide mode) | | +/- 2.5kHz (Narrow mode) |
| Spurious emission | - 60 dB | | |
| Adjacent channel power | - 60 dB | | |
| Noise and hum ratio | - 40 dB (Wide mode) | | - 34 dB (Narrow mode) |
| Microphone impedance | 2kohm | | |

■ Receiver

| | | | |
|------------------------------------|------------------------------------|------------|--------------------------|
| Sensitivity | - 14 dBu for 12 dB SINAD | | |
| Receiver circuit | Double conversion super-heterodyne | | |
| Intermediate frequency | 1st 21.7 MHz | 2nd 450kHz | 1st 30.85 MHz 2nd 455kHz |
| Squelch sensitivity | - 18 dBu | | |
| Adjacent channel selectivity | - 65 dB (Wide mode) | | - 55 dB (Narrow mode) |
| Inter-modulation rejection ratio | 60 dB | | |
| Spurious and image rejection ratio | 70 dB | | |
| Audio output power | 2.0 W (8ohm , 10 % THD) | | |

! NOTE : All specifications are subject to change without notice or obligation.

CIRCUIT DESCRIPTION

1) Receiver System DR- 135

The receiver system is a double super-heterodyne system with a 21.7MHz first IF and a 450kHz second IF.

1. Front End

The received signal at any frequency in the 136.000MHz to 173.995MHz range is passed through the low-pass filter (L116, L115, L114, L113, C204, C203, C202, C216 and C215) and tuning circuit (L105, L104 and D105, D104), and amplified by the RF amplifier (Q107). The signal from Q107 is then passed through the tuning circuit (L103, L102, and variable capacitor D103, D102) and converted into 21.7MHz by the mixer (Q106). The tuning circuit, which consists of L105, L104, variable capacitor D105 and D104, L103, L102, variable capacitor D103 and D102, is controlled by the tracking voltage from the VCO. The local signal from the VCO is passed through the buffer (Q145), and supplied to the source of the mixer (Q106). The radio uses the lower side of the super-heterodyne system.

2. IF Circuit

The mixer mixes the received signal with the local signal to obtain the sum of and difference between them. The crystal filter (XF102, XF101) selects 21.7 MHz frequency from the results and eliminates the signal of the unwanted frequencies. The first IF amplifier (Q105) then amplifies the signal of the selected frequency.

3. Demodulation Circuit

After the signal is amplified by the first IF amplifier (Q105), it is input to pin16 of the demodulator IC (IC108). The second local signal of 21.25MHz (shared with PLL IC reference oscillation), which is oscillated the external oscillator X601 and IC601, is input through pin 1 of IC108. Then, these two signals are mixed by the internal mixer in IC108 and the result is converted into the second IF signal with a frequency of 450kHz. The second IF signal is output from pin 3 of IC108 to the ceramic filter (FL102 or FL101), where the unwanted frequency band of that signal is eliminated, and the resulting signal is sent back to the IC108 through pin 5. The second IF signal input via pin 5 is demodulated by the internal limiter amplifier and quadrature detection circuit in IC 108, and output as an audio signal through pin 9.

4. Audio Circuit

The audio signal from pin 9 of IC 108 is amplified by the audio amplifier (IC120:A), and switched by the signal switch IC (IC111) and then input it to the de-emphasis circuit.

And is compensated to the audio frequency characteristics in the de-emphasis circuit (R203, R207, R213, R209, C191, C218, C217) and amplified by the AF amplifier (IC120:B). The signal is then input to volume (VR1). The adjusted signal is sent to the audio power amplifier (IC117) through the pin 1 to drive the speaker.

5. Squelch Circuit

The detected output which is outputted from pin 9 of IC108 is inputted to pin 8 of IC108 after it was been amplified IC120:A and it is outputted from pin 7 after the noise component was been eliminated from the composed band pass filter in the built in amplifier of the IC, then the signal is rectified by the internal diode in IC108 to convert into DC component. The adjusted voltage level at VR101 is delivered to the comparator of the CPU.

The voltage is led to pin 2 of CPU and compared with the setting voltage. The squelch will open if the input voltage is lower than the setting voltage. During open squelch, pin 30 (SQC) of the CPU becomes "L" level, AF control signal is begin controlled and sounds is outputted from speaker.

6. WIDE/NARROW Switching circuit

The second IF 450kHz signal which passes through filter FL101 (wide) and FL102 (narrow) during narrow, changes its width using the width control switching D116 and D115.

2) Transmitter System DR- 135

1. Modulator Circuit

The audio signal is converted to an electrical signal by the microphone, and input it to the microphone amplifier (Q6). Amplified signal which passes through mic-mute control IC109 is adjusted to an appropriate mic-volume by means of mic-gain adjust VR106.

IC114:D and C consists of two operational amplifiers; one amplifier (pin 12, 13 and 14) is composed of pre-emphasis and IDC circuit and the other (pin 8, 9 and 10) is composed of a splatter filter. The maximum frequency deviation is obtained by VR107. And input to the signal switch (IC113) (9600 bps packet signal input switch) and input to the cathode of the variable capacitor of the VCO, to change the electric capacity in the oscillation circuit. This produces the frequency modulation.

2. Power Amplifier Circuit

The transmitted signal is oscillated by the VCO, amplified by the younger amplifier (Q115), and input to the final power module (IC110). The signal is then amplified by the final power module (IC110) and led to the antenna switch (D110) and low-pass filter (L113, L114, L115, L116, C215, C216, C202, C203 and C204), where unwanted high harmonic waves are reduced as needed, and the resulting signal is supplied to the antenna.

3. APC Circuit

Part of the transmission power from the low-pass filter is detected by D111, converted to DC. The detection voltage is passed through the APC circuit (IC114:A, IC114:B), then it controls the APC voltage supplied to final power module IC110 to fix the transmission power.

3) PLL Synthesizer Circuit DR- 135

1. PLL

The dividing ratio is obtained by sending data from CPU (IC1) to pin 10 and sending clock pulses to pin 9 of the PLL IC (IC116). The oscillated signal from the VCO is amplified by the buffer (Q134 and Q135) and input to pin 8 of IC116. Each programmable divider in IC116 divides the frequency of the input signal by N according to the frequency data, to generate a comparison frequency of 5 or 6.25 kHz.

2. Reference Frequency Circuit

The reference frequency appropriate for the channel steps is obtained by dividing the 21.25 MHz reference oscillation (X102) by 4250 or 3400, according to the data from the CPU (IC1). When the resulting frequency is 5 kHz, channel step of 5, 10, 15, 20, 25, 30 and 50 kHz are used. When it is 6.25 kHz, the 12.5 kHz channel step is used.

3. Phase Comparator Circuit

The PLL (IC116) uses the reference frequency, 5 or 6.25 kHz. The phase comparator in the IC116 compares the phase of the frequency from the VCO with that of the comparison frequency, 5 or 6.25 kHz, which is obtained by the internal divider in IC116.

4. PLL Loop Filter Circuit

If a phase difference is found in the phase comparison between the reference frequency and the VCO output frequency, the charge pump output (pin 5) of IC116 generates a pulse signal, which is converted DC voltage by the PLL loop filter and input to the input to the variable capacitor of the VCO unit for oscillation frequency control.

5. VCO Circuit

A Colpitts oscillation circuit driven by Q131 directly oscillates the desired frequency. The frequency control voltage determine in the CPU (IC1) and PLL circuit is input to the variable capacitor (D122 and D123). This change the oscillation frequency, which is amplified by the VCO buffer (Q134, Q145) and output from the VCO area.

6. VCO Shift Circuit

During transmission or the AIR band Reception (118 ~ 136 MHz), the VCO shift circuit turns ON Q138, change control the capacitance of L123 and safely oscillates the VCO by means of H signal from pin 42 of IC1.

4) Receiver System DR- 435

The receiver system is a double super-heterodyne system with a 30.85MHz first IF and a 455kHz second IF.

1. Front End

The received signal at any frequency in the 430.000MHz to 439.995MHz range is passed through the low-pass filter (L115, L114, L116, C204, C203, C202, C216 and C215) and amplified by the RF amplifier (Q107). The signal from Q107 is then passed through the BPF circuit (L103, L102) and converted into 30.85MHz by the mixer (Q106). The local signal from the VCO is passed through the buffer (Q134, Q145), and supplied to the source of the mixer (Q106). The radio uses the lower side of the super-heterodyne system.

2. IF Circuit

The mixer mixes the received signal with the local signal to obtain the sum of and difference between them. The crystal filter (XF101) selects 30.85 MHz frequency from the results and eliminates the signal of the unwanted frequencies. The first IF amplifier (Q105) then amplifies the signal of the selected frequency.

3. Demodulation Circuit

After the signal is amplified by the first IF amplifier (Q105), it is input to pin16 of the demodulator IC (IC108). The second local signal of 30.395MHz (Crystal oscillator) is input through pin 1 of IC108. Then, these two signals are mixed by the internal mixer in IC108 and the result is converted into the second IF signal with a frequency of 455kHz. The second IF signal is output from pin 3 of IC108 to the ceramic filter (FL101 or FL102), where the unwanted frequency band of that signal is eliminated, and the resulting signal is sent back to the IC108 through pin 5.

The second IF signal input via pin 5 is demodulated by the internal limiter amplifier and quadrature detection circuit in IC 108, and output as an audio signal through pin 9.

4. Audio Circuit

The audio signal from pin 9 of IC 108 is amplified by the audio amplifier (IC120:A), and switched by the signal switch IC (IC111) and then input it to the de-emphasis circuit.

And is compensated to the audio frequency characteristics in the de-emphasis circuit (R203, R207, R213, R209, C191, C218, C217) and amplified by the AF amplifier (IC120:B). The signal is then input to volume (VR1). The adjusted signal is sent to the audio power amplifier (IC117) through the pin 1 to drive the speaker.

5. Squelch Circuit

The detected output which is outputted from pin 9 of IC108 is inputted to pin 8 of IC108 after it was been amplified IC120:A and it is outputted from pin 7 after the noise component was been eliminated from the composed band pass filter in the built in amplifier of the IC, then the signal is rectified by the internal diode in IC108 to convert into DC component. The adjusted voltage level at VR101 is delivered to the comparator of the CPU.

The voltage is led to pin 2 of CPU and compared with the setting voltage. The squelch will open if the input voltage is lower than the setting voltage. During open squelch, pin 30 (SQC) of the CPU becomes "L" level, AF control signal is begin controlled and sounds is outputted from speaker.

6. WIDE/NARROW Switching circuit

The second IF 455kHz signal which passes through filter FL101 (wide) and FL102 (narrow) during narrow, changes its width using the width control switching D116 and D115.

5) Transmitter System DR- 435

1. Modulator Circuit

The audio signal is converted to an electrical signal by the microphone, and input it to the microphone amplifier (Q6). Amplified signal which passes through mic-mute control IC109 is adjusted to an appropriate mic-volume by means of mic-gain adjust VR106.

IC114:D and C consists of two operational amplifiers; one amplifier (pin 12, 13 and 14) is composed of pre-emphasis and IDC circuit and the other (pin 8, 9 and 10) is composed of a splatter filter. The maximum frequency deviation is obtained by VR107. And input to the signal switch (IC113) (9600 bps packet signal input switch) and input to the cathode of the variable capacitor of the VCO, to change the electric capacity in the oscillation circuit. This produces the frequency modulation.

2. Power Amplifier Circuit

The transmitted signal is oscillated by the VCO, amplified by the drive amplifier (Q138) and younger amplifier (Q115), and input to the final power module (IC110). The signal is then amplified by the final power module (IC110) and led to the antenna switch (D110) and low-pass filter (L116, L114, L115, C215, C216, C202, C203 and C204), where unwanted high harmonic waves are reduced as needed, and the resulting signal is supplied to the antenna.

3. APC Circuit

Part of the transmission power from the low-pass filter is detected by D111, converted to DC. The detection voltage is passed through the APC circuit (IC114:A, IC114:B), then it controls the APC voltage supplied to the final power module IC110 to fix the transmission power.

6) PLL Synthesizer Circuit DR- 435

1. PLL

The dividing ratio is obtained by sending data from CPU (IC1) to pin 10 and sending clock pulses to pin 9 of the PLL IC (IC116). The oscillated signal from the VCO is amplified by the buffer (Q134 and Q135) and input to pin 8 of IC116. Each programmable divider in IC116 divides the frequency of the input signal by N according to the frequency data, to generate a comparison frequency of 5 or 6.25 kHz.

2. Reference Frequency Circuit

The reference frequency appropriate for the channel steps is obtained by dividing the 21.25 MHz reference oscillation (X102) by 4250 or 3400, according to the data from the CPU (IC1). When the resulting frequency is 5 kHz, channel step of 5, 10, 15, 20, 25, 30 and 50 kHz are used. When it is 6.25 kHz, the 12.5 kHz channel step is used.

3. Phase Comparator Circuit

The PLL (IC116) uses the reference frequency, 5 or 6.25 kHz. The phase comparator in the IC116 compares the phase of the frequency from the VCO with that of the comparison frequency, 5 or 6.25 kHz, which is obtained by the internal divider in IC116.

4. PLL Loop Filter Circuit

If a phase difference is found in the phase comparison between the reference frequency and the VCO output frequency, the charge pump output (pin 5) of IC116 generates a pulse signal, which is converted DC voltage by the PLL loop filter and input to the input to the variable capacitor of the VCO unit for oscillation frequency control.

5. VCO Circuit

A Colpitts oscillation circuit driven by Q131 directly oscillates the desired frequency. The frequency control voltage determine in the CPU (IC1) and PLL circuit is input to the variable capacitor (D122 and D123). This change the oscillation frequency, which is amplified by the VCO buffer (Q134, Q145) and output from the VCO unit.

7) CPU and Peripheral Circuits

1. LCD Display Circuit

The CPU turns ON the LCD via segment and common terminals with 1/4 the duty and 1/3 the bias, at the frame frequency is 64 Hz.

2. Reset and Backup

When the power from the DC cable increases from Circuits 0 V to 2.5 V or more, "H" level reset signal is output from the reset IC (IC4) to pin 33 of the CPU (IC1), causing the CPU to reset. The reset signal, however, waits at 100, and does not enter the CPU until the CPU clock (X1) has stabilized.

3. S (Signal) Meter Circuit

The DC potential of IF IC is input to pin 1 of the CPU (IC1), converted from an analog to a digital signal, and displayed as the S-meter signal on the LCD.

4. DTMF Encoder

The CPU (IC1) is equipped with an internal DTMF encoder. The DTMF signal is output from pin 10, through R35, R34 and R261 (for level adjustment), and then through the microphone amplifier (IC114:A), and is sent to the variable capacitor of the VCO for modulation. At the same time, the monitoring tone passes through the AF circuit and is output from the speaker.

5. Tone Encoder

The CPU (IC1) is equipped with an internal tone encoder. The tone signal (67.0 to 250.3 Hz) is output from pin 9 of CPU to the variable capacitor (D122 and D123) of the VCO for modulation.

6. DCS Encoder

The CPU (IC1) is equipped with an internal DCS code encoder. The code (023 to 754) is output from pin 9 of CPU to the voltage control pin of VCTCXO (X102) of the PLL reference oscillator. When DCS is ON, DCS MUTE circuit (Q126-ON, Q133-ON, Q132-OFF) works. The modulation activates in X102 side only.

7. CTCSS, DCS Decoder

The voice band of the AF output signal from pin 1 of IC120:A is cut by sharp active filter IC104:A, B and C (VCVS) and amplified, then led to pin 4 of CPU. The input signal is compared with the programmed tone frequency code in the CPU. The squelch will open when they match. During DCS, Q108 is ON, C419 is working and cut off frequency is lowered.

8) Power Supply Circuit

When power supply is ON, there is a "L" signal being inputted to pin 39 (PSW) of CPU which enables the CPU to work. Then, "H" signal is outputted from pin 41 (C5C) of CPU and drives ON the power supply switch control Q8 and Q7 which turns the 5VS ON. 5VS turns ON the PLL IC (IC116), main power supply switch Q127 and Q122, AF POWER IC117 and the 8V of AVR (IC115). During reception, pin 29 (R5) of CPU outputs "H" level, Q124 is ON, and the reception circuits supplied by 8 V. While during transmission, pin 28 (T5) of CPU outputs "L" level which is reverse by Q11 so that the output in Q128 will be "H" level, Q123 is ON, and the transmission circuit is supplied by 8 V. Or, in the case when the condition of PLL is UNLOCK, "H" level is outputted from pin 14 of PLL IC, UNLOCK switch Q129 is ON, transmission switch Q128 is OFF which makes the transmission to stop.

9) M38268MCL075GP (XA1130)

CPU

Terminal Connection
(TOP VIEW)

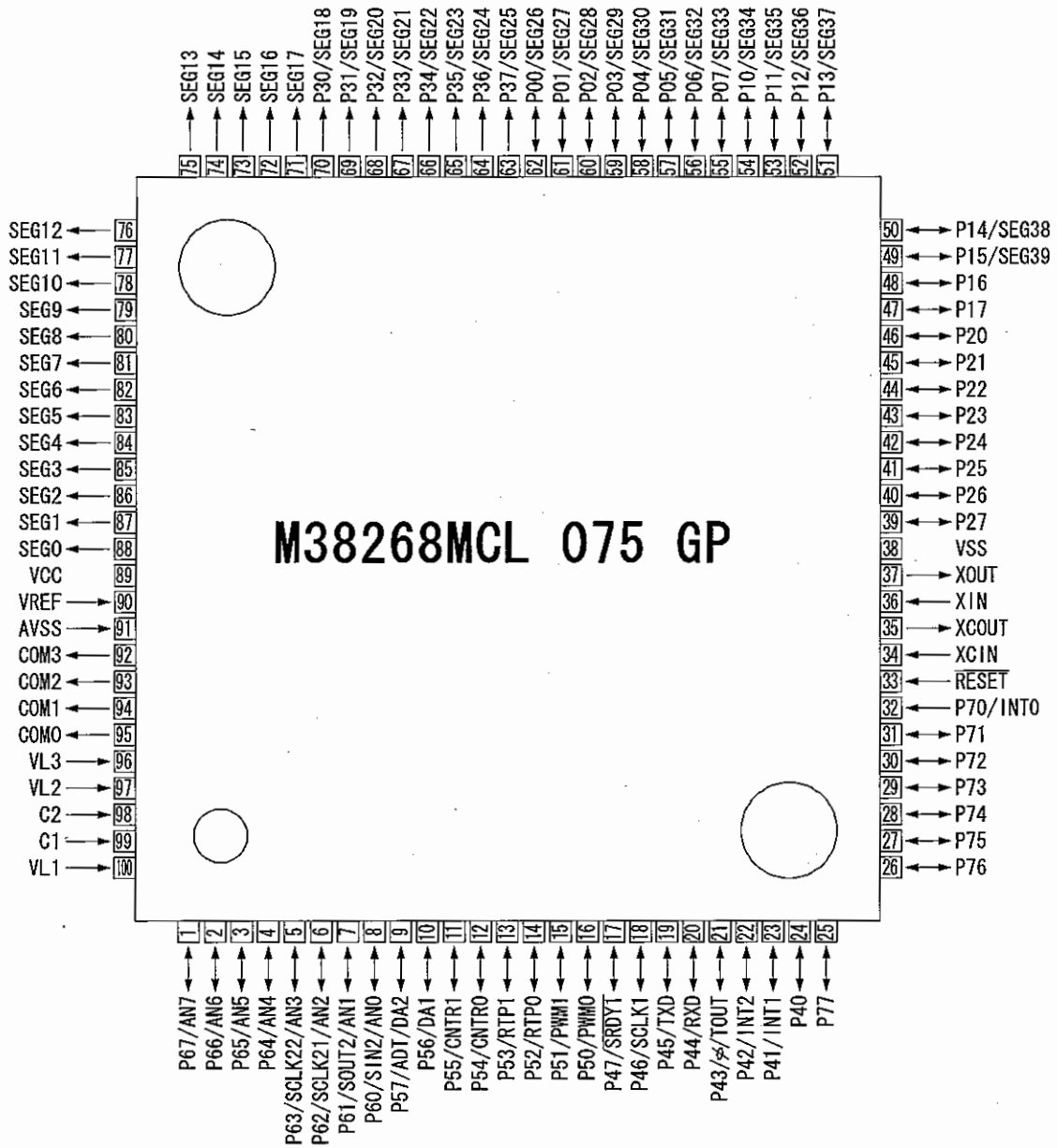

| No. | Terminal | Signal | I/O | Description |
|-----|-------------------|--------|-----|--|
| 1 | P67/AN7 | SMT | I | S-meter input |
| 2 | P66/AN6 | SQL | I | Noise level input for squelch |
| 3 | P65/AN5 | BP5 | I | Band plan 5 |
| 4 | P64/AN4 | TIN | I | CTCSS tone input / DCS code input |
| 5 | P63/SCLK22/AN3 | BP1 | I | Band plan 1 |
| 6 | P62/SCLK21/AN2 | BP2 | I | Band plan 2 |
| 7 | P61/SOUT2/AN1 | DCSW | O | DCS signal mute |
| 8 | P60/SIN2/AN0 | RE2 | I | Rotary encoder input |
| 9 | P57/ADT/DA2 | TOUT | O | CTCSS tone output / DCS tone output |
| 10 | P56/DA1 | DOUT | O | DTMF output |
| 11 | P55/CNTR1 | SCL | O | Serial clock for EEPROM |
| 12 | P54/CNTR0 | TBST | O | Tone burst output |
| 13 | P53/RTP1 | BP4 | I/O | Band plan 4 |
| 14 | P52/RTP0 | MUTE | I/O | Microphone mute / Security alarm SW |
| 15 | P51/PWM1 | CLK | O | Serial clock output for PLL |
| 16 | P50/PWM0 | DATA | I/O | Serial data output for PLL / PLL unlock signal input |
| 17 | P47/SRDY1 | TSTB | I/O | Trunking board detection / Strobe signal to trunking board |
| 18 | P46/SCLK1 | STB | O | Strobe for PLL IC |
| 19 | P45/TXD | UTX | O | UART data transmission output |
| 20 | P44/RXD | RTX | I | UART data reception output |
| 21 | P43/ ϕ /TOUT | BEEP | I/O | Beep tone / Band plan 3 |
| 22 | P42/INT2 | SEC | I | Security voltage input |
| 23 | P41/INT1 | RE1 | I | Rotary encoder input |
| 24 | P40 | | | |
| 25 | P77 | PTT | I | PTT input |
| 26 | P76 | SSTB | O | Security mode |
| 27 | P75 | W/N | O | Wide Narrow SW |
| 28 | P74 | T5 | O | TX power ON / OFF output |
| 29 | P73 | R5 | O | RX power ON / OFF output |
| 30 | P72 | SQC | O | SQL ON / OFF |
| 31 | P71 | | | |
| 32 | P70/INT0 | BU | I | Backup signal detection input |
| 33 | RESET | RESET | I | Reset input |
| 34 | XCIN | Xcin | - | - |
| 35 | XCOU | Xcout | - | - |
| 36 | XIN | Xin | - | Main clock input |
| 37 | XOUT | Xout | - | Main clock output |
| 38 | VSS | GND | - | CPU GND |
| 39 | P27 | PSW | I | Power switch input |
| 40 | P26 | SDA | O | Serial data for EEPROM |
| 41 | P25 | C5C | O | C5V power ON / OFF output |
| 42 | P24 | AIR | O | Tx middle power |
| 43 | P23 | LOW | O | Tx low power |
| 44 | P22 | EXP | O | Trunking / Packet data SW |
| 45 | P21 | SW6 | I | Key sw 6 (SQL) |
| 46 | P20 | SW5 | I | Key sw 5 (CALL) |
| 47 | P17 | SW4 | I | Key sw 4 (TSQ) |
| 48 | P16 | SW3 | I | Key sw 3 (MHz) |
| 49 | P15/SEG39 | SW2 | I | Key sw 2 (V/M) |
| 50 | P14/SEG38 | SW1 | I | Key sw 1 (FUNC) |

| No. | Terminal | Signal | I/O | Description |
|-----|-----------|--------|-----|---------------------------|
| 51 | P13/SEG37 | DOWN | I | Mic down input |
| 52 | P12/SEG36 | | | |
| 53 | P11/SEG35 | | | |
| 54 | P10/SEG34 | UP | I | Mic up input |
| 55 | P07/SEG33 | S33 | O | LCD segment signal |
| 56 | P06/SEG32 | S32 | O | |
| 57 | P05/SEG31 | S31 | O | |
| 58 | P04/SEG30 | S30 | O | |
| 59 | P03/SEG29 | S29 | O | |
| 60 | P02/SEG28 | S28 | O | |
| 61 | P01/SEG27 | S27 | O | |
| 62 | P00/SEG26 | S26 | O | |
| 63 | P37/SEG25 | S25 | O | |
| 64 | P36/SEG24 | S24 | O | |
| 65 | P35/SEG23 | S23 | O | |
| 66 | P34/SEG22 | S22 | O | |
| 67 | P33/SEG21 | S21 | O | |
| 68 | P32/SEG20 | S20 | O | |
| 69 | P31/SEG19 | S19 | O | |
| 70 | P30/SEG18 | S18 | O | |
| 71 | SEG17 | S17 | O | |
| 72 | SEG16 | S16 | O | |
| 73 | SEG15 | S15 | O | |
| 74 | SEG14 | S14 | O | |
| 75 | SEG13 | S13 | O | |
| 76 | SEG12 | S12 | O | |
| 77 | SEG11 | S11 | O | |
| 78 | SEG10 | S10 | O | |
| 79 | SEG9 | S9 | O | |
| 80 | SEG8 | S8 | O | |
| 81 | SEG7 | S7 | O | |
| 82 | SEG6 | S6 | O | |
| 83 | SEG5 | S5 | O | |
| 84 | SEG4 | S4 | O | |
| 85 | SEG3 | S3 | O | |
| 86 | SEG2 | S2 | O | |
| 87 | SEG1 | S1 | O | |
| 88 | SEG0 | S0 | O | |
| 89 | VCC | VDD | - | CPU power terminal |
| 90 | VREF | Vref | - | AD converter power supply |
| 91 | AVSS | Avss | - | AD converter GND |
| 92 | COM3 | COM3 | O | LCD COM3 output |
| 93 | COM2 | COM2 | O | LCD COM2 output |
| 94 | COM1 | COM1 | O | LCD COM1 output |
| 95 | COM0 | COM0 | O | LCD COM0 output |
| 96 | VL3 | VL3 | - | LCD power supply |
| 97 | VL2 | VL2 | - | LCD power supply |
| 98 | C2 | I | - | - |
| 99 | C1 | C1 | - | - |
| 100 | VL1 | VL1 | I | LCD power supply |

SEMICONDUCTOR DATA

1) NJM7808FA (XA0102)

8V (1A) Voltage Regulator

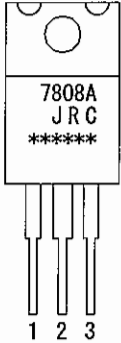

- 1. INPUT
- 2. COMMON
- 3. OUTPUT

2) TC4S66F (XA0115)

Bilateral Switch

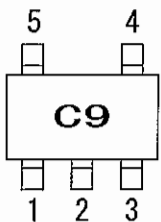

- 1. IN / OUT
- 2. OUT / IN
- 3. VSS
- 4. CONT
- 5. VDD

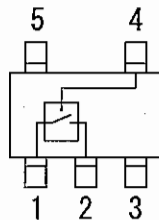

| CONT | Function (IN-OUT) |
|------|-----------------------|
| L | Disconnect (Hi Z) |
| H | Connect (290ohm typ.) |

3) AN8010M (XA0119)

10V (50mA) Voltage Regulator

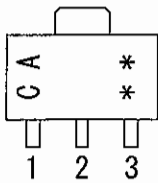

- 1. OUTPUT
- 2. COMMON
- 3. INPUT

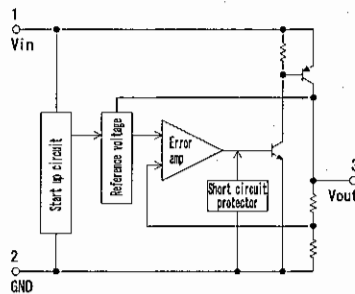

4) TC4W53FU (XA0348)

Multiplexer / De-multiplexer

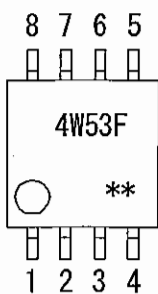

- 1. COMMON
- 2. INH
- 3. VEE
- 4. VSS
- 5. A
- 6. ch 1
- 7. ch 0
- 8. VDD

| Control input | | ON channel |
|---------------|---|------------|
| INH | A | |
| L | L | ch 0 |
| L | H | ch 1 |
| H | * | NONE |

* Don't care

5) TA31136FN (XA0404)

Narrow Band FM IF IC

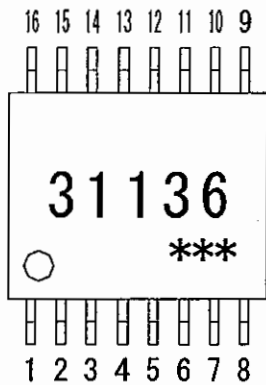

- | | |
|------------|------------|
| 1. OSC IN | 9. AF OUT |
| 2. OSC OUT | 10. QUAD |
| 3. MIX OUT | 11. IF OUT |
| 4. Vcc | 12. RSSI |
| 5. IF IN | 13. N-DET |
| 6. DEC | 14. N-REC |
| 7. FIL OUT | 15. GND |
| 8. FIL IN | 16. MIX IN |

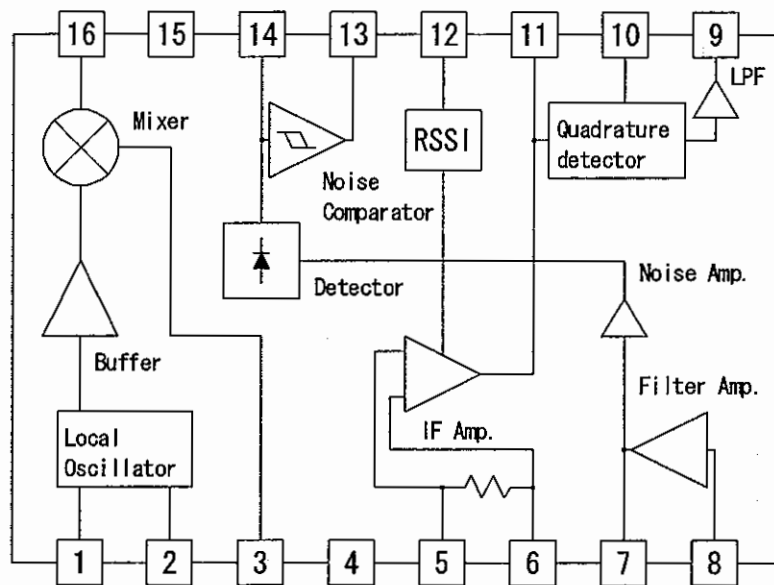

6) LA4425A (XA0410)

5W Audio Power Amplifier

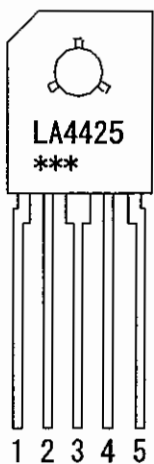

1. Input
2. Small signal GND
3. Large signal GND
4. Output
5. Vcc

Test Circuit

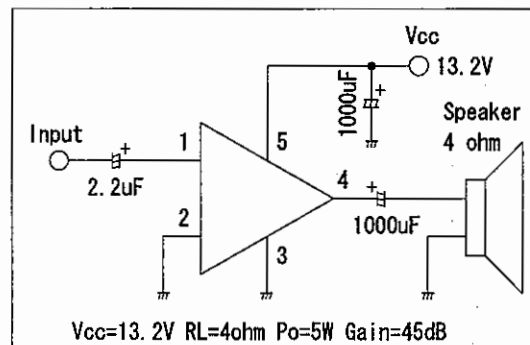

7) BR24L32FJ (XA0604Z)

32K-Bit EEPROM

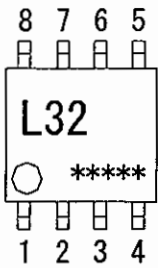

1. A0
2. A1
3. A2
4. Vss
5. SDA
6. SCL
7. WP
8. Vcc

| Name | Function |
|---------|-------------------------------|
| A0...A2 | User Configurable Chip Select |
| Vss | Ground |
| SDA | Serial Address / Data / I/O |
| SCL | Serial Clock |
| WP | Write Protect Input |
| Vcc | +2.5 ~ 6.0V Power Supply |

8) S-80845ALMP (XA0620)

4.5V Voltage Detector

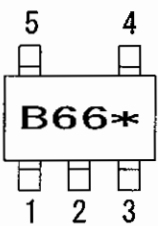

1. GND
2. Vin
3. Vout
4. NC
5. NC

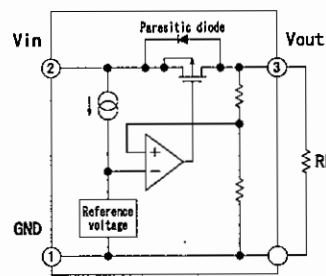

9) S-816A50AMC (XA0925)

External Transistor Type 5V Voltage Regulator with On/Off Function

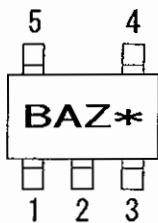

1. EXT
2. Vss
3. ON/OFF
4. Vin
5. Vout

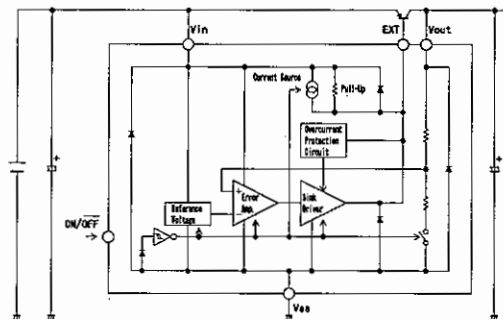

10) NJM78M05DL1A (XA0947)

5V (500mA) Voltage Regulator

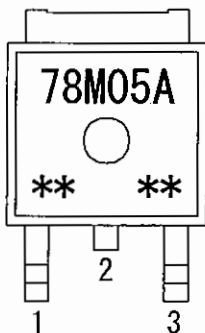

1. Input
2. GND
3. Output

11) LM2904PWR (XA1103)

Dual Operational Amplifiers

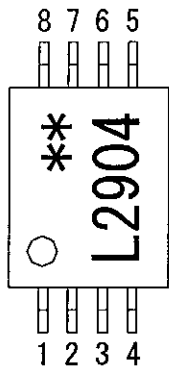

1. Output A
2. Inverting Input A
3. Non-inverting Input A
4. GND
5. Non-inverting Input B
6. Inverting Input B
7. Output B
8. Vcc

12) LM2902PWR (XA1106)

Quad Operational Amplifiers

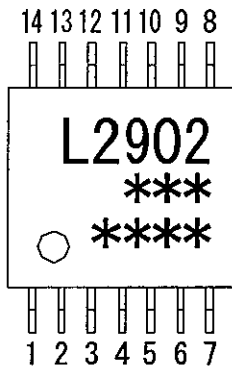

1. Output A
2. Inverting Input A
3. Non-inverting Input A
4. Vcc
5. Non-inverting Input B
6. Inverting Input B
7. Output B
8. Output C
9. Inverting Input C
10. Non-inverting Input C
11. GND
12. Non-inverting Input D
13. Inverting Input D
14. Output D

13) MB15E07SR (XA1107)

PLL Synthesizer

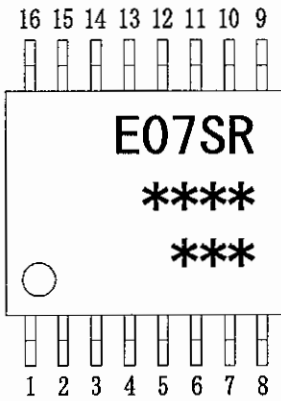

- | | |
|-----------|---------------|
| 1. OSC IN | 9. Clock |
| 2. N. C. | 10. Data |
| 3. Vp | 11. LE |
| 4. Vcc | 12. PS |
| 5. Do | 13. N. C. |
| 6. GND | 14. LD / fout |
| 7. Xfin | 15. N. C. |
| 8. fin | 16. N. C. |

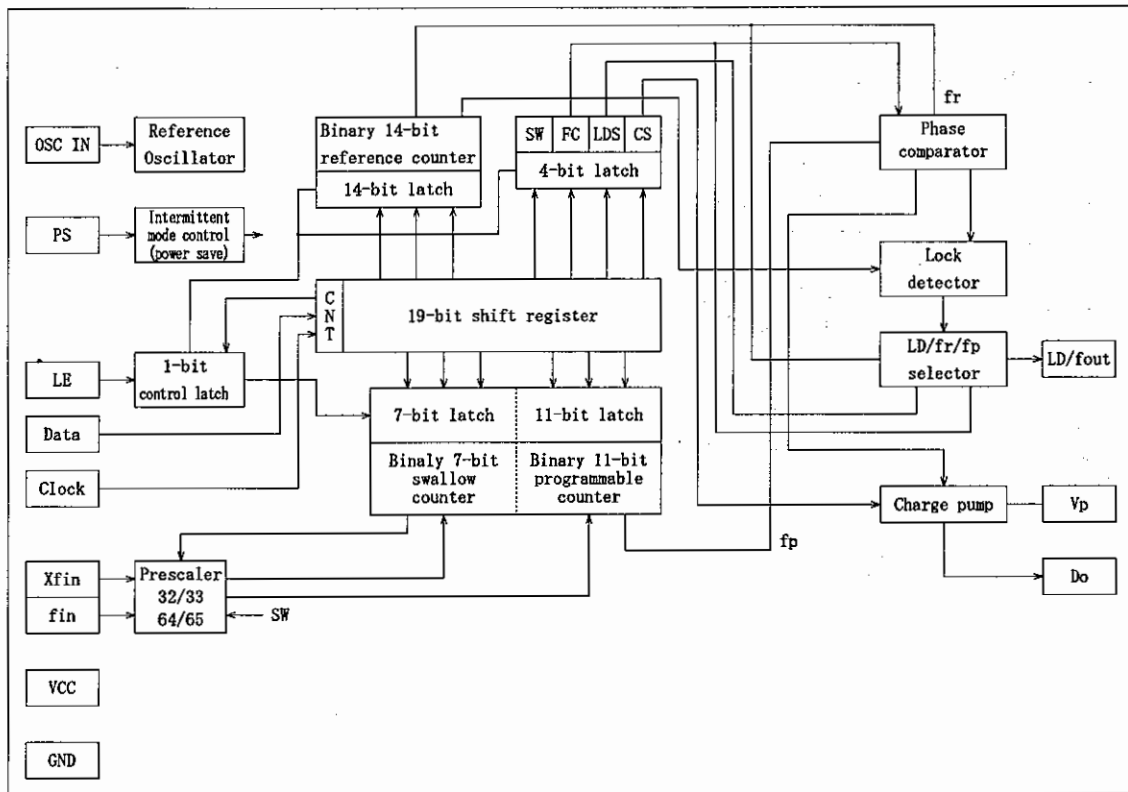

(Vcc = 2.7 to 5.0V, Ta = -40°C to +85oC)

| Parameter | Symbol | Condition | Min. | Typ. | Max. | Unit |
|----------------------------------|--------|---------------------------------------|-----------|------|----------|------|
| Power supply voltage | Vcc | - | 2.7 | 3.75 | 5.0 | V |
| Power supply current | Icc | 2500MHz Vcc=Vp=3.75V | | 8.0 | | mA |
| LPF supply voltage | Vp | - | Vcc | - | 5.5 | V |
| Local oscillator input level | Vfin | 100MHz to 300MHz 300MHz to 2500MHz | -6 -15 | | +2 +2 | dBm |
| Local oscillator input frequency | fin | - | 100 | | 2500 | MHz |
| Xin input level | Vxin | - | 0.5 | | Vcc | Vp-p |
| Xin input frequency | Fxin | - | 3 | | 40 | MHz |

14) RA60H1317M1 (XA1108)

144 ~ 146MHz 60W RF Power Module

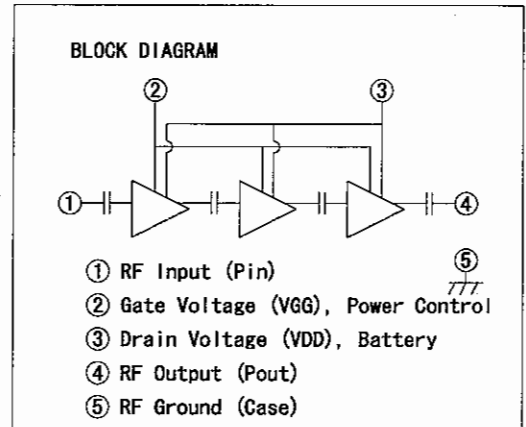
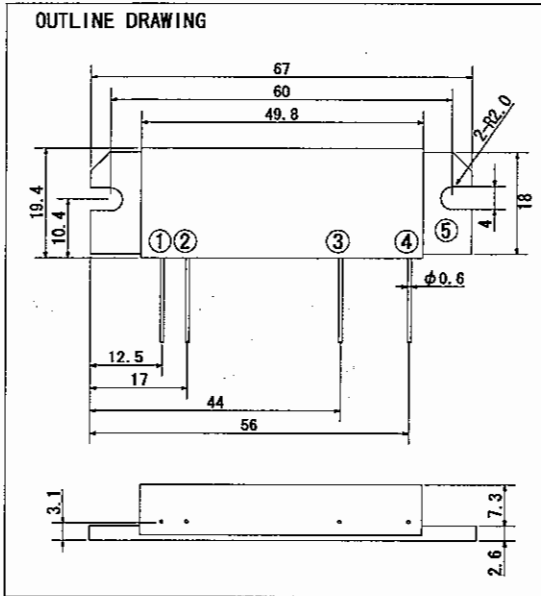

ABSOLUTE MAXIMUM RATING (Tc = 25 °C, unless otherwise noted)

| Symbol | Parameter | Conditions | Ratings | Unit |
|------------|----------------------------|-----------------------------|-------------|------|
| VDD | Drain Voltage | VGG < 5V, ZG = ZL = 50ohm | 17 | V |
| VGG | Gate Voltage | VDD < 12.5V, Pin=50mW | 5.5 | V |
| IDD | Drain Current | ZG = ZL = 50ohm | 15 | A |
| Pin | Input Power | f = 135 – 175 MHz, Pin=50mW | 100 | mW |
| Pout | Output Power | ZG = ZL = 50ohm | 80 | W |
| Tcase (OP) | Operation Case Temperature | | -30 to +110 | °C |
| Tstg | Storage Temperature | | -40 to +110 | °C |

ELECTRICAL CHARACTERISTICS (Tc = 25 °C, unless otherwise noted)

| Symbol | Parameter | Conditions | Ratings | | | Unit |
|----------|--------------------------|--|---------------------------|-----|-----|------|
| | | | Min | Typ | Max | |
| f | Frequency Range | VDD = 12.5V VGG = 5V Pin = 50mW | 135 | | 175 | MHz |
| Pout | Output Power | | 60 | | | W |
| ηT | Total Efficiency | | 45 | | | % |
| 2fo | 2 nd Harmonic | | | | -50 | dBc |
| Pin | Input VSWR | | | | 3:1 | - |
| IGG | Gate Current | | | 1 | | mA |
| - | Stability | VDD=10.0-15.2V, Pin=25-70mW, Pout<70W (VGG control), Load VSWR=3:1 | No parasitic oscillation | | | - |
| - | Load VSWR Tolerance | VDD=15.2V, Pin=50mW, Pout=60W (VGG control), Load VSWR=8:1 | No degradation or destroy | | | |

15) S-AU82L (XA1142)

400 ~ 470MHz 60W RF Power Module

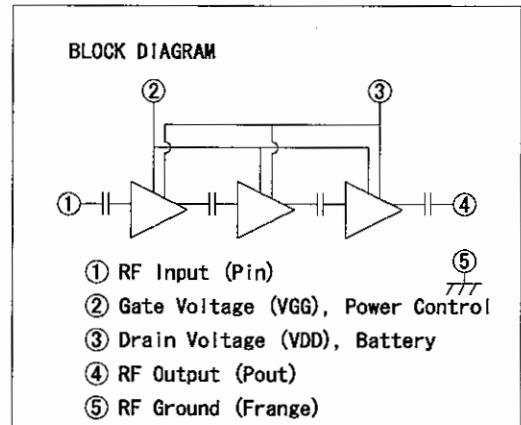
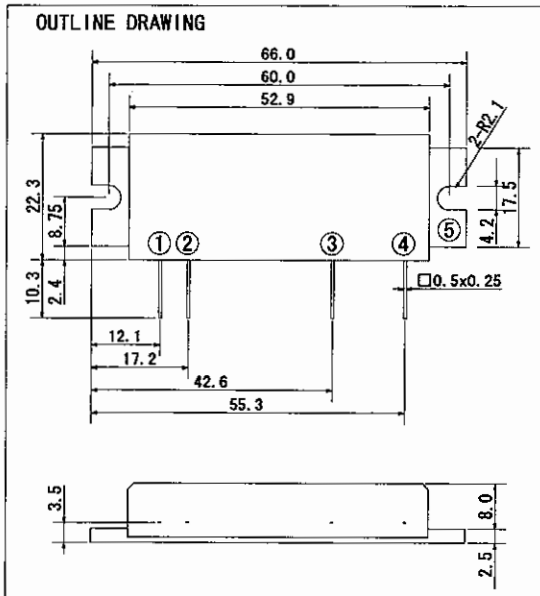

ABSOLUTE MAXIMUM RATING (Tc = 25 °C, unless otherwise noted)

















































































| Symbol | Parameter | Conditions | Ratings | Unit |
|------------|----------------------------|--|-------------|------|
| VDD | Drain Voltage | VGG < 5V, Pi = 50mW, Po < 60W | 16.5 | V |
| VGG | Gate Voltage | VDD < 12.5V, Pin=50mW | 5.5 | V |
| IDD | Drain Current | | 15 | A |
| Pin | Input Power | VDD < 12.5V, VGG < 5V | 100 | MW |
| Pout | Output Power | 12.5V < VDD < 16.5V, VGG = 5V, Pi = 50mW | 80 | W |
| Tcase (OP) | Operation Case Temperature | | -30 to +100 | °C |
| Tstg | Storage Temperature | | -40 to +100 | °C |

ELECTRICAL CHARACTERISTICS (Tc = 25 °C, unless otherwise noted)

| Symbol | Parameter | Conditions | Ratings | | | Unit |
|----------|--------------------------|--|---|-----|-----|------|
| | | | Min | Typ | Max | |
| f | Frequency Range | VDD = 12.5V VGG = 5V Pin = 50mW ZL = 50ohm | 400 | | 470 | MHz |
| Pout | Output Power | | 60 | | | W |
| η T | Total Efficiency | | 40 | | | % |
| 2fo | 2 nd Harmonic | | | | -30 | dBc |
| P in | Input VSWR | | | | 3.0 | - |
| IGG | Gate Current | | | 1 | | mA |
| - | Stability | VDD=10.5-16.5V, VGG=0-5V, Pin=50mW, Pout<60W (VGG control), Load VSWR=3:1 ALL PHASE | All spurious output than 60dB bellow desired signal | | | - |
| - | Load VSWR Tolerance | VDD=10.5-16.5V, VGG=0-5V, Pin=50mW, Pout=60W (VGG control), Load VSWR=20:1 ALL PHASE | No degradation | | | |

16) Transistor, Diode and LED Outline Drawing

Top View

| | | | | | | |
|--|--|--|--|--|--|--|
| MI407 XD0013 | DA204U XD0130 | 1SV215 XD0132 | 1SV237 XD0141 | MA728 XD0234 | 1SS355 XD0254 | 1SV268 XD0301 |
|   |   |   |   |   |   |   |
| DAN235E XD0320 | MA2S111 XD0323 | 1SS390 XD0342 | RLS-73 XD0363 | 1SV278 XD0374 | MA4S713 XD0375 | 1SV282 XD0376 |
|   |   |   |   |   |   |   |
| MAZS0270H XD0377 | CRG01 XD0391 | UDZS5. 6B XD0395 | DAN222M XD0400 | VDZ5. 1B XD0402 | S3V60 XD0414 | 2SK880GR XE0021 |
|   |   |   |   |   |   |   |
| 3SK293 XE0053 | 2SK2539 XE0066 | FA1111C XL0069 | FA1111C XL0077 | 2SC4081 XT0095 | 2SA1036K XT0110 | 2SC4215Y XT0124 |
|   |   |   |   |   |   |   |
| 2SC4245Y XT0125 | 2SC4226 XT0141 | 2SB766A XT0170 | 2SC4915 XT0178 | 2SB1386 XT0190 | 2SC5551 XT0194 | 2SD2620J XT0208 |
|   |   |   |   |   |   |   |
| XP1215 XU0178 | RN1104 XU0195 | EMD6 XU0209 | RN1107FV XU0210 | RN2107FV XU0211 | | |
|   |   |   |   |   | | |
| Rb=10kohm Rbe=none | Rb=47kohm Rbe=47kohm | Rb=4. 7kohm Rbe=none | Rb=10kohm Rbe=47kohm | Rb=10kohm Rbe=47kohm | | |

17) LCD Connection (TTR3626UPFDHN)

SEG

SEG33
SEG32
SEG31
SEG30
SEG29
SEG28
SEG26
SEG25
SEG24
SEG23
SEG22
SEG21
SEG20
SEG19
SEG18
SEG17
SEG16
SEG15
SEG14
SEG13
SEG12
SEG11
SEG10
SEG9
SEG8
SEG7
SEG6
SEG5
SEG4
SEG3
SEG2
SEG1
SEG0

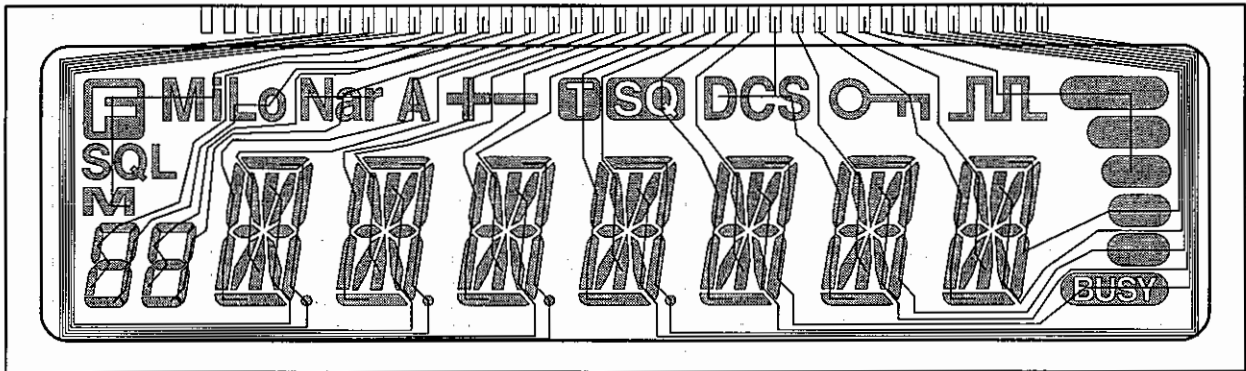

COM

COM3
COM2
COM1
COM0

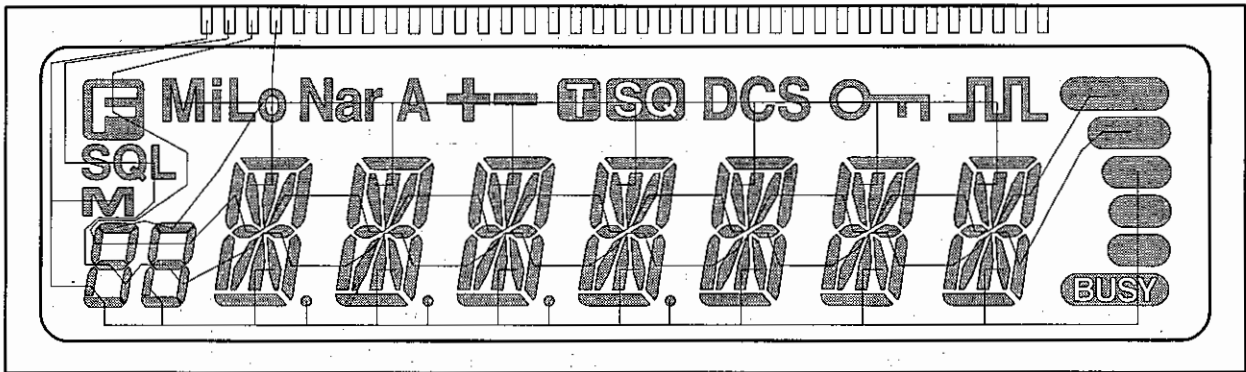

EXPLODED VIEW

1) Top and Front View

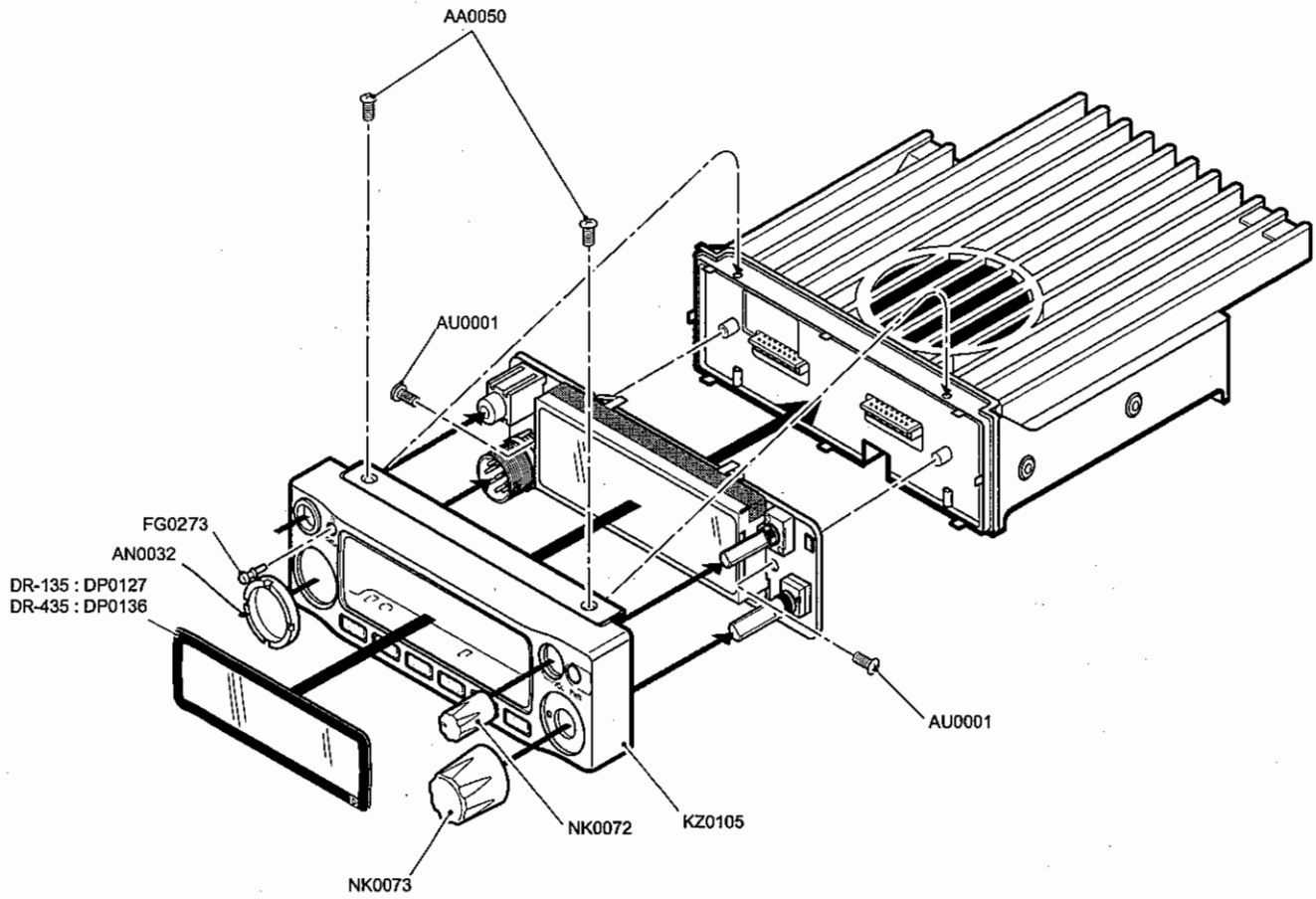

2) Bottom View

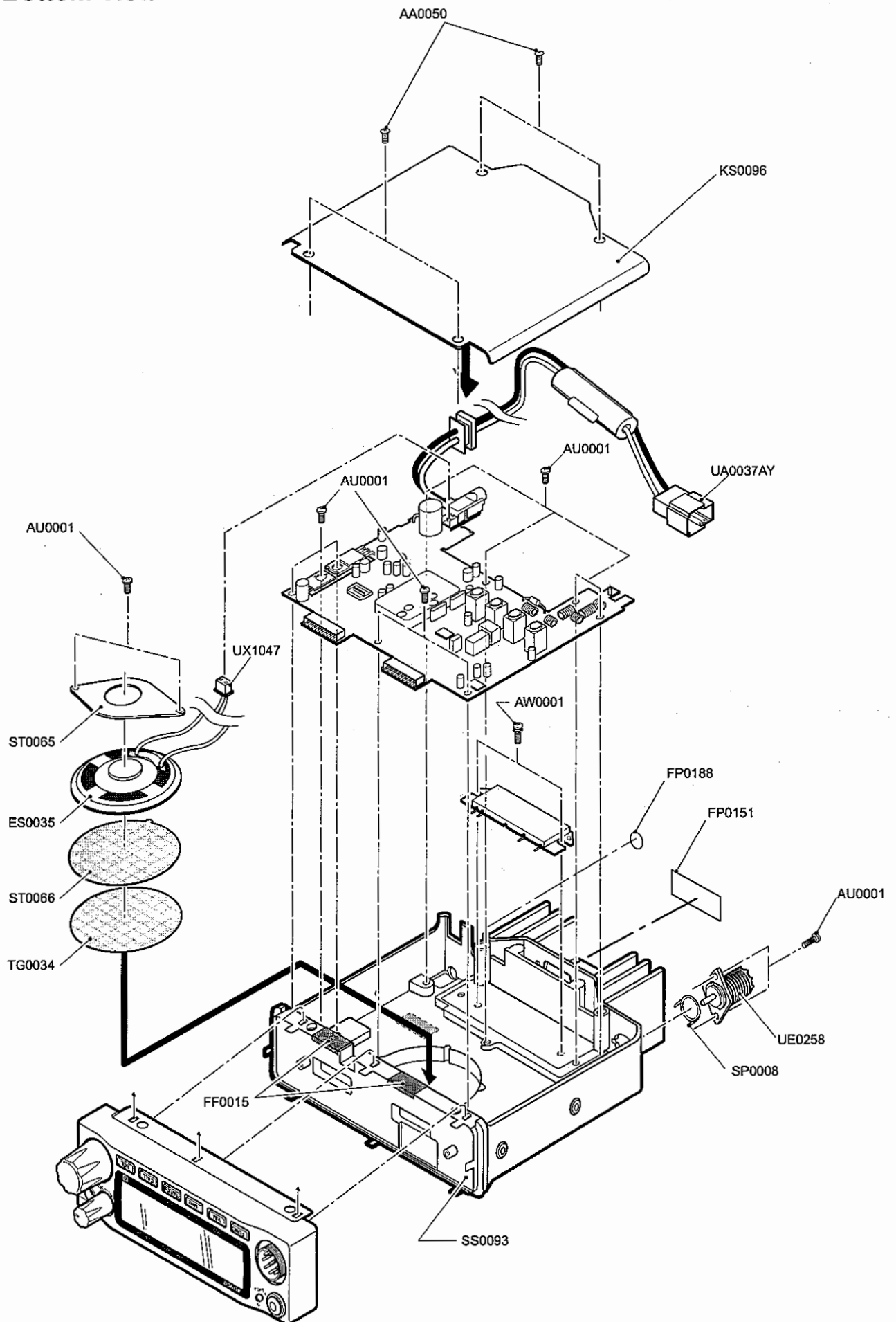

3) LCD Assembly

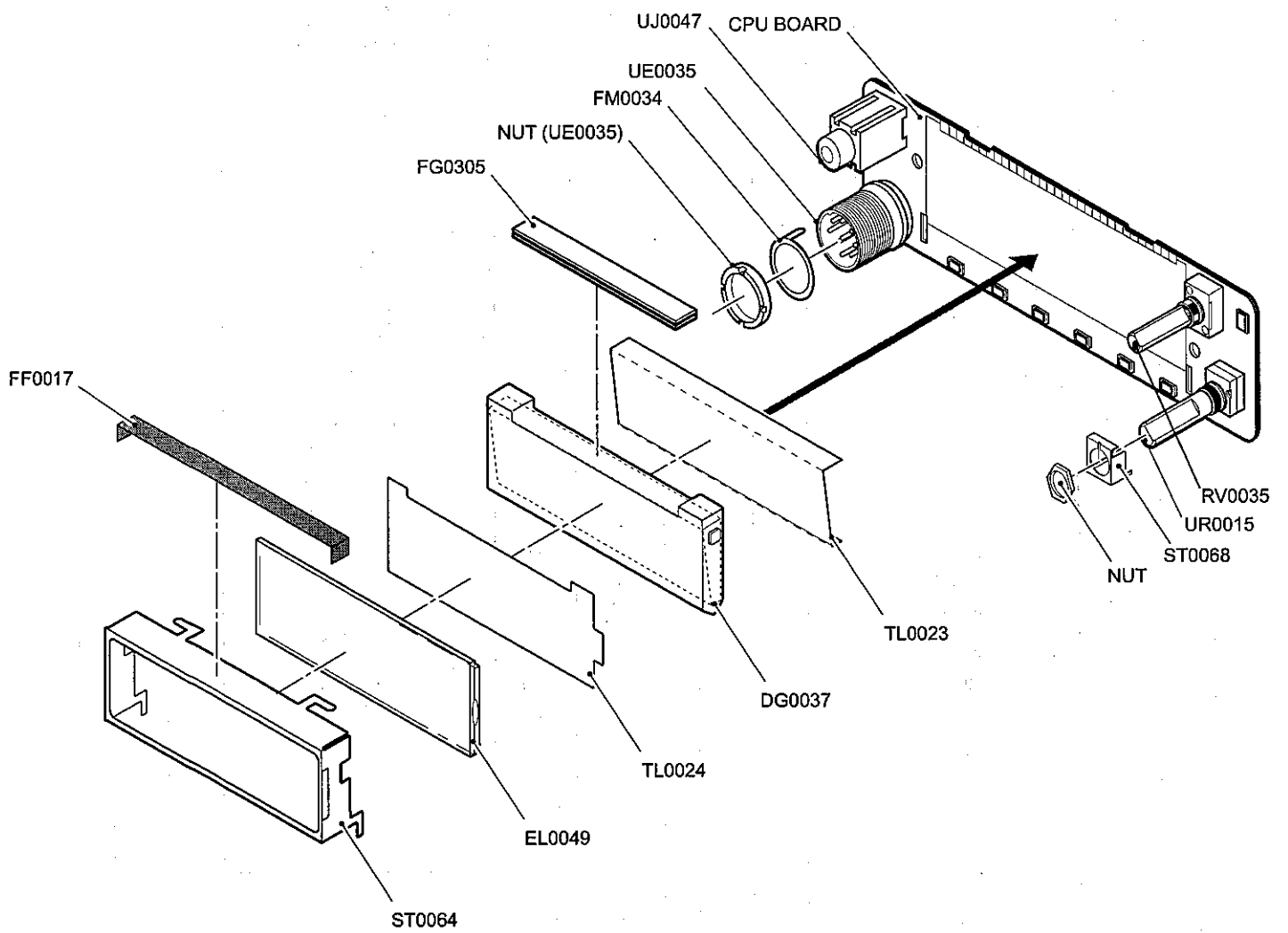

PARTS LIST

CPU Unit

| Ref No. | Part No. | Description | Parts Name | Qty. | | Ver. |
|---------|----------|---------------|--------------------|--------|--------|------|
| | | | | DR-135 | DR-435 | |
| C1 | CU3554 | Chip C. | GRM155B11A104KA01D | 1 | 1 | |
| C2 | CU3554 | Chip C. | GRM155B11A104KA01D | 1 | 1 | |
| C3 | CU3549 | Chip C. | GRM155B11C153KA01D | 1 | 1 | |
| C4 | CU3549 | Chip C. | GRM155B11C153KA01D | 1 | 1 | |
| C5 | CU3554 | Chip C. | GRM155B11A104KA01D | 1 | 1 | |
| C6 | CU3523 | Chip C. | GRM1552C1H101JD01D | 1 | 1 | |
| C7 | CU3523 | Chip C. | GRM1552C1H101JD01D | 1 | 1 | |
| C8 | CU3543 | Chip C. | GRM155B11E472KA01D | 1 | 1 | |
| C9 | CU3554 | Chip C. | GRM155B11A104KA01D | 1 | 1 | |
| C10 | CU3543 | Chip C. | GRM155B11E472KA01D | 1 | 1 | |
| C11 | CU3543 | Chip C. | GRM155B11E472KA01D | 1 | 1 | |
| C12 | CU3553 | Chip C. | GRM155B11A473KA01D | 1 | 1 | |
| C13 | CS0049 | Chip tantalum | TMCSA1C105MTRF | 1 | 1 | |
| C14 | CU3514 | Chip C. | GRM1552C1H180JZ01D | 1 | 1 | |
| C15 | CU3514 | Chip C. | GRM1552C1H180JZ01D | 1 | 1 | |
| C16 | CU3535 | Chip C. | GRM155B11H102KA01D | 1 | 1 | |
| C17 | CS0424 | Chip tantalum | TMCMA1C106MTR | 1 | 1 | |
| C18 | CU3535 | Chip C. | GRM155B11H102KA01D | 1 | 1 | |
| C19 | CU3554 | Chip C. | GRM155B11A104KA01D | 1 | 1 | |
| C20 | CU3547 | Chip C. | GRM155B11C103KA01D | 1 | 1 | |
| C21 | CU3547 | Chip C. | GRM155B11C103KA01D | 1 | 1 | |
| C22 | CU3535 | Chip C. | GRM155B11H102KA01D | 1 | 1 | |
| C23 | CU3547 | Chip C. | GRM155B11C103KA01D | 1 | 1 | |
| C24 | CU3535 | Chip C. | GRM155B11H102KA01D | 1 | 1 | |
| C25 | CU3535 | Chip C. | GRM155B11H102KA01D | 1 | 1 | |
| C26 | CU3535 | Chip C. | GRM155B11H102KA01D | 1 | 1 | |
| C27 | CU3535 | Chip C. | GRM155B11H102KA01D | 1 | 1 | |
| CN1 | UE0291 | Connector | 17R-JE(LF)(SN) | 1 | 1 | |
| CN2 | UE0291 | Connector | 17R-JE(LF)(SN) | 1 | 1 | |
| CN3 | UE0035 | Mic Connector | MIC FM214-BSMPY | 1 | 1 | |
| D1 | XL0069 | Chip LED | FA1111C-TR | 1 | 1 | |
| D2 | XL0077 | Chip LED | FA1111C-732-TR | 1 | 1 | |
| D3 | XL0077 | Chip LED | FA1111C-732-TR | 1 | 1 | |
| D4 | XL0069 | Chip LED | FA1111C-TR | 1 | 1 | |
| D5 | XL0077 | Chip LED | FA1111C-732-TR | 1 | 1 | |
| D6 | XL0077 | Chip LED | FA1111C-732-TR | 1 | 1 | |
| D8 | XD0323 | Chip Diode | MA2S11100L | 1 | 1 | |
| D9 | XD0234 | Chip Diode | MA2J72800L | 1 | 1 | |
| D11 | XL0077 | Chip LED | FA1111C-732-TR | 1 | 1 | |
| D17 | XD0234 | Chip Diode | MA2J72800L | 1 | 1 | |
| IC1 | XA1130 | CPU | CPU DR135MK3 | 1 | 1 | |
| IC2 | XA0604Z | IC | BR24L32F-WE2 | 1 | 1 | |
| IC4 | XA0620 | IC | S80845CLMC-866-T2G | 1 | 1 | |
| IC6 | XA0348 | TC4W53FU | TC4W53FU(TE12L) | 1 | 1 | |
| JK1 | UJ0047 | Jack | HSJ2013-01-120 | 1 | 1 | |
| JP3 | MACL04G | Wire | #30AH1-040-H1 | 1 | 1 | FXE |
| LCD1 | LE0049 | LCD | TTR3626 UPTDHN | 1 | 1 | |
| Q4 | XU0210 | Chip | RN1107MFV(TPL3) | 1 | 1 | |
| Q6 | XT0095 | Chip | 2SC4081 T106R | 1 | 1 | |
| Q7 | XT0170 | Chip | 2SB0766ARL | 1 | 1 | |
| Q8 | XU0210 | Chip | RN1107MFV(TPL3) | 1 | 1 | |
| Q10 | XU0210 | Chip | RN1107MFV(TPL3) | 1 | 1 | |
| Q11 | XU0211 | Chip | RN2107FV(TPL3) | 1 | 1 | |
| Q12 | XU0211 | Chip | RN2107FV(TPL3) | 1 | 1 | |
| R1 | RK3554 | Chip R. | ERJ2GEJ223X | 1 | 1 | |
| R4 | RK3554 | Chip R. | ERJ2GEJ223X | 1 | 1 | |
| R5 | RK3550 | Chip R. | ERJ2GEJ103X | 1 | 1 | |
| R6 | RK3550 | Chip R. | ERJ2GEJ103X | 1 | 1 | |
| R7 | RK3026 | Chip R. | MCR03EJPJ101 | 1 | 1 | |
| R8 | RK3026 | Chip R. | MCR03EJPJ101 | 1 | 1 | |
| R10 | RK3032 | Chip R. | MCR03EJPJ331 | 1 | 1 | |
| R11 | RK3548 | Chip R. | ERJ2GEJ472X | 1 | 1 | |
| R13 | RK3001 | Chip R. | MCR03EJPJ000 | 1 | 1 | FXE |
| R14 | RK3548 | Chip R. | ERJ2GEJ682X | 1 | 1 | |
| R15 | RK3501 | Chip R. | ERJ2GEDR00X | 1 | 1 | |
| R16 | RK3001 | Chip R. | MCR03EJPJ000 | 1 | 1 | FX |
| R19 | RK3562 | Chip R. | ERJ2GEJ104X | 1 | 1 | |
| R20 | RK3546 | Chip R. | ERJ2GEJ472X | 1 | 1 | |
| R22 | RK3538 | Chip R. | ERJ2GEJ102X | 1 | 1 | |
| R25 | RK3550 | Chip R. | ERJ2GEJ103X | 1 | 1 | |
| R26 | RK3550 | Chip R. | ERJ2GEJ103X | 1 | 1 | |
| R27 | RK3550 | Chip R. | ERJ2GEJ103X | 1 | 1 | |
| R28 | RK3538 | Chip R. | ERJ2GEJ102X | 1 | 1 | |
| R29 | RK3538 | Chip R. | ERJ2GEJ102X | 1 | 1 | |
| R30 | RK3538 | Chip R. | ERJ2GEJ102X | 1 | 1 | |
| R32 | RK3544 | Chip R. | ERJ2GEJ332X | 1 | 1 | |
| R33 | RK3534 | Chip R. | ERJ2GEJ471X | 1 | 1 | |
| R34 | RK3547 | Chip R. | ERJ2GEJ562X | 1 | 1 | |
| R35 | RK3552 | Chip R. | ERJ2GEJ153X | 1 | 1 | |
| R36 | RK3562 | Chip R. | ERJ2GEJ104X | 1 | 1 | |
| R37 | RK3549 | Chip R. | ERJ2GEJ822X | 1 | 1 | |
| R38 | RK3551 | Chip R. | ERJ2GEJ123X | 1 | 1 | |
| R39 | RK3558 | Chip R. | ERJ2GEJ473X | 1 | 1 | |
| R40 | RK3562 | Chip R. | ERJ2GEJ104X | 1 | 1 | |
| R41 | RK3526 | Chip R. | ERJ2GEJ101X | 1 | 1 | |
| R42 | RK3550 | Chip R. | ERJ2GEJ103X | 1 | 1 | |

| Ref No. | Part No. | Description | Parts Name | Qty. | | Ver. |
|---------|----------|-------------|---------------------|--------|--------|------|
| | | | | DR-135 | DR-435 | |
| R43 | RK3550 | Chip R. | ERJ2GEJ103X | 1 | 1 | |
| R44 | RK3026 | Chip R. | MCR03EJPJ101 | 1 | 1 | |
| R45 | RK3550 | Chip R. | ERJ2GEJ103X | 1 | 1 | |
| R48 | RK3538 | Chip R. | ERJ2GEJ102X | 1 | 1 | |
| R50 | RK3570 | Chip R. | ERJ2GEJ474X | 1 | 1 | |
| R51 | RK3538 | Chip R. | ERJ2GEJ102X | 1 | 1 | |
| R52 | RK3538 | Chip R. | ERJ2GEJ102X | 1 | 1 | |
| R53 | RK3562 | Chip R. | ERJ2GEJ104X | 1 | 1 | |
| R54 | RK3550 | Chip R. | ERJ2GEJ103X | 1 | 1 | |
| R55 | RK3574 | Chip R. | ERJ2GEJ105X | 1 | 1 | |
| R56 | RK3550 | Chip R. | ERJ2GEJ103X | 1 | 1 | |
| R57 | RK3566 | Chip R. | ERJ2GEJ224X | 1 | 1 | |
| R58 | RK3534 | Chip R. | ERJ2GEJ471X | 1 | 1 | |
| R59 | RK3526 | Chip R. | ERJ2GEJ101X | 1 | 1 | |
| R60 | RK3034 | Chip R. | MCR03EJPJ471 | 1 | 1 | |
| R61 | RK3574 | Chip R. | ERJ2GEJ105X | 1 | 1 | |
| R62 | RK3550 | Chip R. | ERJ2GEJ103X | 1 | 1 | |
| R63 | RK3526 | Chip R. | ERJ2GEJ101X | 1 | 1 | |
| R64 | RK3549 | Chip R. | ERJ2GEJ822X | 1 | 1 | |
| R65 | RK3526 | Chip R. | ERJ2GEJ101X | 1 | 1 | |
| R66 | RK3550 | Chip R. | ERJ2GEJ103X | 1 | 1 | |
| R67 | RK3526 | Chip R. | ERJ2GEJ101X | 1 | 1 | |
| R68 | RK3550 | Chip R. | ERJ2GEJ103X | 1 | 1 | |
| R70 | RK3562 | Chip R. | ERJ2GEJ104X | 1 | 1 | |
| R71 | RK3574 | Chip R. | ERJ2GEJ105X | 1 | 1 | |
| R72 | RK3550 | Chip R. | ERJ2GEJ103X | 1 | 1 | |
| R73 | RK3032 | Chip R. | MCR03EJPJ331 | 1 | 1 | |
| R74 | RK3526 | Chip R. | ERJ2GEJ101X | 1 | 1 | |
| R76 | RK3532 | Chip R. | ERJ2GEJ331X | 1 | 1 | |
| R79 | RK3538 | Chip R. | ERJ2GEJ102X | 1 | 1 | |
| R80 | RK3538 | Chip R. | ERJ2GEJ102X | 1 | 1 | |
| R83 | RK3538 | Chip R. | ERJ2GEJ102X | 1 | 1 | |
| R85 | RK3546 | Chip R. | ERJ2GEJ472X | 1 | 1 | |
| R87 | RK3554 | Chip R. | ERJ2GEJ223X | 1 | 1 | |
| R88 | RK3550 | Chip R. | ERJ2GEJ103X | 1 | 1 | |
| R89 | RK3558 | Chip R. | ERJ2GEJ473X | 1 | 1 | |
| R90 | RK3558 | Chip R. | ERJ2GEJ473X | 1 | 1 | |
| R98 | RK3501 | Chip R. | ERJ2GEDR00X | 1 | 1 | |
| RE1 | UR0015 | Dial | RH90N74E20-A90770 | 1 | 1 | |
| SW1 | UU0015Z | Switch | EVQPPPA25 | 1 | 0 | |
| SW1 | UU0042 | Switch | SKQYAAE010 | 0 | 1 | |
| SW2 | UU0015Z | Switch | EVQPPPA25 | 1 | 0 | |
| SW2 | UU0042 | Switch | SKQYAAE010 | 0 | 1 | |
| SW3 | UU0015Z | Switch | EVQPPPA25 | 1 | 0 | |
| SW3 | UU0042 | Switch | SKQYAAE010 | 0 | 1 | |
| SW4 | UU0015Z | Switch | EVQPPPA25 | 1 | 0 | |
| SW4 | UU0042 | Switch | SKQYAAE010 | 0 | 1 | |
| SW5 | UU0015Z | Switch | EVQPPPA25 | 1 | 0 | |
| SW5 | UU0042 | Switch | SKQYAAE010 | 0 | 1 | |
| SW6 | UU0015Z | Switch | EVQPPPA25 | 1 | 0 | |
| SW6 | UU0042 | Switch | SKQYAAE010 | 0 | 1 | |
| SW7 | UU0015Z | Switch | EVQPPPA25 | 1 | 0 | |
| SW7 | UU0042 | Switch | SKQYAAE010 | 0 | 1 | |
| VR1 | RV0035 | Variable R. | EVUF2JFK4B14 | 1 | 1 | |
| X1 | XQ0131 | Xtal | CSA310 3.6864MHZ | 1 | 1 | |
| | DG0037 | | LCD LIGHT DR135 | 1 | 1 | |
| | FG0305 | | LCD RUB. CONNECT. | 1 | 1 | |
| | FM0034 | | MIC GND PLATE | 1 | 1 | |
| | FP0034 | | MIC SPACER DR110 | 1 | 1 | |
| | FP0234 | | MIC SPACER A DR135 | 1 | 1 | |
| | ST0064 | | LCD HOLDER DR135 | 1 | 1 | |
| | ST0068 | | DIAL FITTING DR135 | 1 | 1 | |
| | TL0023 | | REFLECTION DR135 | 1 | 1 | |
| | TL0024 | | DIFFUSION SHEET 135 | 1 | 1 | |
| | YZ0042 | | CEMENT G17 / 1G | 1 | 1 | |

MAIN Unit DR-135

| Ref No. | Part No. | Description | Parts Name | Qty. | Ver. |
|---------|----------|-----------------|--------------------|------|------|
| C104 | CU3047 | Chip C. | C1608JB1H103KT-NS | 1 | |
| C105 | CS0394 | Chip tantalum | TMCMBOJ476MTRF | 1 | |
| C107 | CU3554 | Chip C. | GRM155B11A104KA01D | 1 | |
| C108 | CU3547 | Chip C. | GRM155B11C103KA01D | 1 | |
| C109 | CE0339 | Electrolytic C. | 16ME10SWB+TS-ALC | 1 | |
| C111 | CU3554 | Chip C. | GRM155B11A104KA01D | 1 | |
| C112 | CU3554 | Chip C. | GRM155B11A104KA01D | 1 | |
| C113 | CU3047 | Chip C. | C1608JB1H103KT-NS | 1 | |
| C114 | CU3547 | Chip C. | GRM155B11C103KA01D | 1 | |
| C116 | CU3019 | Chip C. | C1608CH1H470JT-NS | 1 | |
| C117 | CU3547 | Chip C. | GRM155B11C103KA01D | 1 | |
| C120 | CU3522 | Chip C. | GRM1552C1H820JD01D | 1 | |
| C121 | CU3503 | Chip C. | GRM1554C1H2R0CZ01D | 1 | |
| C122 | CU3502 | Chip C. | GRM1554C1H1R0CZ01D | 1 | |
| C123 | CU3515 | Chip C. | GRM1552C1H220JZ01D | 1 | |

| Ref No. | Part No. | Description | Parts Name | Qty. | Ver. |
|---------|----------|-----------------|--------------------|------|------|
| C130 | CU0108 | Chip C. | LMK212BJ105KG-T | 1 | |
| C131 | CU3535 | Chip C. | GRM155B11H102KA01D | 1 | |
| C132 | CU3535 | Chip C. | GRM155B11H102KA01D | 1 | |
| C133 | CU3503 | Chip C. | GRM1554C1H2R0CZ01D | 1 | |
| C135 | CU3547 | Chip C. | GRM155B11C103KA01D | 1 | |
| C136 | CU3011 | Chip C. | C1608CH1H100DT-NS | 1 | |
| C137 | CU3517 | Chip C. | GRM1552C1H330JZ01D | 1 | |
| C139 | CU3517 | Chip C. | GRM1552C1H330JZ01D | 1 | |
| C140 | CU3517 | Chip C. | GRM1552C1H330JZ01D | 1 | |
| C143 | CU3554 | Chip C. | GRM155B11A104KA01D | 1 | |
| C144 | CU3547 | Chip C. | GRM155B11C103KA01D | 1 | |
| C145 | CU3503 | Chip C. | GRM1554C1H2R0CZ01D | 1 | |
| C146 | CE0364 | Electrolytic C. | 16ME47SWB+TS | 1 | |
| C148 | CU3517 | Chip C. | GRM1552C1H330JZ01D | 1 | |
| C149 | CU3517 | Chip C. | GRM1552C1H330JZ01D | 1 | |
| C151 | CU3547 | Chip C. | GRM155B11C103KA01D | 1 | |
| C152 | CE0339 | Electrolytic C. | 16ME10SWB+TS-ALC | 1 | |
| C153 | CU3535 | Chip C. | GRM155B11H102KA01D | 1 | |
| C154 | CU3535 | Chip C. | GRM155B11H102KA01D | 1 | |
| C155 | CU3506 | Chip C. | GRM1552C1H5R0CZ01D | 1 | |
| C157 | CU3535 | Chip C. | GRM155B11H102KA01D | 1 | |
| C158 | CU3535 | Chip C. | GRM155B11H102KA01D | 1 | |
| C159 | CU3535 | Chip C. | GRM155B11H102KA01D | 1 | |
| C163 | CU3535 | Chip C. | GRM155B11H102KA01D | 1 | |
| C164 | CU3535 | Chip C. | GRM155B11H102KA01D | 1 | |
| C165 | CU3559 | Chip C. | GRM155B30J105KE18D | 1 | |
| C166 | CE0420 | Electrolytic C. | 16ME22S2 | 1 | |
| C169 | CU3527 | Chip C. | GRM1552C1E221JD01D | 1 | |
| C170 | CU3554 | Chip C. | GRM155B11A104KA01D | 1 | |
| C171 | CU3515 | Chip C. | GRM1552C1H220JZ01D | 1 | |
| C173 | CU3535 | Chip C. | GRM155B11H102KA01D | 1 | |
| C174 | CU3527 | Chip C. | GRM1552C1E221JD01D | 1 | |
| C175 | CU3535 | Chip C. | GRM155B11H102KA01D | 1 | |
| C178 | CU3554 | Chip C. | GRM155B11A104KA01D | 1 | |
| C179 | CU3554 | Chip C. | GRM155B11A104KA01D | 1 | |
| C180 | CU3535 | Chip C. | GRM155B11H102KA01D | 1 | |
| C183 | CU3035 | Chip C. | C1608JB1H102KT-NS | 1 | |
| C185 | CS0232 | Chip tantalum | TMCMA1V474MTRF | 1 | |
| C186 | CU3511 | Chip C. | GRM1552C1H100JZ01D | 1 | |
| C187 | CU3535 | Chip C. | GRM155B11H102KA01D | 1 | |
| C188 | CU3535 | Chip C. | GRM155B11H102KA01D | 1 | |
| C189 | CU3019 | Chip C. | C1608CH1H470JT-NS | 1 | |
| C190 | CU3547 | Chip C. | GRM155B11C103KA01D | 1 | |
| C191 | CU3552 | Chip C. | GRM155B11A333KA01D | 1 | |
| C193 | CU4033 | Chip C. | GRM31BR72J102KW01L | 1 | |
| C194 | CU3019 | Chip C. | C1608CH1H470JT-NS | 1 | |
| C195 | CU3015 | Chip C. | C1608CH1H220JT-NS | 1 | |
| C196 | CU3516 | Chip C. | GRM1552C1H270JZ01D | 1 | |
| C199 | CE0339 | Electrolytic C. | 16ME10SWB+TS-ALC | 1 | |
| C200 | CU3035 | Chip C. | C1608JB1H102KT-NS | 1 | |
| C201 | CU4013 | Chip C. | GRM42-6CH150J500PT | 1 | |
| C202 | CU4016 | Chip C. | GRM42-6CH270J500PT | 1 | |
| C203 | CU4018 | Chip C. | GRM42-6CH270J500PT | 1 | |
| C204 | CU4011 | Chip C. | GRM42-6CH100D500PT | 1 | |
| C205 | CU3035 | Chip C. | C1608JB1H102KT-NS | 1 | |
| C206 | CE0339 | Electrolytic C. | 16ME10SWB+TS-ALC | 1 | |
| C207 | CU3064 | Chip C. | C1608CH1H1R5CT-NS | 1 | |
| C208 | CU3064 | Chip C. | C1608CH1H1R5CT-NS | 1 | |
| C209 | CU3035 | Chip C. | C1608JB1H102KT-NS | 1 | |
| C210 | CU3011 | Chip C. | C1608CH1H100DT-NS | 1 | |
| C211 | CU3011 | Chip C. | C1608CH1H100DT-NS | 1 | |
| C212 | CE0364 | Electrolytic C. | 16ME47SWB+TS | 1 | |
| C213 | CU3035 | Chip C. | C1608JB1H102KT-NS | 1 | |
| C215 | CU4015 | Chip C. | GRM42-6CH220J500PT | 1 | |
| C216 | CU4015 | Chip C. | GRM42-6CH220J500PT | 1 | |
| C217 | CU3551 | Chip C. | GRM155B11C223KA01D | 1 | |
| C218 | CU3551 | Chip C. | GRM155B11C223KA01D | 1 | |
| C219 | CU3035 | Chip C. | C1608JB1H102KT-NS | 1 | |
| C220 | CU3035 | Chip C. | C1608JB1H102KT-NS | 1 | |
| C222 | CU3535 | Chip C. | GRM155B11H102KA01D | 1 | |
| C223 | CE0364 | Electrolytic C. | 16ME47SWB+TS | 1 | |
| C224 | CU3023 | Chip C. | C1608CH1H101JT-NS | 1 | |
| C225 | CU3035 | Chip C. | C1608JB1H102KT-NS | 1 | |
| C226 | CU3035 | Chip C. | C1608JB1H102KT-NS | 1 | |
| C227 | CU0108 | Chip C. | LMK212BJ105KG-T | 1 | |
| C228 | CU3535 | Chip C. | GRM155B11H102KA01D | 1 | |
| C229 | CU3553 | Chip C. | GRM155B11A473KA01D | 1 | |
| C230 | CU3535 | Chip C. | GRM155B11H102KA01D | 1 | |
| C231 | CU3535 | Chip C. | GRM155B11H102KA01D | 1 | |
| C232 | CU3535 | Chip C. | GRM155B11H102KA01D | 1 | |
| C233 | CU3535 | Chip C. | GRM155B11H102KA01D | 1 | |
| C235 | CU3504 | Chip C. | GRM1553C1H3R0CZ01D | 1 | |
| C237 | CU3535 | Chip C. | GRM155B11H102KA01D | 1 | |
| C238 | CU3111 | Chip C. | C1608JB1E104KT-NS | 1 | |
| C239 | CU3535 | Chip C. | GRM155B11H102KA01D | 1 | |
| C241 | CU3522 | Chip C. | GRM1552C1H820JD01D | 1 | |
| C242 | CU3551 | Chip C. | GRM155B11C223KA01D | 1 | |
| C243 | CE0339 | Electrolytic C. | 16ME10SWB+TS-ALC | 1 | |
| C244 | CE0339 | Electrolytic C. | 16ME10SWB+TS-ALC | 1 | |
| C245 | CU0108 | Chip C. | LMK212BJ105KG-T | 1 | |
| C246 | CU3543 | Chip C. | GRM155B11E472KA01D | 1 | |

| Ref No. | Part No. | Description | Parts Name | Qty. | Ver. |
|---------|----------|-----------------|--------------------|------|------|
| C248 | CU3547 | Chip C. | GRM155B11C103KA01D | 1 | |
| C249 | CU3538 | Chip C. | GRM155B11H182KA01D | 1 | |
| C250 | CU3526 | Chip C. | GRM1552C1E181JD01D | 1 | |
| C252 | CU3535 | Chip C. | GRM155B11H102KA01D | 1 | |
| C253 | CU3549 | Chip C. | GRM155B11C153KA01D | 1 | |
| C254 | CU3111 | Chip C. | C1608JB1E104KT-NS | 1 | |
| C255 | CE0364 | Electrolytic C. | 16ME47SWB+TS | 1 | |
| C256 | CU3111 | Chip C. | C1608JB1E104KT-NS | 1 | |
| C257 | CE0339 | Electrolytic C. | 16ME10SWB+TS-ALC | 1 | |
| C258 | CU0108 | Chip C. | LMK212BJ105KG-T | 1 | |
| C260 | CE0339 | Electrolytic C. | 16ME10SWB+TS-ALC | 1 | |
| C261 | CU3535 | Chip C. | GRM155B11H102KA01D | 1 | |
| C262 | CU3535 | Chip C. | GRM155B11H102KA01D | 1 | |
| C263 | CS0424 | Chip tantalum | TMCMA1C106MTRF | 1 | |
| C264 | CU3519 | Chip C. | GRM1552C1H470JZ01D | 1 | |
| C265 | CU3535 | Chip C. | GRM155B11H102KA01D | 1 | |
| C266 | CU3503 | Chip C. | GRM1554C1H2R0CZ01D | 1 | |
| C267 | CU3535 | Chip C. | GRM155B11H102KA01D | 1 | |
| C268 | CU3535 | Chip C. | GRM155B11H102KA01D | 1 | |
| C269 | CU3535 | Chip C. | GRM155B11H102KA01D | 1 | |
| C270 | CU3047 | Chip C. | C1608JB1H103KT-NS | 1 | |
| C271 | CU3535 | Chip C. | GRM155B11H102KA01D | 1 | |
| C272 | CS0220 | Chip tantalum | TMCMA1C225MTRF | 1 | |
| C273 | CS0220 | Chip tantalum | TMCMA1C225MTRF | 1 | |
| C274 | CU3535 | Chip C. | GRM155B11H102KA01D | 1 | |
| C275 | CU3547 | Chip C. | GRM155B11C103KA01D | 1 | |
| C276 | CE0339 | Electrolytic C. | 16ME10SWB+TS-ALC | 1 | |
| C277 | CE0343 | Electrolytic C. | 16ME1000HC+T | 1 | |
| C278 | CU3535 | Chip C. | GRM155B11H102KA01D | 1 | |
| C279 | CU3551 | Chip C. | GRM155B11C223KA01D | 1 | |
| C281 | CU3512 | Chip C. | GRM1552C1H120JZ01D | 1 | |
| C282 | CU3502 | Chip C. | GRM1554C1H1R0CZ01D | 1 | |
| C283 | CU3531 | Chip C. | GRM155B11H471KA01D | 1 | |
| C284 | CU3502 | Chip C. | GRM1554C1H1R0CZ01D | 1 | |
| C285 | CU3535 | Chip C. | GRM155B11H102KA01D | 1 | |
| C286 | CU3027 | Chip C. | C1608CH1H221JT-NS | 1 | |
| C287 | CS0063 | Chip tantalum | TMCMA1V104MTRF | 1 | |
| C288 | CU3511 | Chip C. | GRM1552C1H100JZ01D | 1 | |
| C289 | CU3535 | Chip C. | GRM155B11H102KA01D | 1 | |
| C290 | CU3535 | Chip C. | GRM155B11H102KA01D | 1 | |
| C293 | CU3535 | Chip C. | GRM155B11H102KA01D | 1 | |
| C294 | CU3035 | Chip C. | C1608JB1H102KT-NS | 1 | |
| C295 | CU3551 | Chip C. | GRM155B11C223KA01D | 1 | |
| C296 | CU3511 | Chip C. | GRM1552C1H100JZ01D | 1 | |
| C297 | CU3535 | Chip C. | GRM155B11H102KA01D | 1 | |
| C299 | CU3547 | Chip C. | GRM155B11C103KA01D | 1 | |
| C300 | CU3515 | Chip C. | GRM1552C1H220JZ01D | 1 | |
| C301 | CU3523 | Chip C. | GRM1552C1H101JD01D | 1 | |
| C302 | CU3523 | Chip C. | GRM1552C1H101JD01D | 1 | |
| C303 | CU3523 | Chip C. | GRM1552C1H101JD01D | 1 | |
| C304 | CU3535 | Chip C. | GRM155B11H102KA01D | 1 | |
| C305 | CU3547 | Chip C. | GRM155B11C103KA01D | 1 | |
| C306 | CU3554 | Chip C. | GRM155B11A104KA01D | 1 | |
| C307 | CU3547 | Chip C. | GRM155B11C103KA01D | 1 | |
| C308 | CE0342 | Electrolytic C. | 16ME470HC+TS | 1 | |
| C309 | CU3551 | Chip C. | GRM155B11C223KA01D | 1 | |
| C310 | CU3523 | Chip C. | GRM1552C1H101JD01D | 1 | |
| C312 | CU3511 | Chip C. | GRM1552C1H100JZ01D | 1 | |
| C313 | CU3535 | Chip C. | GRM155B11H102KA01D | 1 | |
| C321 | CS0220 | Chip tantalum | TMCMA1C225MTRF | 1 | |
| C322 | CU3035 | Chip C. | C1608JB1H102KT-NS | 1 | |
| C328 | CU0108 | Chip C. | LMK212BJ105KG-T | 1 | |
| C331 | CU3547 | Chip C. | GRM155B11C103KA01D | 1 | |
| C332 | CE0339 | Electrolytic C. | 16ME10SWB+TS-ALC | 1 | |
| C333 | CU3535 | Chip C. | GRM155B11H102KA01D | 1 | |
| C401 | CU3549 | Chip C. | GRM155B11C153KA01D | 1 | |
| C402 | CU3550 | Chip C. | GRM155B11C183KA01D | 1 | |
| C403 | CU3552 | Chip C. | GRM155B11A333KA01D | 1 | |
| C404 | CU3559 | Chip C. | GRM155B30J105KE18D | 1 | |
| C405 | CU3542 | Chip C. | GRM155B11H392KA01D | 1 | |
| C406 | CU3545 | Chip C. | GRM155B11E882KA01D | 1 | |
| C407 | CU3541 | Chip C. | GRM155B11H332KA01D | 1 | |
| C408 | CU3544 | Chip C. | GRM155B11E562KA01D | 1 | |
| C409 | CU3535 | Chip C. | GRM155B11H102KA01D | 1 | |
| C410 | CU3539 | Chip C. | GRM155B11H222KA01D | 1 | |
| C412 | CU0108 | Chip C. | LMK212BJ105KG-T | 1 | |
| C413 | CU3541 | Chip C. | GRM155B11H332KA01D | 1 | |
| C414 | CU3542 | Chip C. | GRM155B11H392KA01D | 1 | |
| C415 | CU3545 | Chip C. | GRM155B11E882KA01D | 1 | |
| C417 | CU3547 | Chip C. | GRM155B11C103KA01D | 1 | |
| C418 | CU3547 | Chip C. | GRM155B11C103KA01D | 1 | |
| C419 | CU3547 | Chip C. | GRM155B11C103KA01D | 1 | |
| C427 | CU3559 | Chip C. | GRM155B30J105KE18D | 1 | |
| C428 | CU0110 | Chip C. | C2012JB1A475KT-NS | 1 | |
| C601 | CU3515 | Chip C. | GRM1552C1H220JZ01D | 1 | |
| C607 | CU3511 | Chip C. | GRM1552C1H100JZ01D | 1 | |
| C611 | CU0108 | Chip C. | LMK212BJ105KG-T | 1 | |
| C613 | CU3515 | Chip C. | GRM1552C1H220JZ01D | 1 | |
| CN101 | UE0359 | Connector | AXN49301616 | 1 | |
| CN102 | UE0293 | Connector | 17PS-JE | 1 | |
| CN103 | UE0293 | Connector | 17PS-JE | 1 | |

| Ref No. | Part No. | Description | Parts Name | Qty. | Ver. |
|---------|----------|----------------|----------------------|------|------|
| CN104 | UA0037AY | Wire | R-82.0X0.2M PLUG 15A | 1 | |
| CN106 | UE0043 | Connector | P122A02M | 1 | |
| D102 | XD0132 | Chip Diode | 1SV215(TPH2,F) | 1 | |
| D103 | XD0132 | Chip Diode | 1SV215(TPH2,F) | 1 | |
| D104 | XD0132 | Chip Diode | 1SV215(TPH2,F) | 1 | |
| D105 | XD0132 | Chip Diode | 1SV215(TPH2,F) | 1 | |
| D106 | XD0402 | Chip Diode | VDZT2R 5.1B | 1 | |
| D108 | XD0130 | Chip Diode | DA204U T106 | 1 | |
| D109 | XD0301 | Chip Diode | 1SV268-TD-E | 1 | |
| D110 | XD0013 | Diode | L407CDB | 1 | |
| D111 | XD0375 | Chip Diode | MA4Z71300L | 1 | |
| D112 | XD0375 | Chip Diode | MA4Z71300L | 1 | |
| D113 | XD0323 | Chip Diode | MA2S11100L | 1 | |
| D114 | XD0141 | Chip Diode | 1SV237(TE85L,F) | 1 | |
| D115 | XD0320 | Chip Diode | DAN235E-TL | 1 | |
| D116 | XD0320 | Chip Diode | DAN235E-TL | 1 | |
| D118 | XD0130 | Chip Diode | DA204U T106 | 1 | |
| D119 | XD0323 | Chip Diode | MA2S11100L | 1 | |
| D120 | XD0374 | Chip Diode | 1SV278(TPH2,F) | 1 | |
| D121 | XD0414 | Diode | S3V60-5000 | 1 | |
| D122 | XD0376 | Chip Diode | 1SV282(TPH2,F) | 1 | |
| D123 | XD0376 | Chip Diode | 1SV282(TPH2,F) | 1 | |
| D125 | XD0342 | Chip Diode | 1S3390 TE61 | 1 | |
| D130 | XD0323 | Chip Diode | MA2S11100L | 1 | |
| D136 | XD0395 | Chip Diode | UDZ5 TE-17 5.6B | 1 | |
| D402 | XD0323 | Chip Diode | MA2S11100L | 1 | |
| D601 | XD0131 | Chip Diode | 1SV214(TPH4,F) | 1 | |
| FL101 | XC0070 | Ceramic Filter | ALFYM450E-K | 1 | |
| FL102 | XC0052 | Ceramic Filter | ALFYM450G-K | 1 | |
| IC101 | XA0947 | IC | NJM78M05DL1ATE1#ZZ | 1 | |
| IC104 | XA1106 | IC | LM2902PWR | 1 | |
| IC108 | XA0404 | IC | TA31136FNG(EL) | 1 | |
| IC109 | XA0115 | IC | TC4S66F(TE85R,F) | 1 | |
| IC110 | XA1108 | IC | RA60H1317M1-101 | 1 | |
| IC111 | XA0115 | IC | TC4S66F(TE85R,F) | 1 | |
| IC113 | XA0115 | IC | TC4S66F(TE85R,F) | 1 | |
| IC114 | XA1106 | IC | LM2902PWR | 1 | |
| IC115 | XA0102 | IC | NJM7808FA-#ZZZB | 1 | |
| IC116 | XA1107 | IC | MB15E07SRPFTGBNDE | 1 | |
| IC117 | XA0410 | IC | LA4425A-E | 1 | |
| IC120 | XA1103 | IC | LM2904PWR | 1 | |
| IC601 | XA1135 | IC | 74LV1GWD4ASCE-E | 1 | |
| JK102 | UJ0024Z | Jack | LGY6501-0900FC | 1 | |
| L101 | QC0043 | Chip Inductor | NLV32T-2R2J-PFS | 1 | |
| L102 | QA0112 | Coil | #V666SNS-063DAQ | 1 | |
| L103 | QA0112 | Coil | #V666SNS-063DAQ | 1 | |
| L104 | QA0112 | Coil | #V666SNS-063DAQ | 1 | |
| L105 | QA0112 | Coil | #V666SNS-063DAQ | 1 | |
| L111 | QKA45E | Coil | MR3.0 4.5T 0.8 | 1 | |
| L112 | QKA35D | Coil | MR3.0 3.5T 0.6 | 1 | |
| L113 | QKA45E | Coil | MR3.0 4.5T 0.8 | 1 | |
| L114 | QKA45E | Coil | MR3.0 4.5T 0.8 | 1 | |
| L115 | QKA45E | Coil | MR3.0 4.5T 0.8 | 1 | |
| L116 | QKA45E | Coil | MR3.0 4.5T 0.8 | 1 | |
| L117 | QC0065 | Chip Inductor | NLV32T-088J-PFS | 1 | |
| L118 | QKA95D | Coil | MR3.0 9.5T 0.6 | 1 | |
| L119 | QC0542 | Chip Inductor | LQW2BHNRR2J03L | 1 | |
| L120 | QC0534 | Chip Inductor | LQW2BHN47NJ03L | 1 | |
| L121 | QC0292 | Chip Inductor | NLV25T-2R2J-PFS | 1 | |
| L122 | QC0288 | Chip Inductor | NLV25T-1R0J-PFS | 1 | |
| L123 | QA0162 | Coil | #657BN-1652GNA=P3 | 1 | |
| L124 | QC0732 | Chip Inductor | LK10051R0K-T | 1 | |
| L125 | QC0627 | Chip Inductor | LL1608-FSLR10J | 1 | |
| L126 | QC0288 | Chip Inductor | NLV25T-1R0J-PFS | 1 | |
| L129 | QC0534 | Chip Inductor | LQW2BHN47NJ03L | 1 | |
| Q104 | XU0210 | Chip | RN1107MFV(TPL3) | 1 | |
| Q105 | XT0178 | Chip | 2SC4915-O(TE85L,F) | 1 | |
| Q106 | XE0053 | Chip FET | 3SK293(TE85L,F) | 1 | |
| Q107 | XE0053 | Chip FET | 3SK293(TE85L,F) | 1 | |
| Q108 | XU0210 | Chip | RN1107MFV(TPL3) | 1 | |
| Q109 | XT0208 | Chip | 2SD2620J0L | 1 | |
| Q110 | XT0208 | Chip | 2SD2620J0L | 1 | |
| Q115 | XT0194 | Chip | 2SC5551-TD-E | 1 | |
| Q116 | XT0110 | Chip | 2SA1036K T146Q | 1 | |
| Q117 | XT0095 | Chip | 2SC4081 T106R | 1 | |
| Q120 | XU0210 | Chip | RN1107MFV(TPL3) | 1 | |
| Q121 | XU0178 | Chip | XP0121500L | 1 | |
| Q122 | XT0190 | Chip | 2SB1386 T100Q | 1 | |
| Q123 | XT0170 | Chip | 2SB0766ARL | 1 | |
| Q124 | XU0209 | Chip | EMD6T2R | 1 | |
| Q125 | XE0021 | Chip FET | 2SK880-GR(TE85L,F) | 1 | |
| Q126 | XU0210 | Chip | RN1107MFV(TPL3) | 1 | |
| Q127 | XT0095 | Chip | 2SC4081 T106R | 1 | |
| Q128 | XU0210 | Chip | RN1107MFV(TPL3) | 1 | |
| Q129 | XU0195 | Chip | RN1104(TE85L,F) | 1 | |
| Q131 | XE0066 | Chip FET | 2SK2539-TB-E | 1 | |
| Q132 | XU0210 | Chip | RN1107MFV(TPL3) | 1 | |
| Q133 | XU0210 | Chip | RN1107MFV(TPL3) | 1 | |
| Q134 | XT0178 | Chip | 2SC4915-O(TE85L,F) | 1 | |
| Q135 | XT0178 | Chip | 2SC4915-O(TE85L,F) | 1 | |
| Q137 | XU0210 | Chip | RN1107MFV(TPL3) | 1 | |

| Ref No. | Part No. | Description | Parts Name | Qty. | Ver. |
|---------|----------|-------------|--------------------|------|------|
| Q138 | XU0210 | Chip | RN1107MFV(TPL3) | 1 | |
| Q141 | XU0211 | Chip | RN2107MFV(TPL3) | 1 | |
| Q144 | XT0095 | Chip | 2SC4081 T106R | 1 | |
| Q145 | XT0124 | Chip | 2SC4215-Y(TE85L,F) | 1 | |
| Q147 | XU0209 | Chip | EMD6T2R | 1 | |
| Q148 | XU0195 | Chip | RN1104(TE85L,F) | 1 | |
| Q149 | XU0210 | Chip | RN1107MFV(TPL3) | 1 | |
| Q401 | XU0210 | Chip | RN1107MFV(TPL3) | 1 | |
| Q402 | XU0211 | Chip | RN2107MFV(TPL3) | 1 | |
| R105 | RK3530 | Chip R. | ERJ2GEJ221X | 1 | |
| R106 | RK3554 | Chip R. | ERJ2GEJ223X | 1 | |
| R107 | RK3554 | Chip R. | ERJ2GEJ223X | 1 | |
| R109 | RK3526 | Chip R. | ERJ2GEJ101X | 1 | |
| R110 | RK3526 | Chip R. | ERJ2GEJ101X | 1 | |
| R112 | RK3526 | Chip R. | ERJ2GEJ101X | 1 | |
| R113 | RK3542 | Chip R. | ERJ2GEJ222X | 1 | |
| R114 | RK3540 | Chip R. | ERJ2GEJ152X | 1 | |
| R116 | RK3534 | Chip R. | ERJ2GEJ471X | 1 | |
| R117 | RK3562 | Chip R. | ERJ2GEJ104X | 1 | |
| R118 | RK3526 | Chip R. | ERJ2GEJ101X | 1 | |
| R125 | RK3541 | Chip R. | ERJ2GEJ182X | 1 | |
| R126 | RK3552 | Chip R. | ERJ2GEJ153X | 1 | |
| R128 | RK3562 | Chip R. | ERJ2GEJ104X | 1 | |
| R129 | RK3550 | Chip R. | ERJ2GEJ103X | 1 | |
| R130 | RK3562 | Chip R. | ERJ2GEJ104X | 1 | |
| R131 | RK3562 | Chip R. | ERJ2GEJ104X | 1 | |
| R132 | RK3550 | Chip R. | ERJ2GEJ103X | 1 | |
| R133 | RK3538 | Chip R. | ERJ2GEJ102X | 1 | |
| R134 | RK3553 | Chip R. | ERJ2GEJ183X | 1 | |
| R136 | RK3534 | Chip R. | ERJ2GEJ471X | 1 | |
| R143 | RK3542 | Chip R. | ERJ2GEJ222X | 1 | |
| R144 | RK3542 | Chip R. | ERJ2GEJ222X | 1 | |
| R145 | RK3552 | Chip R. | ERJ2GEJ153X | 1 | |
| R146 | RK3552 | Chip R. | ERJ2GEJ153X | 1 | |
| R147 | RK3550 | Chip R. | ERJ2GEJ103X | 1 | |
| R148 | RK3538 | Chip R. | ERJ2GEJ102X | 1 | |
| R149 | RK3562 | Chip R. | ERJ2GEJ104X | 1 | |
| R151 | RK3550 | Chip R. | ERJ2GEJ103X | 1 | |
| R152 | RK3538 | Chip R. | ERJ2GEJ102X | 1 | |
| R153 | RK3562 | Chip R. | ERJ2GEJ104X | 1 | |
| R155 | RK3552 | Chip R. | ERJ2GEJ153X | 1 | |
| R156 | RK3558 | Chip R. | ERJ2GEJ473X | 1 | |
| R157 | RK3562 | Chip R. | ERJ2GEJ104X | 1 | |
| R158 | RK3522 | Chip R. | ERJ2GEJ470X | 1 | |
| R160 | RK3562 | Chip R. | ERJ2GEJ104X | 1 | |
| R161 | RK3562 | Chip R. | ERJ2GEJ104X | 1 | |
| R162 | RK3521 | Chip R. | ERJ2GEJ390X | 1 | |
| R163 | RK3514 | Chip R. | ERJ2GEJ100X | 1 | |
| R164 | RK3025 | Chip R. | MCR03EZP1820 | 1 | |
| R165 | RK3574 | Chip R. | ERJ2GEJ105X | 1 | |
| R166 | RK3562 | Chip R. | ERJ2GEJ104X | 1 | |
| R167 | RK3564 | Chip R. | ERJ2GEJ154X | 1 | |
| R168 | RK3554 | Chip R. | ERJ2GEJ223X | 1 | |
| R171 | RK3562 | Chip R. | ERJ2GEJ104X | 1 | |
| R172 | RK3562 | Chip R. | ERJ2GEJ104X | 1 | |
| R173 | RK3526 | Chip R. | ERJ2GEJ101X | 1 | |
| R178 | RK3544 | Chip R. | ERJ2GEJ332X | 1 | |
| R183 | RK3568 | Chip R. | ERJ2GEJ334X | 1 | |
| R184 | RK3526 | Chip R. | ERJ2GEJ101X | 1 | |
| R185 | RK3570 | Chip R. | ERJ2GEJ474X | 1 | |
| R186 | RK3562 | Chip R. | ERJ2GEJ104X | 1 | |
| R187 | RK3558 | Chip R. | ERJ2GEJ473X | 1 | |
| R189 | RK3538 | Chip R. | ERJ2GEJ102X | 1 | |
| R190 | RK3538 | Chip R. | ERJ2GEJ102X | 1 | |
| R191 | RK3538 | Chip R. | ERJ2GEJ102X | 1 | |
| R193 | RK3538 | Chip R. | ERJ2GEJ102X | 1 | |
| R195 | RK3570 | Chip R. | ERJ2GEJ474X | 1 | |
| R196 | RK3538 | Chip R. | ERJ2GEJ102X | 1 | |
| R200 | RK3570 | Chip R. | ERJ2GEJ474X | 1 | |
| R202 | RK0028 | Chip R. | ERJ6GEYJ471V | 1 | |
| R203 | RK3556 | Chip R. | ERJ2GEJ333X | 1 | |
| R204 | RK3562 | Chip R. | ERJ2GEJ104X | 1 | |
| R205 | RK0069 | Chip R. | ERJ6GEYJ104V | 1 | |
| R206 | RK0003 | Chip R. | ERJ6GEYJ150V | 1 | |
| R207 | RK3552 | Chip R. | ERJ2GEJ153X | 1 | |
| R208 | RK3534 | Chip R. | ERJ2GEJ471X | 1 | |
| R209 | RK3561 | Chip R. | ERJ2GEJ823X | 1 | |
| R210 | RK3538 | Chip R. | ERJ2GEJ102X | 1 | |
| R211 | RK4018 | Chip R. | ERJ12YJ220U | 1 | |
| R212 | RK4026 | Chip R. | ERJ12YJ101U | 1 | |
| R213 | RK3549 | Chip R. | ERJ2GEJ822X | 1 | |
| R214 | RK3550 | Chip R. | ERJ2GEJ103X | 1 | |
| R215 | RK3543 | Chip R. | ERJ2GEJ272X | 1 | |
| R216 | RK3050 | Chip R. | MCR03EZP1103 | 1 | |
| R217 | RK3050 | Chip R. | MCR03EZP1103 | 1 | |
| R218 | RK3554 | Chip R. | ERJ2GEJ223X | 1 | |
| R219 | RK3538 | Chip R. | ERJ2GEJ102X | 1 | |
| R220 | RK4034 | Chip R. | ERJ12YJ471U | 1 | |
| R222 | RK3550 | Chip R. | ERJ2GEJ103X | 1 | |
| R223 | RK3526 | Chip R. | ERJ2GEJ101X | 1 | |
| R224 | RK3526 | Chip R. | ERJ2GEJ101X | 1 | |

| Ref No. | Part No. | Description | Parts Name | Qty. | Ver. |
|---------|----------|-------------|--------------|------|------|
| R225 | RK3545 | Chip R. | ERJ2GEJ392X | 1 | |
| R226 | RK3038 | Chip R. | MCR03EZPJ102 | 1 | |
| R227 | RK3501 | Chip R. | ERJ2GE0R00X | 1 | |
| R228 | RK3538 | Chip R. | ERJ2GEJ102X | 1 | |
| R229 | RK3551 | Chip R. | ERJ2GEJ123X | 1 | |
| R230 | RK3546 | Chip R. | ERJ2GEJ472X | 1 | |
| R231 | RK3050 | Chip R. | MCR03EZPJ103 | 1 | |
| R232 | RK3526 | Chip R. | ERJ2GEJ101X | 1 | |
| R233 | RK3538 | Chip R. | ERJ2GEJ102X | 1 | |
| R234 | RK3556 | Chip R. | ERJ2GEJ333X | 1 | |
| R235 | RK3562 | Chip R. | ERJ2GEJ104X | 1 | |
| R236 | RK3551 | Chip R. | ERJ2GEJ123X | 1 | |
| R237 | RK3526 | Chip R. | ERJ2GEJ101X | 1 | |
| R238 | RK3562 | Chip R. | ERJ2GEJ104X | 1 | |
| R239 | RK3550 | Chip R. | ERJ2GEJ103X | 1 | |
| R241 | RK3550 | Chip R. | ERJ2GEJ103X | 1 | |
| R242 | RK3522 | Chip R. | ERJ2GEJ470X | 1 | |
| R243 | RK3550 | Chip R. | ERJ2GEJ103X | 1 | |
| R244 | RK3568 | Chip R. | ERJ2GEJ334X | 1 | |
| R247 | RK3538 | Chip R. | ERJ2GEJ102X | 1 | |
| R249 | RK3058 | Chip R. | MCR03EZPJ473 | 1 | |
| R251 | RK3550 | Chip R. | ERJ2GEJ103X | 1 | |
| R253 | RK3557 | Chip R. | ERJ2GEJ393X | 1 | |
| R254 | RK3557 | Chip R. | ERJ2GEJ393X | 1 | |
| R255 | RK3546 | Chip R. | ERJ2GEJ472X | 1 | |
| R256 | RK3526 | Chip R. | ERJ2GEJ101X | 1 | |
| R258 | RK3557 | Chip R. | ERJ2GEJ393X | 1 | |
| R259 | RK3550 | Chip R. | ERJ2GEJ103X | 1 | |
| R261 | RK3554 | Chip R. | ERJ2GEJ223X | 1 | |
| R262 | RK3562 | Chip R. | ERJ2GEJ104X | 1 | |
| R264 | RK3538 | Chip R. | ERJ2GEJ102X | 1 | |
| R265 | RK3546 | Chip R. | ERJ2GEJ472X | 1 | |
| R266 | RK3550 | Chip R. | ERJ2GEJ103X | 1 | |
| R267 | RK3522 | Chip R. | ERJ2GEJ470X | 1 | |
| R268 | RK3550 | Chip R. | ERJ2GEJ103X | 1 | |
| R269 | RK3562 | Chip R. | ERJ2GEJ104X | 1 | |
| R270 | RK3560 | Chip R. | ERJ2GEJ683X | 1 | |
| R271 | RK4034 | Chip R. | ERJ12YJ471U | 1 | |
| R272 | RK3550 | Chip R. | ERJ2GEJ103X | 1 | |
| R273 | RK3562 | Chip R. | ERJ2GEJ104X | 1 | |
| R274 | RK3550 | Chip R. | ERJ2GEJ103X | 1 | |
| R275 | RK3550 | Chip R. | ERJ2GEJ103X | 1 | |
| R276 | RK3534 | Chip R. | ERJ2GEJ471X | 1 | |
| R278 | RK3526 | Chip R. | ERJ2GEJ101X | 1 | |
| R279 | RK3046 | Chip R. | MCR03EZPJ472 | 1 | |
| R280 | RK3558 | Chip R. | ERJ2GEJ473X | 1 | |
| R281 | RK3041 | Chip R. | MCR03EZPJ162 | 1 | |
| R282 | RK3550 | Chip R. | ERJ2GEJ103X | 1 | |
| R283 | RK3038 | Chip R. | MCR03EZPJ102 | 1 | |
| R284 | RK3526 | Chip R. | ERJ2GEJ101X | 1 | |
| R286 | RK3534 | Chip R. | ERJ2GEJ471X | 1 | |
| R287 | RK3546 | Chip R. | ERJ2GEJ472X | 1 | |
| R288 | RK3547 | Chip R. | ERJ2GEJ562X | 1 | |
| R289 | RK3540 | Chip R. | ERJ2GEJ152X | 1 | |
| R290 | RK3554 | Chip R. | ERJ2GEJ223X | 1 | |
| R292 | RK3518 | Chip R. | ERJ2GEJ220X | 1 | |
| R293 | RK3542 | Chip R. | ERJ2GEJ222X | 1 | |
| R294 | RK3546 | Chip R. | ERJ2GEJ472X | 1 | |
| R296 | RK3568 | Chip R. | ERJ2GEJ334X | 1 | |
| R298 | RK3542 | Chip R. | ERJ2GEJ222X | 1 | |
| R299 | RK3542 | Chip R. | ERJ2GEJ222X | 1 | |
| R300 | RK3526 | Chip R. | ERJ2GEJ101X | 1 | |
| R301 | RK3538 | Chip R. | ERJ2GEJ102X | 1 | |
| R302 | RK3524 | Chip R. | ERJ2GEJ680X | 1 | |
| R303 | RK3547 | Chip R. | ERJ2GEJ562X | 1 | |
| R304 | RK3547 | Chip R. | ERJ2GEJ562X | 1 | |
| R305 | RK3558 | Chip R. | ERJ2GEJ473X | 1 | |
| R307 | RK3543 | Chip R. | ERJ2GEJ272X | 1 | |
| R308 | RK3526 | Chip R. | ERJ2GEJ101X | 1 | |
| R309 | RK3550 | Chip R. | ERJ2GEJ103X | 1 | |
| R310 | RK3526 | Chip R. | ERJ2GEJ101X | 1 | |
| R311 | RK3538 | Chip R. | ERJ2GEJ102X | 1 | |
| R312 | RK3538 | Chip R. | ERJ2GEJ102X | 1 | |
| R313 | RK3538 | Chip R. | ERJ2GEJ102X | 1 | |
| R315 | RK3544 | Chip R. | ERJ2GEJ332X | 1 | |
| R321 | RK3543 | Chip R. | ERJ2GEJ272X | 1 | |
| R322 | RD0108 | Jumper | J1/6ZC | 1 | |
| R323 | RK3554 | Chip R. | ERJ2GEJ223X | 1 | |
| R325 | RK3566 | Chip R. | ERJ2GEJ224X | 1 | |
| R337 | RK3570 | Chip R. | ERJ2GEJ474X | 1 | |
| R339 | RK3550 | Chip R. | ERJ2GEJ103X | 1 | |
| R340 | RK3550 | Chip R. | ERJ2GEJ103X | 1 | |
| R341 | RK3561 | Chip R. | ERJ2GEJ823X | 1 | |
| R342 | RK3545 | Chip R. | ERJ2GEJ392X | 1 | |
| R344 | RK3550 | Chip R. | ERJ2GEJ103X | 1 | |
| R345 | RK3501 | Chip R. | ERJ2GE0R00X | 1 | |
| R346 | RK3561 | Chip R. | ERJ2GEJ823X | 1 | |
| R347 | RK3551 | Chip R. | ERJ2GEJ123X | 1 | |
| R348 | RK3534 | Chip R. | ERJ2GEJ471X | 1 | |
| R349 | RK3562 | Chip R. | ERJ2GEJ104X | 1 | |
| R401 | RK3553 | Chip R. | ERJ2GEJ183X | 1 | |

| Ref No. | Part No. | Description | Parts Name | Qty. | Ver. |
|---------|----------|---------------|--------------------|------|------|
| R402 | RK3551 | Chip R. | ERJ2GEJ123X | 1 | |
| R403 | RK3542 | Chip R. | ERJ2GEJ222X | 1 | |
| R404 | RK3562 | Chip R. | ERJ2GEJ104X | 1 | |
| R405 | RK3563 | Chip R. | ERJ2GEJ124X | 1 | |
| R406 | RK3559 | Chip R. | ERJ2GEJ563X | 1 | |
| R407 | RK3562 | Chip R. | ERJ2GEJ104X | 1 | |
| R408 | RK3558 | Chip R. | ERJ2GEJ473X | 1 | |
| R409 | RK3560 | Chip R. | ERJ2GEJ683X | 1 | |
| R410 | RK3557 | Chip R. | ERJ2GEJ393X | 1 | |
| R411 | RK3562 | Chip R. | ERJ2GEJ104X | 1 | |
| R412 | RK3550 | Chip R. | ERJ2GEJ103X | 1 | |
| R413 | RK3550 | Chip R. | ERJ2GEJ103X | 1 | |
| R414 | RK3566 | Chip R. | ERJ2GEJ224X | 1 | |
| R415 | RK3558 | Chip R. | ERJ2GEJ473X | 1 | |
| R416 | RK3550 | Chip R. | ERJ2GEJ103X | 1 | |
| R417 | RK3570 | Chip R. | ERJ2GEJ474X | 1 | |
| R418 | RK3560 | Chip R. | ERJ2GEJ683X | 1 | |
| R419 | RK3550 | Chip R. | ERJ2GEJ103X | 1 | |
| R420 | RK3574 | Chip R. | ERJ2GEJ105X | 1 | |
| R421 | RK3568 | Chip R. | ERJ2GEJ334X | 1 | |
| R422 | RK3562 | Chip R. | ERJ2GEJ104X | 1 | |
| R423 | RK3501 | Chip R. | ERJ2GE0R00X | 1 | |
| R424 | RK3501 | Chip R. | ERJ2GE0R00X | 1 | |
| R429 | RK3501 | Chip R. | ERJ2GE0R00X | 1 | |
| R431 | RK3558 | Chip R. | ERJ2GEJ473X | 1 | |
| R601 | RK3558 | Chip R. | ERJ2GEJ473X | 1 | |
| R603 | RK3554 | Chip R. | ERJ2GEJ223X | 1 | |
| R609 | RK3522 | Chip R. | ERJ2GEJ470X | 1 | |
| R611 | RK3564 | Chip R. | ERJ2GEJ154X | 1 | |
| R613 | RK3574 | Chip R. | ERJ2GEJ105X | 1 | |
| R615 | RK3574 | Chip R. | ERJ2GEJ105X | 1 | |
| R617 | RK3562 | Chip R. | ERJ2GEJ104X | 1 | |
| R619 | RK3546 | Chip R. | ERJ2GEJ472X | 1 | |
| R621 | RK3556 | Chip R. | ERJ2GEJ333X | 1 | |
| R623 | RK3546 | Chip R. | ERJ2GEJ472X | 1 | |
| R627 | RK3542 | Chip R. | ERJ2GEJ222X | 1 | |
| R629 | RK3550 | Chip R. | ERJ2GEJ103X | 1 | |
| R631 | RK3562 | Chip R. | ERJ2GEJ104X | 1 | |
| R635 | RK3574 | Chip R. | ERJ2GEJ105X | 1 | |
| R637 | RK3501 | Chip R. | ERJ2GE0R00X | 1 | |
| SH101 | TS0172 | Case | VCO CASE DR620 | 1 | |
| TC601 | CT0046 | Trimmer C. | TC03C100A-TP02 | 1 | |
| TH101 | XS0031 | Chip | NTCG164BH682JT-S | 1 | |
| TH102 | XS0050 | Chip | NTCG164QH105JT-S | 1 | |
| VR101 | RH0233 | Trimmer R. | RH02B1C15X | 1 | |
| VR102 | RH0231 | Trimmer R. | RH02B1CS4X | 1 | |
| VR103 | RH0231 | Trimmer R. | RH02B1CS4X | 1 | |
| VR104 | RH0233 | Trimmer R. | RH02B1C15X | 1 | |
| VR106 | RH0231 | Trimmer R. | RH02B1CS4X | 1 | |
| VR107 | RH0225 | Trimmer R. | RH02B1CS3X | 1 | |
| VR108 | RH0233 | Trimmer R. | RH02B1C15X | 1 | |
| VR109 | RH0231 | Trimmer R. | RH02B1CS4X | 1 | |
| X101 | XK0003 | Discriminator | CDBLB450KCAAY07-B0 | 1 | |
| X604 | XQ0112 | Xtal | UM-5 21.25MHZ | 1 | |
| XF101 | XF0041 | Xtal Filter | UM5 21.7M 21R15A5 | 1 | |
| XF102 | XF0041 | Xtal Filter | UM5 21.7M 21R15A5 | 1 | |
| | FG0320 | SP Cushion | SP CUSHION DR135 | 1 | |
| | FG0327 | Cushion | CUSHION DR135 | 1 | |
| | SD0034 | Spring | GND SPRING DR130 | 2 | |
| | TZ0049 | Dumper | SILICON DUMPER | 3 | |
| | UP0538A | P.C.BOARD | DR135FX INTEGRATED | 1 | |

MAIN Unit DR-435

| Ref No. | Part No. | Description | Parts Name | Qty. | Ver. |
|---------|----------|-----------------|--------------------|------|------|
| C104 | CU3547 | Chip C. | GRM155B11C103KA01D | 1 | |
| C105 | CE0364 | Electrolytic C. | 16ME47SWB+TS | 1 | |
| C107 | CU3554 | Chip C. | GRM155B11A104KA01D | 1 | |
| C108 | CU3547 | Chip C. | GRM155B11C103KA01D | 1 | |
| C109 | CE0339 | Electrolytic C. | 16ME10SWB+TS-ALC | 1 | |
| C110 | CU3547 | Chip C. | GRM155B11C103KA01D | 1 | |
| C111 | CU3554 | Chip C. | GRM155B11A104KA01D | 1 | |
| C112 | CU3554 | Chip C. | GRM155B11A104KA01D | 1 | |
| C113 | CU3047 | Chip C. | C1608JB1H103KT-NS | 1 | |
| C114 | CU3547 | Chip C. | GRM155B11C103KA01D | 1 | |
| C116 | CU3019 | Chip C. | C1608CHI1H470JT-NS | 1 | |
| C117 | CU3547 | Chip C. | GRM155B11C103KA01D | 1 | |
| C120 | CU3522 | Chip C. | GRM1552C1H820JD01D | 1 | |
| C121 | CU3535 | Chip C. | GRM155B11H102KA01D | 1 | |
| C123 | CU3512 | Chip C. | GRM1552C1H120JZ01D | 1 | |
| C129 | CU3547 | Chip C. | GRM155B11C103KA01D | 1 | |
| C130 | CU0108 | Chip C. | LMK212B1J105KG-T | 1 | |
| C131 | CU3535 | Chip C. | GRM155B11H102KA01D | 1 | |
| C132 | CU3535 | Chip C. | GRM155B11H102KA01D | 1 | |
| C133 | CU3527 | Chip C. | GRM1552C1E221JD01D | 1 | |
| C135 | CU3547 | Chip C. | GRM155B11C103KA01D | 1 | |
| C136 | CU3011 | Chip C. | C1608CHI1H100TD-NS | 1 | |
| C137 | CU3517 | Chip C. | GRM1552C1H330JZ01D | 1 | |
| C139 | CU3531 | Chip C. | GRM155B11H471KA01D | 1 | |

| Ref No. | Part No. | Description | Parts Name | Qty. | Ver. |
|---------|----------|-----------------|--------------------|------|------|
| C140 | CU3535 | Chip C. | GRM155B11H102KA01D | 1 | |
| C141 | CU3512 | Chip C. | GRM1552C1H120JZ01D | 1 | |
| C142 | CU3515 | Chip C. | GRM1552C1H220JZ01D | 1 | |
| C143 | CU3554 | Chip C. | GRM155B11A104KA01D | 1 | |
| C144 | CU3512 | Chip C. | GRM1552C1H120JZ01D | 1 | |
| C145 | CU3064 | Chip C. | C1608CH1H1R5CT-NS | 1 | |
| C146 | CE0364 | Electrolytic C. | 16ME47SWB+TS | 1 | |
| C151 | CU3535 | Chip C. | GRM155B11H102KA01D | 1 | |
| C152 | CE0339 | Electrolytic C. | 16ME10SWB+TS-ALC | 1 | |
| C153 | CU3003 | Chip C. | C1608CH1H020CT-NS | 1 | |
| C154 | CU3535 | Chip C. | GRM155B11H102KA01D | 1 | |
| C155 | CU3511 | Chip C. | GRM1552C1H100JZ01D | 1 | |
| C157 | CU3535 | Chip C. | GRM155B11H102KA01D | 1 | |
| C158 | CU3504 | Chip C. | GRM1553C1H3R0CZ01D | 1 | |
| C159 | CU3518 | Chip C. | GRM1552C1H390JZ01D | 1 | |
| C161 | CU3554 | Chip C. | GRM155B11A104KA01D | 1 | |
| C164 | CU3535 | Chip C. | GRM155B11H102KA01D | 1 | |
| C165 | CU3559 | Chip C. | GRM155B30J105KE18D | 1 | |
| C166 | CE0420 | Electrolytic C. | 16ME22SZ | 1 | |
| C167 | CU3535 | Chip C. | GRM155B11H102KA01D | 1 | |
| C169 | CU3527 | Chip C. | GRM1552C1E221JD01D | 1 | |
| C170 | CU3554 | Chip C. | GRM155B11A104KA01D | 1 | |
| C171 | CU3516 | Chip C. | GRM1552C1H270JZ01D | 1 | |
| C173 | CU3537 | Chip C. | GRM155B11H152KA01D | 1 | |
| C174 | CU3527 | Chip C. | GRM1552C1E221JD01D | 1 | |
| C175 | CU3535 | Chip C. | GRM155B11H102KA01D | 1 | |
| C176 | CU3516 | Chip C. | GRM1552C1H270JZ01D | 1 | |
| C178 | CU3554 | Chip C. | GRM155B11A104KA01D | 1 | |
| C179 | CU3554 | Chip C. | GRM155B11A104KA01D | 1 | |
| C180 | CU3535 | Chip C. | GRM155B11H102KA01D | 1 | |
| C181 | CU3535 | Chip C. | GRM155B11H102KA01D | 1 | |
| C182 | CU3547 | Chip C. | GRM155B11C103KA01D | 1 | |
| C183 | CU3035 | Chip C. | C1608JB1H102KT-NS | 1 | |
| C184 | CU3035 | Chip C. | C1608JB1H102KT-NS | 1 | |
| C185 | CS0232 | Chip tantalum | TMCMA1V474MTRF | 1 | |
| C186 | CU3506 | Chip C. | GRM1552C1H5R0CZ01D | 1 | |
| C187 | CU3535 | Chip C. | GRM155B11H102KA01D | 1 | |
| C188 | CU3535 | Chip C. | GRM155B11H102KA01D | 1 | |
| C189 | CU3015 | Chip C. | C1608CH1H220JT-NS | 1 | |
| C190 | CU3547 | Chip C. | GRM155B11C103KA01D | 1 | |
| C191 | CU3552 | Chip C. | GRM155B11A333KA01D | 1 | |
| C192 | CU3547 | Chip C. | GRM155B11C103KA01D | 1 | |
| C193 | CU4033 | Chip C. | GRM31BR72J102KW01L | 1 | |
| C194 | CU3004 | Chip C. | C1608CH1H030CT-NS | 1 | |
| C195 | CU3535 | Chip C. | GRM155B11H102KA01D | 1 | |
| C196 | CU3504 | Chip C. | GRM1553C1H3R0CZ01D | 1 | |
| C199 | CE0339 | Electrolytic C. | 16ME10SWB+TS-ALC | 1 | |
| C200 | CU3035 | Chip C. | C1608JB1H102KT-NS | 1 | |
| C201 | CU4003 | Chip C. | GRM31M4C2H2R0CY21L | 1 | |
| C202 | CU4011 | Chip C. | GRM31M2C2H100JV01L | 1 | |
| C203 | CU4004 | Chip C. | GRM31M3C2H3R0CY21L | 1 | |
| C204 | CU4003 | Chip C. | GRM31M4C2H2R0CY21L | 1 | |
| C205 | CU3035 | Chip C. | C1608JB1H102KT-NS | 1 | |
| C206 | CE0339 | Electrolytic C. | 16ME10SWB+TS-ALC | 1 | |
| C207 | CU3001 | Chip C. | C1608CH1H0R5CT-NS | 1 | |
| C208 | CU3001 | Chip C. | C1608CH1H0R5CT-NS | 1 | |
| C209 | CU3035 | Chip C. | C1608JB1H102KT-NS | 1 | |
| C210 | CU3005 | Chip C. | C1608CH1H040CT-NS | 1 | |
| C211 | CU3005 | Chip C. | C1608CH1H040CT-NS | 1 | |
| C212 | CE0364 | Electrolytic C. | 16ME47SWB+TS | 1 | |
| C213 | CU3035 | Chip C. | C1608JB1H102KT-NS | 1 | |
| C215 | CU4008 | Chip C. | GRM31M2C2H7R0DV01L | 1 | |
| C216 | CU4011 | Chip C. | GRM31M2C2H100JV01L | 1 | |
| C217 | CU3551 | Chip C. | GRM155B11C223KA01D | 1 | |
| C218 | CU3551 | Chip C. | GRM155B11C223KA01D | 1 | |
| C219 | CU3035 | Chip C. | C1608JB1H102KT-NS | 1 | |
| C220 | CU3035 | Chip C. | C1608JB1H102KT-NS | 1 | |
| C221 | CU3547 | Chip C. | GRM155B11C103KA01D | 1 | |
| C222 | CU3535 | Chip C. | GRM155B11H102KA01D | 1 | |
| C223 | CE0364 | Electrolytic C. | 16ME47SWB+TS | 1 | |
| C224 | CU3023 | Chip C. | C1608CH1H101JT-NS | 1 | |
| C225 | CU3035 | Chip C. | C1608JB1H102KT-NS | 1 | |
| C226 | CU3035 | Chip C. | C1608JB1H102KT-NS | 1 | |
| C227 | CU0108 | Chip C. | LMK212BJ105KG-T | 1 | |
| C228 | CU3535 | Chip C. | GRM155B11H102KA01D | 1 | |
| C229 | CU3553 | Chip C. | GRM155B11A473KA01D | 1 | |
| C230 | CU3535 | Chip C. | GRM155B11H102KA01D | 1 | |
| C231 | CU3535 | Chip C. | GRM155B11H102KA01D | 1 | |
| C232 | CU3535 | Chip C. | GRM155B11H102KA01D | 1 | |
| C236 | CU3535 | Chip C. | GRM155B11H102KA01D | 1 | |
| C237 | CU3535 | Chip C. | GRM155B11H102KA01D | 1 | |
| C238 | CU3111 | Chip C. | C1608JB1E104KT-NS | 1 | |
| C239 | CU3535 | Chip C. | GRM155B11H102KA01D | 1 | |
| C241 | CU3522 | Chip C. | GRM1552C1H620JD01D | 1 | |
| C242 | CU3551 | Chip C. | GRM155B11C223KA01D | 1 | |
| C243 | CE0339 | Electrolytic C. | 16ME10SWB+TS-ALC | 1 | |
| C244 | CE0339 | Electrolytic C. | 16ME10SWB+TS-ALC | 1 | |
| C245 | CS0405Z | Chip tantalum | TAJA475M010Y | 1 | |
| C246 | CU3543 | Chip C. | GRM155B11E472KA01D | 1 | |
| C248 | CU3547 | Chip C. | GRM155B11C103KA01D | 1 | |
| C249 | CU3538 | Chip C. | GRM155B11H182KA01D | 1 | |

| Ref No. | Part No. | Description | Parts Name | Qty. | Ver. |
|---------|----------|-----------------|----------------------|------|------|
| C250 | CU3526 | Chip C. | GRM1552C1E181JD01D | 1 | |
| C252 | CU3535 | Chip C. | GRM155B11H102KA01D | 1 | |
| C253 | CU3551 | Chip C. | GRM155B11C223KA01D | 1 | |
| C254 | CU3111 | Chip C. | C1608JB1E104KT-NS | 1 | |
| C255 | CE0364 | Electrolytic C. | 16ME47SWB+TS | 1 | |
| C256 | CU3111 | Chip C. | C1608JB1E104KT-NS | 1 | |
| C257 | CE0339 | Electrolytic C. | 16ME10SWB+TS-ALC | 1 | |
| C258 | CU0108 | Chip C. | LMK212BJ105KG-T | 1 | |
| C262 | CU3535 | Chip C. | GRM155B11H102KA01D | 1 | |
| C263 | CS0424 | Chip tantalum | TMCMA1C106MTRF | 1 | |
| C264 | CU3511 | Chip C. | GRM1552C1H100JZ01D | 1 | |
| C265 | CU3535 | Chip C. | GRM155B11H102KA01D | 1 | |
| C266 | CU3503 | Chip C. | GRM1554C1H2R0CZ01D | 1 | |
| C269 | CU3535 | Chip C. | GRM155B11H102KA01D | 1 | |
| C270 | CU3047 | Chip C. | C1608JB1H103KT-NS | 1 | |
| C272 | CS0220 | Chip tantalum | TMCMA1C225MTRF | 1 | |
| C273 | CS0220 | Chip tantalum | TMCMA1C225MTRF | 1 | |
| C274 | CU3535 | Chip C. | GRM155B11H102KA01D | 1 | |
| C276 | CE0339 | Electrolytic C. | 16ME10SWB+TS-ALC | 1 | |
| C277 | CE0343 | Electrolytic C. | 16ME1000HC+T | 1 | |
| C278 | CU3535 | Chip C. | GRM155B11H102KA01D | 1 | |
| C279 | CU3551 | Chip C. | GRM155B11C223KA01D | 1 | |
| C281 | CU3504 | Chip C. | GRM1553C1H3R0CZ01D | 1 | |
| C282 | CU3502 | Chip C. | GRM1554C1H1R0CZ01D | 1 | |
| C283 | CU3523 | Chip C. | GRM1552C1H101JD01D | 1 | |
| C285 | CU3535 | Chip C. | GRM155B11H102KA01D | 1 | |
| C286 | CU3027 | Chip C. | C1608CH1H221JT-NS | 1 | |
| C287 | CS0063 | Chip tantalum | TMCSA1V104MTRF | 1 | |
| C288 | CU3506 | Chip C. | GRM1552C1H15R0CZ01D | 1 | |
| C289 | CU3535 | Chip C. | GRM155B11H102KA01D | 1 | |
| C290 | CU3535 | Chip C. | GRM155B11H102KA01D | 1 | |
| C294 | CU3035 | Chip C. | C1608JB1H102KT-NS | 1 | |
| C295 | CU3551 | Chip C. | GRM155B11C223KA01D | 1 | |
| C296 | CU3503 | Chip C. | GRM1554C1H2R0CZ01D | 1 | |
| C297 | CU3535 | Chip C. | GRM155B11H102KA01D | 1 | |
| C300 | CU3511 | Chip C. | GRM1552C1H100JZ01D | 1 | |
| C301 | CU3523 | Chip C. | GRM1552C1H101JD01D | 1 | |
| C302 | CU3523 | Chip C. | GRM1552C1H101JD01D | 1 | |
| C303 | CU3523 | Chip C. | GRM1552C1H101JD01D | 1 | |
| C304 | CU3535 | Chip C. | GRM155B11H102KA01D | 1 | |
| C305 | CU3547 | Chip C. | GRM155B11C103KA01D | 1 | |
| C306 | CU3554 | Chip C. | GRM155B11A104KA01D | 1 | |
| C307 | CU3547 | Chip C. | GRM155B11C103KA01D | 1 | |
| C308 | CE0342 | Electrolytic C. | 16ME470HC+TS | 1 | |
| C309 | CU3551 | Chip C. | GRM155B11C223KA01D | 1 | |
| C310 | CU3523 | Chip C. | GRM1552C1H101JD01D | 1 | |
| C311 | CU3535 | Chip C. | GRM155B11H102KA01D | 1 | |
| C312 | CU3506 | Chip C. | GRM1552C1H5R0CZ01D | 1 | |
| C318 | CU3535 | Chip C. | GRM155B11H102KA01D | 1 | |
| C321 | CS0220 | Chip tantalum | TMCMA1C225MTRF | 1 | |
| C322 | CU3035 | Chip C. | C1608JB1H102KT-NS | 1 | |
| C328 | CU0108 | Chip C. | LMK212BJ105KG-T | 1 | |
| C331 | CU3547 | Chip C. | GRM155B11C103KA01D | 1 | |
| C332 | CE0339 | Electrolytic C. | 16ME10SWB+TS-ALC | 1 | |
| C333 | CU3535 | Chip C. | GRM155B11H102KA01D | 1 | |
| C385 | CU0108 | Chip C. | LMK212BJ105KG-T | 1 | |
| C401 | CU3549 | Chip C. | GRM155B11C153KA01D | 1 | |
| C402 | CU3550 | Chip C. | GRM155B11C183KA01D | 1 | |
| C403 | CU3552 | Chip C. | GRM155B11A333KA01D | 1 | |
| C404 | CU3559 | Chip C. | GRM155B30J105KE18D | 1 | |
| C405 | CU3541 | Chip C. | GRM155B11H332KA01D | 1 | |
| C406 | CU3545 | Chip C. | GRM155B11E682KA01D | 1 | |
| C407 | CU3540 | Chip C. | GRM155B11H272KA01D | 1 | |
| C408 | CU3544 | Chip C. | GRM155B11E562KA01D | 1 | |
| C409 | CU3536 | Chip C. | GRM155B11H122KA01D | 1 | |
| C410 | CU3539 | Chip C. | GRM155B11H222KA01D | 1 | |
| C412 | CU0108 | Chip C. | LMK212BJ105KG-T | 1 | |
| C413 | CU3541 | Chip C. | GRM155B11H332KA01D | 1 | |
| C414 | CU3542 | Chip C. | GRM155B11H392KA01D | 1 | |
| C415 | CU3545 | Chip C. | GRM155B11E682KA01D | 1 | |
| C417 | CU3548 | Chip C. | GRM155B11C123KA01D | 1 | |
| C418 | CU3547 | Chip C. | GRM155B11C103KA01D | 1 | |
| C419 | CU3548 | Chip C. | GRM155B11C123KA01D | 1 | |
| C420 | CE0339 | Electrolytic C. | 16ME10SWB+TS-ALC | 1 | |
| C421 | CU3035 | Chip C. | C1608JB1H102KT-NS | 1 | |
| C422 | CS0220 | Chip tantalum | TMCMA1C225MTRF | 1 | |
| C423 | CU3111 | Chip C. | C1608JB1E104KT-NS | 1 | |
| C424 | CU3535 | Chip C. | GRM155B11H102KA01D | 1 | |
| C427 | CU3559 | Chip C. | GRM155B30J105KE18D | 1 | |
| C428 | CU0110 | Chip C. | C2012JB1A475KT-NS | 1 | |
| CN101 | UE0369 | Connector | AXN49301618 | 1 | |
| CN102 | UE0293 | Connector | 17PS-JE | 1 | |
| CN103 | UE0293 | Connector | 17PS-JE | 1 | |
| CN104 | UA0037AY | Wire | R-B2.0X0.2M PLUG 15A | 1 | |
| CN106 | UE0043 | Connector | PI22A02M | 1 | |
| CN109 | UE0041 | Connector | TMPJ01XV6 | 1 | |
| D101 | XD0141 | Chip Diode | 1SV237(TE85L,F) | 1 | |
| D102 | XD0254 | Chip Diode | 1SS355 TE17 | 1 | |
| D106 | XD0402 | Chip Diode | VDZT2R 5.1B | 1 | |
| D107 | XD0141 | Chip Diode | 1SV237(TE85L,F) | 1 | |
| D108 | XD0254 | Chip Diode | 1SS355 TE17 | 1 | |

| Ref No. | Part No. | Description | Parts Name | Qty. | Ver. |
|---------|----------|----------------|--------------------|------|------|
| D109 | XD0301 | Chip Diode | 1SV268-TD-E | 1 | |
| D110 | XD0013 | Diode | L407CDB | 1 | |
| D111 | XD0375 | Chip Diode | MA4Z71300L | 1 | |
| D112 | XD0375 | Chip Diode | MA4Z71300L | 1 | |
| D113 | XD0323 | Chip Diode | MA2S11100L | 1 | |
| D114 | XD0141 | Chip Diode | 1SV237(TE85L,F) | 1 | |
| D115 | XD0320 | Chip Diode | DAN235E-TL | 1 | |
| D116 | XD0320 | Chip Diode | DAN235E-TL | 1 | |
| D118 | XD0130 | Chip Diode | DA204U T108 | 1 | |
| D119 | XD0323 | Chip Diode | MA2S11100L | 1 | |
| D120 | XD0374 | Chip Diode | 1SV278(TPH2,F) | 1 | |
| D121 | XD0414 | Diode | S3V60-5000 | 1 | |
| D122 | XD0364 | Chip Diode | 1SV279(TPH3) | 1 | |
| D123 | XD0364 | Chip Diode | 1SV279(TPH3) | 1 | |
| D124 | XD0377 | Chip Diode | MAZS0270HL | 1 | |
| D130 | XD0323 | Chip Diode | MA2S11100L | 1 | |
| D136 | XD0395 | Chip Diode | UDZS TE-17 5.6B | 1 | |
| D402 | XD0323 | Chip Diode | MA2S11100L | 1 | |
| FL101 | XC0047 | Ceramic Filter | ALFYM455E=K | 1 | |
| FL102 | XC0036 | Ceramic Filter | ALFYM455G=K | 1 | |
| IC101 | XA0947 | IC | NJM78M05DL1ATE1#ZZ | 1 | |
| IC104 | XA1106 | IC | LM2902PWR | 1 | |
| IC108 | XA0404 | IC | TA31136FNG(EL) | 1 | |
| IC109 | XA0115 | IC | TC4S66F(TE85R,F) | 1 | |
| IC110 | XA1142 | IC | S-AU82L(F) | 1 | |
| IC111 | XA0115 | IC | TC4S66F(TE85R,F) | 1 | |
| IC112 | XA0119 | IC | AN8010M-E1 | 1 | |
| IC113 | XA0115 | IC | TC4S66F(TE85R,F) | 1 | |
| IC114 | XA1106 | IC | LM2902PWR | 1 | |
| IC115 | XA0102 | IC | NJM7808FA-#ZZZB | 1 | |
| IC116 | XA1107 | IC | MB15E07SRPFTGBNDE | 1 | |
| IC117 | XA0410 | IC | LA4425A-E | 1 | |
| IC120 | XA1103 | IC | LM2904PWR | 1 | |
| JK102 | UJ0024Z | Jack | LGY8501-0900FC | 1 | |
| L101 | QC0043 | Chip Inductor | NLV32T-2R2J-PFS | 1 | |
| L102 | QA0165 | Coil | #252MNP-3213A | 1 | |
| L103 | QA0165 | Coil | #252MNP-3213A | 1 | |
| L104 | QC0057 | Chip Inductor | NLV32T-015J-PFS | 1 | |
| L105 | QC0057 | Chip Inductor | NLV32T-015J-PFS | 1 | |
| L106 | QC0055 | Chip Inductor | NLV32T-010J-PFS | 1 | |
| L107 | QC0057 | Chip Inductor | NLV32T-015J-PFS | 1 | |
| L108 | QC0124 | Chip Inductor | NLV32T-R15J-PFS | 1 | |
| L109 | QC0061 | Chip Inductor | NLV32T-033J-PFS | 1 | |
| L111 | QKA25E | Coil | MR3.0 2.5T 0.8 | 1 | |
| L112 | QKA15D | Coil | MR3.0 1.5T 0.6 | 1 | |
| L113 | QKA15E | Coil | MR3.0 1.5T 0.8 | 1 | |
| L114 | QKA15E | Coil | MR3.0 1.5T 0.8 | 1 | |
| L115 | QKA15E | Coil | MR3.0 1.5T 0.8 | 1 | |
| L117 | QKA25D | Coil | MR3.0 2.5T 0.6 | 1 | |
| L118 | QKA95D | Coil | MR3.0 9.5T 0.6 | 1 | |
| L119 | QC0058 | Chip Inductor | LQW2BHN10J03L | 1 | |
| L120 | QC0059 | Chip Inductor | NLV32T-022J-PFS | 1 | |
| L121 | QC0740 | Chip Inductor | KQ0805TTER82J | 1 | |
| L122 | QC0740 | Chip Inductor | KQ0805TTER82J | 1 | |
| L123 | QA0163 | Coil | SMD-1380 | 1 | |
| L125 | QC0627 | Chip Inductor | LL1608-FSLR10J | 1 | |
| L126 | QC0739 | Chip Inductor | KQ0805TTER33J | 1 | |
| Q103 | XU0209 | Chip | EMD6T2R | 1 | |
| Q104 | XU0210 | Chip | RN1107MFV(TPL3) | 1 | |
| Q105 | XT0125 | Chip | 2SC4245-Y(TE85L) | 1 | |
| Q106 | XE0053 | Chip FET | 3SK293(TE85L,F) | 1 | |
| Q107 | XE0053 | Chip FET | 3SK293(TE85L,F) | 1 | |
| Q108 | XU0210 | Chip | RN1107MFV(TPL3) | 1 | |
| Q109 | XT0208 | Chip | 2SD2620J0L | 1 | |
| Q110 | XT0208 | Chip | 2SD2620J0L | 1 | |
| Q111 | XT0141 | Chip | 2SC4226-T1(R24) | 1 | |
| Q112 | XT0141 | Chip | 2SC4226-T1(R24) | 1 | |
| Q113 | XU0209 | Chip | EMD6T2R | 1 | |
| Q114 | XU0210 | Chip | RN1107MFV(TPL3) | 1 | |
| Q115 | XT0194 | Chip | 2SC5551-TD-E | 1 | |
| Q116 | XT0110 | Chip | 2SA1036K T146Q | 1 | |
| Q117 | XT0095 | Chip | 2SC4081 T106R | 1 | |
| Q120 | XU0210 | Chip | RN1107MFV(TPL3) | 1 | |
| Q121 | XU0178 | Chip | XP0121500L | 1 | |
| Q122 | XT0190 | Chip | 2SB1386 T100Q | 1 | |
| Q123 | XT0170 | Chip | 2SB0766ARL | 1 | |
| Q124 | XU0209 | Chip | EMD6T2R | 1 | |
| Q126 | XU0210 | Chip | RN1107MFV(TPL3) | 1 | |
| Q127 | XT0095 | Chip | 2SC4081 T106R | 1 | |
| Q128 | XU0210 | Chip | RN1107MFV(TPL3) | 1 | |
| Q129 | XU0195 | Chip | RN1104(TE85L,F) | 1 | |
| Q131 | XE0066 | Chip FET | 2SK2539-TB-E | 1 | |
| Q132 | XU0210 | Chip | RN1107MFV(TPL3) | 1 | |
| Q133 | XU0210 | Chip | RN1107MFV(TPL3) | 1 | |
| Q134 | XT0125 | Chip | 2SC4245-Y(TE85L) | 1 | |
| Q135 | XT0124 | Chip | 2SC4215-Y(TE85L,F) | 1 | |
| Q137 | XU0210 | Chip | RN1107MFV(TPL3) | 1 | |
| Q138 | XT0141 | Chip | 2SC4226-T1(R24) | 1 | |
| Q141 | XU0211 | Chip | RN1207MFV(TPL3) | 1 | |
| Q144 | XT0095 | Chip | 2SC4081 T106R | 1 | |
| Q145 | XT0125 | Chip | 2SC4245-Y(TE85L) | 1 | |

| Ref No. | Part No. | Description | Parts Name | Qty. | Ver. |
|---------|----------|-------------|-----------------|------|------|
| Q147 | XU0209 | Chip | EMD6T2R | 1 | |
| Q148 | XU0195 | Chip | RN1104(TE85L,F) | 1 | |
| Q149 | XU0210 | Chip | RN1107MFV(TPL3) | 1 | |
| Q401 | XU0210 | Chip | RN1107MFV(TPL3) | 1 | |
| Q402 | XU0211 | Chip | RN2107MFV(TPL3) | 1 | |
| R105 | RK3530 | Chip R. | ERJ2GEJ221X | 1 | |
| R106 | RK3554 | Chip R. | ERJ2GEJ223X | 1 | |
| R107 | RK3554 | Chip R. | ERJ2GEJ223X | 1 | |
| R109 | RK3526 | Chip R. | ERJ2GEJ101X | 1 | |
| R110 | RK3526 | Chip R. | ERJ2GEJ101X | 1 | |
| R112 | RK3522 | Chip R. | ERJ2GEJ470X | 1 | |
| R113 | RK3544 | Chip R. | ERJ2GEJ332X | 1 | |
| R114 | RK3540 | Chip R. | ERJ2GEJ152X | 1 | |
| R116 | RK3530 | Chip R. | ERJ2GEJ221X | 1 | |
| R117 | RK3570 | Chip R. | ERJ2GEJ474X | 1 | |
| R118 | RK3526 | Chip R. | ERJ2GEJ101X | 1 | |
| R125 | RK3535 | Chip R. | ERJ2GEJ561X | 1 | |
| R126 | RK3552 | Chip R. | ERJ2GEJ153X | 1 | |
| R128 | RK3562 | Chip R. | ERJ2GEJ104X | 1 | |
| R129 | RK3534 | Chip R. | ERJ2GEJ471X | 1 | |
| R130 | RK3562 | Chip R. | ERJ2GEJ104X | 1 | |
| R131 | RK3562 | Chip R. | ERJ2GEJ104X | 1 | |
| R132 | RK3550 | Chip R. | ERJ2GEJ103X | 1 | |
| R133 | RK3526 | Chip R. | ERJ2GEJ101X | 1 | |
| R134 | RK3553 | Chip R. | ERJ2GEJ183X | 1 | |
| R136 | RK3534 | Chip R. | ERJ2GEJ471X | 1 | |
| R138 | RK3562 | Chip R. | ERJ2GEJ104X | 1 | |
| R139 | RK3562 | Chip R. | ERJ2GEJ104X | 1 | |
| R140 | RK3554 | Chip R. | ERJ2GEJ223X | 1 | |
| R143 | RK3522 | Chip R. | ERJ2GEJ470X | 1 | |
| R144 | RK3542 | Chip R. | ERJ2GEJ222X | 1 | |
| R145 | RK3552 | Chip R. | ERJ2GEJ153X | 1 | |
| R146 | RK3552 | Chip R. | ERJ2GEJ153X | 1 | |
| R147 | RK3550 | Chip R. | ERJ2GEJ103X | 1 | |
| R148 | RK3538 | Chip R. | ERJ2GEJ102X | 1 | |
| R151 | RK3550 | Chip R. | ERJ2GEJ103X | 1 | |
| R152 | RK3538 | Chip R. | ERJ2GEJ102X | 1 | |
| R153 | RK3562 | Chip R. | ERJ2GEJ104X | 1 | |
| R154 | RK3542 | Chip R. | ERJ2GEJ222X | 1 | |
| R155 | RK3551 | Chip R. | ERJ2GEJ123X | 1 | |
| R156 | RK3558 | Chip R. | ERJ2GEJ473X | 1 | |
| R158 | RK3526 | Chip R. | ERJ2GEJ101X | 1 | |
| R162 | RK3526 | Chip R. | ERJ2GEJ101X | 1 | |
| R163 | RK3526 | Chip R. | ERJ2GEJ101X | 1 | |
| R164 | RK3025 | Chip R. | MCR03EZP620 | 1 | |
| R165 | RK3574 | Chip R. | ERJ2GEJ105X | 1 | |
| R166 | RK3562 | Chip R. | ERJ2GEJ104X | 1 | |
| R167 | RK3564 | Chip R. | ERJ2GEJ154X | 1 | |
| R168 | RK3554 | Chip R. | ERJ2GEJ223X | 1 | |
| R172 | RK3556 | Chip R. | ERJ2GEJ333X | 1 | |
| R173 | RK3526 | Chip R. | ERJ2GEJ101X | 1 | |
| R176 | RK3550 | Chip R. | ERJ2GEJ103X | 1 | |
| R177 | RK3544 | Chip R. | ERJ2GEJ332X | 1 | |
| R178 | RK3542 | Chip R. | ERJ2GEJ222X | 1 | |
| R180 | RK3538 | Chip R. | ERJ2GEJ102X | 1 | |
| R181 | RK3562 | Chip R. | ERJ2GEJ104X | 1 | |
| R182 | RK3542 | Chip R. | ERJ2GEJ222X | 1 | |
| R183 | RK3568 | Chip R. | ERJ2GEJ334X | 1 | |
| R184 | RK3526 | Chip R. | ERJ2GEJ101X | 1 | |
| R185 | RK3570 | Chip R. | ERJ2GEJ474X | 1 | |
| R186 | RK3562 | Chip R. | ERJ2GEJ104X | 1 | |
| R187 | RK3558 | Chip R. | ERJ2GEJ473X | 1 | |
| R188 | RK3526 | Chip R. | ERJ2GEJ101X | 1 | |
| R189 | RK3538 | Chip R. | ERJ2GEJ102X | 1 | |
| R190 | RK3538 | Chip R. | ERJ2GEJ102X | 1 | |
| R191 | RK3538 | Chip R. | ERJ2GEJ102X | 1 | |
| R193 | RK3538 | Chip R. | ERJ2GEJ102X | 1 | |
| R195 | RK3570 | Chip R. | ERJ2GEJ474X | 1 | |
| R196 | RK3538 | Chip R. | ERJ2GEJ102X | 1 | |
| R197 | RK3550 | Chip R. | ERJ2GEJ103X | 1 | |
| R198 | RK3542 | Chip R. | ERJ2GEJ222X | 1 | |
| R199 | RK3542 | Chip R. | ERJ2GEJ222X | 1 | |
| R200 | RK3570 | Chip R. | ERJ2GEJ474X | 1 | |
| R201 | RK3542 | Chip R. | ERJ2GEJ222X | 1 | |
| R202 | RK0028 | Chip R. | ERJ6GEYJ471V | 1 | |
| R203 | RK3556 | Chip R. | ERJ2GEJ333X | 1 | |
| R204 | RK3562 | Chip R. | ERJ2GEJ104X | 1 | |
| R205 | RK0069 | Chip R. | ERJ6GEYJ104V | 1 | |
| R206 | RK0005 | Chip R. | ERJ6GEYJ220V | 1 | |
| R207 | RK3552 | Chip R. | ERJ2GEJ153X | 1 | |
| R208 | RK3536 | Chip R. | ERJ2GEJ881X | 1 | |
| R209 | RK3561 | Chip R. | ERJ2GEJ823X | 1 | |
| R210 | RK3542 | Chip R. | ERJ2GEJ222X | 1 | |
| R211 | RK4018 | Chip R. | ERJ12YJ220U | 1 | |
| R212 | RK4026 | Chip R. | ERJ12YJ101U | 1 | |
| R213 | RK3549 | Chip R. | ERJ2GEJ822X | 1 | |
| R214 | RK3550 | Chip R. | ERJ2GEJ103X | 1 | |
| R215 | RK3536 | Chip R. | ERJ2GEJ881X | 1 | |
| R216 | RK3050 | Chip R. | MCR03EZPJ103 | 1 | |
| R217 | RK3050 | Chip R. | MCR03EZPJ103 | 1 | |
| R218 | RK3554 | Chip R. | ERJ2GEJ223X | 1 | |

| Ref No. | Part No. | Description | Parts Name | Qty. | Ver. |
|---------|----------|-------------|--------------|------|------|
| R219 | RK3538 | Chip R. | ERJ2GEJ102X | 1 | |
| R220 | RK4034 | Chip R. | ERJ12YJ471U | 1 | |
| R222 | RK3550 | Chip R. | ERJ2GEJ103X | 1 | |
| R223 | RK3526 | Chip R. | ERJ2GEJ101X | 1 | |
| R224 | RK3530 | Chip R. | ERJ2GEJ221X | 1 | |
| R225 | RK3550 | Chip R. | ERJ2GEJ103X | 1 | |
| R226 | RK3038 | Chip R. | MCR03EZPJ102 | 1 | |
| R227 | RK3501 | Chip R. | ERJ2GE0R00X | 1 | |
| R228 | RK3538 | Chip R. | ERJ2GEJ102X | 1 | |
| R229 | RK3550 | Chip R. | ERJ2GEJ103X | 1 | |
| R230 | RK3546 | Chip R. | ERJ2GEJ472X | 1 | |
| R231 | RK3050 | Chip R. | MCR03EZPJ103 | 1 | |
| R232 | RK3522 | Chip R. | ERJ2GEJ470X | 1 | |
| R233 | RK3542 | Chip R. | ERJ2GEJ222X | 1 | |
| R234 | RK3558 | Chip R. | ERJ2GEJ333X | 1 | |
| R235 | RK3556 | Chip R. | ERJ2GEJ333X | 1 | |
| R236 | RK3551 | Chip R. | ERJ2GEJ123X | 1 | |
| R237 | RK3526 | Chip R. | ERJ2GEJ101X | 1 | |
| R238 | RK3562 | Chip R. | ERJ2GEJ104X | 1 | |
| R239 | RK3550 | Chip R. | ERJ2GEJ103X | 1 | |
| R241 | RK3550 | Chip R. | ERJ2GEJ103X | 1 | |
| R242 | RK3522 | Chip R. | ERJ2GEJ470X | 1 | |
| R243 | RK3554 | Chip R. | ERJ2GEJ223X | 1 | |
| R244 | RK3568 | Chip R. | ERJ2GEJ334X | 1 | |
| R245 | RK3538 | Chip R. | ERJ2GEJ102X | 1 | |
| R246 | RK3546 | Chip R. | ERJ2GEJ472X | 1 | |
| R247 | RK3538 | Chip R. | ERJ2GEJ102X | 1 | |
| R249 | RK3084 | Chip R. | MCR03EZPJ154 | 1 | |
| R251 | RK3550 | Chip R. | ERJ2GEJ103X | 1 | |
| R253 | RK3557 | Chip R. | ERJ2GEJ393X | 1 | |
| R254 | RK3557 | Chip R. | ERJ2GEJ393X | 1 | |
| R255 | RK3546 | Chip R. | ERJ2GEJ472X | 1 | |
| R256 | RK3526 | Chip R. | ERJ2GEJ101X | 1 | |
| R257 | RK3547 | Chip R. | ERJ2GEJ562X | 1 | |
| R258 | RK3557 | Chip R. | ERJ2GEJ393X | 1 | |
| R259 | RK3550 | Chip R. | ERJ2GEJ103X | 1 | |
| R260 | RK3550 | Chip R. | ERJ2GEJ103X | 1 | |
| R261 | RK3554 | Chip R. | ERJ2GEJ223X | 1 | |
| R262 | RK3568 | Chip R. | ERJ2GEJ334X | 1 | |
| R264 | RK3538 | Chip R. | ERJ2GEJ102X | 1 | |
| R266 | RK3550 | Chip R. | ERJ2GEJ103X | 1 | |
| R267 | RK3522 | Chip R. | ERJ2GEJ470X | 1 | |
| R268 | RK3550 | Chip R. | ERJ2GEJ103X | 1 | |
| R269 | RK3550 | Chip R. | ERJ2GEJ103X | 1 | |
| R270 | RK3560 | Chip R. | ERJ2GEJ683X | 1 | |
| R271 | RK4034 | Chip R. | ERJ12YJ471U | 1 | |
| R272 | RK3550 | Chip R. | ERJ2GEJ103X | 1 | |
| R274 | RK3550 | Chip R. | ERJ2GEJ103X | 1 | |
| R275 | RK3560 | Chip R. | ERJ2GEJ683X | 1 | |
| R276 | RK3530 | Chip R. | ERJ2GEJ221X | 1 | |
| R278 | RK3522 | Chip R. | ERJ2GEJ470X | 1 | |
| R279 | RK3046 | Chip R. | MCR03EZPJ472 | 1 | |
| R281 | RK3041 | Chip R. | MCR03EZPJ182 | 1 | |
| R283 | RK3038 | Chip R. | MCR03EZPJ102 | 1 | |
| R284 | RK3526 | Chip R. | ERJ2GEJ101X | 1 | |
| R286 | RK3534 | Chip R. | ERJ2GEJ471X | 1 | |
| R287 | RK3546 | Chip R. | ERJ2GEJ472X | 1 | |
| R288 | RK3550 | Chip R. | ERJ2GEJ103X | 1 | |
| R289 | RK3542 | Chip R. | ERJ2GEJ222X | 1 | |
| R290 | RK3554 | Chip R. | ERJ2GEJ223X | 1 | |
| R292 | RK3522 | Chip R. | ERJ2GEJ470X | 1 | |
| R293 | RK3542 | Chip R. | ERJ2GEJ222X | 1 | |
| R294 | RK3546 | Chip R. | ERJ2GEJ472X | 1 | |
| R296 | RK3568 | Chip R. | ERJ2GEJ334X | 1 | |
| R297 | RK3532 | Chip R. | ERJ2GEJ331X | 1 | |
| R299 | RK3545 | Chip R. | ERJ2GEJ392X | 1 | |
| R300 | RK3558 | Chip R. | ERJ2GEJ473X | 1 | |
| R301 | RK3538 | Chip R. | ERJ2GEJ102X | 1 | |
| R302 | RK3522 | Chip R. | ERJ2GEJ470X | 1 | |
| R303 | RK3549 | Chip R. | ERJ2GEJ822X | 1 | |
| R304 | RK3549 | Chip R. | ERJ2GEJ822X | 1 | |
| R307 | RK3541 | Chip R. | ERJ2GEJ182X | 1 | |
| R308 | RK3530 | Chip R. | ERJ2GEJ221X | 1 | |
| R309 | RK3550 | Chip R. | ERJ2GEJ103X | 1 | |
| R311 | RK3538 | Chip R. | ERJ2GEJ102X | 1 | |
| R312 | RK3538 | Chip R. | ERJ2GEJ102X | 1 | |
| R313 | RK3538 | Chip R. | ERJ2GEJ102X | 1 | |
| R315 | RK3544 | Chip R. | ERJ2GEJ332X | 1 | |
| R318 | RK3568 | Chip R. | ERJ2GEJ334X | 1 | |
| R319 | RK3561 | Chip R. | ERJ2GEJ823X | 1 | |
| R320 | RK3562 | Chip R. | ERJ2GEJ104X | 1 | |
| R321 | RK3543 | Chip R. | ERJ2GEJ272X | 1 | |
| R322 | RD0108 | Jumper | J1/6ZC | 1 | |
| R323 | RK3554 | Chip R. | ERJ2GEJ223X | 1 | |
| R325 | RK3566 | Chip R. | ERJ2GEJ224X | 1 | |
| R337 | RK3570 | Chip R. | ERJ2GEJ474X | 1 | |
| R339 | RK3550 | Chip R. | ERJ2GEJ103X | 1 | |
| R340 | RK3550 | Chip R. | ERJ2GEJ103X | 1 | |
| R341 | RK3561 | Chip R. | ERJ2GEJ823X | 1 | |
| R342 | RK3545 | Chip R. | ERJ2GEJ392X | 1 | |
| R344 | RK3550 | Chip R. | ERJ2GEJ103X | 1 | |

| Ref No. | Part No. | Description | Parts Name | Qty. | Ver. |
|---------|----------|---------------|--------------------|------|------|
| R345 | RK3501 | Chip R. | ERJ2GE0R00X | 1 | |
| R346 | RK3561 | Chip R. | ERJ2GEJ823X | 1 | |
| R347 | RK3551 | Chip R. | ERJ2GEJ123X | 1 | |
| R348 | RK3534 | Chip R. | ERJ2GEJ471X | 1 | |
| R349 | RK3562 | Chip R. | ERJ2GEJ104X | 1 | |
| R401 | RK3553 | Chip R. | ERJ2GEJ183X | 1 | |
| R402 | RK3551 | Chip R. | ERJ2GEJ123X | 1 | |
| R403 | RK3542 | Chip R. | ERJ2GEJ222X | 1 | |
| R404 | RK3562 | Chip R. | ERJ2GEJ104X | 1 | |
| R405 | RK3563 | Chip R. | ERJ2GEJ124X | 1 | |
| R406 | RK3559 | Chip R. | ERJ2GEJ563X | 1 | |
| R407 | RK3562 | Chip R. | ERJ2GEJ104X | 1 | |
| R408 | RK3558 | Chip R. | ERJ2GEJ473X | 1 | |
| R409 | RK3560 | Chip R. | ERJ2GEJ683X | 1 | |
| R410 | RK3557 | Chip R. | ERJ2GEJ393X | 1 | |
| R411 | RK3562 | Chip R. | ERJ2GEJ104X | 1 | |
| R412 | RK3550 | Chip R. | ERJ2GEJ103X | 1 | |
| R413 | RK3550 | Chip R. | ERJ2GEJ103X | 1 | |
| R414 | RK3566 | Chip R. | ERJ2GEJ224X | 1 | |
| R415 | RK3558 | Chip R. | ERJ2GEJ473X | 1 | |
| R416 | RK3550 | Chip R. | ERJ2GEJ103X | 1 | |
| R417 | RK3568 | Chip R. | ERJ2GEJ334X | 1 | |
| R418 | RK3560 | Chip R. | ERJ2GEJ683X | 1 | |
| R419 | RK3550 | Chip R. | ERJ2GEJ103X | 1 | |
| R420 | RK3574 | Chip R. | ERJ2GEJ105X | 1 | |
| R421 | RK3566 | Chip R. | ERJ2GEJ224X | 1 | |
| R422 | RK3562 | Chip R. | ERJ2GEJ104X | 1 | |
| R429 | RK3501 | Chip R. | ERJ2GE0R00X | 1 | |
| R430 | RK3538 | Chip R. | ERJ2GEJ102X | 1 | |
| R431 | RK3558 | Chip R. | ERJ2GEJ473X | 1 | |
| R432 | RK3550 | Chip R. | ERJ2GEJ103X | 1 | |
| SH101 | TS0172 | Case | VCO CASE DR620 | 1 | |
| TC102 | CT0046 | Trimmer C. | TC03C100A-TP02 | 1 | |
| TC103 | CT0046 | Trimmer C. | TC03C100A-TP02 | 1 | |
| TH101 | XS0031 | Chip | NTCG164BH682JT-S | 1 | |
| TH102 | XS0050 | Chip | NTCG164QH105JT-S | 1 | |
| VR101 | RH0233 | Trimmer R. | RH02B1C15X | 1 | |
| VR102 | RH0231 | Trimmer R. | RH02B1CS4X | 1 | |
| VR103 | RH0229 | Trimmer R. | RH02B1CJ4X | 1 | |
| VR104 | RH0233 | Trimmer R. | RH02B1C15X | 1 | |
| VR106 | RH0231 | Trimmer R. | RH02B1CS4X | 1 | |
| VR107 | RH0225 | Trimmer R. | RH02B1CS3X | 1 | |
| VR108 | RH0233 | Trimmer R. | RH02B1C15X | 1 | |
| VR109 | RH0229 | Trimmer R. | RH02B1CJ4X | 1 | |
| VR110 | RH0233 | Trimmer R. | RH02B1C15X | 1 | |
| X101 | XK0002 | Discriminator | CDBLB455KCAY07-B0 | 1 | |
| X102 | XQ0170 | VCTCXO | GS46128 21.25M | 1 | |
| X104 | XQ0058Z | Xtal | UM5 30.395MHZ | 1 | |
| XF101 | XF0014Z | Xtal Filter | 30M152A 30.85MHZ | 1 | |
| | FG0320 | SP Cushion | SP CUSHION DR135 | 1 | |
| | FG0327 | Cushion | CUSHION DR135 | 1 | |
| | SD0034 | Spring | GND SPRING DR130 | 1 | |
| | TZ0049 | Dumper | SILICON DUMPER | 3 | |
| | UP0545 | P.C. BOARD | DR435FX INTEGRATED | 1 | |

Mechanical Parts

| Ref No. | Part No. | Description | Parts Name | Qty. | | Ver. |
|---------|----------|--------------|----------------------|--------|--------|------|
| | | | | DR-135 | DR-435 | |
| | ES0035 | Speaker | 57-8BC-35 ROHS | 1 | 1 | |
| | UX1047 | Wire | WIRE DR130 | 1 | 1 | |
| | AA0050 | Screw | OH M2.6+6 FE/B.ZN | 6 | 6 | |
| | AN0032 | Nut | MIC NUT | 1 | 1 | |
| | AU0001 | Screw | PH/S B26+8 FEN | 15 | 15 | |
| | AW0001 | Screw | PH/D6 3+8 FE/N | 2 | 2 | |
| | DP0127 | LCD Panel | LCD PANNEL DR135 | 1 | 0 | |
| | DP0136 | LCD Panel | LCD PANNEL DR435 | 0 | 1 | |
| | FF0015 | Cloth | BLIND CLOTH DR110 | 3 | 3 | |
| | FF0017 | Cloth | BLIND CLOTH DR570 | 1 | 1 | |
| | FG0273 | Rubber | ON AIR KEY RUBBER | 1 | 1 | |
| | FP0151 | Panel | REAR PANEL DR135 | 1 | 1 | |
| | FP0188 | Panel | JACK PANEL DR135 | 1 | 1 | |
| | KS0098 | Bottom Case | BOTTOM CASE DR135 | 1 | 1 | |
| | KZ0105 | Front Case | FRONT ASSY. DR135 | 1 | 1 | |
| | NK0072 | Knob | VOL KNOB DR135 | 1 | 1 | |
| | NK0073 | Knob | DIAL KNOB DR135 | 1 | 1 | |
| | SP0008 | GND Terminal | GND TERM XM601 | 1 | 1 | |
| | SS0093 | Chassis | CHASSIS DR135 | 1 | 1 | |
| | ST0085 | SP Holder | SP HOLDER DR135 | 1 | 1 | |
| | ST0066 | SP Fitting | SP FITTING DR135 | 1 | 1 | |
| | TG0034 | SP Himeron | SP HIMERON DR135 | 1 | 1 | |
| | UE0258 | ANT | FM-M.D.R-(4) | 1 | 1 | |
| | YZ0131 | Tape | #9110 12X1MM | 30 | 30 | |
| | DS0446 | Label | NITTO MODEL PLATE(S) | 1 | 1 | FX |
| | DS0446 | Label | NITTO MODEL PLATE(S) | 2 | 2 | FXE |
| | PR0288 | Label | SCREW STKR DX70 | 2 | 2 | |
| | PR0478 | Label | SERIAL SEAL | 1 | 1 | FXE |
| | PR0610 | Label | N-10X49SEAL(YELLOW) | 1 | 1 | |

Packing Parts

| Ref No. | Part No. | Description | Parts Name | Qty. | | Ver. |
|---------|----------|--------------|----------------------|--------|--------|------|
| | | | | DR-135 | DR-435 | |
| | DS0446 | Label | NITTO MODEL PLATE(S) | 1.4 | 1.4 | FXE |
| | HK0539 | Package | PACKAGE DR135Z | 1 | 0 | |
| | HK0540 | Package | PACKAGE DR435Z | 0 | 1 | |
| | HM0218Z | Carton Box | MASTER CARTON | 0.2 | 0.2 | |
| | HU0099Z | P.MTL/Carton | FRONT INNER DR605 | 1 | 1 | |
| | HU0159Z | P.MTL/Carton | INNER DR135T | 1 | 1 | |
| | HU0161Z | P.MTL/Carton | INNER 5 PCS | 0.4 | 0.4 | |
| | PR0478 | Label | SERIAL SEAL | 1.2 | 1.2 | |
| | PR0513 | Label | NITTO 13X13 LABEL(W) | 3 | 3 | |
| | PR0513 | Label | NITTO 13X13 LABEL(W) | 4 | 4 | |
| | PR0514 | Label | EPSON 10X49 LABEL(W) | 2 | 2 | |
| | PR0635 | Label | N-30*50 | 1 | 1 | |

ACCESSORIES

| Ref No. | Part No. | Description | Parts Name | Qty. | | Ver. |
|---------|----------|-------------|----------------------|--------|--------|------|
| | | | | DR-135 | DR-435 | |
| | ADFM78 | Bracket | BRACKET DR130 | 1 | 1 | FXE |
| | ADUA38 | Power Cable | R-B2.0X3M RECEPT.15A | 1 | 1 | |
| | EHM53B | Microphone | MICROPHON EMS53B | 1 | 1 | |
| | HP0009 | Plastic Bag | PLA.BAG 5X125X250 | 1 | 1 | |
| | HP0035 | Plastic Bag | E.BAG 5X200X250 | 1 | 1 | |
| | PK0111 | Diagram | SCHEMATIC DR135MK3 | 1 | 0 | |
| | PK0113 | Diagram | SCHEMATIC DR435MK3 | 0 | 1 | |
| | PS0513A | Manual | INSTRUCTION | 1 | 1 | |

ACCESSORIES (SCREW SET)

| Ref No. | Part No. | Description | Parts Name | Qty. | | Ver. |
|---------|----------|-------------|----------------------|--------|--------|------|
| | | | | DR-135 | DR-435 | |
| | AA0013 | Screw | BH M5*20 FE/ZN | 4 | 4 | |
| | AE0012 | Screw | HEX/H/D M4*8 FE/3BBC | 4 | 4 | |
| | AJ0003 | Screw | BH T5*20 FE/ZN 1 | 4 | 4 | |
| | AN0002 | Nut | HEX N5X0.8 FE/ZN | 4 | 4 | |
| | AZ0009 | Washer | SW 5X9.2X1.3 FE/ZN | 4 | 4 | |
| | AZ0010 | Washer | SW 5X12X0.8 FE/ZN | 4 | 4 | |
| | EF0005 | Fuse | FGBO 15A | 2 | 2 | |
| | FM0079Z | Spanner | SPANNER DR130 | 1 | 1 | |
| | HP0006 | Plastic Bag | 5X90X170 | 1 | 1 | |
| | YZ0121 | Tape | TAPE 10MM | 2 | 2 | |

DR-135 ADJUSTMENT

1) Adjustment Spot

Power Supply Voltage 13.8V

Output of SSG is all EMF indication.

If without instruction, WIDE mode.

If without instruction, SSG output is MOD 1KHz WIDE DEV 3.5KHz/DEV,
NARROW DEV 1.75KHz/DEV.

Standard modulation is also based above.

Speaker load is 8 ohm and output is 50 ~ 100 mV.

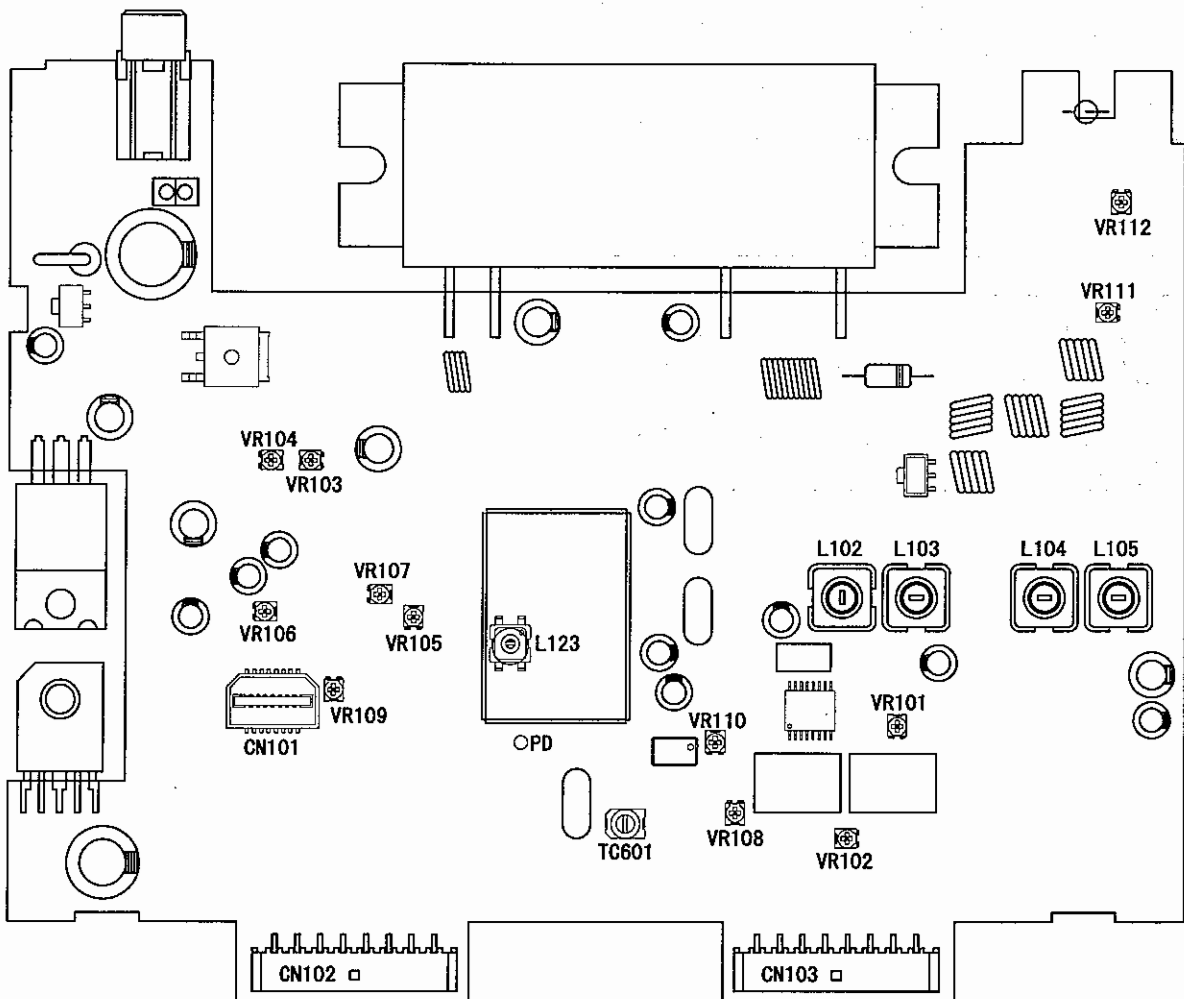

2) VCO and RX Adjustment Specification

| ITEM | CONDITION | UNIT | ADJ. SPOT | ADJUSTING MRTHOD |
|----------------------------------|--|------|--------------------------|---|
| Adjustment Frequency | 145.90MHz TX | MAIN | TC601 | Adjust so that Tx Frequency becomes within 145.90MHz +/- 100Hz |
| VCO Adjustment | 146.00MHz RX | MAIN | L123 | Adjust so that PD voltage becomes 2.7V |
| VCO Confirmation | 173.99MHz RX | MAIN | | Confirm if PD voltage becomes less than 7.3V |
| Rx Signal Sensitivity Adjustment | 146.05MHz 136.05MHz 146.05MHz 173.95MHz | MAIN | L105, L104 L103, L102 | Repeatedly adjust so that the Rx sensitivity becoms in maximum/. Confirm: At -7dBu SINAD more than 12dB At -8dBu SINAD more than 12dB At -6dBu SINAD more than 12dB |
| Squelch Adjustment | 146.05MHz SSG OFF Indicate 01 | MAIN | VR101 | Adjust so that the squelch stops at perfectly close location |
| S Meter Adjustment | 146.05MHz SSG 20dBu 1KHz Indicate 01 | MAIN | VR102 | Adjust so that all the indicator appears |

3) TX Adjustment Specification

| ITEM | CONDITION | UNIT | ADJ. SPOT | ADJUSTING MRTHOD |
|-------------------------------------|--|------|-----------|------------------------------------|
| HI POWER Adjustment | 146.00MHz HI POWER | MAIN | VR103 | Adjust to 50.0 +/- 1.0W |
| MID POWER Adjustment | 146.00MHz MID POWER | MAIN | VR104 | Adjust to 20.0 +/- 1.0W |
| LOW POWER Confirmation | 146.00MHz LOW POWER | MAIN | | Confirm if it becomes 5.0 +/- 1.0W |
| Maximum Deviation Adjustment | 146.00MHz MOD 1KHz 40mVemf WIDE | MAIN | VR107 | 4.5 +/- 0.1KHz/DEV |
| Maximum Deviation Confirmation | 146.00MHz MOD 1KHz 40mVemf NARROW | MAIN | | 2.2 +/- 0.2KHz/DEV |
| Mic Gain Adjustment | 146.00MHz MOD 1KHz 4mVemf WIDE | MAIN | VR106 | 3.0 +/- 0.1KHz/DEV |
| CTCSS Modulation Level Confirmation | 146.00MHz 88.5Hz | MAIN | | 800 +/- 200Hz/DEV 3KHz LPF ON |
| DCS Modulation Level Adjustment | 146.00MHz 255 Code | MAIN | VR108 | 800 +/- 50Hz/DEV 3KHz LPF ON |
| 1750Hz Modulation Level Adjustment | 146.00MHz 1750Hz | MAIN | VR109 | 3.0 +/- 0.5KHz/DEV |
| DTMF Modulation Level Confirmation | 146.00MHz DTMF 1 Press the V/M key during TX | MAIN | | 3.0 +/- 0.5KHz/DEV |

4) RX Test Specification

| TEST ITEM | CONDITION | ADJ. STANDARD | TEST STANDARD | NOTE |
|-----------------------|-------------------------------------|---|---|--|
| RX Signal Sensitivity | 136.05MHz 146.05MHz 173.95MHz | Less than -7dBu Less than -8dBu Less than -6dBu | Less than -6dBu Less than -7dBu Less than -5dBu | 12dB SINAD |
| | 146.05MHz NARROW | Less than -8dBu | Less than -7dBu | |
| RX Distortion | 146.05MHz WIDE NARROW | Less than 4% | Less than 5% | SSG Output 30dBu |
| RX S/N | 146.05MHz WIDE | More than 40dB | More than 38dB | SSG Output 30dBu 0.3 ~ 3KHz BPF OFF |
| | 146.00MHz NARROW | More than 34dB | More than 32dB | |
| Squelch Sensitivity | 146.05MHz Indication 02 | Squelch Open | Squelch Open | SSG Output -10dBu |
| | | Squelch Close | Squelch Close | SSG Output OFF |
| S Meter | 146.05MHz 1KHz 3.5KHz/DEV | All appears at 20dBu | All appears at 25dBu | Decrease SSG level and decrease S Meter level |
| AF Output | 146.05MHz | More than 2W | More than 2W | SSG Output 30dBu |
| CTCSS Sensitivity | 146.05MHz WIDE | Open at 500Hz/DEV | Open at 500Hz/DEV | SSG Output 0dBu 88.5Hz |
| | 146.05MHz NARROW | Open at 250Hz/DEV | Open at 250Hz/DEV | |
| DCS Sensitivity | 146.05MHz WIDE | Opens when Test Equipment is in TX | Opens when Test Equipment is in TX | 255 Code |
| | 146.05MHz NARROW | Opens when Test Equipment is in TX | Opens when Test Equipment is in TX | |
| Drain Current | 146.05MHz | Less than 0.65A | Less than 0.65A | Max volume |
| Power off Current | 146.05MHz | Less than 10mA | Less than 10mA | Power off |
| Howling | 146.05MHz | Don't occur | Don't occur | SSG Output 60dBu Mod off, Max volume |

5) TX Test Specification

| TEST ITEM | CONDITION | ADJ. STANDARD | TEST STANDARD | NOTE |
|----------------------------|-------------------------------------|--|--|--|
| Tx Output HI POWER | 144.00MHz 146.00MHz 148.00MHz | 50 +/- 1W | 50 +/- 3W 50 +/- 3W 50 +/- 3W | |
| Tx Output MID POWER | 146.00MHz | 20 +/- 1W | 20 +/- 2W | |
| Tx Output LOW POWER | 146.00MHz | 5 +/- 1W | 3 ~ 6W | |
| Drain Current | 146.00MHz | Less than 11A | Less than 12A | |
| Frequency Deviation | 146.00MHz | Within +/- 0.1KHz | Within +/- 0.5KHz | |
| Spurious | 144.00MHz 146.00MHz 148.00MHz | More than 65dB More than 65dB More than 65dB | More than 60dB More than 60dB More than 60dB | MID and LOW standard power is also the same as of HI power level |
| Modulation Level | 146.00MHz WIDE | 3.0 +/- 0.1KHz/DEV 4.5 +/- 0.1KHz/DEV | 3.0 +/- 0.2KHz/DEV 4.5 +/- 0.2KHz/DEV | MIC in 1KHz 4mVemf MIC in 1KHz 40mVemf |
| | 146.00MHz NARROW | 2.2 +/- 0.2KHz/DEV | 2.2 +/- 0.3KHz/DEV | MIC in 1KHz 40mVemf |
| CTCSS Modulation Level | 146.00MHz WIDE | 800 +/- 200Hz/DEV | 800 +/- 200Hz/DEV | 88.5Hz 3KHz LPF ON |
| DCS Modulation Level | 146.00MHz WIDE | 800 +/- 200Hz/DEV | 800 +/- 200Hz/DEV | 255 Code 3KHz LPF ON |
| | 146.00MHz NARROW | 450 +/- 100Hz/DEV | 450 +/- 100Hz/DEV | |
| 1750Hz Modulation Level | 146.00MHz WIDE | 3.0 +/- 0.5KHz/DEV | 3.0 +/- 0.5KHz/DEV | |
| DTMF Modulation Level | 146.00MHz WIDE | 3.0 +/- 0.5KHz/DEV | 3.0 +/- 0.5KHz/DEV | Press the V/M key during TX |
| Modulation Distortion | 146.00MHz WIDE | Less than 3% | Less than 4% | |
| TX S/N | 146.00MHz WIDE | More than 40dB | More than 38dB | 0.3 ~ 3KHz BPF ON |
| | 146.00MHz NARROW | More than 34dB | More than 32dB | |

DR-435 ADJUSTMENT

1) Adjustment Spot

Power Supply Voltage 13.8V

Output of SSG is all EMF indication.

If without instruction, WIDE mode.

If without instruction, SSG output is MOD 1KHz WIDE DEV 3.5KHz/DEV,
NARROW DEV 1.75KHz/DEV.

Standard modulation is also based above.

Speaker load is 8 ohm and output is 50 ~ 100 mV.

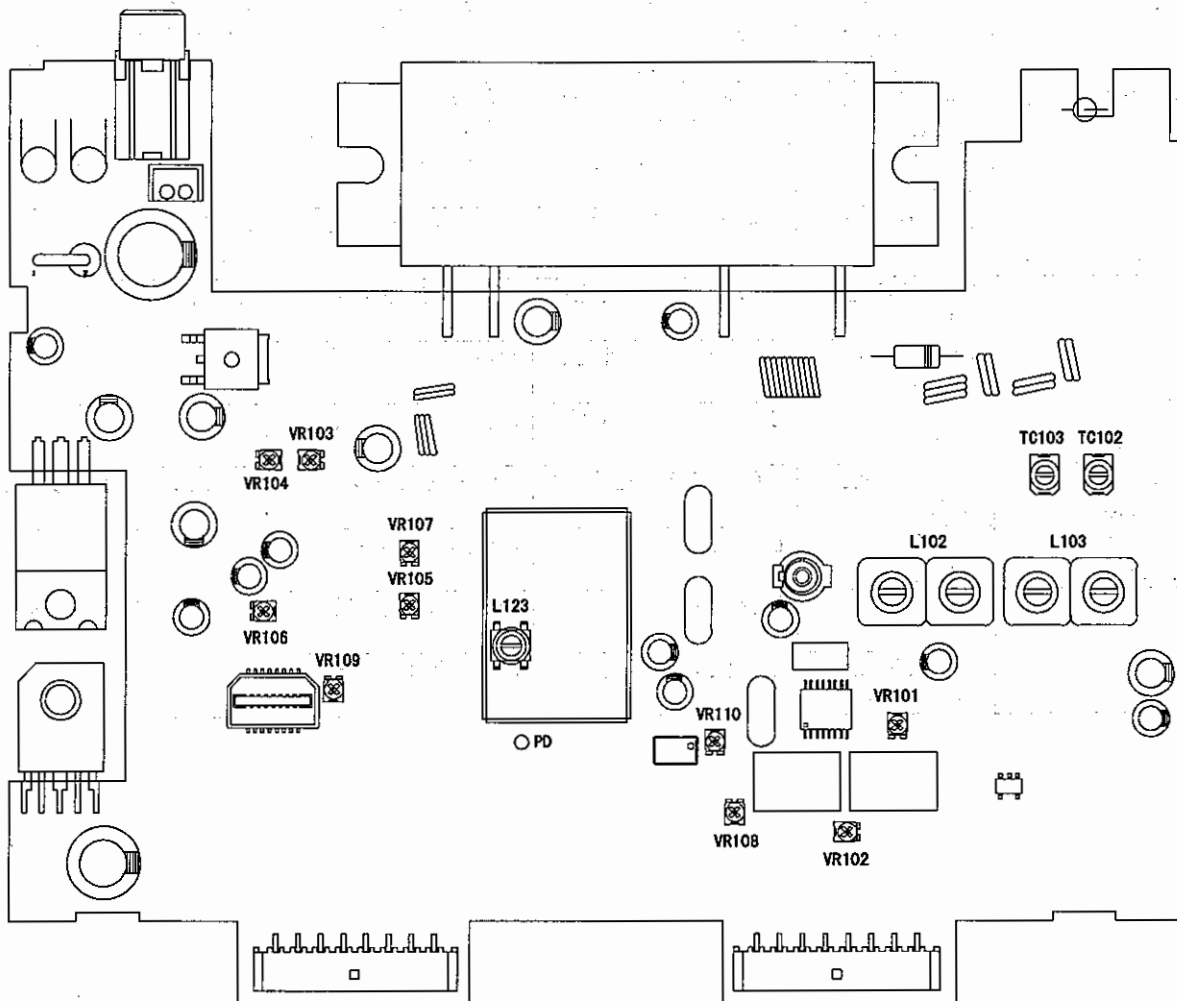

2) VCO and RX Adjustment Specification

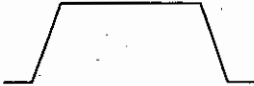
| ITEM | CONDITION | UNIT | ADJ. SPOT | ADJUSTING MRTHOD |
|----------------------------------|--|------|-------------------------------|--|
| Adjustment Frequency | 439.90MHz TX | MAIN | VR110 | Adjust so that Tx Frequency becomes within 439.90MHz +/- 100Hz |
| VCO Adjustment | 425.00MHz RX | MAIN | L123 | Adjust so that PD voltage becomes 2.0V |
| VCO Confirmation | 511.99MHz RX | MAIN | | Confirm if PD voltage becomes less than 9.0V |
| Rx Signal Sensitivity Adjustment | 440.05MHz 430.05MHz 440.05MHz 450.05MHz | MAIN | TC103, TC102 L103, L102 | <p>It is a tracking generator from an antenna connector. -30dBm is inputted. And when CN109 is seen with a spectrum analyzer, by the maximum gain, it becomes as it is shown in the following figure, and appearance adjustment is carried out.</p>  <p style="text-align: center;">430.00MHz 450.00MHz</p> <p>At -7.5dBu SINAD more than 12dB At -7.5dBu SINAD more than 12dB At -7.5dBu SINAD more than 12dB</p> |
| Squelch Adjustment | 440.05MHz SSG OFF Indicate 01 | MAIN | VR101 | Adjust so that the squelch stops at perfectly close location |
| S Meter Adjustment | 440.05MHz SSG 20dBu 1KHz Indicate 01 | MAIN | VR102 | Adjust so that all the indicator appears |

3) TX Adjustment Specification

| ITEM | CONDITION | UNIT | ADJ. SPOT | ADJUSTING MRTHOD |
|-------------------------------------|--|------|-----------|------------------------------------|
| HI POWER Adjustment | 440.00MHz HI POWER | MAIN | VR103 | Adjust to 35.0 +/- 1.0W |
| MID POWER Adjustment | 440.00MHz MID POWER | MAIN | VR104 | Adjust to 20.0 +/- 1.0W |
| LOW POWER Confirmation | 440.00MHz LOW POWER | MAIN | | Confirm if it becomes 5.0 +/- 1.0W |
| Maximum Deviation Adjustment | 440.00MHz MOD 1KHz 40mVemf WIDE | MAIN | VR107 | 4.5 +/- 0.1KHz/DEV |
| Maximum Deviation Confirmation | 440.00MHz MOD 1KHz 40mVemf NARROW | MAIN | | 2.2 +/- 0.2KHz/DEV |
| Mic Gain Adjustment | 440.00MHz MOD 1KHz 4mVemf WIDE | MAIN | VR106 | 3.0 +/- 0.1KHz/DEV |
| CTCSS Modulation Level Confirmation | 440.00MHz 88.5Hz | MAIN | | 800 +/- 200Hz/DEV 3KHz LPF ON |
| DCS Modulation Level Adjustment | 440.00MHz 255 Code | MAIN | VR108 | 800 +/- 50Hz/DEV 3KHz LPF ON |
| 1750Hz Modulation Level Adjustment | 440.00MHz 1750Hz | MAIN | VR109 | 3.0 +/- 0.5KHz/DEV |
| DTMF Modulation Level Confirmation | 440.00MHz DTMF 1 Press the V/M key during TX | MAIN | | 3.0 +/- 0.5KHz/DEV |

4) RX Test Specification

| TEST ITEM | CONDITION | ADJ. STANDARD | TEST STANDARD | NOTE |
|-----------------------|---------------------------------|---------------------------------------|---------------------------------------|--|
| RX Signal Sensitivity | 350.05MHz | Less than -1.0dBu | Less than +0.0dBu | 12dB SINAD |
| | 430.05MHz | Less than -7.5dBu | Less than -6.5dBu | |
| | 440.05MHz | Less than -7.5dBu | Less than -6.5dBu | |
| | 450.05MHz | Less than -7.5dBu | Less than -6.5dBu | |
| | 511.95MHz | Less than +1.0dBu | Less than +2.0dBu | |
| | 440.05MHz NARROW | Less than -8dBu | Less than -7dBu | |
| RX Distortion | 440.05MHz WIDE NARROW | Less than 4% | Less than 5% | SSG Output 40dBu |
| RX S/N | 440.05MHz WIDE | More than 40dB | More than 38dB | SSG Output 40dBu 0.3 ~ 3KHz BPF OFF |
| | 440.00MHz NARROW | More than 34dB | More than 32dB | |
| Squelch Sensitivity | 440.05MHz Indication 02 | Squelch Open | Squelch Open | SSG Output -10dBu |
| | | Squelch Close | Squelch Close | SSG Output OFF |
| S Meter | 440.05MHz 1KHz 3.5KHz/DEV | All appears at 20dBu | All appears at 25dBu | Decrease SSG level and decrease S Meter level |
| AF Output | 440.05MHz | More than 2W | More than 2W | SSG Output 30dBu |
| CTCSS Sensitivity | 440.05MHz WIDE | Open at 500Hz/DEV | Open at 500Hz/DEV | SSG Output 0dBu 88.5Hz |
| | 440.05MHz NARROW | Open at 250Hz/DEV | Open at 250Hz/DEV | |
| DCS Sensitivity | 440.05MHz WIDE | Opens when Test Equipment is in TX | Opens when Test Equipment is in TX | 255 Code |
| | 440.05MHz NARROW | Opens when Test Equipment is in TX | Opens when Test Equipment is in TX | |
| Drain Current | 440.05MHz | Less than 0.65A | Less than 0.65A | Max volume |
| Power off Current | 440.05MHz | Less than 10mA | Less than 10mA | Power off |
| Howling | 440.05MHz | Don't occur | Don't occur | SSG Output 60dBu Mod off, Max volume |

5) TX Test Specification

| TEST ITEM | CONDITION | ADJ. STANDARD | TEST STANDARD | NOTE |
|----------------------------|-------------------------------------|--|--|--|
| Tx Output HI POWER | 430.00MHz 440.00MHz 450.00MHz | 35 +/- 1W | 35 +/- 5W 35 +/- 3W 35 +/- 5W | |
| Tx Output MID POWER | 440.00MHz | 20 +/- 1W | 20 +/- 2W | |
| Tx Output LOW POWER | 440.00MHz | 5 +/- 1W | 3 ~ 6W | |
| Drain Current | 440.00MHz | Less than 11A | Less than 12A | |
| Frequency Deviation | 440.00MHz | Within +/- 0.1KHz | Within +/- 0.3KHz | |
| Spurious | 430.00MHz 440.00MHz 450.00MHz | More than 65dB More than 65dB More than 65dB | More than 60dB More than 60dB More than 60dB | MID and LOW standard power is also the same as of HI power level |
| Modulation Level | 440.00MHz WIDE | 3.0 +/- 0.1KHz/DEV 4.5 +/- 0.1KHz/DEV | 3.0 +/- 0.2KHz/DEV 4.5 +/- 0.2KHz/DEV | MIC in 1KHz 4mVemf MIC in 1KHz 40mVemf |
| | 440.00MHz NARROW | 2.2 +/- 0.2KHz/DEV | 2.2 +/- 0.3KHz/DEV | MIC in 1KHz 40mVemf |
| CTCSS Modulation Level | 440.00MHz WIDE | 800 +/- 200Hz/DEV | 800 +/- 200Hz/DEV | 88.5Hz 3KHz LPF ON |
| DCS Modulation Level | 440.00MHz WIDE | 800 +/- 200Hz/DEV | 800 +/- 200Hz/DEV | 255 Code 3KHz LPF ON |
| | 440.00MHz NARROW | 450 +/- 100Hz/DEV | 450 +/- 100Hz/DEV | |
| 1750Hz Modulation Level | 440.00MHz WIDE | 3.0 +/- 0.5KHz/DEV | 3.0 +/- 0.5KHz/DEV | |
| DTMF Modulation Level | 440.00MHz WIDE | 3.0 +/- 0.5KHz/DEV | 3.0 +/- 0.5KHz/DEV | Press the V/M key during TX |
| Modulation Distortion | 440.00MHz WIDE | Less than 3% | Less than 4% | |
| TX S/N | 440.00MHz WIDE | More than 40dB | More than 38dB | 0.3 ~ 3KHz BPF ON |
| | 440.00MHz NARROW | More than 34dB | More than 32dB | |

BLOCK DIAGRAM

1) DR-135

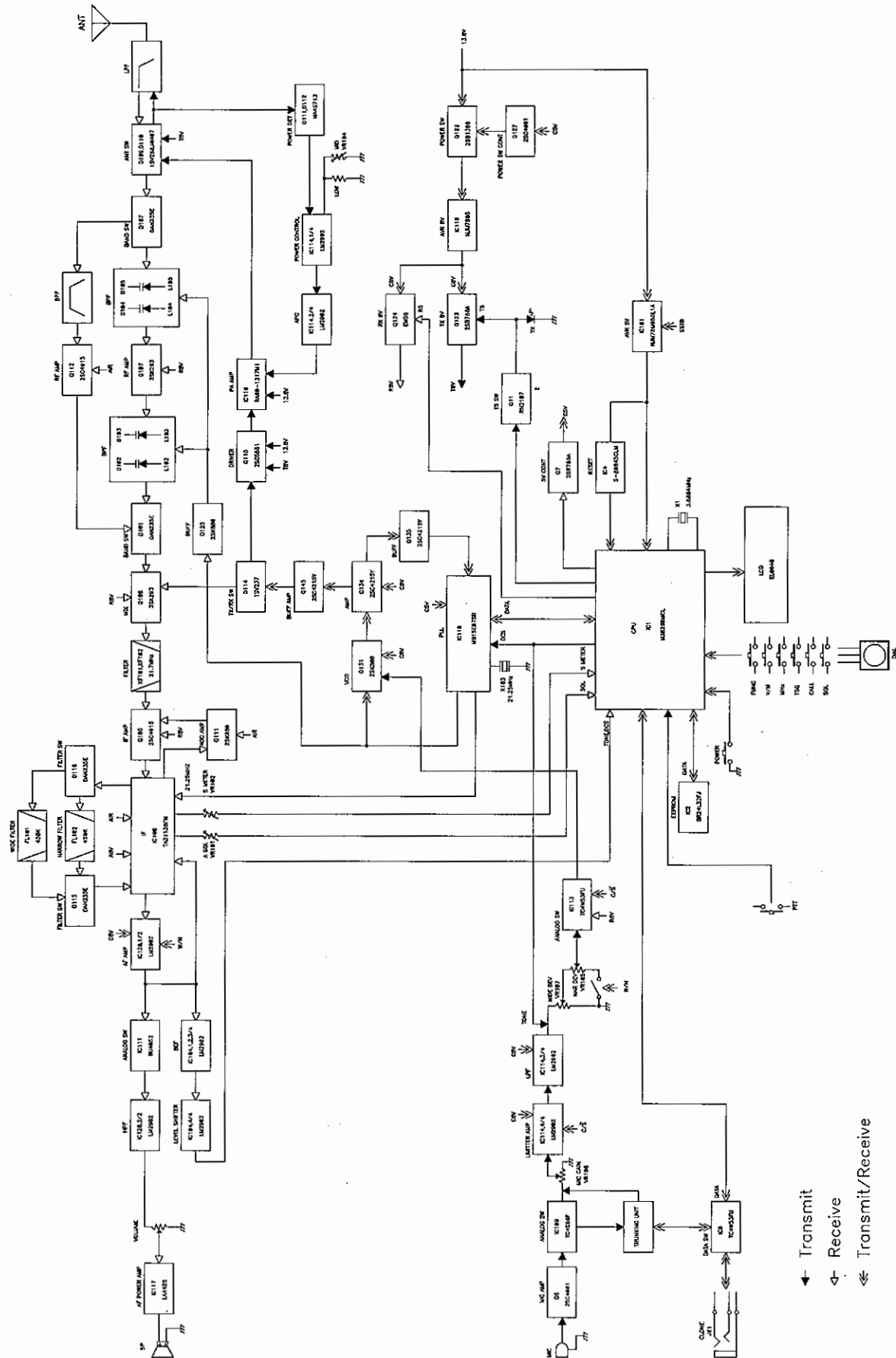

- ← Transmit
- ← Receive
- ← Transmit/Receive

2) DR-435

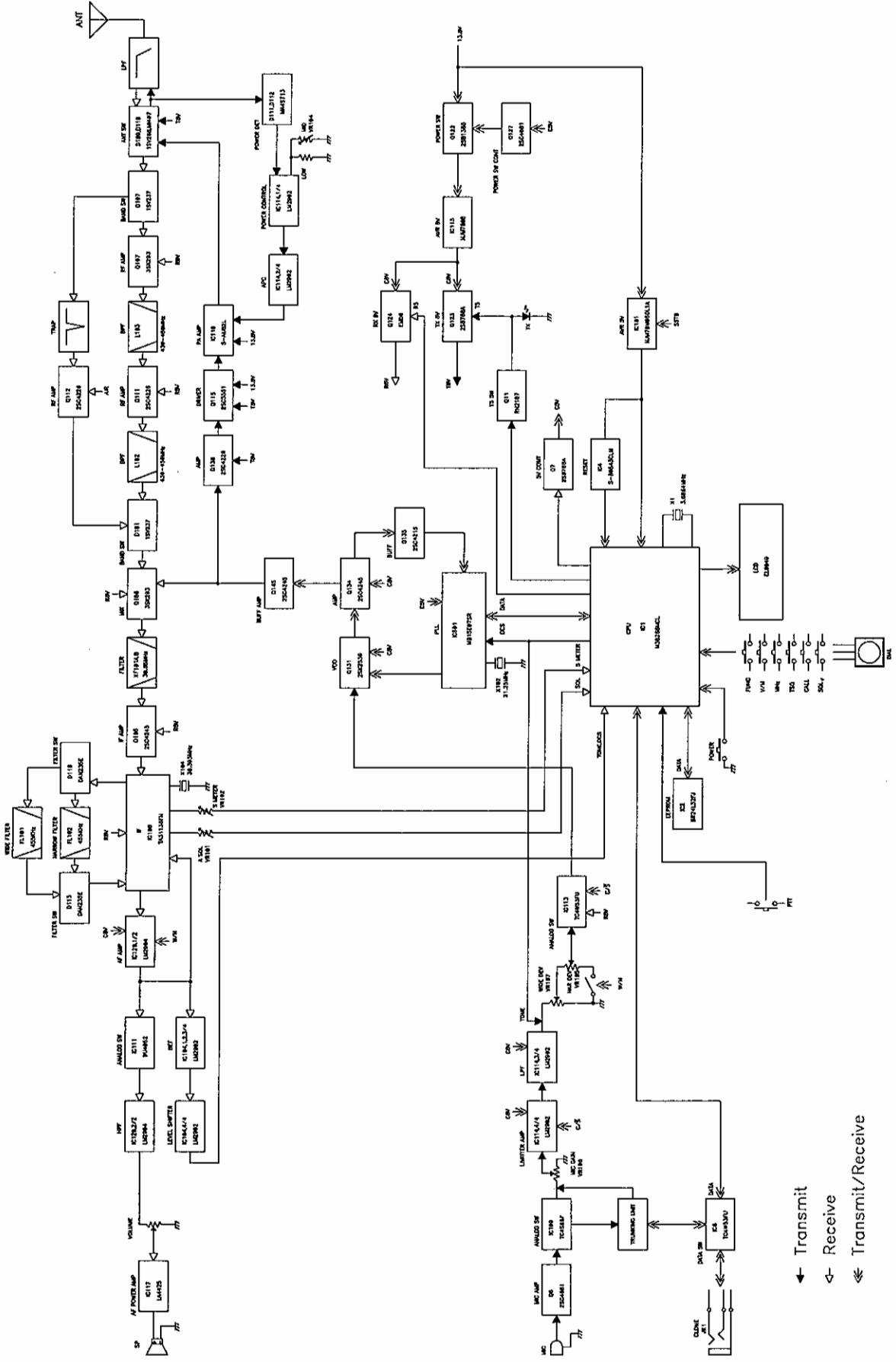

PC BOARD VIEW

1) CPU Unit SIDE A DR-135 (UP0538A)

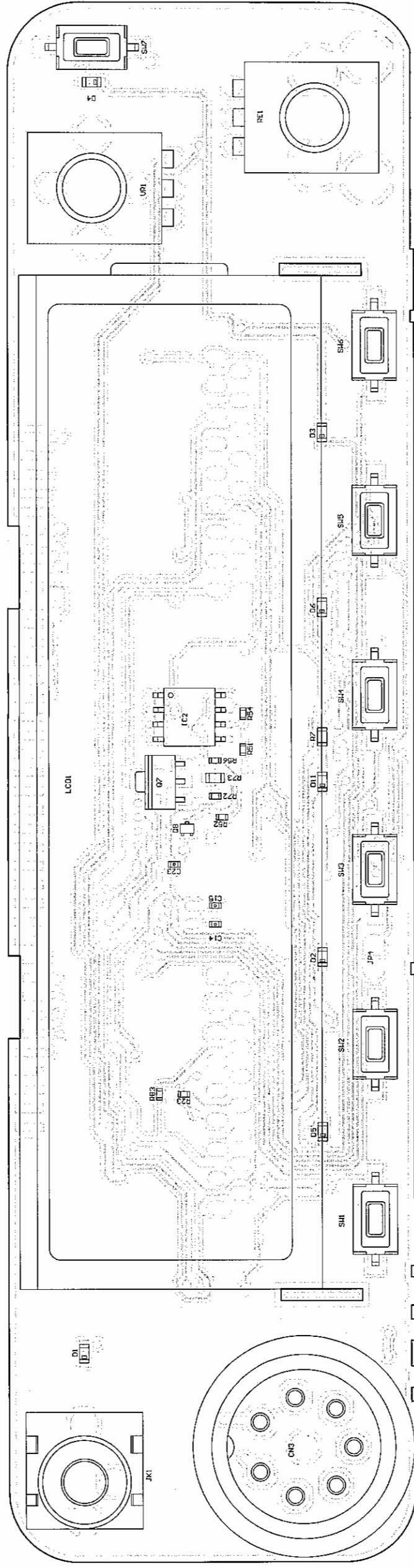

2) CPU Unit SIDE B DR-135 (UP0538A)

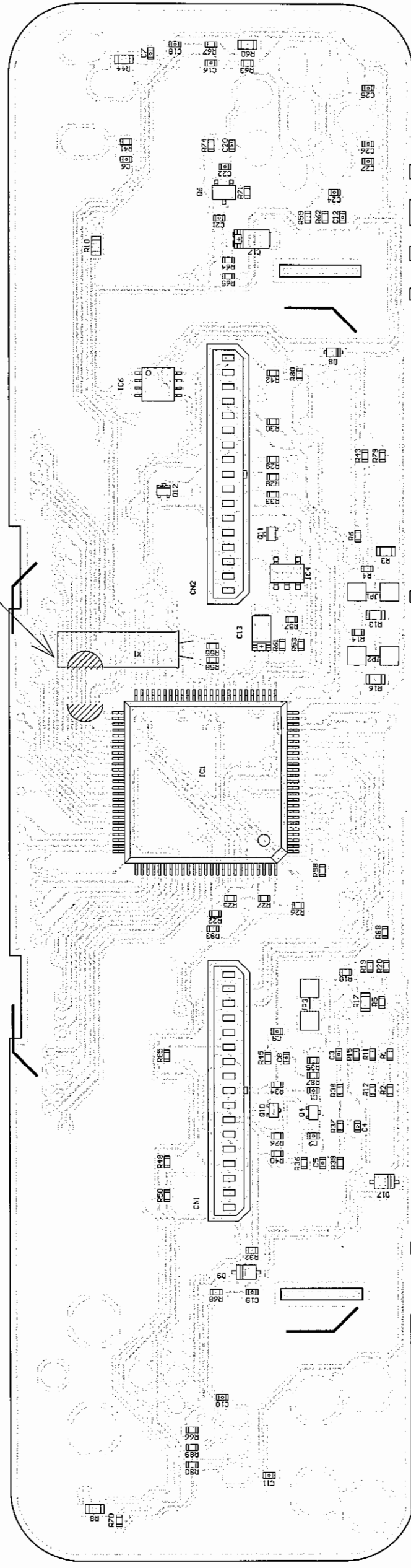

| | R13 | R16 | JP3 |
|----------|-----|-----|--------|
| DR135FX | NC | 0 | NC |
| DR135FXE | 0 | NC | JUMPER |

3) CPU Unit SIDE A DR-435 (UP0545)

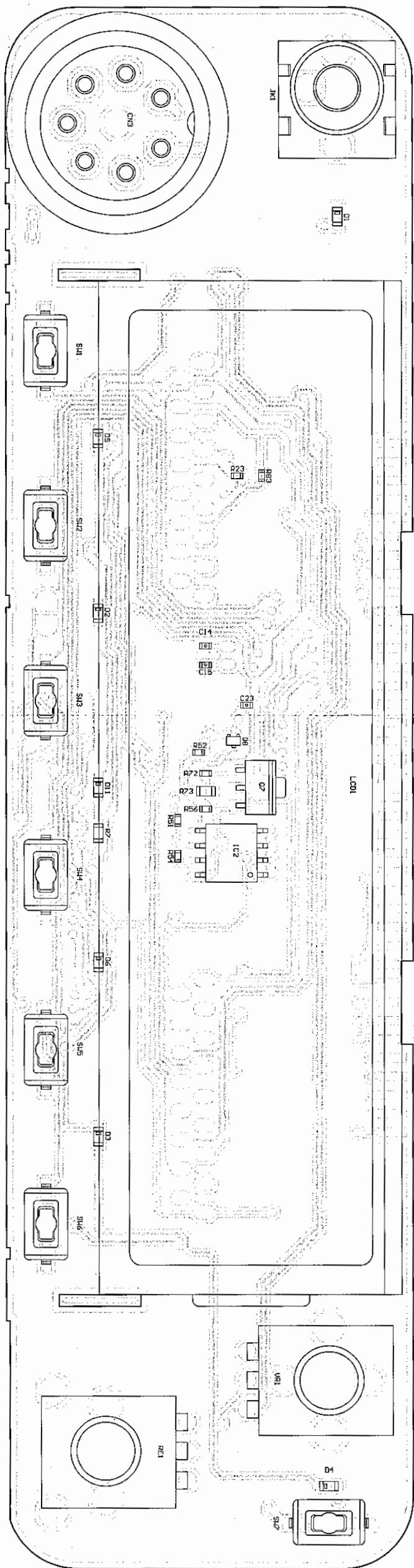

4) CPU Unit SIDE B DR-435 (UP0545)

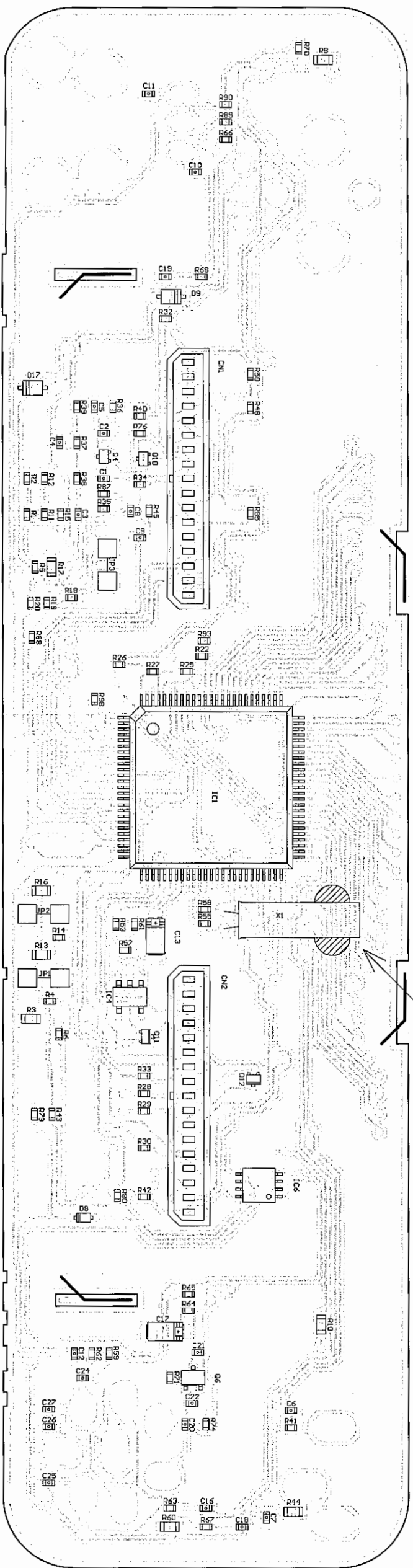

Bonding

| | | | |
|----------|-----|-----|--------|
| | R13 | R16 | JP3 |
| DR435FX | NC | 0 | NC |
| DR435FXE | 0 | NC | JUMPER |

5) MAIN Unit Side A DR-135 (UP0538A)

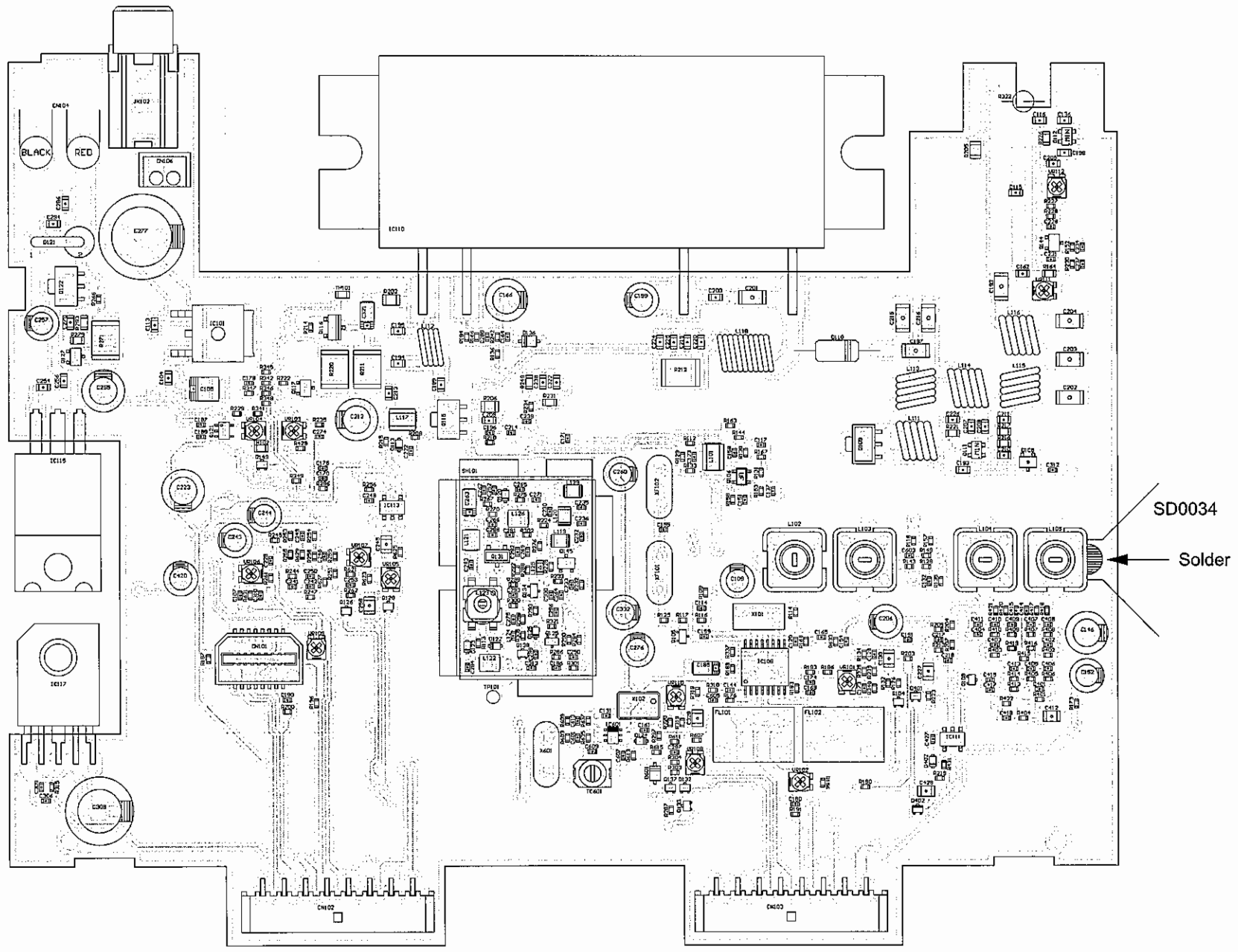

6) MAIN Unit Side B DR-135 (UP0538A)

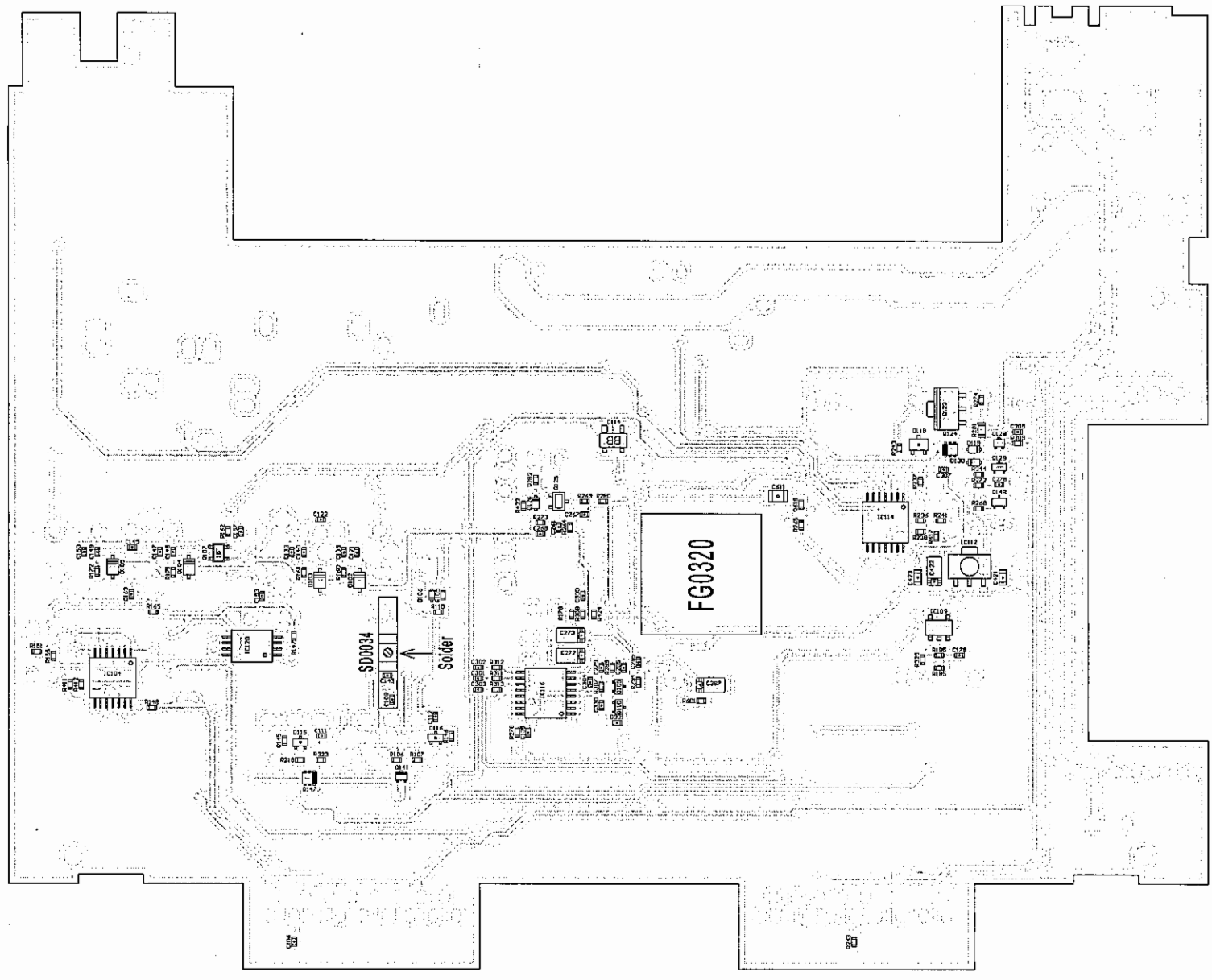

7) MAIN Unit Side A DR-435 (UP0545)

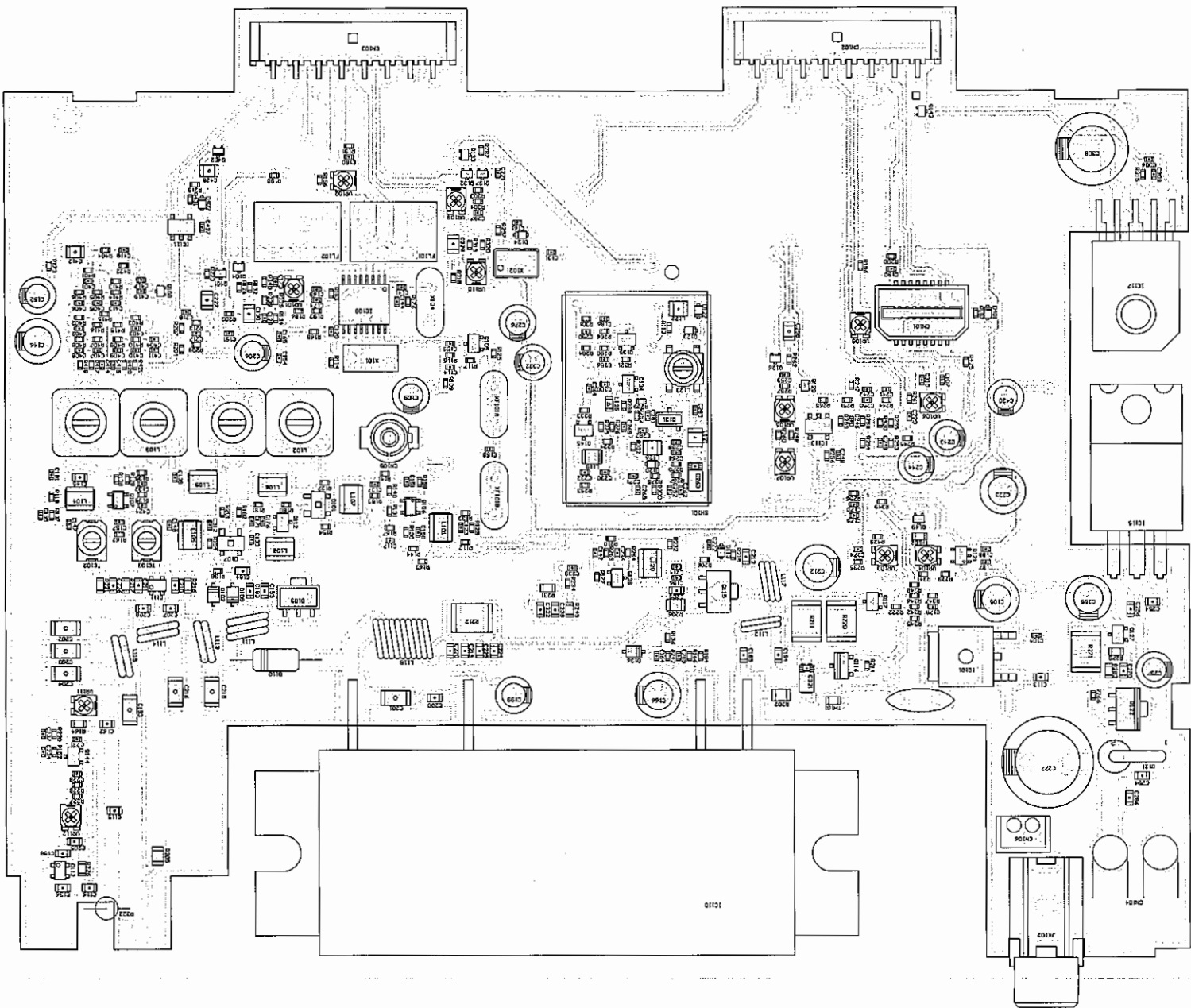

8) MAIN Unit Side B DR-435 (UP0545)

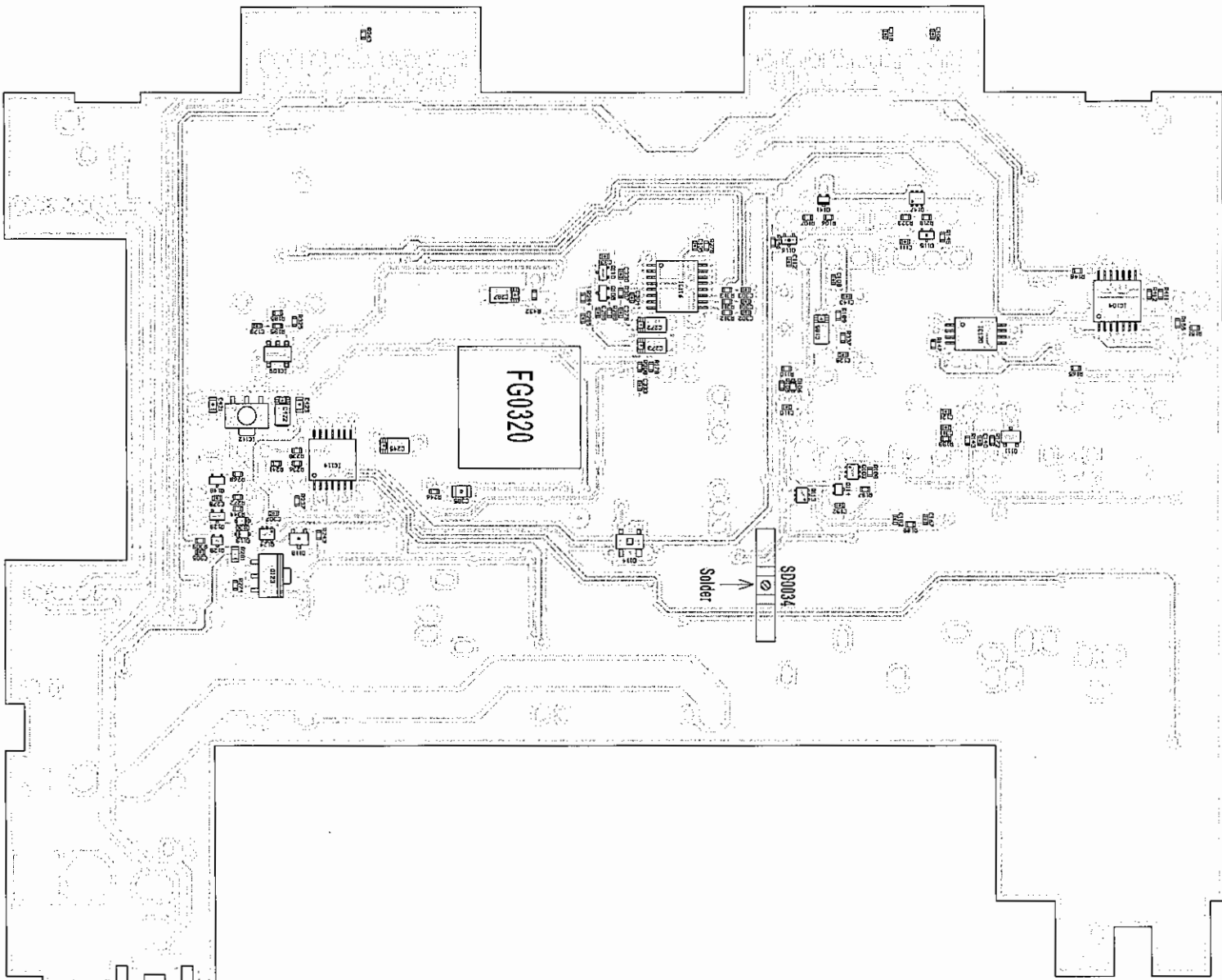

SCHEMATIC DIAGRAM

1) CPU Unit DR-135

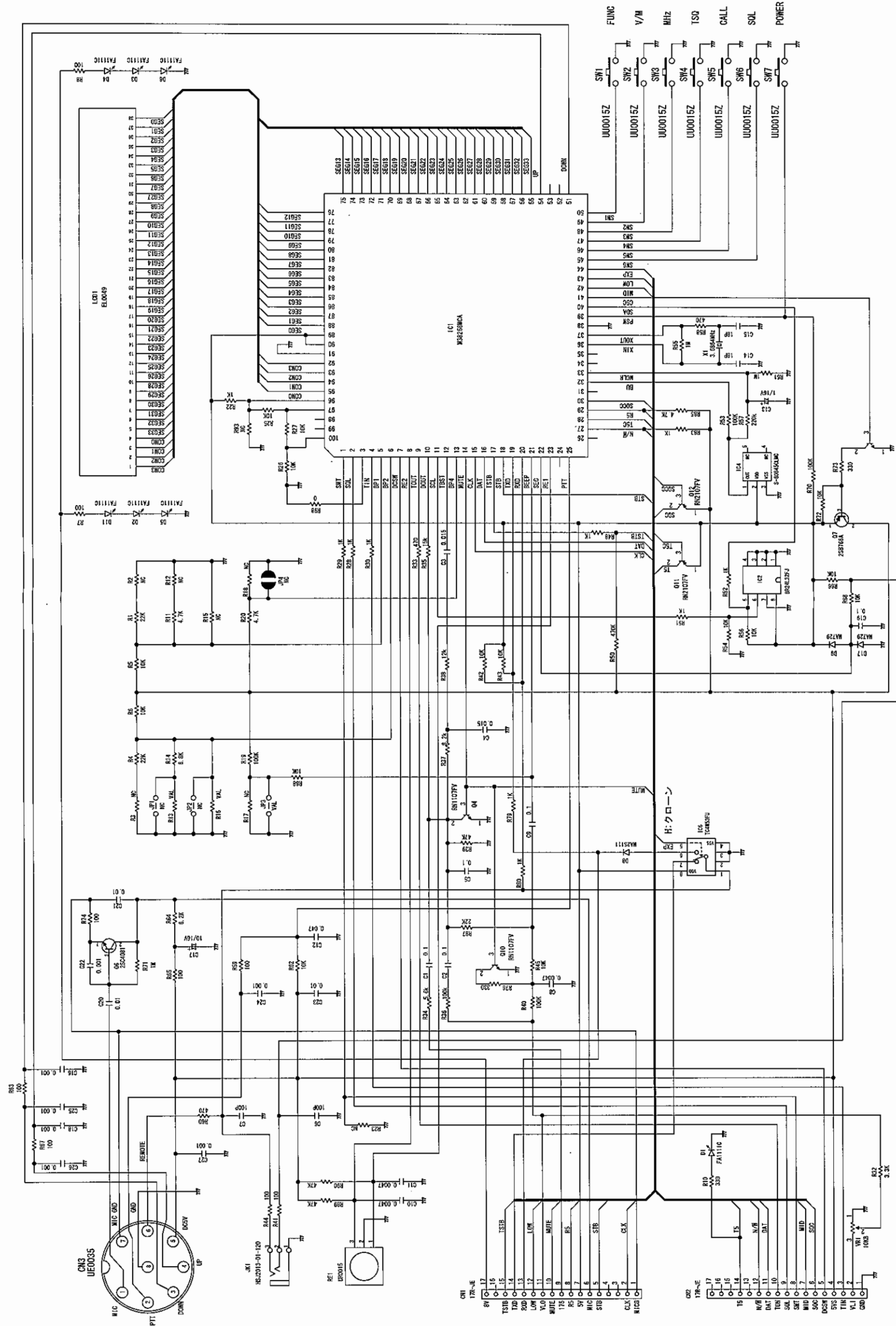

| | | | |
|----------|-----|-----|--------|
| | R13 | R16 | JP3 |
| DR135FX | NC | 0 | JUMPER |
| DR135FXE | 0 | NC | JUMPER |

2) CPU Unit DR-435

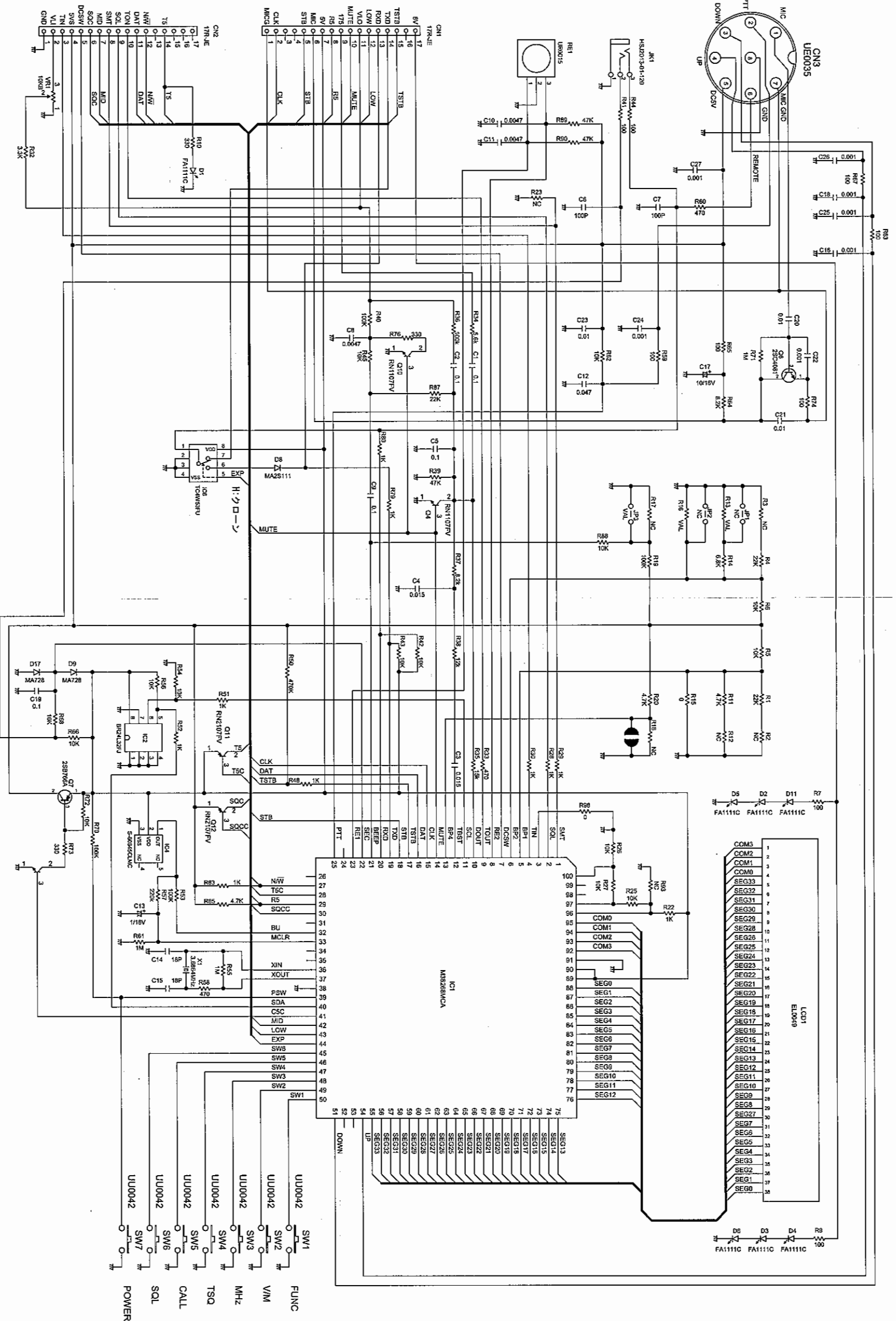

| | | | |
|----------|-----|-----|--------|
| | R13 | R16 | JP3 |
| DR435FX | NC | 0 | JUMPER |
| DR435FXE | 0 | NC | JUMPER |

3) MAIN Unit DR-135

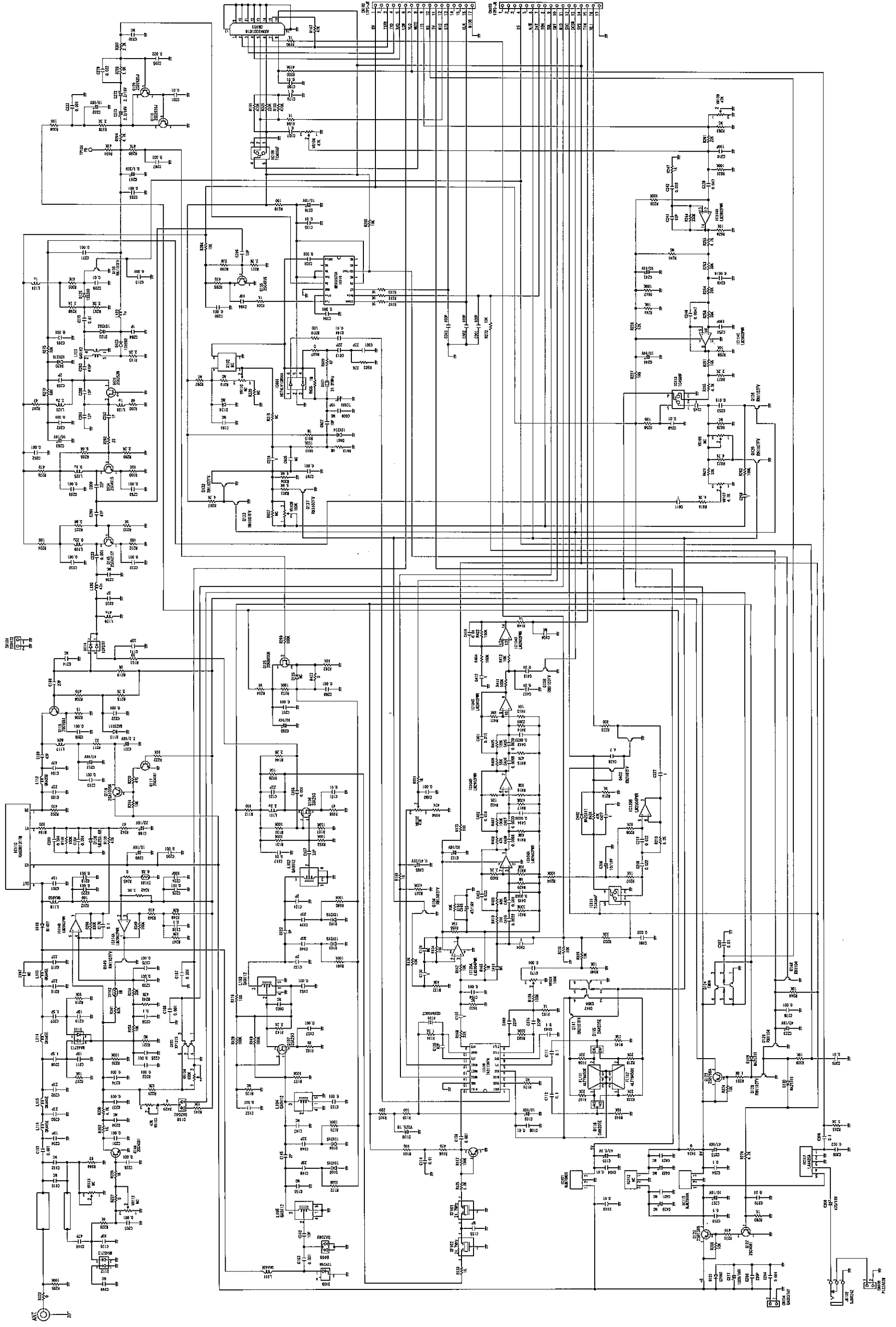

4) MAIN Unit DR-435

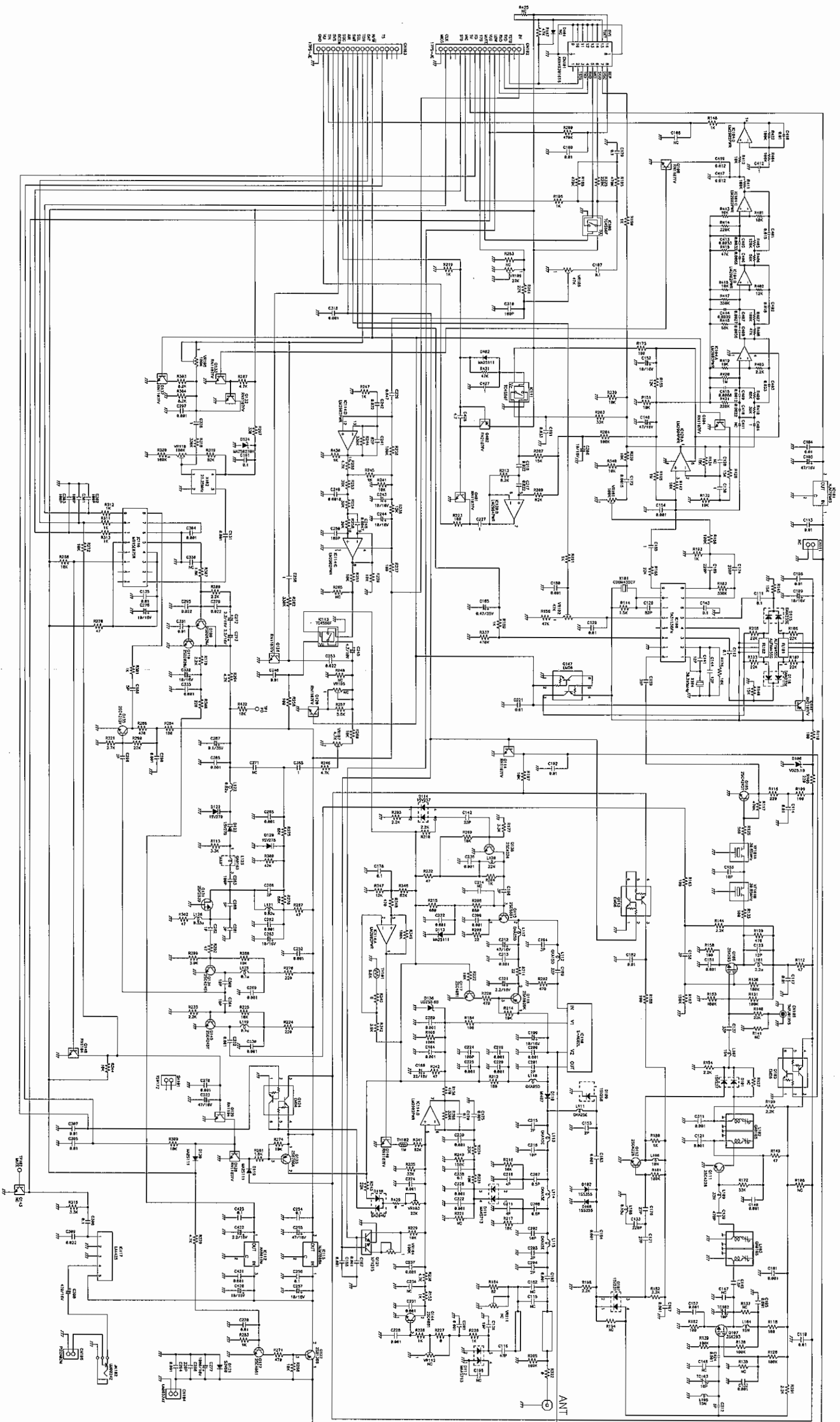

ALINCO, INC.

Head Office: Shin-Dai Building 9th Floor
2-6, 1-Chome, Dojimahama, Kita-ku, Osaka 530-0004, JAPAN
Phone: +81-6-4797-2136 Fax: +81-6-4797-2157
E-mail: export@alinco.co.jp

Dealer/Distributor